



**K21-H**

**Hydraulische Teile /  
Hydraulic components  
2014**

**Bremsen-Ersatzteilprogramm  
Brake Parts Program**



# Kompetenz und Aktualität

## Competence and topicality

### Besuch uns auf Facebook

#### Visit us at facebook



[www.facebook.com/ATE](http://www.facebook.com/ATE)

### ATE Online-Katalog

#### ATE online-catalog



Noch aktuellere Informationen finden Sie im **Online-Katalog** von ATE. Hier werden die Kataloginformationen mindestens monatlich aktualisiert. Sie finden den ATE Online-Katalog in der Rubrik "Kataloge -> Ersatzteile online" im Internet auf unserer Homepage unter [www.ate.de](http://www.ate.de).

Even more current information you find in the **ATE online-catalog**. Here the spare part information are posted at least monthly. You find the ATE online-catalog in the column "Catalogs -> replacement parts" on the Internet on our homepage [www.ate.de](http://www.ate.de).

### ATE wird mobil

#### ATE goes mobile



Das Produktportfolio des Bremsenspezialisten ATE ist jetzt auch mobil

über die Smartphonereihe von

Apple zu erreichen. Mit dieser Applikation können Anwender alle Produkte der Marke ATE auf vielfältige Weise suchen und identifizieren. Die Software steht kostenlos im App Store von Apple zum Download bereit. Sie kann über Suchbegriffe wie „ATE“ oder „Bremsen“ leicht gefunden und installiert werden.

The product range of brake specialists ATE is now also accessible on the move using smartphones from Apple. With this application, users can search for and identify all products belonging to the ATE brand in a number of different ways. The software is available for download free of charge in Apple's App Store. It can easily be found and installed using search terms such as "ATE" or "brakes".

Jetzt auch für iPad und Android  
Now also for iPad and Android

### Hier geht's rund:

#### Die ATE Katalog CD-Rom

#### Keeping you informed:

#### The ATE catalog CD-Rom

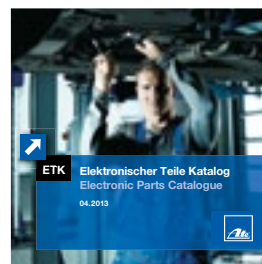

Die zweimal pro Jahr erscheinende ATE Katalog CD-Rom „ETK“ basiert auf der TecDoc-Engine. Wer die TecDoc DVD kennt, kommt also genau so leicht mit der ATE Katalog CD zurecht.

The ATE catalog CD-Rom "ETK" appears twice a year and is based on the TecDoc engine. The ATE catalog CD will thus be easy to use for anyone familiar with the TecDoc DVD.



# K21-H

- (D)** Bremsen-Ersatzteilprogramm  
Hydraulische Teile
- (EN)** Brake parts program  
Hydraulic components
- (FR)** Programme de pièces détachées pour freins  
Pièces hydrauliques
- (IT)** Programma in pianti frenanti  
Componenti idraulici
- (ES)** Programa de repuestos para sistema de frenado  
Piezas hidráulicas
- (NL)** Remonderdelenprogramma  
Hydraulische onderdelen
- (DA)** Reservedelsprogram bremser  
Hydrauliske dele
- (SV)** Reservdelsprogram bromsar  
Hydrauliska delar
- (HU)** Fékrendszer – Tartalékalkatrész-program  
Hidraulikai alkatrészek
- (PT)** Programa de peças sobressalentes dos travões  
Componentes hidráulicos
- (RU)** Программа запасных деталей тормозов  
Гидравлические детали
- (CZ)** Program náhradních dílů brzd  
Hydraulické díly
- (PL)** Program części zamiennych do układów hamulcowych  
Części hydrauliczne
- (EL)** Πρόγραμμα ανταλλακτικών φρένων  
Υδραυλικά εξαρτήματα
- (TR)** Fren yedek parça programı  
Hidrolik parçalar
- (ZH)** 制动——替换件程序  
液压件
- (JA)** ブレーキ交換部品プログラム  
静水圧部品
- (AR)** برنامج قطع غيار المكابح  
ةيلورديهلأءازجالأ

**D Inhaltsverzeichnis**

|                                |      |
|--------------------------------|------|
| Bremsflüssigkeit               | 8    |
| Neue Artikel                   | 15   |
| Ersetzte Artikel               | 25   |
| Fahrzeugregister               | 27   |
| Fahrzeugverwendungen           | 33   |
| Abbildungen Hauptbremszylinder | 829  |
| Armaturen                      | 905  |
| Bremsgeräte komplett           | 919  |
| Reparatursätze                 | 941  |
| Abbildungen Bremssättel        | 967  |
| Abbildungen Bremsschläuche     | 1093 |
| Technische Übersetzungen       | 1155 |
| So benutzen Sie den K21-H      | 1185 |

**EN Table of contents**

|                               |      |
|-------------------------------|------|
| Brake fluid                   | 8    |
| New parts                     | 15   |
| Replaced parts                | 25   |
| Index of vehicles             | 27   |
| Applications of vehicles      | 33   |
| Illustrations master cylinder | 829  |
| Fittings                      | 905  |
| Booster units complete        | 919  |
| Repair kits                   | 941  |
| Illustrations brake calipers  | 967  |
| Illustrations brake hoses     | 1093 |
| Technical translations        | 1155 |
| How to use the K21-H          | 1185 |

**FR Table des matières**

|                                  |      |
|----------------------------------|------|
| Liquides de frein                | 8    |
| Nouvelles références             | 15   |
| Références remplacées            | 25   |
| Liste des véhicules              | 27   |
| Applications                     | 33   |
| Illustrations maître-cylindres   | 829  |
| Composants et accessoires        | 905  |
| Servo-freins complets            | 919  |
| Kits de réparation               | 941  |
| Illustrations étriers de frein   | 967  |
| Illustrations flexibles de frein | 1093 |
| Traductions techniques           | 1155 |
| Utilisation du catalogue K21-H   | 1185 |

**IT Sommario**

|                                   |      |
|-----------------------------------|------|
| Liquido freni                     | 8    |
| Codici nuovi                      | 15   |
| Codici sostitutivi                | 25   |
| Indice autoveature                | 27   |
| Applicazioni autoveicoli          | 33   |
| Illustrazioni pompe freno         | 829  |
| Attrezzature                      | 905  |
| Servofreni completi               | 919  |
| Corredi riparazione               | 941  |
| Illustrazioni pinze freno         | 967  |
| Illustrazioni flessibile freno    | 1093 |
| Traduzioni tecniche               | 1155 |
| Come consultare il catalogo K21-H | 1185 |

**ES Índice**

|                                       |      |
|---------------------------------------|------|
| Líquido de freno                      | 8    |
| Nuevas referencias                    | 15   |
| Referencias de sustitución            | 25   |
| Índice de vehículos                   | 27   |
| Aplicaciones                          | 33   |
| Ilustraciones cilindro freno          | 829  |
| Accesorios                            | 905  |
| Servofreno completo                   | 919  |
| Juegos de reparación                  | 941  |
| Ilustraciones pinzas de freno         | 967  |
| Ilustraciones tubos flexible de freno | 1093 |
| Traducciones técnicas                 | 1155 |
| Use así el K21-H                      | 1185 |

**NL Inhoudsopgave**

|                                |      |
|--------------------------------|------|
| Remvloeistof                   | 8    |
| Nieuwe artikelen               | 15   |
| Vervangen artikelen            | 25   |
| Voertuigregister               | 27   |
| Voertuigtoepassingen           | 33   |
| Afbeeldingen hoofdremcilinders | 829  |
| Armaturen                      | 905  |
| Complete remapparaten          | 919  |
| Reparatiesets                  | 941  |
| Afbeeldingen remzadel          | 967  |
| Afbeeldingen remslangen        | 1093 |
| Technische vertalingen         | 1155 |
| Zo gebruikt u de K21-H         | 1185 |

**DA Indholdsfortegnelse**

|                            |      |
|----------------------------|------|
| Bremsevæske                | 8    |
| Nye artikler               | 15   |
| Erstattede artikler        | 25   |
| Køretøjsregister           | 27   |
| Køretøjsanvendelser        | 33   |
| Tegning hovedbremsecylinde | 829  |
| Fittings                   | 905  |
| Bremseenheder (kompl.)     | 919  |
| Reparationssæt             | 941  |
| Tegning bremsecaliper      | 967  |
| Tegning bremsslange        | 1093 |
| Tekniske oversættelser     | 1155 |
| Sådan anvendes K21-H       | 1185 |

**SV Innehållsförteckning**

|                                 |      |
|---------------------------------|------|
| Bromsvätska                     | 8    |
| Nya artiklar                    | 15   |
| Utbytt artiklar                 | 25   |
| Fordonsregister                 | 27   |
| Fordonsanvändningar             | 33   |
| Avbildningar huvudbromscylinder | 829  |
| Tillbehör                       | 905  |
| Bromsapparater komplett         | 919  |
| Reparationssatser               | 941  |
| Avbildningar bromssadel         | 967  |
| Avbildningar bromsslang         | 1093 |
| Tekniska översättningar         | 1155 |
| Så använder du K21-H            | 1185 |

**HU Tartalomjegyzék**

|                            |      |
|----------------------------|------|
| Fékfolyadék                | 8    |
| Új termékek                | 15   |
| Helyettesített alkatrészek | 25   |
| Járműlista                 | 27   |
| Járműalkalmazások          | 33   |
| Ábrák - főfékhengerek      | 829  |
| Tartozékok                 | 905  |
| Teljes fékberendezés       | 919  |
| Javítókészletek            | 941  |
| Ábrák féknyereg            | 967  |
| Ábrák féktömlő             | 1093 |
| Műszaki fordítás           | 1155 |
| How to use the K21-H       | 1185 |

**PT Índice**

|                                      |      |
|--------------------------------------|------|
| Líquido para travões                 | 8    |
| Novo artigos                         | 15   |
| Artigos substituídos                 | 25   |
| Registo automóvel                    | 27   |
| Utilizações do veículo               | 33   |
| Figuras Cilindro principal do travão | 829  |
| Equipamentos                         | 905  |
| Aparelho de travagem completo        | 919  |
| Kit de reparação                     | 941  |
| Figuras pinças de travões            | 967  |
| Figuras tubos de travão              | 1093 |
| Glossário técnico                    | 1155 |
| Como utilizar o K21-H                | 1185 |

**RU Содержание**

|   |      |
|---|------|
| Тормозная жидкость                                  | 8    |
| Новые позиции                                       | 15   |
| Замененные номера                                   | 25   |
| Перечень автомобилей                                | 27   |
| Применение в автомобилях                            | 33   |
| Рисунки главных тормозных цилиндров                 | 829  |
| Приспособления                                      | 905  |
| Тормозные усилители в сборе                         | 919  |
| Ремонтные комплекты                                 | 941  |
| Изображение суппортов дисковых тормозных механизмов | 967  |
| Изображение Тормозной шланг                         | 1093 |
| Перевод технических терминов                        | 1155 |
| Как пользоваться каталогом K21-H                    | 1185 |

**CZ Obsah**

|                                    |      |
|------------------------------------|------|
| Brzdová kapalina                   | 8    |
| Nové výrobky                       | 15   |
| Nahrazené výrobky                  | 25   |
| Rejstřík vozidel                   | 27   |
| Použití vozidel                    | 33   |
| Zobrazení hlavního brzdového válce | 829  |
| Armatury                           | 905  |
| Brzdová zařízení kompletní         | 919  |
| Sady pro opravu                    | 941  |
| Zobrazení třmenů kotoučové brzdy   | 967  |
| Hadice brzdy                       | 1093 |
| Technické překlady                 | 1155 |
| Jak používat K21-H                 | 1185 |

**PL Spis treści**

|                                  |      |
|----------------------------------|------|
| Płyn hamulcowy                   | 8    |
| Nowe artykuły                    | 15   |
| Artykuły zastąpione              | 25   |
| Indeks pojazdów                  | 27   |
| Zastosowania pojazdów            | 33   |
| Rysunki pomp hamulcowych         | 829  |
| Armatury                         | 905  |
| Serwa hamulcowe kompletne        | 919  |
| Zestawy naprawcze                | 941  |
| Rysunki gniazda hamulcowe        | 967  |
| Rysunki Przewód hamulcowy giętki | 1093 |
| Tłumaczenia techniczne           | 1155 |
| Tak należy korzystać z K21-H     | 1185 |

**EL Πίνακας περιεχομένων**

|                                     |      |
|-------------------------------------|------|
| Υγρό φρένων                         | 8    |
| Νέο προϊόν                          | 15   |
| Αντικατεστημένοι αριθμοί            | 25   |
| Κατάλογος οχημάτων                  | 27   |
| Χρήσεις οχημάτων                    | 33   |
| Εικόνες κεντρικών κυλίνδρων πέδησης | 829  |
| Εξαρτήματα συναρμολόγησης           | 905  |
| Μονάδες φρένων κομπλέ               | 919  |
| Σετ επισκευής                       | 941  |
| Εικόνες διχάλων φρένων              | 967  |
| Εικόνες Εύκαμπτος σωλήνας φρένου    | 1093 |
| Τεχνικές Ισαφράσεις                 | 1155 |
| Έτσι χρησιμοποιείτε τον K21-H       | 1185 |

**TR İçindekiler**

|   |      |
|---|------|
| Fren sıvısı                             | 8    |
| Yeni ürün                               | 15   |
| Değiştirilen ürün                       | 25   |
| Araç kaydı                              | 27   |
| Araç kullanımları                       | 33   |
| Ana fren silindiri resimleri            | 829  |
| Armatürler                              | 905  |
| Tüm fren cihazları                      | 919  |
| Tamir takımları                         | 941  |
| Fren kaliperi resimleri                 | 967  |
| Fren hortumu resimleri                  | 1093 |
| Teknik çeviriler                        | 1155 |
| K21-H'i Broşürünü Nasıl Kullanacaksınız | 1185 |

**ZH 目录**

|            |      |
|------------|------|
| 制动液        | 8    |
| 新件         | 15   |
| 替代件        | 25   |
| 汽吹登端翻      | 27   |
| 汽吹用户       | 33   |
| 主缸制动缸图片    | 829  |
| 仪表盘        | 905  |
| 制动器总成      | 919  |
| 维修组        | 941  |
| 制动钳的图示     | 967  |
| 制动器软管图     | 1093 |
| 技术翻译       | 1155 |
| 这样使用 K21-H | 1185 |

**JA 目次**

|                  |      |
|------------------|------|
| ブレーキフルード         | 8    |
| 新商品              | 15   |
| 販売商品             | 25   |
| 然商索引             | 27   |
| 然商利用方法           | 33   |
| 図版 マスターブレーキシリンダー | 829  |
| 計器類              | 905  |
| ブレーキ機器 全品        | 919  |
| リペアキット           | 941  |
| 図:ブレーキキャリパ       | 967  |
| 図:ブレーキホース        | 1093 |
| テクニカルトランスミッション   | 1155 |
| カタログNo.21のご利用法   | 1185 |

**AR الفهرس**

|      |                             |
|------|-----------------------------|
| 8    | زيت المكابح                 |
| 15   | المنتجات الجديدة            |
| 25   | المنتجات المعوّضة           |
| 27   | سجل العربّة                 |
| 33   | إستعمالات العربّة           |
| 829  | صور إسطوانة المكبح الرئيسي  |
| 905  | بطانة المكبح                |
| 919  | أنظمة المكابح بالكامل       |
| 941  | طواقم التصليح               |
| 967  | لمارفلل ةيئفلا تايلآل الشأ  |
| 1093 | خرطوم المكبح للشأ           |
| 1155 | الترجمات التقنية            |
| 1185 | طريقة استعمال الكتلوج K21-H |



# Modernste Technologie, bestechende Optik

## Latest technology, striking look



### Herausragende Optik, breites Sortiment, höchste Qualität – ATE bietet Ihnen mit seinen Bremscheiben:

- Das derzeit größte Programm an beschichteten Bremscheiben.
- Modernste Technologie durch hoch gekohlte (z. B. GG 25 HC-) Bremscheiben.
- Rostfreie Ausführung durch Beschichtung aus umweltverträglichem Material.
- Auch nach dem Einbau bleiben beschichtete Bereiche rostfrei.
- Attraktives Design, insbesondere auf Alufelgen.

#### Ihr Nutzen:

Höchste Qualität in einem neuen, dauerhaft rostfreiem Look.

### Outstanding appearance, wide range, top-quality – ATE's brake discs offer you:

- The largest range of coated brake discs available at present.
- The latest technology through high-carbon brake discs (e.g. GG 25 HC discs).
- Non-rusting through coating with environmentally compatible material.
- Coated areas remain free from rust even after installation.
- Attractive design, particularly on aluminum wheel rims.

#### Your benefit:

Top-quality with a new, permanently non-rusting look.

# Bremsscheiben von ATE – eine runde Sache

## Brake discs from ATE – good all round

### Schon auf den ersten Blick besonders – Brems-scheiben von ATE

- Kein Bremsenrubbeln.
- Geringste Fertigungstoleranzen.
- Auswuchtung belüfteter Brems-scheiben.
- Breites Programm an Brems-scheiben inklusive Befestigungsschrauben.
- Keine aufwendige Umstellung Ihrer internen Systeme durch gleiche Artikelnummern von unbeschichteten und beschichteten Brems-scheiben.
- Komplettlösungen über die Brems-scheibe hinaus.



#### INNOVATION INSIDE:

Mit diesem Symbol sind die ATE Verpackungen für die beschichteten Brems-scheiben gekennzeichnet.

### Special, even at first glance – brake discs from ATE

- No brake judder.
- Very tight manufacturing tolerances.
- Balancing of ventilated brake discs.
- Wide range of brake discs, including fastening screws.
- No complicated changes to your internal systems due to identical item numbers of uncoated and coated brake discs.
- Complete solutions above and beyond brake discs.



#### INNOVATION INSIDE:

This symbol identifies the ATE packaging for the coated brake discs.

#### Ihr Nutzen:

Hochgekohlte Scheiben mit zusätzlicher Legierung – als Systemlieferant mit OE-Kompetenz bietet ATE auch für den Aftermarket perfekte Lösungen.

#### Your benefit:

high-carbon discs with additional alloying – as a system supplier with OE expertise, ATE also offers ideal solutions for the aftermarket.

### Überzeugende Materialmischungen, überzeugende Technik – Bremsbeläge von ATE

- Marktabdeckung von über 95 % in Europa.
- Regelmäßig in der Spitze bei härtesten Prüfverfahren (E1 bei der ECE-Norm).
- Hochentwickelte Materialmischung für optimales Reibwertverhalten.
- Keine Fadinggefahr und volle Bremsleistung von Anfang an durch Scorching.
- Kein Bremsenquietschen durch den Einsatz von Underlayers.
- Geringe Lagerhaltungskosten durch abverkaufstarke Produkte.
- Einfache Rückverfolgung im Produkthaftungsfall.
- Auf Wunsch Komplettlieferung inklusive Bremsbelagzubehör.

### Remarkable material mixtures, remarkable technology – brake pads from ATE

- A market coverage of more than 95 % in Europe.
- Regularly comes out top in the toughest test procedures. ATE products have always been tested according to the standard for OEMs – a standard which meets the toughest safety requirements and which exceeds the ECE test requirements by far.
- Sophisticated material mixture for optimum friction performance.
- No risk of fading, and full braking performance from the beginning all the way to scorching.
- No brake squeal thanks to the use of underlayers.
- Low inventory maintenance costs thanks to top-selling products.
- Simple tracing in the event of product liability.
- Total supply, including brake pad accessories, available if required.



# ATE Ceramic Bremsbeläge

## ATE Ceramic brake pads



Die staubarme Arbeitsweise der ATE Ceramic Bremsbeläge verleiht wertvollen Alu-Felgen eine lang anhaltende attraktive Optik.  
The low-dust operation of the ATE Ceramic brake pads ensures that valuable aluminum rims retain an attractive appearance for longer.



### **Innovative Bremsbelagmischung**

ATE Ceramic lautet die Lösung von Continental für staubarmes, geräuschreduziertes, materialschonendes und umweltfreundliches Bremsen. Das Geheimnis der Bremsbeläge liegt in einer innovativen Bremsbelagmischung. Sie erzeugt beim Bremsen einen so genannten Transferfilm auf der Bremsscheibe. Dieser schützt die Bremsscheibe vor übermäßigem Abrieb. Das Ergebnis: weniger Bremsstaub, mehr Komfort, weniger Verschleiß.

### **Innovative brake pad compound**

ATE Ceramic is Continental's solution for low dust, low noise, resource-saving and environmentally friendly braking. The secret of the new brake pads lies in an innovative brake pad compound. During braking it produces a "transfer film" on the brake disk which protects the brake disk from excessive wear. The result: less brake dust, more comfort, less wear.



# Staubarm – geräuscharm – langlebig

## Low dust – low noise – long-life



Ceramic macht den Unterschied – nicht nur bei der Felgenoptik.  
Ceramic makes the difference – and not just to the look of the rims.

### Weniger Verschleiß, geringere Kosten

Umfangreiche Vergleichstests unter harten Alltagsbedingungen haben gezeigt, dass ATE Ceramic Bremsbeläge im Vergleich zu Standard-Bremsbelägen deutlich weniger verschleßen. Sie verlängern auch wesentlich die Lebensdauer der Bremsscheiben. Der geringere Abrieb senkt die Reparaturkosten und schont den Geldbeutel des Autofahrers.

### Less wear, lower costs

Extensive comparative tests under tough everyday operating conditions have shown that ATE Ceramic brake pads wear significantly less than standard brake pads. They also significantly extend the service life of the brake discs. This reduction in wear reduces repair costs and saves drivers' money.

#### Die Vorzüge der Belag-Technologie auf einen Blick:

- Staubarm
- Geräuschreduziert
- Langlebig

ATE Ceramic Bremsbeläge basieren auf einer neuen Bremsbelagmischung, die gegenüber herkömmlichen Mischungen fast keinen Abrieb mehr erzeugen.

Felgen behalten damit ihren Glanz, und die Lebensdauer der Bremsscheiben verlängert sich nachhaltig.

Mit ATE Ceramic Bremsbelägen wird das Bremsen zudem deutlich leiser.

ATE Ceramic Bremsbeläge sind für zahlreiche Modelle unterschiedlicher Hersteller verfügbar. Das Programm wird ständig erweitert.

#### The benefits of the pad technology at a glance:

- Low dust
- Low noise
- Long life

ATE Ceramic brake pads are based on a new brake pad compound which, compared to conventional compounds, produces almost no wear debris.

This ensures that rims stay shiny, and the service life of the brake discs is sustainably extended.

With ATE Ceramic brake pads, braking is also much quieter.

ATE Ceramic brake pads are available for numerous vehicle models from various manufacturers. The product range is being continuously expanded.

# Die richtige Wahl für mehr Sicherheit

## The right choice for greater safety

**ATE bietet Ihnen die richtige Bremsflüssigkeit für jede Anforderung und Gebindegröße:**  
**ATE has the right brake fluid for you, whatever the requirement or container size:**

|  | Bremsflüssigkeit/<br>Brake fluid  | Siedepunkt<br>mind./<br>Minimum<br>boiling point | Nass-Siede-<br>punkt mind./ Mi-<br>nimum wet<br>boiling point | Viskosität bei<br>-40 °C/<br>Viscosity<br>at -40 °C | Wechsel-<br>intervall/<br>Replacement<br>interval |
|--|---|--|---|---|---|
| Für Fahrzeugbaujahre bis ca. 1990/<br>For vehicles built up to around 1990 |  <p><b>ATE G</b><br/>DOT 3<br/>Unsere Traditionsreiche!<br/>Steeped in tradition!</p>  | 245 °C   | 150 °C  | max.<br>1.500 mm <sup>2</sup> /s                    | bis<br>1 Jahr<br>up to<br>1 year                  |
|  |  <p><b>ATE SL</b><br/>DOT 4<br/>Millionenfach bewährte<br/>DOT 4- Qualität<br/>DOT 4 quality, proven a million<br/>times over</p>   | 260 °C   | 165 °C  | max.<br>1.400 mm <sup>2</sup> /s                    | bis<br>1 Jahr<br>up to<br>1 year                  |
| Für Fahrzeugbaujahre ab ca. 1990/<br>For vehicles built from around 1990   |  <p><b>ATE SL.6</b><br/>DOT 4, ISO CLASS 6<br/>Niedrigviskose Flüssigkeit,<br/>ersetzt die Super DOT 4, für<br/>elektronische Bremssysteme<br/>Low-viscosity fluid that replaces<br/>Super DOT 4, for electronic bra-<br/>king systems</p> | 265 °C   | 175 °C  | max.<br>700 mm <sup>2</sup> /s                      | bis<br>2 Jahre<br>up to<br>2 years                |
|  |  <p><b>ATE TYPE 200</b><br/>DOT 4<br/>Minimaler Siedepunktabfall<br/>durch hervorragendes Wasser-<br/>bindungsvermögen<br/>Minimum fall-off in boiling point<br/>thanks to outstanding water-<br/>binding capacity</p>                     | 280 °C   | 198 °C  | max.<br>1.400 mm <sup>2</sup> /s                    | bis<br>3 Jahre<br>up to<br>3 years                |
|  |  <p><b>ATE Super Blue Racing</b><br/>DOT 4<br/>Flüssigkeit für Rennsport-<br/>begeisterte<br/>Fluid for racing enthusiasts</p>   | 280 °C   | 198 °C  | max.<br>1.400 mm <sup>2</sup> /s                    | bis<br>3 Jahre<br>up to<br>3 years                |

Zur Erhaltung der Funktionssicherheit der Bremsanlage muss Bremsflüssigkeit entsprechend der vom Fahrzeughersteller vorgegebenen Qualität und den Wechselintervallen gewechselt werden. Weitere Details erhalten Sie im Internet unter [www.ate.de](http://www.ate.de)  
 To maintain the operational reliability and safety of the brake system, you must change the brake fluid in accordance with the vehicle manufacturers' recommendations on quality and replacement intervals. You will find more details on the Internet under [www.ate.de](http://www.ate.de)

# Bremsflüssigkeiten für jeden Bedarf

## Brake fluids for every need

| Typ<br>Type   | ATE Sachnummer<br>ATE partnumber           | EAN-Nr. 4006633<br>EAN-No. 4006633   | Gebinde<br>Container size | Paletteneinheit*<br>Pallet units* |   |
|---|--|--|---------------------------|-----------------------------------|---|
| <b>G</b>  | SAE Spezifikation<br>J1703-FMVSS 116/DOT 3 | <b>705302</b> 03.9901-5302.2/02  | 10199 8                   | 1l                                | D |
|   |  | <b>705303</b> 03.9901-5303.2/02  | 10201 8                   | 5l                                | F |
|   |  | größere Gebinde auf Anfrage - <a href="#">Bigger container sizes on demand</a> |                           |                                   |   |
| <b>SL</b>   | SAE Spezifikation<br>J1703-FMVSS 116/DOT 4 | <b>705808</b> 03.9901-5808.2/02  | 49000 9                   | 1/4l                              | A |
|   |  | <b>705801</b> 03.9901-5801.2/02  | 49001 6                   | 1/2l                              | B |
|   |  | <b>705802</b> 03.9901-5802.2/02  | 49002 3                   | 1l                                | D |
|   |  | <b>705803</b> 03.9901-5803.2/02  | 49003 0                   | 5l                                | F |
|   |  | <b>705811</b> 03.9901-5811.2/02  | 29907 7                   | 20l                               | R |
|   |  | <b>705820</b> 03.9901-5820.2/01  | 10824 9                   | 30l                               | H |
|   |  | <b>705814</b> 03.9901-5814.2/01  | 10366 4                   | 50l                               | P |
|   |  | <b>705805</b> 03.9901-5805.2/01  | 49005 4                   | 200l                              | S |
|   |  | <b>706408</b> 03.9901-6408.2/02  | 22762 9                   | 1/4l                              | A |
|   |  | <b>706402</b> 03.9901-6402.2/02  | 20746 1                   | 1l                                | D |
| <b>SL.6</b>   |  | <b>706403</b> 03.9901-6403.2/02  | 20748 5                   | 5l                                | F |
|   |  | <b>706411</b> 03.9901-6411.2/02  | 20750 8                   | 20l                               | R |
|   |  | <b>706420</b> 03.9901-6420.2/02  | 23120 6                   | 30l                               | H |
|   |  | <b>706414</b> 03.9901-6414.2/02  | 23005 6                   | 50l                               | P |
|   |  | <b>706405</b> 03.9901-6405.2/02  | 23121 3                   | 200l                              | S |
|   |  | <b>706202</b> 03.9901-6202.2/02  | 10825 6                   | 1l                                | D |
|   |  | <b>706203</b> 03.9901-6203.2/02  | 12166 8                   | 5l                                | F |
|   |  | <b>706220</b> 03.9901-6220.2/01  | 12780 6                   | 30l                               | H |
|   |  | <b>706214</b> 03.9901-6214.2/01  | 12779 0                   | 50l                               | P |
|   |  | <b>706205</b> 03.9901-6205.2/01  | 12778 3                   | 200l                              | S |
|   | <b>706302</b> 03.9901-6302.2/02            | 10828 7  | 1l                        | D                                 |   |
| <b>SUPER BLUE RACING</b> **   |  |  |                           |                                   |   |
| <b>SUPER DOT 4</b>  |  | <b>706020</b> 03.9901-6020.2/01  | 14544 2                   | 30l                               | H |
|   |  | <b>706005</b> 03.9901-6005.2/01  | 07769 9                   | 200l                              | S |
| <b>LHM PLUS</b><br>Mineral-Hydrauliköl, ISO 7308<br>Mineral-Hydraulic Oil, ISO 7308 | <b>700016</b> 24.9903-5001.2/02            | 07259 5  | 1l                        | N                                 |   |
|   | <b>700017</b> 24.9903-5005.2/02            | 07261 8  | 5l                        | O                                 |   |
| <b>ATE Bremszylinder-Paste</b><br><b>ATE Brake Cylinder Paste</b>                   | <b>700009</b> 03.9902-0501.2/02            | 13536 8  | 180 g                     | L                                 |   |
|   | <b>700010</b> 03.9902-0503.2/01            | 13532 0  | 5 kg                      | K                                 |   |
|   | <b>700011</b> 03.9902-0504.2/01            | 13530 6  | 40 kg                     | P                                 |   |
| <b>ATE Prüfflüssigkeit</b><br><b>ATE Testing Fluid</b>                              | <b>700002</b> 03.9902-0116.2/02            | 10374 9  | 5l                        | F                                 |   |
| <b>ATE plastilube®</b>  | <b>700014</b> 03.9902-1001.2/02            | 05176 7  | 35 ml                     | I                                 |   |
|   | <b>700015</b> 03.9902-1002.2/02            | 05184 2  | 75 ml                     | J                                 |   |
| <b>ATE Leerkanne</b><br><b>ATE neutral empty container</b>                          | <b>740169</b> 03.9302-1474.1/01            | 07782 8  | 25l                       | S                                 |   |
| <b>Ausgiesser für 5-l-Kanne</b><br><b>Spout for 5l container</b>                    | <b>760070</b> 03.9314-5940.3/01            | 07786 6  | -                         | S                                 |   |
| <b>Kannen-Auslass-Hahn für 5-l- und 20-l-Kanne</b><br><b>Tap for 5l and 20l tin</b> | <b>760153</b> 03.9314-5960.3/02            | 30855 7  | -                         | S                                 |   |

### \*Paletteneinheit:

|   |                          |                       |
|---|--------------------------|-----------------------|
| A | = 1728 Kannen je Palette | (24 Kannen je Karton) |
| B | = 1200 Kannen je Palette | (20 Kannen je Karton) |
| D | = 600 Kannen je Palette  | (10 Kannen je Karton) |
| E | = 360 Kannen je Palette  | (10 Kannen je Karton) |
| F | = 144 Kannen je Palette  | ( 4 Kannen je Karton) |
| G | = 50 Kannen je Palette   |                       |
| H | = 22 Kannen je Palette   |                       |
| I | = 5040 Tuben je Palette  | (24 Tuben je Karton)  |
| J | = 1728 Tuben je Palette  | (12 Tuben je Karton)  |
| K | = 60 Eimer je Palette    |                       |
| L | = 1800 Tuben je Palette  | (40 Tuben je Karton)  |
| M | = 18 Kannen je Palette   |                       |
| N | = 300 Kannen je Palette  | (10 Kannen je Karton) |
| O | = 64 Kannen je Palette   | ( 4 Kannen je Karton) |
| P | = 12 Kannen je Palette   |                       |
| R | = 36 Kannen je Palette   |                       |
| S | = 1 Stück                |                       |

### \*Pallet units:

|   |                              |                         |
|---|------------------------------|-------------------------|
| A | = 1728 containers per pallet | (24 containers per box) |
| B | = 1200 containers per pallet | (20 containers per box) |
| D | = 600 containers per pallet  | (10 containers per box) |
| E | = 360 containers per pallet  | (10 containers per box) |
| F | = 144 containers per pallet  | ( 4 containers per box) |
| G | = 50 containers per pallet   |                         |
| H | = 22 containers per pallet   |                         |
| I | = 5040 tubes per pallet      | (24 tubes per box)      |
| J | = 1728 tubes per pallet      | (12 tubes per box)      |
| K | = 60 buckets per pallet      |                         |
| L | = 1800 tubes per pallet      | (40 tubes per box)      |
| M | = 18 containers per pallet   |                         |
| N | = 300 containers per pallet  | (10 tubes per box)      |
| O | = 64 containers per pallet   | ( 4 containers per box) |
| P | = 12 containers per pallet   |                         |
| R | = 36 containers per pallet   |                         |
| S | = 1 piece                    |                         |

\*\* not available in the USA and CANADA



# Bremsen-Servicegeräte und Werkzeug

## Brake service equipment and tools

Um Werkstätten sicheres und professionelles Arbeiten rund um die Bremse zu ermöglichen, bietet ATE zudem ein breites Sortiment an Prüfgeräten und Spezialwerkzeugen an. Es reicht von qualitativ hochwertigen Bremsenwerkzeugen für den täglichen Gebrauch bis hin zu komplexen Prüfgeräten für Service- und Diagnosearbeiten.

To enable garages to perform safe and professional work on any aspect of brake systems, ATE also offers a wide range of testing equipment and special tools. Its scope covers high quality brake tools for everyday use as well as sophisticated testing equipment for servicing and diagnostics work.

### Neue Produkteigenschaften

### New product features



#### Der mobile Bremsflüssigkeitstester mit Drucker

##### ATE BFT 320P in Kürze:

Der ATE BFT 320P ermöglicht durch direktes und laborgenaues Messen der Siedetemperatur eine sichere Aussage über den Zustand der Bremsflüssigkeit. Bei diesem Vorgang wird die Bremsflüssigkeit durch Aufkochen bis zum Siedepunkt erhitzt. Die dabei ermittelte Temperatur wird in Grad Celsius angezeigt. Zusätzlich zu dieser Messung ist es ratsam, die Bremsflüssigkeit einer Sichtkontrolle zu unterziehen. Bei zu hohem Verschmutzungsgrad muss sie ebenfalls gewechselt werden.

#### The mobile brake fluid tester and printer

##### ATE BFT 320P in brief:

The ATE BFT 320P measures the boiling temperature of brake fluid directly and with laboratory precision, providing an accurate assessment of its state. In this process, the brake fluid is heated up to boiling point. The boiling point temperature that has been found is displayed in degrees Celsius. Besides measuring the temperature, you are also advised to check the brake fluid visually. If it is too dirty, it must also be changed.

# Spezialwerkzeuge für den professionellen Bremsenservice Special tools for professional brake servicing



**Neue Produkteigenschaften  
New product features**

## **ATE FB 30<sup>SR</sup> in Kürze:**

Das neue ATE FB 30<sup>SR</sup> setzt Maßstäbe bei den Bremsenlüftungsgeräten. Durch die elektronische Druckregelung (EDR) mit vorgegebenen Druckstufen nach Fahrzeugherstellervorgaben, die integrierte Absaugvorrichtung sowie die drei Signalleuchten wird der Bremsflüssigkeitswechsel und das Entlüften der Bremsanlage noch professioneller und sicherer. Das neue Fahrgestell mit vier Rädern, davon zwei Lenkrollen und der verbesserte Handgriff machen das neue FB 30<sup>SR</sup> noch bedienungsfreundlicher.

[www.ate.de](http://www.ate.de)



Weitere Informationen zu den Werkzeugen gibt es im ATE Online Werkzeugkatalog unter [www.ate.de](http://www.ate.de) oder bei Ihrem ATE Fachhändler.

## **ATE FB 30<sup>SR</sup> in brief:**

The ATE FB 30<sup>SR</sup> was specially developed for modern, low-viscosity brake fluids with a view to ensuring absolute safety and ease-of-use. Thanks to its switched-mode power pack and countryspecific power cable, the FB 30<sup>SR</sup> can be used anywhere in the world with all usual power supply voltages. The power cables are plugged securely into the FB 30<sup>SR</sup> by means an IEC power plug that can be locked in position and are available as accessories. The FB 30<sup>SR</sup> is supplied with a power cable and earthed plug.

[www.ate-brakes.com](http://www.ate-brakes.com)

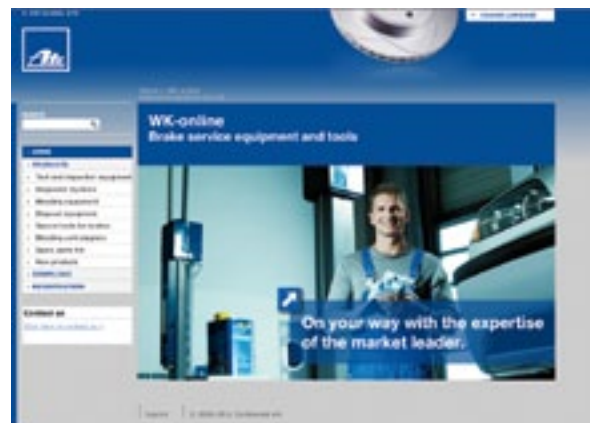

Further information about the tools can be found in the ATE online tool catalogue at [www.ate-brakes.com](http://www.ate-brakes.com) or from your specialist ATE dealer.

# Feldübergreifende Sicherheit

## Safety across the board



### Qualität benötigt professionellen Schutz

ATE setzt auf Produktverpackungen bereits seit Jahren erfolgreich ein zweistufiges Sicherheitsetikett ein, das eine eindeutige Identifizierung von Original ATE Produkten ermöglicht.

Die erste Stufe des Sicherheitsetiketts stellt der tesa Priospot® dar. Die Holografie-Technik mit verschiedenen Prüf- und Sicherheitsmechanismen ist nicht zu fälschen und schützt somit sogar das Etikett selbst vor Nachahmern. Mit dem tesa Priospot® wurden die Merkmale des tesa Holospot® – der weiterhin im Markt verfügbar ist und nach wie vor höchste Sicherheit bietet – noch weiter entwickelt.

### Quality requires professional protection

ATE has for years been affixing a two-stage safety label on its product packaging with great success as it permits a clear identification of original ATE products.

The first stage of the safety label is the tesa Priospot®. This holographic technology with a variety of checking and security mechanisms is forgery-proof and protects even the label itself from imitations. With the tesa Priospot®, the features of the tesa Holospot® – still available on the market and still providing the highest level of security – were further enhanced.



# Produkt- und Markenschutz

## Product and trademark protection

Die zweite Stufe ist ein DataMatrix Code, genannt MAPP Code. Die vier letzten Ziffern dieses MAPP Codes werden immer auch im Holo- bzw. Priospot dargestellt – für ein Höchstmaß an Sicherheit. Der Code kann per Scanner oder durch manuelle Eingabe auf der ATE Website überprüft werden und zeigt sofort an, ob es sich bei dem Produkt um ein Originalteil handelt. Außerdem ist die Abfrage per Mobiltelefon in Verbindung mit entsprechender Software wie der ATE App möglich.

The second stage is a DataMatrix code, called the MAPP code. The last four characters of this MAPP code are always imaged in the HoloSpot/Priospot – for maximum security. The code can be checked by scanner or by manual entry at the ATE Website and indicates immediately whether the product is an original part. An inquiry can also be made by a mobile phone in conjunction with suitable software such as the ATE app.



tesa HoloSpot®

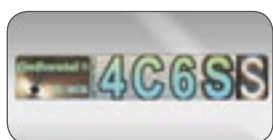

tesa Priospot®

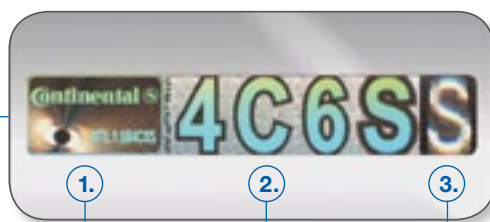

**1. Hochauflösende HDI Grafik & Micro Code**  
Identifizierung mit einfacher Lupe.

**1. High definition HDI graphics & Micro Code**  
Identification with a simple magnifier.

**2. Serien Code**

Findet sich in den letzten 4 Ziffern des MAPP Codes wieder. Identifizierung mit bloßem Auge.

**2. Series code**

Found in the last four characters of the MAPP code. Identification with the naked eye.

**3. Moving Code**

Wiederholt die letzte Stelle des Sicherheitscodes. Identifizierung mit bloßem Auge.

**3. Moving Code**

Repeats the last digit of the security code. Identification with the naked eye.



### MAPP Code

Die letzten vier Ziffern entsprechen dem Serien Code des Holo- bzw. Priospots.

### MAPP Code

The last four characters match the series code of the HoloSpot/Priospot.

# Wir lieben Oldies

## We like oldies

In dem Ihnen vorliegenden Katalog befinden sich keine ATE Classic Artikel. Weitere Informationen, sowie den ATE Classic Katalog finden Sie unter: [www.ate-classic.de](http://www.ate-classic.de)

There are no ATE Classic products in this catalogue. For more information and the ATE Classic catalogue visit: [www.ate-classic.de](http://www.ate-classic.de)



Old- und Youngtimer wecken Emotionen. Sie werden liebevoll restauriert und gepflegt. Denn sie sollen ihren Besitzern möglichst lange erhalten bleiben. Neben dem optischen Anspruch sollen sie natürlich auch sicher im Straßenverkehr unterwegs sein. Hierzu brauchen sie vor allem intakte Bremsen.

Classic cars touch our emotions. They are lovingly restored and cared for. Their owners want to keep them in good condition for as long as possible. In addition to looking right they must, of course, also be safe on the roads. Above all, this means that brakes must be working properly.

### ATE Classic: Vorteile im Überblick

- Umfangreiches Produktprogramm – speziell für Pkw und Nutzfahrzeuge, die älter sind als 20 Jahre
- Übersichtlicher ATE Classic Katalog
- Schnelle Lieferung der im Katalog gelisteten Ersatzteile über den Fachhandel
- Verfügbarkeit des ATE Classic Programms in elektronischen Teilekatalogen (TecDoc)
- Sichere und originalgetreue Bremsenreparatur dank ATE Bremserersatzteilen in OE-Qualität
- Beratung über technisch gleichwertige Alternativen
- Hilfestellung beim Beschaffen vergriffener Ersatzteile
- Stärkt die Klassik-Kompetenz von Handel und Kfz-Werkstätten und öffnet den Zugang zu neuen Kundengruppen

### ATE Classic: Overview of benefits

- Comprehensive product range – especially for cars and commercial vehicles over 20 years old
- ATE Classic catalogue in clearly arranged format
- Fast delivery of spare parts listed in the catalogue through specialist retailers
- Availability of ATE Classic range in electronic parts catalogs (TecDoc)
- Safe and true-to-original brake repairs with ATE spare brake parts in OE quality.
- Advice about alternatives meeting the same technical standards
- Help obtaining spare parts that are no longer generally available
- Reinforces the expertise with classic cars at dealers and motor-vehicle garages, and opens up access to new customer groups



- ⓓ Neue Artikel
- ⓔⓃ New parts
- ⓕⓗ Nouvelles références
- ⓔⓣ Codici nuovi
- ⓔⓢ Nuevas referencias
- Ⓝⓕ Nieuwe artikelen
- ⓓⓐ Nye artikler
- Ⓢⓕ Nya artiklar
- ⓗⓤ Új termékek
- ⓔⓣ Novo artigos
- ⓕⓤ Новые позиции
- ⓕⓗ Nové výrobky
- ⓔⓕ Nowe artykuły
- ⓔⓕ Νέο προϊόν
- ⓣⓗ Yeni ürün
- ⓗⓗ 新件
- ⓙⓐ 新商品
- ⓐⓗ المنتجات الجديدة



# Neue Artikel

New parts - Codici nuovi - Nouvelles références - Nuevas referencias



|                |        |               |   |                |        |               |   |
|----------------|--------|---------------|---|----------------|--------|---------------|---|
| 03.2120-4611.3 | 010937 | DACIA         | LOGAN Limousine (LS_) (04-13)                               | 03.7760-2232.4 | 300266 | FORD          | FOCUS II (05-11)  |
| 03.2120-4611.3 | 010937 | DACIA         | SANDERO (08-13)   | 03.7760-2232.4 | 300266 | FORD          | FOCUS C-MAX (03-07)   |
| 03.2120-4611.3 | 010937 | RENAULT       | SANDERO (BS_) (09-)   | 03.7760-2232.4 | 300266 | FORD          | KUGA I (08-12)  |
| 03.2120-4641.3 | 010932 | RENAULT       | TWINGO II (CN_) (07-)                                       | 03.7760-2332.4 | 300267 | FORD          | FOCUS II (05-11)  |
| 03.2122-2031.3 | 010938 | DACIA         | DUSTER (HS_) (10-)  | 03.7760-2332.4 | 300267 | FORD          | FOCUS C-MAX (03-07)   |
| 03.2122-2031.3 | 010938 | DACIA         | LOGAN Express (FS_) (09-)                                   | 03.7845-0103.4 | 300268 | BMW           | 1er Reihe/E82 Coupe (07-)                                   |
| 03.2122-2031.3 | 010938 | DACIA         | LOGAN MCV Kombi (KS_) (07-13)                               | 03.7845-0103.4 | 300268 | BMW           | 1er Reihe/E88 Cabrio (08-)                                  |
| 03.2122-2031.3 | 010938 | DACIA         | LOGAN Pick-up (US_) (08-)                                   | 03.7845-0103.4 | 300268 | BMW           | 3er Reihe/E90 Limousine (05-12)                             |
| 03.2122-2031.3 | 010938 | DACIA         | SANDERO (08-13)   | 03.7845-0103.4 | 300268 | BMW           | 3er Reihe/E91 Touring (05-12)                               |
| 03.2122-2031.3 | 010938 | RENAULT       | DUSTER (HS-) (11-)  | 03.7845-0103.4 | 300268 | BMW           | 3er Reihe/E92 Coupe (06-13)                                 |
| 03.2122-2031.3 | 010938 | RENAULT       | LOGAN Express (07-)   | 03.7845-0103.4 | 300268 | BMW           | 3er Reihe/E93 Cabrio (07-)                                  |
| 03.2123-2821.3 | 010944 | RENAULT       | CLIO III (BR_/CR_) (05-12)                                  | 03.7845-0103.4 | 300268 | BMW           | X1 (09-)  |
| 03.2123-2821.3 | 010944 | RENAULT       | CLIO III Grandtour (KR_) (08-12)                            | 03.7853-2702.4 | 300269 | PEUGEOT       | 206 Limousine (98-09)                                       |
| 03.2123-2821.3 | 010944 | RENAULT       | MODUS/GRAND MODUS (JP_) (04-13)                             | 03.7853-2702.4 | 300269 | PEUGEOT       | 206 CC (00-07)  |
| 03.2123-3421.3 | 010933 | CITROEN       | BERLINGO (B9) (08-)   | 03.7853-2702.4 | 300269 | PEUGEOT       | 206 SW (02-07)  |
| 03.2123-3421.3 | 010933 | CITROEN       | C8 (02-)  | 03.7853-3902.4 | 300270 | RENAULT       | TWINGO II (CN_) (07-)                                       |
| 03.2123-3421.3 | 010933 | PEUGEOT       | 807 (02-)   | 03.7853-4102.4 | 300271 | DACIA         | LOGAN Limousine (LS_) (04-13)                               |
| 03.2123-3421.3 | 010933 | PEUGEOT       | PARTNER Tepee/Kasten (B9) (08-)                             | 03.7853-4102.4 | 300271 | DACIA         | SANDERO (08-13)   |
| 03.2125-0421.3 | 010934 | CHEVROLET     | CRUZE (09-)   | 03.7853-4102.4 | 300271 | RENAULT       | LOGAN (LS_) (04-13)   |
| 03.2125-0421.3 | 010934 | CHEVROLET     | MALIBU (V300) (12-)   | 03.7853-4102.4 | 300271 | RENAULT       | LOGAN Kombi (KS_) (04-13)                                   |
| 03.2125-0421.3 | 010934 | CHEVROLET     | ORLANDO (11-)   | 03.7853-4102.4 | 300271 | RENAULT       | SANDERO (BS_) (09-)   |
| 03.2125-0421.3 | 010934 | OPEL          | ASTRA J / GTC / Vauxhall Astra MK VI (09-)                  | 03.7858-0102.4 | 300262 | MERCEDES BENZ | S-Klasse (W140) (93-98)                                     |
| 03.2125-0421.3 | 010934 | OPEL          | ASTRA J Sports Tourer/Vaux Astra Sports Tourer (10-)        | 03.7858-0732.4 | 300272 | CHEVROLET     | CRUZE (09-)   |
| 03.2125-0421.3 | 010934 | OPEL          | CASCADA / Vauxhall Cascada (13-)                            | 03.7858-0732.4 | 300272 | CHEVROLET     | MALIBU (V300) (12-)   |
| 03.2125-0421.3 | 010934 | OPEL          | INSIGNIA / Vauxhall Insignia (08-)                          | 03.7858-0732.4 | 300272 | CHEVROLET     | ORLANDO (11-)   |
| 03.2125-0421.3 | 010934 | OPEL          | INSIGNIA Sports Tourer / Vauxh. Insignia SportsTourer (08-) | 03.7858-0732.4 | 300272 | OPEL          | ASTRA J / GTC / Vauxhall Astra MK VI (09-)                  |
| 03.2125-0421.3 | 010934 | OPEL          | ZAFIRA III Tourer / Vauxhall Zafira III Tourer (11-)        | 03.7858-0732.4 | 300272 | OPEL          | ASTRA J Sports Tourer/Vaux Astra Sports Tourer (10-)        |
| 03.2125-0421.3 | 010934 | SAAB          | 9-5 II (10-12)  | 03.7858-0732.4 | 300272 | OPEL          | CASCADA / Vauxhall Cascada (13-)                            |
| 03.2125-0531.3 | 010945 | NISSAN        | PATHFINDER (R51M) (05-)                                     | 03.7858-0732.4 | 300272 | OPEL          | INSIGNIA / Vauxhall Insignia (08-)                          |
| 03.2125-0651.3 | 010935 | FORD          | FOCUS II (05-11)  | 03.7858-0732.4 | 300272 | OPEL          | INSIGNIA Sports Tourer / Vauxh. Insignia SportsTourer (08-) |
| 03.2125-0651.3 | 010935 | FORD          | KUGA I (08-12)  | 03.7858-0732.4 | 300272 | OPEL          | ZAFIRA III Tourer / Vauxhall Zafira III Tourer (11-)        |
| 03.2125-7743.3 | 010921 | VOLVO         | S60 I (00-09)   | 03.7858-0732.4 | 300272 | SAAB          | 9-5 II (10-12)  |
| 03.2125-7743.3 | 010921 | VOLVO         | S80 I (98-06)   | 03.7858-1932.4 | 300263 | MERCEDES BENZ | CL-Klasse (C216) Coupe (06-)                                |
| 03.2125-7743.3 | 010921 | VOLVO         | V70 II (00-07)  | 03.7858-1932.4 | 300263 | MERCEDES BENZ | CLS-Klasse (X218) Shooting Brake (12-)                      |
| 03.2125-7743.3 | 010921 | VOLVO         | XC70 I CROSS COUNTRY (00-07)                                | 03.7858-1932.4 | 300263 | MERCEDES BENZ | S-Klasse (W221) (06-13)                                     |
| 03.2126-3146.3 | 010936 | MERCEDES BENZ | CLS-Klasse (C218) Coupe (10-)                               | 03.7858-4632.4 | 300273 | AUDI          | A4 (B8) Limousine (07-)                                     |
| 03.2126-3146.3 | 010936 | MERCEDES BENZ | CLS-Klasse (X218) Shooting Brake (12-)                      | 03.7858-4632.4 | 300273 | AUDI          | A4 (B8) Avant (08-)   |
| 03.2126-3146.3 | 010936 | MERCEDES BENZ | E-Klasse (W212) Limousine (09-)                             | 03.7858-4632.4 | 300273 | AUDI          | A4 Allroad (09-)  |
| 03.2126-3146.3 | 010936 | MERCEDES BENZ | E-Klasse (S212) Kombi (09-)                                 | 03.7858-4632.4 | 300273 | AUDI          | A5 / A5 Sportback (07-)                                     |
| 03.4156-0014.3 | 010930 | MERCEDES BENZ | GL-Klasse (X164) (06-12)                                    | 03.7858-4632.4 | 300273 | AUDI          | A5 Cabrio (09-)   |
| 03.4156-0014.3 | 010930 | MERCEDES BENZ | M-Klasse (W164) (05-11)                                     | 03.7858-4632.4 | 300273 | AUDI          | Q5 (08-)  |
| 03.4156-0014.3 | 010930 | MERCEDES BENZ | R-Klasse (W251, V251) (06-12)                               | 03.7858-4832.4 | 300274 | VOLVO         | S80 II (06-)  |
| 03.6043-1733.3 | 320284 | SKODA         | FABIA I (6Y) (99-07)  | 03.7858-4832.4 | 300274 | VOLVO         | V70 III (07-)   |
| 03.6583-0165.3 | 320285 | FORD          | MONDEO II (96-00)   | 03.7858-5032.4 | 300275 | VOLVO         | S80 II (06-)  |
| 03.7750-8532.4 | 300264 | DACIA         | LOGAN Express (FS_) (09-)                                   | 03.7858-5032.4 | 300275 | VOLVO         | V70 III (07-)   |
| 03.7750-8532.4 | 300264 | DACIA         | LOGAN Limousine (LS_) (04-13)                               | 03.7858-5032.4 | 300275 | VOLVO         | XC70 II CROSS COUNTRY (07-)                                 |
| 03.7750-8532.4 | 300264 | DACIA         | LOGAN MCV Kombi (KS_) (07-13)                               | 03.7858-5132.4 | 300276 | VOLVO         | XC60 (08-)  |
| 03.7750-8532.4 | 300264 | DACIA         | LOGAN Pick-up (US_) (08-)                                   | 03.7858-5132.4 | 300276 | VOLVO         | XC70 II CROSS COUNTRY (07-)                                 |
| 03.7750-8532.4 | 300264 | DACIA         | SANDERO (08-13)   | 03.7858-7602.4 | 300277 | NISSAN        | PATHFINDER (R51M) (05-)                                     |
| 03.7750-8532.4 | 300264 | RENAULT       | LOGAN (LS_) (04-13)   | 03.7860-3902.4 | 300278 | VOLKSWAGEN    | GOLF VI (08-)   |
| 03.7750-8532.4 | 300264 | RENAULT       | LOGAN Kombi (KS_) (04-13)                                   | 03.7860-3902.4 | 300278 | VOLKSWAGEN    | GOLF Plus (05-)   |
| 03.7750-8532.4 | 300264 | RENAULT       | LOGAN Express (07-)   | 03.7860-3902.4 | 300278 | VOLKSWAGEN    | SCIROCCO (08-)  |
| 03.7755-0132.4 | 300265 | VOLVO         | XC60 (08-)  | 03.7860-5702.4 | 300279 | CITROEN       | C4 I Grand Picasso (06-13)                                  |
| 03.7755-0132.4 | 300265 | VOLVO         | XC70 II CROSS COUNTRY (07-)                                 | 03.7860-5702.4 | 300279 | CITROEN       | C4 I Picasso (07-13)  |
| 03.7755-1232.4 | 300260 | LAND ROVER    | FREELANDER 2 (FA) (07-)                                     | 03.7860-7802.4 | 300280 | CITROEN       | C5 III Limousine (X7) (08-)                                 |



# Neue Artikel

New parts - Codici nuovi - Nouvelles références - Nuevas referencias



|                |        |               |  |
|----------------|--------|---------------|--|
| 03.7860-7802.4 | 300280 | CITROEN       | C5 III Kombi (X7) (08-)                        |
| 03.7860-7802.4 | 300280 | PEUGEOT       | 508 (10-)                                      |
| 03.7860-7802.4 | 300280 | PEUGEOT       | 508 SW (10-)                                   |
| 03.7863-3932.4 | 300288 | FORD          | C-MAX I (07-10)                                |
| 03.7863-3932.4 | 300288 | FORD          | FOCUS II (05-11)                               |
| 03.7863-3932.4 | 300288 | FORD          | FOCUS C-MAX (03-07)                            |
| 03.7863-9802.4 | 300281 | VOLKSWAGEN    | GOLF V (03-08)                                 |
| 03.7863-9802.4 | 300281 | VOLKSWAGEN    | GOLF V Variant (07-09)                         |
| 03.7863-9802.4 | 300281 | VOLKSWAGEN    | GOLF Plus (05-)                                |
| 03.7863-9802.4 | 300281 | VOLKSWAGEN    | JETTA V (05-10)                                |
| 03.7870-1002.4 | 300282 | CITROEN       | C4 I Grand Picasso (06-13)                     |
| 03.7870-1002.4 | 300282 | CITROEN       | C4 I Picasso (07-13)                           |
| 03.7873-3702.4 | 300283 | VOLKSWAGEN    | TOURAN (03-)                                   |
| 03.7873-4502.4 | 300284 | SEAT          | ALHAMBRA II (10-)                              |
| 03.7873-4502.4 | 300284 | VOLKSWAGEN    | CC COUPE (11-)                                 |
| 03.7873-4502.4 | 300284 | VOLKSWAGEN    | PASSAT CC (08-11)                              |
| 03.7873-4502.4 | 300284 | VOLKSWAGEN    | PASSAT / PASSAT VARIANT (10-)                  |
| 03.7873-4502.4 | 300284 | VOLKSWAGEN    | PASSAT ALLTRACK (12-)                          |
| 03.7873-4502.4 | 300284 | VOLKSWAGEN    | SHARAN II (10-)                                |
| 03.7873-4502.4 | 300284 | VOLKSWAGEN    | TIGUAN (07-)                                   |
| 10.6350-4002.4 | 300285 | SEAT          | CORDOBA II (6K2) (99-02)                       |
| 10.6350-4002.4 | 300285 | SEAT          | IBIZA II (93-99)                               |
| 10.6350-4002.4 | 300285 | SEAT          | IBIZA III (6K1) (99-02)                        |
| 10.6350-4002.4 | 300285 | SEAT          | INCA (6K9) (96-03)                             |
| 10.6350-4002.4 | 300285 | VOLKSWAGEN    | CADDY II (96-03)                               |
| 10.6350-4002.4 | 300285 | VOLKSWAGEN    | POLO Classic (96-01)                           |
| 10.6360-1302.4 | 300286 | FORD          | TRANSIT (95-00)                                |
| 10.6360-1903.4 | 300093 | BMW           | 3er Reihe/E36 (91-00)                          |
| 11.8116-0007.2 | 390602 | BMW           | 5er Reihe/F10 Limousine (10-)                  |
| 11.8116-0007.2 | 390602 | BMW           | 5er Reihe/F11 Touring (10-)                    |
| 11.8116-0007.2 | 390602 | BMW           | 5er Reihe/F07 GT GRAN TURISMO (09-)            |
| 11.8116-0007.2 | 390602 | BMW           | 6er Reihe/F12 Cabrio (11-)                     |
| 11.8116-0007.2 | 390602 | BMW           | 6er Reihe/F13 Coupe (11-)                      |
| 11.8116-0007.2 | 390602 | BMW           | 7er Reihe/F01/F02/F03/F04 (08-)                |
| 11.8116-0008.2 | 390603 | BMW           | 5er Reihe/F07 GT GRAN TURISMO (09-)            |
| 11.8116-0008.2 | 390603 | BMW           | 7er Reihe/F01/F02/F03/F04 (08-)                |
| 11.8116-0018.2 | 390604 | AUDI          | A8 (09-)                                       |
| 11.8116-0018.2 | 390604 | AUDI          | Q5 (08-)                                       |
| 11.8116-0086.2 | 390606 | MERCEDES BENZ | CL-Klasse (C216) Coupe (06-)                   |
| 11.8116-0086.2 | 390606 | MERCEDES BENZ | CLS-Klasse (C219) Coupe (04-10)                |
| 11.8116-0086.2 | 390606 | MERCEDES BENZ | E-Klasse (W211) Limousine (02-09)              |
| 11.8116-0086.2 | 390606 | MERCEDES BENZ | E-Klasse (S211) Kombi (03-09)                  |
| 11.8116-0086.2 | 390606 | MERCEDES BENZ | S-Klasse (W221) (06-13)                        |
| 11.8116-0086.2 | 390606 | MERCEDES BENZ | SL-Klasse (R230) (01-11)                       |
| 11.8116-0087.2 | 390607 | MERCEDES BENZ | CLS-Klasse (C218) Coupe (10-)                  |
| 11.8116-0087.2 | 390607 | MERCEDES BENZ | CLS-Klasse (X218) Shooting Brake (12-)         |
| 11.8116-0087.2 | 390607 | MERCEDES BENZ | E-Klasse (W212) Limousine (09-)                |
| 11.8116-0087.2 | 390607 | MERCEDES BENZ | E-Klasse (S212) Kombi (09-)                    |
| 11.8116-0126.2 | 390608 | VOLKSWAGEN    | TRANSPORTER (T5) BUS / MULTIVAN / KASTEN (03-) |
| 11.8116-0126.2 | 390608 | VOLKSWAGEN    | TRANSPORTER (T5) PRITSCHKE / FAHRGESTELL (03-) |
| 11.8116-0260.1 | 390597 | AUDI          | A4 (B5) (95-01)                                |
| 11.8116-0260.1 | 390597 | AUDI          | A8 (94-02)                                     |
| 11.8116-0260.1 | 390597 | BMW           | Z8 (00-03)                                     |
| 11.8116-0260.1 | 390597 | VOLKSWAGEN    | GOLF IV (98-05)                                |
| 11.8116-0260.1 | 390597 | VOLKSWAGEN    | PASSAT (97-05)                                 |



|                |        |            |  |
|----------------|--------|------------|--|
| 11.8116-0272.1 | 390598 | VOLKSWAGEN | SHARAN I (95-10)                               |
| 11.8116-0272.1 | 390598 | VOLKSWAGEN | TRANSPORTER (T4) (90-03)                       |
| 11.8116-0283.2 | 390609 | LAND ROVER | RANGE ROVER III (LM) (02-12)                   |
| 11.8116-0301.1 | 390610 | FORD       | COUGAR (98-00)                                 |
| 11.8116-0301.1 | 390610 | FORD       | FIESTA V (02-08)                               |
| 11.8116-0301.1 | 390610 | FORD       | MONDEO I (93-96)                               |
| 11.8116-0301.1 | 390610 | FORD       | MONDEO II (96-00)                              |
| 11.8116-0301.1 | 390610 | FORD       | SCORPIO / GRANADA (GB) (95-98)                 |
| 11.8116-0301.1 | 390610 | RENAULT    | CLIO III (BR_/CR_) (05-12)                     |
| 11.8116-0301.1 | 390610 | RENAULT    | ESPACE IV (JK_) (02-)                          |
| 11.8116-0301.1 | 390610 | RENAULT    | LAGUNA II Limousine (BG_) (01-07)              |
| 11.8116-0301.1 | 390610 | RENAULT    | LAGUNA II Grandtour (KG_) (01-07)              |
| 11.8116-0301.1 | 390610 | RENAULT    | LAGUNA III Limousine (BT0/1) (07-)             |
| 11.8116-0301.1 | 390610 | RENAULT    | LAGUNA III Coupe (DT0/1) (07-)                 |
| 11.8116-0301.1 | 390610 | RENAULT    | LAGUNA III Grandtour (KT0/1) (07-)             |
| 11.8116-0301.1 | 390610 | RENAULT    | MEGANE II Limousine 3/5-türig (BM/CM_) (02-08) |
| 11.8116-0301.1 | 390610 | RENAULT    | MEGANE II Limousine 4-türig (LM_) (03-08)      |
| 11.8116-0301.1 | 390610 | RENAULT    | MEGANE II Coupe/Cabrio (EM_) (03-10)           |
| 11.8116-0301.1 | 390610 | RENAULT    | MEGANE II Grandtour (KM_) (03-08)              |
| 11.8116-0301.1 | 390610 | RENAULT    | SCENIC II (JM_) (03-09)                        |
| 11.8116-0301.1 | 390610 | RENAULT    | GRAND SCENIC (JM_) (04-09)                     |
| 11.8116-0301.1 | 390610 | RENAULT    | TWINGO II (CN0_) (07-)                         |
| 11.8116-0301.1 | 390610 | RENAULT    | VEL SATIS (BJ0_) (02-09)                       |
| 11.8116-0301.1 | 390610 | RENAULT    | WIND (E4M_) (10-13)                            |
| 11.8116-0327.1 | 390599 | VOLVO      | XC90 (02-)                                     |
| 11.8116-0367.1 | 390600 | VOLKSWAGEN | TRANSPORTER (T5) BUS / MULTIVAN / KASTEN (03-) |
| 11.8116-0367.1 | 390600 | VOLKSWAGEN | TRANSPORTER (T5) PRITSCHKE / FAHRGESTELL (03-) |
| 11.8170-0306.1 | 260102 | AUDI       | 100 (91-94)                                    |
| 11.8170-0306.1 | 260102 | AUDI       | 100 Quattro (91-94)                            |
| 11.8170-0306.1 | 260102 | AUDI       | A3 (96-03)                                     |
| 11.8170-0306.1 | 260102 | AUDI       | A4 (B5) (95-01)                                |
| 11.8170-0306.1 | 260102 | AUDI       | A6 / A6 Avant (4A/C4) (94-97)                  |
| 11.8170-0306.1 | 260102 | AUDI       | A6 / A6 Avant (4B/C5) (97-05)                  |
| 11.8170-0306.1 | 260102 | SEAT       | LEON I (1M1) (99-05)                           |
| 11.8170-0306.1 | 260102 | SEAT       | TOLEDO II (1M2) (98-04)                        |
| 11.8170-0306.1 | 260102 | SKODA      | OCTAVIA I (1U) (97-10)                         |
| 11.8170-0306.1 | 260102 | SKODA      | SUPERB I (02-08)                               |
| 11.8170-0306.1 | 260102 | VOLKSWAGEN | BORA (98-04)                                   |
| 11.8170-0306.1 | 260102 | VOLKSWAGEN | GOLF III (92-97)                               |
| 11.8170-0306.1 | 260102 | VOLKSWAGEN | GOLF III Variant (93-99)                       |
| 11.8170-0306.1 | 260102 | VOLKSWAGEN | GOLF IV (98-05)                                |
| 11.8170-0306.1 | 260102 | VOLKSWAGEN | GOLF IV Variant (99-06)                        |
| 11.8170-0306.1 | 260102 | VOLKSWAGEN | NEW BEETLE (98-10)                             |
| 11.8170-0306.1 | 260102 | VOLKSWAGEN | NEW BEETLE Cabriolet (03-10)                   |
| 11.8170-0306.1 | 260102 | VOLKSWAGEN | PASSAT (94-96)                                 |
| 11.8170-0306.1 | 260102 | VOLKSWAGEN | PASSAT (97-05)                                 |
| 11.8170-0306.1 | 260102 | VOLKSWAGEN | VENTO (92-98)                                  |
| 11.8170-0729.1 | 260107 | BMW        | 3er Reihe/E36 (91-00)                          |
| 11.8170-0729.1 | 260107 | BMW        | 3er Reihe/E46 (98-06)                          |
| 11.8170-0729.1 | 260107 | BMW        | Z3 (95-02)                                     |
| 11.8170-0729.1 | 260107 | BMW        | Z4 Roadster/E85 (03-08)                        |
| 11.8170-0955.1 | 260109 | VOLKSWAGEN | TRANSPORTER (T5) BUS / MULTIVAN / KASTEN (03-) |
| 11.8170-0955.1 | 260109 | VOLKSWAGEN | TRANSPORTER (T5) PRITSCHKE / FAHRGESTELL (03-) |
| 11.8171-0067.1 | 250153 | AUDI       | A6 (4F2/C6) Limousine (04-11)                  |
| 11.8171-0067.1 | 250153 | AUDI       | A6 (4F5/C6) Avant (05-11)                      |

# Neue Artikel

New parts - Codici nuovi - Nouvelles références - Nuevas referencias



|                |        |               |  |
|----------------|--------|---------------|--|
| 11.8171-0067.1 | 250153 | AUDI          | A8 (03-09)   |
| 11.8171-0067.1 | 250153 | BMW           | 3er Reihe/E90 Limousine (05-12)                        |
| 11.8171-0067.1 | 250153 | BMW           | 3er Reihe/E91 Touring (05-12)                          |
| 11.8171-0067.1 | 250153 | BMW           | 3er Reihe/E92 Coupe (06-13)                            |
| 11.8171-0067.1 | 250153 | BMW           | 3er Reihe/E93 Cabrio (07-)                             |
| 11.8171-0067.1 | 250153 | BMW           | 5er Reihe/E60 Limousine (03-10)                        |
| 11.8171-0067.1 | 250153 | BMW           | 5er Reihe/E61 Touring (04-10)                          |
| 11.8171-0067.1 | 250153 | BMW           | 6er Reihe/E63 Coupe (04-11)                            |
| 11.8171-0067.1 | 250153 | BMW           | 6er Reihe/E64 Cabrio (04-11)                           |
| 11.8171-0067.1 | 250153 | BMW           | 7er Reihe/E65/E66 (02-08)                              |
| 11.8171-0067.1 | 250153 | BMW           | X1 (09-)   |
| 11.8171-0067.1 | 250153 | BMW           | X5 (00-07)   |
| 11.8171-0067.1 | 250153 | MERCEDES BENZ | M-Klasse (W164) (05-11)                                |
| 11.8171-0067.1 | 250153 | MERCEDES BENZ | R-Klasse (W251,V251) (06-12)                           |
| 11.8171-0067.1 | 250153 | SEAT          | ALHAMBRA I (7V) (96-10)                                |
| 11.8171-0067.1 | 250153 | VOLKSWAGEN    | PHAETON (02-)  |
| 11.8171-0067.1 | 250153 | VOLKSWAGEN    | SHARAN I (95-10)                                       |
| 11.8171-0067.1 | 250153 | VOLKSWAGEN    | TOUAREG I (03-10)                                      |
| 11.8171-0067.1 | 250153 | VOLKSWAGEN    | TRANSPORTER (T4) (90-03)                               |
| 11.8171-0067.1 | 250153 | VOLKSWAGEN    | TRANSPORTER (T5) BUS / MULTIVAN / KASTEN (03-)         |
| 11.8171-0067.1 | 250153 | VOLKSWAGEN    | TRANSPORTER (T5) PRITSCHEN / FAHRGESTELL (03-)         |
| 11.8171-0067.1 | 250153 | VOLVO         | S60 I (00-09)  |
| 11.8171-0067.1 | 250153 | VOLVO         | V70 II (00-07)   |
| 11.8171-0067.1 | 250153 | VOLVO         | XC90 (02-)   |
| 11.9361-9961.2 | 220855 | MG            | ZT Limousine (01-05)                                   |
| 11.9361-9961.2 | 220855 | MG            | ZT-T Kombi (01-05)                                     |
| 11.9361-9961.2 | 220855 | ROVER         | 75-Serie (RJ) (99-04)                                  |
| 11.9361-9961.2 | 220855 | ROVER         | 75 Serie (RX) (04-)                                    |
| 11.9361-9962.2 | 220856 | MG            | ZT Limousine (01-05)                                   |
| 11.9361-9962.2 | 220856 | MG            | ZT-T Kombi (01-05)                                     |
| 11.9361-9962.2 | 220856 | ROVER         | 75-Serie (RJ) (99-04)                                  |
| 11.9361-9962.2 | 220856 | ROVER         | 75 Serie (RX) (04-)                                    |
| 11.9382-7001.2 | 220889 | CHEVROLET     | CRUZE (09-)  |
| 11.9382-7001.2 | 220889 | CHEVROLET     | VOLT (11-)   |
| 11.9382-7001.2 | 220889 | OPEL          | AMPERA / Vauxhall Ampera (11-)                         |
| 11.9382-7001.2 | 220889 | OPEL          | ASTRA J / GTC / Vauxhall Astra MK VI (09-)             |
| 11.9382-7001.2 | 220889 | OPEL          | CASCADA / Vauxhall Cascada (13-)                       |
| 11.9382-7002.2 | 220890 | CHEVROLET     | CRUZE (09-)  |
| 11.9382-7002.2 | 220890 | CHEVROLET     | VOLT (11-)   |
| 11.9382-7002.2 | 220890 | OPEL          | AMPERA / Vauxhall Ampera (11-)                         |
| 11.9382-7002.2 | 220890 | OPEL          | ASTRA J / GTC / Vauxhall Astra MK VI (09-)             |
| 11.9382-7002.2 | 220890 | OPEL          | CASCADA / Vauxhall Cascada (13-)                       |
| 11.9382-7003.2 | 220891 | CHEVROLET     | CRUZE (09-)  |
| 11.9382-7003.2 | 220891 | CHEVROLET     | TRAX (12-)   |
| 11.9382-7003.2 | 220891 | OPEL          | ASTRA J / GTC / Vauxhall Astra MK VI (09-)             |
| 11.9382-7003.2 | 220891 | OPEL          | ASTRA J Sports Tourer / Vau. Astra Sports Tourer (10-) |
| 11.9382-7003.2 | 220891 | OPEL          | CASCADA / Vauxhall Cascada (13-)                       |
| 11.9382-7003.2 | 220891 | OPEL          | MOKKA / Vauxhall Mokka (12-)                           |
| 11.9382-7004.2 | 220892 | CHEVROLET     | CRUZE (09-)  |
| 11.9382-7004.2 | 220892 | CHEVROLET     | TRAX (12-)   |
| 11.9382-7004.2 | 220892 | OPEL          | ASTRA J / GTC / Vauxhall Astra MK VI (09-)             |
| 11.9382-7004.2 | 220892 | OPEL          | ASTRA J Sports Tourer / Vau. Astra Sports Tourer (10-) |
| 11.9382-7004.2 | 220892 | OPEL          | CASCADA / Vauxhall Cascada (13-)                       |
| 11.9382-7004.2 | 220892 | OPEL          | MOKKA / Vauxhall Mokka (12-)                           |
| 11.9386-9991.2 | 220949 | MERCEDES BENZ | C-Klasse (W204) Limousine (07-)                        |



|                |        |               |   |
|----------------|--------|---------------|---|
| 11.9386-9991.2 | 220949 | MERCEDES BENZ | C-Klasse (S204) Kombi (07-)                 |
| 11.9386-9991.2 | 220949 | MERCEDES BENZ | C-Klasse (C204) Coupe (11-)                 |
| 11.9386-9991.2 | 220949 | MERCEDES BENZ | E-Klasse (C207) Coupe (09-)                 |
| 11.9386-9991.2 | 220949 | MERCEDES BENZ | E-Klasse (A207) Cabrio (10-)                |
| 11.9386-9992.2 | 220950 | MERCEDES BENZ | C-Klasse (W204) Limousine (07-)             |
| 11.9386-9992.2 | 220950 | MERCEDES BENZ | C-Klasse (S204) Kombi (07-)                 |
| 11.9386-9992.2 | 220950 | MERCEDES BENZ | C-Klasse (C204) Coupe (11-)                 |
| 11.9386-9992.2 | 220950 | MERCEDES BENZ | E-Klasse (C207) Coupe (09-)                 |
| 11.9386-9992.2 | 220950 | MERCEDES BENZ | E-Klasse (A207) Cabrio (10-)                |
| 11.9387-7027.2 | 220893 | RENAULT       | LAGUNA III Limousine (BT0/1) (07-)          |
| 11.9387-7027.2 | 220893 | RENAULT       | LAGUNA III Coupe (DT0/1) (07-)              |
| 11.9387-7027.2 | 220893 | RENAULT       | LAGUNA III Grandtour (KT0/1) (07-)          |
| 11.9387-7028.2 | 220894 | RENAULT       | LAGUNA III Limousine (BT0/1) (07-)          |
| 11.9387-7028.2 | 220894 | RENAULT       | LAGUNA III Coupe (DT0/1) (07-)              |
| 11.9387-7028.2 | 220894 | RENAULT       | LAGUNA III Grandtour (KT0/1) (07-)          |
| 11.9387-7041.2 | 220865 | CITROEN       | C5 III Limousine (X7) (08-)                 |
| 11.9387-7041.2 | 220865 | CITROEN       | C5 III Kombi (X7) (08-)                     |
| 11.9387-7042.2 | 220866 | CITROEN       | C5 III Limousine (X7) (08-)                 |
| 11.9387-7042.2 | 220866 | CITROEN       | C5 III Kombi (X7) (08-)                     |
| 11.9401-9959.2 | 220833 | BMW           | Z3 (95-02)                                  |
| 11.9401-9960.2 | 220834 | BMW           | Z3 (95-02)                                  |
| 11.9406-9961.2 | 220951 | MERCEDES BENZ | C-Klasse (W204) Limousine (07-)             |
| 11.9406-9961.2 | 220951 | MERCEDES BENZ | C-Klasse (S204) Kombi (07-)                 |
| 11.9406-9961.2 | 220951 | MERCEDES BENZ | C-Klasse (C204) Coupe (11-)                 |
| 11.9406-9961.2 | 220951 | MERCEDES BENZ | E-Klasse (C207) Coupe (09-)                 |
| 11.9406-9961.2 | 220951 | MERCEDES BENZ | E-Klasse (A207) Cabrio (10-)                |
| 11.9406-9962.2 | 220952 | MERCEDES BENZ | C-Klasse (W204) Limousine (07-)             |
| 11.9406-9962.2 | 220952 | MERCEDES BENZ | C-Klasse (S204) Kombi (07-)                 |
| 11.9406-9962.2 | 220952 | MERCEDES BENZ | C-Klasse (C204) Coupe (11-)                 |
| 11.9406-9962.2 | 220952 | MERCEDES BENZ | E-Klasse (C207) Coupe (09-)                 |
| 11.9406-9962.2 | 220952 | MERCEDES BENZ | E-Klasse (A207) Cabrio (10-)                |
| 11.9406-9993.2 | 220413 | BMW           | 5er Reihe/E39 (96-03)                       |
| 11.9406-9994.2 | 220414 | BMW           | 5er Reihe/E39 (96-03)                       |
| 11.9407-7003.2 | 220835 | OPEL          | SIGNUM / Vauxhall Signum (03-08)            |
| 11.9407-7003.2 | 220835 | OPEL          | VECTRA C Caravan (F35) / Vau. MK II (03-08) |
| 11.9407-7003.2 | 220835 | SAAB          | 9-3 Limousine (YS3F) (03-12)                |
| 11.9407-7003.2 | 220835 | SAAB          | 9-3 SportCombi (05-12)                      |
| 11.9407-7003.2 | 220835 | SAAB          | 9-3 Cabriolet (YS3F) (03-12)                |
| 11.9407-7007.2 | 220867 | OPEL          | SIGNUM / Vauxhall Signum (03-08)            |
| 11.9407-7007.2 | 220867 | OPEL          | VECTRA C Caravan (F35) / Vau. MK II (03-08) |
| 11.9421-9937.2 | 220909 | BMW           | X5 (00-07)                                  |
| 11.9421-9938.2 | 220910 | BMW           | X5 (00-07)                                  |
| 11.9421-9954.2 | 220838 | BMW           | 3er Reihe/E46 (98-06)                       |
| 11.9421-9965.2 | 220799 | MERCEDES BENZ | GL-Klasse (X164) (06-12)                    |
| 11.9421-9965.2 | 220799 | MERCEDES BENZ | M-Klasse (W164) (05-11)                     |
| 11.9421-9965.2 | 220799 | MERCEDES BENZ | R-Klasse (W251,V251) (06-12)                |
| 11.9421-9966.2 | 220800 | MERCEDES BENZ | GL-Klasse (X164) (06-12)                    |
| 11.9421-9966.2 | 220800 | MERCEDES BENZ | M-Klasse (W164) (05-11)                     |
| 11.9421-9966.2 | 220800 | MERCEDES BENZ | R-Klasse (W251,V251) (06-12)                |
| 11.9426-9959.2 | 220801 | MERCEDES BENZ | CL-Klasse (C216) Coupe (06-)                |
| 11.9426-9959.2 | 220801 | MERCEDES BENZ | CLS-Klasse (C219) Coupe (04-10)             |
| 11.9426-9959.2 | 220801 | MERCEDES BENZ | CLS-Klasse (C218) Coupe (10-)               |
| 11.9426-9959.2 | 220801 | MERCEDES BENZ | CLS-Klasse (X218) Shooting Brake (12-)      |
| 11.9426-9959.2 | 220801 | MERCEDES BENZ | E-Klasse (W211) Limousine (02-09)           |
| 11.9426-9959.2 | 220801 | MERCEDES BENZ | E-Klasse (S211) Kombi (03-09)               |



# Neue Artikel

New parts - Codici nuovi - Nouvelles références - Nuevas referencias



|                |        |   |
|----------------|--------|---|
| 11.9426-9959.2 | 220801 | MERCEDES BENZ E-Klasse (W212) Limousine (09-)             |
| 11.9426-9959.2 | 220801 | MERCEDES BENZ E-Klasse (S212) Kombi (09-)                 |
| 11.9426-9959.2 | 220801 | MERCEDES BENZ S-Klasse (W221) (06-13)                     |
| 11.9426-9959.2 | 220801 | MERCEDES BENZ SL-Klasse (R230) (01-11)                    |
| 11.9426-9960.2 | 220802 | MERCEDES BENZ CL-Klasse (C216) Coupe (06-)                |
| 11.9426-9960.2 | 220802 | MERCEDES BENZ CLS-Klasse (C219) Coupe (04-10)             |
| 11.9426-9960.2 | 220802 | MERCEDES BENZ CLS-Klasse (C218) Coupe (10-)               |
| 11.9426-9960.2 | 220802 | MERCEDES BENZ CLS-Klasse (X218) Shooting Brake (12-)      |
| 11.9426-9960.2 | 220802 | MERCEDES BENZ E-Klasse (W211) Limousine (02-09)           |
| 11.9426-9960.2 | 220802 | MERCEDES BENZ E-Klasse (S211) Kombi (03-09)               |
| 11.9426-9960.2 | 220802 | MERCEDES BENZ E-Klasse (W212) Limousine (09-)             |
| 11.9426-9960.2 | 220802 | MERCEDES BENZ E-Klasse (S212) Kombi (09-)                 |
| 11.9426-9960.2 | 220802 | MERCEDES BENZ S-Klasse (W221) (06-13)                     |
| 11.9426-9960.2 | 220802 | MERCEDES BENZ SL-Klasse (R230) (01-11)                    |
| 11.9426-9977.2 | 220897 | BMW 5er Reihe/E60 Limousine (03-10)                       |
| 11.9426-9977.2 | 220897 | BMW 6er Reihe/E63 Coupe (04-11)                           |
| 11.9426-9977.2 | 220897 | BMW 6er Reihe/E64 Cabrio (04-11)                          |
| 11.9426-9979.2 | 220921 | MERCEDES BENZ S-Klasse (W220) (98-06)                     |
| 11.9426-9980.2 | 220922 | MERCEDES BENZ S-Klasse (W220) (98-06)                     |
| 11.9441-9933.2 | 220911 | VOLKSWAGEN TRANSPORTER (T5) BUS / MULTIVAN / KASTEN (03-) |
| 11.9441-9933.2 | 220911 | VOLKSWAGEN TRANSPORTER (T5) PRITSCHKE / FAHRGESTELL (03-) |
| 11.9441-9934.2 | 220912 | VOLKSWAGEN TRANSPORTER (T5) BUS / MULTIVAN / KASTEN (03-) |
| 11.9441-9934.2 | 220912 | VOLKSWAGEN TRANSPORTER (T5) PRITSCHKE / FAHRGESTELL (03-) |
| 11.9486-0009.2 | 220841 | AUDI A2 (00-05)   |
| 11.9486-0009.2 | 220841 | VOLKSWAGEN LUPO (98-05)                                   |
| 11.9486-0010.2 | 220842 | AUDI A2 (00-05)   |
| 11.9486-0010.2 | 220842 | VOLKSWAGEN LUPO (98-05)                                   |
| 11.9541-9831.2 | 220953 | FIAT 500 (07-)  |
| 11.9541-9831.2 | 220953 | FIAT 500C Cabrio (09-)                                    |
| 11.9541-9831.2 | 220953 | FIAT PANDA (12-)  |
| 11.9541-9831.2 | 220953 | LANCIA YPSILON (11-)                                      |
| 11.9541-9832.2 | 220954 | FIAT 500 (07-)  |
| 11.9541-9832.2 | 220954 | FIAT 500C Cabrio (09-)                                    |
| 11.9541-9832.2 | 220954 | FIAT PANDA (12-)  |
| 11.9541-9832.2 | 220954 | LANCIA YPSILON (11-)                                      |
| 11.9571-9753.2 | 220929 | BMW 3er Reihe/E90 Limousine (05-12)                       |
| 11.9571-9753.2 | 220929 | BMW 3er Reihe/E91 Touring (05-12)                         |
| 11.9571-9753.2 | 220929 | BMW 3er Reihe/E92 Coupe (06-13)                           |
| 11.9571-9753.2 | 220929 | BMW 3er Reihe/E93 Cabrio (07-)                            |
| 11.9571-9753.2 | 220929 | BMW X1 (09-)  |
| 11.9571-9754.2 | 220930 | BMW 3er Reihe/E90 Limousine (05-12)                       |
| 11.9571-9754.2 | 220930 | BMW 3er Reihe/E91 Touring (05-12)                         |
| 11.9571-9754.2 | 220930 | BMW 3er Reihe/E92 Coupe (06-13)                           |
| 11.9571-9754.2 | 220930 | BMW 3er Reihe/E93 Cabrio (07-)                            |
| 11.9571-9754.2 | 220930 | BMW X1 (09-)  |
| 11.9571-9969.2 | 220955 | ALFA ROMEO GIULIETTA (10-)                                |
| 11.9571-9970.2 | 220956 | ALFA ROMEO GIULIETTA (10-)                                |
| 11.9601-2601.2 | 220913 | CHEVROLET CRUZE (09-)                                     |
| 11.9601-2601.2 | 220913 | CHEVROLET ORLANDO (11-)                                   |
| 11.9601-2601.2 | 220913 | CHEVROLET TRAX (12-)                                      |
| 11.9601-2601.2 | 220913 | CHEVROLET VOLT (11-)                                      |
| 11.9601-2601.2 | 220913 | OPEL AMPERA / Vauxhall Ampera (11-)                       |
| 11.9601-2601.2 | 220913 | OPEL ASTRA J / GTC / Vauxhall Astra MK VI (09-)           |
| 11.9601-2601.2 | 220913 | OPEL ASTRA J Sports Tourer/Vau.Astra Sports Tourer (10-)  |
| 11.9601-2601.2 | 220913 | OPEL MOKKA / Vauxhall Mokka (12-)                         |



|                |        |   |
|----------------|--------|---|
| 11.9601-2601.2 | 220913 | OPEL ZAFIRA III Tourer / Vauxhall Zafira III Tourer (11-) |
| 11.9601-2602.2 | 220914 | CHEVROLET CRUZE (09-)                                     |
| 11.9601-2602.2 | 220914 | CHEVROLET ORLANDO (11-)                                   |
| 11.9601-2602.2 | 220914 | CHEVROLET TRAX (12-)                                      |
| 11.9601-2602.2 | 220914 | CHEVROLET VOLT (11-)                                      |
| 11.9601-2602.2 | 220914 | OPEL AMPERA / Vauxhall Ampera (11-)                       |
| 11.9601-2602.2 | 220914 | OPEL ASTRA J / GTC / Vauxhall Astra MK VI (09-)           |
| 11.9601-2602.2 | 220914 | OPEL ASTRA J Sports Tourer/Vau.Astra Sports Tourer (10-)  |
| 11.9601-2602.2 | 220914 | OPEL MOKKA / Vauxhall Mokka (12-)                         |
| 11.9601-2602.2 | 220914 | OPEL ZAFIRA III Tourer / Vauxhall Zafira III Tourer (11-) |
| 11.9601-2603.2 | 220915 | CHEVROLET AVEO (T300) (11-)                               |
| 11.9601-2603.2 | 220915 | CHEVROLET CRUZE (09-)                                     |
| 11.9601-2603.2 | 220915 | OPEL ASTRA J / GTC / Vauxhall Astra MK VI (09-)           |
| 11.9601-2603.2 | 220915 | OPEL ASTRA J Sports Tourer/Vau.Astra Sports Tourer (10-)  |
| 11.9601-9717.2 | 220901 | CITROEN BERLINGO (B9) (08-)                               |
| 11.9601-9717.2 | 220901 | CITROEN C4 I Grand Picasso (06-13)                        |
| 11.9601-9717.2 | 220901 | CITROEN C4 I Picasso (07-13)                              |
| 11.9601-9717.2 | 220901 | CITROEN C4 II Limousine (B7) (10-)                        |
| 11.9601-9717.2 | 220901 | CITROEN DS4 (11-)   |
| 11.9601-9717.2 | 220901 | CITROEN DS5 (11-)   |
| 11.9601-9717.2 | 220901 | PEUGEOT 3008 (09-)  |
| 11.9601-9717.2 | 220901 | PEUGEOT 5008 (09-)  |
| 11.9601-9717.2 | 220901 | PEUGEOT PARTNER Tepee/Kasten (B9) (08-)                   |
| 11.9601-9718.2 | 220902 | CITROEN BERLINGO (B9) (08-)                               |
| 11.9601-9718.2 | 220902 | CITROEN C4 I Grand Picasso (06-13)                        |
| 11.9601-9718.2 | 220902 | CITROEN C4 I Picasso (07-13)                              |
| 11.9601-9718.2 | 220902 | CITROEN C4 II Limousine (B7) (10-)                        |
| 11.9601-9718.2 | 220902 | CITROEN DS4 (11-)   |
| 11.9601-9718.2 | 220902 | CITROEN DS5 (11-)   |
| 11.9601-9718.2 | 220902 | PEUGEOT 3008 (09-)  |
| 11.9601-9718.2 | 220902 | PEUGEOT 5008 (09-)  |
| 11.9601-9718.2 | 220902 | PEUGEOT PARTNER Tepee/Kasten (B9) (08-)                   |
| 11.9601-9721.2 | 220875 | VOLKSWAGEN TRANSPORTER (T5) BUS / MULTIVAN / KASTEN (03-) |
| 11.9601-9721.2 | 220875 | VOLKSWAGEN TRANSPORTER (T5) PRITSCHKE / FAHRGESTELL (03-) |
| 11.9601-9722.2 | 220876 | VOLKSWAGEN TRANSPORTER (T5) BUS / MULTIVAN / KASTEN (03-) |
| 11.9601-9722.2 | 220876 | VOLKSWAGEN TRANSPORTER (T5) PRITSCHKE / FAHRGESTELL (03-) |
| 11.9601-9883.2 | 220917 | CITROEN C5 III Limousine (X7) (08-)                       |
| 11.9601-9883.2 | 220917 | CITROEN C5 III Kombi (X7) (08-)                           |
| 11.9601-9883.2 | 220917 | CITROEN C6 (05-12)  |
| 11.9601-9883.2 | 220917 | CITROEN DS4 (11-)   |
| 11.9601-9883.2 | 220917 | CITROEN DS5 (11-)   |
| 11.9601-9883.2 | 220917 | PEUGEOT 308 Limousine (07-)                               |
| 11.9601-9883.2 | 220917 | PEUGEOT 308 CC (09-)                                      |
| 11.9601-9883.2 | 220917 | PEUGEOT 407 Limousine / SW (04-11)                        |
| 11.9601-9883.2 | 220917 | PEUGEOT 407 Coupe (05-11)                                 |
| 11.9601-9883.2 | 220917 | PEUGEOT 508 (10-)   |
| 11.9601-9883.2 | 220917 | PEUGEOT 508 SW (10-)                                      |
| 11.9601-9883.2 | 220917 | PEUGEOT RCZ (10-)   |
| 11.9601-9884.2 | 220918 | CITROEN C5 III Limousine (X7) (08-)                       |
| 11.9601-9884.2 | 220918 | CITROEN C5 III Kombi (X7) (08-)                           |
| 11.9601-9884.2 | 220918 | CITROEN C6 (05-12)  |
| 11.9601-9884.2 | 220918 | CITROEN DS4 (11-)   |
| 11.9601-9884.2 | 220918 | CITROEN DS5 (11-)   |
| 11.9601-9884.2 | 220918 | PEUGEOT 308 Limousine (07-)                               |
| 11.9601-9884.2 | 220918 | PEUGEOT 308 CC (09-)                                      |



# Neue Artikel

New parts - Codici nuovi - Nouvelles références - Nuevas referencias



|                |        |               |  |
|----------------|--------|---------------|--|
| 11.9601-9884.2 | 220918 | PEUGEOT       | 407 Limousine / SW (04-11)                     |
| 11.9601-9884.2 | 220918 | PEUGEOT       | 407 Coupe (05-11)                              |
| 11.9601-9884.2 | 220918 | PEUGEOT       | 508 (10-)                                      |
| 11.9601-9884.2 | 220918 | PEUGEOT       | 508 SW (10-)                                   |
| 11.9601-9884.2 | 220918 | PEUGEOT       | RCZ (10-)                                      |
| 11.9601-9947.2 | 220903 | VOLKSWAGEN    | TOUAREG I (03-10)                              |
| 11.9601-9947.2 | 220903 | VOLKSWAGEN    | TRANSPORTER (T5) BUS / MULTIVAN / KASTEN (03-) |
| 11.9601-9947.2 | 220903 | VOLKSWAGEN    | TRANSPORTER (T5) PRITSCHKE / FAHRGESTELL (03-) |
| 11.9606-9955.2 | 220919 | BMW           | 5er Reihe/E60 Limousine (03-10)                |
| 11.9606-9955.2 | 220919 | BMW           | 5er Reihe/E61 Touring (04-10)                  |
| 11.9606-9956.2 | 220920 | BMW           | 5er Reihe/E60 Limousine (03-10)                |
| 11.9606-9956.2 | 220920 | BMW           | 5er Reihe/E61 Touring (04-10)                  |
| 13.9421-7009.2 | 210269 | MERCEDES BENZ | E-Klasse (W210) Limousine (95-02)              |
| 13.9421-7009.2 | 210269 | MERCEDES BENZ | E-Klasse (S210) Kombi (96-03)                  |
| 13.9421-7010.2 | 210270 | MERCEDES BENZ | E-Klasse (W210) Limousine (95-02)              |
| 13.9421-7010.2 | 210270 | MERCEDES BENZ | E-Klasse (S210) Kombi (96-03)                  |
| 13.9571-0041.2 | 210259 | VOLKSWAGEN    | LT/LT 4x4 (75-96)                              |
| 13.9571-0042.2 | 210260 | VOLKSWAGEN    | LT/LT 4x4 (75-96)                              |
| 24.1294-0010.3 | 331253 | FORD          | MONDEO IV (07-)                                |
| 24.1294-0011.3 | 331254 | FORD          | MONDEO IV (07-)                                |
| 24.2026-1703.3 | 010910 | BMW           | X5 (07-13)                                     |
| 24.2026-1703.3 | 010910 | BMW           | X5 (13-)                                       |
| 24.2026-1703.3 | 010910 | BMW           | X6 (08-)                                       |
| 24.2120-1753.3 | 010946 | OPEL          | VIVARO (01-)                                   |
| 24.2120-1753.3 | 010946 | RENAULT       | TRAFIC II (JL/FL/EL) (01-)                     |
| 24.2120-1754.3 | 010949 | DACIA         | LOGAN Limousine (LS_) (04-13)                  |
| 24.2120-1754.3 | 010949 | DACIA         | LOGAN MCV Kombi (KS_) (07-13)                  |
| 24.2120-1754.3 | 010949 | RENAULT       | LOGAN (LS_) (04-13)                            |
| 24.2120-1754.3 | 010949 | RENAULT       | LOGAN Kombi (KS_) (04-13)                      |
| 24.2123-1777.3 | 010943 | OPEL          | VECTRA B / Vauxhall Vectra (96-02)             |
| 24.2123-1778.3 | 010947 | MERCEDES BENZ | VITO (BM639) (03-)                             |
| 24.2125-1738.3 | 010931 | FORD          | MAVERICK (97-98)                               |
| 24.2125-1738.3 | 010931 | NISSAN        | TERRANO II (R20) (93-06)                       |
| 24.2125-1739.3 | 010948 | AUDI          | A4 (B8) Limousine (07-)                        |
| 24.2125-1739.3 | 010948 | AUDI          | A4 (B8) Avant (08-)                            |
| 24.2125-1739.3 | 010948 | AUDI          | A4 Allroad (09-)                               |
| 24.2125-1739.3 | 010948 | AUDI          | A5 / A5 Sportback (07-)                        |
| 24.2125-1739.3 | 010948 | AUDI          | A5 Cabrio (09-)                                |
| 24.2125-1739.3 | 010948 | AUDI          | A8 (09-)                                       |
| 24.2126-1702.3 | 010950 | KIA           | SORENTO (JC) (02-09)                           |
| 24.2415-1712.3 | 030131 | SEAT          | CORDOBA II (6K2) (99-02)                       |
| 24.2415-1712.3 | 030131 | SEAT          | IBIZA III (6K1) (99-02)                        |
| 24.2415-1713.3 | 030132 | AUDI          | A3 Cabrio (08-13)                              |
| 24.2415-1713.3 | 030132 | AUDI          | TT Coupe (06-)                                 |
| 24.2415-1713.3 | 030132 | AUDI          | TT Roadster (07-)                              |
| 24.2415-1713.3 | 030132 | SEAT          | ALTEA (5P1) (04-)                              |
| 24.2415-1713.3 | 030132 | SEAT          | ALTEA XL (5P5) (06-)                           |
| 24.2415-1713.3 | 030132 | SKODA         | OCTAVIA II (1Z) (04-13)                        |
| 24.2415-1713.3 | 030132 | SKODA         | SUPERB II (08-)                                |
| 24.2415-1713.3 | 030132 | SKODA         | SUPERB Kombi (09-)                             |
| 24.2415-1713.3 | 030132 | SKODA         | YETI (09-)                                     |
| 24.2415-1713.3 | 030132 | VOLKSWAGEN    | CADDY III (04-)                                |
| 24.2415-1713.3 | 030132 | VOLKSWAGEN    | GOLF VI Variant (09-)                          |
| 24.2415-1713.3 | 030132 | VOLKSWAGEN    | GOLF VI Cabriolet (11-)                        |
| 24.2415-1713.3 | 030132 | VOLKSWAGEN    | GOLF Plus (05-)                                |



|                |        |               |                                  |
|----------------|--------|---------------|----------------------------------|
| 24.2415-1713.3 | 030132 | VOLKSWAGEN    | JETTA VI (11-)                   |
| 24.2415-1713.3 | 030132 | VOLKSWAGEN    | BEETLE (11-)                     |
| 24.2415-1713.3 | 030132 | VOLKSWAGEN    | BEETLE Cabriolet (12-)           |
| 24.2415-1713.3 | 030132 | VOLKSWAGEN    | SCIROCCO (08-)                   |
| 24.2415-1713.3 | 030132 | VOLKSWAGEN    | TOURAN (03-)                     |
| 24.3217-1729.3 | 020535 | KIA           | RIO I (DC) (00-05)               |
| 24.3219-1761.3 | 020536 | DACIA         | DUSTER (HS_) (10-)               |
| 24.3219-1761.3 | 020536 | DACIA         | LOGAN Express (FS_) (09-)        |
| 24.3219-1761.3 | 020536 | DACIA         | LOGAN MCV Kombi (KS_) (07-13)    |
| 24.3219-1761.3 | 020536 | RENAULT       | CAPTUR (J87) (13-)               |
| 24.3219-1761.3 | 020536 | RENAULT       | CLIO IV (B98_) (12-)             |
| 24.3219-1761.3 | 020536 | RENAULT       | CLIO IV Grandtour (K98_) (12-)   |
| 24.3219-1761.3 | 020536 | RENAULT       | DUSTER (HS-) (11-)               |
| 24.3219-1761.3 | 020536 | RENAULT       | LOGAN Express (07-)              |
| 24.3219-1763.3 | 020543 | DACIA         | DUSTER (HS_) (10-)               |
| 24.3219-1763.3 | 020543 | RENAULT       | DUSTER (HS-) (11-)               |
| 24.3219-1764.3 | 020544 | DACIA         | DUSTER (HS_) (10-)               |
| 24.3219-1764.3 | 020544 | RENAULT       | DUSTER (HS-) (11-)               |
| 24.3220-1737.3 | 020540 | MAZDA         | 626 (97-02)                      |
| 24.3220-1737.3 | 020540 | MAZDA         | PREMACY (CP) (99-05)             |
| 24.3222-1730.3 | 020533 | TOYOTA        | HILUX (97-05)                    |
| 24.3222-1734.3 | 020539 | CITROEN       | BERLINGO (MF) Kombi (96-08)      |
| 24.3222-1734.3 | 020539 | CITROEN       | BERLINGO (M_) Kasten (96-08)     |
| 24.3222-1734.3 | 020539 | CITROEN       | XSARA Picasso (N68) (00-10)      |
| 24.3222-1734.3 | 020539 | PEUGEOT       | PARTNER Kombi (96-08)            |
| 24.3222-1734.3 | 020539 | PEUGEOT       | PARTNER Kasten (96-08)           |
| 24.3225-1704.3 | 020541 | FIAT          | DOBLO (10-)                      |
| 24.3225-1704.3 | 020541 | OPEL          | COMBO D / Vauxhall Combo D (11-) |
| 24.3304-1701.5 | 240113 | HONDA         | CIVIC (5-türig) (94-96)          |
| 24.3304-1701.5 | 240113 | HONDA         | CONCERTO (90-95)                 |
| 24.3304-1701.5 | 240113 | ROVER         | 200 II-Serie (RF) (95-00)        |
| 24.3304-1702.5 | 240114 | HONDA         | CIVIC (5-türig) (94-96)          |
| 24.3304-1702.5 | 240114 | HONDA         | CONCERTO (90-95)                 |
| 24.3304-1702.5 | 240114 | ROVER         | 200 II-Serie (RF) (95-00)        |
| 24.3331-1701.5 | 240543 | MERCEDES BENZ | V-Klasse (BM638) (96-03)         |
| 24.3331-1701.5 | 240543 | MERCEDES BENZ | VITO (BM638) (96-03)             |
| 24.3331-1702.5 | 240544 | MERCEDES BENZ | V-Klasse (BM638) (96-03)         |
| 24.3331-1702.5 | 240544 | MERCEDES BENZ | VITO (BM638) (96-03)             |
| 24.3414-1715.5 | 240589 | CITROEN       | JUMPY (07-)                      |
| 24.3414-1715.5 | 240589 | PEUGEOT       | EXPERT / Expert Tepee (07-)      |
| 24.3414-1716.5 | 240590 | CITROEN       | JUMPY (07-)                      |
| 24.3414-1716.5 | 240590 | PEUGEOT       | EXPERT / Expert Tepee (07-)      |
| 24.3421-9937.5 | 240563 | BMW           | X5 (00-07)                       |
| 24.3421-9938.5 | 240564 | BMW           | X5 (00-07)                       |
| 24.3426-9957.5 | 240565 | BMW           | 5er Reihe/E61 Touring (04-10)    |
| 24.3426-9958.5 | 240566 | BMW           | 5er Reihe/E61 Touring (04-10)    |
| 24.3426-9977.5 | 240567 | BMW           | 5er Reihe/E60 Limousine (03-10)  |
| 24.3426-9977.5 | 240567 | BMW           | 6er Reihe/E63 Coupe (04-11)      |
| 24.3426-9977.5 | 240567 | BMW           | 6er Reihe/E64 Cabrio (04-11)     |
| 24.3431-1708.7 | 220936 | TOYOTA        | AVENSIS VERSO (01-05)            |
| 24.3431-1708.7 | 220936 | TOYOTA        | PREVIA (00-05)                   |
| 24.3511-1719.7 | 220937 | HONDA         | JAZZ (02-08)                     |
| 24.3511-1720.7 | 220938 | HONDA         | JAZZ (02-08)                     |
| 24.3541-1811.5 | 240429 | FIAT          | BRAVO (07-)                      |
| 24.3541-1811.5 | 240429 | FIAT          | IDEA (04-12)                     |



# Neue Artikel

New parts - Codici nuovi - Nouvelles références - Nuevas referencias



|                |        |               |   |
|----------------|--------|---------------|---|
| 24.3541-1811.5 | 240429 | FIAT          | STILO / STILO Multi Wagon (01-08)                           |
| 24.3541-1811.5 | 240429 | LANCIA        | MUSA (04-12)  |
| 24.3541-1812.5 | 240430 | FIAT          | BRAVO (07-)   |
| 24.3541-1812.5 | 240430 | FIAT          | IDEA (04-12)  |
| 24.3541-1812.5 | 240430 | FIAT          | STILO / STILO Multi Wagon (01-08)                           |
| 24.3541-1812.5 | 240430 | LANCIA        | MUSA (04-12)  |
| 24.3541-1843.5 | 240585 | MINI          | R55 Clubman (07-)   |
| 24.3541-1843.5 | 240585 | MINI          | R55 Clubvan (12-)   |
| 24.3541-1843.5 | 240585 | MINI          | R56 (06-)   |
| 24.3541-1843.5 | 240585 | MINI          | R57 Cabrio (09-)  |
| 24.3541-1843.5 | 240585 | MINI          | R58 Coupe (11-)   |
| 24.3541-1843.5 | 240585 | MINI          | R59 Roadster (12-)  |
| 24.3541-1844.5 | 240586 | MINI          | R55 Clubman (07-)   |
| 24.3541-1844.5 | 240586 | MINI          | R55 Clubvan (12-)   |
| 24.3541-1844.5 | 240586 | MINI          | R56 (06-)   |
| 24.3541-1844.5 | 240586 | MINI          | R57 Cabrio (09-)  |
| 24.3541-1844.5 | 240586 | MINI          | R58 Coupe (11-)   |
| 24.3541-1844.5 | 240586 | MINI          | R59 Roadster (12-)  |
| 24.3606-9967.5 | 240571 | BMW           | 5er Reihe/E60 Limousine (03-10)                             |
| 24.3606-9967.5 | 240571 | BMW           | 5er Reihe/E61 Touring (04-10)                               |
| 24.3606-9968.5 | 240572 | BMW           | 5er Reihe/E60 Limousine (03-10)                             |
| 24.3606-9968.5 | 240572 | BMW           | 5er Reihe/E61 Touring (04-10)                               |
| 24.3606-9977.5 | 240573 | BMW           | 5er Reihe/E60 Limousine (03-10)                             |
| 24.3606-9977.5 | 240573 | BMW           | 5er Reihe/E61 Touring (04-10)                               |
| 24.3606-9977.5 | 240573 | BMW           | 6er Reihe/E63 Coupe (04-11)                                 |
| 24.3606-9977.5 | 240573 | BMW           | 6er Reihe/E64 Cabrio (04-11)                                |
| 24.3606-9977.5 | 240573 | BMW           | 7er Reihe/E65/E66 (02-08)                                   |
| 24.3606-9978.5 | 240574 | BMW           | 5er Reihe/E60 Limousine (03-10)                             |
| 24.3606-9978.5 | 240574 | BMW           | 5er Reihe/E61 Touring (04-10)                               |
| 24.3606-9978.5 | 240574 | BMW           | 6er Reihe/E63 Coupe (04-11)                                 |
| 24.3606-9978.5 | 240574 | BMW           | 6er Reihe/E64 Cabrio (04-11)                                |
| 24.3606-9978.5 | 240574 | BMW           | 7er Reihe/E65/E66 (02-08)                                   |
| 24.3727-0247.2 | 580247 | BMW           | 5er Reihe/E39 (96-03)                                       |
| 24.3727-0470.2 | 580470 | MERCEDES BENZ | C-Klasse (W204) Limousine (07-)                             |
| 24.3727-0470.2 | 580470 | MERCEDES BENZ | C-Klasse (S204) Kombi (07-)                                 |
| 24.3727-0470.2 | 580470 | MERCEDES BENZ | C-Klasse (C204) Coupe (11-)                                 |
| 24.3727-0470.2 | 580470 | MERCEDES BENZ | E-Klasse (C207) Coupe (09-)                                 |
| 24.3727-0470.2 | 580470 | MERCEDES BENZ | E-Klasse (A207) Cabrio (10-)                                |
| 24.3727-0471.2 | 580471 | MERCEDES BENZ | Transporter (BM 906) SPRINTER (06-)                         |
| 24.3727-0474.2 | 580474 | MERCEDES BENZ | Transporter (BM 906) SPRINTER (06-)                         |
| 24.3727-0578.2 | 580578 | FIAT          | PUNTO / PUNTO EVO (09-)                                     |
| 24.3727-0578.2 | 580578 | FIAT          | GRANDE PUNTO (06-11)  |
| 24.3727-0580.2 | 580580 | ALFA ROMEO    | MITO (08-)  |
| 24.3727-0580.2 | 580580 | FIAT          | PUNTO / PUNTO EVO (09-)                                     |
| 24.3727-0580.2 | 580580 | FIAT          | GRANDE PUNTO (06-11)  |
| 24.3727-0677.2 | 580677 | FORD          | GALAXY II (06-)   |
| 24.3727-0677.2 | 580677 | FORD          | MONDEO IV (07-)   |
| 24.3727-0677.2 | 580677 | FORD          | S-MAX (06-)   |
| 24.3727-0678.2 | 580678 | FORD          | C-MAX I (07-10)   |
| 24.3727-0678.2 | 580678 | FORD          | C-MAX II (10-)  |
| 24.3727-0678.2 | 580678 | FORD          | GRAND C-MAX (10-)   |
| 24.3727-0678.2 | 580678 | FORD          | FOCUS II (05-11)  |
| 24.3727-0678.2 | 580678 | FORD          | FOCUS C-MAX (03-07)   |
| 24.3727-0789.2 | 580789 | OPEL          | INSIGNIA / Vauxhall Insignia (08-)                          |
| 24.3727-0789.2 | 580789 | OPEL          | INSIGNIA Sports Tourer / Vauxh. Insignia SportsTourer (08-) |



|                |        |            |   |
|----------------|--------|------------|---|
| 24.3727-0790.2 | 580790 | OPEL       | ZAFIRA II / Vauxhall Zafira II (05-11)                      |
| 24.3727-0791.2 | 580791 | OPEL       | INSIGNIA / Vauxhall Insignia (08-)                          |
| 24.3727-0791.2 | 580791 | OPEL       | INSIGNIA Sports Tourer / Vauxh. Insignia SportsTourer (08-) |
| 24.3727-0792.2 | 580792 | OPEL       | AGILA / Vauxhall Agila Mk II (08-)                          |
| 24.3727-0792.2 | 580792 | SUZUKI     | SPLASH (08-)  |
| 24.3727-0793.2 | 580793 | OPEL       | AGILA / Vauxhall Agila Mk II (08-)                          |
| 24.3727-0793.2 | 580793 | SUZUKI     | SPLASH (08-)  |
| 24.3727-0796.2 | 580796 | NISSAN     | PRIMASTAR (X83) Bus (01-)                                   |
| 24.3727-0796.2 | 580796 | NISSAN     | PRIMASTAR (X83) Kasten/Pritsche (02-)                       |
| 24.3727-0796.2 | 580796 | OPEL       | VIVARO (01-)  |
| 24.3727-0796.2 | 580796 | RENAULT    | TRAFIC II (JL/FL/EL) (01-)                                  |
| 24.3727-0797.2 | 580797 | NISSAN     | PRIMASTAR (X83) Bus (01-)                                   |
| 24.3727-0797.2 | 580797 | NISSAN     | PRIMASTAR (X83) Kasten/Pritsche (02-)                       |
| 24.3727-0797.2 | 580797 | OPEL       | VIVARO (01-)  |
| 24.3727-0797.2 | 580797 | RENAULT    | TRAFIC II (JL/FL/EL) (01-)                                  |
| 24.3727-1088.2 | 581088 | RENAULT    | KOLEOS (HY0_) (08-)   |
| 24.3727-1089.2 | 581089 | RENAULT    | LAGUNA III Limousine (BT0/1) (07-)                          |
| 24.3727-1089.2 | 581089 | RENAULT    | LAGUNA III Coupe (DT0/1) (07-)                              |
| 24.3727-1089.2 | 581089 | RENAULT    | LAGUNA III Grandtour (KT0/1) (07-)                          |
| 24.3727-1090.2 | 581090 | RENAULT    | CLIO III (BR_/CR_) (05-12)                                  |
| 24.3727-1090.2 | 581090 | RENAULT    | CLIO III Grandtour (KR_) (08-12)                            |
| 24.3727-1091.2 | 581091 | RENAULT    | CLIO III (BR_/CR_) (05-12)                                  |
| 24.3727-1091.2 | 581091 | RENAULT    | CLIO III Grandtour (KR_) (08-12)                            |
| 24.3727-1735.2 | 581735 | NISSAN     | ALMERA TINO (V10M) (00-05)                                  |
| 24.3727-1939.2 | 581939 | TOYOTA     | COROLLA VERSO (04-09)                                       |
| 24.3727-1940.2 | 581940 | TOYOTA     | COROLLA VERSO (04-09)                                       |
| 24.3727-2005.2 | 582005 | SUZUKI     | SWIFT III (05-10)   |
| 24.3727-3112.2 | 583112 | HYUNDAI    | ELANTRA (00-06)   |
| 24.3727-3113.2 | 583113 | HYUNDAI    | ELANTRA (00-06)   |
| 24.3727-3114.2 | 583114 | HYUNDAI    | ELANTRA (06-11)   |
| 24.3727-3114.2 | 583114 | HYUNDAI    | i30 (07-11)   |
| 24.3727-3115.2 | 583115 | HYUNDAI    | ELANTRA (06-11)   |
| 24.3727-3115.2 | 583115 | HYUNDAI    | i30 (07-11)   |
| 24.3727-3116.2 | 583116 | HYUNDAI    | i30 CW Kombi (08-12)  |
| 24.3727-3117.2 | 583117 | HYUNDAI    | i30 CW Kombi (08-12)  |
| 24.3727-3206.2 | 583206 | KIA        | PICANTO (BA) (04-11)  |
| 24.3727-3207.2 | 583207 | KIA        | PICANTO (BA) (04-11)  |
| 24.3728-0343.2 | 590343 | CITROEN    | BERLINGO (MF) Kombi (96-08)                                 |
| 24.3728-0343.2 | 590343 | CITROEN    | BERLINGO (M_) Kasten (96-08)                                |
| 24.3728-0343.2 | 590343 | PEUGEOT    | PARTNER Kombi (96-08)                                       |
| 24.3728-0343.2 | 590343 | PEUGEOT    | PARTNER Kasten (96-08)                                      |
| 24.5112-0402.3 | 331297 | ALFA ROMEO | MITO (08-)  |
| 24.5112-0402.3 | 331297 | FIAT       | 500L Kombi (12-)  |
| 24.5112-0402.3 | 331297 | FIAT       | FIORINO / FIORINO QUBO (08-)                                |
| 24.5112-0402.3 | 331297 | FIAT       | LINEA (07-11)   |
| 24.5112-0402.3 | 331297 | FIAT       | PUNTO / PUNTO EVO (09-)                                     |
| 24.5112-0402.3 | 331297 | FIAT       | GRANDE PUNTO (06-11)  |
| 24.5112-0402.3 | 331297 | OPEL       | CORSAD / Vauxhall Corsa MK III (06-)                        |
| 24.5112-0417.3 | 331298 | CITROEN    | JUMPER (06-)  |
| 24.5112-0417.3 | 331298 | FIAT       | DUCATO (06-)  |
| 24.5112-0417.3 | 331298 | PEUGEOT    | BOXER (06-)   |
| 24.5112-0492.3 | 331217 | CITROEN    | JUMPER (06-)  |
| 24.5112-0492.3 | 331217 | FIAT       | DUCATO (06-)  |
| 24.5112-0492.3 | 331217 | PEUGEOT    | BOXER (06-)   |
| 24.5113-0440.3 | 331239 | BMW        | 3er Reihe/E90 Limousine (05-12)                             |

# Neue Artikel

New parts - Codici nuovi - Nouvelles références - Nuevas referencias



|                |        |               |                                     |
|----------------|--------|---------------|-------------------------------------|
| 24.5113-0440.3 | 331239 | BMW           | 3er Reihe/E91 Touring (05-12)       |
| 24.5113-0440.3 | 331239 | BMW           | 3er Reihe/E92 Coupe (06-13)         |
| 24.5123-0380.3 | 331256 | MERCEDES BENZ | CLS-Klasse (C219) Coupe (04-10)     |
| 24.5123-0380.3 | 331256 | MERCEDES BENZ | E-Klasse (W211) Limousine (02-09)   |
| 24.5123-0380.3 | 331256 | MERCEDES BENZ | E-Klasse (S211) Kombi (03-09)       |
| 24.5123-0380.3 | 331256 | MERCEDES BENZ | S-Klasse (W220) (98-06)             |
| 24.5123-0545.3 | 331240 | MERCEDES BENZ | GL-Klasse (X164) (06-12)            |
| 24.5123-0545.3 | 331240 | MERCEDES BENZ | M-Klasse (W164) (05-11)             |
| 24.5123-0610.3 | 331241 | MERCEDES BENZ | GL-Klasse (X164) (06-12)            |
| 24.5123-0610.3 | 331241 | MERCEDES BENZ | M-Klasse (W164) (05-11)             |
| 24.5124-0252.3 | 331218 | FORD          | TRANSIT (06-)                       |
| 24.5124-0420.3 | 331276 | FORD          | FOCUS C-MAX (03-07)                 |
| 24.5125-0230.3 | 331277 | BMW           | 1er Reihe/E81/E87 Limousine (04-11) |
| 24.5125-0230.3 | 331277 | BMW           | 1er Reihe/E82 Coupe (07-)           |
| 24.5125-0230.3 | 331277 | BMW           | 1er Reihe/E88 Cabrio (08-)          |
| 24.5125-0230.3 | 331277 | BMW           | 1er Reihe/F20/F21 Limousine (11-)   |
| 24.5125-0230.3 | 331277 | BMW           | 3er Reihe/E90 Limousine (05-12)     |
| 24.5125-0230.3 | 331277 | BMW           | 3er Reihe/E91 Touring (05-12)       |
| 24.5125-0230.3 | 331277 | BMW           | 3er Reihe/E92 Coupe (06-13)         |
| 24.5125-0230.3 | 331277 | BMW           | 3er Reihe/E93 Cabrio (07-)          |
| 24.5125-0230.3 | 331277 | BMW           | 3er Reihe/F30 Limousine (12-)       |
| 24.5125-0230.3 | 331277 | BMW           | 3er Reihe/F31 Touring (12-)         |
| 24.5125-0230.3 | 331277 | BMW           | 3er Reihe/F34 GT (13-)              |
| 24.5125-0230.3 | 331277 | BMW           | 4er Reihe/F32 Coupe (13-)           |
| 24.5125-0230.3 | 331277 | BMW           | X1 (09-)                            |
| 24.5131-0415.3 | 331238 | MERCEDES BENZ | Transporter (BM 906) SPRINTER (06-) |
| 24.5131-0415.3 | 331238 | VOLKSWAGEN    | CRAFTER (06-)                       |
| 24.5137-0221.3 | 331302 | BMW           | 1er Reihe/E81/E87 Limousine (04-11) |
| 24.5137-0221.3 | 331302 | BMW           | 1er Reihe/E82 Coupe (07-)           |
| 24.5137-0221.3 | 331302 | BMW           | 1er Reihe/E88 Cabrio (08-)          |
| 24.5137-0221.3 | 331302 | BMW           | 3er Reihe/E90 Limousine (05-12)     |
| 24.5137-0221.3 | 331302 | BMW           | 3er Reihe/E91 Touring (05-12)       |
| 24.5137-0221.3 | 331302 | BMW           | 3er Reihe/E92 Coupe (06-13)         |
| 24.5137-0221.3 | 331302 | BMW           | 3er Reihe/E93 Cabrio (07-)          |
| 24.5137-0221.3 | 331302 | BMW           | 3er Reihe/F30 Limousine (12-)       |
| 24.5137-0221.3 | 331302 | BMW           | X1 (09-)                            |
| 24.5141-0473.3 | 331303 | FORD          | FIESTA V (02-08)                    |
| 24.5144-0410.3 | 331242 | RENAULT       | LAGUNA III Limousine (BT0/1) (07-)  |
| 24.5144-0410.3 | 331242 | RENAULT       | LAGUNA III Coupe (DT0/1) (07-)      |
| 24.5144-0410.3 | 331242 | RENAULT       | LAGUNA III Grandtour (KT0/1) (07-)  |
| 24.5145-0176.3 | 330965 | TOYOTA        | AVENSIS VERSO (01-05)               |
| 24.5157-0273.3 | 331305 | BMW           | X5 (00-07)                          |
| 24.5161-0313.3 | 331219 | CITROEN       | C5 III Limousine (X7) (08-)         |
| 24.5161-0313.3 | 331219 | CITROEN       | C5 III Kombi (X7) (08-)             |
| 24.5161-0313.3 | 331219 | CITROEN       | C6 (05-12)                          |
| 24.5161-0313.3 | 331219 | PEUGEOT       | 407 Limousine / SW (04-11)          |
| 24.5161-0313.3 | 331219 | PEUGEOT       | 407 Coupe (05-11)                   |
| 24.5161-0314.3 | 331220 | CITROEN       | C5 III Limousine (X7) (08-)         |
| 24.5161-0314.3 | 331220 | CITROEN       | C5 III Kombi (X7) (08-)             |
| 24.5161-0314.3 | 331220 | CITROEN       | C6 (05-12)                          |
| 24.5161-0314.3 | 331220 | PEUGEOT       | 407 Limousine / SW (04-11)          |
| 24.5161-0314.3 | 331220 | PEUGEOT       | 407 Coupe (05-11)                   |
| 24.5161-0315.3 | 331186 | CITROEN       | C6 (05-12)                          |
| 24.5161-0315.3 | 331186 | PEUGEOT       | 407 Limousine / SW (04-11)          |
| 24.5161-0315.3 | 331186 | PEUGEOT       | 407 Coupe (05-11)                   |



|                |        |               |                               |
|----------------|--------|---------------|-------------------------------|
| 24.5161-0316.3 | 331187 | CITROEN       | C6 (05-12)                    |
| 24.5161-0316.3 | 331187 | PEUGEOT       | 407 Limousine / SW (04-11)    |
| 24.5161-0316.3 | 331187 | PEUGEOT       | 407 Coupe (05-11)             |
| 24.5164-0315.3 | 331209 | FORD          | MONDEO I (93-96)              |
| 24.5164-0315.3 | 331209 | FORD          | MONDEO II (96-00)             |
| 24.5164-0316.3 | 331210 | FORD          | MONDEO II (96-00)             |
| 24.5164-0317.3 | 331211 | FORD          | MONDEO II (96-00)             |
| 24.5165-0450.3 | 331259 | MERCEDES BENZ | G-Klasse (W463) (90-)         |
| 24.5165-0450.3 | 331259 | MERCEDES BENZ | G-Klasse (W463) Cabrio (90-)  |
| 24.5166-0325.3 | 331293 | SKODA         | FAVORIT (781) (87-95)         |
| 24.5166-0325.3 | 331293 | SKODA         | FELICIA I (791/795) (95-97)   |
| 24.5166-0325.3 | 331293 | SKODA         | FELICIA II (6U) (98-01)       |
| 24.5166-0325.3 | 331293 | SKODA         | FELICIA PICK-UP (797) (97-00) |
| 24.5166-0325.3 | 331293 | VOLKSWAGEN    | CADDY Pickup (97-02)          |
| 24.5166-0454.3 | 331306 | FORD          | GALAXY I (95-06)              |
| 24.5166-0454.3 | 331306 | SEAT          | ALHAMBRA I (7V) (96-10)       |
| 24.5166-0454.3 | 331306 | VOLKSWAGEN    | SHARAN I (95-10)              |
| 24.5167-0420.3 | 331278 | FORD          | FOCUS C-MAX (03-07)           |
| 24.5170-0361.3 | 331310 | VOLVO         | S70 (97-00)                   |
| 24.5170-0361.3 | 331310 | VOLVO         | V70 I (97-00)                 |
| 24.5224-0299.3 | 331262 | VOLKSWAGEN    | LT/LT 4x4 (75-96)             |
| 24.5224-0460.3 | 331264 | MERCEDES BENZ | G-Klasse (W463) (90-)         |
| 24.5224-0460.3 | 331264 | MERCEDES BENZ | G-Klasse (W463) Cabrio (90-)  |
| 24.5228-0181.3 | 331279 | CITROEN       | NEMO (08-)                    |
| 24.5228-0181.3 | 331279 | FIAT          | FIORINO / FIORINO QUBO (08-)  |
| 24.5228-0181.3 | 331279 | FIAT          | LINEA (07-11)                 |
| 24.5228-0181.3 | 331279 | PEUGEOT       | BIPPER (08-)                  |
| 24.5235-0200.3 | 331280 | SUBARU        | TREZIA (11-)                  |
| 24.5235-0200.3 | 331280 | TOYOTA        | VERSO S (10-)                 |
| 24.5235-0200.3 | 331280 | TOYOTA        | YARIS (06-)                   |
| 24.5235-0200.3 | 331280 | TOYOTA        | YARIS (11-)                   |
| 24.5237-0360.3 | 331212 | AUDI          | A8 (94-02)                    |
| 24.5237-0360.3 | 331212 | VOLKSWAGEN    | PASSAT (97-05)                |
| 24.5239-0355.3 | 331243 | CITROEN       | JUMPY (07-)                   |
| 24.5239-0355.3 | 331243 | FIAT          | SCUDO (07-)                   |
| 24.5239-0355.3 | 331243 | PEUGEOT       | EXPERT / Expert Tepee (07-)   |
| 24.5239-0365.3 | 331281 | CITROEN       | JUMPY (07-)                   |
| 24.5239-0365.3 | 331281 | PEUGEOT       | EXPERT / Expert Tepee (07-)   |
| 24.5247-0275.3 | 331244 | CITROEN       | C-CROSSER (07-13)             |
| 24.5247-0275.3 | 331244 | PEUGEOT       | 4007 (07-12)                  |
| 24.5247-0276.3 | 331245 | CITROEN       | C-CROSSER (07-13)             |
| 24.5247-0276.3 | 331245 | PEUGEOT       | 4007 (07-12)                  |
| 24.5261-0256.3 | 331246 | HYUNDAI       | ACCENT II (00-05)             |
| 24.5263-0440.3 | 331282 | TOYOTA        | YARIS (99-05)                 |
| 24.5263-0441.3 | 331283 | TOYOTA        | YARIS (99-05)                 |
| 24.5263-0592.3 | 331284 | TOYOTA        | YARIS (99-05)                 |
| 24.5263-0593.3 | 331285 | TOYOTA        | YARIS (99-05)                 |
| 24.5263-0594.3 | 331286 | TOYOTA        | YARIS (99-05)                 |
| 24.5263-0595.3 | 331287 | TOYOTA        | YARIS (99-05)                 |
| 24.5270-0200.3 | 331247 | HONDA         | CIVIC Hatchback (FK/FN) (05-) |
| 24.5270-0200.3 | 331247 | HONDA         | CIVIC Stufenheck (FD) (05-)   |
| 24.5270-0201.3 | 331248 | HONDA         | CIVIC Hatchback (FK/FN) (05-) |
| 24.5270-0201.3 | 331248 | HONDA         | CIVIC Stufenheck (FD) (05-)   |
| 24.5286-0488.3 | 331221 | DAIHATSU      | CHARADE (11-)                 |
| 24.5286-0488.3 | 331221 | TOYOTA        | YARIS (06-)                   |

# Neue Artikel

New parts - Codici nuovi - Nouvelles références - Nuevas referencias



|                |        |               |  |
|----------------|--------|---------------|--|
| 24.5286-0489.3 | 331222 | DAIHATSU      | CHARADE (11-)                          |
| 24.5286-0489.3 | 331222 | TOYOTA        | YARIS (06-)                            |
| 24.5286-0524.3 | 331223 | KIA           | CEE'D Limousine (06-)                  |
| 24.5286-0524.3 | 331223 | KIA           | CEE'D Kombi (07-)                      |
| 24.5286-0524.3 | 331223 | KIA           | PRO CEE'D (08-)                        |
| 24.5286-0525.3 | 331224 | KIA           | CEE'D Limousine (06-)                  |
| 24.5286-0525.3 | 331224 | KIA           | CEE'D Kombi (07-)                      |
| 24.5286-0525.3 | 331224 | KIA           | PRO CEE'D (08-)                        |
| 24.5286-0540.3 | 331249 | MAZDA         | PAJERO (00-07)                         |
| 24.5286-0540.3 | 331249 | MAZDA         | PAJERO (07-)                           |
| 24.5286-0545.3 | 331250 | MAZDA         | LANCER Evolution (04-07)               |
| 24.5286-0545.3 | 331250 | MAZDA         | LANCER Limousine (03-07)               |
| 24.5286-0545.3 | 331250 | MAZDA         | LANCER Kombi (03-07)                   |
| 24.5286-0556.3 | 331251 | MAZDA         | PAJERO (07-)                           |
| 24.5286-0660.3 | 331252 | MAZDA         | PAJERO (00-07)                         |
| 24.5286-0660.3 | 331252 | MAZDA         | PAJERO (07-)                           |
| 24.5288-0270.3 | 331227 | MAZDA         | 6 Limousine (GG) (02-07)               |
| 24.5288-0270.3 | 331227 | MAZDA         | 6 Kombi (GY) (02-07)                   |
| 24.5292-0240.3 | 331225 | NISSAN        | QASHQAI / QASHQAI +2 (J10, JJ10) (07-) |
| 24.5292-0241.3 | 331226 | NISSAN        | QASHQAI / QASHQAI +2 (J10, JJ10) (07-) |
| 24.5298-0322.3 | 331314 | OPEL          | ASTRA F / Vauxhall Astra MKIII (91-01) |
| 24.5298-0322.3 | 331314 | OPEL          | CALIBRA / Vauxhall Calibra (89-97)     |
| 24.5298-0322.3 | 331314 | OPEL          | VECTRAA / Vauxhall Cavalier (89-95)    |
| 24.5298-0322.3 | 331314 | SAAB          | 9-3 (YS3D) (98-02)                     |
| 24.5298-0322.3 | 331314 | SAAB          | 9-3 Cabriolet (YS3D) (98-03)           |
| 24.5298-0322.3 | 331314 | SAAB          | 900 (94-98)                            |
| 24.5298-0475.3 | 331255 | MAZDA         | COLT (04-)                             |
| 24.5298-0475.3 | 331255 | MAZDA         | COLT CZC Cabriolet (06-08)             |
| 24.6238-1701.7 | 220819 | VOLKSWAGEN    | PASSAT Limousine (05-10)               |
| 24.6238-1701.7 | 220819 | VOLKSWAGEN    | PASSAT Variant (05-10)                 |
| 24.6238-1702.7 | 220820 | VOLKSWAGEN    | PASSAT Limousine (05-10)               |
| 24.6238-1702.7 | 220820 | VOLKSWAGEN    | PASSAT Variant (05-10)                 |
| 24.6241-1701.7 | 220821 | AUDI          | A6 (4F2/C6) Limousine (04-11)          |
| 24.6241-1701.7 | 220821 | AUDI          | A6 (4F5/C6) Avant (05-11)              |
| 24.6241-1701.7 | 220821 | AUDI          | A6 Allroad (06-11)                     |
| 24.6241-1702.7 | 220822 | AUDI          | A6 (4F2/C6) Limousine (04-11)          |
| 24.6241-1702.7 | 220822 | AUDI          | A6 (4F5/C6) Avant (05-11)              |
| 24.6241-1702.7 | 220822 | AUDI          | A6 Allroad (06-11)                     |
| 24.6243-1701.7 | 220823 | AUDI          | A6 (4F2/C6) Limousine (04-11)          |
| 24.6243-1701.7 | 220823 | AUDI          | A6 (4F5/C6) Avant (05-11)              |
| 24.6243-1701.7 | 220823 | AUDI          | A6 Allroad (06-11)                     |
| 24.6243-1702.7 | 220824 | AUDI          | A6 (4F2/C6) Limousine (04-11)          |
| 24.6243-1702.7 | 220824 | AUDI          | A6 (4F5/C6) Avant (05-11)              |
| 24.6243-1702.7 | 220824 | AUDI          | A6 Allroad (06-11)                     |
| 24.9571-7005.5 | 230061 | MERCEDES BENZ | S-Klasse (W140) (91-93)                |
| 83.1294-0250.3 | 331267 | BMW           | Z4 Roadster/E85 (03-08)                |
| 83.1294-0250.3 | 331267 | BMW           | Z4 Coupe/E86 (06-08)                   |
| 83.1294-0260.3 | 331268 | BMW           | Z4 Roadster/E85 (03-08)                |
| 83.1294-0260.3 | 331268 | BMW           | Z4 Coupe/E86 (06-08)                   |
| 83.7713-0483.3 | 331229 | AUDI          | Q5 (08-)                               |
| 83.7724-0204.3 | 331206 | BMW           | 8er Reihe/E31 (90-99)                  |
| 83.7750-0524.3 | 331230 | MINI          | R55 Clubman (07-)                      |
| 83.7750-0524.3 | 331230 | MINI          | R55 Clubvan (12-)                      |
| 83.7750-0524.3 | 331230 | MINI          | R56 (06-)                              |
| 83.7750-0524.3 | 331230 | MINI          | R57 Cabrio (09-)                       |



|                |        |            |                                |
|----------------|--------|------------|--------------------------------|
| 83.7750-0524.3 | 331230 | MINI       | R58 Coupe (11-)                |
| 83.7750-0524.3 | 331230 | MINI       | R59 Roadster (12-)             |
| 83.7769-0275.3 | 331207 | VOLVO      | V70 I (97-00)                  |
| 83.7812-0400.3 | 331214 | AUDI       | Q7 (06-)                       |
| 83.7812-0400.3 | 331214 | PORSCHE    | CAYENNE I (03-10)              |
| 83.7812-0400.3 | 331214 | VOLKSWAGEN | TOUAREG I (03-10)              |
| 83.7812-0400.3 | 331214 | VOLKSWAGEN | TOUAREG II (10-)               |
| 83.7856-0369.3 | 331237 | JAGUAR     | X-Type (CF1) Limousine (01-09) |
| 83.7856-0369.3 | 331237 | JAGUAR     | X-Type (CF1) Kombi (03-09)     |



A large rectangular area containing 30 horizontal lines, intended for writing or drawing.









- Ⓓ Ersetzte Artikel
- Ⓔ Replaced parts
- Ⓕ Références remplacées
- Ⓖ Codici sostitutivi
- Ⓔ Referencias de sustitución
- Ⓗ Vervangen artikelen
- Ⓓ Erstattede artikler
- Ⓔ Utbytta artiklar
- Ⓗ Helyettesített alkatrészek
- Ⓖ Artigos substituídos
- Ⓔ Замененные номера
- Ⓒ Nahrazené výrobky
- Ⓖ Artykuły zastąpione
- Ⓔ Αντικατεστημένοι αριθμοί
- Ⓖ Değiştirilen ürün
- Ⓔ 替代件
- Ⓔ 呢充商品
- Ⓔ المنتجات المعوّضة

# Ersetzte Artikel

Replaced parts - Codici sostitutivi - Références remplacées - Referencias de sustitución

|  Vorgänger Nr.<br>Replaced No.<br>Codice precedente<br>Ancienne référence<br>Número anterior |  Nachfolge Nr.<br>Replacing No.<br>Codice nuovo<br>Nouvelle référence<br>Número posterior |  Nachfolge Nr.<br>Replacing No.<br>Codice nuovo<br>Nouvelle référence<br>Número posterior |  Vorgänger Nr.<br>Replaced No.<br>Codice precedente<br>Ancienne référence<br>Número anterior |                |        |                |        |
|--|--|--|---|----------------|--------|----------------|--------|
| 03.2125-7737.3   | 010709   | 03.2125-7743.3   | 010921  | 03.2125-7743.3 | 010921 | 03.2125-7737.3 | 010709 |
| 03.3222-7501.3   | 020086   | 24.3222-1733.3   | 020538  | 03.7863-6502.4 | 300232 | 03.7863-4402.4 | 300184 |
| 03.3222-7501.3   | 020086   | 24.3222-1733.3   | 020538  | 03.3520-0302-1 | 390381 | 03.3520-0300.1 | 390380 |
| 03.3520-0300.1   | 390380   | 03.3520-0302-1   | 390381  | 11.0441-5702.2 | 250033 | 11.0441-5701.2 | 250032 |
| 03.5808-0225.3   | 330034   | 24.5901-0225.3   | 331288  | 11.0441-6003.2 | 250037 | 11.0441-6001.2 | 250035 |
| 03.7863-4402.4   | 300184   | 03.7863-6502.4   | 300232  | 11.8116-0301.1 | 390610 | 11.8116-0118.1 | 390508 |
| 11.0230-0042.2   | 260027   | 11.8170-0306.1   | 260102  | 11.8170-0306.1 | 260102 | 11.0230-0042.2 | 260027 |
| 11.0230-0233.2   | 260093   | 11.8170-0729.1   | 260107  | 11.8170-0729.1 | 260107 | 11.0230-0233.2 | 260093 |
| 11.0441-5701.2   | 250032   | 11.0441-5702.2   | 250033  | 11.9601-9711.2 | 220873 | 11.9601-9745.2 | 220653 |
| 11.0441-6001.2   | 250035   | 11.0441-6003.2   | 250037  | 11.9601-9947.2 | 220903 | 11.9601-8501.2 | 220593 |
| 11.3541-8086.2   | 220288   | 24.3541-8086.5   | 240526  | 13.4441-8016.2 | 210264 | 13.4441-8016.3 | 210202 |
| 11.8116-0118.1   | 390508   | 11.8116-0301.1   | 390610  | 13.4441-8017.2 | 210265 | 13.4441-8017.3 | 210203 |
| 11.9341-9991.2   | 220407   | 24.3341-9991.5   | 240511  | 13.9571-0041-2 | 210259 | 13.2571-8015.2 | 210125 |
| 11.9341-9992.2   | 220408   | 24.3341-9992.5   | 240512  | 13.9571-0042-2 | 210260 | 13.2571-8016.2 | 210126 |
| 11.9601-8501.2   | 220593   | 11.9601-9947.2   | 220903  | 24.3222-1733.3 | 020538 | 03.3222-7501.3 | 020086 |
| 11.9601-9745.2   | 220653   | 11.9601-9711.2   | 220873  | 24.3222-1733.3 | 020538 | 03.3222-7501.3 | 020086 |
| 13.2571-8015.2   | 210125   | 13.9571-0041-2   | 210259  | 24.3331-1701.5 | 240543 | 24.3331-1701.7 | 220611 |
| 13.2571-8016.2   | 210126   | 13.9571-0042-2   | 210260  | 24.3331-1702.5 | 240544 | 24.3331-1702.7 | 220612 |
| 13.4421-8003.2   | 210197   | 24.9442-8003-5   | 230053  | 24.3341-9991.5 | 240511 | 11.9341-9991.2 | 220407 |
| 13.4441-8016.3   | 210202   | 13.4441-8016.2   | 210264  | 24.3341-9992.5 | 240512 | 11.9341-9992.2 | 220408 |
| 13.4441-8017.3   | 210203   | 13.4441-8017.2   | 210265  | 24.3541-1632.5 | 240414 | 24.3541-1632.7 | 220326 |
| 24.3331-1701.7   | 220611   | 24.3331-1701.5   | 240543  | 24.3541-1811.5 | 240429 | 24.3541-1811.7 | 220623 |
| 24.3331-1702.7   | 220612   | 24.3331-1702.5   | 240544  | 24.3541-1812.5 | 240430 | 24.3541-1812.7 | 220624 |
| 24.3541-1632.7   | 220326   | 24.3541-1632.5   | 240414  | 24.3541-8086.5 | 240526 | 11.3541-8086.2 | 220288 |
| 24.3541-1811.7   | 220623   | 24.3541-1811.5   | 240429  | 24.5112-0402.3 | 331297 | 83.7101-9402.3 | 330897 |
| 24.3541-1812.7   | 220624   | 24.3541-1812.5   | 240430  | 24.5123-0380.3 | 331256 | 83.6115-0380.3 | 330539 |
| 24.3727-0225.2   | 580225   | 24-3727-0247-2   | 580247  | 24.5141-0473.3 | 331303 | 83.7769-0470.3 | 330869 |
| 24.5112-0409.3   | 330652   | 83.6401-0413.3   | 330748  | 24.5164-0315.3 | 331209 | 83.6230-0316.3 | 330328 |
| 83.6115-0380.3   | 330539   | 24.5123-0380.3   | 331256  | 24.5164-0316.3 | 331210 | 83.6241-0316.3 | 330563 |
| 83.6117-0320.3   | 330601   | 24.5166-0325.3   | 331293  | 24.5164-0317.3 | 331211 | 83.6241-0315.3 | 330562 |
| 83.6201-0240.3   | 330293   | 24.5224-0240.3   | 331260  | 24.5165-0350.3 | 331257 | 83.7701-0350.3 | 330840 |
| 83.6201-0300.3   | 330295   | 24.5224-0295.3   | 331261  | 24.5165-0425.3 | 331258 | 83.7701-0410.3 | 330850 |
| 83.6201-0331.3   | 330913   | 24.5224-0330.3   | 331263  | 24.5165-0450.3 | 331259 | 83.7701-0450.3 | 330841 |
| 83.6205-0300.3   | 330316   | 24.5225-0300.3   | 331266  | 24.5166-0325.3 | 331293 | 83.6117-0320.3 | 330601 |
| 83.6210-0220.3   | 330317   | 24.5201-0220.3   | 331272  | 24.5201-0220.3 | 331272 | 83.6210-0220.3 | 330317 |
| 83.6212-0400.3   | 330865   | 83.78120-400.3   | 331214  | 24.5224-0240.3 | 331260 | 83.6201-0240.3 | 330293 |
| 83.6221-0460.3   | 330326   | 24.5224-0460.3   | 331264  | 24.5224-0295.3 | 331261 | 83.6201-0300.3 | 330295 |
| 83.6230-0316.3   | 330328   | 24.5164-0315.3   | 331209  | 24.5224-0299.3 | 331262 | 83.7821-0300.3 | 330855 |
| 83.6241-0315.3   | 330562   | 24.5164-0317.3   | 331211  | 24.5224-0330.3 | 331263 | 83.6201-0331.3 | 330913 |
| 83.6241-0316.3   | 330563   | 24.5164-0316.3   | 331210  | 24.5224-0460.3 | 331264 | 83.6221-0460.3 | 330326 |
| 83.6314-0276.3   | 330356   | 24.5303-0275.3   | 331213  | 24.5225-0300.3 | 331266 | 83.6205-0300.3 | 330316 |
| 83.7101-9402.3   | 330897   | 24.5112-0402.3   | 331297  | 24.5237-0360.3 | 331212 | 83.7855-0362.3 | 331108 |
| 83.7701-0350.3   | 330840   | 24.5165-0350.3   | 331257  | 24.5303-0275.3 | 331213 | 83.6314-0276.3 | 330356 |
| 83.7701-0410.3   | 330850   | 24.5165-0425.3   | 331258  | 24.5901-0225.3 | 331288 | 03.5808-0225.3 | 330034 |
| 83.7701-0450.3   | 330841   | 24.5165-0450.3   | 331259  | 24-3727-0247-2 | 580247 | 24.3727-0225.2 | 580225 |
| 83.7769-0470.3   | 330869   | 24.5141-0473.3   | 331303  | 24-9442-8003-5 | 230053 | 13.4421-8003.2 | 210197 |
| 83.7821-0300.3   | 330855   | 24.5224-0299.3   | 331262  | 83.6401-0413.3 | 330748 | 24.5112-0409.3 | 330652 |
| 83.7855-0362.3   | 331108   | 24.5237-0360.3   | 331212  | 83.78120-400.3 | 331214 | 83.6212-0400.3 | 330865 |



- 
- ① Fahrzeugregister
  - ② Index of vehicles
  - ③ Liste des véhicules
  - ④ Indice autovetture
  - ⑤ Índice de vehículos
  - ⑥ Voertuigregister
  - ⑦ Køretøjsregister
  - ⑧ Fordonsregister
  - ⑨ Járműlista
  - ⑩ Registo automóvel
  - ⑪ Перечень автомобилей
  - ⑫ Rejstřík vozidel
  - ⑬ Indeks pojazdów
  - ⑭ Κατάλογος οχημάτων
  - ⑮ Araç kaydı
  - ⑯ 汽耿登瑞翻
  - ⑰ 然兩索引
  - ⑱ سجل العربة



**ALFA ROMEO**

|                  |    |
|------------------|----|
| 145 (94-01)      | 34 |
| 146 (94-01)      | 35 |
| 147 (01-10)      | 36 |
| 155 (92-97)      | 37 |
| 156 (97-05)      | 37 |
| 159 (05-11)      | 38 |
| 164 (92-98)      | 39 |
| 166 (98-07)      | 39 |
| BRERA (06-11)    | 40 |
| GIULIETTA (10- ) | 40 |
| GT (04-10)       | 41 |
| GTV (95-05)      | 41 |
| MITO (08- )      | 41 |
| SPIDER (95-05)   | 42 |
| SPIDER (06-11)   | 42 |

**AUDI**

|                               |    |
|-------------------------------|----|
| 80 (91-95)                    | 43 |
| 80 Quattro (92-95)            | 44 |
| 100 (91-94)                   | 45 |
| 100 Quattro (91-94)           | 47 |
| A1 / A1 Sportback (10- )      | 47 |
| A2 (00-05)                    | 48 |
| A3 (96-03)                    | 49 |
| A3 / A3 Sportback (03-13)     | 51 |
| A3 Cabrio (08-13)             | 57 |
| A3 / A3 Sportback (12- )      | 58 |
| A4 (B5) (95-01)               | 58 |
| A4 (B6/B7) (01-08)            | 62 |
| A4 (B8) Limousine (07- )      | 67 |
| A4 (B8) Avant (08- )          | 69 |
| A4 Allroad (09- )             | 71 |
| A4 Cabrio (02-08)             | 71 |
| A5 / A5 Sportback (07- )      | 74 |
| A5 Cabrio (09- )              | 75 |
| A6 / A6 Avant (4A/C4) (94-97) | 76 |
| A6 / A6 Avant (4B/C5) (97-05) | 78 |
| A6 Allroad (00-05)            | 82 |
| A6 (4F2/C6) Limousine (04-11) | 83 |
| A6 (4F5/C6) Avant (05-11)     | 85 |
| A6 Allroad (06-11)            | 87 |
| A8 (94-02)                    | 88 |
| A8 (03-09)                    | 89 |
| A8 (09- )                     | 89 |
| CABRIO (91-00)                | 90 |
| COUPE (89-96)                 | 91 |
| COUPE Quattro (87-96)         | 92 |
| Q3 (11- )                     | 93 |
| Q5 (08- )                     | 94 |
| Q7 (06- )                     | 94 |
| TT Coupe (98-06)              | 95 |
| TT Roadster (99-06)           | 96 |
| TT Coupe (06- )               | 97 |
| TT Roadster (07- )            | 99 |

**BMW**

|                                      |     |
|--------------------------------------|-----|
| 1er Reihe/E81/E87 Limousine (04-11)  | 100 |
| 1er Reihe/E82 Coupe (07- )           | 102 |
| 1er Reihe/E88 Cabrio (08- )          | 102 |
| 1er Reihe/F20/F21 Limousine (11- )   | 103 |
| 3er Reihe/E36 (91-00)                | 103 |
| 3er Reihe/E46 (98-06)                | 109 |
| 3er Reihe/E90 Limousine (05-12)      | 116 |
| 3er Reihe/E91 Touring (05-12)        | 119 |
| 3er Reihe/E92 Coupe (06-13)          | 122 |
| 3er Reihe/E93 Cabrio (07- )          | 124 |
| 3er Reihe/F30 Limousine (12- )       | 125 |
| 3er Reihe/F31 Touring (12- )         | 125 |
| 3er Reihe/F34 GT (13- )              | 126 |
| 4er Reihe/F32 Coupe (13- )           | 126 |
| 5er Reihe/E34 (88-96)                | 126 |
| 5er Reihe/E39 (96-03)                | 129 |
| 5er Reihe/E60 Limousine (03-10)      | 132 |
| 5er Reihe/E61 Touring (04-10)        | 135 |
| 5er Reihe/F10 Limousine (10- )       | 137 |
| 5er Reihe/F11 Touring (10- )         | 138 |
| 5er Reihe/F07 GT GRAN TURISMO (09- ) | 138 |
| 6er Reihe/E63 Coupe (04-11)          | 138 |
| 6er Reihe/E64 Cabrio (04-11)         | 139 |
| 6er Reihe/F12 Cabrio (11- )          | 139 |
| 6er Reihe/F13 Coupe (11- )           | 140 |
| 7er Reihe/E32 (86-94)                | 140 |
| 7er Reihe/E38 (93-01)                | 141 |
| 7er Reihe/E65/E66 (02-08)            | 142 |
| 7er Reihe/F01/F02/F03/F04 (08- )     | 143 |
| 8er Reihe/E31 (90-99)                | 144 |
| X1 (09- )                            | 145 |
| X3 (03-10)                           | 146 |
| X5 (00-07)                           | 147 |
| X5 (07-13)                           | 148 |
| X5 (13- )                            | 148 |
| X6 (08- )                            | 149 |
| Z3 (95-02)                           | 149 |
| Z4 Roadster/E85 (03-08)              | 151 |
| Z4 Coupe/E86 (06-08)                 | 152 |
| Z4 Roadster/E89 (09- )               | 152 |
| Z8 (00-03)                           | 152 |

**CHEVROLET**

|                          |     |
|--------------------------|-----|
| AVEO (T200,T250) (04-11) | 153 |
| AVEO (T300) (11- )       | 153 |
| CRUZE (09- )             | 153 |
| KALOS (05-08)            | 154 |
| LANOS (05- )             | 154 |
| MALIBU (V300) (12- )     | 155 |
| MATIZ (05-10)            | 155 |
| ORLANDO (11- )           | 155 |
| SPARK (05-10)            | 155 |
| TRAX (12- )              | 156 |
| VOLT (11- )              | 156 |

**CITROEN**

|                                     |     |
|-------------------------------------|-----|
| AX (86-98)                          | 156 |
| BERLINGO (MF) Kombi (96-08)         | 158 |
| BERLINGO (M_) Kasten (96-08)        | 161 |
| BERLINGO (B9) (08- )                | 162 |
| C1 (05- )                           | 163 |
| C2 (03-09)                          | 163 |
| C3 (02-09)                          | 164 |
| C3 Picasso (09- )                   | 166 |
| C3 Pluriel (03-10)                  | 166 |
| C3 II (09- )                        | 167 |
| C4 I Limousine (LC_) (04-10)        | 167 |
| C4 I Coupe (04-10)                  | 169 |
| C4 I Grand Picasso (06-13)          | 170 |
| C4 I Picasso (07-13)                | 171 |
| C4 II Limousine (B7) (10- )         | 172 |
| C4 II Picasso (13- )                | 172 |
| C4 II Grand Picasso (13- )          | 172 |
| C-ELYSEE (12- )                     | 172 |
| C5 I Limousine (01-04)              | 172 |
| C5 I Kombi (01-04)                  | 173 |
| C5 II Limousine (04-08)             | 173 |
| C5 II Kombi (04-08)                 | 173 |
| C5 III Limousine (X7) (08- )        | 174 |
| C5 III Kombi (X7) (08- )            | 175 |
| C6 (05-12)                          | 177 |
| C8 (02- )                           | 178 |
| C-CROSSER (07-13)                   | 179 |
| DS3 (09- )                          | 179 |
| DS3 Cabrio (13- )                   | 179 |
| DS4 (11- )                          | 179 |
| DS5 (11- )                          | 180 |
| EVASION (94-02)                     | 180 |
| JUMPER Bus (94-02)                  | 181 |
| JUMPER Kasten (94-02)               | 184 |
| JUMPER Pritsche/Fahrgestell (94-02) | 187 |
| JUMPER (02-06)                      | 189 |
| JUMPER (06- )                       | 190 |
| JUMPY Kombi (95-06)                 | 190 |
| JUMPY Kasten (95-06)                | 192 |
| JUMPY Pritsche/Fahrgestell (99-06)  | 193 |
| JUMPY (07- )                        | 193 |
| NEMO (08- )                         | 193 |
| SAXO (96-04)                        | 194 |
| XANTIA (X1) Limousine (93-97)       | 195 |
| XANTIA (X1) Kombi (95-97)           | 196 |
| XANTIA (X2) Limousine (98-03)       | 196 |
| XANTIA (X2) Kombi (98-03)           | 196 |
| XM (Y3) Limousine (89-94)           | 197 |
| XM (Y3) Kombi (91-94)               | 197 |
| XM (Y4) Limousine (94-00)           | 197 |
| XM (Y4) Kombi (94-00)               | 198 |
| XSARA (N1) Limousine (97-05)        | 198 |
| XSARA (N2) Kombi (97-05)            | 200 |
| XSARA (N0) Coupe (97-05)            | 203 |
| XSARA Picasso (N68) (00-10)         | 205 |
| ZX (N2) Limousine (91-97)           | 206 |
| ZX (N2) Kombi (93-98)               | 209 |

**DACIA**

|                                  |     |
|----------------------------------|-----|
| DOKKER (12- )                    | 211 |
| DOKKER Express (12- )            | 211 |
| DUSTER (HS_) (10- )              | 217 |
| LODGY (JS_) (12- )               | 211 |
| LOGAN Express (FS_) (09- )       | 212 |
| LOGAN Limousine (LS_) (04-13)    | 212 |
| LOGAN MCV Kombi (KS_) (07-13)    | 214 |
| LOGAN Pick-up (US_) (08- )       | 215 |
| LOGAN II Limousine (L52_) (12- ) | 215 |
| SANDERO (08-13)                  | 215 |
| SANDERO II (B52_) (12- )         | 216 |

**DAEWOO**

|                |     |
|----------------|-----|
| ARANOS (95-97) | 217 |
| ESPERO (95-99) | 217 |
| KALOS (02-05)  | 217 |
| LANOS (97-02)  | 217 |
| MATIZ (98-05)  | 217 |
| NEXIA (95-97)  | 217 |
| NUBIRA (97-99) | 218 |
| NUBIRA (99-05) | 218 |

**DAIHATSU**

|                 |     |
|-----------------|-----|
| CHARADE (93-01) | 218 |
| CHARADE (11- )  | 218 |
| CUORE (07- )    | 218 |
| MATERIA (06- )  | 218 |
| SIRION (05- )   | 218 |
| TREVIS (06- )   | 218 |

**FIAT**

|                                      |     |
|--------------------------------------|-----|
| 500 (07- )                           | 218 |
| 500C Cabrio (09- )                   | 219 |
| 500L Kombi (12- )                    | 220 |
| BARCETTA (95-04)                     | 220 |
| BRAVA (95-01)                        | 220 |
| BRAVO (95-01)                        | 221 |
| BRAVO (07- )                         | 222 |
| CINQUECENTO (92-98)                  | 223 |
| COUPE (94-00)                        | 223 |
| CROMA (91-96)                        | 223 |
| CROMA (05-10)                        | 224 |
| DOBLO (01-10)                        | 224 |
| DOBLO (10- )                         | 226 |
| DUCATO (94-02)                       | 226 |
| DUCATO (02-06)                       | 228 |
| DUCATO (06- )                        | 229 |
| FIORINO (93-01)                      | 229 |
| FIORINO / FIORINO QUBO (08- )        | 230 |
| IDEA (04-12)                         | 230 |
| LINEA (07-11)                        | 231 |
| MAREA (96-02)                        | 231 |
| MULTIPLA (98-08)                     | 232 |
| PALIO / PALIO WEEKEND EUROPA (97-06) | 233 |
| PALIO SW / SIENA (PL) (98-06)        | 233 |
| PANDA (86-02)                        | 233 |
| PANDA (03-13)                        | 234 |
| PANDA SUV (06- )                     | 235 |
| PANDA (12- )                         | 235 |
| PUNTO (93-00)                        | 235 |
| PUNTO (00-03)                        | 236 |
| PUNTO (03-06)                        | 237 |
| PUNTO / PUNTO EVO (09- )             | 237 |
| GRANDE PUNTO (06-11)                 | 238 |
| SCUDO (95-06)                        | 239 |
| SCUDO (07- )                         | 240 |
| SEDICI (06- )                        | 240 |
| SEICENTO (98-08)                     | 241 |
| STILO / STILO Multi Wagon (01-08)    | 241 |
| STRADA / PICK-UP (99- )              | 242 |
| STRADA II (11- )                     | 242 |
| TALENTO (88-94)                      | 242 |
| TEMPRA (93-96)                       | 242 |
| TIPO (93-95)                         | 243 |
| ULYSSE (94-02)                       | 243 |
| ULYSSE (02-11)                       | 244 |

**FORD**

|  |     |
|--|-----|
| C-MAX I (07-10)                          | 245 |
| C-MAX II (10- )                          | 246 |
| GRAND C-MAX (10- )                       | 246 |
| COUGAR (98-00)                           | 247 |
| ESCORT / ORION (91-94)                   | 247 |
| ESCORT VII (95-00)                       | 248 |
| FIESTA III (89-96)                       | 249 |
| FIESTA IV (96-02)                        | 251 |
| FIESTA V (02-08)                         | 253 |
| FIESTA VI (08- )                         | 253 |
| FOCUS I (98-04)                          | 254 |
| FOCUS II (05-11)                         | 255 |
| FOCUS III (11- )                         | 256 |
| FOCUS C-MAX (03-07)                      | 257 |
| FUSION (02-12)                           | 258 |
| GALAXY I (95-06)                         | 258 |
| GALAXY II (06- )                         | 260 |
| KA I (96-08)                             | 261 |
| KA II (08- )                             | 261 |
| KUGA I (08-12)                           | 262 |
| KUGA II (13- )                           | 262 |
| MAVERICK (93-96)                         | 262 |
| MAVERICK (97-98)                         | 262 |
| MAVERICK (01-07)                         | 263 |
| MONDEO I (93-96)                         | 263 |
| MONDEO II (96-00)                        | 264 |
| MONDEO III (00-07)                       | 265 |
| MONDEO IV (07- )                         | 266 |
| PUMA (97-01)                             | 267 |
| RANGER (11- )                            | 268 |
| SCORPIO / GRANADA (GB) (95-98)           | 268 |
| S-MAX (06- )                             | 268 |
| STREET KA (03-06)                        | 269 |
| TOURNEO (94-00)                          | 270 |
| TRANSIT (92-94)                          | 270 |
| TRANSIT (95-00)                          | 272 |
| TRANSIT (00-06)                          | 274 |
| TRANSIT (06- )                           | 274 |
| TRANSIT CONNECT / TOURNEO CONNECT (03- ) | 274 |

**HONDA**

|                |     |
|----------------|-----|
| ACCORD (90-93) | 275 |
|----------------|-----|





**HONDA**

|                               |     |
|-------------------------------|-----|
| ACCORD (98-02)                | 275 |
| ACCORD Limousine (03-08)      | 275 |
| ACCORD Kombi (03-08)          | 275 |
| CITY (08-)                    | 276 |
| CIVIC (3-türig) (91-95)       | 276 |
| CIVIC (4-türig) (91-95)       | 276 |
| CIVIC (3/4-türig) (95-01)     | 276 |
| CIVIC (3-türig) (01-05)       | 276 |
| CIVIC (4-türig) (01-05)       | 276 |
| CIVIC (5-türig) (94-96)       | 276 |
| CIVIC (5-türig) (01-05)       | 276 |
| CIVIC Hatchback (FK/FN) (05-) | 277 |
| CIVIC Stufenheck (FD) (05-)   | 277 |
| CIVIC AERODECK (98-01)        | 277 |
| CIVIC COUPE (94-95)           | 277 |
| CIVIC COUPE (96-01)           | 277 |
| CIVIC COUPE (01-04)           | 277 |
| CONCERTO (90-95)              | 277 |
| CR-V I (97-02)                | 278 |
| CR-V II (02-06)               | 278 |
| CR-V III (07-12)              | 278 |
| CRX (92-98)                   | 278 |
| HR-V (99-05)                  | 278 |
| JAZZ (02-08)                  | 278 |
| JAZZ (08-)                    | 279 |
| LOGO (99-02)                  | 279 |
| PRELUDE (96-00)               | 279 |

**HYUNDAI**

|                         |     |
|-------------------------|-----|
| ACCENT I (94-99)        | 279 |
| ACCENT II (00-05)       | 279 |
| ATOS (98-08)            | 280 |
| ATOS PRIME (99-08)      | 280 |
| COUPE (RD) (96-02)      | 280 |
| ELANTRA (00-06)         | 280 |
| ELANTRA (06-11)         | 281 |
| GALLOPER (98-03)        | 281 |
| GETZ (02-09)            | 281 |
| i10 (08-)               | 282 |
| i30 (07-11)             | 282 |
| i30 CW Kombi (08-12)    | 282 |
| LANTRA/ELANTRA (90-95)  | 282 |
| LANTRA/ELANTRA (95-00)  | 282 |
| LANTRA (00-03)          | 282 |
| MATRIX (01-08)          | 282 |
| PONY/EXCEL (89-94)      | 283 |
| S-COUPE (90-96)         | 283 |
| SANTA FE I (SM) (01-06) | 283 |
| SONATA (93-98)          | 283 |
| TUCSON (04-10)          | 283 |

**ISUZU**

|                   |     |
|-------------------|-----|
| D-MAX (8DH) (02-) | 283 |
|-------------------|-----|

**IVECO**

|                          |     |
|--------------------------|-----|
| DAILY I / GRINTA (78-99) | 283 |
|--------------------------|-----|

**JAGUAR**

|                                |     |
|--------------------------------|-----|
| X-Type (CF1) Limousine (01-09) | 283 |
| X-Type (CF1) Kombi (03-09)     | 284 |
| XJ (X300) (94-97)              | 284 |

**KIA**

|                        |     |
|------------------------|-----|
| CARENS II (02-06)      | 284 |
| CARNIVAL I (99-01)     | 284 |
| CARNIVAL II (01-06)    | 284 |
| CEE'D Limousine (06-)  | 284 |
| CEE'D Kombi (07-)      | 285 |
| MENTOR II (GB) (01-04) | 285 |
| PICANTO (BA) (04-11)   | 285 |
| PRO CEE'D (08-)        | 285 |
| RIO I (DC) (00-05)     | 286 |
| SEDONA I (GB) (99-01)  | 286 |
| SEDONA II (GB) (01-06) | 286 |
| SEPHIA I (93-98)       | 286 |
| SEPHIA II (01-04)      | 286 |
| SHUMA I (97-01)        | 286 |
| SHUMA II (01-04)       | 286 |
| SORENTO (JC) (02-09)   | 286 |
| SPORTAGE (04-10)       | 286 |

**LADA**

|                               |     |
|-------------------------------|-----|
| 110 Stufenheck (2110) (95-07) | 287 |
| 111 Kombi (2111) (95-08)      | 287 |
| 112 Fließheck (2112) (95-08)  | 287 |
| FORMA (2108) (89-95)          | 287 |
| KALINA (1117/1118/1119) (04-) | 287 |
| PRIORA (2170/2172) (08-)      | 287 |
| SAMARA (2108/2109) (86-99)    | 287 |

**LADA**

|                        |     |
|------------------------|-----|
| TOSCANA (2107) (83-96) | 288 |
| NIVA II (2123) (02-)   | 288 |

**LANCIA**

|                 |     |
|-----------------|-----|
| DEDRA (94-99)   | 288 |
| DELTA (94-99)   | 288 |
| DELTA (08-)     | 288 |
| KAPPA (95-01)   | 289 |
| LYBRA (99-05)   | 289 |
| MUSA (04-12)    | 289 |
| PHEDRA (02-10)  | 290 |
| THEMA (92-94)   | 290 |
| Y 10 (85-95)    | 290 |
| Y (96-03)       | 291 |
| YPSILON (03-11) | 291 |
| YPSILON (11-)   | 292 |
| ZETA (94-02)    | 292 |

**LAND ROVER**

|                                |     |
|--------------------------------|-----|
| DISCOVERY I (89-98)            | 293 |
| DISCOVERY II (94-04)           | 293 |
| FREELANDER (LN) (98-06)        | 293 |
| FREELANDER 2 (FA) (07-)        | 293 |
| RANGE ROVER II (LP) (94-02)    | 294 |
| RANGE ROVER III (LM) (02-12)   | 294 |
| RANGE ROVER EVOQUE (SAL) (11-) | 294 |

**LEXUS**

|                |     |
|----------------|-----|
| LX 470 (98-08) | 294 |
|----------------|-----|

**MAZDA**

|   |     |
|---|-----|
| 121 (96-03)                             | 294 |
| 2 (DY) (03-07)                          | 294 |
| 2 (DE) (07-)                            | 295 |
| 3 (BK) (03-09)                          | 295 |
| 3 (BL) (09-)                            | 296 |
| 323 Limousine/323 F (89-94)             | 296 |
| 323 Limousine/323 C/323 F/323 S (94-98) | 296 |
| 323 Limousine/323 F/323 P/323 S (98-03) | 297 |
| 323 Kombi (86-94)                       | 297 |
| 5 (CR) (05-10)                          | 297 |
| 5 (CW) (10-)                            | 297 |
| 6 Limousine (GG) (02-07)                | 298 |
| 6 Kombi (GY) (02-07)                    | 298 |
| 6 (GH) (07-)                            | 298 |
| 626 (91-97)                             | 298 |
| 626 (97-02)                             | 298 |
| 626 Kombi (88-92)                       | 299 |
| 626 Kombi (92-98)                       | 299 |
| 626 Kombi (98-02)                       | 299 |
| DEMIO (98-02)                           | 299 |
| DEMIO (03-)                             | 299 |
| MX-3 (91-98)                            | 299 |
| MX-5 (98-05)                            | 299 |
| MX-6 (91-97)                            | 299 |
| PREMACY (CP) (99-05)                    | 299 |
| PREMACY (CR) (05-10)                    | 300 |
| XEDOS 6 (92-00)                         | 300 |

**MERCEDES BENZ**

|  |     |
|--|-----|
| A-Klasse (W168) (97-04)                | 300 |
| A-Klasse (W169) (04-11)                | 301 |
| B-Klasse (W245) (05-11)                | 302 |
| C-Klasse (W202) Limousine (93-00)      | 303 |
| C-Klasse (S202) Kombi (96-01)          | 306 |
| C-Klasse (W203) Limousine (00-07)      | 308 |
| C-Klasse (S203) Kombi (01-07)          | 310 |
| C-Klasse (CL203) Sportcoupe (01-08)    | 313 |
| C-Klasse (CLC203) Coupe (08-10)        | 314 |
| C-Klasse (W204) Limousine (07-)        | 315 |
| C-Klasse (S204) Kombi (07-)            | 318 |
| C-Klasse (C204) Coupe (11-)            | 320 |
| CL-Klasse (C140) Coupe (96-99)         | 320 |
| CL-Klasse (C215) Coupe (99-06)         | 321 |
| CL-Klasse (C216) Coupe (06-)           | 321 |
| CLK-Klasse (C208) Coupe (97-02)        | 321 |
| CLK-Klasse (A208) Cabrio (98-03)       | 322 |
| CLK-Klasse (C209) Coupe (02-09)        | 323 |
| CLK-Klasse (A209) Cabrio (03-09)       | 325 |
| CLS-Klasse (C219) Coupe (04-10)        | 326 |
| CLS-Klasse (C218) Coupe (10-)          | 326 |
| CLS-Klasse (X218) Shooting Brake (12-) | 327 |
| E-Klasse (W124) Limousine (93-95)      | 327 |
| E-Klasse (S124) Kombi (93-96)          | 329 |
| E-Klasse (C124) Coupe (93-97)          | 330 |
| E-Klasse (A124) Cabrio (93-98)         | 331 |
| E-Klasse (W210) Limousine (95-02)      | 331 |
| E-Klasse (S210) Kombi (96-03)          | 334 |
| E-Klasse (W211) Limousine (02-09)      | 336 |
| E-Klasse (S211) Kombi (03-09)          | 339 |
| E-Klasse (W212) Limousine (09-)        | 341 |

**MERCEDES BENZ**

|   |     |
|---|-----|
| E-Klasse (S212) Kombi (09-)               | 341 |
| E-Klasse (C207) Coupe (09-)               | 342 |
| E-Klasse (A207) Cabrio (10-)              | 344 |
| G-Klasse (W463) (90-)                     | 345 |
| G-Klasse (W463) Cabrio (90-)              | 347 |
| GL-Klasse (X164) (06-12)                  | 348 |
| GLK-Klasse (X204) (08-)                   | 348 |
| M-Klasse (W163) (98-05)                   | 349 |
| M-Klasse (W164) (05-11)                   | 349 |
| R-Klasse (W251,V251) (06-12)              | 350 |
| S-Klasse (W140) (91-93)                   | 350 |
| S-Klasse (W140) (93-98)                   | 351 |
| S-Klasse (W220) (98-06)                   | 353 |
| S-Klasse (W221) (06-13)                   | 354 |
| S-Klasse (W222) (13-)                     | 355 |
| SL-Klasse (R129) (93-01)                  | 355 |
| SL-Klasse (R230) (01-11)                  | 356 |
| SLK-Klasse (R170) (96-04)                 | 357 |
| SLK-Klasse (R171) (04-11)                 | 358 |
| SLK-Klasse (R172) (11-)                   | 358 |
| VANEO (BM414) (02-05)                     | 358 |
| V-Klasse (BM638) (96-03)                  | 359 |
| VIANO (BM639) (03-)                       | 359 |
| VITO (BM638) (96-03)                      | 360 |
| VITO (BM639) (03-)                        | 361 |
| Transporter (BM 631) MB 100 D (87-96)     | 362 |
| Transporter (BM 901/902) SPRINTER (95-06) | 362 |
| Transporter (BM 903/904) SPRINTER (95-06) | 364 |
| Transporter (BM 905) SPRINTER (01-06)     | 366 |
| Transporter (BM 906) SPRINTER (06-)       | 366 |
| Transporter VARIO (96-)                   | 368 |

**MG**

|                      |     |
|----------------------|-----|
| ZT Limousine (01-05) | 368 |
| ZT-T Kombi (01-05)   | 368 |

**MINI**

|                      |     |
|----------------------|-----|
| R50/R53 (00-06)      | 368 |
| R52 Cabrio (04-08)   | 369 |
| R55 Clubman (07-)    | 369 |
| R55 Clubvan (12-)    | 370 |
| R56 (06-)            | 370 |
| R57 Cabrio (09-)     | 371 |
| R58 Coupe (11-)      | 372 |
| R59 Roadster (12-)   | 372 |
| R60 Countryman (10-) | 372 |
| R61 Paceman (12-)    | 372 |

**MITSUBISHI**

|  |     |
|--|-----|
| CARISMA (95-06)                          | 372 |
| COLT/LANCER Limousine (88-92)            | 373 |
| COLT/LANCER Limousine (92-96)            | 374 |
| COLT/LANCER Limousine (96-03)            | 374 |
| COLT (04-)                               | 374 |
| COLT CZC Cabriolet (06-08)               | 374 |
| GALANT (4-türig) (87-92)                 | 375 |
| GALANT (5-türig) (88-92)                 | 375 |
| GALANT (92-96)                           | 375 |
| GALANT (96-03)                           | 375 |
| i-MIEV (11-)                             | 375 |
| L 200 (86-96)                            | 375 |
| L 200 (96-06)                            | 375 |
| L 300 (86-94)                            | 375 |
| L 400 (96-02)                            | 375 |
| LANCER Evolution (04-07)                 | 376 |
| LANCER Limousine (03-07)                 | 376 |
| LANCER Kombi (92-96)                     | 376 |
| LANCER Kombi (03-07)                     | 376 |
| OUTLANDER I (03-06)                      | 376 |
| OUTLANDER II (06-)                       | 376 |
| PAJERO (90-00)                           | 376 |
| PAJERO (00-07)                           | 376 |
| PAJERO (07-)                             | 376 |
| PAJERO PININ / SHOGUN PININ (GB) (99-05) | 377 |
| PAJERO SPORT / MONTERO (USA) (98-09)     | 377 |
| SIGMA (90-96)                            | 377 |
| SPACE GEAR (95-00)                       | 377 |
| SPACE RUNNER (91-99)                     | 377 |
| SPACE RUNNER (99-03)                     | 377 |
| SPACE STAR (98-06)                       | 377 |
| SPACE STAR (A05A) (12-)                  | 378 |
| SPACE WAGON (91-98)                      | 378 |
| SPACE WAGON (98-05)                      | 378 |

**NISSAN**

|                              |     |
|------------------------------|-----|
| 100 NX (B13) (90-94)         | 378 |
| ALMERA (N15) (95-00)         | 378 |
| ALMERA (N16) (00-06)         | 379 |
| ALMERA (B10RS) (06-)         | 379 |
| ALMERA TINO (V10M) (00-05)   | 380 |
| INTERSTAR (X70) (02-10)      | 380 |
| KUBISTAR (X76) Kombi (03-09) | 381 |
| MICRA (K11E) (92-02)         | 382 |

**NISSAN**

|   |     |
|---|-----|
| MICRA (K12E) (03-10)                    | 382 |
| MICRA C+C (CK12E) (05-10)               | 383 |
| NAVARA (D40M) (05-)                     | 383 |
| NOTE (E11E) (06-)                       | 383 |
| NP 300 (D40M) (08-)                     | 384 |
| PATHFINDER (R51M) (05-)                 | 384 |
| PRAIRIE (M11) (EUROPA) (88-94)          | 384 |
| PRIMASTAR (X83) Bus (01-)               | 384 |
| PRIMASTAR (X83) Kasten/Pritsche (02-)   | 385 |
| PRIMERA (P10E) Limousine (90-96)        | 386 |
| PRIMERA (P11E) Limousine (96-02)        | 386 |
| PRIMERA (P12E) Limousine (02-08)        | 387 |
| PRIMERA (W10) Kombi (90-98)             | 387 |
| PRIMERA (W11) Kombi (98-02)             | 387 |
| PRIMERA (W12) Kombi (02-08)             | 388 |
| QASHQAI / QASHQAI +2 (J10, JJ10) (07-)  | 388 |
| SERENA/VANETTE CARGO (C23M/963) (92-01) | 389 |
| SUNNY (N14) Limousine (90-95)           | 389 |
| SUNNY (Y10) Kombi (90-00)               | 389 |
| TERRANO II (R20) (93-06)                | 389 |
| VANETTE (C220) (87-95)                  | 390 |
| X-TRAIL (T30) (01-07)                   | 390 |

**OPEL**

|   |     |
|---|-----|
| ADAM / Vauxhall Adam (13-)                                  | 390 |
| AGILA / Vauxhall Agila Mk I (00-07)                         | 391 |
| AGILA / Vauxhall Agila Mk II (08-)                          | 391 |
| AMPERA / Vauxhall Ampera (11-)                              | 391 |
| ARENA / Vauxhall Arena (97-01)                              | 391 |
| ASTRA F / Vauxhall Astra MKIII (91-01)                      | 391 |
| ASTRA G / Vauxhall Astra MKIV (98-04)                       | 394 |
| ASTRA H / GTC / Vauxhall Astra Mk V (04-10)                 | 397 |
| ASTRA H Caravan/Vau. Astra MKV Estate (04-10)               | 400 |
| ASTRA H TwinTop (06-10)                                     | 402 |
| ASTRA J / GTC / Vauxhall Astra MK VI (09-)                  | 403 |
| ASTRA J Sports Tourer/Vau. Astra Sports Tourer (10-)        | 404 |
| CALIBRA / Vauxhall Calibra (89-97)                          | 405 |
| CAMPO (91-96)   | 406 |
| CAMPO (97-01)   | 406 |
| CASCADA / Vauxhall Cascada (13-)                            | 406 |
| COMBO / Vauxhall Combo (01-11)                              | 406 |
| COMBO D / Vauxhall Combo D (11-)                            | 407 |
| CORSA B / Vauxhall Corsa (93-00)                            | 407 |
| CORSA C / Vauxhall Corsa MK II (00-06)                      | 409 |
| CORSA D / Vauxhall Corsa MK III (06-)                       | 410 |
| FRONTERA A (92-98)  | 411 |
| FRONTERA B (98-04)  | 411 |
| INSIGNIA / Vauxhall Insignia (08-)                          | 411 |
| INSIGNIA Sports Tourer / Vauxh. Insignia SportsTourer (08-) | 412 |
| MERIVA A / Vauxhall Meriva Mk I (03-10)                     | 413 |
| MERIVA B / Vauxhall Meriva Mk II (10-)                      | 414 |
| MOKKA / Vauxhall Mokka (12-)                                | 414 |
| MONTEREY (92-98)  | 414 |
| MONTEREY (98-99)  | 415 |
| MOVANO A (98-10)  | 415 |
| OMEGA B / Vauxhall Omega (94-03)                            | 416 |
| SIGNUM / Vauxhall Signum (03-08)                            | 417 |
| TIGRA / Vauxhall Tigra (94-00)                              | 418 |
| TIGRA TWIN TOP / Vau. Tigra Twin Top (04-09)                | 418 |
| VECTRA A / Vauxhall Cavalier (89-95)                        | 419 |
| VECTRA B / Vauxhall Vectra (96-02)                          | 420 |
| VECTRA C (F68, F69)/Vau. Vectra MK II (02-08)               | 423 |
| VECTRA C Caravan (F35) / Vau. MK II (03-08)                 | 425 |
| VIVARO (01-)  | 426 |
| ZAFIRA I / Vauxhall Zafira I (99-05)                        | 428 |
| ZAFIRA II / Vauxhall Zafira II (05-11)                      | 430 |
| ZAFIRA III Tourer / Vauxhall Zafira III Tourer (11-)        | 431 |

**PEUGEOT**

|                                   |     |
|-----------------------------------|-----|
| 106 (91-96)                       | 431 |
| 106 (96-04)                       | 433 |
| 107 (05-)                         | 435 |
| 205 (91-98)                       | 435 |
| 206 Limousine (98-09)             | 437 |
| 206 CC (00-07)                    | 439 |
| 206 SW (02-07)                    | 440 |
| 206 PLUS (09-13)                  | 441 |
| 207 Limousine (06-12)             | 442 |
| 207 CC (07-)                      | 443 |
| 207 SW (07-)                      | 444 |
| 208 (12-)                         | 444 |
| 301 (12-)                         | 445 |
| 306 Limousine (3/5-türig) (93-01) | 445 |
| 306 Limousine (4-türig) (94-01)   | 449 |
| 306 Cabriolet (94-03)             | 451 |
| 306 Kombi (97-02)                 | 452 |
| 307 Limousine (00-07)             | 454 |
| 307 Break (02-08)                 | 455 |
| 307 CC (03-09)                    | 456 |
| 307 SW (02-08)                    | 456 |
| 308 Limousine (07-)               | 457 |
| 308 SW (08-)                      | 457 |
| 308 CC (09-)                      | 458 |
| 308 II (T9) (13-)                 | 458 |
| 309 (85-93)                       | 458 |
| 405 (93-95)                       | 460 |

**PEUGEOT**

|                                     |     |
|-------------------------------------|-----|
| 406 Limousine (95-04)               | 461 |
| 406 Kombi (96-04)                   | 464 |
| 406 Coupe (97-05)                   | 467 |
| 407 Limousine / SW (04-11)          | 467 |
| 407 Coupe (05-11)                   | 469 |
| 505 (79-93)                         | 470 |
| 508 (10-)                           | 472 |
| 508 SW (10-)                        | 472 |
| 605 (90-99)                         | 472 |
| 607 (00-10)                         | 473 |
| 806 (94-02)                         | 474 |
| 807 (02-)                           | 475 |
| 1007 (05-11)                        | 476 |
| 2008 (13-)                          | 477 |
| 3008 (09-)                          | 477 |
| 4007 (07-12)                        | 477 |
| 5008 (09-)                          | 477 |
| BIPPER (08-)                        | 478 |
| BOXER Bus (94-02)                   | 478 |
| BOXER Kasten (94-02)                | 480 |
| BOXER Pritsche/Fahrgestell (94-02)  | 483 |
| BOXER (02-06)                       | 486 |
| BOXER (06-)                         | 486 |
| EXPERT Kombi (95-06)                | 487 |
| EXPERT Kasten (95-06)               | 488 |
| EXPERT Pritsche/Fahrgestell (95-06) | 489 |
| EXPERT / Expert Tepee (07-)         | 490 |
| PARTNER Kombi (96-08)               | 490 |
| PARTNER Kasten (96-08)              | 492 |
| PARTNER Tepee/Kasten (B9) (08-)     | 493 |
| RCZ (10-)                           | 494 |

**PORSCHE**

|                          |     |
|--------------------------|-----|
| 911 CABRIO (964) (89-94) | 494 |
| 911 (993) (93-97)        | 494 |
| 911 TARGA (993) (95-97)  | 494 |
| 911 CABRIO (993) (94-97) | 494 |
| 911 (996) (97-05)        | 495 |
| 911 TARGA (996) (01-05)  | 495 |
| 911 CABRIO (996) (98-05) | 495 |
| 911 COUPE (997) (04-)    | 495 |
| 911 CABRIO (997) (05-)   | 496 |
| 911 TARGA (997) (06-)    | 496 |
| 968 COUPE (91-95)        | 496 |
| 968 CABRIO (91-95)       | 496 |
| BOXSTER (986) (96-04)    | 496 |
| BOXSTER (987) (05-11)    | 497 |
| CAYENNE I (03-10)        | 497 |
| CAYMAN (987C) (05-12)    | 497 |

**PROTON**

|                     |     |
|---------------------|-----|
| PERSONA 400 (94-00) | 498 |
| WIRA (00-05)        | 498 |

**RENAULT**

|  |     |
|--|-----|
| AVANTIME (01-03)                                   | 498 |
| CAPTUR (J87) (13-)                                 | 498 |
| CLIO I Limousine (B/C 57_) (90-98)                 | 498 |
| CLIO I Kasten (S 57_) (91-98)                      | 501 |
| CLIO II Limousine (BB_/CB_) (98-12)                | 502 |
| CLIO II Kasten (SB_) (98-12)                       | 505 |
| CLIO III (BR_/CR_) (05-12)                         | 506 |
| CLIO III Grandtour (KR_) (08-12)                   | 508 |
| CLIO IV (B98_) (12-)                               | 509 |
| CLIO IV Grandtour (K98_) (12-)                     | 510 |
| DOKKER (K67/F67) (12-)                             | 510 |
| DUSTER (HS-) (11-)                                 | 510 |
| ESPACE II (J/S 63_) (91-96)                        | 510 |
| ESPACE III (JE_) (96-02)                           | 511 |
| ESPACE IV (JK_) (02-)                              | 512 |
| EXPRESS/RAPID (F40_) (85-98)                       | 513 |
| FLUENCE (L30_) (10-)                               | 516 |
| KANGOO I (KC_) (98-07)                             | 516 |
| KANGOO II (KW_) (08-)                              | 518 |
| KANGOO Be Bop (KWO_) (09-10)                       | 518 |
| KANGOO Express/Rapid (FC_) (98-07)                 | 518 |
| KANGOO Express/Rapid (FW_) (08-)                   | 520 |
| KOLEOS (HY0_) (08-)                                | 521 |
| LAGUNA I Limousine (B56/556_) (93-00)              | 521 |
| LAGUNA I Grandtour (K56_) (95-00)                  | 523 |
| LAGUNA II Limousine (BG_) (01-07)                  | 525 |
| LAGUNA II Grandtour (KG_) (01-07)                  | 527 |
| LAGUNA III Limousine (BT0/1) (07-)                 | 529 |
| LAGUNA III Coupe (DT0/1) (07-)                     | 530 |
| LAGUNA III Grandtour (KT0/1) (07-)                 | 531 |
| LATITUDE (L70_) (11-13)                            | 532 |
| LOGAN (LS_) (04-13)                                | 532 |
| LOGAN Kombi (KS_) (04-13)                          | 533 |
| LOGAN Express (07-)                                | 533 |
| MASTER I Bus (80-98)                               | 533 |
| MASTER I Kasten (80-98)                            | 534 |
| MASTER I Pritsche/Fahrgestell (80-98)              | 534 |
| MASTER II Bus (JD/ND_) (98-06)                     | 535 |
| MASTER II Kasten (FD_) (98-06)                     | 535 |
| MASTER II Pritsche/Fahrgestell (ED/HD/UD_) (98-06) | 537 |

**RENAULT**

|  |     |
|--|-----|
| MASTER II Bus (JD_) (06-10)                        | 537 |
| MASTER II Kasten (FD_) (06-10)                     | 538 |
| MASTER II Pritsche/Fahrgestell (ED/HD/UD_) (06-10) | 538 |
| MEGANE I Limousine 3/5-türig (BA/SA_) (96-02)      | 538 |
| MEGANE I Classic (LA_) (96-02)                     | 542 |
| MEGANE I Coach (DA_) (95-03)                       | 545 |
| MEGANE I Cabrio (EA_) (96-03)                      | 546 |
| MEGANE I Grandtour (KA_) (98-03)                   | 547 |
| MEGANE II Limousine 3/5-türig (BM/CM_) (02-08)     | 549 |
| MEGANE II Limousine 4-türig (LM_) (03-08)          | 550 |
| MEGANE II Coupe/Cabrio (EM_) (03-10)               | 552 |
| MEGANE II Grandtour (KM_) (03-08)                  | 553 |
| MEGANE III Schrägheck (BZ0_) (08-)                 | 554 |
| MEGANE III CC (EZ0_) (10-)                         | 555 |
| MEGANE III Coupe (DZ0_) (08-)                      | 555 |
| MEGANE III Grandtour (KZ_) (08-)                   | 556 |
| MEGANE SCENIC (JA_) (96-99)                        | 556 |
| MODUS/GRAND MODUS (JP0_) (04-13)                   | 558 |
| R19 (3/5-türig) (B53/C53/S53_) (88-95)             | 559 |
| R19 CHAMADE (L53_) (89-95)                         | 562 |
| R19 Cabriolet (D53_) (91-96)                       | 564 |
| R21 NEVADA (K48_) (86-95)                          | 565 |
| SAFRANE (B54_) (92-00)                             | 568 |
| SANDERO (BS0_) (09-)                               | 569 |
| SCENIC I (JA_) (99-03)                             | 570 |
| SCENIC II (JM_) (03-09)                            | 571 |
| SCENIC III (JZ_) (09-)                             | 572 |
| GRAND SCENIC (JM_) (04-09)                         | 573 |
| GRAND SCENIC (JZ_) (09-)                           | 574 |
| SPIDER (95-99)                                     | 574 |
| THALIA I (LB_) (98-)                               | 574 |
| THALIA II / SYMBOL (LU_) (08-)                     | 575 |
| TRAFIC I Propulsion (PXX) (89-97)                  | 575 |
| TRAFIC I Kasten (TXX) (89-01)                      | 576 |
| TRAFIC I Bus (TXW) (89-01)                         | 577 |
| TRAFIC II (JL/FL/EL) (01-)                         | 578 |
| TWINGO I Limousine (C06_) (93-07)                  | 579 |
| TWINGO II Kasten (S06_) (93-07)                    | 580 |
| TWINGO II (CNO_) (07-)                             | 580 |
| VEL SATIS (BJO_) (02-09)                           | 581 |
| WIND (E4M_) (10-13)                                | 582 |
| ZOE (12-)  | 582 |

**ROVER**

|                           |     |
|---------------------------|-----|
| 25-Serie (RF) (99-)       | 582 |
| 45-Serie (RT) (00-)       | 582 |
| 75-Serie (RJ) (99-04)     | 583 |
| 75 Serie (RX) (04-)       | 583 |
| 200-Serie (XW) (90-95)    | 583 |
| 200 II-Serie (RF) (95-00) | 583 |
| 400-Serie (RT) (95-00)    | 583 |
| MINI (91-95)              | 583 |

**Saab**

|                              |     |
|------------------------------|-----|
| 9-3 (YS3D) (98-02)           | 583 |
| 9-3 Limousine (YS3F) (03-12) | 585 |
| 9-3 SportCombi (05-12)       | 587 |
| 9-3 Cabriolet (YS3D) (98-03) | 588 |
| 9-3 Cabriolet (YS3F) (03-12) | 590 |
| 9-3 X (09-12)                | 591 |
| 9-5 Limousine (YS3E) (97-10) | 592 |
| 9-5 Kombi (YS3E) (98-10)     | 595 |
| 9-5 II (10-12)               | 598 |
| 900 (94-98)                  | 598 |
| 9000 (85-93)                 | 599 |
| 9000 (94-98)                 | 599 |

**SEAT**

|                                 |     |
|---------------------------------|-----|
| ALHAMBRA I (96-10)              | 600 |
| ALHAMBRA II (10-)               | 601 |
| ALTEA (5P1) (04-)               | 602 |
| ALTEA XL (5P5) (06-)            | 604 |
| AROSA (6H) (97-05)              | 606 |
| CORDOBA I (93-99)               | 607 |
| CORDOBA II (6K2) (99-02)        | 610 |
| CORDOBA III (6L2) (02-09)       | 611 |
| EXEO / ST (09-13)               | 612 |
| IBIZA I (85-92)                 | 613 |
| IBIZA II (93-99)                | 613 |
| IBIZA III (6K1) (99-02)         | 616 |
| IBIZA IV (6L1) (02-10)          | 618 |
| IBIZA V / ST / SPORTCOUPE (08-) | 621 |
| INCA (6K9) (96-03)              | 622 |
| LEON I (1M1) (99-05)            | 622 |
| LEON II (1P1) (05-12)           | 626 |
| MALAGA (85-92)                  | 630 |
| MARBELLA (87-98)                | 631 |
| Mii (12-)                       | 631 |
| TERRA (87-96)                   | 631 |
| TOLEDO I (1L) (91-98)           | 631 |
| TOLEDO II (1M2) (98-04)         | 632 |
| TOLEDO III (5P2) (05-09)        | 635 |
| TOLEDO IV (KG3) (12-)           | 636 |



**SKODA**

|                               |     |
|-------------------------------|-----|
| CITIGO (12-)                  | 637 |
| FABIA I (6Y) (99-07)          | 637 |
| FABIA II (5J) (07-)           | 638 |
| FAVORIT (781) (87-95)         | 640 |
| FELICIA I (791/795) (95-97)   | 640 |
| FELICIA II (6U) (98-01)       | 641 |
| FELICIA PICK-UP (797) (97-00) | 641 |
| FORMAN (785) (91-95)          | 642 |
| OCTAVIA I (1U) (97-10)        | 642 |
| OCTAVIA II (1Z) (04-13)       | 645 |
| PICK-UP (93-95)               | 648 |
| RAPID / RAPID Spaceback (12-) | 648 |
| ROOMSTER (5J) (06-)           | 648 |
| SUPERB I (02-08)              | 649 |
| SUPERB II (08-)               | 650 |
| SUPERB Kombi (09-)            | 652 |
| YETI (09-)                    | 653 |

**SMART**

|                                |     |
|--------------------------------|-----|
| CABRIO (BM450) (00-03)         | 654 |
| CITY COUPE (BM450) (98-04)     | 655 |
| CROSSBLADE (BM450) (02-04)     | 656 |
| FORFOUR (BM454) (04-06)        | 656 |
| FORTWO CABRIO (BM450) (04-07)  | 656 |
| FORTWO COUPE (BM450) (04-07)   | 657 |
| FORTWO CABRIO (BM451) (07-)    | 657 |
| FORTWO COUPE (BM451) (07-)     | 657 |
| ROADSTER (BM452) (03-05)       | 657 |
| ROADSTER COUPE (BM452) (03-05) | 658 |

**SUBARU**

|                     |     |
|---------------------|-----|
| FORESTER (97-02)    | 658 |
| FORESTER (02-08)    | 658 |
| JUSTY (95-03)       | 658 |
| JUSTY (G3X) (03-07) | 658 |
| JUSTY (07-)         | 658 |
| TREZIA (11-)        | 658 |

**SUZUKI**

|                      |     |
|----------------------|-----|
| ALTO (93-02)         | 658 |
| ALTO (02-08)         | 658 |
| BALENO (95-02)       | 658 |
| CARRY (99-04)        | 659 |
| GRAND VITARA (98-05) | 659 |
| GRAND VITARA (05-)   | 659 |
| IGNIS I (00-03)      | 659 |
| IGNIS II (03-)       | 659 |
| JIMNY (98-)          | 659 |
| LIANA (01-07)        | 660 |
| SPLASH (08-)         | 660 |
| SWIFT II (89-96)     | 660 |
| SWIFT II (96-04)     | 661 |
| SWIFT III (05-10)    | 661 |
| SX4 (06-)            | 661 |
| VITARA (89-98)       | 662 |
| WAGON R+ (00-)       | 662 |

**TOYOTA**

|                          |     |
|--------------------------|-----|
| AURIS (06-12)            | 662 |
| AVENSIS (97-03)          | 663 |
| AVENSIS (03-09)          | 663 |
| AVENSIS VERSO (01-05)    | 664 |
| AYGO (05-)               | 664 |
| CARINA II (87-92)        | 664 |
| CARINA E (92-97)         | 664 |
| CELICA (89-93)           | 664 |
| CELICA (93-99)           | 664 |
| CELICA (99-05)           | 664 |
| COROLLA (87-92)          | 664 |
| COROLLA (92-97)          | 664 |
| COROLLA (97-02)          | 665 |
| COROLLA (02-04)          | 665 |
| COROLLA (04-06)          | 666 |
| COROLLA (06-)            | 666 |
| COROLLA VERSO (02-04)    | 666 |
| COROLLA VERSO (04-09)    | 666 |
| HIACE (06-)              | 666 |
| HILUX (97-05)            | 667 |
| HILUX (05-)              | 667 |
| IQ (09-)                 | 667 |
| LAND CRUISER 100 (98-08) | 667 |
| PASEO (95-99)            | 667 |
| PICNIC (96-01)           | 667 |
| PREVIA (00-05)           | 667 |
| PRIUS (03-09)            | 667 |
| RAV4 I (94-00)           | 667 |
| RAV4 II (00-05)          | 667 |
| STARLET (96-99)          | 667 |
| VERSO (09-)              | 668 |
| VERSO S (10-)            | 668 |
| YARIS (99-05)            | 668 |
| YARIS (06-)              | 668 |
| YARIS (11-)              | 669 |

**TOYOTA**

|                     |     |
|---------------------|-----|
| YARIS VERSO (99-05) | 669 |
|---------------------|-----|

**VOLKSWAGEN**

|  |     |
|--|-----|
| BORA (98-04)                                   | 670 |
| CADDY II (96-03)                               | 676 |
| CADDY III (04-)                                | 677 |
| CADDY Pickup (97-02)                           | 679 |
| CC COUPE (11-)                                 | 679 |
| CRAFTER (06-)                                  | 680 |
| EOS (06-)                                      | 680 |
| FOX (05-)                                      | 683 |
| GOLF II (84-93)                                | 683 |
| GOLF III (92-97)                               | 686 |
| GOLF III Variant (93-99)                       | 690 |
| GOLF III Cabriolet (94-02)                     | 693 |
| GOLF IV (98-05)                                | 694 |
| GOLF IV Variant (99-06)                        | 699 |
| GOLF V (03-08)                                 | 703 |
| GOLF V Variant (07-09)                         | 707 |
| GOLF VI (08-)                                  | 708 |
| GOLF VI Variant (09-)                          | 712 |
| GOLF VI Cabriolet (11-)                        | 713 |
| GOLF Plus (05-)                                | 714 |
| JETTA V (05-10)                                | 718 |
| JETTA VI (11-)                                 | 720 |
| LT/LT 4x4 (75-96)                              | 721 |
| LT/LT 4x4 (96-06)                              | 721 |
| LUPU (98-05)                                   | 722 |
| NEW BEETLE (98-10)                             | 724 |
| NEW BEETLE Cabriolet (03-10)                   | 726 |
| BEETLE (11-)                                   | 727 |
| BEETLE Cabriolet (12-)                         | 727 |
| PASSAT (88-93)                                 | 728 |
| PASSAT (94-96)                                 | 730 |
| PASSAT (97-05)                                 | 732 |
| PASSAT Limousine (05-10)                       | 736 |
| PASSAT Variant (05-10)                         | 738 |
| PASSAT CC (08-11)                              | 740 |
| PASSAT / PASSAT VARIANT (10-)                  | 742 |
| PASSAT ALLTRACK (12-)                          | 743 |
| PHAETON (02-)                                  | 743 |
| POLO II (81-94)                                | 744 |
| POLO III (95-01)                               | 745 |
| POLO IV (02-09)                                | 747 |
| POLO V (09-)                                   | 750 |
| POLO Classic (96-01)                           | 752 |
| POLO Variant (97-01)                           | 753 |
| SCIROCCO (08-)                                 | 755 |
| SHARAN I (95-10)                               | 756 |
| SHARAN II (10-)                                | 758 |
| TIGUAN (07-)                                   | 759 |
| TOUAREG I (03-10)                              | 759 |
| TOUAREG II (10-)                               | 761 |
| TOURAN (03-)                                   | 761 |
| TRANSPORTER (T4) (90-03)                       | 763 |
| TRANSPORTER (T5) BUS / MULTIVAN / KASTEN (03-) | 767 |
| TRANSPORTER (T5) PRITSCHKE / FAHRGESTELL (03-) | 771 |
| VENTO (92-98)                                  | 775 |
| up (11-)                                       | 777 |

**VOLVO**

|                              |     |
|------------------------------|-----|
| 440 (88-96)                  | 778 |
| 460 (88-96)                  | 779 |
| 480 (86-96)                  | 781 |
| 850 Limousine (91-96)        | 782 |
| 850 Kombi (92-96)            | 783 |
| 940 I Limousine (90-95)      | 784 |
| 940 I Kombi (90-95)          | 786 |
| 940 II Limousine (95-98)     | 787 |
| 940 II Kombi (95-98)         | 788 |
| 960 I Limousine (90-94)      | 788 |
| 960 I Kombi (90-94)          | 789 |
| 960 II Limousine (94-96)     | 790 |
| 960 II Kombi (94-96)         | 790 |
| C30 Coupe (06-12)            | 790 |
| C70 Coupe (97-02)            | 792 |
| C70 I Cabrio (98-06)         | 792 |
| C70 II Cabrio (06-13)        | 793 |
| S40 I (95-03)                | 794 |
| S40 II (04-12)               | 796 |
| S60 I (00-09)                | 798 |
| S60 II (10-)                 | 800 |
| S70 (97-00)                  | 801 |
| S80 I (98-06)                | 804 |
| S80 II (06-)                 | 806 |
| S90 (97-98)                  | 809 |
| V40 (95-04)                  | 809 |
| V40 (12-)                    | 811 |
| V50 (04-12)                  | 811 |
| V60 (10-)                    | 813 |
| V70 I (97-00)                | 814 |
| V70 II (00-07)               | 817 |
| V70 III (07-)                | 820 |
| V90 (97-98)                  | 823 |
| XC60 (08-)                   | 823 |
| XC70 I CROSS COUNTRY (00-07) | 824 |
| XC70 II CROSS COUNTRY (07-)  | 824 |

**VOLVO**

















|            |     |
|------------|-----|
| XC90 (02-) | 826 |
|------------|-----|







- ① Fahrzeugverwendungen
- ② Applications of vehicles
- ③ Applications
- ④ Applicazioni autoveicoli
- ⑤ Aplicaciones
- ⑥ Voertuigtoepassingen
- ⑦ Køretøjsanvendelser
- ⑧ Fordonsanvändningar
- ⑨ J arm alkalmaz sok
- ⑩ Utiliza  es do ve culo
- ⑪  rimeneni  v avtomobilyah
- ⑫ Pou it  vozidel
- ⑬ Zastosowania pojazd w
- ⑭  r seis o h  twn
- ⑮ Ara  kullanımları
- ⑯       
- ⑰         
- ⑱           

|     |    |  |    |  |   |    |    |    |
|--|--|--|--|--|--|--|--|--|
| <b>ALFA ROMEO 145 (94-01)</b>  |  |  |  |  |  |  |  |  |
|    | 1.4 i.e. 66<br>1.4 i.e. T.Spark 76<br>1.6 i.e. 76<br>1.6 i.e. T.Spark 76<br>1.7 i.e. 16V 76<br>1.8 i.e. T.Spark 76<br>1.9 JTD 77<br>2.0 i.e. 16V 76<br>2.0 TD 66   |  | 07.94 12.96<br>01.97 02.01<br>07.94 12.96<br>01.97 02.01<br>07.94 12.96<br>01.97 02.01<br>02.99 02.01<br>10.95 02.01<br>07.94 02.99  |  | 24.2122-1716.3 010485  |  |  | THz 22,20  |
|    | 1.4 i.e. T.Spark 76<br>1.6 i.e. T.Spark 76<br>1.9 JTD 77<br>2.0 TD 66<br>1.8 i.e. T.Spark 76<br>2.0 i.e. 16V 66  |  | 01.97 02.01<br>01.97 02.01<br>02.99 02.01<br>01.97 02.99<br>01.97 02.01<br>10.95 02.01   |  | 24.3541-1789.5 240291<br>24.3541-1790.5 240292<br>24.3541-1791.5 240293<br>24.3541-1792.5 240294<br>24.3541-1791.5 240293<br>24.3541-1792.5 240294 | <input type="checkbox"/><br><input type="checkbox"/><br><input type="checkbox"/><br><input type="checkbox"/><br><input type="checkbox"/><br><input type="checkbox"/>   |  | D=54, - Halter ATE<br>D=54, - Halter ATE<br>D=54, - Halter ATE<br>D=54, - Halter ATE<br>D=54, - Halter ATE<br>D=54, - Halter ATE |
|    | 1.4 i.e. 66<br>1.4 i.e. T.Spark 76<br>1.6 i.e. 76<br>1.6 i.e. T.Spark 76<br>1.7 i.e. 16V 76<br>1.8 i.e. T.Spark 76<br>1.9 JTD 77<br>2.0 i.e. 16V 76<br>2.0 TD 66<br>1.4 i.e. T.Spark 76<br>1.6 i.e. T.Spark 76<br>1.8 i.e. T.Spark 76<br>1.9 JTD 77<br>2.0 i.e. 16V 76               |  | 07.94 12.96<br>01.97 04.99<br>07.94 12.96<br>01.97 04.99<br>07.94 12.96<br>01.97 04.99<br>02.99 04.99<br>10.95 04.99<br>07.94 02.99<br>05.99 02.01<br>05.99 02.01<br>05.99 02.01<br>05.99 02.01<br>05.99 02.01   |  | 24.5112-0388.3 330518<br>24.5112-0387.3 330519   | 2<br>2   |  | L=385<br>L=387   |
|    | 1.4 i.e. 66<br>1.6 i.e. 76<br>1.7 i.e. 16V 76<br>2.0 TD 66<br>1.4 i.e. T.Spark 76<br>1.6 i.e. T.Spark 76<br>1.8 i.e. T.Spark 76<br>1.9 JTD 77<br>2.0 i.e. 16V 76   |  | 07.94 12.96 + ABS<br>07.94 12.96 + ABS<br>07.94 12.96<br>07.94 02.99 + ABS<br>01.97 02.01 + ABS<br>01.97 02.01 + ABS<br>01.97 02.01<br>02.99 02.01 + ABS<br>10.95 02.01  |  | 24.3344-1715.5 240327<br>24.3344-1716.5 240328<br>24.3344-1703.5 240117<br>24.3344-1704.5 240118<br>24.3344-1715.5 240327<br>24.3344-1716.5 240328 | <input type="checkbox"/><br><input type="checkbox"/><br><input type="checkbox"/><br><input type="checkbox"/><br><input type="checkbox"/><br><input type="checkbox"/><br><input type="checkbox"/><br><input type="checkbox"/><br><input type="checkbox"/>   | D=34, - Halter LUC<br>D=34, - Halter LUC<br>D=34, - Halter LUC<br>D=34, - Halter LUC<br>D=34, - Halter LUC<br>D=34, - Halter LUC |  |
|  | 1.4 i.e. 66<br>1.4 i.e. T.Spark 76<br>1.6 i.e. 76<br>1.6 i.e. T.Spark 76<br>1.7 i.e. 16V 76<br>1.8 i.e. T.Spark 76<br>1.9 JTD 77<br>2.0 i.e. 16V 76<br>2.0 TD 66   |  | 07.94 12.96<br>01.97 02.01<br>07.94 12.96<br>01.97 02.01<br>07.94 12.96<br>01.97 02.01<br>02.99 02.01<br>10.95 02.01<br>07.94 02.99  |  | 24.5112-0160.3 330612<br>83.6401-0159.3 330746   | 2<br>2   |  | L=160<br>L=160   |
|  | 1.4 i.e. 66<br>1.6 i.e. 76<br>2.0 TD 66<br>1.4 i.e. T.Spark 76<br>1.6 i.e. T.Spark 76<br>1.9 JTD 77<br>2.0 TD 66   |  | 07.94 12.96 - ABS<br>07.94 12.96 - ABS<br>07.94 12.96 - ABS<br>01.97 02.01 - ABS<br>01.97 02.01 - ABS<br>02.99 02.01 - ABS<br>01.97 02.99 - ABS  |  | 24.3220-1116.3 020313<br>24.3222-1707.3 020104   |  |  | Rz 20,64<br>Rz 22,20 BDX   |
|  | 1.4 i.e. 66<br>1.6 i.e. 76<br>2.0 TD 66<br>1.4 i.e. T.Spark 76<br>1.6 i.e. T.Spark 76<br>1.9 JTD 77<br>2.0 TD 66<br>1.4 i.e. 66<br>1.4 i.e. T.Spark 76<br>1.6 i.e. 76<br>1.6 i.e. T.Spark 76<br>1.7 i.e. 16V 76<br>1.8 i.e. T.Spark 76<br>1.9 JTD 77<br>2.0 i.e. 16V 76<br>2.0 TD 66 |  | 07.94 12.96 - ABS<br>07.94 12.96 - ABS<br>07.94 12.96 - ABS<br>01.97 02.01 - ABS<br>01.97 02.01 - ABS<br>02.99 02.01 - ABS<br>01.97 02.99 - ABS<br>07.94 12.96 + ABS<br>01.97 02.01 + ABS<br>07.94 12.96 + ABS<br>01.97 02.01 + ABS<br>07.94 12.96<br>01.97 02.01<br>02.99 02.01 + ABS<br>10.95 02.01<br>01.97 02.99 + ABS |  | 24.3727-0008.2 580008<br>24.3727-0521.2 580521<br>24.3727-0540.2 580540<br>24.3727-0521.2 580521<br>24.3727-0006.2 580006                          | <input type="checkbox"/><br><input type="checkbox"/><br><input type="checkbox"/><br><input type="checkbox"/><br><input type="checkbox"/><br><input type="checkbox"/><br><input type="checkbox"/><br><input type="checkbox"/><br><input type="checkbox"/><br><input type="checkbox"/><br><input type="checkbox"/><br><input type="checkbox"/><br><input type="checkbox"/><br><input type="checkbox"/><br><input type="checkbox"/><br><input type="checkbox"/> | L=1461<br>L=1517<br>L=1383<br>L=1517<br>L=1460   |  |
|  | 1.4 i.e. 66<br>1.4 i.e. T.Spark 76<br>1.6 i.e. 76<br>1.6 i.e. T.Spark 76<br>1.7 i.e. 16V 76<br>1.8 i.e. T.Spark 76<br>1.9 JTD 77<br>2.0 i.e. 16V 76<br>2.0 TD 66   |  | 07.94 12.96<br>01.97 02.01<br>07.94 12.96<br>01.97 02.01<br>07.94 12.96<br>01.97 02.01<br>02.99 02.01<br>10.95 02.01<br>07.94 02.99  |  | 24.6584-1701.3 320173  |  |  | BRL (4)  |

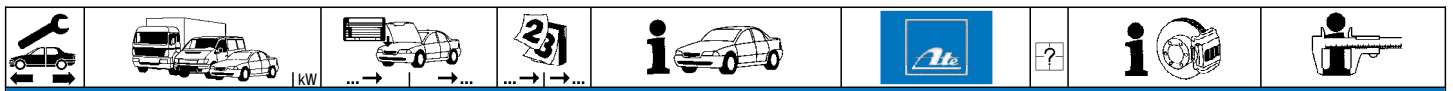

| ALFA ROMEO 145 (94-01) |                  |    |       |       |       |                |        |  |  |          |
|------------------------|------------------|----|-------|-------|-------|----------------|--------|--|--|----------|
|                        | 1.4 i.e.         | 66 |       | 07.94 | 08.95 | 24.2419-1720.3 | 030101 |  |  | Gz 19,05 |
|                        | 1.6 i.e.         | 76 |       | 07.94 | 08.95 |                |        |  |  |          |
|                        | 1.7 i.e. 16V     |    |       | 07.94 | 08.95 |                |        |  |  |          |
|                        | 1.4 i.e. T.Spark | 76 |       | 01.97 | 02.01 | 24.2419-1721.3 | 030100 |  |  | Gz 19,05 |
|                        | 1.6 i.e. T.Spark |    |       | 01.97 | 02.01 |                |        |  |  |          |
|                        | 1.8 i.e. T.Spark |    |       | 01.97 | 02.01 |                |        |  |  |          |
|                        | 1.9 JTD          | 77 |       | 02.99 | 02.01 |                |        |  |  |          |
|                        | 2.0 i.e. 16V     |    |       | 10.95 | 02.01 |                |        |  |  |          |
|                        | 2.0 TD           | 66 |       | 07.94 | 02.99 |                |        |  |  |          |
|                        | 1.4 i.e.         | 66 |       | 07.94 | 12.96 |                |        |  |  |          |
| 1.6 i.e.               | 76               |    | 07.94 | 12.96 |       |                |        |  |  |          |
| 1.7 i.e. 16V           |                  |    | 07.94 | 12.96 |       |                |        |  |  |          |
| 1.9 JTD                | 77               |    | 02.99 | 02.01 |       |                |        |  |  |          |
|                        | 1.4 i.e. T.Spark | 76 |       | 01.97 | 02.01 | 24.2525-1705.3 | 040083 |  |  | Nz 25,40 |
|                        | 1.6 i.e. T.Spark |    |       | 01.97 | 02.01 |                |        |  |  |          |
|                        | 1.8 i.e. T.Spark |    |       | 01.97 | 02.01 |                |        |  |  |          |
|                        | 2.0 i.e. 16V     |    |       | 10.95 | 02.01 |                |        |  |  |          |
|                        | 2.0 TD           | 66 |       | 07.94 | 02.99 |                |        |  |  |          |

| ALFA ROMEO 146 (94-01) |                  |                  |       |       |                |                |                                     |                                     |                |                |                |                |                                     |                                     |        |                |        |
|------------------------|------------------|------------------|-------|-------|----------------|----------------|-------------------------------------|-------------------------------------|----------------|----------------|----------------|----------------|-------------------------------------|-------------------------------------|--------|----------------|--------|
|                        | 1.4 i.e.         | 66               |       | 12.94 | 12.96          | 24.2122-1716.3 | 010485                              |                                     |                | THz 22,20      |                |                |                                     |                                     |        |                |        |
|                        | 1.4 i.e. T.Spark | 76               |       | 01.97 | 02.01          |                |                                     |                                     |                |                |                |                |                                     |                                     |        |                |        |
|                        | 1.6 i.e.         | 76               |       | 12.94 | 12.96          |                |                                     |                                     |                |                |                |                |                                     |                                     |        |                |        |
|                        | 1.6 i.e. T.Spark |                  |       | 01.97 | 02.01          |                |                                     |                                     |                |                |                |                |                                     |                                     |        |                |        |
|                        | 1.7 i.e. 16V     |                  |       | 12.94 | 12.96          |                |                                     |                                     |                |                |                |                |                                     |                                     |        |                |        |
|                        | 1.8 i.e. T.Spark |                  |       | 01.97 | 02.01          |                |                                     |                                     |                |                |                |                |                                     |                                     |        |                |        |
|                        | 1.9 JTD          | 77               |       | 02.99 | 02.01          |                |                                     |                                     |                |                |                |                |                                     |                                     |        |                |        |
|                        | 2.0 i.e. 16V     |                  |       | 10.95 | 02.01          |                |                                     |                                     |                |                |                |                |                                     |                                     |        |                |        |
|                        | 2.0 TD           | 66               |       | 12.94 | 02.99          |                |                                     |                                     |                |                |                |                |                                     |                                     |        |                |        |
|                        |                  | 1.4 i.e. T.Spark | 76    |       | 01.97          |                |                                     |                                     |                |                | 02.01          | 24.3541-1789.5 | 240291                              | <input checked="" type="checkbox"/> |        | D=54, - Halter | ATE    |
| 1.6 i.e. T.Spark       |                  |                  |       | 01.97 | 02.01          | 24.3541-1790.5 | 240292                              | <input checked="" type="checkbox"/> |                | D=54, - Halter | ATE            |                |                                     |                                     |        |                |        |
| 1.9 JTD                |                  | 77               |       | 02.99 | 02.01          |                |                                     |                                     |                |                |                |                |                                     |                                     |        |                |        |
| 2.0 TD                 |                  | 66               |       | 07.94 | 02.99          |                |                                     |                                     |                |                |                |                |                                     |                                     |        |                |        |
| 1.8 i.e. T.Spark       |                  |                  |       | 01.97 | 02.01          | 24.3541-1791.5 | 240293                              | <input checked="" type="checkbox"/> |                | D=54, - Halter | ATE            |                |                                     |                                     |        |                |        |
| 2.0 i.e. 16V           |                  |                  | 10.95 | 02.01 | 24.3541-1792.5 | 240294         | <input checked="" type="checkbox"/> |                                     | D=54, - Halter | ATE            |                |                |                                     |                                     |        |                |        |
|                        | 1.4 i.e.         | 66               |       | 12.94 | 12.96          | 24.5112-0388.3 | 330518                              | 2                                   |                | L=385          |                |                |                                     |                                     |        |                |        |
|                        | 1.4 i.e. T.Spark | 76               |       | 01.97 | 04.99          |                |                                     |                                     |                |                |                |                |                                     |                                     |        |                |        |
|                        | 1.6 i.e.         | 76               |       | 12.94 | 12.96          |                |                                     |                                     |                |                |                |                |                                     |                                     |        |                |        |
|                        | 1.6 i.e. T.Spark |                  |       | 01.97 | 04.99          |                |                                     |                                     |                |                |                |                |                                     |                                     |        |                |        |
|                        | 1.7 i.e. 16V     |                  |       | 12.94 | 12.96          |                |                                     |                                     |                |                |                |                |                                     |                                     |        |                |        |
|                        | 1.8 i.e. T.Spark |                  |       | 01.97 | 04.99          |                |                                     |                                     |                |                |                |                |                                     |                                     |        |                |        |
|                        | 1.9 JTD          | 77               |       | 02.99 | 04.99          |                |                                     |                                     |                |                |                |                |                                     |                                     |        |                |        |
|                        | 2.0 i.e. 16V     |                  |       | 10.95 | 04.99          |                |                                     |                                     |                |                |                |                |                                     |                                     |        |                |        |
|                        | 2.0 TD           | 66               |       | 12.94 | 02.99          |                |                                     |                                     |                |                |                |                |                                     |                                     |        |                |        |
|                        | 1.4 i.e. T.Spark | 76               |       | 05.99 | 02.01          |                |                                     |                                     |                |                | 24.5112-0387.3 | 330519         | 2                                   |                                     | L=387  |                |        |
| 1.6 i.e. T.Spark       |                  |                  | 05.99 | 02.01 |                |                |                                     |                                     |                |                |                |                |                                     |                                     |        |                |        |
| 1.8 i.e. T.Spark       |                  |                  | 05.99 | 02.01 |                |                |                                     |                                     |                |                |                |                |                                     |                                     |        |                |        |
| 1.9 JTD                | 77               |                  | 05.99 | 02.01 |                |                |                                     |                                     |                |                |                |                |                                     |                                     |        |                |        |
| 2.0 i.e. 16V           |                  |                  | 05.99 | 02.01 |                |                |                                     |                                     |                |                |                |                |                                     |                                     |        |                |        |
|                        | 1.4 i.e.         | 66               |       | 07.94 | 12.96          | 24.3344-1715.5 | 240327                              | <input checked="" type="checkbox"/> |                | D=34, - Halter | LUC            |                |                                     |                                     |        |                |        |
|                        | 1.6 i.e.         | 76               |       | 07.94 | 12.96          |                |                                     |                                     |                |                |                | 24.3344-1716.5 | 240328                              | <input checked="" type="checkbox"/> |        | D=34, - Halter | LUC    |
|                        | 1.7 i.e. 16V     |                  |       | 07.94 | 12.96          |                |                                     |                                     |                |                |                |                |                                     |                                     |        |                |        |
|                        | 2.0 TD           | 66               |       | 07.94 | 02.99          |                |                                     |                                     |                |                |                | 24.3344-1704.5 | 240118                              | <input checked="" type="checkbox"/> |        | D=34, - Halter | LUC    |
|                        | 1.4 i.e. T.Spark | 76               |       | 01.97 | 02.01          | 24.3344-1715.5 | 240327                              | <input checked="" type="checkbox"/> |                | D=34, - Halter | LUC            |                |                                     |                                     |        |                |        |
|                        | 1.6 i.e. T.Spark |                  |       | 01.97 | 02.01          |                |                                     |                                     |                |                |                | 24.3344-1716.5 | 240328                              | <input checked="" type="checkbox"/> |        | D=34, - Halter | LUC    |
|                        | 1.8 i.e. T.Spark |                  |       | 01.97 | 02.01          |                |                                     |                                     |                |                |                |                |                                     |                                     |        |                |        |
|                        | 1.9 JTD          | 77               |       | 02.99 | 02.01          |                |                                     |                                     |                |                |                |                |                                     |                                     |        |                |        |
|                        | 2.0 i.e. 16V     |                  |       | 10.95 | 02.01          |                |                                     |                                     |                |                |                |                |                                     |                                     |        |                |        |
|                        |                  | 1.4 i.e.         | 66    |       | 12.94          | 12.96          | 24.5112-0160.3                      | 330612                              | 2              |                | L=160          |                |                                     |                                     |        |                |        |
| 1.4 i.e. T.Spark       |                  | 76               |       | 01.97 | 02.01          |                |                                     |                                     |                |                |                |                |                                     |                                     |        |                |        |
| 1.6 i.e.               |                  | 76               |       | 12.94 | 12.96          |                |                                     |                                     |                |                |                |                |                                     |                                     |        |                |        |
| 1.6 i.e. T.Spark       |                  |                  |       | 01.97 | 02.01          |                |                                     |                                     |                |                |                |                |                                     |                                     |        |                |        |
| 1.7 i.e. 16V           |                  |                  |       | 12.94 | 12.96          |                |                                     |                                     |                |                |                |                |                                     |                                     |        |                |        |
| 1.8 i.e. T.Spark       |                  |                  |       | 01.97 | 02.01          |                |                                     |                                     |                |                |                |                |                                     |                                     |        |                |        |
| 1.9 JTD                |                  | 77               |       | 02.99 | 02.01          |                |                                     |                                     |                |                |                |                |                                     |                                     |        |                |        |
| 2.0 i.e. 16V           |                  |                  |       | 10.95 | 02.01          |                |                                     |                                     |                |                |                |                |                                     |                                     |        |                |        |
| 2.0 TD                 |                  | 66               |       | 12.94 | 02.99          |                |                                     |                                     |                |                |                |                |                                     |                                     |        |                |        |
|                        |                  | 1.4 i.e.         | 66    |       | 12.94          | 12.96          |                                     |                                     |                |                |                | 24.3220-1116.3 | 020313                              |                                     |        | Rz 20,64       |        |
|                        | 1.6 i.e.         | 76               |       | 12.94 | 12.96          |                |                                     |                                     |                |                |                |                |                                     |                                     |        |                |        |
|                        | 2.0 TD           | 66               |       | 12.94 | 12.96          |                |                                     |                                     |                |                |                |                |                                     |                                     |        |                |        |
|                        | 1.4 i.e. T.Spark | 76               |       | 01.97 | 02.01          | 24.3222-1707.3 | 020104                              |                                     |                | Rz 22,20       |                |                |                                     |                                     |        |                |        |
| 1.6 i.e. T.Spark       |                  |                  | 01.97 | 02.01 |                |                |                                     |                                     |                |                |                |                |                                     |                                     |        |                |        |
| 1.9 JTD                | 77               |                  | 02.99 | 02.01 |                |                |                                     |                                     |                |                |                |                |                                     |                                     |        |                |        |
| 2.0 TD                 | 66               |                  | 01.97 | 02.99 |                |                |                                     |                                     |                |                |                |                |                                     |                                     |        |                |        |
|                        | 1.4 i.e.         | 66               |       | 12.94 | 12.96          | 24.3727-0008.2 | 580008                              | <input checked="" type="checkbox"/> |                | L=1461         |                |                |                                     |                                     |        |                |        |
|                        | 1.6 i.e.         | 76               |       | 12.94 | 12.96          |                |                                     |                                     |                |                |                |                |                                     |                                     |        |                |        |
|                        | 2.0 TD           | 66               |       | 12.94 | 12.96          |                |                                     |                                     |                |                |                |                |                                     |                                     |        |                |        |
|                        | 1.4 i.e. T.Spark | 76               |       | 01.97 | 02.01          |                |                                     |                                     |                |                | 24.3727-0521.2 | 580521         | <input checked="" type="checkbox"/> |                                     | L=1517 |                |        |
|                        | 1.6 i.e. T.Spark |                  |       | 01.97 | 02.01          |                |                                     |                                     |                |                |                |                |                                     |                                     |        | 24.3727-0540.2 | 580540 |
|                        | 1.9 JTD          | 77               |       | 02.99 | 02.01          |                |                                     |                                     |                |                |                |                |                                     |                                     |        |                |        |
| 2.0 TD                 | 66               |                  | 01.97 | 02.99 |                |                |                                     |                                     |                |                |                |                |                                     |                                     |        |                |        |
|                        | 1.4 i.e.         | 66               |       | 12.94 | 12.96          | 24.3727-0521.2 | 580521                              | <input checked="" type="checkbox"/> |                | L=1517         |                |                |                                     |                                     |        |                |        |
|                        | 1.4 i.e. T.Spark | 76               |       | 01.97 | 02.01          |                |                                     |                                     |                |                | 24.3727-0006.2 | 580006         | <input checked="" type="checkbox"/> |                                     | L=1460 |                |        |



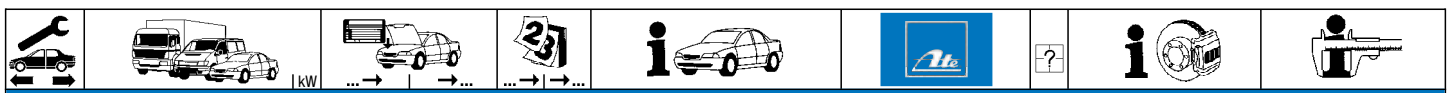

**ALFA ROMEO 146 (94-01)**

|  |   |                            |  |   |   |                |                                  |                  |                          |  |                  |
|--|---|----------------------------|--|---|---|----------------|----------------------------------|------------------|--------------------------|--|------------------|
|  | 1.6 i.e.<br>1.6 i.e. T.Spark<br>1.7 i.e. 16V<br>1.8 i.e. T.Spark  | 76                         |  | 12.94<br>01.97<br>12.94<br>01.97  | 12.96<br>02.01<br>12.96<br>02.01  | + ABS<br>+ ABS | 24.3727-0521.2<br>24.3727-0006.2 | 580521<br>580006 | <input type="checkbox"/> |  | L=1517<br>L=1460 |
|  | 1.9 JTD<br>2.0 i.e. 16V<br>2.0 TD   | 77<br>66                   |  | 02.99<br>10.95<br>01.97   | 02.01<br>02.01<br>02.99   | + ABS<br>+ ABS |                                  |                  |                          |  |                  |
|  | 1.4 i.e.<br>1.4 i.e. T.Spark<br>1.6 i.e.<br>1.6 i.e. T.Spark<br>1.7 i.e. 16V<br>1.8 i.e. T.Spark<br>1.9 JTD<br>2.0 i.e. 16V<br>2.0 TD | 66<br>76<br>76<br>77<br>66 |  | 12.94<br>01.97<br>12.94<br>01.97<br>12.94<br>01.97<br>02.99<br>10.95<br>12.94 | 12.96<br>02.01<br>12.96<br>02.01<br>12.96<br>02.01<br>02.01<br>02.01<br>02.99 |                | 24.6584-1701.3                   | 320173           |                          |  | BRL (4)          |
|  | 1.4 i.e.<br>1.6 i.e.<br>1.7 i.e. 16V  | 66<br>76<br>76             |  | 12.94<br>12.94<br>12.94   | 08.95<br>08.95<br>08.95   |                | 24.2419-1720.3                   | 030101           |                          |  | Gz 19,05         |
|  | 1.4 i.e. T.Spark<br>1.6 i.e. T.Spark<br>1.8 i.e. T.Spark<br>1.9 JTD<br>2.0 i.e. 16V<br>2.0 TD   | 76<br>76<br>77<br>66       |  | 01.97<br>01.97<br>01.97<br>02.99<br>10.95<br>12.94                            | 02.01<br>02.01<br>02.01<br>02.01<br>02.01<br>02.99                            |                | 24.2419-1721.3                   | 030100           |                          |  | Gz 19,05         |
|  | 1.4 i.e.<br>1.6 i.e.<br>1.7 i.e. 16V<br>1.9 JTD   | 66<br>76<br>77             |  | 12.94<br>12.94<br>12.94<br>02.99  | 12.96<br>12.96<br>12.96<br>02.01  |                | 03.2525-2201.3                   | 040026           |                          |  | Nz 25,40         |
|  | 1.4 i.e. T.Spark<br>1.6 i.e. T.Spark<br>1.8 i.e. T.Spark<br>2.0 i.e. 16V<br>2.0 TD  | 76<br>76<br>77<br>66       |  | 01.97<br>01.97<br>01.97<br>10.95<br>12.94                                     | 02.01<br>02.01<br>02.01<br>02.01<br>02.99                                     |                | 24.2525-1705.3                   | 040083           |                          |  | Nz 25,40         |











**ALFA ROMEO 147 (01-10)**

|  |   |  |  |  |  |                |                                  |                  |  |  |                                  |                          |
|--|---|--|--|--|--|----------------|----------------------------------|------------------|--|--|----------------------------------|--------------------------|
|  | 1.6 i 16V T.Spark<br>1.6 i 16V T.Spark<br>1.9 JTD<br>1.9 JTD<br>1.9 JTD<br>1.9 JTD 16V<br>1.9 JTDM 16V<br>1.9 JTDM 8V<br>2.0 i 16V T.Spark            | 77<br>88<br>74<br>81<br>85<br>88<br>88<br>110        |  | 01.01<br>01.01<br>06.03<br>11.00<br>01.01<br>11.02<br>07.05<br>07.05<br>01.01          | 10.10<br>10.10<br>10.10<br>10.10<br>10.10<br>10.10<br>10.10<br>10.10<br>10.10          |                | 24.2122-1752.3<br>24.4122-1702.3 | 010749<br>010753 |  | - Dynamic Control <sup>1)</sup><br>+ Dynamic Control <sup>2)</sup> | THz 22,20<br>THz 22,20           |                          |
|  | 1.6 i 16V T.Spark<br>1.6 i 16V T.Spark<br>1.9 JTD<br>1.9 JTD<br>1.9 JTD<br>1.9 JTD 16V<br>1.9 JTDM 16V<br>1.9 JTDM 8V<br>2.0 i 16V T.Spark            | 77<br>88<br>74<br>81<br>85<br>88<br>88<br>110        |  | 10.10<br>01.01<br>06.03<br>11.00<br>01.01<br>11.02<br>07.05<br>07.05<br>01.01          | 10.10<br>10.10<br>10.10<br>10.10<br>10.10<br>10.10<br>10.10<br>10.10<br>10.10          | VET: 3021489 - | 24.3541-1793.5<br>24.3541-1794.5 | 240299<br>240300 | <input type="checkbox"/><br><input type="checkbox"/> |  | D=54, - Halter<br>D=54, - Halter | <b>BOS</b><br><b>BOS</b> |
|  | 1.6 i 16V T.Spark<br>1.6 i 16V T.Spark<br>1.9 JTD<br>1.9 JTD<br>1.9 JTD<br>1.9 JTD 16V<br>1.9 JTDM 16V<br>1.9 JTDM 8V<br>2.0 i 16V T.Spark<br>3.2 GTA | 77<br>88<br>74<br>81<br>85<br>88<br>88<br>110<br>184 |  | 01.01<br>01.01<br>06.03<br>11.00<br>01.01<br>11.02<br>07.05<br>07.05<br>01.01<br>02.03 | 10.10<br>10.10<br>10.10<br>10.10<br>10.10<br>10.10<br>10.10<br>10.10<br>10.10<br>10.10 |                | 24.5112-0397.3                   | 330666           | 2  |  | L=396                            |                          |
|  | 1.6 i 16V T.Spark<br>1.6 i 16V T.Spark<br>1.9 JTD<br>1.9 JTD<br>1.9 JTD<br>1.9 JTD 16V<br>1.9 JTDM 16V<br>1.9 JTDM 8V<br>2.0 i 16V T.Spark            | 77<br>88<br>74<br>81<br>85<br>88<br>88<br>110        |  | 01.01<br>01.01<br>06.03<br>11.00<br>01.01<br>11.02<br>07.05<br>07.05<br>01.01          | 10.10<br>10.10<br>10.10<br>10.10<br>10.10<br>10.10<br>10.10<br>10.10<br>10.10          |                | 24.3384-1741.7<br>24.3384-1742.7 | 220599<br>220600 | <input type="checkbox"/><br><input type="checkbox"/> |  | D=38, - Halter<br>D=38, - Halter | <b>LUC</b><br><b>LUC</b> |
|  | 1.6 i 16V T.Spark<br>1.6 i 16V T.Spark<br>1.9 JTD<br>1.9 JTD<br>1.9 JTD<br>1.9 JTD 16V<br>1.9 JTDM 16V<br>1.9 JTDM 8V<br>2.0 i 16V T.Spark<br>3.2 GTA | 77<br>88<br>74<br>81<br>85<br>88<br>88<br>110<br>184 |  | 01.01<br>01.01<br>06.03<br>11.00<br>01.01<br>11.02<br>07.05<br>07.05<br>01.01<br>02.03 | 10.10<br>10.10<br>10.10<br>10.10<br>10.10<br>10.10<br>10.10<br>10.10<br>10.10<br>10.10 |                | 24.5112-0408.3                   | 330667           | 2  |  | L=410                            |                          |

















<sup>1)</sup> - dynamic control / - dynamic control / - dynamic control / - Control dinámico  
<sup>2)</sup> + dynamic control / + dynamic control / + dynamic control / + Control dinámico

























| ALFA ROMEO 147 (01-10)   |   |  |   |  |  |
|--|---|--|---|--|--|
|     | 1.6 i 16V T.Spark 77<br>1.6 i 16V T.Spark 88<br>1.9 JTD 74<br>1.9 JTD 81<br>1.9 JTD 85<br>1.9 JTD 16V<br>1.9 JTDM 16V<br>1.9 JTDM 8V 88<br>2.0 i 16V T.Spark 110<br>3.2 GTA 184                     | 01.01 10.10<br>01.01 10.10<br>06.03 10.10<br>11.00 10.10<br>01.01 10.10<br>11.02 10.10<br>07.05 10.10<br>07.05 10.10<br>01.01 10.10<br>02.03 10.10                               | 24.3727-0011.2 580011<br>24.3727-0010.2 580010                          | <input type="checkbox"/><br><input checked="" type="checkbox"/>  | L=1235<br>L=1170   |
| ALFA ROMEO 155 (92-97)   |   |  |   |  |  |
|    | 1.7 T.S.<br>1.8 T.S.<br>1.9 TD<br>2.0 16V Turbo Q4<br>2.0 T.S.<br>2.5 TD<br>2.5 V6  | 04.93 12.97<br>05.92 12.97<br>03.93 12.97<br>11.92 12.97<br>05.92 12.97<br>03.93 12.97<br>05.92 12.97  | 24.2122-1716.3 010485   |  | Thz 22,20  |
|    | 1.7 T.S.<br>1.8 T.S.<br>1.9 TD<br>2.0 16V Turbo Q4<br>2.0 T.S.<br>2.5 TD<br>2.5 V6  | 04.93 12.97<br>05.92 12.97<br>03.93 12.97<br>11.92 12.97<br>05.92 12.97<br>03.93 12.97<br>05.92 12.97  | 24.3344-1703.5 240117<br>24.3344-1704.5 240118<br>24.0101-3601.2 260044 | <input checked="" type="checkbox"/> + GG-Sättel 1)<br><input checked="" type="checkbox"/> + GG-Sättel 1) | D=34, - Halter LUC<br>D=34, - Halter LUC<br>Einbausatz LUC |
|    | 1.7 T.S.<br>1.8 T.S.<br>1.9 TD<br>2.0 16V Turbo Q4<br>2.0 T.S.<br>2.5 TD<br>2.5 V6  | 04.93 12.97<br>05.92 12.97<br>03.93 12.97<br>11.92 12.97<br>05.92 12.97<br>03.93 12.97<br>05.92 12.97  | 24.5112-0160.3 330612<br>83.6401-0159.3 330746                          | 2<br>2   | L=160<br>L=160   |
|    | 1.7 T.S.<br>1.8 T.S.<br>1.9 TD<br>2.0 T.S.<br>2.5 TD<br>2.5 V6  | 04.93 12.97<br>05.92 12.97<br>03.93 12.97<br>05.92 12.97<br>03.93 12.97<br>05.92 12.97   | 24.3727-0521.2 580521<br>24.3727-0006.2 580006                          | <input type="checkbox"/><br><input checked="" type="checkbox"/>  | L=1517<br>L=1460   |
|   | 1.7 T.S.<br>1.8 T.S.<br>1.9 TD<br>2.0 16V Turbo Q4<br>2.0 T.S.<br>2.5 TD<br>2.5 V6  | 04.93 12.97<br>05.92 12.97<br>03.93 12.97<br>11.92 12.97<br>05.92 12.97<br>03.93 12.97<br>05.92 12.97  | 24.6584-1701.3 320173   |  | BRL (4)  |
|  | 1.7 T.S.<br>1.8 T.S.<br>1.9 TD<br>2.0 16V Turbo Q4<br>2.0 T.S.<br>2.5 TD  | 04.93 12.97<br>05.92 12.97<br>03.93 12.97<br>11.92 12.97<br>05.92 12.97<br>03.93 12.97   | 24.2419-1721.3 030100   |  | Gz 19,05   |
|  | 1.7 T.S.<br>1.8 T.S.<br>1.9 TD<br>2.0 16V Turbo Q4<br>2.0 T.S.<br>2.5 TD  | 04.93 12.97<br>05.92 12.97<br>03.93 12.97<br>11.92 12.97<br>05.92 12.97<br>03.93 12.97   | 24.2525-1705.3 040083   |  | Nz 25,40   |
|  | 2.5 TD  | 03.93 12.97  | 24.2525-1706.3 040088   |  | Nz 25,40   |
| ALFA ROMEO 156 (97-05)   |   |  |   |  |  |
|  | 1.6 i 16V T.Spark<br>1.8 i 16V T.Spark<br>1.9 JTD<br>1.9 JTD 16V 103<br>1.9 JTD 16V 110<br>2.0 16V T.Spark<br>2.0 JTS 122<br>2.4 JTD 100<br>2.4 JTD 103<br>2.4 JTD 110<br>2.4 JTD 129<br>2.5 V6 24V | 10.97 07.05<br>10.97 07.05<br>10.97 07.05<br>11.02 07.05<br>07.04 07.05<br>10.97 07.05<br>03.02 07.05<br>10.97 10.00<br>10.00 07.05<br>03.02 07.05<br>10.03 07.05<br>10.97 07.05 | 24.2120-1735.3 010726<br>24.2122-1749.3 010722                          |  | Thz 20,64<br>Thz 22,20                                     |
|  | 1.6 i 16V T.Spark<br>1.8 i 16V T.Spark<br>1.9 JTD<br>1.9 JTD 16V 103<br>2.0 16V T.Spark<br>2.0 JTS 122<br>2.4 JTD 100<br>2.4 JTD 103<br>2.5 V6 24V  | 10.97 02.01<br>10.97 02.01<br>10.97 02.01<br>11.02 07.05<br>10.97 07.05<br>03.02 07.05<br>10.97 10.00<br>10.00 07.05<br>10.97 07.05  | 11.0101-5407.2 260011<br>24.3541-1793.5 240299<br>24.3541-1794.5 240300 | <input checked="" type="checkbox"/><br><input checked="" type="checkbox"/>                               | Hülsensatz ATE<br>D=54, - Halter BOS<br>D=54, - Halter BOS |
|  | 1.6 i 16V T.Spark<br>1.8 i 16V T.Spark<br>1.9 JTD<br>1.9 JTD 16V 103<br>1.9 JTD 16V 110   | 10.97 07.05<br>10.97 07.05<br>10.97 07.05<br>11.02 07.05<br>07.04 07.05  | 24.5112-0397.3 330666   | 2  | L=396  |

1) + cast iron caliper / + pinza in ghisa / + étriers en fonte grise / + fundición gris-pinza

|     |    |  |  |   |  |  |  |  |                                  |            |
|--|--|--|--|---|---|--|--|--|----------------------------------|------------|
| <b>ALFA ROMEO 156 (97-05)</b>  |  |  |  |   |   |  |  |  |                                  |            |
|    | 2.0 16V T.Spark<br>2.0 JTS<br>2.4 JTD<br>2.4 JTD<br>2.4 JTD<br>2.4 JTD<br>2.5 V6 24V<br>3.2 GTA  | 122<br>100<br>103<br>110<br>129<br>184   |  | 10.97 07.05<br>03.02 07.05<br>10.97 10.00<br>10.00 07.05<br>03.02 07.05<br>10.03 07.05<br>10.97 07.05<br>03.02 07.05  |   | 24.5112-0397.3   | 330666   | 2  | L=396                            |            |
|    | 1.6 i 16V T.Spark<br>1.8 i 16V T.Spark<br>1.9 JTD<br>2.0 16V T.Spark<br>2.4 JTD<br>2.4 JTD<br>2.5 V6 24V   | 100<br>103   |  | 10.97 02.02<br>10.97 02.02<br>10.97 02.02<br>10.97 02.02<br>10.97 10.00<br>10.00 02.02<br>10.97 02.02   |   | 24.3384-1727.7<br>24.3384-1728.7   | 220533<br>220534   | <input type="checkbox"/><br><input type="checkbox"/>                               | D=38, - Halter<br>D=38, - Halter | LUC<br>LUC |
|    | 1.6 i 16V T.Spark<br>1.8 i 16V T.Spark<br>1.9 JTD<br>1.9 JTD 16V<br>2.0 16V T.Spark<br>2.0 JTS<br>2.4 JTD<br>2.4 JTD<br>2.4 JTD<br>2.4 JTD<br>2.5 V6 24V                           | 103<br>122<br>103<br>110<br>129<br>184   |  | 03.02 07.05<br>03.02 07.05<br>03.02 07.05<br>11.02 07.05<br>03.02 07.05<br>03.02 07.05<br>03.02 07.05<br>03.02 07.05<br>10.03 07.05<br>10.97 07.05<br>03.02 07.05                               |   | 24.3384-1741.7<br>24.3384-1742.7   | 220599<br>220600   | <input type="checkbox"/><br><input type="checkbox"/>                               | D=38, - Halter<br>D=38, - Halter | LUC<br>LUC |
|    | 1.6 i 16V T.Spark<br>1.8 i 16V T.Spark<br>1.9 JTD<br>1.9 JTD 16V<br>1.9 JTD 16V<br>2.0 16V T.Spark<br>2.0 JTS<br>2.4 JTD<br>2.4 JTD<br>2.4 JTD<br>2.4 JTD<br>2.5 V6 24V<br>3.2 GTA | 103<br>110<br>122<br>100<br>103<br>110<br>129<br>184                             |  | 10.97 07.05<br>10.97 07.05<br>10.97 07.05<br>11.02 07.05<br>07.04 07.05<br>10.97 07.05<br>03.02 07.05<br>10.97 10.00<br>10.00 07.05<br>03.02 07.05<br>10.03 07.05<br>10.97 07.05<br>03.02 07.05 |   | 24.5112-0437.3   | 330886   | 2  | L=435                            |            |
|   | 1.6 i 16V T.Spark<br>1.8 i 16V T.Spark<br>1.9 JTD<br>1.9 JTD 16V<br>1.9 JTD 16V<br>2.0 16V T.Spark<br>2.0 JTS<br>2.4 JTD<br>2.4 JTD<br>2.4 JTD<br>2.4 JTD<br>2.5 V6 24V<br>3.2 GTA | 103<br>110<br>122<br>100<br>103<br>110<br>129<br>184                             |  | 10.97 07.05<br>10.97 07.05<br>10.97 07.05<br>11.02 07.05<br>07.04 07.05<br>10.97 07.05<br>03.02 07.05<br>10.97 10.00<br>10.00 07.05<br>03.02 07.05<br>10.03 07.05<br>10.97 07.05<br>03.02 07.05 |   | 24.3727-0005.2<br>24.3727-0004.2   | 580005<br>580004   | <input type="checkbox"/><br><input type="checkbox"/>                               | L=1256<br>L=1196                 |            |
|  | 1.6 i 16V T.Spark<br>1.8 i 16V T.Spark<br>1.9 JTD<br>1.9 JTD 16V<br>1.9 JTD 16V<br>2.0 16V T.Spark<br>2.0 JTS<br>2.4 JTD<br>2.4 JTD<br>2.4 JTD<br>2.4 JTD<br>2.5 V6 24V<br>3.2 GTA | 103<br>110<br>122<br>100<br>103<br>110<br>129<br>184                             |  | 10.97 07.05<br>10.97 07.05<br>10.97 07.05<br>11.02 07.05<br>07.04 07.05<br>10.97 07.05<br>03.02 07.05<br>10.97 10.00<br>10.00 07.05<br>03.02 07.05<br>10.03 07.05<br>10.97 07.05<br>03.02 07.05 |   | 03.2525-2201.3   | 040026   |  | Nz 25,40                         |            |
| <b>ALFA ROMEO 159 (05-11)</b>  |  |  |  |   |   |  |  |  |                                  |            |
|  | 1.8 MPI<br>1.9 JTDM 16V<br>1.9 JTDM 8V<br>1.9 JTS<br>2.2 JTS<br>2.4 JTDM 20V<br>2.4 JTDM 20V<br>2.4 JTDM 20V Q4<br>3.2 JTS<br>3.2 JTS Q4   | 103<br>118<br>136<br>147<br>154<br>154<br>191<br>191                             |  | 03.07 06.08<br>06.05 06.08<br>06.05 06.08<br>06.05 06.08<br>06.05 06.08<br>05.07 06.08<br>05.07 06.08<br>02.08 06.08<br>12.05 06.08   |   | 24.2125-1733.3<br>24.2125-1732.3   | 010830<br>010827   | - Dynamic Control <sup>1)</sup><br>+ Dynamic Control <sup>2)</sup>                 | THz 25,40<br>THz 25,40           | LUC<br>LUC |
|  | 1.8 MPI<br>1.8 TBi<br>1.9 JTDM 16V<br>1.9 JTDM 8V<br>1.9 JTS<br>2.0 JTDM<br>2.0 JTDM<br>2.0 JTDM<br>2.2 JTS<br>2.4 JTDM 20V<br>2.4 JTDM 20V  | 103<br>147<br>120<br>125<br>136<br>147<br>154                                    |  | 07.08 10.11<br>05.09 10.11<br>07.08 10.11<br>07.08 10.11<br>07.08 10.11<br>06.10 10.11<br>05.09 10.11<br>05.09 10.11<br>07.08 10.11<br>07.08 10.11<br>07.08 10.11                               |   | 24.2125-1733.3   | 010830   |  | THz 25,40                        | LUC        |





















<sup>1)</sup> - dynamic control / - dynamic control / - dynamic control / - Control dinámico  
<sup>2)</sup> + dynamic control / + dynamic control / + dynamic control / + Control dinámico



|     |   |  |  |    |    |  |  |    |        |
|--|---|--|--|--|---|--|--|--|--------|
| <b>ALFA ROMEO 159 (05-11)</b>  |   |  |  |  |   |  |  |  |        |
|    | 2.4 JTDM 20V Q4<br>3.2 JTS<br>3.2 JTS Q4  | 154<br>191<br>191  |  | 07.08<br>07.08<br>07.08  | 10.11<br>10.11<br>10.11   | 24.2125-1733.3<br>010830   |  | THz 25,40<br><b>LUC</b>  |        |
|    | 1.8 MPI<br>1.9 JTDM 16V<br>1.9 JTDM 8V<br>1.9 JTS<br>2.2 JTS  | 103<br>118<br>136  |  | 03.07<br>06.05<br>06.05<br>06.05<br>06.05  | 10.11<br>10.11<br>10.11<br>10.11<br>10.11   | 11.8171-0008.1<br>11.0101-5407.2<br>11.8116-0237.1<br>260011<br>390509             | 2  | Führungsbolzen<br>Hülzensatz<br>Haltefeder<br><b>ATE</b><br><b>ATE</b><br><b>ATE</b> |        |
|    | 1.8 MPI<br>1.9 JTDM 16V<br>1.9 JTDM 8V<br>1.9 JTS<br>2.2 JTS  | 103<br>118<br>136  |  | 03.07<br>06.05<br>06.05<br>06.05<br>06.05  | 10.11<br>10.11<br>10.11<br>10.11<br>10.11   | 83.7101-9504.3   | 2  | L=504  |        |
|    | 1.8 MPI<br>1.9 JTDM 16V<br>1.9 JTDM 8V<br>1.9 JTS<br>2.0 JTDM<br>2.0 JTDM<br>2.0 JTDM<br>2.2 JTS  | 103<br>118<br>100<br>120<br>125<br>136   |  | 03.07<br>06.05<br>06.05<br>06.05<br>06.10<br>05.09<br>05.09<br>06.05   | 10.11<br>10.11<br>10.11<br>10.11<br>10.11<br>10.11<br>10.11<br>10.11  | 24.3387-1713.7<br>24.3387-1714.7<br>220749<br>220750                               | <input type="checkbox"/><br><input type="checkbox"/>                               | D=38, - Halter<br>D=38, - Halter<br><b>LUC</b><br><b>LUC</b>                         |        |
|    | 1.8 Tbi<br>2.4 JTDM 20V<br>2.4 JTDM 20V<br>2.4 JTDM 20V Q4<br>3.2 JTS<br>3.2 JTS Q4   | 147<br>147<br>154<br>154<br>191<br>191   |  | 05.09<br>06.05<br>05.07<br>05.07<br>02.08<br>12.05   | 10.11<br>10.11<br>10.11<br>10.11<br>10.11<br>10.11  | 24.3417-1705.7<br>24.3417-1706.7<br>220769<br>220770                               | <input type="checkbox"/><br><input type="checkbox"/>                               | D=41, - Halter<br>D=41, - Halter<br><b>LUC</b><br><b>LUC</b>                         |        |
|    | 1.8 MPI<br>1.8 Tbi<br>1.9 JTDM 16V<br>1.9 JTDM 8V<br>1.9 JTS<br>2.0 JTDM<br>2.0 JTDM<br>2.0 JTDM<br>2.2 JTS<br>2.4 JTDM 20V<br>2.4 JTDM 20V<br>2.4 JTDM 20V Q4<br>3.2 JTS<br>3.2 JTS Q4 | 103<br>147<br>118<br>100<br>120<br>125<br>136<br>147<br>154<br>154<br>191<br>191 |  | 03.07<br>05.09<br>06.05<br>06.05<br>06.05<br>06.10<br>05.09<br>05.09<br>06.05<br>06.05<br>05.07<br>05.07<br>02.08<br>12.05 | 10.11<br>10.11<br>10.11<br>10.11<br>10.11<br>10.11<br>10.11<br>10.11<br>10.11<br>10.11<br>10.11<br>10.11<br>10.11<br>10.11<br>10.11 | 83.7101-9399.3   | 2  | L=399  |        |
| <b>ALFA ROMEO 164 (92-98)</b>  |   |  |  |  |   |  |  |  |        |
|  | 2.0 Turbo   |  |  | 09.91  | 09.98   | 24.2122-0802.3<br>010374   |  | THz 22,20  |        |
|  | 2.0 T.Spark<br>2.0 Turbo<br>2.5 TD<br>3.0 i 24V Super<br>3.0 i V6<br>3.0 i V6<br>3.0 i V6 Q.V.<br>3.0 i V6 Q.V.   | 155<br>135<br>155<br>147<br>171  |  | 09.91<br>09.91<br>09.91<br>12.92<br>09.91<br>12.92<br>09.91<br>12.92   | 09.98<br>09.98<br>09.98<br>09.98<br>11.92<br>09.98<br>11.92<br>09.98  | 24.3384-1608.5<br>240168   | <input type="checkbox"/>   | D=38, - Halter<br><b>LUC</b>   |        |
|  | 2.0 Turbo   |  |  | 09.91  | 09.98   | - Serie Super 1)   | 24.3727-0514.2<br>580514   | 1 <input type="checkbox"/>   | L=2950 |
|  | 2.0 T.Spark<br>2.5 TD<br>3.0 i V6<br>3.0 i V6<br>3.0 i V6 Q.V.<br>3.0 i V6 Q.V.   | #135<br>#155<br>#147<br>#171   |  | 09.91<br>09.91<br>09.91<br>12.92<br>09.91<br>12.92   | 09.98<br>02.93<br>11.92<br>09.98<br>11.92<br>02.93  | 24.2523-1702.3<br>040087   |  | Nz 23,81   |        |
|  | 2.0 Turbo<br>2.5 TD<br>3.0 i 24V Super<br>3.0 i V6 Q.V.<br>3.0 i V6 Q.V. Q4   | 155<br>#171<br>171   |  | 09.91<br>03.93<br>12.92<br>03.93<br>04.94  | 09.98<br>09.98<br>09.98<br>09.98<br>09.98   | 03.2525-2201.3<br>040026   |  | Nz 25,40   |        |
| <b>ALFA ROMEO 166 (98-07)</b>  |   |  |  |  |   |  |  |  |        |
|  | 2.0 i 16V T.Spark<br>2.0 i V6 Turbo<br>2.4 JTD<br>2.4 JTD<br>2.4 JTD<br>2.4 JTD<br>2.4 JTD<br>2.4 JTD<br>2.5 i V6<br>3.0 i V6<br>3.2 i V6   | 100<br>103<br>110<br>120<br>129<br>132<br>136                                    |  | 10.98<br>10.98<br>10.98<br>10.00<br>04.02<br>10.03<br>10.03<br>07.06<br>07.05<br>10.98<br>10.98<br>10.03                   | 10.00<br>12.07<br>10.00<br>12.07<br>12.07<br>12.07<br>12.07<br>12.07<br>12.07<br>12.07<br>12.07<br>12.07                            | 24.2125-1723.3<br>24.2125-1729.3<br>010689<br>010752                               | + ABS<br>+ Dynamic Control 2)  | THz 25,40<br>THz 25,40   |        |























1) - series super / - serie super / - Série super / - serie súper

2) + dynamic control / + dynamic control / + dynamic control / + Control dinámico

|     |    |  |    |    |  |  |  |                                      |  |
|--|--|--|--|--|---|--|--|--|--|
| <b>ALFA ROMEO 166 (98-07)</b>  |  |  |  |  |   |  |  |  |  |
|    | 2.0 i 16V T.Spark<br>2.4 JTD<br>2.4 JTD<br>2.4 JTD<br>2.4 JTD<br>2.4 JTD<br>2.4 JTD  | 100<br>103<br>110<br>120<br>132<br>136   |  | 10.98 12.07<br>10.98 10.00<br>10.00 12.07<br>04.02 12.07<br>10.03 12.07<br>07.06 12.07<br>07.05 12.07  |   | 24.3571-1719.5   | 240303   | <input type="checkbox"/>   | D=57, - Halter<br><b>ATE</b>   |
|    | 2.0 i 16V T.Spark<br>2.0 i V6 Turbo<br>2.5 i V6<br>3.0 i V6<br>3.2 i V6<br>2.4 JTD<br>2.4 JTD<br>2.4 JTD<br>2.4 JTD<br>2.4 JTD<br>2.4 JTD<br>2.4 JTD |  | 10.98 12.07<br>10.98 12.07<br>10.98 12.07<br>10.98 12.07<br>10.03 12.07<br>10.98 10.00<br>10.00 12.07<br>04.02 12.07<br>10.03 12.07<br>10.03 12.07<br>07.06 12.07<br>07.05 12.07 |  | 24.3384-1727.7<br>24.3384-1728.7  | 220533<br>220534   | <input type="checkbox"/><br><input type="checkbox"/>                               | D=38, - Halter<br>D=38, - Halter<br><b>LUC</b><br><b>LUC</b>   |  |
|    | 2.0 i 16V T.Spark<br>2.0 i V6 Turbo<br>2.5 i V6<br>3.0 i V6<br>3.2 i V6<br>2.4 JTD<br>2.4 JTD<br>2.4 JTD<br>2.4 JTD<br>2.4 JTD<br>2.4 JTD<br>2.4 JTD |  | 10.98 12.07<br>10.98 12.07<br>10.98 12.07<br>10.98 12.07<br>10.03 12.07<br>10.98 10.00<br>10.00 12.07<br>04.02 12.07<br>10.03 12.07<br>10.03 12.07<br>07.06 12.07<br>07.05 12.07 |  | 24.3727-0013.2<br>24.3727-0012.2  | 580013<br>580012   | <input type="checkbox"/><br><input checked="" type="checkbox"/>                    | L=1445, + Zub<br>L=1427, + Zub   |  |
|    | 2.0 i 16V T.Spark<br>2.0 i V6 Turbo<br>2.4 JTD<br>2.4 JTD<br>2.4 JTD<br>2.4 JTD<br>2.4 JTD<br>2.4 JTD<br>2.4 JTD<br>2.5 i V6<br>3.0 i V6<br>3.2 i V6 | 100<br>103<br>110<br>120<br>129<br>132<br>136                                    |  | 10.98 12.07<br>10.98 12.07<br>10.98 10.00<br>10.00 12.07<br>04.02 12.07<br>10.03 12.07<br>10.03 12.07<br>07.06 12.07<br>07.05 12.07<br>10.98 12.07<br>10.98 12.07<br>10.03 12.07 |   | 24.2525-1706.3   | 040088   |  | Nz 25,40   |
| <b>ALFA ROMEO BRERA (06-11)</b>  |  |  |  |  |   |  |  |  |  |
|  | 1.8 TBi<br>2.0 JTDM<br>2.2 JTS<br>2.4 JTDM 20V<br>2.4 JTDM 20V<br>3.2 JTS<br>3.2 JTS Q4  | 147<br>125<br>136<br>147<br>154<br>191<br>191                                    |  | 05.09 09.11<br>05.09 09.11<br>12.05 09.11<br>12.05 09.11<br>02.07 09.11<br>03.08 09.11<br>12.05 09.11  |   | 24.2125-1732.3   | 010827   |  | Thz 25,40<br><b>LUC</b>  |
|  | 2.2 JTS  | 136  |  | 12.05 09.11  |   | 11.8171-0008.1<br>11.0101-5407.2<br>11.8116-0237.1                                 | 990049<br>260011<br>390509   | <input type="checkbox"/><br><input type="checkbox"/><br><input type="checkbox"/>                                       | Führungsbolzen<br>Hülzensatz<br>Haltefeder<br><b>ATE</b><br><b>ATE</b><br><b>ATE</b> |
|  | 2.2 JTS  | 136  |  | 12.05 09.11  |   | 83.7101-9504.3   | 330898   | 2  | L=504  |
|  | 2.0 JTDM<br>2.2 JTS<br>1.8 TBi<br>2.4 JTDM 20V<br>2.4 JTDM 20V<br>3.2 JTS<br>3.2 JTS Q4  | 125<br>136<br>147<br>147<br>154<br>191<br>191                                    |  | 05.09 09.11<br>12.05 09.11<br>05.09 09.11<br>12.05 09.11<br>02.07 09.11<br>03.08 09.11<br>12.05 09.11  |   | 24.3387-1713.7<br>24.3387-1714.7   | 220749<br>220750   | <input type="checkbox"/><br><input type="checkbox"/>   | D=38, - Halter<br>D=38, - Halter<br><b>LUC</b><br><b>LUC</b>                         |
|  | 1.8 TBi<br>2.0 JTDM<br>2.2 JTS<br>2.4 JTDM 20V<br>2.4 JTDM 20V<br>3.2 JTS<br>3.2 JTS Q4  | 147<br>125<br>136<br>147<br>154<br>191<br>191                                    |  | 05.09 09.11<br>05.09 09.11<br>12.05 09.11<br>12.05 09.11<br>02.07 09.11<br>03.08 09.11<br>12.05 09.11  |   | 83.7101-9399.3   | 330904   | 2  | L=399  |
|  | 1.8 TBi<br>2.0 JTDM<br>2.2 JTS<br>2.4 JTDM 20V<br>2.4 JTDM 20V<br>3.2 JTS<br>3.2 JTS Q4  | 147<br>125<br>136<br>147<br>154<br>191<br>191                                    |  | 05.09 09.11<br>05.09 09.11<br>12.05 09.11<br>12.05 09.11<br>02.07 09.11<br>03.08 09.11<br>12.05 09.11  |   | 24.3727-0014.2<br>24.3727-0015.2   | 580014<br>580015   | <input type="checkbox"/><br><input checked="" type="checkbox"/>  | L=1662<br>L=1577   |
| <b>ALFA ROMEO GIULIETTA (10- )</b>   |  |  |  |  |   |  |  |  |  |
|  | 1.4 BiFuel<br>1.4 TB<br>1.6 JTDM   | 88<br>88<br>77   |  | 12.11<br>04.10<br>04.10  |   | 11.9571-9969.2<br>11.9571-9970.2   | 220955<br>220956   | <input type="checkbox"/> - Sonderbremszange <sup>1)</sup><br><input type="checkbox"/> - Sonderbremszange <sup>1)</sup> | D=57, - Halter<br>D=57, - Halter<br><b>ATE</b><br><b>ATE</b>                         |

<sup>1)</sup> - special brake caliper / - pinza freno speciale / - pince à frein spéciale / - pinza freno especial



|     |   |     |  |    |  |  |  |                                      |                                  |                |
|--|---|---|--|--|---|--|--|--|----------------------------------|----------------|
| <b>ALFA ROMEO GIULIETTA (10-)</b>  |   |   |  |  |   |  |  |  |                                  |                |
|    | 2.0 JTDM<br>2.0 JTDM  | 103<br>125  |  | 04.10<br>04.10   |   | 11.9571-9953.2<br>11.9571-9954.2   | 220871<br>220872   | <input type="checkbox"/> - Sonderbremszange <sup>1)</sup><br><input type="checkbox"/> - Sonderbremszange <sup>1)</sup> | D=57, - Halter<br>D=57, - Halter | ATE<br>ATE     |
| <b>ALFA ROMEO GT (04-10)</b>   |   |   |  |  |   |  |  |  |                                  |                |
|    | 1.8 TS<br>1.9 JTD<br>1.9 JTD<br>2.0 JTS   | 103<br>110<br>125<br>121  |  | 11.03<br>11.03<br>05.08<br>11.03   | 07.10<br>07.10<br>07.10<br>07.10  | 24.2122-1752.3   | 010749   |  | Thz 22,20                        |                |
|    | 1.8 TS<br>1.9 JTD<br>1.9 JTD<br>2.0 JTS   | 103<br>110<br>125<br>121  |  | 11.03<br>11.03<br>05.08<br>11.03   | 07.10<br>07.10<br>07.10<br>07.10  | 24.5112-0397.3   | 330666   | 2  | L=396                            |                |
|    | 1.8 TS<br>1.9 JTD<br>1.9 JTD<br>2.0 JTS   | 103<br>110<br>125<br>121  |  | 11.03<br>11.03<br>05.08<br>11.03   | 07.10<br>07.10<br>07.10<br>07.10  | 24.3384-1741.7<br>24.3384-1742.7   | 220599<br>220600   | <input type="checkbox"/><br><input type="checkbox"/>   | D=38, - Halter<br>D=38, - Halter | LUC<br>LUC     |
|    | 1.8 TS<br>1.9 JTD<br>1.9 JTD<br>2.0 JTS<br>3.2 i V6   | 103<br>110<br>125<br>121<br>176   |  | 11.03<br>11.03<br>05.08<br>11.03<br>11.03  | 07.10<br>07.10<br>07.10<br>07.10<br>07.10   | 24.5112-0437.3   | 330886   | 2  | L=435                            |                |
|    | 1.8 TS<br>1.9 JTD<br>1.9 JTD<br>2.0 JTS<br>3.2 i V6   | 103<br>110<br>125<br>121<br>176   |  | 11.03<br>11.03<br>05.08<br>11.03<br>11.03  | 07.10<br>07.10<br>07.10<br>07.10<br>07.10   | 24.3727-0005.2<br>24.3727-0004.2   | 580005<br>580004   | <input type="checkbox"/><br><input type="checkbox"/>   | L=1256<br>L=1196                 |                |
|  |   |   |  | 11.03  | 07.10   | 24.3727-0004.2   | 580004   | <input type="checkbox"/>   | L=1196                           |                |
| <b>ALFA ROMEO GTV (95-05)</b>  |   |   |  |  |   |  |  |  |                                  |                |
|    | 1.8 i 16V<br>2.0 i 16V<br>2.0 i V6 Turbo<br>2.0 JTS<br>3.0 i V6<br>3.2 i V6   | 106<br>148<br>121<br>176  |  | 04.98<br>05.95<br>05.95<br>04.03<br>10.96<br>04.03   | 12.05<br>12.05<br>12.05<br>12.05<br>12.05<br>12.05                                | 24.2122-1716.3   | 010485   |  | Thz 22,20                        |                |
|    | 1.8 i 16V<br>2.0 i 16V<br>2.0 i V6 Turbo<br>2.0 JTS<br>3.0 i V6<br>3.2 i V6   | 106<br>148<br>121<br>176  |  | 04.98<br>05.95<br>05.95<br>04.03<br>10.96<br>04.03   | 12.05<br>12.05<br>12.05<br>12.05<br>12.05<br>12.05                                | 24.2419-1721.3   | 030100   |  | Gz 19,05                         |                |
|  | 1.8 i 16V<br>2.0 i 16V<br>2.0 i V6 Turbo<br>2.0 JTS<br>3.0 i V6<br>3.2 i V6   | 106<br>148<br>121<br>176  |  | 04.98<br>05.95<br>05.95<br>04.03<br>10.96<br>04.03   | 12.05<br>12.05<br>12.05<br>12.05<br>12.05<br>12.05                                | 24.2525-1705.3   | 040083   |  | Nz 25,40                         |                |
| <b>ALFA ROMEO MITO (08-)</b>   |   |   |  |  |   |  |  |  |                                  |                |
|  | 0.9<br>0.9<br>1.4 i 16V<br>1.4 i 16V<br>1.4 i 16V   | 63<br>77<br>51<br>58<br>70  |  | 07.11<br>04.13<br>05.11<br>08.08<br>08.08  |   | 24.4122-1709.3   | 010871   |  | Thz 22,20 + Behälter             | BOS            |
|  | 0.9<br>0.9<br>1.4 i 16V<br>1.4 i 16V<br>1.4 i 16V   | 63<br>77<br>51<br>58<br>70  |  | 07.11<br>04.13<br>05.11<br>08.08<br>08.08  |   | 24.3541-1769.7<br>24.3541-1770.7   | 220707<br>220708   | <input type="checkbox"/><br><input type="checkbox"/>   | D=54, - Halter<br>D=54, - Halter | BOS<br>BOS     |
|  | 0.9<br>0.9<br>1.3 JTDM<br>1.3 JTDM<br>1.3 JTDM<br>1.4<br>1.4 Bifuel<br>1.4 i 16V<br>1.4 i 16V<br>1.4 i 16V<br>1.4 TB<br>1.6 JTD<br>1.6 JTDM           | 63<br>77<br>62<br>66<br>70<br>88<br>88<br>51<br>58<br>70<br>99<br>88<br>85          |  | 07.11<br>04.13<br>01.11<br>08.08<br>10.09<br>08.08<br>07.11<br>05.11<br>08.08<br>08.08<br>09.09<br>08.08<br>09.08          |   | 24.5112-0402.3   | 331297   | 2  | L=402                            |                |
|  | 0.9<br>0.9<br>1.3 JTDM<br>1.3 JTDM<br>1.3 JTDM<br>1.4<br>1.4 Bifuel<br>1.4 i 16V<br>1.4 i 16V<br>1.4 i 16V<br>1.4 TB<br>1.4 TB<br>1.4 TB<br>1.4 Turbo | 63<br>77<br>62<br>66<br>70<br>88<br>88<br>51<br>58<br>70<br>99<br>114<br>125<br>110 |  | 07.11<br>04.13<br>01.11<br>08.08<br>10.09<br>08.08<br>07.11<br>05.11<br>08.08<br>08.08<br>09.09<br>08.08<br>10.09<br>09.08 |   | 24.5112-0142.3<br>24.5228-0216.3   | 331016<br>330908   | 2<br>2   | am Bremssattel <sup>2)</sup>     | L=142<br>L=216 |

<sup>1)</sup> - special brake caliper / - pinza freno speciale / - pince à frein spéciale / - pinza freno especial

<sup>2)</sup> on the brake caliper / sulla pinza freno / sur l'étrier de frein / a la pinza de freno

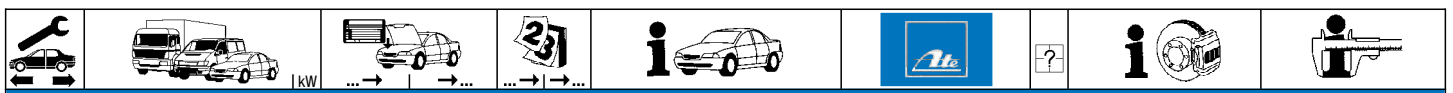

| ALFA ROMEO MITO (08-) |   |   |  |  |  |                                  |                  |  |                              |                  |
|-----------------------|---|---|--|--|--|----------------------------------|------------------|--|------------------------------|------------------|
|                       | 1.6 JTD<br>1.6 JTDM   | 88<br>85  |  | 08.08<br>09.08   |  | 24.5112-0142.3<br>24.5228-0216.3 | 331016<br>330908 | 2<br>2   | am Bremssattel <sup>1)</sup> | L=142<br>L=216   |
|                       | 0.9<br>0.9<br>1.3 JTDM<br>1.3 JTDM<br>1.3 JTDM<br>1.4<br>1.4 Bifuel<br>1.4 i 16V<br>1.4 i 16V<br>1.4 TB<br>1.4 TB<br>1.4 TB<br>1.4 Turbo<br>1.6 JTD<br>1.6 JTDM | 63<br>77<br>62<br>66<br>70<br>88<br>88<br>51<br>58<br>70<br>99<br>114<br>125<br>110<br>88<br>85 |  | 07.11<br>04.13<br>01.11<br>08.08<br>10.09<br>08.08<br>07.11<br>05.11<br>08.08<br>08.08<br>10.09<br>09.08<br>08.08<br>09.08 |  | 24.3727-0579.2<br>24.3727-0580.2 | 580579<br>580580 | <input type="checkbox"/><br><input type="checkbox"/> |                              | L=1654<br>L=1673 |

| ALFA ROMEO SPIDER (95-05) |  |   |  |   |   |                                  |                  |  |                |                                  |            |
|---------------------------|--|---|--|---|---|----------------------------------|------------------|--|----------------|----------------------------------|------------|
|                           | 1.8 i 16V<br>2.0 16V<br>2.0 i 16V<br>2.0 i V6 Turbo<br>2.0 JTS<br>3.0 i V6<br>3.0 V6<br>3.0 V6 24V<br>3.2 i V6 | 106<br>114<br>110<br>148<br>121<br>141<br>160<br>162<br>176 |  | 04.98<br>05.98<br>05.95<br>05.98<br>04.03<br>05.95<br>10.00<br>01.99<br>04.03 | 12.05<br>12.05<br>12.05<br>12.05<br>12.05<br>12.05<br>12.05<br>12.05<br>12.05 | 24.2122-1716.3                   | 010485           |  |                | Thz 22,20                        |            |
|                           | 3.0 i V6   | 141   |  | 12.05   | 12.05   | 24.3541-1791.5<br>24.3541-1792.5 | 240293<br>240294 | <input type="checkbox"/><br><input type="checkbox"/>   | VEF: 6009487 - | D=54, - Halter<br>D=54, - Halter | ATE<br>ATE |
|                           | 2.0 i 16V<br>3.0 i V6  | 110<br>141  |  | 05.95<br>05.95  | 12.05<br>12.05  | 24.3344-1703.5<br>24.3344-1704.5 | 240117<br>240118 | <input type="checkbox"/> + GG-Sättel <sup>2)</sup><br><input type="checkbox"/> + GG-Sättel <sup>2)</sup> |                | D=34, - Halter<br>D=34, - Halter | LUC<br>LUC |
|                           | 1.8 i 16V<br>2.0 16V<br>2.0 i 16V<br>2.0 i V6 Turbo<br>2.0 JTS<br>3.0 i V6<br>3.0 V6<br>3.0 V6 24V<br>3.2 i V6 | 106<br>114<br>110<br>148<br>121<br>141<br>160<br>162<br>176 |  | 04.98<br>05.98<br>05.95<br>05.98<br>04.03<br>05.95<br>10.00<br>01.99<br>04.03 | 12.05<br>12.05<br>12.05<br>12.05<br>12.05<br>12.05<br>12.05<br>12.05<br>12.05 | 24.2419-1721.3                   | 030100           |  |                | Gz 19,05                         |            |
|                           | 1.8 i 16V<br>2.0 16V<br>2.0 i 16V<br>2.0 i V6 Turbo<br>2.0 JTS<br>3.0 i V6<br>3.0 V6<br>3.0 V6 24V<br>3.2 i V6 | 106<br>114<br>110<br>148<br>121<br>141<br>160<br>162<br>176 |  | 04.98<br>05.98<br>05.95<br>05.98<br>04.03<br>05.95<br>10.00<br>01.99<br>04.03 | 12.05<br>12.05<br>12.05<br>12.05<br>12.05<br>12.05<br>12.05<br>12.05<br>12.05 | 24.2525-1705.3                   | 040083           |  |                | Nz 25,40                         |            |

| ALFA ROMEO SPIDER (06-11) |   |  |  |  |  |  |                            |  |  |  |                   |
|---------------------------|---|--|--|--|--|--|----------------------------|--|--|--|-------------------|
|                           | 2.2 JTS<br>3.2 JTS Q4   | 136<br>191   |  | 04.06<br>04.06   | 09.06<br>09.06   | 24.2125-1732.3                                     | 010827                     |  |  | Thz 25,40                                  | LUC               |
|                           | 1.8 TBi<br>2.0 JTDM<br>2.0 JTDM<br>2.2 JTS<br>2.4 JTDM 20V<br>2.4 JTDM 20V<br>3.2 JTS<br>3.2 JTS Q4 | 147<br>120<br>125<br>136<br>147<br>154<br>191<br>191 |  | 05.09<br>04.09<br>05.09<br>10.06<br>02.07<br>05.07<br>03.08<br>10.06 | 09.11<br>09.11<br>09.11<br>09.11<br>09.11<br>09.11<br>09.11<br>09.11 | 24.2125-1733.3                                     | 010830                     |  |  | Thz 25,40                                  | LUC               |
|                           | 2.2 JTS   | 136  |  | 04.06  | 02.08  | 11.8171-0008.1<br>11.0101-5407.2<br>11.8116-0237.1 | 990049<br>260011<br>390509 | 2  |  | Führungsbolzen<br>Hülzensatz<br>Haltefeder | ATE<br>ATE<br>ATE |
|                           | 2.2 JTS   | 136  |  | 04.06  | 02.08  | 83.7101-9504.3                                     | 330898                     | 2  |  | L=504                                      |                   |
|                           | 2.0 JTDM<br>2.0 JTDM<br>2.2 JTS   | 120<br>125<br>136                                    |  | 04.09<br>05.09<br>04.06  | 09.11<br>09.11<br>09.11  | 24.3387-1713.7<br>24.3387-1714.7                   | 220749<br>220750           | <input type="checkbox"/><br><input type="checkbox"/> |  | D=38, - Halter<br>D=38, - Halter           | LUC<br>LUC        |
|                           | 1.8 TBi<br>2.4 JTDM 20V<br>2.4 JTDM 20V<br>3.2 JTS<br>3.2 JTS Q4                                    | 147<br>147<br>154<br>191<br>191                      |  | 05.09<br>02.07<br>05.07<br>03.08<br>04.06                            | 09.11<br>09.11<br>09.11<br>09.11<br>09.11                            | 24.3417-1705.7<br>24.3417-1706.7                   | 220769<br>220770           | <input type="checkbox"/><br><input type="checkbox"/> |  | D=41, - Halter<br>D=41, - Halter           | LUC<br>LUC        |
|                           | 1.8 TBi<br>2.0 JTDM<br>2.0 JTDM<br>2.2 JTS<br>2.4 JTDM 20V<br>2.4 JTDM 20V                          | 147<br>120<br>125<br>136<br>147<br>154               |  | 05.09<br>04.09<br>05.09<br>04.06<br>02.07<br>05.07                   | 09.11<br>09.11<br>09.11<br>09.11<br>09.11<br>09.11                   | 83.7101-9399.3                                     | 330904                     | 2  |  | L=399                                      |                   |

<sup>1)</sup> on the brake caliper / sulla pinza freno / sur l'étrier de frein / a la pinza de freno  
<sup>2)</sup> + cast iron caliper / + pinza in ghisa / + étriers en fonte grise / + fundición gris-pinza



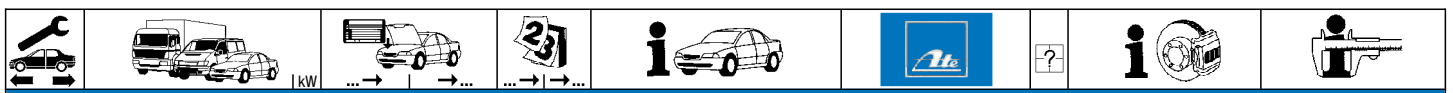

| ALFA ROMEO SPIDER (06-11) |   |  |   |  |  |  |                                      |  |                                      |  |
|---------------------------|---|--|---|--|--|--|--------------------------------------|--|--------------------------------------|--|
|                           | 3.2 JTS<br>3.2 JTS Q4   | 191<br>191   |   | 03.08<br>04.06   | 09.11<br>09.11   | 83.7101-9399.3   | 330904                               | 2  |                                      | L=399  |
|                           | 1.8 Tbi<br>2.0 JTDM<br>2.0 JTDM<br>2.2 JTS<br>2.4 JTDM 20V<br>2.4 JTDM 20V<br>3.2 JTS<br>3.2 JTS Q4   | 147<br>120<br>125<br>136<br>147<br>154<br>191<br>191 |   | 05.09<br>04.09<br>05.09<br>04.06<br>02.07<br>05.07<br>03.08<br>04.06                                     | 09.11<br>09.11<br>09.11<br>09.11<br>09.11<br>09.11<br>09.11<br>09.11   | 24.3727-0014.2<br>24.3727-0015.2                                     | 580014<br>580015                     | <input type="checkbox"/><br><input type="checkbox"/> |                                      | L=1662<br>L=1577   |
| AUDI 80 (91-95)           |   |  |   |  |  |  |                                      |  |                                      |  |
|                           | 1.6<br>1.9 TD<br>1.9 TDI<br>2.0<br>2.3  |  | 8C-N-300000<br>8C-N-300000<br>8C-N-300000<br>8C-N-300000<br>8C-N-300000   | 08.91<br>09.91<br>09.91<br>08.91<br>09.91  |  | 03.7750-0302.4   | 300071                               |  |                                      | 9" ATE   |
|                           | 1.6<br>1.6<br>1.9 TD<br>1.9 TD<br>1.9 TDI<br>1.9 TDI<br>2.0<br>2.0<br>2.3<br>2.3                      |  | 8C-N-300000<br>8C-N-300000<br>8C-N-300000<br>8C-N-300000<br>8C-N-300000<br>8C-N-300000<br>8C-N-300000<br>8C-N-300000<br>8C-N-300000<br>8C-N-300000  | 08.91<br>08.91<br>09.91<br>09.91<br>09.91<br>09.91<br>08.91<br>08.91<br>09.91<br>09.91                   | - ABS<br>- ABS<br>- ABS<br>- ABS<br>- ABS<br>- ABS<br>- ABS<br>- ABS<br>- ABS<br>- ABS   | 24.2122-1601.3   | 010380                               |  |                                      | Thz 22,20 LUC  |
|                           | 1.6<br>1.9 TD<br>1.9 TDI<br>2.0<br>2.3  |  | 8C-P-000001<br>8C-P-000001<br>8C-P-000001<br>8C-P-000001<br>8C-P-000001   | 12.95<br>12.95<br>12.95<br>12.95<br>12.95  | - ABS<br>- ABS<br>- ABS<br>- ABS<br>- ABS  | 03.2123-0491.3   | 010167                               |  |                                      | Thz 23,81 ATE  |
|                           | 1.6<br>1.9 TD<br>1.9 TDI<br>2.0<br>2.3<br>2.6<br>2.8  |  |   | 08.91<br>09.91<br>09.91<br>08.91<br>08.91<br>08.91<br>09.91  | 12.95 + ABS<br>12.95 + ABS<br>12.95 + ABS<br>12.95 + ABS / - Hydraulikverstärker 1)<br>12.95 + ABS<br>12.95 + ABS / - Hydraulikverstärker 1)<br>12.95 + ABS / - Hydraulikverstärker 1)   | 24.2123-1602.3   | 010384                               |  |                                      | Thz 23,81 LUC  |
|                           | 2.0<br>2.6<br>2.8   |  |   | 08.91<br>07.92<br>09.91  | 12.95 + ABS/ + Hydraulikverstärker 2)<br>12.95 + ABS/ + Hydraulikverstärker 2)<br>12.95 + ABS/ + Hydraulikverstärker 2)  | 03.2123-0566.3   | 010169                               |  |                                      | Thz 23,81 ATE  |
|                           | 1.6<br>1.9 TD<br>1.9 TDI<br>2.0   | 52<br>55<br>66<br>66                                 | 8C-N-300000<br>8C-N-300000<br>8C-N-300000<br>8C-N-300000  | 08.91<br>08.91<br>08.91<br>08.91   |  | 24.3541-1610.5<br>24.3541-1609.5<br>24.0101-4301.2<br>11.0101-5403.2 | 240040<br>240039<br>260047<br>260010 | <input type="checkbox"/><br><input type="checkbox"/> |                                      | D=54, - Halter LUC<br>D=54, - Halter LUC<br>Einbausatz LUC<br>Fallenbalgsatz LUC |
|                           | 1.6<br>1.6<br>1.9 TD<br>1.9 TD<br>1.9 TDI<br>1.9 TDI<br>2.0<br>2.0                                    | 52<br>52<br>55<br>55<br>66<br>66<br>66<br>66         | 8C-P-000001<br>8C-P-000001<br>8C-P-000001<br>8C-P-000001<br>8C-P-000001<br>8C-P-000001<br>8C-P-000001<br>8C-P-000001  | 08.93<br>08.93<br>08.93<br>07.93<br>12.95<br>12.95<br>12.95<br>12.95                                     | + Schaltgetriebe 3)<br>+ Schaltgetriebe 3)<br>+ Schaltgetriebe 3)<br>+ Schaltgetriebe 3)   | 24.3541-1743.5<br>24.3541-1744.5                                     | 240219<br>240220                     | <input type="checkbox"/><br><input type="checkbox"/> |                                      | D=54, - Halter LUC<br>D=54, - Halter LUC   |
|                           | 1.6<br>1.6<br>1.9 TD<br>1.9 TDI<br>2.0<br>2.0<br>2.0<br>2.0<br>2.3<br>2.6<br>2.8                      | 52<br>74<br>55<br>66<br>66<br>85<br>101<br>103       |   | 08.93<br>08.91<br>08.93<br>08.93<br>08.91<br>08.91<br>08.91<br>08.91<br>09.91<br>08.92<br>09.91          | + Automatikgetriebe 4)<br>+ Automatikgetriebe 4)<br>+ Automatikgetriebe 4)<br>+ Automatikgetriebe 4)<br>+ Automatikgetriebe 4)<br>+ Automatikgetriebe 4)<br>+ Automatikgetriebe 4)<br>+ Automatikgetriebe 4)<br>+ Automatikgetriebe 4)<br>+ Automatikgetriebe 4)<br>+ Automatikgetriebe 4) | 24.0101-4301.2<br>11.0101-5403.2                                     | 260047<br>260010                     |  | Einbausatz LUC<br>Fallenbalgsatz LUC |  |
|                           | 1.6<br>1.9 TD<br>1.9 TDI<br>2.0<br>2.3<br>2.6<br>2.8  | 55<br>66   |   | 08.91<br>09.91<br>09.91<br>08.91<br>09.91<br>07.92<br>09.91  | 12.95<br>12.95<br>12.95<br>12.95<br>12.95<br>12.95<br>12.95  | 83.7813-0285.3<br>83.7704-0160.3                                     | 330798<br>330805                     | 2<br>2   | am Bremsattel 5)                     | L=285<br>L=160   |
|                           | 1.6<br>1.6<br>1.9 TD<br>1.9 TD<br>1.9 TDI<br>1.9 TDI<br>2.0<br>2.0<br>2.0<br>2.0<br>2.3<br>2.6<br>2.8 |  | 8C-P-050000<br>8C-P-050000<br>8C-P-050000<br>8C-P-050000<br>8C-P-050000<br>8C-P-050000<br>8C-P-050000<br>8C-P-050000<br>8C-P-050000<br>8C-P-050000<br>8C-P-050000<br>8C-P-050000<br>8C-P-050000 | 08.91<br>09.91<br>09.91<br>09.91<br>09.91<br>08.91<br>08.91<br>08.91<br>08.91<br>09.91<br>08.92<br>09.91 | + ABS<br>+ ABS<br>+ ABS<br>+ ABS<br>+ ABS<br>+ ABS<br>+ ABS<br>+ ABS<br>+ ABS<br>+ ABS<br>+ ABS<br>+ ABS<br>+ ABS  | 24.3384-1701.5<br>24.3384-1702.5                                     | 240169<br>240170                     | <input type="checkbox"/><br><input type="checkbox"/> |                                      | D=38, - Halter LUC<br>D=38, - Halter LUC   |

1) + ABS/ - hydraulic booster / + ABS/ - servofreno idraulico / + ABS/ - amplificateur hydraulique / + ABS/ - servo hidráulico  
2) + ABS/ + hydraulic booster / + ABS/ + servofreno idraulico / + ABS/ + amplificateur hydraulique / + ABS/ + servo hidráulico  
3) + manual transmission / + scatola cambio velocità / + transmission mécanique / + cambio de velocidad  
4) + autom.transmission / + scatola cambio automatico / + transmission automatique / + cambio automático  
5) on the brake caliper / sulla pinza freno / sur l'étrier de frein / a la pinza de freno

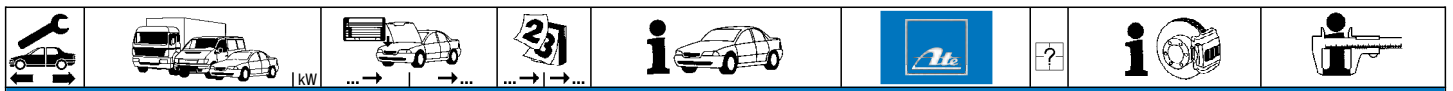

| AUDI 80 (91-95) |         |             |             |             |       |                |                |        |                                   |                                   |
|-----------------|---------|-------------|-------------|-------------|-------|----------------|----------------|--------|-----------------------------------|-----------------------------------|
|                 | 1.6     |             |             | 8C-P-050000 | 08.91 | - ABS          | 83.7812-0200.3 | 330846 | 2                                 | L=200                             |
|                 | 1.9 TD  | 55          |             | 8C-P-050000 | 09.91 | - ABS          |                |        |                                   |                                   |
|                 | 1.9 TDI | 66          |             | 8C-P-050000 | 09.91 | - ABS          |                |        |                                   |                                   |
|                 | 2.0     | 66          |             | 8C-P-050000 | 09.91 | - ABS          |                |        |                                   |                                   |
|                 | 1.6     |             | 8C-P-050001 | 8C-P-050000 | 08.91 | + ABS          | 83.7812-0200.3 | 330846 | 2                                 | L=200                             |
|                 | 1.6     | 55          |             | 8C-P-050000 | 09.91 | + ABS          | 83.7724-0202.3 | 330852 | 2                                 | L=200                             |
|                 | 1.9 TD  | 55          | 8C-P-050001 | 8C-P-050000 | 09.91 | + ABS          |                |        |                                   | am Bremssattel <sup>1)</sup>      |
|                 | 1.9 TD  | 66          |             | 8C-P-050000 | 09.91 | + ABS          |                |        |                                   |                                   |
|                 | 1.9 TDI | 66          | 8C-P-050001 | 8C-P-050000 | 08.91 | + ABS          |                |        |                                   |                                   |
|                 | 2.0     | 66          |             | 8C-P-050000 | 08.91 | + ABS          |                |        |                                   |                                   |
| 2.0             | 85      |             |             | 08.91       | 12.95 |                |                |        |                                   |                                   |
| 2.0             | 101     |             |             | 08.91       | 07.92 |                |                |        |                                   |                                   |
| 2.0             | 103     |             |             | 08.91       | 12.95 |                |                |        |                                   |                                   |
| 2.3             |         |             |             | 09.91       | 12.95 |                |                |        |                                   |                                   |
| 2.6             |         |             |             | 08.92       | 12.95 |                |                |        |                                   |                                   |
| 2.8             |         |             |             | 09.91       | 12.95 |                |                |        |                                   |                                   |
|                 | 1.6     | 52          |             | 8C-P-050000 | 08.91 | - ABS          | 03.3217-2112.3 | 020027 |                                   | + GG <sup>2)</sup>                |
|                 | 1.9 TD  | 55          |             | 8C-P-050000 | 09.91 | - ABS          | 24.3217-0908.3 | 020167 |                                   | + ALU <sup>3)</sup>               |
|                 | 1.6     | 74          |             | 8C-N-300000 | 08.91 | - ABS          | 24.3219-0909.3 | 020188 |                                   | Rz 19,05                          |
|                 | 1.9 TDI | 66          |             | 8C-N-300000 | 08.91 | - ABS          |                |        |                                   |                                   |
|                 | 2.0     |             |             | 8C-N-300000 | 08.91 | - ABS          |                |        |                                   |                                   |
|                 | 1.6     | 74          | 8C-P-000001 | 8C-P-050000 |       | - ABS          | 24.3220-0909.3 | 020210 |                                   | Rz 20,64                          |
|                 | 1.9 TDI | 66          | 8C-P-000001 | 8C-P-050000 |       | - ABS          |                |        |                                   |                                   |
|                 | 2.0     |             | 8C-P-000001 | 8C-P-050000 |       | - ABS          |                |        |                                   |                                   |
|                 | 1.6     |             | 8C-P-050001 | 8C-P-050000 | 08.91 | - ABS          | 24.3727-0148.2 | 580148 | 2                                 | + HA-Trommelbremse <sup>4)</sup>  |
|                 | 1.9 TD  | 55          |             | 8C-P-050000 | 09.91 | - ABS          |                |        |                                   | L=1578                            |
| 1.9 TDI         | 66      |             | 8C-P-050000 | 09.91       | - ABS |                |                |        |                                   |                                   |
| 2.0             | 66      |             | 8C-P-050000 | 08.91       | - ABS |                |                |        |                                   |                                   |
| 1.6             |         | 8C-P-050001 | 8C-P-235351 |             |       | 24.3727-0147.2 | 580147         | 2      | + HA-Scheibenbremse <sup>5)</sup> |                                   |
| 1.6             |         |             | 8C-P-050000 | 09.91       | + ABS |                |                |        | L=1722                            |                                   |
| 1.9 TD          | 55      | 8C-P-050001 | 8C-P-235351 |             | + ABS |                |                |        |                                   |                                   |
| 1.9 TD          | 55      |             | 8C-P-050000 | 09.91       | + ABS |                |                |        |                                   |                                   |
| 1.9 TDI         | 66      | 8C-P-050001 | 8C-P-235351 |             | + ABS |                |                |        |                                   |                                   |
| 1.9 TDI         | 66      |             | 8C-P-050000 | 09.91       | + ABS |                |                |        |                                   |                                   |
| 2.0             | 66      | 8C-P-050001 | 8C-P-235351 |             | + ABS |                |                |        |                                   |                                   |
| 2.0             | 66      |             | 8C-P-050000 | 09.91       | + ABS |                |                |        |                                   |                                   |
| 2.0             | 85      |             | 8C-P-235351 | 09.91       |       |                |                |        |                                   |                                   |
| 2.0             | 101     |             | 8C-P-235351 | 09.91       |       |                |                |        |                                   |                                   |
| 2.0             | 103     |             | 8C-P-235351 | 09.91       |       |                |                |        |                                   |                                   |
| 2.3             |         |             | 8C-P-235351 | 09.91       |       |                |                |        |                                   |                                   |
| 2.6             |         |             | 8C-P-235351 | 07.92       |       |                |                |        |                                   |                                   |
| 2.8             |         |             | 8C-P-235351 | 09.91       |       |                |                |        |                                   |                                   |
| 1.6             |         | 8C-P-235352 |             |             | 12.95 |                | 24.3727-0191.2 | 580191 |                                   | + HA-Scheibenbremse <sup>5)</sup> |
| 1.9 TD          | 55      | 8C-P-235352 |             |             | 12.95 |                | 24.3727-0192.2 | 580192 |                                   | + HA-Scheibenbremse <sup>5)</sup> |
| 1.9 TDI         | 66      | 8C-P-235352 |             |             | 12.95 |                |                |        |                                   | L=1723                            |
| 2.0             | 66      | 8C-P-235352 |             |             | 12.95 |                |                |        |                                   |                                   |
| 2.0             | 85      | 8C-P-235352 |             |             | 12.95 |                |                |        |                                   |                                   |
| 2.0             | 101     | 8C-P-235352 |             |             | 07.92 |                |                |        |                                   |                                   |
| 2.0             | 103     | 8C-P-235352 |             |             | 12.95 |                |                |        |                                   |                                   |
| 2.3             |         | 8C-P-235352 |             |             | 12.95 |                |                |        |                                   |                                   |
| 2.6             |         | 8C-P-235352 |             |             | 12.95 |                |                |        |                                   |                                   |
| 2.8             |         | 8C-P-235352 |             |             | 12.95 |                |                |        |                                   |                                   |
|                 | 1.6     |             |             |             | 08.91 | 12.95          | 03.6584-0107.3 | 320110 |                                   | BRL 8/4 (4) ATE                   |
|                 | 1.9 TD  | 55          |             |             | 09.91 | 12.95          |                |        |                                   |                                   |
|                 | 1.9 TDI | 66          |             |             | 09.91 | 12.95          |                |        |                                   |                                   |
|                 | 2.0     |             |             |             | 08.91 | 12.95          |                |        |                                   |                                   |
|                 | 2.3     |             |             |             | 09.91 | 12.95          |                |        |                                   |                                   |
|                 | 2.6     |             |             |             | 07.92 | 12.95          |                |        |                                   |                                   |
|                 | 2.8     |             |             |             | 09.91 | 12.95          |                |        |                                   |                                   |
|                 | 1.6     |             |             |             | 08.91 | 12.95          | 03.2419-9210.3 | 030026 |                                   | Gz 19,05                          |
|                 | 1.9 TD  | 55          |             |             | 09.91 | 12.95          |                |        |                                   |                                   |
|                 | 1.9 TDI | 66          |             |             | 09.91 | 12.95          |                |        |                                   |                                   |
|                 | 2.0     |             |             |             | 08.91 | 12.95          |                |        |                                   |                                   |
|                 | 2.3     |             |             |             | 09.91 | 12.95          |                |        |                                   |                                   |
|                 | 2.6     |             |             |             | 07.92 | 12.95          |                |        |                                   |                                   |
|                 | 2.8     |             |             |             | 09.91 | 12.95          |                |        |                                   |                                   |
|                 | 1.6     |             |             |             | 08.91 | 12.95          | 03.2522-4300.3 | 040085 |                                   | Nz 22,20                          |
|                 | 1.9 TD  | 55          |             |             | 09.91 | 12.95          |                |        |                                   |                                   |
|                 | 1.9 TDI | 66          |             |             | 09.91 | 12.95          |                |        |                                   |                                   |
|                 | 2.0     |             |             |             | 08.91 | 12.95          |                |        |                                   |                                   |
|                 | 2.3     |             |             |             | 09.91 | 12.95          |                |        |                                   |                                   |
|                 | 2.6     |             |             |             | 07.92 | 12.95          |                |        |                                   |                                   |
|                 | 2.8     |             |             |             | 09.91 | 12.95          |                |        |                                   |                                   |

| AUDI 80 Quattro (92-95) |         |             |             |             |       |       |                |        |  |                      |
|-------------------------|---------|-------------|-------------|-------------|-------|-------|----------------|--------|--|----------------------|
|                         | 2.0     | ‡           |             |             | 09.91 | 12.95 | 03.7750-0302.4 | 300071 |  | 9" ATE               |
|                         | 2.3     | ‡           |             |             | 09.91 | 12.95 |                |        |  |                      |
|                         | RS2 2.2 | ‡232        |             | 8C-S-000368 | 03.94 |       | 10.0124-3202.3 | 340011 |  | Hydraulik Verstärker |
| S2 2.2                  | ‡169    |             |             | 02.93       | 12.95 |       |                |        |  |                      |
|                         | 2.0     | ‡           |             | 8C-N-300000 | 09.91 |       | 24.2122-1601.3 | 010380 |  | THz 22,20 LUC        |
|                         | 2.3     | ‡           |             | 8C-N-300000 | 09.91 |       |                |        |  |                      |
|                         | 2.0     | ‡           | 8C-P-000001 |             |       | 12.95 | 03.2123-0491.3 | 010167 |  | THz 23,81 ATE        |
| 2.0                     | ‡       | 8C-P-000001 |             |             | 12.95 |       |                |        |  |                      |

















<sup>1)</sup> on the brake caliper / sulla pinza freno / sur l'étrier de frein / a la pinza de freno  
<sup>2)</sup> + cast iron / + ghisa / + fonte grise / + fundición de gris  
<sup>3)</sup> + aluminium / + alluminio / + aluminium / + aluminio  
<sup>4)</sup> + RA drum brake / + P freno a tamburo / + frein à tambour essieu AR / + ET-tambores de freno  
<sup>5)</sup> + RA disc brake / + P disco freno / + frein à disque essieu AR / + ET-disco de freno





| AUDI 80 Quattro (92-95) |         |             |             |       |       |                |        |   |                   |                |          |
|-------------------------|---------|-------------|-------------|-------|-------|----------------|--------|---|-------------------|----------------|----------|
|                         | RS2 2.2 | 232         | 8C-S-000368 | 03.94 | 07.95 | 03.2125-3610.3 | 010214 |   |                   | THz 25,40      | ATE      |
|                         | RS2 2.2 | 232         |             | 03.94 | 07.95 |                |        |   |                   |                |          |
|                         | S2 2.2  | 169         |             | 02.93 | 12.95 |                |        |   |                   |                |          |
|                         | 2.6     |             |             | 08.92 | 12.95 | 24.2123-1601.3 | 010383 |   |                   | THz 23,81      | LUC      |
|                         | 2.8     |             |             | 09.91 | 12.95 |                |        |   |                   |                |          |
|                         | 2.0     |             |             | 09.91 | 12.95 | 03.2123-0566.3 | 010169 |   |                   | THz 23,81      | ATE      |
|                         | 2.6     |             |             | 08.92 | 12.95 |                |        |   |                   |                |          |
|                         | 2.8     |             |             | 09.91 | 12.95 |                |        |   |                   |                |          |
|                         | 2.0     |             |             | 09.91 | 12.95 | 24.0101-4301.2 | 260047 |   |                   | Einbausatz     | LUC      |
|                         | 2.3     |             |             | 09.91 | 12.95 | 11.0101-5403.2 | 260010 |   |                   | Faltenbalgsatz | LUC      |
|                         | 2.6     |             |             | 08.92 | 12.95 |                |        |   |                   |                |          |
|                         | 2.8     |             |             | 09.91 | 12.95 | 24.0101-3401.2 | 260043 |   |                   | Einbausatz     | LUC      |
|                         | S2 2.2  | 169         |             | 02.93 | 12.95 | 11.0101-5403.2 | 260010 |   |                   | Faltenbalgsatz | LUC      |
|                         | 2.0     |             |             | 09.91 | 12.95 | 83.7813-0285.3 | 330798 | 2 |                   |                | L=285    |
|                         | 2.3     |             |             | 09.91 | 12.95 | 83.7704-0160.3 | 330805 | 2 | am Bremssattel 1) |                | L=160    |
|                         | 2.6     |             |             | 08.92 | 12.95 |                |        |   |                   |                |          |
|                         | 2.8     |             |             | 09.91 | 12.95 |                |        |   |                   |                |          |
|                         | RS2 2.2 | 232         |             | 03.94 | 07.95 |                |        |   |                   |                |          |
|                         | S2 2.2  | 169         |             | 02.93 | 12.95 |                |        |   |                   |                |          |
|                         | 2.0     |             |             | 09.91 | 12.95 | 83.6212-0160.3 | 330318 | 2 |                   |                | L=160    |
|                         | 2.3     |             |             | 09.91 | 12.95 | 83.7724-0215.3 | 330843 | 2 | am Bremssattel 1) |                | L=215    |
|                         | 2.6     |             |             | 08.92 | 12.95 |                |        |   |                   |                |          |
|                         | 2.8     |             |             | 09.91 | 12.95 |                |        |   |                   |                |          |
|                         | RS2 2.2 | 232         |             | 03.94 | 07.95 |                |        |   |                   |                |          |
|                         | S2 2.2  | 169         |             | 02.93 | 12.95 |                |        |   |                   |                |          |
|                         | 2.0     |             |             | 09.91 | 12.95 | 03.2419-9210.3 | 030026 |   |                   |                | Gz 19,05 |
|                         | 2.3     |             |             | 09.91 | 12.95 |                |        |   |                   |                |          |
|                         | 2.6     |             |             | 08.92 | 12.95 |                |        |   |                   |                |          |
|                         | 2.8     |             |             | 09.91 | 12.95 |                |        |   |                   |                |          |
|                         | 2.0     |             |             | 09.91 | 12.95 | 03.2522-4300.3 | 040085 |   |                   |                | Nz 22,20 |
|                         | 2.3     |             |             | 09.91 | 12.95 |                |        |   |                   |                |          |
|                         | 2.6     |             |             | 08.92 | 12.95 |                |        |   |                   |                |          |
|                         | 2.8     |             |             | 09.91 | 12.95 |                |        |   |                   |                |          |
|                         | RS2 2.2 | 232         |             | 03.94 | 07.95 |                |        |   |                   |                |          |
|                         | S2 2.2  | 169         |             | 02.93 | 12.95 |                |        |   |                   |                |          |
| AUDI 100 (91-94)        |         |             |             |       |       |                |        |   |                   |                |          |
|                         | 1.6     |             |             | 03.92 | 07.93 | 03.2123-0491.3 | 010167 |   | - ABS             | THz 23,81      | ATE      |
|                         | 2.0     |             |             | 12.90 | 07.94 | 24.2123-1602.3 | 010384 |   | + ABS             | THz 23,81      | LUC      |
|                         | 2.0 16V |             |             | 01.92 | 07.94 |                |        |   |                   |                |          |
|                         | 2.3     |             |             | 12.90 | 07.94 |                |        |   |                   |                |          |
|                         | 2.4 D   |             |             | 05.91 | 07.94 |                |        |   |                   |                |          |
|                         | 2.5 TDI |             |             | 06.91 | 07.94 |                |        |   |                   |                |          |
|                         | 2.6     |             |             | 04.92 | 07.94 |                |        |   |                   |                |          |
|                         | 2.8     |             |             | 12.90 | 07.94 |                |        |   |                   |                |          |
|                         | 1.6     |             |             | 03.92 | 07.93 | 11.3571-8506.2 | 220126 |   |                   | D=57, - Halter | ATE      |
|                         | 2.0     |             |             | 12.90 | 07.94 | 24.3571-8505.5 | 240489 |   |                   | D=57, - Halter | ATE      |
|                         | 2.0 16V |             |             | 01.92 | 07.94 | 24.3571-8506.5 | 240490 |   |                   | D=57, - Halter | ATE      |
|                         | 2.3     |             |             | 12.90 | 07.94 | 11.0441-5704.2 | 250034 |   |                   | Dichtungssatz  | ATE      |
|                         | 2.4 D   |             |             | 05.91 | 07.94 | 11.0101-5409.2 | 260035 |   |                   | Hülsensatz     | ATE      |
|                         | 2.5 TDI |             |             | 06.91 | 07.94 | 11.8171-0008.1 | 990049 |   |                   | Führungsbolzen | ATE      |
|                         | 2.6     |             |             | 04.92 | 07.94 | 11.8116-0143.1 | 390513 | 2 |                   | Haltefeder     | ATE      |
|                         | 2.8     |             |             | 04.92 | 07.94 | 11.3571-8507.2 | 220127 |   |                   | D=57, - Halter | ATE      |
|                         |         |             |             | 12.90 | 07.94 | 11.3571-8508.2 | 220128 |   |                   | D=57, - Halter | ATE      |
|                         |         |             |             |       |       | 24.3571-8507.5 | 240555 |   |                   | D=57, - Halter | ATE      |
|                         |         |             |             |       |       | 24.3571-8508.5 | 240556 |   |                   | D=57, - Halter | ATE      |
|                         |         |             |             |       |       | 11.0441-5704.2 | 250034 |   |                   | Dichtungssatz  | ATE      |
|                         |         |             |             |       |       | 11.8170-0306.1 | 260102 | 2 |                   | Halter         | ATE      |
|                         |         |             |             |       |       | 11.0101-5409.2 | 260035 |   |                   | Hülsensatz     | ATE      |
|                         |         |             |             |       |       | 11.8171-0008.1 | 990049 |   |                   | Führungsbolzen | ATE      |
|                         |         |             |             |       |       | 11.8116-0143.1 | 390513 | 2 |                   | Haltefeder     | ATE      |
|                         | 1.6     |             |             | 03.92 | 07.93 | 83.7813-0270.3 | 330797 | 2 |                   |                | L=270    |
|                         | 2.0     |             |             | 12.90 | 07.94 |                |        |   |                   |                |          |
|                         | 2.0 16V |             |             | 01.92 | 07.94 |                |        |   |                   |                |          |
|                         | 2.3     |             |             | 12.90 | 07.94 |                |        |   |                   |                |          |
|                         | 2.4 D   |             |             | 05.91 | 07.94 |                |        |   |                   |                |          |
|                         | 2.5 TDI |             |             | 06.91 | 07.94 |                |        |   |                   |                |          |
|                         | 2.6     |             |             | 04.92 | 07.94 |                |        |   |                   |                |          |
|                         | 2.8     |             |             | 12.90 | 07.94 |                |        |   |                   |                |          |
|                         | 1.6     |             | 4A-P-078948 | 03.92 |       | 24.3384-1601.5 | 240013 |   |                   | D=38, - Halter | LUC      |
|                         | 2.0     |             | 4A-P-078948 | 12.90 | + ABS | 24.3384-1602.5 | 240014 |   |                   | D=38, - Halter | LUC      |
|                         | 2.0 16V |             | 4A-P-078948 | 01.92 | + ABS | 24.0101-3601.2 | 260044 |   |                   | Einbausatz     | LUC      |
|                         | 2.3     |             | 4A-P-078948 | 12.90 |       |                |        |   |                   |                |          |
|                         | 2.4 D   |             | 4A-P-078948 | 05.91 | + ABS |                |        |   |                   |                |          |
|                         | 2.5 TDI |             | 4A-P-078948 | 06.91 |       |                |        |   |                   |                |          |
|                         | 2.6     |             | 4A-P-078948 | 04.92 |       |                |        |   |                   |                |          |
|                         | 2.8     |             | 4A-P-078948 | 12.90 |       |                |        |   |                   |                |          |
|                         | 1.6     | 4A-P-078949 |             | 07.93 | + ABS | 24.3384-1709.5 | 240257 |   |                   | D=38, - Halter | LUC      |
|                         | 2.0     | 4A-P-078949 |             | 07.93 | 07.94 | 24.3384-1710.5 | 240258 |   |                   | D=38, - Halter | LUC      |
|                         | 2.0     | 4A-P-078949 |             | 06.93 | + ABS |                |        |   |                   |                |          |
|                         | 2.0 16V | 4A-P-078949 |             | 07.94 |       |                |        |   |                   |                |          |
|                         | 2.3     | 4A-P-078949 |             | 07.94 |       |                |        |   |                   |                |          |
|                         | 2.4 D   | 4A-P-078949 |             | 07.93 | 07.94 |                |        |   |                   |                |          |
|                         | 2.4 D   | 4A-P-078949 |             | 06.93 | + ABS |                |        |   |                   |                |          |
|                         | 2.5 TDI | 4A-P-078949 |             | 07.94 |       |                |        |   |                   |                |          |
|                         | 2.6     | 4A-P-078949 |             | 07.94 |       |                |        |   |                   |                |          |
|                         | 2.8     | 4A-P-078949 |             | 07.94 |       |                |        |   |                   |                |          |

1) on the brake caliper / sulla pinza freno / sur l'étrier de frein / a la pinza de freno

|     |   |    |   |  |    |  |  |   |                                  |  |                                  |                  |        |                             |                |     |
|--|---|--|---|--|---|--|--|---|----------------------------------|--|----------------------------------|------------------|--------|-----------------------------|----------------|-----|
| <b>AUDI 100 (91-94)</b>  |   |  |   |  |   |  |  |   |                                  |  |                                  |                  |        |                             |                |     |
|    | 2.8   |  | 4A-P-078949   |  | 07.94   | 24.3384-1709.5<br>24.3384-1710.5   | 240257<br>240258   |  | D=38, - Halter<br>D=38, - Halter | LUC<br>LUC   |                                  |                  |        |                             |                |     |
|    | 1.6<br>2.0<br>2.0<br>2.4 D  | 74<br>85   |   |  | 03.92 07.93<br>12.90 06.93<br>12.90 06.93<br>05.91 06.93  |  |  |   |                                  | - ABS<br>- ABS<br>- ABS<br>- ABS   | 83.7824-0180.3<br>330812         | 2                |        | L=180                       |                |     |
|  | 1.6<br>2.0<br>2.0<br>2.0<br>2.0<br>2.0 16V<br>2.3<br>2.4 D<br>2.4 D<br>2.5 TDI<br>2.6<br>2.8                              | 74<br>74<br>85<br>85   |   |  | 03.92 07.93<br>07.93 07.94<br>12.90 06.93<br>07.93 07.94<br>12.90 06.93<br>01.92 07.94<br>12.90 07.94<br>07.93 07.94<br>05.91 06.93<br>06.91 07.94<br>04.92 07.94<br>12.90 07.94  |  |  |   |                                  | + ABS<br>+ ABS<br>+ ABS<br>+ ABS<br>+ ABS  | 83.7824-0180.3<br>83.7724-0215.3 | 330812<br>330843 | 2<br>2 | am Bremsattel <sup>1)</sup> | L=180<br>L=215 |     |
|    | 1.6<br>2.0<br>2.0<br>2.4 D  | 74<br>85   |   |  | 03.92 07.93<br>12.90 07.93<br>12.90 07.93<br>05.91 07.93  |  |  |   |                                  | - ABS<br>- ABS<br>- ABS<br>- ABS   | 24.3220-0909.3                   | 020210           |        |                             | Rz 20,64       |     |
|    | 1.6<br>2.0<br>2.0<br>2.4 D  | 74<br>85   |   |  | 03.92 07.93<br>12.90 07.93<br>12.90 07.93<br>05.91 07.93  |  |  |   |                                  | - ABS<br>- ABS<br>- ABS<br>- ABS   | 24.3727-0141.2                   | 580141           | 2      |                             | L=1420         |     |
|  | 1.6<br>2.0<br>2.0<br>2.0 16V<br>2.3<br>2.4 D<br>2.5 TDI<br>2.6<br>2.8   | 74<br>85   | 4A-P-078948<br>4A-P-078948<br>4A-P-078948<br>4A-P-078948<br>4A-P-078948<br>4A-P-078948<br>4A-P-078948<br>4A-P-078948<br>4A-P-078948 |  | 03.92<br>12.90<br>12.90<br>01.92<br>12.90<br>05.91<br>06.91<br>04.92<br>12.90   |  |  |   |                                  | + ABS<br>+ ABS<br>+ ABS<br>+ ABS   | 24.3727-0142.2                   | 580142           | 2      |                             | L=1476         |     |
|  | 1.6<br>2.0<br>2.0<br>2.0<br>2.0 16V<br>2.3<br>2.4 D<br>2.4 D<br>2.5 TDI<br>2.6<br>2.8                                     | 4A-P-078949<br>74<br>74<br>85<br>85<br>4A-P-078949<br>4A-P-078949<br>4A-P-078949<br>4A-P-078949<br>4A-P-078949<br>4A-P-078949<br>4A-P-078949 |   |  | 07.93<br>07.93<br>07.93<br>06.93<br>07.94<br>07.94<br>07.94<br>06.93<br>07.94<br>07.94<br>07.94   |  |  |   |                                  | + ABS<br>+ ABS<br>+ ABS<br>+ ABS   | 24.3727-0154.2                   | 580154           | 2      |                             | L=1491         |     |
|  | 1.6<br>2.0<br>2.0 16V<br>2.3<br>2.4 D<br>2.5 TDI<br>2.6<br>2.8  |  |   |  | 03.92 07.93<br>12.90 07.94<br>01.92 07.94<br>12.90 07.94<br>05.91 07.94<br>06.91 07.94<br>04.92 07.94<br>12.90 07.94  |  |  |   |                                  | - Niveauregulierung <sup>2)</sup><br>- Niveauregulierung <sup>2)</sup><br>- Niveauregulierung <sup>2)</sup><br>- Niveauregulierung <sup>2)</sup><br>- Niveauregulierung <sup>2)</sup><br>- Niveauregulierung <sup>2)</sup> | 03.6585-0108.3                   | 320115           |        |                             | BRL 8/5 (4)    | ATE |
|  | 1.6<br>2.0<br>2.0<br>2.0 16V<br>2.0 16V<br>2.3<br>2.3<br>2.4 D<br>2.4 D<br>2.5 TDI<br>2.5 TDI<br>2.6<br>2.6<br>2.8<br>2.8 |  |   |  | 03.92 09.92<br>12.90 07.94<br>12.90 09.92<br>01.92 07.94<br>01.92 09.92<br>12.90 07.94<br>12.90 09.92<br>05.91 07.94<br>05.91 09.92<br>06.91 07.94<br>06.91 09.92<br>04.92 07.94<br>04.92 09.92<br>12.90 07.94<br>12.90 09.92 |  |  |   |                                  |  | 03.2419-9610.3                   | 030029           |        |                             | Gz 19,05       |     |
|  | 1.6<br>2.0<br>2.0 16V<br>2.3<br>2.4 D<br>2.5 TDI<br>2.6<br>2.8  |  |   |  | 10.92 07.93<br>10.92 07.94<br>10.92 07.94<br>10.92 07.94<br>10.92 07.94<br>10.92 07.94<br>10.92 07.94<br>10.92 07.94  |  |  |   |                                  |  | 24.2419-1731.3                   | 030121           |        |                             | Gz 19,05       |     |
|  | 1.6<br>2.0<br>2.0 16V<br>2.3<br>2.4 D<br>2.5 TDI<br>2.6   |  |   |  | 03.92 07.93<br>12.90 07.94<br>01.92 07.94<br>12.90 07.94<br>05.91 07.94<br>06.91 07.94<br>04.92 07.94   |  |  |   |                                  |  | 03.2522-4300.3                   | 040085           |        |                             | Nz 22,20       |     |

<sup>1)</sup> on the brake caliper / sulla pinza freno / sur l'étrier de frein / a la pinza de freno

<sup>2)</sup> - suspension level control / - correttore assetto / - correcteur d'assiette / - regulación altura suspensión

| 🔧                                   | 🚚  | 🚗   | 📺  | 📑   | 📍  | 🔍       | 🔧  | 🔑  |   |
|-------------------------------------|--|-----|--|---|--|---------|--|--|---|
| <b>AUDI 100 (91-94)</b>             |  |     |  |   |  |         |  |  |   |
| 🔧                                   | 2.8  |     |  | 12.90   | 07.94  |         | 03.2522-4300.3   | 040085   | Nz 22,20  |
| <b>AUDI 100 Quattro (91-94)</b>     |  |     |  |   |  |         |  |  |   |
| 🔧                                   | S4 2.2<br>S4 4.2   | 169 |  | 08.91<br>10.92  | 07.94<br>07.94   |         | 10.0124-3202.3   | 340011   | Hydraulik Verstärker  |
| 🔧                                   | 2.0<br>2.3<br>2.6<br>2.8   |     |  | 12.90<br>12.90<br>03.92<br>12.90  | 07.94<br>07.94<br>07.94<br>07.94                                     |         | 24.2123-1601.3   | 010383   | Thz 23,81 <b>LUC</b>  |
| 🔧                                   | S4 2.2<br>S4 4.2   | 169 |  | 08.91<br>10.92  | 07.94<br>07.94   |         | 03.2125-3610.3   | 010214   | Thz 25,40 <b>ATE</b>  |
| 🔧                                   | 2.0<br>2.3   |     |  | 12.90<br>12.90  | 07.94<br>07.94   |         | 11.3571-8506.2<br>24.3571-8505.5<br>24.3571-8506.5<br>11.0441-5704.2<br>11.0101-5409.2<br>11.8171-0008.1<br>11.8116-0143.1                                     | 220126<br>240489<br>240490<br>250034<br>260035<br>990049<br>390513                     | D=57, - Halter <b>ATE</b><br>D=57, - Halter <b>ATE</b><br>D=57, - Halter <b>ATE</b><br>Dichtungssatz <b>ATE</b><br>Hülssensatz <b>ATE</b><br>Führungsbolzen <b>ATE</b><br>Haltefeder <b>ATE</b>   |
|                                     | 2.6<br>2.8   |     |  | 03.92<br>12.90  | 07.94<br>07.94   |         | 11.3571-8507.2<br>11.3571-8508.2<br>24.3571-8507.5<br>24.3571-8508.5<br>11.8170-0306.1<br>11.0441-5704.2<br>11.0101-5409.2<br>11.8171-0008.1<br>11.8116-0143.1 | 220127<br>220128<br>240555<br>240556<br>260102<br>250034<br>260035<br>990049<br>390513 | D=57, - Halter <b>ATE</b><br>D=57, - Halter <b>ATE</b><br>D=57, - Halter <b>ATE</b><br>D=57, - Halter <b>ATE</b><br>Halter <b>ATE</b><br>Dichtungssatz <b>ATE</b><br>Hülssensatz <b>ATE</b><br>Führungsbolzen <b>ATE</b><br>Haltefeder <b>ATE</b> |
| 🔧                                   | S4 2.2   | 169 | 4A-P-150000  | 08.91   |  |         | 11.0441-6003.2   | 250037   | Dichtungssatz   |
| 🔧                                   | 2.0<br>2.3<br>2.6<br>2.8   |     |  | 12.90<br>12.90<br>03.92<br>12.90  | 07.94<br>07.94<br>07.94<br>07.94                                     |         | 83.7813-0270.3   | 330797   | L=270   |
|                                     | S4 2.2<br>S4 4.2   | 169 |  | 08.91<br>10.92  | 07.94<br>07.94   |         |  |  |   |
| 🔧                                   | 2.0<br>2.3<br>2.6<br>2.8   |     |  | 12.90<br>12.90<br>03.92<br>12.90  | 07.94<br>07.94<br>07.94<br>07.94                                     |         | 24.3384-1704.5<br>24.3384-1703.5<br>24.0101-3601.2   | 240056<br>240055<br>260044   | D=38, - Halter <b>LUC</b><br>D=38, - Halter <b>LUC</b><br>Einbausatz <b>LUC</b>   |
|                                     | S4 2.2<br>S4 4.2   | 169 |  | 08.91<br>10.92  | 07.94<br>07.94   |         | 24.3434-1702.5<br>24.3434-1701.5<br>11.0101-5403.2   | 240358<br>240357<br>260010   | D=43, - Halter <b>LUC</b><br>D=43, - Halter <b>LUC</b><br>Faltenbalgsatz <b>LUC</b>   |
| 🔧                                   | 2.0<br>2.3<br>2.8  |     | 4A-M-150000<br>4A-M-150000<br>4A-M-150000  | 12.90<br>12.90<br>12.90   |  |         | 83.7724-0215.3   | 330843   | L=215   |
|                                     | 2.0<br>2.3<br>2.6<br>2.8<br>S4 2.2<br>S4 4.2                             | 169 | 4A-N-000001<br>4A-N-000001<br>4A-N-000001  | 03.92<br>08.91<br>10.92   | 07.94<br>07.94<br>07.94<br>07.94                                     |         | 83.6134-0205.3   | 330380   | L=205   |
| 🔧                                   | 2.0<br>2.0<br>2.3<br>2.3<br>2.6<br>2.6<br>2.8<br>2.8<br>S4 2.2<br>S4 2.2 |     | 4A-P-038000<br>4A-P-038000<br>4A-P-038000<br>4A-P-038000<br>4A-P-038000<br>4A-P-038000 | 12.90<br>12.90<br>12.90<br>03.92<br>03.92<br>12.90<br>12.90<br>08.91<br>08.91 | 07.94<br>07.94<br>07.94<br>07.94<br>07.94<br>07.94<br>07.94<br>07.94 |         | 03.2419-9610.3   | 030029   | Gz 19,05  |
|                                     | 2.0<br>2.3<br>2.6<br>2.8<br>S4 2.2                                       | 169 | 4A-P-038001<br>4A-P-038001<br>4A-P-038001<br>4A-P-038001                               | 07.94<br>07.94<br>07.94<br>07.94  |  |         | 24.2419-1731.3   | 030121   | Gz 19,05  |
| 🔧                                   | 2.0<br>2.3<br>2.6<br>2.8<br>S4 2.2<br>S4 4.2                             | 169 |  | 12.90<br>12.90<br>03.92<br>12.90<br>08.91<br>12.90                            | 07.94<br>07.94<br>07.94<br>07.94<br>07.94<br>07.94                   |         | 03.2522-4300.3   | 040085   | Nz 22,20  |
| <b>AUDI A1 / A1 Sportback (10-)</b> |  |     |  |   |  |         |  |  |   |
| 🔧                                   | 1.2 TFSI   | 63  |  | 05.10   |  | PR: 1ZG | 11.9541-9549.2   | 220575   | D=54, - Halter <b>ATE</b>   |
|                                     | 1.4 TFSI   | 90  |  | 05.10   |  | PR: 1ZG | 11.9541-9550.2   | 220576   | D=54, - Halter <b>ATE</b>   |
|                                     | 1.4 TFSI   | 103 |  | 04.12   |  | PR: 1ZG | 11.0101-5409.2   | 260035   | Hülssensatz <b>ATE</b>  |
|                                     | 1.4 TFSI   | 136 |  | 11.10   |  | PR: 1ZG | 11.8171-0008.1   | 990049   | Führungsbolzen <b>ATE</b>   |
|                                     | 1.6 TDI  | 66  |  | 05.10   |  | PR: 1ZG |  |  |   |
|                                     | 1.6 TDI  | 77  |  | 05.10   |  | PR: 1ZG |  |  |   |
|                                     | 2.0 TDI  | 105 |  | 09.11   |  | PR: 1ZG |  |  |   |
| 2.0 TFSI quattro                    | 188  |     | 10.12  |   | PR: 1ZG  |         |  |  |   |



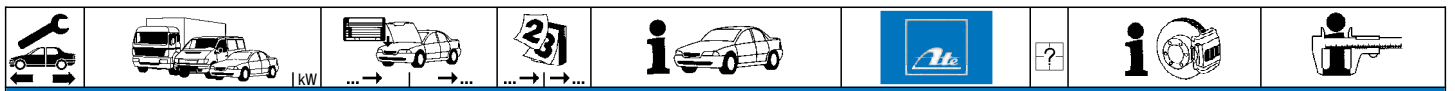

**AUDI A1 / A1 Sportback (10-)**

|                  |                  |     |       |         |               |                |        |  |  |                          |  |  |                          |  |                              |            |   |       |  |
|------------------|------------------|-----|-------|---------|---------------|----------------|--------|--|--|--------------------------|--|--|--------------------------|--|------------------------------|------------|---|-------|--|
|                  | 1.2 TFSI         | 63  |       | 05.10   | PR: 1ZC       | 11.9541-9553.2 | 220563 | <input type="checkbox"/><br><input type="checkbox"/> | D=54, - Halter<br>D=54, - Halter<br>Hülsensatz<br>Führungsbolzen | ATE<br>ATE<br>ATE<br>ATE |  |  |                          |  |                              |            |   |       |  |
|                  | 1.4 TFSI         | 90  |       | 05.10   | PR: 1ZC       | 11.9541-9554.2 | 220564 |  |  |                          |  |  |                          |  |                              |            |   |       |  |
|                  | 1.4 TFSI         | 103 |       | 04.12   | PR: 1ZC       | 11.0101-5409.2 | 260035 |  |  |                          |  |  |                          |  |                              |            |   |       |  |
|                  | 1.4 TFSI         | 136 |       | 11.10   | PR: 1ZC       | 11.8171-0008.1 | 990049 |  |  |                          |  |  |                          |  |                              |            |   |       |  |
|                  | 1.6 TDI          | 66  |       | 05.10   | PR: 1ZC       |                |        |  |  |                          |  |  |                          |  |                              |            |   |       |  |
|                  | 1.6 TDI          | 77  |       | 05.10   | PR: 1ZC       |                |        |  |  |                          |  |  |                          |  |                              |            |   |       |  |
|                  | 2.0 TDI          | 105 |       | 09.11   | PR: 1ZC       |                |        |  |  |                          |  |  |                          |  |                              |            |   |       |  |
|                  | 2.0 TFSI quattro | 188 |       | 10.12   | PR: 1ZC       |                |        |  |  |                          |  |  |                          |  |                              |            |   |       |  |
|                  | 1.2 TFSI         | 63  |       | 05.10   | PR: 1ZS       | 11.9541-9553.2 | 220563 |  |  |                          | <input type="checkbox"/><br><input type="checkbox"/> | D=54, - Halter<br>D=54, - Halter<br>Haltefeder<br>Hülsensatz<br>Führungsbolzen | ATE<br>ATE<br>ATE<br>ATE |  |                              |            |   |       |  |
|                  | 1.4 TFSI         | 90  |       | 05.10   | PR: 1ZS       | 11.9541-9554.2 | 220564 |  |  |                          |  |  |                          |  |                              |            |   |       |  |
|                  | 1.4 TFSI         | 103 |       | 04.12   | PR: 1ZS       | 11.8116-0351.1 | 390538 |  |  |                          |  |  |                          |  |                              |            |   |       |  |
|                  | 1.4 TFSI         | 136 |       | 11.10   | PR: 1ZS       | 11.0101-5407.2 | 260011 |  |  |                          |  |  |                          |  |                              |            |   |       |  |
|                  | 1.6 TDI          | 66  |       | 05.10   | PR: 1ZS       | 11.8171-0008.1 | 990049 |  |  |                          |  |  |                          |  |                              |            |   |       |  |
|                  | 1.6 TDI          | 77  |       | 05.10   | PR: 1ZS       |                |        |  |  |                          |  |  |                          |  |                              |            |   |       |  |
|                  | 2.0 TDI          | 105 |       | 09.11   | PR: 1ZS       |                |        |  |  |                          |  |  |                          |  |                              |            |   |       |  |
|                  | 2.0 TFSI quattro | 188 |       | 10.12   | PR: 1ZS       |                |        |  |  |                          |  |  |                          |  |                              |            |   |       |  |
|                  | 1.2 TFSI         | 63  |       | 05.10   | PR: 1LJ       | 11.0101-5407.2 | 260011 |  |  |                          |  |  |                          | <input type="checkbox"/><br><input type="checkbox"/> | Hülsensatz<br>Führungsbolzen | ATE<br>ATE |   |       |  |
|                  | 1.4 TFSI         | 90  |       | 05.10   | PR: 1LJ       | 11.8171-0008.1 | 990049 |  |  |                          |  |  |                          |  |                              |            |   |       |  |
|                  | 1.4 TFSI         | 103 |       | 04.12   | PR: 1LJ       |                |        |  |  |                          |  |  |                          |  |                              |            |   |       |  |
|                  | 1.4 TFSI         | 136 |       | 11.10   | PR: 1LJ       |                |        |  |  |                          |  |  |                          |  |                              |            |   |       |  |
|                  | 1.6 TDI          | 66  |       | 05.10   | PR: 1LJ       |                |        |  |  |                          |  |  |                          |  |                              |            |   |       |  |
|                  | 1.6 TDI          | 77  |       | 05.10   | PR: 1LJ       |                |        |  |  |                          |  |  |                          |  |                              |            |   |       |  |
|                  | 2.0 TDI          | 105 |       | 09.11   | PR: 1LJ       |                |        |  |  |                          |  |  |                          |  |                              |            |   |       |  |
|                  | 2.0 TFSI quattro | 188 |       | 10.12   | PR: 1LJ       |                |        |  |  |                          |  |  |                          |  |                              |            |   |       |  |
|                  | 1.2 TFSI         | 63  |       | 05.10   | 05.11 PR: 1KT | 83.7858-0140.3 | 330837 | 2  | L=140  |                          |  |  |                          |  |                              |            |   |       |  |
|                  | 1.4 TFSI         | 90  |       | 05.10   | 05.11 PR: 1KT |                |        |  |  |                          |  |  |                          |  |                              |            |   |       |  |
|                  | 1.4 TFSI         | 136 |       | 11.10   | 05.11 PR: 1KT |                |        |  |  |                          |  |  |                          |  |                              |            |   |       |  |
|                  | 1.6 TDI          | 66  |       | 05.10   | 05.11 PR: 1KT |                |        |  |  |                          |  |  |                          |  |                              |            |   |       |  |
|                  | 1.6 TDI          | 77  |       | 05.10   | 05.11 PR: 1KT |                |        |  |  |                          |  |  |                          |  |                              |            |   |       |  |
|                  | 1.2 TFSI         | 63  |       | 06.11   | PR: 1KT       | 83.7858-0140.3 | 330837 |  |  |                          |  |  |                          |  |                              |            | 2 | L=140 |  |
|                  | 1.4 TFSI         | 90  |       | 06.11   | PR: 1KT       |                |        |  |  |                          |  |  |                          |  |                              |            |   |       |  |
|                  | 1.4 TFSI         | 103 |       | 04.12   | PR: 1KT       |                |        |  |  |                          |  |  |                          |  |                              |            |   |       |  |
|                  | 1.4 TFSI         | 136 |       | 06.11   | PR: 1KT       |                |        |  |  |                          |  |  |                          |  |                              |            |   |       |  |
|                  | 1.6 TDI          | 66  |       | 06.11   | PR: 1KT       |                |        |  |  |                          |  |  |                          |  |                              |            |   |       |  |
|                  | 1.6 TDI          | 77  |       | 06.11   | PR: 1KT       |                |        |  |  |                          |  |  |                          |  |                              |            |   |       |  |
|                  | 2.0 TDI          | 105 |       | 09.11   | PR: 1KT       |                |        |  |  |                          |  |  |                          |  |                              |            |   |       |  |
| 2.0 TFSI quattro | 188              |     | 10.12 | PR: 1KT |               |                |        |  |  |                          |  |  |                          |  |                              |            |   |       |  |

**AUDI A2 (00-05)**

|         |         |             |             |       |                |                |                |  |  |  |  |
|---------|---------|-------------|-------------|-------|----------------|----------------|----------------|--|--|--|--|
|         | 1.2 TDI | 45          | 8Z-2-013000 | 03.01 |                | 03.7853-0202.4 | 300181         | <input type="checkbox"/><br><input type="checkbox"/> | 9"   | ATE  |  |
|         | 1.4     | 55          | 8Z-2-013000 | 06.00 |                |                |                |  |  |  |  |
|         | 1.4 TDI | 55          | 8Z-2-013000 | 06.00 |                |                |                |  |  |  |  |
|         | 1.2 TDI | 45          | 8Z-2-013001 |       | 07.05          | 03.7850-0102.4 | 300180         | <input type="checkbox"/><br><input type="checkbox"/> | 9"   | ATE  |  |
|         | 1.4     | 55          | 8Z-2-013001 |       | 07.05          |                |                |  |  |  |  |
|         | 1.4 TDI | 55          | 8Z-2-013001 |       | 07.05          |                |                |  |  |  |  |
|         | 1.4 TDI | 66          |             | 11.03 | 07.05          |                |                |  |  |  |  |
|         | 1.6 FSI | 81          |             | 05.02 | 07.05          |                |                |  |  |  |  |
|         | 1.2 TDI | 45          | 8Z-2-013000 | 03.01 |                | 03.2122-1663.3 | 010734         |  |  |  | <input type="checkbox"/><br><input type="checkbox"/> |
| 1.4     | 55      | 8Z-2-013000 | 06.00       |       |                |                |                |  |  |  |  |
| 1.4 TDI | 55      | 8Z-2-013000 | 06.00       |       |                |                |                |  |  |  |  |
| 1.2 TDI | 45      | 8Z-3-019000 |             |       | 03.2122-1883.3 | 010735         |                |  |  |  |  |
| 1.4     | 55      | 8Z-2-013001 | 8Z-3-019000 |       |                |                |                |  |  |  |  |
| 1.4 TDI | 55      | 8Z-2-013001 | 8Z-3-019000 |       |                |                |                |  |  |  |  |
| 1.6 FSI | 81      |             | 8Z-3-019000 | 05.02 |                |                |                |  |  |  |  |
|         | 1.2 TDI | 45          | 8Z-3-019001 |       | 07.05          | 03.2122-1888.3 | 010736         | <input type="checkbox"/><br><input type="checkbox"/> | THz 22,20  | ATE  |  |
|         | 1.4     | 55          | 8Z-3-019001 |       | 07.05          |                |                |  |  |  |  |
|         | 1.4 TDI | 55          | 8Z-3-019001 |       | 07.05          |                |                |  |  |  |  |
|         | 1.4 TDI | 66          |             | 11.03 | 07.05          |                |                |  |  |  |  |
|         | 1.6 FSI | 81          | 8Z-3-019001 |       | 07.05          |                |                |  |  |  |  |
|         | 1.2 TDI | 45          |             |       | 03.01          | 07.05          | 11.9486-0009.2 |  |  |  | 220841   |
| 1.4     | 55      |             |             | 06.00 | 07.05          | 11.9486-0010.2 | 220842         |  |  |  |  |
| 1.4 TDI | 55      |             |             | 06.00 | 07.05          | 11.9541-9549.2 | 220575         |  |  |  |  |
| 1.4 TDI | 66      |             |             | 11.03 | 07.05          | 11.9541-9550.2 | 220576         |  |  |  |  |
| 1.4 TDI | 81      |             |             | 05.02 | 07.05          | 11.0101-5409.2 | 260035         |  |  |  |  |
| 1.6 FSI | 81      |             |             | 05.02 | 07.05          | 11.8171-0008.1 | 990049         |  |  |  |  |
|         | 1.2 TDI | 45          |             |       | 03.01          | 07.05          | 83.6243-0385.3 | 330632   | 2  | L=385  |  |
|         | 1.4     | 55          |             |       | 06.00          | 07.05          | 83.6238-0508.3 | 330631   |  |  |  |
|         | 1.4 TDI | 55          |             |       | 06.00          | 07.05          |                |  |  |  |  |
|         | 1.4 TDI | 66          |             |       | 11.03          | 07.05          |                |  |  |  |  |
|         | 1.6 FSI | 81          |             |       | 05.02          | 07.05          |                |  |  |  |  |
|         | 1.4 TDI | 66          |             |       | 11.03          | 07.05          | 24.3344-1709.7 | 220537   | <input type="checkbox"/><br><input type="checkbox"/> | D=34, - Halter<br>D=34, - Halter                     | LUC<br>LUC   |
|         | 1.6 FSI | 81          |             |       | 05.02          | 07.05          | 24.3344-1710.7 | 220538   |  |  |  |
|         | 1.2 TDI | 45          |             |       | 03.01          | 07.05          | 24.5242-0190.3 | 330675   | 2  | L=190  |  |
|         | 1.4     | 55          |             |       | 06.00          | 07.05          |                |  |  |  |  |
|         | 1.4 TDI | 55          |             |       | 06.00          | 07.05          |                |  |  |  |  |
|         | 1.4 TDI | 66          |             |       | 11.03          | 07.05          |                |  |  |  |  |
|         | 1.6 FSI | 81          |             |       | 05.02          | 07.05          |                |  |  |  |  |
|         | 1.2 TDI | 45          |             |       | 03.01          | 07.05          | PR: 1KR        | 24.3215-0903.3                                       | 020154   | <input type="checkbox"/><br><input type="checkbox"/> | Rz 15,87   |
|         | 1.4 TDI | 55          |             |       | 06.00          | 07.05          | PR: 1KR        | 24.3217-0908.3                                       | 020167   |  |  |
|         | 1.4     | 55          |             |       | 06.00          | 07.05          | PR: 1KB        |  |  |  |  |
|         | 1.4 TDI | 55          |             |       | 06.00          | 07.05          | PR: 1KB        |  |  |  |  |





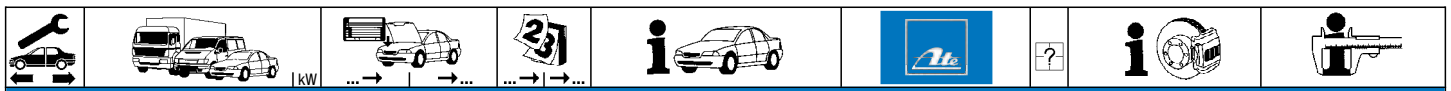











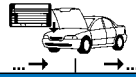

**AUDI A2 (00-05)**

|  |         |    |             |       |       |                |                |        |                          |        |
|--|---------|----|-------------|-------|-------|----------------|----------------|--------|--------------------------|--------|
|  | 1.2 TDI | 45 | 8Z-3-010000 | 03.01 |       | 24.3727-0100.2 | 580100         | 2 ↓    |                          | L=1075 |
|  | 1.4     | 55 | 8Z-3-010000 | 06.00 |       |                |                |        |                          |        |
|  | 1.4 TDI | 55 | 8Z-3-010000 | 06.00 |       |                |                |        |                          |        |
|  | 1.2 TDI | 45 | 8Z-3-010001 |       | 07.05 |                | 24.3727-0185.2 | 580185 | <input type="checkbox"/> | L=1056 |
|  | 1.4     | 55 | 8Z-3-010001 |       | 07.05 |                | 24.3727-0100.2 | 580100 | <input type="checkbox"/> | L=1075 |
|  | 1.4 TDI | 55 | 8Z-3-010001 |       | 07.05 |                |                |        |                          |        |

**AUDI A3 (96-03)**

|                 |                 |             |             |             |                |                |        |  |           |           |     |
|-----------------|-----------------|-------------|-------------|-------------|----------------|----------------|--------|--|-----------|-----------|-----|
|                 | 1.6             | 75          |             | 09.96       | 08.00 + ESP    | 03.7863-0402.4 | 300124 |  |           | 10"       | ATE |
|                 | 1.8             | 92          |             | 09.96       | 08.00 + ESP    |                |        |  |           |           |     |
|                 | 1.8 quattro     | 92          |             | 08.98       | 08.00 + ESP    |                |        |  |           |           |     |
|                 | 1.8 T           | 110         |             | 12.96       | 08.00 + ESP    |                |        |  |           |           |     |
|                 | 1.8 T           | 132         |             | 12.98       | 08.00 + ESP    |                |        |  |           |           |     |
|                 | 1.8 T quattro   | 110         |             | 08.98       | 08.00 + ESP    |                |        |  |           |           |     |
|                 | 1.8 T quattro   | 132         |             | 10.98       | 08.00 + ESP    |                |        |  |           |           |     |
|                 | 1.9 TDI         | 66          |             | 09.96       | 08.00 + ESP    |                |        |  |           |           |     |
|                 | 1.9 TDI         | 81          |             | 03.97       | 08.00 + ESP    |                |        |  |           |           |     |
|                 | S3 quattro      |             |             | 08.98       | 08.00 + ESP    |                |        |  |           |           |     |
|                 | 1.6             | 75          | 8L-2-037877 | 09.00       | + ESP          | 03.7860-0602.4 | 300141 |  |           | 10"       | ATE |
|                 | 1.8             | 92          | 8L-2-037877 | 09.00       | + ESP          |                |        |  |           |           |     |
|                 | 1.8 quattro     | 92          | 8L-2-037877 | 09.00       | + ESP          |                |        |  |           |           |     |
|                 | 1.8 T           | 110         | 8L-2-037877 | 09.00       | + ESP          |                |        |  |           |           |     |
|                 | 1.8 T           | 132         | 8L-2-037877 | 09.00       | + ESP          |                |        |  |           |           |     |
| 1.8 T quattro   | 110             | 8L-2-037877 | 09.00       | + ESP       |                |                |        |  |           |           |     |
| 1.8 T quattro   | 132             | 8L-2-037877 | 09.00       | + ESP       |                |                |        |  |           |           |     |
| 1.9 TDI         | 66              |             | 09.00       | 06.01 + ESP |                |                |        |  |           |           |     |
| 1.9 TDI         | 74              | 8L-2-037877 | 09.00       | + ESP       |                |                |        |  |           |           |     |
| 1.9 TDI         | 81              |             | 09.00       | 06.01 + ESP |                |                |        |  |           |           |     |
| 1.9 TDI         | 96              | 8L-2-037877 | 09.00       | + ESP       |                |                |        |  |           |           |     |
| 1.9 TDI quattro | 96              | 8L-2-037877 | 09.00       | + ESP       |                |                |        |  |           |           |     |
| S3 quattro      |                 | 8L-2-037877 | 09.00       | + ESP       |                |                |        |  |           |           |     |
| 1.6             | 75              | 8L-2-037878 |             | 06.03 + ESP | 03.7863-3502.4 | 300128         |        |  | 10"       | ATE       |     |
| 1.8             | 92              | 8L-2-037878 |             | 06.03 + ESP |                |                |        |  |           |           |     |
| 1.8 quattro     | 92              | 8L-2-037878 |             | 06.03 + ESP |                |                |        |  |           |           |     |
| 1.8 T           | 110             | 8L-2-037878 |             | 06.03 + ESP |                |                |        |  |           |           |     |
| 1.8 T           | 132             | 8L-2-037878 |             | 06.03 + ESP |                |                |        |  |           |           |     |
| 1.8 T quattro   | 110             | 8L-2-037878 |             | 06.03 + ESP |                |                |        |  |           |           |     |
| 1.8 T quattro   | 132             | 8L-2-037878 |             | 06.03 + ESP |                |                |        |  |           |           |     |
| 1.9 TDI         | 74              | 8L-2-037878 |             | 06.03 + ESP |                |                |        |  |           |           |     |
| 1.9 TDI         | 96              | 8L-2-037878 |             | 06.03 + ESP |                |                |        |  |           |           |     |
| 1.9 TDI quattro | 96              | 8L-2-037878 |             | 06.03 + ESP |                |                |        |  |           |           |     |
| S3 quattro      |                 | 8L-2-037878 |             | 06.03 + ESP |                |                |        |  |           |           |     |
|                 | 1.6             | 75          |             | 09.96       | 06.03 - ESP    | 24.2123-1709.3 | 010503 |  |           | Thz 23,81 |     |
|                 | 1.8             | 92          |             | 09.96       | 06.03 - ESP    |                |        |  |           |           |     |
|                 | 1.8 quattro     | 92          |             | 08.98       | 06.03 - ESP    |                |        |  |           |           |     |
|                 | 1.8 T           | 110         |             | 12.96       | 06.03 - ESP    |                |        |  |           |           |     |
|                 | 1.8 T           | 132         |             | 12.98       | 06.03 - ESP    |                |        |  |           |           |     |
|                 | 1.8 T quattro   | 110         |             | 08.98       | 06.03 - ESP    |                |        |  |           |           |     |
|                 | 1.8 T quattro   | 132         |             | 10.98       | 06.03 - ESP    |                |        |  |           |           |     |
|                 | 1.9 TDI         | 66          |             | 09.96       | 06.01 - ESP    |                |        |  |           |           |     |
|                 | 1.9 TDI         | 74          |             | 09.00       | 06.03 - ESP    |                |        |  |           |           |     |
|                 | 1.9 TDI         | 81          |             | 03.97       | 06.01 - ESP    |                |        |  |           |           |     |
|                 | 1.9 TDI         | 96          |             | 09.00       | 06.03 - ESP    |                |        |  |           |           |     |
|                 | 1.9 TDI quattro | 96          |             | 09.00       | 06.03 - ESP    |                |        |  |           |           |     |
|                 | S3 quattro      |             |             | 08.98       | 06.03 - ESP    |                |        |  |           |           |     |
|                 | 1.6             | 75          |             | 09.96       | 08.00 + ESP    | 03.2123-2024.3 | 010597 |  |           | Thz 23,81 | ATE |
|                 | 1.8             | 92          |             | 09.96       | 08.00 + ESP    |                |        |  |           |           |     |
| 1.8 T           | 110             |             | 12.96       | 08.00 + ESP |                |                |        |  |           |           |     |
| 1.8 T           | 132             |             | 12.98       | 08.00 + ESP |                |                |        |  |           |           |     |
| 1.9 TDI         | 66              |             | 09.96       | 08.00 + ESP |                |                |        |  |           |           |     |
| 1.9 TDI         | 81              |             | 03.97       | 08.00 + ESP |                |                |        |  |           |           |     |
| S3 quattro      |                 |             | 08.98       | 08.00 + ESP |                |                |        |  |           |           |     |
| 1.6             | 75              |             | 09.00       | 06.03 + ESP | 03.2123-2715.3 | 010802         |        |  | Thz 23,81 | ATE       |     |
| 1.8             | 92              |             | 09.00       | 06.03 + ESP |                |                |        |  |           |           |     |
| 1.8 quattro     | 92              |             | 09.00       | 06.03 + ESP |                |                |        |  |           |           |     |
| 1.8 T           | 110             |             | 09.00       | 06.03 + ESP |                |                |        |  |           |           |     |
| 1.8 T           | 132             |             | 09.00       | 06.03 + ESP |                |                |        |  |           |           |     |
| 1.8 T quattro   | 110             |             | 09.00       | 06.03 + ESP |                |                |        |  |           |           |     |
| 1.8 T quattro   | 132             |             | 09.00       | 06.03 + ESP |                |                |        |  |           |           |     |
| 1.9 TDI         | 66              |             | 09.00       | 06.01 + ESP |                |                |        |  |           |           |     |
| 1.9 TDI         | 74              |             | 09.00       | 06.03 + ESP |                |                |        |  |           |           |     |
| 1.9 TDI         | 81              |             | 09.00       | 06.01 + ESP |                |                |        |  |           |           |     |
| 1.9 TDI         | 96              |             | 09.00       | 06.03 + ESP |                |                |        |  |           |           |     |
| 1.9 TDI quattro | 96              |             | 09.00       | 06.03 + ESP |                |                |        |  |           |           |     |
| S3 quattro      |                 |             | 09.00       | 06.03 + ESP |                |                |        |  |           |           |     |
| 1.6             | 75              |             | 09.96       | 08.00 + ESP | 03.2123-2064.3 | 010598         |        |  | Thz 23,81 | ATE       |     |
| 1.8             | 92              |             | 09.96       | 08.00 + ESP |                |                |        |  |           |           |     |
| 1.8 quattro     | 92              |             | 08.98       | 08.00 + ESP |                |                |        |  |           |           |     |
| 1.8 T           | 110             |             | 12.96       | 08.00 + ESP |                |                |        |  |           |           |     |
| 1.8 T           | 132             |             | 12.98       | 08.00 + ESP |                |                |        |  |           |           |     |
| 1.8 T quattro   | 110             |             | 08.98       | 08.00 + ESP |                |                |        |  |           |           |     |
| 1.8 T quattro   | 132             |             | 10.98       | 08.00 + ESP |                |                |        |  |           |           |     |
| 1.9 TDI         | 66              |             | 09.96       | 08.00 + ESP |                |                |        |  |           |           |     |
| 1.9 TDI         | 81              |             | 03.97       | 08.00 + ESP |                |                |        |  |           |           |     |
| S3 quattro      |                 |             | 08.98       | 08.00 + ESP |                |                |        |  |           |           |     |
| 1.6             | 75              |             | 09.00       | 06.03 + ESP | 03.2123-2774.3 | 010803         |        |  | Thz 23,81 | ATE       |     |



|     |    |  |    |   |    |    |      |    |
|--|--|--|--|---|---|--|--|--|
| <b>AUDI A3 (96-03)</b>   |  |  |  |   |   |  |  |  |
|    | 1.8<br>1.8 quattro<br>1.8 T<br>1.8 T<br>1.8 T quattro<br>1.8 T quattro<br>1.9 TDI<br>1.9 TDI<br>1.9 TDI<br>1.9 TDI<br>1.9 TDI quattro<br>S3 quattro        | 92<br>92<br>110<br>132<br>110<br>132<br>66<br>74<br>81<br>96<br>96<br>92         |  | 09.00<br>09.00<br>09.00<br>09.00<br>09.00<br>09.00<br>09.00<br>09.00<br>09.00<br>09.00<br>09.00<br>09.00                            | 06.03 + ESP<br>06.03 + ESP<br>06.03 + ESP<br>06.03 + ESP<br>06.03 + ESP<br>06.03 + ESP<br>06.01 + ESP<br>06.03 + ESP<br>06.01 + ESP<br>06.03 + ESP<br>06.03 + ESP<br>06.03 + ESP  | 03.2123-2774.3<br>010803   |  | Thz 23,81<br><b>ATE</b>  |
|    | 1.6<br>1.8<br>1.8 T<br>1.9 TDI<br>1.9 TDI  | 75<br>92<br>110<br>66<br>81  | 8L-W-094814<br>8L-W-094814<br>8L-W-094814<br>8L-W-094814<br>8L-W-094814  | 09.96<br>09.96<br>12.96<br>09.96<br>03.97   | PR: 1LQ,1LR,1LS<br>PR: 1LQ,1LR,1LS<br>PR: 1LQ,1LR,1LS<br>PR: 1LQ,1LR,1LS<br>PR: 1LQ,1LR,1LS   | 11.9541-9549.2<br>11.9541-9550.2<br>11.0441-5409.2<br>11.0101-5409.2<br>11.8171-0008.1   | 220575<br>220576<br>250031<br>260035<br>990049   | D=54, - Halter<br>D=54, - Halter<br>Dichtungssatz<br>Hülensatz<br>Führungsbolzen<br><b>ATE</b><br><b>ATE</b><br><b>ATE</b><br><b>ATE</b><br><b>ATE</b>   |
|  | 1.6<br>1.8<br>1.8 quattro<br>1.8 T<br>1.8 T<br>1.8 T quattro<br>1.8 T quattro<br>1.9 TDI<br>1.9 TDI<br>1.9 TDI<br>1.9 TDI<br>1.9 TDI quattro<br>S3 quattro | 75<br>92<br>92<br>110<br>132<br>110<br>132<br>66<br>74<br>81<br>96<br>96         | 8L-W-094815<br>8L-W-094815<br>8L-W-094815<br>8L-W-094815<br>8L-W-094815<br>8L-W-094815<br>8L-W-094815<br>8L-W-094815<br>8L-W-094815<br>8L-W-094815<br>8L-W-094815<br>8L-W-094815 | 09.96<br>06.03<br>08.98<br>06.03<br>12.98<br>08.98<br>10.98<br>06.01<br>09.00<br>06.03<br>09.00<br>06.03<br>08.98                   | PR: 1LQ,1LR,1LS,1ZP<br>PR: 1LQ,1LR,1LS,1ZP<br>PR: 1LQ,1LR,1LS,1ZP<br>PR: 1LQ,1LR,1LS,1ZP<br>PR: 1LQ,1LR,1LS,1ZP<br>PR: 1LQ,1LR,1LS,1ZP<br>PR: 1LQ,1LR,1LS,1ZP<br>PR: 1LQ,1LR,1LS,1ZP<br>PR: 1LQ,1LR,1LS,1ZP<br>PR: 1LQ,1LR,1LS,1ZP<br>PR: 1LQ,1LR,1LS,1ZP<br>PR: 1LQ,1LR,1LS,1ZP<br>PR: 1LQ,1LR,1LS,1ZP | 11.9541-9549.2<br>11.9541-9550.2<br>11.0101-5409.2<br>11.8171-0008.1   | 220575<br>220576<br>260035<br>990049   | D=54, - Halter<br>D=54, - Halter<br>Hülensatz<br>Führungsbolzen<br><b>ATE</b><br><b>ATE</b><br><b>ATE</b><br><b>ATE</b><br><b>ATE</b><br><b>ATE</b><br><b>ATE</b><br><b>ATE</b><br><b>ATE</b>  |
|  | 1.6<br>1.8<br>1.8 quattro<br>1.8 T<br>1.8 T<br>1.8 T quattro<br>1.9 TDI<br>1.9 TDI<br>1.9 TDI<br>1.9 TDI<br>1.9 TDI quattro<br>S3 quattro                  | 75<br>92<br>92<br>110<br>132<br>110<br>132<br>66<br>74<br>81<br>96<br>96         |  | 09.96<br>06.03<br>08.98<br>06.03<br>12.96<br>12.98<br>08.98<br>10.98<br>09.96<br>06.01<br>09.00<br>06.03<br>09.00<br>06.03<br>08.98 | PR: 1LE,1LN,1ZD<br>PR: 1LE,1LN,1ZD<br>PR: 1LE,1LN,1ZD<br>PR: 1LE,1LN,1ZD<br>PR: 1LE,1LN,1ZD<br>PR: 1LE,1LN,1ZD<br>PR: 1LE,1LN,1ZD<br>PR: 1LE,1LN,1ZD<br>PR: 1LE,1LN,1ZD<br>PR: 1LE,1LN,1ZD<br>PR: 1LE,1LN,1ZD<br>PR: 1LE,1LN,1ZD<br>PR: 1LE,1LN,1ZD   | 11.3541-8523.2<br>11.3541-8524.2<br>24.3541-8523.5<br>24.3541-8524.5<br>11.8170-0306.1<br>11.0441-5409.2<br>11.0101-5409.2<br>11.8171-0008.1<br>11.8116-0143.1 | 220115<br>220116<br>240551<br>240552<br>260102<br>250031<br>260035<br>990049<br>390513 | D=54, - Halter<br>D=54, - Halter<br>D=54, - Halter<br>D=54, - Halter<br>Halter<br>Dichtungssatz<br>Hülensatz<br>Führungsbolzen<br>Haltefeder<br><b>ATE</b><br><b>ATE</b><br><b>ATE</b><br><b>ATE</b><br><b>ATE</b><br><b>ATE</b><br><b>ATE</b><br><b>ATE</b><br><b>ATE</b> |
|  | S3 quattro   |  |  | 08.98   | PR: 1LT   | 11.9541-9595.2<br>11.9541-9596.2<br>11.0441-5409.2<br>11.0101-5409.2<br>11.8171-0008.1<br>11.8116-0143.1   | 220501<br>220502<br>250031<br>260035<br>990049<br>390513                               | D=54, - Halter<br>D=54, - Halter<br>Dichtungssatz<br>Hülensatz<br>Führungsbolzen<br>Haltefeder<br><b>ATE</b><br><b>ATE</b><br><b>ATE</b><br><b>ATE</b><br><b>ATE</b>   |
|  | 1.6<br>1.8<br>1.8 T<br>1.8 T<br>1.9 TDI<br>1.9 TDI<br>1.9 TDI<br>1.9 TDI   | 75<br>92<br>110<br>132<br>66<br>74<br>81<br>96                                   |  | 09.96<br>09.96<br>12.96<br>12.98<br>09.96<br>09.00<br>03.97<br>09.00  | 06.03<br>06.03<br>06.03<br>06.03<br>06.01<br>06.03<br>06.01<br>06.03  | 83.7838-0435.3<br>330834   | 2  | L=435  |
|  | 1.8 quattro<br>1.8 T quattro<br>1.8 T quattro<br>1.9 TDI quattro<br>S3 quattro   | 92<br>110<br>132<br>96   |  | 08.98<br>08.98<br>10.98<br>09.00<br>08.98   | 06.03<br>06.03<br>06.03<br>06.03<br>08.00   | 83.6247-0562.3<br>330594   | 2  | L=560  |
|  | S3 quattro   |  |  | 09.00   | 06.03   | 83.6252-0560.3<br>330557   | 2  | L=560  |
|  | 1.6<br>1.8<br>1.8 T<br>1.8 T<br>1.9 TDI<br>1.9 TDI   | 75<br>92<br>110<br>132<br>66<br>81   | 8L-X-200000<br>8L-X-200000<br>8L-X-200000<br>8L-X-200000<br>8L-X-200000<br>8L-X-200000   | 09.96<br>09.96<br>12.96<br>12.98<br>09.96<br>03.97  | PR: 1KK<br>PR: 1KK<br>PR: 1KK<br>PR: 1KK<br>PR: 1KK<br>PR: 1KK  | 24.3384-1723.7<br>24.3384-1724.7   | 220523<br>220524   | D=38(M12x1), - Halter<br>D=38(M12x1), - Halter<br><b>LUC</b><br><b>LUC</b>   |
|  | 1.6<br>1.8<br>1.8 T<br>1.8 T<br>1.9 TDI<br>1.9 TDI<br>1.9 TDI<br>1.9 TDI   | 75<br>92<br>110<br>132<br>66<br>74<br>81<br>96                                   | 8L-Y-000001<br>8L-Y-000001<br>8L-Y-000001<br>8L-Y-000001<br>8L-Y-000001<br>8L-Y-000001<br>8L-Y-000001<br>8L-Y-000001   | 06.03<br>06.03<br>06.03<br>06.03<br>09.00<br>06.01<br>09.00   | PR: 1KK,1KV<br>PR: 1KK,1KV<br>PR: 1KK,1KV<br>PR: 1KK,1KV<br>PR: 1KK,1KV<br>PR: 1KK,1KV<br>PR: 1KK,1KV   | 24.3384-1729.7<br>24.3384-1730.7   | 220541<br>220542   | D=38(M12x1), - Halter<br>D=38(M12x1), - Halter<br><b>LUC</b><br><b>LUC</b>   |
|  | 1.8 quattro<br>1.8 T quattro<br>1.8 T quattro<br>1.9 TDI quattro<br>S3 quattro   | 92<br>110<br>132<br>96   |  | 08.98<br>08.98<br>10.98<br>09.00<br>08.98   | PR: 1KE<br>PR: 1KE<br>PR: 1KE<br>PR: 1KE  | 24.3414-1705.7<br>24.3414-1706.7   | 220549<br>220550   | D=41, - Halter<br>D=41, - Halter<br><b>LUC</b><br><b>LUC</b>   |
|  | S3 quattro   |  |  | 08.98   | PR: 1KF   | 24.3384-1745.7<br>24.3384-1746.7   | 220609<br>220610   | D=38, - Halter<br>D=38, - Halter<br><b>LUC</b><br><b>LUC</b>   |

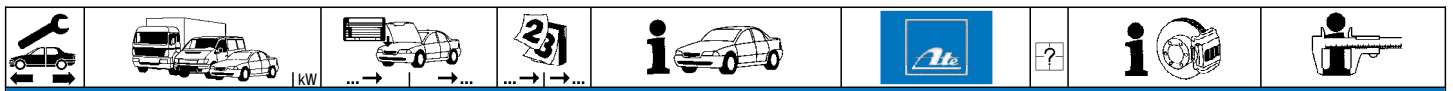

| AUDI A3 (96-03) |                 |             |             |       |       |                |        |     |                                |          |
|-----------------|-----------------|-------------|-------------|-------|-------|----------------|--------|-----|--------------------------------|----------|
|                 | 1.6             | 75          |             | 09.96 | 06.03 | 83.7858-0140.3 | 330837 | 2   |                                | L=140    |
|                 | 1.8             | 92          |             | 09.96 | 06.03 |                |        |     |                                |          |
|                 | 1.8 T           | 110         |             | 12.96 | 06.03 |                |        |     |                                |          |
|                 | 1.8 T           | 132         |             | 12.98 | 06.03 |                |        |     |                                |          |
|                 | 1.9 TDI         | 66          |             | 09.96 | 06.01 |                |        |     |                                |          |
|                 | 1.9 TDI         | 74          |             | 09.00 | 06.03 |                |        |     |                                |          |
|                 | 1.9 TDI         | 81          |             | 03.97 | 06.01 |                |        |     |                                |          |
|                 | 1.9 TDI         | 96          |             | 09.00 | 06.03 |                |        |     |                                |          |
|                 | 1.8 quattro     | 92          |             | 08.98 | 06.03 |                |        |     |                                |          |
|                 | 1.8 T quattro   | 110         |             | 08.98 | 06.03 |                |        |     |                                |          |
| 1.8 T quattro   | 132             |             | 10.98       | 06.03 |       |                |        |     |                                |          |
| 1.9 TDI quattro | 96              |             | 09.00       | 06.03 |       |                |        |     |                                |          |
| S3 quattro      |                 |             | 08.98       | 06.03 |       |                |        |     |                                |          |
|                 | 1.6             | 75          | 8L-X-200000 | 09.96 |       | 24.3727-0149.2 | 580149 | 2 ↓ |                                | L=1688   |
|                 | 1.8             | 92          | 8L-X-200000 | 09.96 |       |                |        |     |                                |          |
|                 | 1.8 T           | 110         | 8L-X-200000 | 12.96 |       |                |        |     |                                |          |
|                 | 1.8 T           | 132         | 8L-X-200000 | 12.98 |       |                |        |     |                                |          |
|                 | 1.9 TDI         | 66          | 8L-X-200000 | 09.96 |       |                |        |     |                                |          |
|                 | 1.9 TDI         | 81          | 8L-X-200000 | 03.97 |       |                |        |     |                                |          |
|                 | 1.6             | 75          | 8L-Y-000001 |       | 06.03 |                |        |     |                                |          |
|                 | 1.8             | 92          | 8L-Y-000001 |       | 06.03 |                |        |     |                                |          |
|                 | 1.8 T           | 110         | 8L-Y-000001 |       | 06.03 |                |        |     |                                |          |
|                 | 1.8 T           | 132         | 8L-Y-000001 |       | 06.03 |                |        |     |                                |          |
| 1.9 TDI         | 66              | 8L-Y-000001 |             | 06.01 |       |                |        |     |                                |          |
| 1.9 TDI         | 74              |             | 09.00       | 06.03 |       |                |        |     |                                |          |
| 1.9 TDI         | 81              | 8L-Y-000001 |             | 06.01 |       |                |        |     |                                |          |
| 1.9 TDI         | 96              |             | 09.00       | 06.03 |       |                |        |     |                                |          |
| 1.8 quattro     | 92              |             | 08.98       | 06.03 |       |                |        |     |                                |          |
| 1.8 T quattro   | 110             |             | 08.98       | 06.03 |       |                |        |     |                                |          |
| 1.8 T quattro   | 132             |             | 10.98       | 06.03 |       |                |        |     |                                |          |
| 1.9 TDI quattro | 96              |             | 09.00       | 06.03 |       |                |        |     |                                |          |
| S3 quattro      |                 |             | 08.98       | 06.03 |       |                |        |     |                                |          |
|                 | 1.6             | 75          |             | 09.96 | 06.03 | 24.2415-1701.3 | 030095 |     |                                | Gz 15,87 |
|                 | 1.8             | 92          |             | 09.96 | 06.03 |                |        |     |                                |          |
|                 | 1.8 quattro     | 92          |             | 08.98 | 06.03 |                |        |     |                                |          |
|                 | 1.8 T           | 110         |             | 12.96 | 06.03 |                |        |     |                                |          |
|                 | 1.8 T           | 132         |             | 12.98 | 06.03 |                |        |     |                                |          |
|                 | 1.8 T quattro   | 110         |             | 08.98 | 06.03 |                |        |     |                                |          |
|                 | 1.8 T quattro   | 132         |             | 10.98 | 06.03 |                |        |     |                                |          |
|                 | 1.9 TDI         | 66          |             | 09.96 | 06.01 |                |        |     |                                |          |
|                 | 1.9 TDI         | 74          |             | 09.00 | 06.03 |                |        |     |                                |          |
|                 | 1.9 TDI         | 81          |             | 03.97 | 06.01 |                |        |     |                                |          |
|                 | 1.9 TDI         | 96          |             | 09.00 | 06.03 |                |        |     |                                |          |
|                 | 1.9 TDI quattro | 96          |             | 09.00 | 06.03 |                |        |     |                                |          |
|                 | S3 quattro      |             |             | 08.98 | 06.03 |                |        |     |                                |          |
|                 | 1.6             | 75          |             | 09.96 | 06.03 |                |        |     |                                |          |
|                 | 1.8             | 92          |             | 09.96 | 06.03 |                |        |     |                                |          |
|                 | 1.8 quattro     | 92          |             | 08.98 | 06.03 |                |        |     |                                |          |
|                 | 1.8 T           | 110         |             | 12.96 | 06.03 |                |        |     |                                |          |
|                 | 1.8 T           | 132         |             | 12.98 | 06.03 |                |        |     |                                |          |
|                 | 1.8 T quattro   | 110         |             | 08.98 | 06.03 |                |        |     |                                |          |
|                 | 1.8 T quattro   | 132         |             | 10.98 | 06.03 |                |        |     |                                |          |
| 1.9 TDI         | 66              |             | 09.96       | 06.01 |       |                |        |     |                                |          |
| 1.9 TDI         | 74              |             | 09.00       | 06.03 |       |                |        |     |                                |          |
| 1.9 TDI         | 81              |             | 03.97       | 06.01 |       |                |        |     |                                |          |
| 1.9 TDI         | 96              |             | 09.00       | 06.03 |       |                |        |     |                                |          |
| 1.9 TDI quattro | 96              |             | 09.00       | 06.03 |       |                |        |     |                                |          |
| S3 quattro      |                 |             | 08.98       | 06.03 |       |                |        |     |                                |          |
|                 | 1.6             | 75          |             | 09.96 | 06.03 | 24.2519-1701.3 | 040075 |     | + Schaltseilzug <sup>1)</sup>  | Nz 19,05 |
|                 | 1.8             | 92          |             | 09.96 | 06.03 |                |        |     |                                |          |
|                 | 1.8 quattro     | 92          |             | 08.98 | 06.03 | 24.2523-1701.3 | 040080 |     | + Schaltgestänge <sup>2)</sup> | Nz 23,81 |
|                 | 1.8 T           | 110         |             | 12.96 | 06.03 |                |        |     |                                |          |
|                 | 1.8 T           | 132         |             | 12.98 | 06.03 |                |        |     |                                |          |
|                 | 1.8 T quattro   | 110         |             | 08.98 | 06.03 |                |        |     |                                |          |
|                 | 1.8 T quattro   | 132         |             | 10.98 | 06.03 |                |        |     |                                |          |
|                 | 1.9 TDI         | 66          |             | 09.96 | 06.01 |                |        |     |                                |          |
|                 | 1.9 TDI         | 74          |             | 09.00 | 06.03 |                |        |     |                                |          |
|                 | 1.9 TDI         | 81          |             | 03.97 | 06.01 |                |        |     |                                |          |
|                 | 1.9 TDI         | 96          |             | 09.00 | 06.03 |                |        |     |                                |          |
|                 | 1.9 TDI quattro | 96          |             | 09.00 | 06.03 |                |        |     |                                |          |
|                 | S3 quattro      |             |             | 08.98 | 06.03 |                |        |     |                                |          |

**AUDI A3 / A3 Sportback (03-13)**

|  |                  |     |  |       |       |                |        |  |  |   |     |
|--|------------------|-----|--|-------|-------|----------------|--------|--|--|---|-----|
|  | 1.2 TSI          | 77  |  | 04.10 | 08.13 | 03.7863-9502.4 | 300204 |  |  | Kolbendurchmesser Ø 22,20mm <sup>3)</sup> 10" | ATE |
|  | 1.4 TFSI         | 92  |  | 07.07 | 08.13 |                |        |  |  |   |     |
|  | 1.6              | 75  |  | 05.03 | 08.13 |                |        |  |  |   |     |
|  | 1.6 FSI          | 85  |  | 08.03 | 08.13 |                |        |  |  |   |     |
|  | 1.6 TDI          | 66  |  | 05.09 | 08.13 |                |        |  |  |   |     |
|  | 1.6 TDI          | 77  |  | 05.09 | 08.13 |                |        |  |  |   |     |
|  | 1.8 TFSI         | 118 |  | 01.07 | 08.13 |                |        |  |  |   |     |
|  | 1.8 TFSI quattro | 118 |  | 05.08 | 08.13 |                |        |  |  |   |     |
|  | 1.9 TDI          | 77  |  | 06.03 | 08.13 |                |        |  |  |   |     |
|  | 2.0 FSI          | 110 |  | 05.03 | 08.13 |                |        |  |  |   |     |
|  | 2.0 TDI          | 100 |  | 05.03 | 08.13 |                |        |  |  |   |     |
|  | 2.0 TDI          | 103 |  | 05.03 | 08.13 |                |        |  |  |   |     |
|  | 2.0 TDI          | 120 |  | 06.06 | 06.08 |                |        |  |  |   |     |

<sup>1)</sup> + gearshift cable / + leva cambio con cavo / + câble de changem.de vitesse / + cable de acc. del cambio  
<sup>2)</sup> + gearshift linkage / + leva cambio con tiranteria / + tige de changem.de vitesse / + varillaje del cambio  
<sup>3)</sup> piston diameter Ø 22,20mm / diametro del pistone Ø 22,20mm / diamètre de piston Ø 22,20mm / diametro del pistón Ø 22,20mm



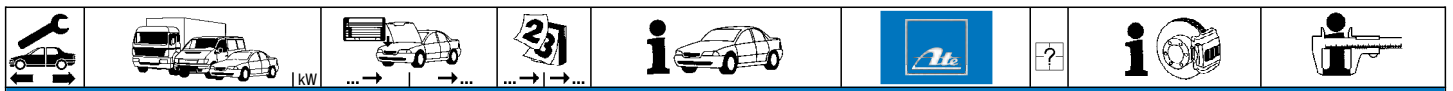

**AUDI A3 / A3 Sportback (03-13)**

|            |                  |             |             |             |       |             |                |        |   |           |     |
|------------|------------------|-------------|-------------|-------------|-------|-------------|----------------|--------|---|-----------|-----|
|            | 2.0 TDI          | 1125        |             | 03.06       | 08.13 | PR: 1AC,1AT | 03.7863-9502.4 | 300204 | Kolbendurchmesser Ø 22,20mm <sup>1)</sup> | 10"       | ATE |
|            | 2.0 TDI quattro  | 1100        |             | 05.03       | 08.13 | PR: 1AC,1AT |                |        |   |           |     |
|            | 2.0 TDI quattro  | 1103        |             | 08.04       | 08.13 | PR: 1AC,1AT |                |        |   |           |     |
|            | 2.0 TDI quattro  | 1125        |             | 03.06       | 08.13 | PR: 1AC,1AT |                |        |   |           |     |
|            | 2.0 TFSI         | 1147        |             | 06.04       | 08.13 | PR: 1AC,1AT |                |        |   |           |     |
|            | 2.0 TFSI quattro | 1147        |             | 06.04       | 08.13 | PR: 1AC,1AT |                |        |   |           |     |
|            | 1.2 TSI          | 77          |             | 04.10       | 08.13 | PR: 1AS     | 03.7863-9602.4 | 300206 | Kolbendurchmesser Ø 22,20mm <sup>1)</sup> | 10"       | ATE |
|            | 1.4 TFSI         | 92          |             | 07.07       | 08.13 | PR: 1AS     |                |        |   |           |     |
|            | 1.6              | 75          |             | 05.03       | 08.13 | PR: 1AS     |                |        |   |           |     |
|            | 1.6 FSI          | 85          |             | 08.03       | 08.13 | PR: 1AS     |                |        |   |           |     |
|            | 1.6 TDI          | 66          |             | 05.09       | 08.13 | PR: 1AS     |                |        |   |           |     |
|            | 1.6 TDI          | 77          |             | 05.09       | 08.13 | PR: 1AS     |                |        |   |           |     |
|            | 1.8 TFSI         | 118         |             | 01.07       | 08.13 | PR: 1AS     |                |        |   |           |     |
|            | 1.8 TFSI quattro | 118         |             | 05.08       | 08.13 | PR: 1AS     |                |        |   |           |     |
|            | 1.9 TDI          | 77          |             | 06.03       | 08.13 | PR: 1AS     |                |        |   |           |     |
|            | 2.0 FSI          | 110         |             | 05.03       | 08.13 | PR: 1AS     |                |        |   |           |     |
|            | 2.0 TDI          | 100         |             | 05.03       | 08.13 | PR: 1AS     |                |        |   |           |     |
|            | 2.0 TDI          | 103         |             | 05.03       | 08.13 | PR: 1AS     |                |        |   |           |     |
|            | 2.0 TDI          | 120         |             | 06.06       | 06.08 | PR: 1AS     |                |        |   |           |     |
|            | 2.0 TDI          | 125         |             | 03.06       | 08.13 | PR: 1AS     |                |        |   |           |     |
|            | 2.0 TDI quattro  | 100         |             | 05.03       | 08.13 | PR: 1AS     |                |        |   |           |     |
|            | 2.0 TDI quattro  | 103         |             | 08.04       | 08.13 | PR: 1AS     |                |        |   |           |     |
|            | 2.0 TDI quattro  | 125         |             | 03.06       | 08.13 | PR: 1AS     |                |        |   |           |     |
|            | 2.0 TFSI         | 147         |             | 06.04       | 08.13 | PR: 1AS     |                |        |   |           |     |
|            | 2.0 TFSI quattro | 147         |             | 06.04       | 08.13 | PR: 1AS     |                |        |   |           |     |
|            |                  | 3.2 quattro | 184         |             | 07.03 | 08.13       |                |        |   |           |     |
| S3 quattro |                  | 188         |             | 07.08       | 08.13 |             |                |        |   |           |     |
| S3 quattro |                  | 195         |             | 11.06       | 08.13 |             |                |        |   |           |     |
|            | 1.2 TSI          | 77          | 8P-6A094000 | 04.10       |       |             | 03.2122-2129.3 | 010799 | PR: 1ZE,1ZF,1ZP,1ZD,1LJ,1ZM               | THz 22,20 | ATE |
|            | 1.6              | 75          | 8P-6A094000 | 05.03       |       |             |                |        |   |           |     |
|            | 1.6 FSI          | 85          | 8P-6A094000 | 08.03       |       |             |                |        |   |           |     |
|            | 1.6 TDI          | 66          | 8P-6A094000 | 05.09       |       |             |                |        |   |           |     |
|            | 1.6 TDI          | 77          | 8P-6A094000 | 05.09       |       |             |                |        |   |           |     |
|            | 1.9 TDI          | 77          | 8P-6A094000 | 06.03       |       |             |                |        |   |           |     |
|            | 2.0 FSI          | 110         | 8P-6A094000 | 05.03       |       |             |                |        |   |           |     |
|            | 2.0 TDI          | 100         | 8P-6A094000 | 05.03       |       |             |                |        |   |           |     |
|            | 2.0 TDI          | 103         | 8P-6A094000 | 05.03       |       |             |                |        |   |           |     |
|            | 2.0 TDI          | 120         | 8P-6A094000 | 06.06       |       |             |                |        |   |           |     |
|            | 2.0 TDI quattro  | 100         | 8P-6A094000 | 05.03       |       |             |                |        |   |           |     |
|            | 2.0 TDI quattro  | 103         | 8P-6A094000 | 08.04       |       |             |                |        |   |           |     |
|            | 2.0 TFSI         | 147         | 8P-6A094001 | 06.04       |       |             |                |        |   |           |     |
|            | 2.0 TFSI quattro | 147         | 8P-6A094001 | 06.04       |       |             |                |        |   |           |     |
|            | 1.2 TSI          | 77          | 8P-6A094001 |             | 08.13 |             | 03.2122-2129.3 | 010799 | PR: 1ZE,1ZF,1ZP,1ZD,1LJ,1ZM               | THz 22,20 | ATE |
|            | 1.6              | 75          | 8P-6A094001 |             | 08.13 |             |                |        |   |           |     |
|            | 1.6 FSI          | 85          | 8P-6A094001 |             | 08.13 |             |                |        |   |           |     |
|            | 1.6 TDI          | 66          | 8P-6A094001 |             | 08.13 |             |                |        |   |           |     |
|            | 1.6 TDI          | 77          | 8P-6A094001 |             | 08.13 |             |                |        |   |           |     |
|            | 1.9 TDI          | 77          | 8P-6A094001 |             | 08.13 |             |                |        |   |           |     |
|            | 2.0 FSI          | 110         | 8P-6A094001 |             | 08.13 |             |                |        |   |           |     |
|            | 2.0 TDI          | 100         | 8P-6A094001 |             | 08.13 |             |                |        |   |           |     |
|            | 2.0 TDI          | 103         | 8P-6A094001 |             | 08.13 |             |                |        |   |           |     |
|            | 2.0 TDI          | 120         | 8P-6A094001 |             | 06.08 |             |                |        |   |           |     |
|            | 2.0 TDI quattro  | 100         | 8P-6A094001 |             | 08.13 |             |                |        |   |           |     |
|            | 2.0 TDI quattro  | 103         | 8P-6A094001 |             | 08.13 |             |                |        |   |           |     |
|            | 2.0 TFSI         | 147         | 8P-6A094001 | 8P-7-103000 |       |             |                |        |   |           |     |
|            | 2.0 TFSI quattro | 147         | 8P-6A094001 | 8P-7-103000 |       |             |                |        |   |           |     |
|            | 1.2 TSI          | 77          | 8P-6B009600 | 04.10       |       |             | 03.2122-2129.3 | 010799 | PR: 1ZE,1ZF,1ZP,1ZD,1LJ,1ZM               | THz 22,20 | ATE |
|            | 1.6              | 75          | 8P-6B009600 | 05.03       |       |             |                |        |   |           |     |
|            | 1.6 FSI          | 85          | 8P-6B009600 | 08.03       |       |             |                |        |   |           |     |
|            | 1.6 TDI          | 66          | 8P-6B009600 | 05.09       |       |             |                |        |   |           |     |
|            | 1.6 TDI          | 77          | 8P-6B009600 | 05.09       |       |             |                |        |   |           |     |
|            | 1.9 TDI          | 77          | 8P-6B009600 | 06.03       |       |             |                |        |   |           |     |
|            | 2.0 FSI          | 110         | 8P-6B009600 | 05.03       |       |             |                |        |   |           |     |
|            | 2.0 TDI          | 100         | 8P-6B009600 | 05.03       |       |             |                |        |   |           |     |
|            | 2.0 TDI          | 103         | 8P-6B009600 | 05.03       |       |             |                |        |   |           |     |
|            | 2.0 TDI          | 120         | 8P-6B009600 | 06.06       |       |             |                |        |   |           |     |
|            | 2.0 TDI quattro  | 100         | 8P-6B009600 | 05.03       |       |             |                |        |   |           |     |
|            | 2.0 TDI quattro  | 103         | 8P-6B009600 | 08.04       |       |             |                |        |   |           |     |
|            | 2.0 TFSI         | 147         | 8P-6B009600 | 06.04       |       |             |                |        |   |           |     |
|            | 2.0 TFSI quattro | 147         | 8P-6B009600 | 06.04       |       |             |                |        |   |           |     |
|            | 1.2 TSI          | 77          |             | 04.10       | 08.13 |             | 03.2122-2129.3 | 010799 | PR: 1ZE,1ZF,1ZP,1ZD,1LJ,1ZM               | THz 22,20 | ATE |
|            | 1.4 TFSI         | 92          |             | 07.07       | 08.13 |             |                |        |   |           |     |
|            | 1.6              | 75          | 8P-6B009601 |             | 08.13 |             |                |        |   |           |     |
|            | 1.6 FSI          | 85          | 8P-6B009601 |             | 08.13 |             |                |        |   |           |     |
|            | 1.6 TDI          | 66          | 8P-6B009601 |             | 08.13 |             |                |        |   |           |     |
|            | 1.6 TDI          | 77          | 8P-6B009601 |             | 08.13 |             |                |        |   |           |     |
|            | 1.8 TFSI         | 118         |             | 01.07       | 08.13 |             |                |        |   |           |     |
|            | 1.8 TFSI quattro | 118         |             | 05.08       | 08.13 |             |                |        |   |           |     |
|            | 1.9 TDI          | 77          | 8P-6B009601 |             | 08.13 |             |                |        |   |           |     |
|            | 2.0 FSI          | 110         | 8P-6B009601 |             | 08.13 |             |                |        |   |           |     |
|            | 2.0 TDI          | 100         | 8P-6B009601 |             | 08.13 |             |                |        |   |           |     |
|            | 2.0 TDI          | 103         | 8P-6B009601 |             | 08.13 |             |                |        |   |           |     |
|            | 2.0 TDI          | 120         | 8P-6B009601 |             | 08.13 |             |                |        |   |           |     |
|            | 2.0 TDI quattro  | 100         | 8P-6B009601 |             | 08.13 |             |                |        |   |           |     |
|            | 2.0 TDI quattro  | 103         | 8P-6B009601 |             | 08.13 |             |                |        |   |           |     |
|            | 2.0 TFSI         | 147         | 8P-6B009601 | 8P-7-103000 |       |             |                |        |   |           |     |
|            | 2.0 TFSI quattro | 147         | 8P-6B009601 | 8P-7-103000 |       |             |                |        |   |           |     |

<sup>1)</sup> piston diameter Ø 22,20mm / diametro del pistone Ø 22,20mm / diamètre de piston Ø 22,20mm / diámetro del pistón Ø 22,20mm

<sup>2)</sup> piston diameter Ø 23,81mm / diametro del pistone Ø 23,81mm / diamètre de piston Ø 23,81mm / diámetro del pistón Ø 23,81mm





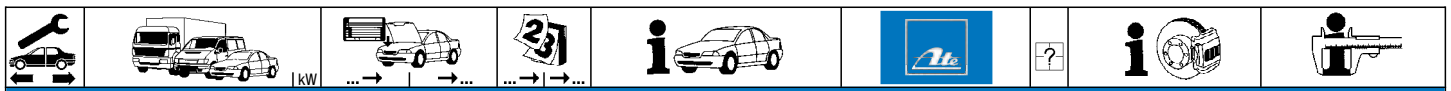

**AUDI A3 / A3 Sportback (03-13)**

|  |                      |             |       |       |                |                |                             |                |     |
|--|----------------------|-------------|-------|-------|----------------|----------------|-----------------------------|----------------|-----|
|  | 2.0 TDI 125          |             | 03.06 | 08.13 | 03.2123-3449.3 | 010808         | PR: 1ZE,1ZF,1ZP,1ZD,1LJ,1ZM | THz 23,81      | ATE |
|  | 2.0 TDI quattro 125  |             | 03.06 | 08.13 |                |                |                             |                |     |
|  | 2.0 TFSI 147         | 8P-7-103001 |       | 08.13 |                |                |                             |                |     |
|  | 2.0 TFSI quattro 147 | 8P-7-103001 |       | 08.13 |                |                |                             |                |     |
|  | 1.2 TSI 77           | 8P-6A094000 | 04.10 |       | 03.2123-3223.3 | 010807         | PR: 1LK                     | THz 23,81      | ATE |
|  | 1.6 75               | 8P-6A094000 | 05.03 |       |                |                |                             |                |     |
|  | 1.6 FSI 85           | 8P-6A094000 | 08.03 |       |                |                |                             |                |     |
|  | 1.6 TDI 66           | 8P-6A094000 | 05.09 |       |                |                |                             |                |     |
|  | 1.6 TDI 77           | 8P-6A094000 | 05.09 |       |                |                |                             |                |     |
|  | 1.9 TDI 77           | 8P-6A094000 | 06.03 |       |                |                |                             |                |     |
|  | 2.0 FSI 110          | 8P-6A094000 | 05.03 |       |                |                |                             |                |     |
|  | 2.0 TDI 100          | 8P-6A094000 | 05.03 |       |                |                |                             |                |     |
|  | 2.0 TDI 103          | 8P-6A094000 | 05.03 |       |                |                |                             |                |     |
|  | 2.0 TDI 120          | 8P-6A094000 | 06.06 |       |                |                |                             |                |     |
|  | 2.0 TDI quattro 100  | 8P-6A094000 | 05.03 |       |                |                |                             |                |     |
|  | 2.0 TDI quattro 103  | 8P-6A094000 | 08.04 |       |                |                |                             |                |     |
|  | 2.0 TFSI 147         | 8P-6A094000 | 06.04 |       |                |                |                             |                |     |
|  | 2.0 TFSI quattro 147 | 8P-6A094000 | 06.04 |       |                |                |                             |                |     |
|  | 1.2 TSI 77           | 8P-6A094001 |       | 08.13 | 03.2123-3449.3 | 010808         | PR: 1LK,1ZK                 | THz 23,81      | ATE |
|  | 1.6 75               | 8P-6A094001 |       | 08.13 |                |                |                             |                |     |
|  | 1.6 FSI 85           | 8P-6A094001 |       | 08.13 |                |                |                             |                |     |
|  | 1.6 TDI 66           | 8P-6A094001 |       | 08.13 |                |                |                             |                |     |
|  | 1.6 TDI 77           | 8P-6A094001 |       | 08.13 |                |                |                             |                |     |
|  | 1.9 TDI 77           | 8P-6A094001 |       | 08.13 |                |                |                             |                |     |
|  | 2.0 FSI 110          | 8P-6A094001 |       | 08.13 |                |                |                             |                |     |
|  | 2.0 TDI 100          | 8P-6A094001 |       | 08.13 |                |                |                             |                |     |
|  | 2.0 TDI 103          | 8P-6A094001 |       | 08.13 |                |                |                             |                |     |
|  | 2.0 TDI 120          | 8P-6A094001 |       | 06.08 |                |                |                             |                |     |
|  | 2.0 TDI quattro 100  | 8P-6A094001 |       | 08.13 |                |                |                             |                |     |
|  | 2.0 TDI quattro 103  | 8P-6A094001 |       | 08.13 |                |                |                             |                |     |
|  | 2.0 TFSI 147         | 8P-6A094001 |       | 08.13 |                |                |                             |                |     |
|  | 2.0 TFSI quattro 147 | 8P-6A094001 |       | 08.13 |                |                |                             |                |     |
|  | 1.2 TSI 77           | 8P-6B009600 | 04.10 |       | 03.2123-3223.3 | 010807         | PR: 1LK                     | THz 23,81      | ATE |
|  | 1.6 75               | 8P-6B009600 | 05.03 |       |                |                |                             |                |     |
|  | 1.6 FSI 85           | 8P-6B009600 | 08.03 |       |                |                |                             |                |     |
|  | 1.6 TDI 66           | 8P-6B009600 | 05.09 |       |                |                |                             |                |     |
|  | 1.6 TDI 77           | 8P-6B009600 | 05.09 |       |                |                |                             |                |     |
|  | 1.9 TDI 77           | 8P-6B009600 | 06.03 |       |                |                |                             |                |     |
|  | 2.0 FSI 110          | 8P-6B009600 | 05.03 |       |                |                |                             |                |     |
|  | 2.0 TDI 100          | 8P-6B009600 | 05.03 |       |                |                |                             |                |     |
|  | 2.0 TDI 103          | 8P-6B009600 | 05.03 |       |                |                |                             |                |     |
|  | 2.0 TDI 120          | 8P-6B009600 | 06.06 |       |                |                |                             |                |     |
|  | 2.0 TDI quattro 100  | 8P-6B009600 | 05.03 |       |                |                |                             |                |     |
|  | 2.0 TDI quattro 103  | 8P-6B009600 | 08.04 |       |                |                |                             |                |     |
|  | 2.0 TFSI 147         | 8P-6B009600 | 06.04 |       |                |                |                             |                |     |
|  | 2.0 TFSI quattro 147 | 8P-6B009600 | 06.04 |       |                |                |                             |                |     |
|  | 1.2 TSI 77           |             | 04.10 | 08.13 | 03.2123-3449.3 | 010808         | PR: 1LK,1ZK                 | THz 23,81      | ATE |
|  | 1.4 TFSI 92          |             | 07.07 | 08.13 |                |                |                             |                |     |
|  | 1.6 75               | 8P-6B009601 |       | 08.13 |                |                |                             |                |     |
|  | 1.6 FSI 85           | 8P-6B009601 |       | 08.13 |                |                |                             |                |     |
|  | 1.6 TDI 66           | 8P-6B009601 |       | 08.13 |                |                |                             |                |     |
|  | 1.6 TDI 77           | 8P-6B009601 |       | 08.13 |                |                |                             |                |     |
|  | 1.8 TFSI 118         |             | 01.07 | 08.13 |                |                |                             |                |     |
|  | 1.8 TFSI quattro 118 |             | 05.08 | 08.13 |                |                |                             |                |     |
|  | 1.9 TDI 77           | 8P-6B009601 |       | 08.13 |                |                |                             |                |     |
|  | 2.0 FSI 110          | 8P-6B009601 |       | 08.13 |                |                |                             |                |     |
|  | 2.0 TDI 100          | 8P-6B009601 |       | 08.13 |                |                |                             |                |     |
|  | 2.0 TDI 103          | 8P-6B009601 |       | 08.13 |                |                |                             |                |     |
|  | 2.0 TDI 125          |             | 03.06 | 08.13 |                |                |                             |                |     |
|  | 2.0 TDI quattro 100  | 8P-6B009601 |       | 08.13 |                |                |                             |                |     |
|  | 2.0 TDI quattro 103  | 8P-6B009601 |       | 08.13 |                |                |                             |                |     |
|  | 2.0 TDI quattro 125  |             | 03.06 | 08.13 |                |                |                             |                |     |
|  | 2.0 TFSI 147         | 8P-6B009601 |       | 08.13 |                |                |                             |                |     |
|  | 2.0 TFSI quattro 147 | 8P-6B009601 |       | 08.13 |                |                |                             |                |     |
|  | 3.2 quattro 184      |             | 07.03 | 08.13 | 03.2122-2129.3 | 010799         | - ESP                       | THz 22,20      | ATE |
|  | S3 quattro 188       |             | 07.08 | 08.13 | 03.2123-3223.3 | 010807         | + ESP                       | THz 23,81      | ATE |
|  | S3 quattro 195       |             | 11.06 | 08.13 |                |                |                             |                |     |
|  | 1.2 TSI 77           |             | 04.10 | 08.13 | PR: 1ZF,1ZM    | 11.9541-9549.2 | 220575                      | D=54, - Halter | ATE |
|  | 1.4 TFSI 92          |             | 07.07 | 08.13 | PR: 1ZF,1ZM    | 11.9541-9550.2 | 220576                      | D=54, - Halter | ATE |
|  | 1.6 75               |             | 05.03 | 08.13 | PR: 1ZF,1ZM    | 11.0101-5409.2 | 260035                      | Hülsensatz     | ATE |
|  | 1.6 FSI 85           |             | 08.03 | 08.13 | PR: 1ZF,1ZM    |                |                             |                |     |
|  | 1.6 TDI 66           |             | 05.09 | 08.13 | PR: 1ZF,1ZM    |                |                             |                |     |
|  | 1.6 TDI 77           |             | 05.09 | 08.13 | PR: 1ZF,1ZM    |                |                             |                |     |
|  | 1.8 TFSI 118         |             | 01.07 | 08.13 | PR: 1ZF,1ZM    |                |                             |                |     |
|  | 1.8 TFSI quattro 118 |             | 05.08 | 08.13 | PR: 1ZF,1ZM    |                |                             |                |     |
|  | 1.9 TDI 77           |             | 06.03 | 08.13 | PR: 1ZF,1ZM    |                |                             |                |     |
|  | 2.0 FSI 110          |             | 05.03 | 08.13 | PR: 1ZF,1ZM    |                |                             |                |     |
|  | 2.0 TDI 100          |             | 05.03 | 08.13 | PR: 1ZF,1ZM    |                |                             |                |     |
|  | 2.0 TDI 103          |             | 05.03 | 08.13 | PR: 1ZF,1ZM    |                |                             |                |     |
|  | 2.0 TDI 120          |             | 06.06 | 06.08 | PR: 1ZF,1ZM    |                |                             |                |     |
|  | 2.0 TDI 125          |             | 03.06 | 08.13 | PR: 1ZF,1ZM    |                |                             |                |     |
|  | 2.0 TDI quattro 100  |             | 05.03 | 08.13 | PR: 1ZF,1ZM    |                |                             |                |     |
|  | 2.0 TDI quattro 103  |             | 08.04 | 08.13 | PR: 1ZF,1ZM    |                |                             |                |     |
|  | 2.0 TDI quattro 125  |             | 03.06 | 08.13 | PR: 1ZF,1ZM    |                |                             |                |     |
|  | 2.0 TFSI 147         |             | 06.04 | 08.13 | PR: 1ZF,1ZM    |                |                             |                |     |
|  | 2.0 TFSI quattro 147 |             | 06.04 | 08.13 | PR: 1ZF,1ZM    |                |                             |                |     |
|  | 3.2 quattro 184      |             | 07.03 | 08.13 | PR: 1ZF,1ZM    |                |                             |                |     |



| AUDI A3 / A3 Sportback (03-13) |                  |       |       |                     |                     |                |        |       |   |     |
|--------------------------------|------------------|-------|-------|---------------------|---------------------|----------------|--------|-------|---|-----|
|                                | 1.2 TSI          | 77    | 04.10 | 08.13               | PR: 1ZE,1ZP         | 11.9541-9553.2 | 220563 | 2     | D=54, - Halter<br>ATE<br>D=54, - Halter<br>ATE<br>Hülsensatz<br>ATE<br>Führungsbolzen<br>ATE<br>Haltefeder<br>ATE | ATE |
|                                | 1.4 TFSI         | 92    | 07.07 | 08.13               | PR: 1ZE,1ZP         | 11.9541-9554.2 | 220564 |       |   |     |
|                                | 1.6              | 75    | 05.03 | 08.13               | PR: 1ZE,1ZP         | 11.0101-5409.2 | 260035 |       |   |     |
|                                | 1.6 FSI          | 85    | 08.03 | 08.13               | PR: 1ZE,1ZP         | 11.8171-0008.1 | 990049 |       |   |     |
|                                | 1.6 TDI          | 66    | 05.09 | 08.13               | PR: 1ZE,1ZP         | 11.8116-0351.1 | 390538 |       |   |     |
|                                | 1.6 TDI          | 77    | 05.09 | 08.13               | PR: 1ZE,1ZP         |                |        |       |   |     |
|                                | 1.8 TFSI         | 118   | 01.07 | 08.13               | PR: 1ZE,1ZP         |                |        |       |   |     |
|                                | 1.8 TFSI quattro | 118   | 05.08 | 08.13               | PR: 1ZE,1ZP         |                |        |       |   |     |
|                                | 1.9 TDI          | 77    | 06.03 | 08.13               | PR: 1ZE,1ZP         |                |        |       |   |     |
|                                | 2.0 FSI          | 110   | 05.03 | 08.13               | PR: 1ZE,1ZP         |                |        |       |   |     |
|                                | 2.0 TDI          | 100   | 05.03 | 08.13               | PR: 1ZE,1ZP         |                |        |       |   |     |
|                                | 2.0 TDI          | 103   | 05.03 | 08.13               | PR: 1ZE,1ZP         |                |        |       |   |     |
|                                | 2.0 TDI          | 120   | 06.06 | 06.08               | PR: 1ZE,1ZP         |                |        |       |   |     |
|                                | 2.0 TDI          | 125   | 03.06 | 08.13               | PR: 1ZE,1ZP         |                |        |       |   |     |
|                                | 2.0 TDI quattro  | 100   | 05.03 | 08.13               | PR: 1ZE,1ZP         |                |        |       |   |     |
|                                | 2.0 TDI quattro  | 103   | 08.04 | 08.13               | PR: 1ZE,1ZP         |                |        |       |   |     |
|                                | 2.0 TDI quattro  | 125   | 03.06 | 08.13               | PR: 1ZE,1ZP         |                |        |       |   |     |
|                                | 2.0 TFSI         | 147   | 06.04 | 08.13               | PR: 1ZE,1ZP         |                |        |       |   |     |
|                                | 2.0 TFSI quattro | 147   | 06.04 | 08.13               | PR: 1ZE,1ZP         |                |        |       |   |     |
|                                | 3.2 quattro      | 184   | 07.03 | 08.13               | PR: 1ZE,1ZP         |                |        |       |   |     |
|                                | 1.2 TSI          | 77    | 04.10 | 08.13               | PR: 1ZD,1LJ,1ZA     | 11.9541-9553.2 | 220563 | 2     | D=54, - Halter<br>ATE<br>D=54, - Halter<br>ATE<br>Hülsensatz<br>ATE<br>Führungsbolzen<br>ATE<br>Haltefeder<br>ATE | ATE |
|                                | 1.4 TFSI         | 92    | 07.07 | 08.13               | PR: 1ZD,1LJ,1ZA     | 11.9541-9554.2 | 220564 |       |   |     |
|                                | 1.6              | 75    | 05.03 | 08.13               | PR: 1ZD,1LJ,1ZA     | 11.0101-5409.2 | 260035 |       |   |     |
|                                | 1.6 FSI          | 85    | 08.03 | 08.13               | PR: 1ZD,1LJ,1ZA     | 11.8171-0008.1 | 990049 |       |   |     |
|                                | 1.6 TDI          | 66    | 05.09 | 08.13               | PR: 1ZD,1LJ,1ZA     | 11.8116-0351.1 | 390538 |       |   |     |
|                                | 1.6 TDI          | 77    | 05.09 | 08.13               | PR: 1ZD,1LJ,1ZA     |                |        |       |   |     |
|                                | 1.8 TFSI         | 118   | 01.07 | 08.13               | PR: 1ZD,1LJ,1ZA     |                |        |       |   |     |
|                                | 1.8 TFSI quattro | 118   | 05.08 | 08.13               | PR: 1ZD,1LJ,1ZA     |                |        |       |   |     |
|                                | 1.9 TDI          | 77    | 06.03 | 08.13               | PR: 1ZD,1LJ,1ZA     |                |        |       |   |     |
|                                | 2.0 FSI          | 110   | 05.03 | 08.13               | PR: 1ZD,1LJ,1ZA     |                |        |       |   |     |
|                                | 2.0 TDI          | 100   | 05.03 | 08.13               | PR: 1ZD,1LJ,1ZA     |                |        |       |   |     |
|                                | 2.0 TDI          | 103   | 05.03 | 08.13               | PR: 1ZD,1LJ,1ZA     |                |        |       |   |     |
|                                | 2.0 TDI          | 120   | 06.06 | 06.08               | PR: 1ZD,1LJ,1ZA     |                |        |       |   |     |
|                                | 2.0 TDI          | 125   | 03.06 | 08.13               | PR: 1ZD,1LJ,1ZA     |                |        |       |   |     |
|                                | 2.0 TDI quattro  | 100   | 05.03 | 08.13               | PR: 1ZD,1LJ,1ZA     |                |        |       |   |     |
|                                | 2.0 TDI quattro  | 103   | 08.04 | 08.13               | PR: 1ZD,1LJ,1ZA     |                |        |       |   |     |
|                                | 2.0 TDI quattro  | 125   | 03.06 | 08.13               | PR: 1ZD,1LJ,1ZA     |                |        |       |   |     |
|                                | 2.0 TFSI         | 147   | 06.04 | 08.13               | PR: 1ZD,1LJ,1ZA     |                |        |       |   |     |
|                                | 2.0 TFSI quattro | 147   | 06.04 | 08.13               | PR: 1ZD,1LJ,1ZA     |                |        |       |   |     |
|                                | 3.2 quattro      | 184   | 07.03 | 08.13               | PR: 1ZD,1LJ,1ZA     |                |        |       |   |     |
|                                | 1.2 TSI          | 77    | 04.10 | 08.13               | PR: 1LK             | 11.9576-9995.2 | 220651 | 2     | D=57, - Halter<br>ATE<br>D=57, - Halter<br>ATE<br>Hülsensatz<br>ATE<br>Führungsbolzen<br>ATE<br>Haltefeder<br>ATE | ATE |
|                                | 1.4 TFSI         | 92    | 07.07 | 08.13               | PR: 1LK             | 11.9576-9996.2 | 220652 |       |   |     |
|                                | 1.6              | 75    | 05.03 | 08.13               | PR: 1LK             | 11.0101-5409.2 | 260035 |       |   |     |
|                                | 1.6 FSI          | 85    | 08.03 | 08.13               | PR: 1LK             | 11.8171-0008.1 | 990049 |       |   |     |
|                                | 1.6 TDI          | 66    | 05.09 | 08.13               | PR: 1LK             | 11.8116-0410.2 | 390589 |       |   |     |
|                                | 1.6 TDI          | 77    | 05.09 | 08.13               | PR: 1LK             |                |        |       |   |     |
|                                | 1.8 TFSI         | 118   | 01.07 | 08.13               | PR: 1LK             |                |        |       |   |     |
|                                | 1.8 TFSI quattro | 118   | 05.08 | 08.13               | PR: 1LK             |                |        |       |   |     |
|                                | 1.9 TDI          | 77    | 06.03 | 08.13               | PR: 1LK             |                |        |       |   |     |
|                                | 2.0 FSI          | 110   | 05.03 | 08.13               | PR: 1LK             |                |        |       |   |     |
|                                | 2.0 TDI          | 100   | 05.03 | 08.13               | PR: 1LK             |                |        |       |   |     |
|                                | 2.0 TDI          | 103   | 05.03 | 08.13               | PR: 1LK             |                |        |       |   |     |
|                                | 2.0 TDI          | 120   | 06.06 | 06.08               | PR: 1LK             |                |        |       |   |     |
|                                | 2.0 TDI          | 125   | 03.06 | 08.13               | PR: 1LK             |                |        |       |   |     |
|                                | 2.0 TDI quattro  | 100   | 05.03 | 08.13               | PR: 1LK             |                |        |       |   |     |
|                                | 2.0 TDI quattro  | 103   | 08.04 | 08.13               | PR: 1LK             |                |        |       |   |     |
|                                | 2.0 TDI quattro  | 125   | 03.06 | 08.13               | PR: 1LK             |                |        |       |   |     |
|                                | 2.0 TFSI         | 147   | 06.04 | 08.13               | PR: 1LK             |                |        |       |   |     |
|                                | 2.0 TFSI quattro | 147   | 06.04 | 08.13               | PR: 1LK             |                |        |       |   |     |
|                                | 3.2 quattro      | 184   | 07.03 | 08.13               | PR: 1LK             |                |        |       |   |     |
|                                | S3 quattro       | 188   | 07.08 | 08.13               |                     | 11.9576-9947.2 | 220809 | 2     | D=57, - Halter<br>ATE<br>D=57, - Halter<br>ATE<br>Hülsensatz<br>ATE<br>Führungsbolzen<br>ATE                      | ATE |
|                                | S3 quattro       | 195   | 11.06 | 08.13               |                     | 11.9576-9948.2 | 220810 |       |   |     |
|                                |                  |       |       |                     |                     | 11.0101-5409.2 | 260035 |       |   |     |
|                                |                  |       |       |                     |                     | 11.8171-0008.1 | 990049 |       |   |     |
|                                | 1.2 TSI          | 77    | 04.10 | 08.13               | PR: 1LJ,1ZE,1ZF,1ZM | 83.7847-0563.3 | 331124 | 2     | L=562   | ATE |
|                                | 1.4 TFSI         | 92    | 07.07 | 08.13               | PR: 1LJ,1ZE,1ZF,1ZM |                |        |       |   |     |
|                                | 1.6              | 75    | 05.03 | 08.13               | PR: 1LJ,1ZE,1ZF,1ZM |                |        |       |   |     |
|                                | 1.6 FSI          | 85    | 08.03 | 08.13               | PR: 1LJ,1ZE,1ZF,1ZM |                |        |       |   |     |
|                                | 1.6 TDI          | 66    | 05.09 | 08.13               | PR: 1LJ,1ZE,1ZF,1ZM |                |        |       |   |     |
|                                | 1.6 TDI          | 77    | 05.09 | 08.13               | PR: 1LJ,1ZE,1ZF,1ZM |                |        |       |   |     |
|                                | 1.8 TFSI         | 118   | 01.07 | 08.13               | PR: 1LJ,1ZE,1ZF,1ZM |                |        |       |   |     |
|                                | 1.8 TFSI quattro | 118   | 05.08 | 08.13               | PR: 1LJ,1ZE,1ZF,1ZM |                |        |       |   |     |
|                                | 1.9 TDI          | 77    | 06.03 | 08.13               | PR: 1LJ,1ZE,1ZF,1ZM |                |        |       |   |     |
|                                | 2.0 FSI          | 110   | 05.03 | 08.13               | PR: 1LJ,1ZE,1ZF,1ZM |                |        |       |   |     |
|                                | 2.0 TDI          | 100   | 05.03 | 08.13               | PR: 1LJ,1ZE,1ZF,1ZM |                |        |       |   |     |
|                                | 2.0 TDI          | 103   | 05.03 | 08.13               | PR: 1LJ,1ZE,1ZF,1ZM |                |        |       |   |     |
|                                | 2.0 TDI          | 120   | 06.06 | 06.08               | PR: 1LJ,1ZE,1ZF,1ZM |                |        |       |   |     |
|                                | 2.0 TDI          | 125   | 03.06 | 08.13               | PR: 1LJ,1ZE,1ZF,1ZM |                |        |       |   |     |
|                                | 2.0 TDI quattro  | 100   | 05.03 | 08.13               | PR: 1LJ,1ZE,1ZF,1ZM |                |        |       |   |     |
|                                | 2.0 TDI quattro  | 103   | 08.04 | 08.13               | PR: 1LJ,1ZE,1ZF,1ZM |                |        |       |   |     |
|                                | 2.0 TDI quattro  | 125   | 03.06 | 08.13               | PR: 1LJ,1ZE,1ZF,1ZM |                |        |       |   |     |
|                                | 2.0 TFSI         | 147   | 06.04 | 08.13               | PR: 1LJ,1ZE,1ZF,1ZM |                |        |       |   |     |
|                                | 2.0 TFSI quattro | 147   | 06.04 | 08.13               | PR: 1LJ,1ZE,1ZF,1ZM |                |        |       |   |     |
|                                | 3.2 quattro      | 184   | 07.03 | 08.13               | PR: 1LJ,1ZE,1ZF,1ZM |                |        |       |   |     |
| S3 quattro                     | 188              | 07.08 | 08.13 | PR: 1LJ,1ZE,1ZF,1ZM |                     |                |        |       |   |     |
| S3 quattro                     | 195              | 11.06 | 08.13 | PR: 1LJ,1ZE,1ZF,1ZM |                     |                |        |       |   |     |
| 1.2 TSI                        | 77               | 04.10 | 08.13 | PR: 1LK             | 83.7849-0502.3      | 331125         | 2      | L=504 | ATE   |     |

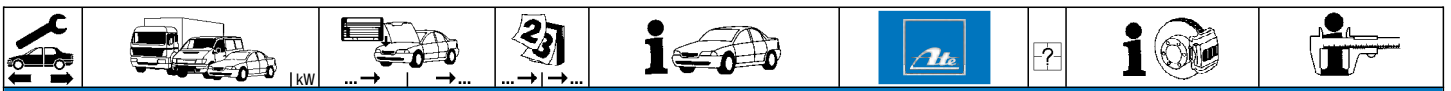

**AUDI A3 / A3 Sportback (03-13)**

|            |                  |          |       |         |                 |                |                |        |  |                |                |         |                |        |  |  |                |     |
|------------|------------------|----------|-------|---------|-----------------|----------------|----------------|--------|--|----------------|----------------|---------|----------------|--------|--|--|----------------|-----|
|            | 1.4 TFSI         | 92       | 07.07 | 08.13   | PR: 1LK         | 83.7849-0502.3 | 331125         | 2      |  | L=504          |                |         |                |        |  |  |                |     |
|            | 1.6              | 75       | 05.03 | 08.13   | PR: 1LK         |                |                |        |  |                |                |         |                |        |  |  |                |     |
|            | 1.6 FSI          | 85       | 08.03 | 08.13   | PR: 1LK         |                |                |        |  |                |                |         |                |        |  |  |                |     |
|            | 1.6 TDI          | 66       | 05.09 | 08.13   | PR: 1LK         |                |                |        |  |                |                |         |                |        |  |  |                |     |
|            | 1.6 TDI          | 77       | 05.09 | 08.13   | PR: 1LK         |                |                |        |  |                |                |         |                |        |  |  |                |     |
|            | 1.8 TFSI         | 118      | 01.07 | 08.13   | PR: 1LK         |                |                |        |  |                |                |         |                |        |  |  |                |     |
|            | 1.9 TDI          | 77       | 06.03 | 08.13   | PR: 1LK         |                |                |        |  |                |                |         |                |        |  |  |                |     |
|            | 2.0 FSI          | 110      | 05.03 | 08.13   | PR: 1LK         |                |                |        |  |                |                |         |                |        |  |  |                |     |
|            | 2.0 TDI          | 100      | 05.03 | 08.13   | PR: 1LK         |                |                |        |  |                |                |         |                |        |  |  |                |     |
|            | 2.0 TDI          | 103      | 05.03 | 08.13   | PR: 1LK         |                |                |        |  |                |                |         |                |        |  |  |                |     |
|            | 2.0 TDI          | 120      | 06.06 | 08.13   | PR: 1LK         |                |                |        |  |                |                |         |                |        |  |  |                |     |
|            | 2.0 TDI          | 125      | 03.06 | 08.13   | PR: 1LK         |                |                |        |  |                |                |         |                |        |  |  |                |     |
|            | 2.0 TDI quattro  | 100      | 05.03 | 08.13   | PR: 1LK         |                |                |        |  |                |                |         |                |        |  |  |                |     |
|            | 2.0 TDI quattro  | 103      | 08.04 | 08.13   | PR: 1LK         |                |                |        |  |                |                |         |                |        |  |  |                |     |
|            | 2.0 TDI quattro  | 125      | 03.06 | 08.13   | PR: 1LK         |                |                |        |  |                |                |         |                |        |  |  |                |     |
|            | 2.0 TFSI         | 147      | 06.04 | 08.13   | PR: 1LK         |                |                |        |  |                |                |         |                |        |  |  |                |     |
|            | 2.0 TFSI quattro | 147      | 06.04 | 08.13   | PR: 1LK         |                |                |        |  |                |                |         |                |        |  |  |                |     |
|            | 3.2 quattro      | 184      | 07.03 | 08.13   | PR: 1LK         |                |                |        |  |                |                |         |                |        |  |  |                |     |
|            | S3 quattro       | 188      | 07.08 | 08.13   | PR: 1LK         |                |                |        |  |                |                |         |                |        |  |  |                |     |
|            | S3 quattro       | 195      | 11.06 | 08.13   | PR: 1LK         |                |                |        |  |                |                |         |                |        |  |  |                |     |
|            | 1.2 TSI          | 77       | 04.10 | 08.13   | PR: 12K         | 83.7249-0536.3 | 330900         | 2      |  | L=536          |                |         |                |        |  |  |                |     |
|            | 1.4 TFSI         | 92       | 07.07 | 08.13   | PR: 12K         |                |                |        |  |                |                |         |                |        |  |  |                |     |
|            | 1.6              | 75       | 05.03 | 08.13   | PR: 12K         |                |                |        |  |                |                |         |                |        |  |  |                |     |
|            | 1.6 FSI          | 85       | 08.03 | 08.13   | PR: 12K         |                |                |        |  |                |                |         |                |        |  |  |                |     |
|            | 1.6 TDI          | 66       | 05.09 | 08.13   | PR: 12K         |                |                |        |  |                |                |         |                |        |  |  |                |     |
|            | 1.6 TDI          | 77       | 05.09 | 08.13   | PR: 12K         |                |                |        |  |                |                |         |                |        |  |  |                |     |
|            | 1.8 TFSI         | 118      | 01.07 | 08.13   | PR: 12K         |                |                |        |  |                |                |         |                |        |  |  |                |     |
|            | 1.8 TFSI quattro | 118      | 05.08 | 08.13   | PR: 12K         |                |                |        |  |                |                |         |                |        |  |  |                |     |
|            | 1.9 TDI          | 77       | 06.03 | 08.13   | PR: 12K         |                |                |        |  |                |                |         |                |        |  |  |                |     |
|            | 2.0 FSI          | 110      | 05.03 | 08.13   | PR: 12K         |                |                |        |  |                |                |         |                |        |  |  |                |     |
|            | 2.0 TDI          | 100      | 05.03 | 08.13   | PR: 12K         |                |                |        |  |                |                |         |                |        |  |  |                |     |
|            | 2.0 TDI          | 103      | 05.03 | 08.13   | PR: 12K         |                |                |        |  |                |                |         |                |        |  |  |                |     |
|            | 2.0 TDI          | 120      | 06.06 | 06.08   | PR: 12K         |                |                |        |  |                |                |         |                |        |  |  |                |     |
|            | 2.0 TDI          | 125      | 03.06 | 08.13   | PR: 12K         |                |                |        |  |                |                |         |                |        |  |  |                |     |
|            | 2.0 TDI quattro  | 100      | 05.03 | 08.13   | PR: 12K         |                |                |        |  |                |                |         |                |        |  |  |                |     |
|            | 2.0 TDI quattro  | 103      | 08.04 | 08.13   | PR: 12K         |                |                |        |  |                |                |         |                |        |  |  |                |     |
|            | 2.0 TDI quattro  | 125      | 03.06 | 08.13   | PR: 12K         |                |                |        |  |                |                |         |                |        |  |  |                |     |
|            | 2.0 TFSI         | 147      | 06.04 | 08.13   | PR: 12K         |                |                |        |  |                |                |         |                |        |  |  |                |     |
|            | 2.0 TFSI quattro | 147      | 06.04 | 08.13   | PR: 12K         |                |                |        |  |                |                |         |                |        |  |  |                |     |
|            | 3.2 quattro      | 184      | 03.06 | 08.13   | PR: 12K         |                |                |        |  |                |                |         |                |        |  |  |                |     |
| S3 quattro | 188              | 07.08    | 08.13 | PR: 12K |                 |                |                |        |  |                |                |         |                |        |  |  |                |     |
| S3 quattro | 195              | 11.06    | 08.13 | PR: 12K |                 |                |                |        |  |                |                |         |                |        |  |  |                |     |
|            | 1.2 TSI          | 77       | 04.10 | 08.13   | PR: 1KQ,1KD     | 24.3384-1755.7 | 220635         |        |  | D=38, - Halter | LUC            |         |                |        |  |  |                |     |
|            | 1.4 TFSI         | 92       | 07.07 | 08.13   | PR: 1KQ,1KD     |                |                |        |  |                |                |         |                |        |  |  |                |     |
|            | 1.6              | 75       | 05.03 | 08.13   | PR: 1KQ,1KD     |                |                |        |  |                |                |         |                |        |  |  |                |     |
|            | 1.6 FSI          | 85       | 08.03 | 08.13   | PR: 1KQ,1KD     |                |                |        |  |                |                |         |                |        |  |  |                |     |
|            | 1.6 TDI          | 66       | 05.09 | 08.13   | PR: 1KQ,1KD     |                |                |        |  |                |                |         |                |        |  |  |                |     |
|            | 1.6 TDI          | 77       | 05.09 | 08.13   | PR: 1KQ,1KD     |                |                |        |  |                |                |         |                |        |  |  |                |     |
|            | 1.8 TFSI         | 118      | 01.07 | 08.13   | PR: 1KQ,1KD     |                |                |        |  |                |                |         |                |        |  |  |                |     |
|            | 1.9 TDI          | 77       | 06.03 | 08.13   | PR: 1KQ,1KD     |                |                |        |  |                |                |         |                |        |  |  |                |     |
|            | 2.0 FSI          | 110      | 05.03 | 08.13   | PR: 1KQ,1KD     |                |                |        |  |                |                |         |                |        |  |  |                |     |
|            | 2.0 TDI          | 100      | 05.03 | 08.13   | PR: 1KQ,1KD     |                |                |        |  |                |                |         |                |        |  |  |                |     |
|            | 2.0 TDI          | 103      | 05.03 | 08.13   | PR: 1KQ,1KD     |                |                |        |  |                |                |         |                |        |  |  |                |     |
|            | 2.0 TDI          | 120      | 06.06 | 06.08   | PR: 1KQ,1KD     |                |                |        |  |                |                |         |                |        |  |  |                |     |
|            | 2.0 TDI          | 125      | 03.06 | 08.13   | PR: 1KQ,1KD     |                |                |        |  |                |                |         |                |        |  |  |                |     |
|            | 2.0 TFSI         | 147      | 06.04 | 08.13   | PR: 1KQ,1KD     |                |                |        |  |                |                |         |                |        |  |  |                |     |
|            |                  | 1.2 TSI  | 77    | 04.10   | 08.13           |                |                |        |  |                |                | PR: 1KZ | 24.3387-1717.7 | 220757 |  |  | D=38, - Halter | LUC |
|            |                  | 1.4 TFSI | 92    | 07.07   | 08.13           |                |                |        |  |                |                | PR: 1KZ |                |        |  |  |                |     |
|            |                  | 1.6      | 75    | 05.03   | 08.13           |                |                |        |  |                |                | PR: 1KZ |                |        |  |  |                |     |
|            |                  | 1.6 FSI  | 85    | 08.03   | 08.13           |                |                |        |  |                |                | PR: 1KZ |                |        |  |  |                |     |
|            |                  | 1.6 TDI  | 66    | 05.09   | 08.13           |                |                |        |  |                |                | PR: 1KZ |                |        |  |  |                |     |
|            |                  | 1.6 TDI  | 77    | 05.09   | 08.13           |                |                |        |  |                |                | PR: 1KZ |                |        |  |  |                |     |
| 1.8 TFSI   |                  | 118      | 01.07 | 08.13   | PR: 1KZ         |                |                |        |  |                |                |         |                |        |  |  |                |     |
| 1.9 TDI    |                  | 77       | 06.03 | 08.13   | PR: 1KZ         |                |                |        |  |                |                |         |                |        |  |  |                |     |
| 2.0 FSI    |                  | 110      | 05.03 | 08.13   | PR: 1KZ         |                |                |        |  |                |                |         |                |        |  |  |                |     |
| 2.0 TDI    |                  | 100      | 05.03 | 08.13   | PR: 1KZ         |                |                |        |  |                |                |         |                |        |  |  |                |     |
| 2.0 TDI    |                  | 103      | 05.03 | 08.13   | PR: 1KZ         |                |                |        |  |                |                |         |                |        |  |  |                |     |
| 2.0 TDI    |                  | 120      | 06.06 | 06.08   | PR: 1KZ         |                |                |        |  |                |                |         |                |        |  |  |                |     |
| 2.0 TDI    |                  | 125      | 03.06 | 08.13   | PR: 1KZ         |                |                |        |  |                |                |         |                |        |  |  |                |     |
| 2.0 TFSI   |                  | 147      | 06.04 | 08.13   | PR: 1KZ         |                |                |        |  |                |                |         |                |        |  |  |                |     |
|            |                  | 1.2 TSI  | 77    | 04.10   | 08.13           | PR: 1KE        | 24.3414-1709.7 | 220631 |  |                | D=41, - Halter | LUC     |                |        |  |  |                |     |
|            |                  | 1.4 TFSI | 92    | 07.07   | 08.13           | PR: 1KE        |                |        |  |                |                |         |                |        |  |  |                |     |
|            |                  | 1.6      | 75    | 05.03   | 08.13           | PR: 1KE        |                |        |  |                |                |         |                |        |  |  |                |     |
|            |                  | 1.6 FSI  | 85    | 08.03   | 08.13           | PR: 1KE        |                |        |  |                |                |         |                |        |  |  |                |     |
|            |                  | 1.6 TDI  | 66    | 05.09   | 08.13           | PR: 1KE        |                |        |  |                |                |         |                |        |  |  |                |     |
|            |                  | 1.6 TDI  | 77    | 05.09   | 08.13           | PR: 1KE        |                |        |  |                |                |         |                |        |  |  |                |     |
|            | 1.8 TFSI         | 118      | 01.07 | 08.13   | PR: 1KE         |                |                |        |  |                |                |         |                |        |  |  |                |     |
|            | 1.8 TFSI quattro | 118      | 05.08 | 08.13   | PR: 1KJ         |                |                |        |  |                |                |         |                |        |  |  |                |     |
|            | 1.9 TDI          | 77       | 06.03 | 08.13   | PR: 1KE         |                |                |        |  |                |                |         |                |        |  |  |                |     |
|            | 2.0 FSI          | 110      | 05.03 | 08.13   | PR: 1KE         |                |                |        |  |                |                |         |                |        |  |  |                |     |
|            | 2.0 TDI          | 100      | 05.03 | 08.13   | PR: 1KE         |                |                |        |  |                |                |         |                |        |  |  |                |     |
|            | 2.0 TDI          | 103      | 05.03 | 08.13   | PR: 1KE         |                |                |        |  |                |                |         |                |        |  |  |                |     |
|            | 2.0 TDI          | 120      | 06.06 | 06.08   | PR: 1KF,1KJ,1KU |                |                |        |  |                |                |         |                |        |  |  |                |     |
|            | 2.0 TDI          | 120      | 06.06 | 06.08   | PR: 1KE         |                |                |        |  |                |                |         |                |        |  |  |                |     |
|            | 2.0 TDI          | 125      | 03.06 | 08.13   | PR: 1KE         |                |                |        |  |                |                |         |                |        |  |  |                |     |
|            | 2.0 TDI quattro  | 100      | 05.03 | 08.13   | PR: 1KF,1KJ,1KU |                |                |        |  |                |                |         |                |        |  |  |                |     |
|            | 2.0 TDI quattro  | 103      | 08.04 | 08.13   | PR: 1KF,1KJ,1KU |                |                |        |  |                |                |         |                |        |  |  |                |     |

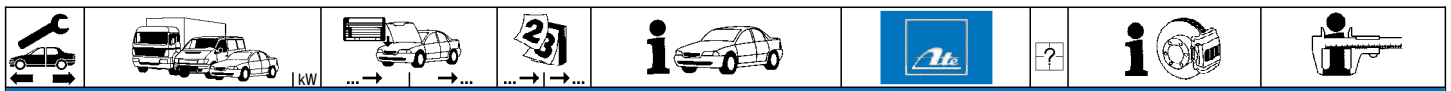

**AUDI A3 / A3 Sportback (03-13)**















|  |  |  |  |  |  |                                  |                  |     |                        |                                  |            |
|--|--|--|--|--|--|----------------------------------|------------------|-----|------------------------|----------------------------------|------------|
|  | 2.0 TDI quattro<br>2.0 TFSI<br>2.0 TFSI quattro<br>3.2 quattro   | 125<br>147<br>147<br>184   |  | 03.06 08.13<br>06.04 08.13<br>06.04 08.13<br>07.03 08.13   | PR: 1KF,1KJ,1KU<br>PR: 1KE<br>PR: 1KF,1KJ,1KU<br>PR: 1KJ | 24.3414-1709.7<br>24.3414-1710.7 | 220631<br>220632 |     |                        | D=41, - Halter<br>D=41, - Halter | LUC<br>LUC |
|  | 1.2 TSI<br>1.4 TFSI<br>1.6<br>1.6 FSI<br>1.6 TDI<br>1.6 TDI<br>1.8 TFSI<br>1.8 TFSI quattro<br>1.9 TDI<br>2.0 FSI<br>2.0 TDI<br>2.0 TDI<br>2.0 TDI<br>2.0 TDI quattro<br>2.0 TDI quattro<br>2.0 TDI quattro<br>2.0 TFSI<br>2.0 TFSI quattro<br>3.2 quattro<br>RS 3 quattro<br>S3 quattro<br>S3 quattro | 77<br>92<br>75<br>85<br>66<br>77<br>118<br>118<br>77<br>110<br>100<br>103<br>120<br>125<br>100<br>103<br>125<br>147<br>147<br>184<br>250<br>188<br>195 |  | 04.10 08.13<br>07.07 08.13<br>05.03 08.13<br>08.03 08.13<br>05.09 08.13<br>05.09 08.13<br>01.07 08.13<br>05.08 08.13<br>06.03 08.13<br>05.03 08.13<br>05.03 08.13<br>06.06 06.08<br>03.06 08.13<br>05.03 08.13<br>08.04 08.13<br>03.06 08.13<br>06.04 08.13<br>06.04 08.13<br>07.03 08.13<br>04.11 08.13<br>07.08 08.13<br>11.06 08.13 |  | 83.7849-0231.3                   | 330872           | 2   |                        | L=233                            |            |
|  | 1.2 TSI<br>1.4 TFSI<br>1.6<br>1.6 FSI<br>1.6 TDI<br>1.6 TDI<br>1.8 TFSI<br>1.8 TFSI quattro<br>1.9 TDI<br>2.0 FSI<br>2.0 TDI<br>2.0 TDI<br>2.0 TDI<br>2.0 TDI<br>2.0 TDI quattro<br>2.0 TDI quattro<br>2.0 TDI quattro<br>2.0 TFSI<br>2.0 TFSI quattro<br>3.2 quattro<br>S3 quattro<br>S3 quattro      | 77<br>92<br>75<br>85<br>66<br>77<br>118<br>118<br>77<br>110<br>100<br>103<br>120<br>125<br>100<br>103<br>125<br>147<br>147<br>184<br>188<br>195        |  | 04.10 08.13<br>07.07 08.13<br>05.03 08.13<br>08.03 08.13<br>05.09 08.13<br>05.09 08.13<br>01.07 08.13<br>05.08 08.13<br>06.03 08.13<br>05.03 08.13<br>05.03 08.13<br>06.06 06.08<br>03.06 08.13<br>05.03 08.13<br>08.04 08.13<br>03.06 08.13<br>06.04 08.13<br>06.04 08.13<br>07.03 08.13<br>07.08 08.13<br>11.06 08.13                |  | 24.3727-2708.2                   | 582708           | 2 ↓ |                        | L=1447                           |            |
|  | RS 3 quattro   | 250  |  | 04.11 08.13  |  | 24.3727-0195.2                   | 580195           | 2 ↓ |                        | L=1447                           |            |
|  | 1.2 TSI<br>1.4 TFSI<br>1.6<br>1.6 FSI<br>1.6 TDI<br>1.6 TDI<br>1.8 TFSI<br>1.8 TFSI quattro<br>1.9 TDI<br>2.0 FSI<br>2.0 TDI<br>2.0 TDI<br>2.0 TDI<br>2.0 TDI<br>2.0 TDI quattro<br>2.0 TDI quattro<br>2.0 TDI quattro<br>2.0 TFSI<br>2.0 TFSI quattro<br>3.2 quattro<br>S3 quattro<br>S3 quattro      | 77<br>92<br>75<br>85<br>66<br>77<br>118<br>118<br>77<br>110<br>100<br>103<br>120<br>125<br>100<br>103<br>125<br>147<br>147<br>184<br>188<br>195        |  | 04.10 08.13<br>07.07 08.13<br>05.03 08.13<br>08.03 08.13<br>05.09 08.13<br>05.09 08.13<br>01.07 08.13<br>05.08 08.13<br>06.03 08.13<br>05.03 08.13<br>05.03 08.13<br>06.06 06.08<br>03.06 08.13<br>05.03 08.13<br>08.04 08.13<br>03.06 08.13<br>06.04 08.13<br>06.04 08.13<br>07.03 08.13<br>07.08 08.13<br>11.06 08.13                |  | 24.2415-1711.3                   | 030130           |     |                        | Gz 15,87                         |            |
|  | 1.2 TSI<br>1.4 TFSI<br>1.6<br>1.6 FSI<br>1.6 TDI<br>1.6 TDI<br>1.8 TFSI<br>1.9 TDI<br>2.0 FSI<br>2.0 TDI<br>2.0 TDI<br>2.0 TDI<br>2.0 TDI<br>2.0 TDI<br>2.0 TDI quattro<br>2.0 TDI quattro<br>2.0 TDI quattro<br>2.0 TFSI<br>2.0 TFSI quattro<br>3.2 quattro<br>S3 quattro<br>S3 quattro               | 77<br>92<br>75<br>85<br>66<br>77<br>118<br>77<br>110<br>100<br>103<br>120<br>120<br>125<br>100<br>103<br>125<br>147<br>147<br>184<br>188<br>195        |  | 04.10 08.13<br>07.07 08.13<br>05.03 08.13<br>08.03 08.13<br>05.09 08.13<br>05.09 08.13<br>01.07 08.13<br>06.03 08.13<br>05.03 08.13<br>05.03 08.13<br>06.06 06.08<br>03.06 08.13<br>05.03 08.13<br>08.04 08.13<br>03.06 08.13<br>06.04 08.13<br>06.04 08.13<br>07.03 08.13<br>07.08 08.13<br>11.06 08.13                               |  | 24.2519-1705.3                   | 040095           |     | + 5-Gang <sup>1)</sup> | Nz 19,05                         |            |

<sup>1)</sup> + 5 gear / + 5 marce / + 5-vitesses / + 5 velocidades







|     |    |                   |   |   |                |  |  |  |
|--|--|---|---|---|---|--|--|--|
| <b>AUDI A3 Cabrio (08-13)</b>  |  |   |   |   |   |  |  |  |
|    | 1.2 TSI<br>1.4 TFSI<br>1.6<br>1.6 TDI<br>1.8 TFSI<br>1.9 TDI<br>2.0 TDI<br>2.0 TDI<br>2.0 TFSI   | 77<br>92<br>75<br>77<br>118<br>77<br>100<br>103<br>147  | 03.10<br>01.11<br>09.08<br>05.09<br>04.08<br>04.08<br>04.08<br>04.08<br>04.08   | 08.13<br>08.13<br>08.13<br>08.13<br>08.13<br>08.13<br>08.13<br>08.13<br>08.13   | 83.7849-0231.3  | 330872   | 2  | L=233  |
|    | 1.2 TSI<br>1.4 TFSI<br>1.6<br>1.6 TDI<br>1.8 TFSI<br>1.9 TDI<br>2.0 TDI<br>2.0 TDI<br>2.0 TFSI   | 77<br>92<br>75<br>77<br>118<br>77<br>100<br>103<br>147  | 03.10<br>01.11<br>09.08<br>05.09<br>04.08<br>04.08<br>04.08<br>04.08<br>04.08   | 08.13<br>08.13<br>08.13<br>08.13<br>08.13<br>08.13<br>08.13<br>08.13<br>08.13   | 24.2415-1711.3<br>24.2415-1713.3  | 030130<br>030132   |  | Gz 15,87<br>Gz 15,87, + Sensor   |
|    | 1.2 TSI<br>1.4 TFSI<br>1.6<br>1.6 TDI<br>1.8 TFSI<br>1.9 TDI<br>2.0 TDI<br>2.0 TDI<br>2.0 TFSI   | 77<br>92<br>75<br>77<br>118<br>77<br>100<br>103<br>147  | 03.10<br>01.11<br>09.08<br>05.09<br>04.08<br>04.08<br>04.08<br>04.08<br>04.08   | 07.11<br>07.11<br>07.11<br>07.11<br>07.11<br>07.11<br>07.11<br>07.11<br>07.11   | PR: OEJ<br>PR: OEJ<br>PR: OEJ<br>PR: OEJ<br>PR: OEJ<br>PR: OEJ<br>PR: OEJ<br>PR: OEJ<br>PR: OEJ | 24.2519-1705.3   | 040095   | Nz 19,05   |
| <b>AUDI A3 / A3 Sportback (12-)</b>  |  |   |   |   |   |  |  |  |
|    | 1.2 TFSI<br>1.4 TFSI<br>1.4 TFSI<br>1.6 TDI<br>1.8 TFSI<br>1.8 TFSI quattro<br>2.0 TDI<br>2.0 TDI<br>2.0 TDI<br>2.0 TDI<br>2.0 TDI<br>2.0 TDI quattro<br>2.0 TDI quattro<br>S3<br>S3 | 77<br>90<br>103<br>77<br>132<br>132<br>81<br>100<br>105<br>110<br>135<br>110<br>135<br>206<br>221 | 02.13<br>08.12<br>10.12<br>09.12<br>08.12<br>08.12<br>01.13<br>05.13<br>08.12<br>08.12<br>12.12<br>10.12<br>12.12<br>02.13<br>10.12 | PR: 1KE<br>PR: 1KE<br>PR: 1KE<br>PR: 1KE<br>PR: 1KE<br>PR: 1KE<br>PR: 1KE<br>PR: 1KE<br>PR: 1KE<br>PR: 1KE<br>PR: 1KE<br>PR: 1KE<br>PR: 1KE<br>PR: 1KE<br>PR: 1KE | 11.0101-5407.2<br>11.8171-0008.1  | 260011<br>990049   |  | Hülsensatz<br>Führungsbolzen<br><b>ATE</b><br><b>ATE</b>                           |
|  | 1.2 TFSI<br>1.4 TFSI<br>1.4 TFSI<br>1.6 TDI<br>1.8 TFSI<br>1.8 TFSI quattro<br>2.0 TDI<br>2.0 TDI<br>2.0 TDI<br>2.0 TDI<br>2.0 TDI<br>2.0 TDI quattro<br>2.0 TDI quattro<br>S3<br>S3 | 77<br>90<br>103<br>77<br>132<br>132<br>81<br>100<br>105<br>110<br>135<br>110<br>135<br>206<br>221 | 02.13<br>08.12<br>10.12<br>09.12<br>08.12<br>08.12<br>01.13<br>05.13<br>08.12<br>08.12<br>12.12<br>10.12<br>12.12<br>02.13<br>10.12 | PR: 1KY<br>PR: 1KY<br>PR: 1KY<br>PR: 1KY<br>PR: 1KY<br>PR: 1KY<br>PR: 1KY<br>PR: 1KY<br>PR: 1KY<br>PR: 1KY<br>PR: 1KY<br>PR: 1KY<br>PR: 1KY<br>PR: 1KY<br>PR: 1KY | 11.0101-5407.2<br>11.8171-0008.1  | 260011<br>990049   |  | Hülsensatz<br>Führungsbolzen<br><b>ATE</b><br><b>ATE</b>                           |
|  | 1.2 TFSI<br>1.4 TFSI<br>1.4 TFSI<br>1.6 TDI<br>1.8 TFSI<br>1.8 TFSI quattro<br>2.0 TDI<br>2.0 TDI<br>2.0 TDI<br>2.0 TDI<br>2.0 TDI<br>2.0 TDI quattro<br>2.0 TDI quattro<br>S3<br>S3 | 77<br>90<br>103<br>77<br>132<br>132<br>81<br>100<br>105<br>110<br>135<br>110<br>135<br>206<br>221 | 02.13<br>08.12<br>10.12<br>09.12<br>08.12<br>08.12<br>01.13<br>05.13<br>08.12<br>08.12<br>12.12<br>10.12<br>12.12<br>02.13<br>10.12 | PR: 1KJ<br>PR: 1KJ<br>PR: 1KJ<br>PR: 1KJ<br>PR: 1KJ<br>PR: 1KJ<br>PR: 1KJ<br>PR: 1KJ<br>PR: 1KJ<br>PR: 1KJ<br>PR: 1KJ<br>PR: 1KJ<br>PR: 1KJ<br>PR: 1KJ<br>PR: 1KJ | 11.0101-5407.2<br>11.8171-0008.1  | 260011<br>990049   |  | Hülsensatz<br>Führungsbolzen<br><b>ATE</b><br><b>ATE</b>                           |
| <b>AUDI A4 (B5) (95-01)</b>  |  |   |   |   |   |  |  |  |
|  | 1.6<br>1.8<br>1.8 quattro<br>1.8 quattro<br>1.8 T<br>1.8 T quattro<br>1.8 T quattro<br>1.9 TDI<br>1.9 TDI<br>1.9 TDI<br>1.9 TDI  | 85<br>92<br>110<br>132<br>55<br>66<br>81<br>85  | 11.94<br>11.94<br>11.94<br>11.94<br>05.95<br>02.95<br>08.97<br>03.96<br>01.95<br>02.96<br>01.98                                     | 01.99<br>01.99<br>- ESP<br>- ESP<br>01.99<br>- ESP<br>- ESP<br>01.99<br>01.99<br>01.99<br>01.99   | 24.2123-1717.3  | 010521   |  | Thz 23,81  |

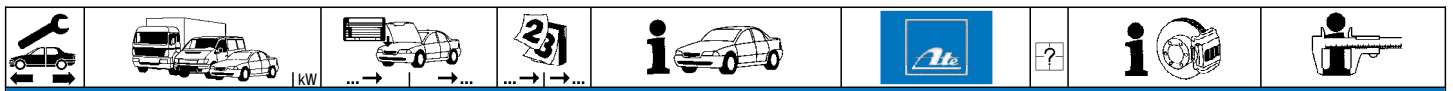

**AUDI A4 (B5) (95-01)**

|  |                 |     |             |              |              |                                  |                       |        |  |   |                |     |
|--|-----------------|-----|-------------|--------------|--------------|----------------------------------|-----------------------|--------|--|---|----------------|-----|
|  | 1.9 TDI quattro | 81  |             | <b>07.96</b> | <b>01.99</b> | - ESP                            | <b>24.2123-1717.3</b> | 010521 |  |   | THz 23,81      |     |
|  | 2.4             |     |             | <b>07.95</b> | <b>07.97</b> | +                                |                       |        |  |   |                |     |
|  | 2.4 quattro     | 121 |             | <b>08.97</b> | <b>01.99</b> | - ESP                            |                       |        |  |   |                |     |
|  | 2.5 TDI         |     |             | <b>08.97</b> | <b>01.99</b> | - ESP                            |                       |        |  |   |                |     |
|  | 2.5 TDI quattro |     |             | <b>11.97</b> | <b>01.99</b> | - ESP                            |                       |        |  |   |                |     |
|  | 2.6             |     |             | <b>11.94</b> | <b>01.99</b> | - ESP                            |                       |        |  |   |                |     |
|  | 2.6 quattro     |     |             | <b>11.94</b> | <b>01.99</b> | - ESP                            |                       |        |  |   |                |     |
|  | 2.8             | 128 |             | <b>11.94</b> | <b>07.97</b> |                                  |                       |        |  |   |                |     |
|  | 2.8 quattro     | 142 |             | <b>03.96</b> | <b>01.99</b> |                                  |                       |        |  |   |                |     |
|  | 2.8 quattro     | 128 |             | <b>11.94</b> | <b>07.96</b> | - ESP                            |                       |        |  |   |                |     |
|  | 2.8 quattro     | 142 |             | <b>09.96</b> | <b>01.99</b> | - ESP                            |                       |        |  |   |                |     |
|  | S4 quattro      |     |             | <b>10.97</b> | <b>01.99</b> | - ESP                            |                       |        |  |   |                |     |
|  | 1.6             |     |             | <b>02.99</b> | <b>04.01</b> | - ESP                            | <b>24.2125-1712.3</b> | 010622 |  |   | THz 25,40      |     |
|  | 1.8             |     |             | <b>02.99</b> | <b>04.01</b> | - ESP                            |                       |        |  |   |                |     |
|  | 1.8 quattro     |     |             | <b>02.99</b> | <b>04.01</b> | - ESP                            |                       |        |  |   |                |     |
|  | 1.8 quattro     | 85  |             | <b>02.99</b> | <b>04.01</b> | - ESP                            |                       |        |  |   |                |     |
|  | 1.8 quattro     | 92  |             | <b>02.99</b> | <b>04.01</b> | - ESP                            |                       |        |  |   |                |     |
|  | 1.8 T           |     |             | <b>02.99</b> | <b>04.01</b> | - ESP                            |                       |        |  |   |                |     |
|  | 1.8 T quattro   |     |             | <b>02.99</b> | <b>04.01</b> | - ESP                            |                       |        |  |   |                |     |
|  | 1.8 T quattro   | 110 |             | <b>02.99</b> | <b>04.01</b> | - ESP                            |                       |        |  |   |                |     |
|  | 1.8 T quattro   | 132 |             | <b>02.99</b> | <b>04.01</b> | - ESP                            |                       |        |  |   |                |     |
|  | 1.9 TDI         |     |             | <b>02.99</b> | <b>04.01</b> | - ESP                            |                       |        |  |   |                |     |
|  | 1.9 TDI         | 55  |             | <b>02.99</b> | <b>04.01</b> | - ESP                            |                       |        |  |   |                |     |
|  | 1.9 TDI         | 66  |             | <b>02.99</b> | <b>04.01</b> | - ESP                            |                       |        |  |   |                |     |
|  | 1.9 TDI         | 81  |             | <b>02.99</b> | <b>04.01</b> | - ESP                            |                       |        |  |   |                |     |
|  | 1.9 TDI         | 85  |             | <b>03.00</b> | <b>04.01</b> | - ESP                            |                       |        |  |   |                |     |
|  | 1.9 TDI quattro |     |             | <b>02.99</b> | <b>04.01</b> | - ESP                            |                       |        |  |   |                |     |
|  | 1.9 TDI quattro | 85  |             | <b>03.00</b> | <b>04.01</b> | - ESP                            |                       |        |  |   |                |     |
|  | 2.4             | 121 |             | <b>02.99</b> | <b>04.01</b> | - ESP                            |                       |        |  |   |                |     |
|  | 2.4 quattro     |     |             | <b>02.99</b> | <b>04.01</b> | - ESP                            |                       |        |  |   |                |     |
|  | 2.5 TDI         |     |             | <b>02.99</b> | <b>04.01</b> | - ESP                            |                       |        |  |   |                |     |
|  | 2.5 TDI quattro |     |             | <b>02.99</b> | <b>04.01</b> | - ESP                            |                       |        |  |   |                |     |
|  | 2.6             |     |             | <b>02.99</b> | <b>04.01</b> | - ESP                            |                       |        |  |   |                |     |
|  | 2.6 quattro     |     |             | <b>02.99</b> | <b>04.01</b> | - ESP                            |                       |        |  |   |                |     |
|  | 2.8             | 142 |             | <b>02.99</b> | <b>04.01</b> | - ESP                            |                       |        |  |   |                |     |
|  | 2.8 quattro     | 142 |             | <b>02.99</b> | <b>04.01</b> | - ESP                            |                       |        |  |   |                |     |
|  | S4 quattro      |     |             | <b>02.99</b> | <b>04.01</b> | - ESP                            |                       |        |  |   |                |     |
|  | 1.8 quattro     | 85  |             | <b>11.94</b> | <b>01.99</b> | + ESP                            | <b>24.2123-1730.3</b> | 010620 |  |   | THz 23,81      |     |
|  | 1.8 quattro     | 92  |             | <b>11.94</b> | <b>01.99</b> | + ESP                            |                       |        |  |   |                |     |
|  | 1.8 T quattro   | 110 |             | <b>02.95</b> | <b>01.99</b> | + ESP                            |                       |        |  |   |                |     |
|  | 1.8 T quattro   | 132 |             | <b>08.97</b> | <b>01.99</b> | + ESP                            |                       |        |  |   |                |     |
|  | 1.9 TDI quattro | 81  |             | <b>07.96</b> | <b>01.99</b> | + ESP                            |                       |        |  |   |                |     |
|  | 2.4 quattro     |     |             | <b>08.97</b> | <b>01.99</b> | + ESP                            |                       |        |  |   |                |     |
|  | 2.5 TDI quattro |     |             | <b>11.97</b> | <b>01.99</b> | + ESP                            |                       |        |  |   |                |     |
|  | 2.6 quattro     |     |             | <b>11.94</b> | <b>01.99</b> | + ESP                            |                       |        |  |   |                |     |
|  | 2.8 quattro     | 128 |             | <b>11.94</b> | <b>07.96</b> | + ESP                            |                       |        |  |   |                |     |
|  | 2.8 quattro     | 142 |             | <b>09.96</b> | <b>01.99</b> | + ESP                            |                       |        |  |   |                |     |
|  | S4 quattro      |     |             | <b>10.97</b> | <b>01.99</b> | + ESP                            |                       |        |  |   |                |     |
|  | 1.6             |     |             | <b>02.99</b> | <b>04.01</b> | + ESP                            | <b>24.2125-1713.3</b> | 010623 |  |   | THz 25,40      |     |
|  | 1.8             |     |             | <b>02.99</b> | <b>04.01</b> | + ESP                            |                       |        |  |   |                |     |
|  | 1.8 quattro     | 85  |             | <b>02.99</b> | <b>04.01</b> | + ESP                            |                       |        |  |   |                |     |
|  | 1.8 quattro     | 92  |             | <b>02.99</b> | <b>04.01</b> | + ESP                            |                       |        |  |   |                |     |
|  | 1.8 T           |     |             | <b>02.99</b> | <b>04.01</b> | + ESP                            |                       |        |  |   |                |     |
|  | 1.8 T quattro   |     |             | <b>02.99</b> | <b>04.01</b> | + ESP                            |                       |        |  |   |                |     |
|  | 1.8 T quattro   | 110 |             | <b>02.99</b> | <b>04.01</b> | + ESP                            |                       |        |  |   |                |     |
|  | 1.8 T quattro   | 132 |             | <b>02.99</b> | <b>04.01</b> | + ESP                            |                       |        |  |   |                |     |
|  | 1.9 TDI         | 55  |             | <b>02.99</b> | <b>04.01</b> | + ESP                            |                       |        |  |   |                |     |
|  | 1.9 TDI         | 66  |             | <b>02.99</b> | <b>04.01</b> | + ESP                            |                       |        |  |   |                |     |
|  | 1.9 TDI         | 81  |             | <b>02.99</b> | <b>04.01</b> | + ESP                            |                       |        |  |   |                |     |
|  | 1.9 TDI         | 85  |             | <b>03.00</b> | <b>04.01</b> | + ESP                            |                       |        |  |   |                |     |
|  | 1.9 TDI quattro |     |             | <b>02.99</b> | <b>04.01</b> | + ESP                            |                       |        |  |   |                |     |
|  | 1.9 TDI quattro | 85  |             | <b>03.00</b> | <b>04.01</b> | + ESP                            |                       |        |  |   |                |     |
|  | 2.4             | 121 |             | <b>02.99</b> | <b>04.01</b> | + ESP                            |                       |        |  |   |                |     |
|  | 2.4 quattro     |     |             | <b>02.99</b> | <b>04.01</b> | + ESP                            |                       |        |  |   |                |     |
|  | 2.5 TDI         |     |             | <b>02.99</b> | <b>04.01</b> | + ESP                            |                       |        |  |   |                |     |
|  | 2.5 TDI quattro |     |             | <b>02.99</b> | <b>04.01</b> | + ESP                            |                       |        |  |   |                |     |
|  | 2.6             |     |             | <b>02.99</b> | <b>04.01</b> | + ESP                            |                       |        |  |   |                |     |
|  | 2.6 quattro     |     |             | <b>02.99</b> | <b>04.01</b> | + ESP                            |                       |        |  |   |                |     |
|  | 2.8             | 142 |             | <b>02.99</b> | <b>04.01</b> | + ESP                            |                       |        |  |   |                |     |
|  | 2.8 quattro     | 142 |             | <b>02.99</b> | <b>04.01</b> | + ESP                            |                       |        |  |   |                |     |
|  | RS4             |     |             | <b>06.00</b> | <b>04.01</b> |                                  |                       |        |  |   |                |     |
|  | S4 quattro      |     |             | <b>02.99</b> | <b>04.01</b> | + ESP                            |                       |        |  |   |                |     |
|  | 1.9 TDI         | 55  | 8D-V-160000 | <b>03.96</b> |              |                                  | <b>24.3541-1745.5</b> | 240217 |  |   | D=54, - Halter | LUC |
|  | 1.9 TDI         | 66  | 8D-V-160000 | <b>01.95</b> |              |                                  | <b>24.3541-1746.5</b> | 240218 |  |   | D=54, - Halter | LUC |
|  | 1.6             |     | 8D-V-054061 | <b>11.94</b> |              |                                  | <b>11.3571-8518.2</b> | 220322 |  |   | D=57, - Halter | ATE |
|  | 1.8             | 85  | 8D-V-054061 | <b>07.95</b> |              | +  / + GUS-Staaten <sup>1)</sup> | <b>11.3571-8517.2</b> | 220321 |  |   | D=57, - Halter | ATE |
|  | 1.8             | 92  | 8D-V-054061 | <b>11.94</b> |              |                                  | <b>24.3571-8518.5</b> | 240494 |  |   | D=57, - Halter | ATE |
|  | 1.8 quattro     | 85  | 8D-V-054061 | <b>11.94</b> |              | + GUS-Staaten <sup>2)</sup>      | <b>24.3571-8517.5</b> | 240493 |  |   | D=57, - Halter | ATE |
|  | 1.8 quattro     | 92  | 8D-V-054061 | <b>11.94</b> |              |                                  | <b>11.0441-5704.2</b> | 250034 |  |   | Dichtungssatz  | ATE |
|  |                 |     |             |              |              |                                  | <b>11.0101-5409.2</b> | 260035 |  |   | Hülsensatz     | ATE |
|  |                 |     |             |              |              |                                  | <b>11.8171-0008.1</b> | 990049 |  |   | Führungsbolzen | ATE |
|  |                 |     |             |              |              |                                  | <b>11.8116-0143.1</b> | 390513 |  | 2 | Haltefeder     | ATE |
|  | 1.6             |     | 8D-V-054062 |              | <b>04.01</b> |                                  | <b>24.3541-1763.5</b> | 240231 |  |   | D=54, - Halter | LUC |
|  | 1.8             | 85  | 8D-V-054062 |              | <b>04.01</b> | +  / + GUS-Staaten <sup>1)</sup> | <b>24.3541-1764.5</b> | 240232 |  |   | D=54, - Halter | LUC |
|  | 1.8             | 92  | 8D-V-054062 |              | <b>04.01</b> |                                  |                       |        |  |   |                |     |
|  | 1.8 quattro     | 85  | 8D-V-054062 |              | <b>04.01</b> | + GUS-Staaten <sup>2)</sup>      |                       |        |  |   |                |     |
|  | 1.8 quattro     | 92  | 8D-V-054062 |              | <b>04.01</b> |                                  |                       |        |  |   |                |     |
|  | 1.9 TDI         | 55  | 8D-V-160001 |              | <b>04.01</b> |                                  |                       |        |  |   |                |     |
|  | 1.9 TDI         | 66  | 8D-V-160001 |              | <b>04.01</b> |                                  |                       |        |  |   |                |     |

<sup>1)</sup> + / + GUS States / + / + Stati del GUS / + / + Etats de la CEI / + / + estados del GUS

<sup>2)</sup> + GUS States / + Stati del GUS / + Etats de la CEI / + estados del GUS

| <b>AUDI A4 (B5) (95-01)</b> |                 |             |             |       |       |       |  |                |        |   |  |  |  |  |  |
|-----------------------------|-----------------|-------------|-------------|-------|-------|-------|--|----------------|--------|---|--|--|--|--|--|
|                             | 1.8 T           |             |             | 05.95 | 04.01 |       |  | 11.3571-8522.2 | 220320 |   |  |  |  |  |  |
|                             | 1.8 T quattro   | 110         |             | 02.95 | 04.01 |       |  | 11.3571-8521.2 | 220319 |   |  |  |  |  |  |
|                             | 1.8 T quattro   | 132         |             | 08.97 | 04.01 |       |  | 24.3571-8522.5 | 240496 |   |  |  |  |  |  |
|                             | 1.9 TDI         | 81          |             | 02.96 | 04.01 |       |  | 24.3571-8521.5 | 240495 |   |  |  |  |  |  |
|                             | 1.9 TDI         | 85          |             | 03.00 | 04.01 |       |  | 11.0441-5704.2 | 250034 |   |  |  |  |  |  |
|                             | 1.9 TDI quattro | 81          |             | 07.96 | 04.01 |       |  | 11.8170-0306.1 | 260102 | 2 |  |  |  |  |  |
|                             | 1.9 TDI quattro | 85          |             | 03.00 | 04.01 |       |  | 11.0101-5409.2 | 260035 |   |  |  |  |  |  |
|                             | 2.4             |             |             | 07.95 | 07.97 | + (T) |  | 11.8171-0008.1 | 990049 |   |  |  |  |  |  |
|                             | 2.4             | 121         |             | 08.97 | 04.01 |       |  | 11.8116-0143.1 | 390513 | 2 |  |  |  |  |  |
|                             | 2.4 quattro     |             |             | 08.97 | 04.01 |       |  |                |        |   |  |  |  |  |  |
|                             | 2.5 TDI         |             |             | 08.97 | 04.01 |       |  |                |        |   |  |  |  |  |  |
|                             | 2.5 TDI quattro |             |             | 11.97 | 04.01 |       |  |                |        |   |  |  |  |  |  |
|                             | 2.6             |             |             | 11.94 | 04.01 |       |  |                |        |   |  |  |  |  |  |
|                             | 2.6 quattro     |             |             | 11.94 | 04.01 |       |  |                |        |   |  |  |  |  |  |
| 2.8                         | 128             |             | 11.94       | 07.97 |       |       |  |                |        |   |  |  |  |  |  |
| 2.8                         | 142             |             | 03.96       | 04.01 |       |       |  |                |        |   |  |  |  |  |  |
| 2.8 quattro                 | 128             |             | 11.94       | 07.96 |       |       |  |                |        |   |  |  |  |  |  |
| 2.8 quattro                 | 142             |             | 06.96       | 04.01 |       |       |  |                |        |   |  |  |  |  |  |
| RS4                         |                 |             | 06.00       | 04.01 |       |       |  |                |        |   |  |  |  |  |  |
|                             |                 |             |             |       |       |       |  | 11.8171-0008.1 | 990049 |   |  |  |  |  |  |
|                             |                 |             |             |       |       |       |  | 11.8116-0260.1 | 390597 | 2 |  |  |  |  |  |
|                             |                 |             |             |       |       |       |  |                |        |   |  |  |  |  |  |
|                             | 1.6             |             |             | 11.94 | 04.01 |       |  | 83.7813-0295.3 | 330799 | 2 |  |  |  |  |  |
|                             | 1.8             |             |             | 11.94 | 04.01 |       |  |                |        |   |  |  |  |  |  |
|                             | 1.8 quattro     | 85          |             | 11.94 | 04.01 |       |  |                |        |   |  |  |  |  |  |
|                             | 1.8 quattro     | 92          |             | 11.94 | 04.01 |       |  |                |        |   |  |  |  |  |  |
|                             | 1.8 T           |             |             | 05.95 | 04.01 |       |  |                |        |   |  |  |  |  |  |
|                             | 1.8 T quattro   | 110         |             | 02.95 | 04.01 |       |  |                |        |   |  |  |  |  |  |
|                             | 1.8 T quattro   | 132         |             | 08.97 | 04.01 |       |  |                |        |   |  |  |  |  |  |
|                             | 1.9 TDI         | 55          |             | 03.96 | 04.01 |       |  |                |        |   |  |  |  |  |  |
|                             | 1.9 TDI         | 66          |             | 01.95 | 04.01 |       |  |                |        |   |  |  |  |  |  |
|                             | 1.9 TDI         | 81          |             | 02.96 | 04.01 |       |  |                |        |   |  |  |  |  |  |
|                             | 1.9 TDI         | 85          |             | 03.00 | 04.01 |       |  |                |        |   |  |  |  |  |  |
|                             | 1.9 TDI quattro | 81          |             | 07.96 | 04.01 |       |  |                |        |   |  |  |  |  |  |
|                             | 1.9 TDI quattro | 85          |             | 03.00 | 04.01 |       |  |                |        |   |  |  |  |  |  |
|                             | 2.4             |             |             | 07.95 | 04.01 | + (T) |  |                |        |   |  |  |  |  |  |
|                             | 2.4             | 121         |             | 08.97 | 04.01 |       |  |                |        |   |  |  |  |  |  |
|                             | 2.4 quattro     |             |             | 08.97 | 04.01 |       |  |                |        |   |  |  |  |  |  |
|                             | 2.5 TDI         |             |             | 08.97 | 04.01 |       |  |                |        |   |  |  |  |  |  |
|                             | 2.5 TDI quattro |             |             | 11.97 | 04.01 |       |  |                |        |   |  |  |  |  |  |
|                             | 2.6             |             |             | 11.94 | 04.01 |       |  |                |        |   |  |  |  |  |  |
|                             | 2.6 quattro     |             |             | 11.94 | 04.01 |       |  |                |        |   |  |  |  |  |  |
|                             | 2.8             | 128         |             | 11.94 | 07.97 |       |  |                |        |   |  |  |  |  |  |
|                             | 2.8             | 142         |             | 03.96 | 04.01 |       |  |                |        |   |  |  |  |  |  |
|                             | 2.8 quattro     | 128         |             | 11.94 | 07.96 |       |  |                |        |   |  |  |  |  |  |
| 2.8 quattro                 | 142             |             | 09.96       | 04.01 |       |       |  |                |        |   |  |  |  |  |  |
| S4 quattro                  |                 |             | 10.97       | 04.01 |       |       |  |                |        |   |  |  |  |  |  |
|                             | 1.6             |             | 8D-V-160000 | 11.94 |       |       |  | 24.3384-1719.5 | 240259 |   |  |  |  |  |  |
|                             | 1.8             |             | 8D-V-160000 | 11.94 |       |       |  | 24.3384-1720.5 | 240260 |   |  |  |  |  |  |
|                             | 1.8 T           |             | 8D-V-160000 | 05.95 |       |       |  |                |        |   |  |  |  |  |  |
|                             | 1.9 TDI         | 55          | 8D-V-160000 | 03.96 |       |       |  |                |        |   |  |  |  |  |  |
|                             | 1.9 TDI         | 66          | 8D-V-160000 | 01.95 |       |       |  |                |        |   |  |  |  |  |  |
|                             | 1.9 TDI         | 81          | 8D-V-160000 | 02.96 |       |       |  |                |        |   |  |  |  |  |  |
|                             | 2.4             |             | 8D-V-160000 | 07.95 |       | + (T) |  |                |        |   |  |  |  |  |  |
|                             | 2.6             |             | 8D-V-160000 | 11.94 |       |       |  |                |        |   |  |  |  |  |  |
|                             | 2.8             | 128         | 8D-V-160000 | 11.94 |       |       |  |                |        |   |  |  |  |  |  |
|                             | 2.8             | 142         | 8D-V-160000 | 03.96 |       |       |  |                |        |   |  |  |  |  |  |
|                             | 1.6             |             | 8D-V-160001 |       | 04.01 |       |  | 24.3384-1731.7 | 220543 |   |  |  |  |  |  |
|                             | 1.8             |             | 8D-V-160001 |       | 04.01 |       |  | 24.3384-1732.7 | 220544 |   |  |  |  |  |  |
|                             | 1.8 T           |             | 8D-V-160001 |       | 04.01 |       |  |                |        |   |  |  |  |  |  |
|                             | 1.9 TDI         | 55          | 8D-V-160001 |       | 04.01 |       |  |                |        |   |  |  |  |  |  |
|                             | 1.9 TDI         | 66          | 8D-V-160001 |       | 04.01 |       |  |                |        |   |  |  |  |  |  |
|                             | 1.9 TDI         | 81          | 8D-V-160001 |       | 04.01 |       |  |                |        |   |  |  |  |  |  |
|                             | 1.9 TDI         | 85          |             | 03.00 | 04.01 |       |  |                |        |   |  |  |  |  |  |
|                             | 2.4             |             | 8D-V-160001 |       | 07.97 | + (T) |  |                |        |   |  |  |  |  |  |
|                             | 2.4             | 121         |             | 08.97 | 04.01 |       |  |                |        |   |  |  |  |  |  |
|                             | 2.5 TDI         |             |             | 08.97 | 04.01 |       |  |                |        |   |  |  |  |  |  |
|                             | 1.8 quattro     | 85          |             | 11.94 | 04.01 |       |  | 24.3384-1725.5 | 240261 |   |  |  |  |  |  |
|                             | 1.8 quattro     | 92          |             | 11.94 | 04.01 |       |  | 24.3384-1726.5 | 240262 |   |  |  |  |  |  |
|                             | 1.8 T quattro   | 110         |             | 02.95 | 04.01 |       |  |                |        |   |  |  |  |  |  |
|                             | 1.8 T quattro   | 132         |             | 08.97 | 04.01 |       |  |                |        |   |  |  |  |  |  |
|                             | 1.9 TDI quattro | 81          |             | 07.96 | 04.01 |       |  |                |        |   |  |  |  |  |  |
|                             | 1.9 TDI quattro | 85          |             | 03.00 | 04.01 |       |  |                |        |   |  |  |  |  |  |
|                             | 2.4 quattro     |             |             | 08.97 | 04.01 |       |  |                |        |   |  |  |  |  |  |
|                             | 2.5 TDI quattro |             |             | 11.97 | 04.01 |       |  |                |        |   |  |  |  |  |  |
|                             | 2.6 quattro     |             |             | 11.94 | 04.01 |       |  |                |        |   |  |  |  |  |  |
|                             | 2.8 quattro     | 128         |             | 11.94 | 07.96 |       |  |                |        |   |  |  |  |  |  |
| 2.8 quattro                 | 142             |             | 06.96       | 04.01 |       |       |  |                |        |   |  |  |  |  |  |
|                             | 1.6             |             | 8D-V-160000 | 11.94 |       |       |  | 83.7812-0180.3 | 330854 | 2 |  |  |  |  |  |
|                             | 1.8             |             | 8D-V-160000 | 11.94 |       |       |  | 83.6105-0200.3 | 330453 | 2 |  |  |  |  |  |
|                             | 1.8 T           |             | 8D-V-160000 | 05.95 |       |       |  |                |        |   |  |  |  |  |  |
|                             | 1.9 TDI         | 55          | 8D-V-160000 | 03.96 |       |       |  |                |        |   |  |  |  |  |  |
|                             | 1.9 TDI         | 66          | 8D-V-160000 | 01.95 |       |       |  |                |        |   |  |  |  |  |  |
|                             | 1.9 TDI         | 81          | 8D-V-160000 | 02.96 |       |       |  |                |        |   |  |  |  |  |  |
|                             | 2.4             |             | 8D-V-160000 | 07.95 |       | + (T) |  |                |        |   |  |  |  |  |  |
| 2.6                         |                 | 8D-V-160000 | 11.94       |       |       |       |  |                |        |   |  |  |  |  |  |
|                             |                 |             |             |       |       |       |  |                |        |   |  |  |  |  |  |

1) on the brake caliper / sulla pinza freno / sur l'étrier de frein / a la pinza de freno



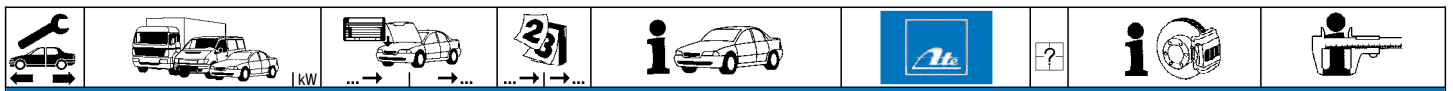

**AUDI A4 (B5) (95-01)**

|                 |                 |             |             |             |       |                |                |        |                              |                              |          |
|-----------------|-----------------|-------------|-------------|-------------|-------|----------------|----------------|--------|------------------------------|------------------------------|----------|
|                 | 2.8             | 128         | 8D-V-160000 | 11.94       |       | 83.7812-0180.3 | 330854         | 2      |                              | L=180                        |          |
|                 | 2.8             | 142         | 8D-V-160000 | 03.96       |       | 83.6105-0200.3 | 330453         | 2      | am Bremssattel <sup>1)</sup> | L=200                        |          |
|                 | 1.6             |             | 8D-V-160001 |             | 04.01 | 83.7812-0180.3 | 330854         | 2      |                              | L=180                        |          |
|                 | 1.8             |             | 8D-V-160001 |             | 04.01 | 24.5244-0240.3 | 330679         | 2      | am Bremssattel <sup>1)</sup> | L=240                        |          |
|                 | 1.8 T           |             | 8D-V-160001 |             | 04.01 |                |                |        |                              |                              |          |
|                 | 1.9 TDI         | 55          | 8D-V-160001 |             | 04.01 |                |                |        |                              |                              |          |
|                 | 1.9 TDI         | 66          | 8D-V-160001 |             | 04.01 |                |                |        |                              |                              |          |
|                 | 1.9 TDI         | 81          | 8D-V-160001 |             | 04.01 |                |                |        |                              |                              |          |
|                 | 1.9 TDI         | 85          |             |             | 03.00 | 04.01          |                |        |                              |                              |          |
|                 | 2.4             |             | 8D-V-160001 |             | 07.97 | + ⓘ            |                |        |                              |                              |          |
|                 | 2.4             | 121         |             |             | 08.97 | 04.01          |                |        |                              |                              |          |
|                 | 2.5 TDI         |             |             |             | 08.97 | 04.01          |                |        |                              |                              |          |
|                 | 2.6             |             | 8D-V-160001 |             |       | 04.01          |                |        |                              |                              |          |
|                 | 2.8             | 128         | 8D-V-160001 |             |       | 07.97          |                |        |                              |                              |          |
|                 | 2.8             | 142         | 8D-V-160001 |             |       | 04.01          |                |        |                              |                              |          |
|                 |                 | 1.8 quattro | 85          |             | 11.94 | 04.01          | 83.6212-0160.3 | 330318 | 2                            |                              | L=160    |
|                 |                 | 1.8 quattro | 92          |             | 11.94 | 04.01          | 83.7724-0215.3 | 330843 | 2                            | am Bremssattel <sup>1)</sup> | L=215    |
| 1.8 T quattro   |                 | 110         |             | 02.95       | 04.01 |                |                |        |                              |                              |          |
| 1.8 T quattro   |                 | 132         |             | 08.97       | 04.01 |                |                |        |                              |                              |          |
| 1.9 TDI quattro |                 | 81          |             | 07.96       | 04.01 |                |                |        |                              |                              |          |
| 1.9 TDI quattro |                 | 85          |             | 03.00       | 04.01 |                |                |        |                              |                              |          |
| 2.4 quattro     |                 |             |             | 08.97       | 04.01 |                |                |        |                              |                              |          |
| 2.5 TDI quattro |                 |             |             | 11.97       | 04.01 |                |                |        |                              |                              |          |
| 2.6 quattro     |                 |             |             | 11.94       | 04.01 |                |                |        |                              |                              |          |
| 2.8 quattro     |                 | 128         |             | 11.94       | 07.96 |                |                |        |                              |                              |          |
| 2.8 quattro     |                 | 142         |             | 06.96       | 04.01 |                |                |        |                              |                              |          |
| RS4             |                 |             |             | 06.00       | 04.01 |                |                |        |                              |                              |          |
|                 | 1.6             |             |             | 11.94       | 04.01 | 24.3727-0155.2 | 580155         | 2      |                              | L=1812                       |          |
|                 | 1.8             |             |             | 11.94       | 04.01 |                |                |        |                              |                              |          |
|                 | 1.8 T           |             |             | 05.95       | 04.01 |                |                |        |                              |                              |          |
|                 | 1.9 TDI         | 55          |             | 03.96       | 04.01 |                |                |        |                              |                              |          |
|                 | 1.9 TDI         | 66          |             | 01.95       | 04.01 |                |                |        |                              |                              |          |
|                 | 1.9 TDI         | 81          |             | 02.96       | 04.01 |                |                |        |                              |                              |          |
|                 | 1.9 TDI         | 85          |             | 03.00       | 04.01 |                |                |        |                              |                              |          |
|                 | 2.4             |             |             | 07.95       | 07.97 | + ⓘ            |                |        |                              |                              |          |
|                 | 2.4             | 121         |             | 08.97       | 04.01 |                |                |        |                              |                              |          |
|                 | 2.5 TDI         |             |             | 08.97       | 04.01 |                |                |        |                              |                              |          |
|                 | 2.6             |             |             | 11.94       | 04.01 |                |                |        |                              |                              |          |
|                 | 2.8             | 128         |             | 11.94       | 07.97 |                |                |        |                              |                              |          |
|                 | 2.8             | 142         |             | 03.96       | 04.01 |                |                |        |                              |                              |          |
|                 |                 | 1.6         |             | 8D-V-180000 | 11.94 |                | 24.2419-1706.3 | 030091 |                              |                              | Gz 19,05 |
|                 |                 | 1.8         |             | 8D-V-180000 | 11.94 |                |                |        |                              |                              |          |
| 1.8 quattro     |                 | 85          | 8D-V-170678 | 11.94       |       |                |                |        |                              |                              |          |
| 1.8 quattro     |                 | 92          | 8D-V-170678 | 11.94       |       |                |                |        |                              |                              |          |
| 1.8 T           |                 |             | 8D-V-180000 | 05.95       |       |                |                |        |                              |                              |          |
| 1.8 T quattro   |                 | 110         | 8D-V-170678 | 02.95       |       |                |                |        |                              |                              |          |
| 1.9 TDI         |                 | 55          | 8D-V-180000 | 03.96       |       |                |                |        |                              |                              |          |
| 1.9 TDI         |                 | 66          | 8D-V-180000 | 01.95       |       |                |                |        |                              |                              |          |
| 1.9 TDI         |                 | 81          | 8D-V-180000 | 02.96       |       |                |                |        |                              |                              |          |
| 1.9 TDI         |                 | 85          | 8D-V-180000 | 03.00       |       |                |                |        |                              |                              |          |
| 1.9 TDI quattro |                 | 81          | 8D-V-277328 | 07.96       |       |                |                |        |                              |                              |          |
| 2.4             |                 |             | 8D-V-180000 | 07.95       | + ⓘ   |                |                |        |                              |                              |          |
| 2.5 TDI         |                 |             | 8D-V-180000 | 08.97       |       |                |                |        |                              |                              |          |
| 2.6             |                 |             | 8D-V-180000 | 11.94       |       |                |                |        |                              |                              |          |
| 2.6 quattro     |                 |             | 8D-V-170678 | 11.94       |       |                |                |        |                              |                              |          |
| 2.8             | 128             | 8D-V-180000 | 11.94       |             |       |                |                |        |                              |                              |          |
| 2.8             | 142             | 8D-V-180000 | 03.96       |             |       |                |                |        |                              |                              |          |
| 2.8 quattro     | 128             | 8D-V-170678 | 11.94       |             |       |                |                |        |                              |                              |          |
| 2.8 quattro     | 142             | 8D-V-170678 | 06.96       |             |       |                |                |        |                              |                              |          |
|                 | 1.6             |             | 8D-V-180001 |             | 04.01 | 24.2419-1707.3 | 030092         |        |                              | Gz 19,05                     |          |
|                 | 1.8             |             | 8D-V-180001 |             | 04.01 |                |                |        |                              |                              |          |
|                 | 1.8 quattro     | 85          | 8D-V-170679 |             | 04.01 |                |                |        |                              |                              |          |
|                 | 1.8 quattro     | 92          | 8D-V-170679 |             | 04.01 |                |                |        |                              |                              |          |
|                 | 1.8 T           |             | 8D-V-180001 |             | 04.01 |                |                |        |                              |                              |          |
|                 | 1.8 T quattro   | 110         | 8D-V-170679 |             | 04.01 |                |                |        |                              |                              |          |
|                 | 1.8 T quattro   | 132         |             | 08.97       | 04.01 |                |                |        |                              |                              |          |
|                 | 1.9 TDI         | 55          | 8D-V-180001 |             | 04.01 |                |                |        |                              |                              |          |
|                 | 1.9 TDI         | 66          | 8D-V-180001 |             | 04.01 |                |                |        |                              |                              |          |
|                 | 1.9 TDI         | 81          | 8D-V-180001 |             | 04.01 |                |                |        |                              |                              |          |
|                 | 1.9 TDI         | 85          | 8D-V-180001 |             | 04.01 |                |                |        |                              |                              |          |
|                 | 1.9 TDI quattro | 81          | 8D-V-277329 |             | 04.01 |                |                |        |                              |                              |          |
|                 | 1.9 TDI quattro | 85          |             | 03.00       | 04.01 |                |                |        |                              |                              |          |
|                 | 2.4             |             | 8D-V-180001 |             | 07.97 | + ⓘ            |                |        |                              |                              |          |
|                 | 2.4             | 121         |             | 08.97       | 04.01 |                |                |        |                              |                              |          |
| 2.4 quattro     |                 |             | 08.97       | 04.01       |       |                |                |        |                              |                              |          |
| 2.5 TDI         |                 | 8D-V-180001 |             |             | 04.01 |                |                |        |                              |                              |          |
| 2.5 TDI quattro |                 |             | 11.97       | 04.01       |       |                |                |        |                              |                              |          |
| 2.6             |                 | 8D-V-180001 |             |             | 04.01 |                |                |        |                              |                              |          |
| 2.6 quattro     |                 | 8D-V-170679 |             |             | 04.01 |                |                |        |                              |                              |          |
| 2.8             | 128             | 8D-V-180001 |             |             | 07.97 |                |                |        |                              |                              |          |
| 2.8             | 142             | 8D-V-180001 |             |             | 04.01 |                |                |        |                              |                              |          |
| 2.8 quattro     | 128             | 8D-V-170679 |             |             | 04.01 |                |                |        |                              |                              |          |
| 2.8 quattro     | 142             | 8D-V-170679 |             |             | 04.01 |                |                |        |                              |                              |          |
| RS4             |                 |             | 06.00       | 04.01       |       |                |                |        |                              |                              |          |
| S4 quattro      |                 |             | 10.97       | 04.01       |       |                |                |        |                              |                              |          |

<sup>1)</sup> on the brake caliper / sulla pinza freno / sur l'étrier de frein / a la pinza de freno



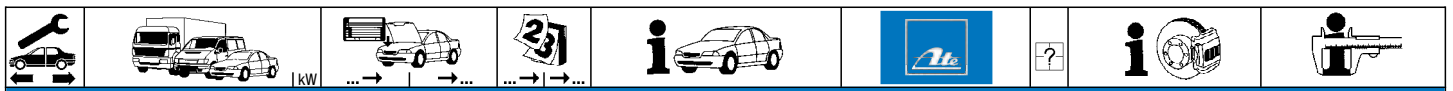

**AUDI A4 (B5) (95-01)**

|  |                 |                 |             |             |                |        |  |          |
|--|-----------------|-----------------|-------------|-------------|----------------|--------|--|----------|
|  | 1.6             | 8D-V-180001     |             | 04.01       | 24.2419-1705.3 | 030090 |  | Gz 19,05 |
|  | 1.8             | 8D-V-180001     |             | 04.01       |                |        |  |          |
|  | 1.8 quattro     | 85 8D-V-170679  |             | 04.01       |                |        |  |          |
|  | 1.8 quattro     | 92 8D-V-170679  |             | 04.01       |                |        |  |          |
|  | 1.8 T           | 8D-V-180001     |             | 04.01       |                |        |  |          |
|  | 1.8 T quattro   | 110 8D-V-170679 |             | 04.01       |                |        |  |          |
|  | 1.8 T quattro   | 132             | 08.97       | 04.01       |                |        |  |          |
|  | 1.9 TDI quattro | 81 8D-V-277329  |             | 04.01       |                |        |  |          |
|  | 1.9 TDI quattro | 85              | 03.00       | 04.01       |                |        |  |          |
|  | 2.4             | 8D-V-180001     |             | 07.97 + (T) |                |        |  |          |
|  | 2.4             | 121             | 08.97       | 04.01       |                |        |  |          |
|  | 2.4 quattro     |                 | 08.97       | 04.01       |                |        |  |          |
|  | 2.5 TDI quattro |                 | 11.97       | 04.01       |                |        |  |          |
|  | 2.6             | 8D-V-180001     |             | 04.01       |                |        |  |          |
|  | 2.6 quattro     | 8D-V-170679     |             | 04.01       |                |        |  |          |
|  | 2.8             | 128 8D-V-180001 |             | 07.97       |                |        |  |          |
|  | 2.8             | 142 8D-V-180001 |             | 04.01       |                |        |  |          |
|  | 2.8 quattro     | 128 8D-V-170679 |             | 04.01       |                |        |  |          |
|  | 2.8 quattro     | 142 8D-V-170679 |             | 04.01       |                |        |  |          |
|  | S4 quattro      |                 | 10.97       | 04.01       |                |        |  |          |
|  | 1.6             |                 | 8D-V-180000 | 11.94       | 24.2519-1702.3 | 040074 |  | Nz 19,05 |
|  | 1.8             |                 | 8D-V-180000 | 11.94       |                |        |  |          |
|  | 1.8 quattro     | 85              | 8D-V-170678 | 11.94       |                |        |  |          |
|  | 1.8 quattro     | 92              | 8D-V-170678 | 11.94       |                |        |  |          |
|  | 1.8 T           |                 | 8D-V-180000 | 05.95       |                |        |  |          |
|  | 1.8 T quattro   | 110             | 8D-V-170678 | 02.95       |                |        |  |          |
|  | 1.9 TDI         | 55              |             | 03.96       | 04.01          |        |  |          |
|  | 1.9 TDI         | 66              |             | 01.95       | 04.01          |        |  |          |
|  | 1.9 TDI         | 81              | 8D-V-180000 | 02.96       |                |        |  |          |
|  | 1.9 TDI         | 81              |             | 02.96       | 04.01 + (BR)   |        |  |          |
|  | 1.9 TDI         | 85              | 8D-V-180000 | 03.00       |                |        |  |          |
|  | 1.9 TDI quattro | 81              | 8D-V-277328 | 07.96       |                |        |  |          |
|  | 2.4             |                 | 8D-V-180000 | 07.95       | + (T)          |        |  |          |
|  | 2.5 TDI         |                 | 8D-V-180000 | 08.97       |                |        |  |          |
|  | 2.6             |                 | 8D-V-180000 | 11.94       |                |        |  |          |
|  | 2.6 quattro     |                 | 8D-V-170678 | 11.94       |                |        |  |          |
|  | 2.8             | 128             | 8D-V-180000 | 11.94       |                |        |  |          |
|  | 2.8             | 142             | 8D-V-180000 | 03.96       |                |        |  |          |
|  | 2.8 quattro     | 128             | 8D-V-170678 | 11.94       |                |        |  |          |
|  | 2.8 quattro     | 142             | 8D-V-170678 | 06.96       |                |        |  |          |
|  | 1.6             | 8D-V-180001     |             | 04.01       | 24.2522-1706.3 | 040090 |  | Nz 22,20 |
|  | 1.8             | 8D-V-180001     |             | 04.01       |                |        |  |          |
|  | 1.8 quattro     | 85 8D-V-170679  |             | 04.01       |                |        |  |          |
|  | 1.8 quattro     | 92 8D-V-170679  |             | 04.01       |                |        |  |          |
|  | 1.8 T           | 8D-V-180001     |             | 04.01       |                |        |  |          |
|  | 1.8 T quattro   | 110 8D-V-170679 |             | 04.01       |                |        |  |          |
|  | 1.8 T quattro   | 132             | 08.97       | 04.01       |                |        |  |          |
|  | 1.9 TDI         | 81 8D-V-180001  |             | 04.01       |                |        |  |          |
|  | 1.9 TDI         | 85 8D-V-180001  |             | 04.01       |                |        |  |          |
|  | 1.9 TDI quattro | 81 8D-V-277329  |             | 04.01       |                |        |  |          |
|  | 1.9 TDI quattro | 85              | 03.00       | 04.01       |                |        |  |          |
|  | 2.4             | 8D-V-180001     |             | 04.01 + (T) |                |        |  |          |
|  | 2.4 quattro     |                 | 08.97       | 04.01       |                |        |  |          |
|  | 2.5 TDI         | 8D-V-180001     |             | 04.01       |                |        |  |          |
|  | 2.5 TDI quattro |                 | 11.97       | 04.01       |                |        |  |          |
|  | 2.6             | 8D-V-180001     |             | 04.01       |                |        |  |          |
|  | 2.6 quattro     | 8D-V-170679     |             | 04.01       |                |        |  |          |
|  | 2.8             | 128 8D-V-180001 |             | 04.01       |                |        |  |          |
|  | 2.8             | 142 8D-V-180001 |             | 04.01       |                |        |  |          |
|  | 2.8 quattro     | 128 8D-V-170679 |             | 04.01       |                |        |  |          |
|  | 2.8 quattro     | 142 8D-V-170679 |             | 04.01       |                |        |  |          |
|  | RS4             |                 | 06.00       | 04.01       |                |        |  |          |
|  | S4 quattro      |                 | 10.97       | 04.01       |                |        |  |          |

**AUDI A4 (B6/B7) (01-08)**

|  |                 |                 |       |       |                |        |  |             |     |
|--|-----------------|-----------------|-------|-------|----------------|--------|--|-------------|-----|
|  | 1.6             | 75 8E-3-235001  |       | 11.08 | 03.7858-4502.4 | 300202 |  | 9/8" Tandem | ATE |
|  | 1.8 T           | 110 8E-3-235001 |       | 11.08 |                |        |  |             |     |
|  | 1.8 T           | 120 8E-3-235001 |       | 11.08 |                |        |  |             |     |
|  | 1.8 T           | 125 8E-3-235001 |       | 11.08 |                |        |  |             |     |
|  | 1.8 T           | 140 8E-3-235001 |       | 11.08 |                |        |  |             |     |
|  | 1.8 T quattro   | 110 8E-3-235001 |       | 11.08 |                |        |  |             |     |
|  | 1.8 T quattro   | 120 8E-3-235001 |       | 11.08 |                |        |  |             |     |
|  | 1.8 T quattro   | 125 8E-3-235001 |       | 11.08 |                |        |  |             |     |
|  | 1.8 T quattro   | 140 8E-3-235001 |       | 11.08 |                |        |  |             |     |
|  | 1.9 TDI         | 74 8E-3-235001  |       | 11.08 |                |        |  |             |     |
|  | 1.9 TDI         | 85              | 06.04 | 11.08 |                |        |  |             |     |
|  | 1.9 TDI         | 96 8E-3-235001  |       | 11.08 |                |        |  |             |     |
|  | 1.9 TDI quattro | 8E-3-235001     |       | 11.08 |                |        |  |             |     |
|  | 2.0             | 96 8E-3-235001  |       | 11.08 |                |        |  |             |     |
|  | 2.0 FSI         | 110 8E-3-235001 |       | 11.08 |                |        |  |             |     |
|  | 2.0 TFSI        | 147             | 11.04 | 11.08 |                |        |  |             |     |
|  | 2.0 TFSI        | 162             | 06.05 | 11.08 |                |        |  |             |     |
|  | 2.4             | 8E-3-235001     |       | 11.08 |                |        |  |             |     |
|  | 2.5 TDI         | 8E-3-235001     |       | 11.08 |                |        |  |             |     |
|  | 2.5 TDI quattro | 8E-3-235001     |       | 11.08 |                |        |  |             |     |
|  | 3.0             | 8E-3-235001     |       | 11.08 |                |        |  |             |     |
|  | 3.0 quattro     | 8E-3-235001     |       | 11.08 |                |        |  |             |     |



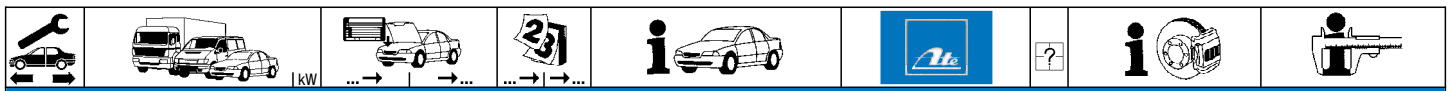

**AUDI A4 (B6/B7) (01-08)**

|  |                  |     |             |       |       |         |                |        |  |                |     |
|--|------------------|-----|-------------|-------|-------|---------|----------------|--------|--|----------------|-----|
|  | 3.2 FSI          | 188 |             | 01.05 | 11.08 |         | 03.7858-4502.4 | 300202 |  | 9/8" Tandem    | ATE |
|  | 2.0 TDI          | 100 | 8E-5-400001 |       | 11.08 |         | 03.7858-4502.4 | 300202 |  | 9/8" Tandem    | ATE |
|  | 2.0 TDI          | 103 | 8E-5-400001 |       | 11.08 |         |                |        |  |                |     |
|  | 2.0 TDI          | 125 |             | 06.06 | 11.08 |         |                |        |  |                |     |
|  | 2.0 TDI quattro  | 103 |             | 01.06 | 11.08 |         |                |        |  |                |     |
|  | 2.0 TDI quattro  | 125 |             | 06.06 | 11.08 |         |                |        |  |                |     |
|  | 2.0 TFSI quattro | 147 | 8E-5-400001 |       | 11.08 |         |                |        |  |                |     |
|  | 2.0 TFSI quattro | 162 | 8E-5-400001 |       | 11.08 |         |                |        |  |                |     |
|  | 2.7 TDI          | 120 |             | 11.05 | 11.08 |         |                |        |  |                |     |
|  | 2.7 TDI          | 132 |             | 01.06 | 11.08 |         |                |        |  |                |     |
|  | 3.0 TDI quattro  | 150 | 8E-5-400001 |       | 11.08 |         |                |        |  |                |     |
|  | 3.0 TDI quattro  | 171 |             | 01.06 | 11.08 |         |                |        |  |                |     |
|  | 3.2 FSI quattro  | 188 | 8E-5-400001 |       | 11.08 |         |                |        |  |                |     |
|  | 1.6              | 75  |             | 12.00 | 11.08 |         | 03.2125-0373.3 | 010810 |  | THz 25,40      | ATE |
|  | 1.8 T            | 110 |             | 12.00 | 11.08 |         | 24.2125-1720.3 | 010688 |  | THz 25,40      | LUC |
|  | 1.8 T            | 120 |             | 07.02 | 11.08 |         |                |        |  |                |     |
|  | 1.8 T            | 125 |             | 07.01 | 11.08 |         |                |        |  |                |     |
|  | 1.8 T            | 140 |             | 11.02 | 11.08 |         |                |        |  |                |     |
|  | 1.8 T quattro    | 110 |             | 12.00 | 11.08 |         |                |        |  |                |     |
|  | 1.8 T quattro    | 120 |             | 07.02 | 11.08 |         |                |        |  |                |     |
|  | 1.8 T quattro    | 125 |             | 07.01 | 11.08 |         |                |        |  |                |     |
|  | 1.8 T quattro    | 140 |             | 11.02 | 11.08 |         |                |        |  |                |     |
|  | 1.9 TDI          | 74  |             | 04.01 | 11.08 |         |                |        |  |                |     |
|  | 1.9 TDI          | 85  |             | 06.04 | 11.08 |         |                |        |  |                |     |
|  | 1.9 TDI          | 96  |             | 12.00 | 11.08 |         |                |        |  |                |     |
|  | 1.9 TDI quattro  |     |             | 12.00 | 11.08 |         |                |        |  |                |     |
|  | 2.0              | 96  |             | 12.00 | 11.08 |         |                |        |  |                |     |
|  | 2.0 FSI          | 110 |             | 07.02 | 11.08 |         |                |        |  |                |     |
|  | 2.0 TDI          | 100 |             | 11.04 | 11.08 |         |                |        |  |                |     |
|  | 2.0 TDI          | 103 |             | 11.03 | 11.08 |         |                |        |  |                |     |
|  | 2.0 TDI          | 125 |             | 06.06 | 11.08 |         |                |        |  |                |     |
|  | 2.0 TDI quattro  | 103 |             | 01.06 | 11.08 |         |                |        |  |                |     |
|  | 2.0 TDI quattro  | 125 |             | 06.06 | 11.08 |         |                |        |  |                |     |
|  | 2.0 TFSI         | 147 |             | 12.04 | 11.08 |         |                |        |  |                |     |
|  | 2.0 TFSI         | 162 |             | 06.05 | 11.08 |         |                |        |  |                |     |
|  | 2.0 TFSI quattro | 147 |             | 11.04 | 11.08 |         |                |        |  |                |     |
|  | 2.0 TFSI quattro | 162 |             | 06.05 | 11.08 |         |                |        |  |                |     |
|  | 2.4              |     |             | 09.01 | 11.08 |         |                |        |  |                |     |
|  | 2.5 TDI          |     |             | 12.00 | 11.08 |         |                |        |  |                |     |
|  | 2.5 TDI quattro  |     |             | 12.00 | 11.08 |         |                |        |  |                |     |
|  | 2.7 TDI          | 120 |             | 11.05 | 11.08 |         |                |        |  |                |     |
|  | 2.7 TDI          | 132 |             | 01.06 | 11.08 |         |                |        |  |                |     |
|  | 3.0              |     |             | 12.00 | 11.08 |         |                |        |  |                |     |
|  | 3.0 quattro      |     |             | 12.00 | 11.08 |         |                |        |  |                |     |
|  | 3.0 TDI quattro  | 150 |             | 11.04 | 11.08 |         |                |        |  |                |     |
|  | 3.0 TDI quattro  | 171 |             | 01.06 | 11.08 |         |                |        |  |                |     |
|  | 3.2 FSI          | 188 |             | 01.05 | 11.08 |         |                |        |  |                |     |
|  | 3.2 FSI quattro  | 188 |             | 01.05 | 11.08 |         |                |        |  |                |     |
|  | 1.6              | 75  | 8E-7-300000 | 12.00 |       | PR: 1LZ | 24.3541-1763.5 | 240231 |  | D=54, - Halter | LUC |
|  | 1.8 T            | 110 | 8E-7-300000 | 12.00 |       | PR: 1LZ | 24.3541-1764.5 | 240232 |  | D=54, - Halter | LUC |
|  | 1.8 T            | 120 | 8E-7-300000 | 07.02 |       | PR: 1LZ |                |        |  |                |     |
|  | 1.8 T            | 125 | 8E-7-300000 | 07.01 |       | PR: 1LZ |                |        |  |                |     |
|  | 1.8 T            | 140 | 8E-7-300000 | 11.02 |       | PR: 1LZ |                |        |  |                |     |
|  | 1.8 T quattro    | 110 | 8E-7-300000 | 12.00 |       | PR: 1LZ |                |        |  |                |     |
|  | 1.8 T quattro    | 120 | 8E-7-300000 | 07.02 |       | PR: 1LZ |                |        |  |                |     |
|  | 1.8 T quattro    | 125 | 8E-7-300000 | 07.01 |       | PR: 1LZ |                |        |  |                |     |
|  | 1.8 T quattro    | 140 | 8E-7-300000 | 11.02 |       | PR: 1LZ |                |        |  |                |     |
|  | 1.9 TDI          | 74  | 8E-7-300000 | 04.01 |       | PR: 1LZ |                |        |  |                |     |
|  | 1.9 TDI          | 85  | 8E-7-300000 | 06.04 |       | PR: 1LZ |                |        |  |                |     |
|  | 1.9 TDI          | 96  | 8E-7-300000 | 12.00 |       | PR: 1LZ |                |        |  |                |     |
|  | 1.9 TDI quattro  |     | 8E-7-300000 | 12.00 |       | PR: 1LZ |                |        |  |                |     |
|  | 2.0              | 96  | 8E-7-300000 | 12.00 |       | PR: 1LZ |                |        |  |                |     |
|  | 2.0 FSI          | 110 | 8E-7-300000 | 07.02 |       | PR: 1LZ |                |        |  |                |     |
|  | 2.0 TDI          | 100 | 8E-7-300000 | 11.04 |       | PR: 1LZ |                |        |  |                |     |
|  | 2.0 TDI          | 103 | 8E-7-300000 | 11.04 |       | PR: 1LZ |                |        |  |                |     |
|  | 2.0 TDI          | 125 | 8E-7-300000 | 06.06 |       | PR: 1LZ |                |        |  |                |     |
|  | 2.0 TDI quattro  | 103 | 8E-7-300000 | 01.06 |       | PR: 1LZ |                |        |  |                |     |
|  | 2.0 TDI quattro  | 125 | 8E-7-300000 | 06.06 |       | PR: 1LZ |                |        |  |                |     |
|  | 2.0 TFSI         | 147 | 8E-7-300000 | 11.04 |       | PR: 1LZ |                |        |  |                |     |
|  | 2.0 TFSI         | 162 | 8E-7-300000 | 06.05 |       | PR: 1LZ |                |        |  |                |     |
|  | 2.0 TFSI quattro | 147 | 8E-7-300000 | 11.04 |       | PR: 1LZ |                |        |  |                |     |
|  | 2.0 TFSI quattro | 162 | 8E-7-300000 | 06.05 |       | PR: 1LZ |                |        |  |                |     |
|  | 2.4              |     | 8E-7-300000 | 09.01 |       | PR: 1LZ |                |        |  |                |     |
|  | 2.5 TDI          |     | 8E-7-300000 | 12.00 |       | PR: 1LZ |                |        |  |                |     |
|  | 2.5 TDI quattro  |     | 8E-7-300000 | 12.00 |       | PR: 1LZ |                |        |  |                |     |
|  | 2.7 TDI          | 120 | 8E-7-300000 | 11.05 |       | PR: 1LZ |                |        |  |                |     |
|  | 2.7 TDI          | 132 | 8E-7-300000 | 01.06 |       | PR: 1LZ |                |        |  |                |     |
|  | 3.0              |     | 8E-7-300000 | 12.00 |       | PR: 1LZ |                |        |  |                |     |
|  | 3.0 quattro      |     | 8E-7-300000 | 12.00 |       | PR: 1LZ |                |        |  |                |     |
|  | 3.0 TDI quattro  | 150 | 8E-7-300000 | 11.04 |       | PR: 1LZ |                |        |  |                |     |
|  | 3.0 TDI quattro  | 171 | 8E-7-300000 | 01.06 |       | PR: 1LZ |                |        |  |                |     |
|  | 3.2 FSI          | 188 | 8E-7-300000 | 01.05 |       | PR: 1LZ |                |        |  |                |     |
|  | 3.2 FSI quattro  | 188 | 8E-7-300000 | 01.05 |       | PR: 1LZ |                |        |  |                |     |
|  | 1.6              | 75  | 8E-8-000001 |       | 11.08 | PR: 1LZ | 24.3541-1763.5 | 240231 |  | D=54, - Halter | LUC |
|  | 1.8 T            | 110 | 8E-8-000001 |       | 11.08 | PR: 1LZ | 24.3541-1764.5 | 240232 |  | D=54, - Halter | LUC |
|  | 1.8 T            | 120 | 8E-8-000001 |       | 11.08 | PR: 1LZ |                |        |  |                |     |
|  | 1.8 T            | 125 | 8E-8-000001 |       | 11.08 | PR: 1LZ |                |        |  |                |     |



**AUDI A4 (B6/B7) (01-08)**

|  |                  |     |             |  |       |                   |                |        |   |  |                |     |
|--|------------------|-----|-------------|--|-------|-------------------|----------------|--------|---|--|----------------|-----|
|  | 1.8 T            | 140 | 8E-8-000001 |  | 11.08 | PR: 1LZ           | 24.3541-1763.5 | 240231 |   |  | D=54, - Halter | LUC |
|  | 1.8 T quattro    | 110 | 8E-8-000001 |  | 11.08 | PR: 1LZ           | 24.3541-1764.5 | 240232 |   |  | D=54, - Halter | LUC |
|  | 1.8 T quattro    | 120 | 8E-8-000001 |  | 11.08 | PR: 1LZ           |                |        |   |  |                |     |
|  | 1.8 T quattro    | 125 | 8E-8-000001 |  | 11.08 | PR: 1LZ           |                |        |   |  |                |     |
|  | 1.8 T quattro    | 140 | 8E-8-000001 |  | 11.08 | PR: 1LZ           |                |        |   |  |                |     |
|  | 1.9 TDI          | 74  | 8E-8-000001 |  | 11.08 | PR: 1LZ           |                |        |   |  |                |     |
|  | 1.9 TDI          | 85  | 8E-8-000001 |  | 11.08 | PR: 1LZ           |                |        |   |  |                |     |
|  | 1.9 TDI          | 96  | 8E-8-000001 |  | 11.08 | PR: 1LZ           |                |        |   |  |                |     |
|  | 1.9 TDI quattro  |     | 8E-8-000001 |  | 11.08 | PR: 1LZ           |                |        |   |  |                |     |
|  | 2.0              | 96  | 8E-8-000001 |  | 11.08 | PR: 1LZ           |                |        |   |  |                |     |
|  | 2.0 FSI          | 110 | 8E-8-000001 |  | 11.08 | PR: 1LZ           |                |        |   |  |                |     |
|  | 2.0 TDI          | 100 | 8E-8-000001 |  | 11.08 | PR: 1LZ           |                |        |   |  |                |     |
|  | 2.0 TDI          | 103 | 8E-8-000001 |  | 11.08 | PR: 1LZ           |                |        |   |  |                |     |
|  | 2.0 TDI          | 125 | 8E-8-000001 |  | 11.08 | PR: 1LZ           |                |        |   |  |                |     |
|  | 2.0 TDI quattro  | 103 | 8E-8-000001 |  | 11.08 | PR: 1LZ           |                |        |   |  |                |     |
|  | 2.0 TDI quattro  | 125 | 8E-8-000001 |  | 11.08 | PR: 1LZ           |                |        |   |  |                |     |
|  | 2.0 TFSI         | 147 | 8E-8-000001 |  | 11.08 | PR: 1LZ           |                |        |   |  |                |     |
|  | 2.0 TFSI         | 162 | 8E-8-000001 |  | 11.08 | PR: 1LZ           |                |        |   |  |                |     |
|  | 2.0 TFSI quattro | 147 | 8E-8-000001 |  | 11.08 | PR: 1LZ           |                |        |   |  |                |     |
|  | 2.0 TFSI quattro | 162 | 8E-8-000001 |  | 11.08 | PR: 1LZ           |                |        |   |  |                |     |
|  | 2.4              |     | 8E-8-000001 |  | 11.08 | PR: 1LZ           |                |        |   |  |                |     |
|  | 2.5 TDI          |     | 8E-8-000001 |  | 11.08 | PR: 1LZ           |                |        |   |  |                |     |
|  | 2.5 TDI quattro  |     | 8E-8-000001 |  | 11.08 | PR: 1LZ           |                |        |   |  |                |     |
|  | 2.7 TDI          | 120 | 8E-8-000001 |  | 11.08 | PR: 1LZ           |                |        |   |  |                |     |
|  | 2.7 TDI          | 132 | 8E-8-000001 |  | 11.08 | PR: 1LZ           |                |        |   |  |                |     |
|  | 3.0              |     | 8E-8-000001 |  | 11.08 | PR: 1LZ           |                |        |   |  |                |     |
|  | 3.0 quattro      |     | 8E-8-000001 |  | 11.08 | PR: 1LZ           |                |        |   |  |                |     |
|  | 3.0 TDI quattro  | 150 | 8E-8-000001 |  | 11.08 | PR: 1LZ           |                |        |   |  |                |     |
|  | 3.0 TDI quattro  | 171 | 8E-8-000001 |  | 11.08 | PR: 1LZ           |                |        |   |  |                |     |
|  | 3.2 FSI          | 188 | 8E-8-000001 |  | 11.08 | PR: 1LZ           |                |        |   |  |                |     |
|  | 3.2 FSI quattro  | 188 | 8E-8-000001 |  | 11.08 | PR: 1LZ           |                |        |   |  |                |     |
|  | 1.6              | 75  |             |  | 12.00 | 11.08 PR: 1LB,1LE | 11.3571-8522.2 | 220320 |   |  | D=57, - Halter | ATE |
|  | 1.8 T            | 110 |             |  | 12.00 | 11.08 PR: 1LB,1LE | 11.3571-8521.2 | 220319 |   |  | D=57, - Halter | ATE |
|  | 1.8 T            | 120 |             |  | 07.02 | 11.08 PR: 1LB,1LE | 24.3571-8522.5 | 240496 |   |  | D=57, - Halter | ATE |
|  | 1.8 T            | 125 |             |  | 07.01 | 11.08 PR: 1LB,1LE | 24.3571-8521.5 | 240495 |   |  | D=57, - Halter | ATE |
|  | 1.8 T            | 140 |             |  | 11.02 | 11.08 PR: 1LB,1LE | 11.0441-5704.2 | 250034 |   |  | Dichtungssatz  | ATE |
|  | 1.8 T quattro    | 110 |             |  | 12.00 | 11.08 PR: 1LB,1LE | 11.0101-5409.2 | 260035 |   |  | Hülssensatz    | ATE |
|  | 1.8 T quattro    | 120 |             |  | 07.02 | 11.08 PR: 1LB,1LE | 11.8171-0008.1 | 990049 |   |  | Führungsbolzen | ATE |
|  | 1.8 T quattro    | 125 |             |  | 07.01 | 11.08 PR: 1LB,1LE | 11.8116-0143.1 | 390513 | 2 |  | Haltefeder     | ATE |
|  | 1.8 T quattro    | 140 |             |  | 11.02 | 11.08 PR: 1LB,1LE |                |        |   |  |                |     |
|  | 1.9 TDI          | 74  |             |  | 04.01 | 11.08 PR: 1LB,1LE |                |        |   |  |                |     |
|  | 1.9 TDI          | 85  |             |  | 06.04 | 11.08 PR: 1LB,1LE |                |        |   |  |                |     |
|  | 1.9 TDI          | 96  |             |  | 12.00 | 11.08 PR: 1LB,1LE |                |        |   |  |                |     |
|  | 1.9 TDI quattro  |     |             |  | 12.00 | 11.08 PR: 1LB,1LE |                |        |   |  |                |     |
|  | 2.0              | 96  |             |  | 12.00 | 11.08 PR: 1LB,1LE |                |        |   |  |                |     |
|  | 2.0 FSI          | 110 |             |  | 07.02 | 11.08 PR: 1LB,1LE |                |        |   |  |                |     |
|  | 2.0 TDI          | 100 |             |  | 11.04 | 11.08 PR: 1LB,1LE |                |        |   |  |                |     |
|  | 2.0 TDI          | 103 |             |  | 11.04 | 11.08 PR: 1LB,1LE |                |        |   |  |                |     |
|  | 2.0 TDI          | 125 |             |  | 06.06 | 11.08 PR: 1LB,1LE |                |        |   |  |                |     |
|  | 2.0 TDI quattro  | 103 |             |  | 01.06 | 11.08 PR: 1LB,1LE |                |        |   |  |                |     |
|  | 2.0 TDI quattro  | 125 |             |  | 06.06 | 11.08 PR: 1LB,1LE |                |        |   |  |                |     |
|  | 2.0 TFSI         | 147 |             |  | 11.04 | 11.08 PR: 1LB,1LE |                |        |   |  |                |     |
|  | 2.0 TFSI         | 162 |             |  | 06.05 | 11.08 PR: 1LB,1LE |                |        |   |  |                |     |
|  | 2.0 TFSI quattro | 147 |             |  | 11.04 | 11.08 PR: 1LB,1LE |                |        |   |  |                |     |
|  | 2.0 TFSI quattro | 162 |             |  | 06.05 | 11.08 PR: 1LB,1LE |                |        |   |  |                |     |
|  | 2.4              |     |             |  | 09.01 | 11.08 PR: 1LB,1LE |                |        |   |  |                |     |
|  | 2.5 TDI          |     |             |  | 12.00 | 11.08 PR: 1LB,1LE |                |        |   |  |                |     |
|  | 2.5 TDI quattro  |     |             |  | 12.00 | 11.08 PR: 1LB,1LE |                |        |   |  |                |     |
|  | 2.7 TDI          | 120 |             |  | 11.05 | 11.08 PR: 1LB,1LE |                |        |   |  |                |     |
|  | 2.7 TDI          | 132 |             |  | 01.06 | 11.08 PR: 1LB,1LE |                |        |   |  |                |     |
|  | 3.0              |     |             |  | 12.00 | 11.08 PR: 1LB,1LE |                |        |   |  |                |     |
|  | 3.0 quattro      |     |             |  | 12.00 | 11.08 PR: 1LB,1LE |                |        |   |  |                |     |
|  | 3.0 TDI quattro  | 150 |             |  | 11.04 | 11.08 PR: 1LB,1LE |                |        |   |  |                |     |
|  | 3.0 TDI quattro  | 171 |             |  | 01.06 | 11.08 PR: 1LB,1LE |                |        |   |  |                |     |
|  | 3.2 FSI          | 188 |             |  | 01.05 | 11.08 PR: 1LB,1LE |                |        |   |  |                |     |
|  | 3.2 FSI quattro  | 188 |             |  | 01.05 | 11.08 PR: 1LB,1LE |                |        |   |  |                |     |
|  | 1.6              | 75  |             |  | 12.00 | 11.08 PR: 1LF,1LT | 11.9571-9836.2 | 220428 |   |  | D=57, - Halter | ATE |
|  | 1.8 T            | 110 |             |  | 12.00 | 11.08 PR: 1LF,1LT | 11.9571-9835.2 | 220427 |   |  | D=57, - Halter | ATE |
|  | 1.8 T            | 120 |             |  | 07.02 | 11.08 PR: 1LF,1LT | 11.0441-5704.2 | 250034 |   |  | Dichtungssatz  | ATE |
|  | 1.8 T            | 125 |             |  | 07.01 | 11.08 PR: 1LF,1LT | 11.0101-5409.2 | 260035 |   |  | Hülssensatz    | ATE |
|  | 1.8 T            | 140 |             |  | 11.02 | 11.08 PR: 1LF,1LT | 11.8171-0008.1 | 990049 |   |  | Führungsbolzen | ATE |
|  | 1.8 T quattro    | 110 |             |  | 12.00 | 11.08 PR: 1LF,1LT | 11.8116-0143.1 | 390513 | 2 |  | Haltefeder     | ATE |
|  | 1.8 T quattro    | 120 |             |  | 07.02 | 11.08 PR: 1LF,1LT |                |        |   |  |                |     |
|  | 1.8 T quattro    | 125 |             |  | 07.01 | 11.08 PR: 1LF,1LT |                |        |   |  |                |     |
|  | 1.8 T quattro    | 140 |             |  | 11.02 | 11.08 PR: 1LF,1LT |                |        |   |  |                |     |
|  | 1.9 TDI          | 74  |             |  | 04.01 | 11.08 PR: 1LF,1LT |                |        |   |  |                |     |
|  | 1.9 TDI          | 85  |             |  | 06.04 | 11.08 PR: 1LF,1LT |                |        |   |  |                |     |
|  | 1.9 TDI          | 96  |             |  | 12.00 | 11.08 PR: 1LF,1LT |                |        |   |  |                |     |
|  | 1.9 TDI quattro  |     |             |  | 12.00 | 11.08 PR: 1LF,1LT |                |        |   |  |                |     |
|  | 2.0              | 96  |             |  | 12.00 | 11.08 PR: 1LF,1LT |                |        |   |  |                |     |
|  | 2.0 FSI          | 110 |             |  | 07.02 | 11.08 PR: 1LF,1LT |                |        |   |  |                |     |
|  | 2.0 TDI          | 100 |             |  | 11.04 | 11.08 PR: 1LF,1LT |                |        |   |  |                |     |
|  | 2.0 TDI          | 103 |             |  | 11.04 | 11.08 PR: 1LF,1LT |                |        |   |  |                |     |
|  | 2.0 TDI          | 125 |             |  | 06.06 | 11.08 PR: 1LF,1LT |                |        |   |  |                |     |
|  | 2.0 TDI quattro  | 103 |             |  | 01.06 | 11.08 PR: 1LF,1LT |                |        |   |  |                |     |
|  | 2.0 TDI quattro  | 125 |             |  | 06.06 | 11.08 PR: 1LF,1LT |                |        |   |  |                |     |
|  | 2.0 TFSI         | 147 |             |  | 11.04 | 11.08 PR: 1LF,1LT |                |        |   |  |                |     |



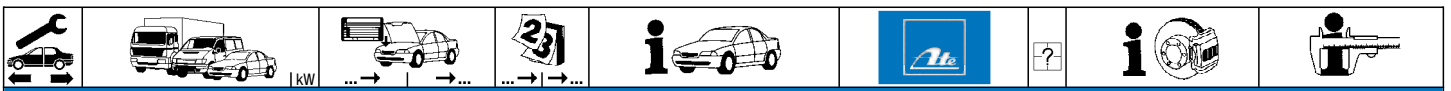

**AUDI A4 (B6/B7) (01-08)**

|                  |                  |              |       |       |             |                |                |        |   |  |   |     |
|------------------|------------------|--------------|-------|-------|-------------|----------------|----------------|--------|---|--|---|-----|
|                  | 2.0 TFSI         | 162          |       | 06.05 | 11.08       | PR: 1LF,1LT    | 11.9571-9836.2 | 220428 | 2 |  | D=57, - Halter<br>ATE<br>D=57, - Halter<br>ATE<br>Dichtungssatz<br>ATE<br>Hülzensatz<br>ATE<br>Führungsbolzen<br>ATE<br>Haltefeder<br>ATE | ATE |
|                  | 2.0 TFSI quattro | 147          |       | 11.04 | 11.08       | PR: 1LF,1LT    | 11.9571-9835.2 | 220427 |   |  |   |     |
|                  | 2.0 TFSI quattro | 162          |       | 06.05 | 11.08       | PR: 1LF,1LT    | 11.0441-5704.2 | 250034 |   |  |   |     |
|                  | 2.4              |              |       | 09.01 | 11.08       | PR: 1LF,1LT    | 11.0101-5409.2 | 260035 |   |  |   |     |
|                  | 2.5 TDI          |              |       | 12.00 | 11.08       | PR: 1LF,1LT    | 11.8171-0008.1 | 990049 |   |  |   |     |
|                  | 2.5 TDI quattro  | 120          |       | 12.00 | 11.08       | PR: 1LF,1LT    | 11.8116-0143.1 | 390513 |   |  |   |     |
|                  | 2.7 TDI          |              |       | 11.05 | 11.08       | PR: 1LF,1LT    |                |        |   |  |   |     |
|                  | 2.7 TDI          | 132          |       | 01.06 | 11.08       | PR: 1LF,1LT    |                |        |   |  |   |     |
|                  | 3.0              |              |       | 12.00 | 11.08       | PR: 1LF,1LT    |                |        |   |  |   |     |
|                  | 3.0 quattro      |              |       | 12.00 | 11.08       | PR: 1LF,1LT    |                |        |   |  |   |     |
|                  | 3.0 TDI quattro  | 150          |       | 11.04 | 11.08       | PR: 1LF,1LT    |                |        |   |  |   |     |
|                  | 3.0 TDI quattro  | 171          |       | 01.06 | 11.08       | PR: 1LF,1LT    |                |        |   |  |   |     |
|                  | 3.2 FSI          | 188          |       | 01.05 | 11.08       | PR: 1LF,1LT    |                |        |   |  |   |     |
|                  | 3.2 FSI quattro  | 188          |       | 01.05 | 11.08       | PR: 1LF,1LT    |                |        |   |  |   |     |
|                  | 1.6              | 75           |       | 12.00 | 11.08       | PR: 1LA,1LC    | 11.9606-9953.2 | 220587 |   |  |   |     |
|                  | 1.8 T            | 110          |       | 12.00 | 11.08       | PR: 1LA,1LC    | 11.9606-9954.2 | 220588 |   |  |   |     |
|                  | 1.8 T            | 120          |       | 07.02 | 11.08       | PR: 1LA,1LC    | 11.0441-6008.2 | 250038 |   |  |   |     |
|                  | 1.8 T            | 125          |       | 07.01 | 11.08       | PR: 1LA,1LC    | 11.0101-5409.2 | 260035 |   |  |   |     |
|                  | 1.8 T            | 140          |       | 11.02 | 11.08       | PR: 1LA,1LC    | 11.8171-0008.1 | 990049 |   |  |   |     |
|                  | 1.8 T quattro    | 110          |       | 12.00 | 11.08       | PR: 1LA,1LC    | 11.8116-0410.2 | 390589 |   |  |   |     |
| 1.8 T quattro    | 120              |              | 07.02 | 11.08 | PR: 1LA,1LC |                |                |        |   |  |   |     |
| 1.8 T quattro    | 125              |              | 07.01 | 11.08 | PR: 1LA,1LC |                |                |        |   |  |   |     |
| 1.8 T quattro    | 140              |              | 11.02 | 11.08 | PR: 1LA,1LC |                |                |        |   |  |   |     |
| 1.9 TDI          | 74               |              | 04.01 | 11.08 | PR: 1LA,1LC |                |                |        |   |  |   |     |
| 1.9 TDI          | 85               |              | 06.04 | 11.08 | PR: 1LA,1LC |                |                |        |   |  |   |     |
| 1.9 TDI          | 96               |              | 12.00 | 11.08 | PR: 1LA,1LC |                |                |        |   |  |   |     |
| 1.9 TDI quattro  |                  |              | 12.00 | 11.08 | PR: 1LA,1LC |                |                |        |   |  |   |     |
| 2.0              | 96               |              | 12.00 | 11.08 | PR: 1LA,1LC |                |                |        |   |  |   |     |
| 2.0 FSI          | 110              |              | 07.02 | 11.08 | PR: 1LA,1LC |                |                |        |   |  |   |     |
| 2.0 TDI          | 100              |              | 11.04 | 11.08 | PR: 1LA,1LC |                |                |        |   |  |   |     |
| 2.0 TDI          | 103              |              | 11.04 | 11.08 | PR: 1LA,1LC |                |                |        |   |  |   |     |
| 2.0 TDI          | 125              |              | 06.06 | 11.08 | PR: 1LA,1LC |                |                |        |   |  |   |     |
| 2.0 TDI quattro  | 103              |              | 01.06 | 11.08 | PR: 1LA,1LC |                |                |        |   |  |   |     |
| 2.0 TDI quattro  | 125              |              | 06.06 | 11.08 | PR: 1LA,1LC |                |                |        |   |  |   |     |
| 2.0 TFSI         | 147              |              | 11.04 | 11.08 | PR: 1LA,1LC |                |                |        |   |  |   |     |
| 2.0 TFSI         | 162              |              | 06.05 | 11.08 | PR: 1LA,1LC |                |                |        |   |  |   |     |
| 2.0 TFSI quattro | 147              |              | 11.04 | 11.08 | PR: 1LA,1LC |                |                |        |   |  |   |     |
| 2.0 TFSI quattro | 162              |              | 06.05 | 11.08 | PR: 1LA,1LC |                |                |        |   |  |   |     |
| 2.4              |                  |              | 09.01 | 11.08 | PR: 1LA,1LC |                |                |        |   |  |   |     |
| 2.5 TDI          |                  |              | 12.00 | 11.08 | PR: 1LA,1LC |                |                |        |   |  |   |     |
| 2.5 TDI quattro  |                  |              | 12.00 | 11.08 | PR: 1LA,1LC |                |                |        |   |  |   |     |
| 2.7 TDI          | 120              |              | 11.05 | 11.08 | PR: 1LA,1LC |                |                |        |   |  |   |     |
| 2.7 TDI          | 132              |              | 01.06 | 11.08 | PR: 1LA,1LC |                |                |        |   |  |   |     |
| 3.0              |                  |              | 12.00 | 11.08 | PR: 1LA,1LC |                |                |        |   |  |   |     |
| 3.0 quattro      |                  |              | 12.00 | 11.08 | PR: 1LA,1LC |                |                |        |   |  |   |     |
| 3.0 TDI quattro  | 150              |              | 11.04 | 11.08 | PR: 1LA,1LC |                |                |        |   |  |   |     |
| 3.0 TDI quattro  | 171              |              | 01.06 | 11.08 | PR: 1LA,1LC |                |                |        |   |  |   |     |
| 3.2 FSI          | 188              |              | 01.05 | 11.08 | PR: 1LA,1LC |                |                |        |   |  |   |     |
| 3.2 FSI quattro  | 188              |              | 01.05 | 11.08 | PR: 1LA,1LC |                |                |        |   |  |   |     |
| S4 4.2           | 253              | 8H-7-900 460 | 03.03 |       | PR: 1LJ     | 11.9606-9961.2 | 220655         |        |   |  |   |     |
|                  |                  |              |       |       |             | 11.9606-9962.2 | 220656         |        |   |  |   |     |
|                  |                  |              |       |       |             | 11.0441-6008.2 | 250038         |        |   |  |   |     |
|                  |                  |              |       |       |             | 11.0101-5409.2 | 260035         |        |   |  |   |     |
|                  |                  |              |       |       |             | 11.8171-0008.1 | 990049         |        |   |  |   |     |
|                  |                  |              |       |       |             | 11.8116-0410.2 | 390589         |        |   |  |   |     |
| S4 4.2           | 253              | 8H-7-900 461 |       | 11.08 | PR: 1LJ     | 11.0441-6008.2 | 250038         |        |   |  |   |     |
|                  |                  |              |       |       |             | 11.0101-5409.2 | 260035         |        |   |  |   |     |
|                  |                  |              |       |       |             | 11.8171-0008.1 | 990049         |        |   |  |   |     |
|                  | 1.6              | 75           |       | 12.00 | 11.08       |                | 83.7213-0307.3 | 330791 | 2 |  | L=305   |     |
|                  | 1.8 T            | 110          |       | 12.00 | 11.08       |                |                |        |   |  |   |     |
|                  | 1.8 T            | 120          |       | 07.02 | 11.08       |                |                |        |   |  |   |     |
|                  | 1.8 T            | 125          |       | 07.01 | 11.08       |                |                |        |   |  |   |     |
|                  | 1.8 T            | 140          |       | 11.02 | 11.08       |                |                |        |   |  |   |     |
|                  | 1.8 T quattro    | 110          |       | 12.00 | 11.08       |                |                |        |   |  |   |     |
|                  | 1.8 T quattro    | 120          |       | 07.02 | 11.08       |                |                |        |   |  |   |     |
|                  | 1.8 T quattro    | 125          |       | 07.01 | 11.08       |                |                |        |   |  |   |     |
|                  | 1.8 T quattro    | 140          |       | 11.02 | 11.08       |                |                |        |   |  |   |     |
|                  | 1.9 TDI          | 74           |       | 04.01 | 11.08       |                |                |        |   |  |   |     |
|                  | 1.9 TDI          | 85           |       | 06.04 | 11.08       |                |                |        |   |  |   |     |
|                  | 1.9 TDI          | 96           |       | 12.00 | 11.08       |                |                |        |   |  |   |     |
|                  | 1.9 TDI quattro  |              |       | 12.00 | 11.08       |                |                |        |   |  |   |     |
|                  | 2.0              | 96           |       | 12.00 | 11.08       |                |                |        |   |  |   |     |
|                  | 2.0 FSI          | 110          |       | 07.02 | 11.08       |                |                |        |   |  |   |     |
|                  | 2.0 TDI          | 100          |       | 11.04 | 11.08       |                |                |        |   |  |   |     |
|                  | 2.0 TDI          | 103          |       | 11.04 | 11.08       |                |                |        |   |  |   |     |
|                  | 2.0 TDI          | 125          |       | 06.06 | 11.08       |                |                |        |   |  |   |     |
|                  | 2.0 TDI quattro  | 103          |       | 01.06 | 11.08       |                |                |        |   |  |   |     |
|                  | 2.0 TDI quattro  | 125          |       | 06.06 | 11.08       |                |                |        |   |  |   |     |
| 2.0 TFSI         | 147              |              | 11.04 | 11.08 |             |                |                |        |   |  |   |     |
| 2.0 TFSI         | 162              |              | 06.05 | 11.08 |             |                |                |        |   |  |   |     |
| 2.0 TFSI quattro | 147              |              | 11.04 | 11.08 |             |                |                |        |   |  |   |     |
| 2.0 TFSI quattro | 162              |              | 06.05 | 11.08 |             |                |                |        |   |  |   |     |
| 2.4              |                  |              | 09.01 | 11.08 |             |                |                |        |   |  |   |     |
| 2.5 TDI          |                  |              | 12.00 | 11.08 |             |                |                |        |   |  |   |     |
| 2.5 TDI quattro  |                  |              | 12.00 | 11.08 |             |                |                |        |   |  |   |     |
| 2.7 TDI          | 120              |              | 11.05 | 11.08 |             |                |                |        |   |  |   |     |
| 2.7 TDI          | 132              |              | 01.06 | 11.08 |             |                |                |        |   |  |   |     |

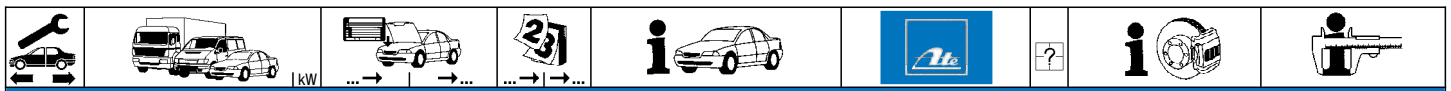

**AUDI A4 (B6/B7) (01-08)**

|  |                  |     |             |       |             |                |        |   |  |                |     |
|--|------------------|-----|-------------|-------|-------------|----------------|--------|---|--|----------------|-----|
|  | 3.0 quattro      |     |             | 12.00 | 11.08       | 83.7213-0307.3 | 330791 | 2 |  | L=305          |     |
|  | 3.0 TDI quattro  | 150 |             | 11.04 | 11.08       |                |        |   |  |                |     |
|  | 3.0 TDI quattro  | 171 |             | 01.06 | 11.08       |                |        |   |  |                |     |
|  | 3.2 FSI          | 188 |             | 01.05 | 11.08       |                |        |   |  |                |     |
|  | 3.2 FSI quattro  | 188 |             | 01.05 | 11.08       |                |        |   |  |                |     |
|  | S4 4.2           | 253 |             | 03.03 | 11.08       |                |        |   |  |                |     |
|  | RS4 4.2          | 309 |             | 11.05 | 11.08       | 83.6169-0418.3 | 330894 | 2 |  | L=422          |     |
|  | 1.6              | 75  | 8E-7-300000 | 12.00 | PR: 1KD,1KP | 24.3384-1735.7 | 220547 |   |  | D=38, - Halter | LUC |
|  | 1.8 T            | 110 | 8E-7-300000 | 12.00 | PR: 1KD,1KP | 24.3384-1736.7 | 220548 |   |  | D=38, - Halter | LUC |
|  | 1.8 T            | 120 | 8E-7-300000 | 07.02 | PR: 1KD,1KP |                |        |   |  |                |     |
|  | 1.8 T            | 125 | 8E-7-300000 | 07.01 | PR: 1KD,1KP |                |        |   |  |                |     |
|  | 1.8 T            | 140 | 8E-7-300000 | 11.02 | PR: 1KD,1KP |                |        |   |  |                |     |
|  | 1.8 T quattro    | 110 | 8E-7-300000 | 12.00 | PR: 1KD,1KP |                |        |   |  |                |     |
|  | 1.8 T quattro    | 120 | 8E-7-300000 | 07.02 | PR: 1KD,1KP |                |        |   |  |                |     |
|  | 1.8 T quattro    | 125 | 8E-7-300000 | 07.01 | PR: 1KD,1KP |                |        |   |  |                |     |
|  | 1.8 T quattro    | 140 | 8E-7-300000 | 11.02 | PR: 1KD,1KP |                |        |   |  |                |     |
|  | 1.9 TDI          | 74  | 8E-7-300000 | 04.01 | PR: 1KD,1KP |                |        |   |  |                |     |
|  | 1.9 TDI          | 85  | 8E-7-300000 | 06.04 | PR: 1KD,1KP |                |        |   |  |                |     |
|  | 1.9 TDI          | 96  | 8E-7-300000 | 12.00 | PR: 1KD,1KP |                |        |   |  |                |     |
|  | 1.9 TDI quattro  |     | 8E-7-300000 | 12.00 | PR: 1KD,1KP |                |        |   |  |                |     |
|  | 2.0              | 96  | 8E-7-300000 | 12.00 | PR: 1KD,1KP |                |        |   |  |                |     |
|  | 2.0 FSI          | 110 | 8E-7-300000 | 07.02 | PR: 1KD,1KP |                |        |   |  |                |     |
|  | 2.0 TDI          | 100 | 8E-7-300000 | 11.04 | PR: 1KD,1KP |                |        |   |  |                |     |
|  | 2.0 TDI          | 103 | 8E-7-300000 | 11.04 | PR: 1KD,1KP |                |        |   |  |                |     |
|  | 2.0 TDI          | 125 | 8E-7-300000 | 06.06 | PR: 1KD,1KP |                |        |   |  |                |     |
|  | 2.0 TDI quattro  | 103 | 8E-7-300000 | 01.06 | PR: 1KD,1KP |                |        |   |  |                |     |
|  | 2.0 TDI quattro  | 125 | 8E-7-300000 | 06.06 | PR: 1KD,1KP |                |        |   |  |                |     |
|  | 2.0 TFSI         | 147 | 8E-7-300000 | 11.04 | PR: 1KD,1KP |                |        |   |  |                |     |
|  | 2.0 TFSI         | 162 | 8E-7-300000 | 06.05 | PR: 1KD,1KP |                |        |   |  |                |     |
|  | 2.0 TFSI quattro | 147 | 8E-7-300000 | 11.04 | PR: 1KD,1KP |                |        |   |  |                |     |
|  | 2.0 TFSI quattro | 162 | 8E-7-300000 | 06.05 | PR: 1KD,1KP |                |        |   |  |                |     |
|  | 2.4              |     | 8E-7-300000 | 09.01 | PR: 1KD,1KP |                |        |   |  |                |     |
|  | 2.5 TDI          |     | 8E-7-300000 | 12.00 | PR: 1KD,1KP |                |        |   |  |                |     |
|  | 2.5 TDI quattro  |     | 8E-7-300000 | 12.00 | PR: 1KD,1KP |                |        |   |  |                |     |
|  | 2.7 TDI          | 120 | 8E-7-300000 | 11.05 | PR: 1KD,1KP |                |        |   |  |                |     |
|  | 2.7 TDI          | 132 | 8E-7-300000 | 01.06 | PR: 1KD,1KP |                |        |   |  |                |     |
|  | 3.0              |     | 8E-7-300000 | 12.00 | PR: 1KD,1KP |                |        |   |  |                |     |
|  | 3.0 quattro      |     | 8E-7-300000 | 12.00 | PR: 1KD,1KP |                |        |   |  |                |     |
|  | 3.0 TDI quattro  | 150 | 8E-7-300000 | 11.04 | PR: 1KD,1KP |                |        |   |  |                |     |
|  | 3.0 TDI quattro  | 171 | 8E-7-300000 | 01.06 | PR: 1KD,1KP |                |        |   |  |                |     |
|  | 3.2 FSI          | 188 | 8E-7-300000 | 01.05 | PR: 1KD,1KP |                |        |   |  |                |     |
|  | 3.2 FSI quattro  | 188 | 8E-7-300000 | 01.05 | PR: 1KD,1KP |                |        |   |  |                |     |
|  | 1.6              | 75  | 8E-5-400001 | 11.08 | PR: 1KW     | 24.3414-1713.7 | 220793 |   |  | D=41, - Halter | LUC |
|  | 1.8 T            | 110 | 8E-5-400001 | 11.08 | PR: 1KW     | 24.3414-1714.7 | 220794 |   |  | D=41, - Halter | LUC |
|  | 1.8 T            | 120 | 8E-5-400001 | 11.08 | PR: 1KW     |                |        |   |  |                |     |
|  | 1.8 T            | 125 | 8E-5-400001 | 11.08 | PR: 1KW     |                |        |   |  |                |     |
|  | 1.8 T            | 140 | 8E-5-400001 | 11.08 | PR: 1KW     |                |        |   |  |                |     |
|  | 1.8 T quattro    | 110 | 8E-5-400001 | 11.08 | PR: 1KW     |                |        |   |  |                |     |
|  | 1.8 T quattro    | 120 | 8E-5-400001 | 11.08 | PR: 1KW     |                |        |   |  |                |     |
|  | 1.8 T quattro    | 125 | 8E-5-400001 | 11.08 | PR: 1KW     |                |        |   |  |                |     |
|  | 1.8 T quattro    | 140 | 8E-5-400001 | 11.08 | PR: 1KW     |                |        |   |  |                |     |
|  | 1.9 TDI          | 74  | 8E-5-400001 | 11.08 | PR: 1KW     |                |        |   |  |                |     |
|  | 1.9 TDI          | 85  | 8E-5-400001 | 11.08 | PR: 1KW     |                |        |   |  |                |     |
|  | 1.9 TDI          | 96  | 8E-5-400001 | 11.08 | PR: 1KW     |                |        |   |  |                |     |
|  | 1.9 TDI quattro  |     | 8E-5-400001 | 11.08 | PR: 1KW     |                |        |   |  |                |     |
|  | 2.0              | 96  | 8E-5-400001 | 11.08 | PR: 1KW     |                |        |   |  |                |     |
|  | 2.0 FSI          | 110 | 8E-5-400001 | 11.08 | PR: 1KW     |                |        |   |  |                |     |
|  | 2.0 TDI          | 100 | 8E-5-400001 | 11.08 | PR: 1KW     |                |        |   |  |                |     |
|  | 2.0 TDI          | 103 | 8E-5-400001 | 11.08 | PR: 1KW     |                |        |   |  |                |     |
|  | 2.0 TDI          | 125 |             | 06.06 | 11.08       | PR: 1KW        |        |   |  |                |     |
|  | 2.0 TDI quattro  | 103 |             | 01.06 | 11.08       | PR: 1KW        |        |   |  |                |     |
|  | 2.0 TDI quattro  | 125 |             | 06.06 | 11.08       | PR: 1KW        |        |   |  |                |     |
|  | 2.0 TFSI         | 147 | 8E-5-400001 | 11.08 | PR: 1KW     |                |        |   |  |                |     |
|  | 2.0 TFSI         | 162 | 8E-5-400001 | 11.08 | PR: 1KW     |                |        |   |  |                |     |
|  | 2.0 TFSI quattro | 147 | 8E-5-400001 | 11.08 | PR: 1KW     |                |        |   |  |                |     |
|  | 2.0 TFSI quattro | 162 | 8E-5-400001 | 11.08 | PR: 1KW     |                |        |   |  |                |     |
|  | 2.4              |     | 8E-5-400001 | 11.08 | PR: 1KW     |                |        |   |  |                |     |
|  | 2.5 TDI          |     | 8E-5-400001 | 11.08 | PR: 1KW     |                |        |   |  |                |     |
|  | 2.5 TDI quattro  |     | 8E-5-400001 | 11.08 | PR: 1KW     |                |        |   |  |                |     |
|  | 2.7 TDI          | 120 |             | 11.05 | 11.08       | PR: 1KW        |        |   |  |                |     |
|  | 2.7 TDI          | 132 |             | 01.06 | 11.08       | PR: 1KW        |        |   |  |                |     |
|  | 3.0              |     | 8E-5-400001 | 11.08 | PR: 1KW     |                |        |   |  |                |     |
|  | 3.0 quattro      |     | 8E-5-400001 | 11.08 | PR: 1KW     |                |        |   |  |                |     |
|  | 3.0 TDI quattro  | 150 | 8E-5-400001 | 11.08 | PR: 1KW     |                |        |   |  |                |     |
|  | 3.0 TDI quattro  | 171 |             | 01.06 | 11.08       | PR: 1KW        |        |   |  |                |     |
|  | 3.2 FSI          | 188 | 8E-5-400001 | 11.08 | PR: 1KW     |                |        |   |  |                |     |
|  | 3.2 FSI quattro  | 188 | 8E-5-400001 | 11.08 | PR: 1KW     |                |        |   |  |                |     |
|  | 1.6              | 75  |             | 12.00 | 11.08       | 24.5138-0263.3 | 330885 | 2 |  | L=263          |     |
|  | 1.8 T            | 110 |             | 12.00 | 11.08       |                |        |   |  |                |     |
|  | 1.8 T            | 120 |             | 07.02 | 11.08       |                |        |   |  |                |     |
|  | 1.8 T            | 125 |             | 07.01 | 11.08       |                |        |   |  |                |     |
|  | 1.8 T            | 140 |             | 11.02 | 11.08       |                |        |   |  |                |     |
|  | 1.8 T quattro    | 110 |             | 12.00 | 11.08       |                |        |   |  |                |     |
|  | 1.8 T quattro    | 120 |             | 07.02 | 11.08       |                |        |   |  |                |     |
|  | 1.8 T quattro    | 125 |             | 07.01 | 11.08       |                |        |   |  |                |     |
|  | 1.8 T quattro    | 140 |             | 11.02 | 11.08       |                |        |   |  |                |     |



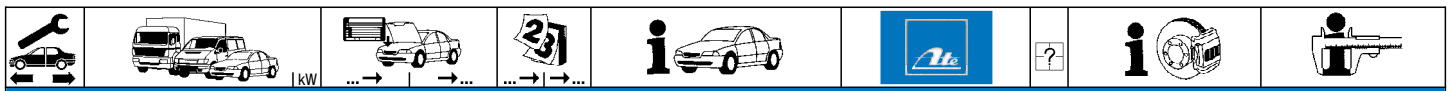

| AUDI A4 (B6/B7) (01-08) |                  |     |  |       |       |                |        |                          |  |          |
|-------------------------|------------------|-----|--|-------|-------|----------------|--------|--------------------------|--|----------|
|                         | 1.9 TDI          | 74  |  | 04.01 | 11.08 | 24.5138-0263.3 | 330885 | 2                        |  | L=263    |
|                         | 1.9 TDI          | 85  |  | 06.04 | 11.08 |                |        |                          |  |          |
|                         | 1.9 TDI          | 96  |  | 12.00 | 11.08 |                |        |                          |  |          |
|                         | 1.9 TDI quattro  |     |  | 12.00 | 11.08 |                |        |                          |  |          |
|                         | 2.0              | 96  |  | 12.00 | 11.08 |                |        |                          |  |          |
|                         | 2.0 FSI          | 110 |  | 07.02 | 11.08 |                |        |                          |  |          |
|                         | 2.0 TDI          | 100 |  | 11.04 | 11.08 |                |        |                          |  |          |
|                         | 2.0 TDI          | 103 |  | 11.04 | 11.08 |                |        |                          |  |          |
|                         | 2.0 TDI          | 125 |  | 06.06 | 11.08 |                |        |                          |  |          |
|                         | 2.0 TDI quattro  | 103 |  | 01.06 | 11.08 |                |        |                          |  |          |
|                         | 2.0 TDI quattro  | 125 |  | 06.06 | 11.08 |                |        |                          |  |          |
|                         | 2.0 TFSI         | 147 |  | 11.04 | 11.08 |                |        |                          |  |          |
|                         | 2.0 TFSI         | 162 |  | 06.05 | 11.08 |                |        |                          |  |          |
|                         | 2.0 TFSI quattro | 147 |  | 11.04 | 11.08 |                |        |                          |  |          |
|                         | 2.0 TFSI quattro | 162 |  | 06.05 | 11.08 |                |        |                          |  |          |
|                         | 2.4              |     |  | 09.01 | 11.08 |                |        |                          |  |          |
|                         | 2.5 TDI          |     |  | 12.00 | 11.08 |                |        |                          |  |          |
|                         | 2.5 TDI quattro  |     |  | 12.00 | 11.08 |                |        |                          |  |          |
|                         | 2.7 TDI          | 120 |  | 11.05 | 11.08 |                |        |                          |  |          |
|                         | 2.7 TDI          | 132 |  | 01.06 | 11.08 |                |        |                          |  |          |
|                         | 3.0              |     |  | 12.00 | 11.08 |                |        |                          |  |          |
|                         | 3.0 quattro      |     |  | 12.00 | 11.08 |                |        |                          |  |          |
|                         | 3.0 TDI quattro  | 150 |  | 11.04 | 11.08 |                |        |                          |  |          |
|                         | 3.0 TDI quattro  | 171 |  | 01.06 | 11.08 |                |        |                          |  |          |
|                         | 3.2 FSI          | 188 |  | 01.05 | 11.08 |                |        |                          |  |          |
|                         | 3.2 FSI quattro  | 188 |  | 01.05 | 11.08 |                |        |                          |  |          |
|                         | S4 4.2           | 253 |  | 03.03 | 11.08 |                |        |                          |  |          |
|                         | 1.6              | 75  |  | 12.00 | 11.08 | 24.3727-0182.2 | 580182 | <input type="checkbox"/> |  | L=1928   |
|                         | 1.8 T            | 110 |  | 12.00 | 11.08 | 24.3727-0183.2 | 580183 | <input type="checkbox"/> |  | L=2005   |
|                         | 1.8 T            | 120 |  | 07.02 | 11.08 |                |        |                          |  |          |
|                         | 1.8 T            | 140 |  | 11.02 | 11.08 |                |        |                          |  |          |
|                         | 1.9 TDI          | 74  |  | 04.01 | 11.08 |                |        |                          |  |          |
|                         | 1.9 TDI          | 85  |  | 06.04 | 11.08 |                |        |                          |  |          |
|                         | 1.9 TDI          | 96  |  | 12.00 | 11.08 |                |        |                          |  |          |
|                         | 2.0              | 96  |  | 12.00 | 11.08 |                |        |                          |  |          |
|                         | 2.0 FSI          | 110 |  | 07.02 | 11.08 |                |        |                          |  |          |
|                         | 2.0 TFSI         | 147 |  | 11.04 | 11.08 |                |        |                          |  |          |
|                         | 2.0 TFSI         | 162 |  | 06.05 | 11.08 |                |        |                          |  |          |
|                         | 2.4              |     |  | 09.01 | 11.08 |                |        |                          |  |          |
|                         | 2.5 TDI          |     |  | 12.00 | 11.08 |                |        |                          |  |          |
|                         | 3.0              |     |  | 12.00 | 11.08 |                |        |                          |  |          |
|                         | 3.2 FSI          | 188 |  | 01.05 | 11.08 |                |        |                          |  |          |
|                         | 1.6              | 75  |  | 12.00 | 11.08 | 24.2522-1706.3 | 040090 |                          |  | Nz 22,20 |
|                         | 1.8 T            | 110 |  | 12.00 | 11.08 |                |        |                          |  |          |
|                         | 1.8 T            | 120 |  | 07.02 | 11.08 |                |        |                          |  |          |
|                         | 1.8 T            | 125 |  | 07.01 | 11.08 |                |        |                          |  |          |
|                         | 1.8 T            | 140 |  | 11.02 | 11.08 |                |        |                          |  |          |
|                         | 1.8 T quattro    | 110 |  | 12.00 | 11.08 |                |        |                          |  |          |
|                         | 1.8 T quattro    | 120 |  | 07.02 | 11.08 |                |        |                          |  |          |
|                         | 1.8 T quattro    | 125 |  | 07.01 | 11.08 |                |        |                          |  |          |
|                         | 1.8 T quattro    | 140 |  | 11.02 | 11.08 |                |        |                          |  |          |
|                         | 1.9 TDI          | 74  |  | 04.01 | 11.08 |                |        |                          |  |          |
|                         | 1.9 TDI          | 85  |  | 06.04 | 11.08 |                |        |                          |  |          |
|                         | 1.9 TDI          | 96  |  | 12.00 | 11.08 |                |        |                          |  |          |
|                         | 1.9 TDI quattro  |     |  | 12.00 | 11.08 |                |        |                          |  |          |
|                         | 2.0              | 96  |  | 12.00 | 11.08 |                |        |                          |  |          |
|                         | 2.0 FSI          | 110 |  | 07.02 | 11.08 |                |        |                          |  |          |
|                         | 2.0 TFSI         | 147 |  | 11.04 | 11.08 |                |        |                          |  |          |
|                         | 2.0 TFSI quattro | 147 |  | 11.04 | 11.08 |                |        |                          |  |          |
|                         | 2.0 TFSI quattro | 162 |  | 06.05 | 11.08 |                |        |                          |  |          |
|                         | 2.4              |     |  | 09.01 | 11.08 |                |        |                          |  |          |
|                         | 2.5 TDI          |     |  | 12.00 | 11.08 |                |        |                          |  |          |
|                         | 2.5 TDI quattro  |     |  | 12.00 | 11.08 |                |        |                          |  |          |
|                         | 3.0              |     |  | 12.00 | 11.08 |                |        |                          |  |          |
|                         | 3.0 quattro      |     |  | 12.00 | 11.08 |                |        |                          |  |          |
|                         | 3.2 FSI          | 188 |  | 01.05 | 11.08 |                |        |                          |  |          |
|                         | 3.2 FSI quattro  | 188 |  | 01.05 | 11.08 |                |        |                          |  |          |

| AUDI A4 (B8) Limousine (07-) |                  |     |  |       |  |                |        |  |  |                 |
|------------------------------|------------------|-----|--|-------|--|----------------|--------|--|--|-----------------|
|                              | 1.8 TFSI         | 88  |  | 01.08 |  | 03.7858-4632.4 | 300273 |  |  | 9/8" Tandem ATE |
|                              | 1.8 TFSI         | 118 |  | 11.07 |  |                |        |  |  |                 |
|                              | 1.8 TFSI quattro | 118 |  | 09.08 |  |                |        |  |  |                 |
|                              | 2.0 TDI          | 88  |  | 06.08 |  |                |        |  |  |                 |
|                              | 2.0 TDI          | 100 |  | 11.07 |  |                |        |  |  |                 |
|                              | 2.0 TDI          | 105 |  | 11.07 |  |                |        |  |  |                 |
|                              | 2.0 TDI          | 120 |  | 08.08 |  |                |        |  |  |                 |
|                              | 2.0 TDI          | 125 |  | 01.08 |  |                |        |  |  |                 |
|                              | 2.0 TDI quattro  | 125 |  | 01.08 |  |                |        |  |  |                 |
|                              | 2.0 TFSI         | 132 |  | 06.08 |  |                |        |  |  |                 |
|                              | 2.0 TFSI         | 155 |  | 06.08 |  |                |        |  |  |                 |
|                              | 2.0 TFSI quattro | 132 |  | 11.09 |  |                |        |  |  |                 |
|                              | 2.0 TFSI quattro | 155 |  | 06.08 |  |                |        |  |  |                 |
|                              | 2.7 TDI          | 120 |  | 11.07 |  |                |        |  |  |                 |
|                              | 2.7 TDI          | 140 |  | 11.07 |  |                |        |  |  |                 |
|                              | 3.0 TDI quattro  | 155 |  | 06.08 |  |                |        |  |  |                 |
|                              | 3.0 TDI quattro  | 176 |  | 11.07 |  |                |        |  |  |                 |
|                              | 3.2 FSI          | 195 |  | 09.08 |  |                |        |  |  |                 |



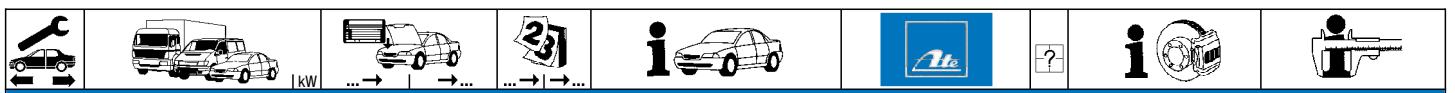

**AUDI A4 (B8) Limousine (07-)**

|  |                    |            |                |         |                |        |   |                |     |
|--|--------------------|------------|----------------|---------|----------------|--------|---|----------------|-----|
|  | 3.2 FSI quattro S4 | 195<br>245 | 11.07<br>11.08 |         | 03.7858-4632.4 | 300273 |   | 9/8" Tandem    | ATE |
|  | 1.8 TFSI           | 88         | 01.08          |         | 24.2125-1739.3 | 010948 |   | Thz 25,40      | LUC |
|  | 1.8 TFSI           | 118        | 11.07          |         |                |        |   |                |     |
|  | 1.8 TFSI quattro   | 118        | 09.08          |         |                |        |   |                |     |
|  | 2.0 TDI            | 88         | 06.08          |         |                |        |   |                |     |
|  | 2.0 TDI            | 100        | 11.07          |         |                |        |   |                |     |
|  | 2.0 TDI            | 105        | 11.07          |         |                |        |   |                |     |
|  | 2.0 TDI            | 120        | 08.08          |         |                |        |   |                |     |
|  | 2.0 TDI            | 125        | 01.08          |         |                |        |   |                |     |
|  | 2.0 TDI quattro    | 125        | 01.08          |         |                |        |   |                |     |
|  | 2.0 TFSI           | 132        | 06.08          |         |                |        |   |                |     |
|  | 2.0 TFSI           | 155        | 06.08          |         |                |        |   |                |     |
|  | 2.0 TFSI quattro   | 132        | 11.09          |         |                |        |   |                |     |
|  | 2.0 TFSI quattro   | 155        | 06.08          |         |                |        |   |                |     |
|  | 2.7 TDI            | 120        | 11.07          |         |                |        |   |                |     |
|  | 2.7 TDI            | 140        | 11.07          |         |                |        |   |                |     |
|  | 3.0 TDI quattro    | 155        | 06.08          |         |                |        |   |                |     |
|  | 3.0 TDI quattro    | 176        | 11.07          |         |                |        |   |                |     |
|  | 3.2 FSI            | 195        | 09.08          |         |                |        |   |                |     |
|  | 3.2 FSI quattro    | 195        | 11.07          |         |                |        |   |                |     |
|  | S4                 | 245        | 11.08          |         |                |        |   |                |     |
|  | 1.8 TFSI           | 88         | 01.08          | PR: 1LT | 11.9571-9755.2 | 220845 |   | D=57, - Halter | ATE |
|  | 1.8 TFSI           | 118        | 11.07          | PR: 1LT | 11.9571-9756.2 | 220846 |   | D=57, - Halter | ATE |
|  | 1.8 TFSI           | 125        | 01.12          | PR: 1LT | 11.8171-0008.1 | 990049 |   | Führungsbolzen | ATE |
|  | 1.8 TFSI quattro   | 118        | 09.08          | PR: 1LT | 11.0101-5409.2 | 260035 |   | Hülzensatz     | ATE |
|  | 1.8 TFSI quattro   | 125        | 01.12          | PR: 1LT | 11.8116-0351.1 | 390538 | 2 | Haltefeder     | ATE |
|  | 2.0 TDI            | 88         | 06.08          | PR: 1LT |                |        |   |                |     |
|  | 2.0 TDI            | 100        | 11.07          | PR: 1LT |                |        |   |                |     |
|  | 2.0 TDI            | 105        | 11.07          | PR: 1LT |                |        |   |                |     |
|  | 2.0 TDI            | 110        | 05.13          | PR: 1LT |                |        |   |                |     |
|  | 2.0 TDI            | 120        | 08.08          | PR: 1LT |                |        |   |                |     |
|  | 2.0 TDI            | 125        | 01.08          | PR: 1LT |                |        |   |                |     |
|  | 2.0 TDI            | 130        | 11.11          | PR: 1LT |                |        |   |                |     |
|  | 2.0 TDI            | 140        | 09.13          | PR: 1LT |                |        |   |                |     |
|  | 2.0 TDI quattro    | 110        | 05.13          | PR: 1LT |                |        |   |                |     |
|  | 2.0 TDI quattro    | 125        | 01.08          | PR: 1LT |                |        |   |                |     |
|  | 2.0 TDI quattro    | 130        | 11.11          | PR: 1LT |                |        |   |                |     |
|  | 2.0 TDI quattro    | 140        | 09.13          | PR: 1LT |                |        |   |                |     |
|  | 2.0 TFSI           | 132        | 06.08          | PR: 1LT |                |        |   |                |     |
|  | 2.0 TFSI           | 155        | 06.08          | PR: 1LT |                |        |   |                |     |
|  | 2.0 TFSI           | 162        | 05.13          | PR: 1LT |                |        |   |                |     |
|  | 2.0 TFSI           | 165        | 05.13          | PR: 1LT |                |        |   |                |     |
|  | 2.0 TFSI quattro   | 132        | 11.09          | PR: 1LT |                |        |   |                |     |
|  | 2.0 TFSI quattro   | 155        | 06.08          | PR: 1LT |                |        |   |                |     |
|  | 2.0 TFSI quattro   | 162        | 05.13          | PR: 1LT |                |        |   |                |     |
|  | 2.0 TFSI quattro   | 165        | 05.13          | PR: 1LT |                |        |   |                |     |
|  | 2.7 TDI            | 120        | 11.07          | PR: 1LT |                |        |   |                |     |
|  | 2.7 TDI            | 140        | 11.07          | PR: 1LT |                |        |   |                |     |
|  | 3.0 TDI            | 150        | 11.11          | PR: 1LT |                |        |   |                |     |
|  | 3.0 TDI quattro    | 155        | 06.08          | PR: 1LT |                |        |   |                |     |
|  | 3.0 TDI quattro    | 176        | 11.07          | PR: 1LT |                |        |   |                |     |
|  | 3.0 TDI quattro    | 180        | 11.11          | PR: 1LT |                |        |   |                |     |
|  | 3.0 TFSI quattro   | 200        | 02.12          | PR: 1LT |                |        |   |                |     |
|  | 3.2 FSI            | 195        | 09.08          | PR: 1LT |                |        |   |                |     |
|  | 3.2 FSI quattro    | 195        | 11.07          | PR: 1LT |                |        |   |                |     |
|  | 1.8 TFSI           | 88         | 01.08          | PR: 1LY | 11.9571-9755.2 | 220845 |   | D=57, - Halter | ATE |
|  | 1.8 TFSI           | 118        | 11.07          | PR: 1LY | 11.9571-9756.2 | 220846 |   | D=57, - Halter | ATE |
|  | 1.8 TFSI           | 125        | 01.12          | PR: 1LY | 11.8171-0008.1 | 990049 |   | Führungsbolzen | ATE |
|  | 1.8 TFSI quattro   | 118        | 09.08          | PR: 1LY | 11.0101-5409.2 | 260035 |   | Hülzensatz     | ATE |
|  | 1.8 TFSI quattro   | 125        | 01.12          | PR: 1LY | 11.8116-0351.1 | 390538 | 2 | Haltefeder     | ATE |
|  | 2.0 TDI            | 88         | 06.08          | PR: 1LY |                |        |   |                |     |
|  | 2.0 TDI            | 100        | 11.07          | PR: 1LY |                |        |   |                |     |
|  | 2.0 TDI            | 105        | 11.07          | PR: 1LY |                |        |   |                |     |
|  | 2.0 TDI            | 110        | 05.13          | PR: 1LY |                |        |   |                |     |
|  | 2.0 TDI            | 120        | 08.08          | PR: 1LY |                |        |   |                |     |
|  | 2.0 TDI            | 125        | 01.08          | PR: 1LY |                |        |   |                |     |
|  | 2.0 TDI            | 130        | 11.11          | PR: 1LY |                |        |   |                |     |
|  | 2.0 TDI            | 140        | 09.13          | PR: 1LY |                |        |   |                |     |
|  | 2.0 TDI quattro    | 110        | 05.13          | PR: 1LY |                |        |   |                |     |
|  | 2.0 TDI quattro    | 125        | 01.08          | PR: 1LY |                |        |   |                |     |
|  | 2.0 TDI quattro    | 130        | 11.11          | PR: 1LY |                |        |   |                |     |
|  | 2.0 TDI quattro    | 140        | 09.13          | PR: 1LY |                |        |   |                |     |
|  | 2.0 TFSI           | 132        | 06.08          | PR: 1LY |                |        |   |                |     |
|  | 2.0 TFSI           | 155        | 06.08          | PR: 1LY |                |        |   |                |     |
|  | 2.0 TFSI           | 162        | 05.13          | PR: 1LY |                |        |   |                |     |
|  | 2.0 TFSI           | 165        | 05.13          | PR: 1LY |                |        |   |                |     |
|  | 2.0 TFSI quattro   | 132        | 11.09          | PR: 1LY |                |        |   |                |     |
|  | 2.0 TFSI quattro   | 155        | 06.08          | PR: 1LY |                |        |   |                |     |
|  | 2.0 TFSI quattro   | 162        | 05.13          | PR: 1LY |                |        |   |                |     |
|  | 2.0 TFSI quattro   | 165        | 05.13          | PR: 1LY |                |        |   |                |     |
|  | 2.7 TDI            | 120        | 11.07          | PR: 1LY |                |        |   |                |     |
|  | 2.7 TDI            | 140        | 11.07          | PR: 1LY |                |        |   |                |     |
|  | 3.0 TDI            | 150        | 11.11          | PR: 1LY |                |        |   |                |     |
|  | 3.0 TDI quattro    | 155        | 06.08          | PR: 1LT |                |        |   |                |     |
|  | 3.0 TDI quattro    | 176        | 11.07          | PR: 1LT |                |        |   |                |     |





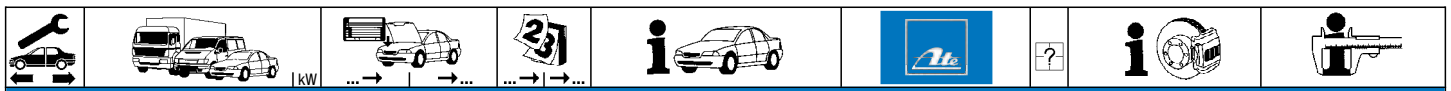

**AUDI A4 (B8) Limousine (07-)**

|  |                  |     |       |         |                |        |   |                |     |
|--|------------------|-----|-------|---------|----------------|--------|---|----------------|-----|
|  | 3.0 TDI quattro  | 180 | 11.11 | PR: 1LT | 11.9571-9755.2 | 220845 |   | D=57, - Halter | ATE |
|  | 3.0 TFSI quattro | 200 | 02.12 | PR: 1LY | 11.9571-9756.2 | 220846 |   | D=57, - Halter | ATE |
|  | 3.2 FSI          | 195 | 09.08 | PR: 1LT | 11.8171-0008.1 | 990049 |   | Führungsbolzen | ATE |
|  | 3.2 FSI quattro  | 195 | 11.07 | PR: 1LT | 11.0101-5409.2 | 260035 |   | Hülzensatz     | ATE |
|  |                  |     |       |         | 11.8116-0351.1 | 390538 | 2 | Haltefeder     | ATE |
|  | 1.8 TFSI         | 88  | 01.08 |         | 83.7713-0476.3 | 331116 | 2 | L=472          |     |
|  | 1.8 TFSI         | 118 | 11.07 |         |                |        |   |                |     |
|  | 1.8 TFSI         | 125 | 01.12 |         |                |        |   |                |     |
|  | 1.8 TFSI quattro | 118 | 09.08 |         |                |        |   |                |     |
|  | 1.8 TFSI quattro | 125 | 01.12 |         |                |        |   |                |     |
|  | 2.0 TDI          | 88  | 06.08 |         |                |        |   |                |     |
|  | 2.0 TDI          | 100 | 11.07 |         |                |        |   |                |     |
|  | 2.0 TDI          | 105 | 11.07 |         |                |        |   |                |     |
|  | 2.0 TDI          | 110 | 05.13 |         |                |        |   |                |     |
|  | 2.0 TDI          | 120 | 08.08 |         |                |        |   |                |     |
|  | 2.0 TDI          | 125 | 01.08 |         |                |        |   |                |     |
|  | 2.0 TDI          | 130 | 11.11 |         |                |        |   |                |     |
|  | 2.0 TDI          | 140 | 09.13 |         |                |        |   |                |     |
|  | 2.0 TDI quattro  | 110 | 05.13 |         |                |        |   |                |     |
|  | 2.0 TDI quattro  | 125 | 01.08 |         |                |        |   |                |     |
|  | 2.0 TDI quattro  | 130 | 11.11 |         |                |        |   |                |     |
|  | 2.0 TDI quattro  | 140 | 09.13 |         |                |        |   |                |     |
|  | 2.0 TFSI         | 132 | 06.08 |         |                |        |   |                |     |
|  | 2.0 TFSI         | 155 | 06.08 |         |                |        |   |                |     |
|  | 2.0 TFSI         | 162 | 05.13 |         |                |        |   |                |     |
|  | 2.0 TFSI         | 165 | 05.13 |         |                |        |   |                |     |
|  | 2.0 TFSI quattro | 132 | 11.09 |         |                |        |   |                |     |
|  | 2.0 TFSI quattro | 155 | 06.08 |         |                |        |   |                |     |
|  | 2.0 TFSI quattro | 162 | 05.13 |         |                |        |   |                |     |
|  | 2.0 TFSI quattro | 165 | 05.13 |         |                |        |   |                |     |
|  | 2.7 TDI          | 120 | 11.07 |         |                |        |   |                |     |
|  | 2.7 TDI          | 140 | 11.07 |         |                |        |   |                |     |
|  | 3.0 TDI          | 150 | 11.11 |         |                |        |   |                |     |
|  | 3.0 TDI quattro  | 155 | 06.08 |         |                |        |   |                |     |
|  | 3.0 TDI quattro  | 176 | 11.07 |         |                |        |   |                |     |
|  | 3.0 TDI quattro  | 180 | 11.11 |         |                |        |   |                |     |
|  | 3.0 TFSI quattro | 200 | 02.12 |         |                |        |   |                |     |
|  | 3.2 FSI          | 195 | 09.08 |         |                |        |   |                |     |
|  | 3.2 FSI quattro  | 195 | 11.07 |         |                |        |   |                |     |
|  | S4               | 245 | 11.08 |         |                |        |   |                |     |

**AUDI A4 (B8) Avant (08-)**

|  |                  |     |       |         |                |        |   |                |     |
|--|------------------|-----|-------|---------|----------------|--------|---|----------------|-----|
|  | 1.8 FSI          | 88  | 04.08 |         | 03.7858-4632.4 | 300273 |   | 9/8" Tandem    | ATE |
|  | 1.8 TFSI         | 118 | 04.08 |         |                |        |   |                |     |
|  | 1.8 TFSI quattro | 118 | 09.08 |         |                |        |   |                |     |
|  | 2.0 TDI          | 88  | 06.08 |         |                |        |   |                |     |
|  | 2.0 TDI          | 100 | 04.08 |         |                |        |   |                |     |
|  | 2.0 TDI          | 105 | 04.08 |         |                |        |   |                |     |
|  | 2.0 TDI          | 125 | 04.08 |         |                |        |   |                |     |
|  | 2.0 TDI quattro  | 105 | 04.08 |         |                |        |   |                |     |
|  | 2.0 TDI quattro  | 125 | 08.08 |         |                |        |   |                |     |
|  | 2.0 TFSI         | 132 | 06.08 |         |                |        |   |                |     |
|  | 2.0 TFSI         | 155 | 04.08 |         |                |        |   |                |     |
|  | 2.0 TFSI quattro | 132 | 11.09 |         |                |        |   |                |     |
|  | 2.0 TFSI quattro | 155 | 04.08 |         |                |        |   |                |     |
|  | 2.7 TDI          | 120 | 06.08 |         |                |        |   |                |     |
|  | 2.7 TDI          | 140 | 06.08 |         |                |        |   |                |     |
|  | 3.0 TDI quattro  | 155 | 06.08 |         |                |        |   |                |     |
|  | 3.0 TDI quattro  | 176 | 04.08 |         |                |        |   |                |     |
|  | 3.2 FSI          | 195 | 09.08 |         |                |        |   |                |     |
|  | 3.2 FSI quattro  | 195 | 04.08 |         |                |        |   |                |     |
|  | S4               | 245 | 11.08 |         |                |        |   |                |     |
|  | 1.8 FSI          | 88  | 04.08 |         | 24.2125-1739.3 | 010948 |   | Thz 25,40      | LUC |
|  | 1.8 TFSI         | 118 | 04.08 |         |                |        |   |                |     |
|  | 1.8 TFSI quattro | 118 | 09.08 |         |                |        |   |                |     |
|  | 2.0 TDI          | 88  | 06.08 |         |                |        |   |                |     |
|  | 2.0 TDI          | 100 | 04.08 |         |                |        |   |                |     |
|  | 2.0 TDI          | 105 | 04.08 |         |                |        |   |                |     |
|  | 2.0 TDI          | 125 | 04.08 |         |                |        |   |                |     |
|  | 2.0 TDI quattro  | 105 | 04.08 |         |                |        |   |                |     |
|  | 2.0 TDI quattro  | 125 | 08.08 |         |                |        |   |                |     |
|  | 2.0 TFSI         | 132 | 06.08 |         |                |        |   |                |     |
|  | 2.0 TFSI         | 155 | 04.08 |         |                |        |   |                |     |
|  | 2.0 TFSI quattro | 132 | 11.09 |         |                |        |   |                |     |
|  | 2.0 TFSI quattro | 155 | 04.08 |         |                |        |   |                |     |
|  | 2.7 TDI          | 120 | 06.08 |         |                |        |   |                |     |
|  | 2.7 TDI          | 140 | 06.08 |         |                |        |   |                |     |
|  | 3.0 TDI quattro  | 155 | 06.08 |         |                |        |   |                |     |
|  | 3.0 TDI quattro  | 176 | 04.08 |         |                |        |   |                |     |
|  | 3.2 FSI          | 195 | 09.08 |         |                |        |   |                |     |
|  | 3.2 FSI quattro  | 195 | 04.08 |         |                |        |   |                |     |
|  | S4               | 245 | 11.08 |         |                |        |   |                |     |
|  | 1.8 FSI          | 88  | 04.08 | PR: 1LT | 11.9571-9755.2 | 220845 |   | D=57, - Halter | ATE |
|  | 1.8 TFSI         | 118 | 04.08 | PR: 1LT | 11.9571-9756.2 | 220846 |   | D=57, - Halter | ATE |
|  | 1.8 TFSI         | 125 | 01.12 | PR: 1LT | 11.8171-0008.1 | 990049 |   | Führungsbolzen | ATE |
|  | 1.8 TFSI quattro | 118 | 09.08 | PR: 1LT | 11.0101-5409.2 | 260035 |   | Hülzensatz     | ATE |
|  | 1.8 TFSI quattro | 125 | 01.12 | PR: 1LT | 11.8116-0351.1 | 390538 | 2 | Haltefeder     | ATE |



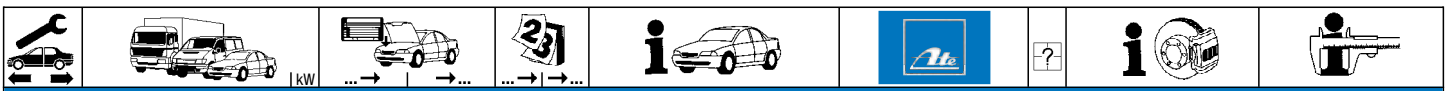

**AUDI A4 (B8) Avant (08-)**

|                  |                  |       |         |         |                |        |   |  |  |                                 |
|------------------|------------------|-------|---------|---------|----------------|--------|---|--|--|---------------------------------|
|                  | 2.0 TDI          | 88    | 06.08   | PR: 1LT | 11.9571-9755.2 | 220845 | 2 |  | D=57, - Halter<br>D=57, - Halter<br>Führungsbolzen<br>Hülzensatz<br>Haltefeder | ATE<br>ATE<br>ATE<br>ATE<br>ATE |
|                  | 2.0 TDI          | 100   | 04.08   | PR: 1LT | 11.9571-9756.2 | 220846 |   |  |  |                                 |
|                  | 2.0 TDI          | 105   | 04.08   | PR: 1LT | 11.8171-0008.1 | 990049 |   |  |  |                                 |
|                  | 2.0 TDI          | 110   | 05.13   | PR: 1LT | 11.0101-5409.2 | 260035 |   |  |  |                                 |
|                  | 2.0 TDI          | 125   | 04.08   | PR: 1LT | 11.8116-0351.1 | 390538 |   |  |  |                                 |
|                  | 2.0 TDI          | 130   | 11.11   | PR: 1LT |                |        |   |  |  |                                 |
|                  | 2.0 TDI          | 140   | 09.13   | PR: 1LT |                |        |   |  |  |                                 |
|                  | 2.0 TDI quattro  | 105   | 04.08   | PR: 1LT |                |        |   |  |  |                                 |
|                  | 2.0 TDI quattro  | 110   | 05.13   | PR: 1LT |                |        |   |  |  |                                 |
|                  | 2.0 TDI quattro  | 125   | 08.08   | PR: 1LT |                |        |   |  |  |                                 |
|                  | 2.0 TDI quattro  | 130   | 11.11   | PR: 1LT |                |        |   |  |  |                                 |
|                  | 2.0 TDI quattro  | 140   | 09.13   | PR: 1LT |                |        |   |  |  |                                 |
|                  | 2.0 TFSI         | 132   | 06.08   | PR: 1LT |                |        |   |  |  |                                 |
|                  | 2.0 TFSI         | 155   | 04.08   | PR: 1LT |                |        |   |  |  |                                 |
|                  | 2.0 TFSI         | 165   | 05.13   | PR: 1LT |                |        |   |  |  |                                 |
|                  | 2.0 TFSI quattro | 132   | 11.09   | PR: 1LT |                |        |   |  |  |                                 |
|                  | 2.0 TFSI quattro | 155   | 04.08   | PR: 1LT |                |        |   |  |  |                                 |
|                  | 2.0 TFSI quattro | 165   | 05.13   | PR: 1LT |                |        |   |  |  |                                 |
|                  | 2.7 TDI          | 120   | 06.08   | PR: 1LT |                |        |   |  |  |                                 |
|                  | 2.7 TDI          | 140   | 06.08   | PR: 1LT |                |        |   |  |  |                                 |
|                  | 3.0 TDI          | 150   | 11.11   | PR: 1LT |                |        |   |  |  |                                 |
|                  | 3.0 TDI quattro  | 155   | 06.08   | PR: 1LT |                |        |   |  |  |                                 |
|                  | 3.0 TDI quattro  | 176   | 04.08   | PR: 1LT |                |        |   |  |  |                                 |
|                  | 3.0 TDI quattro  | 180   | 11.11   | PR: 1LT |                |        |   |  |  |                                 |
|                  | 3.0 TFSI quattro | 200   | 02.12   | PR: 1LT |                |        |   |  |  |                                 |
|                  | 3.2 FSI          | 195   | 09.08   | PR: 1LT |                |        |   |  |  |                                 |
|                  | 3.2 FSI quattro  | 195   | 04.08   | PR: 1LT |                |        |   |  |  |                                 |
|                  | 1.8 FSI          | 88    | 04.08   | PR: 1LY | 11.9571-9755.2 | 220845 |   |  |  |                                 |
|                  | 1.8 TFSI         | 118   | 04.08   | PR: 1LY | 11.9571-9756.2 | 220846 |   |  |  |                                 |
|                  | 1.8 TFSI         | 125   | 01.12   | PR: 1LY | 11.8171-0008.1 | 990049 |   |  |  |                                 |
|                  | 1.8 TFSI quattro | 118   | 09.08   | PR: 1LY | 11.0101-5409.2 | 260035 |   |  |  |                                 |
|                  | 1.8 TFSI quattro | 125   | 01.12   | PR: 1LY | 11.8116-0351.1 | 390538 |   |  |  |                                 |
| 2.0 TDI          | 88               | 06.08 | PR: 1LY |         |                |        |   |  |  |                                 |
| 2.0 TDI          | 100              | 04.08 | PR: 1LY |         |                |        |   |  |  |                                 |
| 2.0 TDI          | 105              | 04.08 | PR: 1LY |         |                |        |   |  |  |                                 |
| 2.0 TDI          | 110              | 05.13 | PR: 1LY |         |                |        |   |  |  |                                 |
| 2.0 TDI          | 125              | 04.08 | PR: 1LY |         |                |        |   |  |  |                                 |
| 2.0 TDI          | 130              | 11.11 | PR: 1LY |         |                |        |   |  |  |                                 |
| 2.0 TDI          | 140              | 09.13 | PR: 1LY |         |                |        |   |  |  |                                 |
| 2.0 TDI quattro  | 105              | 04.08 | PR: 1LY |         |                |        |   |  |  |                                 |
| 2.0 TDI quattro  | 110              | 05.13 | PR: 1LY |         |                |        |   |  |  |                                 |
| 2.0 TDI quattro  | 125              | 08.08 | PR: 1LY |         |                |        |   |  |  |                                 |
| 2.0 TDI quattro  | 130              | 11.11 | PR: 1LY |         |                |        |   |  |  |                                 |
| 2.0 TDI quattro  | 140              | 09.13 | PR: 1LY |         |                |        |   |  |  |                                 |
| 2.0 TFSI         | 132              | 06.08 | PR: 1LY |         |                |        |   |  |  |                                 |
| 2.0 TFSI         | 155              | 04.08 | PR: 1LY |         |                |        |   |  |  |                                 |
| 2.0 TFSI         | 165              | 05.13 | PR: 1LY |         |                |        |   |  |  |                                 |
| 2.0 TFSI quattro | 132              | 11.09 | PR: 1LY |         |                |        |   |  |  |                                 |
| 2.0 TFSI quattro | 155              | 04.08 | PR: 1LY |         |                |        |   |  |  |                                 |
| 2.0 TFSI quattro | 165              | 05.13 | PR: 1LY |         |                |        |   |  |  |                                 |
| 2.7 TDI          | 120              | 06.08 | PR: 1LY |         |                |        |   |  |  |                                 |
| 2.7 TDI          | 140              | 06.08 | PR: 1LY |         |                |        |   |  |  |                                 |
| 3.0 TDI          | 150              | 11.11 | PR: 1LY |         |                |        |   |  |  |                                 |
| 3.0 TDI quattro  | 155              | 06.08 | PR: 1LY |         |                |        |   |  |  |                                 |
| 3.0 TDI quattro  | 176              | 04.08 | PR: 1LY |         |                |        |   |  |  |                                 |
| 3.0 TDI quattro  | 180              | 11.11 | PR: 1LY |         |                |        |   |  |  |                                 |
| 3.0 TFSI quattro | 200              | 02.12 | PR: 1LY |         |                |        |   |  |  |                                 |
| 3.2 FSI          | 195              | 09.08 | PR: 1LY |         |                |        |   |  |  |                                 |
| 3.2 FSI quattro  | 195              | 04.08 | PR: 1LY |         |                |        |   |  |  |                                 |
|                  | 1.8 FSI          | 88    | 04.08   |         | 83.7713-0476.3 | 331116 | 2 |  | L=472  |                                 |
|                  | 1.8 TFSI         | 118   | 04.08   |         |                |        |   |  |  |                                 |
|                  | 1.8 TFSI         | 125   | 01.12   |         |                |        |   |  |  |                                 |
|                  | 1.8 TFSI quattro | 118   | 09.08   |         |                |        |   |  |  |                                 |
|                  | 1.8 TFSI quattro | 125   | 01.12   |         |                |        |   |  |  |                                 |
|                  | 2.0 TDI          | 88    | 06.08   |         |                |        |   |  |  |                                 |
|                  | 2.0 TDI          | 100   | 04.08   |         |                |        |   |  |  |                                 |
|                  | 2.0 TDI          | 105   | 04.08   |         |                |        |   |  |  |                                 |
|                  | 2.0 TDI          | 110   | 05.13   |         |                |        |   |  |  |                                 |
|                  | 2.0 TDI          | 125   | 04.08   |         |                |        |   |  |  |                                 |
|                  | 2.0 TDI          | 130   | 11.11   |         |                |        |   |  |  |                                 |
|                  | 2.0 TDI          | 140   | 09.13   |         |                |        |   |  |  |                                 |
|                  | 2.0 TDI quattro  | 105   | 04.08   |         |                |        |   |  |  |                                 |
|                  | 2.0 TDI quattro  | 110   | 05.13   |         |                |        |   |  |  |                                 |
|                  | 2.0 TDI quattro  | 125   | 08.08   |         |                |        |   |  |  |                                 |
|                  | 2.0 TDI quattro  | 130   | 11.11   |         |                |        |   |  |  |                                 |
|                  | 2.0 TDI quattro  | 140   | 09.13   |         |                |        |   |  |  |                                 |
|                  | 2.0 TFSI         | 132   | 06.08   |         |                |        |   |  |  |                                 |
|                  | 2.0 TFSI         | 155   | 04.08   |         |                |        |   |  |  |                                 |
|                  | 2.0 TFSI         | 165   | 05.13   |         |                |        |   |  |  |                                 |
|                  | 2.0 TFSI quattro | 132   | 11.09   |         |                |        |   |  |  |                                 |
|                  | 2.0 TFSI quattro | 155   | 04.08   |         |                |        |   |  |  |                                 |
|                  | 2.0 TFSI quattro | 165   | 05.13   |         |                |        |   |  |  |                                 |
|                  | 2.7 TDI          | 120   | 06.08   |         |                |        |   |  |  |                                 |
|                  | 2.7 TDI          | 140   | 06.08   |         |                |        |   |  |  |                                 |
|                  | 3.0 TDI          | 150   | 11.11   |         |                |        |   |  |  |                                 |
| 3.0 TDI quattro  | 155              | 06.08 |         |         |                |        |   |  |  |                                 |
| 3.0 TDI quattro  | 176              | 04.08 |         |         |                |        |   |  |  |                                 |



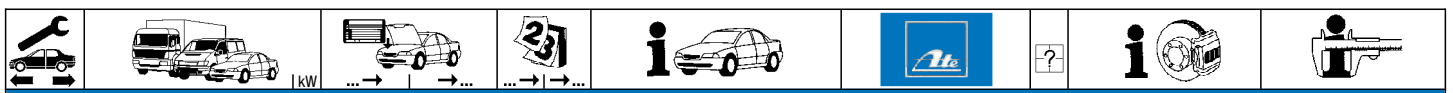

| AUDI A4 (B8) Avant (08-) |                  |     |  |       |  |                |        |   |  |       |
|--------------------------|------------------|-----|--|-------|--|----------------|--------|---|--|-------|
|                          | 3.0 TDI quattro  | 180 |  | 11.11 |  | 83.7713-0476.3 | 331116 | 2 |  | L=472 |
|                          | 3.0 TFSI quattro | 200 |  | 02.12 |  |                |        |   |  |       |
|                          | 3.2 FSI          | 195 |  | 09.08 |  |                |        |   |  |       |
|                          | 3.2 FSI quattro  | 195 |  | 04.08 |  |                |        |   |  |       |
|                          | S4               | 245 |  | 11.08 |  |                |        |   |  |       |

| AUDI A4 Allroad (09-) |                  |     |  |       |         |                |        |             |  |                    |
|-----------------------|------------------|-----|--|-------|---------|----------------|--------|-------------|--|--------------------|
|                       | 2.0 TDI quattro  | 105 |  | 09.09 |         | 03.7858-4632.4 | 300273 |             |  | 9/8" Tandem ATE    |
|                       | 2.0 TDI quattro  | 120 |  | 04.09 |         |                |        |             |  |                    |
|                       | 2.0 TDI quattro  | 125 |  | 02.09 |         |                |        |             |  |                    |
|                       | 2.0 TFSI quattro | 155 |  | 04.09 |         |                |        |             |  |                    |
|                       | 3.0 TDI quattro  | 176 |  | 04.09 |         |                |        |             |  |                    |
|                       | 2.0 TDI quattro  | 110 |  | 05.13 |         | 03.7858-4632.4 | 300273 | PR: GP0,GP1 |  | 9/8" Tandem ATE    |
|                       | 2.0 TDI quattro  | 130 |  | 01.12 |         |                |        |             |  |                    |
|                       | 2.0 TFSI quattro | 162 |  | 05.13 |         |                |        |             |  |                    |
|                       | 2.0 TFSI quattro | 165 |  | 04.13 |         |                |        |             |  |                    |
|                       | 3.0 TDI quattro  | 180 |  | 01.12 |         |                |        |             |  |                    |
|                       | 2.0 TDI quattro  | 105 |  | 09.09 |         | 24.2125-1739.3 | 010948 |             |  | THz 25,40 LUC      |
|                       | 2.0 TDI quattro  | 120 |  | 04.09 |         |                |        |             |  |                    |
|                       | 2.0 TDI quattro  | 125 |  | 02.09 |         |                |        |             |  |                    |
|                       | 2.0 TFSI quattro | 155 |  | 04.09 |         |                |        |             |  |                    |
|                       | 3.0 TDI quattro  | 176 |  | 04.09 |         |                |        |             |  |                    |
|                       | 2.0 TDI quattro  | 110 |  | 05.13 |         | 24.2125-1739.3 | 010948 | PR: GP0,GP1 |  | THz 25,40 LUC      |
|                       | 2.0 TDI quattro  | 130 |  | 01.12 |         |                |        |             |  |                    |
|                       | 2.0 TFSI quattro | 162 |  | 05.13 |         |                |        |             |  |                    |
|                       | 2.0 TFSI quattro | 165 |  | 04.13 |         |                |        |             |  |                    |
|                       | 3.0 TDI quattro  | 180 |  | 01.12 |         |                |        |             |  |                    |
|                       | 2.0 TDI quattro  | 105 |  | 09.09 | PR: 1LT | 11.9571-9755.2 | 220845 |             |  | D=57, - Halter ATE |
|                       | 2.0 TDI quattro  | 110 |  | 05.13 | PR: 1LT | 11.9571-9756.2 | 220846 |             |  | D=57, - Halter ATE |
|                       | 2.0 TDI quattro  | 120 |  | 04.09 | PR: 1LT | 11.0101-5409.2 | 260035 |             |  | Hülsensatz ATE     |
|                       | 2.0 TDI quattro  | 125 |  | 02.09 | PR: 1LT | 11.8171-0008.1 | 990049 |             |  | Führungsbolzen ATE |
|                       | 2.0 TDI quattro  | 130 |  | 01.12 | PR: 1LT | 11.8116-0351.1 | 390538 | 2           |  | Haltefeder ATE     |
|                       | 2.0 TFSI quattro | 155 |  | 04.09 | PR: 1LT |                |        |             |  |                    |
|                       | 2.0 TFSI quattro | 162 |  | 05.13 | PR: 1LT |                |        |             |  |                    |
|                       | 2.0 TFSI quattro | 165 |  | 04.13 | PR: 1LT |                |        |             |  |                    |
|                       | 3.0 TDI quattro  | 176 |  | 04.09 | PR: 1LT |                |        |             |  |                    |
|                       | 3.0 TDI quattro  | 180 |  | 01.12 | PR: 1LT |                |        |             |  |                    |
|                       | 2.0 TDI quattro  | 105 |  | 09.09 |         | 83.7713-0476.3 | 331116 | 2           |  | L=472              |
|                       | 2.0 TDI quattro  | 110 |  | 05.13 |         |                |        |             |  |                    |
|                       | 2.0 TDI quattro  | 120 |  | 04.09 |         |                |        |             |  |                    |
|                       | 2.0 TDI quattro  | 125 |  | 02.09 |         |                |        |             |  |                    |
|                       | 2.0 TDI quattro  | 130 |  | 01.12 |         |                |        |             |  |                    |
|                       | 2.0 TFSI quattro | 155 |  | 04.09 |         |                |        |             |  |                    |
|                       | 2.0 TFSI quattro | 162 |  | 05.13 |         |                |        |             |  |                    |
|                       | 2.0 TFSI quattro | 165 |  | 04.13 |         |                |        |             |  |                    |
|                       | 3.0 TDI quattro  | 176 |  | 04.09 |         |                |        |             |  |                    |
|                       | 3.0 TDI quattro  | 180 |  | 01.12 |         |                |        |             |  |                    |

| AUDI A4 Cabrio (02-08) |                  |     |             |             |       |                |        |  |  |                 |
|------------------------|------------------|-----|-------------|-------------|-------|----------------|--------|--|--|-----------------|
|                        | 1.8 T            | 120 | 8H-3-017415 |             | 11.08 | 03.7858-4502.4 | 300202 |  |  | 9/8" Tandem ATE |
|                        | 1.8 T quattro    | 120 |             | 05.03       | 11.08 |                |        |  |  |                 |
|                        | 2.0              | 96  |             | 05.04       | 11.08 |                |        |  |  |                 |
|                        | 2.0 TDI          |     |             | 10.05       | 11.08 |                |        |  |  |                 |
|                        | 2.0 TFSI         | 120 |             | 10.05       | 11.08 |                |        |  |  |                 |
|                        | 2.0 TFSI         | 147 |             | 01.06       | 11.08 |                |        |  |  |                 |
|                        | 2.0 TFSI quattro | 147 |             | 11.05       | 11.08 |                |        |  |  |                 |
|                        | 2.4              | 120 | 8H-3-017415 |             | 11.08 |                |        |  |  |                 |
|                        | 2.4              | 125 | 8H-3-017415 |             | 11.08 |                |        |  |  |                 |
|                        | 2.5 TDI          | 120 | 8H-3-017415 |             | 11.08 |                |        |  |  |                 |
|                        | 2.7 TDI          | 132 |             | 06.06       | 11.08 |                |        |  |  |                 |
|                        | 3.0              | 162 | 8H-3-017415 |             | 11.08 |                |        |  |  |                 |
|                        | 3.0 quattro      | 162 |             | 05.03       | 11.08 |                |        |  |  |                 |
|                        | 3.0 TDI quattro  | 150 |             | 01.06       | 11.08 |                |        |  |  |                 |
|                        | 3.0 TDI quattro  | 171 |             | 10.05       | 11.08 |                |        |  |  |                 |
|                        | 3.2 FSI          | 188 |             | 10.05       | 11.08 |                |        |  |  |                 |
|                        | 3.2 FSI quattro  | 188 |             | 10.05       | 11.08 |                |        |  |  |                 |
|                        | 1.8 T            | 120 |             | 04.02       | 11.08 | 24.2125-1720.3 | 010688 |  |  | THz 25,40 LUC   |
|                        | 1.8 T quattro    | 120 |             | 05.03       | 11.08 |                |        |  |  |                 |
|                        | 2.0              | 96  |             | 05.04       | 11.08 |                |        |  |  |                 |
|                        | 2.0 TDI          |     |             | 10.05       | 11.08 |                |        |  |  |                 |
|                        | 2.0 TFSI         | 120 |             | 10.05       | 11.08 |                |        |  |  |                 |
|                        | 2.0 TFSI         | 147 |             | 01.06       | 11.08 |                |        |  |  |                 |
|                        | 2.0 TFSI quattro | 147 |             | 11.05       | 11.08 |                |        |  |  |                 |
|                        | 2.4              | 120 |             | 04.02       | 11.08 |                |        |  |  |                 |
|                        | 2.4              | 125 |             | 04.02       | 11.08 |                |        |  |  |                 |
|                        | 2.5 TDI          | 120 |             | 08.02       | 11.08 |                |        |  |  |                 |
|                        | 2.7 TDI          | 132 |             | 06.06       | 11.08 |                |        |  |  |                 |
|                        | 3.0              | 162 |             | 04.02       | 11.08 |                |        |  |  |                 |
|                        | 3.0 quattro      | 162 |             | 05.03       | 11.08 |                |        |  |  |                 |
|                        | 3.0 TDI quattro  | 150 |             | 01.06       | 11.08 |                |        |  |  |                 |
|                        | 3.0 TDI quattro  | 171 |             | 10.05       | 11.08 |                |        |  |  |                 |
|                        | 3.2 FSI          | 188 |             | 10.05       | 11.08 |                |        |  |  |                 |
|                        | 3.2 FSI quattro  | 188 |             | 10.05       | 11.08 |                |        |  |  |                 |
|                        | 1.8 T            | 120 | 8H-3-017415 | 8H-7-022000 |       | 03.2125-0373.3 | 010810 |  |  | THz 25,40 ATE   |
|                        | 1.8 T quattro    | 120 |             | 8H-7-022000 | 05.03 |                |        |  |  |                 |
|                        | 2.0              | 96  |             | 8H-7-022000 | 05.04 |                |        |  |  |                 |



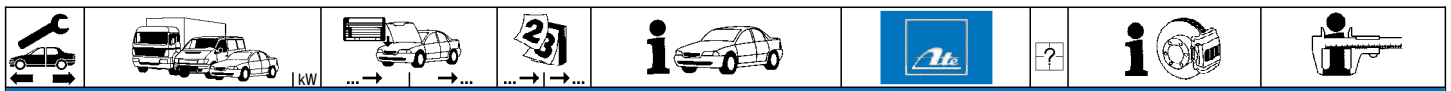







































**AUDI A4 Cabrio (02-08)**

|  |                  |     |             |             |       |                |                |        |           |                |     |
|--|------------------|-----|-------------|-------------|-------|----------------|----------------|--------|-----------|----------------|-----|
|  | 2.0 TDI          | 120 | 8H-7-022000 | 10.05       |       | 03.2125-0373.3 | 010810         |        | Thz 25,40 | ATE            |     |
|  | 2.0 TFSI         | 147 | 8H-7-022000 | 10.05       |       |                |                |        |           |                |     |
|  | 2.0 TFSI         | 147 | 8H-7-022000 | 01.06       |       |                |                |        |           |                |     |
|  | 2.0 TFSI quattro | 147 | 8H-7-022000 | 11.05       |       |                |                |        |           |                |     |
|  | 2.4              | 120 | 8H-3-017415 | 8H-7-022000 |       |                |                |        |           |                |     |
|  | 2.4              | 125 | 8H-3-017415 | 8H-7-022000 |       |                |                |        |           |                |     |
|  | 2.5 TDI          | 120 | 8H-3-017415 | 8H-7-022000 |       |                |                |        |           |                |     |
|  | 2.7 TDI          | 132 | 8H-7-022000 | 06.06       |       |                |                |        |           |                |     |
|  | 3.0              | 162 | 8H-3-017415 | 8H-7-022000 |       |                |                |        |           |                |     |
|  | 3.0 quattro      | 162 | 8H-7-022000 | 05.03       |       |                |                |        |           |                |     |
|  | 3.0 TDI quattro  | 150 | 8H-7-022000 | 01.06       |       |                |                |        |           |                |     |
|  | 3.0 TDI quattro  | 171 | 8H-7-022000 | 10.05       |       |                |                |        |           |                |     |
|  | 3.2 FSI          | 188 | 8H-7-022000 | 10.05       |       |                |                |        |           |                |     |
|  | 3.2 FSI quattro  | 188 | 8H-7-022000 | 10.05       |       |                |                |        |           |                |     |
|  | 1.8 T            | 120 | 8H-7-022001 | 11.08       |       | 03.2125-0373.3 | 010810         |        | Thz 25,40 | ATE            |     |
|  | 1.8 T quattro    | 120 | 8H-7-022001 | 11.08       |       |                |                |        |           |                |     |
|  | 2.0              | 96  | 8H-7-022001 | 11.08       |       |                |                |        |           |                |     |
|  | 2.0 TDI          |     | 8H-7-022001 | 11.08       |       |                |                |        |           |                |     |
|  | 2.0 TFSI         | 120 | 8H-7-022001 | 11.08       |       |                |                |        |           |                |     |
|  | 2.0 TFSI         | 147 | 8H-7-022001 | 11.08       |       |                |                |        |           |                |     |
|  | 2.0 TFSI quattro | 147 | 8H-7-022001 | 11.08       |       |                |                |        |           |                |     |
|  | 2.4              | 120 | 8H-7-022001 | 11.08       |       |                |                |        |           |                |     |
|  | 2.4              | 125 | 8H-7-022001 | 11.08       |       |                |                |        |           |                |     |
|  | 2.5 TDI          | 120 | 8H-7-022001 | 11.08       |       |                |                |        |           |                |     |
|  | 2.7 TDI          | 132 | 8H-7-022001 | 11.08       |       |                |                |        |           |                |     |
|  | 3.0              | 162 | 8H-7-022001 | 11.08       |       |                |                |        |           |                |     |
|  | 3.0 quattro      | 162 | 8H-7-022001 | 11.08       |       |                |                |        |           |                |     |
|  | 3.0 TDI quattro  | 150 | 8H-7-022001 | 11.08       |       |                |                |        |           |                |     |
|  | 3.0 TDI quattro  | 171 | 8H-7-022001 | 11.08       |       |                |                |        |           |                |     |
|  | 3.2 FSI          | 188 | 8H-7-022001 | 11.08       |       |                |                |        |           |                |     |
|  | 3.2 FSI quattro  | 188 | 8H-7-022001 | 11.08       |       |                |                |        |           |                |     |
|  | 1.8 T            | 120 |             | 04.02       | 11.08 | PR: 1LB,1LE    | 11.3571-8522.2 | 220320 |           | D=57, - Halter | ATE |
|  | 1.8 T quattro    | 120 |             | 05.03       | 11.08 | PR: 1LB,1LE    | 11.3571-8521.2 | 220319 |           | D=57, - Halter | ATE |
|  | 2.0              | 96  |             | 05.04       | 11.08 | PR: 1LB,1LE    | 24.3571-8522.5 | 240496 |           | D=57, - Halter | ATE |
|  | 2.0 TDI          |     |             | 10.05       | 11.08 | PR: 1LB,1LE    | 24.3571-8521.5 | 240495 |           | D=57, - Halter | ATE |
|  | 2.0 TFSI         | 120 |             | 10.05       | 11.08 | PR: 1LB,1LE    | 11.0441-5704.2 | 250034 |           | Dichtungssatz  | ATE |
|  | 2.0 TFSI         | 147 |             | 01.06       | 11.08 | PR: 1LB,1LE    | 11.0101-5409.2 | 260035 |           | Hülssensatz    | ATE |
|  | 2.0 TFSI quattro | 147 |             | 11.05       | 11.08 | PR: 1LB,1LE    | 11.8171-0008.1 | 990049 |           | Führungsbolzen | ATE |
|  | 2.4              | 120 |             | 04.02       | 11.08 | PR: 1LB,1LE    | 11.8116-0143.1 | 390513 | 2         | Haltefeder     | ATE |
|  | 2.4              | 125 |             | 04.02       | 11.08 | PR: 1LB,1LE    |                |        |           |                |     |
|  | 2.5 TDI          | 120 |             | 08.02       | 11.08 | PR: 1LB,1LE    |                |        |           |                |     |
|  | 2.7 TDI          | 132 |             | 06.06       | 11.08 | PR: 1LB,1LE    |                |        |           |                |     |
|  | 3.0              | 162 |             | 04.02       | 11.08 | PR: 1LB,1LE    |                |        |           |                |     |
|  | 3.0 quattro      | 162 |             | 05.03       | 11.08 | PR: 1LB,1LE    |                |        |           |                |     |
|  | 3.0 TDI quattro  | 150 |             | 01.06       | 11.08 | PR: 1LB,1LE    |                |        |           |                |     |
|  | 3.0 TDI quattro  | 171 |             | 10.05       | 11.08 | PR: 1LB,1LE    |                |        |           |                |     |
|  | 3.2 FSI          | 188 |             | 10.05       | 11.08 | PR: 1LB,1LE    |                |        |           |                |     |
|  | 3.2 FSI quattro  | 188 |             | 10.05       | 11.08 | PR: 1LB,1LE    |                |        |           |                |     |
|  | 1.8 T            | 120 |             | 04.02       | 11.08 | PR: 1LF,1LT    | 11.9571-9836.2 | 220428 |           | D=57, - Halter | ATE |
|  | 1.8 T quattro    | 120 |             | 05.03       | 11.08 | PR: 1LF,1LT    | 11.9571-9835.2 | 220427 |           | D=57, - Halter | ATE |
|  | 2.0              | 96  |             | 05.04       | 11.08 | PR: 1LF,1LT    | 11.0441-5704.2 | 250034 |           | Dichtungssatz  | ATE |
|  | 2.0 TDI          |     |             | 10.05       | 11.08 | PR: 1LF,1LT    | 11.0101-5409.2 | 260035 |           | Hülssensatz    | ATE |
|  | 2.0 TFSI         | 120 |             | 10.05       | 11.08 | PR: 1LF,1LT    | 11.8171-0008.1 | 990049 |           | Führungsbolzen | ATE |
|  | 2.0 TFSI         | 147 |             | 01.06       | 11.08 | PR: 1LF,1LT    | 11.8116-0143.1 | 390513 | 2         | Haltefeder     | ATE |
|  | 2.0 TFSI quattro | 147 |             | 11.05       | 11.08 | PR: 1LF,1LT    |                |        |           |                |     |
|  | 2.4              | 120 |             | 04.02       | 11.08 | PR: 1LF,1LT    |                |        |           |                |     |
|  | 2.4              | 125 |             | 04.02       | 11.08 | PR: 1LF,1LT    |                |        |           |                |     |
|  | 2.5 TDI          | 120 |             | 08.02       | 11.08 | PR: 1LF,1LT    |                |        |           |                |     |
|  | 2.7 TDI          | 132 |             | 06.06       | 11.08 | PR: 1LF,1LT    |                |        |           |                |     |
|  | 3.0              | 162 |             | 04.02       | 11.08 | PR: 1LF,1LT    |                |        |           |                |     |
|  | 3.0 quattro      | 162 |             | 05.03       | 11.08 | PR: 1LF,1LT    |                |        |           |                |     |
|  | 3.0 TDI quattro  | 150 |             | 01.06       | 11.08 | PR: 1LF,1LT    |                |        |           |                |     |
|  | 3.0 TDI quattro  | 171 |             | 10.05       | 11.08 | PR: 1LF,1LT    |                |        |           |                |     |
|  | 3.2 FSI          | 188 |             | 10.05       | 11.08 | PR: 1LF,1LT    |                |        |           |                |     |
|  | 3.2 FSI quattro  | 188 |             | 10.05       | 11.08 | PR: 1LF,1LT    |                |        |           |                |     |
|  | 1.8 T            | 120 |             | 04.02       | 11.08 | PR: 1LA        | 11.9606-9957.2 | 220815 |           | D=60, - Halter | ATE |
|  | 1.8 T quattro    | 120 |             | 05.03       | 11.08 | PR: 1LA        | 11.9606-9958.2 | 220816 |           | D=60, - Halter | ATE |
|  | 2.0              | 96  |             | 05.04       | 11.08 | PR: 1LA        | 11.0441-6008.2 | 250038 |           | Dichtungssatz  | ATE |
|  | 2.0 TDI          |     |             | 10.05       | 11.08 | PR: 1LA        | 11.0101-5409.2 | 260035 |           | Hülssensatz    | ATE |
|  | 2.0 TFSI         | 120 |             | 10.05       | 11.08 | PR: 1LA        | 11.8171-0008.1 | 990049 |           | Führungsbolzen | ATE |
|  | 2.0 TFSI         | 147 |             | 01.06       | 11.08 | PR: 1LA        | 11.8116-0410.2 | 390589 | 2         | Haltefeder     | ATE |
|  | 2.0 TFSI quattro | 147 |             | 11.05       | 11.08 | PR: 1LA        |                |        |           |                |     |
|  | 2.4              | 120 |             | 04.02       | 11.08 | PR: 1LA        |                |        |           |                |     |
|  | 2.4              | 125 |             | 04.02       | 11.08 | PR: 1LA        |                |        |           |                |     |
|  | 2.5 TDI          | 120 |             | 08.02       | 11.08 | PR: 1LA        |                |        |           |                |     |
|  | 2.7 TDI          | 132 |             | 06.06       | 11.08 | PR: 1LA        |                |        |           |                |     |
|  | 3.0              | 162 |             | 04.02       | 11.08 | PR: 1LA        |                |        |           |                |     |
|  | 3.0 quattro      | 162 |             | 05.03       | 11.08 | PR: 1LA        |                |        |           |                |     |
|  | 3.0 TDI quattro  | 150 |             | 01.06       | 11.08 | PR: 1LA        |                |        |           |                |     |
|  | 3.0 TDI quattro  | 171 |             | 10.05       | 11.08 | PR: 1LA        |                |        |           |                |     |
|  | 3.2 FSI          | 188 |             | 10.05       | 11.08 | PR: 1LA        |                |        |           |                |     |
|  | 3.2 FSI quattro  | 188 |             | 10.05       | 11.08 | PR: 1LA        |                |        |           |                |     |



|     |    |                                    |   |    |   |    |    |    |  |  |
|--|--|--|---|--|--|--|--|--|--|--|
| <b>AUDI A4 Cabrio (02-08)</b>  |  |  |   |  |  |  |  |  |  |  |
|    | S4 4.2 quattro   | 253  |   | 02.04  | 11.08  |  | 11.9606-9961.2 220655<br>11.9606-9962.2 220656<br>11.0441-6008.2 250038<br>11.0101-5409.2 260035<br>11.8171-0008.1 990049<br>11.8116-0410.2 390589 | <br>     | D=60, - Halter<br>D=60, - Halter<br>Dichtungssatz<br>Hülensatz<br>Führungsbolzen<br>Haltefeder | ATE<br>ATE<br>ATE<br>ATE<br>ATE<br>ATE |
|    | 1.8 T<br>1.8 T quattro<br>2.0<br>2.0 TDI<br>2.0 TFSI<br>2.0 TFSI<br>2.0 TFSI quattro<br>2.4<br>2.4<br>2.5 TDI<br>2.7 TDI<br>3.0<br>3.0 quattro<br>3.0 TDI quattro<br>3.0 TDI quattro<br>3.2 FSI<br>3.2 FSI quattro<br>S4 4.2 quattro | 120<br>120<br>96<br>120<br>147<br>147<br>120<br>125<br>120<br>132<br>162<br>162<br>150<br>171<br>188<br>188<br>253 |   | 04.02<br>05.03<br>05.04<br>10.05<br>10.05<br>01.06<br>11.05<br>04.02<br>04.02<br>08.02<br>06.06<br>04.02<br>05.03<br>01.06<br>10.05<br>10.05<br>10.05<br>02.04 | 11.08<br>11.08<br>11.08<br>11.08<br>11.08<br>11.08<br>11.08<br>11.08<br>11.08<br>11.08<br>11.08<br>11.08<br>11.08<br>11.08<br>11.08<br>11.08<br>11.08<br>11.08 |  | 83.7213-0307.3 330791  | 2  | L=305  |  |
|  | RS4 4.2  | 309  |   | 05.06  | 11.08  |  | 83.6169-0418.3 330894  | 2  | L=422  |  |
|    | 1.8 T<br>1.8 T quattro<br>2.0<br>2.0 TDI<br>2.0 TFSI<br>2.0 TFSI quattro<br>2.4<br>2.4<br>2.5 TDI<br>3.0<br>3.0 quattro  | 120<br>120<br>96<br>120<br>147<br>147<br>120<br>125<br>120<br>162<br>162   |   | 04.02<br>05.03<br>05.04<br>10.05<br>10.05<br>01.06<br>11.05<br>04.02<br>04.02<br>08.02<br>04.02<br>05.03   | 11.08<br>11.08<br>11.08<br>11.08<br>11.08<br>11.08<br>12.05<br>12.05<br>12.05<br>12.05<br>12.05  | PR: 1KD,1KP<br>PR: 1KD,1KP<br>PR: 1KD,1KP<br>PR: 1KD,1KP<br>PR: 1KD,1KP<br>PR: 1KD,1KP   | 24.3384-1735.7 220547<br>24.3384-1736.7 220548   | <br>     | D=38, - Halter<br>D=38, - Halter   | LUC<br>LUC                             |
|  | 1.8 T<br>1.8 T quattro<br>2.0<br>2.0 TDI<br>2.0 TFSI<br>2.0 TFSI quattro<br>2.4<br>2.4<br>2.5 TDI<br>2.7 TDI<br>3.0<br>3.0 quattro<br>3.0 TDI quattro<br>3.0 TDI quattro<br>3.2 FSI<br>3.2 FSI quattro                               | 120<br>120<br>96<br>120<br>147<br>147<br>120<br>125<br>120<br>132<br>162<br>162<br>150<br>171<br>188<br>188        | 8E-5-400001<br>8E-5-400001<br>8E-5-400001<br>8E-5-400001<br>8E-5-400001<br>8E-5-400001<br>8E-5-400001<br>8E-5-400001<br>8E-5-400001<br>8E-5-400001<br>8E-5-400001<br>8E-5-400001<br>8E-5-400001<br>8E-5-400001<br>8E-5-400001 |  | 11.08<br>11.08<br>11.08<br>11.08<br>11.08<br>11.08<br>11.08<br>11.08<br>11.08<br>11.08<br>11.08<br>11.08<br>11.08<br>11.08<br>11.08<br>11.08                   | PR: 1KW<br>PR: 1KW<br>PR: 1KW<br>PR: 1KW<br>PR: 1KW<br>PR: 1KW<br>PR: 1KW<br>PR: 1KW<br>PR: 1KW<br>PR: 1KW<br>PR: 1KW<br>PR: 1KW<br>PR: 1KW<br>PR: 1KW<br>PR: 1KW<br>PR: 1KW | 24.3414-1713.7 220793<br>24.3414-1714.7 220794   | <br>    | D=41, - Halter<br>D=41, - Halter   | LUC<br>LUC                             |
|  | 1.8 T<br>1.8 T quattro<br>2.0<br>2.0 TDI<br>2.0 TFSI<br>2.0 TFSI<br>2.0 TFSI quattro<br>2.4<br>2.4<br>2.5 TDI<br>2.7 TDI<br>3.0<br>3.0 quattro<br>3.0 TDI quattro<br>3.0 TDI quattro<br>3.2 FSI<br>3.2 FSI quattro<br>S4 4.2 quattro | 120<br>120<br>96<br>120<br>147<br>147<br>120<br>125<br>120<br>132<br>162<br>162<br>150<br>171<br>188<br>188<br>253 |   | 04.02<br>05.03<br>05.04<br>10.05<br>10.05<br>01.06<br>11.05<br>04.02<br>04.02<br>08.02<br>06.06<br>04.02<br>05.03<br>01.06<br>10.05<br>10.05<br>10.05<br>02.04 | 11.08<br>11.08<br>11.08<br>11.08<br>11.08<br>11.08<br>11.08<br>11.08<br>11.08<br>11.08<br>11.08<br>11.08<br>11.08<br>11.08<br>11.08<br>11.08<br>11.08          |  | 24.5138-0263.3 330885  | 2  | L=263  |  |
|  | 1.8 T<br>2.0<br>2.0 TDI<br>2.0 TFSI<br>2.0 TFSI<br>2.4<br>2.4<br>2.5 TDI<br>2.7 TDI<br>3.0<br>3.2 FSI  | 120<br>96<br>120<br>147<br>147<br>120<br>125<br>120<br>132<br>162<br>188   |   | 04.02<br>05.04<br>10.05<br>10.05<br>01.06<br>04.02<br>04.02<br>08.02<br>06.06<br>04.02<br>10.05  | 11.08<br>11.08<br>11.08<br>11.08<br>11.08<br>11.08<br>11.08<br>11.08<br>11.08<br>11.08<br>11.08  |  | 24.3727-0182.2 580182<br>24.3727-0183.2 580183   | <br> | L=1928<br>L=2005   |  |



| AUDI A4 Cabrio (02-08)   |  |  |  |  |   |  |  |  |  |
|--|--|--|--|--|---|--|--|--|--|
|     |  |  |  |  |  |  |  |  |  |
|    | 1.8 T  | 120  |  | 04.02  | 11.08   |  | 24.2522-1706.3   | 040090   | Nz 22,20   |
|  | 1.8 T quattro  | 120  |  | 05.03  | 11.08   |  |  |  |  |
|  | 2.0  | 96   |  | 05.04  | 11.08   |  |  |  |  |
|  | 2.0 TDI  |  |  | 10.05  | 11.08   |  |  |  |  |
|  | 2.0 TFSI   | 120  |  | 10.05  | 11.08   |  |  |  |  |
|  | 2.4  | 120  |  | 04.02  | 11.08   |  |  |  |  |
|  | 2.4  | 125  |  | 04.02  | 11.08   |  |  |  |  |
|  | 2.5 TDI  | 120  |  | 08.02  | 11.08   |  |  |  |  |
|  | 3.0  | 162  |  | 04.02  | 11.08   |  |  |  |  |
|  | 3.0 quattro  | 162  |  | 05.03  | 11.08   |  |  |  |  |
|  | 3.2 FSI  | 188  |  | 10.05  | 11.08   |  |  |  |  |
| AUDI A5 / A5 Sportback (07-)   |  |  |  |  |   |  |  |  |  |
|    | 1.8 TFSI   | 118  |  | 05.09  |   |  | 03.7858-4632.4   | 300273   | 9/8" Tandem ATE  |
|  | 1.8 TFSI   | 125  |  | 10.07  |   |  |  |  |  |
|  | 2.0 TDI  | 105  |  | 09.09  |   |  |  |  |  |
|  | 2.0 TDI  | 120  |  | 10.08  |   |  |  |  |  |
|  | 2.0 TDI  | 125  |  | 08.08  |   |  |  |  |  |
|  | 2.0 TDI  | 130  |  | 07.11  |   |  |  |  |  |
|  | 2.0 TDI quattro  | 124  |  | 10.08  |   |  |  |  |  |
|  | 2.0 TDI quattro  | 125  |  | 08.08  |   |  |  |  |  |
|  | 2.0 TFSI   | 132  |  | 11.08  |   |  |  |  |  |
|  | 2.0 TFSI   | 155  |  | 06.08  |   |  |  |  |  |
|  | 2.0 TFSI quattro   | 155  |  | 06.08  |   |  |  |  |  |
|  | 2.7 TDI  | 120  |  | 09.07  |   |  |  |  |  |
|  | 2.7 TDI  | 140  |  | 05.07  |   |  |  |  |  |
|  | 3.0 TDI  | 150  |  | 07.11  |   |  |  |  |  |
|  | 3.0 TDI quattro  | 155  |  | 03.08  |   |  |  |  |  |
|  | 3.0 TDI quattro  | 176  |  | 05.07  |   |  |  |  |  |
|  | 3.0 TDI quattro  | 180  |  | 07.11  |   |  |  |  |  |
|  | 3.2 FSI  | 195  |  | 05.07  |   |  |  |  |  |
|  | 3.2 FSI quattro  | 195  |  | 05.07  |   |  |  |  |  |
|  | S5 quattro   | 245  |  | 01.10  |   |  |  |  |  |
|  | S5 quattro   | 260  |  | 05.07  |   |  |  |  |  |
|    | 1.8 TFSI   | 118  |  | 05.09  |   |  | 24.2125-1739.3   | 010948   | THz 25,40 LUC  |
|  | 1.8 TFSI   | 125  |  | 10.07  |   |  |  |  |  |
|  | 2.0 TDI  | 105  |  | 09.09  |   |  |  |  |  |
|  | 2.0 TDI  | 120  |  | 10.08  |   |  |  |  |  |
|  | 2.0 TDI  | 125  |  | 08.08  |   |  |  |  |  |
|  | 2.0 TDI  | 130  |  | 07.11  |   |  |  |  |  |
|  | 2.0 TDI quattro  | 124  |  | 10.08  |   |  |  |  |  |
|  | 2.0 TDI quattro  | 125  |  | 08.08  |   |  |  |  |  |
|  | 2.0 TFSI   | 132  |  | 11.08  |   |  |  |  |  |
|  | 2.0 TFSI   | 155  |  | 06.08  |   |  |  |  |  |
|  | 2.0 TFSI quattro   | 155  |  | 06.08  |   |  |  |  |  |
|  | 2.7 TDI  | 120  |  | 09.07  |   |  |  |  |  |
|  | 2.7 TDI  | 140  |  | 05.07  |   |  |  |  |  |
|  | 3.0 TDI  | 150  |  | 07.11  |   |  |  |  |  |
|  | 3.0 TDI quattro  | 155  |  | 03.08  |   |  |  |  |  |
|  | 3.0 TDI quattro  | 176  |  | 05.07  |   |  |  |  |  |
|  | 3.0 TDI quattro  | 180  |  | 07.11  |   |  |  |  |  |
|  | 3.2 FSI  | 195  |  | 05.07  |   |  |  |  |  |
|  | 3.2 FSI quattro  | 195  |  | 05.07  |   |  |  |  |  |
|  | S5 quattro   | 245  |  | 01.10  |   |  |  |  |  |
|  | S5 quattro   | 260  |  | 05.07  |   |  |  |  |  |
|  | 1.8 TFSI   | 118  |  | 05.09  |   | PR: 1LT  | 11.9571-9755.2   | 220845   |  D=57, - Halter ATE |
|  | 1.8 TFSI   | 125  |  | 10.07  |   | PR: 1LT  | 11.9571-9756.2   | 220846   |  D=57, - Halter ATE |
|  | 2.0 TDI  | 105  |  | 09.09  |   | PR: 1LT  | 11.8171-0008.1   | 990049   | Führungsbolzen ATE   |
|  | 2.0 TDI  | 110  |  | 05.13  |   | PR: 1LT  | 11.0101-5409.2   | 260035   | Hülzensatz ATE   |
|  | 2.0 TDI  | 120  |  | 10.08  |   | PR: 1LT  | 11.8116-0351.1   | 390538   | 2 Haltefeder ATE   |
|  | 2.0 TDI  | 125  |  | 08.08  |   | PR: 1LT  |  |  |  |
|  | 2.0 TDI  | 130  |  | 07.11  |   | PR: 1LT  |  |  |  |
|  | 2.0 TDI quattro  | 124  |  | 10.08  |   | PR: 1LT  |  |  |  |
|  | 2.0 TDI quattro  | 125  |  | 08.08  |   | PR: 1LT  |  |  |  |
|  | 2.0 TDI quattro  | 130  |  | 12.11  |   | PR: 1LT  |  |  |  |
|  | 2.0 TFSI   | 132  |  | 11.08  |   | PR: 1LT  |  |  |  |
|  | 2.0 TFSI   | 155  |  | 06.08  |   | PR: 1LT  |  |  |  |
|  | 2.0 TFSI   | 165  |  | 05.13  |   | PR: 1LT  |  |  |  |
|  | 2.0 TFSI quattro   | 155  |  | 06.08  |   | PR: 1LT  |  |  |  |
|  | 2.0 TFSI quattro   | 165  |  | 05.13  |   | PR: 1LT  |  |  |  |
|  | 2.7 TDI  | 120  |  | 09.07  |   | PR: 1LT  |  |  |  |
|  | 2.7 TDI  | 140  |  | 05.07  |   | PR: 1LT  |  |  |  |
|  | 3.0 TDI  | 150  |  | 07.11  |   | PR: 1LT  |  |  |  |
|  | 3.0 TDI quattro  | 155  |  | 03.08  |   | PR: 1LT  |  |  |  |
|  | 3.0 TDI quattro  | 176  |  | 05.07  |   | PR: 1LT  |  |  |  |
|  | 3.0 TDI quattro  | 180  |  | 07.11  |   | PR: 1LT  |  |  |  |
|  | 3.0 TFSI quattro   | 200  |  | 12.11  |   | PR: 1LT  |  |  |  |
|  | 3.2 FSI  | 195  |  | 05.07  |   | PR: 1LT  |  |  |  |
|  | 3.2 FSI quattro  | 195  |  | 06.07  |   | PR: 1LT  |  |  |  |
|  | 1.8 TFSI   | 118  |  | 05.09  |   |  | 83.7713-0476.3   | 331116   | 2 L=472  |
|  | 1.8 TFSI   | 125  |  | 10.07  |   |  |  |  |  |
|  | 2.0 TDI  | 105  |  | 09.09  |   |  |  |  |  |
|  | 2.0 TDI  | 110  |  | 05.13  |   |  |  |  |  |
|  | 2.0 TDI  | 120  |  | 10.08  |   |  |  |  |  |
|  | 2.0 TDI  | 125  |  | 08.08  |   |  |  |  |  |
|  | 2.0 TDI  | 130  |  | 07.11  |   |  |  |  |  |
|  | 2.0 TDI quattro  | 124  |  | 10.08  |   |  |  |  |  |

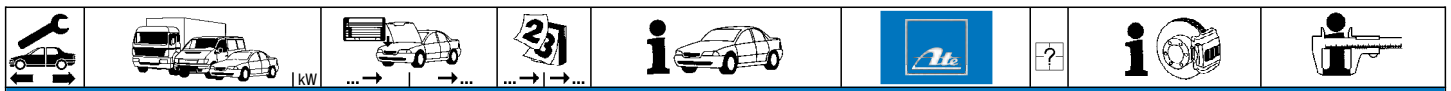















| AUDI A5 / A5 Sportback (07-) |                  |     |  |       |  |                |        |   |  |       |
|------------------------------|------------------|-----|--|-------|--|----------------|--------|---|--|-------|
|                              | 2.0 TDI quattro  | 125 |  | 08.08 |  | 83.7713-0476.3 | 331116 | 2 |  | L=472 |
|                              | 2.0 TDI quattro  | 130 |  | 12.11 |  |                |        |   |  |       |
|                              | 2.0 TFSI         | 132 |  | 11.08 |  |                |        |   |  |       |
|                              | 2.0 TFSI         | 155 |  | 06.08 |  |                |        |   |  |       |
|                              | 2.0 TFSI         | 165 |  | 05.13 |  |                |        |   |  |       |
|                              | 2.0 TFSI quattro | 155 |  | 06.08 |  |                |        |   |  |       |
|                              | 2.0 TFSI quattro | 165 |  | 05.13 |  |                |        |   |  |       |
|                              | 2.7 TDI          | 120 |  | 09.07 |  |                |        |   |  |       |
|                              | 2.7 TDI          | 140 |  | 05.07 |  |                |        |   |  |       |
|                              | 3.0 TDI          | 150 |  | 07.11 |  |                |        |   |  |       |
|                              | 3.0 TDI quattro  | 155 |  | 03.08 |  |                |        |   |  |       |
|                              | 3.0 TDI quattro  | 176 |  | 05.07 |  |                |        |   |  |       |
|                              | 3.0 TDI quattro  | 180 |  | 07.11 |  |                |        |   |  |       |
|                              | 3.0 TFSI quattro | 200 |  | 12.11 |  |                |        |   |  |       |
|                              | 3.2 FSI          | 195 |  | 05.07 |  |                |        |   |  |       |
|                              | 3.2 FSI quattro  | 195 |  | 05.07 |  |                |        |   |  |       |
|                              | S5 quattro       | 245 |  | 01.10 |  |                |        |   |  |       |
|                              | S5 quattro       | 260 |  | 05.07 |  |                |        |   |  |       |

| AUDI A5 Cabrio (09-) |                  |     |  |       |         |                |        |   |  |                    |
|----------------------|------------------|-----|--|-------|---------|----------------|--------|---|--|--------------------|
|                      | 1.8 TFSI         | 118 |  | 09.09 |         | 03.7858-4632.4 | 300273 |   |  | 9/8" Tandem ATE    |
|                      | 1.8 TFSI         | 125 |  | 07.11 |         |                |        |   |  |                    |
|                      | 2.0 TDI          | 120 |  | 05.09 |         |                |        |   |  |                    |
|                      | 2.0 TDI          | 125 |  | 05.09 |         |                |        |   |  |                    |
|                      | 2.0 TDI          | 130 |  | 07.11 |         |                |        |   |  |                    |
|                      | 2.0 TFSI         | 132 |  | 03.09 |         |                |        |   |  |                    |
|                      | 2.0 TFSI         | 155 |  | 03.09 |         |                |        |   |  |                    |
|                      | 2.0 TFSI quattro | 155 |  | 03.09 |         |                |        |   |  |                    |
|                      | 2.7 TDI          | 120 |  | 05.09 |         |                |        |   |  |                    |
|                      | 2.7 TDI          | 140 |  | 03.09 |         |                |        |   |  |                    |
|                      | 3.0 TDI          | 150 |  | 07.11 |         |                |        |   |  |                    |
|                      | 3.0 TDI quattro  | 176 |  | 03.09 |         |                |        |   |  |                    |
|                      | 3.0 TDI quattro  | 180 |  | 07.11 |         |                |        |   |  |                    |
|                      | 3.2 FSI          | 195 |  | 03.09 |         |                |        |   |  |                    |
|                      | 3.2 FSI quattro  | 195 |  | 03.09 |         |                |        |   |  |                    |
|                      | S5               | 245 |  | 04.09 |         |                |        |   |  |                    |
|                      | 1.8 TFSI         | 118 |  | 09.09 |         | 24.2125-1739.3 | 010948 |   |  | Thz 25,40 LUC      |
|                      | 1.8 TFSI         | 125 |  | 07.11 |         |                |        |   |  |                    |
|                      | 2.0 TDI          | 120 |  | 05.09 |         |                |        |   |  |                    |
|                      | 2.0 TDI          | 125 |  | 05.09 |         |                |        |   |  |                    |
|                      | 2.0 TDI          | 130 |  | 07.11 |         |                |        |   |  |                    |
|                      | 2.0 TFSI         | 132 |  | 03.09 |         |                |        |   |  |                    |
|                      | 2.0 TFSI         | 155 |  | 03.09 |         |                |        |   |  |                    |
|                      | 2.0 TFSI quattro | 155 |  | 03.09 |         |                |        |   |  |                    |
|                      | 2.7 TDI          | 120 |  | 05.09 |         |                |        |   |  |                    |
|                      | 2.7 TDI          | 140 |  | 03.09 |         |                |        |   |  |                    |
|                      | 3.0 TDI          | 150 |  | 07.11 |         |                |        |   |  |                    |
|                      | 3.0 TDI quattro  | 176 |  | 03.09 |         |                |        |   |  |                    |
|                      | 3.0 TDI quattro  | 180 |  | 07.11 |         |                |        |   |  |                    |
|                      | 3.2 FSI          | 195 |  | 03.09 |         |                |        |   |  |                    |
|                      | 3.2 FSI quattro  | 195 |  | 03.09 |         |                |        |   |  |                    |
|                      | S5               | 245 |  | 04.09 |         |                |        |   |  |                    |
|                      | 1.8 TFSI         | 118 |  | 09.09 | PR: 1LT | 11.9571-9755.2 | 220845 |   |  | D=57, - Halter ATE |
|                      | 1.8 TFSI         | 125 |  | 07.11 | PR: 1LT | 11.9571-9756.2 | 220846 |   |  | D=57, - Halter ATE |
|                      | 2.0 TDI          | 105 |  | 11.11 | PR: 1LT | 11.8171-0008.1 | 990049 |   |  | Führungsbolzen ATE |
|                      | 2.0 TDI          | 110 |  | 05.13 | PR: 1LT | 11.0101-5409.2 | 260035 |   |  | Hülzensatz ATE     |
|                      | 2.0 TDI          | 120 |  | 05.09 | PR: 1LT | 11.8116-0351.1 | 390538 | 2 |  | Haltefeder ATE     |
|                      | 2.0 TDI          | 125 |  | 05.09 | PR: 1LT |                |        |   |  |                    |
|                      | 2.0 TDI          | 130 |  | 07.11 | PR: 1LT |                |        |   |  |                    |
|                      | 2.0 TDI quattro  | 130 |  | 01.12 | PR: 1LT |                |        |   |  |                    |
|                      | 2.0 TFSI         | 132 |  | 03.09 | PR: 1LT |                |        |   |  |                    |
|                      | 2.0 TFSI         | 155 |  | 03.09 | PR: 1LT |                |        |   |  |                    |
|                      | 2.0 TFSI         | 165 |  | 05.13 | PR: 1LT |                |        |   |  |                    |
|                      | 2.0 TFSI quattro | 155 |  | 03.09 | PR: 1LT |                |        |   |  |                    |
|                      | 2.0 TFSI quattro | 165 |  | 05.13 | PR: 1LT |                |        |   |  |                    |
|                      | 2.7 TDI          | 120 |  | 05.09 | PR: 1LT |                |        |   |  |                    |
|                      | 2.7 TDI          | 140 |  | 03.09 | PR: 1LT |                |        |   |  |                    |
|                      | 3.0 TDI          | 150 |  | 07.11 | PR: 1LT |                |        |   |  |                    |
|                      | 3.0 TDI quattro  | 176 |  | 03.09 | PR: 1LT |                |        |   |  |                    |
|                      | 3.0 TDI quattro  | 180 |  | 07.11 | PR: 1LT |                |        |   |  |                    |
|                      | 3.0 TFSI quattro | 200 |  | 11.11 | PR: 1LT |                |        |   |  |                    |
|                      | 3.2 FSI          | 195 |  | 03.09 | PR: 1LT |                |        |   |  |                    |
|                      | 3.2 FSI quattro  | 195 |  | 03.09 | PR: 1LT |                |        |   |  |                    |
|                      | 1.8 TFSI         | 118 |  | 09.09 |         | 83.7713-0476.3 | 331116 | 2 |  | L=472              |
|                      | 1.8 TFSI         | 125 |  | 07.11 |         |                |        |   |  |                    |
|                      | 2.0 TDI          | 105 |  | 11.11 |         |                |        |   |  |                    |
|                      | 2.0 TDI          | 110 |  | 05.13 |         |                |        |   |  |                    |
|                      | 2.0 TDI          | 120 |  | 05.09 |         |                |        |   |  |                    |
|                      | 2.0 TDI          | 125 |  | 05.09 |         |                |        |   |  |                    |
|                      | 2.0 TDI          | 130 |  | 07.11 |         |                |        |   |  |                    |
|                      | 2.0 TDI quattro  | 130 |  | 01.12 |         |                |        |   |  |                    |
|                      | 2.0 TFSI         | 132 |  | 03.09 |         |                |        |   |  |                    |
|                      | 2.0 TFSI         | 155 |  | 03.09 |         |                |        |   |  |                    |
|                      | 2.0 TFSI         | 165 |  | 05.13 |         |                |        |   |  |                    |
|                      | 2.0 TFSI quattro | 155 |  | 03.09 |         |                |        |   |  |                    |
|                      | 2.0 TFSI quattro | 165 |  | 05.13 |         |                |        |   |  |                    |
|                      | 2.7 TDI          | 120 |  | 05.09 |         |                |        |   |  |                    |



| <b>AUDI A5 Cabrio (09-)</b>               |                  |     |  |       |                    |                |        |   |                      |
|---|------------------|-----|--|-------|--------------------|----------------|--------|---|----------------------|
|   | 2.7 TDI          | 140 |  | 03.09 |                    | 83.7713-0476.3 | 331116 | 2 | L=472                |
|   | 3.0 TDI          | 150 |  | 07.11 |                    |                |        |   |                      |
|   | 3.0 TDI quattro  | 176 |  | 03.09 |                    |                |        |   |                      |
|   | 3.0 TDI quattro  | 180 |  | 07.11 |                    |                |        |   |                      |
|   | 3.0 TFSI quattro | 200 |  | 11.11 |                    |                |        |   |                      |
|   | 3.2 FSI          | 195 |  | 03.09 |                    |                |        |   |                      |
|   | 3.2 FSI quattro  | 195 |  | 03.09 |                    |                |        |   |                      |
|   | S5               | 245 |  | 04.09 |                    |                |        |   |                      |
| <b>AUDI A6 / A6 Avant (4A/C4) (94-97)</b> |                  |     |  |       |                    |                |        |   |                      |
|   | S6 2.2           | 169 |  | 06.94 | 12.97              | 10.0124-3202.3 | 340011 |   | Hydraulik Verstärker |
|   | S6 4.2           | 213 |  | 09.94 | 12.97              |                |        |   |                      |
|   | S6 4.2 plus      | 235 |  | 06.96 | 12.97              |                |        |   |                      |
|   | 1.9 TDI          |     |  | 06.94 | 06.95 - ABS        | 03.2123-0491.3 | 010167 |   | THz 23,81 ATE        |
|   | 2.0              |     |  | 06.94 | 06.95 - ABS        |                |        |   |                      |
|   | 2.0 16V          |     |  | 06.94 | 06.95 - ABS        |                |        |   |                      |
|   | 2.3              |     |  | 06.94 | 06.95 - ABS        |                |        |   |                      |
|   | 2.5 TDI          |     |  | 06.94 | 06.95 - ABS        |                |        |   |                      |
|   | 2.6              |     |  | 06.94 | 06.95 - ABS        |                |        |   |                      |
|   | 2.8              | 128 |  | 06.94 | 06.95 - ABS        |                |        |   |                      |
|   | 1.9 TDI          |     |  | 06.94 | 06.95 + ABS/ - EDS | 24.2123-1602.3 | 010384 |   | THz 23,81 LUC        |
|   | 2.0              |     |  | 06.94 | 06.95 + ABS/ - EDS |                |        |   |                      |
|   | 2.0 16V          |     |  | 06.94 | 06.95 + ABS/ - EDS |                |        |   |                      |
|   | 2.3              |     |  | 06.94 | 06.95 + ABS/ - EDS |                |        |   |                      |
|   | 2.5 TDI          |     |  | 06.94 | 06.95 + ABS/ - EDS |                |        |   |                      |
|   | 2.6              |     |  | 06.94 | 06.95 + ABS/ - EDS |                |        |   |                      |
|   | 2.8              | 128 |  | 06.94 | 06.95 + ABS/ - EDS |                |        |   |                      |
|   | 1.8              |     |  | 10.95 | 12.97 + ABS        | 24.2123-1731.3 | 010621 |   | THz 23,81            |
|   | 1.8 quattro      |     |  | 10.95 | 12.97              |                |        |   |                      |
|   | 1.9 TDI          |     |  | 07.95 | 12.97 + ABS        |                |        |   |                      |
|   | 1.9 TDI          |     |  | 06.94 | 06.95 + ABS/ + EDS |                |        |   |                      |
|   | 2.0              |     |  | 07.95 | 12.97 + ABS        |                |        |   |                      |
|   | 2.0              |     |  | 06.94 | 06.95 + ABS/ + EDS |                |        |   |                      |
|   | 2.0 16V          |     |  | 07.95 | 12.97 + ABS        |                |        |   |                      |
|   | 2.0 16V          |     |  | 06.94 | 06.95 + ABS/ + EDS |                |        |   |                      |
|   | 2.0 quattro      |     |  | 06.94 | 12.97              |                |        |   |                      |
|   | 2.3              |     |  | 07.95 | 12.95 + ABS        |                |        |   |                      |
|   | 2.3              |     |  | 06.94 | 06.95 + ABS/ + EDS |                |        |   |                      |
|   | 2.3 quattro      |     |  | 08.94 | 12.95              |                |        |   |                      |
|   | 2.5 TDI          |     |  | 07.95 | 12.97 + ABS        |                |        |   |                      |
|   | 2.5 TDI          |     |  | 06.94 | 06.95 + ABS/ + EDS |                |        |   |                      |
|   | 2.5 TDI quattro  |     |  | 07.95 | 12.97              |                |        |   |                      |
|   | 2.6              |     |  | 07.95 | 12.97 + ABS        |                |        |   |                      |
|   | 2.6              |     |  | 06.94 | 06.95 + ABS/ + EDS |                |        |   |                      |
|   | 2.6 quattro      |     |  | 06.94 | 12.97              |                |        |   |                      |
|   | 2.8              | 128 |  | 07.95 | 12.97 + ABS        |                |        |   |                      |
|   | 2.8              | 128 |  | 06.94 | 06.95 + ABS/ + EDS |                |        |   |                      |
|   | 2.8              | 142 |  | 10.95 | 12.97 + ABS        |                |        |   |                      |
|   | 2.8 quattro      |     |  | 06.94 | 12.97              |                |        |   |                      |
|   | 1.8              |     |  | 10.95 | 12.97              | 11.3571-8506.2 | 220126 |   | D=57, - Halter ATE   |
|   | 1.9 TDI          |     |  | 06.94 | 12.97              | 24.3571-8505.5 | 240489 |   | D=57, - Halter ATE   |
|   | 2.0              |     |  | 06.94 | 12.97              | 24.3571-8506.5 | 240490 |   | D=57, - Halter ATE   |
|   | 2.0 16V          |     |  | 06.94 | 12.97              | 11.0441-5704.2 | 250034 |   | Dichtungssatz ATE    |
|   | 2.3              |     |  | 06.94 | 12.95              | 11.0101-5409.2 | 260035 |   | Hülzensatz ATE       |
|   | 2.5 TDI          | 85  |  | 06.94 | 12.97              | 11.8171-0008.1 | 990049 |   | Führungsbolzen ATE   |
|   |                  |     |  | 06.94 | 12.97              | 11.8116-0143.1 | 390513 | 2 | Haltefeder ATE       |
|   | 2.5 TDI          | 103 |  | 10.94 | 12.97              | 11.3571-8507.2 | 220127 |   | D=57, - Halter ATE   |
|   | 2.6              |     |  | 06.94 | 12.97              | 11.3571-8508.2 | 220128 |   | D=57, - Halter ATE   |
|   | 2.8              | 128 |  | 06.94 | 12.97              | 24.3571-8507.5 | 240555 |   | D=57, - Halter ATE   |
|   | 2.8              | 142 |  | 10.95 | 12.97              | 24.3571-8508.5 | 240556 |   | D=57, - Halter ATE   |
|   |                  |     |  |       |                    | 11.8170-0306.1 | 260102 | 2 | Halter ATE           |
|   |                  |     |  |       |                    | 11.0441-5704.2 | 250034 |   | Dichtungssatz ATE    |
|   |                  |     |  |       |                    | 11.0101-5409.2 | 260035 |   | Hülzensatz ATE       |
|   |                  |     |  |       |                    | 11.8171-0008.1 | 990049 |   | Führungsbolzen ATE   |
|   |                  |     |  |       |                    | 11.8116-0143.1 | 390513 | 2 | Haltefeder ATE       |
|   | 1.8 quattro      |     |  | 10.95 | 12.97              | 11.3571-8506.2 | 220126 |   | D=57, - Halter ATE   |
|   | 2.0 quattro      |     |  | 06.94 | 12.97              | 24.3571-8505.5 | 240489 |   | D=57, - Halter ATE   |
|   | 2.3 quattro      |     |  | 08.94 | 12.95              | 24.3571-8506.5 | 240490 |   | D=57, - Halter ATE   |
|   |                  |     |  |       |                    | 11.0441-5704.2 | 250034 |   | Dichtungssatz ATE    |
|   |                  |     |  |       |                    | 11.0101-5409.2 | 260035 |   | Hülzensatz ATE       |
|   |                  |     |  |       |                    | 11.8171-0008.1 | 990049 |   | Führungsbolzen ATE   |
|   |                  |     |  |       |                    | 11.8116-0143.1 | 390513 | 2 | Haltefeder ATE       |
|   | 2.5 TDI quattro  |     |  | 07.95 | 12.97              | 11.3571-8507.2 | 220127 |   | D=57, - Halter ATE   |
|   | 2.6 quattro      |     |  | 06.94 | 12.97              | 11.3571-8508.2 | 220128 |   | D=57, - Halter ATE   |
|   | 2.8 quattro      |     |  | 06.94 | 12.97              | 24.3571-8507.5 | 240555 |   | D=57, - Halter ATE   |
|   |                  |     |  |       |                    | 24.3571-8508.5 | 240556 |   | D=57, - Halter ATE   |
|   |                  |     |  |       |                    | 11.8170-0306.1 | 260102 | 2 | Halter ATE           |
|   |                  |     |  |       |                    | 11.0441-5704.2 | 250034 |   | Dichtungssatz ATE    |
|   |                  |     |  |       |                    | 11.0101-5409.2 | 260035 |   | Hülzensatz ATE       |
|   |                  |     |  |       |                    | 11.8171-0008.1 | 990049 |   | Führungsbolzen ATE   |
|   |                  |     |  |       |                    | 11.8116-0143.1 | 390513 | 2 | Haltefeder ATE       |
|   | 1.8              |     |  | 10.95 | 12.97              | 83.7813-0270.3 | 330797 | 2 | L=270                |
|   | 1.8 quattro      |     |  | 10.95 | 12.97              |                |        |   |                      |
|   | 1.9 TDI          |     |  | 06.94 | 12.97              |                |        |   |                      |
|   | 2.0              |     |  | 06.94 | 12.97              |                |        |   |                      |
|   | 2.0 16V          |     |  | 06.94 | 12.97              |                |        |   |                      |
|   | 2.0 quattro      |     |  | 06.94 | 12.97              |                |        |   |                      |
|   | 2.3              |     |  | 06.94 | 12.95              |                |        |   |                      |

|     |   |  |  |    |   |  |  |  |   |                   |     |
|--|---|--|--|--|--|--|--|--|---|-------------------|-----|
| <b>AUDI A6 / A6 Avant (4A/C4) (94-97)</b>  |   |  |  |  |  |  |  |  |   |                   |     |
|    | 2.3 quattro<br>2.5 TDI<br>2.5 TDI quattro<br>2.6<br>2.6 quattro<br>2.8<br>2.8<br>2.8 quattro<br>S6 2.2<br>S6 4.2<br>S6 4.2 plus   |  |  | 08.94<br>06.94<br>07.95<br>06.94<br>06.94<br>06.94<br>10.95<br>06.94<br>06.94<br>09.94<br>06.96  | 12.95<br>12.97<br>12.97<br>12.97<br>12.97<br>12.97<br>12.97<br>12.97<br>12.97<br>12.97<br>12.97  | 83.7813-0270.3   | 330797   | 2  | L=270   |                   |     |
|    | 1.8<br>1.9 TDI<br>2.0<br>2.0 16V<br>2.3<br>2.5 TDI<br>2.6<br>2.8<br>2.8   |  |  | 10.95<br>06.94<br>06.94<br>06.94<br>06.94<br>06.94<br>06.94<br>06.94<br>10.95  | 12.97<br>12.97<br>12.97<br>12.97<br>12.95<br>12.97<br>12.97<br>12.97<br>12.97  | 24.3384-1709.5<br>24.3384-1710.5   | 240257<br>240258   | <input type="checkbox"/><br><input type="checkbox"/>                               | D=38, - Halter<br>D=38, - Halter  | LUC<br>LUC        |     |
|  | 1.8 quattro<br>2.0 quattro<br>2.3 quattro<br>2.5 TDI quattro<br>2.6 quattro<br>2.8 quattro<br>S6 2.2<br>S6 4.2  |  |  | 10.95<br>06.94<br>08.94<br>07.95<br>06.94<br>06.94<br>06.94<br>09.94   | 12.97<br>12.97<br>12.95<br>12.97<br>12.97<br>12.97<br>12.97<br>12.97   | 24.3384-1704.5<br>24.3384-1703.5   | 240056<br>240055   | <input type="checkbox"/><br><input type="checkbox"/>                               | D=38, - Halter<br>D=38, - Halter  | LUC<br>LUC        |     |
|  | S6 2.2<br>S6 4.2  | 169<br>213   |  | 06.94<br>09.94   | 12.97<br>12.97   | 24.3434-1702.5<br>24.3434-1701.5<br>11.0101-5403.2                                 | 240358<br>240357<br>260010   | <input type="checkbox"/><br><input type="checkbox"/>                               | D=43, - Halter<br>D=43, - Halter<br>Faltenbalgsatz  | LUC<br>LUC<br>LUC |     |
|    | 1.8<br>1.9 TDI<br>2.0<br>2.0 16V<br>2.3<br>2.5 TDI<br>2.6<br>2.8<br>2.8   |  |  | 10.95<br>06.94<br>06.94<br>06.94<br>06.94<br>06.94<br>06.94<br>06.94<br>10.95  | 12.97<br>12.97<br>12.97<br>12.97<br>12.95<br>12.97<br>12.97<br>12.97<br>12.97  | 83.7824-0180.3<br>83.6104-0180.3   | 330812<br>330510   | 2<br>2   | am Bremssattel <sup>1)</sup>  | L=180<br>L=180    |     |
|  | 1.8 quattro<br>2.0 quattro<br>2.3 quattro<br>2.5 TDI quattro<br>2.6 quattro<br>2.8 quattro<br>S6 2.2<br>S6 4.2<br>S6 4.2 plus   |  |  | 10.95<br>06.94<br>08.94<br>07.95<br>06.94<br>06.94<br>06.94<br>09.94<br>06.96  | 12.97<br>12.97<br>12.95<br>12.97<br>12.97<br>12.97<br>12.97<br>12.97<br>12.97  | 83.6134-0205.3   | 330380   | 2  |   | L=205             |     |
|  | 1.8<br>1.9 TDI<br>2.0<br>2.0 16V<br>2.3<br>2.5 TDI<br>2.6<br>2.8<br>2.8   |  |  | 10.95<br>06.94<br>06.94<br>06.94<br>06.94<br>06.94<br>06.94<br>06.94<br>10.95  | 12.97<br>12.97<br>12.97<br>12.97<br>12.95<br>12.97<br>12.97<br>12.97<br>12.97  | 24.3727-0154.2   | 580154   | 2  |   | L=1491            |     |
|  | 1.8<br>1.9 TDI<br>2.0<br>2.0 16V<br>2.3<br>2.5 TDI<br>2.6<br>2.8<br>2.8   |  |  | 10.95<br>06.94<br>06.94<br>06.94<br>06.94<br>06.94<br>06.94<br>06.94<br>10.95  | 12.97<br>12.97<br>12.97<br>12.97<br>12.95<br>12.97<br>12.97<br>12.97<br>12.97  | 03.6585-0108.3   | 320115   |  | - Niveauregulierung <sup>2)</sup><br>- Niveauregulierung <sup>2)</sup><br>- Niveauregulierung <sup>2)</sup><br>- Niveauregulierung <sup>2)</sup><br>- Niveauregulierung <sup>2)</sup><br>- Niveauregulierung <sup>2)</sup><br>- Niveauregulierung <sup>2)</sup><br>- Niveauregulierung <sup>2)</sup><br>- Niveauregulierung <sup>2)</sup> | BRL 8/5 (4)       | ATE |
|  | 1.8<br>1.8 quattro<br>1.9 TDI<br>2.0<br>2.0 16V<br>2.0 quattro<br>2.3<br>2.3 quattro<br>2.5 TDI<br>2.5 TDI<br>2.5 TDI<br>2.5 TDI quattro<br>2.6<br>2.6 quattro<br>2.8<br>2.8<br>2.8 quattro<br>S6 2.2 |  |  | 10.95<br>10.95<br>06.94<br>06.94<br>06.94<br>06.94<br>06.94<br>08.94<br>06.94<br>06.94<br>10.94<br>07.95<br>06.94<br>06.94<br>06.94<br>06.94<br>10.95<br>06.94 | 12.97<br>12.97<br>12.97<br>12.97<br>12.97<br>12.97<br>12.95<br>12.95<br>12.97<br>12.97<br>12.97<br>12.97<br>12.97<br>12.97<br>12.97<br>12.97<br>12.97<br>12.97 | 24.2419-1731.3   | 030121   |  |   | Gz 19,05          |     |
|  | 1.8<br>1.8 quattro<br>1.9 TDI   |  |  | 10.95<br>10.95<br>06.94  | 12.97<br>12.97<br>12.97  | 03.2419-9610.3   | 030029   |  |   | Gz 19,05          |     |

<sup>1)</sup> on the brake caliper / sulla pinza freno / sur l'étrier de frein / a la pinza de freno

<sup>2)</sup> - suspension level control / - correttore assetto / - correcteur d'assiette / - regulación altura suspensión

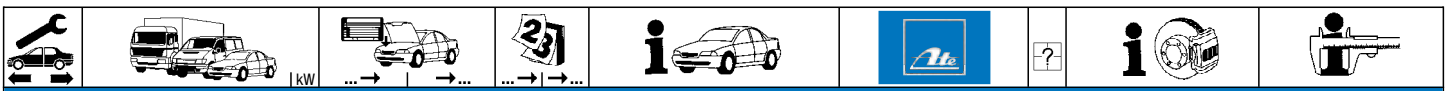

**AUDI A6 / A6 Avant (4A/C4) (94-97)**

|  |                 |     |  |       |       |                |        |  |          |
|--|-----------------|-----|--|-------|-------|----------------|--------|--|----------|
|  | 2.0             |     |  | 06.94 | 12.97 | 03.2419-9610.3 | 030029 |  | Gz 19,05 |
|  | 2.0 16V         |     |  | 06.94 | 12.97 |                |        |  |          |
|  | 2.0 quattro     |     |  | 06.94 | 12.97 |                |        |  |          |
|  | 2.3             |     |  | 06.94 | 12.95 |                |        |  |          |
|  | 2.3 quattro     |     |  | 08.94 | 12.95 |                |        |  |          |
|  | 2.5 TDI         |     |  | 06.94 | 12.97 |                |        |  |          |
|  | 2.5 TDI         | 85  |  | 06.94 | 12.97 |                |        |  |          |
|  | 2.5 TDI         | 103 |  | 10.94 | 12.97 |                |        |  |          |
|  | 2.5 TDI quattro |     |  | 07.95 | 12.97 |                |        |  |          |
|  | 2.6             |     |  | 06.94 | 12.97 |                |        |  |          |
|  | 2.6 quattro     |     |  | 06.94 | 12.97 |                |        |  |          |
|  | 2.8             | 128 |  | 06.94 | 12.97 |                |        |  |          |
|  | 2.8             | 142 |  | 10.95 | 12.97 |                |        |  |          |
|  | 2.8 quattro     |     |  | 06.94 | 12.97 |                |        |  |          |
|  | S6 2.2          | 169 |  | 06.94 | 12.97 |                |        |  |          |
|  | 1.8             |     |  | 10.95 | 12.97 | 03.2522-4300.3 | 040085 |  | Nz 22,20 |
|  | 1.8 quattro     |     |  | 10.95 | 12.97 |                |        |  |          |
|  | 1.9 TDI         |     |  | 06.94 | 12.97 |                |        |  |          |
|  | 2.0             |     |  | 06.94 | 12.97 |                |        |  |          |
|  | 2.0 16V         |     |  | 06.94 | 12.97 |                |        |  |          |
|  | 2.0 quattro     |     |  | 06.94 | 12.97 |                |        |  |          |
|  | 2.3             |     |  | 06.94 | 12.95 |                |        |  |          |
|  | 2.3 quattro     |     |  | 08.94 | 12.95 |                |        |  |          |
|  | 2.5 TDI         |     |  | 06.94 | 12.97 |                |        |  |          |
|  | 2.5 TDI quattro |     |  | 07.95 | 12.97 |                |        |  |          |
|  | 2.6             |     |  | 06.94 | 12.97 |                |        |  |          |
|  | 2.6 quattro     |     |  | 06.94 | 12.97 |                |        |  |          |
|  | 2.8             | 128 |  | 06.94 | 12.97 |                |        |  |          |
|  | 2.8             | 142 |  | 10.95 | 12.97 |                |        |  |          |
|  | 2.8 quattro     |     |  | 06.94 | 12.97 |                |        |  |          |
|  | S6 2.2          | 169 |  | 06.94 | 12.97 |                |        |  |          |
|  | S6 4.2          | 213 |  | 09.94 | 12.97 |                |        |  |          |
|  | S6 4.2 plus     | 235 |  | 06.96 | 12.97 |                |        |  |          |

**AUDI A6 / A6 Avant (4B/C5) (97-05)**

























|  |                 |     |              |       |             |                |        |  |             |     |
|--|-----------------|-----|--------------|-------|-------------|----------------|--------|--|-------------|-----|
|  | 1.8             |     | 4B-2-130 001 |       | 01.05       | 03.7858-4502.4 | 300202 |  | 9/8" Tandem | ATE |
|  | 1.8 T           | 110 | 4B-2-130 001 |       | 01.05       |                |        |  |             |     |
|  | 1.8 T           | 132 | 4B-2-130 001 |       | 01.05       |                |        |  |             |     |
|  | 1.8 T quattro   |     | 4B-2-130 001 |       | 01.05       |                |        |  |             |     |
|  | 1.9 TDI         |     | 4B-2-130 001 |       | 01.05       |                |        |  |             |     |
|  | 2.0             |     | 4B-2-130 001 |       | 01.05       |                |        |  |             |     |
|  | 2.4             | 100 | 4B-2-130 001 |       | 01.05       |                |        |  |             |     |
|  | 2.4             | 115 | 4B-2-130 001 |       | 01.05       |                |        |  |             |     |
|  | 2.4             | 121 | 4B-2-130 001 |       | 01.05       |                |        |  |             |     |
|  | 2.4 quattro     |     | 4B-2-130 001 |       | 01.05       |                |        |  |             |     |
|  | 2.5 TDI         | 110 | 4B-2-130 001 |       | 01.05       |                |        |  |             |     |
|  | 2.5 TDI         | 120 | 4B-2-130 001 |       | 01.05       |                |        |  |             |     |
|  | 2.5 TDI         | 132 | 4B-2-130 001 |       | 01.05       |                |        |  |             |     |
|  | 2.5 TDI quattro |     | 4B-2-130 001 |       | 01.05       |                |        |  |             |     |
|  | 2.7 T           |     | 4B-2-130 001 |       | 01.05       |                |        |  |             |     |
|  | 2.7 T quattro   |     | 4B-2-130 001 |       | 01.05       |                |        |  |             |     |
|  | 2.8             |     | 4B-2-130 001 |       | 01.05       |                |        |  |             |     |
|  | 2.8 quattro     |     | 4B-2-130 001 |       | 01.05       |                |        |  |             |     |
|  | 3.0             |     | 4B-2-130 001 |       | 01.05       |                |        |  |             |     |
|  | 3.0 quattro     |     | 4B-2-130 001 |       | 01.05       |                |        |  |             |     |
|  | 4.2 quattro     |     | 4B-2-130 001 |       | 01.05       |                |        |  |             |     |
|  | S6 4.2          |     | 4B-2-130 001 |       | 01.05       |                |        |  |             |     |
|  | 1.8             |     | 4B-X-130000  | 04.97 | + EDS       | 24.2123-1717.3 | 010521 |  | Thz 23,81   |     |
|  | 1.8 T           | 110 | 4B-X-130000  | 04.97 | + EDS       |                |        |  |             |     |
|  | 1.8 T           | 132 | 4B-X-130000  | 12.97 | + EDS       |                |        |  |             |     |
|  | 1.8 T quattro   |     | 4B-X-130000  | 04.97 | + EDS       |                |        |  |             |     |
|  | 1.9 TDI         |     | 4B-X-130000  | 04.97 | + EDS       |                |        |  |             |     |
|  | 2.4             | 100 | 4B-X-130000  | 07.98 | + EDS       |                |        |  |             |     |
|  | 2.4             | 115 | 4B-X-130000  | 04.97 | + EDS       |                |        |  |             |     |
|  | 2.4             | 121 | 4B-X-130000  | 04.97 | + EDS       |                |        |  |             |     |
|  | 2.4 quattro     |     | 4B-X-130000  | 04.97 | + EDS       |                |        |  |             |     |
|  | 2.5 TDI         | 110 | 4B-X-130000  | 04.97 | + EDS       |                |        |  |             |     |
|  | 2.5 TDI quattro |     | 4B-X-130000  | 07.97 | + EDS       |                |        |  |             |     |
|  | 2.7 T quattro   |     | 4B-X-130000  | 10.97 | + EDS       |                |        |  |             |     |
|  | 2.8             |     | 4B-X-130000  | 04.97 | + EDS       |                |        |  |             |     |
|  | 2.8 quattro     |     | 4B-X-130000  | 04.97 | + EDS       |                |        |  |             |     |
|  | 1.8             |     | 4B-X-130001  |       | 05.01 + EDS | 24.2125-1712.3 | 010622 |  | Thz 25,40   |     |
|  | 1.8 T           | 110 | 4B-X-130001  |       | 05.01 + EDS |                |        |  |             |     |
|  | 1.8 T           | 132 | 4B-X-130001  |       | 05.01 + EDS |                |        |  |             |     |
|  | 1.8 T quattro   |     | 4B-X-130001  |       | 05.01 + EDS |                |        |  |             |     |
|  | 1.9 TDI         |     | 4B-X-130001  |       | 05.01 + EDS |                |        |  |             |     |
|  | 2.4             | 100 | 4B-X-130001  |       | 05.01 + EDS |                |        |  |             |     |
|  | 2.4             | 115 | 4B-X-130001  |       | 05.01 + EDS |                |        |  |             |     |
|  | 2.4             | 121 | 4B-X-130001  |       | 05.01 + EDS |                |        |  |             |     |
|  | 2.4 quattro     |     | 4B-X-130001  |       | 05.01 + EDS |                |        |  |             |     |
|  | 2.5 TDI         | 110 | 4B-X-130001  |       | 05.01 + EDS |                |        |  |             |     |
|  | 2.5 TDI         | 132 | 4B-X-130001  |       | 05.01 + EDS |                |        |  |             |     |
|  | 2.5 TDI quattro |     | 4B-X-130001  | 02.00 | 05.01 + EDS |                |        |  |             |     |
|  | 2.7 T           |     | 4B-X-130001  | 03.98 | 05.01 + EDS |                |        |  |             |     |
|  | 2.7 T quattro   |     | 4B-X-130001  | 10.97 | 05.01 + EDS |                |        |  |             |     |
|  | 2.8             |     | 4B-X-130001  |       | 05.01 + EDS |                |        |  |             |     |
|  | 2.8 quattro     |     | 4B-X-130001  |       | 05.01 + EDS |                |        |  |             |     |









|     |   |  |  |    |  |                |                            |  |  |                          |
|--|---|--|--|--|---|--|--|--|--|--------------------------|
| <b>AUDI A6 / A6 Avant (4B/C5) (97-05)</b>  |   |  |  |  |   |  |  |  |  |                          |
|    | 2.5 TDI 120<br>2.5 TDI 132<br>2.5 TDI quattro<br>2.7 T<br>2.7 T quattro<br>2.8<br>2.8 quattro<br>3.0<br>3.0 quattro<br>4.2 quattro<br>RS6 4.2<br>S6 4.2   |  |  | 07.02 01.05<br>02.00 01.05<br>07.97 01.05<br>03.98 01.05<br>10.97 01.05<br>04.97 01.05<br>04.97 01.05<br>06.01 01.05<br>06.01 01.05<br>11.98 01.05<br>07.02 01.05<br>09.99 01.05                               |   | 83.7813-0295.3 330799  | 2  |  | L=295  |                          |
|    | 1.8<br>1.8 T 110<br>1.8 T 132<br>1.9 TDI<br>2.0<br>2.4 100<br>2.4 115<br>2.4 121<br>2.5 TDI 110<br>2.5 TDI 120<br>2.5 TDI 132<br>2.7 T<br>2.8<br>3.0  |  |  | 04.97 01.05<br>04.97 01.05<br>12.97 01.05<br>04.97 01.05<br>08.01 01.05<br>07.98 01.05<br>04.97 01.05<br>04.97 01.05<br>04.97 01.05<br>07.02 01.05<br>02.00 01.05<br>03.98 01.05<br>04.97 01.05<br>06.01 01.05 |   | 24.3384-1731.7 220543<br>24.3384-1732.7 220544   | <input type="checkbox"/><br><input type="checkbox"/>   |  | D=38, - Halter<br>D=38, - Halter                                     | LUC<br>LUC               |
|  | 1.8 T quattro<br>2.4 quattro<br>2.5 TDI quattro<br>2.7 T quattro<br>2.8 quattro<br>3.0 quattro<br>4.2 quattro<br>S6 4.2   |  |  | 04.97 01.05<br>04.97 01.05<br>07.97 01.05<br>10.97 01.05<br>04.97 01.05<br>06.01 01.05<br>11.98 01.05<br>09.99 01.05   |   | 24.3384-1733.7 220545<br>24.3384-1734.7 220546<br>24.3437-1701.7 220761<br>24.3437-1702.7 220762 | <input type="checkbox"/><br><input type="checkbox"/><br><input type="checkbox"/><br><input type="checkbox"/> |  | D=38, - Halter<br>D=38, - Halter<br>D=43, - Halter<br>D=43, - Halter | LUC<br>LUC<br>LUC<br>LUC |
|    | 1.8<br>1.8 T 110<br>1.8 T 132<br>1.9 TDI<br>2.0<br>2.4 100<br>2.4 115<br>2.4 121<br>2.5 TDI 110<br>2.5 TDI 120<br>2.5 TDI 132<br>2.7 T<br>2.8<br>3.0  |  |  | 04.97 01.05<br>04.97 01.05<br>12.97 01.05<br>04.97 01.05<br>08.01 01.05<br>07.98 01.05<br>04.97 01.05<br>04.97 01.05<br>04.97 01.05<br>07.02 01.05<br>02.00 01.05<br>03.98 01.05<br>04.97 01.05<br>06.01 01.05 |   | 83.6212-0170.3 330625  | 2  |  | L=170  |                          |
|  | 1.8 T quattro<br>2.4 quattro<br>2.5 TDI quattro<br>2.7 T quattro<br>2.8 quattro<br>3.0 quattro<br>4.2 quattro<br>S6 4.2   |  |  | 04.97 01.05<br>04.97 01.05<br>07.97 01.05<br>10.97 01.05<br>04.97 01.05<br>06.01 01.05<br>11.98 01.05<br>09.99 01.05   |   | 24.5243-0310.3 330755  | 2  |  | L=310  |                          |
|  | 1.8<br>1.8 T 110<br>1.8 T 132<br>1.9 TDI<br>2.0<br>2.4 100<br>2.4 115<br>2.4 121<br>2.5 TDI 110<br>2.5 TDI 120<br>2.5 TDI 132<br>2.7 T<br>2.8<br>3.0  |  |  | 04.97 01.05<br>04.97 01.05<br>12.97 01.05<br>04.97 01.05<br>08.01 01.05<br>07.98 01.05<br>04.97 01.05<br>04.97 01.05<br>04.97 01.05<br>07.02 01.05<br>02.00 01.05<br>03.98 01.05<br>04.97 01.05<br>06.01 01.05 |   | 24.3727-0171.2 580171<br>24.3727-0172.2 580172   | <input type="checkbox"/><br><input type="checkbox"/>   |  | L=1958<br>L=1958   |                          |
|  | 1.8 T quattro<br>2.4 quattro<br>2.5 TDI quattro<br>2.7 T quattro<br>2.8 quattro<br>3.0 quattro<br>4.2 quattro<br>S6 4.2   |  |  | 04.97 01.05<br>04.97 01.05<br>07.97 01.05<br>10.97 01.05<br>04.97 01.05<br>06.01 01.05<br>11.98 01.05<br>09.99 01.05   |   | 24.3727-0178.2 580178  | 2                       |  | L=1925   |                          |
|  | 1.9 TDI    |  | 4B-W-019484 04.97  |  |   | 24.2419-1706.3 030091  |  |  | Gz 19,05   |                          |
|  | 1.8 <br>1.8 T <br>1.8 T <br>1.8 T quattro <br>1.9 TDI <br>2.0 <br>2.4  |  |  | 04.97 01.05<br>04.97 01.05<br>12.97 01.05<br>04.97 01.05<br>08.01 01.05<br>07.98 01.05   |   | 24.2419-1707.3 030092  |  |  | Gz 19,05   |                          |
|  |    |  | 4B-W-019485  |  |   |  |  |  |  |                          |

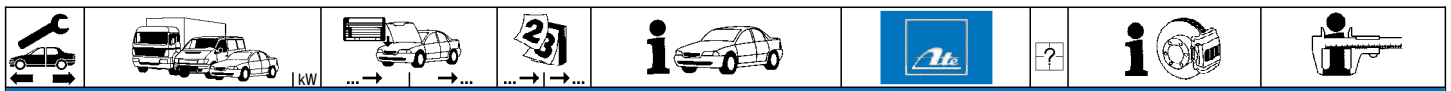

**AUDI A6 / A6 Avant (4B/C5) (97-05)**

|  |   |                                 |   |   |   |                |        |  |          |
|--|---|---------------------------------|---|---|---|----------------|--------|--|----------|
|  | 2.4<br>2.4<br>2.4 quattro<br>2.5 TDI<br>2.5 TDI<br>2.5 TDI<br>2.5 TDI quattro<br>2.7 T<br>2.7 T quattro<br>2.8<br>2.8 quattro<br>3.0<br>3.0 quattro<br>4.2 quattro<br>S6 4.2  | 115<br>121<br>110<br>120<br>132 |   | 04.97<br>04.97<br>04.97<br>04.97<br>07.02<br>02.00<br>07.97<br>03.98<br>10.97<br>04.97<br>06.01<br>06.01<br>11.98<br>09.99  | 01.05<br>01.05<br>01.05<br>01.05<br>01.05<br>01.05<br>01.05<br>01.05<br>01.05<br>01.05<br>01.05<br>01.05<br>01.05   | 24.2419-1707.3 | 030092 |  | Gz 19,05 |
|  | 1.8<br>1.8 T<br>1.8 T<br>1.8 T quattro<br>1.9 TDI<br>2.4<br>2.4<br>2.4<br>2.4 quattro<br>2.5 TDI<br>2.5 TDI quattro<br>2.7 T<br>2.7 T quattro<br>2.8<br>2.8 quattro<br>3.0 quattro<br>4.2 quattro<br>S6 4.2                                     | 110<br>132                      | 4B-X-200000<br>4B-X-200000<br>4B-X-200000<br>4B-W-019485<br>4B-X-200000<br>4B-X-200000<br>4B-X-200000<br>4B-X-200000<br>4B-X-200000<br>4B-X-200000<br>4B-X-200000<br>4B-X-200000<br>4B-X-200000<br>4B-X-200000<br>4B-X-200000 | 04.97<br>04.97<br>12.97<br>04.97<br>04.97<br>07.98<br>04.97<br>04.97<br>04.97<br>04.97<br>07.97<br>03.98<br>10.97<br>04.97<br>04.97<br>06.01<br>11.98<br>09.99                            | 01.05<br>01.05<br>01.05<br>10.04<br>01.05<br>07.98<br>04.97<br>04.97<br>10.04<br>10.04<br>10.04<br>03.98<br>10.04<br>10.04<br>10.04<br>10.04<br>10.04<br>10.04                            | 24.2419-1705.3 | 030090 |  | Gz 19,05 |
|  | 1.9 TDI   |                                 | 4B-W-019484   | 04.97   | 01.05   | 24.2519-1702.3 | 040074 |  | Nz 19,05 |
|  | 1.8<br>1.8 T<br>1.8 T<br>1.8 T quattro<br>1.9 TDI<br>2.0<br>2.4<br>2.4<br>2.4<br>2.4 quattro<br>2.5 TDI<br>2.5 TDI<br>2.5 TDI<br>2.5 TDI quattro<br>2.7 T<br>2.7 T quattro<br>2.8<br>2.8 quattro<br>3.0<br>3.0 quattro<br>4.2 quattro<br>S6 4.2 | 110<br>132                      | 4B-W-019485   | 04.97<br>04.97<br>12.97<br>04.97<br>01.05<br>08.01<br>07.98<br>04.97<br>04.97<br>04.97<br>04.97<br>07.02<br>02.00<br>07.97<br>03.98<br>10.97<br>04.97<br>04.97<br>06.01<br>11.98<br>09.99 | 01.05<br>01.05<br>01.05<br>01.05<br>01.05<br>01.05<br>01.05<br>01.05<br>01.05<br>01.05<br>01.05<br>01.05<br>01.05<br>01.05<br>01.05<br>01.05<br>01.05<br>01.05<br>01.05<br>01.05<br>01.05 | 24.2522-1706.3 | 040090 |  | Nz 22,20 |

**AUDI A6 Allroad (00-05)**

|  |                         |  |   |                         |                         |  |  |                               |   |  |
|--|-------------------------|--|---|-------------------------|-------------------------|--|--|-------------------------------|---|--|
|  | 2.5 TDI<br>2.7 T<br>4.2 |  |   | 05.00<br>05.00<br>07.02 | 07.05<br>07.05<br>07.05 | 24.2125-1713.3   | 010623   |                               | Thz 25,40   |  |
|  | 2.5 TDI<br>2.7 T<br>4.2 |  |   | 05.00<br>05.00<br>07.02 | 07.05<br>07.05<br>07.05 | 11.9606-9965.2<br>11.9606-9966.2<br>11.0441-6008.2<br>11.0101-5409.2<br>11.8171-0008.1<br>11.8116-0299.1 | 220817<br>220818<br>250038<br>260035<br>990049<br>390446 | PR: 1LA<br>PR: 1LA<br>PR: 1LA | D=60, - Halter<br>D=60, - Halter<br>Dichtungssatz<br>Hülzensatz<br>Führungsbolzen<br>Haltefeder | ATE<br>ATE<br>ATE<br>ATE<br>ATE<br>ATE |
|  | 2.5 TDI<br>2.7 T<br>4.2 |  |   | 05.00<br>05.00<br>07.02 | 07.05<br>07.05<br>07.05 | 83.6213-0335.3   | 330459   | 2                             | L=335   |  |
|  | 2.5 TDI<br>2.7 T<br>4.2 |  |   | 05.00<br>05.00<br>07.02 | 07.05<br>07.05<br>07.05 | 24.3384-1733.7<br>24.3384-1734.7<br>24.3437-1701.7<br>24.3437-1702.7                                     | 220545<br>220546<br>220761<br>220762                     |                               | D=38, - Halter<br>D=38, - Halter<br>D=43, - Halter<br>D=43, - Halter                            | LUC<br>LUC<br>LUC<br>LUC               |
|  | 2.5 TDI<br>2.7 T<br>4.2 |  |   | 05.00<br>05.00<br>07.02 | 07.05<br>07.05<br>07.05 | 24.3727-0178.2   | 580178   | 2                             | L=1925  |  |
|  | 2.5 TDI<br>2.7 T<br>4.2 |  | 4B-1-200000<br>4B-1-200000<br>4B-1-200000 | 05.00<br>05.00<br>07.02 |                         | 24.2419-1707.3   | 030092   |                               | Gz 19,05  |  |
|  | 2.5 TDI<br>2.7 T<br>4.2 |  |   | 05.00<br>05.00<br>07.02 | 07.05<br>07.05<br>07.05 | 24.2522-1706.3   | 040090   |                               | Nz 22,20  |  |



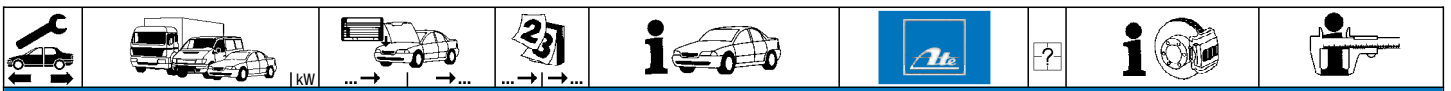













**AUDI A6 (4F2/C6) Limousine (04-11)**

|                  |                  |       |       |             |                |                |        |   |   |     |   |   |     |
|------------------|------------------|-------|-------|-------------|----------------|----------------|--------|---|---|-----|---|---|-----|
|                  | 2.0 TDI          | 100   | 06.05 | 03.11       | PR: 1LT        | 11.9571-9836.2 | 220428 | 2   | D=57, - Halter<br>ATE<br>D=57, - Halter<br>ATE<br>Dichtungssatz<br>ATE<br>Hülsensatz<br>ATE<br>Führungsbolzen<br>ATE<br>Haltefeder<br>ATE | ATE |   |   |     |
|                  | 2.0 TDI          | 103   | 07.04 | 03.11       | PR: 1LT        | 11.9571-9835.2 | 220427 |   |   |     |   |   |     |
|                  | 2.0 TDI          | 125   | 10.08 | 03.11       | PR: 1LT        | 11.0441-5704.2 | 250034 |   |   |     |   |   |     |
|                  | 2.0 TFSI         | 125   | 06.05 | 03.11       | PR: 1LT        | 11.0101-5409.2 | 260035 |   |   |     |   |   |     |
|                  | 2.4              | 130   | 04.04 | 03.11       | PR: 1LT        | 11.8171-0008.1 | 990049 |   |   |     |   |   |     |
|                  | 2.4 quattro      | 130   | 01.05 | 03.11       | PR: 1LT        | 11.8116-0347.2 | 390535 |   |   |     |   |   |     |
|                  | 2.7 TDI          | 120   | 11.04 | 03.11       | PR: 1LT        |                |        |   |   |     |   |   |     |
|                  | 2.7 TDI          | 132   | 11.04 | 03.11       | PR: 1LT        |                |        |   |   |     |   |   |     |
|                  | 2.7 TDI          | 140   | 10.08 | 03.11       | PR: 1LT        |                |        |   |   |     |   |   |     |
|                  | 2.7 TDI quattro  | 120   | 06.05 | 03.11       | PR: 1LT        |                |        |   |   |     |   |   |     |
|                  | 2.7 TDI quattro  | 132   | 11.04 | 03.11       | PR: 1LT        |                |        |   |   |     |   |   |     |
|                  | 2.7 TDI quattro  | 140   | 10.08 | 03.11       | PR: 1LT        |                |        |   |   |     |   |   |     |
|                  | 2.8 FSI          | 140   | 10.08 | 03.11       | PR: 1LT        |                |        |   |   |     |   |   |     |
|                  | 2.8 FSI          | 154   | 11.06 | 03.11       | PR: 1LT        |                |        |   |   |     |   |   |     |
|                  | 2.8 FSI          | 162   | 10.08 | 03.11       | PR: 1LT        |                |        |   |   |     |   |   |     |
|                  | 2.8 FSI quattro  | 140   | 10.08 | 03.11       | PR: 1LT        |                |        |   |   |     |   |   |     |
|                  | 2.8 FSI quattro  | 154   | 04.07 | 03.11       | PR: 1LT        |                |        |   |   |     |   |   |     |
|                  | 2.8 FSI quattro  | 162   | 10.08 | 03.11       | PR: 1LT        |                |        |   |   |     |   |   |     |
|                  | 3.0              | 160   | 04.04 | 03.11       | PR: 1LT        |                |        |   |   |     |   |   |     |
|                  | 3.0 quattro      | 160   | 04.04 | 03.11       | PR: 1LT        |                |        |   |   |     |   |   |     |
|                  | 3.0 TDI quattro  | 155   | 04.04 | 03.11       | PR: 1LT        |                |        |   |   |     |   |   |     |
|                  | 3.0 TDI quattro  | 165   | 04.04 | 03.11       | PR: 1LT        |                |        |   |   |     |   |   |     |
|                  | 3.0 TDI quattro  | 171   | 06.06 | 03.11       | PR: 1LT        |                |        |   |   |     |   |   |     |
|                  | 3.0 TDI quattro  | 176   | 10.08 | 03.11       | PR: 1LT        |                |        |   |   |     |   |   |     |
|                  | 3.0 TFSI quattro |       | 10.08 | 03.11       | PR: 1LT        |                |        |   |   |     |   |   |     |
|                  | 3.2 FSI          |       | 04.04 | 03.11       | PR: 1LT        |                |        |   |   |     |   |   |     |
|                  | 3.2 FSI quattro  | 188   | 04.04 | 03.11       | PR: 1LT        |                |        |   |   |     |   |   |     |
|                  | 4.2 FSI quattro  | 257   | 06.06 | 03.11       | PR: 1LT        |                |        |   |   |     |   |   |     |
|                  | 4.2 quattro      | 246   | 04.04 | 03.11       | PR: 1LT        |                |        |   |   |     |   |   |     |
|                  | 2.0 TDI          | 100   | 06.05 | 03.11       | PR: 1LG,1LD    | 11.9606-9953.2 | 220587 |   |   |     | 2 | D=60, - Halter<br>ATE<br>D=60, - Halter<br>ATE<br>Dichtungssatz<br>ATE<br>Hülsensatz<br>ATE<br>Führungsbolzen<br>ATE<br>Haltefeder<br>ATE | ATE |
|                  | 2.0 TDI          | 103   | 07.04 | 03.11       | PR: 1LG,1LD    | 11.9606-9954.2 | 220588 |   |   |     |   |   |     |
|                  | 2.0 TDI          | 125   | 10.08 | 03.11       | PR: 1LG        | 11.0441-6008.2 | 250038 |   |   |     |   |   |     |
|                  | 2.0 TFSI         | 125   | 06.05 | 03.11       | PR: 1LG,1LD    | 11.0101-5409.2 | 260035 |   |   |     |   |   |     |
|                  | 2.4              | 130   | 04.04 | 03.11       | PR: 1LG,1LD    | 11.8171-0008.1 | 990049 |   |   |     |   |   |     |
| 2.4 quattro      | 130              | 01.05 | 03.11 | PR: 1LG,1LD | 11.8116-0347.2 | 390535         |        |   |   |     |   |   |     |
| 2.7 TDI          | 120              | 11.04 | 03.11 | PR: 1LG,1LD |                |                |        |   |   |     |   |   |     |
| 2.7 TDI          | 132              | 11.04 | 03.11 | PR: 1LG,1LD |                |                |        |   |   |     |   |   |     |
| 2.7 TDI          | 140              | 10.08 | 03.11 | PR: 1LG     |                |                |        |   |   |     |   |   |     |
| 2.7 TDI quattro  | 120              | 06.05 | 03.11 | PR: 1LG,1LD |                |                |        |   |   |     |   |   |     |
| 2.7 TDI quattro  | 132              | 11.04 | 03.11 | PR: 1LG,1LD |                |                |        |   |   |     |   |   |     |
| 2.7 TDI quattro  | 140              | 10.08 | 03.11 | PR: 1LG     |                |                |        |   |   |     |   |   |     |
| 2.8 FSI          | 140              | 10.08 | 03.11 | PR: 1LG     |                |                |        |   |   |     |   |   |     |
| 2.8 FSI          | 154              | 11.06 | 03.11 | PR: 1LG,1LD |                |                |        |   |   |     |   |   |     |
| 2.8 FSI          | 162              | 10.08 | 03.11 | PR: 1LG     |                |                |        |   |   |     |   |   |     |
| 2.8 FSI quattro  | 140              | 10.08 | 03.11 | PR: 1LG     |                |                |        |   |   |     |   |   |     |
| 2.8 FSI quattro  | 154              | 04.07 | 03.11 | PR: 1LG,1LD |                |                |        |   |   |     |   |   |     |
| 2.8 FSI quattro  | 162              | 10.08 | 03.11 | PR: 1LG     |                |                |        |   |   |     |   |   |     |
| 3.0              | 160              | 04.04 | 03.11 | PR: 1LG,1LD |                |                |        |   |   |     |   |   |     |
| 3.0 quattro      | 160              | 04.04 | 03.11 | PR: 1LG,1LD |                |                |        |   |   |     |   |   |     |
| 3.0 TDI quattro  | 155              | 04.04 | 03.11 | PR: 1LG,1LD |                |                |        |   |   |     |   |   |     |
| 3.0 TDI quattro  | 165              | 04.04 | 03.11 | PR: 1LG,1LD |                |                |        |   |   |     |   |   |     |
| 3.0 TDI quattro  | 171              | 06.06 | 03.11 | PR: 1LG,1LD |                |                |        |   |   |     |   |   |     |
| 3.0 TDI quattro  | 176              | 10.08 | 03.11 | PR: 1LG     |                |                |        |   |   |     |   |   |     |
| 3.0 TFSI quattro |                  | 10.08 | 03.11 | PR: 1LG     |                |                |        |   |   |     |   |   |     |
| 3.2 FSI          |                  | 04.04 | 03.11 | PR: 1LG,1LD |                |                |        |   |   |     |   |   |     |
| 3.2 FSI quattro  | 188              | 04.04 | 03.11 | PR: 1LG,1LD |                |                |        |   |   |     |   |   |     |
| 4.2 FSI quattro  | 257              | 06.06 | 03.11 | PR: 1LG,1LD |                |                |        |   |   |     |   |   |     |
| 4.2 quattro      | 246              | 04.04 | 03.11 | PR: 1LG,1LD |                |                |        |   |   |     |   |   |     |
| 2.0 TDI          | 100              | 06.05 | 03.11 | PR: 1ZL,1LH | 11.9606-9961.2 | 220655         | 2      | D=60, - Halter<br>ATE<br>D=60, - Halter<br>ATE<br>Dichtungssatz<br>ATE<br>Hülsensatz<br>ATE<br>Führungsbolzen<br>ATE<br>Haltefeder<br>ATE | ATE   |     |   |   |     |
| 2.0 TDI          | 103              | 07.04 | 03.11 | PR: 1ZL,1LH | 11.9606-9962.2 | 220656         |        |   |   |     |   |   |     |
| 2.0 TDI          | 125              | 10.08 | 03.11 | PR: 1ZL     | 11.0441-6008.2 | 250038         |        |   |   |     |   |   |     |
| 2.0 TFSI         | 125              | 06.05 | 03.11 | PR: 1ZL,1LH | 11.0101-5409.2 | 260035         |        |   |   |     |   |   |     |
| 2.4              | 130              | 04.04 | 03.11 | PR: 1ZL,1LH | 11.8171-0008.1 | 990049         |        |   |   |     |   |   |     |
| 2.4 quattro      | 130              | 01.05 | 03.11 | PR: 1ZL,1LH | 11.8116-0410.2 | 390589         |        |   |   |     |   |   |     |
| 2.7 TDI          | 120              | 11.04 | 03.11 | PR: 1ZL,1LH |                |                |        |   |   |     |   |   |     |
| 2.7 TDI          | 132              | 11.04 | 03.11 | PR: 1ZL,1LH |                |                |        |   |   |     |   |   |     |
| 2.7 TDI          | 140              | 10.08 | 03.11 | PR: 1ZL     |                |                |        |   |   |     |   |   |     |
| 2.7 TDI quattro  | 120              | 06.05 | 03.11 | PR: 1ZL,1LH |                |                |        |   |   |     |   |   |     |
| 2.7 TDI quattro  | 132              | 11.04 | 03.11 | PR: 1ZL,1LH |                |                |        |   |   |     |   |   |     |
| 2.7 TDI quattro  | 140              | 10.08 | 03.11 | PR: 1ZL     |                |                |        |   |   |     |   |   |     |
| 2.8 FSI          | 140              | 10.08 | 03.11 | PR: 1ZL     |                |                |        |   |   |     |   |   |     |
| 2.8 FSI          | 154              | 11.06 | 03.11 | PR: 1ZL,1LH |                |                |        |   |   |     |   |   |     |
| 2.8 FSI          | 162              | 10.08 | 03.11 | PR: 1ZL     |                |                |        |   |   |     |   |   |     |
| 2.8 FSI quattro  | 140              | 10.08 | 03.11 | PR: 1ZL     |                |                |        |   |   |     |   |   |     |
| 2.8 FSI quattro  | 154              | 04.07 | 03.11 | PR: 1ZL,1LH |                |                |        |   |   |     |   |   |     |
| 2.8 FSI quattro  | 162              | 10.08 | 03.11 | PR: 1ZL     |                |                |        |   |   |     |   |   |     |
| 3.0              | 160              | 04.04 | 03.11 | PR: 1ZL,1LH |                |                |        |   |   |     |   |   |     |
| 3.0 quattro      | 160              | 04.04 | 03.11 | PR: 1ZL,1LH |                |                |        |   |   |     |   |   |     |
| 3.0 TDI quattro  | 155              | 04.04 | 03.11 | PR: 1ZL,1LH |                |                |        |   |   |     |   |   |     |
| 3.0 TDI quattro  | 165              | 04.04 | 03.11 | PR: 1ZL,1LH |                |                |        |   |   |     |   |   |     |
| 3.0 TDI quattro  | 171              | 06.06 | 03.11 | PR: 1ZL,1LH |                |                |        |   |   |     |   |   |     |
| 3.0 TDI quattro  | 176              | 10.08 | 03.11 | PR: 1ZL     |                |                |        |   |   |     |   |   |     |
| 3.0 TFSI quattro |                  | 10.08 | 03.11 | PR: 1ZL     |                |                |        |   |   |     |   |   |     |
| 3.2 FSI          |                  | 04.04 | 03.11 | PR: 1ZL,1LH |                |                |        |   |   |     |   |   |     |
| 3.2 FSI quattro  | 188              | 04.04 | 03.11 | PR: 1ZL,1LH |                |                |        |   |   |     |   |   |     |
| 4.2 FSI quattro  | 257              | 06.06 | 03.11 | PR: 1ZL,1LH |                |                |        |   |   |     |   |   |     |
| 4.2 quattro      | 246              | 04.04 | 03.11 | PR: 1ZL,1LH |                |                |        |   |   |     |   |   |     |



| AUDI A6 (4F2/C6) Limousine (04-11)   |  |  |  |  |   |  |  |  |  |                |       |
|--|--|--|--|--|---|--|--|--|--|----------------|-------|
|     |  |  |  |  |  |  |  |  |  |                |       |
|    | S6   | 320  |  | 03.06  | 03.11   |  |  |  | Hülsensatz<br>Führungsbolzen                                       | ATE<br>ATE     |       |
|    | 2.0 TDI  | 100  |  | 06.05  | 03.11   |  |  |  |  |                |       |
|  | 2.0 TDI  | 103  |  | 07.04  | 03.11   | 83.7813-0315.3   | 260099   | 2  |  | L=315          |       |
|  | 2.0 TDI  | 125  |  | 10.08  | 03.11   |  | 250153   |  |  |                |       |
|  | 2.0 TFSI   | 125  |  | 06.05  | 03.11   |  |  |  |  |                |       |
|  | 2.4  | 130  |  | 04.04  | 03.11   |  |  |  |  |                |       |
|  | 2.4 quattro  | 130  |  | 01.05  | 03.11   |  |  |  |  |                |       |
|  | 2.7 TDI  | 120  |  | 11.04  | 03.11   |  |  |  |  |                |       |
|  | 2.7 TDI  | 132  |  | 11.04  | 03.11   |  |  |  |  |                |       |
|  | 2.7 TDI  | 140  |  | 10.08  | 03.11   |  |  |  |  |                |       |
|  | 2.7 TDI quattro  | 120  |  | 06.05  | 03.11   |  |  |  |  |                |       |
|  | 2.7 TDI quattro  | 132  |  | 11.04  | 03.11   |  |  |  |  |                |       |
|  | 2.7 TDI quattro  | 140  |  | 10.08  | 03.11   |  |  |  |  |                |       |
|  | 2.8 FSI  | 140  |  | 10.08  | 03.11   |  |  |  |  |                |       |
|  | 2.8 FSI  | 154  |  | 11.06  | 03.11   |  |  |  |  |                |       |
|  | 2.8 FSI  | 162  |  | 10.08  | 03.11   |  |  |  |  |                |       |
|  | 2.8 FSI quattro  | 140  |  | 10.08  | 03.11   |  |  |  |  |                |       |
|  | 2.8 FSI quattro  | 154  |  | 04.07  | 03.11   |  |  |  |  |                |       |
|  | 2.8 FSI quattro  | 162  |  | 10.08  | 03.11   |  |  |  |  |                |       |
|  | 3.0  | 160  |  | 04.04  | 03.11   |  |  |  |  |                |       |
|  | 3.0 quattro  | 160  |  | 04.04  | 03.11   |  |  |  |  |                |       |
|  | 3.0 TDI quattro  | 155  |  | 04.04  | 03.11   |  |  |  |  |                |       |
|  | 3.0 TDI quattro  | 165  |  | 04.04  | 03.11   |  |  |  |  |                |       |
|  | 3.0 TDI quattro  | 171  |  | 06.06  | 03.11   |  |  |  |  |                |       |
|  | 3.0 TDI quattro  | 176  |  | 10.08  | 03.11   |  |  |  |  |                |       |
|  | 3.0 TFSI quattro   |  |  | 10.08  | 03.11   |  |  |  |  |                |       |
|  | 3.2 FSI  |  |  | 04.04  | 03.11   |  |  |  |  |                |       |
|  | 3.2 FSI quattro  | 188  |  | 04.04  | 03.11   |  |  |  |  |                |       |
|  | 4.2 FSI quattro  | 257  |  | 06.06  | 03.11   |  |  |  |  |                |       |
|  | 4.2 quattro  | 246  |  | 04.04  | 03.11   |  |  |  |  |                |       |
|  | S6   | 320  |  | 03.06  | 03.11   |  |  |  |  |                |       |
|    | 2.0 TDI  | 100  | 4F-7-016200  | 06.05  |   | PR: 1KD,2ED  | 24.6241-1701.7   | 220821   | <input type="checkbox"/> elektrische Feststellbremse <sup>1)</sup> | D=41, - Halter | LUC   |
|  | 2.0 TDI  | 103  | 4F-7-016200  | 07.04  |   | PR: 1KD,2ED  | 24.6241-1702.7   | 220822   | <input type="checkbox"/> elektrische Feststellbremse <sup>1)</sup> | D=41, - Halter | LUC   |
|  | 2.0 TFSI   | 125  | 4F-7-016200  | 06.05  |   | PR: 1KD,2ED  |  |  |  |                |       |
|  | 2.4  | 130  | 4F-7-016200  | 04.04  |   | PR: 1KD,2ED  |  |  |  |                |       |
|  | 2.4 quattro  | 130  | 4F-7-016200  | 01.05  |   | PR: 1KD,2ED  |  |  |  |                |       |
|  | 2.7 TDI  | 120  | 4F-7-016200  | 11.04  |   | PR: 1KD,2ED  |  |  |  |                |       |
|  | 2.7 TDI  | 132  | 4F-7-016200  | 11.04  |   | PR: 1KD,2ED  |  |  |  |                |       |
|  | 2.7 TDI quattro  | 120  | 4F-7-016200  | 06.05  |   | PR: 1KD,2ED  |  |  |  |                |       |
|  | 2.7 TDI quattro  | 132  | 4F-7-016200  | 11.04  |   | PR: 1KD,2ED  |  |  |  |                |       |
|  | 2.8 FSI  | 154  | 4F-7-016200  | 11.06  |   | PR: 1KD,2ED  |  |  |  |                |       |
|  | 2.8 FSI quattro  | 154  | 4F-7-016200  | 04.07  |   | PR: 1KD,2ED  |  |  |  |                |       |
|  | 3.0  | 160  | 4F-7-016200  | 04.04  |   | PR: 1KD,2ED  |  |  |  |                |       |
|  | 3.0 quattro  | 160  | 4F-7-016200  | 04.04  |   | PR: 1KD,2ED  |  |  |  |                |       |
|  | 3.0 TDI quattro  | 155  | 4F-7-016200  | 04.04  |   | PR: 1KD,2ED  |  |  |  |                |       |
|  | 3.0 TDI quattro  | 165  | 4F-7-016200  | 04.04  |   | PR: 1KD,2ED  |  |  |  |                |       |
|  | 3.0 TDI quattro  | 171  | 4F-7-016200  | 06.06  |   | PR: 1KD,2ED  |  |  |  |                |       |
|  | 3.2 FSI  |  | 4F-7-016200  | 04.04  |   | PR: 1KD,2ED  |  |  |  |                |       |
|  | 3.2 FSI quattro  | 188  | 4F-7-016200  | 04.04  |   | PR: 1KD,2ED  |  |  |  |                |       |
|  | 4.2 FSI quattro  | 257  | 4F-7-016200  | 06.06  |   | PR: 1KD,2ED  |  |  |  |                |       |
|  | 4.2 quattro  | 246  | 4F-7-016200  | 04.04  |   | PR: 1KD,2ED  |  |  |  |                |       |
|  | 2.0 TDI  | 100  | 4F-7-016201  | 06.05  |   | PR: 1KW,2EE  | 24.6243-1701.7   | 220823   | <input type="checkbox"/> elektrische Feststellbremse <sup>1)</sup> | D=43, - Halter | LUC   |
|  | 2.0 TDI  | 103  | 4F-7-016200  | 07.04  |   | PR: 1KW,2EE  | 24.6243-1702.7   | 220824   | <input type="checkbox"/> elektrische Feststellbremse <sup>1)</sup> | D=43, - Halter | LUC   |
|  | 2.0 TFSI   | 125  | 4F-7-016200  | 06.05  |   | PR: 1KW,2EE  |  |  |  |                |       |
|  | 2.4  | 130  | 4F-7-016200  | 04.04  |   | PR: 1KW,2EE  |  |  |  |                |       |
|  | 2.4 quattro  | 130  | 4F-7-016200  | 01.05  |   | PR: 1KW,2EE  |  |  |  |                |       |
|  | 2.7 TDI  | 120  | 4F-7-016200  | 11.04  |   | PR: 1KW,2EE  |  |  |  |                |       |
|  | 2.7 TDI  | 132  | 4F-7-016200  | 11.04  |   | PR: 1KW,2EE  |  |  |  |                |       |
|  | 2.7 TDI quattro  | 120  | 4F-7-016200  | 06.05  |   | PR: 1KW,2EE  |  |  |  |                |       |
|  | 2.7 TDI quattro  | 132  | 4F-7-016200  | 11.04  |   | PR: 1KW,2EE  |  |  |  |                |       |
|  | 2.8 FSI  | 154  | 4F-7-016200  | 11.06  |   | PR: 1KW,2EE  |  |  |  |                |       |
|  | 2.8 FSI quattro  | 154  | 4F-7-016201  | 04.07  |   | PR: 1KW,2EE  |  |  |  |                |       |
|  | 3.0  | 160  | 4F-7-016200  | 04.04  |   | PR: 1KW,2EE  |  |  |  |                |       |
|  | 3.0 quattro  | 160  | 4F-7-016200  | 04.04  |   | PR: 1KW,2EE  |  |  |  |                |       |
|  | 3.0 TDI quattro  | 155  | 4F-7-016200  | 04.04  |   | PR: 1KW,2EE  |  |  |  |                |       |
|  | 3.0 TDI quattro  | 165  | 4F-7-016200  | 04.04  |   | PR: 1KW,2EE  |  |  |  |                |       |
|  | 3.0 TDI quattro  | 171  | 4F-7-016200  | 06.06  |   | PR: 1KW,2EE  |  |  |  |                |       |
|  | 3.2 FSI  |  | 4F-7-016200  | 04.04  |   | PR: 1KW,2EE  |  |  |  |                |       |
|  | 3.2 FSI quattro  | 188  | 4F-7-016200  | 04.04  |   | PR: 1KW,2EE  |  |  |  |                |       |
|  | 4.2 FSI quattro  | 257  | 4F-7-016200  | 06.06  |   | PR: 1KW,2EE  |  |  |  |                |       |
|  | 4.2 quattro  | 246  | 4F-7-016200  | 04.04  |   | PR: 1KW,2EE  |  |  |  |                |       |
|  | 2.0 TDI  | 100  |  | 06.05  | 03.11   |  | 24.5125-0323.3   | 330911   |  |                | L=323 |
|  | 2.0 TDI  | 103  |  | 07.04  | 03.11   |  |  |  |  |                |       |
|  | 2.0 TDI  | 125  |  | 10.08  | 03.11   |  |  |  |  |                |       |
|  | 2.0 TFSI   | 125  |  | 06.05  | 03.11   |  |  |  |  |                |       |
|  | 2.4  | 130  |  | 04.04  | 03.11   |  |  |  |  |                |       |
|  | 2.4 quattro  | 130  |  | 01.05  | 03.11   |  |  |  |  |                |       |
|  | 2.7 TDI  | 120  |  | 11.04  | 03.11   |  |  |  |  |                |       |
|  | 2.7 TDI  | 132  |  | 11.04  | 03.11   |  |  |  |  |                |       |
|  | 2.7 TDI  | 140  |  | 10.08  | 03.11   |  |  |  |  |                |       |
|  | 2.7 TDI quattro  | 120  |  | 06.05  | 03.11   |  |  |  |  |                |       |
|  | 2.7 TDI quattro  | 132  |  | 11.04  | 03.11   |  |  |  |  |                |       |
|  | 2.7 TDI quattro  | 140  |  | 10.08  | 03.11   |  |  |  |  |                |       |
|  | 2.8 FSI  | 140  |  | 10.08  | 03.11   |  |  |  |  |                |       |
|  | 2.8 FSI  | 154  |  | 11.06  | 03.11   |  |  |  |  |                |       |

<sup>1)</sup> electric parking brake / fr.di stazionamento elettrico / frein à main électrique / freno de mano eléctrico

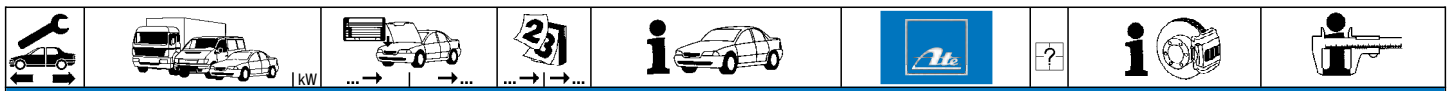

| AUDI A6 (4F2/C6) Limousine (04-11) |                  |     |  |       |       |  |                |        |   |       |
|------------------------------------|------------------|-----|--|-------|-------|--|----------------|--------|---|-------|
|                                    | 2.8 FSI          | 162 |  | 10.08 | 03.11 |  | 24.5125-0323.3 | 330911 | 2 | L=323 |
|                                    | 2.8 FSI quattro  | 140 |  | 10.08 | 03.11 |  |                |        |   |       |
|                                    | 2.8 FSI quattro  | 154 |  | 04.07 | 03.11 |  |                |        |   |       |
|                                    | 2.8 FSI quattro  | 162 |  | 10.08 | 03.11 |  |                |        |   |       |
|                                    | 3.0              | 160 |  | 04.04 | 03.11 |  |                |        |   |       |
|                                    | 3.0 quattro      | 160 |  | 04.04 | 03.11 |  |                |        |   |       |
|                                    | 3.0 TDI quattro  | 155 |  | 04.04 | 03.11 |  |                |        |   |       |
|                                    | 3.0 TDI quattro  | 165 |  | 04.04 | 03.11 |  |                |        |   |       |
|                                    | 3.0 TDI quattro  | 171 |  | 06.06 | 03.11 |  |                |        |   |       |
|                                    | 3.0 TDI quattro  | 176 |  | 10.08 | 03.11 |  |                |        |   |       |
|                                    | 3.0 TFSI quattro |     |  | 10.08 | 03.11 |  |                |        |   |       |
|                                    | 3.2 FSI          |     |  | 04.04 | 03.11 |  |                |        |   |       |
|                                    | 3.2 FSI quattro  | 188 |  | 04.04 | 03.11 |  |                |        |   |       |
|                                    | 4.2 FSI quattro  | 257 |  | 06.06 | 03.11 |  |                |        |   |       |
|                                    | 4.2 quattro      | 246 |  | 04.04 | 03.11 |  |                |        |   |       |
|                                    | S6               | 320 |  | 03.06 | 03.11 |  |                |        |   |       |

| AUDI A6 (4F5/C6) Avant (05-11) |                  |     |  |       |       |             |                |        |   |                |     |
|--------------------------------|------------------|-----|--|-------|-------|-------------|----------------|--------|---|----------------|-----|
|                                | 2.0 TDI          | 100 |  | 06.05 | 08.11 | PR: 1LT     | 11.9571-9836.2 | 220428 |   | D=57, - Halter | ATE |
|                                | 2.0 TDI          | 103 |  | 03.05 | 08.11 | PR: 1LT     | 11.9571-9835.2 | 220427 |   | D=57, - Halter | ATE |
|                                | 2.0 TDI          | 125 |  | 10.08 | 08.11 | PR: 1LT     | 11.0441-5704.2 | 250034 |   | Dichtungssatz  | ATE |
|                                | 2.0 TFSI         | 125 |  | 06.05 | 08.11 | PR: 1LT     | 11.0101-5409.2 | 260035 |   | Hülsensatz     | ATE |
|                                | 2.4              | 130 |  | 03.05 | 08.11 | PR: 1LT     | 11.8171-0008.1 | 990049 |   | Führungsbolzen | ATE |
|                                | 2.4 quattro      | 130 |  | 03.05 | 08.11 | PR: 1LT     | 11.8116-0347.2 | 390535 | 2 | Haltefeder     | ATE |
|                                | 2.7 TDI          | 120 |  | 03.05 | 08.11 | PR: 1LT     |                |        |   |                |     |
|                                | 2.7 TDI          | 132 |  | 03.05 | 08.11 | PR: 1LT     |                |        |   |                |     |
|                                | 2.7 TDI          | 140 |  | 10.08 | 08.11 | PR: 1LT     |                |        |   |                |     |
|                                | 2.7 TDI quattro  | 120 |  | 06.05 | 08.11 | PR: 1LT     |                |        |   |                |     |
|                                | 2.7 TDI quattro  | 132 |  | 03.05 | 08.11 | PR: 1LT     |                |        |   |                |     |
|                                | 2.7 TDI quattro  | 140 |  | 10.08 | 08.11 | PR: 1LT     |                |        |   |                |     |
|                                | 2.8 FSI          | 140 |  | 10.08 | 08.11 | PR: 1LT     |                |        |   |                |     |
|                                | 2.8 FSI          | 154 |  | 11.06 | 08.11 | PR: 1LT     |                |        |   |                |     |
|                                | 2.8 FSI          | 162 |  | 10.08 | 08.11 | PR: 1LT     |                |        |   |                |     |
|                                | 2.8 FSI quattro  | 140 |  | 10.08 | 08.11 | PR: 1LT     |                |        |   |                |     |
|                                | 2.8 FSI quattro  | 154 |  | 04.07 | 08.11 | PR: 1LT     |                |        |   |                |     |
|                                | 2.8 FSI quattro  | 162 |  | 10.08 | 08.11 | PR: 1LT     |                |        |   |                |     |
|                                | 3.0              | 160 |  | 03.05 | 08.11 | PR: 1LT     |                |        |   |                |     |
|                                | 3.0 quattro      | 160 |  | 03.05 | 08.11 | PR: 1LT     |                |        |   |                |     |
|                                | 3.0 TDI quattro  | 155 |  | 03.05 | 08.11 | PR: 1LT     |                |        |   |                |     |
|                                | 3.0 TDI quattro  | 165 |  | 03.05 | 08.11 | PR: 1LT     |                |        |   |                |     |
|                                | 3.0 TDI quattro  | 171 |  | 06.06 | 08.11 | PR: 1LT     |                |        |   |                |     |
|                                | 3.0 TDI quattro  | 176 |  | 10.08 | 08.11 | PR: 1LT     |                |        |   |                |     |
|                                | 3.0 TFSI quattro |     |  | 10.08 | 08.11 | PR: 1LT     |                |        |   |                |     |
|                                | 3.2 FSI          | 188 |  | 03.05 | 08.11 | PR: 1LT     |                |        |   |                |     |
|                                | 3.2 FSI quattro  | 188 |  | 03.05 | 08.11 | PR: 1LT     |                |        |   |                |     |
|                                | 4.2 FSI quattro  | 257 |  | 06.06 | 08.11 | PR: 1LT     |                |        |   |                |     |
|                                | 4.2 quattro      | 246 |  | 03.05 | 08.11 | PR: 1LT     |                |        |   |                |     |
|                                | 2.0 TDI          | 100 |  | 06.05 | 08.11 | PR: 1LG,1LD | 11.9606-9953.2 | 220587 |   | D=60, - Halter | ATE |
|                                | 2.0 TDI          | 103 |  | 03.05 | 08.11 | PR: 1LG,1LD | 11.9606-9954.2 | 220588 |   | D=60, - Halter | ATE |
|                                | 2.0 TDI          | 125 |  | 10.08 | 08.11 | PR: 1LG     | 11.0441-6008.2 | 250038 |   | Dichtungssatz  | ATE |
|                                | 2.0 TFSI         | 125 |  | 06.05 | 08.11 | PR: 1LG,1LD | 11.0101-5409.2 | 260035 |   | Hülsensatz     | ATE |
|                                | 2.4              | 130 |  | 03.05 | 08.11 | PR: 1LG,1LD | 11.8171-0008.1 | 990049 |   | Führungsbolzen | ATE |
|                                | 2.4 quattro      | 130 |  | 03.05 | 08.11 | PR: 1LG,1LD | 11.8116-0347.2 | 390535 | 2 | Haltefeder     | ATE |
|                                | 2.7 TDI          | 120 |  | 03.05 | 08.11 | PR: 1LG,1LD |                |        |   |                |     |
|                                | 2.7 TDI          | 132 |  | 03.05 | 08.11 | PR: 1LG,1LD |                |        |   |                |     |
|                                | 2.7 TDI          | 140 |  | 10.08 | 08.11 | PR: 1LG     |                |        |   |                |     |
|                                | 2.7 TDI quattro  | 120 |  | 06.05 | 08.11 | PR: 1LG,1LD |                |        |   |                |     |
|                                | 2.7 TDI quattro  | 132 |  | 03.05 | 08.11 | PR: 1LG,1LD |                |        |   |                |     |
|                                | 2.7 TDI quattro  | 140 |  | 10.08 | 08.11 | PR: 1LG     |                |        |   |                |     |
|                                | 2.8 FSI          | 140 |  | 10.08 | 08.11 | PR: 1LG     |                |        |   |                |     |
|                                | 2.8 FSI          | 154 |  | 11.06 | 08.11 | PR: 1LG,1LD |                |        |   |                |     |
|                                | 2.8 FSI          | 162 |  | 10.08 | 08.11 | PR: 1LG     |                |        |   |                |     |
|                                | 2.8 FSI quattro  | 140 |  | 10.08 | 08.11 | PR: 1LG     |                |        |   |                |     |
|                                | 2.8 FSI quattro  | 154 |  | 04.07 | 08.11 | PR: 1LG,1LD |                |        |   |                |     |
|                                | 2.8 FSI quattro  | 162 |  | 10.08 | 08.11 | PR: 1LG     |                |        |   |                |     |
|                                | 3.0              | 160 |  | 03.05 | 08.11 | PR: 1LG,1LD |                |        |   |                |     |
|                                | 3.0 quattro      | 160 |  | 03.05 | 08.11 | PR: 1LG,1LD |                |        |   |                |     |
|                                | 3.0 TDI quattro  | 155 |  | 03.05 | 08.11 | PR: 1LG,1LD |                |        |   |                |     |
|                                | 3.0 TDI quattro  | 165 |  | 03.05 | 08.11 | PR: 1LG,1LD |                |        |   |                |     |
|                                | 3.0 TDI quattro  | 171 |  | 06.06 | 08.11 | PR: 1LG,1LD |                |        |   |                |     |
|                                | 3.0 TDI quattro  | 176 |  | 10.08 | 08.11 | PR: 1LG     |                |        |   |                |     |
|                                | 3.0 TFSI quattro |     |  | 10.08 | 08.11 | PR: 1LG     |                |        |   |                |     |
|                                | 3.2 FSI          | 188 |  | 03.05 | 08.11 | PR: 1LG,1LD |                |        |   |                |     |
|                                | 3.2 FSI quattro  | 188 |  | 03.05 | 08.11 | PR: 1LG,1LD |                |        |   |                |     |
|                                | 4.2 FSI quattro  | 257 |  | 06.06 | 08.11 | PR: 1LG,1LD |                |        |   |                |     |
|                                | 4.2 quattro      | 246 |  | 03.05 | 08.11 | PR: 1LG,1LD |                |        |   |                |     |
|                                | 2.0 TDI          | 100 |  | 06.05 | 08.11 | PR: 1ZL,1LH | 11.9606-9961.2 | 220655 |   | D=60, - Halter | ATE |
|                                | 2.0 TDI          | 103 |  | 03.05 | 08.11 | PR: 1ZL,1LH | 11.9606-9962.2 | 220656 |   | D=60, - Halter | ATE |
|                                | 2.0 TDI          | 125 |  | 10.08 | 08.11 | PR: 1ZL     | 11.0441-6008.2 | 250038 |   | Dichtungssatz  | ATE |
|                                | 2.0 TFSI         | 125 |  | 06.05 | 08.11 | PR: 1ZL,1LH | 11.0101-5409.2 | 260035 |   | Hülsensatz     | ATE |
|                                | 2.4              | 130 |  | 03.05 | 08.11 | PR: 1ZL,1LH | 11.8171-0008.1 | 990049 |   | Führungsbolzen | ATE |
|                                | 2.4 quattro      | 130 |  | 03.05 | 08.11 | PR: 1ZL,1LH | 11.8116-0410.2 | 390589 | 2 | Haltefeder     | ATE |
|                                | 2.7 TDI          | 120 |  | 03.05 | 08.11 | PR: 1ZL,1LH |                |        |   |                |     |
|                                | 2.7 TDI          | 132 |  | 03.05 | 08.11 | PR: 1ZL,1LH |                |        |   |                |     |
|                                | 2.7 TDI          | 140 |  | 10.08 | 08.11 | PR: 1ZL     |                |        |   |                |     |
|                                | 2.7 TDI quattro  | 120 |  | 06.05 | 08.11 | PR: 1ZL,1LH |                |        |   |                |     |
|                                | 2.7 TDI quattro  | 132 |  | 03.05 | 08.11 | PR: 1ZL,1LH |                |        |   |                |     |



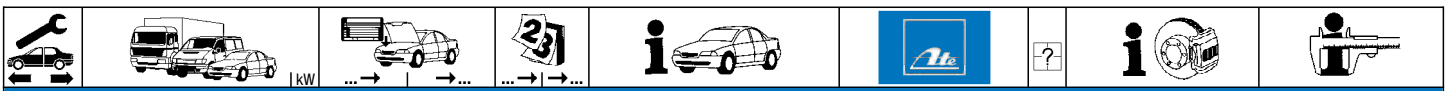









**AUDI A6 (4F5/C6) Avant (05-11)**







|  |   |   |  |  |   |  |  |                                  |   |  |
|--|---|---|--|--|---|--|--|----------------------------------|---|--|
|  | 2.7 TDI quattro<br>2.8 FSI<br>2.8 FSI<br>2.8 FSI quattro<br>2.8 FSI quattro<br>2.8 FSI quattro<br>3.0<br>3.0 quattro<br>3.0 TDI quattro<br>3.0 TDI quattro<br>3.0 TDI quattro<br>3.0 TDI quattro<br>3.0 TFSI quattro<br>3.2 FSI<br>3.2 FSI quattro<br>4.2 FSI quattro<br>4.2 quattro  | 140<br>140<br>154<br>162<br>140<br>154<br>162<br>160<br>160<br>155<br>165<br>171<br>176<br>188<br>188<br>257<br>246   |  | 10.08 08.11<br>10.08 08.11<br>11.06 08.11<br>10.08 08.11<br>10.08 08.11<br>04.07 08.11<br>10.08 08.11<br>03.05 08.11<br>03.05 08.11<br>03.05 08.11<br>03.05 08.11<br>06.06 08.11<br>10.08 08.11<br>10.08 08.11<br>03.05 08.11<br>03.05 08.11<br>06.06 08.11<br>03.05 08.11   | PR: 1ZL<br>PR: 1ZL<br>PR: 1ZL,1LH<br>PR: 1ZL<br>PR: 1ZL<br>PR: 1ZL,1LH<br>PR: 1ZL,1LH<br>PR: 1ZL,1LH<br>PR: 1ZL,1LH<br>PR: 1ZL,1LH<br>PR: 1ZL,1LH<br>PR: 1ZL<br>PR: 1ZL<br>PR: 1ZL,1LH<br>PR: 1ZL,1LH<br>PR: 1ZL,1LH<br>PR: 1ZL,1LH   | 11.9606-9961.2 220655<br>11.9606-9962.2 220656<br>11.0441-6008.2 250038<br>11.0101-5409.2 260035<br>11.8171-0008.1 990049<br>11.8116-0410.2 390589 | 2  |                                  | D=60, - Halter<br>D=60, - Halter<br>Dichtungssatz<br>Hülsensatz<br>Führungsbolzen<br>Haltefeder | ATE<br>ATE<br>ATE<br>ATE<br>ATE<br>ATE |
|  | S6  | 320   |  | 03.06 08.11  |   | 11.0101-6010.2 260099<br>11.8171-0067.1 250153   |  | Hülsensatz<br>Führungsbolzen     | ATE<br>ATE  |  |
|  | 2.0 TDI<br>2.0 TDI<br>2.0 TDI<br>2.0 TFSI<br>2.4<br>2.4 quattro<br>2.7 TDI<br>2.7 TDI<br>2.7 TDI<br>2.7 TDI quattro<br>2.7 TDI quattro<br>2.7 TDI quattro<br>2.8 FSI<br>2.8 FSI<br>2.8 FSI<br>2.8 FSI quattro<br>2.8 FSI quattro<br>2.8 FSI quattro<br>3.0<br>3.0 quattro<br>3.0 TDI quattro<br>3.0 TDI quattro<br>3.0 TDI quattro<br>3.0 TDI quattro<br>3.0 TFSI quattro<br>3.2 FSI<br>3.2 FSI quattro<br>4.2 FSI quattro<br>4.2 quattro<br>S6 | 100<br>103<br>125<br>125<br>130<br>130<br>120<br>132<br>140<br>120<br>132<br>140<br>140<br>140<br>154<br>162<br>140<br>154<br>162<br>140<br>154<br>162<br>160<br>160<br>155<br>165<br>171<br>176<br>188<br>188<br>257<br>246<br>320 |  | 06.05 08.11<br>03.05 08.11<br>10.08 08.11<br>06.05 08.11<br>03.05 08.11<br>03.05 08.11<br>03.05 08.11<br>03.05 08.11<br>10.08 08.11<br>03.05 08.11<br>10.08 08.11<br>10.08 08.11<br>11.06 08.11<br>10.08 08.11<br>10.08 08.11<br>04.07 08.11<br>10.08 08.11<br>03.05 08.11<br>03.05 08.11<br>03.05 08.11<br>06.06 08.11<br>03.05 08.11<br>03.05 08.11<br>06.06 08.11<br>03.05 08.11<br>03.06 08.11 |   | 83.7813-0315.3 330870  | 2  |                                  | L=315   |  |
|  | 2.0 TDI<br>2.0 TDI<br>2.0 TFSI<br>2.4<br>2.4 quattro<br>2.7 TDI<br>2.7 TDI<br>2.7 TDI quattro<br>2.7 TDI quattro<br>2.8 FSI<br>2.8 FSI quattro<br>3.0<br>3.0 quattro<br>3.0 TDI quattro<br>3.0 TDI quattro<br>3.0 TDI quattro<br>3.2 FSI<br>3.2 FSI quattro<br>4.2 FSI quattro<br>4.2 quattro   | 100<br>103<br>125<br>130<br>130<br>120<br>132<br>120<br>132<br>140<br>154<br>154<br>160<br>160<br>155<br>165<br>171<br>188<br>188<br>257<br>246   | 4F-7-016200<br>4F-7-016200<br>4F-7-016200<br>4F-7-016200<br>4F-7-016200<br>4F-7-016200<br>4F-7-016200<br>4F-7-016200<br>4F-7-016200<br>4F-7-016200<br>4F-7-016200<br>4F-7-016200<br>4F-7-016200<br>4F-7-016200<br>4F-7-016200<br>4F-7-016200<br>4F-7-016200<br>4F-7-016200<br>4F-7-016200<br>4F-7-016200<br>4F-7-016200<br>4F-7-016200 | 06.05<br>03.05<br>06.05<br>03.05<br>03.05<br>03.05<br>06.05<br>03.05<br>11.06<br>04.07<br>03.05<br>03.05<br>03.05<br>03.05<br>06.06<br>03.05<br>03.05<br>03.05<br>06.06<br>03.05   | PR: 1KD,2ED<br>PR: 1KD,2ED<br>PR: 1KD,2ED<br>PR: 1KD,2ED<br>PR: 1KD,2ED<br>PR: 1KD,2ED<br>PR: 1KD,2ED<br>PR: 1KD,2ED<br>PR: 1KD,2ED<br>PR: 1KD,2ED<br>PR: 1KD,2ED<br>PR: 1KD,2ED<br>PR: 1KD,2ED<br>PR: 1KD,2ED<br>PR: 1KD,2ED<br>PR: 1KD,2ED<br>PR: 1KD,2ED<br>PR: 1KD,2ED<br>PR: 1KD,2ED<br>PR: 1KD,2ED<br>PR: 1KD,2ED | 24.6241-1701.7 220821<br>24.6241-1702.7 220822   | <input type="checkbox"/> elektrische Feststellbremse 1)<br><input type="checkbox"/> elektrische Feststellbremse 1) | D=41, - Halter<br>D=41, - Halter | LUC<br>LUC  |  |
|  | 2.0 TDI<br>2.0 TDI<br>2.0 TFSI<br>2.4<br>2.4 quattro<br>2.7 TDI<br>2.7 TDI<br>2.7 TDI quattro<br>2.7 TDI quattro<br>2.8 FSI<br>2.8 FSI quattro<br>3.0<br>3.0 quattro<br>3.0 TDI quattro<br>3.0 TDI quattro<br>3.0 TDI quattro<br>3.2 FSI<br>3.2 FSI quattro<br>4.2 FSI quattro<br>4.2 quattro   | 100<br>103<br>125<br>130<br>130<br>120<br>132<br>120<br>132<br>140<br>154<br>154<br>160<br>160<br>155<br>165<br>171<br>188<br>188<br>257<br>246   | 4F-7-016200<br>4F-7-016200<br>4F-7-016200<br>4F-7-016200<br>4F-7-016200<br>4F-7-016200<br>4F-7-016200<br>4F-7-016200<br>4F-7-016200<br>4F-7-016200<br>4F-7-016200<br>4F-7-016200<br>4F-7-016200<br>4F-7-016200<br>4F-7-016200<br>4F-7-016200<br>4F-7-016200<br>4F-7-016200<br>4F-7-016200<br>4F-7-016200<br>4F-7-016200<br>4F-7-016200 | 06.05<br>03.05<br>06.05<br>03.05<br>03.05<br>03.05<br>06.05<br>03.05<br>11.06<br>04.07<br>03.05<br>03.05<br>03.05<br>03.05<br>06.06<br>03.05<br>03.05<br>03.05<br>06.06<br>03.05   | PR: 1KW,2EE<br>PR: 1KW,2EE<br>PR: 1KW,2EE<br>PR: 1KW,2EE<br>PR: 1KW,2EE<br>PR: 1KW,2EE<br>PR: 1KW,2EE<br>PR: 1KW,2EE<br>PR: 1KW,2EE<br>PR: 1KW,2EE<br>PR: 1KW,2EE<br>PR: 1KW,2EE<br>PR: 1KW,2EE<br>PR: 1KW,2EE<br>PR: 1KW,2EE<br>PR: 1KW,2EE<br>PR: 1KW,2EE<br>PR: 1KW,2EE<br>PR: 1KW,2EE<br>PR: 1KW,2EE<br>PR: 1KW,2EE | 24.6243-1701.7 220823<br>24.6243-1702.7 220824   | <input type="checkbox"/> elektrische Feststellbremse 1)<br><input type="checkbox"/> elektrische Feststellbremse 1) | D=43, - Halter<br>D=43, - Halter | LUC<br>LUC  |  |

1) electric parking brake / fr.di stazionamento elettrico / frein à main électrique / freno de mano eléctrico



| AUDI A6 (4F5/C6) Avant (05-11)   |   |                 |       |             |                |                |   |                          |   |                          |                |                 |         |             |       |             |                |         |   |                |                          |                |     |             |       |             |       |       |         |                |        |          |               |             |         |         |  |       |       |         |                |         |     |             |       |         |     |  |       |       |         |                |        |             |                |         |         |     |  |       |       |          |                |             |       |             |                |          |   |                |       |         |         |             |       |             |                |        |   |                |     |         |       |             |       |             |  |  |  |         |     |                 |       |             |         |             |  |  |  |  |         |                 |     |             |       |             |                |        |                          |                |     |                 |     |             |       |             |         |                |        |                          |                |         |         |     |       |       |       |         |                |        |  |               |     |         |       |       |       |       |         |                |        |         |            |     |         |       |  |       |       |         |                |                 |     |                |       |         |     |  |       |       |         |                 |        |   |            |       |          |     |  |       |       |                 |     |  |       |       |  |         |     |  |       |       |         |  |       |       |  |  |         |     |  |             |       |         |       |       |  |  |  |         |     |                 |       |       |       |                |        |   |       |  |         |                 |     |       |       |       |  |  |  |  |  |                 |     |  |       |       |  |  |  |  |  |                 |         |     |       |       |       |  |  |  |  |                  |  |         |       |       |       |       |  |  |  |         |     |  |         |       |  |       |       |  |  |                 |     |  |       |          |     |  |       |       |  |                 |     |  |       |       |         |     |  |       |       |             |     |  |       |       |  |         |     |  |       |       |     |  |       |       |  |  |  |   |         |     |             |       |         |                |        |   |                |     |         |     |             |       |         |                |        |   |                |     |         |     |             |       |         |  |  |  |  |  |         |     |             |       |         |  |  |  |  |  |         |     |             |       |         |  |  |  |  |  |         |     |             |       |         |  |  |  |  |  |         |     |             |       |             |                |        |   |                |     |         |     |             |       |             |                |        |   |                |     |         |     |             |       |             |  |  |  |  |  |         |     |             |       |             |  |  |  |  |  |         |     |             |       |             |  |  |  |  |  |         |     |             |       |             |  |  |  |  |  |  |   |         |     |  |       |       |  |                |        |   |       |         |     |  |       |       |  |  |  |  |  |         |     |  |       |       |  |  |  |  |  |         |     |  |       |       |  |  |  |  |  |         |     |  |       |       |  |  |  |  |  |         |     |  |       |       |  |  |  |  |  |          |     |  |       |       |  |  |  |  |  |         |     |  |       |       |  |  |  |  |  |         |     |  |       |       |  |  |  |  |  |
|--|---|-----------------|-------|-------------|----------------|----------------|---|--------------------------|---|--------------------------|----------------|-----------------|---------|-------------|-------|-------------|----------------|---------|---|----------------|--------------------------|----------------|-----|-------------|-------|-------------|-------|-------|---------|----------------|--------|----------|---------------|-------------|---------|---------|--|-------|-------|---------|----------------|---------|-----|-------------|-------|---------|-----|--|-------|-------|---------|----------------|--------|-------------|----------------|---------|---------|-----|--|-------|-------|----------|----------------|-------------|-------|-------------|----------------|----------|---|----------------|-------|---------|---------|-------------|-------|-------------|----------------|--------|---|----------------|-----|---------|-------|-------------|-------|-------------|--|--|--|---------|-----|-----------------|-------|-------------|---------|-------------|--|--|--|--|---------|-----------------|-----|-------------|-------|-------------|----------------|--------|--------------------------|----------------|-----|-----------------|-----|-------------|-------|-------------|---------|----------------|--------|--------------------------|----------------|---------|---------|-----|-------|-------|-------|---------|----------------|--------|--|---------------|-----|---------|-------|-------|-------|-------|---------|----------------|--------|---------|------------|-----|---------|-------|--|-------|-------|---------|----------------|-----------------|-----|----------------|-------|---------|-----|--|-------|-------|---------|-----------------|--------|---|------------|-------|----------|-----|--|-------|-------|-----------------|-----|--|-------|-------|--|---------|-----|--|-------|-------|---------|--|-------|-------|--|--|---------|-----|--|-------------|-------|---------|-------|-------|--|--|--|---------|-----|-----------------|-------|-------|-------|----------------|--------|---|-------|--|---------|-----------------|-----|-------|-------|-------|--|--|--|--|--|-----------------|-----|--|-------|-------|--|--|--|--|--|-----------------|---------|-----|-------|-------|-------|--|--|--|--|------------------|--|---------|-------|-------|-------|-------|--|--|--|---------|-----|--|---------|-------|--|-------|-------|--|--|-----------------|-----|--|-------|----------|-----|--|-------|-------|--|-----------------|-----|--|-------|-------|---------|-----|--|-------|-------|-------------|-----|--|-------|-------|--|---------|-----|--|-------|-------|-----|--|-------|-------|--|--|--|---|---------|-----|-------------|-------|---------|----------------|--------|---|----------------|-----|---------|-----|-------------|-------|---------|----------------|--------|---|----------------|-----|---------|-----|-------------|-------|---------|--|--|--|--|--|---------|-----|-------------|-------|---------|--|--|--|--|--|---------|-----|-------------|-------|---------|--|--|--|--|--|---------|-----|-------------|-------|---------|--|--|--|--|--|---------|-----|-------------|-------|-------------|----------------|--------|---|----------------|-----|---------|-----|-------------|-------|-------------|----------------|--------|---|----------------|-----|---------|-----|-------------|-------|-------------|--|--|--|--|--|---------|-----|-------------|-------|-------------|--|--|--|--|--|---------|-----|-------------|-------|-------------|--|--|--|--|--|---------|-----|-------------|-------|-------------|--|--|--|--|--|--|---|---------|-----|--|-------|-------|--|----------------|--------|---|-------|---------|-----|--|-------|-------|--|--|--|--|--|---------|-----|--|-------|-------|--|--|--|--|--|---------|-----|--|-------|-------|--|--|--|--|--|---------|-----|--|-------|-------|--|--|--|--|--|---------|-----|--|-------|-------|--|--|--|--|--|----------|-----|--|-------|-------|--|--|--|--|--|---------|-----|--|-------|-------|--|--|--|--|--|---------|-----|--|-------|-------|--|--|--|--|--|
|    | <table border="1"> <tr> <td>3.2 FSI quattro</td> <td>188</td> <td>4F-7-016200</td> <td>03.05</td> <td>PR: 1KW,2EE</td> <td>24.6243-1701.7</td> <td>220823</td> <td><input type="checkbox"/> elektrische Feststellbremse 1)</td> <td>D=43, - Halter</td> <td>LUC</td> </tr> <tr> <td>4.2 FSI quattro</td> <td>257</td> <td>4F-7-016200</td> <td>06.06</td> <td>PR: 1KW,2EE</td> <td>24.6243-1702.7</td> <td>220824</td> <td><input type="checkbox"/> elektrische Feststellbremse 1)</td> <td>D=43, - Halter</td> <td>LUC</td> </tr> <tr> <td>4.2 quattro</td> <td>246</td> <td>4F-7-016200</td> <td>03.05</td> <td>PR: 1KW,2EE</td> <td></td> <td></td> <td></td> <td></td> <td></td> </tr> </table>   | 3.2 FSI quattro | 188   | 4F-7-016200 | 03.05          | PR: 1KW,2EE    | 24.6243-1701.7  | 220823                   | <input type="checkbox"/> elektrische Feststellbremse 1) | D=43, - Halter           | LUC            | 4.2 FSI quattro | 257     | 4F-7-016200 | 06.06 | PR: 1KW,2EE | 24.6243-1702.7 | 220824  | <input type="checkbox"/> elektrische Feststellbremse 1) | D=43, - Halter | LUC                      | 4.2 quattro    | 246 | 4F-7-016200 | 03.05 | PR: 1KW,2EE |       |       |         |                |        |          |               |             |         |         |  |       |       |         |                |         |     |             |       |         |     |  |       |       |         |                |        |             |                |         |         |     |  |       |       |          |                |             |       |             |                |          |   |                |       |         |         |             |       |             |                |        |   |                |     |         |       |             |       |             |  |  |  |         |     |                 |       |             |         |             |  |  |  |  |         |                 |     |             |       |             |                |        |                          |                |     |                 |     |             |       |             |         |                |        |                          |                |         |         |     |       |       |       |         |                |        |  |               |     |         |       |       |       |       |         |                |        |         |            |     |         |       |  |       |       |         |                |                 |     |                |       |         |     |  |       |       |         |                 |        |   |            |       |          |     |  |       |       |                 |     |  |       |       |  |         |     |  |       |       |         |  |       |       |  |  |         |     |  |             |       |         |       |       |  |  |  |         |     |                 |       |       |       |                |        |   |       |  |         |                 |     |       |       |       |  |  |  |  |  |                 |     |  |       |       |  |  |  |  |  |                 |         |     |       |       |       |  |  |  |  |                  |  |         |       |       |       |       |  |  |  |         |     |  |         |       |  |       |       |  |  |                 |     |  |       |          |     |  |       |       |  |                 |     |  |       |       |         |     |  |       |       |             |     |  |       |       |  |         |     |  |       |       |     |  |       |       |  |  |  |   |         |     |             |       |         |                |        |   |                |     |         |     |             |       |         |                |        |   |                |     |         |     |             |       |         |  |  |  |  |  |         |     |             |       |         |  |  |  |  |  |         |     |             |       |         |  |  |  |  |  |         |     |             |       |         |  |  |  |  |  |         |     |             |       |             |                |        |   |                |     |         |     |             |       |             |                |        |   |                |     |         |     |             |       |             |  |  |  |  |  |         |     |             |       |             |  |  |  |  |  |         |     |             |       |             |  |  |  |  |  |         |     |             |       |             |  |  |  |  |  |  |   |         |     |  |       |       |  |                |        |   |       |         |     |  |       |       |  |  |  |  |  |         |     |  |       |       |  |  |  |  |  |         |     |  |       |       |  |  |  |  |  |         |     |  |       |       |  |  |  |  |  |         |     |  |       |       |  |  |  |  |  |          |     |  |       |       |  |  |  |  |  |         |     |  |       |       |  |  |  |  |  |         |     |  |       |       |  |  |  |  |  |
| 3.2 FSI quattro  | 188   | 4F-7-016200     | 03.05 | PR: 1KW,2EE | 24.6243-1701.7 | 220823         | <input type="checkbox"/> elektrische Feststellbremse 1) | D=43, - Halter           | LUC   |                          |                |                 |         |             |       |             |                |         |   |                |                          |                |     |             |       |             |       |       |         |                |        |          |               |             |         |         |  |       |       |         |                |         |     |             |       |         |     |  |       |       |         |                |        |             |                |         |         |     |  |       |       |          |                |             |       |             |                |          |   |                |       |         |         |             |       |             |                |        |   |                |     |         |       |             |       |             |  |  |  |         |     |                 |       |             |         |             |  |  |  |  |         |                 |     |             |       |             |                |        |                          |                |     |                 |     |             |       |             |         |                |        |                          |                |         |         |     |       |       |       |         |                |        |  |               |     |         |       |       |       |       |         |                |        |         |            |     |         |       |  |       |       |         |                |                 |     |                |       |         |     |  |       |       |         |                 |        |   |            |       |          |     |  |       |       |                 |     |  |       |       |  |         |     |  |       |       |         |  |       |       |  |  |         |     |  |             |       |         |       |       |  |  |  |         |     |                 |       |       |       |                |        |   |       |  |         |                 |     |       |       |       |  |  |  |  |  |                 |     |  |       |       |  |  |  |  |  |                 |         |     |       |       |       |  |  |  |  |                  |  |         |       |       |       |       |  |  |  |         |     |  |         |       |  |       |       |  |  |                 |     |  |       |          |     |  |       |       |  |                 |     |  |       |       |         |     |  |       |       |             |     |  |       |       |  |         |     |  |       |       |     |  |       |       |  |  |  |   |         |     |             |       |         |                |        |   |                |     |         |     |             |       |         |                |        |   |                |     |         |     |             |       |         |  |  |  |  |  |         |     |             |       |         |  |  |  |  |  |         |     |             |       |         |  |  |  |  |  |         |     |             |       |         |  |  |  |  |  |         |     |             |       |             |                |        |   |                |     |         |     |             |       |             |                |        |   |                |     |         |     |             |       |             |  |  |  |  |  |         |     |             |       |             |  |  |  |  |  |         |     |             |       |             |  |  |  |  |  |         |     |             |       |             |  |  |  |  |  |  |   |         |     |  |       |       |  |                |        |   |       |         |     |  |       |       |  |  |  |  |  |         |     |  |       |       |  |  |  |  |  |         |     |  |       |       |  |  |  |  |  |         |     |  |       |       |  |  |  |  |  |         |     |  |       |       |  |  |  |  |  |          |     |  |       |       |  |  |  |  |  |         |     |  |       |       |  |  |  |  |  |         |     |  |       |       |  |  |  |  |  |
| 4.2 FSI quattro  | 257   | 4F-7-016200     | 06.06 | PR: 1KW,2EE | 24.6243-1702.7 | 220824         | <input type="checkbox"/> elektrische Feststellbremse 1) | D=43, - Halter           | LUC   |                          |                |                 |         |             |       |             |                |         |   |                |                          |                |     |             |       |             |       |       |         |                |        |          |               |             |         |         |  |       |       |         |                |         |     |             |       |         |     |  |       |       |         |                |        |             |                |         |         |     |  |       |       |          |                |             |       |             |                |          |   |                |       |         |         |             |       |             |                |        |   |                |     |         |       |             |       |             |  |  |  |         |     |                 |       |             |         |             |  |  |  |  |         |                 |     |             |       |             |                |        |                          |                |     |                 |     |             |       |             |         |                |        |                          |                |         |         |     |       |       |       |         |                |        |  |               |     |         |       |       |       |       |         |                |        |         |            |     |         |       |  |       |       |         |                |                 |     |                |       |         |     |  |       |       |         |                 |        |   |            |       |          |     |  |       |       |                 |     |  |       |       |  |         |     |  |       |       |         |  |       |       |  |  |         |     |  |             |       |         |       |       |  |  |  |         |     |                 |       |       |       |                |        |   |       |  |         |                 |     |       |       |       |  |  |  |  |  |                 |     |  |       |       |  |  |  |  |  |                 |         |     |       |       |       |  |  |  |  |                  |  |         |       |       |       |       |  |  |  |         |     |  |         |       |  |       |       |  |  |                 |     |  |       |          |     |  |       |       |  |                 |     |  |       |       |         |     |  |       |       |             |     |  |       |       |  |         |     |  |       |       |     |  |       |       |  |  |  |   |         |     |             |       |         |                |        |   |                |     |         |     |             |       |         |                |        |   |                |     |         |     |             |       |         |  |  |  |  |  |         |     |             |       |         |  |  |  |  |  |         |     |             |       |         |  |  |  |  |  |         |     |             |       |         |  |  |  |  |  |         |     |             |       |             |                |        |   |                |     |         |     |             |       |             |                |        |   |                |     |         |     |             |       |             |  |  |  |  |  |         |     |             |       |             |  |  |  |  |  |         |     |             |       |             |  |  |  |  |  |         |     |             |       |             |  |  |  |  |  |  |   |         |     |  |       |       |  |                |        |   |       |         |     |  |       |       |  |  |  |  |  |         |     |  |       |       |  |  |  |  |  |         |     |  |       |       |  |  |  |  |  |         |     |  |       |       |  |  |  |  |  |         |     |  |       |       |  |  |  |  |  |          |     |  |       |       |  |  |  |  |  |         |     |  |       |       |  |  |  |  |  |         |     |  |       |       |  |  |  |  |  |
| 4.2 quattro  | 246   | 4F-7-016200     | 03.05 | PR: 1KW,2EE |                |                |   |                          |   |                          |                |                 |         |             |       |             |                |         |   |                |                          |                |     |             |       |             |       |       |         |                |        |          |               |             |         |         |  |       |       |         |                |         |     |             |       |         |     |  |       |       |         |                |        |             |                |         |         |     |  |       |       |          |                |             |       |             |                |          |   |                |       |         |         |             |       |             |                |        |   |                |     |         |       |             |       |             |  |  |  |         |     |                 |       |             |         |             |  |  |  |  |         |                 |     |             |       |             |                |        |                          |                |     |                 |     |             |       |             |         |                |        |                          |                |         |         |     |       |       |       |         |                |        |  |               |     |         |       |       |       |       |         |                |        |         |            |     |         |       |  |       |       |         |                |                 |     |                |       |         |     |  |       |       |         |                 |        |   |            |       |          |     |  |       |       |                 |     |  |       |       |  |         |     |  |       |       |         |  |       |       |  |  |         |     |  |             |       |         |       |       |  |  |  |         |     |                 |       |       |       |                |        |   |       |  |         |                 |     |       |       |       |  |  |  |  |  |                 |     |  |       |       |  |  |  |  |  |                 |         |     |       |       |       |  |  |  |  |                  |  |         |       |       |       |       |  |  |  |         |     |  |         |       |  |       |       |  |  |                 |     |  |       |          |     |  |       |       |  |                 |     |  |       |       |         |     |  |       |       |             |     |  |       |       |  |         |     |  |       |       |     |  |       |       |  |  |  |   |         |     |             |       |         |                |        |   |                |     |         |     |             |       |         |                |        |   |                |     |         |     |             |       |         |  |  |  |  |  |         |     |             |       |         |  |  |  |  |  |         |     |             |       |         |  |  |  |  |  |         |     |             |       |         |  |  |  |  |  |         |     |             |       |             |                |        |   |                |     |         |     |             |       |             |                |        |   |                |     |         |     |             |       |             |  |  |  |  |  |         |     |             |       |             |  |  |  |  |  |         |     |             |       |             |  |  |  |  |  |         |     |             |       |             |  |  |  |  |  |  |   |         |     |  |       |       |  |                |        |   |       |         |     |  |       |       |  |  |  |  |  |         |     |  |       |       |  |  |  |  |  |         |     |  |       |       |  |  |  |  |  |         |     |  |       |       |  |  |  |  |  |         |     |  |       |       |  |  |  |  |  |          |     |  |       |       |  |  |  |  |  |         |     |  |       |       |  |  |  |  |  |         |     |  |       |       |  |  |  |  |  |
|    | <table border="1"> <tr> <td>2.0 TDI</td> <td>100</td> <td></td> <td>06.05</td> <td>08.11</td> <td></td> <td>24.5125-0323.3</td> <td>330911</td> <td>2</td> <td>L=323</td> </tr> <tr> <td>2.0 TDI</td> <td>103</td> <td></td> <td>03.05</td> <td>08.11</td> <td></td> <td></td> <td></td> <td></td> <td></td> </tr> <tr> <td>2.0 TDI</td> <td>125</td> <td></td> <td>10.08</td> <td>08.11</td> <td></td> <td></td> <td></td> <td></td> <td></td> </tr> <tr> <td>2.0 TFSI</td> <td>125</td> <td></td> <td>06.05</td> <td>08.11</td> <td></td> <td></td> <td></td> <td></td> <td></td> </tr> <tr> <td>2.4</td> <td>130</td> <td></td> <td>03.05</td> <td>08.11</td> <td></td> <td></td> <td></td> <td></td> <td></td> </tr> <tr> <td>2.4 quattro</td> <td>130</td> <td></td> <td>03.05</td> <td>08.11</td> <td></td> <td></td> <td></td> <td></td> <td></td> </tr> <tr> <td>2.7 TDI</td> <td>120</td> <td></td> <td>03.05</td> <td>08.11</td> <td></td> <td></td> <td></td> <td></td> <td></td> </tr> <tr> <td>2.7 TDI</td> <td>132</td> <td></td> <td>03.05</td> <td>08.11</td> <td></td> <td></td> <td></td> <td></td> <td></td> </tr> <tr> <td>2.7 TDI</td> <td>140</td> <td></td> <td>10.08</td> <td>08.11</td> <td></td> <td></td> <td></td> <td></td> <td></td> </tr> <tr> <td>2.7 TDI quattro</td> <td>120</td> <td></td> <td>06.05</td> <td>08.11</td> <td></td> <td></td> <td></td> <td></td> <td></td> </tr> <tr> <td>2.7 TDI quattro</td> <td>132</td> <td></td> <td>03.05</td> <td>08.11</td> <td></td> <td></td> <td></td> <td></td> <td></td> </tr> <tr> <td>2.7 TDI quattro</td> <td>140</td> <td></td> <td>10.08</td> <td>08.11</td> <td></td> <td></td> <td></td> <td></td> <td></td> </tr> <tr> <td>2.8 FSI</td> <td>140</td> <td></td> <td>10.08</td> <td>08.11</td> <td></td> <td></td> <td></td> <td></td> <td></td> </tr> <tr> <td>2.8 FSI</td> <td>154</td> <td></td> <td>11.06</td> <td>08.11</td> <td></td> <td></td> <td></td> <td></td> <td></td> </tr> <tr> <td>2.8 FSI</td> <td>162</td> <td></td> <td>10.08</td> <td>08.11</td> <td></td> <td></td> <td></td> <td></td> <td></td> </tr> <tr> <td>2.8 FSI quattro</td> <td>140</td> <td></td> <td>10.08</td> <td>08.11</td> <td></td> <td></td> <td></td> <td></td> <td></td> </tr> <tr> <td>2.8 FSI quattro</td> <td>154</td> <td></td> <td>04.07</td> <td>08.11</td> <td></td> <td></td> <td></td> <td></td> <td></td> </tr> <tr> <td>2.8 FSI quattro</td> <td>162</td> <td></td> <td>10.08</td> <td>08.11</td> <td></td> <td></td> <td></td> <td></td> <td></td> </tr> <tr> <td>3.0</td> <td>160</td> <td></td> <td>03.05</td> <td>08.11</td> <td></td> <td></td> <td></td> <td></td> <td></td> </tr> <tr> <td>3.0 quattro</td> <td>160</td> <td></td> <td>03.05</td> <td>08.11</td> <td></td> <td></td> <td></td> <td></td> <td></td> </tr> <tr> <td>3.0 TDI quattro</td> <td>155</td> <td></td> <td>03.05</td> <td>08.11</td> <td></td> <td></td> <td></td> <td></td> <td></td> </tr> <tr> <td>3.0 TDI quattro</td> <td>165</td> <td></td> <td>03.05</td> <td>08.11</td> <td></td> <td></td> <td></td> <td></td> <td></td> </tr> <tr> <td>3.0 TDI quattro</td> <td>171</td> <td></td> <td>06.06</td> <td>08.11</td> <td></td> <td></td> <td></td> <td></td> <td></td> </tr> <tr> <td>3.0 TDI quattro</td> <td>176</td> <td></td> <td>10.08</td> <td>08.11</td> <td></td> <td></td> <td></td> <td></td> <td></td> </tr> <tr> <td>3.0 TFSI quattro</td> <td></td> <td></td> <td>10.08</td> <td>08.11</td> <td></td> <td></td> <td></td> <td></td> <td></td> </tr> <tr> <td>3.2 FSI</td> <td>188</td> <td></td> <td>03.05</td> <td>08.11</td> <td></td> <td></td> <td></td> <td></td> <td></td> </tr> <tr> <td>3.2 FSI quattro</td> <td>188</td> <td></td> <td>03.05</td> <td>08.11</td> <td></td> <td></td> <td></td> <td></td> <td></td> </tr> <tr> <td>4.2 FSI quattro</td> <td>257</td> <td></td> <td>06.06</td> <td>08.11</td> <td></td> <td></td> <td></td> <td></td> <td></td> </tr> <tr> <td>4.2 quattro</td> <td>246</td> <td></td> <td>03.05</td> <td>08.11</td> <td></td> <td></td> <td></td> <td></td> <td></td> </tr> <tr> <td>S6</td> <td>320</td> <td></td> <td>03.06</td> <td>08.11</td> <td></td> <td></td> <td></td> <td></td> <td></td> </tr> </table>   | 2.0 TDI         | 100   |             | 06.05          | 08.11          |   | 24.5125-0323.3           | 330911  | 2                        | L=323          | 2.0 TDI         | 103     |             | 03.05 | 08.11       |                |         |   |                |                          | 2.0 TDI        | 125 |             | 10.08 | 08.11       |       |       |         |                |        | 2.0 TFSI | 125           |             | 06.05   | 08.11   |  |       |       |         |                | 2.4     | 130 |             | 03.05 | 08.11   |     |  |       |       |         | 2.4 quattro    | 130    |             | 03.05          | 08.11   |         |     |  |       |       | 2.7 TDI  | 120            |             | 03.05 | 08.11       |                |          |   |                |       | 2.7 TDI | 132     |             | 03.05 | 08.11       |                |        |   |                |     | 2.7 TDI | 140   |             | 10.08 | 08.11       |  |  |  |         |     | 2.7 TDI quattro | 120   |             | 06.05   | 08.11       |  |  |  |  |         | 2.7 TDI quattro | 132 |             | 03.05 | 08.11       |                |        |                          |                |     | 2.7 TDI quattro | 140 |             | 10.08 | 08.11       |         |                |        |                          |                | 2.8 FSI | 140     |     | 10.08 | 08.11 |       |         |                |        |  | 2.8 FSI       | 154 |         | 11.06 | 08.11 |       |       |         |                |        | 2.8 FSI | 162        |     | 10.08   | 08.11 |  |       |       |         |                | 2.8 FSI quattro | 140 |                | 10.08 | 08.11   |     |  |       |       |         | 2.8 FSI quattro | 154    |   | 04.07      | 08.11 |          |     |  |       |       | 2.8 FSI quattro | 162 |  | 10.08 | 08.11 |  |         |     |  |       | 3.0   | 160     |  | 03.05 | 08.11 |  |  |         |     |  | 3.0 quattro | 160   |         | 03.05 | 08.11 |  |  |  |         |     | 3.0 TDI quattro | 155   |       | 03.05 | 08.11          |        |   |       |  |         | 3.0 TDI quattro | 165 |       | 03.05 | 08.11 |  |  |  |  |  | 3.0 TDI quattro | 171 |  | 06.06 | 08.11 |  |  |  |  |  | 3.0 TDI quattro | 176     |     | 10.08 | 08.11 |       |  |  |  |  | 3.0 TFSI quattro |  |         | 10.08 | 08.11 |       |       |  |  |  | 3.2 FSI | 188 |  | 03.05   | 08.11 |  |       |       |  |  | 3.2 FSI quattro | 188 |  | 03.05 | 08.11    |     |  |       |       |  | 4.2 FSI quattro | 257 |  | 06.06 | 08.11 |         |     |  |       |       | 4.2 quattro | 246 |  | 03.05 | 08.11 |  |         |     |  |       | S6    | 320 |  | 03.06 | 08.11 |  |  |  |   |         |     |             |       |         |                |        |   |                |     |         |     |             |       |         |                |        |   |                |     |         |     |             |       |         |  |  |  |  |  |         |     |             |       |         |  |  |  |  |  |         |     |             |       |         |  |  |  |  |  |         |     |             |       |         |  |  |  |  |  |         |     |             |       |             |                |        |   |                |     |         |     |             |       |             |                |        |   |                |     |         |     |             |       |             |  |  |  |  |  |         |     |             |       |             |  |  |  |  |  |         |     |             |       |             |  |  |  |  |  |         |     |             |       |             |  |  |  |  |  |  |   |         |     |  |       |       |  |                |        |   |       |         |     |  |       |       |  |  |  |  |  |         |     |  |       |       |  |  |  |  |  |         |     |  |       |       |  |  |  |  |  |         |     |  |       |       |  |  |  |  |  |         |     |  |       |       |  |  |  |  |  |          |     |  |       |       |  |  |  |  |  |         |     |  |       |       |  |  |  |  |  |         |     |  |       |       |  |  |  |  |  |
| 2.0 TDI  | 100   |                 | 06.05 | 08.11       |                | 24.5125-0323.3 | 330911  | 2                        | L=323   |                          |                |                 |         |             |       |             |                |         |   |                |                          |                |     |             |       |             |       |       |         |                |        |          |               |             |         |         |  |       |       |         |                |         |     |             |       |         |     |  |       |       |         |                |        |             |                |         |         |     |  |       |       |          |                |             |       |             |                |          |   |                |       |         |         |             |       |             |                |        |   |                |     |         |       |             |       |             |  |  |  |         |     |                 |       |             |         |             |  |  |  |  |         |                 |     |             |       |             |                |        |                          |                |     |                 |     |             |       |             |         |                |        |                          |                |         |         |     |       |       |       |         |                |        |  |               |     |         |       |       |       |       |         |                |        |         |            |     |         |       |  |       |       |         |                |                 |     |                |       |         |     |  |       |       |         |                 |        |   |            |       |          |     |  |       |       |                 |     |  |       |       |  |         |     |  |       |       |         |  |       |       |  |  |         |     |  |             |       |         |       |       |  |  |  |         |     |                 |       |       |       |                |        |   |       |  |         |                 |     |       |       |       |  |  |  |  |  |                 |     |  |       |       |  |  |  |  |  |                 |         |     |       |       |       |  |  |  |  |                  |  |         |       |       |       |       |  |  |  |         |     |  |         |       |  |       |       |  |  |                 |     |  |       |          |     |  |       |       |  |                 |     |  |       |       |         |     |  |       |       |             |     |  |       |       |  |         |     |  |       |       |     |  |       |       |  |  |  |   |         |     |             |       |         |                |        |   |                |     |         |     |             |       |         |                |        |   |                |     |         |     |             |       |         |  |  |  |  |  |         |     |             |       |         |  |  |  |  |  |         |     |             |       |         |  |  |  |  |  |         |     |             |       |         |  |  |  |  |  |         |     |             |       |             |                |        |   |                |     |         |     |             |       |             |                |        |   |                |     |         |     |             |       |             |  |  |  |  |  |         |     |             |       |             |  |  |  |  |  |         |     |             |       |             |  |  |  |  |  |         |     |             |       |             |  |  |  |  |  |  |   |         |     |  |       |       |  |                |        |   |       |         |     |  |       |       |  |  |  |  |  |         |     |  |       |       |  |  |  |  |  |         |     |  |       |       |  |  |  |  |  |         |     |  |       |       |  |  |  |  |  |         |     |  |       |       |  |  |  |  |  |          |     |  |       |       |  |  |  |  |  |         |     |  |       |       |  |  |  |  |  |         |     |  |       |       |  |  |  |  |  |
| 2.0 TDI  | 103   |                 | 03.05 | 08.11       |                |                |   |                          |   |                          |                |                 |         |             |       |             |                |         |   |                |                          |                |     |             |       |             |       |       |         |                |        |          |               |             |         |         |  |       |       |         |                |         |     |             |       |         |     |  |       |       |         |                |        |             |                |         |         |     |  |       |       |          |                |             |       |             |                |          |   |                |       |         |         |             |       |             |                |        |   |                |     |         |       |             |       |             |  |  |  |         |     |                 |       |             |         |             |  |  |  |  |         |                 |     |             |       |             |                |        |                          |                |     |                 |     |             |       |             |         |                |        |                          |                |         |         |     |       |       |       |         |                |        |  |               |     |         |       |       |       |       |         |                |        |         |            |     |         |       |  |       |       |         |                |                 |     |                |       |         |     |  |       |       |         |                 |        |   |            |       |          |     |  |       |       |                 |     |  |       |       |  |         |     |  |       |       |         |  |       |       |  |  |         |     |  |             |       |         |       |       |  |  |  |         |     |                 |       |       |       |                |        |   |       |  |         |                 |     |       |       |       |  |  |  |  |  |                 |     |  |       |       |  |  |  |  |  |                 |         |     |       |       |       |  |  |  |  |                  |  |         |       |       |       |       |  |  |  |         |     |  |         |       |  |       |       |  |  |                 |     |  |       |          |     |  |       |       |  |                 |     |  |       |       |         |     |  |       |       |             |     |  |       |       |  |         |     |  |       |       |     |  |       |       |  |  |  |   |         |     |             |       |         |                |        |   |                |     |         |     |             |       |         |                |        |   |                |     |         |     |             |       |         |  |  |  |  |  |         |     |             |       |         |  |  |  |  |  |         |     |             |       |         |  |  |  |  |  |         |     |             |       |         |  |  |  |  |  |         |     |             |       |             |                |        |   |                |     |         |     |             |       |             |                |        |   |                |     |         |     |             |       |             |  |  |  |  |  |         |     |             |       |             |  |  |  |  |  |         |     |             |       |             |  |  |  |  |  |         |     |             |       |             |  |  |  |  |  |  |   |         |     |  |       |       |  |                |        |   |       |         |     |  |       |       |  |  |  |  |  |         |     |  |       |       |  |  |  |  |  |         |     |  |       |       |  |  |  |  |  |         |     |  |       |       |  |  |  |  |  |         |     |  |       |       |  |  |  |  |  |          |     |  |       |       |  |  |  |  |  |         |     |  |       |       |  |  |  |  |  |         |     |  |       |       |  |  |  |  |  |
| 2.0 TDI  | 125   |                 | 10.08 | 08.11       |                |                |   |                          |   |                          |                |                 |         |             |       |             |                |         |   |                |                          |                |     |             |       |             |       |       |         |                |        |          |               |             |         |         |  |       |       |         |                |         |     |             |       |         |     |  |       |       |         |                |        |             |                |         |         |     |  |       |       |          |                |             |       |             |                |          |   |                |       |         |         |             |       |             |                |        |   |                |     |         |       |             |       |             |  |  |  |         |     |                 |       |             |         |             |  |  |  |  |         |                 |     |             |       |             |                |        |                          |                |     |                 |     |             |       |             |         |                |        |                          |                |         |         |     |       |       |       |         |                |        |  |               |     |         |       |       |       |       |         |                |        |         |            |     |         |       |  |       |       |         |                |                 |     |                |       |         |     |  |       |       |         |                 |        |   |            |       |          |     |  |       |       |                 |     |  |       |       |  |         |     |  |       |       |         |  |       |       |  |  |         |     |  |             |       |         |       |       |  |  |  |         |     |                 |       |       |       |                |        |   |       |  |         |                 |     |       |       |       |  |  |  |  |  |                 |     |  |       |       |  |  |  |  |  |                 |         |     |       |       |       |  |  |  |  |                  |  |         |       |       |       |       |  |  |  |         |     |  |         |       |  |       |       |  |  |                 |     |  |       |          |     |  |       |       |  |                 |     |  |       |       |         |     |  |       |       |             |     |  |       |       |  |         |     |  |       |       |     |  |       |       |  |  |  |   |         |     |             |       |         |                |        |   |                |     |         |     |             |       |         |                |        |   |                |     |         |     |             |       |         |  |  |  |  |  |         |     |             |       |         |  |  |  |  |  |         |     |             |       |         |  |  |  |  |  |         |     |             |       |         |  |  |  |  |  |         |     |             |       |             |                |        |   |                |     |         |     |             |       |             |                |        |   |                |     |         |     |             |       |             |  |  |  |  |  |         |     |             |       |             |  |  |  |  |  |         |     |             |       |             |  |  |  |  |  |         |     |             |       |             |  |  |  |  |  |  |   |         |     |  |       |       |  |                |        |   |       |         |     |  |       |       |  |  |  |  |  |         |     |  |       |       |  |  |  |  |  |         |     |  |       |       |  |  |  |  |  |         |     |  |       |       |  |  |  |  |  |         |     |  |       |       |  |  |  |  |  |          |     |  |       |       |  |  |  |  |  |         |     |  |       |       |  |  |  |  |  |         |     |  |       |       |  |  |  |  |  |
| 2.0 TFSI   | 125   |                 | 06.05 | 08.11       |                |                |   |                          |   |                          |                |                 |         |             |       |             |                |         |   |                |                          |                |     |             |       |             |       |       |         |                |        |          |               |             |         |         |  |       |       |         |                |         |     |             |       |         |     |  |       |       |         |                |        |             |                |         |         |     |  |       |       |          |                |             |       |             |                |          |   |                |       |         |         |             |       |             |                |        |   |                |     |         |       |             |       |             |  |  |  |         |     |                 |       |             |         |             |  |  |  |  |         |                 |     |             |       |             |                |        |                          |                |     |                 |     |             |       |             |         |                |        |                          |                |         |         |     |       |       |       |         |                |        |  |               |     |         |       |       |       |       |         |                |        |         |            |     |         |       |  |       |       |         |                |                 |     |                |       |         |     |  |       |       |         |                 |        |   |            |       |          |     |  |       |       |                 |     |  |       |       |  |         |     |  |       |       |         |  |       |       |  |  |         |     |  |             |       |         |       |       |  |  |  |         |     |                 |       |       |       |                |        |   |       |  |         |                 |     |       |       |       |  |  |  |  |  |                 |     |  |       |       |  |  |  |  |  |                 |         |     |       |       |       |  |  |  |  |                  |  |         |       |       |       |       |  |  |  |         |     |  |         |       |  |       |       |  |  |                 |     |  |       |          |     |  |       |       |  |                 |     |  |       |       |         |     |  |       |       |             |     |  |       |       |  |         |     |  |       |       |     |  |       |       |  |  |  |   |         |     |             |       |         |                |        |   |                |     |         |     |             |       |         |                |        |   |                |     |         |     |             |       |         |  |  |  |  |  |         |     |             |       |         |  |  |  |  |  |         |     |             |       |         |  |  |  |  |  |         |     |             |       |         |  |  |  |  |  |         |     |             |       |             |                |        |   |                |     |         |     |             |       |             |                |        |   |                |     |         |     |             |       |             |  |  |  |  |  |         |     |             |       |             |  |  |  |  |  |         |     |             |       |             |  |  |  |  |  |         |     |             |       |             |  |  |  |  |  |  |   |         |     |  |       |       |  |                |        |   |       |         |     |  |       |       |  |  |  |  |  |         |     |  |       |       |  |  |  |  |  |         |     |  |       |       |  |  |  |  |  |         |     |  |       |       |  |  |  |  |  |         |     |  |       |       |  |  |  |  |  |          |     |  |       |       |  |  |  |  |  |         |     |  |       |       |  |  |  |  |  |         |     |  |       |       |  |  |  |  |  |
| 2.4  | 130   |                 | 03.05 | 08.11       |                |                |   |                          |   |                          |                |                 |         |             |       |             |                |         |   |                |                          |                |     |             |       |             |       |       |         |                |        |          |               |             |         |         |  |       |       |         |                |         |     |             |       |         |     |  |       |       |         |                |        |             |                |         |         |     |  |       |       |          |                |             |       |             |                |          |   |                |       |         |         |             |       |             |                |        |   |                |     |         |       |             |       |             |  |  |  |         |     |                 |       |             |         |             |  |  |  |  |         |                 |     |             |       |             |                |        |                          |                |     |                 |     |             |       |             |         |                |        |                          |                |         |         |     |       |       |       |         |                |        |  |               |     |         |       |       |       |       |         |                |        |         |            |     |         |       |  |       |       |         |                |                 |     |                |       |         |     |  |       |       |         |                 |        |   |            |       |          |     |  |       |       |                 |     |  |       |       |  |         |     |  |       |       |         |  |       |       |  |  |         |     |  |             |       |         |       |       |  |  |  |         |     |                 |       |       |       |                |        |   |       |  |         |                 |     |       |       |       |  |  |  |  |  |                 |     |  |       |       |  |  |  |  |  |                 |         |     |       |       |       |  |  |  |  |                  |  |         |       |       |       |       |  |  |  |         |     |  |         |       |  |       |       |  |  |                 |     |  |       |          |     |  |       |       |  |                 |     |  |       |       |         |     |  |       |       |             |     |  |       |       |  |         |     |  |       |       |     |  |       |       |  |  |  |   |         |     |             |       |         |                |        |   |                |     |         |     |             |       |         |                |        |   |                |     |         |     |             |       |         |  |  |  |  |  |         |     |             |       |         |  |  |  |  |  |         |     |             |       |         |  |  |  |  |  |         |     |             |       |         |  |  |  |  |  |         |     |             |       |             |                |        |   |                |     |         |     |             |       |             |                |        |   |                |     |         |     |             |       |             |  |  |  |  |  |         |     |             |       |             |  |  |  |  |  |         |     |             |       |             |  |  |  |  |  |         |     |             |       |             |  |  |  |  |  |  |   |         |     |  |       |       |  |                |        |   |       |         |     |  |       |       |  |  |  |  |  |         |     |  |       |       |  |  |  |  |  |         |     |  |       |       |  |  |  |  |  |         |     |  |       |       |  |  |  |  |  |         |     |  |       |       |  |  |  |  |  |          |     |  |       |       |  |  |  |  |  |         |     |  |       |       |  |  |  |  |  |         |     |  |       |       |  |  |  |  |  |
| 2.4 quattro  | 130   |                 | 03.05 | 08.11       |                |                |   |                          |   |                          |                |                 |         |             |       |             |                |         |   |                |                          |                |     |             |       |             |       |       |         |                |        |          |               |             |         |         |  |       |       |         |                |         |     |             |       |         |     |  |       |       |         |                |        |             |                |         |         |     |  |       |       |          |                |             |       |             |                |          |   |                |       |         |         |             |       |             |                |        |   |                |     |         |       |             |       |             |  |  |  |         |     |                 |       |             |         |             |  |  |  |  |         |                 |     |             |       |             |                |        |                          |                |     |                 |     |             |       |             |         |                |        |                          |                |         |         |     |       |       |       |         |                |        |  |               |     |         |       |       |       |       |         |                |        |         |            |     |         |       |  |       |       |         |                |                 |     |                |       |         |     |  |       |       |         |                 |        |   |            |       |          |     |  |       |       |                 |     |  |       |       |  |         |     |  |       |       |         |  |       |       |  |  |         |     |  |             |       |         |       |       |  |  |  |         |     |                 |       |       |       |                |        |   |       |  |         |                 |     |       |       |       |  |  |  |  |  |                 |     |  |       |       |  |  |  |  |  |                 |         |     |       |       |       |  |  |  |  |                  |  |         |       |       |       |       |  |  |  |         |     |  |         |       |  |       |       |  |  |                 |     |  |       |          |     |  |       |       |  |                 |     |  |       |       |         |     |  |       |       |             |     |  |       |       |  |         |     |  |       |       |     |  |       |       |  |  |  |   |         |     |             |       |         |                |        |   |                |     |         |     |             |       |         |                |        |   |                |     |         |     |             |       |         |  |  |  |  |  |         |     |             |       |         |  |  |  |  |  |         |     |             |       |         |  |  |  |  |  |         |     |             |       |         |  |  |  |  |  |         |     |             |       |             |                |        |   |                |     |         |     |             |       |             |                |        |   |                |     |         |     |             |       |             |  |  |  |  |  |         |     |             |       |             |  |  |  |  |  |         |     |             |       |             |  |  |  |  |  |         |     |             |       |             |  |  |  |  |  |  |   |         |     |  |       |       |  |                |        |   |       |         |     |  |       |       |  |  |  |  |  |         |     |  |       |       |  |  |  |  |  |         |     |  |       |       |  |  |  |  |  |         |     |  |       |       |  |  |  |  |  |         |     |  |       |       |  |  |  |  |  |          |     |  |       |       |  |  |  |  |  |         |     |  |       |       |  |  |  |  |  |         |     |  |       |       |  |  |  |  |  |
| 2.7 TDI  | 120   |                 | 03.05 | 08.11       |                |                |   |                          |   |                          |                |                 |         |             |       |             |                |         |   |                |                          |                |     |             |       |             |       |       |         |                |        |          |               |             |         |         |  |       |       |         |                |         |     |             |       |         |     |  |       |       |         |                |        |             |                |         |         |     |  |       |       |          |                |             |       |             |                |          |   |                |       |         |         |             |       |             |                |        |   |                |     |         |       |             |       |             |  |  |  |         |     |                 |       |             |         |             |  |  |  |  |         |                 |     |             |       |             |                |        |                          |                |     |                 |     |             |       |             |         |                |        |                          |                |         |         |     |       |       |       |         |                |        |  |               |     |         |       |       |       |       |         |                |        |         |            |     |         |       |  |       |       |         |                |                 |     |                |       |         |     |  |       |       |         |                 |        |   |            |       |          |     |  |       |       |                 |     |  |       |       |  |         |     |  |       |       |         |  |       |       |  |  |         |     |  |             |       |         |       |       |  |  |  |         |     |                 |       |       |       |                |        |   |       |  |         |                 |     |       |       |       |  |  |  |  |  |                 |     |  |       |       |  |  |  |  |  |                 |         |     |       |       |       |  |  |  |  |                  |  |         |       |       |       |       |  |  |  |         |     |  |         |       |  |       |       |  |  |                 |     |  |       |          |     |  |       |       |  |                 |     |  |       |       |         |     |  |       |       |             |     |  |       |       |  |         |     |  |       |       |     |  |       |       |  |  |  |   |         |     |             |       |         |                |        |   |                |     |         |     |             |       |         |                |        |   |                |     |         |     |             |       |         |  |  |  |  |  |         |     |             |       |         |  |  |  |  |  |         |     |             |       |         |  |  |  |  |  |         |     |             |       |         |  |  |  |  |  |         |     |             |       |             |                |        |   |                |     |         |     |             |       |             |                |        |   |                |     |         |     |             |       |             |  |  |  |  |  |         |     |             |       |             |  |  |  |  |  |         |     |             |       |             |  |  |  |  |  |         |     |             |       |             |  |  |  |  |  |  |   |         |     |  |       |       |  |                |        |   |       |         |     |  |       |       |  |  |  |  |  |         |     |  |       |       |  |  |  |  |  |         |     |  |       |       |  |  |  |  |  |         |     |  |       |       |  |  |  |  |  |         |     |  |       |       |  |  |  |  |  |          |     |  |       |       |  |  |  |  |  |         |     |  |       |       |  |  |  |  |  |         |     |  |       |       |  |  |  |  |  |
| 2.7 TDI  | 132   |                 | 03.05 | 08.11       |                |                |   |                          |   |                          |                |                 |         |             |       |             |                |         |   |                |                          |                |     |             |       |             |       |       |         |                |        |          |               |             |         |         |  |       |       |         |                |         |     |             |       |         |     |  |       |       |         |                |        |             |                |         |         |     |  |       |       |          |                |             |       |             |                |          |   |                |       |         |         |             |       |             |                |        |   |                |     |         |       |             |       |             |  |  |  |         |     |                 |       |             |         |             |  |  |  |  |         |                 |     |             |       |             |                |        |                          |                |     |                 |     |             |       |             |         |                |        |                          |                |         |         |     |       |       |       |         |                |        |  |               |     |         |       |       |       |       |         |                |        |         |            |     |         |       |  |       |       |         |                |                 |     |                |       |         |     |  |       |       |         |                 |        |   |            |       |          |     |  |       |       |                 |     |  |       |       |  |         |     |  |       |       |         |  |       |       |  |  |         |     |  |             |       |         |       |       |  |  |  |         |     |                 |       |       |       |                |        |   |       |  |         |                 |     |       |       |       |  |  |  |  |  |                 |     |  |       |       |  |  |  |  |  |                 |         |     |       |       |       |  |  |  |  |                  |  |         |       |       |       |       |  |  |  |         |     |  |         |       |  |       |       |  |  |                 |     |  |       |          |     |  |       |       |  |                 |     |  |       |       |         |     |  |       |       |             |     |  |       |       |  |         |     |  |       |       |     |  |       |       |  |  |  |   |         |     |             |       |         |                |        |   |                |     |         |     |             |       |         |                |        |   |                |     |         |     |             |       |         |  |  |  |  |  |         |     |             |       |         |  |  |  |  |  |         |     |             |       |         |  |  |  |  |  |         |     |             |       |         |  |  |  |  |  |         |     |             |       |             |                |        |   |                |     |         |     |             |       |             |                |        |   |                |     |         |     |             |       |             |  |  |  |  |  |         |     |             |       |             |  |  |  |  |  |         |     |             |       |             |  |  |  |  |  |         |     |             |       |             |  |  |  |  |  |  |   |         |     |  |       |       |  |                |        |   |       |         |     |  |       |       |  |  |  |  |  |         |     |  |       |       |  |  |  |  |  |         |     |  |       |       |  |  |  |  |  |         |     |  |       |       |  |  |  |  |  |         |     |  |       |       |  |  |  |  |  |          |     |  |       |       |  |  |  |  |  |         |     |  |       |       |  |  |  |  |  |         |     |  |       |       |  |  |  |  |  |
| 2.7 TDI  | 140   |                 | 10.08 | 08.11       |                |                |   |                          |   |                          |                |                 |         |             |       |             |                |         |   |                |                          |                |     |             |       |             |       |       |         |                |        |          |               |             |         |         |  |       |       |         |                |         |     |             |       |         |     |  |       |       |         |                |        |             |                |         |         |     |  |       |       |          |                |             |       |             |                |          |   |                |       |         |         |             |       |             |                |        |   |                |     |         |       |             |       |             |  |  |  |         |     |                 |       |             |         |             |  |  |  |  |         |                 |     |             |       |             |                |        |                          |                |     |                 |     |             |       |             |         |                |        |                          |                |         |         |     |       |       |       |         |                |        |  |               |     |         |       |       |       |       |         |                |        |         |            |     |         |       |  |       |       |         |                |                 |     |                |       |         |     |  |       |       |         |                 |        |   |            |       |          |     |  |       |       |                 |     |  |       |       |  |         |     |  |       |       |         |  |       |       |  |  |         |     |  |             |       |         |       |       |  |  |  |         |     |                 |       |       |       |                |        |   |       |  |         |                 |     |       |       |       |  |  |  |  |  |                 |     |  |       |       |  |  |  |  |  |                 |         |     |       |       |       |  |  |  |  |                  |  |         |       |       |       |       |  |  |  |         |     |  |         |       |  |       |       |  |  |                 |     |  |       |          |     |  |       |       |  |                 |     |  |       |       |         |     |  |       |       |             |     |  |       |       |  |         |     |  |       |       |     |  |       |       |  |  |  |   |         |     |             |       |         |                |        |   |                |     |         |     |             |       |         |                |        |   |                |     |         |     |             |       |         |  |  |  |  |  |         |     |             |       |         |  |  |  |  |  |         |     |             |       |         |  |  |  |  |  |         |     |             |       |         |  |  |  |  |  |         |     |             |       |             |                |        |   |                |     |         |     |             |       |             |                |        |   |                |     |         |     |             |       |             |  |  |  |  |  |         |     |             |       |             |  |  |  |  |  |         |     |             |       |             |  |  |  |  |  |         |     |             |       |             |  |  |  |  |  |  |   |         |     |  |       |       |  |                |        |   |       |         |     |  |       |       |  |  |  |  |  |         |     |  |       |       |  |  |  |  |  |         |     |  |       |       |  |  |  |  |  |         |     |  |       |       |  |  |  |  |  |         |     |  |       |       |  |  |  |  |  |          |     |  |       |       |  |  |  |  |  |         |     |  |       |       |  |  |  |  |  |         |     |  |       |       |  |  |  |  |  |
| 2.7 TDI quattro  | 120   |                 | 06.05 | 08.11       |                |                |   |                          |   |                          |                |                 |         |             |       |             |                |         |   |                |                          |                |     |             |       |             |       |       |         |                |        |          |               |             |         |         |  |       |       |         |                |         |     |             |       |         |     |  |       |       |         |                |        |             |                |         |         |     |  |       |       |          |                |             |       |             |                |          |   |                |       |         |         |             |       |             |                |        |   |                |     |         |       |             |       |             |  |  |  |         |     |                 |       |             |         |             |  |  |  |  |         |                 |     |             |       |             |                |        |                          |                |     |                 |     |             |       |             |         |                |        |                          |                |         |         |     |       |       |       |         |                |        |  |               |     |         |       |       |       |       |         |                |        |         |            |     |         |       |  |       |       |         |                |                 |     |                |       |         |     |  |       |       |         |                 |        |   |            |       |          |     |  |       |       |                 |     |  |       |       |  |         |     |  |       |       |         |  |       |       |  |  |         |     |  |             |       |         |       |       |  |  |  |         |     |                 |       |       |       |                |        |   |       |  |         |                 |     |       |       |       |  |  |  |  |  |                 |     |  |       |       |  |  |  |  |  |                 |         |     |       |       |       |  |  |  |  |                  |  |         |       |       |       |       |  |  |  |         |     |  |         |       |  |       |       |  |  |                 |     |  |       |          |     |  |       |       |  |                 |     |  |       |       |         |     |  |       |       |             |     |  |       |       |  |         |     |  |       |       |     |  |       |       |  |  |  |   |         |     |             |       |         |                |        |   |                |     |         |     |             |       |         |                |        |   |                |     |         |     |             |       |         |  |  |  |  |  |         |     |             |       |         |  |  |  |  |  |         |     |             |       |         |  |  |  |  |  |         |     |             |       |         |  |  |  |  |  |         |     |             |       |             |                |        |   |                |     |         |     |             |       |             |                |        |   |                |     |         |     |             |       |             |  |  |  |  |  |         |     |             |       |             |  |  |  |  |  |         |     |             |       |             |  |  |  |  |  |         |     |             |       |             |  |  |  |  |  |  |   |         |     |  |       |       |  |                |        |   |       |         |     |  |       |       |  |  |  |  |  |         |     |  |       |       |  |  |  |  |  |         |     |  |       |       |  |  |  |  |  |         |     |  |       |       |  |  |  |  |  |         |     |  |       |       |  |  |  |  |  |          |     |  |       |       |  |  |  |  |  |         |     |  |       |       |  |  |  |  |  |         |     |  |       |       |  |  |  |  |  |
| 2.7 TDI quattro  | 132   |                 | 03.05 | 08.11       |                |                |   |                          |   |                          |                |                 |         |             |       |             |                |         |   |                |                          |                |     |             |       |             |       |       |         |                |        |          |               |             |         |         |  |       |       |         |                |         |     |             |       |         |     |  |       |       |         |                |        |             |                |         |         |     |  |       |       |          |                |             |       |             |                |          |   |                |       |         |         |             |       |             |                |        |   |                |     |         |       |             |       |             |  |  |  |         |     |                 |       |             |         |             |  |  |  |  |         |                 |     |             |       |             |                |        |                          |                |     |                 |     |             |       |             |         |                |        |                          |                |         |         |     |       |       |       |         |                |        |  |               |     |         |       |       |       |       |         |                |        |         |            |     |         |       |  |       |       |         |                |                 |     |                |       |         |     |  |       |       |         |                 |        |   |            |       |          |     |  |       |       |                 |     |  |       |       |  |         |     |  |       |       |         |  |       |       |  |  |         |     |  |             |       |         |       |       |  |  |  |         |     |                 |       |       |       |                |        |   |       |  |         |                 |     |       |       |       |  |  |  |  |  |                 |     |  |       |       |  |  |  |  |  |                 |         |     |       |       |       |  |  |  |  |                  |  |         |       |       |       |       |  |  |  |         |     |  |         |       |  |       |       |  |  |                 |     |  |       |          |     |  |       |       |  |                 |     |  |       |       |         |     |  |       |       |             |     |  |       |       |  |         |     |  |       |       |     |  |       |       |  |  |  |   |         |     |             |       |         |                |        |   |                |     |         |     |             |       |         |                |        |   |                |     |         |     |             |       |         |  |  |  |  |  |         |     |             |       |         |  |  |  |  |  |         |     |             |       |         |  |  |  |  |  |         |     |             |       |         |  |  |  |  |  |         |     |             |       |             |                |        |   |                |     |         |     |             |       |             |                |        |   |                |     |         |     |             |       |             |  |  |  |  |  |         |     |             |       |             |  |  |  |  |  |         |     |             |       |             |  |  |  |  |  |         |     |             |       |             |  |  |  |  |  |  |   |         |     |  |       |       |  |                |        |   |       |         |     |  |       |       |  |  |  |  |  |         |     |  |       |       |  |  |  |  |  |         |     |  |       |       |  |  |  |  |  |         |     |  |       |       |  |  |  |  |  |         |     |  |       |       |  |  |  |  |  |          |     |  |       |       |  |  |  |  |  |         |     |  |       |       |  |  |  |  |  |         |     |  |       |       |  |  |  |  |  |
| 2.7 TDI quattro  | 140   |                 | 10.08 | 08.11       |                |                |   |                          |   |                          |                |                 |         |             |       |             |                |         |   |                |                          |                |     |             |       |             |       |       |         |                |        |          |               |             |         |         |  |       |       |         |                |         |     |             |       |         |     |  |       |       |         |                |        |             |                |         |         |     |  |       |       |          |                |             |       |             |                |          |   |                |       |         |         |             |       |             |                |        |   |                |     |         |       |             |       |             |  |  |  |         |     |                 |       |             |         |             |  |  |  |  |         |                 |     |             |       |             |                |        |                          |                |     |                 |     |             |       |             |         |                |        |                          |                |         |         |     |       |       |       |         |                |        |  |               |     |         |       |       |       |       |         |                |        |         |            |     |         |       |  |       |       |         |                |                 |     |                |       |         |     |  |       |       |         |                 |        |   |            |       |          |     |  |       |       |                 |     |  |       |       |  |         |     |  |       |       |         |  |       |       |  |  |         |     |  |             |       |         |       |       |  |  |  |         |     |                 |       |       |       |                |        |   |       |  |         |                 |     |       |       |       |  |  |  |  |  |                 |     |  |       |       |  |  |  |  |  |                 |         |     |       |       |       |  |  |  |  |                  |  |         |       |       |       |       |  |  |  |         |     |  |         |       |  |       |       |  |  |                 |     |  |       |          |     |  |       |       |  |                 |     |  |       |       |         |     |  |       |       |             |     |  |       |       |  |         |     |  |       |       |     |  |       |       |  |  |  |   |         |     |             |       |         |                |        |   |                |     |         |     |             |       |         |                |        |   |                |     |         |     |             |       |         |  |  |  |  |  |         |     |             |       |         |  |  |  |  |  |         |     |             |       |         |  |  |  |  |  |         |     |             |       |         |  |  |  |  |  |         |     |             |       |             |                |        |   |                |     |         |     |             |       |             |                |        |   |                |     |         |     |             |       |             |  |  |  |  |  |         |     |             |       |             |  |  |  |  |  |         |     |             |       |             |  |  |  |  |  |         |     |             |       |             |  |  |  |  |  |  |   |         |     |  |       |       |  |                |        |   |       |         |     |  |       |       |  |  |  |  |  |         |     |  |       |       |  |  |  |  |  |         |     |  |       |       |  |  |  |  |  |         |     |  |       |       |  |  |  |  |  |         |     |  |       |       |  |  |  |  |  |          |     |  |       |       |  |  |  |  |  |         |     |  |       |       |  |  |  |  |  |         |     |  |       |       |  |  |  |  |  |
| 2.8 FSI  | 140   |                 | 10.08 | 08.11       |                |                |   |                          |   |                          |                |                 |         |             |       |             |                |         |   |                |                          |                |     |             |       |             |       |       |         |                |        |          |               |             |         |         |  |       |       |         |                |         |     |             |       |         |     |  |       |       |         |                |        |             |                |         |         |     |  |       |       |          |                |             |       |             |                |          |   |                |       |         |         |             |       |             |                |        |   |                |     |         |       |             |       |             |  |  |  |         |     |                 |       |             |         |             |  |  |  |  |         |                 |     |             |       |             |                |        |                          |                |     |                 |     |             |       |             |         |                |        |                          |                |         |         |     |       |       |       |         |                |        |  |               |     |         |       |       |       |       |         |                |        |         |            |     |         |       |  |       |       |         |                |                 |     |                |       |         |     |  |       |       |         |                 |        |   |            |       |          |     |  |       |       |                 |     |  |       |       |  |         |     |  |       |       |         |  |       |       |  |  |         |     |  |             |       |         |       |       |  |  |  |         |     |                 |       |       |       |                |        |   |       |  |         |                 |     |       |       |       |  |  |  |  |  |                 |     |  |       |       |  |  |  |  |  |                 |         |     |       |       |       |  |  |  |  |                  |  |         |       |       |       |       |  |  |  |         |     |  |         |       |  |       |       |  |  |                 |     |  |       |          |     |  |       |       |  |                 |     |  |       |       |         |     |  |       |       |             |     |  |       |       |  |         |     |  |       |       |     |  |       |       |  |  |  |   |         |     |             |       |         |                |        |   |                |     |         |     |             |       |         |                |        |   |                |     |         |     |             |       |         |  |  |  |  |  |         |     |             |       |         |  |  |  |  |  |         |     |             |       |         |  |  |  |  |  |         |     |             |       |         |  |  |  |  |  |         |     |             |       |             |                |        |   |                |     |         |     |             |       |             |                |        |   |                |     |         |     |             |       |             |  |  |  |  |  |         |     |             |       |             |  |  |  |  |  |         |     |             |       |             |  |  |  |  |  |         |     |             |       |             |  |  |  |  |  |  |   |         |     |  |       |       |  |                |        |   |       |         |     |  |       |       |  |  |  |  |  |         |     |  |       |       |  |  |  |  |  |         |     |  |       |       |  |  |  |  |  |         |     |  |       |       |  |  |  |  |  |         |     |  |       |       |  |  |  |  |  |          |     |  |       |       |  |  |  |  |  |         |     |  |       |       |  |  |  |  |  |         |     |  |       |       |  |  |  |  |  |
| 2.8 FSI  | 154   |                 | 11.06 | 08.11       |                |                |   |                          |   |                          |                |                 |         |             |       |             |                |         |   |                |                          |                |     |             |       |             |       |       |         |                |        |          |               |             |         |         |  |       |       |         |                |         |     |             |       |         |     |  |       |       |         |                |        |             |                |         |         |     |  |       |       |          |                |             |       |             |                |          |   |                |       |         |         |             |       |             |                |        |   |                |     |         |       |             |       |             |  |  |  |         |     |                 |       |             |         |             |  |  |  |  |         |                 |     |             |       |             |                |        |                          |                |     |                 |     |             |       |             |         |                |        |                          |                |         |         |     |       |       |       |         |                |        |  |               |     |         |       |       |       |       |         |                |        |         |            |     |         |       |  |       |       |         |                |                 |     |                |       |         |     |  |       |       |         |                 |        |   |            |       |          |     |  |       |       |                 |     |  |       |       |  |         |     |  |       |       |         |  |       |       |  |  |         |     |  |             |       |         |       |       |  |  |  |         |     |                 |       |       |       |                |        |   |       |  |         |                 |     |       |       |       |  |  |  |  |  |                 |     |  |       |       |  |  |  |  |  |                 |         |     |       |       |       |  |  |  |  |                  |  |         |       |       |       |       |  |  |  |         |     |  |         |       |  |       |       |  |  |                 |     |  |       |          |     |  |       |       |  |                 |     |  |       |       |         |     |  |       |       |             |     |  |       |       |  |         |     |  |       |       |     |  |       |       |  |  |  |   |         |     |             |       |         |                |        |   |                |     |         |     |             |       |         |                |        |   |                |     |         |     |             |       |         |  |  |  |  |  |         |     |             |       |         |  |  |  |  |  |         |     |             |       |         |  |  |  |  |  |         |     |             |       |         |  |  |  |  |  |         |     |             |       |             |                |        |   |                |     |         |     |             |       |             |                |        |   |                |     |         |     |             |       |             |  |  |  |  |  |         |     |             |       |             |  |  |  |  |  |         |     |             |       |             |  |  |  |  |  |         |     |             |       |             |  |  |  |  |  |  |   |         |     |  |       |       |  |                |        |   |       |         |     |  |       |       |  |  |  |  |  |         |     |  |       |       |  |  |  |  |  |         |     |  |       |       |  |  |  |  |  |         |     |  |       |       |  |  |  |  |  |         |     |  |       |       |  |  |  |  |  |          |     |  |       |       |  |  |  |  |  |         |     |  |       |       |  |  |  |  |  |         |     |  |       |       |  |  |  |  |  |
| 2.8 FSI  | 162   |                 | 10.08 | 08.11       |                |                |   |                          |   |                          |                |                 |         |             |       |             |                |         |   |                |                          |                |     |             |       |             |       |       |         |                |        |          |               |             |         |         |  |       |       |         |                |         |     |             |       |         |     |  |       |       |         |                |        |             |                |         |         |     |  |       |       |          |                |             |       |             |                |          |   |                |       |         |         |             |       |             |                |        |   |                |     |         |       |             |       |             |  |  |  |         |     |                 |       |             |         |             |  |  |  |  |         |                 |     |             |       |             |                |        |                          |                |     |                 |     |             |       |             |         |                |        |                          |                |         |         |     |       |       |       |         |                |        |  |               |     |         |       |       |       |       |         |                |        |         |            |     |         |       |  |       |       |         |                |                 |     |                |       |         |     |  |       |       |         |                 |        |   |            |       |          |     |  |       |       |                 |     |  |       |       |  |         |     |  |       |       |         |  |       |       |  |  |         |     |  |             |       |         |       |       |  |  |  |         |     |                 |       |       |       |                |        |   |       |  |         |                 |     |       |       |       |  |  |  |  |  |                 |     |  |       |       |  |  |  |  |  |                 |         |     |       |       |       |  |  |  |  |                  |  |         |       |       |       |       |  |  |  |         |     |  |         |       |  |       |       |  |  |                 |     |  |       |          |     |  |       |       |  |                 |     |  |       |       |         |     |  |       |       |             |     |  |       |       |  |         |     |  |       |       |     |  |       |       |  |  |  |   |         |     |             |       |         |                |        |   |                |     |         |     |             |       |         |                |        |   |                |     |         |     |             |       |         |  |  |  |  |  |         |     |             |       |         |  |  |  |  |  |         |     |             |       |         |  |  |  |  |  |         |     |             |       |         |  |  |  |  |  |         |     |             |       |             |                |        |   |                |     |         |     |             |       |             |                |        |   |                |     |         |     |             |       |             |  |  |  |  |  |         |     |             |       |             |  |  |  |  |  |         |     |             |       |             |  |  |  |  |  |         |     |             |       |             |  |  |  |  |  |  |   |         |     |  |       |       |  |                |        |   |       |         |     |  |       |       |  |  |  |  |  |         |     |  |       |       |  |  |  |  |  |         |     |  |       |       |  |  |  |  |  |         |     |  |       |       |  |  |  |  |  |         |     |  |       |       |  |  |  |  |  |          |     |  |       |       |  |  |  |  |  |         |     |  |       |       |  |  |  |  |  |         |     |  |       |       |  |  |  |  |  |
| 2.8 FSI quattro  | 140   |                 | 10.08 | 08.11       |                |                |   |                          |   |                          |                |                 |         |             |       |             |                |         |   |                |                          |                |     |             |       |             |       |       |         |                |        |          |               |             |         |         |  |       |       |         |                |         |     |             |       |         |     |  |       |       |         |                |        |             |                |         |         |     |  |       |       |          |                |             |       |             |                |          |   |                |       |         |         |             |       |             |                |        |   |                |     |         |       |             |       |             |  |  |  |         |     |                 |       |             |         |             |  |  |  |  |         |                 |     |             |       |             |                |        |                          |                |     |                 |     |             |       |             |         |                |        |                          |                |         |         |     |       |       |       |         |                |        |  |               |     |         |       |       |       |       |         |                |        |         |            |     |         |       |  |       |       |         |                |                 |     |                |       |         |     |  |       |       |         |                 |        |   |            |       |          |     |  |       |       |                 |     |  |       |       |  |         |     |  |       |       |         |  |       |       |  |  |         |     |  |             |       |         |       |       |  |  |  |         |     |                 |       |       |       |                |        |   |       |  |         |                 |     |       |       |       |  |  |  |  |  |                 |     |  |       |       |  |  |  |  |  |                 |         |     |       |       |       |  |  |  |  |                  |  |         |       |       |       |       |  |  |  |         |     |  |         |       |  |       |       |  |  |                 |     |  |       |          |     |  |       |       |  |                 |     |  |       |       |         |     |  |       |       |             |     |  |       |       |  |         |     |  |       |       |     |  |       |       |  |  |  |   |         |     |             |       |         |                |        |   |                |     |         |     |             |       |         |                |        |   |                |     |         |     |             |       |         |  |  |  |  |  |         |     |             |       |         |  |  |  |  |  |         |     |             |       |         |  |  |  |  |  |         |     |             |       |         |  |  |  |  |  |         |     |             |       |             |                |        |   |                |     |         |     |             |       |             |                |        |   |                |     |         |     |             |       |             |  |  |  |  |  |         |     |             |       |             |  |  |  |  |  |         |     |             |       |             |  |  |  |  |  |         |     |             |       |             |  |  |  |  |  |  |   |         |     |  |       |       |  |                |        |   |       |         |     |  |       |       |  |  |  |  |  |         |     |  |       |       |  |  |  |  |  |         |     |  |       |       |  |  |  |  |  |         |     |  |       |       |  |  |  |  |  |         |     |  |       |       |  |  |  |  |  |          |     |  |       |       |  |  |  |  |  |         |     |  |       |       |  |  |  |  |  |         |     |  |       |       |  |  |  |  |  |
| 2.8 FSI quattro  | 154   |                 | 04.07 | 08.11       |                |                |   |                          |   |                          |                |                 |         |             |       |             |                |         |   |                |                          |                |     |             |       |             |       |       |         |                |        |          |               |             |         |         |  |       |       |         |                |         |     |             |       |         |     |  |       |       |         |                |        |             |                |         |         |     |  |       |       |          |                |             |       |             |                |          |   |                |       |         |         |             |       |             |                |        |   |                |     |         |       |             |       |             |  |  |  |         |     |                 |       |             |         |             |  |  |  |  |         |                 |     |             |       |             |                |        |                          |                |     |                 |     |             |       |             |         |                |        |                          |                |         |         |     |       |       |       |         |                |        |  |               |     |         |       |       |       |       |         |                |        |         |            |     |         |       |  |       |       |         |                |                 |     |                |       |         |     |  |       |       |         |                 |        |   |            |       |          |     |  |       |       |                 |     |  |       |       |  |         |     |  |       |       |         |  |       |       |  |  |         |     |  |             |       |         |       |       |  |  |  |         |     |                 |       |       |       |                |        |   |       |  |         |                 |     |       |       |       |  |  |  |  |  |                 |     |  |       |       |  |  |  |  |  |                 |         |     |       |       |       |  |  |  |  |                  |  |         |       |       |       |       |  |  |  |         |     |  |         |       |  |       |       |  |  |                 |     |  |       |          |     |  |       |       |  |                 |     |  |       |       |         |     |  |       |       |             |     |  |       |       |  |         |     |  |       |       |     |  |       |       |  |  |  |   |         |     |             |       |         |                |        |   |                |     |         |     |             |       |         |                |        |   |                |     |         |     |             |       |         |  |  |  |  |  |         |     |             |       |         |  |  |  |  |  |         |     |             |       |         |  |  |  |  |  |         |     |             |       |         |  |  |  |  |  |         |     |             |       |             |                |        |   |                |     |         |     |             |       |             |                |        |   |                |     |         |     |             |       |             |  |  |  |  |  |         |     |             |       |             |  |  |  |  |  |         |     |             |       |             |  |  |  |  |  |         |     |             |       |             |  |  |  |  |  |  |   |         |     |  |       |       |  |                |        |   |       |         |     |  |       |       |  |  |  |  |  |         |     |  |       |       |  |  |  |  |  |         |     |  |       |       |  |  |  |  |  |         |     |  |       |       |  |  |  |  |  |         |     |  |       |       |  |  |  |  |  |          |     |  |       |       |  |  |  |  |  |         |     |  |       |       |  |  |  |  |  |         |     |  |       |       |  |  |  |  |  |
| 2.8 FSI quattro  | 162   |                 | 10.08 | 08.11       |                |                |   |                          |   |                          |                |                 |         |             |       |             |                |         |   |                |                          |                |     |             |       |             |       |       |         |                |        |          |               |             |         |         |  |       |       |         |                |         |     |             |       |         |     |  |       |       |         |                |        |             |                |         |         |     |  |       |       |          |                |             |       |             |                |          |   |                |       |         |         |             |       |             |                |        |   |                |     |         |       |             |       |             |  |  |  |         |     |                 |       |             |         |             |  |  |  |  |         |                 |     |             |       |             |                |        |                          |                |     |                 |     |             |       |             |         |                |        |                          |                |         |         |     |       |       |       |         |                |        |  |               |     |         |       |       |       |       |         |                |        |         |            |     |         |       |  |       |       |         |                |                 |     |                |       |         |     |  |       |       |         |                 |        |   |            |       |          |     |  |       |       |                 |     |  |       |       |  |         |     |  |       |       |         |  |       |       |  |  |         |     |  |             |       |         |       |       |  |  |  |         |     |                 |       |       |       |                |        |   |       |  |         |                 |     |       |       |       |  |  |  |  |  |                 |     |  |       |       |  |  |  |  |  |                 |         |     |       |       |       |  |  |  |  |                  |  |         |       |       |       |       |  |  |  |         |     |  |         |       |  |       |       |  |  |                 |     |  |       |          |     |  |       |       |  |                 |     |  |       |       |         |     |  |       |       |             |     |  |       |       |  |         |     |  |       |       |     |  |       |       |  |  |  |   |         |     |             |       |         |                |        |   |                |     |         |     |             |       |         |                |        |   |                |     |         |     |             |       |         |  |  |  |  |  |         |     |             |       |         |  |  |  |  |  |         |     |             |       |         |  |  |  |  |  |         |     |             |       |         |  |  |  |  |  |         |     |             |       |             |                |        |   |                |     |         |     |             |       |             |                |        |   |                |     |         |     |             |       |             |  |  |  |  |  |         |     |             |       |             |  |  |  |  |  |         |     |             |       |             |  |  |  |  |  |         |     |             |       |             |  |  |  |  |  |  |   |         |     |  |       |       |  |                |        |   |       |         |     |  |       |       |  |  |  |  |  |         |     |  |       |       |  |  |  |  |  |         |     |  |       |       |  |  |  |  |  |         |     |  |       |       |  |  |  |  |  |         |     |  |       |       |  |  |  |  |  |          |     |  |       |       |  |  |  |  |  |         |     |  |       |       |  |  |  |  |  |         |     |  |       |       |  |  |  |  |  |
| 3.0  | 160   |                 | 03.05 | 08.11       |                |                |   |                          |   |                          |                |                 |         |             |       |             |                |         |   |                |                          |                |     |             |       |             |       |       |         |                |        |          |               |             |         |         |  |       |       |         |                |         |     |             |       |         |     |  |       |       |         |                |        |             |                |         |         |     |  |       |       |          |                |             |       |             |                |          |   |                |       |         |         |             |       |             |                |        |   |                |     |         |       |             |       |             |  |  |  |         |     |                 |       |             |         |             |  |  |  |  |         |                 |     |             |       |             |                |        |                          |                |     |                 |     |             |       |             |         |                |        |                          |                |         |         |     |       |       |       |         |                |        |  |               |     |         |       |       |       |       |         |                |        |         |            |     |         |       |  |       |       |         |                |                 |     |                |       |         |     |  |       |       |         |                 |        |   |            |       |          |     |  |       |       |                 |     |  |       |       |  |         |     |  |       |       |         |  |       |       |  |  |         |     |  |             |       |         |       |       |  |  |  |         |     |                 |       |       |       |                |        |   |       |  |         |                 |     |       |       |       |  |  |  |  |  |                 |     |  |       |       |  |  |  |  |  |                 |         |     |       |       |       |  |  |  |  |                  |  |         |       |       |       |       |  |  |  |         |     |  |         |       |  |       |       |  |  |                 |     |  |       |          |     |  |       |       |  |                 |     |  |       |       |         |     |  |       |       |             |     |  |       |       |  |         |     |  |       |       |     |  |       |       |  |  |  |   |         |     |             |       |         |                |        |   |                |     |         |     |             |       |         |                |        |   |                |     |         |     |             |       |         |  |  |  |  |  |         |     |             |       |         |  |  |  |  |  |         |     |             |       |         |  |  |  |  |  |         |     |             |       |         |  |  |  |  |  |         |     |             |       |             |                |        |   |                |     |         |     |             |       |             |                |        |   |                |     |         |     |             |       |             |  |  |  |  |  |         |     |             |       |             |  |  |  |  |  |         |     |             |       |             |  |  |  |  |  |         |     |             |       |             |  |  |  |  |  |  |   |         |     |  |       |       |  |                |        |   |       |         |     |  |       |       |  |  |  |  |  |         |     |  |       |       |  |  |  |  |  |         |     |  |       |       |  |  |  |  |  |         |     |  |       |       |  |  |  |  |  |         |     |  |       |       |  |  |  |  |  |          |     |  |       |       |  |  |  |  |  |         |     |  |       |       |  |  |  |  |  |         |     |  |       |       |  |  |  |  |  |
| 3.0 quattro  | 160   |                 | 03.05 | 08.11       |                |                |   |                          |   |                          |                |                 |         |             |       |             |                |         |   |                |                          |                |     |             |       |             |       |       |         |                |        |          |               |             |         |         |  |       |       |         |                |         |     |             |       |         |     |  |       |       |         |                |        |             |                |         |         |     |  |       |       |          |                |             |       |             |                |          |   |                |       |         |         |             |       |             |                |        |   |                |     |         |       |             |       |             |  |  |  |         |     |                 |       |             |         |             |  |  |  |  |         |                 |     |             |       |             |                |        |                          |                |     |                 |     |             |       |             |         |                |        |                          |                |         |         |     |       |       |       |         |                |        |  |               |     |         |       |       |       |       |         |                |        |         |            |     |         |       |  |       |       |         |                |                 |     |                |       |         |     |  |       |       |         |                 |        |   |            |       |          |     |  |       |       |                 |     |  |       |       |  |         |     |  |       |       |         |  |       |       |  |  |         |     |  |             |       |         |       |       |  |  |  |         |     |                 |       |       |       |                |        |   |       |  |         |                 |     |       |       |       |  |  |  |  |  |                 |     |  |       |       |  |  |  |  |  |                 |         |     |       |       |       |  |  |  |  |                  |  |         |       |       |       |       |  |  |  |         |     |  |         |       |  |       |       |  |  |                 |     |  |       |          |     |  |       |       |  |                 |     |  |       |       |         |     |  |       |       |             |     |  |       |       |  |         |     |  |       |       |     |  |       |       |  |  |  |   |         |     |             |       |         |                |        |   |                |     |         |     |             |       |         |                |        |   |                |     |         |     |             |       |         |  |  |  |  |  |         |     |             |       |         |  |  |  |  |  |         |     |             |       |         |  |  |  |  |  |         |     |             |       |         |  |  |  |  |  |         |     |             |       |             |                |        |   |                |     |         |     |             |       |             |                |        |   |                |     |         |     |             |       |             |  |  |  |  |  |         |     |             |       |             |  |  |  |  |  |         |     |             |       |             |  |  |  |  |  |         |     |             |       |             |  |  |  |  |  |  |   |         |     |  |       |       |  |                |        |   |       |         |     |  |       |       |  |  |  |  |  |         |     |  |       |       |  |  |  |  |  |         |     |  |       |       |  |  |  |  |  |         |     |  |       |       |  |  |  |  |  |         |     |  |       |       |  |  |  |  |  |          |     |  |       |       |  |  |  |  |  |         |     |  |       |       |  |  |  |  |  |         |     |  |       |       |  |  |  |  |  |
| 3.0 TDI quattro  | 155   |                 | 03.05 | 08.11       |                |                |   |                          |   |                          |                |                 |         |             |       |             |                |         |   |                |                          |                |     |             |       |             |       |       |         |                |        |          |               |             |         |         |  |       |       |         |                |         |     |             |       |         |     |  |       |       |         |                |        |             |                |         |         |     |  |       |       |          |                |             |       |             |                |          |   |                |       |         |         |             |       |             |                |        |   |                |     |         |       |             |       |             |  |  |  |         |     |                 |       |             |         |             |  |  |  |  |         |                 |     |             |       |             |                |        |                          |                |     |                 |     |             |       |             |         |                |        |                          |                |         |         |     |       |       |       |         |                |        |  |               |     |         |       |       |       |       |         |                |        |         |            |     |         |       |  |       |       |         |                |                 |     |                |       |         |     |  |       |       |         |                 |        |   |            |       |          |     |  |       |       |                 |     |  |       |       |  |         |     |  |       |       |         |  |       |       |  |  |         |     |  |             |       |         |       |       |  |  |  |         |     |                 |       |       |       |                |        |   |       |  |         |                 |     |       |       |       |  |  |  |  |  |                 |     |  |       |       |  |  |  |  |  |                 |         |     |       |       |       |  |  |  |  |                  |  |         |       |       |       |       |  |  |  |         |     |  |         |       |  |       |       |  |  |                 |     |  |       |          |     |  |       |       |  |                 |     |  |       |       |         |     |  |       |       |             |     |  |       |       |  |         |     |  |       |       |     |  |       |       |  |  |  |   |         |     |             |       |         |                |        |   |                |     |         |     |             |       |         |                |        |   |                |     |         |     |             |       |         |  |  |  |  |  |         |     |             |       |         |  |  |  |  |  |         |     |             |       |         |  |  |  |  |  |         |     |             |       |         |  |  |  |  |  |         |     |             |       |             |                |        |   |                |     |         |     |             |       |             |                |        |   |                |     |         |     |             |       |             |  |  |  |  |  |         |     |             |       |             |  |  |  |  |  |         |     |             |       |             |  |  |  |  |  |         |     |             |       |             |  |  |  |  |  |  |   |         |     |  |       |       |  |                |        |   |       |         |     |  |       |       |  |  |  |  |  |         |     |  |       |       |  |  |  |  |  |         |     |  |       |       |  |  |  |  |  |         |     |  |       |       |  |  |  |  |  |         |     |  |       |       |  |  |  |  |  |          |     |  |       |       |  |  |  |  |  |         |     |  |       |       |  |  |  |  |  |         |     |  |       |       |  |  |  |  |  |
| 3.0 TDI quattro  | 165   |                 | 03.05 | 08.11       |                |                |   |                          |   |                          |                |                 |         |             |       |             |                |         |   |                |                          |                |     |             |       |             |       |       |         |                |        |          |               |             |         |         |  |       |       |         |                |         |     |             |       |         |     |  |       |       |         |                |        |             |                |         |         |     |  |       |       |          |                |             |       |             |                |          |   |                |       |         |         |             |       |             |                |        |   |                |     |         |       |             |       |             |  |  |  |         |     |                 |       |             |         |             |  |  |  |  |         |                 |     |             |       |             |                |        |                          |                |     |                 |     |             |       |             |         |                |        |                          |                |         |         |     |       |       |       |         |                |        |  |               |     |         |       |       |       |       |         |                |        |         |            |     |         |       |  |       |       |         |                |                 |     |                |       |         |     |  |       |       |         |                 |        |   |            |       |          |     |  |       |       |                 |     |  |       |       |  |         |     |  |       |       |         |  |       |       |  |  |         |     |  |             |       |         |       |       |  |  |  |         |     |                 |       |       |       |                |        |   |       |  |         |                 |     |       |       |       |  |  |  |  |  |                 |     |  |       |       |  |  |  |  |  |                 |         |     |       |       |       |  |  |  |  |                  |  |         |       |       |       |       |  |  |  |         |     |  |         |       |  |       |       |  |  |                 |     |  |       |          |     |  |       |       |  |                 |     |  |       |       |         |     |  |       |       |             |     |  |       |       |  |         |     |  |       |       |     |  |       |       |  |  |  |   |         |     |             |       |         |                |        |   |                |     |         |     |             |       |         |                |        |   |                |     |         |     |             |       |         |  |  |  |  |  |         |     |             |       |         |  |  |  |  |  |         |     |             |       |         |  |  |  |  |  |         |     |             |       |         |  |  |  |  |  |         |     |             |       |             |                |        |   |                |     |         |     |             |       |             |                |        |   |                |     |         |     |             |       |             |  |  |  |  |  |         |     |             |       |             |  |  |  |  |  |         |     |             |       |             |  |  |  |  |  |         |     |             |       |             |  |  |  |  |  |  |   |         |     |  |       |       |  |                |        |   |       |         |     |  |       |       |  |  |  |  |  |         |     |  |       |       |  |  |  |  |  |         |     |  |       |       |  |  |  |  |  |         |     |  |       |       |  |  |  |  |  |         |     |  |       |       |  |  |  |  |  |          |     |  |       |       |  |  |  |  |  |         |     |  |       |       |  |  |  |  |  |         |     |  |       |       |  |  |  |  |  |
| 3.0 TDI quattro  | 171   |                 | 06.06 | 08.11       |                |                |   |                          |   |                          |                |                 |         |             |       |             |                |         |   |                |                          |                |     |             |       |             |       |       |         |                |        |          |               |             |         |         |  |       |       |         |                |         |     |             |       |         |     |  |       |       |         |                |        |             |                |         |         |     |  |       |       |          |                |             |       |             |                |          |   |                |       |         |         |             |       |             |                |        |   |                |     |         |       |             |       |             |  |  |  |         |     |                 |       |             |         |             |  |  |  |  |         |                 |     |             |       |             |                |        |                          |                |     |                 |     |             |       |             |         |                |        |                          |                |         |         |     |       |       |       |         |                |        |  |               |     |         |       |       |       |       |         |                |        |         |            |     |         |       |  |       |       |         |                |                 |     |                |       |         |     |  |       |       |         |                 |        |   |            |       |          |     |  |       |       |                 |     |  |       |       |  |         |     |  |       |       |         |  |       |       |  |  |         |     |  |             |       |         |       |       |  |  |  |         |     |                 |       |       |       |                |        |   |       |  |         |                 |     |       |       |       |  |  |  |  |  |                 |     |  |       |       |  |  |  |  |  |                 |         |     |       |       |       |  |  |  |  |                  |  |         |       |       |       |       |  |  |  |         |     |  |         |       |  |       |       |  |  |                 |     |  |       |          |     |  |       |       |  |                 |     |  |       |       |         |     |  |       |       |             |     |  |       |       |  |         |     |  |       |       |     |  |       |       |  |  |  |   |         |     |             |       |         |                |        |   |                |     |         |     |             |       |         |                |        |   |                |     |         |     |             |       |         |  |  |  |  |  |         |     |             |       |         |  |  |  |  |  |         |     |             |       |         |  |  |  |  |  |         |     |             |       |         |  |  |  |  |  |         |     |             |       |             |                |        |   |                |     |         |     |             |       |             |                |        |   |                |     |         |     |             |       |             |  |  |  |  |  |         |     |             |       |             |  |  |  |  |  |         |     |             |       |             |  |  |  |  |  |         |     |             |       |             |  |  |  |  |  |  |   |         |     |  |       |       |  |                |        |   |       |         |     |  |       |       |  |  |  |  |  |         |     |  |       |       |  |  |  |  |  |         |     |  |       |       |  |  |  |  |  |         |     |  |       |       |  |  |  |  |  |         |     |  |       |       |  |  |  |  |  |          |     |  |       |       |  |  |  |  |  |         |     |  |       |       |  |  |  |  |  |         |     |  |       |       |  |  |  |  |  |
| 3.0 TDI quattro  | 176   |                 | 10.08 | 08.11       |                |                |   |                          |   |                          |                |                 |         |             |       |             |                |         |   |                |                          |                |     |             |       |             |       |       |         |                |        |          |               |             |         |         |  |       |       |         |                |         |     |             |       |         |     |  |       |       |         |                |        |             |                |         |         |     |  |       |       |          |                |             |       |             |                |          |   |                |       |         |         |             |       |             |                |        |   |                |     |         |       |             |       |             |  |  |  |         |     |                 |       |             |         |             |  |  |  |  |         |                 |     |             |       |             |                |        |                          |                |     |                 |     |             |       |             |         |                |        |                          |                |         |         |     |       |       |       |         |                |        |  |               |     |         |       |       |       |       |         |                |        |         |            |     |         |       |  |       |       |         |                |                 |     |                |       |         |     |  |       |       |         |                 |        |   |            |       |          |     |  |       |       |                 |     |  |       |       |  |         |     |  |       |       |         |  |       |       |  |  |         |     |  |             |       |         |       |       |  |  |  |         |     |                 |       |       |       |                |        |   |       |  |         |                 |     |       |       |       |  |  |  |  |  |                 |     |  |       |       |  |  |  |  |  |                 |         |     |       |       |       |  |  |  |  |                  |  |         |       |       |       |       |  |  |  |         |     |  |         |       |  |       |       |  |  |                 |     |  |       |          |     |  |       |       |  |                 |     |  |       |       |         |     |  |       |       |             |     |  |       |       |  |         |     |  |       |       |     |  |       |       |  |  |  |   |         |     |             |       |         |                |        |   |                |     |         |     |             |       |         |                |        |   |                |     |         |     |             |       |         |  |  |  |  |  |         |     |             |       |         |  |  |  |  |  |         |     |             |       |         |  |  |  |  |  |         |     |             |       |         |  |  |  |  |  |         |     |             |       |             |                |        |   |                |     |         |     |             |       |             |                |        |   |                |     |         |     |             |       |             |  |  |  |  |  |         |     |             |       |             |  |  |  |  |  |         |     |             |       |             |  |  |  |  |  |         |     |             |       |             |  |  |  |  |  |  |   |         |     |  |       |       |  |                |        |   |       |         |     |  |       |       |  |  |  |  |  |         |     |  |       |       |  |  |  |  |  |         |     |  |       |       |  |  |  |  |  |         |     |  |       |       |  |  |  |  |  |         |     |  |       |       |  |  |  |  |  |          |     |  |       |       |  |  |  |  |  |         |     |  |       |       |  |  |  |  |  |         |     |  |       |       |  |  |  |  |  |
| 3.0 TFSI quattro   |   |                 | 10.08 | 08.11       |                |                |   |                          |   |                          |                |                 |         |             |       |             |                |         |   |                |                          |                |     |             |       |             |       |       |         |                |        |          |               |             |         |         |  |       |       |         |                |         |     |             |       |         |     |  |       |       |         |                |        |             |                |         |         |     |  |       |       |          |                |             |       |             |                |          |   |                |       |         |         |             |       |             |                |        |   |                |     |         |       |             |       |             |  |  |  |         |     |                 |       |             |         |             |  |  |  |  |         |                 |     |             |       |             |                |        |                          |                |     |                 |     |             |       |             |         |                |        |                          |                |         |         |     |       |       |       |         |                |        |  |               |     |         |       |       |       |       |         |                |        |         |            |     |         |       |  |       |       |         |                |                 |     |                |       |         |     |  |       |       |         |                 |        |   |            |       |          |     |  |       |       |                 |     |  |       |       |  |         |     |  |       |       |         |  |       |       |  |  |         |     |  |             |       |         |       |       |  |  |  |         |     |                 |       |       |       |                |        |   |       |  |         |                 |     |       |       |       |  |  |  |  |  |                 |     |  |       |       |  |  |  |  |  |                 |         |     |       |       |       |  |  |  |  |                  |  |         |       |       |       |       |  |  |  |         |     |  |         |       |  |       |       |  |  |                 |     |  |       |          |     |  |       |       |  |                 |     |  |       |       |         |     |  |       |       |             |     |  |       |       |  |         |     |  |       |       |     |  |       |       |  |  |  |   |         |     |             |       |         |                |        |   |                |     |         |     |             |       |         |                |        |   |                |     |         |     |             |       |         |  |  |  |  |  |         |     |             |       |         |  |  |  |  |  |         |     |             |       |         |  |  |  |  |  |         |     |             |       |         |  |  |  |  |  |         |     |             |       |             |                |        |   |                |     |         |     |             |       |             |                |        |   |                |     |         |     |             |       |             |  |  |  |  |  |         |     |             |       |             |  |  |  |  |  |         |     |             |       |             |  |  |  |  |  |         |     |             |       |             |  |  |  |  |  |  |   |         |     |  |       |       |  |                |        |   |       |         |     |  |       |       |  |  |  |  |  |         |     |  |       |       |  |  |  |  |  |         |     |  |       |       |  |  |  |  |  |         |     |  |       |       |  |  |  |  |  |         |     |  |       |       |  |  |  |  |  |          |     |  |       |       |  |  |  |  |  |         |     |  |       |       |  |  |  |  |  |         |     |  |       |       |  |  |  |  |  |
| 3.2 FSI  | 188   |                 | 03.05 | 08.11       |                |                |   |                          |   |                          |                |                 |         |             |       |             |                |         |   |                |                          |                |     |             |       |             |       |       |         |                |        |          |               |             |         |         |  |       |       |         |                |         |     |             |       |         |     |  |       |       |         |                |        |             |                |         |         |     |  |       |       |          |                |             |       |             |                |          |   |                |       |         |         |             |       |             |                |        |   |                |     |         |       |             |       |             |  |  |  |         |     |                 |       |             |         |             |  |  |  |  |         |                 |     |             |       |             |                |        |                          |                |     |                 |     |             |       |             |         |                |        |                          |                |         |         |     |       |       |       |         |                |        |  |               |     |         |       |       |       |       |         |                |        |         |            |     |         |       |  |       |       |         |                |                 |     |                |       |         |     |  |       |       |         |                 |        |   |            |       |          |     |  |       |       |                 |     |  |       |       |  |         |     |  |       |       |         |  |       |       |  |  |         |     |  |             |       |         |       |       |  |  |  |         |     |                 |       |       |       |                |        |   |       |  |         |                 |     |       |       |       |  |  |  |  |  |                 |     |  |       |       |  |  |  |  |  |                 |         |     |       |       |       |  |  |  |  |                  |  |         |       |       |       |       |  |  |  |         |     |  |         |       |  |       |       |  |  |                 |     |  |       |          |     |  |       |       |  |                 |     |  |       |       |         |     |  |       |       |             |     |  |       |       |  |         |     |  |       |       |     |  |       |       |  |  |  |   |         |     |             |       |         |                |        |   |                |     |         |     |             |       |         |                |        |   |                |     |         |     |             |       |         |  |  |  |  |  |         |     |             |       |         |  |  |  |  |  |         |     |             |       |         |  |  |  |  |  |         |     |             |       |         |  |  |  |  |  |         |     |             |       |             |                |        |   |                |     |         |     |             |       |             |                |        |   |                |     |         |     |             |       |             |  |  |  |  |  |         |     |             |       |             |  |  |  |  |  |         |     |             |       |             |  |  |  |  |  |         |     |             |       |             |  |  |  |  |  |  |   |         |     |  |       |       |  |                |        |   |       |         |     |  |       |       |  |  |  |  |  |         |     |  |       |       |  |  |  |  |  |         |     |  |       |       |  |  |  |  |  |         |     |  |       |       |  |  |  |  |  |         |     |  |       |       |  |  |  |  |  |          |     |  |       |       |  |  |  |  |  |         |     |  |       |       |  |  |  |  |  |         |     |  |       |       |  |  |  |  |  |
| 3.2 FSI quattro  | 188   |                 | 03.05 | 08.11       |                |                |   |                          |   |                          |                |                 |         |             |       |             |                |         |   |                |                          |                |     |             |       |             |       |       |         |                |        |          |               |             |         |         |  |       |       |         |                |         |     |             |       |         |     |  |       |       |         |                |        |             |                |         |         |     |  |       |       |          |                |             |       |             |                |          |   |                |       |         |         |             |       |             |                |        |   |                |     |         |       |             |       |             |  |  |  |         |     |                 |       |             |         |             |  |  |  |  |         |                 |     |             |       |             |                |        |                          |                |     |                 |     |             |       |             |         |                |        |                          |                |         |         |     |       |       |       |         |                |        |  |               |     |         |       |       |       |       |         |                |        |         |            |     |         |       |  |       |       |         |                |                 |     |                |       |         |     |  |       |       |         |                 |        |   |            |       |          |     |  |       |       |                 |     |  |       |       |  |         |     |  |       |       |         |  |       |       |  |  |         |     |  |             |       |         |       |       |  |  |  |         |     |                 |       |       |       |                |        |   |       |  |         |                 |     |       |       |       |  |  |  |  |  |                 |     |  |       |       |  |  |  |  |  |                 |         |     |       |       |       |  |  |  |  |                  |  |         |       |       |       |       |  |  |  |         |     |  |         |       |  |       |       |  |  |                 |     |  |       |          |     |  |       |       |  |                 |     |  |       |       |         |     |  |       |       |             |     |  |       |       |  |         |     |  |       |       |     |  |       |       |  |  |  |   |         |     |             |       |         |                |        |   |                |     |         |     |             |       |         |                |        |   |                |     |         |     |             |       |         |  |  |  |  |  |         |     |             |       |         |  |  |  |  |  |         |     |             |       |         |  |  |  |  |  |         |     |             |       |         |  |  |  |  |  |         |     |             |       |             |                |        |   |                |     |         |     |             |       |             |                |        |   |                |     |         |     |             |       |             |  |  |  |  |  |         |     |             |       |             |  |  |  |  |  |         |     |             |       |             |  |  |  |  |  |         |     |             |       |             |  |  |  |  |  |  |   |         |     |  |       |       |  |                |        |   |       |         |     |  |       |       |  |  |  |  |  |         |     |  |       |       |  |  |  |  |  |         |     |  |       |       |  |  |  |  |  |         |     |  |       |       |  |  |  |  |  |         |     |  |       |       |  |  |  |  |  |          |     |  |       |       |  |  |  |  |  |         |     |  |       |       |  |  |  |  |  |         |     |  |       |       |  |  |  |  |  |
| 4.2 FSI quattro  | 257   |                 | 06.06 | 08.11       |                |                |   |                          |   |                          |                |                 |         |             |       |             |                |         |   |                |                          |                |     |             |       |             |       |       |         |                |        |          |               |             |         |         |  |       |       |         |                |         |     |             |       |         |     |  |       |       |         |                |        |             |                |         |         |     |  |       |       |          |                |             |       |             |                |          |   |                |       |         |         |             |       |             |                |        |   |                |     |         |       |             |       |             |  |  |  |         |     |                 |       |             |         |             |  |  |  |  |         |                 |     |             |       |             |                |        |                          |                |     |                 |     |             |       |             |         |                |        |                          |                |         |         |     |       |       |       |         |                |        |  |               |     |         |       |       |       |       |         |                |        |         |            |     |         |       |  |       |       |         |                |                 |     |                |       |         |     |  |       |       |         |                 |        |   |            |       |          |     |  |       |       |                 |     |  |       |       |  |         |     |  |       |       |         |  |       |       |  |  |         |     |  |             |       |         |       |       |  |  |  |         |     |                 |       |       |       |                |        |   |       |  |         |                 |     |       |       |       |  |  |  |  |  |                 |     |  |       |       |  |  |  |  |  |                 |         |     |       |       |       |  |  |  |  |                  |  |         |       |       |       |       |  |  |  |         |     |  |         |       |  |       |       |  |  |                 |     |  |       |          |     |  |       |       |  |                 |     |  |       |       |         |     |  |       |       |             |     |  |       |       |  |         |     |  |       |       |     |  |       |       |  |  |  |   |         |     |             |       |         |                |        |   |                |     |         |     |             |       |         |                |        |   |                |     |         |     |             |       |         |  |  |  |  |  |         |     |             |       |         |  |  |  |  |  |         |     |             |       |         |  |  |  |  |  |         |     |             |       |         |  |  |  |  |  |         |     |             |       |             |                |        |   |                |     |         |     |             |       |             |                |        |   |                |     |         |     |             |       |             |  |  |  |  |  |         |     |             |       |             |  |  |  |  |  |         |     |             |       |             |  |  |  |  |  |         |     |             |       |             |  |  |  |  |  |  |   |         |     |  |       |       |  |                |        |   |       |         |     |  |       |       |  |  |  |  |  |         |     |  |       |       |  |  |  |  |  |         |     |  |       |       |  |  |  |  |  |         |     |  |       |       |  |  |  |  |  |         |     |  |       |       |  |  |  |  |  |          |     |  |       |       |  |  |  |  |  |         |     |  |       |       |  |  |  |  |  |         |     |  |       |       |  |  |  |  |  |
| 4.2 quattro  | 246   |                 | 03.05 | 08.11       |                |                |   |                          |   |                          |                |                 |         |             |       |             |                |         |   |                |                          |                |     |             |       |             |       |       |         |                |        |          |               |             |         |         |  |       |       |         |                |         |     |             |       |         |     |  |       |       |         |                |        |             |                |         |         |     |  |       |       |          |                |             |       |             |                |          |   |                |       |         |         |             |       |             |                |        |   |                |     |         |       |             |       |             |  |  |  |         |     |                 |       |             |         |             |  |  |  |  |         |                 |     |             |       |             |                |        |                          |                |     |                 |     |             |       |             |         |                |        |                          |                |         |         |     |       |       |       |         |                |        |  |               |     |         |       |       |       |       |         |                |        |         |            |     |         |       |  |       |       |         |                |                 |     |                |       |         |     |  |       |       |         |                 |        |   |            |       |          |     |  |       |       |                 |     |  |       |       |  |         |     |  |       |       |         |  |       |       |  |  |         |     |  |             |       |         |       |       |  |  |  |         |     |                 |       |       |       |                |        |   |       |  |         |                 |     |       |       |       |  |  |  |  |  |                 |     |  |       |       |  |  |  |  |  |                 |         |     |       |       |       |  |  |  |  |                  |  |         |       |       |       |       |  |  |  |         |     |  |         |       |  |       |       |  |  |                 |     |  |       |          |     |  |       |       |  |                 |     |  |       |       |         |     |  |       |       |             |     |  |       |       |  |         |     |  |       |       |     |  |       |       |  |  |  |   |         |     |             |       |         |                |        |   |                |     |         |     |             |       |         |                |        |   |                |     |         |     |             |       |         |  |  |  |  |  |         |     |             |       |         |  |  |  |  |  |         |     |             |       |         |  |  |  |  |  |         |     |             |       |         |  |  |  |  |  |         |     |             |       |             |                |        |   |                |     |         |     |             |       |             |                |        |   |                |     |         |     |             |       |             |  |  |  |  |  |         |     |             |       |             |  |  |  |  |  |         |     |             |       |             |  |  |  |  |  |         |     |             |       |             |  |  |  |  |  |  |   |         |     |  |       |       |  |                |        |   |       |         |     |  |       |       |  |  |  |  |  |         |     |  |       |       |  |  |  |  |  |         |     |  |       |       |  |  |  |  |  |         |     |  |       |       |  |  |  |  |  |         |     |  |       |       |  |  |  |  |  |          |     |  |       |       |  |  |  |  |  |         |     |  |       |       |  |  |  |  |  |         |     |  |       |       |  |  |  |  |  |
| S6   | 320   |                 | 03.06 | 08.11       |                |                |   |                          |   |                          |                |                 |         |             |       |             |                |         |   |                |                          |                |     |             |       |             |       |       |         |                |        |          |               |             |         |         |  |       |       |         |                |         |     |             |       |         |     |  |       |       |         |                |        |             |                |         |         |     |  |       |       |          |                |             |       |             |                |          |   |                |       |         |         |             |       |             |                |        |   |                |     |         |       |             |       |             |  |  |  |         |     |                 |       |             |         |             |  |  |  |  |         |                 |     |             |       |             |                |        |                          |                |     |                 |     |             |       |             |         |                |        |                          |                |         |         |     |       |       |       |         |                |        |  |               |     |         |       |       |       |       |         |                |        |         |            |     |         |       |  |       |       |         |                |                 |     |                |       |         |     |  |       |       |         |                 |        |   |            |       |          |     |  |       |       |                 |     |  |       |       |  |         |     |  |       |       |         |  |       |       |  |  |         |     |  |             |       |         |       |       |  |  |  |         |     |                 |       |       |       |                |        |   |       |  |         |                 |     |       |       |       |  |  |  |  |  |                 |     |  |       |       |  |  |  |  |  |                 |         |     |       |       |       |  |  |  |  |                  |  |         |       |       |       |       |  |  |  |         |     |  |         |       |  |       |       |  |  |                 |     |  |       |          |     |  |       |       |  |                 |     |  |       |       |         |     |  |       |       |             |     |  |       |       |  |         |     |  |       |       |     |  |       |       |  |  |  |   |         |     |             |       |         |                |        |   |                |     |         |     |             |       |         |                |        |   |                |     |         |     |             |       |         |  |  |  |  |  |         |     |             |       |         |  |  |  |  |  |         |     |             |       |         |  |  |  |  |  |         |     |             |       |         |  |  |  |  |  |         |     |             |       |             |                |        |   |                |     |         |     |             |       |             |                |        |   |                |     |         |     |             |       |             |  |  |  |  |  |         |     |             |       |             |  |  |  |  |  |         |     |             |       |             |  |  |  |  |  |         |     |             |       |             |  |  |  |  |  |  |   |         |     |  |       |       |  |                |        |   |       |         |     |  |       |       |  |  |  |  |  |         |     |  |       |       |  |  |  |  |  |         |     |  |       |       |  |  |  |  |  |         |     |  |       |       |  |  |  |  |  |         |     |  |       |       |  |  |  |  |  |          |     |  |       |       |  |  |  |  |  |         |     |  |       |       |  |  |  |  |  |         |     |  |       |       |  |  |  |  |  |
| AUDI A6 Allroad (06-11)  |   |                 |       |             |                |                |   |                          |   |                          |                |                 |         |             |       |             |                |         |   |                |                          |                |     |             |       |             |       |       |         |                |        |          |               |             |         |         |  |       |       |         |                |         |     |             |       |         |     |  |       |       |         |                |        |             |                |         |         |     |  |       |       |          |                |             |       |             |                |          |   |                |       |         |         |             |       |             |                |        |   |                |     |         |       |             |       |             |  |  |  |         |     |                 |       |             |         |             |  |  |  |  |         |                 |     |             |       |             |                |        |                          |                |     |                 |     |             |       |             |         |                |        |                          |                |         |         |     |       |       |       |         |                |        |  |               |     |         |       |       |       |       |         |                |        |         |            |     |         |       |  |       |       |         |                |                 |     |                |       |         |     |  |       |       |         |                 |        |   |            |       |          |     |  |       |       |                 |     |  |       |       |  |         |     |  |       |       |         |  |       |       |  |  |         |     |  |             |       |         |       |       |  |  |  |         |     |                 |       |       |       |                |        |   |       |  |         |                 |     |       |       |       |  |  |  |  |  |                 |     |  |       |       |  |  |  |  |  |                 |         |     |       |       |       |  |  |  |  |                  |  |         |       |       |       |       |  |  |  |         |     |  |         |       |  |       |       |  |  |                 |     |  |       |          |     |  |       |       |  |                 |     |  |       |       |         |     |  |       |       |             |     |  |       |       |  |         |     |  |       |       |     |  |       |       |  |  |  |   |         |     |             |       |         |                |        |   |                |     |         |     |             |       |         |                |        |   |                |     |         |     |             |       |         |  |  |  |  |  |         |     |             |       |         |  |  |  |  |  |         |     |             |       |         |  |  |  |  |  |         |     |             |       |         |  |  |  |  |  |         |     |             |       |             |                |        |   |                |     |         |     |             |       |             |                |        |   |                |     |         |     |             |       |             |  |  |  |  |  |         |     |             |       |             |  |  |  |  |  |         |     |             |       |             |  |  |  |  |  |         |     |             |       |             |  |  |  |  |  |  |   |         |     |  |       |       |  |                |        |   |       |         |     |  |       |       |  |  |  |  |  |         |     |  |       |       |  |  |  |  |  |         |     |  |       |       |  |  |  |  |  |         |     |  |       |       |  |  |  |  |  |         |     |  |       |       |  |  |  |  |  |          |     |  |       |       |  |  |  |  |  |         |     |  |       |       |  |  |  |  |  |         |     |  |       |       |  |  |  |  |  |
|    | <table border="1"> <tr> <td>2.7 TDI</td> <td>120</td> <td></td> <td>05.06</td> <td>05.11</td> <td>PR: 1LG</td> <td>11.9606-9953.2</td> <td>220587</td> <td><input type="checkbox"/></td> <td>D=60, - Halter</td> <td>ATE</td> </tr> <tr> <td>2.7 TDI</td> <td>132</td> <td></td> <td>05.06</td> <td>05.11</td> <td>PR: 1LG</td> <td>11.9606-9954.2</td> <td>220588</td> <td><input type="checkbox"/></td> <td>D=60, - Halter</td> <td>ATE</td> </tr> <tr> <td>2.7 TDI</td> <td>140</td> <td></td> <td>10.08</td> <td>05.11</td> <td>PR: 1LG</td> <td>11.0441-6008.2</td> <td>250038</td> <td></td> <td>Dichtungssatz</td> <td>ATE</td> </tr> <tr> <td>3.0 TDI</td> <td>155</td> <td></td> <td>05.06</td> <td>05.11</td> <td>PR: 1LG</td> <td>11.0101-5409.2</td> <td>260035</td> <td></td> <td>Hülsensatz</td> <td>ATE</td> </tr> <tr> <td>3.0 TDI</td> <td>171</td> <td></td> <td>05.06</td> <td>05.11</td> <td>PR: 1LG</td> <td>11.8171-0008.1</td> <td>990049</td> <td></td> <td>Führungsbolzen</td> <td>ATE</td> </tr> <tr> <td>3.0 TDI</td> <td>176</td> <td></td> <td>10.08</td> <td>05.11</td> <td>PR: 1LG</td> <td>11.8116-0410.2</td> <td>390589</td> <td>2</td> <td>Haltefeder</td> <td>ATE</td> </tr> <tr> <td>3.0 TFSI</td> <td>213</td> <td></td> <td>10.08</td> <td>05.11</td> <td>PR: 1LG</td> <td></td> <td></td> <td></td> <td></td> <td></td> </tr> <tr> <td>3.2 FSI</td> <td>188</td> <td></td> <td>05.06</td> <td>05.11</td> <td>PR: 1LG</td> <td></td> <td></td> <td></td> <td></td> <td></td> </tr> <tr> <td>4.2 FSI</td> <td>257</td> <td></td> <td>05.06</td> <td>05.11</td> <td>PR: 1LG</td> <td></td> <td></td> <td></td> <td></td> <td></td> </tr> <tr> <td>2.7 TDI</td> <td>120</td> <td></td> <td>05.06</td> <td>05.11</td> <td>PR: 1ZL</td> <td>11.9606-9961.2</td> <td>220655</td> <td><input type="checkbox"/></td> <td>D=60, - Halter</td> <td>ATE</td> </tr> <tr> <td>2.7 TDI</td> <td>132</td> <td></td> <td>05.06</td> <td>05.11</td> <td>PR: 1ZL</td> <td>11.9606-9962.2</td> <td>220656</td> <td><input type="checkbox"/></td> <td>D=60, - Halter</td> <td>ATE</td> </tr> <tr> <td>2.7 TDI</td> <td>140</td> <td></td> <td>10.08</td> <td>05.11</td> <td>PR: 1ZL</td> <td>11.0441-6008.2</td> <td>250038</td> <td></td> <td>Dichtungssatz</td> <td>ATE</td> </tr> <tr> <td>3.0 TDI</td> <td>155</td> <td></td> <td>05.06</td> <td>05.11</td> <td>PR: 1ZL</td> <td>11.0101-5409.2</td> <td>260035</td> <td></td> <td>Hülsensatz</td> <td>ATE</td> </tr> <tr> <td>3.0 TDI</td> <td>171</td> <td></td> <td>05.06</td> <td>05.11</td> <td>PR: 1ZL</td> <td>11.8171-0008.1</td> <td>990049</td> <td></td> <td>Führungsbolzen</td> <td>ATE</td> </tr> <tr> <td>3.0 TDI</td> <td>176</td> <td></td> <td>10.08</td> <td>05.11</td> <td>PR: 1ZL</td> <td>11.8116-0410.2</td> <td>390589</td> <td>2</td> <td>Haltefeder</td> <td>ATE</td> </tr> <tr> <td>3.0 TFSI</td> <td>213</td> <td></td> <td>10.08</td> <td>05.11</td> <td>PR: 1ZL</td> <td></td> <td></td> <td></td> <td></td> <td></td> </tr> <tr> <td>3.2 FSI</td> <td>188</td> <td></td> <td>05.06</td> <td>05.11</td> <td>PR: 1ZL</td> <td></td> <td></td> <td></td> <td></td> <td></td> </tr> <tr> <td>4.2 FSI</td> <td>257</td> <td></td> <td>05.06</td> <td>05.11</td> <td>PR: 1ZL</td> <td></td> <td></td> <td></td> <td></td> <td></td> </tr> <tr> <td>2.7 TDI</td> <td>120</td> <td></td> <td>05.06</td> <td>05.11</td> <td></td> <td>83.7813-0315.3</td> <td>330870</td> <td>2</td> <td>L=315</td> <td></td> </tr> <tr> <td>2.7 TDI</td> <td>132</td> <td></td> <td>05.06</td> <td>05.11</td> <td></td> <td></td> <td></td> <td></td> <td></td> <td></td> </tr> <tr> <td>2.7 TDI</td> <td>140</td> <td></td> <td>10.08</td> <td>05.11</td> <td></td> <td></td> <td></td> <td></td> <td></td> <td></td> </tr> <tr> <td>3.0 TDI</td> <td>155</td> <td></td> <td>05.06</td> <td>05.11</td> <td></td> <td></td> <td></td> <td></td> <td></td> <td></td> </tr> <tr> <td>3.0 TDI</td> <td>171</td> <td></td> <td>05.06</td> <td>05.11</td> <td></td> <td></td> <td></td> <td></td> <td></td> <td></td> </tr> <tr> <td>3.0 TDI</td> <td>176</td> <td></td> <td>10.08</td> <td>05.11</td> <td></td> <td></td> <td></td> <td></td> <td></td> <td></td> </tr> <tr> <td>3.0 TFSI</td> <td>213</td> <td></td> <td>10.08</td> <td>05.11</td> <td></td> <td></td> <td></td> <td></td> <td></td> <td></td> </tr> <tr> <td>3.2 FSI</td> <td>188</td> <td></td> <td>05.06</td> <td>05.11</td> <td></td> <td></td> <td></td> <td></td> <td></td> <td></td> </tr> <tr> <td>4.2 FSI</td> <td>257</td> <td></td> <td>05.06</td> <td>05.11</td> <td></td> <td></td> <td></td> <td></td> <td></td> <td></td> </tr> <tr> <td></td> <td> <table border="1"> <tr> <td>2.7 TDI</td> <td>120</td> <td>4F-7-032500</td> <td>05.06</td> <td>PR: 1KD</td> <td>24.6241-1701.7</td> <td>220821</td> <td><input type="checkbox"/> elektrische Feststellbremse 1)</td> <td>D=41, - Halter</td> <td>LUC</td> </tr> <tr> <td>2.7 TDI</td> <td>132</td> <td>4F-7-032500</td> <td>05.06</td> <td>PR: 1KD</td> <td>24.6241-1702.7</td> <td>220822</td> <td><input type="checkbox"/> elektrische Feststellbremse 1)</td> <td>D=41, - Halter</td> <td>LUC</td> </tr> <tr> <td>3.0 TDI</td> <td>155</td> <td>4F-7-032500</td> <td>05.06</td> <td>PR: 1KD</td> <td></td> <td></td> <td></td> <td></td> <td></td> </tr> <tr> <td>3.0 TDI</td> <td>171</td> <td>4F-7-032500</td> <td>05.06</td> <td>PR: 1KD</td> <td></td> <td></td> <td></td> <td></td> <td></td> </tr> <tr> <td>3.2 FSI</td> <td>188</td> <td>4F-7-032500</td> <td>05.06</td> <td>PR: 1KD</td> <td></td> <td></td> <td></td> <td></td> <td></td> </tr> <tr> <td>4.2 FSI</td> <td>257</td> <td>4F-7-032500</td> <td>05.06</td> <td>PR: 1KD</td> <td></td> <td></td> <td></td> <td></td> <td></td> </tr> <tr> <td>2.7 TDI</td> <td>120</td> <td>4F-7-032500</td> <td>05.06</td> <td>PR: 1KW,2EE</td> <td>24.6243-1701.7</td> <td>220823</td> <td><input type="checkbox"/> elektrische Feststellbremse 1)</td> <td>D=43, - Halter</td> <td>LUC</td> </tr> <tr> <td>2.7 TDI</td> <td>132</td> <td>4F-7-032500</td> <td>05.06</td> <td>PR: 1KW,2EE</td> <td>24.6243-1702.7</td> <td>220824</td> <td><input type="checkbox"/> elektrische Feststellbremse 1)</td> <td>D=43, - Halter</td> <td>LUC</td> </tr> <tr> <td>3.0 TDI</td> <td>155</td> <td>4F-7-032500</td> <td>05.06</td> <td>PR: 1KW,2EE</td> <td></td> <td></td> <td></td> <td></td> <td></td> </tr> <tr> <td>3.0 TDI</td> <td>171</td> <td>4F-7-032500</td> <td>05.06</td> <td>PR: 1KW,2EE</td> <td></td> <td></td> <td></td> <td></td> <td></td> </tr> <tr> <td>3.2 FSI</td> <td>188</td> <td>4F-7-032500</td> <td>05.06</td> <td>PR: 1KW,2EE</td> <td></td> <td></td> <td></td> <td></td> <td></td> </tr> <tr> <td>4.2 FSI</td> <td>257</td> <td>4F-7-032500</td> <td>05.06</td> <td>PR: 1KW,2EE</td> <td></td> <td></td> <td></td> <td></td> <td></td> </tr> </table> </td> </tr> <tr> <td></td> <td> <table border="1"> <tr> <td>2.7 TDI</td> <td>120</td> <td></td> <td>05.06</td> <td>05.11</td> <td></td> <td>24.5125-0323.3</td> <td>330911</td> <td>2</td> <td>L=323</td> </tr> <tr> <td>2.7 TDI</td> <td>132</td> <td></td> <td>05.06</td> <td>05.11</td> <td></td> <td></td> <td></td> <td></td> <td></td> </tr> <tr> <td>2.7 TDI</td> <td>140</td> <td></td> <td>10.08</td> <td>05.11</td> <td></td> <td></td> <td></td> <td></td> <td></td> </tr> <tr> <td>3.0 TDI</td> <td>155</td> <td></td> <td>05.06</td> <td>05.11</td> <td></td> <td></td> <td></td> <td></td> <td></td> </tr> <tr> <td>3.0 TDI</td> <td>171</td> <td></td> <td>05.06</td> <td>05.11</td> <td></td> <td></td> <td></td> <td></td> <td></td> </tr> <tr> <td>3.0 TDI</td> <td>176</td> <td></td> <td>10.08</td> <td>05.11</td> <td></td> <td></td> <td></td> <td></td> <td></td> </tr> <tr> <td>3.0 TFSI</td> <td>213</td> <td></td> <td>10.08</td> <td>05.11</td> <td></td> <td></td> <td></td> <td></td> <td></td> </tr> <tr> <td>3.2 FSI</td> <td>188</td> <td></td> <td>05.06</td> <td>05.11</td> <td></td> <td></td> <td></td> <td></td> <td></td> </tr> <tr> <td>4.2 FSI</td> <td>257</td> <td></td> <td>05.06</td> <td>05.11</td> <td></td> <td></td> <td></td> <td></td> <td></td> </tr> </table> </td> </tr> </table> | 2.7 TDI         | 120   |             | 05.06          | 05.11          | PR: 1LG   | 11.9606-9953.2           | 220587  | <input type="checkbox"/> | D=60, - Halter | ATE             | 2.7 TDI | 132         |       | 05.06       | 05.11          | PR: 1LG | 11.9606-9954.2  | 220588         | <input type="checkbox"/> | D=60, - Halter | ATE | 2.7 TDI     | 140   |             | 10.08 | 05.11 | PR: 1LG | 11.0441-6008.2 | 250038 |          | Dichtungssatz | ATE         | 3.0 TDI | 155     |  | 05.06 | 05.11 | PR: 1LG | 11.0101-5409.2 | 260035  |     | Hülsensatz  | ATE   | 3.0 TDI | 171 |  | 05.06 | 05.11 | PR: 1LG | 11.8171-0008.1 | 990049 |             | Führungsbolzen | ATE     | 3.0 TDI | 176 |  | 10.08 | 05.11 | PR: 1LG  | 11.8116-0410.2 | 390589      | 2     | Haltefeder  | ATE            | 3.0 TFSI | 213   |                | 10.08 | 05.11   | PR: 1LG |             |       |             |                |        | 3.2 FSI   | 188            |     | 05.06   | 05.11 | PR: 1LG     |       |             |  |  |  | 4.2 FSI | 257 |                 | 05.06 | 05.11       | PR: 1LG |             |  |  |  |  | 2.7 TDI | 120             |     | 05.06       | 05.11 | PR: 1ZL     | 11.9606-9961.2 | 220655 | <input type="checkbox"/> | D=60, - Halter | ATE | 2.7 TDI         | 132 |             | 05.06 | 05.11       | PR: 1ZL | 11.9606-9962.2 | 220656 | <input type="checkbox"/> | D=60, - Halter | ATE     | 2.7 TDI | 140 |       | 10.08 | 05.11 | PR: 1ZL | 11.0441-6008.2 | 250038 |  | Dichtungssatz | ATE | 3.0 TDI | 155   |       | 05.06 | 05.11 | PR: 1ZL | 11.0101-5409.2 | 260035 |         | Hülsensatz | ATE | 3.0 TDI | 171   |  | 05.06 | 05.11 | PR: 1ZL | 11.8171-0008.1 | 990049          |     | Führungsbolzen | ATE   | 3.0 TDI | 176 |  | 10.08 | 05.11 | PR: 1ZL | 11.8116-0410.2  | 390589 | 2 | Haltefeder | ATE   | 3.0 TFSI | 213 |  | 10.08 | 05.11 | PR: 1ZL         |     |  |       |       |  | 3.2 FSI | 188 |  | 05.06 | 05.11 | PR: 1ZL |  |       |       |  |  | 4.2 FSI | 257 |  | 05.06       | 05.11 | PR: 1ZL |       |       |  |  |  | 2.7 TDI | 120 |                 | 05.06 | 05.11 |       | 83.7813-0315.3 | 330870 | 2 | L=315 |  | 2.7 TDI | 132             |     | 05.06 | 05.11 |       |  |  |  |  |  | 2.7 TDI         | 140 |  | 10.08 | 05.11 |  |  |  |  |  |                 | 3.0 TDI | 155 |       | 05.06 | 05.11 |  |  |  |  |                  |  | 3.0 TDI | 171   |       | 05.06 | 05.11 |  |  |  |         |     |  | 3.0 TDI | 176   |  | 10.08 | 05.11 |  |  |                 |     |  |       | 3.0 TFSI | 213 |  | 10.08 | 05.11 |  |                 |     |  |       |       | 3.2 FSI | 188 |  | 05.06 | 05.11 |             |     |  |       |       |  | 4.2 FSI | 257 |  | 05.06 | 05.11 |     |  |       |       |  |  |  | <table border="1"> <tr> <td>2.7 TDI</td> <td>120</td> <td>4F-7-032500</td> <td>05.06</td> <td>PR: 1KD</td> <td>24.6241-1701.7</td> <td>220821</td> <td><input type="checkbox"/> elektrische Feststellbremse 1)</td> <td>D=41, - Halter</td> <td>LUC</td> </tr> <tr> <td>2.7 TDI</td> <td>132</td> <td>4F-7-032500</td> <td>05.06</td> <td>PR: 1KD</td> <td>24.6241-1702.7</td> <td>220822</td> <td><input type="checkbox"/> elektrische Feststellbremse 1)</td> <td>D=41, - Halter</td> <td>LUC</td> </tr> <tr> <td>3.0 TDI</td> <td>155</td> <td>4F-7-032500</td> <td>05.06</td> <td>PR: 1KD</td> <td></td> <td></td> <td></td> <td></td> <td></td> </tr> <tr> <td>3.0 TDI</td> <td>171</td> <td>4F-7-032500</td> <td>05.06</td> <td>PR: 1KD</td> <td></td> <td></td> <td></td> <td></td> <td></td> </tr> <tr> <td>3.2 FSI</td> <td>188</td> <td>4F-7-032500</td> <td>05.06</td> <td>PR: 1KD</td> <td></td> <td></td> <td></td> <td></td> <td></td> </tr> <tr> <td>4.2 FSI</td> <td>257</td> <td>4F-7-032500</td> <td>05.06</td> <td>PR: 1KD</td> <td></td> <td></td> <td></td> <td></td> <td></td> </tr> <tr> <td>2.7 TDI</td> <td>120</td> <td>4F-7-032500</td> <td>05.06</td> <td>PR: 1KW,2EE</td> <td>24.6243-1701.7</td> <td>220823</td> <td><input type="checkbox"/> elektrische Feststellbremse 1)</td> <td>D=43, - Halter</td> <td>LUC</td> </tr> <tr> <td>2.7 TDI</td> <td>132</td> <td>4F-7-032500</td> <td>05.06</td> <td>PR: 1KW,2EE</td> <td>24.6243-1702.7</td> <td>220824</td> <td><input type="checkbox"/> elektrische Feststellbremse 1)</td> <td>D=43, - Halter</td> <td>LUC</td> </tr> <tr> <td>3.0 TDI</td> <td>155</td> <td>4F-7-032500</td> <td>05.06</td> <td>PR: 1KW,2EE</td> <td></td> <td></td> <td></td> <td></td> <td></td> </tr> <tr> <td>3.0 TDI</td> <td>171</td> <td>4F-7-032500</td> <td>05.06</td> <td>PR: 1KW,2EE</td> <td></td> <td></td> <td></td> <td></td> <td></td> </tr> <tr> <td>3.2 FSI</td> <td>188</td> <td>4F-7-032500</td> <td>05.06</td> <td>PR: 1KW,2EE</td> <td></td> <td></td> <td></td> <td></td> <td></td> </tr> <tr> <td>4.2 FSI</td> <td>257</td> <td>4F-7-032500</td> <td>05.06</td> <td>PR: 1KW,2EE</td> <td></td> <td></td> <td></td> <td></td> <td></td> </tr> </table> | 2.7 TDI | 120 | 4F-7-032500 | 05.06 | PR: 1KD | 24.6241-1701.7 | 220821 | <input type="checkbox"/> elektrische Feststellbremse 1) | D=41, - Halter | LUC | 2.7 TDI | 132 | 4F-7-032500 | 05.06 | PR: 1KD | 24.6241-1702.7 | 220822 | <input type="checkbox"/> elektrische Feststellbremse 1) | D=41, - Halter | LUC | 3.0 TDI | 155 | 4F-7-032500 | 05.06 | PR: 1KD |  |  |  |  |  | 3.0 TDI | 171 | 4F-7-032500 | 05.06 | PR: 1KD |  |  |  |  |  | 3.2 FSI | 188 | 4F-7-032500 | 05.06 | PR: 1KD |  |  |  |  |  | 4.2 FSI | 257 | 4F-7-032500 | 05.06 | PR: 1KD |  |  |  |  |  | 2.7 TDI | 120 | 4F-7-032500 | 05.06 | PR: 1KW,2EE | 24.6243-1701.7 | 220823 | <input type="checkbox"/> elektrische Feststellbremse 1) | D=43, - Halter | LUC | 2.7 TDI | 132 | 4F-7-032500 | 05.06 | PR: 1KW,2EE | 24.6243-1702.7 | 220824 | <input type="checkbox"/> elektrische Feststellbremse 1) | D=43, - Halter | LUC | 3.0 TDI | 155 | 4F-7-032500 | 05.06 | PR: 1KW,2EE |  |  |  |  |  | 3.0 TDI | 171 | 4F-7-032500 | 05.06 | PR: 1KW,2EE |  |  |  |  |  | 3.2 FSI | 188 | 4F-7-032500 | 05.06 | PR: 1KW,2EE |  |  |  |  |  | 4.2 FSI | 257 | 4F-7-032500 | 05.06 | PR: 1KW,2EE |  |  |  |  |  |  | <table border="1"> <tr> <td>2.7 TDI</td> <td>120</td> <td></td> <td>05.06</td> <td>05.11</td> <td></td> <td>24.5125-0323.3</td> <td>330911</td> <td>2</td> <td>L=323</td> </tr> <tr> <td>2.7 TDI</td> <td>132</td> <td></td> <td>05.06</td> <td>05.11</td> <td></td> <td></td> <td></td> <td></td> <td></td> </tr> <tr> <td>2.7 TDI</td> <td>140</td> <td></td> <td>10.08</td> <td>05.11</td> <td></td> <td></td> <td></td> <td></td> <td></td> </tr> <tr> <td>3.0 TDI</td> <td>155</td> <td></td> <td>05.06</td> <td>05.11</td> <td></td> <td></td> <td></td> <td></td> <td></td> </tr> <tr> <td>3.0 TDI</td> <td>171</td> <td></td> <td>05.06</td> <td>05.11</td> <td></td> <td></td> <td></td> <td></td> <td></td> </tr> <tr> <td>3.0 TDI</td> <td>176</td> <td></td> <td>10.08</td> <td>05.11</td> <td></td> <td></td> <td></td> <td></td> <td></td> </tr> <tr> <td>3.0 TFSI</td> <td>213</td> <td></td> <td>10.08</td> <td>05.11</td> <td></td> <td></td> <td></td> <td></td> <td></td> </tr> <tr> <td>3.2 FSI</td> <td>188</td> <td></td> <td>05.06</td> <td>05.11</td> <td></td> <td></td> <td></td> <td></td> <td></td> </tr> <tr> <td>4.2 FSI</td> <td>257</td> <td></td> <td>05.06</td> <td>05.11</td> <td></td> <td></td> <td></td> <td></td> <td></td> </tr> </table> | 2.7 TDI | 120 |  | 05.06 | 05.11 |  | 24.5125-0323.3 | 330911 | 2 | L=323 | 2.7 TDI | 132 |  | 05.06 | 05.11 |  |  |  |  |  | 2.7 TDI | 140 |  | 10.08 | 05.11 |  |  |  |  |  | 3.0 TDI | 155 |  | 05.06 | 05.11 |  |  |  |  |  | 3.0 TDI | 171 |  | 05.06 | 05.11 |  |  |  |  |  | 3.0 TDI | 176 |  | 10.08 | 05.11 |  |  |  |  |  | 3.0 TFSI | 213 |  | 10.08 | 05.11 |  |  |  |  |  | 3.2 FSI | 188 |  | 05.06 | 05.11 |  |  |  |  |  | 4.2 FSI | 257 |  | 05.06 | 05.11 |  |  |  |  |  |
| 2.7 TDI  | 120   |                 | 05.06 | 05.11       | PR: 1LG        | 11.9606-9953.2 | 220587  | <input type="checkbox"/> | D=60, - Halter  | ATE                      |                |                 |         |             |       |             |                |         |   |                |                          |                |     |             |       |             |       |       |         |                |        |          |               |             |         |         |  |       |       |         |                |         |     |             |       |         |     |  |       |       |         |                |        |             |                |         |         |     |  |       |       |          |                |             |       |             |                |          |   |                |       |         |         |             |       |             |                |        |   |                |     |         |       |             |       |             |  |  |  |         |     |                 |       |             |         |             |  |  |  |  |         |                 |     |             |       |             |                |        |                          |                |     |                 |     |             |       |             |         |                |        |                          |                |         |         |     |       |       |       |         |                |        |  |               |     |         |       |       |       |       |         |                |        |         |            |     |         |       |  |       |       |         |                |                 |     |                |       |         |     |  |       |       |         |                 |        |   |            |       |          |     |  |       |       |                 |     |  |       |       |  |         |     |  |       |       |         |  |       |       |  |  |         |     |  |             |       |         |       |       |  |  |  |         |     |                 |       |       |       |                |        |   |       |  |         |                 |     |       |       |       |  |  |  |  |  |                 |     |  |       |       |  |  |  |  |  |                 |         |     |       |       |       |  |  |  |  |                  |  |         |       |       |       |       |  |  |  |         |     |  |         |       |  |       |       |  |  |                 |     |  |       |          |     |  |       |       |  |                 |     |  |       |       |         |     |  |       |       |             |     |  |       |       |  |         |     |  |       |       |     |  |       |       |  |  |  |   |         |     |             |       |         |                |        |   |                |     |         |     |             |       |         |                |        |   |                |     |         |     |             |       |         |  |  |  |  |  |         |     |             |       |         |  |  |  |  |  |         |     |             |       |         |  |  |  |  |  |         |     |             |       |         |  |  |  |  |  |         |     |             |       |             |                |        |   |                |     |         |     |             |       |             |                |        |   |                |     |         |     |             |       |             |  |  |  |  |  |         |     |             |       |             |  |  |  |  |  |         |     |             |       |             |  |  |  |  |  |         |     |             |       |             |  |  |  |  |  |  |   |         |     |  |       |       |  |                |        |   |       |         |     |  |       |       |  |  |  |  |  |         |     |  |       |       |  |  |  |  |  |         |     |  |       |       |  |  |  |  |  |         |     |  |       |       |  |  |  |  |  |         |     |  |       |       |  |  |  |  |  |          |     |  |       |       |  |  |  |  |  |         |     |  |       |       |  |  |  |  |  |         |     |  |       |       |  |  |  |  |  |
| 2.7 TDI  | 132   |                 | 05.06 | 05.11       | PR: 1LG        | 11.9606-9954.2 | 220588  | <input type="checkbox"/> | D=60, - Halter  | ATE                      |                |                 |         |             |       |             |                |         |   |                |                          |                |     |             |       |             |       |       |         |                |        |          |               |             |         |         |  |       |       |         |                |         |     |             |       |         |     |  |       |       |         |                |        |             |                |         |         |     |  |       |       |          |                |             |       |             |                |          |   |                |       |         |         |             |       |             |                |        |   |                |     |         |       |             |       |             |  |  |  |         |     |                 |       |             |         |             |  |  |  |  |         |                 |     |             |       |             |                |        |                          |                |     |                 |     |             |       |             |         |                |        |                          |                |         |         |     |       |       |       |         |                |        |  |               |     |         |       |       |       |       |         |                |        |         |            |     |         |       |  |       |       |         |                |                 |     |                |       |         |     |  |       |       |         |                 |        |   |            |       |          |     |  |       |       |                 |     |  |       |       |  |         |     |  |       |       |         |  |       |       |  |  |         |     |  |             |       |         |       |       |  |  |  |         |     |                 |       |       |       |                |        |   |       |  |         |                 |     |       |       |       |  |  |  |  |  |                 |     |  |       |       |  |  |  |  |  |                 |         |     |       |       |       |  |  |  |  |                  |  |         |       |       |       |       |  |  |  |         |     |  |         |       |  |       |       |  |  |                 |     |  |       |          |     |  |       |       |  |                 |     |  |       |       |         |     |  |       |       |             |     |  |       |       |  |         |     |  |       |       |     |  |       |       |  |  |  |   |         |     |             |       |         |                |        |   |                |     |         |     |             |       |         |                |        |   |                |     |         |     |             |       |         |  |  |  |  |  |         |     |             |       |         |  |  |  |  |  |         |     |             |       |         |  |  |  |  |  |         |     |             |       |         |  |  |  |  |  |         |     |             |       |             |                |        |   |                |     |         |     |             |       |             |                |        |   |                |     |         |     |             |       |             |  |  |  |  |  |         |     |             |       |             |  |  |  |  |  |         |     |             |       |             |  |  |  |  |  |         |     |             |       |             |  |  |  |  |  |  |   |         |     |  |       |       |  |                |        |   |       |         |     |  |       |       |  |  |  |  |  |         |     |  |       |       |  |  |  |  |  |         |     |  |       |       |  |  |  |  |  |         |     |  |       |       |  |  |  |  |  |         |     |  |       |       |  |  |  |  |  |          |     |  |       |       |  |  |  |  |  |         |     |  |       |       |  |  |  |  |  |         |     |  |       |       |  |  |  |  |  |
| 2.7 TDI  | 140   |                 | 10.08 | 05.11       | PR: 1LG        | 11.0441-6008.2 | 250038  |                          | Dichtungssatz   | ATE                      |                |                 |         |             |       |             |                |         |   |                |                          |                |     |             |       |             |       |       |         |                |        |          |               |             |         |         |  |       |       |         |                |         |     |             |       |         |     |  |       |       |         |                |        |             |                |         |         |     |  |       |       |          |                |             |       |             |                |          |   |                |       |         |         |             |       |             |                |        |   |                |     |         |       |             |       |             |  |  |  |         |     |                 |       |             |         |             |  |  |  |  |         |                 |     |             |       |             |                |        |                          |                |     |                 |     |             |       |             |         |                |        |                          |                |         |         |     |       |       |       |         |                |        |  |               |     |         |       |       |       |       |         |                |        |         |            |     |         |       |  |       |       |         |                |                 |     |                |       |         |     |  |       |       |         |                 |        |   |            |       |          |     |  |       |       |                 |     |  |       |       |  |         |     |  |       |       |         |  |       |       |  |  |         |     |  |             |       |         |       |       |  |  |  |         |     |                 |       |       |       |                |        |   |       |  |         |                 |     |       |       |       |  |  |  |  |  |                 |     |  |       |       |  |  |  |  |  |                 |         |     |       |       |       |  |  |  |  |                  |  |         |       |       |       |       |  |  |  |         |     |  |         |       |  |       |       |  |  |                 |     |  |       |          |     |  |       |       |  |                 |     |  |       |       |         |     |  |       |       |             |     |  |       |       |  |         |     |  |       |       |     |  |       |       |  |  |  |   |         |     |             |       |         |                |        |   |                |     |         |     |             |       |         |                |        |   |                |     |         |     |             |       |         |  |  |  |  |  |         |     |             |       |         |  |  |  |  |  |         |     |             |       |         |  |  |  |  |  |         |     |             |       |         |  |  |  |  |  |         |     |             |       |             |                |        |   |                |     |         |     |             |       |             |                |        |   |                |     |         |     |             |       |             |  |  |  |  |  |         |     |             |       |             |  |  |  |  |  |         |     |             |       |             |  |  |  |  |  |         |     |             |       |             |  |  |  |  |  |  |   |         |     |  |       |       |  |                |        |   |       |         |     |  |       |       |  |  |  |  |  |         |     |  |       |       |  |  |  |  |  |         |     |  |       |       |  |  |  |  |  |         |     |  |       |       |  |  |  |  |  |         |     |  |       |       |  |  |  |  |  |          |     |  |       |       |  |  |  |  |  |         |     |  |       |       |  |  |  |  |  |         |     |  |       |       |  |  |  |  |  |
| 3.0 TDI  | 155   |                 | 05.06 | 05.11       | PR: 1LG        | 11.0101-5409.2 | 260035  |                          | Hülsensatz  | ATE                      |                |                 |         |             |       |             |                |         |   |                |                          |                |     |             |       |             |       |       |         |                |        |          |               |             |         |         |  |       |       |         |                |         |     |             |       |         |     |  |       |       |         |                |        |             |                |         |         |     |  |       |       |          |                |             |       |             |                |          |   |                |       |         |         |             |       |             |                |        |   |                |     |         |       |             |       |             |  |  |  |         |     |                 |       |             |         |             |  |  |  |  |         |                 |     |             |       |             |                |        |                          |                |     |                 |     |             |       |             |         |                |        |                          |                |         |         |     |       |       |       |         |                |        |  |               |     |         |       |       |       |       |         |                |        |         |            |     |         |       |  |       |       |         |                |                 |     |                |       |         |     |  |       |       |         |                 |        |   |            |       |          |     |  |       |       |                 |     |  |       |       |  |         |     |  |       |       |         |  |       |       |  |  |         |     |  |             |       |         |       |       |  |  |  |         |     |                 |       |       |       |                |        |   |       |  |         |                 |     |       |       |       |  |  |  |  |  |                 |     |  |       |       |  |  |  |  |  |                 |         |     |       |       |       |  |  |  |  |                  |  |         |       |       |       |       |  |  |  |         |     |  |         |       |  |       |       |  |  |                 |     |  |       |          |     |  |       |       |  |                 |     |  |       |       |         |     |  |       |       |             |     |  |       |       |  |         |     |  |       |       |     |  |       |       |  |  |  |   |         |     |             |       |         |                |        |   |                |     |         |     |             |       |         |                |        |   |                |     |         |     |             |       |         |  |  |  |  |  |         |     |             |       |         |  |  |  |  |  |         |     |             |       |         |  |  |  |  |  |         |     |             |       |         |  |  |  |  |  |         |     |             |       |             |                |        |   |                |     |         |     |             |       |             |                |        |   |                |     |         |     |             |       |             |  |  |  |  |  |         |     |             |       |             |  |  |  |  |  |         |     |             |       |             |  |  |  |  |  |         |     |             |       |             |  |  |  |  |  |  |   |         |     |  |       |       |  |                |        |   |       |         |     |  |       |       |  |  |  |  |  |         |     |  |       |       |  |  |  |  |  |         |     |  |       |       |  |  |  |  |  |         |     |  |       |       |  |  |  |  |  |         |     |  |       |       |  |  |  |  |  |          |     |  |       |       |  |  |  |  |  |         |     |  |       |       |  |  |  |  |  |         |     |  |       |       |  |  |  |  |  |
| 3.0 TDI  | 171   |                 | 05.06 | 05.11       | PR: 1LG        | 11.8171-0008.1 | 990049  |                          | Führungsbolzen  | ATE                      |                |                 |         |             |       |             |                |         |   |                |                          |                |     |             |       |             |       |       |         |                |        |          |               |             |         |         |  |       |       |         |                |         |     |             |       |         |     |  |       |       |         |                |        |             |                |         |         |     |  |       |       |          |                |             |       |             |                |          |   |                |       |         |         |             |       |             |                |        |   |                |     |         |       |             |       |             |  |  |  |         |     |                 |       |             |         |             |  |  |  |  |         |                 |     |             |       |             |                |        |                          |                |     |                 |     |             |       |             |         |                |        |                          |                |         |         |     |       |       |       |         |                |        |  |               |     |         |       |       |       |       |         |                |        |         |            |     |         |       |  |       |       |         |                |                 |     |                |       |         |     |  |       |       |         |                 |        |   |            |       |          |     |  |       |       |                 |     |  |       |       |  |         |     |  |       |       |         |  |       |       |  |  |         |     |  |             |       |         |       |       |  |  |  |         |     |                 |       |       |       |                |        |   |       |  |         |                 |     |       |       |       |  |  |  |  |  |                 |     |  |       |       |  |  |  |  |  |                 |         |     |       |       |       |  |  |  |  |                  |  |         |       |       |       |       |  |  |  |         |     |  |         |       |  |       |       |  |  |                 |     |  |       |          |     |  |       |       |  |                 |     |  |       |       |         |     |  |       |       |             |     |  |       |       |  |         |     |  |       |       |     |  |       |       |  |  |  |   |         |     |             |       |         |                |        |   |                |     |         |     |             |       |         |                |        |   |                |     |         |     |             |       |         |  |  |  |  |  |         |     |             |       |         |  |  |  |  |  |         |     |             |       |         |  |  |  |  |  |         |     |             |       |         |  |  |  |  |  |         |     |             |       |             |                |        |   |                |     |         |     |             |       |             |                |        |   |                |     |         |     |             |       |             |  |  |  |  |  |         |     |             |       |             |  |  |  |  |  |         |     |             |       |             |  |  |  |  |  |         |     |             |       |             |  |  |  |  |  |  |   |         |     |  |       |       |  |                |        |   |       |         |     |  |       |       |  |  |  |  |  |         |     |  |       |       |  |  |  |  |  |         |     |  |       |       |  |  |  |  |  |         |     |  |       |       |  |  |  |  |  |         |     |  |       |       |  |  |  |  |  |          |     |  |       |       |  |  |  |  |  |         |     |  |       |       |  |  |  |  |  |         |     |  |       |       |  |  |  |  |  |
| 3.0 TDI  | 176   |                 | 10.08 | 05.11       | PR: 1LG        | 11.8116-0410.2 | 390589  | 2                        | Haltefeder  | ATE                      |                |                 |         |             |       |             |                |         |   |                |                          |                |     |             |       |             |       |       |         |                |        |          |               |             |         |         |  |       |       |         |                |         |     |             |       |         |     |  |       |       |         |                |        |             |                |         |         |     |  |       |       |          |                |             |       |             |                |          |   |                |       |         |         |             |       |             |                |        |   |                |     |         |       |             |       |             |  |  |  |         |     |                 |       |             |         |             |  |  |  |  |         |                 |     |             |       |             |                |        |                          |                |     |                 |     |             |       |             |         |                |        |                          |                |         |         |     |       |       |       |         |                |        |  |               |     |         |       |       |       |       |         |                |        |         |            |     |         |       |  |       |       |         |                |                 |     |                |       |         |     |  |       |       |         |                 |        |   |            |       |          |     |  |       |       |                 |     |  |       |       |  |         |     |  |       |       |         |  |       |       |  |  |         |     |  |             |       |         |       |       |  |  |  |         |     |                 |       |       |       |                |        |   |       |  |         |                 |     |       |       |       |  |  |  |  |  |                 |     |  |       |       |  |  |  |  |  |                 |         |     |       |       |       |  |  |  |  |                  |  |         |       |       |       |       |  |  |  |         |     |  |         |       |  |       |       |  |  |                 |     |  |       |          |     |  |       |       |  |                 |     |  |       |       |         |     |  |       |       |             |     |  |       |       |  |         |     |  |       |       |     |  |       |       |  |  |  |   |         |     |             |       |         |                |        |   |                |     |         |     |             |       |         |                |        |   |                |     |         |     |             |       |         |  |  |  |  |  |         |     |             |       |         |  |  |  |  |  |         |     |             |       |         |  |  |  |  |  |         |     |             |       |         |  |  |  |  |  |         |     |             |       |             |                |        |   |                |     |         |     |             |       |             |                |        |   |                |     |         |     |             |       |             |  |  |  |  |  |         |     |             |       |             |  |  |  |  |  |         |     |             |       |             |  |  |  |  |  |         |     |             |       |             |  |  |  |  |  |  |   |         |     |  |       |       |  |                |        |   |       |         |     |  |       |       |  |  |  |  |  |         |     |  |       |       |  |  |  |  |  |         |     |  |       |       |  |  |  |  |  |         |     |  |       |       |  |  |  |  |  |         |     |  |       |       |  |  |  |  |  |          |     |  |       |       |  |  |  |  |  |         |     |  |       |       |  |  |  |  |  |         |     |  |       |       |  |  |  |  |  |
| 3.0 TFSI   | 213   |                 | 10.08 | 05.11       | PR: 1LG        |                |   |                          |   |                          |                |                 |         |             |       |             |                |         |   |                |                          |                |     |             |       |             |       |       |         |                |        |          |               |             |         |         |  |       |       |         |                |         |     |             |       |         |     |  |       |       |         |                |        |             |                |         |         |     |  |       |       |          |                |             |       |             |                |          |   |                |       |         |         |             |       |             |                |        |   |                |     |         |       |             |       |             |  |  |  |         |     |                 |       |             |         |             |  |  |  |  |         |                 |     |             |       |             |                |        |                          |                |     |                 |     |             |       |             |         |                |        |                          |                |         |         |     |       |       |       |         |                |        |  |               |     |         |       |       |       |       |         |                |        |         |            |     |         |       |  |       |       |         |                |                 |     |                |       |         |     |  |       |       |         |                 |        |   |            |       |          |     |  |       |       |                 |     |  |       |       |  |         |     |  |       |       |         |  |       |       |  |  |         |     |  |             |       |         |       |       |  |  |  |         |     |                 |       |       |       |                |        |   |       |  |         |                 |     |       |       |       |  |  |  |  |  |                 |     |  |       |       |  |  |  |  |  |                 |         |     |       |       |       |  |  |  |  |                  |  |         |       |       |       |       |  |  |  |         |     |  |         |       |  |       |       |  |  |                 |     |  |       |          |     |  |       |       |  |                 |     |  |       |       |         |     |  |       |       |             |     |  |       |       |  |         |     |  |       |       |     |  |       |       |  |  |  |   |         |     |             |       |         |                |        |   |                |     |         |     |             |       |         |                |        |   |                |     |         |     |             |       |         |  |  |  |  |  |         |     |             |       |         |  |  |  |  |  |         |     |             |       |         |  |  |  |  |  |         |     |             |       |         |  |  |  |  |  |         |     |             |       |             |                |        |   |                |     |         |     |             |       |             |                |        |   |                |     |         |     |             |       |             |  |  |  |  |  |         |     |             |       |             |  |  |  |  |  |         |     |             |       |             |  |  |  |  |  |         |     |             |       |             |  |  |  |  |  |  |   |         |     |  |       |       |  |                |        |   |       |         |     |  |       |       |  |  |  |  |  |         |     |  |       |       |  |  |  |  |  |         |     |  |       |       |  |  |  |  |  |         |     |  |       |       |  |  |  |  |  |         |     |  |       |       |  |  |  |  |  |          |     |  |       |       |  |  |  |  |  |         |     |  |       |       |  |  |  |  |  |         |     |  |       |       |  |  |  |  |  |
| 3.2 FSI  | 188   |                 | 05.06 | 05.11       | PR: 1LG        |                |   |                          |   |                          |                |                 |         |             |       |             |                |         |   |                |                          |                |     |             |       |             |       |       |         |                |        |          |               |             |         |         |  |       |       |         |                |         |     |             |       |         |     |  |       |       |         |                |        |             |                |         |         |     |  |       |       |          |                |             |       |             |                |          |   |                |       |         |         |             |       |             |                |        |   |                |     |         |       |             |       |             |  |  |  |         |     |                 |       |             |         |             |  |  |  |  |         |                 |     |             |       |             |                |        |                          |                |     |                 |     |             |       |             |         |                |        |                          |                |         |         |     |       |       |       |         |                |        |  |               |     |         |       |       |       |       |         |                |        |         |            |     |         |       |  |       |       |         |                |                 |     |                |       |         |     |  |       |       |         |                 |        |   |            |       |          |     |  |       |       |                 |     |  |       |       |  |         |     |  |       |       |         |  |       |       |  |  |         |     |  |             |       |         |       |       |  |  |  |         |     |                 |       |       |       |                |        |   |       |  |         |                 |     |       |       |       |  |  |  |  |  |                 |     |  |       |       |  |  |  |  |  |                 |         |     |       |       |       |  |  |  |  |                  |  |         |       |       |       |       |  |  |  |         |     |  |         |       |  |       |       |  |  |                 |     |  |       |          |     |  |       |       |  |                 |     |  |       |       |         |     |  |       |       |             |     |  |       |       |  |         |     |  |       |       |     |  |       |       |  |  |  |   |         |     |             |       |         |                |        |   |                |     |         |     |             |       |         |                |        |   |                |     |         |     |             |       |         |  |  |  |  |  |         |     |             |       |         |  |  |  |  |  |         |     |             |       |         |  |  |  |  |  |         |     |             |       |         |  |  |  |  |  |         |     |             |       |             |                |        |   |                |     |         |     |             |       |             |                |        |   |                |     |         |     |             |       |             |  |  |  |  |  |         |     |             |       |             |  |  |  |  |  |         |     |             |       |             |  |  |  |  |  |         |     |             |       |             |  |  |  |  |  |  |   |         |     |  |       |       |  |                |        |   |       |         |     |  |       |       |  |  |  |  |  |         |     |  |       |       |  |  |  |  |  |         |     |  |       |       |  |  |  |  |  |         |     |  |       |       |  |  |  |  |  |         |     |  |       |       |  |  |  |  |  |          |     |  |       |       |  |  |  |  |  |         |     |  |       |       |  |  |  |  |  |         |     |  |       |       |  |  |  |  |  |
| 4.2 FSI  | 257   |                 | 05.06 | 05.11       | PR: 1LG        |                |   |                          |   |                          |                |                 |         |             |       |             |                |         |   |                |                          |                |     |             |       |             |       |       |         |                |        |          |               |             |         |         |  |       |       |         |                |         |     |             |       |         |     |  |       |       |         |                |        |             |                |         |         |     |  |       |       |          |                |             |       |             |                |          |   |                |       |         |         |             |       |             |                |        |   |                |     |         |       |             |       |             |  |  |  |         |     |                 |       |             |         |             |  |  |  |  |         |                 |     |             |       |             |                |        |                          |                |     |                 |     |             |       |             |         |                |        |                          |                |         |         |     |       |       |       |         |                |        |  |               |     |         |       |       |       |       |         |                |        |         |            |     |         |       |  |       |       |         |                |                 |     |                |       |         |     |  |       |       |         |                 |        |   |            |       |          |     |  |       |       |                 |     |  |       |       |  |         |     |  |       |       |         |  |       |       |  |  |         |     |  |             |       |         |       |       |  |  |  |         |     |                 |       |       |       |                |        |   |       |  |         |                 |     |       |       |       |  |  |  |  |  |                 |     |  |       |       |  |  |  |  |  |                 |         |     |       |       |       |  |  |  |  |                  |  |         |       |       |       |       |  |  |  |         |     |  |         |       |  |       |       |  |  |                 |     |  |       |          |     |  |       |       |  |                 |     |  |       |       |         |     |  |       |       |             |     |  |       |       |  |         |     |  |       |       |     |  |       |       |  |  |  |   |         |     |             |       |         |                |        |   |                |     |         |     |             |       |         |                |        |   |                |     |         |     |             |       |         |  |  |  |  |  |         |     |             |       |         |  |  |  |  |  |         |     |             |       |         |  |  |  |  |  |         |     |             |       |         |  |  |  |  |  |         |     |             |       |             |                |        |   |                |     |         |     |             |       |             |                |        |   |                |     |         |     |             |       |             |  |  |  |  |  |         |     |             |       |             |  |  |  |  |  |         |     |             |       |             |  |  |  |  |  |         |     |             |       |             |  |  |  |  |  |  |   |         |     |  |       |       |  |                |        |   |       |         |     |  |       |       |  |  |  |  |  |         |     |  |       |       |  |  |  |  |  |         |     |  |       |       |  |  |  |  |  |         |     |  |       |       |  |  |  |  |  |         |     |  |       |       |  |  |  |  |  |          |     |  |       |       |  |  |  |  |  |         |     |  |       |       |  |  |  |  |  |         |     |  |       |       |  |  |  |  |  |
| 2.7 TDI  | 120   |                 | 05.06 | 05.11       | PR: 1ZL        | 11.9606-9961.2 | 220655  | <input type="checkbox"/> | D=60, - Halter  | ATE                      |                |                 |         |             |       |             |                |         |   |                |                          |                |     |             |       |             |       |       |         |                |        |          |               |             |         |         |  |       |       |         |                |         |     |             |       |         |     |  |       |       |         |                |        |             |                |         |         |     |  |       |       |          |                |             |       |             |                |          |   |                |       |         |         |             |       |             |                |        |   |                |     |         |       |             |       |             |  |  |  |         |     |                 |       |             |         |             |  |  |  |  |         |                 |     |             |       |             |                |        |                          |                |     |                 |     |             |       |             |         |                |        |                          |                |         |         |     |       |       |       |         |                |        |  |               |     |         |       |       |       |       |         |                |        |         |            |     |         |       |  |       |       |         |                |                 |     |                |       |         |     |  |       |       |         |                 |        |   |            |       |          |     |  |       |       |                 |     |  |       |       |  |         |     |  |       |       |         |  |       |       |  |  |         |     |  |             |       |         |       |       |  |  |  |         |     |                 |       |       |       |                |        |   |       |  |         |                 |     |       |       |       |  |  |  |  |  |                 |     |  |       |       |  |  |  |  |  |                 |         |     |       |       |       |  |  |  |  |                  |  |         |       |       |       |       |  |  |  |         |     |  |         |       |  |       |       |  |  |                 |     |  |       |          |     |  |       |       |  |                 |     |  |       |       |         |     |  |       |       |             |     |  |       |       |  |         |     |  |       |       |     |  |       |       |  |  |  |   |         |     |             |       |         |                |        |   |                |     |         |     |             |       |         |                |        |   |                |     |         |     |             |       |         |  |  |  |  |  |         |     |             |       |         |  |  |  |  |  |         |     |             |       |         |  |  |  |  |  |         |     |             |       |         |  |  |  |  |  |         |     |             |       |             |                |        |   |                |     |         |     |             |       |             |                |        |   |                |     |         |     |             |       |             |  |  |  |  |  |         |     |             |       |             |  |  |  |  |  |         |     |             |       |             |  |  |  |  |  |         |     |             |       |             |  |  |  |  |  |  |   |         |     |  |       |       |  |                |        |   |       |         |     |  |       |       |  |  |  |  |  |         |     |  |       |       |  |  |  |  |  |         |     |  |       |       |  |  |  |  |  |         |     |  |       |       |  |  |  |  |  |         |     |  |       |       |  |  |  |  |  |          |     |  |       |       |  |  |  |  |  |         |     |  |       |       |  |  |  |  |  |         |     |  |       |       |  |  |  |  |  |
| 2.7 TDI  | 132   |                 | 05.06 | 05.11       | PR: 1ZL        | 11.9606-9962.2 | 220656  | <input type="checkbox"/> | D=60, - Halter  | ATE                      |                |                 |         |             |       |             |                |         |   |                |                          |                |     |             |       |             |       |       |         |                |        |          |               |             |         |         |  |       |       |         |                |         |     |             |       |         |     |  |       |       |         |                |        |             |                |         |         |     |  |       |       |          |                |             |       |             |                |          |   |                |       |         |         |             |       |             |                |        |   |                |     |         |       |             |       |             |  |  |  |         |     |                 |       |             |         |             |  |  |  |  |         |                 |     |             |       |             |                |        |                          |                |     |                 |     |             |       |             |         |                |        |                          |                |         |         |     |       |       |       |         |                |        |  |               |     |         |       |       |       |       |         |                |        |         |            |     |         |       |  |       |       |         |                |                 |     |                |       |         |     |  |       |       |         |                 |        |   |            |       |          |     |  |       |       |                 |     |  |       |       |  |         |     |  |       |       |         |  |       |       |  |  |         |     |  |             |       |         |       |       |  |  |  |         |     |                 |       |       |       |                |        |   |       |  |         |                 |     |       |       |       |  |  |  |  |  |                 |     |  |       |       |  |  |  |  |  |                 |         |     |       |       |       |  |  |  |  |                  |  |         |       |       |       |       |  |  |  |         |     |  |         |       |  |       |       |  |  |                 |     |  |       |          |     |  |       |       |  |                 |     |  |       |       |         |     |  |       |       |             |     |  |       |       |  |         |     |  |       |       |     |  |       |       |  |  |  |   |         |     |             |       |         |                |        |   |                |     |         |     |             |       |         |                |        |   |                |     |         |     |             |       |         |  |  |  |  |  |         |     |             |       |         |  |  |  |  |  |         |     |             |       |         |  |  |  |  |  |         |     |             |       |         |  |  |  |  |  |         |     |             |       |             |                |        |   |                |     |         |     |             |       |             |                |        |   |                |     |         |     |             |       |             |  |  |  |  |  |         |     |             |       |             |  |  |  |  |  |         |     |             |       |             |  |  |  |  |  |         |     |             |       |             |  |  |  |  |  |  |   |         |     |  |       |       |  |                |        |   |       |         |     |  |       |       |  |  |  |  |  |         |     |  |       |       |  |  |  |  |  |         |     |  |       |       |  |  |  |  |  |         |     |  |       |       |  |  |  |  |  |         |     |  |       |       |  |  |  |  |  |          |     |  |       |       |  |  |  |  |  |         |     |  |       |       |  |  |  |  |  |         |     |  |       |       |  |  |  |  |  |
| 2.7 TDI  | 140   |                 | 10.08 | 05.11       | PR: 1ZL        | 11.0441-6008.2 | 250038  |                          | Dichtungssatz   | ATE                      |                |                 |         |             |       |             |                |         |   |                |                          |                |     |             |       |             |       |       |         |                |        |          |               |             |         |         |  |       |       |         |                |         |     |             |       |         |     |  |       |       |         |                |        |             |                |         |         |     |  |       |       |          |                |             |       |             |                |          |   |                |       |         |         |             |       |             |                |        |   |                |     |         |       |             |       |             |  |  |  |         |     |                 |       |             |         |             |  |  |  |  |         |                 |     |             |       |             |                |        |                          |                |     |                 |     |             |       |             |         |                |        |                          |                |         |         |     |       |       |       |         |                |        |  |               |     |         |       |       |       |       |         |                |        |         |            |     |         |       |  |       |       |         |                |                 |     |                |       |         |     |  |       |       |         |                 |        |   |            |       |          |     |  |       |       |                 |     |  |       |       |  |         |     |  |       |       |         |  |       |       |  |  |         |     |  |             |       |         |       |       |  |  |  |         |     |                 |       |       |       |                |        |   |       |  |         |                 |     |       |       |       |  |  |  |  |  |                 |     |  |       |       |  |  |  |  |  |                 |         |     |       |       |       |  |  |  |  |                  |  |         |       |       |       |       |  |  |  |         |     |  |         |       |  |       |       |  |  |                 |     |  |       |          |     |  |       |       |  |                 |     |  |       |       |         |     |  |       |       |             |     |  |       |       |  |         |     |  |       |       |     |  |       |       |  |  |  |   |         |     |             |       |         |                |        |   |                |     |         |     |             |       |         |                |        |   |                |     |         |     |             |       |         |  |  |  |  |  |         |     |             |       |         |  |  |  |  |  |         |     |             |       |         |  |  |  |  |  |         |     |             |       |         |  |  |  |  |  |         |     |             |       |             |                |        |   |                |     |         |     |             |       |             |                |        |   |                |     |         |     |             |       |             |  |  |  |  |  |         |     |             |       |             |  |  |  |  |  |         |     |             |       |             |  |  |  |  |  |         |     |             |       |             |  |  |  |  |  |  |   |         |     |  |       |       |  |                |        |   |       |         |     |  |       |       |  |  |  |  |  |         |     |  |       |       |  |  |  |  |  |         |     |  |       |       |  |  |  |  |  |         |     |  |       |       |  |  |  |  |  |         |     |  |       |       |  |  |  |  |  |          |     |  |       |       |  |  |  |  |  |         |     |  |       |       |  |  |  |  |  |         |     |  |       |       |  |  |  |  |  |
| 3.0 TDI  | 155   |                 | 05.06 | 05.11       | PR: 1ZL        | 11.0101-5409.2 | 260035  |                          | Hülsensatz  | ATE                      |                |                 |         |             |       |             |                |         |   |                |                          |                |     |             |       |             |       |       |         |                |        |          |               |             |         |         |  |       |       |         |                |         |     |             |       |         |     |  |       |       |         |                |        |             |                |         |         |     |  |       |       |          |                |             |       |             |                |          |   |                |       |         |         |             |       |             |                |        |   |                |     |         |       |             |       |             |  |  |  |         |     |                 |       |             |         |             |  |  |  |  |         |                 |     |             |       |             |                |        |                          |                |     |                 |     |             |       |             |         |                |        |                          |                |         |         |     |       |       |       |         |                |        |  |               |     |         |       |       |       |       |         |                |        |         |            |     |         |       |  |       |       |         |                |                 |     |                |       |         |     |  |       |       |         |                 |        |   |            |       |          |     |  |       |       |                 |     |  |       |       |  |         |     |  |       |       |         |  |       |       |  |  |         |     |  |             |       |         |       |       |  |  |  |         |     |                 |       |       |       |                |        |   |       |  |         |                 |     |       |       |       |  |  |  |  |  |                 |     |  |       |       |  |  |  |  |  |                 |         |     |       |       |       |  |  |  |  |                  |  |         |       |       |       |       |  |  |  |         |     |  |         |       |  |       |       |  |  |                 |     |  |       |          |     |  |       |       |  |                 |     |  |       |       |         |     |  |       |       |             |     |  |       |       |  |         |     |  |       |       |     |  |       |       |  |  |  |   |         |     |             |       |         |                |        |   |                |     |         |     |             |       |         |                |        |   |                |     |         |     |             |       |         |  |  |  |  |  |         |     |             |       |         |  |  |  |  |  |         |     |             |       |         |  |  |  |  |  |         |     |             |       |         |  |  |  |  |  |         |     |             |       |             |                |        |   |                |     |         |     |             |       |             |                |        |   |                |     |         |     |             |       |             |  |  |  |  |  |         |     |             |       |             |  |  |  |  |  |         |     |             |       |             |  |  |  |  |  |         |     |             |       |             |  |  |  |  |  |  |   |         |     |  |       |       |  |                |        |   |       |         |     |  |       |       |  |  |  |  |  |         |     |  |       |       |  |  |  |  |  |         |     |  |       |       |  |  |  |  |  |         |     |  |       |       |  |  |  |  |  |         |     |  |       |       |  |  |  |  |  |          |     |  |       |       |  |  |  |  |  |         |     |  |       |       |  |  |  |  |  |         |     |  |       |       |  |  |  |  |  |
| 3.0 TDI  | 171   |                 | 05.06 | 05.11       | PR: 1ZL        | 11.8171-0008.1 | 990049  |                          | Führungsbolzen  | ATE                      |                |                 |         |             |       |             |                |         |   |                |                          |                |     |             |       |             |       |       |         |                |        |          |               |             |         |         |  |       |       |         |                |         |     |             |       |         |     |  |       |       |         |                |        |             |                |         |         |     |  |       |       |          |                |             |       |             |                |          |   |                |       |         |         |             |       |             |                |        |   |                |     |         |       |             |       |             |  |  |  |         |     |                 |       |             |         |             |  |  |  |  |         |                 |     |             |       |             |                |        |                          |                |     |                 |     |             |       |             |         |                |        |                          |                |         |         |     |       |       |       |         |                |        |  |               |     |         |       |       |       |       |         |                |        |         |            |     |         |       |  |       |       |         |                |                 |     |                |       |         |     |  |       |       |         |                 |        |   |            |       |          |     |  |       |       |                 |     |  |       |       |  |         |     |  |       |       |         |  |       |       |  |  |         |     |  |             |       |         |       |       |  |  |  |         |     |                 |       |       |       |                |        |   |       |  |         |                 |     |       |       |       |  |  |  |  |  |                 |     |  |       |       |  |  |  |  |  |                 |         |     |       |       |       |  |  |  |  |                  |  |         |       |       |       |       |  |  |  |         |     |  |         |       |  |       |       |  |  |                 |     |  |       |          |     |  |       |       |  |                 |     |  |       |       |         |     |  |       |       |             |     |  |       |       |  |         |     |  |       |       |     |  |       |       |  |  |  |   |         |     |             |       |         |                |        |   |                |     |         |     |             |       |         |                |        |   |                |     |         |     |             |       |         |  |  |  |  |  |         |     |             |       |         |  |  |  |  |  |         |     |             |       |         |  |  |  |  |  |         |     |             |       |         |  |  |  |  |  |         |     |             |       |             |                |        |   |                |     |         |     |             |       |             |                |        |   |                |     |         |     |             |       |             |  |  |  |  |  |         |     |             |       |             |  |  |  |  |  |         |     |             |       |             |  |  |  |  |  |         |     |             |       |             |  |  |  |  |  |  |   |         |     |  |       |       |  |                |        |   |       |         |     |  |       |       |  |  |  |  |  |         |     |  |       |       |  |  |  |  |  |         |     |  |       |       |  |  |  |  |  |         |     |  |       |       |  |  |  |  |  |         |     |  |       |       |  |  |  |  |  |          |     |  |       |       |  |  |  |  |  |         |     |  |       |       |  |  |  |  |  |         |     |  |       |       |  |  |  |  |  |
| 3.0 TDI  | 176   |                 | 10.08 | 05.11       | PR: 1ZL        | 11.8116-0410.2 | 390589  | 2                        | Haltefeder  | ATE                      |                |                 |         |             |       |             |                |         |   |                |                          |                |     |             |       |             |       |       |         |                |        |          |               |             |         |         |  |       |       |         |                |         |     |             |       |         |     |  |       |       |         |                |        |             |                |         |         |     |  |       |       |          |                |             |       |             |                |          |   |                |       |         |         |             |       |             |                |        |   |                |     |         |       |             |       |             |  |  |  |         |     |                 |       |             |         |             |  |  |  |  |         |                 |     |             |       |             |                |        |                          |                |     |                 |     |             |       |             |         |                |        |                          |                |         |         |     |       |       |       |         |                |        |  |               |     |         |       |       |       |       |         |                |        |         |            |     |         |       |  |       |       |         |                |                 |     |                |       |         |     |  |       |       |         |                 |        |   |            |       |          |     |  |       |       |                 |     |  |       |       |  |         |     |  |       |       |         |  |       |       |  |  |         |     |  |             |       |         |       |       |  |  |  |         |     |                 |       |       |       |                |        |   |       |  |         |                 |     |       |       |       |  |  |  |  |  |                 |     |  |       |       |  |  |  |  |  |                 |         |     |       |       |       |  |  |  |  |                  |  |         |       |       |       |       |  |  |  |         |     |  |         |       |  |       |       |  |  |                 |     |  |       |          |     |  |       |       |  |                 |     |  |       |       |         |     |  |       |       |             |     |  |       |       |  |         |     |  |       |       |     |  |       |       |  |  |  |   |         |     |             |       |         |                |        |   |                |     |         |     |             |       |         |                |        |   |                |     |         |     |             |       |         |  |  |  |  |  |         |     |             |       |         |  |  |  |  |  |         |     |             |       |         |  |  |  |  |  |         |     |             |       |         |  |  |  |  |  |         |     |             |       |             |                |        |   |                |     |         |     |             |       |             |                |        |   |                |     |         |     |             |       |             |  |  |  |  |  |         |     |             |       |             |  |  |  |  |  |         |     |             |       |             |  |  |  |  |  |         |     |             |       |             |  |  |  |  |  |  |   |         |     |  |       |       |  |                |        |   |       |         |     |  |       |       |  |  |  |  |  |         |     |  |       |       |  |  |  |  |  |         |     |  |       |       |  |  |  |  |  |         |     |  |       |       |  |  |  |  |  |         |     |  |       |       |  |  |  |  |  |          |     |  |       |       |  |  |  |  |  |         |     |  |       |       |  |  |  |  |  |         |     |  |       |       |  |  |  |  |  |
| 3.0 TFSI   | 213   |                 | 10.08 | 05.11       | PR: 1ZL        |                |   |                          |   |                          |                |                 |         |             |       |             |                |         |   |                |                          |                |     |             |       |             |       |       |         |                |        |          |               |             |         |         |  |       |       |         |                |         |     |             |       |         |     |  |       |       |         |                |        |             |                |         |         |     |  |       |       |          |                |             |       |             |                |          |   |                |       |         |         |             |       |             |                |        |   |                |     |         |       |             |       |             |  |  |  |         |     |                 |       |             |         |             |  |  |  |  |         |                 |     |             |       |             |                |        |                          |                |     |                 |     |             |       |             |         |                |        |                          |                |         |         |     |       |       |       |         |                |        |  |               |     |         |       |       |       |       |         |                |        |         |            |     |         |       |  |       |       |         |                |                 |     |                |       |         |     |  |       |       |         |                 |        |   |            |       |          |     |  |       |       |                 |     |  |       |       |  |         |     |  |       |       |         |  |       |       |  |  |         |     |  |             |       |         |       |       |  |  |  |         |     |                 |       |       |       |                |        |   |       |  |         |                 |     |       |       |       |  |  |  |  |  |                 |     |  |       |       |  |  |  |  |  |                 |         |     |       |       |       |  |  |  |  |                  |  |         |       |       |       |       |  |  |  |         |     |  |         |       |  |       |       |  |  |                 |     |  |       |          |     |  |       |       |  |                 |     |  |       |       |         |     |  |       |       |             |     |  |       |       |  |         |     |  |       |       |     |  |       |       |  |  |  |   |         |     |             |       |         |                |        |   |                |     |         |     |             |       |         |                |        |   |                |     |         |     |             |       |         |  |  |  |  |  |         |     |             |       |         |  |  |  |  |  |         |     |             |       |         |  |  |  |  |  |         |     |             |       |         |  |  |  |  |  |         |     |             |       |             |                |        |   |                |     |         |     |             |       |             |                |        |   |                |     |         |     |             |       |             |  |  |  |  |  |         |     |             |       |             |  |  |  |  |  |         |     |             |       |             |  |  |  |  |  |         |     |             |       |             |  |  |  |  |  |  |   |         |     |  |       |       |  |                |        |   |       |         |     |  |       |       |  |  |  |  |  |         |     |  |       |       |  |  |  |  |  |         |     |  |       |       |  |  |  |  |  |         |     |  |       |       |  |  |  |  |  |         |     |  |       |       |  |  |  |  |  |          |     |  |       |       |  |  |  |  |  |         |     |  |       |       |  |  |  |  |  |         |     |  |       |       |  |  |  |  |  |
| 3.2 FSI  | 188   |                 | 05.06 | 05.11       | PR: 1ZL        |                |   |                          |   |                          |                |                 |         |             |       |             |                |         |   |                |                          |                |     |             |       |             |       |       |         |                |        |          |               |             |         |         |  |       |       |         |                |         |     |             |       |         |     |  |       |       |         |                |        |             |                |         |         |     |  |       |       |          |                |             |       |             |                |          |   |                |       |         |         |             |       |             |                |        |   |                |     |         |       |             |       |             |  |  |  |         |     |                 |       |             |         |             |  |  |  |  |         |                 |     |             |       |             |                |        |                          |                |     |                 |     |             |       |             |         |                |        |                          |                |         |         |     |       |       |       |         |                |        |  |               |     |         |       |       |       |       |         |                |        |         |            |     |         |       |  |       |       |         |                |                 |     |                |       |         |     |  |       |       |         |                 |        |   |            |       |          |     |  |       |       |                 |     |  |       |       |  |         |     |  |       |       |         |  |       |       |  |  |         |     |  |             |       |         |       |       |  |  |  |         |     |                 |       |       |       |                |        |   |       |  |         |                 |     |       |       |       |  |  |  |  |  |                 |     |  |       |       |  |  |  |  |  |                 |         |     |       |       |       |  |  |  |  |                  |  |         |       |       |       |       |  |  |  |         |     |  |         |       |  |       |       |  |  |                 |     |  |       |          |     |  |       |       |  |                 |     |  |       |       |         |     |  |       |       |             |     |  |       |       |  |         |     |  |       |       |     |  |       |       |  |  |  |   |         |     |             |       |         |                |        |   |                |     |         |     |             |       |         |                |        |   |                |     |         |     |             |       |         |  |  |  |  |  |         |     |             |       |         |  |  |  |  |  |         |     |             |       |         |  |  |  |  |  |         |     |             |       |         |  |  |  |  |  |         |     |             |       |             |                |        |   |                |     |         |     |             |       |             |                |        |   |                |     |         |     |             |       |             |  |  |  |  |  |         |     |             |       |             |  |  |  |  |  |         |     |             |       |             |  |  |  |  |  |         |     |             |       |             |  |  |  |  |  |  |   |         |     |  |       |       |  |                |        |   |       |         |     |  |       |       |  |  |  |  |  |         |     |  |       |       |  |  |  |  |  |         |     |  |       |       |  |  |  |  |  |         |     |  |       |       |  |  |  |  |  |         |     |  |       |       |  |  |  |  |  |          |     |  |       |       |  |  |  |  |  |         |     |  |       |       |  |  |  |  |  |         |     |  |       |       |  |  |  |  |  |
| 4.2 FSI  | 257   |                 | 05.06 | 05.11       | PR: 1ZL        |                |   |                          |   |                          |                |                 |         |             |       |             |                |         |   |                |                          |                |     |             |       |             |       |       |         |                |        |          |               |             |         |         |  |       |       |         |                |         |     |             |       |         |     |  |       |       |         |                |        |             |                |         |         |     |  |       |       |          |                |             |       |             |                |          |   |                |       |         |         |             |       |             |                |        |   |                |     |         |       |             |       |             |  |  |  |         |     |                 |       |             |         |             |  |  |  |  |         |                 |     |             |       |             |                |        |                          |                |     |                 |     |             |       |             |         |                |        |                          |                |         |         |     |       |       |       |         |                |        |  |               |     |         |       |       |       |       |         |                |        |         |            |     |         |       |  |       |       |         |                |                 |     |                |       |         |     |  |       |       |         |                 |        |   |            |       |          |     |  |       |       |                 |     |  |       |       |  |         |     |  |       |       |         |  |       |       |  |  |         |     |  |             |       |         |       |       |  |  |  |         |     |                 |       |       |       |                |        |   |       |  |         |                 |     |       |       |       |  |  |  |  |  |                 |     |  |       |       |  |  |  |  |  |                 |         |     |       |       |       |  |  |  |  |                  |  |         |       |       |       |       |  |  |  |         |     |  |         |       |  |       |       |  |  |                 |     |  |       |          |     |  |       |       |  |                 |     |  |       |       |         |     |  |       |       |             |     |  |       |       |  |         |     |  |       |       |     |  |       |       |  |  |  |   |         |     |             |       |         |                |        |   |                |     |         |     |             |       |         |                |        |   |                |     |         |     |             |       |         |  |  |  |  |  |         |     |             |       |         |  |  |  |  |  |         |     |             |       |         |  |  |  |  |  |         |     |             |       |         |  |  |  |  |  |         |     |             |       |             |                |        |   |                |     |         |     |             |       |             |                |        |   |                |     |         |     |             |       |             |  |  |  |  |  |         |     |             |       |             |  |  |  |  |  |         |     |             |       |             |  |  |  |  |  |         |     |             |       |             |  |  |  |  |  |  |   |         |     |  |       |       |  |                |        |   |       |         |     |  |       |       |  |  |  |  |  |         |     |  |       |       |  |  |  |  |  |         |     |  |       |       |  |  |  |  |  |         |     |  |       |       |  |  |  |  |  |         |     |  |       |       |  |  |  |  |  |          |     |  |       |       |  |  |  |  |  |         |     |  |       |       |  |  |  |  |  |         |     |  |       |       |  |  |  |  |  |
| 2.7 TDI  | 120   |                 | 05.06 | 05.11       |                | 83.7813-0315.3 | 330870  | 2                        | L=315   |                          |                |                 |         |             |       |             |                |         |   |                |                          |                |     |             |       |             |       |       |         |                |        |          |               |             |         |         |  |       |       |         |                |         |     |             |       |         |     |  |       |       |         |                |        |             |                |         |         |     |  |       |       |          |                |             |       |             |                |          |   |                |       |         |         |             |       |             |                |        |   |                |     |         |       |             |       |             |  |  |  |         |     |                 |       |             |         |             |  |  |  |  |         |                 |     |             |       |             |                |        |                          |                |     |                 |     |             |       |             |         |                |        |                          |                |         |         |     |       |       |       |         |                |        |  |               |     |         |       |       |       |       |         |                |        |         |            |     |         |       |  |       |       |         |                |                 |     |                |       |         |     |  |       |       |         |                 |        |   |            |       |          |     |  |       |       |                 |     |  |       |       |  |         |     |  |       |       |         |  |       |       |  |  |         |     |  |             |       |         |       |       |  |  |  |         |     |                 |       |       |       |                |        |   |       |  |         |                 |     |       |       |       |  |  |  |  |  |                 |     |  |       |       |  |  |  |  |  |                 |         |     |       |       |       |  |  |  |  |                  |  |         |       |       |       |       |  |  |  |         |     |  |         |       |  |       |       |  |  |                 |     |  |       |          |     |  |       |       |  |                 |     |  |       |       |         |     |  |       |       |             |     |  |       |       |  |         |     |  |       |       |     |  |       |       |  |  |  |   |         |     |             |       |         |                |        |   |                |     |         |     |             |       |         |                |        |   |                |     |         |     |             |       |         |  |  |  |  |  |         |     |             |       |         |  |  |  |  |  |         |     |             |       |         |  |  |  |  |  |         |     |             |       |         |  |  |  |  |  |         |     |             |       |             |                |        |   |                |     |         |     |             |       |             |                |        |   |                |     |         |     |             |       |             |  |  |  |  |  |         |     |             |       |             |  |  |  |  |  |         |     |             |       |             |  |  |  |  |  |         |     |             |       |             |  |  |  |  |  |  |   |         |     |  |       |       |  |                |        |   |       |         |     |  |       |       |  |  |  |  |  |         |     |  |       |       |  |  |  |  |  |         |     |  |       |       |  |  |  |  |  |         |     |  |       |       |  |  |  |  |  |         |     |  |       |       |  |  |  |  |  |          |     |  |       |       |  |  |  |  |  |         |     |  |       |       |  |  |  |  |  |         |     |  |       |       |  |  |  |  |  |
| 2.7 TDI  | 132   |                 | 05.06 | 05.11       |                |                |   |                          |   |                          |                |                 |         |             |       |             |                |         |   |                |                          |                |     |             |       |             |       |       |         |                |        |          |               |             |         |         |  |       |       |         |                |         |     |             |       |         |     |  |       |       |         |                |        |             |                |         |         |     |  |       |       |          |                |             |       |             |                |          |   |                |       |         |         |             |       |             |                |        |   |                |     |         |       |             |       |             |  |  |  |         |     |                 |       |             |         |             |  |  |  |  |         |                 |     |             |       |             |                |        |                          |                |     |                 |     |             |       |             |         |                |        |                          |                |         |         |     |       |       |       |         |                |        |  |               |     |         |       |       |       |       |         |                |        |         |            |     |         |       |  |       |       |         |                |                 |     |                |       |         |     |  |       |       |         |                 |        |   |            |       |          |     |  |       |       |                 |     |  |       |       |  |         |     |  |       |       |         |  |       |       |  |  |         |     |  |             |       |         |       |       |  |  |  |         |     |                 |       |       |       |                |        |   |       |  |         |                 |     |       |       |       |  |  |  |  |  |                 |     |  |       |       |  |  |  |  |  |                 |         |     |       |       |       |  |  |  |  |                  |  |         |       |       |       |       |  |  |  |         |     |  |         |       |  |       |       |  |  |                 |     |  |       |          |     |  |       |       |  |                 |     |  |       |       |         |     |  |       |       |             |     |  |       |       |  |         |     |  |       |       |     |  |       |       |  |  |  |   |         |     |             |       |         |                |        |   |                |     |         |     |             |       |         |                |        |   |                |     |         |     |             |       |         |  |  |  |  |  |         |     |             |       |         |  |  |  |  |  |         |     |             |       |         |  |  |  |  |  |         |     |             |       |         |  |  |  |  |  |         |     |             |       |             |                |        |   |                |     |         |     |             |       |             |                |        |   |                |     |         |     |             |       |             |  |  |  |  |  |         |     |             |       |             |  |  |  |  |  |         |     |             |       |             |  |  |  |  |  |         |     |             |       |             |  |  |  |  |  |  |   |         |     |  |       |       |  |                |        |   |       |         |     |  |       |       |  |  |  |  |  |         |     |  |       |       |  |  |  |  |  |         |     |  |       |       |  |  |  |  |  |         |     |  |       |       |  |  |  |  |  |         |     |  |       |       |  |  |  |  |  |          |     |  |       |       |  |  |  |  |  |         |     |  |       |       |  |  |  |  |  |         |     |  |       |       |  |  |  |  |  |
| 2.7 TDI  | 140   |                 | 10.08 | 05.11       |                |                |   |                          |   |                          |                |                 |         |             |       |             |                |         |   |                |                          |                |     |             |       |             |       |       |         |                |        |          |               |             |         |         |  |       |       |         |                |         |     |             |       |         |     |  |       |       |         |                |        |             |                |         |         |     |  |       |       |          |                |             |       |             |                |          |   |                |       |         |         |             |       |             |                |        |   |                |     |         |       |             |       |             |  |  |  |         |     |                 |       |             |         |             |  |  |  |  |         |                 |     |             |       |             |                |        |                          |                |     |                 |     |             |       |             |         |                |        |                          |                |         |         |     |       |       |       |         |                |        |  |               |     |         |       |       |       |       |         |                |        |         |            |     |         |       |  |       |       |         |                |                 |     |                |       |         |     |  |       |       |         |                 |        |   |            |       |          |     |  |       |       |                 |     |  |       |       |  |         |     |  |       |       |         |  |       |       |  |  |         |     |  |             |       |         |       |       |  |  |  |         |     |                 |       |       |       |                |        |   |       |  |         |                 |     |       |       |       |  |  |  |  |  |                 |     |  |       |       |  |  |  |  |  |                 |         |     |       |       |       |  |  |  |  |                  |  |         |       |       |       |       |  |  |  |         |     |  |         |       |  |       |       |  |  |                 |     |  |       |          |     |  |       |       |  |                 |     |  |       |       |         |     |  |       |       |             |     |  |       |       |  |         |     |  |       |       |     |  |       |       |  |  |  |   |         |     |             |       |         |                |        |   |                |     |         |     |             |       |         |                |        |   |                |     |         |     |             |       |         |  |  |  |  |  |         |     |             |       |         |  |  |  |  |  |         |     |             |       |         |  |  |  |  |  |         |     |             |       |         |  |  |  |  |  |         |     |             |       |             |                |        |   |                |     |         |     |             |       |             |                |        |   |                |     |         |     |             |       |             |  |  |  |  |  |         |     |             |       |             |  |  |  |  |  |         |     |             |       |             |  |  |  |  |  |         |     |             |       |             |  |  |  |  |  |  |   |         |     |  |       |       |  |                |        |   |       |         |     |  |       |       |  |  |  |  |  |         |     |  |       |       |  |  |  |  |  |         |     |  |       |       |  |  |  |  |  |         |     |  |       |       |  |  |  |  |  |         |     |  |       |       |  |  |  |  |  |          |     |  |       |       |  |  |  |  |  |         |     |  |       |       |  |  |  |  |  |         |     |  |       |       |  |  |  |  |  |
| 3.0 TDI  | 155   |                 | 05.06 | 05.11       |                |                |   |                          |   |                          |                |                 |         |             |       |             |                |         |   |                |                          |                |     |             |       |             |       |       |         |                |        |          |               |             |         |         |  |       |       |         |                |         |     |             |       |         |     |  |       |       |         |                |        |             |                |         |         |     |  |       |       |          |                |             |       |             |                |          |   |                |       |         |         |             |       |             |                |        |   |                |     |         |       |             |       |             |  |  |  |         |     |                 |       |             |         |             |  |  |  |  |         |                 |     |             |       |             |                |        |                          |                |     |                 |     |             |       |             |         |                |        |                          |                |         |         |     |       |       |       |         |                |        |  |               |     |         |       |       |       |       |         |                |        |         |            |     |         |       |  |       |       |         |                |                 |     |                |       |         |     |  |       |       |         |                 |        |   |            |       |          |     |  |       |       |                 |     |  |       |       |  |         |     |  |       |       |         |  |       |       |  |  |         |     |  |             |       |         |       |       |  |  |  |         |     |                 |       |       |       |                |        |   |       |  |         |                 |     |       |       |       |  |  |  |  |  |                 |     |  |       |       |  |  |  |  |  |                 |         |     |       |       |       |  |  |  |  |                  |  |         |       |       |       |       |  |  |  |         |     |  |         |       |  |       |       |  |  |                 |     |  |       |          |     |  |       |       |  |                 |     |  |       |       |         |     |  |       |       |             |     |  |       |       |  |         |     |  |       |       |     |  |       |       |  |  |  |   |         |     |             |       |         |                |        |   |                |     |         |     |             |       |         |                |        |   |                |     |         |     |             |       |         |  |  |  |  |  |         |     |             |       |         |  |  |  |  |  |         |     |             |       |         |  |  |  |  |  |         |     |             |       |         |  |  |  |  |  |         |     |             |       |             |                |        |   |                |     |         |     |             |       |             |                |        |   |                |     |         |     |             |       |             |  |  |  |  |  |         |     |             |       |             |  |  |  |  |  |         |     |             |       |             |  |  |  |  |  |         |     |             |       |             |  |  |  |  |  |  |   |         |     |  |       |       |  |                |        |   |       |         |     |  |       |       |  |  |  |  |  |         |     |  |       |       |  |  |  |  |  |         |     |  |       |       |  |  |  |  |  |         |     |  |       |       |  |  |  |  |  |         |     |  |       |       |  |  |  |  |  |          |     |  |       |       |  |  |  |  |  |         |     |  |       |       |  |  |  |  |  |         |     |  |       |       |  |  |  |  |  |
| 3.0 TDI  | 171   |                 | 05.06 | 05.11       |                |                |   |                          |   |                          |                |                 |         |             |       |             |                |         |   |                |                          |                |     |             |       |             |       |       |         |                |        |          |               |             |         |         |  |       |       |         |                |         |     |             |       |         |     |  |       |       |         |                |        |             |                |         |         |     |  |       |       |          |                |             |       |             |                |          |   |                |       |         |         |             |       |             |                |        |   |                |     |         |       |             |       |             |  |  |  |         |     |                 |       |             |         |             |  |  |  |  |         |                 |     |             |       |             |                |        |                          |                |     |                 |     |             |       |             |         |                |        |                          |                |         |         |     |       |       |       |         |                |        |  |               |     |         |       |       |       |       |         |                |        |         |            |     |         |       |  |       |       |         |                |                 |     |                |       |         |     |  |       |       |         |                 |        |   |            |       |          |     |  |       |       |                 |     |  |       |       |  |         |     |  |       |       |         |  |       |       |  |  |         |     |  |             |       |         |       |       |  |  |  |         |     |                 |       |       |       |                |        |   |       |  |         |                 |     |       |       |       |  |  |  |  |  |                 |     |  |       |       |  |  |  |  |  |                 |         |     |       |       |       |  |  |  |  |                  |  |         |       |       |       |       |  |  |  |         |     |  |         |       |  |       |       |  |  |                 |     |  |       |          |     |  |       |       |  |                 |     |  |       |       |         |     |  |       |       |             |     |  |       |       |  |         |     |  |       |       |     |  |       |       |  |  |  |   |         |     |             |       |         |                |        |   |                |     |         |     |             |       |         |                |        |   |                |     |         |     |             |       |         |  |  |  |  |  |         |     |             |       |         |  |  |  |  |  |         |     |             |       |         |  |  |  |  |  |         |     |             |       |         |  |  |  |  |  |         |     |             |       |             |                |        |   |                |     |         |     |             |       |             |                |        |   |                |     |         |     |             |       |             |  |  |  |  |  |         |     |             |       |             |  |  |  |  |  |         |     |             |       |             |  |  |  |  |  |         |     |             |       |             |  |  |  |  |  |  |   |         |     |  |       |       |  |                |        |   |       |         |     |  |       |       |  |  |  |  |  |         |     |  |       |       |  |  |  |  |  |         |     |  |       |       |  |  |  |  |  |         |     |  |       |       |  |  |  |  |  |         |     |  |       |       |  |  |  |  |  |          |     |  |       |       |  |  |  |  |  |         |     |  |       |       |  |  |  |  |  |         |     |  |       |       |  |  |  |  |  |
| 3.0 TDI  | 176   |                 | 10.08 | 05.11       |                |                |   |                          |   |                          |                |                 |         |             |       |             |                |         |   |                |                          |                |     |             |       |             |       |       |         |                |        |          |               |             |         |         |  |       |       |         |                |         |     |             |       |         |     |  |       |       |         |                |        |             |                |         |         |     |  |       |       |          |                |             |       |             |                |          |   |                |       |         |         |             |       |             |                |        |   |                |     |         |       |             |       |             |  |  |  |         |     |                 |       |             |         |             |  |  |  |  |         |                 |     |             |       |             |                |        |                          |                |     |                 |     |             |       |             |         |                |        |                          |                |         |         |     |       |       |       |         |                |        |  |               |     |         |       |       |       |       |         |                |        |         |            |     |         |       |  |       |       |         |                |                 |     |                |       |         |     |  |       |       |         |                 |        |   |            |       |          |     |  |       |       |                 |     |  |       |       |  |         |     |  |       |       |         |  |       |       |  |  |         |     |  |             |       |         |       |       |  |  |  |         |     |                 |       |       |       |                |        |   |       |  |         |                 |     |       |       |       |  |  |  |  |  |                 |     |  |       |       |  |  |  |  |  |                 |         |     |       |       |       |  |  |  |  |                  |  |         |       |       |       |       |  |  |  |         |     |  |         |       |  |       |       |  |  |                 |     |  |       |          |     |  |       |       |  |                 |     |  |       |       |         |     |  |       |       |             |     |  |       |       |  |         |     |  |       |       |     |  |       |       |  |  |  |   |         |     |             |       |         |                |        |   |                |     |         |     |             |       |         |                |        |   |                |     |         |     |             |       |         |  |  |  |  |  |         |     |             |       |         |  |  |  |  |  |         |     |             |       |         |  |  |  |  |  |         |     |             |       |         |  |  |  |  |  |         |     |             |       |             |                |        |   |                |     |         |     |             |       |             |                |        |   |                |     |         |     |             |       |             |  |  |  |  |  |         |     |             |       |             |  |  |  |  |  |         |     |             |       |             |  |  |  |  |  |         |     |             |       |             |  |  |  |  |  |  |   |         |     |  |       |       |  |                |        |   |       |         |     |  |       |       |  |  |  |  |  |         |     |  |       |       |  |  |  |  |  |         |     |  |       |       |  |  |  |  |  |         |     |  |       |       |  |  |  |  |  |         |     |  |       |       |  |  |  |  |  |          |     |  |       |       |  |  |  |  |  |         |     |  |       |       |  |  |  |  |  |         |     |  |       |       |  |  |  |  |  |
| 3.0 TFSI   | 213   |                 | 10.08 | 05.11       |                |                |   |                          |   |                          |                |                 |         |             |       |             |                |         |   |                |                          |                |     |             |       |             |       |       |         |                |        |          |               |             |         |         |  |       |       |         |                |         |     |             |       |         |     |  |       |       |         |                |        |             |                |         |         |     |  |       |       |          |                |             |       |             |                |          |   |                |       |         |         |             |       |             |                |        |   |                |     |         |       |             |       |             |  |  |  |         |     |                 |       |             |         |             |  |  |  |  |         |                 |     |             |       |             |                |        |                          |                |     |                 |     |             |       |             |         |                |        |                          |                |         |         |     |       |       |       |         |                |        |  |               |     |         |       |       |       |       |         |                |        |         |            |     |         |       |  |       |       |         |                |                 |     |                |       |         |     |  |       |       |         |                 |        |   |            |       |          |     |  |       |       |                 |     |  |       |       |  |         |     |  |       |       |         |  |       |       |  |  |         |     |  |             |       |         |       |       |  |  |  |         |     |                 |       |       |       |                |        |   |       |  |         |                 |     |       |       |       |  |  |  |  |  |                 |     |  |       |       |  |  |  |  |  |                 |         |     |       |       |       |  |  |  |  |                  |  |         |       |       |       |       |  |  |  |         |     |  |         |       |  |       |       |  |  |                 |     |  |       |          |     |  |       |       |  |                 |     |  |       |       |         |     |  |       |       |             |     |  |       |       |  |         |     |  |       |       |     |  |       |       |  |  |  |   |         |     |             |       |         |                |        |   |                |     |         |     |             |       |         |                |        |   |                |     |         |     |             |       |         |  |  |  |  |  |         |     |             |       |         |  |  |  |  |  |         |     |             |       |         |  |  |  |  |  |         |     |             |       |         |  |  |  |  |  |         |     |             |       |             |                |        |   |                |     |         |     |             |       |             |                |        |   |                |     |         |     |             |       |             |  |  |  |  |  |         |     |             |       |             |  |  |  |  |  |         |     |             |       |             |  |  |  |  |  |         |     |             |       |             |  |  |  |  |  |  |   |         |     |  |       |       |  |                |        |   |       |         |     |  |       |       |  |  |  |  |  |         |     |  |       |       |  |  |  |  |  |         |     |  |       |       |  |  |  |  |  |         |     |  |       |       |  |  |  |  |  |         |     |  |       |       |  |  |  |  |  |          |     |  |       |       |  |  |  |  |  |         |     |  |       |       |  |  |  |  |  |         |     |  |       |       |  |  |  |  |  |
| 3.2 FSI  | 188   |                 | 05.06 | 05.11       |                |                |   |                          |   |                          |                |                 |         |             |       |             |                |         |   |                |                          |                |     |             |       |             |       |       |         |                |        |          |               |             |         |         |  |       |       |         |                |         |     |             |       |         |     |  |       |       |         |                |        |             |                |         |         |     |  |       |       |          |                |             |       |             |                |          |   |                |       |         |         |             |       |             |                |        |   |                |     |         |       |             |       |             |  |  |  |         |     |                 |       |             |         |             |  |  |  |  |         |                 |     |             |       |             |                |        |                          |                |     |                 |     |             |       |             |         |                |        |                          |                |         |         |     |       |       |       |         |                |        |  |               |     |         |       |       |       |       |         |                |        |         |            |     |         |       |  |       |       |         |                |                 |     |                |       |         |     |  |       |       |         |                 |        |   |            |       |          |     |  |       |       |                 |     |  |       |       |  |         |     |  |       |       |         |  |       |       |  |  |         |     |  |             |       |         |       |       |  |  |  |         |     |                 |       |       |       |                |        |   |       |  |         |                 |     |       |       |       |  |  |  |  |  |                 |     |  |       |       |  |  |  |  |  |                 |         |     |       |       |       |  |  |  |  |                  |  |         |       |       |       |       |  |  |  |         |     |  |         |       |  |       |       |  |  |                 |     |  |       |          |     |  |       |       |  |                 |     |  |       |       |         |     |  |       |       |             |     |  |       |       |  |         |     |  |       |       |     |  |       |       |  |  |  |   |         |     |             |       |         |                |        |   |                |     |         |     |             |       |         |                |        |   |                |     |         |     |             |       |         |  |  |  |  |  |         |     |             |       |         |  |  |  |  |  |         |     |             |       |         |  |  |  |  |  |         |     |             |       |         |  |  |  |  |  |         |     |             |       |             |                |        |   |                |     |         |     |             |       |             |                |        |   |                |     |         |     |             |       |             |  |  |  |  |  |         |     |             |       |             |  |  |  |  |  |         |     |             |       |             |  |  |  |  |  |         |     |             |       |             |  |  |  |  |  |  |   |         |     |  |       |       |  |                |        |   |       |         |     |  |       |       |  |  |  |  |  |         |     |  |       |       |  |  |  |  |  |         |     |  |       |       |  |  |  |  |  |         |     |  |       |       |  |  |  |  |  |         |     |  |       |       |  |  |  |  |  |          |     |  |       |       |  |  |  |  |  |         |     |  |       |       |  |  |  |  |  |         |     |  |       |       |  |  |  |  |  |
| 4.2 FSI  | 257   |                 | 05.06 | 05.11       |                |                |   |                          |   |                          |                |                 |         |             |       |             |                |         |   |                |                          |                |     |             |       |             |       |       |         |                |        |          |               |             |         |         |  |       |       |         |                |         |     |             |       |         |     |  |       |       |         |                |        |             |                |         |         |     |  |       |       |          |                |             |       |             |                |          |   |                |       |         |         |             |       |             |                |        |   |                |     |         |       |             |       |             |  |  |  |         |     |                 |       |             |         |             |  |  |  |  |         |                 |     |             |       |             |                |        |                          |                |     |                 |     |             |       |             |         |                |        |                          |                |         |         |     |       |       |       |         |                |        |  |               |     |         |       |       |       |       |         |                |        |         |            |     |         |       |  |       |       |         |                |                 |     |                |       |         |     |  |       |       |         |                 |        |   |            |       |          |     |  |       |       |                 |     |  |       |       |  |         |     |  |       |       |         |  |       |       |  |  |         |     |  |             |       |         |       |       |  |  |  |         |     |                 |       |       |       |                |        |   |       |  |         |                 |     |       |       |       |  |  |  |  |  |                 |     |  |       |       |  |  |  |  |  |                 |         |     |       |       |       |  |  |  |  |                  |  |         |       |       |       |       |  |  |  |         |     |  |         |       |  |       |       |  |  |                 |     |  |       |          |     |  |       |       |  |                 |     |  |       |       |         |     |  |       |       |             |     |  |       |       |  |         |     |  |       |       |     |  |       |       |  |  |  |   |         |     |             |       |         |                |        |   |                |     |         |     |             |       |         |                |        |   |                |     |         |     |             |       |         |  |  |  |  |  |         |     |             |       |         |  |  |  |  |  |         |     |             |       |         |  |  |  |  |  |         |     |             |       |         |  |  |  |  |  |         |     |             |       |             |                |        |   |                |     |         |     |             |       |             |                |        |   |                |     |         |     |             |       |             |  |  |  |  |  |         |     |             |       |             |  |  |  |  |  |         |     |             |       |             |  |  |  |  |  |         |     |             |       |             |  |  |  |  |  |  |   |         |     |  |       |       |  |                |        |   |       |         |     |  |       |       |  |  |  |  |  |         |     |  |       |       |  |  |  |  |  |         |     |  |       |       |  |  |  |  |  |         |     |  |       |       |  |  |  |  |  |         |     |  |       |       |  |  |  |  |  |          |     |  |       |       |  |  |  |  |  |         |     |  |       |       |  |  |  |  |  |         |     |  |       |       |  |  |  |  |  |
|  | <table border="1"> <tr> <td>2.7 TDI</td> <td>120</td> <td>4F-7-032500</td> <td>05.06</td> <td>PR: 1KD</td> <td>24.6241-1701.7</td> <td>220821</td> <td><input type="checkbox"/> elektrische Feststellbremse 1)</td> <td>D=41, - Halter</td> <td>LUC</td> </tr> <tr> <td>2.7 TDI</td> <td>132</td> <td>4F-7-032500</td> <td>05.06</td> <td>PR: 1KD</td> <td>24.6241-1702.7</td> <td>220822</td> <td><input type="checkbox"/> elektrische Feststellbremse 1)</td> <td>D=41, - Halter</td> <td>LUC</td> </tr> <tr> <td>3.0 TDI</td> <td>155</td> <td>4F-7-032500</td> <td>05.06</td> <td>PR: 1KD</td> <td></td> <td></td> <td></td> <td></td> <td></td> </tr> <tr> <td>3.0 TDI</td> <td>171</td> <td>4F-7-032500</td> <td>05.06</td> <td>PR: 1KD</td> <td></td> <td></td> <td></td> <td></td> <td></td> </tr> <tr> <td>3.2 FSI</td> <td>188</td> <td>4F-7-032500</td> <td>05.06</td> <td>PR: 1KD</td> <td></td> <td></td> <td></td> <td></td> <td></td> </tr> <tr> <td>4.2 FSI</td> <td>257</td> <td>4F-7-032500</td> <td>05.06</td> <td>PR: 1KD</td> <td></td> <td></td> <td></td> <td></td> <td></td> </tr> <tr> <td>2.7 TDI</td> <td>120</td> <td>4F-7-032500</td> <td>05.06</td> <td>PR: 1KW,2EE</td> <td>24.6243-1701.7</td> <td>220823</td> <td><input type="checkbox"/> elektrische Feststellbremse 1)</td> <td>D=43, - Halter</td> <td>LUC</td> </tr> <tr> <td>2.7 TDI</td> <td>132</td> <td>4F-7-032500</td> <td>05.06</td> <td>PR: 1KW,2EE</td> <td>24.6243-1702.7</td> <td>220824</td> <td><input type="checkbox"/> elektrische Feststellbremse 1)</td> <td>D=43, - Halter</td> <td>LUC</td> </tr> <tr> <td>3.0 TDI</td> <td>155</td> <td>4F-7-032500</td> <td>05.06</td> <td>PR: 1KW,2EE</td> <td></td> <td></td> <td></td> <td></td> <td></td> </tr> <tr> <td>3.0 TDI</td> <td>171</td> <td>4F-7-032500</td> <td>05.06</td> <td>PR: 1KW,2EE</td> <td></td> <td></td> <td></td> <td></td> <td></td> </tr> <tr> <td>3.2 FSI</td> <td>188</td> <td>4F-7-032500</td> <td>05.06</td> <td>PR: 1KW,2EE</td> <td></td> <td></td> <td></td> <td></td> <td></td> </tr> <tr> <td>4.2 FSI</td> <td>257</td> <td>4F-7-032500</td> <td>05.06</td> <td>PR: 1KW,2EE</td> <td></td> <td></td> <td></td> <td></td> <td></td> </tr> </table>   | 2.7 TDI         | 120   | 4F-7-032500 | 05.06          | PR: 1KD        | 24.6241-1701.7  | 220821                   | <input type="checkbox"/> elektrische Feststellbremse 1) | D=41, - Halter           | LUC            | 2.7 TDI         | 132     | 4F-7-032500 | 05.06 | PR: 1KD     | 24.6241-1702.7 | 220822  | <input type="checkbox"/> elektrische Feststellbremse 1) | D=41, - Halter | LUC                      | 3.0 TDI        | 155 | 4F-7-032500 | 05.06 | PR: 1KD     |       |       |         |                |        | 3.0 TDI  | 171           | 4F-7-032500 | 05.06   | PR: 1KD |  |       |       |         |                | 3.2 FSI | 188 | 4F-7-032500 | 05.06 | PR: 1KD |     |  |       |       |         | 4.2 FSI        | 257    | 4F-7-032500 | 05.06          | PR: 1KD |         |     |  |       |       | 2.7 TDI  | 120            | 4F-7-032500 | 05.06 | PR: 1KW,2EE | 24.6243-1701.7 | 220823   | <input type="checkbox"/> elektrische Feststellbremse 1) | D=43, - Halter | LUC   | 2.7 TDI | 132     | 4F-7-032500 | 05.06 | PR: 1KW,2EE | 24.6243-1702.7 | 220824 | <input type="checkbox"/> elektrische Feststellbremse 1) | D=43, - Halter | LUC | 3.0 TDI | 155   | 4F-7-032500 | 05.06 | PR: 1KW,2EE |  |  |  |         |     | 3.0 TDI         | 171   | 4F-7-032500 | 05.06   | PR: 1KW,2EE |  |  |  |  |         | 3.2 FSI         | 188 | 4F-7-032500 | 05.06 | PR: 1KW,2EE |                |        |                          |                |     | 4.2 FSI         | 257 | 4F-7-032500 | 05.06 | PR: 1KW,2EE |         |                |        |                          |                |         |         |     |       |       |       |         |                |        |  |               |     |         |       |       |       |       |         |                |        |         |            |     |         |       |  |       |       |         |                |                 |     |                |       |         |     |  |       |       |         |                 |        |   |            |       |          |     |  |       |       |                 |     |  |       |       |  |         |     |  |       |       |         |  |       |       |  |  |         |     |  |             |       |         |       |       |  |  |  |         |     |                 |       |       |       |                |        |   |       |  |         |                 |     |       |       |       |  |  |  |  |  |                 |     |  |       |       |  |  |  |  |  |                 |         |     |       |       |       |  |  |  |  |                  |  |         |       |       |       |       |  |  |  |         |     |  |         |       |  |       |       |  |  |                 |     |  |       |          |     |  |       |       |  |                 |     |  |       |       |         |     |  |       |       |             |     |  |       |       |  |         |     |  |       |       |     |  |       |       |  |  |  |   |         |     |             |       |         |                |        |   |                |     |         |     |             |       |         |                |        |   |                |     |         |     |             |       |         |  |  |  |  |  |         |     |             |       |         |  |  |  |  |  |         |     |             |       |         |  |  |  |  |  |         |     |             |       |         |  |  |  |  |  |         |     |             |       |             |                |        |   |                |     |         |     |             |       |             |                |        |   |                |     |         |     |             |       |             |  |  |  |  |  |         |     |             |       |             |  |  |  |  |  |         |     |             |       |             |  |  |  |  |  |         |     |             |       |             |  |  |  |  |  |  |   |         |     |  |       |       |  |                |        |   |       |         |     |  |       |       |  |  |  |  |  |         |     |  |       |       |  |  |  |  |  |         |     |  |       |       |  |  |  |  |  |         |     |  |       |       |  |  |  |  |  |         |     |  |       |       |  |  |  |  |  |          |     |  |       |       |  |  |  |  |  |         |     |  |       |       |  |  |  |  |  |         |     |  |       |       |  |  |  |  |  |
| 2.7 TDI  | 120   | 4F-7-032500     | 05.06 | PR: 1KD     | 24.6241-1701.7 | 220821         | <input type="checkbox"/> elektrische Feststellbremse 1) | D=41, - Halter           | LUC   |                          |                |                 |         |             |       |             |                |         |   |                |                          |                |     |             |       |             |       |       |         |                |        |          |               |             |         |         |  |       |       |         |                |         |     |             |       |         |     |  |       |       |         |                |        |             |                |         |         |     |  |       |       |          |                |             |       |             |                |          |   |                |       |         |         |             |       |             |                |        |   |                |     |         |       |             |       |             |  |  |  |         |     |                 |       |             |         |             |  |  |  |  |         |                 |     |             |       |             |                |        |                          |                |     |                 |     |             |       |             |         |                |        |                          |                |         |         |     |       |       |       |         |                |        |  |               |     |         |       |       |       |       |         |                |        |         |            |     |         |       |  |       |       |         |                |                 |     |                |       |         |     |  |       |       |         |                 |        |   |            |       |          |     |  |       |       |                 |     |  |       |       |  |         |     |  |       |       |         |  |       |       |  |  |         |     |  |             |       |         |       |       |  |  |  |         |     |                 |       |       |       |                |        |   |       |  |         |                 |     |       |       |       |  |  |  |  |  |                 |     |  |       |       |  |  |  |  |  |                 |         |     |       |       |       |  |  |  |  |                  |  |         |       |       |       |       |  |  |  |         |     |  |         |       |  |       |       |  |  |                 |     |  |       |          |     |  |       |       |  |                 |     |  |       |       |         |     |  |       |       |             |     |  |       |       |  |         |     |  |       |       |     |  |       |       |  |  |  |   |         |     |             |       |         |                |        |   |                |     |         |     |             |       |         |                |        |   |                |     |         |     |             |       |         |  |  |  |  |  |         |     |             |       |         |  |  |  |  |  |         |     |             |       |         |  |  |  |  |  |         |     |             |       |         |  |  |  |  |  |         |     |             |       |             |                |        |   |                |     |         |     |             |       |             |                |        |   |                |     |         |     |             |       |             |  |  |  |  |  |         |     |             |       |             |  |  |  |  |  |         |     |             |       |             |  |  |  |  |  |         |     |             |       |             |  |  |  |  |  |  |   |         |     |  |       |       |  |                |        |   |       |         |     |  |       |       |  |  |  |  |  |         |     |  |       |       |  |  |  |  |  |         |     |  |       |       |  |  |  |  |  |         |     |  |       |       |  |  |  |  |  |         |     |  |       |       |  |  |  |  |  |          |     |  |       |       |  |  |  |  |  |         |     |  |       |       |  |  |  |  |  |         |     |  |       |       |  |  |  |  |  |
| 2.7 TDI  | 132   | 4F-7-032500     | 05.06 | PR: 1KD     | 24.6241-1702.7 | 220822         | <input type="checkbox"/> elektrische Feststellbremse 1) | D=41, - Halter           | LUC   |                          |                |                 |         |             |       |             |                |         |   |                |                          |                |     |             |       |             |       |       |         |                |        |          |               |             |         |         |  |       |       |         |                |         |     |             |       |         |     |  |       |       |         |                |        |             |                |         |         |     |  |       |       |          |                |             |       |             |                |          |   |                |       |         |         |             |       |             |                |        |   |                |     |         |       |             |       |             |  |  |  |         |     |                 |       |             |         |             |  |  |  |  |         |                 |     |             |       |             |                |        |                          |                |     |                 |     |             |       |             |         |                |        |                          |                |         |         |     |       |       |       |         |                |        |  |               |     |         |       |       |       |       |         |                |        |         |            |     |         |       |  |       |       |         |                |                 |     |                |       |         |     |  |       |       |         |                 |        |   |            |       |          |     |  |       |       |                 |     |  |       |       |  |         |     |  |       |       |         |  |       |       |  |  |         |     |  |             |       |         |       |       |  |  |  |         |     |                 |       |       |       |                |        |   |       |  |         |                 |     |       |       |       |  |  |  |  |  |                 |     |  |       |       |  |  |  |  |  |                 |         |     |       |       |       |  |  |  |  |                  |  |         |       |       |       |       |  |  |  |         |     |  |         |       |  |       |       |  |  |                 |     |  |       |          |     |  |       |       |  |                 |     |  |       |       |         |     |  |       |       |             |     |  |       |       |  |         |     |  |       |       |     |  |       |       |  |  |  |   |         |     |             |       |         |                |        |   |                |     |         |     |             |       |         |                |        |   |                |     |         |     |             |       |         |  |  |  |  |  |         |     |             |       |         |  |  |  |  |  |         |     |             |       |         |  |  |  |  |  |         |     |             |       |         |  |  |  |  |  |         |     |             |       |             |                |        |   |                |     |         |     |             |       |             |                |        |   |                |     |         |     |             |       |             |  |  |  |  |  |         |     |             |       |             |  |  |  |  |  |         |     |             |       |             |  |  |  |  |  |         |     |             |       |             |  |  |  |  |  |  |   |         |     |  |       |       |  |                |        |   |       |         |     |  |       |       |  |  |  |  |  |         |     |  |       |       |  |  |  |  |  |         |     |  |       |       |  |  |  |  |  |         |     |  |       |       |  |  |  |  |  |         |     |  |       |       |  |  |  |  |  |          |     |  |       |       |  |  |  |  |  |         |     |  |       |       |  |  |  |  |  |         |     |  |       |       |  |  |  |  |  |
| 3.0 TDI  | 155   | 4F-7-032500     | 05.06 | PR: 1KD     |                |                |   |                          |   |                          |                |                 |         |             |       |             |                |         |   |                |                          |                |     |             |       |             |       |       |         |                |        |          |               |             |         |         |  |       |       |         |                |         |     |             |       |         |     |  |       |       |         |                |        |             |                |         |         |     |  |       |       |          |                |             |       |             |                |          |   |                |       |         |         |             |       |             |                |        |   |                |     |         |       |             |       |             |  |  |  |         |     |                 |       |             |         |             |  |  |  |  |         |                 |     |             |       |             |                |        |                          |                |     |                 |     |             |       |             |         |                |        |                          |                |         |         |     |       |       |       |         |                |        |  |               |     |         |       |       |       |       |         |                |        |         |            |     |         |       |  |       |       |         |                |                 |     |                |       |         |     |  |       |       |         |                 |        |   |            |       |          |     |  |       |       |                 |     |  |       |       |  |         |     |  |       |       |         |  |       |       |  |  |         |     |  |             |       |         |       |       |  |  |  |         |     |                 |       |       |       |                |        |   |       |  |         |                 |     |       |       |       |  |  |  |  |  |                 |     |  |       |       |  |  |  |  |  |                 |         |     |       |       |       |  |  |  |  |                  |  |         |       |       |       |       |  |  |  |         |     |  |         |       |  |       |       |  |  |                 |     |  |       |          |     |  |       |       |  |                 |     |  |       |       |         |     |  |       |       |             |     |  |       |       |  |         |     |  |       |       |     |  |       |       |  |  |  |   |         |     |             |       |         |                |        |   |                |     |         |     |             |       |         |                |        |   |                |     |         |     |             |       |         |  |  |  |  |  |         |     |             |       |         |  |  |  |  |  |         |     |             |       |         |  |  |  |  |  |         |     |             |       |         |  |  |  |  |  |         |     |             |       |             |                |        |   |                |     |         |     |             |       |             |                |        |   |                |     |         |     |             |       |             |  |  |  |  |  |         |     |             |       |             |  |  |  |  |  |         |     |             |       |             |  |  |  |  |  |         |     |             |       |             |  |  |  |  |  |  |   |         |     |  |       |       |  |                |        |   |       |         |     |  |       |       |  |  |  |  |  |         |     |  |       |       |  |  |  |  |  |         |     |  |       |       |  |  |  |  |  |         |     |  |       |       |  |  |  |  |  |         |     |  |       |       |  |  |  |  |  |          |     |  |       |       |  |  |  |  |  |         |     |  |       |       |  |  |  |  |  |         |     |  |       |       |  |  |  |  |  |
| 3.0 TDI  | 171   | 4F-7-032500     | 05.06 | PR: 1KD     |                |                |   |                          |   |                          |                |                 |         |             |       |             |                |         |   |                |                          |                |     |             |       |             |       |       |         |                |        |          |               |             |         |         |  |       |       |         |                |         |     |             |       |         |     |  |       |       |         |                |        |             |                |         |         |     |  |       |       |          |                |             |       |             |                |          |   |                |       |         |         |             |       |             |                |        |   |                |     |         |       |             |       |             |  |  |  |         |     |                 |       |             |         |             |  |  |  |  |         |                 |     |             |       |             |                |        |                          |                |     |                 |     |             |       |             |         |                |        |                          |                |         |         |     |       |       |       |         |                |        |  |               |     |         |       |       |       |       |         |                |        |         |            |     |         |       |  |       |       |         |                |                 |     |                |       |         |     |  |       |       |         |                 |        |   |            |       |          |     |  |       |       |                 |     |  |       |       |  |         |     |  |       |       |         |  |       |       |  |  |         |     |  |             |       |         |       |       |  |  |  |         |     |                 |       |       |       |                |        |   |       |  |         |                 |     |       |       |       |  |  |  |  |  |                 |     |  |       |       |  |  |  |  |  |                 |         |     |       |       |       |  |  |  |  |                  |  |         |       |       |       |       |  |  |  |         |     |  |         |       |  |       |       |  |  |                 |     |  |       |          |     |  |       |       |  |                 |     |  |       |       |         |     |  |       |       |             |     |  |       |       |  |         |     |  |       |       |     |  |       |       |  |  |  |   |         |     |             |       |         |                |        |   |                |     |         |     |             |       |         |                |        |   |                |     |         |     |             |       |         |  |  |  |  |  |         |     |             |       |         |  |  |  |  |  |         |     |             |       |         |  |  |  |  |  |         |     |             |       |         |  |  |  |  |  |         |     |             |       |             |                |        |   |                |     |         |     |             |       |             |                |        |   |                |     |         |     |             |       |             |  |  |  |  |  |         |     |             |       |             |  |  |  |  |  |         |     |             |       |             |  |  |  |  |  |         |     |             |       |             |  |  |  |  |  |  |   |         |     |  |       |       |  |                |        |   |       |         |     |  |       |       |  |  |  |  |  |         |     |  |       |       |  |  |  |  |  |         |     |  |       |       |  |  |  |  |  |         |     |  |       |       |  |  |  |  |  |         |     |  |       |       |  |  |  |  |  |          |     |  |       |       |  |  |  |  |  |         |     |  |       |       |  |  |  |  |  |         |     |  |       |       |  |  |  |  |  |
| 3.2 FSI  | 188   | 4F-7-032500     | 05.06 | PR: 1KD     |                |                |   |                          |   |                          |                |                 |         |             |       |             |                |         |   |                |                          |                |     |             |       |             |       |       |         |                |        |          |               |             |         |         |  |       |       |         |                |         |     |             |       |         |     |  |       |       |         |                |        |             |                |         |         |     |  |       |       |          |                |             |       |             |                |          |   |                |       |         |         |             |       |             |                |        |   |                |     |         |       |             |       |             |  |  |  |         |     |                 |       |             |         |             |  |  |  |  |         |                 |     |             |       |             |                |        |                          |                |     |                 |     |             |       |             |         |                |        |                          |                |         |         |     |       |       |       |         |                |        |  |               |     |         |       |       |       |       |         |                |        |         |            |     |         |       |  |       |       |         |                |                 |     |                |       |         |     |  |       |       |         |                 |        |   |            |       |          |     |  |       |       |                 |     |  |       |       |  |         |     |  |       |       |         |  |       |       |  |  |         |     |  |             |       |         |       |       |  |  |  |         |     |                 |       |       |       |                |        |   |       |  |         |                 |     |       |       |       |  |  |  |  |  |                 |     |  |       |       |  |  |  |  |  |                 |         |     |       |       |       |  |  |  |  |                  |  |         |       |       |       |       |  |  |  |         |     |  |         |       |  |       |       |  |  |                 |     |  |       |          |     |  |       |       |  |                 |     |  |       |       |         |     |  |       |       |             |     |  |       |       |  |         |     |  |       |       |     |  |       |       |  |  |  |   |         |     |             |       |         |                |        |   |                |     |         |     |             |       |         |                |        |   |                |     |         |     |             |       |         |  |  |  |  |  |         |     |             |       |         |  |  |  |  |  |         |     |             |       |         |  |  |  |  |  |         |     |             |       |         |  |  |  |  |  |         |     |             |       |             |                |        |   |                |     |         |     |             |       |             |                |        |   |                |     |         |     |             |       |             |  |  |  |  |  |         |     |             |       |             |  |  |  |  |  |         |     |             |       |             |  |  |  |  |  |         |     |             |       |             |  |  |  |  |  |  |   |         |     |  |       |       |  |                |        |   |       |         |     |  |       |       |  |  |  |  |  |         |     |  |       |       |  |  |  |  |  |         |     |  |       |       |  |  |  |  |  |         |     |  |       |       |  |  |  |  |  |         |     |  |       |       |  |  |  |  |  |          |     |  |       |       |  |  |  |  |  |         |     |  |       |       |  |  |  |  |  |         |     |  |       |       |  |  |  |  |  |
| 4.2 FSI  | 257   | 4F-7-032500     | 05.06 | PR: 1KD     |                |                |   |                          |   |                          |                |                 |         |             |       |             |                |         |   |                |                          |                |     |             |       |             |       |       |         |                |        |          |               |             |         |         |  |       |       |         |                |         |     |             |       |         |     |  |       |       |         |                |        |             |                |         |         |     |  |       |       |          |                |             |       |             |                |          |   |                |       |         |         |             |       |             |                |        |   |                |     |         |       |             |       |             |  |  |  |         |     |                 |       |             |         |             |  |  |  |  |         |                 |     |             |       |             |                |        |                          |                |     |                 |     |             |       |             |         |                |        |                          |                |         |         |     |       |       |       |         |                |        |  |               |     |         |       |       |       |       |         |                |        |         |            |     |         |       |  |       |       |         |                |                 |     |                |       |         |     |  |       |       |         |                 |        |   |            |       |          |     |  |       |       |                 |     |  |       |       |  |         |     |  |       |       |         |  |       |       |  |  |         |     |  |             |       |         |       |       |  |  |  |         |     |                 |       |       |       |                |        |   |       |  |         |                 |     |       |       |       |  |  |  |  |  |                 |     |  |       |       |  |  |  |  |  |                 |         |     |       |       |       |  |  |  |  |                  |  |         |       |       |       |       |  |  |  |         |     |  |         |       |  |       |       |  |  |                 |     |  |       |          |     |  |       |       |  |                 |     |  |       |       |         |     |  |       |       |             |     |  |       |       |  |         |     |  |       |       |     |  |       |       |  |  |  |   |         |     |             |       |         |                |        |   |                |     |         |     |             |       |         |                |        |   |                |     |         |     |             |       |         |  |  |  |  |  |         |     |             |       |         |  |  |  |  |  |         |     |             |       |         |  |  |  |  |  |         |     |             |       |         |  |  |  |  |  |         |     |             |       |             |                |        |   |                |     |         |     |             |       |             |                |        |   |                |     |         |     |             |       |             |  |  |  |  |  |         |     |             |       |             |  |  |  |  |  |         |     |             |       |             |  |  |  |  |  |         |     |             |       |             |  |  |  |  |  |  |   |         |     |  |       |       |  |                |        |   |       |         |     |  |       |       |  |  |  |  |  |         |     |  |       |       |  |  |  |  |  |         |     |  |       |       |  |  |  |  |  |         |     |  |       |       |  |  |  |  |  |         |     |  |       |       |  |  |  |  |  |          |     |  |       |       |  |  |  |  |  |         |     |  |       |       |  |  |  |  |  |         |     |  |       |       |  |  |  |  |  |
| 2.7 TDI  | 120   | 4F-7-032500     | 05.06 | PR: 1KW,2EE | 24.6243-1701.7 | 220823         | <input type="checkbox"/> elektrische Feststellbremse 1) | D=43, - Halter           | LUC   |                          |                |                 |         |             |       |             |                |         |   |                |                          |                |     |             |       |             |       |       |         |                |        |          |               |             |         |         |  |       |       |         |                |         |     |             |       |         |     |  |       |       |         |                |        |             |                |         |         |     |  |       |       |          |                |             |       |             |                |          |   |                |       |         |         |             |       |             |                |        |   |                |     |         |       |             |       |             |  |  |  |         |     |                 |       |             |         |             |  |  |  |  |         |                 |     |             |       |             |                |        |                          |                |     |                 |     |             |       |             |         |                |        |                          |                |         |         |     |       |       |       |         |                |        |  |               |     |         |       |       |       |       |         |                |        |         |            |     |         |       |  |       |       |         |                |                 |     |                |       |         |     |  |       |       |         |                 |        |   |            |       |          |     |  |       |       |                 |     |  |       |       |  |         |     |  |       |       |         |  |       |       |  |  |         |     |  |             |       |         |       |       |  |  |  |         |     |                 |       |       |       |                |        |   |       |  |         |                 |     |       |       |       |  |  |  |  |  |                 |     |  |       |       |  |  |  |  |  |                 |         |     |       |       |       |  |  |  |  |                  |  |         |       |       |       |       |  |  |  |         |     |  |         |       |  |       |       |  |  |                 |     |  |       |          |     |  |       |       |  |                 |     |  |       |       |         |     |  |       |       |             |     |  |       |       |  |         |     |  |       |       |     |  |       |       |  |  |  |   |         |     |             |       |         |                |        |   |                |     |         |     |             |       |         |                |        |   |                |     |         |     |             |       |         |  |  |  |  |  |         |     |             |       |         |  |  |  |  |  |         |     |             |       |         |  |  |  |  |  |         |     |             |       |         |  |  |  |  |  |         |     |             |       |             |                |        |   |                |     |         |     |             |       |             |                |        |   |                |     |         |     |             |       |             |  |  |  |  |  |         |     |             |       |             |  |  |  |  |  |         |     |             |       |             |  |  |  |  |  |         |     |             |       |             |  |  |  |  |  |  |   |         |     |  |       |       |  |                |        |   |       |         |     |  |       |       |  |  |  |  |  |         |     |  |       |       |  |  |  |  |  |         |     |  |       |       |  |  |  |  |  |         |     |  |       |       |  |  |  |  |  |         |     |  |       |       |  |  |  |  |  |          |     |  |       |       |  |  |  |  |  |         |     |  |       |       |  |  |  |  |  |         |     |  |       |       |  |  |  |  |  |
| 2.7 TDI  | 132   | 4F-7-032500     | 05.06 | PR: 1KW,2EE | 24.6243-1702.7 | 220824         | <input type="checkbox"/> elektrische Feststellbremse 1) | D=43, - Halter           | LUC   |                          |                |                 |         |             |       |             |                |         |   |                |                          |                |     |             |       |             |       |       |         |                |        |          |               |             |         |         |  |       |       |         |                |         |     |             |       |         |     |  |       |       |         |                |        |             |                |         |         |     |  |       |       |          |                |             |       |             |                |          |   |                |       |         |         |             |       |             |                |        |   |                |     |         |       |             |       |             |  |  |  |         |     |                 |       |             |         |             |  |  |  |  |         |                 |     |             |       |             |                |        |                          |                |     |                 |     |             |       |             |         |                |        |                          |                |         |         |     |       |       |       |         |                |        |  |               |     |         |       |       |       |       |         |                |        |         |            |     |         |       |  |       |       |         |                |                 |     |                |       |         |     |  |       |       |         |                 |        |   |            |       |          |     |  |       |       |                 |     |  |       |       |  |         |     |  |       |       |         |  |       |       |  |  |         |     |  |             |       |         |       |       |  |  |  |         |     |                 |       |       |       |                |        |   |       |  |         |                 |     |       |       |       |  |  |  |  |  |                 |     |  |       |       |  |  |  |  |  |                 |         |     |       |       |       |  |  |  |  |                  |  |         |       |       |       |       |  |  |  |         |     |  |         |       |  |       |       |  |  |                 |     |  |       |          |     |  |       |       |  |                 |     |  |       |       |         |     |  |       |       |             |     |  |       |       |  |         |     |  |       |       |     |  |       |       |  |  |  |   |         |     |             |       |         |                |        |   |                |     |         |     |             |       |         |                |        |   |                |     |         |     |             |       |         |  |  |  |  |  |         |     |             |       |         |  |  |  |  |  |         |     |             |       |         |  |  |  |  |  |         |     |             |       |         |  |  |  |  |  |         |     |             |       |             |                |        |   |                |     |         |     |             |       |             |                |        |   |                |     |         |     |             |       |             |  |  |  |  |  |         |     |             |       |             |  |  |  |  |  |         |     |             |       |             |  |  |  |  |  |         |     |             |       |             |  |  |  |  |  |  |   |         |     |  |       |       |  |                |        |   |       |         |     |  |       |       |  |  |  |  |  |         |     |  |       |       |  |  |  |  |  |         |     |  |       |       |  |  |  |  |  |         |     |  |       |       |  |  |  |  |  |         |     |  |       |       |  |  |  |  |  |          |     |  |       |       |  |  |  |  |  |         |     |  |       |       |  |  |  |  |  |         |     |  |       |       |  |  |  |  |  |
| 3.0 TDI  | 155   | 4F-7-032500     | 05.06 | PR: 1KW,2EE |                |                |   |                          |   |                          |                |                 |         |             |       |             |                |         |   |                |                          |                |     |             |       |             |       |       |         |                |        |          |               |             |         |         |  |       |       |         |                |         |     |             |       |         |     |  |       |       |         |                |        |             |                |         |         |     |  |       |       |          |                |             |       |             |                |          |   |                |       |         |         |             |       |             |                |        |   |                |     |         |       |             |       |             |  |  |  |         |     |                 |       |             |         |             |  |  |  |  |         |                 |     |             |       |             |                |        |                          |                |     |                 |     |             |       |             |         |                |        |                          |                |         |         |     |       |       |       |         |                |        |  |               |     |         |       |       |       |       |         |                |        |         |            |     |         |       |  |       |       |         |                |                 |     |                |       |         |     |  |       |       |         |                 |        |   |            |       |          |     |  |       |       |                 |     |  |       |       |  |         |     |  |       |       |         |  |       |       |  |  |         |     |  |             |       |         |       |       |  |  |  |         |     |                 |       |       |       |                |        |   |       |  |         |                 |     |       |       |       |  |  |  |  |  |                 |     |  |       |       |  |  |  |  |  |                 |         |     |       |       |       |  |  |  |  |                  |  |         |       |       |       |       |  |  |  |         |     |  |         |       |  |       |       |  |  |                 |     |  |       |          |     |  |       |       |  |                 |     |  |       |       |         |     |  |       |       |             |     |  |       |       |  |         |     |  |       |       |     |  |       |       |  |  |  |   |         |     |             |       |         |                |        |   |                |     |         |     |             |       |         |                |        |   |                |     |         |     |             |       |         |  |  |  |  |  |         |     |             |       |         |  |  |  |  |  |         |     |             |       |         |  |  |  |  |  |         |     |             |       |         |  |  |  |  |  |         |     |             |       |             |                |        |   |                |     |         |     |             |       |             |                |        |   |                |     |         |     |             |       |             |  |  |  |  |  |         |     |             |       |             |  |  |  |  |  |         |     |             |       |             |  |  |  |  |  |         |     |             |       |             |  |  |  |  |  |  |   |         |     |  |       |       |  |                |        |   |       |         |     |  |       |       |  |  |  |  |  |         |     |  |       |       |  |  |  |  |  |         |     |  |       |       |  |  |  |  |  |         |     |  |       |       |  |  |  |  |  |         |     |  |       |       |  |  |  |  |  |          |     |  |       |       |  |  |  |  |  |         |     |  |       |       |  |  |  |  |  |         |     |  |       |       |  |  |  |  |  |
| 3.0 TDI  | 171   | 4F-7-032500     | 05.06 | PR: 1KW,2EE |                |                |   |                          |   |                          |                |                 |         |             |       |             |                |         |   |                |                          |                |     |             |       |             |       |       |         |                |        |          |               |             |         |         |  |       |       |         |                |         |     |             |       |         |     |  |       |       |         |                |        |             |                |         |         |     |  |       |       |          |                |             |       |             |                |          |   |                |       |         |         |             |       |             |                |        |   |                |     |         |       |             |       |             |  |  |  |         |     |                 |       |             |         |             |  |  |  |  |         |                 |     |             |       |             |                |        |                          |                |     |                 |     |             |       |             |         |                |        |                          |                |         |         |     |       |       |       |         |                |        |  |               |     |         |       |       |       |       |         |                |        |         |            |     |         |       |  |       |       |         |                |                 |     |                |       |         |     |  |       |       |         |                 |        |   |            |       |          |     |  |       |       |                 |     |  |       |       |  |         |     |  |       |       |         |  |       |       |  |  |         |     |  |             |       |         |       |       |  |  |  |         |     |                 |       |       |       |                |        |   |       |  |         |                 |     |       |       |       |  |  |  |  |  |                 |     |  |       |       |  |  |  |  |  |                 |         |     |       |       |       |  |  |  |  |                  |  |         |       |       |       |       |  |  |  |         |     |  |         |       |  |       |       |  |  |                 |     |  |       |          |     |  |       |       |  |                 |     |  |       |       |         |     |  |       |       |             |     |  |       |       |  |         |     |  |       |       |     |  |       |       |  |  |  |   |         |     |             |       |         |                |        |   |                |     |         |     |             |       |         |                |        |   |                |     |         |     |             |       |         |  |  |  |  |  |         |     |             |       |         |  |  |  |  |  |         |     |             |       |         |  |  |  |  |  |         |     |             |       |         |  |  |  |  |  |         |     |             |       |             |                |        |   |                |     |         |     |             |       |             |                |        |   |                |     |         |     |             |       |             |  |  |  |  |  |         |     |             |       |             |  |  |  |  |  |         |     |             |       |             |  |  |  |  |  |         |     |             |       |             |  |  |  |  |  |  |   |         |     |  |       |       |  |                |        |   |       |         |     |  |       |       |  |  |  |  |  |         |     |  |       |       |  |  |  |  |  |         |     |  |       |       |  |  |  |  |  |         |     |  |       |       |  |  |  |  |  |         |     |  |       |       |  |  |  |  |  |          |     |  |       |       |  |  |  |  |  |         |     |  |       |       |  |  |  |  |  |         |     |  |       |       |  |  |  |  |  |
| 3.2 FSI  | 188   | 4F-7-032500     | 05.06 | PR: 1KW,2EE |                |                |   |                          |   |                          |                |                 |         |             |       |             |                |         |   |                |                          |                |     |             |       |             |       |       |         |                |        |          |               |             |         |         |  |       |       |         |                |         |     |             |       |         |     |  |       |       |         |                |        |             |                |         |         |     |  |       |       |          |                |             |       |             |                |          |   |                |       |         |         |             |       |             |                |        |   |                |     |         |       |             |       |             |  |  |  |         |     |                 |       |             |         |             |  |  |  |  |         |                 |     |             |       |             |                |        |                          |                |     |                 |     |             |       |             |         |                |        |                          |                |         |         |     |       |       |       |         |                |        |  |               |     |         |       |       |       |       |         |                |        |         |            |     |         |       |  |       |       |         |                |                 |     |                |       |         |     |  |       |       |         |                 |        |   |            |       |          |     |  |       |       |                 |     |  |       |       |  |         |     |  |       |       |         |  |       |       |  |  |         |     |  |             |       |         |       |       |  |  |  |         |     |                 |       |       |       |                |        |   |       |  |         |                 |     |       |       |       |  |  |  |  |  |                 |     |  |       |       |  |  |  |  |  |                 |         |     |       |       |       |  |  |  |  |                  |  |         |       |       |       |       |  |  |  |         |     |  |         |       |  |       |       |  |  |                 |     |  |       |          |     |  |       |       |  |                 |     |  |       |       |         |     |  |       |       |             |     |  |       |       |  |         |     |  |       |       |     |  |       |       |  |  |  |   |         |     |             |       |         |                |        |   |                |     |         |     |             |       |         |                |        |   |                |     |         |     |             |       |         |  |  |  |  |  |         |     |             |       |         |  |  |  |  |  |         |     |             |       |         |  |  |  |  |  |         |     |             |       |         |  |  |  |  |  |         |     |             |       |             |                |        |   |                |     |         |     |             |       |             |                |        |   |                |     |         |     |             |       |             |  |  |  |  |  |         |     |             |       |             |  |  |  |  |  |         |     |             |       |             |  |  |  |  |  |         |     |             |       |             |  |  |  |  |  |  |   |         |     |  |       |       |  |                |        |   |       |         |     |  |       |       |  |  |  |  |  |         |     |  |       |       |  |  |  |  |  |         |     |  |       |       |  |  |  |  |  |         |     |  |       |       |  |  |  |  |  |         |     |  |       |       |  |  |  |  |  |          |     |  |       |       |  |  |  |  |  |         |     |  |       |       |  |  |  |  |  |         |     |  |       |       |  |  |  |  |  |
| 4.2 FSI  | 257   | 4F-7-032500     | 05.06 | PR: 1KW,2EE |                |                |   |                          |   |                          |                |                 |         |             |       |             |                |         |   |                |                          |                |     |             |       |             |       |       |         |                |        |          |               |             |         |         |  |       |       |         |                |         |     |             |       |         |     |  |       |       |         |                |        |             |                |         |         |     |  |       |       |          |                |             |       |             |                |          |   |                |       |         |         |             |       |             |                |        |   |                |     |         |       |             |       |             |  |  |  |         |     |                 |       |             |         |             |  |  |  |  |         |                 |     |             |       |             |                |        |                          |                |     |                 |     |             |       |             |         |                |        |                          |                |         |         |     |       |       |       |         |                |        |  |               |     |         |       |       |       |       |         |                |        |         |            |     |         |       |  |       |       |         |                |                 |     |                |       |         |     |  |       |       |         |                 |        |   |            |       |          |     |  |       |       |                 |     |  |       |       |  |         |     |  |       |       |         |  |       |       |  |  |         |     |  |             |       |         |       |       |  |  |  |         |     |                 |       |       |       |                |        |   |       |  |         |                 |     |       |       |       |  |  |  |  |  |                 |     |  |       |       |  |  |  |  |  |                 |         |     |       |       |       |  |  |  |  |                  |  |         |       |       |       |       |  |  |  |         |     |  |         |       |  |       |       |  |  |                 |     |  |       |          |     |  |       |       |  |                 |     |  |       |       |         |     |  |       |       |             |     |  |       |       |  |         |     |  |       |       |     |  |       |       |  |  |  |   |         |     |             |       |         |                |        |   |                |     |         |     |             |       |         |                |        |   |                |     |         |     |             |       |         |  |  |  |  |  |         |     |             |       |         |  |  |  |  |  |         |     |             |       |         |  |  |  |  |  |         |     |             |       |         |  |  |  |  |  |         |     |             |       |             |                |        |   |                |     |         |     |             |       |             |                |        |   |                |     |         |     |             |       |             |  |  |  |  |  |         |     |             |       |             |  |  |  |  |  |         |     |             |       |             |  |  |  |  |  |         |     |             |       |             |  |  |  |  |  |  |   |         |     |  |       |       |  |                |        |   |       |         |     |  |       |       |  |  |  |  |  |         |     |  |       |       |  |  |  |  |  |         |     |  |       |       |  |  |  |  |  |         |     |  |       |       |  |  |  |  |  |         |     |  |       |       |  |  |  |  |  |          |     |  |       |       |  |  |  |  |  |         |     |  |       |       |  |  |  |  |  |         |     |  |       |       |  |  |  |  |  |
|  | <table border="1"> <tr> <td>2.7 TDI</td> <td>120</td> <td></td> <td>05.06</td> <td>05.11</td> <td></td> <td>24.5125-0323.3</td> <td>330911</td> <td>2</td> <td>L=323</td> </tr> <tr> <td>2.7 TDI</td> <td>132</td> <td></td> <td>05.06</td> <td>05.11</td> <td></td> <td></td> <td></td> <td></td> <td></td> </tr> <tr> <td>2.7 TDI</td> <td>140</td> <td></td> <td>10.08</td> <td>05.11</td> <td></td> <td></td> <td></td> <td></td> <td></td> </tr> <tr> <td>3.0 TDI</td> <td>155</td> <td></td> <td>05.06</td> <td>05.11</td> <td></td> <td></td> <td></td> <td></td> <td></td> </tr> <tr> <td>3.0 TDI</td> <td>171</td> <td></td> <td>05.06</td> <td>05.11</td> <td></td> <td></td> <td></td> <td></td> <td></td> </tr> <tr> <td>3.0 TDI</td> <td>176</td> <td></td> <td>10.08</td> <td>05.11</td> <td></td> <td></td> <td></td> <td></td> <td></td> </tr> <tr> <td>3.0 TFSI</td> <td>213</td> <td></td> <td>10.08</td> <td>05.11</td> <td></td> <td></td> <td></td> <td></td> <td></td> </tr> <tr> <td>3.2 FSI</td> <td>188</td> <td></td> <td>05.06</td> <td>05.11</td> <td></td> <td></td> <td></td> <td></td> <td></td> </tr> <tr> <td>4.2 FSI</td> <td>257</td> <td></td> <td>05.06</td> <td>05.11</td> <td></td> <td></td> <td></td> <td></td> <td></td> </tr> </table>   | 2.7 TDI         | 120   |             | 05.06          | 05.11          |   | 24.5125-0323.3           | 330911  | 2                        | L=323          | 2.7 TDI         | 132     |             | 05.06 | 05.11       |                |         |   |                |                          | 2.7 TDI        | 140 |             | 10.08 | 05.11       |       |       |         |                |        | 3.0 TDI  | 155           |             | 05.06   | 05.11   |  |       |       |         |                | 3.0 TDI | 171 |             | 05.06 | 05.11   |     |  |       |       |         | 3.0 TDI        | 176    |             | 10.08          | 05.11   |         |     |  |       |       | 3.0 TFSI | 213            |             | 10.08 | 05.11       |                |          |   |                |       | 3.2 FSI | 188     |             | 05.06 | 05.11       |                |        |   |                |     | 4.2 FSI | 257   |             | 05.06 | 05.11       |  |  |  |         |     |                 |       |             |         |             |  |  |  |  |         |                 |     |             |       |             |                |        |                          |                |     |                 |     |             |       |             |         |                |        |                          |                |         |         |     |       |       |       |         |                |        |  |               |     |         |       |       |       |       |         |                |        |         |            |     |         |       |  |       |       |         |                |                 |     |                |       |         |     |  |       |       |         |                 |        |   |            |       |          |     |  |       |       |                 |     |  |       |       |  |         |     |  |       |       |         |  |       |       |  |  |         |     |  |             |       |         |       |       |  |  |  |         |     |                 |       |       |       |                |        |   |       |  |         |                 |     |       |       |       |  |  |  |  |  |                 |     |  |       |       |  |  |  |  |  |                 |         |     |       |       |       |  |  |  |  |                  |  |         |       |       |       |       |  |  |  |         |     |  |         |       |  |       |       |  |  |                 |     |  |       |          |     |  |       |       |  |                 |     |  |       |       |         |     |  |       |       |             |     |  |       |       |  |         |     |  |       |       |     |  |       |       |  |  |  |   |         |     |             |       |         |                |        |   |                |     |         |     |             |       |         |                |        |   |                |     |         |     |             |       |         |  |  |  |  |  |         |     |             |       |         |  |  |  |  |  |         |     |             |       |         |  |  |  |  |  |         |     |             |       |         |  |  |  |  |  |         |     |             |       |             |                |        |   |                |     |         |     |             |       |             |                |        |   |                |     |         |     |             |       |             |  |  |  |  |  |         |     |             |       |             |  |  |  |  |  |         |     |             |       |             |  |  |  |  |  |         |     |             |       |             |  |  |  |  |  |  |   |         |     |  |       |       |  |                |        |   |       |         |     |  |       |       |  |  |  |  |  |         |     |  |       |       |  |  |  |  |  |         |     |  |       |       |  |  |  |  |  |         |     |  |       |       |  |  |  |  |  |         |     |  |       |       |  |  |  |  |  |          |     |  |       |       |  |  |  |  |  |         |     |  |       |       |  |  |  |  |  |         |     |  |       |       |  |  |  |  |  |
| 2.7 TDI  | 120   |                 | 05.06 | 05.11       |                | 24.5125-0323.3 | 330911  | 2                        | L=323   |                          |                |                 |         |             |       |             |                |         |   |                |                          |                |     |             |       |             |       |       |         |                |        |          |               |             |         |         |  |       |       |         |                |         |     |             |       |         |     |  |       |       |         |                |        |             |                |         |         |     |  |       |       |          |                |             |       |             |                |          |   |                |       |         |         |             |       |             |                |        |   |                |     |         |       |             |       |             |  |  |  |         |     |                 |       |             |         |             |  |  |  |  |         |                 |     |             |       |             |                |        |                          |                |     |                 |     |             |       |             |         |                |        |                          |                |         |         |     |       |       |       |         |                |        |  |               |     |         |       |       |       |       |         |                |        |         |            |     |         |       |  |       |       |         |                |                 |     |                |       |         |     |  |       |       |         |                 |        |   |            |       |          |     |  |       |       |                 |     |  |       |       |  |         |     |  |       |       |         |  |       |       |  |  |         |     |  |             |       |         |       |       |  |  |  |         |     |                 |       |       |       |                |        |   |       |  |         |                 |     |       |       |       |  |  |  |  |  |                 |     |  |       |       |  |  |  |  |  |                 |         |     |       |       |       |  |  |  |  |                  |  |         |       |       |       |       |  |  |  |         |     |  |         |       |  |       |       |  |  |                 |     |  |       |          |     |  |       |       |  |                 |     |  |       |       |         |     |  |       |       |             |     |  |       |       |  |         |     |  |       |       |     |  |       |       |  |  |  |   |         |     |             |       |         |                |        |   |                |     |         |     |             |       |         |                |        |   |                |     |         |     |             |       |         |  |  |  |  |  |         |     |             |       |         |  |  |  |  |  |         |     |             |       |         |  |  |  |  |  |         |     |             |       |         |  |  |  |  |  |         |     |             |       |             |                |        |   |                |     |         |     |             |       |             |                |        |   |                |     |         |     |             |       |             |  |  |  |  |  |         |     |             |       |             |  |  |  |  |  |         |     |             |       |             |  |  |  |  |  |         |     |             |       |             |  |  |  |  |  |  |   |         |     |  |       |       |  |                |        |   |       |         |     |  |       |       |  |  |  |  |  |         |     |  |       |       |  |  |  |  |  |         |     |  |       |       |  |  |  |  |  |         |     |  |       |       |  |  |  |  |  |         |     |  |       |       |  |  |  |  |  |          |     |  |       |       |  |  |  |  |  |         |     |  |       |       |  |  |  |  |  |         |     |  |       |       |  |  |  |  |  |
| 2.7 TDI  | 132   |                 | 05.06 | 05.11       |                |                |   |                          |   |                          |                |                 |         |             |       |             |                |         |   |                |                          |                |     |             |       |             |       |       |         |                |        |          |               |             |         |         |  |       |       |         |                |         |     |             |       |         |     |  |       |       |         |                |        |             |                |         |         |     |  |       |       |          |                |             |       |             |                |          |   |                |       |         |         |             |       |             |                |        |   |                |     |         |       |             |       |             |  |  |  |         |     |                 |       |             |         |             |  |  |  |  |         |                 |     |             |       |             |                |        |                          |                |     |                 |     |             |       |             |         |                |        |                          |                |         |         |     |       |       |       |         |                |        |  |               |     |         |       |       |       |       |         |                |        |         |            |     |         |       |  |       |       |         |                |                 |     |                |       |         |     |  |       |       |         |                 |        |   |            |       |          |     |  |       |       |                 |     |  |       |       |  |         |     |  |       |       |         |  |       |       |  |  |         |     |  |             |       |         |       |       |  |  |  |         |     |                 |       |       |       |                |        |   |       |  |         |                 |     |       |       |       |  |  |  |  |  |                 |     |  |       |       |  |  |  |  |  |                 |         |     |       |       |       |  |  |  |  |                  |  |         |       |       |       |       |  |  |  |         |     |  |         |       |  |       |       |  |  |                 |     |  |       |          |     |  |       |       |  |                 |     |  |       |       |         |     |  |       |       |             |     |  |       |       |  |         |     |  |       |       |     |  |       |       |  |  |  |   |         |     |             |       |         |                |        |   |                |     |         |     |             |       |         |                |        |   |                |     |         |     |             |       |         |  |  |  |  |  |         |     |             |       |         |  |  |  |  |  |         |     |             |       |         |  |  |  |  |  |         |     |             |       |         |  |  |  |  |  |         |     |             |       |             |                |        |   |                |     |         |     |             |       |             |                |        |   |                |     |         |     |             |       |             |  |  |  |  |  |         |     |             |       |             |  |  |  |  |  |         |     |             |       |             |  |  |  |  |  |         |     |             |       |             |  |  |  |  |  |  |   |         |     |  |       |       |  |                |        |   |       |         |     |  |       |       |  |  |  |  |  |         |     |  |       |       |  |  |  |  |  |         |     |  |       |       |  |  |  |  |  |         |     |  |       |       |  |  |  |  |  |         |     |  |       |       |  |  |  |  |  |          |     |  |       |       |  |  |  |  |  |         |     |  |       |       |  |  |  |  |  |         |     |  |       |       |  |  |  |  |  |
| 2.7 TDI  | 140   |                 | 10.08 | 05.11       |                |                |   |                          |   |                          |                |                 |         |             |       |             |                |         |   |                |                          |                |     |             |       |             |       |       |         |                |        |          |               |             |         |         |  |       |       |         |                |         |     |             |       |         |     |  |       |       |         |                |        |             |                |         |         |     |  |       |       |          |                |             |       |             |                |          |   |                |       |         |         |             |       |             |                |        |   |                |     |         |       |             |       |             |  |  |  |         |     |                 |       |             |         |             |  |  |  |  |         |                 |     |             |       |             |                |        |                          |                |     |                 |     |             |       |             |         |                |        |                          |                |         |         |     |       |       |       |         |                |        |  |               |     |         |       |       |       |       |         |                |        |         |            |     |         |       |  |       |       |         |                |                 |     |                |       |         |     |  |       |       |         |                 |        |   |            |       |          |     |  |       |       |                 |     |  |       |       |  |         |     |  |       |       |         |  |       |       |  |  |         |     |  |             |       |         |       |       |  |  |  |         |     |                 |       |       |       |                |        |   |       |  |         |                 |     |       |       |       |  |  |  |  |  |                 |     |  |       |       |  |  |  |  |  |                 |         |     |       |       |       |  |  |  |  |                  |  |         |       |       |       |       |  |  |  |         |     |  |         |       |  |       |       |  |  |                 |     |  |       |          |     |  |       |       |  |                 |     |  |       |       |         |     |  |       |       |             |     |  |       |       |  |         |     |  |       |       |     |  |       |       |  |  |  |   |         |     |             |       |         |                |        |   |                |     |         |     |             |       |         |                |        |   |                |     |         |     |             |       |         |  |  |  |  |  |         |     |             |       |         |  |  |  |  |  |         |     |             |       |         |  |  |  |  |  |         |     |             |       |         |  |  |  |  |  |         |     |             |       |             |                |        |   |                |     |         |     |             |       |             |                |        |   |                |     |         |     |             |       |             |  |  |  |  |  |         |     |             |       |             |  |  |  |  |  |         |     |             |       |             |  |  |  |  |  |         |     |             |       |             |  |  |  |  |  |  |   |         |     |  |       |       |  |                |        |   |       |         |     |  |       |       |  |  |  |  |  |         |     |  |       |       |  |  |  |  |  |         |     |  |       |       |  |  |  |  |  |         |     |  |       |       |  |  |  |  |  |         |     |  |       |       |  |  |  |  |  |          |     |  |       |       |  |  |  |  |  |         |     |  |       |       |  |  |  |  |  |         |     |  |       |       |  |  |  |  |  |
| 3.0 TDI  | 155   |                 | 05.06 | 05.11       |                |                |   |                          |   |                          |                |                 |         |             |       |             |                |         |   |                |                          |                |     |             |       |             |       |       |         |                |        |          |               |             |         |         |  |       |       |         |                |         |     |             |       |         |     |  |       |       |         |                |        |             |                |         |         |     |  |       |       |          |                |             |       |             |                |          |   |                |       |         |         |             |       |             |                |        |   |                |     |         |       |             |       |             |  |  |  |         |     |                 |       |             |         |             |  |  |  |  |         |                 |     |             |       |             |                |        |                          |                |     |                 |     |             |       |             |         |                |        |                          |                |         |         |     |       |       |       |         |                |        |  |               |     |         |       |       |       |       |         |                |        |         |            |     |         |       |  |       |       |         |                |                 |     |                |       |         |     |  |       |       |         |                 |        |   |            |       |          |     |  |       |       |                 |     |  |       |       |  |         |     |  |       |       |         |  |       |       |  |  |         |     |  |             |       |         |       |       |  |  |  |         |     |                 |       |       |       |                |        |   |       |  |         |                 |     |       |       |       |  |  |  |  |  |                 |     |  |       |       |  |  |  |  |  |                 |         |     |       |       |       |  |  |  |  |                  |  |         |       |       |       |       |  |  |  |         |     |  |         |       |  |       |       |  |  |                 |     |  |       |          |     |  |       |       |  |                 |     |  |       |       |         |     |  |       |       |             |     |  |       |       |  |         |     |  |       |       |     |  |       |       |  |  |  |   |         |     |             |       |         |                |        |   |                |     |         |     |             |       |         |                |        |   |                |     |         |     |             |       |         |  |  |  |  |  |         |     |             |       |         |  |  |  |  |  |         |     |             |       |         |  |  |  |  |  |         |     |             |       |         |  |  |  |  |  |         |     |             |       |             |                |        |   |                |     |         |     |             |       |             |                |        |   |                |     |         |     |             |       |             |  |  |  |  |  |         |     |             |       |             |  |  |  |  |  |         |     |             |       |             |  |  |  |  |  |         |     |             |       |             |  |  |  |  |  |  |   |         |     |  |       |       |  |                |        |   |       |         |     |  |       |       |  |  |  |  |  |         |     |  |       |       |  |  |  |  |  |         |     |  |       |       |  |  |  |  |  |         |     |  |       |       |  |  |  |  |  |         |     |  |       |       |  |  |  |  |  |          |     |  |       |       |  |  |  |  |  |         |     |  |       |       |  |  |  |  |  |         |     |  |       |       |  |  |  |  |  |
| 3.0 TDI  | 171   |                 | 05.06 | 05.11       |                |                |   |                          |   |                          |                |                 |         |             |       |             |                |         |   |                |                          |                |     |             |       |             |       |       |         |                |        |          |               |             |         |         |  |       |       |         |                |         |     |             |       |         |     |  |       |       |         |                |        |             |                |         |         |     |  |       |       |          |                |             |       |             |                |          |   |                |       |         |         |             |       |             |                |        |   |                |     |         |       |             |       |             |  |  |  |         |     |                 |       |             |         |             |  |  |  |  |         |                 |     |             |       |             |                |        |                          |                |     |                 |     |             |       |             |         |                |        |                          |                |         |         |     |       |       |       |         |                |        |  |               |     |         |       |       |       |       |         |                |        |         |            |     |         |       |  |       |       |         |                |                 |     |                |       |         |     |  |       |       |         |                 |        |   |            |       |          |     |  |       |       |                 |     |  |       |       |  |         |     |  |       |       |         |  |       |       |  |  |         |     |  |             |       |         |       |       |  |  |  |         |     |                 |       |       |       |                |        |   |       |  |         |                 |     |       |       |       |  |  |  |  |  |                 |     |  |       |       |  |  |  |  |  |                 |         |     |       |       |       |  |  |  |  |                  |  |         |       |       |       |       |  |  |  |         |     |  |         |       |  |       |       |  |  |                 |     |  |       |          |     |  |       |       |  |                 |     |  |       |       |         |     |  |       |       |             |     |  |       |       |  |         |     |  |       |       |     |  |       |       |  |  |  |   |         |     |             |       |         |                |        |   |                |     |         |     |             |       |         |                |        |   |                |     |         |     |             |       |         |  |  |  |  |  |         |     |             |       |         |  |  |  |  |  |         |     |             |       |         |  |  |  |  |  |         |     |             |       |         |  |  |  |  |  |         |     |             |       |             |                |        |   |                |     |         |     |             |       |             |                |        |   |                |     |         |     |             |       |             |  |  |  |  |  |         |     |             |       |             |  |  |  |  |  |         |     |             |       |             |  |  |  |  |  |         |     |             |       |             |  |  |  |  |  |  |   |         |     |  |       |       |  |                |        |   |       |         |     |  |       |       |  |  |  |  |  |         |     |  |       |       |  |  |  |  |  |         |     |  |       |       |  |  |  |  |  |         |     |  |       |       |  |  |  |  |  |         |     |  |       |       |  |  |  |  |  |          |     |  |       |       |  |  |  |  |  |         |     |  |       |       |  |  |  |  |  |         |     |  |       |       |  |  |  |  |  |
| 3.0 TDI  | 176   |                 | 10.08 | 05.11       |                |                |   |                          |   |                          |                |                 |         |             |       |             |                |         |   |                |                          |                |     |             |       |             |       |       |         |                |        |          |               |             |         |         |  |       |       |         |                |         |     |             |       |         |     |  |       |       |         |                |        |             |                |         |         |     |  |       |       |          |                |             |       |             |                |          |   |                |       |         |         |             |       |             |                |        |   |                |     |         |       |             |       |             |  |  |  |         |     |                 |       |             |         |             |  |  |  |  |         |                 |     |             |       |             |                |        |                          |                |     |                 |     |             |       |             |         |                |        |                          |                |         |         |     |       |       |       |         |                |        |  |               |     |         |       |       |       |       |         |                |        |         |            |     |         |       |  |       |       |         |                |                 |     |                |       |         |     |  |       |       |         |                 |        |   |            |       |          |     |  |       |       |                 |     |  |       |       |  |         |     |  |       |       |         |  |       |       |  |  |         |     |  |             |       |         |       |       |  |  |  |         |     |                 |       |       |       |                |        |   |       |  |         |                 |     |       |       |       |  |  |  |  |  |                 |     |  |       |       |  |  |  |  |  |                 |         |     |       |       |       |  |  |  |  |                  |  |         |       |       |       |       |  |  |  |         |     |  |         |       |  |       |       |  |  |                 |     |  |       |          |     |  |       |       |  |                 |     |  |       |       |         |     |  |       |       |             |     |  |       |       |  |         |     |  |       |       |     |  |       |       |  |  |  |   |         |     |             |       |         |                |        |   |                |     |         |     |             |       |         |                |        |   |                |     |         |     |             |       |         |  |  |  |  |  |         |     |             |       |         |  |  |  |  |  |         |     |             |       |         |  |  |  |  |  |         |     |             |       |         |  |  |  |  |  |         |     |             |       |             |                |        |   |                |     |         |     |             |       |             |                |        |   |                |     |         |     |             |       |             |  |  |  |  |  |         |     |             |       |             |  |  |  |  |  |         |     |             |       |             |  |  |  |  |  |         |     |             |       |             |  |  |  |  |  |  |   |         |     |  |       |       |  |                |        |   |       |         |     |  |       |       |  |  |  |  |  |         |     |  |       |       |  |  |  |  |  |         |     |  |       |       |  |  |  |  |  |         |     |  |       |       |  |  |  |  |  |         |     |  |       |       |  |  |  |  |  |          |     |  |       |       |  |  |  |  |  |         |     |  |       |       |  |  |  |  |  |         |     |  |       |       |  |  |  |  |  |
| 3.0 TFSI   | 213   |                 | 10.08 | 05.11       |                |                |   |                          |   |                          |                |                 |         |             |       |             |                |         |   |                |                          |                |     |             |       |             |       |       |         |                |        |          |               |             |         |         |  |       |       |         |                |         |     |             |       |         |     |  |       |       |         |                |        |             |                |         |         |     |  |       |       |          |                |             |       |             |                |          |   |                |       |         |         |             |       |             |                |        |   |                |     |         |       |             |       |             |  |  |  |         |     |                 |       |             |         |             |  |  |  |  |         |                 |     |             |       |             |                |        |                          |                |     |                 |     |             |       |             |         |                |        |                          |                |         |         |     |       |       |       |         |                |        |  |               |     |         |       |       |       |       |         |                |        |         |            |     |         |       |  |       |       |         |                |                 |     |                |       |         |     |  |       |       |         |                 |        |   |            |       |          |     |  |       |       |                 |     |  |       |       |  |         |     |  |       |       |         |  |       |       |  |  |         |     |  |             |       |         |       |       |  |  |  |         |     |                 |       |       |       |                |        |   |       |  |         |                 |     |       |       |       |  |  |  |  |  |                 |     |  |       |       |  |  |  |  |  |                 |         |     |       |       |       |  |  |  |  |                  |  |         |       |       |       |       |  |  |  |         |     |  |         |       |  |       |       |  |  |                 |     |  |       |          |     |  |       |       |  |                 |     |  |       |       |         |     |  |       |       |             |     |  |       |       |  |         |     |  |       |       |     |  |       |       |  |  |  |   |         |     |             |       |         |                |        |   |                |     |         |     |             |       |         |                |        |   |                |     |         |     |             |       |         |  |  |  |  |  |         |     |             |       |         |  |  |  |  |  |         |     |             |       |         |  |  |  |  |  |         |     |             |       |         |  |  |  |  |  |         |     |             |       |             |                |        |   |                |     |         |     |             |       |             |                |        |   |                |     |         |     |             |       |             |  |  |  |  |  |         |     |             |       |             |  |  |  |  |  |         |     |             |       |             |  |  |  |  |  |         |     |             |       |             |  |  |  |  |  |  |   |         |     |  |       |       |  |                |        |   |       |         |     |  |       |       |  |  |  |  |  |         |     |  |       |       |  |  |  |  |  |         |     |  |       |       |  |  |  |  |  |         |     |  |       |       |  |  |  |  |  |         |     |  |       |       |  |  |  |  |  |          |     |  |       |       |  |  |  |  |  |         |     |  |       |       |  |  |  |  |  |         |     |  |       |       |  |  |  |  |  |
| 3.2 FSI  | 188   |                 | 05.06 | 05.11       |                |                |   |                          |   |                          |                |                 |         |             |       |             |                |         |   |                |                          |                |     |             |       |             |       |       |         |                |        |          |               |             |         |         |  |       |       |         |                |         |     |             |       |         |     |  |       |       |         |                |        |             |                |         |         |     |  |       |       |          |                |             |       |             |                |          |   |                |       |         |         |             |       |             |                |        |   |                |     |         |       |             |       |             |  |  |  |         |     |                 |       |             |         |             |  |  |  |  |         |                 |     |             |       |             |                |        |                          |                |     |                 |     |             |       |             |         |                |        |                          |                |         |         |     |       |       |       |         |                |        |  |               |     |         |       |       |       |       |         |                |        |         |            |     |         |       |  |       |       |         |                |                 |     |                |       |         |     |  |       |       |         |                 |        |   |            |       |          |     |  |       |       |                 |     |  |       |       |  |         |     |  |       |       |         |  |       |       |  |  |         |     |  |             |       |         |       |       |  |  |  |         |     |                 |       |       |       |                |        |   |       |  |         |                 |     |       |       |       |  |  |  |  |  |                 |     |  |       |       |  |  |  |  |  |                 |         |     |       |       |       |  |  |  |  |                  |  |         |       |       |       |       |  |  |  |         |     |  |         |       |  |       |       |  |  |                 |     |  |       |          |     |  |       |       |  |                 |     |  |       |       |         |     |  |       |       |             |     |  |       |       |  |         |     |  |       |       |     |  |       |       |  |  |  |   |         |     |             |       |         |                |        |   |                |     |         |     |             |       |         |                |        |   |                |     |         |     |             |       |         |  |  |  |  |  |         |     |             |       |         |  |  |  |  |  |         |     |             |       |         |  |  |  |  |  |         |     |             |       |         |  |  |  |  |  |         |     |             |       |             |                |        |   |                |     |         |     |             |       |             |                |        |   |                |     |         |     |             |       |             |  |  |  |  |  |         |     |             |       |             |  |  |  |  |  |         |     |             |       |             |  |  |  |  |  |         |     |             |       |             |  |  |  |  |  |  |   |         |     |  |       |       |  |                |        |   |       |         |     |  |       |       |  |  |  |  |  |         |     |  |       |       |  |  |  |  |  |         |     |  |       |       |  |  |  |  |  |         |     |  |       |       |  |  |  |  |  |         |     |  |       |       |  |  |  |  |  |          |     |  |       |       |  |  |  |  |  |         |     |  |       |       |  |  |  |  |  |         |     |  |       |       |  |  |  |  |  |
| 4.2 FSI  | 257   |                 | 05.06 | 05.11       |                |                |   |                          |   |                          |                |                 |         |             |       |             |                |         |   |                |                          |                |     |             |       |             |       |       |         |                |        |          |               |             |         |         |  |       |       |         |                |         |     |             |       |         |     |  |       |       |         |                |        |             |                |         |         |     |  |       |       |          |                |             |       |             |                |          |   |                |       |         |         |             |       |             |                |        |   |                |     |         |       |             |       |             |  |  |  |         |     |                 |       |             |         |             |  |  |  |  |         |                 |     |             |       |             |                |        |                          |                |     |                 |     |             |       |             |         |                |        |                          |                |         |         |     |       |       |       |         |                |        |  |               |     |         |       |       |       |       |         |                |        |         |            |     |         |       |  |       |       |         |                |                 |     |                |       |         |     |  |       |       |         |                 |        |   |            |       |          |     |  |       |       |                 |     |  |       |       |  |         |     |  |       |       |         |  |       |       |  |  |         |     |  |             |       |         |       |       |  |  |  |         |     |                 |       |       |       |                |        |   |       |  |         |                 |     |       |       |       |  |  |  |  |  |                 |     |  |       |       |  |  |  |  |  |                 |         |     |       |       |       |  |  |  |  |                  |  |         |       |       |       |       |  |  |  |         |     |  |         |       |  |       |       |  |  |                 |     |  |       |          |     |  |       |       |  |                 |     |  |       |       |         |     |  |       |       |             |     |  |       |       |  |         |     |  |       |       |     |  |       |       |  |  |  |   |         |     |             |       |         |                |        |   |                |     |         |     |             |       |         |                |        |   |                |     |         |     |             |       |         |  |  |  |  |  |         |     |             |       |         |  |  |  |  |  |         |     |             |       |         |  |  |  |  |  |         |     |             |       |         |  |  |  |  |  |         |     |             |       |             |                |        |   |                |     |         |     |             |       |             |                |        |   |                |     |         |     |             |       |             |  |  |  |  |  |         |     |             |       |             |  |  |  |  |  |         |     |             |       |             |  |  |  |  |  |         |     |             |       |             |  |  |  |  |  |  |   |         |     |  |       |       |  |                |        |   |       |         |     |  |       |       |  |  |  |  |  |         |     |  |       |       |  |  |  |  |  |         |     |  |       |       |  |  |  |  |  |         |     |  |       |       |  |  |  |  |  |         |     |  |       |       |  |  |  |  |  |          |     |  |       |       |  |  |  |  |  |         |     |  |       |       |  |  |  |  |  |         |     |  |       |       |  |  |  |  |  |

1) electric parking brake / fr.di stazionamento elettrico / frein à main électrique / freno de mano eléctrico

| AUDI A8 (94-02)  |                 |      |             |       |       |                         |                |        |   |                |
|--|-----------------|------|-------------|-------|-------|-------------------------|----------------|--------|---|----------------|
|    | 2.5 TDI         |      |             | 06.97 | 09.02 | - ESP                   | 24.2125-1712.3 | 010622 |   | THz 25,40      |
|  | 2.5 TDI quattro |      |             | 06.97 | 09.02 | - ESP                   |                |        |   |                |
|  | 2.8             | 120  |             | 07.95 | 03.96 | - ESP                   |                |        |   |                |
|  | 2.8             | 128  |             | 06.94 | 03.96 | - ESP                   |                |        |   |                |
|  | 2.8 30V         | 142  |             | 04.96 | 09.02 | - ESP                   |                |        |   |                |
|  | 2.8 30V quattro | 142  |             | 04.96 | 09.02 | - ESP                   |                |        |   |                |
|  | 2.8 quattro     | 120  |             | 07.95 | 03.96 | - ESP                   |                |        |   |                |
|  | 2.8 quattro     | 128  |             | 06.94 | 03.96 | - ESP                   |                |        |   |                |
|  | 3.3 TDI quattro |      |             | 12.99 | 09.02 | - ESP                   |                |        |   |                |
|  | 3.7             |      |             | 07.95 | 09.02 | - ESP                   |                |        |   |                |
|  | 3.7 quattro     |      |             | 10.95 | 09.02 | - ESP                   |                |        |   |                |
|  | 4.2 quattro     |      |             | 06.94 | 09.02 | - ESP                   |                |        |   |                |
|  | 6.0 W12 quattro |      |             | 01.01 | 09.02 | - ESP                   |                |        |   |                |
|  | S8 4.2          |      |             | 06.96 | 09.02 | - ESP                   |                |        |   |                |
|  | 2.5 TDI         |      |             | 06.97 | 09.02 | + ESP                   | 24.2125-1713.3 | 010623 |   | THz 25,40      |
|  | 2.5 TDI quattro |      |             | 06.97 | 09.02 | + ESP                   |                |        |   |                |
|  | 2.8             | 120  |             | 07.95 | 03.96 | + ESP                   |                |        |   |                |
|  | 2.8             | 128  |             | 06.94 | 03.96 | + ESP                   |                |        |   |                |
|  | 2.8 30V         | 142  |             | 04.96 | 09.02 | + ESP                   |                |        |   |                |
|  | 2.8 30V quattro | 142  |             | 04.96 | 09.02 | + ESP                   |                |        |   |                |
|  | 2.8 quattro     | 120  |             | 07.95 | 03.96 | + ESP                   |                |        |   |                |
|  | 2.8 quattro     | 128  |             | 06.94 | 03.96 | + ESP                   |                |        |   |                |
|  | 3.3 TDI quattro |      |             | 12.99 | 09.02 | + ESP                   |                |        |   |                |
|  | 3.7             |      |             | 07.95 | 09.02 | + ESP                   |                |        |   |                |
|  | 3.7 quattro     |      |             | 10.95 | 09.02 | + ESP                   |                |        |   |                |
|  | 4.2 quattro     |      |             | 06.94 | 09.02 | + ESP                   |                |        |   |                |
|  | 6.0 W12 quattro |      |             | 01.01 | 09.02 | + ESP                   |                |        |   |                |
|  | S8 4.2          |      |             | 06.96 | 09.02 | + ESP                   |                |        |   |                |
|    | 6.0 W12 quattro |      |             | 01.01 | 09.02 |                         | 11.8171-0008.1 | 990049 |   | Führungsbolzen |
|  |                 |      |             |       |       |                         | 11.8116-0260.1 | 390597 | 2 | Haltefeder     |
|  |                 |      |             |       |       |                         |                |        |   | ATE            |
|  |                 |      |             |       |       |                         |                |        |   | ATE            |
|    | 2.5 TDI         |      |             | 06.97 | 09.02 |                         | 24.5237-0360.3 | 331212 | 2 | L=360          |
|  | 2.5 TDI quattro |      |             | 06.97 | 09.02 |                         |                |        |   |                |
|  | 2.8             | 120  |             | 07.95 | 03.96 |                         |                |        |   |                |
|  | 2.8             | 128  |             | 06.94 | 03.96 |                         |                |        |   |                |
|  | 2.8 30V         | 142  |             | 04.96 | 09.02 |                         |                |        |   |                |
|  | 2.8 30V quattro | 142  |             | 04.96 | 09.02 |                         |                |        |   |                |
|  | 2.8 quattro     | 120  |             | 07.95 | 03.96 |                         |                |        |   |                |
|  | 2.8 quattro     | 128  |             | 06.94 | 03.96 |                         |                |        |   |                |
|  | 3.3 TDI quattro |      |             | 12.99 | 09.02 |                         |                |        |   |                |
|  | 3.7             |      |             | 07.95 | 09.02 |                         |                |        |   |                |
|  | 3.7 quattro     |      |             | 10.95 | 09.02 |                         |                |        |   |                |
|  | 4.2 quattro     |      |             | 06.94 | 09.02 |                         |                |        |   |                |
|  | 6.0 W12 quattro |      |             | 01.01 | 09.02 |                         |                |        |   |                |
|  | S8 4.2          |      |             | 06.96 | 09.02 |                         |                |        |   |                |
|  | 2.5 TDI         | 120  |             | 06.97 | 09.98 | - 18" Rad <sup>1)</sup> | 24.3384-1704.5 | 240056 |   | D=38, - Halter |
|  | 2.8             | 128  |             | 07.95 | 03.96 | - 18" Rad <sup>1)</sup> | 24.3384-1703.5 | 240055 |   | D=38, - Halter |
|  | 2.8             | 128  |             | 06.94 | 03.96 | - 18" Rad <sup>1)</sup> | 24.0101-3601.2 | 260044 |   | Einbausatz     |
|  |                 |      |             |       |       |                         |                |        |   | LUC            |
|  |                 |      |             |       |       |                         |                |        |   | LUC            |
|  |                 |      |             |       |       |                         |                |        |   | LUC            |
|  | 2.5 TDI         | 120  |             | 06.97 | 09.98 |                         | 83.6124-0282.3 | 330490 | 2 | L=280          |
|  | 2.8             | 128  | 4D-R-000346 | 07.95 | 03.96 |                         |                |        |   |                |
|  | 2.8             | 128  |             | 03.96 |       |                         |                |        |   |                |
|  | 2.8 30V         | 142  |             | 04.96 | 09.98 |                         |                |        |   |                |
|  | 2.5 TDI quattro | 142  |             | 06.97 | 09.98 |                         | 83.6124-0252.3 | 330456 | 2 | L=250          |
|  | 2.8 30V quattro | 142  |             | 04.96 | 09.98 |                         |                |        |   |                |
|  | 2.8 quattro     | 120  |             | 07.95 | 03.96 |                         |                |        |   |                |
|  | 2.8 quattro     | 128  |             | 06.94 | 03.96 |                         |                |        |   |                |
|  | 3.7             |      |             | 07.95 | 09.98 |                         |                |        |   |                |
|  | 3.7 quattro     |      |             | 10.95 | 09.98 |                         |                |        |   |                |
|  | 4.2 quattro     |      |             | 06.94 | 09.98 |                         |                |        |   |                |
|  | S8 4.2          |      |             | 06.96 | 09.98 |                         |                |        |   |                |
|  | 2.5 TDI         | 142  |             | 10.98 | 09.02 |                         | 24.5135-0280.3 | 330775 | 2 | L=280          |
|  | 2.5 TDI quattro | 142  |             | 10.98 | 09.02 |                         |                |        |   |                |
|  | 2.8 30V         | 142  |             | 10.98 | 09.02 |                         |                |        |   |                |
|  | 2.8 30V quattro | 142  |             | 10.98 | 09.02 |                         |                |        |   |                |
|  | 3.3 TDI quattro |      |             | 12.99 | 09.02 |                         |                |        |   |                |
|  | 3.7             |      |             | 10.98 | 09.02 |                         |                |        |   |                |
|  | 3.7 quattro     |      |             | 10.98 | 09.02 |                         |                |        |   |                |
|  | 4.2 quattro     |      |             | 10.98 | 09.02 |                         |                |        |   |                |
|  | 6.0 W12 quattro |      |             | 01.01 | 09.02 |                         |                |        |   |                |
|  | S8 4.2          |      |             | 10.98 | 09.02 |                         |                |        |   |                |
|  | 2.8             | ≠120 |             | 07.95 | 03.96 |                         | 03.2522-4300.3 | 040085 |   | Nz 22,20       |
|  | 2.8             | ≠128 |             | 06.94 | 03.96 |                         |                |        |   |                |
|  | 2.8 30V         | ≠142 |             | 04.96 | 09.02 |                         |                |        |   |                |
|  | 2.8 30V quattro | ≠142 |             | 04.96 | 09.02 |                         |                |        |   |                |
|  | 2.8 quattro     | ≠120 |             | 07.95 | 03.96 |                         |                |        |   |                |
|  | 2.8 quattro     | ≠128 |             | 06.94 | 03.96 |                         |                |        |   |                |
|  | 3.7             | ≠    |             | 07.95 | 09.02 |                         |                |        |   |                |
|  | 3.7 quattro     | ≠    |             | 10.95 | 03.02 |                         |                |        |   |                |
|  | 2.5 TDI         | ≠    |             | 06.97 | 09.02 |                         | 24.2522-1706.3 | 040090 |   | Nz 22,20       |
|  | 2.5 TDI quattro | ≠    |             | 06.97 | 09.02 |                         |                |        |   |                |
|  | 3.3 TDI quattro | ≠    |             | 12.99 | 09.02 |                         |                |        |   |                |

<sup>1)</sup> - 18" wheel / - ruota 18" / - roue 18" / - rueda 18"



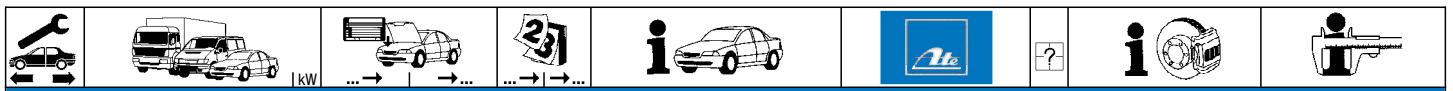

















| AUDI A8 (03-09) |                 |             |             |         |                   |                |        |   |                              |   |
|-----------------|-----------------|-------------|-------------|---------|-------------------|----------------|--------|---|------------------------------|---|
|                 | 3.0             |             | 4E-5-003250 | 07.03   | PR: 1LG           | 11.9606-9957.2 | 220815 | 2 | ATE                          | D=60, - Halter<br>D=60, - Halter<br>Dichtungssatz<br>Hülsensatz<br>Führungsbolzen<br>Haltefeder |
|                 | 3.0 TDI quattro |             | 4E-5-003250 | 11.03   | PR: 1LG           | 11.9606-9958.2 | 220816 |   |                              |   |
|                 | 3.2 FSI         | 191         | 4E-5-003250 | 06.05   | PR: 1LG           | 11.0441-6008.2 | 250038 |   |                              |   |
|                 | 3.2 FSI quattro | 191         | 4E-5-003250 | 06.05   | PR: 1LG           | 11.0101-5409.2 | 260035 |   |                              |   |
|                 | 3.7 quattro     |             | 4E-5-003250 | 11.02   | PR: 1LG           | 11.8171-0008.1 | 990049 |   |                              |   |
|                 | 4.0 TDI quattro |             | 4E-5-003250 | 03.03   | PR: 1LG           | 11.8116-0410.2 | 390589 |   |                              |   |
|                 | 4.2 FSI quattro | 257         | 4E-5-003250 | 06.06   | PR: 1LG           |                |        |   |                              |   |
|                 | 4.2 quattro     |             | 4E-5-003250 | 11.02   | PR: 1LG           |                |        |   |                              |   |
|                 | 4.2 TDI quattro |             | 4E-5-003250 | 07.05   | PR: 1LG           |                |        |   |                              |   |
|                 | 6.0 W12 quattro |             | 4E-5-003250 | 02.04   | PR: 1LG           |                |        |   |                              |   |
|                 | 2.8 FSI         | 154         |             | 08.07   | 10.09 PR: 1LG     | 11.9606-9953.2 | 220587 | 2 | ATE                          | D=60, - Halter<br>D=60, - Halter<br>Dichtungssatz<br>Hülsensatz<br>Führungsbolzen<br>Haltefeder |
|                 | 3.0             |             | 4E-5-003251 | 10.09   | PR: 1LG           | 11.9606-9954.2 | 220588 |   |                              |   |
|                 | 3.0 TDI quattro |             | 4E-5-003251 | 10.09   | PR: 1LG           | 11.0441-6008.2 | 250038 |   |                              |   |
|                 | 3.2 FSI         | 191         | 4E-5-003251 | 10.09   | PR: 1LG           | 11.0101-5409.2 | 260035 |   |                              |   |
|                 | 3.2 FSI quattro | 191         | 4E-5-003251 | 10.09   | PR: 1LG           | 11.8171-0008.1 | 990049 |   |                              |   |
|                 | 3.7 quattro     |             | 4E-5-003251 | 10.09   | PR: 1LG           | 11.8116-0410.2 | 390589 |   |                              |   |
|                 | 4.0 TDI quattro |             | 4E-5-003251 | 10.09   | PR: 1LG           |                |        |   |                              |   |
|                 | 4.2 FSI quattro | 257         | 4E-5-003251 | 10.09   | PR: 1LG           |                |        |   |                              |   |
|                 | 4.2 quattro     |             | 4E-5-003251 | 10.09   | PR: 1LG           |                |        |   |                              |   |
|                 | 4.2 TDI quattro |             | 4E-5-003251 | 10.09   | PR: 1LG           |                |        |   |                              |   |
|                 | 6.0 W12 quattro |             | 4E-5-003251 | 10.09   | PR: 1LG           |                |        | 2 | ATE                          | Hülsensatz<br>Führungsbolzen<br>Haltefeder  |
|                 | 2.8 FSI         | 154         |             | 08.07   | 10.09 PR: 1LL,1LM | 11.0101-6010.2 | 260099 |   |                              |   |
|                 | 3.0             |             |             | 07.03   | 10.09 PR: 1LL,1LM | 11.8171-0067.1 | 250153 |   |                              |   |
|                 | 3.0 TDI quattro |             |             | 11.03   | 10.09 PR: 1LL,1LM | 11.8116-0347.2 | 390535 |   |                              |   |
|                 | 3.2 FSI         | 191         |             | 06.05   | 10.09 PR: 1LL,1LM |                |        |   |                              |   |
|                 | 3.2 FSI quattro | 191         |             | 06.05   | 10.09 PR: 1LL,1LM |                |        |   |                              |   |
|                 | 3.7 quattro     |             |             | 11.02   | 10.09 PR: 1LL,1LM |                |        |   |                              |   |
|                 | 4.0 TDI quattro |             |             | 03.03   | 10.09 PR: 1LL,1LM |                |        |   |                              |   |
|                 | 4.2 FSI quattro | 257         |             | 06.06   | 10.09 PR: 1LL,1LM |                |        |   |                              |   |
|                 | 4.2 quattro     |             |             | 11.02   | 10.09 PR: 1LL,1LM |                |        |   |                              |   |
|                 | 4.2 TDI quattro |             |             | 07.05   | 10.09 PR: 1LL,1LM |                |        | 2 | ATE                          | Hülsensatz<br>Führungsbolzen  |
|                 | 6.0 W12 quattro |             |             | 02.04   | 10.09 PR: 1LL,1LM |                |        |   |                              |   |
|                 | 2.8 FSI         | 154         |             | 08.07   | 10.09 PR: 1LJ     | 11.0101-6010.2 | 260099 |   |                              |   |
|                 | 3.0             |             |             | 07.03   | 10.09 PR: 1LJ     | 11.8171-0067.1 | 250153 |   |                              |   |
|                 | 3.0 TDI quattro |             |             | 11.03   | 10.09 PR: 1LJ     |                |        |   |                              |   |
|                 | 3.2 FSI         | 191         |             | 06.05   | 10.09 PR: 1LJ     |                |        |   |                              |   |
|                 | 3.2 FSI quattro | 191         |             | 06.05   | 10.09 PR: 1LJ     |                |        |   |                              |   |
|                 | 3.7 quattro     |             |             | 11.02   | 10.09 PR: 1LJ     |                |        |   |                              |   |
|                 | 4.0 TDI quattro |             |             | 03.03   | 10.09 PR: 1LJ     |                |        |   |                              |   |
|                 | 4.2 FSI quattro | 257         |             | 06.06   | 10.09 PR: 1LJ     |                |        |   |                              |   |
|                 | 4.2 quattro     |             |             | 11.02   | 10.09 PR: 1LJ     |                |        | 2 | ATE                          | Hülsensatz<br>Führungsbolzen  |
|                 | 4.2 TDI quattro |             |             | 07.05   | 10.09 PR: 1LJ     |                |        |   |                              |   |
|                 | 6.0 W12 quattro |             |             | 02.04   | 10.09 PR: 1LJ     |                |        |   |                              |   |
|                 | S8              | 331         |             | 06.06   | 10.09             | 11.0101-6010.2 | 260099 |   |                              |   |
|                 |                 |             |             |         |                   | 11.8171-0067.1 | 250153 |   |                              |   |
|                 | 2.8 FSI         | 154         | 4E-7-009000 | 08.07   | PR: 1LW           | 83.7849-0419.3 | 331114 |   |                              |   |
|                 | 3.0             |             | 4E-7-009000 | 07.03   | PR: 1LW           |                |        |   |                              |   |
|                 | 3.0 TDI quattro |             | 4E-7-009000 | 11.03   | PR: 1LW           |                |        |   |                              |   |
|                 | 3.2 FSI         | 191         | 4E-7-009000 | 06.05   | PR: 1LW           |                |        |   |                              |   |
|                 | 3.2 FSI quattro | 191         | 4E-7-009000 | 06.05   | PR: 1LW           |                |        |   |                              |   |
| 3.7 quattro     |                 | 4E-7-009000 | 11.02       | PR: 1LW |                   |                |        |   |                              |   |
| 4.0 TDI quattro |                 | 4E-7-009000 | 03.03       | PR: 1LW |                   |                |        |   |                              |   |
| 4.2 FSI quattro | 257             | 4E-7-009000 | 06.06       | PR: 1LW |                   |                |        |   |                              |   |
| 4.2 quattro     |                 | 4E-7-009000 | 11.02       | PR: 1LW |                   |                |        |   |                              |   |
| 4.2 TDI quattro |                 | 4E-7-009000 | 07.05       | PR: 1LW |                   |                |        |   |                              |   |
| 6.0 W12 quattro |                 | 4E-7-009000 | 02.04       | PR: 1LW |                   |                |        |   |                              |   |
| S8              | 331             | 4E-7-009000 | 06.06       | PR: 1LW |                   |                |        |   |                              |   |
|                 | 2.8 FSI         | 154         |             | 08.07   | 10.09             | 83.7812-0180.3 | 330854 | 2 | am Bremssattel <sup>1)</sup> | L=180<br>L=190  |
|                 | 3.0             |             |             | 07.03   | 10.09             | 24.5154-0190.3 | 331056 |   |                              |   |
|                 | 3.0 TDI quattro |             |             | 11.03   | 10.09             |                |        |   |                              |   |
|                 | 3.2 FSI         | 191         |             | 06.05   | 10.09             |                |        |   |                              |   |
|                 | 3.2 FSI quattro | 191         |             | 06.05   | 10.09             |                |        |   |                              |   |
|                 | 3.7 quattro     |             |             | 11.02   | 10.09             |                |        |   |                              |   |
|                 | 4.0 TDI quattro |             |             | 03.03   | 10.09             |                |        |   |                              |   |
|                 | 4.2 FSI quattro | 257         |             | 06.06   | 10.09             |                |        |   |                              |   |
|                 | 4.2 quattro     |             |             | 11.02   | 10.09             |                |        |   |                              |   |
|                 | 4.2 TDI quattro |             |             | 07.05   | 10.09             |                |        |   |                              |   |
|                 | 6.0 W12 quattro |             | 4E-7-008500 | 02.04   |                   | 83.7812-0180.3 | 330854 | 2 |                              | L=180   |
|                 | S8              | 331         | 4E-7-008500 | 06.06   |                   |                |        |   |                              |   |
|                 | 6.0 W12 quattro |             | 4E-7-008501 |         | 10.09             | 83.7812-0180.3 | 330854 | 2 |                              | L=180   |
|                 | S8              | 331         | 4E-7-008501 |         | 10.09             |                |        |   |                              |   |

| AUDI A8 (09-) |                    |     |  |       |  |                |        |   |                                     |           |     |
|---------------|--------------------|-----|--|-------|--|----------------|--------|---|-------------------------------------|-----------|-----|
|               | 2.0 TFSI hybrid    | 155 |  | 05.12 |  | 24.2125-1739.3 | 010948 | - | gepanzerete Fahrzeuge <sup>2)</sup> | Thz 25,40 | LUC |
|               | 3.0 TDI            | 150 |  | 09.11 |  |                |        |   |                                     |           |     |
|               | 3.0 TDI quattro    |     |  | 07.10 |  |                |        |   |                                     |           |     |
|               | 3.0 TDI quattro cd | 190 |  | 09.13 |  |                |        |   |                                     |           |     |
|               | 3.0 TFSI quattro   |     |  | 07.10 |  |                |        |   |                                     |           |     |
|               | 3.0 TFSI quattro   | 228 |  | 09.13 |  |                |        |   |                                     |           |     |
|               | 4.0 TFSI quattro   | 309 |  | 03.12 |  |                |        |   |                                     |           |     |
|               | 4.0 TFSI quattro   | 320 |  | 09.13 |  |                |        |   |                                     |           |     |
|               | 4.2 FSI quattro    | 273 |  | 11.09 |  |                |        |   |                                     |           |     |
|               | 4.2 TDI quattro    | 258 |  | 11.09 |  |                |        |   |                                     |           |     |
|               | 4.2 TDI quattro cd | 283 |  | 09.13 |  |                |        |   |                                     |           |     |
|               | 6.3 W12 quattro    | 368 |  | 01.11 |  |                |        |   |                                     |           |     |
|               | S8                 | 381 |  | 04.12 |  |                |        |   |                                     |           |     |

<sup>1)</sup> on the brake caliper / sulla pinza freno / sur l'étrier de frein / a la pinza de freno  
<sup>2)</sup> - armoured vehicles / - veicoli blindati / - véhicule blindé / - vehículo blindado

|     |    |  |  |                                   |  |    |    |  |  |                             |  |   |
|--|--|--|--|---|---|--|--|--|--|-----------------------------|--|---|
| <b>AUDI A8 (09-)</b>   |  |  |  |   |   |  |  |  |  |                             |  |   |
|    | 4.2 FSI quattro<br>4.2 TDI quattro   | 273<br>258   |  | 11.09<br>11.09  | 06.10<br>06.10  | PR: 1LJ<br>PR: 1LJ   | 11.8116-0018.2   | 390604   | 2  |                             | Haltefeder   | ATE   |
|  | 2.0 TFSI hybrid<br>3.0 TDI<br>3.0 TDI quattro<br>3.0 TDI quattro cd<br>3.0 TFSI quattro<br>3.0 TFSI quattro<br>4.0 TFSI quattro<br>4.0 TFSI quattro<br>4.2 FSI quattro<br>4.2 TDI quattro<br>4.2 TDI quattro cd<br>6.3 W12 quattro<br>S8 | 155<br>150<br>190<br>190<br>228<br>309<br>320<br>273<br>258<br>283<br>368<br>381 |  | 05.12<br>09.11<br>07.10<br>09.13<br>07.10<br>09.13<br>03.12<br>09.13<br>07.10<br>07.10<br>09.13<br>01.11<br>04.12 |   | PR: 1LJ<br>PR: 1LJ<br>PR: 1LJ<br>PR: 1LJ<br>PR: 1LJ<br>PR: 1LJ<br>PR: 1LJ<br>PR: 1LJ<br>PR: 1LJ<br>PR: 1LJ<br>PR: 1LJ<br>PR: 1LJ | 11.8116-0018.2   | 390604   | 2  |                             | Haltefeder   | ATE   |
| <b>AUDI CABRIO (91-00)</b>   |  |  |  |   |   |  |  |  |  |                             |  |   |
|    | 2.3  | 8G-N-000001  | 8G-N-015000  |   |   |  | 03.7750-0302.4   | 300071   |  |                             | 9"   | ATE   |
|    | 1.9 TDI<br>2.0<br>2.3<br>2.3   |  | 8G-V-010000<br>8G-V-010000<br>8G-V-010000<br>8G-N-015000                         | 07.95<br>01.93<br>07.91<br>07.91  |   | - ABS<br>- ABS<br>- ABS<br>- ABS   | 03.2122-9612.3   | 010159   |  |                             | THz 22,20  | ATE   |
|  | 1.9 TDI<br>2.0<br>2.0<br>2.3   | 8G-P-000001<br>85 8G-P-000001<br>103 8G-P-000001<br>8G-P-000001                  | 8G-V-010000<br>8G-V-010000<br>8G-V-010000<br>8G-V-010000                         | 07.95<br>01.93<br>07.91<br>07.91  |   | - ABS<br>- ABS<br>- ABS/ + ⊕<br>- ABS  | 03.2123-0491.3<br>03.3517-0101.2   | 010167<br>390322   |  |                             | THz 23,81<br>Verschlußschraube   | ATE   |
|  | 1.9 TDI<br>2.0<br>2.3<br>2.3   | 85<br>85<br>85<br>85   | 8G-N-015000<br>8G-N-015000<br>8G-N-015000<br>8G-N-015000                         | 07.95<br>01.93<br>07.91<br>07.91  | 08.00<br>07.98<br>06.94<br>06.94  | + ABS<br>+ ABS<br>+ ABS<br>+ ABS   | 24.2122-1601.3   | 010380   |  |                             | THz 22,20  | LUC   |
|  | 1.9 TDI<br>2.0<br>2.3<br>2.6<br>2.8  | 85<br>103<br>8G-P-000001<br>8G-P-000001  | 8G-R-012000<br>8G-R-012000<br>8G-R-012000<br>8G-R-012000                         | 07.95<br>05.95<br>01.94<br>11.92  | 08.00<br>07.96<br>08.00<br>08.00  | + ABS<br>+ ABS<br>+ ABS<br>+ ABS   | 24.2123-1602.3   | 010384   |  |                             | THz 23,81  | LUC   |
|  | 1.8<br>2.6<br>2.8  | 8G-W-000001  | 8G-V-010000<br>8G-V-010000   | 08.00<br>01.94<br>11.92   |   |  | 03.2123-1963.3   | 010737   |  |                             | THz 23,81  | ATE   |
|  | 2.6<br>2.8   |  | 8G-V-010000<br>8G-V-010000   | 01.94<br>11.92  |   |  | 03.2123-0566.3   | 010169   |  |                             | THz 23,81  | ATE   |
|  | 2.3  |  | 8G-N-025000  | 07.91   |   |  | 11.3541-8522.2<br>11.3541-8521.2<br>24.3541-8522.5<br>24.3541-8521.5<br>11.0441-5405.2<br>11.0101-5409.2<br>24.0101-4301.2<br>11.0101-5403.2 | 220114<br>220113<br>240488<br>240487<br>250030<br>260035<br>260047<br>260010       | <input type="checkbox"/><br><input type="checkbox"/><br><input type="checkbox"/><br><input type="checkbox"/><br><input type="checkbox"/><br><input type="checkbox"/><br><input type="checkbox"/><br><input type="checkbox"/> |                             | D=54, - Halter<br>D=54, - Halter<br>D=54, - Halter<br>D=54, - Halter<br>Dichtungssatz<br>Hülensatz<br>Einbausatz<br>Faltenbalgsatz | ATE<br>ATE<br>ATE<br>ATE<br>ATE<br>LUC<br>LUC |
|  | 1.8<br>1.9 TDI<br>2.0<br>2.0<br>2.3<br>2.6<br>2.8  | 85<br>103<br>8G-P-000001   |  | 04.97<br>07.95<br>01.93<br>05.95<br>07.91<br>01.94<br>11.92   | 08.00<br>08.00<br>07.98<br>07.96<br>06.94<br>08.00<br>08.00                       | + ⊕<br>+ ⊕   | 24.0101-4301.2   | 260047   |  |                             | Einbausatz<br>Faltenbalgsatz   | LUC<br>LUC                                    |
|  | 1.8<br>1.9 TDI<br>2.0<br>2.0<br>2.3<br>2.6<br>2.8  | 85<br>103  |  | 04.97<br>07.95<br>01.93<br>05.95<br>07.91<br>01.94<br>11.92   | 08.00<br>08.00<br>07.98<br>07.96<br>06.94<br>08.00<br>08.00                       | + ⊕<br>+ ⊕   | 83.7813-0285.3<br>83.7704-0160.3   | 330798<br>330805   | 2<br>2   | am Bremsattel <sup>1)</sup> | L=285<br>L=160   |   |
|  | 2.0<br>2.3<br>2.8  | 85   | 8G-P-005533<br>8G-P-005533<br>8G-P-005533  | 01.93<br>07.91<br>11.92   |   |  | 24.3384-1601.5<br>24.3384-1602.5<br>24.0101-3601.2   | 240013<br>240014<br>260044   | <input type="checkbox"/><br><input type="checkbox"/><br><input type="checkbox"/>   |                             | D=38, - Halter<br>D=38, - Halter<br>Einbausatz   | LUC<br>LUC<br>LUC                             |
|  | 1.8<br>1.9 TDI<br>2.0<br>2.0<br>2.3<br>2.6<br>2.8  | 85<br>85 8G-P-005534<br>103 8G-P-005534<br>8G-P-005534                           |  | 04.97<br>07.95<br>01.93<br>05.95<br>07.91<br>01.94<br>11.92   | 08.00<br>08.00<br>07.98<br>07.96<br>06.94<br>08.00<br>08.00                       | + ⊕<br>+ ⊕   | 24.3384-1709.5<br>24.3384-1710.5   | 240257<br>240258   | <input type="checkbox"/><br><input type="checkbox"/><br><input type="checkbox"/><br><input type="checkbox"/>   |                             | D=38, - Halter<br>D=38, - Halter   | LUC<br>LUC                                    |
|  | 1.8<br>1.9 TDI<br>2.0<br>2.0<br>2.3<br>2.6<br>2.8  | 85<br>103  |  | 04.97<br>07.95<br>01.93<br>05.95<br>07.91<br>01.94<br>11.92   | 08.00<br>08.00<br>07.98<br>07.96<br>06.94<br>08.00<br>08.00                       | + ⊕<br>+ ⊕   | 83.6224-0200.3<br>83.7804-0150.3<br>83.7704-0160.3   | 330729<br>330853<br>330805   | 2  | am Bremsattel <sup>1)</sup> | L=200<br>L=150<br>L=160  |   |
|  | 2.0<br>2.3<br>2.8  | 85   | 8G-P-005533<br>8G-P-005533<br>8G-P-005533  | 01.93<br>07.91<br>11.92   |   |  | 24.3727-0143.2<br>24.3727-0144.2   | 580143<br>580144   | <input type="checkbox"/><br><input type="checkbox"/>   |                             | L=1398<br>L=1358   |   |

<sup>1)</sup> on the brake caliper / sulla pinza freno / sur l'étrier de frein / a la pinza de freno

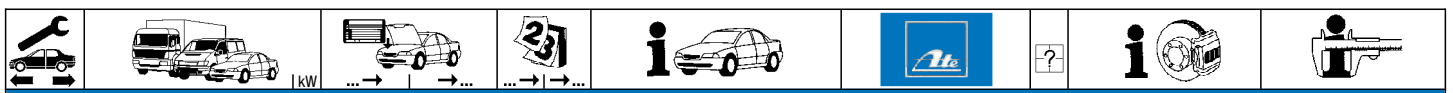











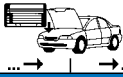









| AUDI CABRIO (91-00) |         |     |  |       |       |     |                |        |  |             |     |
|---------------------|---------|-----|--|-------|-------|-----|----------------|--------|--|-------------|-----|
|                     | 1.8     |     |  | 04.97 | 08.00 |     | 03.6585-0108.3 | 320115 |  | BRL 8/5 (4) | ATE |
|                     | 1.9 TDI |     |  | 07.95 | 08.00 |     |                |        |  |             |     |
|                     | 2.0     | 85  |  | 01.93 | 07.98 |     |                |        |  |             |     |
|                     | 2.0     | 103 |  | 05.95 | 07.96 | + ① |                |        |  |             |     |
|                     | 2.3     |     |  | 07.91 | 06.94 |     |                |        |  |             |     |
|                     | 2.6     |     |  | 01.94 | 08.00 |     |                |        |  |             |     |
|                     | 1.8     |     |  | 04.97 | 08.00 |     | 03.2419-9210.3 | 030026 |  | Gz 19,05    |     |
|                     | 1.9 TDI |     |  | 07.95 | 08.00 |     |                |        |  |             |     |
|                     | 2.0     | 85  |  | 01.93 | 07.98 |     |                |        |  |             |     |
|                     | 2.0     | 103 |  | 05.95 | 07.96 | + ① |                |        |  |             |     |
|                     | 2.3     |     |  | 07.91 | 06.94 |     |                |        |  |             |     |
|                     | 2.6     |     |  | 01.94 | 08.00 |     |                |        |  |             |     |
|                     | 2.8     |     |  | 11.92 | 08.00 |     |                |        |  |             |     |
|                     | 1.8     |     |  | 04.97 | 08.00 |     | 03.2522-4300.3 | 040085 |  | Nz 22,20    |     |
|                     | 1.9 TDI |     |  | 07.95 | 08.00 |     |                |        |  |             |     |
|                     | 2.0     | 85  |  | 01.93 | 07.98 |     |                |        |  |             |     |
|                     | 2.0     | 103 |  | 05.95 | 07.96 | + ① |                |        |  |             |     |
|                     | 2.3     |     |  | 07.91 | 06.94 |     |                |        |  |             |     |
|                     | 2.6     |     |  | 01.94 | 08.00 |     |                |        |  |             |     |
|                     | 2.8     |     |  | 11.92 | 08.00 |     |                |        |  |             |     |

| AUDI COUPE (89-96) |         |     |  |             |       |                                 |                |        |  |                      |     |
|--------------------|---------|-----|--|-------------|-------|---------------------------------|----------------|--------|--|----------------------|-----|
|                    | 1.8     |     |  | 8B-N-500000 | 08.88 |                                 | 03.7750-0302.4 | 300071 |  | 9"                   | ATE |
|                    | 2.0     |     |  | 8B-N-500000 | 08.88 |                                 |                |        |  |                      |     |
|                    | 2.0 16V |     |  | 8B-N-500000 | 01.92 |                                 |                |        |  |                      |     |
|                    | 2.0 20V | 118 |  | 8B-N-500000 | 08.89 |                                 |                |        |  |                      |     |
|                    | 2.2     |     |  | 8B-N-500000 | 08.88 |                                 |                |        |  |                      |     |
|                    | 2.3     | 98  |  | 8B-N-500000 | 03.90 |                                 |                |        |  |                      |     |
|                    | 2.3     | 100 |  | 8B-N-500000 | 08.88 |                                 |                |        |  |                      |     |
|                    | 2.3 20V | 123 |  | 8B-M-020000 | 08.90 |                                 | 10.0124-3202.3 | 340011 |  | Hydraulik Verstärker |     |
|                    | 2.3 20V | 125 |  | 8B-M-020000 | 08.89 |                                 |                |        |  |                      |     |
|                    | 1.8     |     |  |             | 08.88 | 07.89                           | 03.2120-2331.3 | 010110 |  | THz 20,64            | ATE |
|                    | 1.8     |     |  | 08.89       | 07.91 | - ABS                           | 03.2122-9612.3 | 010159 |  | THz 22,20            | ATE |
|                    | 2.0     | 85  |  | 08.88       | 12.96 | - ABS                           |                |        |  |                      |     |
|                    | 2.0     | 85  |  | 08.88       | 07.92 | - ABS                           |                |        |  |                      |     |
|                    | 2.2     |     |  | 08.88       | 07.91 | - ABS                           |                |        |  |                      |     |
|                    | 2.3     | 98  |  | 03.90       | 07.94 | - ABS                           |                |        |  |                      |     |
|                    | 2.3     | 98  |  | 03.90       | 07.92 | - ABS                           |                |        |  |                      |     |
|                    | 2.3     | 100 |  | 08.88       | 07.94 | - ABS                           |                |        |  |                      |     |
|                    | 2.3     | 100 |  | 08.88       | 07.92 | - ABS                           |                |        |  |                      |     |
|                    | 2.0     |     |  | 08.92       | 12.96 | - ABS/ - Hydraulikverstärker 1) | 03.2123-0491.3 | 010167 |  | THz 23,81            | ATE |
|                    | 2.3     | 98  |  | 08.92       | 12.96 | - ABS                           |                |        |  |                      |     |
|                    | 2.3     | 100 |  | 08.92       | 07.94 | - ABS                           |                |        |  |                      |     |
|                    | 2.8     |     |  | 09.91       | 12.96 | - ABS                           |                |        |  |                      |     |
|                    | 1.8     |     |  | 08.89       | 07.91 | + ABS                           | 24.2122-1601.3 | 010380 |  | THz 22,20            | LUC |
|                    | 2.0     | 85  |  | 05.89       | 12.96 | + ABS/ - Hydraulikverstärker 2) |                |        |  |                      |     |
|                    | 2.0     | 85  |  | 05.89       | 07.92 | + ABS                           |                |        |  |                      |     |
|                    | 2.3     | 98  |  | 03.90       | 07.94 | + ABS                           |                |        |  |                      |     |
|                    | 2.3     | 98  |  | 03.90       | 07.92 | + ABS                           |                |        |  |                      |     |
|                    | 2.3     | 100 |  | 11.88       | 07.94 | + ABS                           |                |        |  |                      |     |
|                    | 2.3     | 100 |  | 11.88       | 07.92 | + ABS                           |                |        |  |                      |     |
|                    | 2.0     |     |  | 08.92       | 12.96 | + ABS/ - Hydraulikverstärker 2) | 24.2123-1602.3 | 010384 |  | THz 23,81            | LUC |
|                    | 2.3     | 98  |  | 08.92       | 12.96 | + ABS                           |                |        |  |                      |     |
|                    | 2.3     | 100 |  | 08.92       | 07.94 | + ABS                           |                |        |  |                      |     |
|                    | 2.6     |     |  | 08.92       | 06.94 | - Hydraulikverstärker 3)        |                |        |  |                      |     |
|                    | 2.8     |     |  | 09.91       | 06.94 | + ABS/ - Hydraulikverstärker 2) |                |        |  |                      |     |
|                    | 2.6     |     |  | 07.94       | 12.96 | - Hydraulikverstärker 3)        | 24.2123-1601.3 | 010383 |  | THz 23,81            | LUC |
|                    | 2.8     |     |  | 07.94       | 12.96 | + ABS/ - Hydraulikverstärker 2) |                |        |  |                      |     |
|                    | 2.0     |     |  | 07.94       | 12.96 | + Hydraulikverstärker 4)        | 03.2123-0566.3 | 010169 |  | THz 23,81            | ATE |
|                    | 2.6     |     |  | 08.92       | 12.96 | + Hydraulikverstärker 4)        | 03.3517-0101.2 | 390322 |  | Verschlußschraube    |     |
|                    | 2.8     |     |  | 09.91       | 12.96 | + Hydraulikverstärker 4)        |                |        |  |                      |     |
|                    | 2.3 20V | 123 |  | 08.90       | 07.91 |                                 | 03.2125-3210.3 | 010212 |  | THz 25,40            | ATE |
|                    | 2.3 20V | 125 |  | 08.89       | 07.91 |                                 |                |        |  |                      |     |
|                    | 2.2     |     |  | 08.88       | 10.88 |                                 | 24.3541-1609.5 | 240039 |  | D=54, - Halter       | LUC |
|                    | 2.3     |     |  | 08.88       | 10.88 |                                 | 24.3541-1610.5 | 240040 |  | D=54, - Halter       | LUC |
|                    |         |     |  |             |       |                                 | 24.0101-4301.2 | 260047 |  | Einbausatz           | LUC |
|                    |         |     |  |             |       |                                 | 11.0101-5403.2 | 260010 |  | Faltenbalgsatz       | LUC |
|                    | 1.8     |     |  | 08.88       | 07.91 |                                 | 11.3541-8522.2 | 220114 |  | D=54, - Halter       | ATE |
|                    | 2.0     |     |  | 05.89       | 07.92 |                                 | 11.3541-8521.2 | 220113 |  | D=54, - Halter       | ATE |
|                    | 2.2     |     |  | 11.88       | 07.91 |                                 | 24.3541-8522.5 | 240488 |  | D=54, - Halter       | ATE |
|                    | 2.3     | 98  |  | 03.90       | 07.92 |                                 | 24.3541-8521.5 | 240487 |  | D=54, - Halter       | ATE |
|                    | 2.3     | 100 |  | 11.88       | 07.92 |                                 | 11.0441-5405.2 | 250030 |  | Dichtungssatz        | ATE |
|                    |         |     |  |             |       |                                 | 11.0101-5409.2 | 260035 |  | Hülensatz            | ATE |
|                    |         |     |  |             |       |                                 | 24.0101-4301.2 | 260047 |  | Einbausatz           | LUC |
|                    |         |     |  |             |       |                                 | 11.0101-5403.2 | 260010 |  | Faltenbalgsatz       | LUC |
|                    | 2.0     |     |  | 08.92       | 12.96 |                                 | 24.0101-4301.2 | 260047 |  | Einbausatz           | LUC |
|                    | 2.3     | 98  |  | 08.92       | 12.96 |                                 | 11.0101-5403.2 | 260010 |  | Faltenbalgsatz       | LUC |
|                    | 2.3     | 100 |  | 08.92       | 07.94 |                                 |                |        |  |                      |     |
|                    | 2.6     |     |  | 08.92       | 12.96 |                                 |                |        |  |                      |     |
|                    | 2.3 20V | 123 |  | 08.90       | 07.91 |                                 | 24.0101-3401.2 | 260043 |  | Einbausatz           | LUC |
|                    | 2.3 20V | 125 |  | 08.89       | 07.91 |                                 | 11.0101-5403.2 | 260010 |  | Faltenbalgsatz       | LUC |
|                    | 2.8     |     |  | 09.91       | 12.96 |                                 |                |        |  |                      |     |

1) - ABS/ - hydraulic booster / - ABS/ - servofreno idraulico / - ABS/ - amplificateur hydraulique / - ABS/ - servo hidráulico  
2) + ABS/ - hydraulic booster / + ABS/ - servofreno idraulico / + ABS/ - amplificateur hydraulique / + ABS/ - servo hidráulico  
3) - hydraulic booster / - servofreno idraulico / - amplificateur hydraulique / - servo hidráulico  
4) + hydraulic booster / + servofreno idraulico / + amplificateur hydraulique / + servo hidráulico



















| AUDI COUPE (89-96)   |  |  |  |   |   |  |  |  |  |
|--|--|--|--|---|---|--|--|--|--|
|     |  |  |  |   |  |  |  |  |  |
|    | 1.8<br>2.0<br>2.2<br>2.3   |  | 8B-L-003791 08.88<br>8B-L-003791 08.88<br>8B-L-003791 08.88<br>8B-L-003791 08.88 |   |   | 83.7775-0312.3   | 330795   | 2  | L=310  |
|    | 1.8<br>2.0<br>2.2<br>2.3<br>2.6<br>2.8   | 8B-L-003792<br>8B-L-003792<br>8B-L-003792<br>8B-L-003792                         |  | 07.91<br>12.96<br>07.91<br>07.94<br>08.92 12.96<br>09.91 12.96  |   | 83.7813-0285.3<br>83.7704-0160.3   | 330798<br>330805   | 2<br>2   | am Bremssattel <sup>1)</sup><br>L=285<br>L=160             |
|    | 2.2<br>2.3   | 100  |  | 08.88 10.88<br>08.88 10.88  |   | 24.0101-3601.2   | 260044   |  | Einbausatz LUC   |
|    | 1.8<br>2.0<br>2.2<br>2.3<br>2.6<br>2.8   |  |  | 08.88 07.91<br>08.88 04.93<br>08.88 07.91<br>08.88 04.93<br>08.92 04.93<br>09.91 04.93                                  |   | 24.3384-1601.5<br>24.3384-1602.5<br>24.0101-3601.2                                 | 240013<br>240014<br>260044   | <input type="checkbox"/><br><input type="checkbox"/>                               | D=38, - Halter LUC<br>D=38, - Halter LUC<br>Einbausatz LUC |
|  | 2.0<br>2.3<br>2.6<br>2.8   |  |  | 05.93 12.96<br>05.93 07.94<br>05.93 12.96<br>05.93 12.96  |   | 24.3384-1709.5<br>24.3384-1710.5   | 240257<br>240258   | <input type="checkbox"/><br><input type="checkbox"/>                               | D=38, - Halter LUC<br>D=38, - Halter LUC                   |
|  | 1.8<br>2.0   |  |  | 08.88 10.88<br>08.88 10.88  |   | 83.6224-0200.3<br>83.7824-0180.3   | 330729<br>330812   | <input type="checkbox"/><br><input type="checkbox"/>                               | L=200<br>L=180   |
|  | 2.2<br>2.3   | 100<br>100   |  | 08.88 10.88<br>08.88 10.88  |   | 83.7704-0160.3   | 330805   | 2  | L=160  |
|  | 1.8<br>2.0<br>2.2<br>2.3<br>2.6<br>2.8   |  |  | 11.88 07.91<br>11.88 12.96<br>11.88 07.91<br>11.88 07.94<br>08.92 12.96<br>09.91 12.96                                  |   | 83.6224-0200.3<br>83.7804-0150.3<br>83.7704-0160.3                                 | 330729<br>330853<br>330805   | 2  | am Bremssattel <sup>1)</sup><br>L=200<br>L=150<br>L=160    |
|  | 1.8  |  |  | 08.88 10.88   |   | 03.3215-2311.3<br>24.3215-0903.3   | 020018<br>020154   | + GG <sup>2)</sup><br>+ ALU <sup>3)</sup>  | Rz 15,87<br>Rz 15,87                                       |
|  | 1.8<br>2.0   |  |  | 08.88 10.88<br>08.88 10.88  |   | 24.3727-0136.2<br>24.3727-0139.2   | 580136<br>580139   | <input type="checkbox"/><br><input type="checkbox"/>                               | L=1195<br>L=1150   |
|  | 1.8<br>2.0<br>2.2<br>2.3<br>2.6<br>2.8   |  |  | 11.88 07.91<br>11.88 04.93<br>11.88 07.91<br>11.88 04.93<br>08.92 04.93<br>09.91 04.93                                  |   | 24.3727-0143.2<br>24.3727-0144.2   | 580143<br>580144   | <input type="checkbox"/><br><input type="checkbox"/>                               | L=1398<br>L=1358   |
|  | 1.8<br>2.0<br>2.0<br>2.2<br>2.3<br>2.6   | 85<br>103  |  | 08.88 07.91<br>08.88 12.96<br>08.88 07.94<br>08.88 07.91<br>03.90 12.96<br>08.88 07.94<br>08.92 12.96                   |   | 03.6585-0108.3   | 320115   |  | BRL 8/5 (4) ATE  |
|  | 2.2<br>2.3   | 1100<br>1100   |  | 08.88 10.88<br>08.88 10.88  |   | 03.2419-8150.3   | 030019   |  | Gz 19,05   |
|  | 1.8<br>2.0<br>2.2<br>2.3<br>2.6<br>2.8   |  |  | 11.88 07.91<br>11.88 12.96<br>11.88 07.91<br>11.88 07.94<br>08.92 12.96<br>09.91 12.96                                  |   | 03.2419-9210.3   | 030026   |  | Gz 19,05   |
|  | 2.2<br>2.3   | 100  |  | 08.88 10.88<br>08.88 10.88  |   | 03.2522-4211.3   | 040017   |  | Nz 22,20   |
|  | 1.8<br>2.0<br>2.2<br>2.3<br>2.6<br>2.8   |  |  | 11.88 07.91<br>11.88 12.96<br>11.88 07.91<br>11.88 07.94<br>08.92 12.96<br>09.91 12.96                                  |   | 03.2522-4300.3   | 040085   |  | Nz 22,20   |
| AUDI COUPE Quattro (87-96)   |  |  |  |   |   |  |  |  |  |
|  | 2.2<br>2.3<br>2.3  | 1100<br>98<br>1100   |  | 01.88 07.91<br>05.90 12.96<br>01.88 07.94   |   | 03.7750-0302.4   | 300071   |  | 9" ATE   |
|  | 2.0<br>2.3 20V<br>2.3 20V<br>S2 2.2<br>S2 2.2                                    | 1100<br>123<br>125<br>162<br>169   |  | 11.88 07.91 + E ①<br>05.90 12.96<br>11.88 07.91<br>09.90 09.92<br>10.92 12.96   |   | 10.0124-3202.3   | 340011   |  | Hydraulik Verstärker                                       |
|  | 2.0<br>2.6<br>2.8  |  |  | 11.88 07.91 + E ①<br>08.92 12.96 + Hydraulikverstärker <sup>4)</sup><br>08.91 12.96 + Hydraulikverstärker <sup>4)</sup> |   | 03.2123-0566.3<br>03.3517-0101.2   | 010169<br>390322   |  | THz 23,81<br>Verschlußschraube ATE                         |
|  | 2.2<br>2.3<br>2.3  | 100<br>98<br>100   |  | 01.88 07.91 - ABS<br>05.90 12.96 - ABS<br>01.88 07.94 - ABS   |   | 03.2122-9612.3   | 010159   |  | THz 22,20 ATE  |
|  | 2.2<br>2.3   | 100<br>98  |  | 11.88 07.91 + ABS<br>05.90 12.96 + ABS  |   | 24.2122-1601.3   | 010380   |  | THz 22,20 LUC  |

<sup>1)</sup> on the brake caliper / sulla pinza freno / sur l'étrier de frein / a la pinza de freno

<sup>2)</sup> + cast iron / + ghisa / + fonte grise / + fundición de gris

<sup>3)</sup> + aluminium / + alluminio / + aluminium / + aluminio

















<sup>4)</sup> + hydraulic booster / + servofreno idraulico / + amplificateur hydraulique / + servo hidráulico

|     |  |  |  |  |  |  |  |  |                  |
|--|--|--|--|--|---|--|--|--|------------------|
| <b>AUDI COUPE Quattro (87-96)</b>  |  |  |  |  |   |  |  |  |                  |
|    | 2.3  | 100  |  | 11.88  | 07.94 + ABS   | 24.2122-1601.3   | 010380   | THz 22,20  | LUC              |
|  | S2 2.2   | 162  |  | 09.90  | 09.92   | 03.2125-3610.3   | 010214   | THz 25,40  | ATE              |
|  | S2 2.2   | 169  |  | 10.92  | 12.96   |  |  |  |                  |
|  | 2.3 20V  | 123  |  | 05.90  | 12.96   | 03.2125-3210.3   | 010212   | THz 25,40  | ATE              |
|  | 2.3 20V  | 125  |  | 11.88  | 07.91   |  |  |  |                  |
|  | 2.6  |  |  | 08.92  | 12.96 - Hydraulikverstärker 1)  | 24.2123-1601.3   | 010383   | THz 23,81  | LUC              |
|  | 2.8  |  |  | 08.91  | 12.96 - Hydraulikverstärker 1)  |  |  |  |                  |
|    | 2.2  | 100  |  | 01.88  | 07.91   | 11.3541-8522.2   | 220114   | D=54, - Halter   | ATE              |
|  | 2.3  | 98   |  | 05.90  | 07.92   | 11.3541-8521.2   | 220113   | D=54, - Halter   | ATE              |
|  | 2.3  | 100  |  | 01.88  | 07.92   | 24.3541-8522.5   | 240488   | D=54, - Halter   | ATE              |
|  | 2.6  |  |  | 08.92  | 12.96   | 24.3541-8521.5   | 240487   | D=54, - Halter   | ATE              |
|  |  |  |  |  |   | 11.0441-5405.2   | 250030   | Dichtungssatz  | ATE              |
|  |  |  |  |  |   | 11.0101-5409.2   | 260035   | Hülssensatz  | ATE              |
|  |  |  |  |  |   | 24.0101-4301.2   | 260047   | Einbausatz   | LUC              |
|  |  |  |  |  |   | 11.0101-5403.2   | 260010   | Faltenbalgsatz   | LUC              |
|  | 2.3  | 98   |  | 08.92  | 12.96   | 24.0101-4301.2   | 260047   | Einbausatz   | LUC              |
|  | 2.3  | 100  |  | 08.92  | 07.94   | 11.0101-5403.2   | 260010   | Faltenbalgsatz   | LUC              |
|  | 2.0  |  | 8B-L-003001  |  | 07.91 + F I   | 24.0101-3401.2   | 260043   | Einbausatz   | LUC              |
|  | 2.3 20V  | 123  | 8B-L-003001  |  | 12.96   | 11.0101-5403.2   | 260010   | Faltenbalgsatz   | LUC              |
|  | 2.3 20V  | 125  | 8B-L-003001  |  | 07.91   |  |  |  |                  |
|  | 2.8  |  |  | 08.91  | 12.96   |  |  |  |                  |
|  | S2 2.2   | 162  |  | 09.90  | 09.92   |  |  |  |                  |
|  | S2 2.2   | 169  |  | 10.92  | 12.96   |  |  |  |                  |
|    | 2.0  |  | 8B-L-003000  | 11.88  | + F I   | 83.7775-0312.3   | 330795   | 2  | L=310            |
|  | 2.2  | 100  | 8B-L-003000  | 01.88  |   |  |  |  |                  |
|  | 2.3  | 98   | 8B-L-003000  | 05.90  |   |  |  |  |                  |
|  | 2.3  | 100  | 8B-L-003000  | 01.88  |   |  |  |  |                  |
|  | 2.3 20V  | 123  | 8B-L-003000  | 05.90  |   | 83.6124-0382.3   | 330724   | 2  | L=380            |
|  | 2.3 20V  | 125  | 8B-L-003000  | 11.88  |   |  |  |  |                  |
|  | 2.0  |  | 8B-L-003001  |  | 07.91 + F I   | 83.7813-0285.3   | 330798   | 2  | L=285            |
|  | 2.2  | 100  | 8B-L-003001  |  | 07.91   | 83.7704-0160.3   | 330805   | 2  | L=160            |
|  | 2.3  | 98   | 8B-L-003001  |  | 12.96   |  |  |  | am Bremsattel 2) |
|  | 2.3  | 100  | 8B-L-003001  |  | 07.94   |  |  |  |                  |
|  | 2.3 20V  | 123  | 8B-L-003001  |  | 12.96   |  |  |  |                  |
|  | 2.3 20V  | 125  | 8B-L-003001  |  | 07.91   |  |  |  |                  |
|  | 2.6  |  |  | 08.92  | 12.96   |  |  |  |                  |
|  | 2.8  |  |  | 08.91  | 12.96   |  |  |  |                  |
|  | S2 2.2   | 162  |  | 09.90  | 09.92   |  |  |  |                  |
|  | S2 2.2   | 169  |  | 10.92  | 12.96   |  |  |  |                  |
|  | 2.0  |  |  | 11.88  | 07.91 + F I   | 24.3384-1703.5   | 240055   |  | D=38, - Halter   |
|  | 2.2  | 100  |  | 01.88  | 07.91   | 24.3384-1704.5   | 240056   |  | D=38, - Halter   |
|  | 2.3  | 98   |  | 05.90  | 12.96   | 24.0101-3601.2   | 260044   |  | Einbausatz       |
|  | 2.3  | 100  |  | 01.88  | 07.94   |  |  |  |                  |
|  | 2.3 20V  | 123  |  | 05.90  | 12.96   |  |  |  |                  |
|  | 2.3 20V  | 125  |  | 11.88  | 07.91   |  |  |  |                  |
|  | 2.6  |  |  | 08.92  | 12.96   |  |  |  |                  |
|  | 2.8  |  |  | 08.91  | 12.96   |  |  |  |                  |
|  | S2 2.2   | 162  |  | 09.90  | 09.92   |  |  |  |                  |
|  | S2 2.2   | 169  |  | 10.92  | 12.96   |  |  |  |                  |
|  | 2.0  |  |  | 11.88  | 07.91 + F I   | 83.6104-0250.3   | 330720   | 2  | L=250            |
|  | 2.2  | 100  |  | 01.88  | 07.91   |  |  |  |                  |
|  | 2.3  | 98   |  | 05.90  | 12.96   |  |  |  |                  |
|  | 2.3  | 100  |  | 01.88  | 07.94   |  |  |  |                  |
|  | 2.3 20V  | 123  |  | 05.90  | 12.96   |  |  |  |                  |
|  | 2.3 20V  | 125  |  | 11.88  | 07.91   |  |  |  |                  |
|  | 2.6  |  |  | 08.92  | 12.96   |  |  |  |                  |
|  | 2.8  |  |  | 08.91  | 12.96   |  |  |  |                  |
|  | S2 2.2   | 162  |  | 09.90  | 09.92   |  |  |  |                  |
|  | S2 2.2   | 169  |  | 10.92  | 12.96   |  |  |  |                  |
|  | 2.0  |  |  | 11.88  | 07.91 + F I   | 03.2419-9210.3   | 030026   |  | Gz 19,05         |
|  | 2.2  | 100  |  | 01.88  | 07.91   |  |  |  |                  |
|  | 2.3  | 98   |  | 05.90  | 12.96   |  |  |  |                  |
|  | 2.3  | 100  |  | 01.88  | 07.94   |  |  |  |                  |
|  | 2.3 20V  | 123  |  | 05.90  | 12.96   |  |  |  |                  |
|  | 2.3 20V  | 125  |  | 11.88  | 07.91   |  |  |  |                  |
|  | 2.6  |  |  | 08.92  | 12.96   |  |  |  |                  |
|  | 2.8  |  |  | 08.91  | 12.96   |  |  |  |                  |
|  | S2 2.2   | 162  |  | 09.90  | 09.92   |  |  |  |                  |
|  | 2.0  |  |  | 11.88  | 07.91 + F I   | 03.2522-4300.3   | 040085   |  | Nz 22,20         |
|  | 2.2  | 100  |  | 01.88  | 07.91   |  |  |  |                  |
|  | 2.3  | 98   |  | 05.90  | 12.96   |  |  |  |                  |
|  | 2.3  | 100  |  | 01.88  | 07.94   |  |  |  |                  |
|  | 2.3 20V  | 123  |  | 05.90  | 12.96   |  |  |  |                  |
|  | 2.3 20V  | 125  |  | 11.88  | 07.91   |  |  |  |                  |
|  | 2.6  |  |  | 08.92  | 12.96   |  |  |  |                  |
|  | 2.8  |  |  | 08.91  | 12.96   |  |  |  |                  |
|  | S2 2.2   | 162  |  | 09.90  | 09.92   |  |  |  |                  |
|  | S2 2.2   | 169  |  | 10.92  | 12.96   |  |  |  |                  |
| <b>AUDI Q3 (11-)</b>   |  |  |  |  |   |  |  |  |                  |
|  | 2.0 TDI  | 1103   |  | 06.11  |   | 03.4153-0186.3   | 010816   | THz 23,81  | ATE              |
|  | 2.0 TDI  | 1130   |  | 05.13  |   |  |  |  |                  |
|  | 2.0 TDI quattro  | 1103   |  | 01.12  |   |  |  |  |                  |
|  | 2.0 TDI quattro  | 1130   |  | 06.11  |   |  |  |  |                  |
|  | 2.0 TFSI quattro   | 1125   |  | 06.11  |   |  |  |  |                  |
|  | 2.0 TFSI quattro   | 1155   |  | 06.11  |   |  |  |  |                  |

1) - hydraulic booster / - servofreno idraulico / - amplificateur hydraulique / - servo hidráulico

2) on the brake caliper / sulla pinza freno / sur l'étrier de frein / a la pinza de freno



|     |                       |  |       |  |                |  |   |  |  |  |  |  |  |  |  |  |                |     |
|--|-----------------------|--|-------|--|----------------|--|---|--|--|---|--|--|--|--|--|--|----------------|-----|
| <b>AUDI Q3 (11-)</b>   |                       |  |       |  |                |  |   |  |  |   |  |  |  |  |  |  |                |     |
|    | 2.0 TDI               | 103  | 06.11 | PR: 1LJ  | 11.9571-9759.2 | 220847   |   |  |  |   |  |  |  |  |  |  | D=57, - Halter | ATE |
|  | 2.0 TDI               | 130  | 05.13 | PR: 1LJ  | 11.9571-9760.2 | 220848   |   |  |  |   |  |  |  |  |  |  | D=57, - Halter | ATE |
|  | 2.0 TDI quattro       | 103  | 01.12 | PR: 1LJ  | 11.8171-0008.1 | 990049   |   |  |  |   |  |  |  |  |  |  | Führungsbolzen | ATE |
|  | 2.0 TDI quattro       | 130  | 06.11 | PR: 1LJ  | 11.0101-5409.2 | 260035   |   |  |  |   |  |  |  |  |  |  | Hülsensatz     | ATE |
|  | 2.0 TFSI quattro      | 125  | 06.11 | PR: 1LJ  |                |  |   |  |  |   |  |  |  |  |  |  |                |     |
|  | 2.0 TFSI quattro      | 155  | 06.11 | PR: 1LJ  |                |  |   |  |  |   |  |  |  |  |  |  |                |     |
| <b>AUDI Q5 (08-)</b>   |                       |  |       |  |                |  |   |  |  |   |  |  |  |  |  |  |                |     |
|    | 2.0 TFSI hybr.quattro | 155  | 06.11 |  | 03.7858-4632.4 | 300273   |   |  |  |   |  |  |  |  |  |  | 9/8" Tandem    | ATE |
|    | S 3.0 TDI quattro     | 230  | 12.12 | PR: 1LV  | 11.8116-0018.2 | 390604   | 2 |  |  |   |  |  |  |  |  |  | Haltefeder     | ATE |
|    | 2.0 TDI               | 100  | 08.09 |  | 83.7713-0483.3 | 331229   | 2 |  |  |   |  |  |  |  |  |  | L=485          |     |
|  | 2.0 TDI               | 105  | 08.09 |  |                |  |   |  |  |   |  |  |  |  |  |  |                |     |
|  | 2.0 TDI               | 110  | 05.13 |  |                |  |   |  |  |   |  |  |  |  |  |  |                |     |
|  | 2.0 TDI quattro       | 100  | 08.09 |  |                |  |   |  |  |   |  |  |  |  |  |  |                |     |
|  | 2.0 TDI quattro       | 105  | 08.09 |  |                |  |   |  |  |   |  |  |  |  |  |  |                |     |
|  | 2.0 TDI quattro       | 110  | 05.13 |  |                |  |   |  |  |   |  |  |  |  |  |  |                |     |
|  | 2.0 TDI quattro       | 120  | 03.09 |  |                |  |   |  |  |   |  |  |  |  |  |  |                |     |
|  | 2.0 TDI quattro       | 125  | 03.09 |  |                |  |   |  |  |   |  |  |  |  |  |  |                |     |
|  | 2.0 TDI quattro       | 130  | 09.12 |  |                |  |   |  |  |   |  |  |  |  |  |  |                |     |
|  | 2.0 TFSI hybr.quattro | 155  | 06.11 |  |                |  |   |  |  |   |  |  |  |  |  |  |                |     |
|  | 2.0 TFSI quattro      | 132  | 08.09 |  |                |  |   |  |  |   |  |  |  |  |  |  |                |     |
|  | 2.0 TFSI quattro      | 155  | 03.09 |  |                |  |   |  |  |   |  |  |  |  |  |  |                |     |
|  | 2.0 TFSI quattro      | 162  | 05.13 |  |                |  |   |  |  |   |  |  |  |  |  |  |                |     |
|  | 2.0 TFSI quattro      | 165  | 09.12 |  |                |  |   |  |  |   |  |  |  |  |  |  |                |     |
|  | 3.0 TDI quattro       | 155  | 03.09 |  |                |  |   |  |  |   |  |  |  |  |  |  |                |     |
|  | 3.0 TDI quattro       | 176  | 03.09 |  |                |  |   |  |  |   |  |  |  |  |  |  |                |     |
|  | 3.0 TDI quattro       | 180  | 09.12 |  |                |  |   |  |  |   |  |  |  |  |  |  |                |     |
|  | 3.0 TFSI quattro      | 200  | 09.12 |  |                |  |   |  |  |   |  |  |  |  |  |  |                |     |
|  | 3.2 FSI quattro       | 199  | 03.09 |  |                |  |   |  |  |   |  |  |  |  |  |  |                |     |
|  | S 3.0 TDI quattro     | 230  | 12.12 |  |                |  |   |  |  |   |  |  |  |  |  |  |                |     |
| <b>AUDI Q7 (06-)</b>   |                       |  |       |  |                |  |   |  |  |   |  |  |  |  |  |  |                |     |
|    | 3.0 TDI               | 150  | 05.10 | - automatische Distanzregelung <sup>1)</sup>                                     | 03.7868-4503.4 | 300245   |   |  |  |   |  |  |  |  |  |  | 10/8" Tandem   | ATE |
|  | 3.0 TDI               | 155  | 03.06 | - automatische Distanzregelung <sup>1)</sup>                                     |                |  |   |  |  |   |  |  |  |  |  |  |                |     |
|  | 3.0 TDI               | 165  | 06.09 | - automatische Distanzregelung <sup>1)</sup>                                     |                |  |   |  |  |   |  |  |  |  |  |  |                |     |
|  | 3.0 TDI               | 171  | 03.06 | - automatische Distanzregelung <sup>1)</sup>                                     |                |  |   |  |  |   |  |  |  |  |  |  |                |     |
|  | 3.0 TDI               | 176  | 11.07 | - automatische Distanzregelung <sup>1)</sup>                                     |                |  |   |  |  |   |  |  |  |  |  |  |                |     |
|  | 3.0 TDI               | 180  | 05.11 | - automatische Distanzregelung <sup>1)</sup>                                     |                |  |   |  |  |   |  |  |  |  |  |  |                |     |
|  | 3.0 TFSI              | 200  | 05.10 | - automatische Distanzregelung <sup>1)</sup>                                     |                |  |   |  |  |   |  |  |  |  |  |  |                |     |
|  | 3.0 TFSI              | 245  | 05.10 | - automatische Distanzregelung <sup>1)</sup>                                     |                |  |   |  |  |   |  |  |  |  |  |  |                |     |
|  | 3.6 FSI               | 206  | 08.06 | - automatische Distanzregelung <sup>1)</sup>                                     |                |  |   |  |  |   |  |  |  |  |  |  |                |     |
|  | 4.2 FSI               | 257  | 03.06 | - automatische Distanzregelung <sup>1)</sup>                                     |                |  |   |  |  |   |  |  |  |  |  |  |                |     |
|  | 4.2 TDI               | 240  | 03.07 | - automatische Distanzregelung <sup>1)</sup>                                     |                |  |   |  |  |   |  |  |  |  |  |  |                |     |
|  | 6.0 TDI               | 368  | 09.08 | - automatische Distanzregelung <sup>1)</sup>                                     |                |  |   |  |  |   |  |  |  |  |  |  |                |     |
|  | 3.0 TDI               | 150  | 05.10 | + automatische Distanzregelung <sup>2)</sup>                                     | 03.7868-4702.4 | 300253   |   |  |  |   |  |  |  |  |  |  | 10/8" Tandem   | ATE |
|  | 3.0 TDI               | 155  | 03.06 | + automatische Distanzregelung <sup>2)</sup>                                     |                |  |   |  |  |   |  |  |  |  |  |  |                |     |
|  | 3.0 TDI               | 165  | 06.09 | + automatische Distanzregelung <sup>2)</sup>                                     |                |  |   |  |  |   |  |  |  |  |  |  |                |     |
|  | 3.0 TDI               | 171  | 03.06 | + automatische Distanzregelung <sup>2)</sup>                                     |                |  |   |  |  |   |  |  |  |  |  |  |                |     |
|  | 3.0 TDI               | 176  | 11.07 | + automatische Distanzregelung <sup>2)</sup>                                     |                |  |   |  |  |   |  |  |  |  |  |  |                |     |
|  | 3.0 TDI               | 180  | 05.11 | + automatische Distanzregelung <sup>2)</sup>                                     |                |  |   |  |  |   |  |  |  |  |  |  |                |     |
|  | 3.0 TFSI              | 200  | 05.10 | + automatische Distanzregelung <sup>2)</sup>                                     |                |  |   |  |  |   |  |  |  |  |  |  |                |     |
|  | 3.0 TFSI              | 245  | 05.10 | + automatische Distanzregelung <sup>2)</sup>                                     |                |  |   |  |  |   |  |  |  |  |  |  |                |     |
|  | 3.6 FSI               | 206  | 08.06 | + automatische Distanzregelung <sup>2)</sup>                                     |                |  |   |  |  |   |  |  |  |  |  |  |                |     |
|  | 4.2 FSI               | 257  | 03.06 | + automatische Distanzregelung <sup>2)</sup>                                     |                |  |   |  |  |   |  |  |  |  |  |  |                |     |
|  | 4.2 TDI               | 240  | 03.07 | + automatische Distanzregelung <sup>2)</sup>                                     |                |  |   |  |  |   |  |  |  |  |  |  |                |     |
|  | 6.0 TDI               | 368  | 09.08 | + automatische Distanzregelung <sup>2)</sup>                                     |                |  |   |  |  |   |  |  |  |  |  |  |                |     |
|  | 3.0 TDI               | 150  | 05.10 |  | 03.2126-3063.3 | 010812   |   |  |  |   |  |  |  |  |  |  | Thz 26,99      | ATE |
|  | 3.0 TDI               | 155  | 03.06 |  |                |  |   |  |  |   |  |  |  |  |  |  |                |     |
|  | 3.0 TDI               | 165  | 06.09 |  |                |  |   |  |  |   |  |  |  |  |  |  |                |     |
|  | 3.0 TDI               | 171  | 03.06 |  |                |  |   |  |  |   |  |  |  |  |  |  |                |     |
|  | 3.0 TDI               | 176  | 11.07 |  |                |  |   |  |  |   |  |  |  |  |  |  |                |     |
|  | 3.0 TDI               | 180  | 05.11 |  |                |  |   |  |  |   |  |  |  |  |  |  |                |     |
|  | 3.0 TFSI              | 200  | 05.10 |  |                |  |   |  |  |   |  |  |  |  |  |  |                |     |
|  | 3.0 TFSI              | 245  | 05.10 |  |                |  |   |  |  |   |  |  |  |  |  |  |                |     |
|  | 3.6 FSI               | 206  | 08.06 |  |                |  |   |  |  |   |  |  |  |  |  |  |                |     |
|  | 4.2 FSI               | 257  | 03.06 |  |                |  |   |  |  |   |  |  |  |  |  |  |                |     |
|  | 4.2 TDI               | 240  | 03.07 |  |                |  |   |  |  |   |  |  |  |  |  |  |                |     |
|  | 6.0 TDI               | 368  | 09.08 |  |                |  |   |  |  |   |  |  |  |  |  |  |                |     |
|  | 3.0 TDI               | 150  | 05.10 |  | 83.6213-0515.3 | 330866   | 2 |  |  |   |  |  |  |  |  |  | L=515          |     |
|  | 3.0 TDI               | 155  | 03.06 |  |                |  |   |  |  |   |  |  |  |  |  |  |                |     |
|  | 3.0 TDI               | 165  | 06.09 |  |                |  |   |  |  |   |  |  |  |  |  |  |                |     |
|  | 3.0 TDI               | 171  | 03.06 |  |                |  |   |  |  |   |  |  |  |  |  |  |                |     |
|  | 3.0 TDI               | 176  | 11.07 |  |                |  |   |  |  |   |  |  |  |  |  |  |                |     |
|  | 3.0 TDI               | 180  | 05.11 |  |                |  |   |  |  |   |  |  |  |  |  |  |                |     |
|  | 3.0 TFSI              | 200  | 05.10 |  |                |  |   |  |  |   |  |  |  |  |  |  |                |     |
|  | 3.0 TFSI              | 245  | 05.10 |  |                |  |   |  |  |   |  |  |  |  |  |  |                |     |
|  | 3.6 FSI               | 206  | 08.06 |  |                |  |   |  |  |   |  |  |  |  |  |  |                |     |
|  | 4.2 FSI               | 257  | 03.06 |  |                |  |   |  |  |   |  |  |  |  |  |  |                |     |
|  | 4.2 TDI               | 240  | 03.07 |  |                |  |   |  |  |   |  |  |  |  |  |  |                |     |
|  | 6.0 TDI               | 368  | 09.08 |  |                |  |   |  |  |   |  |  |  |  |  |  |                |     |

<sup>1)</sup> - autom. distance control / - regolazione della distanza autom. / - compensation de distance autom. / - regulaci3n de distancia autom.

<sup>2)</sup> + autom. distance control / + regolazione della distanza autom. / + compensation de distance autom. / + regulaci3n de distancia autom.

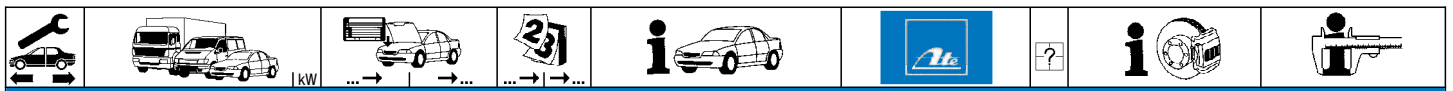

| AUDI Q7 (06-)         |               |     |             |       |       |                     |                |        |   |   |                    |
|-----------------------|---------------|-----|-------------|-------|-------|---------------------|----------------|--------|---|---|--------------------|
|                       | 3.0 TDI       | 150 |             | 05.10 |       |                     | 83.7812-0400.3 | 331214 | 2 |   | L=400              |
|                       | 3.0 TDI       | 155 |             | 03.06 |       |                     |                |        |   |   |                    |
|                       | 3.0 TDI       | 165 |             | 06.09 |       |                     |                |        |   |   |                    |
|                       | 3.0 TDI       | 171 |             | 03.06 |       |                     |                |        |   |   |                    |
|                       | 3.0 TDI       | 176 |             | 11.07 |       |                     |                |        |   |   |                    |
|                       | 3.0 TDI       | 180 |             | 05.11 |       |                     |                |        |   |   |                    |
|                       | 3.0 TFSI      | 200 |             | 05.10 |       |                     |                |        |   |   |                    |
|                       | 3.0 TFSI      | 245 |             | 05.10 |       |                     |                |        |   |   |                    |
|                       | 3.6 FSI       | 206 |             | 08.06 |       |                     |                |        |   |   |                    |
|                       | 4.2 FSI       | 257 |             | 03.06 |       |                     |                |        |   |   |                    |
|                       | 4.2 TDI       | 240 |             | 03.07 |       |                     |                |        |   |   |                    |
|                       | 6.0 TDI       | 368 |             | 09.08 |       |                     |                |        |   |   |                    |
|                       | 3.0 TDI       | 150 |             | 06.10 |       | PR: 1KF,2EA,1KD,2EF | 24.3727-3400.2 | 583400 | 2 | ↓ | L=1890             |
|                       | 3.0 TDI       | 155 |             | 06.10 |       | PR: 1KF,2EA,1KD,2EF |                |        |   |   |                    |
|                       | 3.0 TDI       | 165 |             | 06.10 |       | PR: 1KF,2EA,1KD,2EF |                |        |   |   |                    |
|                       | 3.0 TDI       | 171 |             | 06.10 |       | PR: 1KF,2EA,1KD,2EF |                |        |   |   |                    |
|                       | 3.0 TDI       | 176 |             | 06.10 |       | PR: 1KF,2EA,1KD,2EF |                |        |   |   |                    |
|                       | 3.0 TDI       | 180 |             | 05.11 |       | PR: 1KF,2EA,1KD,2EF |                |        |   |   |                    |
|                       | 3.0 TFSI      | 200 |             | 06.10 |       | PR: 1KF,2EA,1KD,2EF |                |        |   |   |                    |
|                       | 3.0 TFSI      | 245 |             | 06.10 |       | PR: 1KF,2EA,1KD,2EF |                |        |   |   |                    |
|                       | 3.6 FSI       | 206 |             | 06.10 |       | PR: 1KF,2EA,1KD,2EF |                |        |   |   |                    |
|                       | 4.2 FSI       | 257 |             | 06.10 |       | PR: 1KF,2EA,1KD,2EF |                |        |   |   |                    |
|                       | 4.2 TDI       | 240 |             | 06.10 |       | PR: 1KF,2EA,1KD,2EF |                |        |   |   |                    |
|                       | 6.0 TDI       | 368 |             | 06.10 |       | PR: 1KF,2EA,1KD,2EF |                |        |   |   |                    |
| AUDI TT Coupe (98-06) |               |     |             |       |       |                     |                |        |   |   |                    |
|                       | 1.8 T         | 132 | 8N-2-014300 | 10.98 |       | + ESP               | 03.7863-0402.4 | 300124 |   |   | 10" ATE            |
|                       | 1.8 T quattro | 132 | 8N-2-014300 | 10.98 |       | + ESP               |                |        |   |   |                    |
|                       | 1.8 T quattro | 165 | 8N-2-014300 | 10.98 |       | + ESP               |                |        |   |   |                    |
|                       | 1.8 T         | 110 |             | 09.02 | 06.06 |                     | 03.7860-0602.4 | 300141 |   |   | 10" ATE            |
|                       | 1.8 T         | 120 |             | 09.05 | 06.06 |                     |                |        |   |   |                    |
|                       | 1.8 T         | 132 | 8N-2-014301 |       | 06.06 |                     |                |        |   |   |                    |
|                       | 1.8 T         | 140 |             | 09.05 | 06.06 |                     |                |        |   |   |                    |
|                       | 1.8 T quattro | 132 | 8N-2-014301 |       | 06.06 |                     |                |        |   |   |                    |
|                       | 1.8 T quattro | 140 |             | 09.05 | 06.06 |                     |                |        |   |   |                    |
|                       | 1.8 T quattro | 165 | 8N-2-014301 |       | 06.06 |                     |                |        |   |   |                    |
|                       | 1.8 T quattro | 176 |             | 03.05 | 06.06 |                     |                |        |   |   |                    |
|                       | 3.2 quattro   | 184 |             | 04.03 | 06.06 |                     |                |        |   |   |                    |
|                       | 1.8 T         | 132 | 8N-2-014300 | 10.98 |       | - ESP               | 24.2123-1709.3 | 010503 |   |   | Thz 23,81          |
|                       | 1.8 T quattro | 132 | 8N-2-014300 | 10.98 |       | - ESP               |                |        |   |   |                    |
|                       | 1.8 T quattro | 165 | 8N-2-014300 | 10.98 |       | - ESP               |                |        |   |   |                    |
|                       | 1.8 T         | 132 | 8N-2-014300 | 10.98 |       | + ESP               | 03.2123-2024.3 | 010597 |   |   | Thz 23,81 ATE      |
|                       | 1.8 T quattro | 132 | 8N-2-014300 | 10.98 |       | + ESP               |                |        |   |   |                    |
|                       | 1.8 T quattro | 165 | 8N-2-014300 | 10.98 |       | + ESP               |                |        |   |   |                    |
|                       | 1.8 T         | 132 | 8N-2-014300 | 10.98 |       | + ESP               | 03.2123-2064.3 | 010598 |   |   | Thz 23,81 ATE      |
|                       | 1.8 T quattro | 132 | 8N-2-014300 | 10.98 |       | + ESP               |                |        |   |   |                    |
|                       | 1.8 T quattro | 165 | 8N-2-014300 | 10.98 |       | + ESP               |                |        |   |   |                    |
|                       | 1.8 T         | 132 | 8N-2-014301 |       | 08.02 |                     | 03.2123-2715.3 | 010802 |   |   | Thz 23,81 ATE      |
|                       | 1.8 T quattro | 132 | 8N-2-014301 |       | 08.02 |                     |                |        |   |   |                    |
|                       | 1.8 T quattro | 165 | 8N-2-014301 |       | 08.02 |                     |                |        |   |   |                    |
|                       | 1.8 T         | 132 | 8N-2-014301 |       | 08.02 |                     | 03.2123-2774.3 | 010803 |   |   | Thz 23,81 ATE      |
|                       | 1.8 T quattro | 132 | 8N-2-014301 |       | 08.02 |                     |                |        |   |   |                    |
|                       | 1.8 T quattro | 165 | 8N-2-014301 |       | 08.02 |                     |                |        |   |   |                    |
|                       | 1.8 T         | 110 |             | 09.02 | 06.06 |                     | 03.2123-2654.3 | 010801 |   |   | Thz 23,81 ATE      |
|                       | 1.8 T         | 120 |             | 09.05 | 06.06 |                     |                |        |   |   |                    |
|                       | 1.8 T         | 132 |             | 09.02 | 06.06 |                     |                |        |   |   |                    |
|                       | 1.8 T         | 140 |             | 09.05 | 06.06 |                     |                |        |   |   |                    |
|                       | 1.8 T quattro | 132 |             | 09.02 | 06.06 |                     |                |        |   |   |                    |
|                       | 1.8 T quattro | 140 |             | 09.05 | 06.06 |                     |                |        |   |   |                    |
|                       | 1.8 T quattro | 165 |             | 09.02 | 06.06 |                     |                |        |   |   |                    |
|                       | 1.8 T quattro | 176 |             | 03.05 | 06.06 |                     |                |        |   |   |                    |
|                       | 3.2 quattro   | 184 |             | 04.03 | 06.06 |                     |                |        |   |   |                    |
|                       | 1.8 T         | 110 |             | 09.02 | 06.06 | PR: 1LD,1LT,1LV     | 11.9541-9595.2 | 220501 |   |   | D=54, - Halter ATE |
|                       | 1.8 T         | 120 |             | 09.05 | 06.06 | PR: 1LD,1LT,1LV     | 11.9541-9596.2 | 220502 |   |   | D=54, - Halter ATE |
|                       | 1.8 T         | 132 |             | 10.98 | 06.06 | PR: 1LD,1LT,1LV     | 11.0101-5409.2 | 260035 |   |   | Hülzensatz ATE     |
|                       | 1.8 T         | 140 |             | 09.05 | 06.06 | PR: 1LD,1LT,1LV     | 11.8171-0008.1 | 990049 |   |   | Führungsbolzen ATE |
|                       | 1.8 T quattro | 132 |             | 10.98 | 06.06 | PR: 1LD,1LT,1LV     | 11.8116-0143.1 | 390513 | 2 |   | Haltefeder ATE     |
|                       | 1.8 T quattro | 140 |             | 09.05 | 06.06 | PR: 1LD,1LT,1LV     |                |        |   |   |                    |
|                       | 1.8 T quattro | 165 |             | 10.98 | 06.06 | PR: 1LD,1LT,1LV     |                |        |   |   |                    |
|                       | 1.8 T quattro | 176 |             | 03.05 | 06.06 | PR: 1LD,1LT,1LV     |                |        |   |   |                    |
|                       | 3.2 quattro   | 184 |             | 04.03 | 06.06 |                     | 11.9421-9915.2 | 220869 |   |   | D=42, - Halter ATE |
|                       |               |     |             |       |       |                     | 11.9421-9916.2 | 220870 |   |   | D=42, - Halter ATE |
|                       |               |     |             |       |       |                     | 11.8171-0008.1 | 990049 |   |   | Führungsbolzen ATE |
|                       | 1.8 T         | 110 |             | 09.02 | 06.06 |                     | 83.6252-0560.3 | 330557 | 2 |   | L=560              |
|                       | 1.8 T         | 120 |             | 09.05 | 06.06 |                     |                |        |   |   |                    |
|                       | 1.8 T         | 132 |             | 10.98 | 06.06 |                     |                |        |   |   |                    |
|                       | 1.8 T         | 140 |             | 09.05 | 06.06 |                     |                |        |   |   |                    |
|                       | 1.8 T quattro | 132 |             | 10.98 | 06.06 |                     |                |        |   |   |                    |
|                       | 1.8 T quattro | 140 |             | 09.05 | 06.06 |                     |                |        |   |   |                    |
|                       | 1.8 T quattro | 165 |             | 10.98 | 06.06 |                     |                |        |   |   |                    |
|                       | 1.8 T quattro | 176 |             | 03.05 | 06.06 |                     |                |        |   |   |                    |
|                       | 3.2 quattro   | 184 |             | 04.03 | 06.06 |                     | 83.7769-0561.3 | 331105 | 2 |   | L=560              |



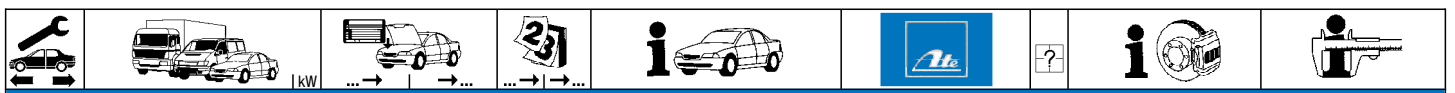



















### AUDI TT Coupe (98-06)



































|               |               |       |             |             |             |                |                |        |   |                       |                |     |
|---------------|---------------|-------|-------------|-------------|-------------|----------------|----------------|--------|---|-----------------------|----------------|-----|
|               | 1.8 T         | 110   | 8N-Y-011100 | 09.02       | PR: 1KK     | 24.3384-1723.7 | 220523         |        |   | D=38(M12x1), - Halter | LUC            |     |
|               | 1.8 T         | 120   | 8N-Y-011100 | 09.05       | PR: 1KK     | 24.3384-1724.7 | 220524         |        |   | D=38(M12x1), - Halter | LUC            |     |
|               | 1.8 T         | 132   | 8N-Y-011100 | 10.98       | PR: 1KK     |                |                |        |   |                       |                |     |
|               | 1.8 T         | 140   | 8N-Y-011100 | 09.05       | PR: 1KK     |                |                |        |   |                       |                |     |
|               | 1.8 T         | 110   | 8N-Y-011101 | 06.06       | PR: 1KK,2EK | 24.3384-1729.7 | 220541         |        |   | D=38(M12x1), - Halter | LUC            |     |
|               | 1.8 T         | 120   | 8N-Y-011101 | 06.06       | PR: 1KK,2EK | 24.3384-1730.7 | 220542         |        |   | D=38(M12x1), - Halter | LUC            |     |
|               | 1.8 T         | 132   | 8N-Y-011101 | 06.06       | PR: 1KK,2EK |                |                |        |   |                       |                |     |
|               | 1.8 T         | 140   | 8N-Y-011101 | 06.06       | PR: 1KK,2EK |                |                |        |   |                       |                |     |
|               | 1.8 T quattro | 132   |             | 10.98       | 06.06       | PR: 1KE        | 24.3414-1705.7 | 220549 |   |                       | D=41, - Halter | LUC |
|               | 1.8 T quattro | 140   |             | 09.05       | 06.06       | PR: 1KE        | 24.3414-1706.7 | 220550 |   |                       | D=41, - Halter | LUC |
| 1.8 T quattro | 165           |       | 10.98       | 06.06       | PR: 1KE     |                |                |        |   |                       |                |     |
| 1.8 T quattro | 176           |       | 03.05       | 06.06       | PR: 1KE     |                |                |        |   |                       |                |     |
| 3.2 quattro   | 184           |       | 04.03       | 06.06       | PR: 1KE     |                |                |        |   |                       |                |     |
| 1.8 T quattro | 132           |       | 10.98       | 06.06       | PR: 1KF     | 24.3384-1745.7 | 220609         |        |   | D=38, - Halter        | LUC            |     |
| 1.8 T quattro | 140           |       | 09.05       | 06.06       | PR: 1KF     | 24.3384-1746.7 | 220610         |        |   | D=38, - Halter        | LUC            |     |
| 1.8 T quattro | 165           |       | 10.98       | 06.06       | PR: 1KF     |                |                |        |   |                       |                |     |
| 1.8 T quattro | 176           |       | 03.05       | 06.06       | PR: 1KF     |                |                |        |   |                       |                |     |
| 3.2 quattro   | 184           |       | 04.03       | 06.06       | PR: 1KF     |                |                |        |   |                       |                |     |
|               | 1.8 T         | 110   |             | 09.02       | 06.06       | 83.7858-0140.3 | 330837         | 2      |   | L=140                 |                |     |
|               | 1.8 T         | 120   |             | 09.05       | 06.06       |                |                |        |   |                       |                |     |
|               | 1.8 T         | 132   |             | 10.98       | 06.06       |                |                |        |   |                       |                |     |
|               | 1.8 T         | 140   |             | 09.05       | 06.06       |                |                |        |   |                       |                |     |
|               | 1.8 T quattro | 132   |             | 10.98       | 06.06       | 83.7858-0140.3 | 330837         | 2      |   | L=140                 |                |     |
|               | 1.8 T quattro | 140   |             | 09.05       | 06.06       |                |                |        |   |                       |                |     |
|               | 1.8 T quattro | 165   |             | 10.98       | 06.06       |                |                |        |   |                       |                |     |
|               | 1.8 T quattro | 176   |             | 03.05       | 06.06       |                |                |        |   |                       |                |     |
|               | 3.2 quattro   | 184   |             | 04.03       | 06.06       |                |                |        |   |                       |                |     |
|               |               | 1.8 T | 132         | 8N-Y-011100 | 10.98       |                | 24.3727-0190.2 | 580190 | 2 |                       | L=1612         |     |
| 1.8 T         |               | 110   |             | 09.02       | 06.06       | 24.3727-0189.2 | 580189         | 2      |   | L=1617                |                |     |
| 1.8 T         |               | 120   |             | 09.05       | 06.06       |                |                |        |   |                       |                |     |
| 1.8 T         |               | 132   | 8N-Y-011101 |             | 06.06       |                |                |        |   |                       |                |     |
| 1.8 T         |               | 140   |             | 09.05       | 06.06       |                |                |        |   |                       |                |     |
|               | 1.8 T         | 110   |             | 09.02       | 06.06       | 24.2415-1701.3 | 030095         |        |   | Gz 15,87              |                |     |
|               | 1.8 T         | 120   |             | 09.05       | 06.06       |                |                |        |   |                       |                |     |
|               | 1.8 T         | 132   |             | 10.98       | 06.06       |                |                |        |   |                       |                |     |
|               | 1.8 T         | 140   |             | 09.05       | 06.06       |                |                |        |   |                       |                |     |
|               | 1.8 T quattro | 132   |             | 10.98       | 06.06       |                |                |        |   |                       |                |     |
|               | 1.8 T quattro | 140   |             | 09.05       | 06.06       |                |                |        |   |                       |                |     |
|               | 1.8 T quattro | 165   |             | 10.98       | 06.06       |                |                |        |   |                       |                |     |
|               | 1.8 T quattro | 176   |             | 03.05       | 06.06       |                |                |        |   |                       |                |     |
|               | 1.8 T         | 110   |             | 09.02       | 06.06       | 24.2415-1702.3 | 030096         |        |   | Gz 15,87              |                |     |
|               | 1.8 T         | 120   |             | 09.05       | 06.06       |                |                |        |   |                       |                |     |
| 1.8 T         | 132           |       | 10.98       | 06.06       |             |                |                |        |   |                       |                |     |
| 1.8 T         | 140           |       | 09.05       | 06.06       |             |                |                |        |   |                       |                |     |
| 1.8 T quattro | 132           |       | 10.98       | 06.06       |             |                |                |        |   |                       |                |     |
| 1.8 T quattro | 140           |       | 09.05       | 06.06       |             |                |                |        |   |                       |                |     |
| 1.8 T quattro | 165           |       | 10.98       | 06.06       |             |                |                |        |   |                       |                |     |
| 1.8 T quattro | 176           |       | 03.05       | 06.06       |             |                |                |        |   |                       |                |     |
|               | 1.8 T         | 132   |             | 10.98       | 08.02       | 24.2519-1701.3 | 040075         |        |   | Nz 19,05              |                |     |

### AUDI TT Roadster (99-06)

|               |               |             |             |       |       |                |        |  |  |           |     |
|---------------|---------------|-------------|-------------|-------|-------|----------------|--------|--|--|-----------|-----|
|               | 1.8 T         | 110         | 8N-2-014300 | 01.01 | + ESP | 03.7863-0402.4 | 300124 |  |  | 10"       | ATE |
|               | 1.8 T         | 132         | 8N-2-014300 | 04.99 | + ESP |                |        |  |  |           |     |
|               | 1.8 T quattro | 132         | 8N-2-014300 | 02.00 | + ESP |                |        |  |  |           |     |
|               | 1.8 T quattro | 165         | 8N-2-014300 | 10.99 | + ESP |                |        |  |  |           |     |
|               | 1.8 T         | 110         | 8N-2-014301 |       | 06.06 | 03.7860-0602.4 | 300141 |  |  | 10"       | ATE |
|               | 1.8 T         | 120         |             | 09.05 | 06.06 |                |        |  |  |           |     |
|               | 1.8 T         | 132         | 8N-2-014301 |       | 06.06 |                |        |  |  |           |     |
|               | 1.8 T         | 140         |             | 09.05 | 06.06 |                |        |  |  |           |     |
|               | 1.8 T quattro | 132         | 8N-2-014301 |       | 06.06 |                |        |  |  |           |     |
|               | 1.8 T quattro | 140         |             | 09.05 | 06.06 |                |        |  |  |           |     |
|               | 1.8 T quattro | 165         | 8N-2-014301 |       | 06.06 |                |        |  |  |           |     |
| 3.2 quattro   | 184           |             | 04.03       | 06.06 |       |                |        |  |  |           |     |
|               | 1.8 T         | 110         | 8N-2-014300 | 01.01 | - ESP | 24.2123-1709.3 | 010503 |  |  | Thz 23,81 |     |
|               | 1.8 T         | 132         | 8N-2-014300 | 04.99 | - ESP |                |        |  |  |           |     |
|               | 1.8 T quattro | 132         | 8N-2-014300 | 02.00 | - ESP |                |        |  |  |           |     |
|               | 1.8 T quattro | 165         | 8N-2-014300 | 10.99 | - ESP |                |        |  |  |           |     |
|               | 1.8 T         | 110         | 8N-2-014300 | 01.01 | + ESP | 03.2123-2024.3 | 010597 |  |  | Thz 23,81 | ATE |
|               | 1.8 T         | 132         | 8N-2-014300 | 04.99 | + ESP |                |        |  |  |           |     |
|               | 1.8 T quattro | 132         | 8N-2-014300 | 02.00 | + ESP |                |        |  |  |           |     |
|               | 1.8 T quattro | 165         | 8N-2-014300 | 10.99 | + ESP |                |        |  |  |           |     |
|               | 1.8 T         | 110         | 8N-2-014300 | 01.01 | + ESP | 03.2123-2064.3 | 010598 |  |  | Thz 23,81 | ATE |
|               | 1.8 T         | 132         | 8N-2-014300 | 04.99 | + ESP |                |        |  |  |           |     |
| 1.8 T quattro | 132           | 8N-2-014300 | 02.00       | + ESP |       |                |        |  |  |           |     |
| 1.8 T quattro | 165           | 8N-2-014300 | 10.99       | + ESP |       |                |        |  |  |           |     |
|               | 1.8 T         | 110         | 8N-2-014301 |       | 08.02 | 03.2123-2715.3 | 010802 |  |  | Thz 23,81 | ATE |
|               | 1.8 T         | 132         | 8N-2-014301 |       | 08.02 |                |        |  |  |           |     |
|               | 1.8 T quattro | 132         | 8N-2-014301 |       | 08.02 |                |        |  |  |           |     |
|               | 1.8 T quattro | 165         | 8N-2-014301 |       | 08.02 |                |        |  |  |           |     |
|               | 1.8 T         | 110         | 8N-2-014301 |       | 08.02 | 03.2123-2774.3 | 010803 |  |  | Thz 23,81 | ATE |
|               | 1.8 T         | 132         | 8N-2-014301 |       | 08.02 |                |        |  |  |           |     |
|               | 1.8 T quattro | 132         | 8N-2-014301 |       | 08.02 |                |        |  |  |           |     |



|     |  |  |  |  |  |  |  |  |                       |     |
|--|--|--|--|--|---|--|--|--|-----------------------|-----|
| <b>AUDI TT Roadster (99-06)</b>  |  |  |  |  |   |  |  |  |                       |     |
|    | 1.8 T quattro  | 165 8N-2-014301  |  | 08.02  |   | 03.2123-2774.3   | 010803   | THz 23,81  | ATE                   |     |
|  | 1.8 T  | 110  |  | 09.02  | 06.06   | 03.2123-2654.3   | 010801   | THz 23,81  | ATE                   |     |
|  | 1.8 T  | 120  |  | 09.05  | 06.06   |  |  |  |                       |     |
|  | 1.8 T  | 132  |  | 09.02  | 06.06   |  |  |  |                       |     |
|  | 1.8 T  | 140  |  | 09.05  | 06.06   |  |  |  |                       |     |
|  | 1.8 T quattro  | 132  |  | 09.02  | 06.06   |  |  |  |                       |     |
|  | 1.8 T quattro  | 140  |  | 09.05  | 06.06   |  |  |  |                       |     |
|  | 1.8 T quattro  | 165  |  | 09.02  | 06.06   |  |  |  |                       |     |
|  | 3.2 quattro  | 184  |  | 04.03  | 06.06   |  |  |  |                       |     |
|    | 1.8 T  | 110  |  | 01.01  | 06.06   | PR: 1LD,1LT,1LV  | 11.9541-9595.2   | 220501   | D=54, - Halter        | ATE |
|  | 1.8 T  | 120  |  | 09.05  | 06.06   | PR: 1LD,1LT,1LV  | 11.9541-9596.2   | 220502   | D=54, - Halter        | ATE |
|  | 1.8 T  | 132  |  | 04.99  | 06.06   | PR: 1LD,1LT,1LV  | 11.0101-5409.2   | 260035   | Hülsensatz            | ATE |
|  | 1.8 T  | 140  |  | 09.05  | 06.06   | PR: 1LD,1LT,1LV  | 11.8171-0008.1   | 990049   | Führungsbolzen        | ATE |
|  | 1.8 T quattro  | 132  |  | 02.00  | 06.06   | PR: 1LD,1LT,1LV  | 11.8116-0143.1   | 390513   | Haltefeder            | ATE |
|  | 1.8 T quattro  | 140  |  | 09.05  | 06.06   | PR: 1LD,1LT,1LV  |  |  |                       |     |
|  | 1.8 T quattro  | 165  |  | 10.99  | 06.06   | PR: 1LD,1LT,1LV  |  |  |                       |     |
|  | 3.2 quattro  | 184  |  | 04.03  | 06.06   |  | 11.9421-9915.2   | 220869   | D=42, - Halter        | ATE |
|  |  |  |  |  |   |  | 11.9421-9916.2   | 220870   | D=42, - Halter        | ATE |
|  |  |  |  |  |   |  | 11.8171-0008.1   | 990049   | Führungsbolzen        | ATE |
|    | 1.8 T  | 110  |  | 01.01  | 06.06   |  | 83.6252-0560.3   | 330557   | L=560                 |     |
|  | 1.8 T  | 120  |  | 09.05  | 06.06   |  |  |  |                       |     |
|  | 1.8 T  | 132  |  | 04.99  | 06.06   |  |  |  |                       |     |
|  | 1.8 T  | 140  |  | 09.05  | 06.06   |  |  |  |                       |     |
|  | 1.8 T quattro  | 132  |  | 02.00  | 06.06   |  |  |  |                       |     |
|  | 1.8 T quattro  | 140  |  | 09.05  | 06.06   |  |  |  |                       |     |
|  | 1.8 T quattro  | 165  |  | 10.99  | 06.06   |  |  |  |                       |     |
|  | 3.2 quattro  | 184  |  | 04.03  | 06.06   |  | 83.7769-0561.3   | 331105   | L=560                 |     |
|    | 1.8 T  | 110  | 8N-Y-011100  | 01.01  | 06.06   | PR: 1KK  | 24.3384-1723.7   | 220523   | D=38(M12x1), - Halter | LUC |
|  | 1.8 T  | 120  | 8N-Y-011100  | 09.05  | 06.06   | PR: 1KK  | 24.3384-1724.7   | 220524   | D=38(M12x1), - Halter | LUC |
|  | 1.8 T  | 132  | 8N-Y-011100  | 04.99  | 06.06   | PR: 1KK  |  |  |                       |     |
|  | 1.8 T  | 140  | 8N-Y-011100  | 09.05  | 06.06   | PR: 1KK  |  |  |                       |     |
|  | 1.8 T  | 110  | 8N-Y-011101  | 06.06  | 06.06   | PR: 1KK,2EK  | 24.3384-1729.7   | 220541   | D=38(M12x1), - Halter | LUC |
|  | 1.8 T  | 120  | 8N-Y-011101  | 06.06  | 06.06   | PR: 1KK,2EK  | 24.3384-1730.7   | 220542   | D=38(M12x1), - Halter | LUC |
|  | 1.8 T  | 132  | 8N-Y-011101  | 06.06  | 06.06   | PR: 1KK,2EK  |  |  |                       |     |
|  | 1.8 T  | 140  | 8N-Y-011101  | 06.06  | 06.06   | PR: 1KK,2EK  |  |  |                       |     |
|  | 1.8 T quattro  | 132  |  | 02.00  | 06.06   | PR: 1KE  | 24.3414-1705.7   | 220549   | D=41, - Halter        | LUC |
|  | 1.8 T quattro  | 140  |  | 09.05  | 06.06   | PR: 1KE  | 24.3414-1706.7   | 220550   | D=41, - Halter        | LUC |
|  | 1.8 T quattro  | 165  |  | 10.99  | 06.06   | PR: 1KE  |  |  |                       |     |
|  | 3.2 quattro  | 184  |  | 04.03  | 06.06   | PR: 1KE  |  |  |                       |     |
|  | 1.8 T quattro  | 132  |  | 02.00  | 06.06   | PR: 1KF  | 24.3384-1745.7   | 220609   | D=38, - Halter        | LUC |
|  | 1.8 T quattro  | 140  |  | 09.05  | 06.06   | PR: 1KF  | 24.3384-1746.7   | 220610   | D=38, - Halter        | LUC |
|  | 1.8 T quattro  | 165  |  | 10.99  | 06.06   | PR: 1KF  |  |  |                       |     |
|  | 3.2 quattro  | 184  |  | 04.03  | 06.06   | PR: 1KF  |  |  |                       |     |
|  | 1.8 T  | 110  |  | 01.01  | 06.06   |  | 83.7858-0140.3   | 330837   | L=140                 |     |
|  | 1.8 T  | 120  |  | 09.05  | 06.06   |  |  |  |                       |     |
|  | 1.8 T  | 132  |  | 04.99  | 06.06   |  |  |  |                       |     |
|  | 1.8 T  | 140  |  | 09.05  | 06.06   |  |  |  |                       |     |
|  | 1.8 T quattro  | 132  |  | 02.00  | 06.06   |  | 83.7858-0140.3   | 330837   | L=140                 |     |
|  | 1.8 T quattro  | 140  |  | 09.05  | 06.06   |  |  |  |                       |     |
|  | 1.8 T quattro  | 165  |  | 10.99  | 06.06   |  |  |  |                       |     |
|  | 3.2 quattro  | 184  |  | 04.03  | 06.06   |  |  |  |                       |     |
|  | 1.8 T  | 132  | 8N-Y-011100  | 04.99  | 06.06   |  | 24.3727-0190.2   | 580190   | L=1612                |     |
|  | 1.8 T  | 110  |  | 01.01  | 06.06   |  | 24.3727-0189.2   | 580189   | L=1617                |     |
|  | 1.8 T  | 120  |  | 09.05  | 06.06   |  |  |  |                       |     |
|  | 1.8 T  | 132  | 8N-Y-011101  | 06.06  | 06.06   |  |  |  |                       |     |
|  | 1.8 T  | 140  |  | 09.05  | 06.06   |  |  |  |                       |     |
|  | 1.8 T  | 110  |  | 01.01  | 06.06   |  | 24.2415-1701.3   | 030095   | Gz 15,87              |     |
|  | 1.8 T  | 120  |  | 09.05  | 06.06   |  |  |  |                       |     |
|  | 1.8 T  | 132  |  | 04.99  | 06.06   |  |  |  |                       |     |
|  | 1.8 T  | 140  |  | 09.05  | 06.06   |  |  |  |                       |     |
|  | 1.8 T quattro  | 132  |  | 02.00  | 06.06   |  |  |  |                       |     |
|  | 1.8 T quattro  | 140  |  | 09.05  | 06.06   |  |  |  |                       |     |
|  | 1.8 T quattro  | 165  |  | 10.99  | 06.06   |  |  |  |                       |     |
|  | 1.8 T  | 110  |  | 01.01  | 06.06   |  | 24.2415-1702.3   | 030096   | Gz 15,87              |     |
|  | 1.8 T  | 120  |  | 09.05  | 06.06   |  |  |  |                       |     |
|  | 1.8 T  | 132  |  | 04.99  | 06.06   |  |  |  |                       |     |
|  | 1.8 T  | 140  |  | 09.05  | 06.06   |  |  |  |                       |     |
|  | 1.8 T quattro  | 132  |  | 02.00  | 06.06   |  |  |  |                       |     |
|  | 1.8 T quattro  | 140  |  | 09.05  | 06.06   |  |  |  |                       |     |
|  | 1.8 T quattro  | 165  |  | 10.99  | 06.06   |  |  |  |                       |     |
|  | 1.8 T  | 110  |  | 01.01  | 12.02   |  | 24.2519-1701.3   | 040075   | Nz 19,05              |     |
|  | 1.8 T  | 132  |  | 04.99  | 12.02   |  |  |  |                       |     |
| <b>AUDI TT Coupe (06-)</b>   |  |  |  |  |   |  |  |  |                       |     |
|  | 1.8 TFSI   | 118  |  | 06.08  |   |  | 03.7860-4203.4   | 300243   | 10"                   | ATE |
|  | 2.0 quattro  | 195  |  | 05.08  |   |  |  |  |                       |     |
|  | 2.0 TDI quattro  | 125  |  | 06.08  |   |  |  |  |                       |     |
|  | 2.0 TFSI   | 147  |  | 07.06  |   |  |  |  |                       |     |
|  | 2.0 TFSI   | 155  |  | 05.10  |   |  |  |  |                       |     |
|  | 2.0 TFSI quattro   | 147  |  | 05.08  |   |  |  |  |                       |     |
|  | 2.0 TFSI quattro   | 155  |  | 05.10  |   |  |  |  |                       |     |

|     |  |  |  |  |  |  |     |  |     |
|--|--|--|--|--|---|--|---|--|-----|
| <b>AUDI TT Coupe (06-)</b>   |  |  |  |  |   |  |   |  |     |
|    | 1.8 TFSI   | 118  | 06.08  |  | 03.2123-3549.3  | 010809   |   | ThZ 23,81  | ATE |
|  | 2.0 quattro  | 195  | 05.08  |  |   |  |   |  |     |
|  | 2.0 TDI quattro  | 125  | 06.08  |  |   |  |   |  |     |
|  | 2.0 TFSI   | 147  | 07.06  |  |   |  |   |  |     |
|  | 2.0 TFSI   | 155  | 05.10  |  |   |  |   |  |     |
|  | 2.0 TFSI quattro   | 147  | 05.08  |  |   |  |   |  |     |
|  | 2.0 TFSI quattro   | 155  | 05.10  |  |   |  |   |  |     |
|    | 1.8 TFSI   | 118  | 06.08  | PR: 1LJ  | 11.9541-9553.2  | 220563   |    | D=54, - Halter   | ATE |
|  | 2.0 quattro  | 195  | 05.08  | PR: 1LJ  | 11.9541-9554.2  | 220564   |    | D=54, - Halter   | ATE |
|  | 2.0 TDI quattro  | 125  | 06.08  | PR: 1LJ  | 11.0101-5409.2  | 260035   |   | Hülzensatz   | ATE |
|  | 2.0 TFSI   | 147  | 07.06  | PR: 1LJ  | 11.8171-0008.1  | 990049   |   | Führungsbolzen   | ATE |
|  | 2.0 TFSI   | 155  | 05.10  | PR: 1LJ  | 11.8116-0351.1  | 390538   | 2   | Haltefeder   | ATE |
|  | 2.0 TFSI quattro   | 147  | 05.08  | PR: 1LJ  |   |  |   |  |     |
|  | 2.0 TFSI quattro   | 155  | 05.10  | PR: 1LJ  |   |  |   |  |     |
|  | 3.2 quattro  | 184  | 07.06  | PR: 1LJ  |   |  |   |  |     |
|  | 1.8 TFSI   | 118  | 06.08  | PR: 1LL  | 11.9541-9553.2  | 220563   |    | D=54, - Halter   | ATE |
|  | 2.0 quattro  | 195  | 05.08  | PR: 1LL  | 11.9541-9554.2  | 220564   |    | D=54, - Halter   | ATE |
|  | 2.0 TDI quattro  | 125  | 06.08  | PR: 1LL  | 11.0101-5409.2  | 260035   |   | Hülzensatz   | ATE |
|  | 2.0 TFSI   | 147  | 07.06  | PR: 1LL  | 11.8171-0008.1  | 990049   |   | Führungsbolzen   | ATE |
|  | 2.0 TFSI   | 155  | 05.10  | PR: 1LL  | 11.8116-0351.1  | 390538   | 2   | Haltefeder   | ATE |
|  | 2.0 TFSI quattro   | 147  | 05.08  | PR: 1LL  |   |  |   |  |     |
|  | 2.0 TFSI quattro   | 155  | 05.10  | PR: 1LL  |   |  |   |  |     |
|  | 3.2 quattro  | 184  | 07.06  | PR: 1LL  |   |  |   |  |     |
|  | 1.8 TFSI   | 118  | 06.08  | PR: 1LK  | 11.9576-9947.2  | 220809   |    | D=57, - Halter   | ATE |
|  | 2.0 quattro  | 195  | 05.08  | PR: 1LK  | 11.9576-9948.2  | 220810   |    | D=57, - Halter   | ATE |
|  | 2.0 TDI quattro  | 125  | 06.08  | PR: 1LK  | 11.0101-5409.2  | 260035   |   | Hülzensatz   | ATE |
|  | 2.0 TFSI   | 147  | 07.06  | PR: 1LK,1LM  | 11.8171-0008.1  | 990049   |   | Führungsbolzen   | ATE |
|  | 2.0 TFSI quattro   | 147  | 05.08  | PR: 1LK  | 11.8116-0410.2  | 390589   | 2   | Haltefeder   | ATE |
|  | 3.2 quattro  | 184  | 07.06  | PR: 1LK,1LM  |   |  |   |  |     |
|  | 1.8 TFSI   | 118  | 06.08  | PR: 1LM  | 11.9576-9947.2  | 220809   |    | D=57, - Halter   | ATE |
|  | 2.0 quattro  | 195  | 05.08  | PR: 1LM  | 11.9576-9948.2  | 220810   |    | D=57, - Halter   | ATE |
|  | 2.0 TDI quattro  | 125  | 06.08  | PR: 1LM  | 11.0101-5409.2  | 260035   |   | Hülzensatz   | ATE |
|  | 2.0 TFSI   | 147  | 07.06  | PR: 1LM  | 11.8171-0008.1  | 990049   |   | Führungsbolzen   | ATE |
|  | 2.0 TFSI   | 155  | 05.10  | PR: 1LM  | 11.8116-0410.2  | 390589   | 2   | Haltefeder   | ATE |
|  | 2.0 TFSI quattro   | 147  | 05.08  | PR: 1LM  |   |  |   |  |     |
|  | 2.0 TFSI quattro   | 155  | 05.10  | PR: 1LM  |   |  |   |  |     |
|  | 3.2 quattro  | 184  | 07.06  | PR: 1LM  |   |  |   |  |     |
|  | TTS 2.0 TFSI   | 200  | 05.08  | PR: 1LN  | 11.9576-9947.2  | 220809   |    | D=57, - Halter   | ATE |
|  |  |  |  |  | 11.9576-9948.2  | 220810   |   | D=57, - Halter   | ATE |
|  |  |  |  |  | 11.0101-5409.2  | 260035   |   | Hülzensatz   | ATE |
|  |  |  |  |  | 11.8171-0008.1  | 990049   |   | Führungsbolzen   | ATE |
|  | 1.8 TFSI   | 118  | 06.08  | PR: 1LJ,1LL  | 83.7847-0620.3  | 331110   | 2   | L=620  |     |
|  | 2.0 quattro  | 195  | 05.08  | PR: 1LJ,1LL  |   |  |   |  |     |
|  | 2.0 TDI quattro  | 125  | 06.08  | PR: 1LJ,1LL  |   |  |   |  |     |
|  | 2.0 TFSI   | 147  | 07.06  | PR: 1LJ,1LL  |   |  |   |  |     |
|  | 2.0 TFSI   | 155  | 05.10  | PR: 1LJ,1LL  |   |  |   |  |     |
|  | 2.0 TFSI quattro   | 147  | 05.08  | PR: 1LJ,1LL  |   |  |   |  |     |
|  | 2.0 TFSI quattro   | 155  | 05.10  | PR: 1LJ,1LL  |   |  |   |  |     |
|  | 3.2 quattro  | 184  | 07.06  | PR: 1LJ,1LL  |   |  |   |  |     |
|  | TTS 2.0 TFSI   | 200  | 05.08  | PR: 1LJ,1LL  |   |  |   |  |     |
|  | 1.8 TFSI   | 118  | 06.08  | PR: 1LK,1LM  | 83.7849-0554.3  | 331112   | 2   | L=554  |     |
|  | 2.0 quattro  | 195  | 05.08  | PR: 1LK,1LM  |   |  |   |  |     |
|  | 2.0 TDI quattro  | 125  | 06.08  | PR: 1LK,1LM  |   |  |   |  |     |
|  | 2.0 TFSI   | 147  | 07.06  | PR: 1LK,1LM  |   |  |   |  |     |
|  | 2.0 TFSI   | 155  | 05.10  | PR: 1LK,1LM  |   |  |   |  |     |
|  | 2.0 TFSI quattro   | 147  | 05.08  | PR: 1LK,1LM  |   |  |   |  |     |
|  | 2.0 TFSI quattro   | 155  | 05.10  | PR: 1LK,1LM  |   |  |   |  |     |
|  | 3.2 quattro  | 184  | 07.06  | PR: 1LK,1LM  |   |  |   |  |     |
|  | TTS 2.0 TFSI   | 200  | 05.08  | PR: 1LK,1LM  |   |  |   |  |     |
|  | 1.8 TFSI   | 118  | 06.08  | PR: 1KZ  | 24.3387-1717.7  | 220757   |  | D=38, - Halter   | LUC |
|  | 2.0 TFSI   | 147  | 07.06  | PR: 1KZ  | 24.3387-1718.7  | 220758   |  | D=38, - Halter   | LUC |
|  | 2.0 TFSI   | 155  | 05.10  | PR: 1KZ  | 24.0101-3803.2  | 260101   |   | Einbausatz   | LUC |
|  | 1.8 TFSI   | 118  | 06.08  | PR: 2ED  | 24.3387-1717.7  | 220757   |  | D=38, - Halter   | LUC |
|  | 2.0 TFSI   | 147  | 07.06  | PR: 2ED  | 24.3387-1718.7  | 220758   |  | D=38, - Halter   | LUC |
|  | 2.0 TFSI   | 155  | 05.10  | PR: 2ED  | 24.0101-3803.2  | 260101   |   | Einbausatz   | LUC |
|  | 2.0 quattro  | 195  | 05.08  | PR: 1KJ  | 24.3414-1709.7  | 220631   |  | D=41, - Halter   | LUC |
|  | 2.0 TDI quattro  | 125  | 06.08  | PR: 1KJ  | 24.3414-1710.7  | 220632   |  | D=41, - Halter   | LUC |
|  | 2.0 TFSI quattro   | 147  | 05.08  | PR: 1KJ  |   |  |   |  |     |
|  | 2.0 TFSI quattro   | 155  | 05.10  | PR: 1KJ  |   |  |   |  |     |
|  | 3.2 quattro  | 184  | 07.06  | PR: 1KJ  |   |  |   |  |     |
|  | 2.0 quattro  | 195  | 05.08  | PR: 2EA  | 24.3417-1711.7  | 220883   |  | D=41, - Halter   | LUC |
|  | 2.0 TDI quattro  | 125  | 06.08  | PR: 2EA  | 24.3417-1712.7  | 220884   |  | D=41, - Halter   | LUC |
|  | 2.0 TFSI quattro   | 147  | 05.08  | PR: 2EA  |   |  |   |  |     |
|  | 3.2 quattro  | 184  | 07.06  | PR: 2EA  |   |  |   |  |     |
|  | 2.0 quattro  | 195  | 05.08  | PR: 2EF  | 24.3417-1711.7  | 220883   |  | D=41, - Halter   | LUC |
|  | 2.0 TDI quattro  | 125  | 06.08  | PR: 2EF  | 24.3417-1712.7  | 220884   |  | D=41, - Halter   | LUC |
|  | 2.0 TFSI quattro   | 147  | 05.08  | PR: 2EF  |   |  |   |  |     |
|  | 3.2 quattro  | 184  | 07.06  | PR: 2EF  |   |  |   |  |     |
|  | 1.8 TFSI   | 118  | 06.08  |  | 83.7849-0250.3  | 331111   | 2   | L=250  |     |
|  | 2.0 quattro  | 195  | 05.08  |  |   |  |   |  |     |
|  | 2.0 TDI quattro  | 125  | 06.08  |  |   |  |   |  |     |
|  | 2.0 TFSI   | 147  | 07.06  |  |   |  |   |  |     |
|  | 2.0 TFSI   | 155  | 05.10  |  |   |  |   |  |     |
|  | 2.0 TFSI quattro   | 147  | 05.08  |  |   |  |   |  |     |
|  | 2.0 TFSI quattro   | 155  | 05.10  |  |   |  |   |  |     |
|  | 3.2 quattro  | 184  | 07.06  |  |   |  |   |  |     |



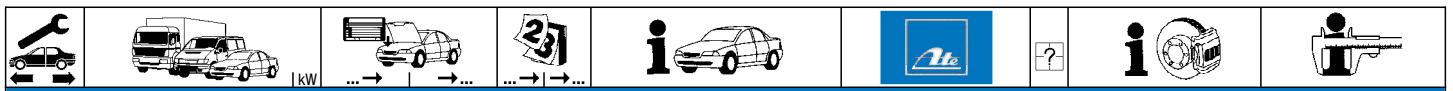

| AUDI TT Coupe (06-) |                  |     |       |  |                |        |   |         |                    |
|---------------------|------------------|-----|-------|--|----------------|--------|---|---------|--------------------|
|                     | RS 2.5 TFSI      | 250 | 05.09 |  | 83.7849-0250.3 | 331111 | 2 |         | L=250              |
|                     | RS 2.5 TFSI plus | 265 | 05.11 |  |                |        |   |         |                    |
|                     | TTS 2.0 TFSI     | 200 | 05.08 |  |                |        |   |         |                    |
|                     | 1.8 TFSI         | 118 | 06.08 |  | 24.2415-1711.3 | 030130 |   |         | Gz 15,87           |
|                     | 2.0 quattro      | 195 | 05.08 |  | 24.2415-1713.3 | 030132 |   |         | Gz 15,87, + Sensor |
|                     | 2.0 TDI quattro  | 125 | 06.08 |  |                |        |   |         |                    |
|                     | 2.0 TFSI         | 147 | 07.06 |  |                |        |   |         |                    |
|                     | 2.0 TFSI         | 155 | 05.10 |  |                |        |   |         |                    |
|                     | 2.0 TFSI quattro | 147 | 05.08 |  |                |        |   |         |                    |
|                     | 2.0 TFSI quattro | 155 | 05.10 |  |                |        |   |         |                    |
|                     | 3.2 quattro      | 184 | 07.06 |  |                |        |   |         |                    |
|                     | RS 2.5 TFSI      | 250 | 05.09 |  |                |        |   |         |                    |
|                     | RS 2.5 TFSI plus | 265 | 05.11 |  |                |        |   |         |                    |
|                     | TTS 2.0 TFSI     | 200 | 05.08 |  |                |        |   |         |                    |
|                     | 1.8 TFSI         | 118 | 06.08 |  | 24.2519-1705.3 | 040095 |   | PR: 0EJ | Nz 19,05           |
|                     | 2.0 quattro      | 195 | 05.08 |  |                |        |   |         |                    |
|                     | 2.0 TDI quattro  | 125 | 06.08 |  |                |        |   |         |                    |
|                     | 2.0 TFSI         | 147 | 07.06 |  |                |        |   |         |                    |
|                     | 2.0 TFSI         | 155 | 05.10 |  |                |        |   |         |                    |
|                     | 2.0 TFSI quattro | 147 | 05.08 |  |                |        |   |         |                    |
|                     | 2.0 TFSI quattro | 155 | 05.10 |  |                |        |   |         |                    |
|                     | 3.2 quattro      | 184 | 07.06 |  |                |        |   |         |                    |
|                     | TTS 2.0 TFSI     | 200 | 05.08 |  |                |        |   |         |                    |

| AUDI TT Roadster (07-) |                  |     |       |             |                |        |   |  |                    |
|------------------------|------------------|-----|-------|-------------|----------------|--------|---|--|--------------------|
|                        | 1.8 TFSI         | 118 | 06.08 |             | 03.7860-4203.4 | 300243 |   |  | 10" ATE            |
|                        | 2.0 quattro      | 195 | 05.08 |             |                |        |   |  |                    |
|                        | 2.0 TDI quattro  | 125 | 06.08 |             |                |        |   |  |                    |
|                        | 2.0 TFSI         | 147 | 02.07 |             |                |        |   |  |                    |
|                        | 2.0 TFSI         | 155 | 05.10 |             |                |        |   |  |                    |
|                        | 2.0 TFSI quattro | 147 | 05.08 |             |                |        |   |  |                    |
|                        | 2.0 TFSI quattro | 155 | 05.10 |             |                |        |   |  |                    |
|                        | 1.8 TFSI         | 118 | 06.08 |             | 03.2123-3549.3 | 010809 |   |  | THz 23,81 ATE      |
|                        | 2.0 quattro      | 195 | 05.08 |             |                |        |   |  |                    |
|                        | 2.0 TDI quattro  | 125 | 06.08 |             |                |        |   |  |                    |
|                        | 2.0 TFSI         | 147 | 02.07 |             |                |        |   |  |                    |
|                        | 2.0 TFSI quattro | 147 | 05.08 |             |                |        |   |  |                    |
|                        | 2.0 TFSI quattro | 155 | 05.10 |             |                |        |   |  |                    |
|                        | 3.2 quattro      | 184 | 02.07 |             |                |        |   |  |                    |
|                        | 1.8 TFSI         | 118 | 06.08 | PR: 1LJ     | 11.9541-9553.2 | 220563 | 2 |  | D=54, - Halter ATE |
|                        | 2.0 quattro      | 195 | 05.08 | PR: 1LJ     | 11.9541-9554.2 | 220564 |   |  | D=54, - Halter ATE |
|                        | 2.0 TDI quattro  | 125 | 06.08 | PR: 1LJ     | 11.0101-5409.2 | 260035 |   |  | Hülsensatz ATE     |
|                        | 2.0 TFSI         | 147 | 02.07 | PR: 1LJ     | 11.8171-0008.1 | 990049 |   |  | Führungsbolzen ATE |
|                        | 2.0 TFSI         | 155 | 05.10 | PR: 1LJ     | 11.8116-0351.1 | 390538 |   |  | Haltefeder ATE     |
|                        | 2.0 TFSI quattro | 147 | 05.08 | PR: 1LJ     |                |        |   |  |                    |
|                        | 2.0 TFSI quattro | 155 | 05.10 | PR: 1LJ     |                |        |   |  |                    |
|                        | 3.2 quattro      | 184 | 02.07 | PR: 1LJ     |                |        |   |  |                    |
|                        | 1.8 TFSI         | 118 | 06.08 | PR: 1LL     | 11.9541-9553.2 | 220563 | 2 |  | D=54, - Halter ATE |
|                        | 2.0 quattro      | 195 | 05.08 | PR: 1LL     | 11.9541-9554.2 | 220564 |   |  | D=54, - Halter ATE |
|                        | 2.0 TDI quattro  | 125 | 06.08 | PR: 1LL     | 11.0101-5409.2 | 260035 |   |  | Hülsensatz ATE     |
|                        | 2.0 TFSI         | 147 | 02.07 | PR: 1LL     | 11.8171-0008.1 | 990049 |   |  | Führungsbolzen ATE |
|                        | 2.0 TFSI         | 155 | 05.10 | PR: 1LL     | 11.8116-0351.1 | 390538 |   |  | Haltefeder ATE     |
|                        | 2.0 TFSI quattro | 147 | 05.08 | PR: 1LL     |                |        |   |  |                    |
|                        | 2.0 TFSI quattro | 155 | 05.10 | PR: 1LL     |                |        |   |  |                    |
|                        | 3.2 quattro      | 184 | 02.07 | PR: 1LL     |                |        |   |  |                    |
|                        | 1.8 TFSI         | 118 | 06.08 | PR: 1LK     | 11.9576-9947.2 | 220809 | 2 |  | D=57, - Halter ATE |
|                        | 2.0 quattro      | 195 | 05.08 | PR: 1LK     | 11.9576-9948.2 | 220810 |   |  | D=57, - Halter ATE |
|                        | 2.0 TDI quattro  | 125 | 06.08 | PR: 1LK     | 11.0101-5409.2 | 260035 |   |  | Hülsensatz ATE     |
|                        | 2.0 TFSI         | 147 | 02.07 | PR: 1LK,1LM | 11.8171-0008.1 | 990049 |   |  | Führungsbolzen ATE |
|                        | 2.0 TFSI quattro | 147 | 05.08 | PR: 1LK     | 11.8116-0410.2 | 390589 |   |  | Haltefeder ATE     |
|                        | 3.2 quattro      | 184 | 02.07 | PR: 1LK,1LM |                |        |   |  |                    |
|                        | 1.8 TFSI         | 118 | 06.08 | PR: 1LM     | 11.9576-9947.2 | 220809 | 2 |  | D=57, - Halter ATE |
|                        | 2.0 quattro      | 195 | 05.08 | PR: 1LM     | 11.9576-9948.2 | 220810 |   |  | D=57, - Halter ATE |
|                        | 2.0 TDI quattro  | 125 | 06.08 | PR: 1LM     | 11.0101-5409.2 | 260035 |   |  | Hülsensatz ATE     |
|                        | 2.0 TFSI         | 147 | 02.07 | PR: 1LM     | 11.8171-0008.1 | 990049 |   |  | Führungsbolzen ATE |
|                        | 2.0 TFSI         | 155 | 05.10 | PR: 1LM     | 11.8116-0410.2 | 390589 |   |  | Haltefeder ATE     |
|                        | 2.0 TFSI quattro | 147 | 05.08 | PR: 1LM     |                |        |   |  |                    |
|                        | 2.0 TFSI quattro | 155 | 05.10 | PR: 1LM     |                |        |   |  |                    |
|                        | TTS 2.0 TFSI     | 200 | 02.07 | PR: 1LM     |                |        |   |  |                    |
|                        | TTS 2.0 TFSI     | 200 | 05.08 | PR: 1LN     | 11.9576-9947.2 | 220809 | 2 |  | D=57, - Halter ATE |
|                        |                  |     |       |             | 11.9576-9948.2 | 220810 |   |  | D=57, - Halter ATE |
|                        |                  |     |       |             | 11.0101-5409.2 | 260035 |   |  | Hülsensatz ATE     |
|                        |                  |     |       |             | 11.8171-0008.1 | 990049 |   |  | Führungsbolzen ATE |
|                        | 1.8 TFSI         | 118 | 06.08 | PR: 1LJ,1LL | 83.7847-0620.3 | 331110 | 2 |  | L=620              |
|                        | 2.0 quattro      | 195 | 05.08 | PR: 1LJ,1LL |                |        |   |  |                    |
|                        | 2.0 TDI quattro  | 125 | 06.08 | PR: 1LJ,1LL |                |        |   |  |                    |
|                        | 2.0 TFSI         | 147 | 02.07 | PR: 1LJ,1LL |                |        |   |  |                    |
|                        | 2.0 TFSI         | 155 | 05.10 | PR: 1LJ,1LL |                |        |   |  |                    |
|                        | 2.0 TFSI quattro | 147 | 05.08 | PR: 1LJ,1LL |                |        |   |  |                    |
|                        | 2.0 TFSI quattro | 155 | 05.10 | PR: 1LJ,1LL |                |        |   |  |                    |
|                        | 3.2 quattro      | 184 | 02.07 | PR: 1LJ,1LL |                |        |   |  |                    |
|                        | TTS 2.0 TFSI     | 200 | 05.08 | PR: 1LJ,1LL |                |        |   |  |                    |
|                        | 1.8 TFSI         | 118 | 06.08 | PR: 1LK,1LM | 83.7849-0554.3 | 331112 | 2 |  | L=554              |
|                        | 2.0 quattro      | 195 | 05.08 | PR: 1LK,1LM |                |        |   |  |                    |
|                        | 2.0 TDI quattro  | 125 | 06.08 | PR: 1LK,1LM |                |        |   |  |                    |
|                        | 2.0 TFSI         | 147 | 02.07 | PR: 1LK,1LM |                |        |   |  |                    |
|                        | 2.0 TFSI         | 155 | 05.10 | PR: 1LK,1LM |                |        |   |  |                    |
|                        | 2.0 TFSI quattro | 147 | 05.08 | PR: 1LK,1LM |                |        |   |  |                    |



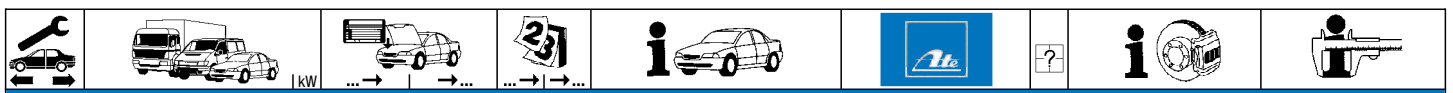

| AUDI TT Roadster (07-) |  |   |  |   |   |  |                            |   |         |  |                   |
|------------------------|--|---|--|---|---|--|----------------------------|---|---------|--|-------------------|
|                        | 2.0 TFSI quattro<br>3.2 quattro<br>TTS 2.0 TFSI  | 155<br>184<br>200   |  | 05.10<br>02.07<br>05.08   | PR: 1LK,1LM<br>PR: 1LK,1LM<br>PR: 1LK,1LM           | 83.7849-0554.3                                     | 331112                     | 2 |         | L=554  |                   |
|                        | 1.8 TFSI<br>2.0 TFSI<br>2.0 TFSI   | 118<br>147<br>155   |  | 06.08<br>02.07<br>05.10   | PR: 1KZ<br>PR: 1KZ<br>PR: 1KZ                       | 24.3387-1717.7<br>24.3387-1718.7<br>24.0101-3803.2 | 220757<br>220758<br>260101 |   |         | D=38, - Halter<br>D=38, - Halter<br>Einbausatz | LUC<br>LUC<br>LUC |
|                        | 1.8 TFSI<br>2.0 TFSI<br>2.0 TFSI   | 118<br>147<br>155   |  | 06.08<br>02.07<br>05.10   | PR: 2ED<br>PR: 2ED<br>PR: 2ED                       | 24.3387-1717.7<br>24.3387-1718.7<br>24.0101-3803.2 | 220757<br>220758<br>260101 |   |         | D=38, - Halter<br>D=38, - Halter<br>Einbausatz | LUC<br>LUC<br>LUC |
|                        | 2.0 quattro<br>2.0 TDI quattro<br>2.0 TFSI quattro<br>2.0 TFSI quattro<br>3.2 quattro  | 195<br>125<br>147<br>155<br>184   |  | 05.08<br>06.08<br>05.05<br>05.10<br>02.07   | PR: 1KJ<br>PR: 1KJ<br>PR: 1KJ<br>PR: 1KJ<br>PR: 1KJ | 24.3414-1709.7<br>24.3414-1710.7                   | 220631<br>220632           |   |         | D=41, - Halter<br>D=41, - Halter               | LUC<br>LUC        |
|                        | 2.0 quattro<br>2.0 TDI quattro<br>2.0 TFSI quattro<br>3.2 quattro  | 195<br>125<br>147<br>184  |  | 05.08<br>06.08<br>05.08<br>02.07  | PR: 2EA<br>PR: 2EA<br>PR: 2EA<br>PR: 2EA            | 24.3417-1711.7<br>24.3417-1712.7                   | 220883<br>220884           |   |         | D=41, - Halter<br>D=41, - Halter               | LUC<br>LUC        |
|                        | 2.0 quattro<br>2.0 TDI quattro<br>2.0 TFSI quattro<br>3.2 quattro<br>RS 2.5 TFSI   | 195<br>125<br>147<br>184<br>250   |  | 05.08<br>06.08<br>05.08<br>02.07<br>05.09   | PR: 2EF<br>PR: 2EF<br>PR: 2EF<br>PR: 2EF<br>PR: 2EF | 24.3417-1711.7<br>24.3417-1712.7                   | 220883<br>220884           |   |         | D=41, - Halter<br>D=41, - Halter               | LUC<br>LUC        |
|                        | 1.8 TFSI<br>2.0 quattro<br>2.0 TDI quattro<br>2.0 TFSI<br>2.0 TFSI<br>2.0 TFSI quattro<br>2.0 TFSI quattro<br>3.2 quattro<br>RS 2.5 TFSI<br>RS 2.5 TFSI plus<br>TTS 2.0 TFSI | 118<br>195<br>125<br>147<br>155<br>147<br>155<br>184<br>250<br>265<br>200 |  | 06.08<br>05.08<br>06.08<br>02.07<br>05.10<br>05.08<br>05.10<br>02.07<br>05.09<br>02.12<br>05.08 |   | 83.7849-0250.3                                     | 331111                     | 2 |         | L=250  |                   |
|                        | 1.8 TFSI<br>2.0 quattro<br>2.0 TDI quattro<br>2.0 TFSI<br>2.0 TFSI<br>2.0 TFSI quattro<br>2.0 TFSI quattro<br>3.2 quattro<br>RS 2.5 TFSI<br>RS 2.5 TFSI plus<br>TTS 2.0 TFSI | 118<br>195<br>125<br>147<br>155<br>147<br>155<br>184<br>250<br>265<br>200 |  | 06.08<br>05.08<br>06.08<br>02.07<br>05.10<br>05.08<br>05.10<br>02.07<br>05.09<br>02.12<br>05.08 |   | 24.2415-1711.3<br>24.2415-1713.3                   | 030130<br>030132           |   |         | Gz 15,87<br>Gz 15,87, + Sensor                 |                   |
|                        | 1.8 TFSI<br>2.0 quattro<br>2.0 TDI quattro<br>2.0 TFSI<br>2.0 TFSI<br>2.0 TFSI quattro<br>2.0 TFSI quattro<br>3.2 quattro<br>RS 2.5 TFSI<br>RS 2.5 TFSI plus<br>TTS 2.0 TFSI | 118<br>195<br>125<br>147<br>155<br>147<br>155<br>184<br>250<br>265<br>200 |  | 06.08<br>05.08<br>06.08<br>02.07<br>05.10<br>05.08<br>05.10<br>02.07<br>05.09<br>02.12<br>05.08 |   | 24.2519-1705.3                                     | 040095                     |   | PR: 0EJ | Nz 19,05                                       |                   |

| BMW 1er Reihe/E81/E87 Limousine (04-11) |   |   |  |  |  |                |        |  |                                   |                 |     |
|---|---|---|--|--|--|----------------|--------|--|-----------------------------------|-----------------|-----|
|   | 116 d<br>116 i<br>116 i<br>116 i<br>118 d<br>118 d<br>118 i<br>118 i<br>118 i<br>120 d<br>120 d<br>120 i<br>120 i | 85<br>85<br>90<br>90<br>90<br>105<br>95<br>105<br>105<br>120<br>130<br>110<br>125 |  | 03.09 08.09<br>09.04 08.07<br>01.09 08.09<br>09.07 12.08<br>09.04 03.07<br>04.07 08.09<br>09.04 03.07<br>04.07 08.09<br>09.04 02.07<br>03.07 08.09<br>09.04 03.07<br>04.07 08.09 |  | 03.7848-4003.4 | 300235 |  |                                   | 8"              | ATE |
|   | 116 d<br>116 d<br>116 i<br>118 d<br>118 i<br>120 d<br>120 i   | 66<br>85<br>90<br>105<br>105<br>130<br>125  |  | 01.11 12.11<br>09.09 05.11<br>09.09 05.11<br>09.09 05.11<br>09.09 05.11<br>09.09 05.11<br>09.09 05.11  |  | 03.7848-4003.4 | 300235 |  | - Start/Stop-Anlage <sup>1)</sup> | 8"              | ATE |
|   | 123 d<br>130 i<br>130 i   | 150<br>190<br>195   |  | 10.07 08.09<br>03.05 08.05<br>09.05 05.11  |  | 03.7848-5003.4 | 300236 |  |                                   | 8"              | ATE |
|   | 123 d   | 150   |  | 09.09 05.11  |  | 03.7848-5003.4 | 300236 |  | - Start/Stop-Anlage <sup>1)</sup> | 8"              | ATE |
|   | 116 d<br>116 d<br>116 i<br>116 i<br>116 i<br>118 d  | 66<br>85<br>85<br>90<br>90<br>90  |  | 01.11 12.11<br>03.09 05.11<br>09.04 08.07<br>01.09 05.11<br>09.07 12.08<br>09.04 03.07   |  | 03.2023-2407.3 | 010796 |  |                                   | THz 23,81/22,20 | ATE |

<sup>1)</sup> - idling stop system / - dispositivo start/stop / - unité marche/arrêt / - unidad arranque/paro



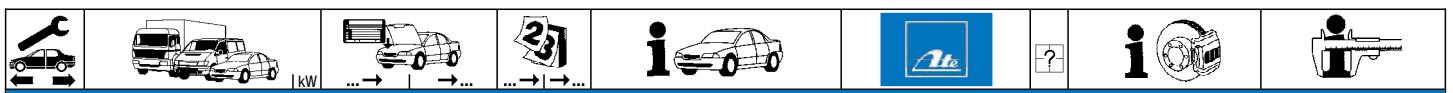

**BMW 1er Reihe/E81/E87 Limousine (04-11)**

|  |       |     |  |       |       |                         |                |        |   |                     |                 |        |
|--|-------|-----|--|-------|-------|-------------------------|----------------|--------|---|---------------------|-----------------|--------|
|  | 118 d | 105 |  | 04.07 | 05.11 |                         | 03.2023-2407.3 | 010796 |   |                     | ThZ 23,81/22,20 | ATE    |
|  | 118 i | 95  |  | 09.04 | 03.07 |                         |                |        |   |                     |                 |        |
|  | 118 i | 105 |  | 04.07 | 05.11 |                         |                |        |   |                     |                 |        |
|  | 120 d | 120 |  | 09.04 | 02.07 |                         |                |        |   |                     |                 |        |
|  | 120 d | 130 |  | 03.07 | 05.11 |                         |                |        |   |                     |                 |        |
|  | 120 i | 110 |  | 09.04 | 03.07 |                         |                |        |   |                     |                 |        |
|  | 120 i | 125 |  | 04.07 | 05.11 |                         |                |        |   |                     |                 |        |
|  | 123 d | 150 |  | 10.07 | 05.11 |                         | 03.2025-1904.3 | 010797 |   |                     | ThZ 25,40/22,20 | ATE    |
|  | 130 i | 190 |  | 03.05 | 08.05 |                         |                |        |   |                     |                 |        |
|  | 130 i | 195 |  | 09.05 | 05.11 |                         |                |        |   |                     |                 |        |
|  | 116 d | 66  |  | 01.11 | 12.11 |                         | 24.3541-1835.7 | 220739 |   | - Performance Parts | D=54, - Halter  | LUC    |
|  | 116 d | 85  |  | 03.09 | 05.11 |                         | 24.3541-1836.7 | 220740 |   | - Performance Parts | D=54, - Halter  | LUC    |
|  | 116 i | 85  |  | 09.04 | 08.07 |                         |                |        |   |                     |                 |        |
|  | 116 i | 90  |  | 09.07 | 12.08 |                         |                |        |   |                     |                 |        |
|  | 118 d | 90  |  | 09.04 | 03.07 | + 5 türig <sup>1)</sup> |                |        |   |                     |                 |        |
|  | 118 i | 95  |  | 09.04 | 03.07 | + 5 türig <sup>1)</sup> |                |        |   |                     |                 |        |
|  | 120 d | 120 |  | 09.04 | 02.07 | + 5 türig <sup>1)</sup> | 11.9541-9575.2 | 220829 |   | - Performance Parts | D=54, - Halter  | ATE    |
|  | 120 i | 110 |  | 09.04 | 12.05 | + 5 türig <sup>1)</sup> | 11.9541-9576.2 | 220830 |   | - Performance Parts | D=54, - Halter  | ATE    |
|  |       |     |  |       |       |                         | 11.0101-5402.2 | 260009 |   |                     | Hülzensatz      | ATE    |
|  |       |     |  |       |       |                         | 11.8171-0008.1 | 990049 |   |                     | Führungsbolzen  | ATE    |
|  |       |     |  |       |       |                         | 11.8116-0206.1 | 390593 | 2 |                     | Haltefeder      | ATE    |
|  | 116 i | 90  |  | 01.09 | 05.11 |                         | 24.3541-1835.7 | 220739 |   | - Performance Parts | D=54, - Halter  | LUC    |
|  | 118 d | 90  |  | 09.04 | 03.07 | + 3 türig <sup>2)</sup> | 24.3541-1836.7 | 220740 |   | - Performance Parts | D=54, - Halter  | LUC    |
|  | 118 d | 105 |  | 04.07 | 05.11 |                         |                |        |   |                     |                 |        |
|  | 118 i | 95  |  | 09.04 | 03.07 | + 3 türig <sup>2)</sup> |                |        |   |                     |                 |        |
|  | 118 i | 105 |  | 04.07 | 05.11 |                         |                |        |   |                     |                 |        |
|  | 120 i | 110 |  | 01.06 | 03.07 | + 5 türig <sup>1)</sup> |                |        |   |                     |                 |        |
|  | 120 d | 120 |  | 09.04 | 02.07 | + 3 türig <sup>2)</sup> | 11.0101-5402.2 | 260009 |   |                     | Hülzensatz      | ATE    |
|  | 120 d | 130 |  | 03.07 | 05.11 |                         | 11.8171-0008.1 | 990049 |   |                     | Führungsbolzen  | ATE    |
|  | 120 i | 110 |  | 09.04 | 03.07 | + 3 türig <sup>2)</sup> | 11.8116-0339.2 | 390528 | 2 |                     | Haltefeder      | ATE    |
|  | 120 i | 125 |  | 04.07 | 05.11 |                         |                |        |   |                     |                 |        |
|  | 123 d | 150 |  | 10.07 | 05.11 |                         | 11.0101-5402.2 | 260009 |   |                     | Hülzensatz      | ATE    |
|  | 130 i | 190 |  | 03.05 | 08.05 |                         | 11.8171-0008.1 | 990049 |   |                     | Führungsbolzen  | ATE    |
|  | 130 i | 195 |  | 09.05 | 05.11 |                         | 11.8116-0339.2 | 390528 | 2 |                     | Haltefeder      | ATE    |
|  | 116 d | 66  |  | 01.11 | 12.11 |                         | 24.3401-1707.7 | 220775 |   | - Performance Parts | D=40, - Halter  | LUC    |
|  | 116 d | 85  |  | 03.09 | 05.11 |                         | 24.3401-1708.7 | 220776 |   | - Performance Parts | D=40, - Halter  | LUC    |
|  | 116 i | 85  |  | 09.04 | 08.07 |                         |                |        |   |                     |                 |        |
|  | 116 i | 90  |  | 09.07 | 12.08 |                         |                |        |   |                     |                 |        |
|  | 118 d | 90  |  | 09.04 | 03.07 | + 5 türig <sup>1)</sup> |                |        |   |                     |                 |        |
|  | 118 i | 95  |  | 09.04 | 03.07 | + 5 türig <sup>1)</sup> |                |        |   |                     |                 |        |
|  | 116 i | 90  |  | 01.09 | 05.11 |                         | 24.3401-1707.7 | 220775 |   | - Performance Parts | D=40, - Halter  | LUC    |
|  | 118 i | 95  |  | 09.04 | 03.07 | + 3 türig <sup>2)</sup> | 24.3401-1708.7 | 220776 |   | - Performance Parts | D=40, - Halter  | LUC    |
|  | 118 i | 105 |  | 04.07 | 05.11 |                         |                |        |   |                     |                 |        |
|  | 120 i | 110 |  | 09.04 | 03.07 |                         |                |        |   |                     |                 |        |
|  | 120 i | 125 |  | 04.07 | 05.11 |                         |                |        |   |                     |                 |        |
|  | 118 d | 90  |  | 09.04 | 03.07 | + 3 türig <sup>2)</sup> | 11.0101-5402.2 | 260009 |   |                     | Hülzensatz      | ATE    |
|  | 118 d | 105 |  | 04.07 | 05.11 |                         | 11.8171-0008.1 | 990049 |   |                     | Führungsbolzen  | ATE    |
|  | 120 d | 120 |  | 09.04 | 02.07 |                         | 11.8116-0066.1 | 390577 | 2 |                     | Haltefeder      | ATE    |
|  | 120 d | 130 |  | 03.07 | 05.11 |                         |                |        |   |                     |                 |        |
|  | 120 d | 130 |  | 03.07 | 05.11 |                         | 11.9421-9911.2 | 220825 |   | - Performance Parts | D=42, - Halter  | ATE    |
|  | 130 i | 190 |  | 03.05 | 08.05 |                         | 11.9421-9912.2 | 220826 |   | - Performance Parts | D=42, - Halter  | ATE    |
|  | 130 i | 195 |  | 09.05 | 05.11 |                         | 11.0101-5402.2 | 260009 |   |                     | Hülzensatz      | ATE    |
|  |       |     |  |       |       |                         | 11.8171-0008.1 | 990049 |   |                     | Führungsbolzen  | ATE    |
|  |       |     |  |       |       |                         | 11.8116-0066.1 | 390577 | 2 |                     | Haltefeder      | ATE    |
|  | 116 d | 66  |  | 01.11 | 12.11 |                         | 24.5125-0230.3 | 331277 | 2 |                     | L=230           |        |
|  | 116 d | 85  |  | 03.09 | 05.11 |                         | 24.5137-0221.3 | 331302 | 2 |                     | L=221           |        |
|  | 116 i | 85  |  | 09.04 | 08.07 |                         | 83.7752-0221.3 | 331053 | 2 |                     | L=220           |        |
|  | 116 i | 90  |  | 01.09 | 05.11 |                         |                |        |   |                     |                 |        |
|  | 116 i | 90  |  | 09.07 | 12.08 |                         |                |        |   |                     |                 |        |
|  | 118 d | 90  |  | 09.04 | 03.07 |                         |                |        |   |                     |                 |        |
|  | 118 d | 105 |  | 04.07 | 05.11 |                         |                |        |   |                     |                 |        |
|  | 118 i | 95  |  | 09.04 | 03.07 |                         |                |        |   |                     |                 |        |
|  | 118 i | 105 |  | 04.07 | 05.11 |                         |                |        |   |                     |                 |        |
|  | 120 d | 120 |  | 09.04 | 02.07 |                         |                |        |   |                     |                 |        |
|  | 120 d | 130 |  | 03.07 | 05.11 |                         |                |        |   |                     |                 |        |
|  | 120 i | 110 |  | 09.04 | 03.07 |                         |                |        |   |                     |                 |        |
|  | 120 i | 125 |  | 04.07 | 05.11 |                         |                |        |   |                     |                 |        |
|  | 123 d | 150 |  | 10.07 | 05.11 |                         |                |        |   |                     |                 |        |
|  | 130 i | 190 |  | 03.05 | 08.05 |                         |                |        |   |                     |                 |        |
|  | 130 i | 195 |  | 09.05 | 05.11 |                         |                |        |   |                     |                 |        |
|  | 116 d | 66  |  | 01.11 | 12.11 |                         | 24.3727-0234.2 | 580234 | 2 |                     |                 | L=1435 |
|  | 116 d | 85  |  | 03.09 | 05.11 |                         |                |        |   |                     |                 |        |
|  | 116 i | 85  |  | 09.04 | 08.07 |                         |                |        |   |                     |                 |        |
|  | 116 i | 90  |  | 01.09 | 05.11 |                         |                |        |   |                     |                 |        |
|  | 116 i | 90  |  | 09.07 | 12.08 |                         |                |        |   |                     |                 |        |
|  | 118 d | 90  |  | 09.04 | 03.07 |                         |                |        |   |                     |                 |        |
|  | 118 d | 105 |  | 04.07 | 05.11 |                         |                |        |   |                     |                 |        |
|  | 118 i | 95  |  | 09.04 | 03.07 |                         |                |        |   |                     |                 |        |
|  | 118 i | 105 |  | 04.07 | 05.11 |                         |                |        |   |                     |                 |        |
|  | 120 d | 120 |  | 09.04 | 02.07 |                         |                |        |   |                     |                 |        |
|  | 120 d | 130 |  | 03.07 | 05.11 |                         |                |        |   |                     |                 |        |
|  | 120 i | 110 |  | 09.04 | 03.07 |                         |                |        |   |                     |                 |        |
|  | 120 i | 125 |  | 04.07 | 05.11 |                         |                |        |   |                     |                 |        |
|  | 123 d | 150 |  | 10.07 | 05.11 |                         |                |        |   |                     |                 |        |
|  | 130 i | 190 |  | 03.05 | 08.05 |                         |                |        |   |                     |                 |        |
|  | 130 i | 195 |  | 09.05 | 05.11 |                         |                |        |   |                     |                 |        |

<sup>1)</sup> + 5 door / + 5 porte / + 5 portes / + 5 puertas

<sup>2)</sup> + 3 door / + 3 porte / + 3 portes / + 3 puertas



| BMW 1er Reihe/E81/E87 Limousine (04-11) |       |     |       |       |                |        |  |  |  |          |
|---|-------|-----|-------|-------|----------------|--------|--|--|--|----------|
|   | 116 d | 66  | 01.11 | 12.11 | 24.2419-1713.3 | 030093 |  |  |  | Gz 19,05 |
|   | 116 d | 85  | 03.09 | 05.11 |                |        |  |  |  |          |
|   | 116 i | 85  | 09.04 | 08.07 |                |        |  |  |  |          |
|   | 116 i | 90  | 01.09 | 05.11 |                |        |  |  |  |          |
|   | 116 i | 90  | 09.07 | 12.08 |                |        |  |  |  |          |
|   | 118 d | 90  | 09.04 | 03.07 |                |        |  |  |  |          |
|   | 118 d | 105 | 04.07 | 05.11 |                |        |  |  |  |          |
|   | 118 i | 95  | 09.04 | 03.07 |                |        |  |  |  |          |
|   | 118 i | 105 | 04.07 | 05.11 |                |        |  |  |  |          |
|   | 120 d | 120 | 09.04 | 02.07 |                |        |  |  |  |          |
|   | 120 d | 130 | 03.07 | 05.11 |                |        |  |  |  |          |
|   | 120 i | 110 | 09.04 | 03.07 |                |        |  |  |  |          |
|   | 120 i | 125 | 04.07 | 05.11 |                |        |  |  |  |          |
|   | 123 d | 150 | 10.07 | 05.11 |                |        |  |  |  |          |
|   | 130 i | 190 | 03.05 | 08.05 |                |        |  |  |  |          |
|   | 130 i | 195 | 09.05 | 05.11 |                |        |  |  |  |          |

















| BMW 1er Reihe/E82 Coupe (07-) |       |     |       |       |                |        |   |  |                             |                     |
|-------------------------------|-------|-----|-------|-------|----------------|--------|---|--|-----------------------------|---------------------|
|                               | 123 d | 150 | 10.07 | 08.09 | 03.7848-4003.4 | 300235 |   |  |                             | 8" ATE              |
|                               | 125 i | 160 | 03.08 |       |                |        |   |  |                             |                     |
|                               | 118 d |     | 09.09 |       | 03.7848-4003.4 | 300235 |   | - Start/Stop-Anlage <sup>1)</sup>            |                             | 8" ATE              |
|                               | 120 d | 130 | 10.07 |       | 03.7848-4003.4 | 300235 |   | - Start/Stop-Anlage <sup>1)</sup>            |                             | 8" ATE              |
|                               | 120 i | 115 | 09.09 |       |                |        |   |  |                             |                     |
|                               | 120 i | 125 | 09.09 |       |                |        |   |  |                             |                     |
|                               | 123 d | 150 | 09.09 |       | 03.7848-5003.4 | 300236 |   | - Start/Stop-Anlage <sup>1)</sup>            |                             | 8" ATE              |
|                               | 135 i | 225 | 10.07 |       | 03.7845-0103.4 | 300268 |   |  |                             | 8" ATE              |
|                               | 118 d | 130 | 09.09 |       | 03.2023-2407.3 | 010796 |   |  |                             | Thz 23,81/22,20 ATE |
|                               | 120 d | 130 | 10.07 |       |                |        |   |  |                             |                     |
|                               | 120 i | 115 | 09.09 |       |                |        |   |  |                             |                     |
|                               | 120 i | 125 | 09.09 |       |                |        |   |  |                             |                     |
|                               | 125 i | 160 | 03.08 |       |                |        |   |  |                             |                     |
|                               | 123 d | 150 | 10.07 |       | 03.2025-1904.3 | 010797 |   |  |                             | Thz 25,40/22,20 ATE |
|                               | 135 i | 225 | 10.07 |       |                |        |   |  |                             |                     |
|                               | 120 d | 130 | 10.07 |       | 11.0101-5402.2 | 260009 |   |  |                             | Hülsensatz ATE      |
|                               | 120 i | 115 | 09.09 |       | 11.8171-0008.1 | 990049 |   |  |                             | Führungsbolzen ATE  |
|                               | 120 i | 125 | 09.09 |       | 11.8116-0339.2 | 390528 | 2 |  |                             | Haltefeder ATE      |
|                               | 125 i | 160 | 03.08 |       |                |        |   |  |                             |                     |
|                               | 118 d |     | 09.09 |       | 24.3541-1835.7 | 220739 |   | <input type="checkbox"/> - Performance Parts |                             | D=54, - Halter LUC  |
|                               |       |     |       |       | 24.3541-1836.7 | 220740 |   | <input type="checkbox"/> - Performance Parts |                             | D=54, - Halter LUC  |
|                               | 123 d | 150 | 10.07 |       | 11.0101-5402.2 | 260009 |   |  |                             | Hülsensatz ATE      |
|                               |       |     |       |       | 11.8171-0008.1 | 990049 |   |  |                             | Führungsbolzen ATE  |
|                               |       |     |       |       | 11.8116-0339.2 | 390528 | 2 |  |                             | Haltefeder ATE      |
|                               | 3.0 M | 250 | 05.11 |       | 11.0441-6008.2 | 250038 |   |  |                             | Dichtungssatz ATE   |
|                               |       |     |       |       | 11.8171-0008.1 | 990049 |   |  |                             | Führungsbolzen ATE  |
|                               | 3.0 M | 250 | 05.11 |       | 83.7751-0502.3 | 331109 | 2 |  |                             | L=502               |
|                               | 118 d |     | 09.09 |       | 11.0101-5402.2 | 260009 |   |  |                             | Hülsensatz ATE      |
|                               | 120 d | 130 | 10.07 |       | 11.8171-0008.1 | 990049 |   |  |                             | Führungsbolzen ATE  |
|                               | 120 i | 115 | 09.09 |       | 11.8116-0066.1 | 390577 | 2 |  |                             | Haltefeder ATE      |
|                               | 120 i | 125 | 09.09 |       |                |        |   |  |                             |                     |
|                               | 125 i | 160 | 03.08 |       |                |        |   |  |                             |                     |
|                               | 123 d | 150 | 10.07 |       | 11.9421-9911.2 | 220825 |   | <input type="checkbox"/> - Performance Parts |                             | D=42, - Halter ATE  |
|                               |       |     |       |       | 11.9421-9912.2 | 220826 |   | <input type="checkbox"/> - Performance Parts |                             | D=42, - Halter ATE  |
|                               |       |     |       |       | 11.0101-5402.2 | 260009 |   |  |                             | Hülsensatz ATE      |
|                               |       |     |       |       | 11.8171-0008.1 | 990049 |   |  |                             | Führungsbolzen ATE  |
|                               |       |     |       |       | 11.8116-0066.1 | 390577 | 2 |  |                             | Haltefeder ATE      |
|                               | 118 d |     | 09.09 |       | 83.7850-0180.3 | 331054 | 2 |  |                             | L=180               |
|                               | 120 d | 130 | 10.07 |       | 83.7752-0221.3 | 331053 | 2 |  | am Bremsattel <sup>2)</sup> | L=220               |
|                               | 120 i | 115 | 09.09 |       | 24.5137-0221.3 | 331302 | 2 |  | am Bremsattel <sup>2)</sup> | L=221               |
|                               | 120 i | 125 | 09.09 |       | 24.5125-0230.3 | 331277 | 2 |  | am Bremsattel <sup>2)</sup> | L=230               |
|                               | 123 d | 150 | 10.07 |       |                |        |   |  |                             |                     |
|                               | 125 i | 160 | 03.08 |       |                |        |   |  |                             |                     |
|                               | 135 i | 225 | 10.07 |       |                |        |   |  |                             |                     |
|                               | 3.0 M | 250 | 05.11 |       |                |        |   |  |                             |                     |
|                               | 118 d |     | 09.09 |       | 24.3727-0234.2 | 580234 | 2 |  |                             | L=1435              |
|                               | 120 d | 130 | 10.07 |       |                |        |   |  |                             |                     |
|                               | 120 i | 115 | 09.09 |       |                |        |   |  |                             |                     |
|                               | 120 i | 125 | 09.09 |       |                |        |   |  |                             |                     |
|                               | 123 d | 150 | 10.07 |       |                |        |   |  |                             |                     |
|                               | 125 i | 160 | 03.08 |       |                |        |   |  |                             |                     |
|                               | 135 i | 225 | 10.07 |       |                |        |   |  |                             |                     |
|                               | 3.0 M | 250 | 05.11 |       |                |        |   |  |                             |                     |

| BMW 1er Reihe/E88 Cabrio (08-) |       |     |       |  |                |        |  |                                   |  |        |
|--------------------------------|-------|-----|-------|--|----------------|--------|--|-----------------------------------|--|--------|
|                                | 118 d | 105 | 09.08 |  | 03.7848-4003.4 | 300235 |  | - Start/Stop-Anlage <sup>1)</sup> |  | 8" ATE |
|                                | 118 i | 105 | 03.08 |  |                |        |  |                                   |  |        |
|                                | 120 d | 130 | 03.08 |  |                |        |  |                                   |  |        |
|                                | 120 d | 145 | 03.08 |  |                |        |  |                                   |  |        |
|                                | 120 i | 115 | 03.08 |  |                |        |  |                                   |  |        |
|                                | 120 i | 125 | 03.08 |  |                |        |  |                                   |  |        |
|                                | 125 i | 160 | 03.08 |  | 03.7848-4003.4 | 300235 |  |                                   |  | 8" ATE |
|                                | 123 d | 150 | 09.08 |  | 03.7848-5003.4 | 300236 |  | - Start/Stop-Anlage <sup>1)</sup> |  | 8" ATE |
|                                | 135 i | 225 | 03.08 |  | 03.7845-0103.4 | 300268 |  |                                   |  | 8" ATE |

<sup>1)</sup> - idling stop system / - dispositivo start/stop / - unité marche/arrêt / - unidad arranque/paro

<sup>2)</sup> on the brake caliper / sulla pinza freno / sur l'étrier de frein / a la pinza de freno



|     |  |  |  |  |  |  |  |  |     |
|--|--|--|--|--|---|--|--|--|-----|
| <b>BMW 1er Reihe/E88 Cabrio (08-)</b>  |  |  |  |  |   |  |  |  |     |
|    | 135 i  | 240  |  | 03.08  |   | 03.7845-0103.4   | 300268   | 8"   | ATE |
|    | 118 d  | 105  |  | 09.08  |   | 03.2023-2407.3   | 010796   | THz 23,81/22,20  | ATE |
|  | 118 i  | 105  |  | 03.08  |   |  |  |  |     |
|  | 120 d  | 130  |  | 03.08  |   |  |  |  |     |
|  | 120 d  | 145  |  | 03.08  |   |  |  |  |     |
|  | 120 i  | 115  |  | 03.08  |   |  |  |  |     |
|  | 120 i  | 125  |  | 03.08  |   |  |  |  |     |
|  | 123 d  | 150  |  | 03.08  |   |  |  |  |     |
|  | 125 i  | 160  |  | 03.08  |   |  |  |  |     |
|  | 123 d  | 150  |  | 09.08  |   | 03.2025-1904.3   | 010797   | THz 25,40/22,20  | ATE |
|  | 135 i  | 225  |  | 03.08  |   |  |  |  |     |
|  | 135 i  | 240  |  | 03.08  |   |  |  |  |     |
|    | 118 d  | 105  |  | 09.08  |   | 24.3541-1835.7   | 220739   | D=54, - Halter   | LUC |
|  | 118 i  | 105  |  | 03.08  |   | 24.3541-1836.7   | 220740   | D=54, - Halter   | LUC |
|  | 120 d  | 130  |  | 03.08  |   | 11.0101-5402.2   | 260009   | Hülsensatz   | ATE |
|  | 120 d  | 145  |  | 03.08  |   | 11.8171-0008.1   | 990049   | Führungsbolzen   | ATE |
|  | 120 i  | 115  |  | 03.08  |   | 11.8116-0339.2   | 390528   | Haltefeder   | ATE |
|  | 120 i  | 125  |  | 03.08  |   |  |  |  |     |
|  | 125 i  | 160  |  | 03.08  |   |  |  |  |     |
|  | 123 d  | 150  |  | 09.08  |   | 11.0101-5402.2   | 260009   | Hülsensatz   | ATE |
|  |  |  |  |  |   | 11.8171-0008.1   | 990049   | Führungsbolzen   | ATE |
|  |  |  |  |  |   | 11.8116-0339.2   | 390528   | Haltefeder   | ATE |
|    | 118 d  | 105  |  | 09.08  |   | 11.0101-5402.2   | 260009   | Hülsensatz   | ATE |
|  | 118 i  | 105  |  | 03.08  |   | 11.8171-0008.1   | 990049   | Führungsbolzen   | ATE |
|  | 120 d  | 130  |  | 03.08  |   | 11.8116-0066.1   | 390577   | Haltefeder   | ATE |
|  | 120 d  | 145  |  | 03.08  |   |  |  |  |     |
|  | 120 i  | 115  |  | 03.08  |   |  |  |  |     |
|  | 120 i  | 125  |  | 03.08  |   |  |  |  |     |
|  | 125 i  | 160  |  | 03.08  |   |  |  |  |     |
|  | 123 d  | 150  |  | 09.08  |   | 11.9421-9911.2   | 220825   | D=42, - Halter   | ATE |
|  |  |  |  |  |   | 11.9421-9912.2   | 220826   | D=42, - Halter   | ATE |
|  |  |  |  |  |   | 11.0101-5402.2   | 260009   | Hülsensatz   | ATE |
|  |  |  |  |  |   | 11.8171-0008.1   | 990049   | Führungsbolzen   | ATE |
|  |  |  |  |  |   | 11.8116-0066.1   | 390577   | Haltefeder   | ATE |
|    | 118 d  | 105  |  | 09.08  |   | 83.7850-0180.3   | 331054   | L=180  |     |
|  | 118 i  | 105  |  | 03.08  |   | 83.7752-0221.3   | 331053   | L=220  |     |
|  | 120 d  | 130  |  | 03.08  |   | 24.5125-0230.3   | 331277   | L=230  |     |
|  | 120 d  | 145  |  | 03.08  |   | 24.5137-0221.3   | 331302   | L=221  |     |
|  | 120 i  | 115  |  | 03.08  |   |  |  |  |     |
|  | 120 i  | 125  |  | 03.08  |   |  |  |  |     |
|  | 123 d  | 150  |  | 09.08  |   |  |  |  |     |
|  | 125 i  | 160  |  | 03.08  |   |  |  |  |     |
|  | 135 i  | 225  |  | 03.08  |   |  |  |  |     |
|  | 135 i  | 240  |  | 03.08  |   |  |  |  |     |
|  | 118 d  | 105  |  | 09.08  |   | 24.3727-0234.2   | 580234   | L=1435   |     |
|  | 118 i  | 105  |  | 03.08  |   |  |  |  |     |
|  | 120 d  | 130  |  | 03.08  |   |  |  |  |     |
|  | 120 d  | 145  |  | 03.08  |   |  |  |  |     |
|  | 120 i  | 115  |  | 03.08  |   |  |  |  |     |
|  | 120 i  | 125  |  | 03.08  |   |  |  |  |     |
|  | 123 d  | 150  |  | 09.08  |   |  |  |  |     |
|  | 125 i  | 160  |  | 03.08  |   |  |  |  |     |
|  | 135 i  | 225  |  | 03.08  |   |  |  |  |     |
|  | 135 i  | 240  |  | 03.08  |   |  |  |  |     |
| <b>BMW 1er Reihe/F20/F21 Limousine (11-)</b>                                       |  |  |  |  |   |  |  |  |     |
|  | 114 d  | 70   |  | 10.12  |   | 24.5125-0230.3   | 331277   | L=230  |     |
|  | 114 i  | 75   |  | 09.12  |   |  |  |  |     |
|  | 116 d  | 85   |  | 06.11  |   |  |  |  |     |
|  | 116 d ed   | 85   |  | 03.12  |   |  |  |  |     |
|  | 116 i  | 100  |  | 06.11  |   |  |  |  |     |
|  | 118 d  |  |  | 06.11  |   |  |  |  |     |
|  | 118 d xDrive   | 105  |  | 05.13  |   |  |  |  |     |
|  | 118 i  | 125  |  | 06.11  |   |  |  |  |     |
|  | 120 d  | 120  |  | 06.11  |   |  |  |  |     |
|  | 120 d  | 135  |  | 06.11  |   |  |  |  |     |
|  | 120 d xDrive   | 135  |  | 07.12  |   |  |  |  |     |
|  | 125 d  |  |  | 03.12  |   |  |  |  |     |
|  | 125 i  | 160  |  | 03.12  |   |  |  |  |     |
|  | M 135 i  | 235  |  | 09.12  |   |  |  |  |     |
|  | M 135 i xDrive   | 235  |  | 07.12  |   |  |  |  |     |
| <b>BMW 3er Reihe/E36 (91-00)</b>   |  |  |  |  |   |  |  |  |     |
|  | 316 i  |  |  | 12.90  | 08.94   | 10.6360-1903.4   | 300093   | 10" (MKIV)   | ATE |
|  | 316 i Compact 1.6  |  |  | 09.93  | 08.94   |  |  |  |     |
|  | 316 i Coupe  |  |  | 03.93  | 08.94   |  |  |  |     |
|  | 318 i  |  |  | 12.90  | 08.94   |  |  |  |     |
|  | 318 i Cabrio   |  |  | 11.93  | 08.94   |  |  |  |     |
|  | 318 iS   |  |  | 01.92  | 08.94   |  |  |  |     |
|  | 318 iS Coupe   |  |  | 01.92  | 08.94   |  |  |  |     |
|  | 320 i  |  |  | 12.90  | 08.94 + ASC   |  |  |  |     |
|  | 320 i Cabrio   |  |  | 11.93  | 08.94   |  |  |  |     |
|  | 320 i Coupe  |  |  | 01.92  | 08.94 + ASC   |  |  |  |     |
|  | 320 i Touring  |  |  | 05.94  | 10.99 + ASC   |  |  |  |     |
|  | 323 i  |  |  | 03.95  | 02.98 + ASC   |  |  |  |     |

1) on the brake caliper / sulla pinza freno / sur l'étrier de frein / a la pinza de freno



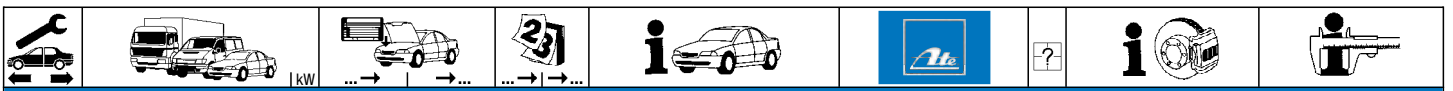

**BMW 3er Reihe/E36 (91-00)**

|  |   |  |  |  |                          |  |                  |     |
|--|---|--|--|--|--------------------------|--|------------------|-----|
|  | 323 i Coupe<br>323 i Touring<br>325 i<br>325 i Cabrio<br>325 i Coupe<br>325 td<br>325 tds<br>328 i<br>328 i Cabrio<br>328 i Coupe<br>328 i Touring<br>M3 3.0 #210<br>M3 Cabrio 3.0 210<br>M3 Coupe 3.0 #210   |  | 03.95<br>07.95 + ASC<br>12.90<br>08.92<br>01.92<br>09.91<br>03.93<br>11.94<br>11.94<br>11.94<br>10.94<br>06.94<br>11.93<br>03.92   | 04.99 + ASC<br>10.99 + ASC<br>08.94<br>08.94<br>08.94<br>08.94 - ASC<br>08.94 - ASC<br>02.98 + ASC<br>04.99 + ASC<br>04.99 + ASC<br>10.99 + ASC<br>09.95<br>10.95<br>09.95   | 10.6360-1903.4<br>300093 |  | 10" (MKIV)       | ATE |
|  | 316 g Compact<br>316 i<br>316 i Compact 1.6 #<br>316 i Compact 1.9<br>316 i Coupe<br>316 i Touring<br>318 i<br>318 i Cabrio<br>318 i Touring<br>318 iS<br>318 iS Coupe<br>318 tds<br>318 tds Compact #<br>318 tds Touring #<br>318 ti Compact<br>320 i<br>320 i Cabrio<br>320 i Coupe<br>320 i Touring<br>323 i<br>323 i Cabrio<br>323 i Coupe<br>323 i Touring<br>323 ti Compact<br>325 i<br>325 i Cabrio<br>325 i Coupe<br>325 td<br>325 td<br>325 tds<br>325 tds<br>325 tds Touring<br>328 i<br>328 i Cabrio<br>328 i Coupe<br>328 i Touring |  | 12.95<br>09.94<br>09.94<br>12.98<br>09.94<br>05.97<br>09.94<br>09.94<br>02.95<br>09.94<br>09.94<br>01.94<br>04.94<br>04.94<br>09.94<br>09.94<br>05.94<br>03.95<br>03.95<br>07.95<br>08.97<br>09.94<br>09.94<br>09.94<br>09.91<br>09.94<br>03.93<br>09.94<br>10.94<br>11.94<br>11.94<br>10.94 | 08.00<br>02.98<br>08.00<br>08.00<br>04.99<br>10.99<br>02.98<br>04.99<br>10.99<br>02.98<br>04.99<br>02.98<br>08.00<br>08.00<br>- ASC<br>04.99<br>- ASC<br>- ASC<br>- ASC<br>- ASC<br>04.99<br>08.00<br>02.98<br>04.99<br>- ASC<br>02.98 + ASC<br>- ASC<br>- ASC<br>- ASC<br>- ASC<br>04.99<br>04.99<br>02.98 + ASC<br>02.98 - ASC<br>02.98 + ASC<br>02.98 - ASC<br>10.99<br>02.98 - ASC<br>04.99 - ASC<br>04.99 - ASC<br>- ASC  | 03.7760-3102.4<br>300139 |  | 10"              | ATE |
|  | 316 i<br>316 i Compact 1.6<br>318 i<br>320 i<br>325 td  |  | 12.90<br>09.93<br>12.90<br>12.90<br>09.91  | 02.98 - ABS<br>08.00 - ABS<br>02.98 - ABS<br>02.98 - ABS<br>02.98 - ABS  | 24.2023-1601.3<br>010341 |  | THz 23,81        | LUC |
|  | 316 i<br>316 i Compact 1.6<br>316 i Coupe<br>318 i<br>318 i Cabrio<br>318 iS<br>318 iS Coupe<br>320 i<br>320 i<br>320 i Cabrio<br>320 i Cabrio<br>320 i Coupe<br>320 i Coupe<br>320 i Touring<br>323 i<br>323 i Cabrio<br>323 i Coupe<br>323 i Touring<br>325 i<br>325 i<br>325 i Cabrio<br>325 i Cabrio<br>325 i Coupe<br>325 i Coupe<br>325 td<br>325 tds<br>328 i<br>328 i Cabrio<br>328 i Coupe<br>328 i Touring  |  | 12.90<br>09.93<br>03.93<br>12.90<br>11.93<br>01.92<br>01.92<br>12.90<br>12.90<br>11.93<br>11.93<br>01.92<br>01.92<br>05.94<br>03.95<br>03.95<br>03.95<br>07.95<br>12.90<br>12.90<br>08.92<br>08.92<br>01.92<br>01.92<br>09.91<br>03.93<br>11.94<br>11.94<br>11.94                            | 08.94 + ABS<br>08.94 + ABS<br>08.94<br>08.94 + ABS<br>08.94<br>08.94<br>08.94<br>02.98 + ABS/+ ASC<br>08.94 + ABS/- ASC<br>04.99 + ASC<br>08.94 - ASC<br>08.94 + ASC<br>02.98 + ASC<br>04.99 + ASC<br>04.99 + ASC<br>10.99 + ASC<br>02.98 + ASC<br>04.99 + ASC<br>04.99 + ASC<br>10.99 + ASC<br>02.98 + ASC<br>08.94 - ASC<br>03.95 + ASC<br>08.94 - ASC<br>04.99 + ASC<br>08.94 - ASC<br>08.94 + ABS/- ASC<br>08.94 - ASC<br>02.98 + ASC<br>04.99 + ASC<br>04.99 + ASC<br>10.99 + ASC | 10.6123-0239.3<br>010335 |  | THz 23,81 (MKIV) | ATE |
|  | 316 g Compact<br>316 i  |  | 12.95<br>09.94   | 08.00<br>02.98 + ABS   | 03.2023-0987.3<br>010473 |  | THz 23,81/20,64  | ATE |









**BMW 3er Reihe/E36 (91-00)**

|                 |                   |           |       |                |        |   |                              |                |       |                |        |   |                              |                |
|-----------------|-------------------|-----------|-------|----------------|--------|---|------------------------------|----------------|-------|----------------|--------|---|------------------------------|----------------|
|                 | 316 i Compact 1.6 | 09.93     | 08.00 | 83.7704-0200.3 | 330825 | 2 | am Bremssattel <sup>1)</sup> | L=200<br>L=200 |       |                |        |   |                              |                |
|                 | 316 i Compact 1.9 | 12.98     | 08.00 | 83.6204-0200.3 | 330306 | 2 |                              |                |       |                |        |   |                              |                |
|                 | 318 tds Compact   | 04.94     | 08.00 |                |        |   |                              |                |       |                |        |   |                              |                |
|                 | 318 ti Compact    | 04.94     | 08.00 |                |        |   |                              |                |       |                |        |   |                              |                |
|                 | 316 i             | 12.90     | 02.98 | 83.7704-0200.3 | 330825 | 2 | am Bremssattel <sup>1)</sup> | L=200<br>L=200 |       |                |        |   |                              |                |
|                 | 316 i Touring     | 05.97     | 10.99 |                |        |   |                              |                |       |                |        |   |                              |                |
|                 | 318 i             | 12.90     | 02.98 |                |        |   |                              |                |       |                |        |   |                              |                |
|                 | 318 i Cabrio      | 11.93     | 04.99 |                |        |   |                              |                |       |                |        |   |                              |                |
|                 | 318 i Touring     | 02.95     | 10.99 |                |        |   |                              |                |       |                |        |   |                              |                |
|                 | 318 iS            | 01.92     | 02.98 |                |        |   |                              |                |       |                |        |   |                              |                |
|                 | 318 iS Coupe      | 01.92     | 04.99 |                |        |   |                              |                |       |                |        |   |                              |                |
|                 | 318 tds           | 01.94     | 02.98 |                |        |   |                              |                |       |                |        |   |                              |                |
|                 | 318 tds Touring   | 10.94     | 10.99 |                |        |   |                              |                |       |                |        |   |                              |                |
|                 | 320 i             | 12.90     | 02.98 |                |        |   |                              |                |       |                |        |   |                              |                |
|                 | 320 i Cabrio      | 11.93     | 04.99 |                |        |   |                              |                |       |                |        |   |                              |                |
|                 | 320 i Coupe       | 01.92     | 04.99 |                |        |   |                              |                |       |                |        |   |                              |                |
|                 | 320 i Touring     | 05.94     | 10.99 |                |        |   |                              |                |       |                |        |   |                              |                |
|                 | 323 i             | 03.95     | 02.98 |                |        |   |                              |                |       |                |        |   |                              |                |
|                 | 323 i Cabrio      | 03.95     | 04.99 |                |        |   |                              |                |       |                |        |   |                              |                |
|                 | 323 i Coupe       | 03.95     | 04.99 |                |        |   |                              |                |       |                |        |   |                              |                |
|                 | 323 i Touring     | 07.95     | 10.99 |                |        |   |                              |                |       |                |        |   |                              |                |
|                 | 325 i             | 12.90     | 02.98 |                |        |   |                              |                |       |                |        |   |                              |                |
|                 | 325 i Cabrio      | 08.92     | 03.95 |                |        |   |                              |                |       |                |        |   |                              |                |
|                 | 325 i Coupe       | 01.92     | 04.99 |                |        |   |                              |                |       |                |        |   |                              |                |
|                 | 325 td            | 09.91     | 02.98 |                |        |   |                              |                |       |                |        |   |                              |                |
|                 | 325 tds           | 03.93     | 02.98 |                |        |   |                              |                |       |                |        |   |                              |                |
|                 | 325 tds Touring   | 10.94     | 10.99 |                |        |   |                              |                |       |                |        |   |                              |                |
|                 | 328 i             | 11.94     | 02.98 |                |        |   |                              |                |       |                |        |   |                              |                |
|                 | 328 i Cabrio      | 11.94     | 04.99 |                |        |   |                              |                |       |                |        |   |                              |                |
|                 | 328 i Coupe       | 11.94     | 04.99 |                |        |   |                              |                |       |                |        |   |                              |                |
|                 | 328 i Touring     | 10.94     | 10.99 |                |        |   |                              |                |       |                |        |   |                              |                |
|                 |                   | M3        | 06.94 |                |        |   |                              |                | 02.98 | 83.6124-0218.3 | 330455 | 2 | am Bremssattel <sup>1)</sup> | L=215<br>L=200 |
|                 |                   | M3 Cabrio | 11.93 |                |        |   |                              |                | 04.99 | 83.6240-0200.3 | 330329 | 2 |                              |                |
|                 |                   | M3 Coupe  | 03.92 |                |        |   |                              |                | 04.99 |                |        |   |                              |                |
|                 |                   | 316 i     | 12.91 |                |        |   |                              |                | 02.98 | 24.3223-1601.3 | 020293 |   |                              | Rz 23,81       |
|                 |                   | 316 i     | 12.90 |                |        |   |                              |                | 02.98 |                |        |   |                              |                |
| 316 i Coupe     |                   | 03.93     | 04.99 |                |        |   |                              |                |       |                |        |   |                              |                |
| 318 i           |                   | 12.90     | 02.98 |                |        |   |                              |                |       |                |        |   |                              |                |
| 318 tds         |                   | 01.94     | 02.98 |                |        |   |                              |                |       |                |        |   |                              |                |
|                 | 316 g Compact     | 12.95     | 08.00 | 24.3222-1616.3 | 020322 |   |                              | Rz 22,20       |       |                |        |   |                              |                |
|                 | 316 i Compact 1.6 | 09.93     | 08.00 |                |        |   |                              |                |       |                |        |   |                              |                |
|                 | 318 tds Compact   | 04.94     | 08.00 |                |        |   |                              |                |       |                |        |   |                              |                |
|                 | 316 i             | 12.91     | 02.98 | 24.3727-0218.2 | 580218 | 2 |                              | L=1764         |       |                |        |   |                              |                |
|                 | 316 i             | 12.90     | 11.91 |                |        |   |                              |                |       |                |        |   |                              |                |
|                 | 316 i Coupe       | 03.93     | 04.99 |                |        |   |                              |                |       |                |        |   |                              |                |
|                 | 318 i             | 12.91     | 02.98 |                |        |   |                              |                |       |                |        |   |                              |                |
|                 | 318 i             | 12.90     | 11.91 |                |        |   |                              |                |       |                |        |   |                              |                |
|                 | 318 tds           | 01.94     | 02.98 |                |        |   |                              |                |       |                |        |   |                              |                |
|                 | 316 i             | 12.90     | 11.91 |                |        |   |                              |                |       |                |        |   |                              |                |
|                 | 316 i Touring     | 05.97     | 10.99 |                |        |   |                              |                |       |                |        |   |                              |                |
|                 | 318 i             | 12.90     | 02.98 |                |        |   |                              |                |       |                |        |   |                              |                |
|                 | 318 i             | 12.90     | 11.91 |                |        |   |                              |                |       |                |        |   |                              |                |
|                 | 318 i Cabrio      | 11.93     | 04.99 |                |        |   |                              |                |       |                |        |   |                              |                |
|                 | 318 i Touring     | 02.95     | 10.99 |                |        |   |                              |                |       |                |        |   |                              |                |
|                 | 318 iS            | 01.92     | 02.98 |                |        |   |                              |                |       |                |        |   |                              |                |
|                 | 318 iS Coupe      | 01.92     | 04.99 |                |        |   |                              |                |       |                |        |   |                              |                |
| 318 tds         | 01.94             | 02.98     |       |                |        |   |                              |                |       |                |        |   |                              |                |
| 318 tds Touring | 10.94             | 10.99     |       |                |        |   |                              |                |       |                |        |   |                              |                |
| 320 i           | 12.90             | 02.98     |       |                |        |   |                              |                |       |                |        |   |                              |                |
| 320 i Cabrio    | 11.93             | 04.99     |       |                |        |   |                              |                |       |                |        |   |                              |                |
| 320 i Coupe     | 01.92             | 04.99     |       |                |        |   |                              |                |       |                |        |   |                              |                |
| 320 i Touring   | 05.94             | 10.99     |       |                |        |   |                              |                |       |                |        |   |                              |                |
| 323 i           | 03.95             | 02.98     |       |                |        |   |                              |                |       |                |        |   |                              |                |
| 323 i Cabrio    | 03.95             | 04.99     |       |                |        |   |                              |                |       |                |        |   |                              |                |
| 323 i Coupe     | 03.95             | 04.99     |       |                |        |   |                              |                |       |                |        |   |                              |                |
| 323 i Touring   | 07.95             | 10.99     |       |                |        |   |                              |                |       |                |        |   |                              |                |
| 325 i           | 12.90             | 02.98     |       |                |        |   |                              |                |       |                |        |   |                              |                |
| 325 i Cabrio    | 08.92             | 03.95     |       |                |        |   |                              |                |       |                |        |   |                              |                |
| 325 i Coupe     | 01.92             | 04.99     |       |                |        |   |                              |                |       |                |        |   |                              |                |
| 325 td          | 09.91             | 02.98     |       |                |        |   |                              |                |       |                |        |   |                              |                |
| 325 tds         | 03.93             | 02.98     |       |                |        |   |                              |                |       |                |        |   |                              |                |
| 325 tds Touring | 10.94             | 10.99     |       |                |        |   |                              |                |       |                |        |   |                              |                |
| 328 i           | 11.94             | 02.98     |       |                |        |   |                              |                |       |                |        |   |                              |                |
| 328 i Cabrio    | 11.94             | 04.99     |       |                |        |   |                              |                |       |                |        |   |                              |                |
| 328 i Coupe     | 11.94             | 04.99     |       |                |        |   |                              |                |       |                |        |   |                              |                |
| 328 i Touring   | 10.94             | 10.99     |       |                |        |   |                              |                |       |                |        |   |                              |                |
| M3              | 06.94             | 02.98     |       |                |        |   |                              |                |       |                |        |   |                              |                |
| M3 Cabrio       | 11.93             | 04.99     |       |                |        |   |                              |                |       |                |        |   |                              |                |
| M3 Coupe        | 03.92             | 04.99     |       |                |        |   |                              |                |       |                |        |   |                              |                |
|                 | 316 g Compact     | 12.95     | 08.00 | 24.3727-0222.2 | 580222 | 2 |                              | L=1740         |       |                |        |   |                              |                |
|                 | 316 i Compact 1.6 | 09.93     | 08.00 |                |        |   |                              |                |       |                |        |   |                              |                |
|                 | 318 tds Compact   | 04.94     | 08.00 |                |        |   |                              |                |       |                |        |   |                              |                |
|                 | 316 g Compact     | 12.95     | 08.00 | 24.3727-0227.2 | 580227 | 2 |                              | L=1683         |       |                |        |   |                              |                |
|                 | 316 i Compact 1.6 | 09.93     | 08.00 |                |        |   |                              |                |       |                |        |   |                              |                |
|                 | 316 i Compact 1.9 | 12.98     | 08.00 |                |        |   |                              |                |       |                |        |   |                              |                |

<sup>1)</sup> on the brake caliper / sulla pinza freno / sur l' étrier de frein / a la pinza de freno

<sup>2)</sup> + authority cars / + enti statali / + véhicule communal / + vehiculos oficiales

<sup>3)</sup> - authority cars / - enti statali / - véhicule communal / - vehiculos oficiales

<sup>4)</sup> - ABS/ - authority cars / - ABS/ - enti statali / - ABS/ - véhicule communal / - ABS/ - vehiculos oficiales

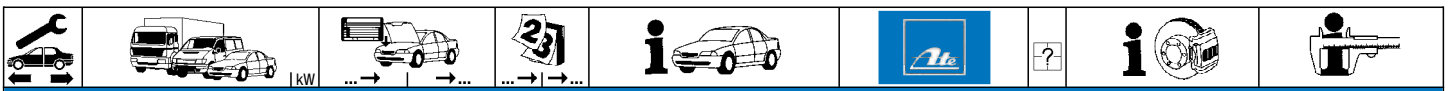

**BMW 3er Reihe/E36 (91-00)**

|  |   |  |   |  |                |        |     |          |
|--|---|--|---|--|----------------|--------|-----|----------|
|  | 318 tds Compact<br>318 ti Compact<br>323 ti Compact   |  | 04.94 08.00<br>04.94 08.00<br>08.97 08.00   |  | 24.3727-0227.2 | 580227 | 2 ↓ | L=1683   |
|  | 316 i<br>316 i Compact 1.6<br>316 i Coupe<br>318 i<br>318 i Cabrio<br>318 iS<br>318 iS Coupe<br>318 tds<br>318 tds Compact<br>318 ti Compact<br>320 i<br>320 i Cabrio<br>320 i Coupe<br>320 i Touring<br>325 i<br>325 i Cabrio<br>325 i Coupe<br>325 td<br>325 tds<br>M3<br>M3 Cabrio<br>M3 Coupe   |  | 12.90 09.94<br>09.93 09.94<br>03.93 09.94<br>12.90 09.94<br>11.93 09.94<br>01.92 09.94<br>01.92 09.94<br>01.94 09.94<br>04.94 09.94<br>04.94 09.94<br>12.90 09.94<br>11.93 09.94<br>01.92 09.94<br>05.94 09.94<br>12.90 09.94<br>11.93 09.94<br>01.92 09.94<br>09.91 09.94<br>03.93 09.94<br>06.94 09.94<br>11.93 09.94<br>03.92 09.94  |  | 24.2419-1702.3 | 030086 |     | Gz 19,05 |
|  | 316 g Compact<br>316 i<br>316 i Compact 1.6<br>316 i Coupe<br>316 i Touring<br>318 i Cabrio<br>318 i Touring<br>318 iS<br>318 iS Coupe<br>318 tds<br>318 tds Compact<br>318 tds Touring<br>318 ti Compact<br>320 i<br>320 i Cabrio<br>320 i Coupe<br>320 i Touring<br>323 i<br>323 i Cabrio<br>323 i Coupe<br>323 i Touring<br>323 ti Compact<br>325 i<br>325 i Cabrio<br>325 i Coupe<br>325 td<br>325 tds<br>325 tds Touring<br>328 i<br>328 i Cabrio<br>328 i Coupe<br>328 i Touring<br>M3<br>M3 Cabrio<br>M3 Coupe |  | 12.95 08.00<br>10.94 02.98<br>10.94 08.00<br>10.94 04.99<br>05.97 10.99<br>10.94 04.99<br>02.95 10.99<br>10.94 02.98<br>10.94 04.99<br>10.94 02.98<br>10.94 08.00<br>10.94 10.99<br>10.94 08.00<br>10.94 02.98<br>10.94 04.99<br>10.94 04.99<br>03.95 02.98<br>03.95 04.99<br>03.95 04.99<br>07.95 10.99<br>08.97 08.00<br>10.94 02.98<br>10.94 03.95<br>10.94 04.99<br>10.94 02.98<br>10.94 02.98<br>10.94 10.99<br>11.94 02.98<br>11.94 04.99<br>11.94 04.99<br>10.94 10.99<br>10.94 02.98<br>10.94 04.99 |  | 24.2419-1718.3 | 030094 |     | Gz 19,05 |
|  | 316 g Compact<br>316 i<br>316 i Compact 1.6<br>316 i Touring<br>318 i<br>318 i Cabrio<br>318 i Touring<br>318 iS<br>318 iS Coupe<br>318 tds<br>318 tds Compact<br>318 tds Touring<br>318 ti Compact<br>320 i<br>320 i Cabrio<br>320 i Coupe<br>320 i Touring<br>323 i<br>323 i Cabrio<br>323 i Coupe<br>323 i Touring<br>323 ti Compact<br>325 i<br>325 i Cabrio<br>325 i Coupe<br>325 td<br>325 tds  |  | 12.95 08.00<br>12.90 02.98<br>09.93 08.00<br>05.97 10.99<br>12.90 02.98<br>11.93 04.99<br>02.95 10.99<br>01.92 02.98<br>01.92 04.99<br>01.94 02.98<br>04.94 08.00<br>10.94 10.99<br>04.94 08.00<br>12.90 02.98<br>11.93 04.99<br>01.92 04.99<br>05.94 10.99<br>03.95 02.98<br>03.95 04.99<br>03.95 04.99<br>07.95 10.99<br>08.97 08.00<br>12.90 02.98<br>08.92 03.95<br>01.92 04.99<br>09.91 02.98<br>03.93 02.98   |  | 24.2520-1701.3 | 040072 |     | Nz 20,64 |





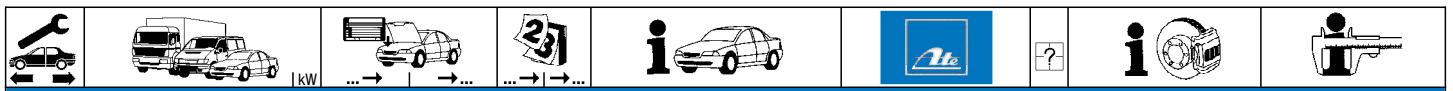

**BMW 3er Reihe/E36 (91-00)**

|                   |                   |               |       |       |                |        |  |  |                                |       |
|-------------------|-------------------|---------------|-------|-------|----------------|--------|--|--|--------------------------------|-------|
|                   | 325 tds Touring   |               | 10.94 | 10.99 | 24.2520-1701.3 | 040072 |  |  | Nz 20,64                       |       |
|                   | 328 i             |               | 11.94 | 02.98 |                |        |  |  |                                |       |
|                   | 328 i Cabrio      |               | 11.94 | 04.99 |                |        |  |  |                                |       |
|                   | 328 i Coupe       |               | 11.94 | 04.99 |                |        |  |  |                                |       |
|                   | 328 i Touring     |               | 10.94 | 10.99 |                |        |  |  |                                |       |
| M3                | M3                |               | 06.94 | 02.98 | 24.2522-0905.3 | 040042 |  |  | Nz 22,20                       |       |
|                   | M3 Cabrio         |               | 11.93 | 04.99 |                |        |  |  |                                |       |
|                   | M3 Coupe          |               | 03.92 | 04.99 |                |        |  |  |                                |       |
|                   | 316 g Compact     |               | 12.95 | 08.00 | 24.5905-0320.3 | 330058 |  |  | ohne Rohrleitung <sup>1)</sup> | L=320 |
|                   | 316 i             |               | 12.90 | 02.98 |                |        |  |  |                                |       |
|                   | 316 i Compact 1.6 |               | 09.93 | 08.00 |                |        |  |  |                                |       |
|                   | 316 i Compact 1.9 |               | 12.98 | 08.00 |                |        |  |  |                                |       |
|                   | 316 i Coupe       |               | 03.93 | 04.99 |                |        |  |  |                                |       |
|                   | 316 i Touring     |               | 05.97 | 10.99 |                |        |  |  |                                |       |
|                   | 318 i             |               | 12.90 | 02.98 |                |        |  |  |                                |       |
|                   | 318 i Cabrio      |               | 11.93 | 04.99 |                |        |  |  |                                |       |
|                   | 318 i Touring     |               | 02.95 | 10.99 |                |        |  |  |                                |       |
|                   | 318 iS Coupe      |               | 01.92 | 04.99 |                |        |  |  |                                |       |
|                   | 318 tds Touring   |               | 10.94 | 10.99 |                |        |  |  |                                |       |
|                   | 318 ti Compact    |               | 04.94 | 08.00 |                |        |  |  |                                |       |
|                   | 320 i             |               | 12.90 | 02.98 |                |        |  |  |                                |       |
|                   | 320 i Cabrio      |               | 11.93 | 02.98 |                |        |  |  |                                |       |
|                   | 320 i Coupe       |               | 01.92 | 02.98 |                |        |  |  |                                |       |
|                   | 320 i Touring     |               | 05.94 | 10.99 |                |        |  |  |                                |       |
|                   | 323 i             |               | 03.95 | 02.98 |                |        |  |  |                                |       |
|                   | 323 i Cabrio      |               | 03.95 | 04.99 |                |        |  |  |                                |       |
|                   | 323 i Coupe       |               | 03.95 | 04.99 |                |        |  |  |                                |       |
|                   | 323 i Touring     |               | 07.95 | 10.99 |                |        |  |  |                                |       |
|                   | 325 i             |               | 12.90 | 02.98 |                |        |  |  |                                |       |
|                   | 325 i Cabrio      |               | 08.92 | 03.95 |                |        |  |  |                                |       |
|                   | 325 i Coupe       |               | 01.92 | 04.99 |                |        |  |  |                                |       |
|                   | 325 td            |               | 09.91 | 02.98 |                |        |  |  |                                |       |
|                   | 325 tds           |               | 03.93 | 02.98 |                |        |  |  |                                |       |
|                   | 328 i             |               | 11.94 | 02.98 |                |        |  |  |                                |       |
|                   | M3                |               | 06.94 | 02.98 |                |        |  |  |                                |       |
|                   | M3 Cabrio         |               | 11.93 | 04.99 |                |        |  |  |                                |       |
|                   | M3 Coupe          |               | 03.92 | 04.94 |                |        |  |  |                                |       |
|                   | <b>DIV</b>        | 316 g Compact |       | 12.95 |                |        |  |  |                                |       |
| 316 i             |                   |               | 12.90 | 02.98 |                |        |  |  |                                |       |
| 316 i Compact 1.6 |                   |               | 09.93 | 08.00 |                |        |  |  |                                |       |
| 316 i Compact 1.9 |                   |               | 12.98 | 08.00 |                |        |  |  |                                |       |
| 316 i Coupe       |                   |               | 03.93 | 04.99 |                |        |  |  |                                |       |
| 316 i Touring     |                   |               | 05.97 | 10.99 |                |        |  |  |                                |       |
| 318 i             |                   |               | 12.90 | 02.98 |                |        |  |  |                                |       |
| 318 i Cabrio      |                   |               | 11.93 | 04.99 |                |        |  |  |                                |       |
| 318 i Touring     |                   |               | 02.95 | 10.99 |                |        |  |  |                                |       |
| 318 iS            |                   |               | 01.92 | 02.98 |                |        |  |  |                                |       |
| 318 iS Coupe      |                   |               | 01.92 | 04.99 |                |        |  |  |                                |       |
| 318 tds           |                   |               | 01.94 | 02.98 |                |        |  |  |                                |       |
| 318 tds Compact   |                   |               | 04.94 | 08.00 |                |        |  |  |                                |       |
| 318 tds Touring   |                   |               | 10.94 | 10.99 |                |        |  |  |                                |       |
| 318 ti Compact    |                   |               | 04.94 | 08.00 |                |        |  |  |                                |       |
| 320 i             |                   |               | 12.90 | 02.98 |                |        |  |  |                                |       |
| 320 i Cabrio      |                   |               | 11.93 | 04.99 |                |        |  |  |                                |       |
| 320 i Coupe       |                   |               | 01.92 | 04.99 |                |        |  |  |                                |       |
| 320 i Touring     |                   |               | 05.94 | 10.99 |                |        |  |  |                                |       |
| 323 i             |                   |               | 03.95 | 02.98 |                |        |  |  |                                |       |
| 323 i Cabrio      |                   |               | 03.95 | 04.99 |                |        |  |  |                                |       |
| 323 i Coupe       |                   |               | 03.95 | 04.99 |                |        |  |  |                                |       |
| 323 i Touring     |                   |               | 07.95 | 10.99 |                |        |  |  |                                |       |
| 323 ti Compact    |                   |               | 08.97 | 08.00 |                |        |  |  |                                |       |
| 325 i             |                   |               | 12.90 | 02.98 |                |        |  |  |                                |       |
| 325 i Cabrio      |                   |               | 08.92 | 03.95 |                |        |  |  |                                |       |
| 325 i Coupe       |                   |               | 01.92 | 04.99 |                |        |  |  |                                |       |
| 325 td            |                   |               | 09.91 | 02.98 |                |        |  |  |                                |       |
| 325 tds           |                   |               | 03.93 | 02.98 |                |        |  |  |                                |       |
| 325 tds Touring   |                   |               | 10.94 | 10.99 |                |        |  |  |                                |       |
| 328 i             |                   | 11.94         | 02.98 |       |                |        |  |  |                                |       |
| 328 i Cabrio      |                   | 11.94         | 04.99 |       |                |        |  |  |                                |       |
| 328 i Coupe       |                   | 11.94         | 04.99 |       |                |        |  |  |                                |       |
| 328 i Touring     |                   | 10.94         | 10.99 |       |                |        |  |  |                                |       |

**BMW 3er Reihe/E46 (98-06)**

|  |                |     |       |       |                |        |  |  |     |     |
|--|----------------|-----|-------|-------|----------------|--------|--|--|-----|-----|
|  | 316 i          |     | 12.98 | 02.05 | 03.7860-0702.4 | 300123 |  |  | 10" | ATE |
|  | 316 i 1.9      | 77  | 12.98 | 02.05 |                |        |  |  |     |     |
|  | 316 i Coupe    |     | 04.00 | 08.06 |                |        |  |  |     |     |
|  | 316 i Touring  | 85  | 03.02 | 07.05 |                |        |  |  |     |     |
|  | 316 ti Compact | 85  | 07.01 | 02.05 |                |        |  |  |     |     |
|  | 318 Ci Cabrio  | 105 | 09.01 | 12.06 |                |        |  |  |     |     |
|  | 318 Ci Cabrio  | 110 | 02.05 | 12.06 |                |        |  |  |     |     |
|  | 318 d          | 85  | 09.01 | 02.05 |                |        |  |  |     |     |
|  | 318 d Touring  | 85  | 03.02 | 07.05 |                |        |  |  |     |     |
|  | 318 i          |     | 04.98 | 02.05 |                |        |  |  |     |     |
|  | 318 i Coupe    |     | 08.99 | 08.06 |                |        |  |  |     |     |
|  | 318 i Touring  |     | 10.99 | 07.05 |                |        |  |  |     |     |
|  | 318 td Compact |     | 03.03 | 02.05 |                |        |  |  |     |     |
|  | 318 ti Compact |     | 09.01 | 02.05 |                |        |  |  |     |     |

<sup>1)</sup> without pipe line / senza tubazione / sans conduite de frein rigide / sin latiguillo

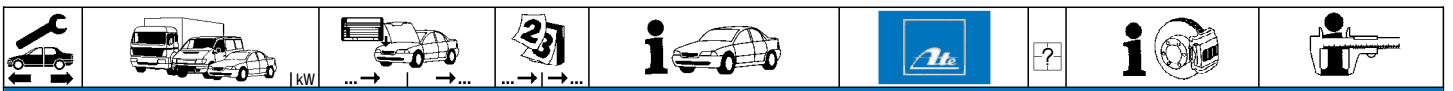

**BMW 3er Reihe/E46 (98-06)**

|  |                |     |  |       |       |       |                |        |  |  |                 |     |
|--|----------------|-----|--|-------|-------|-------|----------------|--------|--|--|-----------------|-----|
|  | 320 Cd Cabrio  | 110 |  | 02.05 | 12.06 |       | 03.7860-0702.4 | 300123 |  |  | 10"             | ATE |
|  | 320 Cd Coupe   | 110 |  | 11.03 | 08.06 |       |                |        |  |  |                 |     |
|  | 320 Ci Cabrio  | 125 |  | 10.00 | 12.06 |       |                |        |  |  |                 |     |
|  | 320 Ci Coupe   |     |  | 06.99 | 08.06 |       |                |        |  |  |                 |     |
|  | 320 d          | 100 |  | 04.98 | 09.01 |       |                |        |  |  |                 |     |
|  | 320 d          | 110 |  | 09.01 | 02.05 |       |                |        |  |  |                 |     |
|  | 320 d Touring  |     |  | 03.00 | 07.05 |       |                |        |  |  |                 |     |
|  | 320 i          | 110 |  | 04.98 | 09.00 |       |                |        |  |  |                 |     |
|  | 320 i          | 125 |  | 09.00 | 02.05 |       |                |        |  |  |                 |     |
|  | 320 i Touring  |     |  | 10.99 | 07.05 |       |                |        |  |  |                 |     |
|  | 320 td Compact |     |  | 09.01 | 02.05 |       |                |        |  |  |                 |     |
|  | 323 Ci Cabrio  | 125 |  | 05.00 | 08.00 |       |                |        |  |  |                 |     |
|  | 323 Ci Coupe   | 125 |  | 04.99 | 08.00 |       |                |        |  |  |                 |     |
|  | 323 i          | 125 |  | 04.98 | 08.00 |       |                |        |  |  |                 |     |
|  | 325 Ci Cabrio  | 141 |  | 10.00 | 12.06 |       |                |        |  |  |                 |     |
|  | 325 Ci Coupe   | 141 |  | 10.00 | 08.06 |       |                |        |  |  |                 |     |
|  | 325 i          | 141 |  | 10.00 | 02.05 |       |                |        |  |  |                 |     |
|  | 325 i Touring  | 141 |  | 10.00 | 07.05 |       |                |        |  |  |                 |     |
|  | 325 ti Compact | 141 |  | 07.01 | 02.05 |       |                |        |  |  |                 |     |
|  | 325 xi         | 141 |  | 10.00 | 02.05 |       |                |        |  |  |                 |     |
|  | 325 xi Touring | 141 |  | 10.00 | 07.05 |       |                |        |  |  |                 |     |
|  | 328 Ci Coupe   | 142 |  | 04.99 | 06.00 |       |                |        |  |  |                 |     |
|  | 328 i          | 142 |  | 04.98 | 06.00 |       |                |        |  |  |                 |     |
|  | 328 i Touring  | 142 |  | 10.99 | 06.00 |       |                |        |  |  |                 |     |
|  | 330 Cd Cabrio  | 150 |  | 05.05 | 12.06 |       |                |        |  |  |                 |     |
|  | 330 Cd Coupe   | 150 |  | 03.03 | 08.06 |       |                |        |  |  |                 |     |
|  | 330 Ci Cabrio  | 170 |  | 09.00 | 12.06 |       |                |        |  |  |                 |     |
|  | 330 Ci Coupe   | 170 |  | 09.00 | 12.06 |       |                |        |  |  |                 |     |
|  | 330 d          |     |  | 10.99 | 02.05 |       |                |        |  |  |                 |     |
|  | 330 d Touring  |     |  | 03.00 | 07.05 |       |                |        |  |  |                 |     |
|  | 330 i          | 168 |  | 01.01 | 04.05 |       |                |        |  |  |                 |     |
|  | 330 i          | 170 |  | 09.00 | 02.05 |       |                |        |  |  |                 |     |
|  | 330 i Touring  | 170 |  | 06.00 | 07.05 |       |                |        |  |  |                 |     |
|  | 330 xd         |     |  | 10.99 | 02.05 |       |                |        |  |  |                 |     |
|  | 330 xd Touring |     |  | 03.00 | 07.05 |       |                |        |  |  |                 |     |
|  | 330 xi         | 170 |  | 09.00 | 02.05 |       |                |        |  |  |                 |     |
|  | 330 xi Touring | 170 |  | 09.00 | 07.05 |       |                |        |  |  |                 |     |
|  | 316 i          |     |  | 12.98 | 08.01 | - DSC | 03.2022-2624.3 | 010588 |  |  | THz 22,20/20,64 | ATE |
|  | 316 i 1.9      | 77  |  | 12.98 | 08.01 | - DSC |                |        |  |  |                 |     |
|  | 316 i Coupe    |     |  | 04.00 | 08.01 | - DSC |                |        |  |  |                 |     |
|  | 318 i          |     |  | 04.98 | 08.01 | - DSC |                |        |  |  |                 |     |
|  | 318 i Coupe    |     |  | 08.99 | 08.01 | - DSC |                |        |  |  |                 |     |
|  | 318 i Touring  |     |  | 10.99 | 08.01 | - DSC |                |        |  |  |                 |     |
|  | 320 d          | 100 |  | 04.98 | 08.01 | - DSC |                |        |  |  |                 |     |
|  | 320 d Touring  |     |  | 03.00 | 08.01 | - DSC |                |        |  |  |                 |     |
|  | 320 i          | 110 |  | 04.98 | 09.00 | - DSC |                |        |  |  |                 |     |
|  | 320 i          | 125 |  | 09.00 | 08.01 | - DSC |                |        |  |  |                 |     |
|  | 320 i Touring  |     |  | 10.99 | 08.01 | - DSC |                |        |  |  |                 |     |
|  | 323 Ci Cabrio  | 125 |  | 05.00 | 08.00 | - DSC |                |        |  |  |                 |     |
|  | 323 Ci Coupe   | 125 |  | 04.99 | 08.00 | - DSC |                |        |  |  |                 |     |
|  | 323 i          | 125 |  | 04.98 | 08.00 | - DSC |                |        |  |  |                 |     |
|  | 328 Ci Coupe   | 142 |  | 04.99 | 06.00 | - DSC |                |        |  |  |                 |     |
|  | 328 i          | 142 |  | 04.98 | 06.00 | - DSC |                |        |  |  |                 |     |
|  | 328 i Touring  | 142 |  | 10.99 | 06.00 | - DSC |                |        |  |  |                 |     |
|  | 316 i          |     |  | 09.01 | 02.05 | - DSC | 03.2023-2344.3 | 010647 |  |  | THz 23,81/22,20 | ATE |
|  | 316 i 1.9      | 77  |  | 09.01 | 02.05 | - DSC |                |        |  |  |                 |     |
|  | 316 i Coupe    |     |  | 09.01 | 08.06 | - DSC |                |        |  |  |                 |     |
|  | 316 i Touring  | 85  |  | 03.02 | 07.05 | - DSC |                |        |  |  |                 |     |
|  | 316 ti Compact | 85  |  | 07.01 | 02.05 | - DSC |                |        |  |  |                 |     |
|  | 318 Ci Cabrio  | 105 |  | 09.01 | 12.06 | - DSC |                |        |  |  |                 |     |
|  | 318 d          | 85  |  | 09.01 | 02.05 | - DSC |                |        |  |  |                 |     |
|  | 318 d Touring  | 85  |  | 03.02 | 07.05 | - DSC |                |        |  |  |                 |     |
|  | 318 i          |     |  | 09.01 | 02.05 | - DSC |                |        |  |  |                 |     |
|  | 318 i Coupe    |     |  | 09.01 | 08.06 | - DSC |                |        |  |  |                 |     |
|  | 318 i Touring  |     |  | 09.01 | 07.05 | - DSC |                |        |  |  |                 |     |
|  | 318 ti Compact |     |  | 09.01 | 08.06 | - DSC |                |        |  |  |                 |     |
|  | 320 d          | 110 |  | 09.01 | 02.05 | - DSC |                |        |  |  |                 |     |
|  | 320 d Touring  |     |  | 09.01 | 07.05 | - DSC |                |        |  |  |                 |     |
|  | 320 i          | 125 |  | 09.01 | 02.05 | - DSC |                |        |  |  |                 |     |
|  | 320 i Touring  |     |  | 09.01 | 07.05 | - DSC |                |        |  |  |                 |     |
|  | 320 td Compact |     |  | 09.01 | 08.06 | - DSC |                |        |  |  |                 |     |
|  | 325 ti Compact | 141 |  | 07.01 | 08.06 | - DSC |                |        |  |  |                 |     |
|  | 320 Ci Cabrio  | 125 |  | 10.00 | 12.06 | - DSC | 03.2023-2304.3 | 010646 |  |  | THz 23,81/22,20 | ATE |
|  | 325 Ci Cabrio  | 141 |  | 10.00 | 12.06 | - DSC |                |        |  |  |                 |     |
|  | 325 Ci Coupe   | 141 |  | 10.00 | 08.06 | - DSC |                |        |  |  |                 |     |
|  | 325 i          | 141 |  | 10.00 | 02.05 | - DSC |                |        |  |  |                 |     |
|  | 325 i Touring  | 141 |  | 10.00 | 07.05 | - DSC |                |        |  |  |                 |     |
|  | 330 Ci Cabrio  | 170 |  | 09.00 | 12.06 | - DSC |                |        |  |  |                 |     |
|  | 330 Ci Coupe   | 170 |  | 09.00 | 08.06 | - DSC |                |        |  |  |                 |     |
|  | 330 d          |     |  | 10.99 | 02.05 | - DSC |                |        |  |  |                 |     |
|  | 330 d Touring  |     |  | 03.00 | 07.05 | - DSC |                |        |  |  |                 |     |
|  | 330 i          | 168 |  | 01.01 | 04.05 | - DSC |                |        |  |  |                 |     |
|  | 330 i          | 170 |  | 09.00 | 02.05 | - DSC |                |        |  |  |                 |     |
|  | 330 i Touring  | 170 |  | 06.00 | 07.05 | - DSC |                |        |  |  |                 |     |
|  | 330 xd         |     |  | 10.99 | 02.05 | - DSC |                |        |  |  |                 |     |
|  | 330 xd Touring |     |  | 03.00 | 07.05 | - DSC |                |        |  |  |                 |     |
|  | 316 i          |     |  | 12.98 | 08.00 | + DSC | 03.2022-2829.3 | 010589 |  |  | THz 22,20/20,64 | ATE |



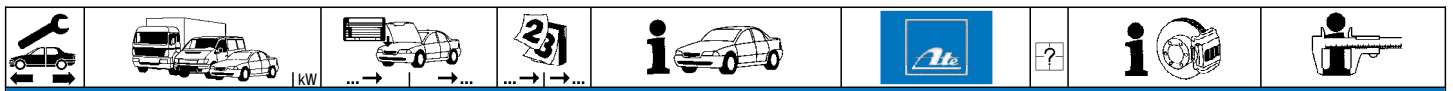

















**BMW 3er Reihe/E46 (98-06)**

|  |                |     |  |       |       |                               |                |        |   |  |                 |     |
|--|----------------|-----|--|-------|-------|-------------------------------|----------------|--------|---|--|-----------------|-----|
|  | 316 i 1.9      | 77  |  | 12.98 | 08.00 | + DSC                         | 03.2022-2829.3 | 010589 |   |  | THz 22,20/20,64 | ATE |
|  | 316 i Coupe    |     |  | 04.00 | 08.00 | + DSC                         |                |        |   |  |                 |     |
|  | 318 i          |     |  | 04.98 | 08.00 | + DSC                         |                |        |   |  |                 |     |
|  | 318 i Coupe    |     |  | 08.99 | 08.00 | + DSC                         |                |        |   |  |                 |     |
|  | 318 i Touring  |     |  | 10.99 | 08.00 | + DSC                         |                |        |   |  |                 |     |
|  | 320 Ci Coupe   |     |  | 06.99 | 08.00 | + DSC                         |                |        |   |  |                 |     |
|  | 320 d          | 100 |  | 04.98 | 08.00 | + DSC                         |                |        |   |  |                 |     |
|  | 320 d Touring  |     |  | 03.00 | 08.00 | + DSC                         |                |        |   |  |                 |     |
|  | 320 i          | 110 |  | 04.98 | 09.00 | + DSC                         |                |        |   |  |                 |     |
|  | 323 Ci Cabrio  | 125 |  | 05.00 | 08.00 | + DSC                         |                |        |   |  |                 |     |
|  | 323 Ci Coupe   | 125 |  | 04.99 | 08.00 | + DSC                         |                |        |   |  |                 |     |
|  | 323 i          | 125 |  | 04.98 | 08.00 | + DSC                         |                |        |   |  |                 |     |
|  | 328 Ci Coupe   | 142 |  | 04.99 | 06.00 | + DSC                         |                |        |   |  |                 |     |
|  | 328 i          | 142 |  | 04.98 | 06.00 | + DSC                         |                |        |   |  |                 |     |
|  | 328 i Touring  | 142 |  | 10.99 | 06.00 | + DSC                         |                |        |   |  |                 |     |
|  | 316 i          |     |  | 02.01 | 02.05 | + DSC                         | 03.2023-2256.3 | 010870 |   |  | THz 23,81/22,20 | ATE |
|  | 316 i 1.9      | 77  |  | 02.01 | 02.05 | + DSC                         |                |        |   |  |                 |     |
|  | 316 i Coupe    |     |  | 02.01 | 08.06 | + DSC                         |                |        |   |  |                 |     |
|  | 316 i Touring  |     |  | 03.02 | 07.05 | + DSC                         |                |        |   |  |                 |     |
|  | 316 ti Compact | 85  |  | 07.01 | 02.05 | + DSC                         |                |        |   |  |                 |     |
|  | 318 Ci Cabrio  | 105 |  | 09.01 | 12.06 | + DSC                         |                |        |   |  |                 |     |
|  | 318 Ci Cabrio  | 110 |  | 02.05 | 12.06 | + DSC                         |                |        |   |  |                 |     |
|  | 318 d          | 85  |  | 09.01 | 02.05 | + DSC                         |                |        |   |  |                 |     |
|  | 318 d Touring  | 85  |  | 03.02 | 07.05 | + DSC                         |                |        |   |  |                 |     |
|  | 318 i          |     |  | 02.01 | 02.05 | + DSC                         |                |        |   |  |                 |     |
|  | 318 i Coupe    |     |  | 02.01 | 08.06 | + DSC                         |                |        |   |  |                 |     |
|  | 318 i Touring  |     |  | 02.01 | 07.05 | + DSC                         |                |        |   |  |                 |     |
|  | 318 td Compact |     |  | 03.03 | 02.05 | + DSC                         |                |        |   |  |                 |     |
|  | 318 ti Compact |     |  | 09.01 | 02.05 | + DSC                         |                |        |   |  |                 |     |
|  | 320 Cd Cabrio  | 110 |  | 02.05 | 12.06 | + DSC                         |                |        |   |  |                 |     |
|  | 320 Cd Coupe   | 110 |  | 11.03 | 08.06 | + DSC                         |                |        |   |  |                 |     |
|  | 320 Ci Coupe   |     |  | 02.01 | 08.06 | + DSC                         |                |        |   |  |                 |     |
|  | 320 d          | 100 |  | 02.01 | 09.01 | + DSC                         |                |        |   |  |                 |     |
|  | 320 d          | 110 |  | 09.01 | 02.05 | + DSC                         |                |        |   |  |                 |     |
|  | 320 d Touring  |     |  | 02.01 | 07.05 | + DSC                         |                |        |   |  |                 |     |
|  | 320 i          | 125 |  | 09.00 | 02.05 | + DSC                         |                |        |   |  |                 |     |
|  | 320 td Compact |     |  | 09.01 | 02.05 | + DSC                         |                |        |   |  |                 |     |
|  | 325 ti Compact | 141 |  | 07.01 | 02.05 | + DSC                         |                |        |   |  |                 |     |
|  | 330 Cd Cabrio  | 150 |  | 05.05 | 12.06 | + DSC                         |                |        |   |  |                 |     |
|  | 330 Cd Coupe   | 150 |  | 03.03 | 08.06 | + DSC                         |                |        |   |  |                 |     |
|  | 320 Ci Cabrio  | 125 |  | 10.00 | 12.06 | + DSC                         | 03.2023-2204.3 | 010644 |   |  | THz 23,81/22,20 | ATE |
|  | 325 Ci Cabrio  | 141 |  | 10.00 | 12.06 | + DSC                         |                |        |   |  |                 |     |
|  | 325 Ci Coupe   | 141 |  | 10.00 | 08.06 | + DSC                         |                |        |   |  |                 |     |
|  | 325 i          | 141 |  | 10.00 | 02.05 | + DSC                         |                |        |   |  |                 |     |
|  | 325 i Touring  | 141 |  | 10.00 | 07.05 | + DSC                         |                |        |   |  |                 |     |
|  | 330 Ci Cabrio  | 170 |  | 09.00 | 12.06 | + DSC                         |                |        |   |  |                 |     |
|  | 330 Ci Coupe   | 170 |  | 09.00 | 08.06 | + DSC                         |                |        |   |  |                 |     |
|  | 330 d          |     |  | 10.99 | 02.05 | + DSC                         |                |        |   |  |                 |     |
|  | 330 d Touring  |     |  | 03.00 | 07.05 | + DSC                         |                |        |   |  |                 |     |
|  | 330 i          | 168 |  | 01.01 | 04.05 | + DSC                         |                |        |   |  |                 |     |
|  | 330 i          | 170 |  | 09.00 | 02.05 | + DSC                         |                |        |   |  |                 |     |
|  | 330 i Touring  | 170 |  | 06.00 | 07.05 | + DSC                         |                |        |   |  |                 |     |
|  | 330 xd         |     |  | 10.99 | 02.05 | + DSC                         |                |        |   |  |                 |     |
|  | 330 xd Touring |     |  | 03.00 | 07.05 | + DSC                         |                |        |   |  |                 |     |
|  | 325 xi         | 141 |  | 10.00 | 02.05 |                               | 03.2023-2233.3 | 010891 |   |  | THz 23,81/22,20 | ATE |
|  | 325 xi Touring | 141 |  | 10.00 | 07.05 |                               |                |        |   |  |                 |     |
|  | 330 xi         | 170 |  | 09.00 | 02.05 |                               |                |        |   |  |                 |     |
|  | 330 xi Touring | 170 |  | 09.00 | 07.05 |                               |                |        |   |  |                 |     |
|  | 316 i          |     |  | 12.98 | 02.05 |                               | 11.9541-9587.2 | 220419 | ☐ |  | D=54, - Halter  | ATE |
|  | 316 i 1.9      | 77  |  | 12.98 | 02.05 |                               | 11.9541-9588.2 | 220420 | ☐ |  | D=54, - Halter  | ATE |
|  | 316 i Coupe    |     |  | 04.00 | 08.06 |                               | 24.3541-9587.5 | 240527 | ☐ |  | D=54, - Halter  | ATE |
|  | 316 i Touring  | 85  |  | 03.02 | 07.05 |                               | 24.3541-9588.5 | 240528 | ☐ |  | D=54, - Halter  | ATE |
|  | 316 ti Compact | 85  |  | 07.01 | 02.05 |                               | 11.0441-5402.2 | 250028 |   |  | Dichtungssatz   | ATE |
|  | 318 Ci Cabrio  | 105 |  | 09.01 | 12.06 |                               | 11.8170-0729.1 | 260107 | 2 |  | Halter          | ATE |
|  | 318 Ci Cabrio  | 110 |  | 02.05 | 12.06 |                               | 11.0101-5402.2 | 260009 |   |  | Hülzensatz      | ATE |
|  | 318 d          | 85  |  | 09.01 | 02.05 |                               | 11.8171-0008.1 | 990049 |   |  | Führungsbolzen  | ATE |
|  | 318 d Touring  | 85  |  | 03.02 | 07.05 | - Behörde 1)                  | 11.8116-0109.1 | 390495 | 2 |  | Haltefeder      | ATE |
|  | 318 i          |     |  | 04.98 | 02.05 | - Behörde 1)                  |                |        |   |  |                 |     |
|  | 318 i Coupe    |     |  | 08.99 | 08.06 |                               |                |        |   |  |                 |     |
|  | 318 i Touring  |     |  | 10.99 | 07.05 | - Behörde 1)                  |                |        |   |  |                 |     |
|  | 318 td Compact |     |  | 03.03 | 02.05 |                               |                |        |   |  |                 |     |
|  | 318 ti Compact |     |  | 09.01 | 02.05 |                               |                |        |   |  |                 |     |
|  | 320 Ci Coupe   |     |  | 06.99 | 08.06 |                               |                |        |   |  |                 |     |
|  | 320 d          | 100 |  | 04.98 | 09.01 |                               |                |        |   |  |                 |     |
|  | 320 d Touring  |     |  | 03.00 | 07.05 | - Behörde 1)                  |                |        |   |  |                 |     |
|  | 320 i          | 110 |  | 04.98 | 09.00 | - Behörde 1)                  |                |        |   |  |                 |     |
|  | 320 i          | 125 |  | 09.00 | 02.05 | - Behörde 1)                  |                |        |   |  |                 |     |
|  | 320 i Touring  |     |  | 10.99 | 07.05 | - Behörde/ + Motorcode M52 2) |                |        |   |  |                 |     |
|  | 323 Ci Cabrio  | 125 |  | 05.00 | 08.00 |                               |                |        |   |  |                 |     |
|  | 323 Ci Coupe   | 125 |  | 04.99 | 08.00 |                               |                |        |   |  |                 |     |
|  | 323 i          | 125 |  | 04.98 | 08.00 |                               |                |        |   |  |                 |     |

1) - authority cars / - enti statali / - véhicule communal / - vehiculos oficiales

2) - authority cars/+engine co.M52 / - enti statali/+codice mot.M52 / - véhicule communal/+moteur co.M52 / - vehiculos oficiales/+motor co.M52

|          |                |     |       |       |  |                |        |   |  |                |     |
|--|----------------|-----|-------|-------|--|----------------|--------|---|--|----------------|-----|
| BMW 3er Reihe/E46 (98-06)  |                |     |       |       |  |                |        |   |  |                |     |
|    | 318 d Touring  | 85  | 03.02 | 07.05 | + Behörde <sup>1)</sup>                  | 11.9541-9587.2 | 220419 |  |  | D=54, - Halter | ATE |
|  | 318 i          |     | 04.98 | 02.05 | + Behörde <sup>1)</sup>                  | 11.9541-9588.2 | 220420 |  |  | D=54, - Halter | ATE |
|  | 318 i Touring  |     | 10.99 | 07.05 |  | 24.3541-9587.5 | 240527 |  |  | D=54, - Halter | ATE |
|  | 320 Cd Cabrio  | 110 | 02.05 | 12.06 |  | 24.3541-9588.5 | 240528 |  |  | D=54, - Halter | ATE |
|  | 320 Cd Coupe   | 110 | 11.03 | 08.06 |  | 11.0441-5402.2 | 250028 |   |  | Dichtungssatz  | ATE |
|  | 320 Ci Cabrio  | 125 | 10.00 | 12.06 |  | 11.0230-0234.2 | 260084 |   |  | Haltersatz     | ATE |
|  | 320 d          | 110 | 09.01 | 02.05 |  | 11.0101-5402.2 | 260009 |   |  | Hülzensatz     | ATE |
|  | 320 d Touring  |     | 03.00 | 07.05 | + Behörde <sup>1)</sup>                  | 11.8171-0008.1 | 990049 |   |  | Führungsbolzen | ATE |
|  | 320 i          | 110 | 04.98 | 09.00 | + Behörde <sup>1)</sup>                  | 11.8116-0109.1 | 390495 | 2   |  | Haltefeder     | ATE |
|  | 320 i          | 125 | 09.00 | 02.05 | + Behörde <sup>1)</sup>                  |                |        |   |  |                |     |
|  | 320 i Touring  |     | 10.99 | 07.05 | + Motorcode M54 <sup>2)</sup>            |                |        |   |  |                |     |
|  | 320 i Touring  |     | 10.99 | 07.05 | + Behörde/ + Motorcode M52 <sup>3)</sup> |                |        |   |  |                |     |
|  | 320 td Compact |     | 09.01 | 02.05 |  |                |        |   |  |                |     |
|  | 325 Ci Cabrio  | 141 | 10.00 | 12.06 |  |                |        |   |  |                |     |
|  | 325 Ci Coupe   | 141 | 10.00 | 08.06 |  |                |        |   |  |                |     |
|  | 325 i          | 141 | 10.00 | 02.05 | - Behörde <sup>4)</sup>                  |                |        |   |  |                |     |
|  | 325 i Touring  | 141 | 10.00 | 07.05 |  |                |        |   |  |                |     |
|  | 325 ti Compact | 141 | 07.01 | 02.05 |  |                |        |   |  |                |     |
|  | 325 xi         | 141 | 10.00 | 02.05 | - Behörde <sup>4)</sup>                  |                |        |   |  |                |     |
|  | 325 xi Touring | 141 | 10.00 | 07.05 |  |                |        |   |  |                |     |
|  | 328 Ci Coupe   | 142 | 04.99 | 06.00 |  |                |        |   |  |                |     |
|  | 328 i          | 142 | 04.98 | 06.00 |  |                |        |   |  |                |     |
|  | 328 i Touring  | 142 | 10.99 | 06.00 |  |                |        |   |  |                |     |
|  | 325 i          | 141 | 10.00 | 02.05 | + Behörde <sup>1)</sup>                  | 24.3571-1733.5 | 240349 |  |  | D=57, - Halter | ATE |
|  | 325 xi         | 141 | 10.00 | 02.05 | + Behörde <sup>1)</sup>                  | 24.3571-1734.5 | 240350 |  |  | D=57, - Halter | ATE |
|  | 330 Cd Cabrio  | 150 | 05.05 | 12.06 |  | 11.0101-5402.2 | 260009 |   |  | Hülzensatz     | ATE |
|  | 330 Cd Coupe   | 150 | 03.03 | 08.06 |  | 11.8171-0008.1 | 990049 |   |  | Führungsbolzen | ATE |
|  | 330 Ci Cabrio  | 170 | 09.00 | 12.06 |  | 11.8116-0273.1 | 390515 | 2   |  | Haltefeder     | ATE |
|  | 330 Ci Coupe   | 170 | 09.00 | 08.06 |  |                |        |   |  |                |     |
|  | 330 d          | 170 | 10.99 | 02.05 |  |                |        |   |  |                |     |
|  | 330 d Touring  |     | 03.00 | 07.05 |  |                |        |   |  |                |     |
|  | 330 i          | 168 | 01.01 | 04.05 |  |                |        |   |  |                |     |
|  | 330 i          | 170 | 09.00 | 02.05 |  |                |        |   |  |                |     |
|  | 330 i Touring  | 170 | 06.00 | 07.05 |  |                |        |   |  |                |     |
|  | 330 xd         |     | 10.99 | 02.05 |  |                |        |   |  |                |     |
|  | 330 xd Touring |     | 03.00 | 07.05 |  |                |        |   |  |                |     |
|  | 330 xi         | 170 | 09.00 | 02.05 |  |                |        |   |  |                |     |
|  | 330 xi Touring | 170 | 09.00 | 07.05 |  |                |        |   |  |                |     |
|  | M3 Cabrio      | 252 | 05.01 | 12.06 |  | 11.0441-6003.2 | 250037 |   |  | Dichtungssatz  |     |
|  | M3 Coupe       | 252 | 06.00 | 08.06 |  | 11.0101-5402.2 | 260009 |   |  | Hülzensatz     | ATE |
|  |                |     |       |       |  | 11.8171-0008.1 | 990049 |   |  | Führungsbolzen | ATE |
|  |                |     |       |       |  | 11.8116-0083.1 | 390501 | 2   |  | Haltefeder     | ATE |
|  | M3 CSL Coupe   | 265 | 05.03 | 08.06 |  | 11.0441-6003.2 | 250037 |   |  | Dichtungssatz  |     |
|  |                |     |       |       |  | 11.0101-5402.2 | 260009 |   |  | Hülzensatz     | ATE |
|  |                |     |       |       |  | 11.8171-0008.1 | 990049 |   |  | Führungsbolzen | ATE |
|  |                |     |       |       |  | 11.8116-0083.1 | 390501 | 2   |  | Haltefeder     | ATE |
|    | 316 i          |     | 12.98 | 02.05 |  | 83.6152-0406.3 | 330789 | 2   |  | L=405          |     |
|  | 316 i 1.9      | 77  | 12.98 | 02.05 |  |                |        |   |  |                |     |
|  | 316 i Coupe    |     | 04.00 | 08.06 |  |                |        |   |  |                |     |
|  | 316 i Touring  | 85  | 03.02 | 07.05 |  |                |        |   |  |                |     |
|  | 316 ti Compact | 85  | 07.01 | 02.05 |  |                |        |   |  |                |     |
|  | 318 Ci Cabrio  | 105 | 09.01 | 12.06 |  |                |        |   |  |                |     |
|  | 318 Ci Cabrio  | 110 | 02.05 | 12.06 |  |                |        |   |  |                |     |
|  | 318 d          | 85  | 09.01 | 02.05 |  |                |        |   |  |                |     |
|  | 318 d Touring  | 85  | 03.02 | 07.05 |  |                |        |   |  |                |     |
|  | 318 i          |     | 04.98 | 02.05 |  |                |        |   |  |                |     |
|  | 318 i Coupe    |     | 08.99 | 08.06 |  |                |        |   |  |                |     |
|  | 318 i Touring  |     | 10.99 | 07.05 |  |                |        |   |  |                |     |
|  | 318 td Compact |     | 03.03 | 02.05 |  |                |        |   |  |                |     |
|  | 318 ti Compact |     | 09.01 | 02.05 |  |                |        |   |  |                |     |
|  | 320 Cd Cabrio  | 110 | 02.05 | 12.06 |  |                |        |   |  |                |     |
|  | 320 Cd Coupe   | 110 | 11.03 | 08.06 |  |                |        |   |  |                |     |
|  | 320 Ci Cabrio  | 125 | 10.00 | 12.06 |  |                |        |   |  |                |     |
|  | 320 Ci Coupe   |     | 06.99 | 08.06 |  |                |        |   |  |                |     |
|  | 320 d          | 100 | 04.98 | 09.01 |  |                |        |   |  |                |     |
|  | 320 d          | 110 | 09.01 | 02.05 |  |                |        |   |  |                |     |
|  | 320 d Touring  |     | 03.00 | 07.05 |  |                |        |   |  |                |     |
|  | 320 i          | 110 | 04.98 | 09.00 |  |                |        |   |  |                |     |
|  | 320 i          | 125 | 09.00 | 02.05 |  |                |        |   |  |                |     |
|  | 320 i Touring  |     | 10.99 | 07.05 |  |                |        |   |  |                |     |
|  | 320 td Compact |     | 09.01 | 02.05 |  |                |        |   |  |                |     |
|  | 323 Ci Cabrio  | 125 | 05.00 | 08.00 |  |                |        |   |  |                |     |
|  | 323 Ci Coupe   | 125 | 04.99 | 08.00 |  |                |        |   |  |                |     |
|  | 323 i          | 125 | 04.98 | 08.00 |  |                |        |   |  |                |     |
|  | 325 Ci Cabrio  | 141 | 10.00 | 12.06 |  |                |        |   |  |                |     |
|  | 325 Ci Coupe   | 141 | 10.00 | 08.06 |  |                |        |   |  |                |     |
|  | 325 i          | 141 | 10.00 | 02.05 |  |                |        |   |  |                |     |
|  | 325 i Touring  | 141 | 10.00 | 07.05 |  |                |        |   |  |                |     |
|  | 325 ti Compact | 141 | 07.01 | 02.05 |  |                |        |   |  |                |     |
|  | 328 Ci Coupe   | 142 | 04.99 | 06.00 |  |                |        |   |  |                |     |
|  | 328 i          | 142 | 04.98 | 06.00 |  |                |        |   |  |                |     |
|  | 328 i Touring  | 142 | 10.99 | 06.00 |  |                |        |   |  |                |     |
|  | 330 Cd Cabrio  | 150 | 05.05 | 12.06 |  |                |        |   |  |                |     |
|  | 330 Cd Coupe   | 150 | 03.03 | 08.06 |  |                |        |   |  |                |     |
|  | 330 Ci Cabrio  | 170 | 09.00 | 12.06 |  |                |        |   |  |                |     |
|  | 330 Ci Coupe   | 170 | 09.00 | 08.06 |  |                |        |   |  |                |     |
|  | 330 d          |     | 10.99 | 02.05 |  |                |        |   |  |                |     |

<sup>1)</sup> + authority cars / + enti statali / + véhicule communal / + vehiculos oficiales

<sup>2)</sup> + engine code M54 / + codice motore M54 / + moteur code M54 / + motor code M54

<sup>3)</sup> + authority cars / + engine no.M52 / + enti statali / + codice mot.M52 / + véhicule communal / + moteur co.M52 / + vehiculos oficiales / + motor co.M52

<sup>4)</sup> - authority cars / - enti statali / - véhicule communal / - vehiculos oficiales

| BMW 3er Reihe/E46 (98-06) |                |     |       |       |                                    |                |        |                          |  |                |
|---------------------------|----------------|-----|-------|-------|------------------------------------|----------------|--------|--------------------------|--|----------------|
|                           | 330 d Touring  |     | 03.00 | 07.05 |                                    | 83.6152-0406.3 | 330789 | 2                        |  | L=405          |
|                           | 330 i          | 168 | 01.01 | 04.05 |                                    |                |        |                          |  |                |
|                           | 330 i          | 170 | 09.00 | 02.05 |                                    |                |        |                          |  |                |
|                           | 330 i Touring  | 170 | 06.00 | 07.05 |                                    |                |        |                          |  |                |
|                           | 316 i          |     | 12.98 | 02.05 |                                    | 24.3401-1705.5 | 240423 | <input type="checkbox"/> |  | D=40, - Halter |
|                           | 316 i 1.9      | 77  | 12.98 | 02.05 | - Behörde 1)                       | 24.3401-1706.5 | 240424 | <input type="checkbox"/> |  | D=40, - Halter |
|                           | 316 i Coupe    |     | 04.00 | 08.06 |                                    | 11.0441-4002.2 | 250011 |                          |  | Dichtungssatz  |
|                           | 316 ti Compact | 85  | 07.01 | 02.05 |                                    | 11.0101-5402.2 | 260009 |                          |  | Hülzensatz     |
|                           | 318 i          |     | 04.98 | 02.05 | + Motorcode M43 2)                 | 11.8171-0008.1 | 990049 |                          |  | Führungsbolzen |
|                           | 318 i Coupe    |     | 08.99 | 08.06 | + Motorcode M43 2)                 | 11.8116-0066.1 | 390577 | 2                        |  | Haltefeder     |
|                           | 316 i 1.9      | 77  | 12.98 | 02.05 | + Behörde 3)                       | 24.3401-1703.5 | 240351 | <input type="checkbox"/> |  | D=40, - Halter |
|                           | 316 i Touring  | 85  | 03.02 | 07.05 |                                    | 24.3401-1704.5 | 240352 | <input type="checkbox"/> |  | D=40, - Halter |
|                           | 318 Ci Cabrio  | 105 | 09.01 | 12.06 |                                    | 11.0441-4002.2 | 250011 |                          |  | Dichtungssatz  |
|                           | 318 Ci Cabrio  | 110 | 02.05 | 12.06 |                                    | 11.0101-5402.2 | 260009 |                          |  | Hülzensatz     |
|                           | 318 d          | 85  | 09.01 | 02.05 |                                    | 11.8171-0008.1 | 990049 |                          |  | Führungsbolzen |
|                           | 318 d Touring  | 85  | 03.02 | 07.05 | - Behörde 1)                       | 11.8116-0066.1 | 390577 | 2                        |  | Haltefeder     |
|                           | 318 i          |     | 04.98 | 02.05 | - Behörde / + Motorcode N42/N46 4) |                |        |                          |  |                |
|                           | 318 i Coupe    |     | 08.99 | 08.06 | + Motorcode N42/N46 5)             |                |        |                          |  |                |
|                           | 318 i Touring  |     | 10.99 | 07.05 | - Behörde 1)                       |                |        |                          |  |                |
|                           | 318 td Compact |     | 03.03 | 02.05 |                                    |                |        |                          |  |                |
|                           | 318 ti Compact |     | 09.01 | 02.05 |                                    |                |        |                          |  |                |
|                           | 320 Ci Coupe   |     | 06.99 | 08.06 |                                    |                |        |                          |  |                |
|                           | 320 d          | 100 | 04.98 | 09.01 |                                    |                |        |                          |  |                |
|                           | 320 d Touring  |     | 03.00 | 07.05 | - Behörde 1)                       |                |        |                          |  |                |
|                           | 320 i          | 110 | 04.98 | 09.00 | - Behörde 1)                       |                |        |                          |  |                |
|                           | 320 i          | 125 | 09.00 | 02.05 | - Behörde 1)                       |                |        |                          |  |                |
|                           | 320 i Touring  |     | 10.99 | 07.05 | - Behörde/ + Motorcode M52 6)      |                |        |                          |  |                |
|                           | 323 i          | 125 | 04.98 | 08.00 | - Behörde 1)                       |                |        |                          |  |                |
|                           | 318 d Touring  | 85  | 03.02 | 07.05 | + Behörde 3)                       | 24.3401-1703.5 | 240351 | <input type="checkbox"/> |  | D=40, - Halter |
|                           | 318 i          |     | 04.98 | 02.05 | + Behörde 3)                       | 24.3401-1704.5 | 240352 | <input type="checkbox"/> |  | D=40, - Halter |
|                           | 318 i Touring  |     | 10.99 | 07.05 | + Behörde 3)                       | 11.0441-4002.2 | 250011 |                          |  | Dichtungssatz  |
|                           | 320 Cd Cabrio  | 110 | 02.05 | 12.06 |                                    | 11.0101-5402.2 | 260009 |                          |  | Hülzensatz     |
|                           | 320 Cd Coupe   | 110 | 11.03 | 08.06 |                                    | 11.8171-0008.1 | 990049 |                          |  | Führungsbolzen |
|                           | 320 Ci Cabrio  | 125 | 10.00 | 12.06 |                                    | 11.8116-0066.1 | 390577 | 2                        |  | Haltefeder     |
|                           | 320 d          | 110 | 09.01 | 02.05 |                                    |                |        |                          |  |                |
|                           | 320 d Touring  |     | 03.00 | 07.05 | + Behörde 3)                       |                |        |                          |  |                |
|                           | 320 i          | 110 | 04.98 | 09.00 | + Behörde 3)                       |                |        |                          |  |                |
|                           | 320 i          | 125 | 09.00 | 02.05 | + Behörde 3)                       |                |        |                          |  |                |
|                           | 320 i Touring  |     | 10.99 | 07.05 | + Motorcode M54 7)                 |                |        |                          |  |                |
|                           | 320 i Touring  |     | 10.99 | 07.05 | + Behörde/ + Motorcode M52 8)      |                |        |                          |  |                |
|                           | 320 td Compact |     | 09.01 | 02.05 |                                    |                |        |                          |  |                |
|                           | 323 Ci Cabrio  | 125 | 05.00 | 08.00 |                                    |                |        |                          |  |                |
|                           | 323 Ci Coupe   | 125 | 04.99 | 08.00 |                                    |                |        |                          |  |                |
|                           | 323 i          | 125 | 04.98 | 08.00 | + Behörde 3)                       |                |        |                          |  |                |
|                           | 325 Ci Cabrio  | 141 | 10.00 | 12.06 |                                    |                |        |                          |  |                |
|                           | 325 Ci Coupe   | 141 | 10.00 | 08.06 |                                    |                |        |                          |  |                |
|                           | 325 i          | 141 | 10.00 | 02.05 | - Behörde 1)                       |                |        |                          |  |                |
|                           | 325 i Touring  | 141 | 10.00 | 07.05 |                                    |                |        |                          |  |                |
|                           | 325 ti Compact | 141 | 07.01 | 02.05 |                                    |                |        |                          |  |                |
|                           | 325 xi         | 141 | 10.00 | 02.05 | - Behörde 1)                       |                |        |                          |  |                |
|                           | 325 xi Touring | 141 | 10.00 | 07.05 |                                    |                |        |                          |  |                |
|                           | 328 Ci Coupe   | 142 | 04.99 | 06.00 |                                    |                |        |                          |  |                |
|                           | 328 i          | 142 | 04.98 | 06.00 |                                    |                |        |                          |  |                |
|                           | 328 i Touring  | 142 | 10.99 | 06.00 |                                    |                |        |                          |  |                |
|                           | 330 Cd Cabrio  | 150 | 05.05 | 12.06 |                                    | 11.0101-5402.2 | 260009 |                          |  | Hülzensatz     |
|                           | 330 Cd Coupe   | 150 | 03.03 | 08.06 |                                    | 11.8171-0008.1 | 990049 |                          |  | Führungsbolzen |
|                           | 330 Ci Cabrio  | 170 | 09.00 | 12.06 |                                    | 11.8116-0296.1 | 390445 | 2                        |  | Haltefeder     |
|                           | 330 Ci Coupe   | 170 | 09.00 | 08.06 |                                    |                |        |                          |  |                |
|                           | 330 d          |     | 10.99 | 02.05 |                                    |                |        |                          |  |                |
|                           | 330 d Touring  |     | 03.00 | 07.05 |                                    |                |        |                          |  |                |
|                           | 330 i          | 168 | 01.01 | 04.05 |                                    |                |        |                          |  |                |
|                           | 330 i          | 170 | 09.00 | 02.05 |                                    |                |        |                          |  |                |
|                           | 330 i Touring  | 170 | 06.00 | 07.05 |                                    |                |        |                          |  |                |
|                           | 325 i          | 141 | 10.00 | 08.04 | + Behörde 3)                       | 11.9401-9951.2 | 220463 | <input type="checkbox"/> |  | D=40, - Halter |
|                           | 325 xi         | 141 | 10.00 | 08.04 | + Behörde 3)                       | 11.9401-9952.2 | 220464 | <input type="checkbox"/> |  | D=40, - Halter |
|                           | 330 xd         |     | 10.99 | 08.04 |                                    | 11.0101-5402.2 | 260009 |                          |  | Hülzensatz     |
|                           | 330 xd Touring |     | 03.00 | 08.04 |                                    | 11.8171-0008.1 | 990049 |                          |  | Führungsbolzen |
|                           | 330 xi         | 170 | 09.00 | 08.04 |                                    | 11.8116-0296.1 | 390445 | 2                        |  | Haltefeder     |
|                           | 330 xi Touring | 170 | 09.00 | 08.04 |                                    |                |        |                          |  |                |
|                           | 325 i          | 141 | 09.04 | 02.05 | + Behörde 3)                       | 11.9401-9951.2 | 220463 | <input type="checkbox"/> |  | D=40, - Halter |
|                           | 325 xi         | 141 | 09.04 | 02.05 | + Behörde 3)                       | 11.9401-9952.2 | 220464 | <input type="checkbox"/> |  | D=40, - Halter |
|                           | 330 xd         |     | 09.04 | 02.05 |                                    | 11.0101-5402.2 | 260009 |                          |  | Hülzensatz     |
|                           | 330 xd Touring |     | 09.04 | 07.05 |                                    | 11.8171-0008.1 | 990049 |                          |  | Führungsbolzen |
|                           | 330 xi         | 170 | 09.04 | 02.05 |                                    | 11.8116-0296.1 | 390445 | 2                        |  | Haltefeder     |
|                           | 330 xi Touring | 170 | 09.04 | 07.05 |                                    |                |        |                          |  |                |
|                           | M3 Cabrio      | 252 | 05.01 | 12.06 |                                    | 11.9421-9953.2 | 220837 | <input type="checkbox"/> |  | D=42, - Halter |
|                           | M3 Coupe       | 252 | 06.00 | 08.06 |                                    | 11.9421-9954.2 | 220838 | <input type="checkbox"/> |  | D=42, - Halter |
|                           | M3 CSL Coupe   | 265 | 05.03 | 08.06 |                                    | 11.0101-5402.2 | 260009 |                          |  | Hülzensatz     |
|                           |                |     |       |       |                                    | 11.8171-0008.1 | 990049 |                          |  | Führungsbolzen |
|                           |                |     |       |       |                                    | 11.8116-0296.1 | 390445 | 2                        |  | Haltefeder     |
|                           | 316 i          |     | 12.98 | 02.05 |                                    | 83.6152-0455.3 | 330545 | 2                        |  | L=455          |
|                           | 316 i 1.9      | 77  | 12.98 | 02.05 |                                    |                |        |                          |  |                |
|                           | 316 i Coupe    |     | 04.00 | 08.06 |                                    |                |        |                          |  |                |
|                           | 316 i Touring  | 85  | 03.02 | 07.05 |                                    |                |        |                          |  |                |
|                           | 316 ti Compact | 85  | 07.01 | 02.05 |                                    |                |        |                          |  |                |
|                           | 318 Ci Cabrio  | 105 | 09.01 | 12.06 |                                    |                |        |                          |  |                |
|                           | 318 Ci Cabrio  | 110 | 02.05 | 12.06 |                                    |                |        |                          |  |                |

1) - authority cars / - enti statali / - véhicule communal / - vehiculos oficiales  
 2) + engine code M43 / + codice motore M43 / + moteur code M43 / + motor code M43  
 3) + authority cars / + enti statali / + véhicule communal / + vehiculos oficiales  
 4) - authority cars/+engine co.N42/N46 / - enti statali/+codice mot.N42/N46 / - véhicule communal/+moteur co.N42/N46 / - vehiculos oficiales/+motor co.N42/N46  
 5) + engine code N42/N46 / + codice motore N42/N46 / + moteur code N42/N46 / + motor code N42/N46  
 6) - authority cars/+engine co.M52 / - enti statali/+codice mot.M52 / - véhicule communal/+moteur co.M52 / - vehiculos oficiales/+motor co.M52  
 7) + engine code M54 / + codice motore M54 / + moteur code M54 / + motor code M54  
 8) + authority cars/+engine no.M52 / + enti statali/+codice mot.M52 / + véhicule communal/+moteur co.M52 / + vehiculos oficiales/+motor co.M52



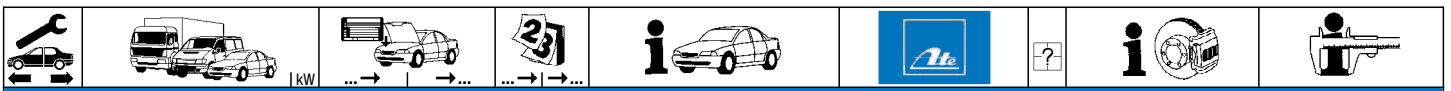

**BMW 3er Reihe/E46 (98-06)**

|  |                |     |       |       |                |        |                          |        |                |
|--|----------------|-----|-------|-------|----------------|--------|--------------------------|--------|----------------|
|  | 318 d          | 85  | 09.01 | 02.05 | 83.6152-0455.3 | 330545 | 2                        |        | L=455          |
|  | 318 d Touring  | 85  | 03.02 | 07.05 |                |        |                          |        |                |
|  | 318 i          |     | 04.98 | 02.05 |                |        |                          |        |                |
|  | 318 i Coupe    |     | 08.99 | 08.06 |                |        |                          |        |                |
|  | 318 i Touring  |     | 10.99 | 07.05 |                |        |                          |        |                |
|  | 318 td Compact |     | 03.03 | 02.05 |                |        |                          |        |                |
|  | 318 ti Compact |     | 09.01 | 02.05 |                |        |                          |        |                |
|  | 320 Cd Cabrio  | 110 | 02.05 | 12.06 |                |        |                          |        |                |
|  | 320 Cd Coupe   | 110 | 11.03 | 08.06 |                |        |                          |        |                |
|  | 320 Ci Cabrio  | 125 | 10.00 | 12.06 |                |        |                          |        |                |
|  | 320 Ci Coupe   |     | 06.99 | 08.06 |                |        |                          |        |                |
|  | 320 d          | 100 | 04.98 | 09.01 |                |        |                          |        |                |
|  | 320 d          | 110 | 09.01 | 02.05 |                |        |                          |        |                |
|  | 320 d Touring  |     | 03.00 | 07.05 |                |        |                          |        |                |
|  | 320 i          | 110 | 04.98 | 09.00 |                |        |                          |        |                |
|  | 320 i          | 125 | 09.00 | 02.05 |                |        |                          |        |                |
|  | 320 i Touring  |     | 10.99 | 07.05 |                |        |                          |        |                |
|  | 320 td Compact |     | 09.01 | 02.05 |                |        |                          |        |                |
|  | 323 Ci Cabrio  | 125 | 05.00 | 08.00 |                |        |                          |        |                |
|  | 323 Ci Coupe   | 125 | 04.99 | 08.00 |                |        |                          |        |                |
|  | 323 i          | 125 | 04.98 | 08.00 |                |        |                          |        |                |
|  | 325 Ci Cabrio  | 141 | 10.00 | 12.06 |                |        |                          |        |                |
|  | 325 Ci Coupe   | 141 | 10.00 | 08.06 |                |        |                          |        |                |
|  | 325 i          | 141 | 10.00 | 02.05 |                |        |                          |        |                |
|  | 325 i Touring  | 141 | 10.00 | 07.05 |                |        |                          |        |                |
|  | 325 ti Compact | 141 | 07.01 | 02.05 |                |        |                          |        |                |
|  | 325 xi         | 141 | 10.00 | 02.05 |                |        |                          |        |                |
|  | 325 xi Touring | 141 | 10.00 | 07.05 |                |        |                          |        |                |
|  | 328 Ci Coupe   | 142 | 04.99 | 06.00 |                |        |                          |        |                |
|  | 328 i          | 142 | 04.98 | 06.00 |                |        |                          |        |                |
|  | 328 i Touring  | 142 | 10.99 | 06.00 |                |        |                          |        |                |
|  | 330 Cd Cabrio  | 150 | 05.05 | 12.06 |                |        |                          |        |                |
|  | 330 Cd Coupe   | 150 | 03.03 | 08.06 |                |        |                          |        |                |
|  | 330 Ci Cabrio  | 170 | 09.00 | 12.06 |                |        |                          |        |                |
|  | 330 Ci Coupe   | 170 | 09.00 | 08.06 |                |        |                          |        |                |
|  | 330 d          |     | 10.99 | 02.05 |                |        |                          |        |                |
|  | 330 d Touring  |     | 03.00 | 07.05 |                |        |                          |        |                |
|  | 330 i          | 168 | 01.01 | 04.05 |                |        |                          |        |                |
|  | 330 i          | 170 | 09.00 | 02.05 |                |        |                          |        |                |
|  | 330 i Touring  | 170 | 06.00 | 07.05 |                |        |                          |        |                |
|  | 330 xd         |     | 10.99 | 02.05 |                |        |                          |        |                |
|  | 330 xd Touring |     | 03.00 | 07.05 |                |        |                          |        |                |
|  | 330 xi         | 170 | 09.00 | 02.05 |                |        |                          |        |                |
|  | 330 xi Touring | 170 | 09.00 | 07.05 |                |        |                          |        |                |
|  | M3 Cabrio      | 252 | 05.01 | 12.06 |                |        |                          |        |                |
|  | M3 Coupe       | 252 | 06.00 | 08.06 |                |        |                          |        |                |
|  | M3 CSL Coupe   | 265 | 05.03 | 08.06 |                |        |                          |        |                |
|  | 316 i          |     | 12.98 | 02.05 | 24.3727-0224.2 | 580224 | <input type="checkbox"/> | L=1693 |                |
|  | 316 i 1.9      | 77  | 12.98 | 02.05 |                |        |                          |        | 24.3727-0223.2 |
|  | 316 i Coupe    |     | 04.00 | 08.06 |                |        |                          |        |                |
|  | 316 i Touring  | 85  | 03.02 | 07.05 |                |        |                          |        |                |
|  | 316 ti Compact | 85  | 07.01 | 02.05 |                |        |                          |        |                |
|  | 318 Ci Cabrio  | 105 | 09.01 | 12.06 |                |        |                          |        |                |
|  | 318 Ci Cabrio  | 110 | 02.05 | 12.06 |                |        |                          |        |                |
|  | 318 d          | 85  | 09.01 | 02.05 |                |        |                          |        |                |
|  | 318 d Touring  | 85  | 03.02 | 07.05 |                |        |                          |        |                |
|  | 318 i          |     | 04.98 | 02.05 |                |        |                          |        |                |
|  | 318 i Coupe    |     | 08.99 | 08.06 |                |        |                          |        |                |
|  | 318 i Touring  |     | 10.99 | 07.05 |                |        |                          |        |                |
|  | 318 td Compact |     | 03.03 | 02.05 |                |        |                          |        |                |
|  | 318 ti Compact |     | 09.01 | 02.05 |                |        |                          |        |                |
|  | 320 Cd Cabrio  | 110 | 02.05 | 12.06 |                |        |                          |        |                |
|  | 320 Cd Coupe   | 110 | 11.03 | 08.06 |                |        |                          |        |                |
|  | 320 Ci Cabrio  | 125 | 10.00 | 12.06 |                |        |                          |        |                |
|  | 320 Ci Coupe   |     | 06.99 | 08.06 |                |        |                          |        |                |
|  | 320 d          | 100 | 04.98 | 09.01 |                |        |                          |        |                |
|  | 320 d          | 110 | 09.01 | 02.05 |                |        |                          |        |                |
|  | 320 d Touring  |     | 03.00 | 07.05 |                |        |                          |        |                |
|  | 320 i          | 110 | 04.98 | 09.00 |                |        |                          |        |                |
|  | 320 i          | 125 | 09.00 | 02.05 |                |        |                          |        |                |
|  | 320 i Touring  |     | 10.99 | 07.05 |                |        |                          |        |                |
|  | 320 td Compact |     | 09.01 | 02.05 |                |        |                          |        |                |
|  | 323 Ci Cabrio  | 125 | 05.00 | 08.00 |                |        |                          |        |                |
|  | 323 Ci Coupe   | 125 | 04.99 | 08.00 |                |        |                          |        |                |
|  | 323 i          | 125 | 04.98 | 08.00 |                |        |                          |        |                |
|  | 325 Ci Cabrio  | 141 | 10.00 | 12.06 |                |        |                          |        |                |
|  | 325 Ci Coupe   | 141 | 10.00 | 08.06 |                |        |                          |        |                |
|  | 325 i          | 141 | 10.00 | 02.05 |                |        |                          |        |                |
|  | 325 i Touring  | 141 | 10.00 | 07.05 |                |        |                          |        |                |
|  | 325 ti Compact | 141 | 07.01 | 02.05 |                |        |                          |        |                |
|  | 325 xi         | 141 | 10.00 | 02.05 |                |        |                          |        |                |
|  | 325 xi Touring | 141 | 10.00 | 07.05 |                |        |                          |        |                |
|  | 328 Ci Coupe   | 142 | 04.99 | 06.00 |                |        |                          |        |                |
|  | 328 i          | 142 | 04.98 | 06.00 |                |        |                          |        |                |
|  | 328 i Touring  | 142 | 10.99 | 06.00 |                |        |                          |        |                |
|  | 330 Cd Cabrio  | 150 | 05.05 | 12.06 |                |        |                          |        |                |
|  | 330 Cd Coupe   | 150 | 03.03 | 08.06 |                |        |                          |        |                |



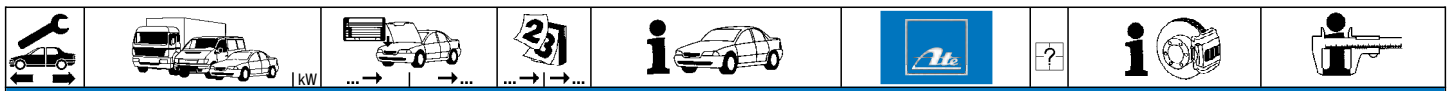

**BMW 3er Reihe/E46 (98-06)**

|  |                    |  |       |       |                |        |                          |  |          |
|--|--------------------|--|-------|-------|----------------|--------|--------------------------|--|----------|
|  | 330 Ci Cabrio 170  |  | 09.00 | 12.06 | 24.3727-0224.2 | 580224 | <input type="checkbox"/> |  | L=1693   |
|  | 330 Ci Coupe 170   |  | 09.00 | 08.06 | 24.3727-0223.2 | 580223 | <input type="checkbox"/> |  | L=1708   |
|  | 330 d              |  | 10.99 | 02.05 |                |        |                          |  |          |
|  | 330 d Touring      |  | 03.00 | 07.05 |                |        |                          |  |          |
|  | 330 i 168          |  | 01.01 | 04.05 |                |        |                          |  |          |
|  | 330 i 170          |  | 09.00 | 02.05 |                |        |                          |  |          |
|  | 330 i Touring 170  |  | 06.00 | 07.05 |                |        |                          |  |          |
|  | 330 xd             |  | 10.99 | 02.05 |                |        |                          |  |          |
|  | 330 xd Touring     |  | 03.00 | 07.05 |                |        |                          |  |          |
|  | 330 xi 170         |  | 09.00 | 02.05 |                |        |                          |  |          |
|  | 330 xi Touring 170 |  | 09.00 | 07.05 |                |        |                          |  |          |
|  | M3 Cabrio 252      |  | 05.01 | 12.06 |                |        |                          |  |          |
|  | M3 Coupe 252       |  | 06.00 | 08.06 |                |        |                          |  |          |
|  | M3 CSL Coupe 265   |  | 05.03 | 08.06 |                |        |                          |  |          |
|  | 316 i              |  | 12.98 | 02.01 | 24.2419-1713.3 | 030093 |                          |  | Gz 19,05 |
|  | 316 i 1.9 77       |  | 12.98 | 02.01 |                |        |                          |  |          |
|  | 316 i Coupe        |  | 04.00 | 02.01 |                |        |                          |  |          |
|  | 318 i              |  | 04.98 | 02.01 |                |        |                          |  |          |
|  | 318 i Coupe        |  | 08.99 | 02.01 |                |        |                          |  |          |
|  | 318 i Touring      |  | 10.99 | 02.01 |                |        |                          |  |          |
|  | 320 Ci Cabrio 125  |  | 10.00 | 02.01 |                |        |                          |  |          |
|  | 320 Ci Coupe       |  | 06.99 | 02.01 |                |        |                          |  |          |
|  | 320 d 100          |  | 04.98 | 02.01 |                |        |                          |  |          |
|  | 320 d Touring      |  | 03.00 | 02.01 |                |        |                          |  |          |
|  | 320 i 110          |  | 04.98 | 09.00 |                |        |                          |  |          |
|  | 320 i 125          |  | 09.00 | 02.01 |                |        |                          |  |          |
|  | 320 i Touring      |  | 10.99 | 02.01 |                |        |                          |  |          |
|  | 323 Ci Cabrio 125  |  | 05.00 | 08.00 |                |        |                          |  |          |
|  | 323 Ci Coupe 125   |  | 04.99 | 08.00 |                |        |                          |  |          |
|  | 323 i 125          |  | 04.98 | 08.00 |                |        |                          |  |          |
|  | 325 Ci Cabrio 141  |  | 10.00 | 02.01 |                |        |                          |  |          |
|  | 325 Ci Coupe 141   |  | 10.00 | 02.01 |                |        |                          |  |          |
|  | 325 i 141          |  | 10.00 | 02.01 |                |        |                          |  |          |
|  | 325 i Touring 141  |  | 10.00 | 02.01 |                |        |                          |  |          |
|  | 325 xi 141         |  | 10.00 | 02.01 |                |        |                          |  |          |
|  | 325 xi Touring 141 |  | 10.00 | 02.01 |                |        |                          |  |          |
|  | 328 Ci Coupe 142   |  | 04.99 | 06.00 |                |        |                          |  |          |
|  | 328 i 142          |  | 04.98 | 06.00 |                |        |                          |  |          |
|  | 328 i Touring 142  |  | 10.99 | 06.00 |                |        |                          |  |          |
|  | 330 Ci Cabrio 170  |  | 09.00 | 02.01 |                |        |                          |  |          |
|  | 330 Ci Coupe 170   |  | 09.00 | 02.01 |                |        |                          |  |          |
|  | 330 d              |  | 10.99 | 02.01 |                |        |                          |  |          |
|  | 330 d Touring      |  | 03.00 | 02.01 |                |        |                          |  |          |
|  | 330 i 168          |  | 01.01 | 02.01 |                |        |                          |  |          |
|  | 330 i 170          |  | 09.00 | 02.01 |                |        |                          |  |          |
|  | 330 i Touring 170  |  | 06.00 | 02.01 |                |        |                          |  |          |
|  | 330 xd             |  | 10.99 | 02.01 |                |        |                          |  |          |
|  | 330 xd Touring     |  | 03.00 | 02.01 |                |        |                          |  |          |
|  | 330 xi 170         |  | 09.00 | 02.01 |                |        |                          |  |          |
|  | 330 xi Touring 170 |  | 09.00 | 02.01 |                |        |                          |  |          |
|  | M3 Coupe 252       |  | 06.00 | 02.01 |                |        |                          |  |          |
|  | 316 i              |  | 03.01 | 02.05 | 24.2419-1713.3 | 030093 |                          |  | Gz 19,05 |
|  | 316 i 1.9 77       |  | 03.01 | 02.05 |                |        |                          |  |          |
|  | 316 i Coupe        |  | 03.01 | 08.06 |                |        |                          |  |          |
|  | 316 i Touring 85   |  | 03.02 | 07.05 |                |        |                          |  |          |
|  | 316 ti Compact 85  |  | 07.01 | 02.05 |                |        |                          |  |          |
|  | 318 Ci Cabrio 105  |  | 09.01 | 12.06 |                |        |                          |  |          |
|  | 318 Ci Cabrio 110  |  | 02.05 | 12.06 |                |        |                          |  |          |
|  | 318 d 85           |  | 09.01 | 02.05 |                |        |                          |  |          |
|  | 318 d Touring 85   |  | 03.02 | 07.05 |                |        |                          |  |          |
|  | 318 i              |  | 03.01 | 02.05 |                |        |                          |  |          |
|  | 318 i Coupe        |  | 03.01 | 08.06 |                |        |                          |  |          |
|  | 318 i Touring      |  | 03.01 | 07.05 |                |        |                          |  |          |
|  | 318 td Compact     |  | 03.03 | 02.05 |                |        |                          |  |          |
|  | 318 ti Compact     |  | 09.01 | 02.05 |                |        |                          |  |          |
|  | 320 Cd Cabrio 110  |  | 02.05 | 12.06 |                |        |                          |  |          |
|  | 320 Cd Coupe 110   |  | 11.03 | 08.06 |                |        |                          |  |          |
|  | 320 Ci Cabrio 125  |  | 03.01 | 12.06 |                |        |                          |  |          |
|  | 320 Ci Coupe       |  | 03.01 | 08.06 |                |        |                          |  |          |
|  | 320 d 100          |  | 03.01 | 09.01 |                |        |                          |  |          |
|  | 320 d 110          |  | 09.01 | 02.05 |                |        |                          |  |          |
|  | 320 d Touring      |  | 03.01 | 07.05 |                |        |                          |  |          |
|  | 320 i 125          |  | 03.01 | 02.05 |                |        |                          |  |          |
|  | 320 i Touring      |  | 03.01 | 07.05 |                |        |                          |  |          |
|  | 320 td Compact     |  | 09.01 | 02.05 |                |        |                          |  |          |
|  | 325 Ci Cabrio 141  |  | 03.01 | 12.06 |                |        |                          |  |          |
|  | 325 Ci Coupe 141   |  | 03.01 | 08.06 |                |        |                          |  |          |
|  | 325 i 141          |  | 03.01 | 02.05 |                |        |                          |  |          |
|  | 325 i Touring 141  |  | 03.01 | 07.05 |                |        |                          |  |          |
|  | 325 ti Compact 141 |  | 07.01 | 02.05 |                |        |                          |  |          |
|  | 325 xi 141         |  | 03.01 | 02.05 |                |        |                          |  |          |
|  | 325 xi Touring 141 |  | 03.01 | 07.05 |                |        |                          |  |          |
|  | 330 Cd Cabrio 150  |  | 05.05 | 12.06 |                |        |                          |  |          |
|  | 330 Cd Coupe 150   |  | 03.03 | 08.06 |                |        |                          |  |          |
|  | 330 Ci Cabrio 170  |  | 03.01 | 12.06 |                |        |                          |  |          |
|  | 330 Ci Coupe 170   |  | 03.01 | 08.06 |                |        |                          |  |          |
|  | 330 d              |  | 03.01 | 02.05 |                |        |                          |  |          |



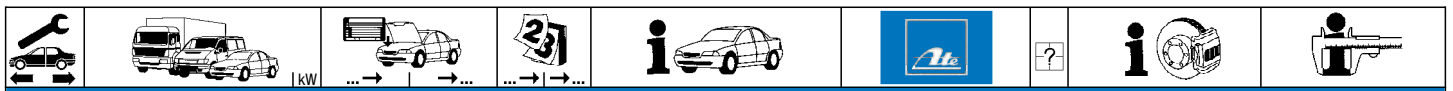

### BMW 3er Reihe/E46 (98-06)

|  |                |     |       |       |                |        |  |          |
|--|----------------|-----|-------|-------|----------------|--------|--|----------|
|  | 330 d Touring  |     | 03.01 | 07.05 | 24.2419-1713.3 | 030093 |  | Gz 19,05 |
|  | 330 i          | 168 | 03.01 | 04.05 |                |        |  |          |
|  | 330 i          | 170 | 03.01 | 02.05 |                |        |  |          |
|  | 330 i Touring  | 170 | 03.01 | 07.05 |                |        |  |          |
|  | 330 xd         |     | 03.01 | 02.05 |                |        |  |          |
|  | 330 xd Touring |     | 03.01 | 07.05 |                |        |  |          |
|  | 330 xi         | 170 | 03.01 | 02.05 |                |        |  |          |
|  | 330 xi Touring | 170 | 03.01 | 07.05 |                |        |  |          |
|  | M3 Cabrio      | 252 | 05.01 | 12.06 |                |        |  |          |
|  | M3 Coupe       | 252 | 03.01 | 08.06 |                |        |  |          |
|  | 316 i          |     | 12.98 | 02.05 | 24.2522-1705.3 | 040079 |  | Nz 22,20 |
|  | 316 i 1.9      | 77  | 12.98 | 02.05 |                |        |  |          |
|  | 316 i Coupe    |     | 04.00 | 08.06 |                |        |  |          |
|  | 316 i Touring  | 85  | 03.02 | 07.05 |                |        |  |          |
|  | 316 ti Compact | 85  | 07.01 | 02.05 |                |        |  |          |
|  | 318 Ci Cabrio  | 105 | 09.01 | 12.06 |                |        |  |          |
|  | 318 Ci Cabrio  | 110 | 02.05 | 12.06 |                |        |  |          |
|  | 318 d          | 85  | 09.01 | 02.05 |                |        |  |          |
|  | 318 d Touring  | 85  | 03.02 | 07.05 |                |        |  |          |
|  | 318 i          |     | 04.98 | 02.05 |                |        |  |          |
|  | 318 i Coupe    |     | 08.99 | 08.06 |                |        |  |          |
|  | 318 i Touring  |     | 10.99 | 07.05 |                |        |  |          |
|  | 318 td Compact |     | 03.03 | 02.05 |                |        |  |          |
|  | 318 ti Compact |     | 09.01 | 02.05 |                |        |  |          |
|  | 320 Cd Cabrio  | 110 | 02.05 | 12.06 |                |        |  |          |
|  | 320 Cd Coupe   | 110 | 11.03 | 08.06 |                |        |  |          |
|  | 320 Ci Cabrio  | 125 | 10.00 | 12.06 |                |        |  |          |
|  | 320 Ci Coupe   |     | 06.99 | 08.06 |                |        |  |          |
|  | 320 d          | 100 | 04.98 | 09.01 |                |        |  |          |
|  | 320 d          | 110 | 09.01 | 02.05 |                |        |  |          |
|  | 320 d Touring  |     | 03.00 | 07.05 |                |        |  |          |
|  | 320 i          | 110 | 04.98 | 09.00 |                |        |  |          |
|  | 320 i          | 125 | 09.00 | 02.05 |                |        |  |          |
|  | 320 i Touring  |     | 10.99 | 07.05 |                |        |  |          |
|  | 320 td Compact |     | 09.01 | 02.05 |                |        |  |          |
|  | 323 Ci Cabrio  | 125 | 05.00 | 08.00 |                |        |  |          |
|  | 323 Ci Coupe   | 125 | 04.99 | 08.00 |                |        |  |          |
|  | 323 i          | 125 | 04.98 | 08.00 |                |        |  |          |
|  | 325 Ci Cabrio  | 141 | 10.00 | 12.06 |                |        |  |          |
|  | 325 Ci Coupe   | 141 | 10.00 | 08.06 |                |        |  |          |
|  | 325 i          | 141 | 10.00 | 02.05 |                |        |  |          |
|  | 325 i Touring  | 141 | 10.00 | 07.05 |                |        |  |          |
|  | 325 ti Compact | 141 | 07.01 | 02.05 |                |        |  |          |
|  | 325 xi         | 141 | 10.00 | 02.05 |                |        |  |          |
|  | 325 xi Touring | 141 | 10.00 | 07.05 |                |        |  |          |
|  | 328 Ci Coupe   | 142 | 04.99 | 06.00 |                |        |  |          |
|  | 328 i          | 142 | 04.98 | 06.00 |                |        |  |          |
|  | 328 i Touring  | 142 | 10.99 | 06.00 |                |        |  |          |
|  | 330 Cd Cabrio  | 150 | 05.05 | 12.06 |                |        |  |          |
|  | 330 Cd Coupe   | 150 | 03.03 | 08.06 |                |        |  |          |
|  | 330 Ci Cabrio  | 170 | 09.00 | 12.06 |                |        |  |          |
|  | 330 Ci Coupe   | 170 | 09.00 | 08.06 |                |        |  |          |
|  | 330 d          |     | 10.99 | 02.05 |                |        |  |          |
|  | 330 d Touring  |     | 03.00 | 07.05 |                |        |  |          |
|  | 330 i          | 168 | 01.01 | 04.05 |                |        |  |          |
|  | 330 i          | 170 | 09.00 | 02.05 |                |        |  |          |
|  | 330 i Touring  | 170 | 06.00 | 07.05 |                |        |  |          |
|  | 330 xd         |     | 10.99 | 02.05 |                |        |  |          |
|  | 330 xd Touring |     | 03.00 | 07.05 |                |        |  |          |
|  | 330 xi         | 170 | 09.00 | 02.05 |                |        |  |          |
|  | 330 xi Touring | 170 | 09.00 | 07.05 |                |        |  |          |
|  | M3 Cabrio      | 252 | 05.01 | 12.06 |                |        |  |          |
|  | M3 Coupe       | 252 | 06.00 | 08.06 |                |        |  |          |

### BMW 3er Reihe/E90 Limousine (05-12)

|  |        |     |       |       |                               |        |                                   |    |     |
|--|--------|-----|-------|-------|-------------------------------|--------|-----------------------------------|----|-----|
|  | 316 d  | 85  | 07.09 | 03.12 | 03.7848-4003.4                | 300235 | - Start/Stop-Anlage <sup>1)</sup> | 8" | ATE |
|  | 316 i  | 85  | 01.05 | 08.07 |                               |        |                                   |    |     |
|  | 316 i  | 90  | 09.07 | 03.12 |                               |        |                                   |    |     |
|  | 318 d  |     | 09.07 | 03.12 |                               |        |                                   |    |     |
|  | 318 d  | 90  | 09.05 | 08.07 |                               |        |                                   |    |     |
|  | 318 i  | 95  | 09.05 | 08.07 |                               |        |                                   |    |     |
|  | 318 i  | 105 | 09.07 | 03.12 |                               |        |                                   |    |     |
|  | 320 i  |     | 12.04 | 08.07 |                               |        |                                   |    |     |
|  | 320 i  | 125 | 09.07 | 03.12 |                               |        |                                   |    |     |
|  | 320 d  | 120 | 12.04 | 08.07 | 03.7848-5003.4                | 300236 |                                   | 8" | ATE |
|  | 320 si | 127 | 06.06 | 03.12 |                               |        |                                   |    |     |
|  | 325 d  | 145 | 09.06 | 03.12 |                               |        |                                   |    |     |
|  | 325 i  | 160 | 12.04 | 03.12 |                               |        |                                   |    |     |
|  | 325 xi | 160 | 09.07 | 03.12 | + Motorcode N53 <sup>2)</sup> |        |                                   |    |     |
|  | 325 xi | 160 | 01.05 | 08.07 | + Motorcode N52 <sup>3)</sup> |        |                                   |    |     |
|  | 330 d  | 170 | 09.05 | 03.12 |                               |        |                                   |    |     |
|  | 330 d  | 180 | 09.09 | 03.12 |                               |        |                                   |    |     |
|  | 330 i  | 190 | 12.04 | 08.07 |                               |        |                                   |    |     |
|  | 330 i  | 200 | 09.09 | 03.12 |                               |        |                                   |    |     |
|  | 330 xd | 170 | 09.05 | 03.12 |                               |        |                                   |    |     |
|  | 330 xd | 180 | 09.09 | 03.12 |                               |        |                                   |    |     |
|  | 330 xi | 190 | 01.05 | 08.07 |                               |        |                                   |    |     |

<sup>1)</sup> - idling stop system / - dispositivo start/stop / - unité marche/arrêt / - unidad arranque/paro

<sup>2)</sup> + engine code N53 / + codice motore N53 / + moteur code N53 / + motor code N53

<sup>3)</sup> + engine code N52 / + codice motore N52 / + moteur code N52 / + motor code N52

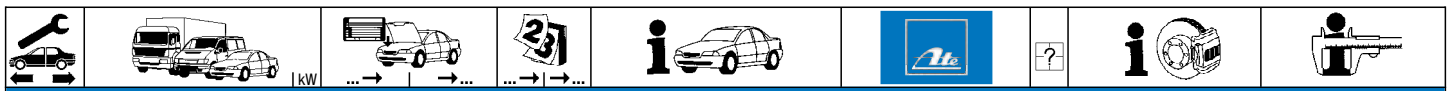

**BMW 3er Reihe/E90 Limousine (05-12)**

|  |        |     |  |       |       |  |                |        |   |                                   |                 |     |
|--|--------|-----|--|-------|-------|--|----------------|--------|---|-----------------------------------|-----------------|-----|
|  | 330 xi | 200 |  | 09.07 | 03.12 |  | 03.7848-5003.4 | 300236 |   |                                   | 8"              | ATE |
|  | 320 d  | 110 |  | 09.05 | 03.12 |  | 03.7845-0103.4 | 300268 |   | - Start/Stop-Anlage <sup>1)</sup> | 8"              | ATE |
|  | 320 d  | 130 |  | 09.07 | 03.12 |  |                |        |   |                                   |                 |     |
|  | 320 xd |     |  | 09.07 | 03.12 |  |                |        |   |                                   |                 |     |
|  | 325 xi | 160 |  | 01.05 | 08.07 | + Motorcode N52N <sup>2)</sup>                     |                |        |   |                                   |                 |     |
|  | 330 d  | 180 |  | 09.08 | 08.09 |  |                |        |   |                                   |                 |     |
|  | 330 i  | 200 |  | 09.07 | 08.09 |  |                |        |   |                                   |                 |     |
|  | 330 xd | 180 |  | 01.09 | 08.09 |  |                |        |   |                                   |                 |     |
|  | 335 d  | 210 |  | 09.06 | 03.12 |  |                |        |   |                                   |                 |     |
|  | 335 i  | 225 |  | 09.06 | 03.12 |  |                |        |   |                                   |                 |     |
|  | 335 xi | 225 |  | 03.07 | 03.12 |  |                |        |   |                                   |                 |     |
|  | 316 d  | 85  |  | 07.09 | 03.12 |  | 03.2023-2407.3 | 010796 |   |                                   | THz 23,81/22,20 | ATE |
|  | 316 i  | 85  |  | 01.05 | 08.07 |  |                |        |   |                                   |                 |     |
|  | 316 i  | 90  |  | 09.07 | 03.12 |  |                |        |   |                                   |                 |     |
|  | 318 d  |     |  | 09.07 | 03.12 |  |                |        |   |                                   |                 |     |
|  | 318 d  | 90  |  | 09.05 | 08.07 |  |                |        |   |                                   |                 |     |
|  | 318 i  | 95  |  | 09.05 | 08.07 |  |                |        |   |                                   |                 |     |
|  | 318 i  | 105 |  | 09.07 | 03.12 |  |                |        |   |                                   |                 |     |
|  | 320 i  |     |  | 12.04 | 08.07 |  |                |        |   |                                   |                 |     |
|  | 320 i  | 125 |  | 09.07 | 03.12 |  |                |        |   |                                   |                 |     |
|  | 320 d  | 110 |  | 09.05 | 03.12 |  | 03.2025-1904.3 | 010797 |   |                                   | THz 25,40/22,20 | ATE |
|  | 320 d  | 120 |  | 12.04 | 08.07 |  |                |        |   |                                   |                 |     |
|  | 320 d  | 130 |  | 09.07 | 03.12 |  |                |        |   |                                   |                 |     |
|  | 320 si | 127 |  | 06.06 | 03.12 |  |                |        |   |                                   |                 |     |
|  | 320 xd |     |  | 09.07 | 03.12 |  |                |        |   |                                   |                 |     |
|  | 325 d  | 145 |  | 09.06 | 03.12 |  |                |        |   |                                   |                 |     |
|  | 325 i  | 160 |  | 12.04 | 03.12 |  |                |        |   |                                   |                 |     |
|  | 325 xi | 160 |  | 01.05 | 03.12 |  |                |        |   |                                   |                 |     |
|  | 330 d  | 170 |  | 09.05 | 03.12 |  |                |        |   |                                   |                 |     |
|  | 330 d  | 180 |  | 09.08 | 03.12 |  |                |        |   |                                   |                 |     |
|  | 330 i  | 190 |  | 12.04 | 08.07 |  |                |        |   |                                   |                 |     |
|  | 330 i  | 200 |  | 09.07 | 03.12 |  |                |        |   |                                   |                 |     |
|  | 330 xd | 170 |  | 01.05 | 03.12 |  |                |        |   |                                   |                 |     |
|  | 330 xd | 180 |  | 01.09 | 03.12 |  |                |        |   |                                   |                 |     |
|  | 330 xi | 190 |  | 01.05 | 08.07 |  |                |        |   |                                   |                 |     |
|  | 330 xi | 200 |  | 09.07 | 03.12 |  |                |        |   |                                   |                 |     |
|  | 335 d  | 210 |  | 09.06 | 03.12 |  |                |        |   |                                   |                 |     |
|  | 335 i  | 225 |  | 09.06 | 03.12 |  |                |        |   |                                   |                 |     |
|  | 335 xi | 225 |  | 03.07 | 03.12 |  |                |        |   |                                   |                 |     |
|  | 316 i  | 85  |  | 01.05 | 08.07 |  | 11.9541-9575.2 | 220829 |   |                                   | D=54, - Halter  | ATE |
|  | 318 d  | 90  |  | 09.05 | 08.07 | - erhöhte Zuladung <sup>3)</sup>                   | 11.9541-9576.2 | 220830 |   |                                   | D=54, - Halter  | ATE |
|  | 318 i  | 95  |  | 09.05 | 08.07 | - erhöhte Zuladung/ + Motorcode N46 <sup>4)</sup>  | 11.0101-5402.2 | 260009 |   |                                   | Hülsensatz      | ATE |
|  | 320 i  |     |  | 12.04 | 08.07 | - erhöhte Zuladung/ + Motorcode N46 <sup>4)</sup>  | 11.8171-0008.1 | 990049 |   |                                   | Führungsbolzen  | ATE |
|  |        |     |  |       |       |  | 11.8116-0206.1 | 390593 | 2 |                                   | Haltefeder      | ATE |
|  | 316 d  | 85  |  | 07.09 | 03.12 |  | 11.0101-5402.2 | 260009 |   |                                   | Hülsensatz      | ATE |
|  | 316 i  | 90  |  | 09.07 | 03.12 |  | 11.8171-0008.1 | 990049 |   |                                   | Führungsbolzen  | ATE |
|  | 318 d  |     |  | 09.07 | 03.12 |  | 11.8116-0339.2 | 390528 | 2 |                                   | Haltefeder      | ATE |
|  | 318 i  | 95  |  | 03.07 | 08.07 | - erhöhte Zuladung/ + Motorcode N46N <sup>5)</sup> |                |        |   |                                   |                 |     |
|  | 318 i  | 105 |  | 09.07 | 03.12 |  |                |        |   |                                   |                 |     |
|  | 320 i  | 125 |  | 09.07 | 03.12 | - erhöhte Zuladung <sup>3)</sup>                   |                |        |   |                                   |                 |     |
|  | 320 i  |     |  | 03.07 | 08.07 | - erhöhte Zuladung/ + Motorcode N46N <sup>5)</sup> | 11.0101-5402.2 | 260009 |   |                                   | Hülsensatz      | ATE |
|  |        |     |  |       |       |  | 11.8171-0008.1 | 990049 |   |                                   | Führungsbolzen  | ATE |
|  |        |     |  |       |       |  | 11.8116-0339.2 | 390528 | 2 |                                   | Haltefeder      | ATE |
|  | 318 d  | 90  |  | 09.05 | 08.07 | + erhöhte Zuladung <sup>6)</sup>                   | 11.9571-9753.2 | 220929 |   |                                   | D=57, - Halter  | ATE |
|  | 318 i  | 95  |  | 03.07 | 08.07 | + erhöhte Zuladung/ + Motorcode N46N <sup>7)</sup> | 11.9571-9754.2 | 220930 |   |                                   | D=57, - Halter  | ATE |
|  | 318 i  | 95  |  | 09.05 | 08.07 | + erhöhte Zuladung/ + Motorcode N46 <sup>8)</sup>  | 11.0101-5402.2 | 260009 |   |                                   | Hülsensatz      | ATE |
|  | 320 d  | 110 |  | 09.05 | 03.12 | - Behörde <sup>9)</sup>                            | 11.8171-0008.1 | 990049 |   |                                   | Führungsbolzen  | ATE |
|  | 320 d  | 120 |  | 12.04 | 08.07 | - Behörde <sup>9)</sup>                            | 11.8116-0339.2 | 390528 | 2 |                                   | Haltefeder      | ATE |
|  | 320 d  | 130 |  | 09.07 | 03.12 | - Behörde <sup>9)</sup>                            |                |        |   |                                   |                 |     |
|  | 320 i  |     |  | 03.07 | 08.07 | + erhöhte Zuladung/ + Motorcode N46N <sup>7)</sup> |                |        |   |                                   |                 |     |
|  | 320 i  |     |  | 12.04 | 08.07 | + erhöhte Zuladung/ + Motorcode N46 <sup>8)</sup>  |                |        |   |                                   |                 |     |
|  | 320 i  | 125 |  | 09.07 | 03.12 | + erhöhte Zuladung <sup>6)</sup>                   |                |        |   |                                   |                 |     |
|  | 320 si | 127 |  | 06.06 | 03.12 |  |                |        |   |                                   |                 |     |
|  | 320 xd |     |  | 09.07 | 03.12 | - Behörde <sup>9)</sup>                            |                |        |   |                                   |                 |     |
|  | 325 i  | 160 |  | 12.04 | 03.12 | - erhöhte Zuladung <sup>3)</sup>                   |                |        |   |                                   |                 |     |
|  | 325 xi | 160 |  | 01.05 | 03.12 | - erhöhte Zuladung <sup>3)</sup>                   |                |        |   |                                   |                 |     |
|  | 320 d  | 110 |  | 09.05 | 03.12 | + Behörde <sup>10)</sup>                           | 11.0101-5402.2 | 260009 |   |                                   | Hülsensatz      | ATE |
|  | 320 d  | 120 |  | 12.04 | 08.07 | + Behörde <sup>10)</sup>                           | 11.8171-0008.1 | 990049 |   |                                   | Führungsbolzen  | ATE |
|  | 320 d  | 130 |  | 09.07 | 03.12 | + Behörde <sup>10)</sup>                           | 11.8116-0339.2 | 390528 | 2 |                                   | Haltefeder      | ATE |
|  | 320 xd |     |  | 09.07 | 03.12 | + Behörde <sup>10)</sup>                           |                |        |   |                                   |                 |     |
|  | 325 d  | 145 |  | 09.06 | 03.12 | - Behörde <sup>9)</sup>                            |                |        |   |                                   |                 |     |
|  | 325 i  | 160 |  | 12.04 | 03.12 | + erhöhte Zuladung <sup>6)</sup>                   |                |        |   |                                   |                 |     |
|  | 325 xi | 160 |  | 01.05 | 03.12 | + erhöhte Zuladung <sup>6)</sup>                   |                |        |   |                                   |                 |     |
|  | 330 d  | 170 |  | 09.05 | 08.07 |  |                |        |   |                                   |                 |     |
|  | 330 i  | 190 |  | 12.04 | 03.12 | - erhöhte Zuladung <sup>3)</sup>                   |                |        |   |                                   |                 |     |
|  | 330 xd | 170 |  | 09.05 | 08.07 |  |                |        |   |                                   |                 |     |
|  | 330 xd | 180 |  | 01.09 | 03.12 | - erhöhte Zuladung <sup>3)</sup>                   |                |        |   |                                   |                 |     |
|  | 330 xi | 190 |  | 01.05 | 08.07 |  |                |        |   |                                   |                 |     |
|  | 330 xi | 200 |  | 09.07 | 03.12 | - erhöhte Zuladung <sup>3)</sup>                   |                |        |   |                                   |                 |     |
|  | 325 d  | 145 |  | 09.06 | 03.12 | + Behörde <sup>10)</sup>                           | 11.0101-6006.2 | 260098 |   |                                   | Hülsensatz      | ATE |
|  | 330 d  | 170 |  | 09.07 | 03.12 |  | 11.8116-0315.2 | 390447 | 2 |                                   | Haltefeder      | ATE |
|  | 330 d  | 180 |  | 09.08 | 03.12 |  | 11.8171-0008.1 | 990049 |   |                                   | Führungsbolzen  | ATE |
|  | 330 i  | 200 |  | 09.07 | 03.12 | + erhöhte Zuladung <sup>6)</sup>                   | 11.8171-0067.1 | 250153 |   |                                   | Führungsbolzen  | ATE |
|  | 330 xd | 170 |  | 09.07 | 03.12 |  |                |        |   |                                   |                 |     |
|  | 330 xd | 180 |  | 01.09 | 03.12 | + erhöhte Zuladung <sup>6)</sup>                   |                |        |   |                                   |                 |     |
|  | 330 xi | 200 |  | 09.07 | 03.12 | + erhöhte Zuladung <sup>6)</sup>                   |                |        |   |                                   |                 |     |

<sup>1)</sup> - idling stop system / - dispositivo start/stop / - unité marche/arrêt / - unidad arranque/paro

<sup>2)</sup> + engine code N52N / + codice motore N52N / + moteur code N52N / + motor code N52N

<sup>3)</sup> - increased payload / - carico utile maggiorato / - charge utile augmentée / - incremento de carga

<sup>4)</sup> - increased payload/+engine co.N46 / - carico utile maggior./+codic.mot.N46 / - charge utile augmentée/+moteur co.N46 / - incremento de carga/+motor co.N46

<sup>5)</sup> - increased payload/+engine co.N46N / - carico utile maggior./+codic.mot.N46N / - charge utile augmentée/+moteur co.N46N / - incremento de carga/+motor co.N46N

<sup>6)</sup> + increased payload / + carico utile maggiorato / + charge utile augmentée / + incremento de carga

<sup>7)</sup> + increased payload/+engine co.N46N / + carico utile maggior./+codic.mot.N46N / + charge utile augmentée/+moteur co.N46N / + incremento de carga/+motor co.N46N

<sup>8)</sup> + increased payload/+engine co.N46 / + carico utile maggior./+codic.mot.N46 / + charge utile augmentée/+moteur co.N46 / + incremento de carga/+motor co.N46

<sup>9)</sup> - authority cars / - enti statali / - véhicule communal / - vehiculos oficiales

<sup>10)</sup> + authority cars / + enti statali / + véhicule communal / + vehiculos oficiales

| BMW 3er Reihe/E90 Limousine (05-12) |        |       |       |       |  |  |                |                |                |                |     |  |                |     |
|-------------------------------------|--------|-------|-------|-------|--|--|----------------|----------------|----------------|----------------|-----|--|----------------|-----|
|                                     | 335 d  | 210   |       | 09.06 | 03.12  | 11.0101-6006.2                                     | 260098         | 2              |                | Hülsensatz     | ATE |  |                |     |
|                                     | 335 i  | 225   |       | 09.06 | 03.12  | 11.8116-0315.2                                     | 390447         |                |                | Haltefeder     | ATE |  |                |     |
|                                     | 335 xi | 225   |       | 03.07 | 03.12  | 11.8171-0008.1                                     | 990049         |                |                | Führungsbolzen | ATE |  |                |     |
|                                     |        |       |       |       |  | 11.8171-0067.1                                     | 250153         |                |                | Führungsbolzen | ATE |  |                |     |
|                                     | M3     | 309   |       | 12.07 | 03.12  | 11.0441-6008.2                                     | 250038         | 2              |                | Dichtungssatz  | ATE |  |                |     |
|                                     |        |       |       |       |  | 11.0101-6006.2                                     | 260098         |                |                | Hülsensatz     | ATE |  |                |     |
|                                     |        |       |       |       |  | 11.8171-0008.1                                     | 990049         |                |                | Führungsbolzen | ATE |  |                |     |
|                                     |        |       |       |       |  | 11.8116-0315.2                                     | 390447         |                |                | Haltefeder     | ATE |  |                |     |
|                                     | 320 xd |       |       | 09.07 | 03.12  | 24.5113-0440.3                                     | 331239         | 2              |                | L=440          |     |  |                |     |
|                                     | 325 xi | 160   |       | 01.05 | 03.12  |  |                |                |                |                |     |  |                |     |
|                                     | 330 xd | 170   |       | 09.05 | 03.12  |  |                |                |                |                |     |  |                |     |
|                                     | 330 xd | 180   |       | 01.09 | 03.12  |  |                |                |                |                |     |  |                |     |
|                                     | 330 xi | 190   |       | 01.05 | 08.07  |  |                |                |                |                |     |  |                |     |
|                                     | 330 xi | 200   |       | 09.07 | 03.12  |  |                |                |                |                |     |  |                |     |
|                                     | 335 xi | 225   |       | 03.07 | 03.12  |  |                |                |                |                |     |  |                |     |
|                                     | M3     | 309   |       | 12.07 | 03.12  | 83.7751-0502.3                                     | 331109         |                |                | L=502          |     |  |                |     |
|                                     |        | 316 d | 85    |       | 07.09  | 03.12  | 24.3401-1707.7 |                |                | 220775         | 2   |  | D=40, - Halter | LUC |
|                                     |        | 316 i | 85    |       | 01.05  | 08.07  | 24.3401-1708.7 |                |                | 220776         |     |  | D=40, - Halter | LUC |
| 316 i                               |        | 90    |       | 09.07 | 03.12  |  |                |                |                |                |     |  |                |     |
| 318 d                               |        | 90    |       | 09.05 | 08.07  | - erhöhte Zuladung <sup>1)</sup>                   |                |                |                |                |     |  |                |     |
| 318 i                               |        | 95    |       | 09.05 | 08.07  | - erhöhte Zuladung/ + Motorcode N46 <sup>2)</sup>  |                |                |                |                |     |  |                |     |
| 320 i                               |        |       |       | 12.04 | 08.07  | - erhöhte Zuladung/ + Motorcode N46 <sup>2)</sup>  |                |                |                |                |     |  |                |     |
| 318 d                               |        | 90    |       | 09.07 | 03.12  |  |                |                |                |                |     |  |                |     |
| 318 d                               |        | 90    |       | 09.05 | 08.07  | + erhöhte Zuladung <sup>3)</sup>                   | 11.9421-9911.2 | 220825         | D=42, - Halter | ATE            |     |  |                |     |
| 318 i                               |        | 95    |       | 03.07 | 08.07  | + Motorcode N46N <sup>4)</sup>                     | 11.9421-9912.2 | 220826         | D=42, - Halter | ATE            |     |  |                |     |
| 318 i                               |        | 95    |       | 09.05 | 08.07  | + erhöhte Zuladung/ + Motorcode N46N <sup>5)</sup> | 11.0101-5402.2 | 260009         | Hülsensatz     | ATE            |     |  |                |     |
| 318 i                               | 105    |       | 09.07 | 03.12 |  | 11.8171-0008.1                                     | 990049         | Führungsbolzen | ATE            |                |     |  |                |     |
| 320 d                               | 110    |       | 09.05 | 03.12 | - Behörde <sup>6)</sup>                            |  |                | Haltefeder     | ATE            |                |     |  |                |     |
| 320 d                               | 120    |       | 12.04 | 08.07 |  |  |                |                |                |                |     |  |                |     |
| 320 d                               | 130    |       | 09.07 | 03.12 | - Behörde <sup>6)</sup>                            |  |                |                |                |                |     |  |                |     |
| 320 i                               |        |       | 03.07 | 08.07 | + Motorcode N46N <sup>4)</sup>                     |  |                |                |                |                |     |  |                |     |
| 320 i                               | 125    |       | 12.04 | 08.07 | + erhöhte Zuladung/ + Motorcode N46 <sup>7)</sup>  |  |                |                |                |                |     |  |                |     |
| 320 i                               | 127    |       | 09.07 | 03.12 |  |  |                |                |                |                |     |  |                |     |
| 320 si                              | 127    |       | 06.06 | 03.12 |  |  |                |                |                |                |     |  |                |     |
| 320 xd                              |        |       | 09.07 | 03.12 | - Behörde <sup>6)</sup>                            |  |                |                |                |                |     |  |                |     |
| 325 i                               | 160    |       | 12.04 | 03.12 | - erhöhte Zuladung <sup>1)</sup>                   |  |                |                |                |                |     |  |                |     |
| 325 xi                              | 160    |       | 09.07 | 03.12 | - erhöhte Zuladung/ + Motorcode N53 <sup>8)</sup>  |  |                |                |                |                |     |  |                |     |
| 325 xi                              | 160    |       | 01.05 | 08.07 | - erhöhte Zuladung/ + Motorcode N52N <sup>9)</sup> |  |                |                |                |                |     |  |                |     |
| 325 xi                              | 160    |       | 01.05 | 08.07 | - erhöhte Zuladung/ + Motorcode N52 <sup>10)</sup> |  |                |                |                |                |     |  |                |     |
| 320 d                               | 110    |       | 09.05 | 03.12 | + Behörde <sup>11)</sup>                           | 11.9441-9957.2                                     | 220827         | 2              |                | D=44, - Halter | ATE |  |                |     |
| 320 d                               | 130    |       | 09.07 | 03.12 | + Behörde <sup>11)</sup>                           | 11.9441-9958.2                                     | 220828         |                |                | D=44, - Halter | ATE |  |                |     |
| 320 xd                              |        |       | 09.07 | 03.12 | + Behörde <sup>11)</sup>                           | 11.0101-5402.2                                     | 260009         |                |                | Hülsensatz     | ATE |  |                |     |
| 325 d                               | 145    |       | 09.06 | 03.12 |  | 11.8171-0008.1                                     | 990049         |                |                | Führungsbolzen | ATE |  |                |     |
| 325 i                               | 160    |       | 12.04 | 03.12 | + erhöhte Zuladung <sup>3)</sup>                   | 11.8116-0296.1                                     | 390445         |                |                | Haltefeder     | ATE |  |                |     |
| 325 xi                              | 160    |       | 01.05 | 03.12 | + erhöhte Zuladung <sup>3)</sup>                   |  |                |                |                |                |     |  |                |     |
| 330 d                               | 170    |       | 09.05 | 03.12 |  |  |                |                |                |                |     |  |                |     |
| 330 d                               | 180    |       | 09.08 | 03.12 |  |  |                |                |                |                |     |  |                |     |
| 330 i                               | 190    |       | 12.04 | 08.07 |  |  |                |                |                |                |     |  |                |     |
| 330 i                               | 200    |       | 09.07 | 03.12 |  |  |                |                |                |                |     |  |                |     |
| 330 xd                              | 170    |       | 09.05 | 03.12 |  |  |                |                |                |                |     |  |                |     |
| 330 xd                              | 180    |       | 01.09 | 03.12 |  |  |                |                |                |                |     |  |                |     |
| 330 xi                              | 190    |       | 01.05 | 08.07 |  |  |                |                |                |                |     |  |                |     |
| 330 xi                              | 200    |       | 09.07 | 03.12 |  |  |                |                |                |                |     |  |                |     |
| 335 d                               | 210    |       | 09.06 | 03.12 |  |  |                |                |                |                |     |  |                |     |
| 335 i                               | 225    |       | 09.06 | 03.12 |  |  |                |                |                |                |     |  |                |     |
| 335 xi                              | 225    |       | 03.07 | 03.12 |  |  |                |                |                |                |     |  |                |     |
|                                     | M3     | 309   |       | 12.07 | 03.12  | 11.0101-5402.2                                     | 260009         | 2              |                | Hülsensatz     | ATE |  |                |     |
|                                     |        |       |       |       |  | 11.8171-0008.1                                     | 990049         |                |                | Führungsbolzen | ATE |  |                |     |
|                                     |        |       |       |       |  | 11.8116-0296.1                                     | 390445         |                |                | Haltefeder     | ATE |  |                |     |
|                                     |        |       |       |       |  |  |                |                |                |                |     |  |                |     |
|                                     | 316 d  | 85    |       | 07.09 | 03.12  | 83.7850-0180.3                                     | 331054         | 2              |                | L=180          |     |  |                |     |
|                                     | 316 i  | 85    |       | 01.05 | 08.07  | 83.7752-0221.3                                     | 331053         |                |                | L=220          |     |  |                |     |
|                                     | 316 i  | 90    |       | 09.07 | 03.12  | 24.5125-0230.3                                     | 331277         |                |                | L=230          |     |  |                |     |
|                                     | 318 d  |       |       | 09.07 | 03.12  | 24.5137-0221.3                                     | 331302         |                |                | L=221          |     |  |                |     |
|                                     | 318 d  | 90    |       | 09.05 | 08.07  |  |                |                |                |                |     |  |                |     |
|                                     | 318 i  | 95    |       | 09.05 | 08.07  |  |                |                |                |                |     |  |                |     |
|                                     | 318 i  | 105   |       | 09.07 | 03.12  |  |                |                |                |                |     |  |                |     |
|                                     | 320 d  | 110   |       | 09.05 | 03.12  |  |                |                |                |                |     |  |                |     |
|                                     | 320 d  | 120   |       | 12.04 | 08.07  |  |                |                |                |                |     |  |                |     |
|                                     | 320 d  | 130   |       | 09.07 | 03.12  |  |                |                |                |                |     |  |                |     |
|                                     | 320 i  |       |       | 12.04 | 08.07  |  |                |                |                |                |     |  |                |     |
|                                     | 320 i  | 125   |       | 09.07 | 03.12  |  |                |                |                |                |     |  |                |     |
|                                     | 320 si | 127   |       | 06.06 | 03.12  |  |                |                |                |                |     |  |                |     |
|                                     | 320 xd |       |       | 09.07 | 03.12  |  |                |                |                |                |     |  |                |     |
|                                     | 325 d  | 145   |       | 09.06 | 03.12  |  |                |                |                |                |     |  |                |     |
|                                     | 325 i  | 160   |       | 12.04 | 03.12  |  |                |                |                |                |     |  |                |     |
|                                     | 325 xi | 160   |       | 01.05 | 03.12  |  |                |                |                |                |     |  |                |     |
|                                     | 330 d  | 170   |       | 09.05 | 03.12  |  |                |                |                |                |     |  |                |     |
|                                     | 330 d  | 180   |       | 09.08 | 03.12  |  |                |                |                |                |     |  |                |     |
|                                     | 330 i  | 190   |       | 12.04 | 08.07  |  |                |                |                |                |     |  |                |     |
| 330 i                               | 200    |       | 09.07 | 03.12 |  |  |                |                |                |                |     |  |                |     |
| 330 xd                              | 170    |       | 09.05 | 03.12 |  |  |                |                |                |                |     |  |                |     |
| 330 xd                              | 180    |       | 01.09 | 03.12 |  |  |                |                |                |                |     |  |                |     |
| 330 xi                              | 190    |       | 01.05 | 08.07 |  |  |                |                |                |                |     |  |                |     |
| 330 xi                              | 200    |       | 09.07 | 03.12 |  |  |                |                |                |                |     |  |                |     |
| 335 d                               | 210    |       | 09.06 | 03.12 |  |  |                |                |                |                |     |  |                |     |
| 335 i                               | 225    |       | 09.06 | 03.12 |  |  |                |                |                |                |     |  |                |     |
| 335 xi                              | 225    |       | 03.07 | 03.12 |  |  |                |                |                |                |     |  |                |     |

1) - increased payload / - carico utile maggiorato / - charge utile augmentée / - incremento de carga  
2) - increased payl./+engine co.N46 / - carico utile maggior./+codic.mot.N46 / - charge utile augmentée/+moteur co.N46 / - incremento de carga/+motor co.N46  
3) + increased payload / + carico utile maggiorato / + charge utile augmentée / + incremento de carga  
4) + engine code N46N / + codice motore N46N / + moteur code N46N / + motor code N46N  
5) + increased payl./+engine co.N46N / + carico utile maggior./+codic.mot.N46N / + charge utile augmentée/+moteur co.N46N / + incremento de carga/+motor co.N46N  
6) - authority cars / - enti statali / - véhicule communal / - vehiculos oficiales

7) + increased payl./+engine co.N46 / + carico utile maggior./+codic.mot.N46 / + charge utile augmentée/+moteur co.N46 / + incremento de carga/+motor co.N46  
8) - increased payl./+engine co.N53 / - carico utile maggior./+codic.mot.N53 / - charge utile augmentée/+moteur co.N53 / - incremento de carga/+motor co.N53  
9) - increased payl./+engine co.N52N / - carico utile maggior./+codic.mot.N52N / - charge utile augmentée/+moteur co.N52N / - incremento de carga/+motor co.N52N  
10) - increased payl./+engine co.N52 / - carico utile maggior./+codic.mot.N52 / - charge utile augmentée/+moteur co.N52 / - incremento de carga/+motor co.N52



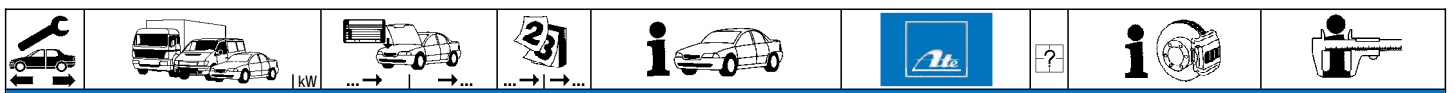

### BMW 3er Reihe/E90 Limousine (05-12)

|  |        |     |  |       |       |                    |                |        |   |                  |  |                |
|--|--------|-----|--|-------|-------|--------------------|----------------|--------|---|------------------|--|----------------|
|  | M3     | 309 |  | 12.07 | 03.12 |                    | 83.7850-0180.3 | 331054 | 2 |                  |  | L=180<br>L=235 |
|  |        |     |  |       |       |                    | 83.7752-0236.3 | 331118 | 2 | am Bremsattel 1) |  |                |
|  | 316 d  | 85  |  | 07.09 | 03.12 |                    | 24.3727-0233.2 | 580233 | 2 | ↓                |  | L=1535         |
|  | 316 i  | 85  |  | 01.05 | 08.07 |                    |                |        |   |                  |  |                |
|  | 316 i  | 90  |  | 09.07 | 03.12 |                    |                |        |   |                  |  |                |
|  | 318 d  |     |  | 09.07 | 03.12 |                    |                |        |   |                  |  |                |
|  | 318 d  | 90  |  | 09.05 | 08.07 |                    |                |        |   |                  |  |                |
|  | 318 i  | 95  |  | 09.05 | 08.07 |                    |                |        |   |                  |  |                |
|  | 318 i  | 105 |  | 09.07 | 03.12 |                    |                |        |   |                  |  |                |
|  | 320 d  | 110 |  | 09.05 | 03.12 |                    |                |        |   |                  |  |                |
|  | 320 d  | 120 |  | 12.04 | 08.07 |                    |                |        |   |                  |  |                |
|  | 320 d  | 130 |  | 09.07 | 03.12 |                    |                |        |   |                  |  |                |
|  | 320 i  |     |  | 12.04 | 08.07 |                    |                |        |   |                  |  |                |
|  | 320 i  | 125 |  | 09.07 | 03.12 |                    |                |        |   |                  |  |                |
|  | 320 si | 127 |  | 06.06 | 03.12 |                    |                |        |   |                  |  |                |
|  | 320 xd |     |  | 09.07 | 03.12 |                    |                |        |   |                  |  |                |
|  | 325 d  | 145 |  | 09.06 | 03.12 |                    |                |        |   |                  |  |                |
|  | 325 i  | 160 |  | 12.04 | 03.12 |                    |                |        |   |                  |  |                |
|  | 325 xi | 160 |  | 01.05 | 03.12 |                    |                |        |   |                  |  |                |
|  | 330 d  | 170 |  | 09.05 | 03.12 |                    |                |        |   |                  |  |                |
|  | 330 d  | 180 |  | 09.08 | 03.12 |                    |                |        |   |                  |  |                |
|  | 330 i  | 190 |  | 12.04 | 08.07 |                    |                |        |   |                  |  |                |
|  | 330 i  | 200 |  | 09.07 | 03.12 |                    |                |        |   |                  |  |                |
|  | 330 xd | 170 |  | 09.05 | 03.12 |                    |                |        |   |                  |  |                |
|  | 330 xd | 180 |  | 01.09 | 03.12 |                    |                |        |   |                  |  |                |
|  | 330 xi | 190 |  | 01.05 | 08.07 |                    |                |        |   |                  |  |                |
|  | 330 xi | 200 |  | 09.07 | 03.12 |                    |                |        |   |                  |  |                |
|  | 335 d  | 210 |  | 09.06 | 03.12 |                    |                |        |   |                  |  |                |
|  | 335 i  | 225 |  | 09.06 | 03.12 |                    |                |        |   |                  |  |                |
|  | 335 xi | 225 |  | 03.07 | 03.12 |                    |                |        |   |                  |  |                |
|  | M3     | 309 |  | 12.07 | 03.12 |                    |                |        |   |                  |  |                |
|  | 316 d  | 85  |  | 07.09 | 03.12 |                    | 24.2419-1713.3 | 030093 |   |                  |  | Gz 19,05       |
|  | 316 i  | 85  |  | 01.05 | 08.07 |                    |                |        |   |                  |  |                |
|  | 316 i  | 90  |  | 09.07 | 03.12 |                    |                |        |   |                  |  |                |
|  | 318 d  |     |  | 09.07 | 03.12 |                    |                |        |   |                  |  |                |
|  | 318 d  | 90  |  | 09.05 | 08.07 |                    |                |        |   |                  |  |                |
|  | 318 i  | 95  |  | 09.05 | 08.07 |                    |                |        |   |                  |  |                |
|  | 318 i  | 105 |  | 09.07 | 03.12 |                    |                |        |   |                  |  |                |
|  | 320 d  | 110 |  | 09.05 | 03.12 |                    |                |        |   |                  |  |                |
|  | 320 d  | 120 |  | 12.04 | 08.07 |                    |                |        |   |                  |  |                |
|  | 320 d  | 130 |  | 09.07 | 03.12 |                    |                |        |   |                  |  |                |
|  | 320 i  |     |  | 12.04 | 08.07 |                    |                |        |   |                  |  |                |
|  | 320 i  | 125 |  | 09.07 | 03.12 |                    |                |        |   |                  |  |                |
|  | 320 si | 127 |  | 06.06 | 03.12 |                    |                |        |   |                  |  |                |
|  | 325 d  | 145 |  | 09.06 | 03.12 |                    |                |        |   |                  |  |                |
|  | 325 i  | 160 |  | 12.04 | 03.12 |                    |                |        |   |                  |  |                |
|  | 325 xi | 160 |  | 01.05 | 03.12 |                    |                |        |   |                  |  |                |
|  | 330 d  | 170 |  | 09.05 | 03.12 |                    |                |        |   |                  |  |                |
|  | 330 d  | 180 |  | 09.08 | 03.12 |                    |                |        |   |                  |  |                |
|  | 330 i  | 190 |  | 12.04 | 08.07 |                    |                |        |   |                  |  |                |
|  | 330 i  | 200 |  | 09.07 | 03.12 |                    |                |        |   |                  |  |                |
|  | 330 xd | 170 |  | 09.05 | 03.12 |                    |                |        |   |                  |  |                |
|  | 330 xd | 180 |  | 01.09 | 03.12 |                    |                |        |   |                  |  |                |
|  | 330 xi | 190 |  | 01.05 | 08.07 |                    |                |        |   |                  |  |                |
|  | 330 xi | 200 |  | 09.07 | 03.12 |                    |                |        |   |                  |  |                |
|  | 335 i  | 225 |  | 09.06 | 03.12 |                    |                |        |   |                  |  |                |
|  | 335 xi | 225 |  | 03.07 | 03.12 |                    |                |        |   |                  |  |                |
|  | M3     | 309 |  | 12.07 | 03.12 |                    |                |        |   |                  |  |                |
|  | 318 d  | 90  |  | 09.05 | 08.07 |                    | 24.2522-0905.3 | 040042 |   |                  |  | Nz 22,20       |
|  | 318 i  | 95  |  | 09.05 | 08.07 |                    |                |        |   |                  |  |                |
|  | 320 d  | 110 |  | 09.05 | 03.12 |                    |                |        |   |                  |  |                |
|  | 320 d  | 120 |  | 12.04 | 08.07 |                    |                |        |   |                  |  |                |
|  | 320 i  |     |  | 12.04 | 08.07 |                    |                |        |   |                  |  |                |
|  | 320 si | 127 |  | 06.06 | 03.12 |                    |                |        |   |                  |  |                |
|  | 325 i  | 160 |  | 12.04 | 03.12 | + Motorcode N52 2) |                |        |   |                  |  |                |
|  | 325 xi | 160 |  | 01.05 | 08.07 |                    |                |        |   |                  |  |                |
|  | 330 d  | 170 |  | 09.05 | 03.12 |                    |                |        |   |                  |  |                |
|  | 330 i  | 190 |  | 12.04 | 08.07 |                    |                |        |   |                  |  |                |
|  | 330 xd | 170 |  | 09.05 | 03.12 |                    |                |        |   |                  |  |                |
|  | 330 xi | 190 |  | 01.05 | 08.07 |                    |                |        |   |                  |  |                |

### BMW 3er Reihe/E91 Touring (05-12)

|  |        |     |  |       |       |                    |                |        |  |                        |  |    |     |
|--|--------|-----|--|-------|-------|--------------------|----------------|--------|--|------------------------|--|----|-----|
|  | 316 d  | 85  |  | 09.09 | 05.12 |                    | 03.7848-4003.4 | 300235 |  | - Start/Stop-Anlage 3) |  | 8" | ATE |
|  | 316i   | 90  |  | 09.07 | 05.12 |                    |                |        |  |                        |  |    |     |
|  | 318 d  | 90  |  | 09.05 | 08.07 |                    | 03.7848-5003.4 | 300236 |  |                        |  | 8" | ATE |
|  | 318 i  |     |  | 01.06 | 08.07 | + Motorcode N46 4) |                |        |  |                        |  |    |     |
|  | 320 d  | 120 |  | 06.05 | 08.07 |                    |                |        |  |                        |  |    |     |
|  | 320 i  |     |  | 06.05 | 08.07 | + Motorcode N46 4) |                |        |  |                        |  |    |     |
|  | 323 i  |     |  | 06.05 | 05.12 |                    |                |        |  |                        |  |    |     |
|  | 325 d  | 145 |  | 09.06 | 05.12 |                    |                |        |  |                        |  |    |     |
|  | 325 i  | 155 |  | 01.12 | 05.12 |                    |                |        |  |                        |  |    |     |
|  | 325 i  | 160 |  | 06.05 | 05.12 |                    |                |        |  |                        |  |    |     |
|  | 325 xi | 160 |  | 06.05 | 05.12 |                    |                |        |  |                        |  |    |     |
|  | 330 d  | 170 |  | 06.05 | 05.12 |                    |                |        |  |                        |  |    |     |
|  | 330 i  | 190 |  | 06.05 | 08.07 |                    |                |        |  |                        |  |    |     |
|  | 330 xd |     |  | 06.05 | 05.12 |                    |                |        |  |                        |  |    |     |

1) on the brake caliper / sulla pinza freno / sur l'étrier de frein / a la pinza de freno

2) + engine code N52 / + codice motore N52 / + moteur code N52 / + motor code N52

3) - idling stop system / - dispositivo start/stop / - unité marche/arrêt / - unidad arranque/paro

4) + engine code N46 / + codice motore N46 / + moteur code N46 / + motor code N46



**BMW 3er Reihe/E91 Touring (05-12)**

|        |        |       |       |   |  |                |        |                |                 |     |
|--------|--------|-------|-------|---|--|----------------|--------|----------------|-----------------|-----|
|        | 330 xi | 190   | 06.05 | 08.07   |  | 03.7848-5003.4 | 300236 |                | 8"              | ATE |
|        | 330 xi | 200   | 09.07 | 05.12   |  |                |        |                |                 |     |
|        | 318 d  | 105   | 09.07 | 05.12   |  | 03.7845-0103.4 | 300268 |                | 8"              | ATE |
|        | 318 i  |       | 03.07 | 08.07   | + Motorcode N46N <sup>1)</sup>                         |                |        |                |                 |     |
|        | 318 i  | 100   | 09.07 | 05.12   |  |                |        |                |                 |     |
|        | 318 i  | 105   | 09.07 | 05.12   |  |                |        |                |                 |     |
|        | 320 d  |       | 09.07 | 05.12   |  |                |        |                |                 |     |
|        | 320 i  |       | 06.05 | 08.07   | + Motorcode N46N <sup>1)</sup>                         |                |        |                |                 |     |
|        | 320 i  | 125   | 09.07 | 05.12   |  |                |        |                |                 |     |
|        | 320 xd | 130   | 09.07 | 05.12   |  |                |        |                |                 |     |
|        | 330 d  | 180   | 09.08 | 05.12   |  |                |        |                |                 |     |
|        | 330 i  | 200   | 09.07 | 05.12   |  |                |        |                |                 |     |
|        | 335 d  | 210   | 09.06 | 05.12   |  |                |        |                |                 |     |
|        | 335 i  | 225   | 09.06 | 05.12   |  |                |        |                |                 |     |
| 335 xi | 225    | 03.07 | 05.12 |   |  |                |        |                |                 |     |
|        | 316 d  | 85    | 09.09 | 05.12   |  | 03.2023-2407.3 | 010796 |                | THz 23,81/22,20 | ATE |
|        | 316i   | 90    | 09.07 | 05.12   |  |                |        |                |                 |     |
|        | 318 d  | 90    | 09.05 | 08.07   |  | 03.2025-1904.3 | 010797 |                | THz 25,40/22,20 | ATE |
|        | 318 d  | 105   | 09.07 | 05.12   |  |                |        |                |                 |     |
|        | 318 i  |       | 01.06 | 08.07   |  |                |        |                |                 |     |
|        | 318 i  | 100   | 09.07 | 05.12   |  |                |        |                |                 |     |
|        | 318 i  | 105   | 09.07 | 05.12   |  |                |        |                |                 |     |
|        | 320 d  |       | 09.07 | 05.12   |  |                |        |                |                 |     |
|        | 320 d  | 120   | 06.05 | 08.07   |  |                |        |                |                 |     |
|        | 320 i  |       | 06.05 | 08.07   |  |                |        |                |                 |     |
|        | 320 i  | 125   | 09.07 | 05.12   |  |                |        |                |                 |     |
|        | 320 xd | 130   | 09.07 | 05.12   |  |                |        |                |                 |     |
|        | 323 i  |       | 06.05 | 05.12   |  |                |        |                |                 |     |
|        | 325 d  | 145   | 09.06 | 05.12   |  |                |        |                |                 |     |
|        | 325 i  | 155   | 01.12 | 05.12   |  |                |        |                |                 |     |
|        | 325 i  | 160   | 06.05 | 05.12   |  |                |        |                |                 |     |
|        | 325 xi | 160   | 06.05 | 05.12   |  |                |        |                |                 |     |
|        | 330 d  | 170   | 06.05 | 05.12   |  |                |        |                |                 |     |
|        | 330 d  | 180   | 09.08 | 05.12   |  |                |        |                |                 |     |
|        | 330 i  | 190   | 06.05 | 08.07   |  |                |        |                |                 |     |
|        | 330 i  | 200   | 09.07 | 05.12   |  |                |        |                |                 |     |
|        | 330 xd |       | 06.05 | 05.12   |  |                |        |                |                 |     |
|        | 330 xi | 190   | 06.05 | 08.07   |  |                |        |                |                 |     |
|        | 330 xi | 200   | 09.07 | 05.12   |  |                |        |                |                 |     |
| 335 d  | 210    | 09.06 | 05.12 |   |  |                |        |                |                 |     |
| 335 i  | 225    | 09.06 | 05.12 |   |  |                |        |                |                 |     |
| 335 xi | 225    | 03.07 | 05.12 |   |  |                |        |                |                 |     |
|        | 318 d  | 90    | 09.05 | 08.07   |  | 11.9571-9753.2 | 220929 |                | D=57, - Halter  | ATE |
|        | 318 d  | 105   | 09.07 | 05.12   |  | 11.9571-9754.2 | 220930 |                | D=57, - Halter  | ATE |
|        | 318 i  |       | 03.07 | 08.07   | + Motorcode N46N <sup>1)</sup>                         | 11.0101-5402.2 | 260009 |                | Hülsensatz      | ATE |
|        | 318 i  |       | 01.06 | 08.07   | + Motorcode N43 <sup>2)</sup>                          | 11.8171-0008.1 | 990049 |                | Führungsbolzen  | ATE |
|        | 318 i  | 100   | 09.07 | 05.12   | + erhöhte Zuladung <sup>3)</sup>                       | 11.8116-0339.2 | 390528 | 2              | Haltefeder      | ATE |
|        | 318 i  | 100   | 09.07 | 02.08   | - erhöhte Zuladung <sup>4)</sup>                       |                |        |                |                 |     |
|        | 318 i  | 105   | 09.07 | 05.12   | + erhöhte Zuladung <sup>3)</sup>                       |                |        |                |                 |     |
|        | 318 i  | 105   | 09.07 | 02.08   | - erhöhte Zuladung <sup>4)</sup>                       |                |        |                |                 |     |
|        | 320 d  |       | 09.07 | 05.12   | - Behörde <sup>5)</sup>                                |                |        |                |                 |     |
|        | 320 d  | 120   | 06.05 | 08.07   | - Behörde <sup>5)</sup>                                |                |        |                |                 |     |
|        | 320 i  |       | 06.05 | 08.07   | + Motorcode N46N <sup>1)</sup>                         |                |        |                |                 |     |
|        | 320 i  |       | 06.05 | 08.07   | + Motorcode N46 <sup>6)</sup>                          |                |        |                |                 |     |
|        | 320 i  | 125   | 09.07 | 05.12   |  |                |        |                |                 |     |
|        | 320 xd | 130   | 09.07 | 05.12   | - Behörde <sup>5)</sup>                                |                |        |                |                 |     |
|        | 323 i  |       | 06.05 | 05.12   |  |                |        |                |                 |     |
|        | 325 i  | 155   | 01.12 | 05.12   | - erhöhte Zuladung <sup>4)</sup>                       |                |        |                |                 |     |
|        | 325 i  | 160   | 06.05 | 05.12   | - erhöhte Zuladung/ + Motorcode N52N/N53 <sup>7)</sup> |                |        |                |                 |     |
|        | 325 xi | 160   | 03.07 | 08.07   | - erhöhte Zuladung/ + Motorcode N52N <sup>8)</sup>     |                |        |                |                 |     |
|        | 316 d  | 85    | 09.09 | 05.12   |  | 11.0101-5402.2 | 260009 |                | Hülsensatz      | ATE |
|        | 316i   | 90    | 09.07 | 05.12   |  | 11.8171-0008.1 | 990049 |                | Führungsbolzen  | ATE |
|        | 318 i  | 100   | 03.08 | 05.12   | - erhöhte Zuladung <sup>4)</sup>                       | 11.8116-0339.2 | 390528 | 2              | Haltefeder      | ATE |
|        | 318 i  | 105   | 03.08 | 05.12   | - erhöhte Zuladung <sup>4)</sup>                       |                |        |                |                 |     |
|        | 320 d  |       | 09.07 | 05.12   | + Behörde <sup>9)</sup>                                | 11.0101-5402.2 | 260009 |                | Hülsensatz      | ATE |
|        | 320 d  | 120   | 06.05 | 08.07   | + Behörde <sup>9)</sup>                                | 11.8171-0008.1 | 990049 |                | Führungsbolzen  | ATE |
| 320 xd | 130    | 09.07 | 05.12 | + Behörde <sup>9)</sup>                             | 11.8116-0339.2   | 390528         | 2      | Haltefeder     | ATE             |     |
| 325 d  | 145    | 09.06 | 05.12 | - Behörde <sup>5)</sup>                             |  |                |        |                |                 |     |
| 325 i  | 155    | 01.12 | 05.12 | + erhöhte Zuladung <sup>3)</sup>                    |  |                |        |                |                 |     |
| 325 i  | 160    | 06.05 | 05.12 | + erhöhte Zuladung <sup>3)</sup>                    |  |                |        |                |                 |     |
| 325 xi | 160    | 03.07 | 08.07 | + erhöhte Zuladung/ + Motorcode N52N <sup>10)</sup> |  |                |        |                |                 |     |
| 325 xi | 160    | 06.05 | 05.12 | + Motorcode N52N/N53 <sup>11)</sup>                 |  |                |        |                |                 |     |
| 330 d  | 170    | 06.05 | 08.07 |   |  |                |        |                |                 |     |
| 330 i  | 190    | 06.05 | 08.07 |   |  |                |        |                |                 |     |
| 330 xd |        | 06.05 | 08.07 |   |  |                |        |                |                 |     |
| 330 xi | 190    | 06.05 | 08.07 |   |  |                |        |                |                 |     |
| 325 d  | 145    | 09.06 | 05.12 | + Behörde <sup>9)</sup>                             | 11.0101-6006.2   | 260098         |        | Hülsensatz     | ATE             |     |
| 330 d  | 170    | 09.07 | 05.12 |   | 11.8116-0315.2   | 390447         | 2      | Haltefeder     | ATE             |     |
| 330 d  | 180    | 09.08 | 05.12 |   | 11.8171-0008.1   | 990049         |        | Führungsbolzen | ATE             |     |
| 330 i  | 200    | 09.07 | 05.12 |   | 11.8171-0067.1   | 250153         |        | Führungsbolzen | ATE             |     |
| 330 xd |        | 09.07 | 05.12 |   |  |                |        |                |                 |     |
| 330 xi | 200    | 09.07 | 05.12 |   |  |                |        |                |                 |     |
| 335 d  | 210    | 09.06 | 05.12 |   |  |                |        |                |                 |     |
| 335 i  | 225    | 09.06 | 05.12 |   |  |                |        |                |                 |     |
| 335 xi | 225    | 03.07 | 05.12 |   |  |                |        |                |                 |     |

<sup>1)</sup> + engine code N46N / + codice motore N46N / + moteur code N46N / + motor code N46N

<sup>2)</sup> + engine code N43 / + codice motore N43 / + moteur code N43 / + motor code N43

<sup>3)</sup> + increased payload / + carico utile maggiorato / + charge utile augmentée / + incremento de carga

<sup>4)</sup> - increased payload / - carico utile maggiorato / - charge utile augmentée / - incremento de carga

<sup>5)</sup> - authority cars / - enti statali / - véhicule communal / - vehiculos oficiales

<sup>6)</sup> + engine code N46 / + codice motore N46 / + moteur code N46 / + motor code N46

<sup>7)</sup> - increased payload / + eng.co.N52N/N53 / - caric.utili.magg./+codic.mot.N52N/N53 / - charge utile augment./+moteur N52N/N53 / - incremento de carga/+motor co.N52N/N53

<sup>8)</sup> - increased payload / +engine co.N52N / - carico utile maggior./+codic.mot.N52N / - charge utile augmentée/+moteur co.N52N / - incremento de carga/+motor co.N52N

<sup>9)</sup> + authority cars / + enti statali / + véhicule communal / + vehiculos oficiales

<sup>10)</sup> + increased payload / +engine co.N52N / + carico utile maggior./+codic.mot.N52N / + charge utile augmentée/+moteur co.N52N / + incremento de carga/+motor co.N52N

<sup>11)</sup> + engine code N52N/N53 / + codice motore N52N/N53 / + moteur code N52N/N53 / + motor code N52N/N53



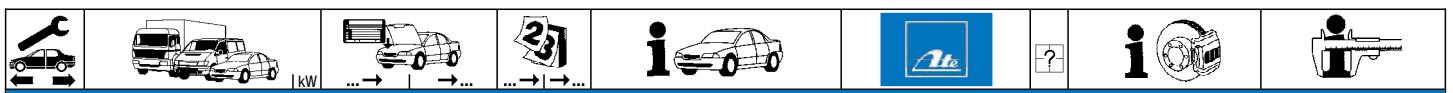

**BMW 3er Reihe/E91 Touring (05-12)**

|  |        |     |  |       |       |  |                |        |   |  |                              |                |     |
|--|--------|-----|--|-------|-------|--|----------------|--------|---|--|------------------------------|----------------|-----|
|  | 320 xd | 130 |  | 09.07 | 05.12 |  | 24.5113-0440.3 | 331239 | 2 |  |                              | L=440          |     |
|  | 325 xi | 160 |  | 06.05 | 05.12 |  |                |        |   |  |                              |                |     |
|  | 330 xd |     |  | 06.05 | 05.12 |  |                |        |   |  |                              |                |     |
|  | 330 xi | 190 |  | 06.05 | 08.07 |  |                |        |   |  |                              |                |     |
|  | 330 xi | 200 |  | 09.07 | 05.12 |  |                |        |   |  |                              |                |     |
|  | 335 xi | 225 |  | 03.07 | 05.12 |  |                |        |   |  |                              |                |     |
|  | 316 d  | 85  |  | 09.09 | 05.12 |  | 11.9421-9911.2 | 220825 |   |  |                              | D=42, - Halter | ATE |
|  | 316i   | 90  |  | 09.07 | 05.12 |  | 11.9421-9912.2 | 220826 |   |  |                              | D=42, - Halter | ATE |
|  | 318 d  | 90  |  | 09.05 | 08.07 |  | 11.0101-5402.2 | 260009 |   |  |                              | Hülsensatz     | ATE |
|  | 318 d  | 105 |  | 09.07 | 05.12 |  | 11.8171-0008.1 | 990049 |   |  |                              | Führungsbolzen | ATE |
|  | 318 i  |     |  | 01.06 | 08.07 |  | 11.8116-0066.1 | 390577 | 2 |  |                              | Haltefeder     | ATE |
|  | 318 i  | 100 |  | 09.07 | 05.12 |  |                |        |   |  |                              |                |     |
|  | 318 i  | 105 |  | 09.07 | 05.12 |  |                |        |   |  |                              |                |     |
|  | 320 d  |     |  | 09.07 | 05.12 | - Behörde <sup>1)</sup>                            |                |        |   |  |                              |                |     |
|  | 320 d  | 120 |  | 06.05 | 08.07 | - Behörde <sup>1)</sup>                            |                |        |   |  |                              |                |     |
|  | 320 i  |     |  | 06.05 | 08.07 |  |                |        |   |  |                              |                |     |
|  | 320 i  | 125 |  | 09.07 | 05.12 |  |                |        |   |  |                              |                |     |
|  | 320 xd | 130 |  | 09.07 | 05.12 | - Behörde <sup>1)</sup>                            |                |        |   |  |                              |                |     |
|  | 323 i  |     |  | 06.05 | 05.12 |  |                |        |   |  |                              |                |     |
|  | 325 i  | 155 |  | 01.12 | 05.12 | - erhöhte Zuladung <sup>2)</sup>                   |                |        |   |  |                              |                |     |
|  | 325 i  | 160 |  | 06.05 | 05.12 | - erhöhte Zuladung <sup>2)</sup>                   |                |        |   |  |                              |                |     |
|  | 325 xi | 160 |  | 03.07 | 08.07 | - erhöhte Zuladung/ + Motorcode N52N <sup>3)</sup> |                |        |   |  |                              |                |     |
|  | 320 d  |     |  | 09.07 | 05.12 | + Behörde <sup>4)</sup>                            | 11.9441-9957.2 | 220827 |   |  |                              | D=44, - Halter | ATE |
|  | 320 d  | 120 |  | 06.05 | 08.07 | + Behörde <sup>4)</sup>                            | 11.9441-9958.2 | 220828 |   |  |                              | D=44, - Halter | ATE |
|  | 320 xd | 130 |  | 09.07 | 05.12 | + Behörde <sup>4)</sup>                            | 11.0101-5402.2 | 260009 |   |  |                              | Hülsensatz     | ATE |
|  | 325 d  | 145 |  | 09.06 | 05.12 |  | 11.8171-0008.1 | 990049 |   |  |                              | Führungsbolzen | ATE |
|  | 325 i  | 155 |  | 01.12 | 05.12 | + erhöhte Zuladung <sup>5)</sup>                   | 11.8116-0296.1 | 390445 | 2 |  |                              | Haltefeder     | ATE |
|  | 325 i  | 160 |  | 06.05 | 05.12 | + erhöhte Zuladung <sup>5)</sup>                   |                |        |   |  |                              |                |     |
|  | 325 xi | 160 |  | 03.07 | 08.07 | + erhöhte Zuladung/ + Motorcode N52N <sup>6)</sup> |                |        |   |  |                              |                |     |
|  | 325 xi | 160 |  | 06.05 | 05.12 | + Motorcode N52N/N53 <sup>7)</sup>                 |                |        |   |  |                              |                |     |
|  | 330 d  | 170 |  | 06.05 | 05.12 |  |                |        |   |  |                              |                |     |
|  | 330 d  | 180 |  | 09.08 | 05.12 |  |                |        |   |  |                              |                |     |
|  | 330 i  | 190 |  | 06.05 | 08.07 |  |                |        |   |  |                              |                |     |
|  | 330 i  | 200 |  | 09.07 | 05.12 |  |                |        |   |  |                              |                |     |
|  | 330 xd |     |  | 06.05 | 05.12 |  |                |        |   |  |                              |                |     |
|  | 330 xi | 190 |  | 06.05 | 08.07 |  |                |        |   |  |                              |                |     |
|  | 330 xi | 200 |  | 09.07 | 05.12 |  |                |        |   |  |                              |                |     |
|  | 335 d  | 210 |  | 09.06 | 05.12 |  |                |        |   |  |                              |                |     |
|  | 335 i  | 225 |  | 09.06 | 05.12 |  |                |        |   |  |                              |                |     |
|  | 335 xi | 225 |  | 03.07 | 05.12 |  |                |        |   |  |                              |                |     |
|  | 316 d  | 85  |  | 09.09 | 05.12 |  | 83.7850-0180.3 | 331054 | 2 |  |                              | L=180          |     |
|  | 316i   | 90  |  | 09.07 | 05.12 |  | 83.7752-0221.3 | 331053 | 2 |  | am Bremssattel <sup>8)</sup> | L=220          |     |
|  | 318 d  | 90  |  | 09.05 | 08.07 |  | 24.5125-0230.3 | 331277 | 2 |  | am Bremssattel <sup>8)</sup> | L=230          |     |
|  | 318 d  | 105 |  | 09.07 | 05.12 |  | 24.5137-0221.3 | 331302 | 2 |  | am Bremssattel <sup>8)</sup> | L=221          |     |
|  | 318 i  |     |  | 01.06 | 08.07 |  |                |        |   |  |                              |                |     |
|  | 318 i  | 100 |  | 09.07 | 05.12 |  |                |        |   |  |                              |                |     |
|  | 318 i  | 105 |  | 09.07 | 05.12 |  |                |        |   |  |                              |                |     |
|  | 320 d  |     |  | 09.07 | 05.12 |  |                |        |   |  |                              |                |     |
|  | 320 d  | 120 |  | 06.05 | 08.07 |  |                |        |   |  |                              |                |     |
|  | 320 i  |     |  | 06.05 | 08.07 |  |                |        |   |  |                              |                |     |
|  | 320 i  | 125 |  | 09.07 | 05.12 |  |                |        |   |  |                              |                |     |
|  | 320 xd | 130 |  | 09.07 | 05.12 |  |                |        |   |  |                              |                |     |
|  | 323 i  |     |  | 06.05 | 05.12 |  |                |        |   |  |                              |                |     |
|  | 325 d  | 145 |  | 09.06 | 05.12 |  |                |        |   |  |                              |                |     |
|  | 325 i  | 155 |  | 01.12 | 05.12 |  |                |        |   |  |                              |                |     |
|  | 325 i  | 160 |  | 06.05 | 05.12 |  |                |        |   |  |                              |                |     |
|  | 325 xi | 160 |  | 06.05 | 05.12 |  |                |        |   |  |                              |                |     |
|  | 330 d  | 170 |  | 06.05 | 05.12 |  |                |        |   |  |                              |                |     |
|  | 330 d  | 180 |  | 09.08 | 05.12 |  |                |        |   |  |                              |                |     |
|  | 330 i  | 190 |  | 06.05 | 08.07 |  |                |        |   |  |                              |                |     |
|  | 330 i  | 200 |  | 09.07 | 05.12 |  |                |        |   |  |                              |                |     |
|  | 330 xd |     |  | 06.05 | 05.12 |  |                |        |   |  |                              |                |     |
|  | 330 xi | 190 |  | 06.05 | 08.07 |  |                |        |   |  |                              |                |     |
|  | 330 xi | 200 |  | 09.07 | 05.12 |  |                |        |   |  |                              |                |     |
|  | 335 d  | 210 |  | 09.06 | 05.12 |  |                |        |   |  |                              |                |     |
|  | 335 i  | 225 |  | 09.06 | 05.12 |  |                |        |   |  |                              |                |     |
|  | 335 xi | 225 |  | 03.07 | 05.12 |  |                |        |   |  |                              |                |     |
|  | 316 d  | 85  |  | 09.09 | 05.12 |  | 24.3727-0233.2 | 580233 | 2 |  |                              | L=1535         |     |
|  | 316i   | 90  |  | 09.07 | 05.12 |  |                |        |   |  |                              |                |     |
|  | 318 d  | 90  |  | 09.05 | 08.07 |  |                |        |   |  |                              |                |     |
|  | 318 d  | 105 |  | 09.07 | 05.12 |  |                |        |   |  |                              |                |     |
|  | 318 i  |     |  | 01.06 | 08.07 |  |                |        |   |  |                              |                |     |
|  | 318 i  | 100 |  | 09.07 | 05.12 |  |                |        |   |  |                              |                |     |
|  | 318 i  | 105 |  | 09.07 | 05.12 |  |                |        |   |  |                              |                |     |
|  | 320 d  |     |  | 09.07 | 05.12 |  |                |        |   |  |                              |                |     |
|  | 320 d  | 120 |  | 06.05 | 08.07 |  |                |        |   |  |                              |                |     |
|  | 320 i  |     |  | 06.05 | 08.07 |  |                |        |   |  |                              |                |     |
|  | 320 i  | 125 |  | 09.07 | 05.12 |  |                |        |   |  |                              |                |     |
|  | 320 xd | 130 |  | 09.07 | 05.12 |  |                |        |   |  |                              |                |     |
|  | 323 i  |     |  | 06.05 | 05.12 |  |                |        |   |  |                              |                |     |
|  | 325 d  | 145 |  | 09.06 | 05.12 |  |                |        |   |  |                              |                |     |
|  | 325 i  | 155 |  | 01.12 | 05.12 |  |                |        |   |  |                              |                |     |
|  | 325 i  | 160 |  | 06.05 | 05.12 |  |                |        |   |  |                              |                |     |
|  | 325 xi | 160 |  | 06.05 | 05.12 |  |                |        |   |  |                              |                |     |
|  | 330 d  | 170 |  | 06.05 | 05.12 |  |                |        |   |  |                              |                |     |
|  | 330 d  | 180 |  | 09.08 | 05.12 |  |                |        |   |  |                              |                |     |
|  | 330 i  | 190 |  | 06.05 | 08.07 |  |                |        |   |  |                              |                |     |

<sup>1)</sup> - authority cars / - enti statali / - véhicule communal / - vehiculos oficiales

<sup>2)</sup> - increased payload / - carico utile maggiorato / - charge utile augmentée / - incremento de carga

<sup>3)</sup> - increased payload/engine co.N52N / - carico utile maggior./+codic.mot.N52N / - charge utile augmentée/+moteur co.N52N / - incremento de carga/+motor co.N52N















<sup>4)</sup> + authority cars / + enti statali / + véhicule communal / + vehiculos oficiales

<sup>5)</sup> + increased payload / + carico utile maggiorato / + charge utile augmentée / + incremento de carga

<sup>6)</sup> + increased payload/engine co.N52N / + carico utile maggior./+codic.mot.N52N / + charge utile augmentée/+moteur co.N52N / + incremento de carga/+motor co.N52N















<sup>7)</sup> + engine code N52N/N53 / + codice motore N52N/N53 / + moteur code N52N/N53 / + motor code N52N/N53

<sup>8)</sup> on the brake caliper / sulla pinza freno / sur l'étrier de frein / a la pinza de freno

|     |  |  |  |  |  |  |  |  |                     |
|--|--|--|--|--|---|--|--|--|---------------------|
| <b>BMW 3er Reihe/E91 Touring (05-12)</b>   |  |  |  |  |   |  |  |  |                     |
|    | 330 i  | 200  |  | 09.07  | 05.12   | 24.3727-0233.2   | 580233   | 2 ↓  | L=1535              |
|  | 330 xd   |  |  | 06.05  | 05.12   |  |  |  |                     |
|  | 330 xi   | 190  |  | 06.05  | 08.07   |  |  |  |                     |
|  | 330 xi   | 200  |  | 09.07  | 05.12   |  |  |  |                     |
|  | 335 d  | 210  |  | 09.06  | 05.12   |  |  |  |                     |
|  | 335 i  | 225  |  | 09.06  | 05.12   |  |  |  |                     |
|  | 335 xi   | 225  |  | 03.07  | 05.12   |  |  |  |                     |
|    | 316 d  | 85   |  | 09.09  | 05.12   | 24.2419-1713.3   | 030093   |  | Gz 19,05            |
|  | 316i   | 90   |  | 09.07  | 05.12   |  |  |  |                     |
|  | 318 d  | 90   |  | 09.05  | 08.07   |  |  |  |                     |
|  | 318 d  | 105  |  | 09.07  | 05.12   |  |  |  |                     |
|  | 318 i  |  |  | 01.06  | 08.07   |  |  |  |                     |
|  | 318 i  | 100  |  | 09.07  | 05.12   |  |  |  |                     |
|  | 318 i  | 105  |  | 09.07  | 05.12   |  |  |  |                     |
|  | 320 d  |  |  | 09.07  | 05.12   |  |  |  |                     |
|  | 320 d  | 120  |  | 06.05  | 08.07   |  |  |  |                     |
|  | 320 i  |  |  | 06.05  | 08.07   |  |  |  |                     |
|  | 320 i  | 125  |  | 09.07  | 05.12   |  |  |  |                     |
|  | 320 xd   | 130  |  | 09.07  | 05.12   |  |  |  |                     |
|  | 323 i  |  |  | 06.05  | 05.12   |  |  |  |                     |
|  | 325 d  | 145  |  | 09.06  | 05.12   |  |  |  |                     |
|  | 325 i  | 155  |  | 01.12  | 05.12   |  |  |  |                     |
|  | 325 i  | 160  |  | 06.05  | 05.12   |  |  |  |                     |
|  | 325 xi   | 160  |  | 06.05  | 05.12   |  |  |  |                     |
|  | 330 d  | 170  |  | 06.05  | 05.12   |  |  |  |                     |
|  | 330 d  | 180  |  | 09.08  | 05.12   |  |  |  |                     |
|  | 330 i  | 190  |  | 06.05  | 08.07   |  |  |  |                     |
|  | 330 i  | 200  |  | 09.07  | 05.12   |  |  |  |                     |
|  | 330 xd   |  |  | 06.05  | 05.12   |  |  |  |                     |
|  | 330 xi   | 190  |  | 06.05  | 08.07   |  |  |  |                     |
|  | 330 xi   | 200  |  | 09.07  | 05.12   |  |  |  |                     |
|  | 335 i  | 225  |  | 09.06  | 05.12   |  |  |  |                     |
|  | 335 xi   | 225  |  | 03.07  | 05.12   |  |  |  |                     |
|    | 318 d  | 90   |  | 09.05  | 08.07   | 24.2522-0905.3   | 040042   |  | Nz 22,20            |
|  | 318 i  |  |  | 01.06  | 08.07   |  |  |  |                     |
|  | 320 d  | 120  |  | 06.05  | 08.07   |  |  |  |                     |
|  | 320 i  |  |  | 06.05  | 08.07   |  |  |  |                     |
|  | 323 i  |  |  | 06.05  | 05.12   |  |  |  |                     |
|  | 325 i  | 155  |  | 01.12  | 05.12   |  |  |  |                     |
|  | 325 i  | 160  |  | 06.05  | 05.12   |  |  |  |                     |
|  | 330 d  | 170  |  | 06.05  | 05.12   |  |  |  |                     |
|  | 330 i  | 190  |  | 06.05  | 08.07   |  |  |  |                     |
|  | 330 xd   |  |  | 06.05  | 05.12   |  |  |  |                     |
|  | 330 xi   | 190  |  | 06.05  | 08.07   |  |  |  |                     |
| <b>BMW 3er Reihe/E92 Coupe (06-13)</b>   |  |  |  |  |   |  |  |  |                     |
|  | 316 i  | 90   |  | 09.09  | 06.13   | 03.7848-4003.4   | 300235   | - Start/Stop-Anlage <sup>1)</sup>  | 8" ATE              |
|  | 318 i  | 105  |  | 03.10  | 06.13   |  |  |  |                     |
|  | 316 i  | 90   |  | 09.07  | 08.09   | 03.7848-4003.4   | 300235   |  | 8" ATE              |
|  | 320 i  | 125  |  | 03.07  | 06.13   |  |  |  |                     |
|  | 320 d  | 130  |  | 03.07  | 06.13   | 03.7848-5003.4   | 300236   |  | 8" ATE              |
|  | 323 i  |  |  | 09.06  | 06.13   |  |  |  |                     |
|  | 325 d  | 145  |  | 03.07  | 06.13   |  |  |  |                     |
|  | 325 i  | 160  |  | 09.06  | 06.13   |  |  |  |                     |
|  | 325 xi   | 160  |  | 09.06  | 06.13   |  |  |  |                     |
|  | 330 i  | 200  |  | 09.06  | 06.13   |  |  |  |                     |
|  | 330 xi   | 200  |  | 09.06  | 06.13   |  |  |  |                     |
|  | 320 xd   | 130  |  | 03.07  | 06.13   | 03.7845-0103.4   | 300268   |  | 8" ATE              |
|  | 330 d  | 170  |  | 09.06  | 06.13   |  |  |  |                     |
|  | 330 d  | 180  |  | 09.08  | 06.13   |  |  |  |                     |
|  | 330 xd   | 170  |  | 09.06  | 06.13   |  |  |  |                     |
|  | 335 d  | 210  |  | 09.06  | 06.13   |  |  |  |                     |
|  | 335 i  | 225  |  | 09.06  | 06.13   |  |  |  |                     |
|  | 335 xi   | 225  |  | 09.07  | 06.13   |  |  |  |                     |
|  | 316 i  | 90   |  | 09.07  | 06.13   | 03.2023-2407.3   | 010796   |  | THz 23,81/22,20 ATE |
|  | 318 i  | 105  |  | 03.10  | 06.13   |  |  |  |                     |
|  | 320 d  | 130  |  | 03.07  | 06.13   | 03.2025-1904.3   | 010797   |  | THz 25,40/22,20 ATE |
|  | 320 i  | 125  |  | 03.07  | 06.13   |  |  |  |                     |
|  | 320 xd   | 130  |  | 03.07  | 06.13   |  |  |  |                     |
|  | 325 d  | 145  |  | 03.07  | 06.13   |  |  |  |                     |
|  | 325 i  | 160  |  | 09.06  | 06.13   |  |  |  |                     |
|  | 325 xi   | 160  |  | 09.06  | 06.13   |  |  |  |                     |
|  | 330 d  | 170  |  | 09.06  | 06.13   |  |  |  |                     |
|  | 330 d  | 180  |  | 09.08  | 06.13   |  |  |  |                     |
|  | 330 i  | 200  |  | 09.06  | 06.13   |  |  |  |                     |
|  | 330 xd   | 170  |  | 09.06  | 06.13   |  |  |  |                     |
|  | 330 xi   | 200  |  | 09.06  | 06.13   |  |  |  |                     |
|  | 335 d  | 210  |  | 09.06  | 06.13   |  |  |  |                     |
|  | 335 i  | 225  |  | 09.06  | 06.13   |  |  |  |                     |
|  | 335 xi   | 225  |  | 09.07  | 06.13   |  |  |  |                     |
|  | 316 i  | 90   |  | 09.07  | 06.13   | 11.0101-5402.2   | 260009   |  | Hülsensatz ATE      |
|  | 318 i  | 105  |  | 03.10  | 06.13   | 11.8171-0008.1   | 990049   |  | Führungsbolzen ATE  |
|  | 320 i  | 125  |  | 03.07  | 06.13   | 11.8116-0339.2   | 390528   | 2  | Haltefeder ATE      |

<sup>1)</sup> - idling stop system / - dispositivo start/stop / - unité marche/arrêt / - unidad arranque/paro



|     |  |  |  |  |  |  |  |                                  |                              |  |        |     |
|--|--|--|--|--|---|--|--|--|------------------------------|--|--------|-----|
| <b>BMW 3er Reihe/E92 Coupe (06-13)</b>   |  |  |  |  |   |  |  |  |                              |  |        |     |
|    | 320 d  | 130  | 03.07  | 06.13  | 11.9571-9753.2  | 220929   | 2  | D=57, - Halter<br>D=57, - Halter<br>Hülsensatz<br>Führungsbolzen<br>Haltefeder                                     | ATE                          |  |        |     |
|  | 320 xd   | 130  | 03.07  | 06.13  | 11.9571-9754.2  | 220930   |  |  | ATE                          |  |        |     |
|  | 323 i  |  | 09.06  | 06.13  | 11.0101-5402.2  | 260009   |  |  | ATE                          |  |        |     |
|  | 325 i  | 160  | 09.07  | 06.13  | + Motorcode N52N <sup>1)</sup>  | 990049   |  |  | ATE                          |  |        |     |
|  | 325 xi   | 160  | 09.07  | 06.13  | + Motorcode N52N <sup>1)</sup>  | 11.8116-0339.2   |  |  | 390528                       | ATE  |        |     |
|  | 325 d  | 145  | 03.07  | 06.13  | 11.0101-5402.2  | 260009   |  |  | 2                            | Hülsensatz<br>Führungsbolzen<br>Haltefeder                                     | ATE    |     |
|  | 325 i  | 160  | 09.06  | 08.07  | + Motorcode N52N <sup>1)</sup>  | 11.8171-0008.1   |  |  |                              |  | 990049 | ATE |
|  | 325 i  | 160  | 09.06  | 06.13  | + Motorcode N53 <sup>2)</sup>   | 11.8116-0339.2   |  |  |                              |  | 390528 | ATE |
|  | 325 xi   | 160  | 09.06  | 08.07  | + Motorcode N52N <sup>1)</sup>  |  |  |  |                              |  |        |     |
|  | 325 xi   | 160  | 09.06  | 06.13  | + Motorcode N53 <sup>2)</sup>   |  |  |  |                              |  |        |     |
|  | 330 i  | 200  | 09.06  | 06.13  | + Motorcode N52N <sup>1)</sup>  |  |  |  |                              |  |        |     |
|  | 330 xi   | 200  | 09.06  | 06.13  |   |  |  |  |                              |  |        |     |
|  | 330 d  | 170  | 09.06  | 06.13  | 11.0101-6006.2  | 260098   |  |  | 2                            | Hülsensatz<br>Haltefeder<br>Führungsbolzen<br>Führungsbolzen                   | ATE    |     |
|  | 330 d  | 180  | 09.08  | 06.13  | 11.8116-0315.2  | 390447   |  |  |                              |  | ATE    |     |
|  | 330 i  | 200  | 09.06  | 06.13  | + Motorcode N53 <sup>2)</sup>   | 11.8171-0008.1   |  |  |                              |  | 990049 | ATE |
| 330 xd   | 170  | 09.06  | 06.13  | 11.8171-0067.1   | 250153  | ATE  |  |  |                              |  |        |     |
| 335 d  | 210  | 09.06  | 06.13  |  |   |  |  |  |                              |  |        |     |
| 335 i  | 225  | 09.06  | 06.13  |  |   |  |  |  |                              |  |        |     |
| 335 xi   | 225  | 09.07  | 06.13  |  |   |  |  |  |                              |  |        |     |
| M3   |  | 03.07  | 06.13  | 11.0441-6008.2   | 250038  | 2  | Dichtungssatz<br>Hülsensatz<br>Haltefeder<br>Führungsbolzen<br>Führungsbolzen      | ATE  |                              |  |        |     |
|  |  |  |  | 11.0101-6006.2   | 260098  |  |  | ATE  |                              |  |        |     |
|  |  |  |  | 11.8116-0315.2   | 390447  |  |  | ATE  |                              |  |        |     |
|  |  |  |  | 11.8171-0008.1   | 990049  |  |  | ATE  |                              |  |        |     |
|  |  |  |  | 11.8171-0067.1   | 250153  |  |  | ATE  |                              |  |        |     |
|    | 320 xd   | 130  | 03.07  | 06.13  | 24.5113-0440.3  | 331239   | 2  | L=440  |                              |  |        |     |
|  | 325 xi   | 160  | 09.06  | 06.13  |   |  |  |  |                              |  |        |     |
|  | 330 xd   | 170  | 09.06  | 06.13  |   |  |  |  |                              |  |        |     |
|  | 330 xi   | 200  | 09.06  | 06.13  |   |  |  |  |                              |  |        |     |
|  | 335 xi   | 225  | 09.07  | 06.13  |   |  |  |  |                              |  |        |     |
|  | M3   |  | 03.07  | 06.13  | 83.7751-0502.3  | 331109   |  |  | 2                            | L=502  |        |     |
|    | 316 i  | 90   | 09.07  | 06.13  | 24.3401-1707.7  | 220775   | 2  | D=40, - Halter<br>D=40, - Halter<br>D=42, - Halter<br>D=42, - Halter<br>Hülsensatz<br>Führungsbolzen<br>Haltefeder | LUC                          |  |        |     |
|  | 318 i  | 105  | 03.10  | 06.13  | 11.9421-9911.2  | 220825   |  |  | ATE                          |  |        |     |
|  | 320 d  | 130  | 03.07  | 06.13  | 11.9421-9912.2  | 220826   |  |  | ATE                          |  |        |     |
|  | 320 i  | 125  | 03.07  | 06.13  | 11.0101-5402.2  | 260009   |  |  | ATE                          |  |        |     |
|  | 320 xd   | 130  | 03.07  | 06.13  | 11.8171-0008.1  | 990049   |  |  | ATE                          |  |        |     |
|  | 323 i  | 130  | 09.06  | 06.13  | 11.8116-0066.1  | 390577   |  |  | ATE                          |  |        |     |
|  | 325 i  | 160  | 09.06  | 06.13  |   |  |  |  |                              |  |        |     |
|  | 325 xi   | 160  | 09.06  | 06.13  |   |  |  |  |                              |  |        |     |
|  | 325 d  | 145  | 03.07  | 06.13  | 11.9441-9957.2  | 220827   |  |  | 2                            | D=44, - Halter<br>D=44, - Halter<br>Hülsensatz<br>Führungsbolzen<br>Haltefeder | ATE    |     |
|  | 330 d  | 170  | 09.06  | 06.13  | 11.9441-9958.2  | 220828   |  |  |                              |  | ATE    |     |
|  | 330 d  | 180  | 09.08  | 06.13  | 11.0101-5402.2  | 260009   |  |  |                              |  | ATE    |     |
|  | 330 i  | 200  | 09.06  | 06.13  | 11.8171-0008.1  | 990049   |  |  |                              |  | ATE    |     |
|  | 330 xd   | 170  | 09.06  | 06.13  | 11.8116-0296.1  | 390445   |  |  |                              |  | ATE    |     |
|  | 330 xi   | 200  | 09.06  | 06.13  |   |  |  |  |                              |  |        |     |
|  | 335 d  | 210  | 09.06  | 06.13  |   |  |  |  |                              |  |        |     |
| 335 i  | 225  | 09.06  | 06.13  |  |   |  |  |  |                              |  |        |     |
| 335 xi   | 225  | 09.07  | 06.13  |  |   |  |  |  |                              |  |        |     |
| M3   |  | 03.07  | 06.13  | 11.0101-5402.2   | 260009  | 2  | Hülsensatz<br>Führungsbolzen<br>Haltefeder   | ATE  |                              |  |        |     |
|  |  |  |  | 11.8171-0008.1   | 990049  |  |  | ATE  |                              |  |        |     |
|  |  |  |  | 11.8116-0296.1   | 390445  |  |  | ATE  |                              |  |        |     |
|  | 316 i  | 90   | 09.07  | 06.13  | 83.7850-0180.3  | 331054   | 2  | L=180<br>L=220<br>L=230<br>L=221   |                              |  |        |     |
|  | 318 i  | 105  | 03.10  | 06.13  | 83.7752-0221.3  | 331053   |  |  | am Bremssattel <sup>3)</sup> |  |        |     |
|  | 320 d  | 130  | 03.07  | 06.13  | 24.5125-0230.3  | 331277   |  |  | am Bremssattel <sup>3)</sup> |  |        |     |
|  | 320 i  | 125  | 03.07  | 06.13  | 24.5137-0221.3  | 331302   |  |  | am Bremssattel <sup>3)</sup> |  |        |     |
|  | 320 xd   | 130  | 03.07  | 06.13  |   |  |  |  |                              |  |        |     |
|  | 323 i  | 130  | 09.06  | 06.13  |   |  |  |  |                              |  |        |     |
|  | 325 d  | 145  | 03.07  | 06.13  |   |  |  |  |                              |  |        |     |
|  | 325 i  | 160  | 09.06  | 06.13  |   |  |  |  |                              |  |        |     |
|  | 325 xi   | 160  | 09.06  | 06.13  |   |  |  |  |                              |  |        |     |
|  | 330 d  | 170  | 09.06  | 06.13  |   |  |  |  |                              |  |        |     |
|  | 330 d  | 180  | 09.08  | 06.13  |   |  |  |  |                              |  |        |     |
|  | 330 i  | 200  | 09.06  | 06.13  |   |  |  |  |                              |  |        |     |
|  | 330 xd   | 170  | 09.06  | 06.13  |   |  |  |  |                              |  |        |     |
|  | 330 xi   | 200  | 09.06  | 06.13  |   |  |  |  |                              |  |        |     |
|  | 335 d  | 210  | 09.06  | 06.13  |   |  |  |  |                              |  |        |     |
| 335 i  | 225  | 09.06  | 06.13  |  |   |  |  |  |                              |  |        |     |
| 335 xi   | 225  | 09.07  | 06.13  |  |   |  |  |  |                              |  |        |     |
| M3   |  | 03.07  | 06.13  | 83.7850-0180.3   | 331054  | 2  | L=180<br>L=235   |  |                              |  |        |     |
|  |  |  |  | 83.7752-0236.3   | 331118  |  |  | am Bremssattel <sup>3)</sup>   |                              |  |        |     |
|  | 316 i  | 90   | 09.07  | 06.13  | 24.3727-0233.2  | 580233   | 2  | L=1535   |                              |  |        |     |
|  | 318 i  | 105  | 03.10  | 06.13  |   |  |  |  |                              |  |        |     |
|  | 320 d  | 130  | 03.07  | 06.13  |   |  |  |  |                              |  |        |     |
|  | 320 i  | 125  | 03.07  | 06.13  |   |  |  |  |                              |  |        |     |
|  | 320 xd   | 130  | 03.07  | 06.13  |   |  |  |  |                              |  |        |     |
|  | 323 i  | 130  | 09.06  | 06.13  |   |  |  |  |                              |  |        |     |
|  | 325 d  | 145  | 03.07  | 06.13  |   |  |  |  |                              |  |        |     |
|  | 325 i  | 160  | 09.06  | 06.13  |   |  |  |  |                              |  |        |     |
|  | 325 xi   | 160  | 09.06  | 06.13  |   |  |  |  |                              |  |        |     |
|  | 330 d  | 170  | 09.06  | 06.13  |   |  |  |  |                              |  |        |     |
|  | 330 d  | 180  | 09.08  | 06.13  |   |  |  |  |                              |  |        |     |
|  | 330 i  | 200  | 09.06  | 06.13  |   |  |  |  |                              |  |        |     |
|  | 330 xd   | 170  | 09.06  | 06.13  |   |  |  |  |                              |  |        |     |
|  | 330 xi   | 200  | 09.06  | 06.13  |   |  |  |  |                              |  |        |     |
|  | 335 d  | 210  | 09.06  | 06.13  |   |  |  |  |                              |  |        |     |
| 335 i  | 225  | 09.06  | 06.13  |  |   |  |  |  |                              |  |        |     |

<sup>1)</sup> + engine code N52N / + codice motore N52N / + moteur code N52N / + motor code N52N

<sup>2)</sup> + engine code N53 / + codice motore N53 / + moteur code N53 / + motor code N53

<sup>3)</sup> on the brake caliper / sulla pinza freno / sur l'étrier de frein / a la pinza de freno



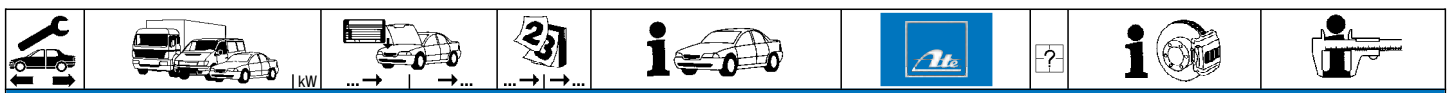

### BMW 3er Reihe/E92 Coupe (06-13)

|  |  |  |  |   |   |  |                |        |     |  |          |
|--|--|--|--|---|---|--|----------------|--------|-----|--|----------|
|  | 335 xi<br>M3   | 225  |  | 09.07<br>03.07  | 06.13<br>06.13  |  | 24.3727-0233.2 | 580233 | 2 ↓ |  | L=1535   |
|  | 316 i<br>318 i<br>320 d<br>320 i<br>323 i<br>325 d<br>325 i<br>325 xi<br>330 d<br>330 i<br>330 xd<br>330 xi<br>335 i<br>335 xi | 90<br>105<br>130<br>125<br>145<br>160<br>160<br>170<br>200<br>170<br>200<br>225<br>225 |  | 09.07<br>03.10<br>03.07<br>03.07<br>09.06<br>03.07<br>09.06<br>09.06<br>09.06<br>09.06<br>09.06<br>09.06<br>09.06 | 06.13<br>06.13<br>06.13<br>06.13<br>06.13<br>06.13<br>06.13<br>06.13<br>06.13<br>06.13<br>06.13<br>06.13<br>06.13 |  | 24.2419-1713.3 | 030093 |     |  | Gz 19,05 |

### BMW 3er Reihe/E93 Cabrio (07-)

|  |   |   |  |  |  |  |  |  |   |                                   |  |                                 |
|--|---|---|--|--|--|--|--|--|---|-----------------------------------|--|---------------------------------|
|  | 318 i<br>320 i  | 105   |  | 03.10<br>04.08   |  |  | 03.7848-4003.4   | 300235   |   | - Start/Stop-Anlage <sup>1)</sup> | 8"   | ATE                             |
|  | 320 i<br>323 i<br>325 i   | 130<br>160  |  | 03.07<br>03.07<br>03.07  | 03.08<br>+ Motorcode N43 <sup>2)</sup><br>+ Motorcode N52N <sup>3)</sup>   |  | 03.7845-0103.4   | 300268   |   |                                   | 8"   | ATE                             |
|  | 320 i<br>325 d<br>325 d<br>325 i<br>330 d<br>330 i<br>330 i                   | 145<br>150<br>160<br>170<br>200<br>200                      |  | 03.07<br>09.07<br>03.10<br>03.07<br>09.09<br>09.09<br>03.07          | 03.08<br>+ Motorcode N46N <sup>4)</sup><br>+ Motorcode N53 <sup>5)</sup><br>+ Motorcode N53 <sup>5)</sup><br>+ Motorcode N52N <sup>3)</sup>              |  | 03.7848-5003.4   | 300236   |   |                                   | 8"   | ATE                             |
|  | 320 d<br>320 d  | 120<br>130  |  | 01.08<br>03.08   |  |  | 03.7845-0103.4   | 300268   |   | - Start/Stop-Anlage <sup>1)</sup> | 8"   | ATE                             |
|  | 330 d<br>330 i<br>335 i   | 170<br>200<br>225   |  | 03.07<br>03.07<br>03.07  | 08.09<br>08.09<br>+ Motorcode N53 <sup>5)</sup>  |  | 03.7845-0103.4   | 300268   |   |                                   | 8"   | ATE                             |
|  | 318 i<br>320 i  | 105   |  | 03.10<br>06.08   |  |  | 03.2023-2407.3   | 010796   |   |                                   | THz 23,81/22,20  | ATE                             |
|  | 320 d<br>320 d<br>320 i<br>325 d<br>325 d<br>325 i<br>330 d<br>330 i<br>335 i | 120<br>130<br>130<br>145<br>150<br>160<br>170<br>200<br>225 |  | 01.08<br>03.08<br>03.07<br>09.07<br>03.10<br>03.07<br>03.07<br>03.07 | 05.08  |  | 03.2025-1904.3   | 010797   |   |                                   | THz 25,40/22,20  | ATE                             |
|  | 320 d<br>320 d<br>320 i<br>323 i<br>325 i                                     | 120<br>130<br>130<br>130<br>160                             |  | 01.08<br>03.08<br>03.07<br>03.07<br>03.07                            | 02.08<br>+ Motorcode N52N <sup>3)</sup>  |  | 11.9571-9753.2<br>11.9571-9754.2<br>11.0101-5402.2<br>11.8171-0008.1<br>11.8116-0339.2 | 220929<br>220930<br>260009<br>990049<br>390528 | 2 |                                   | D=57, - Halter<br>D=57, - Halter<br>Hülsensatz<br>Führungsbolzen<br>Haltefeder | ATE<br>ATE<br>ATE<br>ATE<br>ATE |
|  | 318 i<br>320 i  | 105   |  | 03.10<br>03.08   |  |  | 11.0101-5402.2<br>11.8171-0008.1<br>11.8116-0339.2                                     | 260009<br>990049<br>390528                     | 2 |                                   | Hülsensatz<br>Führungsbolzen<br>Haltefeder                                     | ATE<br>ATE<br>ATE               |
|  | 325 d<br>325 d<br>325 i<br>330 d<br>330 i<br>330 i                            | 145<br>150<br>160<br>170<br>200<br>200                      |  | 09.07<br>03.10<br>03.07<br>09.09<br>09.08<br>03.07                   | + Motorcode N53 <sup>5)</sup><br>- erhöhte Zuladung <sup>6)</sup><br>- erhöhte Zuladung/ + Motorcode N53 <sup>7)</sup><br>+ Motorcode N52N <sup>3)</sup> |  | 11.0101-5402.2<br>11.8171-0008.1<br>11.8116-0339.2                                     | 260009<br>990049<br>390528                     | 2 |                                   | Hülsensatz<br>Führungsbolzen<br>Haltefeder                                     | ATE<br>ATE<br>ATE               |
|  | 330 d<br>330 d<br>330 i<br>330 i<br>335 i                                     | 170<br>170<br>200<br>200<br>225                             |  | 09.09<br>03.07<br>09.09<br>03.07<br>03.07                            | + erhöhte Zuladung <sup>6)</sup><br>+ erhöhte Zuladung/ + Motorcode N53 <sup>3)</sup><br>+ Motorcode N53 <sup>5)</sup>                                   |  | 11.0101-6006.2<br>11.8171-0008.1<br>11.8171-0067.1<br>11.8116-0315.2                   | 260098<br>990049<br>250153<br>390447           | 2 |                                   | Hülsensatz<br>Führungsbolzen<br>Führungsbolzen<br>Haltefeder                   | ATE<br>ATE<br>ATE<br>ATE        |
|  | M3  | 309   |  | 03.08  |  |  | 11.0441-6008.2<br>11.0101-6006.2<br>11.8171-0008.1<br>11.8171-0067.1<br>11.8116-0315.2 | 250038<br>260098<br>990049<br>250153<br>390447 | 2 |                                   | Dichtungssatz<br>Hülsensatz<br>Führungsbolzen<br>Führungsbolzen<br>Haltefeder  | ATE<br>ATE<br>ATE<br>ATE<br>ATE |
|  | M3  | 309   |  | 03.08  |  |  | 83.7751-0502.3   | 331109   | 2 |                                   | L=502  |                                 |
|  | 318 i<br>320 d<br>320 d<br>320 i<br>323 i<br>325 i                            | 105<br>120<br>130<br>130<br>130<br>160                      |  | 03.10<br>01.08<br>03.08<br>03.07<br>03.07<br>03.07                   |  |  | 11.9421-9911.2<br>11.9421-9912.2<br>11.0101-5402.2<br>11.8171-0008.1<br>11.8116-0066.1 | 220825<br>220826<br>260009<br>990049<br>390577 | 2 |                                   | D=42, - Halter<br>D=42, - Halter<br>Hülsensatz<br>Führungsbolzen<br>Haltefeder | ATE<br>ATE<br>ATE<br>ATE<br>ATE |
|  | 325 d<br>325 d<br>330 d<br>330 i<br>335 i                                     | 145<br>150<br>170<br>200<br>225                             |  | 09.07<br>03.10<br>03.07<br>03.07<br>03.07                            |  |  | 11.9441-9957.2<br>11.9441-9958.2<br>11.0101-5402.2<br>11.8171-0008.1<br>11.8116-0296.1 | 220827<br>220828<br>260009<br>990049<br>390445 | 2 |                                   | D=44, - Halter<br>D=44, - Halter<br>Hülsensatz<br>Führungsbolzen<br>Haltefeder | ATE<br>ATE<br>ATE<br>ATE<br>ATE |

<sup>1)</sup> - idling stop system / - dispositivo start/stop / - unité marche/arrêt / - unidad arranque/paro

<sup>2)</sup> + engine code N43 / + codice motore N43 / + moteur code N43 / + motor code N43

<sup>3)</sup> + engine code N52N / + codice motore N52N / + moteur code N52N / + motor code N52N

<sup>4)</sup> + engine code N46N / + codice motore N46N / + moteur code N46N / + motor code N46N

















<sup>5)</sup> + engine code N53 / + codice motore N53 / + moteur code N53 / + motor code N53

<sup>6)</sup> - increased payload / - carico utile maggiorato / - charge utile augmentée / - incremento de carga



















<sup>7)</sup> - increased payload/+engine co.N53 / - carico utile maggior/+codic.mot.N53 / - charge utile augmentée/+moteur co.N53 / - incremento de carga/+motor co.N53

<sup>8)</sup> + increased payload / + carico utile maggiorato / + charge utile augmentée / + incremento de carga  
<sup>9)</sup> + increased payload/+engine co.N53 / + carico utile maggior/+codic.mot.N53 / + charge utile augmentée/+moteur co.N53 / + incremento de carga/+motor co.N53































|     |   |    |  |   |  |                |  |            |                                  |
|--|---|--|--|---|---|--|--|--|----------------------------------|
| <b>BMW 3er Reihe/E93 Cabrio (07-)</b>  |   |  |  |   |   |  |  |  |                                  |
|    | M3  | 309  |  | 03.08   |   | 11.0101-5402.2 260009<br>11.8171-0008.1 990049<br>11.8116-0296.1 390445                          | 2  | Hülsensatz<br>Führungsbolzen<br>Haltefeder   | ATE<br>ATE<br>ATE                |
|    | 318 i<br>320 d<br>320 d<br>320 i<br>323 i<br>325 d<br>325 d<br>325 i<br>330 d<br>330 i<br>335 i   | 105<br>120<br>130<br>130<br>145<br>150<br>160<br>170<br>200<br>225   |  | 03.10<br>01.08<br>03.08<br>03.07<br>03.07<br>09.07<br>03.10<br>03.07<br>03.07<br>03.07<br>03.07   |   | 83.7850-0180.3 331054<br>83.7752-0221.3 331053<br>24.5125-0230.3 331277<br>24.5137-0221.3 331302 | 2<br>2<br>2<br>2   | am Bremssattel <sup>1)</sup><br>am Bremssattel <sup>1)</sup><br>am Bremssattel <sup>1)</sup> | L=180<br>L=220<br>L=230<br>L=221 |
|  | M3  | 309  |  | 03.08   |   | 83.7850-0180.3 331054<br>83.7752-0236.3 331118   | 2<br>2   | am Bremssattel <sup>1)</sup>   | L=180<br>L=235                   |
|    | 318 i<br>320 d<br>320 d<br>320 i<br>323 i<br>325 d<br>325 d<br>325 i<br>330 d<br>330 i<br>335 i<br>M3   | 105<br>120<br>130<br>130<br>145<br>150<br>160<br>170<br>200<br>225<br>309  |  | 03.10<br>01.08<br>03.08<br>03.07<br>03.07<br>09.07<br>03.10<br>03.07<br>03.07<br>03.07<br>03.07<br>03.08  |   | 24.3727-0233.2 580233  | 2<br>2   |  | L=1535                           |
|    | 318 i<br>320 d<br>320 d<br>320 i<br>323 i<br>325 d<br>325 d<br>325 i<br>330 d<br>330 i<br>335 i<br>M3   | 105<br>120<br>130<br>130<br>145<br>150<br>160<br>170<br>200<br>225<br>309  |  | 03.10<br>01.08<br>03.08<br>03.07<br>03.07<br>09.07<br>03.10<br>03.07<br>03.07<br>03.07<br>03.07<br>03.08  |   | 24.2419-1713.3 030093  |  |  | Gz 19,05                         |
| <b>BMW 3er Reihe/F30 Limousine (12-)</b>   |   |  |  |   |   |  |  |  |                                  |
|  | 316 d<br>316 i<br>318 d<br>320 d<br>320 d ed<br>320 i<br>320 i ed<br>325 d<br>328 i<br>330 d<br>335 i<br>ActiveHybrid 3<br>xDrive 318 d<br>xDrive 320 d<br>xDrive 320 i<br>xDrive 328 i<br>xDrive 330 d<br>xDrive 335 d<br>xDrive 335 i | 85<br>100<br>105<br>135<br>120<br>135<br>125<br>160<br>180<br>190<br>225<br>225<br>105<br>135<br>135<br>180<br>190<br>230<br>225 |  | 02.12<br>11.12<br>02.12<br>02.12<br>02.12<br>02.12<br>11.12<br>04.13<br>02.12<br>07.12<br>02.12<br>07.12<br>05.13<br>02.12<br>02.12<br>02.12<br>03.13<br>07.13<br>02.12 |   | 83.7752-0221.3 331053<br>24.5137-0221.3 331302<br>24.5125-0230.3 331277                          | 2<br>2<br>2  |  | L=220<br>L=221<br>L=230          |
|  | 316 d<br>316 i<br>318 d<br>320 d<br>320 d ed<br>320 i<br>320 i ed<br>325 d<br>328 i<br>335 i<br>xDrive 318 d<br>xDrive 320 d<br>xDrive 320 i<br>xDrive 328 i<br>xDrive 335 i  | 85<br>100<br>105<br>135<br>120<br>135<br>125<br>160<br>180<br>225<br>105<br>135<br>135<br>180<br>225                             |  | 02.12<br>11.12<br>02.12<br>02.12<br>02.12<br>02.12<br>11.12<br>04.13<br>02.12<br>02.12<br>02.12<br>05.13<br>02.12<br>02.12<br>02.12<br>02.12                            |   | 24.2419-1713.3 030093  |  |  | Gz 19,05                         |
| <b>BMW 3er Reihe/F31 Touring (12-)</b>   |   |  |  |   |   |  |  |  |                                  |
|  | 316 d<br>316 i<br>318 d<br>320 d<br>320 d<br>320 d ed<br>320 i<br>325 d<br>328 i  | 85<br>100<br>105<br>120<br>135<br>120<br>135<br>160<br>180   |  | 05.12<br>03.13<br>05.12<br>05.12<br>05.12<br>05.12<br>05.12<br>04.13<br>05.12   |   | 24.5125-0230.3 331277  | 2  |  | L=230                            |















<sup>1)</sup> on the brake caliper / sulla pinza freno / sur l'étrier de frein / a la pinza de freno

|     |  |  |  |  |  |  |     |  |
|--|--|--|--|--|---|--|---|--|
| <b>BMW 3er Reihe/F31 Touring (12-)</b>   |  |  |  |  |   |  |   |  |
|    | 330 d  | 190  |  | 05.12  | 24.5125-0230.3  | 331277   | 2   | L=230  |
|  | 335 i  | 225  |  | 03.13  |   |  |   |  |
|  | xDrive 318 d   | 105  |  | 05.13  |   |  |   |  |
|  | xDrive 320 d   | 135  |  | 03.13  |   |  |   |  |
|  | xDrive 320 i   | 135  |  | 03.13  |   |  |   |  |
|  | xDrive 328 i   | 180  |  | 03.13  |   |  |   |  |
|  | xDrive 330 d   | 190  |  | 03.13  |   |  |   |  |
|  | xDrive 335 i   | 225  |  | 03.13  |   |  |   |  |
| <b>BMW 3er Reihe/F34 GT (13-)</b>  |  |  |  |  |   |  |   |  |
|    | 318 d  | 105  |  | 03.13  | 24.5125-0230.3  | 331277   | 2   | L=230  |
|  | 320 d  | 135  |  | 03.13  |   |  |   |  |
|  | 320 i  | 135  |  | 03.13  |   |  |   |  |
|  | 325 d  | 160  |  | 03.13  |   |  |   |  |
|  | 328 i  | 180  |  | 03.13  |   |  |   |  |
|  | 335 i  | 225  |  | 03.13  |   |  |   |  |
|  | xDrive 320 d   | 135  |  | 03.13  |   |  |   |  |
|  | xDrive 320 i   | 135  |  | 03.13  |   |  |   |  |
|  | xDrive 328 i   | 180  |  | 03.13  |   |  |   |  |
|  | xDrive 335 i   | 225  |  | 03.13  |   |  |   |  |
|    | 318 d  | 105  |  | 03.13  | 24.2419-1713.3  | 030093   |   | Gz 19,05   |
|  | 320 d  | 135  |  | 03.13  |   |  |   |  |
|  | 320 i  | 135  |  | 03.13  |   |  |   |  |
|  | 325 d  | 160  |  | 03.13  |   |  |   |  |
|  | 328 i  | 180  |  | 03.13  |   |  |   |  |
|  | 335 i  | 225  |  | 03.13  |   |  |   |  |
|  | xDrive 320 d   | 135  |  | 03.13  |   |  |   |  |
|  | xDrive 320 i   | 135  |  | 03.13  |   |  |   |  |
|  | xDrive 328 i   | 180  |  | 03.13  |   |  |   |  |
| <b>BMW 4er Reihe/F32 Coupe (13-)</b>   |  |  |  |  |   |  |   |  |
|    | 420 d  | 135  |  | 07.13  | 24.5125-0230.3  | 331277   | 2   | L=230  |
|  | 420 d xDrive   | 135  |  | 07.13  |   |  |   |  |
|  | 420 i  | 135  |  | 07.13  |   |  |   |  |
|  | 420 i xDrive   | 135  |  | 07.13  |   |  |   |  |
|  | 428 i  | 180  |  | 07.13  |   |  |   |  |
|  | 428 i xDrive   | 180  |  | 07.13  |   |  |   |  |
|  | 430 d  | 190  |  | 07.13  |   |  |   |  |
|  | 435 d xDrive   | 230  |  | 07.13  |   |  |   |  |
|  | 435 i  | 225  |  | 07.13  |   |  |   |  |
|  | 435 i xDrive   | 225  |  | 07.13  |   |  |   |  |
| <b>BMW 5er Reihe/E34 (88-96)</b>   |  |  |  |  |   |  |   |  |
|  | 518 i  |  |  | 04.89 08.91  | 03.2125-3011.3  | 010211   |   | THz 25,40 ATE  |
|  | 520 i  | 95   |  | 01.88 09.90  |   |  |   |  |
|  | 520 i 24V  | 110  |  | 03.89 08.91  |   |  |   |  |
|  | 524 td   | 85   |  | 03.88 08.91  |   |  |   |  |
|  | 525 i  | 125  |  | 01.88 09.90  |   |  |   |  |
|  | 525 i 24V  | 141  |  | 09.89 08.91  |   |  |   |  |
|  | 530 i  | 138  |  | 01.88 09.95  |   |  |   |  |
|  | 535 i  | 155  |  | 01.88 09.95  |   |  |   |  |
|  | M5 3.6   | 232  |  | 04.88 09.95  |   |  |   |  |
|  | M5 3.8   | 250  |  | 04.88 09.95  |   |  |   |  |
|  | M5 Touring   | 250  |  | 09.94 11.96  |   |  |   |  |
|  | 518 i  |  |  | 09.91 09.95  | 03.2025-1211.3  | 010475   |   | THz 25,40/20,64 ATE  |
|  | 520 i 24V  | 110  |  | 09.91 09.95  | 24.2025-1701.3  | 010490   |   | THz 25,40/20,64 LUC  |
|  | 525 i 24V  | 141  |  | 09.91 09.95  |   |  |   |  |
|  | 525 tds  | 105  |  | 09.91 09.95  |   |  |   |  |
|  | 530 i V8   | 160  |  | 03.92 08.93  | 24.2125-1716.3  | 010663   |   | THz 25,40  |
|  | 530 i V8 Touring   | 160  |  | 05.92 08.93  |   |  |   |  |
|  | 540 i V8   | 210  |  | 03.92 08.93  |   |  |   |  |
|  | 518 i Touring  |  |  | 03.93 11.96  | 24.2025-1701.3  | 010490   |   | THz 25,40/20,64 LUC  |
|  | 520 i Touring  | 110  |  | 11.91 11.96  |   |  |   |  |
|  | 525 i Touring  | 141  |  | 11.91 11.96  |   |  |   |  |
|  | 525 ix   | 141  |  | 09.91 09.95  |   |  |   |  |
|  | 525 ix Touring   | 141  |  | 02.92 11.96  |   |  |   |  |
|  | 525 td   | 85   |  | 04.93 09.95  |   |  |   |  |
|  | 525 td Touring   | 85   |  | 03.93 11.96  |   |  |   |  |
|  | 525 tds Touring  | 105  |  | 12.91 11.96  |   |  |   |  |
|  | 530 i V8   | 160  |  | 09.93 09.95  |   |  |   |  |
|  | 530 i V8 Touring   | 160  |  | 09.93 11.96  |   |  |   |  |
|  | 540 i Touring  | 210  |  | 05.93 11.96  |   |  |   |  |
|  | 540 i V8   | 210  |  | 09.93 09.95  |   |  |   |  |
|  | 518 i  |  |  | 04.89 09.95  | 11.3601-8501.2  | 220145   |  | D=60, - Halter ATE   |
|  | 518 i Touring  |  |  | 03.93 09.95  | 11.3601-8502.2  | 220146   |  | D=60, - Halter ATE   |
|  | 520 i  | 95   |  | 01.88 09.90  | 24.3601-8501.5  | 240533   |  | D=60, - Halter ATE   |
|  | 520 i 24V  | 110  |  | 03.89 09.95  | 24.3601-8502.5  | 240534   |  | D=60, - Halter ATE   |
|  | 524 td   | 85   |  | 03.88 08.91  | 11.0441-6003.2  | 250037   |   | Dichtungssatz  |
|  | 525 td   | 85   |  | 04.93 09.95  | 11.0230-0020.2  | 260023   |   | Haltsatz ATE   |
|  | 525 tds  | 105  |  | 09.91 09.95  | 11.0101-5402.2  | 260009   |   | Hülsensatz ATE   |
|  |  |  |  |  | 11.8171-0008.1  | 990049   |   | Führungsbolzen ATE   |
|  |  |  |  |  | 11.8116-0083.1  | 390501   |   | Haltefeder ATE   |

1) - authority cars / - enti statali / - véhicule communal / - vehiculos oficiales

|     |  |  |  |  |  |  |     |     |                |     |
|--|--|--|--|--|---|--|---|---|----------------|-----|
| <b>BMW 5er Reihe/E34 (88-96)</b>   |  |  |  |  |   |  |   |   |                |     |
|    | 520 i  | 95   | 01.88  | 09.90  | + Behörde <sup>1)</sup>   | 11.3601-8505.2   | 220149  |    | D=60, - Halter | ATE |
|  | 520 i 24V  | 110  | 03.89  | 09.95  | + Behörde <sup>1)</sup>   | 11.3601-8506.2   | 220150  |    | D=60, - Halter | ATE |
|  | 520 i Touring  | 110  | 11.91  | 11.96  |   | 24.3601-8505.5   | 240537  |    | D=60, - Halter | ATE |
|  | 525 i  | 125  | 01.88  | 09.90  |   | 24.3601-8506.5   | 240538  |    | D=60, - Halter | ATE |
|  | 525 i 24V  | 141  | 09.89  | 09.95  |   | 11.0441-6003.2   | 250037  |   | Dichtungssatz  |     |
|  | 525 i Touring  | 141  | 11.91  | 11.96  |   | 11.0101-5402.2   | 260009  |   | Hülzensatz     | ATE |
|  | 525 td Touring   | 85   | 03.93  | 11.96  |   | 11.8171-0008.1   | 990049  |   | Führungsbolzen | ATE |
|  | 525 tds Touring  | 105  | 12.91  | 11.96  |   | 11.8116-0083.1   | 390501  | 2   | Haltefeder     | ATE |
|  | 530 i  | 138  | 01.88  | 09.95  |   |  |   |   |                |     |
|  | 530 i V8   | 160  | 03.92  | 09.95  |   |  |   |   |                |     |
|  | 530 i V8 Touring   | 160  | 05.92  | 11.96  |   |  |   |   |                |     |
|  | 535 i  | 155  | 01.88  | 09.95  |   |  |   |   |                |     |
|  | 525 ix   | 141  | 04.91  | 09.95  |   | 11.0441-6003.2   | 250037  |   | Dichtungssatz  |     |
|  | 525 ix Touring   | 141  | 02.92  | 11.96  |   | 11.0101-5402.2   | 260009  |   | Hülzensatz     | ATE |
|  |  |  |  |  |   | 11.8171-0008.1   | 990049  |   | Führungsbolzen | ATE |
| 540 i Touring  | 210  | 05.93  | 11.96  |  | 11.3601-8503.2  | 220147   |    | D=60, - Halter  | ATE            |     |
| 540 i V8   | 210  | 03.92  | 09.95  |  | 11.3601-8504.2  | 220148   |    | D=60, - Halter  | ATE            |     |
|  |  |  |  |  | 24.3601-8503.5  | 240535   |    | D=60, - Halter  | ATE            |     |
|  |  |  |  |  | 24.3601-8504.5  | 240536   |    | D=60, - Halter  | ATE            |     |
|  |  |  |  |  | 11.0441-6003.2  | 250037   |   | Dichtungssatz   |                |     |
|  |  |  |  |  | 11.0101-5402.2  | 260009   |   | Hülzensatz  | ATE            |     |
|  |  |  |  |  | 11.8171-0008.1  | 990049   |   | Führungsbolzen  | ATE            |     |
| M5 3.6   | 232  | 10.88  | 09.95  |  | 11.0441-6003.2  | 250037   |   | Dichtungssatz   |                |     |
| M5 3.8   | 250  | 03.92  | 05.94  |  | 11.0101-5402.2  | 260009   |   | Hülzensatz  | ATE            |     |
|  |  |  |  |  | 11.8171-0008.1  | 990049   |   | Führungsbolzen  | ATE            |     |
|    | 518 i  |  | 04.89  | 09.95  |   | 83.6134-0420.3   | 330279  | 2   | L=420          |     |
|  | 518 i Touring  |  | 03.93  | 11.96  |   |  |   |   |                |     |
|  | 520 i  | 95   | 01.88  | 09.90  |   |  |   |   |                |     |
|  | 520 i 24V  | 110  | 03.89  | 09.95  |   |  |   |   |                |     |
|  | 520 i Touring  | 110  | 11.91  | 11.96  |   |  |   |   |                |     |
|  | 524 td   | 85   | 03.88  | 08.91  |   |  |   |   |                |     |
|  | 525 i  | 125  | 01.88  | 09.90  |   |  |   |   |                |     |
|  | 525 i 24V  | 141  | 09.89  | 09.95  |   |  |   |   |                |     |
|  | 525 i Touring  | 141  | 11.91  | 11.96  |   |  |   |   |                |     |
|  | 525 ix   | 141  | 04.91  | 08.91  |   |  |   |   |                |     |
|  | 525 ix Touring   | 141  | 02.92  | 11.96  |   |  |   |   |                |     |
|  | 525 td   | 85   | 04.93  | 09.95  |   |  |   |   |                |     |
|  | 525 td Touring   | 85   | 03.93  | 11.96  |   |  |   |   |                |     |
|  | 525 tds  | 105  | 09.91  | 09.95  |   |  |   |   |                |     |
|  | 525 tds Touring  | 105  | 12.91  | 11.96  |   |  |   |   |                |     |
|  | 530 i  | 138  | 01.88  | 09.95  |   |  |   |   |                |     |
|  | 530 i V8   | 160  | 03.92  | 09.95  |   |  |   |   |                |     |
|  | 530 i V8 Touring   | 160  | 05.92  | 11.96  |   |  |   |   |                |     |
|  | 535 i  | 155  | 01.88  | 09.95  |   |  |   |   |                |     |
|  | 540 i Touring  | 210  | 05.93  | 11.96  |   |  |   |   |                |     |
| 540 i V8   | 210  | 03.92  | 09.95  |  |   |  |   |   |                |     |
| M5 3.6   | 232  | 10.88  | 09.95  |  |   |  |   |   |                |     |
| M5 3.8   | 250  | 10.88  | 09.95  |  |   |  |   |   |                |     |
| M5 Touring   | 250  | 09.94  | 11.96  |  |   |  |   |   |                |     |
|  | 518 i  |  | 04.89  | 09.95  | + ABS   | 11.3381-8503.2   | 220020  |  | D=38, - Halter | ATE |
|  | 520 i  | 95   | 01.88  | 09.90  |   | 11.3381-8504.2   | 220021  |  | D=38, - Halter | ATE |
|  | 520 i 24V  | 110  | 03.89  | 09.95  |   | 24.3381-8503.5   | 240515  |  | D=38, - Halter | ATE |
|  | 524 td   | 85   | 03.88  | 08.91  |   | 24.3381-8504.5   | 240516  |  | D=38, - Halter | ATE |
|  | 525 i  | 125  | 01.88  | 09.90  |   | 11.0441-3803.2   | 250010  |   | Dichtungssatz  | ATE |
|  | 525 i 24V  | 141  | 09.89  | 09.95  |   | 11.0101-5402.2   | 260009  |   | Hülzensatz     | ATE |
|  | 525 ix   | 141  | 04.91  | 09.95  |   | 11.8171-0008.1   | 990049  |   | Führungsbolzen | ATE |
|  | 525 td   | 85   | 04.93  | 09.95  |   | 11.8116-0066.1   | 390577  | 2   | Haltefeder     | ATE |
|  | 525 tds  | 105  | 09.91  | 09.95  |   |  |   |   |                |     |
|  | 530 i  | 138  | 01.88  | 09.95  |   |  |   |   |                |     |
|  | 530 i V8   | 160  | 03.92  | 09.95  |   |  |   |   |                |     |
|  | 535 i  | 155  | 01.88  | 09.95  |   |  |   |   |                |     |
|  | M5 3.6   | 232  | 04.88  | 09.88  |   |  |   |   |                |     |
|  | M5 3.8   | 250  | 04.88  | 09.88  |   |  |   |   |                |     |
|  | M5 3.6   | 232  | 10.88  | 12.89  |   | 11.0441-4002.2   | 250011  |   | Dichtungssatz  | ATE |
| M5 3.8   | 250  | 10.88  | 12.89  |  | 11.0101-5402.2  | 260009   |   | Hülzensatz  | ATE            |     |
|  |  |  |  |  | 11.8171-0008.1  | 990049   |   | Führungsbolzen  | ATE            |     |
|  |  |  |  |  | 11.8116-0296.1  | 390445   | 2   | Haltefeder  | ATE            |     |
| 518 i Touring  |  | 11.92  | 11.96  |  | 11.3401-8503.2  | 220030   |  | D=40, - Halter  | ATE            |     |
| 520 i Touring  | 110  | 11.91  | 11.96  |  | 11.3401-8504.2  | 220031   |  | D=40, - Halter  | ATE            |     |
| 525 i Touring  | 141  | 11.91  | 11.96  |  | 24.3401-8503.5  | 240521   |  | D=40, - Halter  | ATE            |     |
| 525 ix Touring   | 141  | 02.92  | 11.96  |  | 24.3401-8504.5  | 240522   |  | D=40, - Halter  | ATE            |     |
| 525 td Touring   | 85   | 03.93  | 11.96  |  | 11.0441-4002.2  | 250011   |   | Dichtungssatz   | ATE            |     |
| 525 tds Touring  | 105  | 12.91  | 11.96  |  | 11.0101-5402.2  | 260009   |   | Hülzensatz  | ATE            |     |
| 530 i V8 Touring   | 160  | 05.92  | 11.96  |  | 11.8171-0008.1  | 990049   |   | Führungsbolzen  | ATE            |     |
|  |  |  |  |  | 11.8116-0066.1  | 390577   | 2   | Haltefeder  | ATE            |     |
| 540 i Touring  | 210  | 05.93  | 11.96  |  | 11.0441-4002.2  | 250011   |   | Dichtungssatz   | ATE            |     |
| 540 i V8   | 210  | 03.92  | 09.95  |  | 11.0101-5402.2  | 260009   |   | Hülzensatz  | ATE            |     |
| M5 3.6   | 232  | 01.90  | 09.95  |  | 11.8171-0008.1  | 990049   |   | Führungsbolzen  | ATE            |     |
| M5 3.8   | 250  | 03.92  | 05.94  |  | 11.8116-0066.1  | 390577   | 2   | Haltefeder  | ATE            |     |
| M5 3.8   | 250  | 06.94  | 09.95  |  | 11.0441-4002.2  | 250011   |   | Dichtungssatz   | ATE            |     |
| M5 Touring   | 250  | 09.94  | 11.96  |  | 11.0101-5402.2  | 260009   |   | Hülzensatz  | ATE            |     |
|  |  |  |  |  | 11.8171-0008.1  | 990049   |   | Führungsbolzen  | ATE            |     |
|  |  |  |  |  | 11.8116-0315.2  | 390447   | 2   | Haltefeder  | ATE            |     |
|  | 518 i  |  | 04.89  | 08.91  | - ABS   | 83.6204-0200.3   | 330306  | 2   | L=200          |     |
|  |  |  |  |  |   |  |   |   |                |     |

<sup>1)</sup> + authority cars / + enti statali / + véhicule communal / + vehiculos oficiales

|          |                  |       |       |       |       |                |        |   |                             |          |  |
|--|------------------|-------|-------|-------|-------|----------------|--------|---|-----------------------------|----------|--|
| BMW 5er Reihe/E34 (88-96)  |                  |       |       |       |       |                |        |   |                             |          |  |
|    | 518 i            |       | 04.89 | 09.95 | + ABS | 83.6204-0200.3 | 330306 | 2 | am Bremsattel <sup>1)</sup> | L=200    |  |
|  | 518 i Touring    |       | 03.93 | 11.96 |       | 83.7704-0200.3 | 330825 | 2 |                             | L=200    |  |
|  | 520 i            | 95    | 01.88 | 09.90 |       |                |        |   |                             |          |  |
|  | 520 i 24V        | 110   | 03.89 | 09.95 |       |                |        |   |                             |          |  |
|  | 520 i Touring    | 110   | 11.91 | 11.96 |       |                |        |   |                             |          |  |
|  | 524 td           | 85    | 03.88 | 08.91 |       |                |        |   |                             |          |  |
|  | 525 i            | 125   | 01.88 | 09.90 |       |                |        |   |                             |          |  |
|  | 525 i 24V        | 141   | 09.89 | 09.95 |       |                |        |   |                             |          |  |
|  | 525 i Touring    | 141   | 11.91 | 11.96 |       |                |        |   |                             |          |  |
|  | 525 ix           | 141   | 04.91 | 09.95 |       |                |        |   |                             |          |  |
|  | 525 ix Touring   | 141   | 02.92 | 11.96 |       |                |        |   |                             |          |  |
|  | 525 td           | 85    | 04.93 | 09.95 |       |                |        |   |                             |          |  |
|  | 525 td Touring   | 85    | 03.93 | 11.96 |       |                |        |   |                             |          |  |
|  | 525 tds          | 105   | 09.91 | 09.95 |       |                |        |   |                             |          |  |
|  | 525 tds Touring  | 105   | 12.91 | 11.96 |       |                |        |   |                             |          |  |
|  | 530 i            | 138   | 01.88 | 09.95 |       |                |        |   |                             |          |  |
|  | 530 i V8         | 160   | 03.92 | 09.95 |       |                |        |   |                             |          |  |
|  | 530 i V8 Touring | 160   | 05.92 | 11.96 |       |                |        |   |                             |          |  |
| 535 i  | 155              | 01.88 | 09.95 |       |       |                |        |   |                             |          |  |
| 540 i Touring  | 210              | 05.93 | 11.96 |       |       |                |        |   |                             |          |  |
| 540 i V8   | 210              | 03.92 | 09.95 |       |       |                |        |   |                             |          |  |
| M5 3.6   | 232              | 10.88 | 09.95 |       |       |                |        |   |                             |          |  |
| M5 3.8   | 250              | 10.88 | 09.95 |       |       |                |        |   |                             |          |  |
| M5 Touring   | 250              | 09.94 | 11.96 |       |       |                |        |   |                             |          |  |
|    | 518 i            |       | 04.89 | 08.91 | - ABS | 03.3223-4200.3 | 020094 |   |                             | Rz 23,81 |  |
|    | 518 i            |       | 04.89 | 09.95 | + ABS | 24.3727-0215.2 | 580215 | 2 | ↓                           | L=1755   |  |
|  | 518 i Touring    |       | 03.93 | 11.96 |       |                |        |   |                             |          |  |
|  | 520 i            | 95    | 01.88 | 09.90 |       |                |        |   |                             |          |  |
|  | 520 i 24V        | 110   | 03.89 | 09.95 |       |                |        |   |                             |          |  |
|  | 520 i Touring    | 110   | 11.91 | 11.96 |       |                |        |   |                             |          |  |
|  | 524 td           | 85    | 03.88 | 08.91 |       |                |        |   |                             |          |  |
|  | 525 i            | 125   | 01.88 | 09.90 |       |                |        |   |                             |          |  |
|  | 525 i 24V        | 141   | 09.89 | 09.95 |       |                |        |   |                             |          |  |
|  | 525 i Touring    | 141   | 11.91 | 11.96 |       |                |        |   |                             |          |  |
|  | 525 ix           | 141   | 04.91 | 09.95 |       |                |        |   |                             |          |  |
|  | 525 ix Touring   | 141   | 02.92 | 11.96 |       |                |        |   |                             |          |  |
|  | 525 td           | 85    | 04.93 | 09.95 |       |                |        |   |                             |          |  |
|  | 525 td Touring   | 85    | 03.93 | 11.96 |       |                |        |   |                             |          |  |
|  | 525 tds          | 105   | 09.91 | 09.95 |       |                |        |   |                             |          |  |
|  | 525 tds Touring  | 105   | 12.91 | 11.96 |       |                |        |   |                             |          |  |
|  | 530 i            | 138   | 01.88 | 09.95 |       |                |        |   |                             |          |  |
|  | 530 i V8         | 160   | 03.92 | 09.95 |       |                |        |   |                             |          |  |
|  | 530 i V8 Touring | 160   | 05.92 | 11.96 |       |                |        |   |                             |          |  |
| 535 i  | 155              | 01.88 | 09.95 |       |       |                |        |   |                             |          |  |
| 540 i Touring  | 210              | 05.93 | 11.96 |       |       |                |        |   |                             |          |  |
| 540 i V8   | 210              | 03.92 | 09.95 |       |       |                |        |   |                             |          |  |
| M5 3.6   | 232              | 10.88 | 09.95 |       |       |                |        |   |                             |          |  |
| M5 3.8   | 250              | 10.88 | 09.95 |       |       |                |        |   |                             |          |  |
| M5 Touring   | 250              | 09.94 | 11.96 |       |       |                |        |   |                             |          |  |
|    | 518 i            |       | 04.89 | 09.95 |       | 24.2419-0922.3 | 030051 |   |                             | Gz 19,05 |  |
|  | 518 i Touring    |       | 03.93 | 11.96 |       |                |        |   |                             |          |  |
|  | 520 i            | 95    | 01.88 | 09.90 |       |                |        |   |                             |          |  |
|  | 520 i 24V        | 110   | 03.89 | 09.95 |       |                |        |   |                             |          |  |
|  | 520 i Touring    | 110   | 11.91 | 11.96 |       |                |        |   |                             |          |  |
|  | 524 td           | 85    | 03.88 | 08.91 |       |                |        |   |                             |          |  |
|  | 525 i            | 125   | 01.88 | 09.90 |       |                |        |   |                             |          |  |
|  | 525 i 24V        | 141   | 09.89 | 09.95 |       |                |        |   |                             |          |  |
|  | 525 i Touring    | 141   | 11.91 | 11.96 |       |                |        |   |                             |          |  |
|  | 525 ix           | 141   | 04.91 | 09.95 |       |                |        |   |                             |          |  |
|  | 525 ix Touring   | 141   | 02.92 | 11.96 |       |                |        |   |                             |          |  |
|  | 525 td           | 85    | 04.93 | 09.95 |       |                |        |   |                             |          |  |
|  | 525 td Touring   | 85    | 03.93 | 11.96 |       |                |        |   |                             |          |  |
|  | 525 tds          | 105   | 09.91 | 09.95 |       |                |        |   |                             |          |  |
|  | 525 tds Touring  | 105   | 12.91 | 11.96 |       |                |        |   |                             |          |  |
|  | 530 i            | 138   | 01.88 | 09.95 |       |                |        |   |                             |          |  |
|  | 530 i V8         | 160   | 03.92 | 09.95 |       |                |        |   |                             |          |  |
|  | 530 i V8 Touring | 160   | 05.92 | 11.96 |       |                |        |   |                             |          |  |
| 535 i  | 155              | 01.88 | 09.95 |       |       |                |        |   |                             |          |  |
| 540 i Touring  | 210              | 05.93 | 11.96 |       |       |                |        |   |                             |          |  |
| 540 i V8   | 210              | 03.92 | 09.95 |       |       |                |        |   |                             |          |  |
|    | 518 i            |       | 04.89 | 09.95 |       | 24.2522-0905.3 | 040042 |   |                             | Nz 22,20 |  |
|  | 518 i Touring    |       | 03.93 | 11.96 |       |                |        |   |                             |          |  |
|  | 520 i 24V        | 110   | 11.90 | 09.95 |       |                |        |   |                             |          |  |
|  | 520 i Touring    | 110   | 11.91 | 11.96 |       |                |        |   |                             |          |  |
|  | 524 td           | 85    | 09.90 | 08.91 |       |                |        |   |                             |          |  |
|  | 525 i 24V        | 141   | 09.89 | 09.95 |       |                |        |   |                             |          |  |
|  | 525 i Touring    | 141   | 11.91 | 11.96 |       |                |        |   |                             |          |  |
|  | 525 ix           | 141   | 04.91 | 09.95 |       |                |        |   |                             |          |  |
|  | 525 ix Touring   | 141   | 02.92 | 11.96 |       |                |        |   |                             |          |  |
|  | 525 td           | 85    | 04.93 | 09.95 |       |                |        |   |                             |          |  |
|  | 525 td Touring   | 85    | 03.93 | 11.96 |       |                |        |   |                             |          |  |
|  | 525 tds          | 105   | 09.91 | 09.95 |       |                |        |   |                             |          |  |
|  | 525 tds Touring  | 105   | 12.91 | 11.96 |       |                |        |   |                             |          |  |
|  | 530 i V8         | 160   | 03.92 | 09.95 |       |                |        |   |                             |          |  |
|  | 530 i V8 Touring | 160   | 05.92 | 11.96 |       |                |        |   |                             |          |  |

<sup>1)</sup> on the brake caliper / sulla pinza freno / sur l'étrier de frein / a la pinza de freno



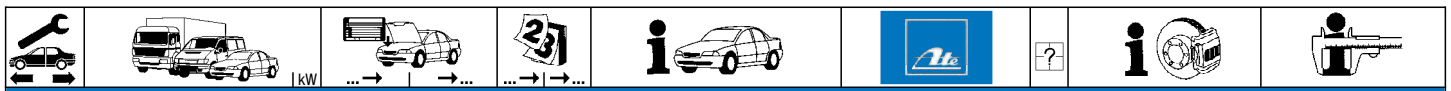













| BMW 5er Reihe/E34 (88-96) |                 |     |       |       |       |  |                |        |  |          |
|---------------------------|-----------------|-----|-------|-------|-------|--|----------------|--------|--|----------|
|                           | 520 i           | 95  |       | 01.88 | 09.90 |  | 03.2522-3601.3 | 040014 |  | Nz 22,20 |
|                           | 520 i 24V       | 110 |       | 03.89 | 10.90 |  |                |        |  |          |
|                           | 524 td          | 85  |       | 03.88 | 08.90 |  |                |        |  |          |
|                           | 525 i           | 125 |       | 01.88 | 09.90 |  |                |        |  |          |
|                           | 530 i           | 138 |       | 01.88 | 09.95 |  |                |        |  |          |
|                           | 535 i           | 155 |       | 01.88 | 09.95 |  |                |        |  |          |
|                           | 540 i Touring   | 210 |       | 05.93 | 11.96 |  | 24.2526-0902.3 | 040052 |  | Nz 26,99 |
|                           | 540 i V8        | 210 |       | 03.92 | 09.95 |  |                |        |  |          |
|                           | 518 i           |     |       | 04.89 | 09.95 |  | 24.5905-0320.3 | 330058 |  | L=320    |
|                           | 518 i Touring   |     |       | 03.93 | 11.96 |  |                |        |  |          |
|                           | 520 i           | 95  |       | 01.88 | 09.90 |  |                |        |  |          |
|                           | 520 i 24V       | 110 |       | 03.89 | 09.95 |  |                |        |  |          |
|                           | 520 i Touring   | 110 |       | 11.91 | 11.96 |  |                |        |  |          |
|                           | 524 td          | 85  |       | 03.88 | 08.91 |  |                |        |  |          |
|                           | 525 i           | 125 |       | 01.88 | 09.90 |  |                |        |  |          |
|                           | 525 i 24V       | 141 |       | 09.89 | 09.95 |  |                |        |  |          |
|                           | 525 i Touring   | 141 |       | 11.91 | 11.96 |  |                |        |  |          |
|                           | 525 ix          | 141 |       | 04.91 | 09.95 |  |                |        |  |          |
|                           | 525 ix Touring  | 141 |       | 02.92 | 11.96 |  |                |        |  |          |
|                           | 525 td          | 85  |       | 04.93 | 09.95 |  |                |        |  |          |
|                           | 525 td Touring  | 85  |       | 03.93 | 11.96 |  |                |        |  |          |
|                           | 525 tds         | 105 |       | 09.91 | 09.95 |  |                |        |  |          |
|                           | 525 tds Touring | 105 |       | 12.91 | 11.96 |  |                |        |  |          |
|                           | 530 i           | 138 |       | 01.88 | 09.95 |  |                |        |  |          |
| 535 i                     | 155             |     | 01.88 | 09.95 |       |  |                |        |  |          |













| BMW 5er Reihe/E39 (96-03) |                 |     |       |       |              |              |                |        |   |                 |
|---------------------------|-----------------|-----|-------|-------|--------------|--------------|----------------|--------|---|-----------------|
|                           | 520 i           |     |       | 03.96 | 08.97        | - DSC        | 24.2120-1721.3 | 010553 |   | THz 20,64       |
|                           | 520 i Touring   |     |       | 05.97 | 08.97        | - DSC        |                |        |   |                 |
|                           | 523 i           | 125 |       | 12.95 | 08.97        | - DSC        |                |        |   |                 |
|                           | 523 i Touring   | 125 |       | 05.97 | 08.97        | - DSC        |                |        |   |                 |
|                           | 525 td          | 85  |       | 01.97 | 08.97        |              |                |        |   |                 |
|                           | 525 tds         | 105 |       | 02.96 | 08.97        |              |                |        |   |                 |
|                           | 528 i           | 142 |       | 12.95 | 08.97        | - DSC        |                |        |   |                 |
|                           | 528 i Touring   | 142 |       | 05.97 | 08.97        | - DSC        |                |        |   |                 |
|                           | 535 i           |     |       | 05.96 | 08.97        |              |                |        |   |                 |
|                           | 540 i           | 210 |       | 05.96 | 08.97        |              |                |        |   |                 |
|                           | 540 i Touring   | 210 |       | 05.97 | 08.97        |              |                |        |   |                 |
|                           | 520 d           | 100 |       | 04.00 | 07.03        |              | 24.2025-1705.3 | 010624 |   | THz 25,40/20,64 |
|                           | 520 d Touring   | 100 |       | 04.00 | 07.03        |              |                |        |   | LUC             |
|                           | 520 i           |     |       | 09.97 | 07.03        | - DSC        |                |        |   |                 |
|                           | 520 i Touring   |     |       | 09.97 | 07.03        | - DSC        |                |        |   |                 |
|                           | 523 i           | 125 |       | 09.97 | 09.00        | - DSC        |                |        |   |                 |
|                           | 523 i Touring   | 125 |       | 09.97 | 09.00        | - DSC        |                |        |   |                 |
|                           | 525 d           | 120 |       | 04.00 | 07.03        | - DSC        |                |        |   |                 |
|                           | 525 d Touring   | 120 |       | 04.00 | 07.03        | - DSC        |                |        |   |                 |
|                           | 525 i           | 141 |       | 10.00 | 07.03        | - DSC        |                |        |   |                 |
|                           | 525 i Touring   | 141 |       | 10.00 | 07.03        | - DSC        |                |        |   |                 |
|                           | 525 td          | 85  |       | 09.97 | 09.00        |              |                |        |   |                 |
|                           | 525 tds         | 105 |       | 09.97 | 09.00        |              |                |        |   |                 |
|                           | 525 tds Touring | 105 |       | 06.98 | 09.00        |              |                |        |   |                 |
|                           | 528 i           | 142 |       | 09.97 | 09.00        | - DSC        |                |        |   |                 |
|                           | 528 i Touring   | 142 |       | 09.97 | 09.00        | - DSC        |                |        |   |                 |
|                           | 530 d           |     |       | 09.98 | 07.03        | - DSC        |                |        |   |                 |
|                           | 530 d Touring   |     |       | 09.98 | 07.03        | - DSC        |                |        |   |                 |
| 530 i                     | 170             |     | 10.00 | 07.03 | - DSC        |              |                |        |   |                 |
| 530 i Touring             | 170             |     | 10.00 | 07.03 | - DSC        |              |                |        |   |                 |
|                           | 520 i           |     |       | 03.96 | 07.03        | + DSC        | 24.2025-1704.3 | 010619 |   | THz 25,40       |
|                           | 520 i Touring   |     |       | 05.97 | 07.03        | + DSC        |                |        |   |                 |
|                           | 523 i           | 125 |       | 12.95 | 09.00        | + DSC        |                |        |   |                 |
|                           | 523 i Touring   | 125 |       | 05.97 | 09.00        | + DSC        |                |        |   |                 |
|                           | 525 d           | 120 |       | 04.00 | 07.03        | + DSC        |                |        |   |                 |
|                           | 525 d Touring   | 120 |       | 04.00 | 07.03        | + DSC        |                |        |   |                 |
|                           | 525 i           | 141 |       | 10.00 | 07.03        | + DSC        |                |        |   |                 |
|                           | 525 i Touring   | 141 |       | 10.00 | 07.03        | + DSC        |                |        |   |                 |
|                           | 528 i           | 142 |       | 12.95 | 09.00        | + DSC        |                |        |   |                 |
|                           | 528 i Touring   | 142 |       | 05.97 | 09.00        | + DSC        |                |        |   |                 |
|                           | 530 d           |     |       | 09.98 | 07.03        | + DSC        |                |        |   |                 |
|                           | 530 d Touring   |     |       | 09.98 | 07.03        | + DSC        |                |        |   |                 |
|                           | 530 i           | 170 |       | 10.00 | 07.03        | + DSC        |                |        |   |                 |
|                           | 530 i Touring   | 170 |       | 10.00 | 07.03        | + DSC        |                |        |   |                 |
|                           | 535 i           |     |       | 09.97 | 07.03        |              |                |        |   |                 |
|                           | 540 i           | 210 |       | 09.97 | 07.03        |              |                |        |   |                 |
| 540 i Touring             | 210             |     | 09.97 | 07.03 |              |              |                |        |   |                 |
| M5                        | 294             |     | 10.98 | 07.03 |              |              |                |        |   |                 |
|                           | 520 i           |     |       | 03.96 | 10.96        | - Behörde 1) | 11.0441-6008.2 | 250038 |   | Dichtungssatz   |
|                           | 523 i           | 125 |       | 12.95 | 10.96        |              | 11.0101-5402.2 | 260009 |   | Hülzensatz      |
|                           | 525 tds         | 105 |       | 02.96 | 10.96        |              | 11.8171-0008.1 | 990049 |   | Führungsbolzen  |
|                           | 528 i           | 142 |       | 12.95 | 10.96        |              | 11.8116-0239.2 | 390510 | 2 | Haltefeder      |
|                           | 535 i           |     |       | 05.96 | 10.96        |              |                |        |   |                 |
|                           | 520 d           | 100 |       | 04.00 | 07.03        | - Behörde 1) | 11.0441-6008.2 | 250038 |   | Dichtungssatz   |
|                           | 520 d Touring   | 100 |       | 04.00 | 07.03        | - Behörde 1) | 11.0101-5402.2 | 260009 |   | Hülzensatz      |
|                           | 520 i           |     |       | 11.96 | 07.03        | - Behörde 1) | 11.8171-0008.1 | 990049 |   | Führungsbolzen  |
|                           | 520 i Touring   |     |       | 05.97 | 07.03        | - Behörde 1) | 11.8116-0239.2 | 390510 | 2 | Haltefeder      |
|                           | 523 i           | 125 |       | 11.96 | 09.00        |              |                |        |   |                 |
| 523 i Touring             | 125             |     | 05.97 | 09.00 |              |              |                |        |   |                 |
| 525 d                     | 120             |     | 04.00 | 07.03 | - Behörde 1) |              |                |        |   |                 |

1) - authority cars / - enti statali / - véhicule communal / - vehiculos oficiales



|     |  |  |  |  |  |  |  |  |  |   |                                 |   |   |                                 |
|--|--|--|--|--|---|--|--|--|--|---|---------------------------------|---|---|---------------------------------|
| <b>BMW 5er Reihe/E39 (96-03)</b>   |  |  |  |  |   |  |  |  |  |   |                                 |   |   |                                 |
|    | 525 d Touring  | 120  |  | 04.00  | 07.03   | - Behörde <sup>1)</sup>  | 11.0441-6008.2   | 250038   | 2  | Dichtungssatz<br>Hülzensatz<br>Führungsbolzen<br>Haltefeder                                     | ATE<br>ATE<br>ATE<br>ATE        |   |   |                                 |
|  | 525 i  | 141  |  | 10.00  | 07.03   | - Behörde <sup>1)</sup>  | 11.0101-5402.2   | 260009   |  |   |                                 |   |   |                                 |
|  | 525 i Touring  | 141  |  | 10.00  | 07.03   | - Behörde <sup>1)</sup>  | 11.8171-0008.1   | 990049   |  |   |                                 |   |   |                                 |
|  | 525 td   | 85   |  | 01.97  | 09.00   |  | 11.8116-0239.2   | 390510   |  |   |                                 |   |   |                                 |
|  | 525 tds  | 105  |  | 11.96  | 09.00   |  |  |  |  |   |                                 |   |   |                                 |
|  | 525 tds Touring  | 105  |  | 06.98  | 09.00   |  |  |  |  |   |                                 |   |   |                                 |
|  | 528 i  | 142  |  | 11.96  | 09.00   |  |  |  |  |   |                                 |   |   |                                 |
|  | 528 i Touring  | 142  |  | 05.97  | 09.00   |  |  |  |  |   |                                 |   |   |                                 |
|  | 530 d  |  |  | 09.98  | 09.00   |  |  |  |  |   |                                 |   |   |                                 |
|  | 530 d Touring  |  |  | 09.98  | 09.00   |  |  |  |  |   |                                 |   |   |                                 |
|  | 535 i  |  |  | 11.96  | 08.97   |  |  |  |  |   |                                 |   |   |                                 |
|  | 520 i  |  |  | 03.96  | 03.00   | + Behörde <sup>2)</sup>  | 24.3601-1713.5   | 240355   |  |   |                                 | 2 | D=60, - Halter<br>D=60, - Halter<br>Hülzensatz<br>Führungsbolzen<br>Haltefeder                  | ATE<br>ATE<br>ATE<br>ATE        |
|  | 520 i Touring  |  |  | 05.97  | 03.00   | + Behörde <sup>2)</sup>  | 24.3601-1714.5   | 240356   |  |   |                                 |   |   |                                 |
|  | 535 i  |  |  | 09.97  | 03.00   |  | 11.0101-5402.2   | 260009   |  |   |                                 |   |   |                                 |
|  | 540 i  | 210  |  | 05.96  | 03.00   |  | 11.8171-0008.1   | 990049   |  |   |                                 |   |   |                                 |
| 540 i Touring  | 210  |  | 05.97  | 03.00  |   | 11.8116-0197.1   | 390523   |  |  |   |                                 |   |   |                                 |
| 520 d  | 100  |  | 04.00  | 07.03  | + Behörde <sup>2)</sup>   | 24.3601-1713.5   | 240355   | 2  | D=60, - Halter<br>D=60, - Halter<br>Hülzensatz<br>Führungsbolzen<br>Haltefeder | ATE<br>ATE<br>ATE<br>ATE  |                                 |   |   |                                 |
| 520 d Touring  | 100  |  | 04.00  | 07.03  | + Behörde <sup>2)</sup>   | 24.3601-1714.5   | 240356   |  |  |   |                                 |   |   |                                 |
| 520 i  |  |  | 04.00  | 07.03  | + Behörde <sup>2)</sup>   | 11.0101-5402.2   | 260009   |  |  |   |                                 |   |   |                                 |
| 520 i Touring  |  |  | 04.00  | 07.03  | + Behörde <sup>2)</sup>   | 11.8171-0008.1   | 990049   |  |  |   |                                 |   |   |                                 |
| 525 d  | 120  |  | 04.00  | 07.03  | + Behörde <sup>2)</sup>   | 11.8116-0290.2   | 390520   |  |  |   |                                 |   |   |                                 |
| 525 d Touring  | 120  |  | 04.00  | 07.03  | + Behörde <sup>2)</sup>   |  |  |  |  |   |                                 |   |   |                                 |
| 525 i  | 141  |  | 10.00  | 07.03  | + Behörde <sup>2)</sup>   |  |  |  |  |   |                                 |   |   |                                 |
| 525 i Touring  | 141  |  | 10.00  | 07.03  | + Behörde <sup>2)</sup>   |  |  |  |  |   |                                 |   |   |                                 |
| 530 d  |  |  | 10.00  | 07.03  |   |  |  |  |  |   |                                 |   |   |                                 |
| 530 d Touring  |  |  | 10.00  | 07.03  |   |  |  |  |  |   |                                 |   |   |                                 |
| 530 i  | 170  |  | 10.00  | 07.03  |   |  |  |  |  |   |                                 |   |   |                                 |
| 530 i Touring  | 170  |  | 10.00  | 07.03  |   |  |  |  |  |   |                                 |   |   |                                 |
| 535 i  |  |  | 04.00  | 07.03  |   |  |  |  |  |   |                                 |   |   |                                 |
| 540 i  | 210  |  | 04.00  | 07.03  |   |  |  |  |  |   |                                 |   |   |                                 |
| 540 i Touring  | 210  |  | 04.00  | 07.03  |   |  |  |  |  |   |                                 |   |   |                                 |
| M5   | 294  |  | 10.98  | 07.03  |   | 11.0441-6003.2   | 250037   | 2  | Dichtungssatz<br>Hülzensatz<br>Führungsbolzen<br>Haltefeder                    | ATE<br>ATE<br>ATE   |                                 |   |   |                                 |
|  |  |  |  |  |   | 11.0101-5402.2   | 260009   |  |  |   |                                 |   |   |                                 |
|  |  |  |  |  |   | 11.8171-0008.1   | 990049   |  |  |   |                                 |   |   |                                 |
|    | 520 d  | 100  |  | 04.00  | 07.03   |  | 83.6235-0100.3   | 330463   | 2  | L=100<br>L=100<br>L=410   | ATE<br>ATE<br>ATE               |   |   |                                 |
|  | 520 d Touring  | 100  |  | 04.00  | 07.03   |  | 83.6204-0100.3   | 330441   |  |   |                                 |   |   |                                 |
|  | 520 i  |  |  | 03.96  | 07.03   |  | 83.6151-0411.3   | 330461   |  |   |                                 |   |   |                                 |
|  | 520 i Touring  |  |  | 05.97  | 07.03   |  |  |  |  |   |                                 |   |   |                                 |
|  | 523 i  | 125  |  | 12.95  | 09.00   |  |  |  |  |   |                                 |   |   |                                 |
|  | 523 i Touring  | 125  |  | 05.97  | 09.00   |  |  |  |  |   |                                 |   |   |                                 |
|  | 525 d  | 120  |  | 04.00  | 07.03   |  |  |  |  |   |                                 |   |   |                                 |
|  | 525 d Touring  | 120  |  | 04.00  | 07.03   |  |  |  |  |   |                                 |   |   |                                 |
|  | 525 i  | 141  |  | 10.00  | 07.03   |  |  |  |  |   |                                 |   |   |                                 |
|  | 525 i Touring  | 141  |  | 10.00  | 07.03   |  |  |  |  |   |                                 |   |   |                                 |
|  | 525 td   | 85   |  | 01.97  | 09.00   |  |  |  |  |   |                                 |   |   |                                 |
|  | 525 tds  | 105  |  | 02.96  | 09.00   |  |  |  |  |   |                                 |   |   |                                 |
|  | 525 tds Touring  | 105  |  | 06.98  | 09.00   |  |  |  |  |   |                                 |   |   |                                 |
|  | 528 i  | 142  |  | 12.95  | 09.00   |  |  |  |  |   |                                 |   |   |                                 |
|  | 528 i Touring  | 142  |  | 05.97  | 09.00   |  |  |  |  |   |                                 |   |   |                                 |
|  | 530 d  |  |  | 09.98  | 07.03   |  |  |  |  |   |                                 |   |   |                                 |
|  | 530 d Touring  |  |  | 09.98  | 07.03   |  |  |  |  |   |                                 |   |   |                                 |
|  | 530 i  | 170  |  | 10.00  | 07.03   |  |  |  |  |   |                                 |   |   |                                 |
|  | 530 i Touring  | 170  |  | 10.00  | 07.03   |  |  |  |  |   |                                 |   |   |                                 |
|  | 535 i  |  |  | 05.96  | 07.03   |  |  |  |  |   |                                 |   |   |                                 |
|  | 540 i  | 210  |  | 05.96  | 07.03   |  |  |  |  |   |                                 |   |   |                                 |
|  | 540 i Touring  | 210  |  | 05.97  | 07.03   |  |  |  |  |   |                                 |   |   |                                 |
|  | M5   | 294  |  | 10.98  | 07.03   |  |  |  |  |   |                                 |   |   |                                 |
|  | 520 d  | 100  |  | 04.00  | 07.03   | - Behörde <sup>1)</sup>  | 11.9406-9995.2   | 220415   | 2  | D=40, - Halter<br>D=40, - Halter<br>Dichtungssatz<br>Hülzensatz<br>Führungsbolzen<br>Haltefeder | ATE<br>ATE<br>ATE<br>ATE<br>ATE |   |   |                                 |
|  | 520 i  |  |  | 03.96  | 07.03   | - Behörde <sup>1)</sup>  | 11.9406-9996.2   | 220416   |  |   |                                 |   |   |                                 |
|  | 523 i  | 125  |  | 12.95  | 08.98   | - Behörde <sup>1)</sup>  | 11.0441-4004.2   | 250012   |  |   |                                 |   |   |                                 |
|  | 525 td   | 85   |  | 01.97  | 09.00   | - Behörde <sup>1)</sup>  | 11.0101-5402.2   | 260009   |  |   |                                 |   |   |                                 |
|  | 525 tds  | 105  |  | 02.96  | 09.00   | - Behörde <sup>1)</sup>  | 11.8171-0008.1   | 990049   |  |   |                                 |   |   |                                 |
|  |  |  |  |  |   |  | 11.8116-0168.1   | 390499   |  |   |                                 |   |   |                                 |
|  | 520 d  | 100  |  | 04.00  | 07.03   | + Behörde <sup>2)</sup>  | 11.9406-9993.2   | 220413   |  |   |                                 | 2 | D=40, - Halter<br>D=40, - Halter<br>Dichtungssatz<br>Hülzensatz<br>Führungsbolzen<br>Haltefeder | ATE<br>ATE<br>ATE<br>ATE<br>ATE |
|  | 520 i  |  |  | 03.96  | 07.03   | + Behörde <sup>2)</sup>  | 11.9406-9994.2   | 220414   |  |   |                                 |   |   |                                 |
|  | 523 i  | 125  |  | 09.98  | 09.00   |  | 11.0441-4004.2   | 250012   |  |   |                                 |   |   |                                 |
|  | 523 i  | 125  |  | 12.95  | 08.98   | + Behörde <sup>2)</sup>  | 11.0101-5402.2   | 260009   |  |   |                                 |   |   |                                 |
|  | 525 d  | 120  |  | 04.00  | 07.03   |  | 11.8171-0008.1   | 990049   |  |   |                                 |   |   |                                 |
|  | 525 i  | 141  |  | 10.00  | 07.03   |  | 11.8116-0168.1   | 390499   |  |   |                                 |   |   |                                 |
|  | 525 td   | 85   |  | 01.97  | 09.00   | + Behörde <sup>2)</sup>  |  |  |  |   |                                 |   |   |                                 |
|  | 525 tds  | 105  |  | 02.96  | 09.00   | + Behörde <sup>2)</sup>  |  |  |  |   |                                 |   |   |                                 |
|  | 528 i  | 142  |  | 12.95  | 09.00   |  |  |  |  |   |                                 |   |   |                                 |
| 530 d  |  |  | 09.98  | 07.03  |   |  |  |  |  |   |                                 |   |   |                                 |
| 530 i  | 170  |  | 10.00  | 07.03  |   |  |  |  |  |   |                                 |   |   |                                 |
| 535 i  |  |  | 05.96  | 07.03  |   |  |  |  |  |   |                                 |   |   |                                 |
| 540 i  | 210  |  | 05.96  | 07.03  |   |  |  |  |  |   |                                 |   |   |                                 |
| 520 d Touring  | 100  |  | 04.00  | 07.03  |   | 11.0441-4203.2   | 250013   | 2  | Dichtungssatz<br>Hülzensatz<br>Führungsbolzen<br>Haltefeder                    | ATE<br>ATE<br>ATE<br>ATE  |                                 |   |   |                                 |
| 520 i Touring  |  |  | 05.97  | 07.03  |   | 11.0101-5402.2   | 260009   |  |  |   |                                 |   |   |                                 |
| 523 i Touring  | 125  |  | 05.97  | 09.00  |   | 11.8171-0008.1   | 990049   |  |  |   |                                 |   |   |                                 |
| 525 d Touring  | 120  |  | 04.00  | 07.03  |   | 11.8116-0168.1   | 390499   |  |  |   |                                 |   |   |                                 |
| 525 i Touring  | 141  |  | 10.00  | 07.03  |   |  |  |  |  |   |                                 |   |   |                                 |
| 525 tds Touring  | 105  |  | 06.98  | 09.00  |   |  |  |  |  |   |                                 |   |   |                                 |
| 528 i Touring  | 142  |  | 05.97  | 09.00  |   |  |  |  |  |   |                                 |   |   |                                 |
| 530 d Touring  |  |  | 09.98  | 07.03  |   |  |  |  |  |   |                                 |   |   |                                 |
| 530 i Touring  | 170  |  | 10.00  | 07.03  |   |  |  |  |  |   |                                 |   |   |                                 |
| 540 i Touring  | 210  |  | 05.97  | 07.03  |   |  |  |  |  |   |                                 |   |   |                                 |

1) - authority cars / - enti statali / - véhicule communal / - vehiculos oficiales  
2) + authority cars / + enti statali / + véhicule communal / + vehiculos oficiales  
3) on the brake caliper / sulla pinza freno / sur l'étrier de frein / a la pinza de freno

|     |  |  |  |  |  |  |  |  |                   |
|--|--|--|--|--|---|--|--|--|-------------------|
| <b>BMW 5er Reihe/E39 (96-03)</b>   |  |  |  |  |   |  |  |  |                   |
|    | M5   | 294  |  | 10.98  | 07.03   |  |  | Hülsensatz<br>Führungsbolzen<br>Haltefeder   | ATE<br>ATE<br>ATE |
|  | 520 d  | 100  |  | 04.00  | 07.03   |  |  |  |                   |
|  | 520 i  |  |  | 03.96  | 07.03   | 83.6113-0276.3   | 330538   | 2 am Bremssattel <sup>1)</sup>   | L=275             |
|  | 520 i Touring  |  |  | 05.97  | 07.03   | 83.6235-0100.3   | 330463   | <input type="checkbox"/> M12X1   | L=100             |
|  | 523 i  | 125  |  | 12.95  | 09.00   | 83.6204-0100.3   | 330441   | <input type="checkbox"/> M10X1   | L=100             |
|  | 523 i Touring  | 125  |  | 05.97  | 09.00   |  |  |  |                   |
|  | 525 d  | 120  |  | 04.00  | 07.03   |  |  |  |                   |
|  | 525 i  | 141  |  | 10.00  | 07.03   |  |  |  |                   |
|  | 525 td   | 85   |  | 01.97  | 09.00   |  |  |  |                   |
|  | 525 tds  | 105  |  | 02.96  | 09.00   |  |  |  |                   |
|  | 525 tds Touring  | 105  |  | 06.98  | 09.00   |  |  |  |                   |
|  | 528 i  | 142  |  | 12.95  | 09.00   |  |  |  |                   |
|  | 528 i Touring  | 142  |  | 05.97  | 09.00   |  |  |  |                   |
|  | 530 d  |  |  | 09.98  | 07.03   |  |  |  |                   |
|  | 530 i  | 170  |  | 10.00  | 07.03   |  |  |  |                   |
|  | 535 i  |  |  | 05.96  | 07.03   |  |  |  |                   |
|  | 540 i  | 210  |  | 05.96  | 07.03   |  |  |  |                   |
|  | M5   | 294  |  | 10.98  | 07.03   |  |  |  |                   |
|  | 520 d Touring  | 100  |  | 04.00  | 07.03   | 24.5113-0275.3   | 330653   | 2 am Bremssattel <sup>1)</sup>   | L=275             |
|  | 525 d Touring  | 120  |  | 04.00  | 07.03   | 83.6235-0100.3   | 330463   | <input type="checkbox"/> M12X1   | L=100             |
|  | 525 i Touring  | 141  |  | 10.00  | 07.03   | 83.6204-0100.3   | 330441   | <input type="checkbox"/> M10X1   | L=100             |
|  | 530 d Touring  |  |  | 09.98  | 07.03   |  |  |  |                   |
|  | 530 i Touring  | 170  |  | 10.00  | 07.03   |  |  |  |                   |
|  | 540 i Touring  | 210  |  | 05.97  | 07.03   |  |  |  |                   |
|    | 520 d  | 100  |  | 04.00  | 07.03   | 24.3727-0247.2   | 580247   | <input type="checkbox"/>   | L=1924, + Zub     |
|  | 520 d Touring  | 100  |  | 04.00  | 07.03   | 24.3727-0246.2   | 580246   | <input type="checkbox"/>   | L=1877, + Zub     |
|  | 520 i  |  |  | 03.96  | 07.03   |  |  |  |                   |
|  | 520 i Touring  |  |  | 05.97  | 07.03   |  |  |  |                   |
|  | 523 i  | 125  |  | 12.95  | 09.00   |  |  |  |                   |
|  | 523 i Touring  | 125  |  | 05.97  | 09.00   |  |  |  |                   |
|  | 525 d  | 120  |  | 04.00  | 07.03   |  |  |  |                   |
|  | 525 d Touring  | 120  |  | 04.00  | 07.03   |  |  |  |                   |
|  | 525 i  | 141  |  | 10.00  | 07.03   |  |  |  |                   |
|  | 525 i Touring  | 141  |  | 10.00  | 07.03   |  |  |  |                   |
|  | 525 td   | 85   |  | 01.97  | 09.00   |  |  |  |                   |
|  | 525 tds  | 105  |  | 02.96  | 09.00   |  |  |  |                   |
|  | 525 tds Touring  | 105  |  | 06.98  | 09.00   |  |  |  |                   |
|  | 528 i  | 142  |  | 12.95  | 09.00   |  |  |  |                   |
|  | 528 i Touring  | 142  |  | 05.97  | 09.00   |  |  |  |                   |
|  | 530 d  |  |  | 09.98  | 07.03   |  |  |  |                   |
|  | 530 d Touring  |  |  | 09.98  | 07.03   |  |  |  |                   |
|  | 530 i  | 170  |  | 10.00  | 07.03   |  |  |  |                   |
|  | 530 i Touring  | 170  |  | 10.00  | 07.03   |  |  |  |                   |
|  | 535 i  |  |  | 05.96  | 07.03   |  |  |  |                   |
|  | 540 i  | 210  |  | 05.96  | 07.03   |  |  |  |                   |
|  | 540 i Touring  | 210  |  | 05.97  | 07.03   |  |  |  |                   |
|  | M5   | 294  |  | 10.98  | 07.03   |  |  |  |                   |
|  | 520 i  |  |  | 03.96  | 08.97   | 24.2419-1710.3   | 030104   |  | Gz 19,05          |
|  | 520 i Touring  |  |  | 05.97  | 08.97   |  |  |  |                   |
|  | 523 i  | 125  |  | 12.95  | 08.97   |  |  |  |                   |
|  | 523 i Touring  | 125  |  | 05.97  | 08.97   |  |  |  |                   |
|  | 525 td   | 85   |  | 01.97  | 08.97   |  |  |  |                   |
|  | 525 tds  | 105  |  | 02.96  | 08.97   |  |  |  |                   |
|  | 528 i  | 142  |  | 12.95  | 08.97   |  |  |  |                   |
|  | 528 i Touring  | 142  |  | 05.97  | 08.97   |  |  |  |                   |
|  | 535 i  |  |  | 05.96  | 08.97   |  |  |  |                   |
|  | 540 i  | 210  |  | 05.96  | 08.97   |  |  |  |                   |
|  | 540 i Touring  | 210  |  | 05.97  | 08.97   |  |  |  |                   |
|  | 520 d  | 100  |  | 04.00  | 07.03   | 24.2419-1713.3   | 030093   |  | Gz 19,05          |
|  | 520 d Touring  | 100  |  | 04.00  | 07.03   |  |  |  |                   |
|  | 520 i  |  |  | 09.97  | 07.03   |  |  |  |                   |
|  | 520 i Touring  |  |  | 09.97  | 07.03   |  |  |  |                   |
|  | 523 i  | 125  |  | 09.97  | 09.00   |  |  |  |                   |
|  | 523 i Touring  | 125  |  | 09.97  | 09.00   |  |  |  |                   |
|  | 525 d  | 120  |  | 04.00  | 07.03   |  |  |  |                   |
|  | 525 d Touring  | 120  |  | 04.00  | 07.03   |  |  |  |                   |
|  | 525 i  | 141  |  | 10.00  | 07.03   |  |  |  |                   |
|  | 525 i Touring  | 141  |  | 10.00  | 07.03   |  |  |  |                   |
|  | 525 td   | 85   |  | 09.97  | 09.00   |  |  |  |                   |
|  | 525 tds  | 105  |  | 09.97  | 09.00   |  |  |  |                   |
|  | 525 tds Touring  | 105  |  | 06.98  | 09.00   |  |  |  |                   |
|  | 528 i  | 142  |  | 09.97  | 09.00   |  |  |  |                   |
|  | 528 i Touring  | 142  |  | 09.97  | 09.00   |  |  |  |                   |
|  | 530 d  |  |  | 09.98  | 07.03   |  |  |  |                   |
|  | 530 d Touring  |  |  | 09.98  | 07.03   |  |  |  |                   |
|  | 530 i  | 170  |  | 10.00  | 07.03   |  |  |  |                   |
|  | 530 i Touring  | 170  |  | 10.00  | 07.03   |  |  |  |                   |
|  | 535 i  |  |  | 09.97  | 07.03   |  |  |  |                   |
|  | 540 i  | 210  |  | 09.97  | 07.03   |  |  |  |                   |
|  | 540 i Touring  | 210  |  | 09.97  | 07.03   |  |  |  |                   |
|  | M5   | 294  |  | 10.98  | 07.03   |  |  |  |                   |

<sup>1)</sup> on the brake caliper / sulla pinza freno / sur l'étrier de frein / a la pinza de freno



**BMW 5er Reihe/E39 (96-03)**

|  |                 |     |  |       |       |  |                |        |  |  |  |          |
|--|-----------------|-----|--|-------|-------|--|----------------|--------|--|--|--|----------|
|  | 520 d           | 100 |  | 04.00 | 07.03 |  | 24.2522-0905.3 | 040042 |  |  |  | Nz 22,20 |
|  | 520 d Touring   | 100 |  | 04.00 | 07.03 |  |                |        |  |  |  |          |
|  | 520 i           |     |  | 03.96 | 07.03 |  |                |        |  |  |  |          |
|  | 520 i Touring   |     |  | 05.97 | 07.03 |  |                |        |  |  |  |          |
|  | 523 i           | 125 |  | 12.95 | 09.00 |  |                |        |  |  |  |          |
|  | 523 i Touring   | 125 |  | 05.97 | 07.03 |  |                |        |  |  |  |          |
|  | 525 d           | 120 |  | 04.00 | 07.03 |  |                |        |  |  |  |          |
|  | 525 d Touring   | 120 |  | 04.00 | 07.03 |  |                |        |  |  |  |          |
|  | 525 i           | 141 |  | 10.00 | 07.03 |  |                |        |  |  |  |          |
|  | 525 i Touring   | 141 |  | 10.00 | 07.03 |  |                |        |  |  |  |          |
|  | 525 td          | 85  |  | 01.97 | 09.00 |  |                |        |  |  |  |          |
|  | 525 tds         | 105 |  | 02.96 | 09.00 |  |                |        |  |  |  |          |
|  | 525 tds Touring | 105 |  | 06.98 | 09.00 |  |                |        |  |  |  |          |
|  | 528 i           | 142 |  | 12.95 | 09.00 |  |                |        |  |  |  |          |
|  | 528 i Touring   | 142 |  | 05.97 | 09.00 |  |                |        |  |  |  |          |
|  | 530 d           |     |  | 09.98 | 07.03 |  |                |        |  |  |  |          |
|  | 530 d Touring   |     |  | 09.98 | 07.03 |  |                |        |  |  |  |          |
|  | 530 i           | 170 |  | 10.00 | 07.03 |  |                |        |  |  |  |          |
|  | 530 i Touring   | 170 |  | 10.00 | 07.03 |  |                |        |  |  |  |          |
|  | 535 i           |     |  | 05.96 | 07.03 |  |                |        |  |  |  |          |
|  | 540 i           | 210 |  | 05.96 | 07.03 |  |                |        |  |  |  |          |
|  | 540 i Touring   | 210 |  | 05.97 | 07.03 |  |                |        |  |  |  |          |

**BMW 5er Reihe/E60 Limousine (03-10)**

|  |        |     |  |       |       |   |                |        |   |  |  |                 |     |
|--|--------|-----|--|-------|-------|---|----------------|--------|---|--|--|-----------------|-----|
|  | 520 i  |     |  | 07.03 | 03.05 |   | 24.2025-1710.3 | 010833 |   |  |  | Thz 25,40/22,20 | LUC |
|  | 525 i  | 141 |  | 07.03 | 06.05 |   |                |        |   |  |  |                 |     |
|  | 530 i  | 170 |  | 07.03 | 03.05 |   |                |        |   |  |  |                 |     |
|  | 520 d  |     |  | 07.05 | 02.10 |   | 24.2026-1702.3 | 010850 |   |  |  | Thz 26,99/22,20 | LUC |
|  | 520 d  | 130 |  | 09.07 | 02.10 |   |                |        |   |  |  |                 |     |
|  | 523 i  | 130 |  | 07.05 | 03.07 |   |                |        |   |  |  |                 |     |
|  | 523 i  | 140 |  | 03.07 | 02.10 |   |                |        |   |  |  |                 |     |
|  | 525 d  |     |  | 10.03 | 03.07 |   |                |        |   |  |  |                 |     |
|  | 525 d  | 145 |  | 03.07 | 02.10 |   |                |        |   |  |  |                 |     |
|  | 525 i  | 160 |  | 07.05 | 02.10 |   |                |        |   |  |  |                 |     |
|  | 525 xd | 145 |  | 03.07 | 02.10 |   |                |        |   |  |  |                 |     |
|  | 525 xi | 160 |  | 07.05 | 02.10 |   |                |        |   |  |  |                 |     |
|  | 530 d  | 160 |  | 07.03 | 08.05 |   |                |        |   |  |  |                 |     |
|  | 530 d  | 170 |  | 07.03 | 03.07 |   |                |        |   |  |  |                 |     |
|  | 530 d  | 173 |  | 03.07 | 02.10 |   |                |        |   |  |  |                 |     |
|  | 530 i  | 190 |  | 07.05 | 03.07 |   |                |        |   |  |  |                 |     |
|  | 530 i  | 200 |  | 01.07 | 02.10 |   |                |        |   |  |  |                 |     |
|  | 530 xd | 170 |  | 07.05 | 03.07 |   |                |        |   |  |  |                 |     |
|  | 530 xd | 173 |  | 03.07 | 02.10 |   |                |        |   |  |  |                 |     |
|  | 530 xi | 190 |  | 07.05 | 03.07 |   |                |        |   |  |  |                 |     |
|  | 530 xi | 200 |  | 03.07 | 02.10 |   |                |        |   |  |  |                 |     |
|  | 535 d  | 200 |  | 09.04 | 03.07 |   |                |        |   |  |  |                 |     |
|  | 535 d  | 210 |  | 03.07 | 02.10 |   |                |        |   |  |  |                 |     |
|  | 540 i  | 225 |  | 07.05 | 02.10 |   |                |        |   |  |  |                 |     |
|  | 545 i  | 245 |  | 07.03 | 08.05 |   |                |        |   |  |  |                 |     |
|  | 550 i  | 270 |  | 07.05 | 02.10 |   |                |        |   |  |  |                 |     |
|  | M5     | 373 |  | 09.04 | 02.10 |   |                |        |   |  |  |                 |     |
|  | 520 d  |     |  | 07.05 | 02.10 | - Behörde <sup>1)</sup>                   | 11.9606-9967.2 | 220905 |   |  |  | D=60, - Halter  | ATE |
|  | 520 i  |     |  | 07.03 | 03.05 | + Schaltgetriebe <sup>2)</sup>            | 11.9606-9968.2 | 220906 |   |  |  | D=60, - Halter  | ATE |
|  | 523 i  | 130 |  | 07.05 | 03.07 | - Behörde <sup>1)</sup>                   | 24.3606-9967.5 | 240571 |   |  |  | D=60, - Halter  | ATE |
|  | 523 i  | 140 |  | 03.07 | 02.10 | - Behörde/ + Motorcode N52N <sup>3)</sup> | 24.3606-9968.5 | 240572 |   |  |  | D=60, - Halter  | ATE |
|  | 525 d  |     |  | 10.03 | 03.07 | - Behörde/ + Schaltgetriebe <sup>4)</sup> | 11.0441-6008.2 | 250038 |   |  |  | Dichtungssatz   | ATE |
|  | 525 i  | 141 |  | 07.03 | 06.05 | - Behörde <sup>1)</sup>                   | 11.0101-5402.2 | 260009 |   |  |  | Hülssensatz     | ATE |
|  | 525 i  | 160 |  | 03.07 | 02.10 | - Behörde/ + Motorcode N52N <sup>3)</sup> | 11.8171-0008.1 | 990049 |   |  |  | Führungsbolzen  | ATE |
|  |        |     |  |       |       |   | 11.8116-0339.2 | 390528 | 2 |  |  | Haltefeder      | ATE |
|  | 520 d  |     |  | 07.05 | 02.10 | + Behörde <sup>5)</sup>                   | 11.9606-9979.2 | 220907 |   |  |  | D=60, - Halter  | ATE |
|  | 520 d  | 130 |  | 09.07 | 02.10 |   | 11.9606-9980.2 | 220908 |   |  |  | D=60, - Halter  | ATE |
|  | 520 i  |     |  | 07.03 | 03.05 | + Automatikgetriebe <sup>6)</sup>         | 24.3606-9979.5 | 240575 |   |  |  | D=60, - Halter  | ATE |
|  | 523 i  | 130 |  | 07.05 | 03.07 | + Behörde <sup>5)</sup>                   | 24.3606-9980.5 | 240576 |   |  |  | D=60, - Halter  | ATE |
|  | 523 i  | 140 |  | 03.07 | 02.10 | + Motorcode N53 <sup>7)</sup>             | 11.0441-6008.2 | 250038 |   |  |  | Dichtungssatz   | ATE |
|  | 523 i  | 140 |  | 03.07 | 02.10 | + Behörde/ + Motorcode N52N <sup>8)</sup> | 11.0101-6006.2 | 260098 |   |  |  | Hülssensatz     | ATE |
|  | 525 d  |     |  | 10.03 | 03.07 | + Automatikgetriebe <sup>6)</sup>         | 11.8171-0008.1 | 990049 |   |  |  | Führungsbolzen  | ATE |
|  | 525 d  |     |  | 10.03 | 03.07 | + Behörde/ + Schaltgetriebe <sup>9)</sup> | 11.8116-0315.2 | 390447 | 2 |  |  | Haltefeder      | ATE |
|  | 525 d  | 145 |  | 03.07 | 02.10 | - Behörde <sup>1)</sup>                   |                |        |   |  |  |                 |     |
|  | 525 i  | 141 |  | 07.03 | 06.05 | + Behörde <sup>5)</sup>                   |                |        |   |  |  |                 |     |
|  | 525 i  | 160 |  | 03.07 | 02.10 | - Behörde/ + Motorcode N53 <sup>10)</sup> |                |        |   |  |  |                 |     |
|  | 525 i  | 160 |  | 03.07 | 02.10 | + Behörde/ + Motorcode N52N <sup>8)</sup> |                |        |   |  |  |                 |     |
|  | 525 i  | 160 |  | 07.05 | 03.07 |   |                |        |   |  |  |                 |     |
|  | 530 d  | 160 |  | 07.03 | 08.05 | - Behörde <sup>1)</sup>                   |                |        |   |  |  |                 |     |
|  | 530 d  | 170 |  | 07.03 | 03.07 | - Behörde <sup>1)</sup>                   |                |        |   |  |  |                 |     |
|  | 530 d  | 173 |  | 03.07 | 02.10 | - Behörde <sup>1)</sup>                   |                |        |   |  |  |                 |     |
|  | 530 i  | 170 |  | 07.03 | 03.05 |   |                |        |   |  |  |                 |     |
|  | 530 i  | 190 |  | 07.05 | 03.07 | - Behörde <sup>1)</sup>                   |                |        |   |  |  |                 |     |
|  | 530 i  | 200 |  | 01.07 | 02.10 | - Behörde/ + Motorcode N52N <sup>3)</sup> |                |        |   |  |  |                 |     |
|  | 525 xd | 145 |  | 03.07 | 02.10 |   | 11.9606-9955.2 | 220919 |   |  |  | D=60, - Halter  | ATE |
|  | 525 xi | 160 |  | 07.05 | 02.10 |   | 11.9606-9956.2 | 220920 |   |  |  | D=60, - Halter  | ATE |
|  | 530 xd | 170 |  | 07.05 | 03.07 |   | 24.3606-9955.5 | 240577 |   |  |  | D=60, - Halter  | ATE |
|  | 530 xd | 173 |  | 03.07 | 02.10 |   | 24.3606-9956.5 | 240578 |   |  |  | D=60, - Halter  | ATE |
|  | 530 xi | 190 |  | 07.05 | 03.07 |   | 11.0441-6008.2 | 250038 |   |  |  | Dichtungssatz   | ATE |
|  | 530 xi | 200 |  | 03.07 | 02.10 |   | 11.0101-6006.2 | 260098 |   |  |  | Hülssensatz     | ATE |
|  |        |     |  |       |       |   | 11.8171-0008.1 | 990049 |   |  |  | Führungsbolzen  | ATE |
|  |        |     |  |       |       |   | 11.8171-0067.1 | 250153 |   |  |  | Führungsbolzen  | ATE |
|  |        |     |  |       |       |   | 11.8116-0315.2 | 390447 | 2 |  |  | Haltefeder      | ATE |

1) - authority cars / - enti statali / - véhicule communal / - vehiculos oficiales  
2) + manual transmission / + scatola cambio velocità / + transmission mécanique / + cambio de velocidad  
3) - authority cars/+engine co.N52N / - enti statali/+codice mot.N52N / - véhicule communal/+moteur co.N52N / - vehiculos oficiales/+motor co.N52N  
4) - authority cars/+manual transm. / - enti statali/+scatola camb.velocità / - véhicule communal/+transm.mécanique / - vehiculos oficiales/+camb.de velocidad  
5) + authority cars / + enti statali / + véhicule communal / + vehiculos oficiales  
6) + autom.transmission / + scatola cambio automatico / + transmission automatique / + cambio automatico  
7) + engine code N53 / + codice motore N53 / + moteur code N53 / + motor code N53  
8) + authority cars/+engine no.N52N / + enti statali/+codice mot.N52N / + véhicule communal/+moteur co.N52N / + vehiculos oficiales/+motor co.N52N  
9) + authority cars/+manual transm. / + enti statali/+scatola camb.velocità / + véhicule communal/+transm. mécanique / + vehiculos oficiales/+camb.de velocidad  
10) - authority cars/+engine co.N53 / - enti statali/+codice mot.N53 / - véhicule communal/+moteur co.N53 / - vehiculos oficiales/+motor co.N53



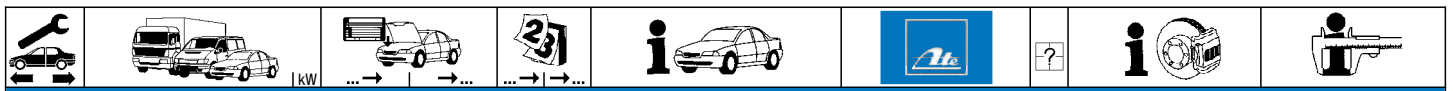

**BMW 5er Reihe/E60 Limousine (03-10)**

|        |        |       |       |  |   |                |        |   |   |   |     |
|--------|--------|-------|-------|--|---|----------------|--------|---|---|---|-----|
|        | 525 d  | 145   | 03.07 | 02.10                                      | + Behörde <sup>1)</sup>                   | 24.3606-9977.5 | 240573 | 2 |   | D=60, - Halter<br>D=60, - Halter<br>Dichtungssatz<br>Hülsensatz<br>Führungsbolzen<br>Führungsbolzen<br>Haltefeder | ATE |
|        | 525 i  | 160   | 03.07 | 02.10                                      | + Behörde/ + Motorcode N53 <sup>2)</sup>  | 24.3606-9978.5 | 240574 |   |   |   | ATE |
|        | 530 d  | 160   | 07.03 | 08.05                                      | + Behörde <sup>1)</sup>                   | 11.0441-6008.2 | 250038 |   |   |   | ATE |
|        | 530 d  | 170   | 07.03 | 03.07                                      | + Behörde <sup>1)</sup>                   | 11.0101-6006.2 | 260098 |   |   |   | ATE |
|        | 530 d  | 173   | 03.07 | 02.10                                      | + Behörde <sup>1)</sup>                   | 11.8171-0008.1 | 990049 |   |   |   | ATE |
|        | 530 i  | 190   | 07.05 | 03.07                                      | + Behörde <sup>1)</sup>                   | 11.8171-0067.1 | 250153 |   |   |   | ATE |
|        | 530 i  | 200   | 01.07 | 02.10                                      | + Motorcode N53 <sup>3)</sup>             | 11.8116-0315.2 | 390447 |   |   |   | ATE |
|        | 530 i  | 200   | 01.07 | 02.10                                      | + Behörde/ + Motorcode N52N <sup>4)</sup> |                |        |   |   |   |     |
|        | 540 i  | 225   | 03.07 | 02.10                                      | - erhöhte Zuladung <sup>5)</sup>          |                |        |   |   |   |     |
|        | 540 i  | 225   | 07.05 | 03.07                                      |   |                |        |   |   |   |     |
| 545 i  | 245    | 07.03 | 08.05 |  |   |                |        |   |   |   |     |
| 550 i  | 270    | 03.07 | 02.10 | +  |   |                |        |   |   |   |     |
| 535 d  | 200    | 09.04 | 03.07 |  | 11.0101-5706.2                            | 260097         | 2      |   | Hülsensatz<br>Führungsbolzen<br>Haltefeder                                | ATE   |     |
| 535 d  | 210    | 03.07 | 02.10 |  | 11.8171-0067.1                            | 250153         |        |   |   | ATE   |     |
| 540 i  | 225    | 03.07 | 02.10 | + erhöhte Zuladung <sup>6)</sup>           | 11.8116-0353.2                            | 390585         |        |   |   | ATE   |     |
| 550 i  | 270    | 03.07 | 02.10 | -  |   |                |        |   |   |   |     |
| 550 i  | 270    | 07.05 | 03.07 |  |   |                |        |   |   |   |     |
| M5     | 373    | 09.04 | 02.10 |  | 11.0101-5706.2                            | 260097         | 2      |   | Hülsensatz<br>Führungsbolzen<br>Haltefeder                                | ATE   |     |
|        |        |       |       |  | 11.8171-0067.1                            | 250153         |        |   |   | ATE   |     |
|        |        |       |       |  | 11.8116-0353.2                            | 390585         |        |   |   | ATE   |     |
|        | 520 d  |       | 07.05 | 02.10                                      |   | 83.6151-0552.3 | 330857 | 2 |   | L=550   |     |
|        | 520 d  | 130   | 09.07 | 02.10                                      |   |                |        |   |   |   |     |
|        | 520 i  |       | 07.03 | 03.05                                      |   |                |        |   |   |   |     |
|        | 523 i  | 130   | 07.05 | 03.07                                      |   |                |        |   |   |   |     |
|        | 523 i  | 140   | 03.07 | 02.10                                      |   |                |        |   |   |   |     |
|        | 525 d  |       | 10.03 | 03.07                                      |   |                |        |   |   |   |     |
|        | 525 d  | 145   | 03.07 | 02.10                                      |   |                |        |   |   |   |     |
|        | 525 i  | 141   | 07.03 | 06.05                                      |   |                |        |   |   |   |     |
|        | 525 i  | 160   | 07.05 | 02.10                                      |   |                |        |   |   |   |     |
|        | 525 xi | 160   | 07.05 | 03.07                                      |   |                |        |   |   |   |     |
|        | 530 d  | 160   | 07.03 | 08.05                                      |   |                |        |   |   |   |     |
|        | 530 d  | 170   | 07.03 | 03.07                                      |   |                |        |   |   |   |     |
|        | 530 d  | 173   | 03.07 | 02.10                                      |   |                |        |   |   |   |     |
|        | 530 i  | 170   | 07.03 | 03.05                                      |   |                |        |   |   |   |     |
|        | 530 i  | 190   | 07.05 | 03.07                                      |   |                |        |   |   |   |     |
|        | 530 i  | 200   | 01.07 | 02.10                                      |   |                |        |   |   |   |     |
|        | 530 xd | 170   | 07.05 | 03.07                                      |   |                |        |   |   |   |     |
|        | 530 xi | 190   | 07.05 | 03.07                                      |   |                |        |   |   |   |     |
|        | 535 d  | 200   | 09.04 | 03.07                                      |   |                |        |   |   |   |     |
|        | 535 d  | 210   | 03.07 | 02.10                                      |   |                |        |   |   |   |     |
| 540 i  | 225    | 07.05 | 02.10 |  |   |                |        |   |   |   |     |
| 545 i  | 245    | 07.03 | 08.05 |  |   |                |        |   |   |   |     |
| 550 i  | 270    | 07.05 | 02.10 |  |   |                |        |   |   |   |     |
| M5     | 373    | 09.04 | 02.10 |  |   |                |        |   |   |   |     |
| 525 xd | 145    | 03.07 | 02.10 |  | 83.7751-0495.3                            | 331104         | 2      |   | L=495   |   |     |
| 525 xi | 160    | 03.07 | 02.10 |  |   |                |        |   |   |   |     |
| 530 xd | 173    | 03.07 | 02.10 |  |   |                |        |   |   |   |     |
| 530 xi | 200    | 03.07 | 02.10 |  |   |                |        |   |   |   |     |
|        | 520 d  |       | 07.05 | 02.10                                      |   | 11.9426-9977.2 | 220897 | 2 |   | D=42, - Halter<br>D=42, - Halter<br>Dichtungssatz<br>Hülsensatz<br>Führungsbolzen<br>Haltefeder                   | ATE |
|        | 520 d  | 130   | 09.07 | 02.10                                      |   | 24.3426-9977.5 | 240567 |   |   |   | ATE |
|        | 520 i  |       | 07.03 | 03.05                                      |   | 11.0441-4203.2 | 250013 |   |   |   | ATE |
|        | 523 i  | 130   | 07.05 | 03.07                                      |   | 11.0101-5402.2 | 260009 |   |   |   | ATE |
|        | 523 i  | 140   | 03.07 | 02.10                                      |   | 11.8171-0008.1 | 990049 |   |   |   | ATE |
|        | 525 d  |       | 10.03 | 03.07                                      |   | 11.8116-0330.1 | 390472 |   |   |   | ATE |
|        | 525 d  | 145   | 03.07 | 02.10                                      | - Behörde <sup>7)</sup>                   |                |        |   |   |   |     |
|        | 525 i  | 141   | 07.03 | 06.05                                      |   |                |        |   |   |   |     |
|        | 525 i  | 160   | 03.07 | 02.10                                      | - Behörde/ + Motorcode N53 <sup>8)</sup>  |                |        |   |   |   |     |
|        | 525 i  | 160   | 03.07 | 02.10                                      | + Motorcode N52N <sup>9)</sup>            |                |        |   |   |   |     |
|        | 525 i  | 160   | 07.05 | 03.07                                      |   |                |        |   |   |   |     |
|        | 525 xd | 145   | 03.07 | 02.10                                      |   |                |        |   |   |   |     |
|        | 525 xi | 160   | 07.05 | 02.10                                      |   |                |        |   |   |   |     |
|        | 530 d  | 160   | 07.03 | 08.05                                      | - Behörde <sup>7)</sup>                   |                |        |   |   |   |     |
|        | 530 d  | 170   | 07.03 | 03.07                                      | - Behörde <sup>7)</sup>                   |                |        |   |   |   |     |
|        | 530 d  | 173   | 03.07 | 02.10                                      | - Behörde <sup>7)</sup>                   |                |        |   |   |   |     |
|        | 530 i  | 170   | 07.03 | 03.05                                      |   |                |        |   |   |   |     |
|        | 530 i  | 190   | 07.05 | 03.07                                      | - Behörde <sup>7)</sup>                   |                |        |   |   |   |     |
| 530 i  | 200    | 01.07 | 02.10 | - Behörde/ + Motorcode N52N <sup>10)</sup> |   |                |        |   |   |   |     |
| 530 xd | 170    | 07.05 | 03.07 |  |   |                |        |   |   |   |     |
| 530 xd | 173    | 03.07 | 02.10 |  |   |                |        |   |   |   |     |
| 530 xi | 190    | 07.05 | 03.07 |  |   |                |        |   |   |   |     |
| 530 xi | 200    | 03.07 | 02.10 |  |   |                |        |   |   |   |     |
| 525 d  | 145    | 03.07 | 02.10 | + Behörde <sup>1)</sup>                    | 11.0441-4203.2                            | 250013         | 2      |   | Dichtungssatz<br>Haltersatz<br>Hülsensatz<br>Führungsbolzen<br>Haltefeder | ATE   |     |
| 525 i  | 160    | 03.07 | 02.10 | + Behörde/ + Motorcode N53 <sup>2)</sup>   | 11.0230-0176.2                            | 260088         |        |   |   | ATE   |     |
| 530 d  | 160    | 07.03 | 08.05 | + Behörde <sup>1)</sup>                    | 11.0101-5402.2                            | 260009         |        |   |   | ATE   |     |
| 530 d  | 170    | 07.03 | 03.07 | + Behörde <sup>1)</sup>                    | 11.8171-0008.1                            | 990049         |        |   |   | ATE   |     |
| 530 d  | 173    | 03.07 | 02.10 | + Behörde <sup>1)</sup>                    | 11.8116-0296.1                            | 390445         |        |   |   | ATE   |     |
| 530 i  | 190    | 07.05 | 03.07 | + Behörde <sup>1)</sup>                    |   |                |        |   |   |   |     |
| 530 i  | 200    | 01.07 | 02.10 | + Motorcode N53 <sup>3)</sup>              |   |                |        |   |   |   |     |
| 530 i  | 200    | 01.07 | 02.10 | + Behörde/ + Motorcode N52N <sup>4)</sup>  |   |                |        |   |   |   |     |
| 535 d  | 200    | 09.04 | 03.07 |  |   |                |        |   |   |   |     |
| 540 i  | 225    | 03.07 | 02.10 |  |   |                |        |   |   |   |     |
| 545 i  | 245    | 07.03 | 08.05 |  |   |                |        |   |   |   |     |
| 540 i  | 225    | 07.05 | 03.07 |  | 11.0101-5402.2                            | 260009         | 2      |   | Hülsensatz<br>Führungsbolzen<br>Haltefeder                                | ATE   |     |
|        |        |       |       |  | 11.8171-0008.1                            | 990049         |        |   |   | ATE   |     |
|        |        |       |       |  | 11.8116-0296.1                            | 390445         |        |   |   | ATE   |     |

<sup>1)</sup> + authority cars / + enti statali / + véhicule communal / + vehiculos oficiales

<sup>2)</sup> + authority cars/+engine no.N53 / + enti statali/+codice mot.N53 / + véhicule communal/+moteur co.N53 / + vehiculos oficiales/+motor co.N53

<sup>3)</sup> + engine code N53 / + codice motore N53 / + moteur code N53 / + motor code N53

<sup>4)</sup> + authority cars/+engine no.N52N / + enti statali/+codice mot.N52N / + véhicule communal/+moteur co.N52N / + vehiculos oficiales/+motor co.N52N

<sup>5)</sup> - increased payload / - carico utile maggiorato / - charge utile augmentée / - incremento de carga

<sup>6)</sup> + increased payload / + carico utile maggiorato / + charge utile augmentée / + incremento de carga













<sup>7)</sup> - authority cars / - enti statali / - véhicule communal / - vehiculos oficiales

<sup>8)</sup> - authority cars/+engine co.N53 / - enti statali/+codice mot.N53 / - véhicule communal/+moteur co.N53 / - vehiculos oficiales/+motor co.N53

<sup>9)</sup> + engine code N52N / + codice motore N52N / + moteur code N52N / + motor code N52N

<sup>10)</sup> - authority cars/+engine co. N52N / - enti statali/+codice mot.N52N / - véhicule communal/+moteur co.N52N / - vehiculos oficiales/+motor co.N52N



|     |  |  |  |  |  |  |  |  |   |                          |
|--|--|--|--|--|---|--|--|--|---|--------------------------|
| <b>BMW 5er Reihe/E60 Limousine (03-10)</b>   |  |  |  |  |   |  |  |  |   |                          |
|    | 550 i  | 270  |  | 07.05  | 02.10   |  |  |  | Haltersatz<br>Hülensatz<br>Führungsbolzen<br>Haltefeder | ATE<br>ATE<br>ATE<br>ATE |
|  | M5   | 373  |  | 09.04  | 02.10   |  |  |  | Hülensatz<br>Führungsbolzen<br>Haltefeder               | ATE<br>ATE<br>ATE        |
|    | 520 d  |  |  | 07.05  | 02.10   |  |  |  | L=300   |                          |
|  | 520 d  | 130  |  | 09.07  | 02.10   |  |  |  |   |                          |
|  | 520 i  |  |  | 07.03  | 03.05   |  |  |  |   |                          |
|  | 523 i  | 130  |  | 07.05  | 03.07   |  |  |  |   |                          |
|  | 523 i  | 140  |  | 03.07  | 02.10   |  |  |  |   |                          |
|  | 525 d  |  |  | 10.03  | 03.07   |  |  |  |   |                          |
|  | 525 d  | 145  |  | 03.07  | 02.10   |  |  |  |   |                          |
|  | 525 i  | 141  |  | 07.03  | 06.05   |  |  |  |   |                          |
|  | 525 i  | 160  |  | 07.05  | 02.10   |  |  |  |   |                          |
|  | 525 xd   | 145  |  | 03.07  | 02.10   |  |  |  |   |                          |
|  | 525 xi   | 160  |  | 07.05  | 02.10   |  |  |  |   |                          |
|  | 530 d  | 160  |  | 07.03  | 08.05   |  |  |  |   |                          |
|  | 530 d  | 170  |  | 07.03  | 03.07   |  |  |  |   |                          |
|  | 530 d  | 173  |  | 03.07  | 02.10   |  |  |  |   |                          |
|  | 530 i  | 170  |  | 07.03  | 03.05   |  |  |  |   |                          |
|  | 530 i  | 190  |  | 07.05  | 03.07   |  |  |  |   |                          |
|  | 530 i  | 200  |  | 01.07  | 02.10   |  |  |  |   |                          |
|  | 530 xd   | 170  |  | 07.05  | 03.07   |  |  |  |   |                          |
|  | 530 xd   | 173  |  | 03.07  | 02.10   |  |  |  |   |                          |
|  | 530 xi   | 190  |  | 07.05  | 03.07   |  |  |  |   |                          |
|  | 530 xi   | 200  |  | 03.07  | 02.10   |  |  |  |   |                          |
|  | 535 d  | 200  |  | 09.04  | 03.07   |  |  |  |   |                          |
|  | 535 d  | 210  |  | 03.07  | 02.10   |  |  |  |   |                          |
|  | 540 i  | 225  |  | 07.05  | 02.10   |  |  |  |   |                          |
| 545 i  | 245  |  | 07.03  | 08.05  |   |  |  |  |   |                          |
| 550 i  | 270  |  | 07.05  | 02.10  |   |  |  |  |   |                          |
| M5   | 373  |  | 09.04  | 02.10  |   |  |  |  |   |                          |
|    | 520 d  |  |  | 07.05  | 02.10   |  |  |  | L=1681<br>L=1673  |                          |
|  | 520 d  | 130  |  | 09.07  | 02.10   |  |  |  |   |                          |
|  | 520 i  |  |  | 07.03  | 03.05   |  |  |  |   |                          |
|  | 523 i  | 130  |  | 07.05  | 03.07   |  |  |  |   |                          |
|  | 523 i  | 140  |  | 03.07  | 02.10   |  |  |  |   |                          |
|  | 525 d  |  |  | 10.03  | 03.07   |  |  |  |   |                          |
|  | 525 d  | 145  |  | 03.07  | 02.10   |  |  |  |   |                          |
|  | 525 i  | 141  |  | 07.03  | 06.05   |  |  |  |   |                          |
|  | 525 i  | 160  |  | 07.05  | 02.10   |  |  |  |   |                          |
|  | 525 xd   | 145  |  | 03.07  | 02.10   |  |  |  |   |                          |
|  | 525 xi   | 160  |  | 07.05  | 02.10   |  |  |  |   |                          |
|  | 530 d  | 160  |  | 07.03  | 08.05   |  |  |  |   |                          |
|  | 530 d  | 170  |  | 07.03  | 03.07   |  |  |  |   |                          |
|  | 530 d  | 173  |  | 03.07  | 02.10   |  |  |  |   |                          |
|  | 530 i  | 170  |  | 07.03  | 03.05   |  |  |  |   |                          |
|  | 530 i  | 190  |  | 07.05  | 03.07   |  |  |  |   |                          |
|  | 530 i  | 200  |  | 01.07  | 02.10   |  |  |  |   |                          |
|  | 530 xd   | 170  |  | 07.05  | 03.07   |  |  |  |   |                          |
|  | 530 xd   | 173  |  | 03.07  | 02.10   |  |  |  |   |                          |
|  | 530 xi   | 190  |  | 07.05  | 03.07   |  |  |  |   |                          |
|  | 530 xi   | 200  |  | 03.07  | 02.10   |  |  |  |   |                          |
|  | 535 d  | 200  |  | 09.04  | 03.07   |  |  |  |   |                          |
|  | 535 d  | 210  |  | 03.07  | 02.10   |  |  |  |   |                          |
|  | 540 i  | 225  |  | 07.05  | 02.10   |  |  |  |   |                          |
| 545 i  | 245  |  | 07.03  | 08.05  |   |  |  |  |   |                          |
| 550 i  | 270  |  | 07.05  | 02.10  |   |  |  |  |   |                          |
| M5   | 373  |  | 09.04  | 02.10  |   |  |  |  |   |                          |
|  | 520 d  |  |  | 07.05  | 02.10   |  |  |  | Nz 22,20  |                          |
|  | 520 i  |  |  | 07.03  | 03.05   |  |  |  |   |                          |
|  | 523 i  | 130  |  | 07.05  | 03.07   |  |  |  |   |                          |
|  | 523 i  | 140  |  | 03.07  | 02.10   |  |  |  |   |                          |
|  | 525 d  |  |  | 10.03  | 03.07   |  |  |  |   |                          |
|  | 525 d  | 145  |  | 03.07  | 02.10   |  |  |  |   |                          |
|  | 525 i  | 141  |  | 07.03  | 06.05   |  |  |  |   |                          |
|  | 525 i  | 160  |  | 07.05  | 02.10   |  |  |  |   |                          |
|  | 525 xi   | 160  |  | 07.05  | 02.10   |  |  |  |   |                          |
|  | 530 d  | 160  |  | 07.03  | 08.05   |  |  |  |   |                          |
|  | 530 d  | 170  |  | 07.03  | 03.07   |  |  |  |   |                          |
|  | 530 d  | 173  |  | 03.07  | 02.10   |  |  |  |   |                          |
|  | 530 i  | 170  |  | 07.03  | 03.05   |  |  |  |   |                          |
|  | 530 i  | 190  |  | 07.05  | 03.07   |  |  |  |   |                          |
|  | 530 i  | 200  |  | 01.07  | 02.10   |  |  |  |   |                          |
|  | 530 xd   | 170  |  | 07.05  | 03.07   |  |  |  |   |                          |
|  | 530 xd   | 173  |  | 03.07  | 02.10   |  |  |  |   |                          |
|  | 530 xi   | 190  |  | 07.05  | 03.07   |  |  |  |   |                          |
|  | 530 xi   | 200  |  | 03.07  | 02.10   |  |  |  |   |                          |
|  | 540 i  | 225  |  | 07.05  | 02.10   |  |  |  |   |                          |
|  | 545 i  | 245  |  | 07.03  | 08.05   |  |  |  |   |                          |
|  | 550 i  | 270  |  | 07.05  | 02.10   |  |  |  |   |                          |



| BMW 5er Reihe/E61 Touring (04-10) |        |     |  |       |       |                |        |   |  |                 |     |
|-----------------------------------|--------|-----|--|-------|-------|----------------|--------|---|--|-----------------|-----|
|                                   | 523 i  | 130 |  | 07.05 | 03.07 | 24.2025-1710.3 | 010833 |   |  | THz 25,40/22,20 | LUC |
|                                   | 525 i  | 141 |  | 05.04 | 03.05 |                |        |   |  |                 |     |
|                                   | 525 i  | 160 |  | 07.05 | 03.07 |                |        |   |  |                 |     |
|                                   | 530 i  | 190 |  | 07.05 | 03.07 |                |        |   |  |                 |     |
|                                   | 520 d  | 110 |  | 09.05 | 05.10 | 24.2026-1702.3 | 010850 |   |  | THz 26,99/22,20 | LUC |
|                                   | 520 d  | 120 |  | 07.05 | 05.10 |                |        |   |  |                 |     |
|                                   | 520 d  | 130 |  | 09.07 | 05.10 |                |        |   |  |                 |     |
|                                   | 520 i  | 125 |  | 06.04 | 05.10 |                |        |   |  |                 |     |
|                                   | 523 i  | 140 |  | 03.07 | 05.10 |                |        |   |  |                 |     |
|                                   | 525 d  | 120 |  | 12.04 | 05.10 |                |        |   |  |                 |     |
|                                   | 525 d  | 130 |  | 05.04 | 03.07 |                |        |   |  |                 |     |
|                                   | 525 d  | 145 |  | 03.07 | 05.10 |                |        |   |  |                 |     |
|                                   | 525 i  | 160 |  | 03.07 | 05.10 |                |        |   |  |                 |     |
|                                   | 525 xd | 145 |  | 03.07 | 05.10 |                |        |   |  |                 |     |
|                                   | 525 xi | 160 |  | 07.05 | 05.10 |                |        |   |  |                 |     |
|                                   | 530 d  | 160 |  | 05.04 | 08.05 |                |        |   |  |                 |     |
|                                   | 530 d  | 170 |  | 07.05 | 03.07 |                |        |   |  |                 |     |
|                                   | 530 d  | 173 |  | 03.07 | 05.10 |                |        |   |  |                 |     |
|                                   | 530 i  | 200 |  | 03.07 | 05.10 |                |        |   |  |                 |     |
|                                   | 530 xd | 170 |  | 07.05 | 03.07 |                |        |   |  |                 |     |
|                                   | 530 xd | 173 |  | 03.07 | 05.10 |                |        |   |  |                 |     |
|                                   | 530 xi | 190 |  | 07.05 | 03.07 |                |        |   |  |                 |     |
|                                   | 530 xi | 200 |  | 03.07 | 05.10 |                |        |   |  |                 |     |
|                                   | 535 d  | 200 |  | 09.04 | 03.07 |                |        |   |  |                 |     |
|                                   | 535 d  | 210 |  | 03.07 | 05.10 |                |        |   |  |                 |     |
|                                   | 545 i  | 245 |  | 05.04 | 08.05 |                |        |   |  |                 |     |
|                                   | 550 i  | 270 |  | 07.05 | 05.10 |                |        |   |  |                 |     |
|                                   | M5     | 373 |  | 02.07 | 05.10 |                |        |   |  |                 |     |
|                                   | 520 d  | 110 |  | 09.05 | 05.10 | 11.9606-9967.2 | 220905 |   |  | D=60, - Halter  | ATE |
|                                   | 520 d  | 120 |  | 07.05 | 05.10 | 11.9606-9968.2 | 220906 |   |  | D=60, - Halter  | ATE |
|                                   | 520 i  | 125 |  | 06.04 | 05.10 | 24.3606-9967.5 | 240571 |   |  | D=60, - Halter  | ATE |
|                                   | 523 i  | 130 |  | 07.05 | 03.07 | 24.3606-9968.5 | 240572 |   |  | D=60, - Halter  | ATE |
|                                   | 523 i  | 140 |  | 03.07 | 05.10 | 11.0441-6008.2 | 250038 |   |  | Dichtungssatz   | ATE |
|                                   | 525 d  | 120 |  | 12.04 | 05.10 | 11.0101-5402.2 | 260009 |   |  | Hülssensatz     | ATE |
|                                   | 525 d  | 130 |  | 05.04 | 03.07 | 11.8171-0008.1 | 990049 |   |  | Führungsbolzen  | ATE |
|                                   | 525 i  | 141 |  | 05.04 | 03.05 | 11.8116-0339.2 | 390528 | 2 |  | Haltefeder      | ATE |
|                                   | 525 i  | 160 |  | 03.07 | 05.10 |                |        |   |  |                 |     |
|                                   | 520 d  | 110 |  | 09.05 | 05.10 | 11.9606-9979.2 | 220907 |   |  | D=60, - Halter  | ATE |
|                                   | 520 d  | 120 |  | 07.05 | 05.10 | 11.9606-9980.2 | 220908 |   |  | D=60, - Halter  | ATE |
|                                   | 520 d  | 130 |  | 09.07 | 05.10 | 24.3606-9979.5 | 240575 |   |  | D=60, - Halter  | ATE |
|                                   | 520 i  | 125 |  | 06.04 | 05.10 | 24.3606-9980.5 | 240576 |   |  | D=60, - Halter  | ATE |
|                                   | 523 i  | 130 |  | 07.05 | 03.07 | 11.0441-6008.2 | 250038 |   |  | Dichtungssatz   | ATE |
|                                   | 523 i  | 140 |  | 03.07 | 05.10 | 11.0101-6006.2 | 260098 |   |  | Hülssensatz     | ATE |
|                                   | 523 i  | 140 |  | 03.07 | 05.10 | 11.8171-0008.1 | 990049 |   |  | Führungsbolzen  | ATE |
|                                   | 525 d  | 120 |  | 12.04 | 05.10 | 11.8116-0315.2 | 390447 | 2 |  | Haltefeder      | ATE |
|                                   | 525 d  | 130 |  | 05.04 | 03.07 |                |        |   |  |                 |     |
|                                   | 525 d  | 145 |  | 03.07 | 05.10 |                |        |   |  |                 |     |
|                                   | 525 i  | 141 |  | 05.04 | 03.05 |                |        |   |  |                 |     |
|                                   | 525 i  | 160 |  | 03.07 | 05.10 |                |        |   |  |                 |     |
|                                   | 525 i  | 160 |  | 03.07 | 05.10 |                |        |   |  |                 |     |
|                                   | 525 i  | 160 |  | 07.05 | 03.07 |                |        |   |  |                 |     |
|                                   | 530 d  | 160 |  | 05.04 | 08.05 |                |        |   |  |                 |     |
|                                   | 530 d  | 170 |  | 07.05 | 03.07 |                |        |   |  |                 |     |
|                                   | 530 d  | 173 |  | 03.07 | 05.10 |                |        |   |  |                 |     |
|                                   | 530 i  | 190 |  | 07.05 | 03.07 |                |        |   |  |                 |     |
|                                   | 530 i  | 200 |  | 03.07 | 05.10 |                |        |   |  |                 |     |
|                                   | 525 d  | 145 |  | 03.07 | 05.10 | 24.3606-9977.5 | 240573 |   |  | D=60, - Halter  | ATE |
|                                   | 525 i  | 160 |  | 03.07 | 05.10 | 24.3606-9978.5 | 240574 |   |  | D=60, - Halter  | ATE |
|                                   | 530 d  | 160 |  | 05.04 | 08.05 | 11.0441-6008.2 | 250038 |   |  | Dichtungssatz   | ATE |
|                                   | 530 d  | 170 |  | 07.05 | 03.07 | 11.0101-6006.2 | 260098 |   |  | Hülssensatz     | ATE |
|                                   | 530 d  | 173 |  | 03.07 | 05.10 | 11.8171-0008.1 | 990049 |   |  | Führungsbolzen  | ATE |
|                                   | 530 i  | 200 |  | 03.07 | 05.10 | 11.8171-0067.1 | 250153 |   |  | Führungsbolzen  | ATE |
|                                   | 530 i  | 200 |  | 03.07 | 05.10 | 11.8116-0315.2 | 390447 | 2 |  | Haltefeder      | ATE |
|                                   | 545 i  | 245 |  | 05.04 | 08.05 |                |        |   |  |                 |     |
|                                   | 550 i  | 270 |  | 03.07 | 05.10 |                |        |   |  |                 |     |
|                                   | 525 xd | 145 |  | 03.07 | 05.10 | 11.9606-9955.2 | 220919 |   |  | D=60, - Halter  | ATE |
|                                   | 525 xi | 160 |  | 07.05 | 05.10 | 11.9606-9956.2 | 220920 |   |  | D=60, - Halter  | ATE |
|                                   | 530 xd | 170 |  | 07.05 | 03.07 | 24.3606-9955.5 | 240577 |   |  | D=60, - Halter  | ATE |
|                                   | 530 xd | 173 |  | 03.07 | 05.10 | 24.3606-9956.5 | 240578 |   |  | D=60, - Halter  | ATE |
|                                   | 530 xi | 190 |  | 07.05 | 03.07 | 11.0441-6008.2 | 250038 |   |  | Dichtungssatz   | ATE |
|                                   | 530 xi | 200 |  | 07.05 | 03.07 | 11.0101-6006.2 | 260098 |   |  | Hülssensatz     | ATE |
|                                   | 530 xi | 200 |  | 03.07 | 05.10 | 11.8171-0008.1 | 990049 |   |  | Führungsbolzen  | ATE |
|                                   |        |     |  |       |       | 11.8171-0067.1 | 250153 |   |  | Führungsbolzen  | ATE |
|                                   |        |     |  |       |       | 11.8116-0315.2 | 390447 | 2 |  | Haltefeder      | ATE |
|                                   | 535 d  | 200 |  | 09.04 | 03.07 | 11.0101-5706.2 | 260097 |   |  | Hülssensatz     | ATE |
|                                   | 535 d  | 210 |  | 03.07 | 05.10 | 11.8171-0067.1 | 250153 |   |  | Führungsbolzen  | ATE |
|                                   | 550 i  | 270 |  | 03.07 | 05.10 | 11.8116-0353.2 | 390585 | 2 |  | Haltefeder      | ATE |
|                                   | 550 i  | 270 |  | 07.05 | 03.07 |                |        |   |  |                 |     |
|                                   | M5     | 373 |  | 02.07 | 05.10 | 11.0101-5706.2 | 260097 |   |  | Hülssensatz     | ATE |
|                                   |        |     |  |       |       | 11.8171-0067.1 | 250153 |   |  | Führungsbolzen  | ATE |
|                                   |        |     |  |       |       | 11.8116-0353.2 | 390585 | 2 |  | Haltefeder      | ATE |
|                                   | 520 d  | 110 |  | 09.05 | 05.10 | 83.6151-0552.3 | 330857 | 2 |  | L=550           |     |
|                                   | 520 d  | 120 |  | 07.05 | 05.10 |                |        |   |  |                 |     |
|                                   | 520 d  | 130 |  | 09.07 | 05.10 |                |        |   |  |                 |     |
|                                   | 520 i  | 125 |  | 06.04 | 05.10 |                |        |   |  |                 |     |
|                                   | 523 i  | 130 |  | 07.05 | 03.07 |                |        |   |  |                 |     |
|                                   | 523 i  | 140 |  | 03.07 | 05.10 |                |        |   |  |                 |     |

1) - authority cars / - enti statali / - véhicule communal / - vehiculos oficiales  
2) - authority cars/+engine co.N52N / - enti statali/+codice mot.N52N / - véhicule communal/+moteur co.N52N / - vehiculos oficiales/+motor co.N52N  
3) + authority cars / + enti statali / + véhicule communal / + vehiculos oficiales  
4) + engine code N53 / + codice motore N53 / + moteur code N53 / + motor code N53  
5) + authority cars/+engine no.N52N / + enti statali/+codice mot.N52N / + véhicule communal/+moteur co.N52N / + vehiculos oficiales/+motor co.N52N  
6) - authority cars/+engine co.N53 / - enti statali/+codice mot.N53 / - véhicule communal/+moteur co.N53 / - vehiculos oficiales/+motor co.N53

7) + authority cars/+engine no.N53 / + enti statali/+codice mot.N53 / + véhicule communal/+moteur co.N53 / + vehiculos oficiales/+motor co.N53

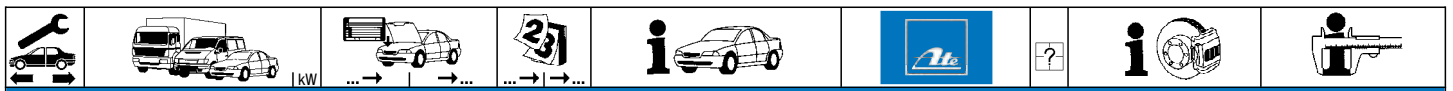

**BMW 5er Reihe/E61 Touring (04-10)**

|        |        |        |       |       |       |                |                |        |                              |               |                |       |                |        |   |  |            |     |
|--------|--------|--------|-------|-------|-------|----------------|----------------|--------|------------------------------|---------------|----------------|-------|----------------|--------|---|--|------------|-----|
|        | 525 d  | 120    |       | 12.04 | 05.10 | 83.6151-0552.3 | 330857         | 2      |                              | L=550         |                |       |                |        |   |  |            |     |
|        | 525 d  | 130    |       | 05.04 | 03.07 |                |                |        |                              |               |                |       |                |        |   |  |            |     |
|        | 525 d  | 145    |       | 03.07 | 05.10 |                |                |        |                              |               |                |       |                |        |   |  |            |     |
|        | 525 i  | 141    |       | 05.04 | 03.05 |                |                |        |                              |               |                |       |                |        |   |  |            |     |
|        | 525 i  | 160    |       | 07.05 | 05.10 |                |                |        |                              |               |                |       |                |        |   |  |            |     |
|        | 530 d  | 160    |       | 05.04 | 08.05 |                |                |        |                              |               |                |       |                |        |   |  |            |     |
|        | 530 d  | 170    |       | 07.05 | 03.07 |                |                |        |                              |               |                |       |                |        |   |  |            |     |
|        | 530 d  | 173    |       | 03.07 | 05.10 |                |                |        |                              |               |                |       |                |        |   |  |            |     |
|        | 530 i  | 190    |       | 07.05 | 03.07 |                |                |        |                              |               |                |       |                |        |   |  |            |     |
|        | 530 i  | 200    |       | 03.07 | 05.10 |                |                |        |                              |               |                |       |                |        |   |  |            |     |
|        | 535 d  | 200    |       | 09.04 | 03.07 |                |                |        |                              |               |                |       |                |        |   |  |            |     |
|        | 535 d  | 210    |       | 03.07 | 05.10 |                |                |        |                              |               |                |       |                |        |   |  |            |     |
|        | 545 i  | 245    |       | 05.04 | 08.05 |                |                |        |                              |               |                |       |                |        |   |  |            |     |
|        | 550 i  | 270    |       | 07.05 | 05.10 |                |                |        |                              |               |                |       |                |        |   |  |            |     |
|        | M5     | 373    |       | 02.07 | 05.10 |                |                |        |                              |               |                |       |                |        |   |  |            |     |
|        |        | 525 xd | 145   |       | 03.07 |                |                |        |                              |               |                | 05.10 | 83.7751-0495.3 | 331104 | 2 |  | L=495      |     |
| 525 xi |        | 160    |       | 07.05 | 05.10 |                |                |        |                              |               |                |       |                |        |   |  |            |     |
| 530 xd |        | 170    |       | 07.05 | 03.07 |                |                |        |                              |               |                |       |                |        |   |  |            |     |
| 530 xd |        | 173    |       | 03.07 | 05.10 |                |                |        |                              |               |                |       |                |        |   |  |            |     |
| 530 xi |        | 190    |       | 07.05 | 03.07 |                |                |        |                              |               |                |       |                |        |   |  |            |     |
| 530 xi |        | 200    |       | 03.07 | 05.10 |                |                |        |                              |               |                |       |                |        |   |  |            |     |
|        |        | 520 d  | 110   |       | 09.05 | 05.10          | 11.9426-9957.2 | 220895 | 2                            |               | D=42, - Halter | ATE   |                |        |   |  |            |     |
|        |        | 520 d  | 120   |       | 07.05 | 05.10          |                |        |                              |               |                |       |                |        |   |  |            |     |
|        |        | 520 d  | 130   |       | 09.07 | 05.10          |                |        |                              |               |                |       |                |        |   |  |            |     |
|        |        | 520 i  | 125   |       | 06.04 | 05.10          |                |        |                              |               |                |       |                |        |   |  |            |     |
|        | 523 i  | 130    |       | 07.05 | 03.07 |                |                |        |                              |               |                |       |                |        |   |  |            |     |
|        | 523 i  | 140    |       | 03.07 | 05.10 |                |                |        |                              |               |                |       |                |        |   |  |            |     |
|        | 525 d  | 120    |       | 12.04 | 05.10 |                |                |        |                              |               |                |       |                |        |   |  |            |     |
|        | 525 d  | 130    |       | 05.04 | 03.07 |                |                |        |                              |               |                |       |                |        |   |  |            |     |
|        | 525 d  | 145    |       | 03.07 | 05.10 |                |                |        |                              |               |                |       |                |        |   |  |            |     |
|        | 525 i  | 141    |       | 05.04 | 03.05 |                |                |        |                              |               |                |       |                |        |   |  |            |     |
|        | 525 i  | 160    |       | 03.07 | 05.10 |                |                |        |                              |               |                |       |                |        |   |  |            |     |
|        | 525 i  | 160    |       | 03.07 | 05.10 |                |                |        |                              |               |                |       |                |        |   |  |            |     |
|        | 525 i  | 160    |       | 07.05 | 03.07 |                |                |        |                              |               |                |       |                |        |   |  |            |     |
|        | 525 xd | 145    |       | 03.07 | 05.10 |                |                |        |                              |               |                |       |                |        |   |  |            |     |
|        | 525 xi | 160    |       | 07.05 | 05.10 |                |                |        |                              |               |                |       |                |        |   |  |            |     |
|        | 530 d  | 160    |       | 05.04 | 08.05 |                |                |        |                              |               |                |       |                |        |   |  |            |     |
|        | 530 d  | 170    |       | 07.05 | 03.07 |                |                |        |                              |               |                |       |                |        |   |  |            |     |
|        | 530 d  | 173    |       | 03.07 | 05.10 |                |                |        |                              |               |                |       |                |        |   |  |            |     |
|        | 530 i  | 190    |       | 07.05 | 03.07 |                |                |        |                              |               |                |       |                |        |   |  |            |     |
|        | 530 i  | 200    |       | 03.07 | 05.10 |                |                |        |                              |               |                |       |                |        |   |  |            |     |
|        | 530 xd | 170    |       | 07.05 | 03.07 |                |                |        |                              |               |                |       |                |        |   |  |            |     |
|        | 530 xd | 173    |       | 03.07 | 05.10 |                |                |        |                              |               |                |       |                |        |   |  |            |     |
|        | 530 xi | 190    |       | 07.05 | 03.07 |                |                |        |                              |               |                |       |                |        |   |  |            |     |
|        | 530 xi | 200    |       | 03.07 | 05.10 |                |                |        |                              |               |                |       |                |        |   |  |            |     |
|        | 525 d  | 145    |       | 03.07 | 05.10 | 11.0441-4203.2 | 250013         | 2      |                              | Dichtungssatz | ATE            |       |                |        |   |  |            |     |
|        | 525 i  | 160    |       | 03.07 | 05.10 |                |                |        |                              |               |                |       |                |        |   |  |            |     |
|        | 530 d  | 160    |       | 05.04 | 08.05 |                |                |        |                              |               |                |       |                |        |   |  |            |     |
|        | 530 d  | 170    |       | 07.05 | 03.07 |                |                |        |                              |               |                |       |                |        |   |  |            |     |
|        | 530 i  | 200    |       | 03.07 | 05.10 |                |                |        |                              |               |                |       |                |        |   |  |            |     |
|        | 530 i  | 200    |       | 03.07 | 05.10 |                |                |        |                              |               |                |       |                |        |   |  |            |     |
|        | 535 d  | 200    |       | 09.04 | 03.07 |                |                |        |                              |               |                |       |                |        |   |  |            |     |
|        | 545 i  | 245    |       | 05.04 | 08.05 |                |                |        |                              |               |                |       |                |        |   |  |            |     |
|        |        | 530 d  | 173   |       | 03.07 |                |                |        |                              |               |                | 05.10 | 11.0230-0176.2 | 260088 | 2 |  | Haltersatz | ATE |
|        |        | 535 d  | 210   |       | 03.07 |                |                |        |                              |               |                | 05.10 |                |        |   |  |            |     |
| 550 i  |        | 270    |       | 07.05 | 05.10 |                |                |        |                              |               |                |       |                |        |   |  |            |     |
| M5     |        | 373    |       | 02.07 | 05.10 |                |                |        |                              |               |                |       |                |        |   |  |            |     |
|        | 520 d  | 110    |       | 09.05 | 05.10 | 83.6104-0315.3 | 330889         | 2      | am Bremssattel <sup>9)</sup> | L=315         |                |       |                |        |   |  |            |     |
|        | 520 d  | 120    |       | 07.05 | 03.07 |                |                |        |                              |               |                |       |                |        |   |  |            |     |
|        | 520 d  | 130    |       | 09.07 | 05.10 |                |                |        |                              |               |                |       |                |        |   |  |            |     |
|        | 520 i  | 125    |       | 06.04 | 05.10 |                |                |        |                              |               |                |       |                |        |   |  |            |     |
|        | 523 i  | 130    |       | 07.05 | 03.07 |                |                |        |                              |               |                |       |                |        |   |  |            |     |
|        | 525 d  | 120    |       | 12.04 | 05.10 |                |                |        |                              |               |                |       |                |        |   |  |            |     |
|        | 525 d  | 130    |       | 05.04 | 03.07 |                |                |        |                              |               |                |       |                |        |   |  |            |     |
|        | 525 i  | 141    |       | 05.04 | 03.05 |                |                |        |                              |               |                |       |                |        |   |  |            |     |
|        | 525 i  | 160    |       | 07.05 | 03.07 |                |                |        |                              |               |                |       |                |        |   |  |            |     |
|        | 525 xi | 160    |       | 07.05 | 03.07 |                |                |        |                              |               |                |       |                |        |   |  |            |     |
|        | 530 d  | 160    |       | 05.04 | 08.05 |                |                |        |                              |               |                |       |                |        |   |  |            |     |
|        | 530 d  | 170    |       | 07.05 | 03.07 |                |                |        |                              |               |                |       |                |        |   |  |            |     |
|        | 530 i  | 190    |       | 07.05 | 03.07 |                |                |        |                              |               |                |       |                |        |   |  |            |     |
|        | 530 xd | 170    |       | 07.05 | 03.07 |                |                |        |                              |               |                |       |                |        |   |  |            |     |
|        | 530 xi | 190    |       | 07.05 | 03.07 |                |                |        |                              |               |                |       |                |        |   |  |            |     |
|        | 535 d  | 200    |       | 09.04 | 03.07 |                |                |        |                              |               |                |       |                |        |   |  |            |     |
| 535 d  | 210    |        | 03.07 | 05.10 |       |                |                |        |                              |               |                |       |                |        |   |  |            |     |
| 545 i  | 245    |        | 05.04 | 08.05 |       |                |                |        |                              |               |                |       |                |        |   |  |            |     |
| 550 i  | 270    |        | 07.05 | 03.07 |       |                |                |        |                              |               |                |       |                |        |   |  |            |     |
| M5     | 373    |        | 02.07 | 05.10 |       |                |                |        |                              |               |                |       |                |        |   |  |            |     |
|        | 520 d  | 110    |       | 09.05 | 05.10 | 83.6124-0303.3 | 330689         | 2      |                              | L=300         |                |       |                |        |   |  |            |     |
|        | 520 d  | 120    |       | 03.07 | 05.10 |                |                |        |                              |               |                |       |                |        |   |  |            |     |
|        | 520 d  | 130    |       | 09.07 | 05.10 |                |                |        |                              |               |                |       |                |        |   |  |            |     |
|        | 520 i  | 125    |       | 06.04 | 05.10 |                |                |        |                              |               |                |       |                |        |   |  |            |     |
|        | 523 i  | 140    |       | 03.07 | 05.10 |                |                |        |                              |               |                |       |                |        |   |  |            |     |
|        | 525 d  | 145    |       | 03.07 | 05.10 |                |                |        |                              |               |                |       |                |        |   |  |            |     |
|        | 525 i  | 160    |       | 03.07 | 05.10 |                |                |        |                              |               |                |       |                |        |   |  |            |     |
|        | M5     | 373    |       | 02.07 | 05.10 |                |                |        |                              |               |                |       |                |        |   |  |            |     |

1) - authority cars / - enti statali / - véhicule communal / - vehiculos oficiales

2) - authority cars/+engine co.N53 / - enti statali/+codice mot.N53 / - véhicule communal/+moteur co.N53 / - vehiculos oficiales/+motor co.N53

3) + engine code N52N / + codice motore N52N / + moteur code N52N / + motor code N52N

4) - authority cars/+engine co. N52N / - enti statali/+codice mot.N52N / - véhicule communal/+moteur co.N52N / - vehiculos oficiales/+motor co.N52N

5) + authority cars / + enti statali / + véhicule communal / + vehiculos oficiales

6) + authority cars/+engine no.N53 / + enti statali/+codice mot.N53 / + véhicule communal/+moteur co.N53 / + vehiculos oficiales/+motor co.N53

7) + engine code N53 / + codice motore N53 / + moteur code N53 / + motor code N53

8) + authority cars/+engine no.N52N / + enti statali/+codice mot.N52N / + véhicule communal/+moteur co.N52N / + vehiculos oficiales/+motor co.N52N

9) on the brake caliper / sulla pinza freno / sur l'étrier de frein / a la pinza de freno



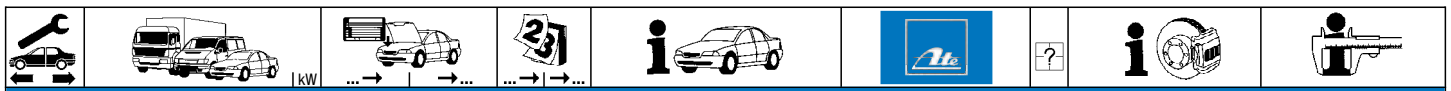













**BMW 5er Reihe/E61 Touring (04-10)**

|  |  |  |  |  |  |                                  |                  |  |  |                  |
|--|--|--|--|--|--|----------------------------------|------------------|--|--|------------------|
|  | 525 xd<br>525 xi<br>530 d<br>530 i<br>530 xd<br>530 xi<br>550 i  | 145<br>160<br>173<br>200<br>173<br>200<br>270  |  | 03.07<br>03.07<br>03.07<br>03.07<br>03.07<br>03.07<br>03.07  | 05.10<br>05.10<br>05.10<br>05.10<br>05.10<br>05.10<br>05.10  | 83.6124-0303.3                   | 330689           | 2  |  | L=300            |
|  | 520 d<br>520 d<br>520 d<br>520 i<br>523 i<br>523 i<br>525 d<br>525 d<br>525 d<br>525 i<br>525 i<br>525 i<br>525 xd<br>525 xi<br>530 d<br>530 d<br>530 d<br>530 i<br>530 i<br>530 i<br>530 xd<br>530 xd<br>530 xi<br>530 xi<br>535 d<br>535 d<br>545 i<br>550 i<br>M5 | 110<br>120<br>130<br>125<br>130<br>140<br>120<br>130<br>145<br>141<br>160<br>145<br>160<br>160<br>160<br>170<br>173<br>190<br>200<br>170<br>173<br>190<br>200<br>200<br>210<br>245<br>270<br>373 |  | 09.05<br>07.05<br>09.07<br>06.04<br>07.05<br>03.07<br>12.04<br>05.04<br>03.07<br>05.04<br>07.05<br>03.07<br>07.05<br>05.04<br>07.05<br>07.05<br>03.07<br>07.05<br>07.05<br>03.07<br>03.07<br>07.05<br>03.07<br>09.04<br>03.07<br>05.04<br>07.05<br>02.07 | 05.10<br>05.10<br>05.10<br>05.10<br>03.07<br>05.10<br>05.10<br>03.07<br>05.10<br>03.05<br>05.10<br>05.10<br>05.10<br>08.05<br>03.07<br>05.10<br>03.07<br>03.07<br>03.07<br>03.07<br>03.07<br>03.07<br>03.07<br>03.07<br>08.05<br>08.05<br>05.10<br>05.10 | 24.3727-0236.2<br>24.3727-0237.2 | 580236<br>580237 | <input type="checkbox"/><br><input type="checkbox"/> |  | L=1681<br>L=1673 |
|  | 520 d<br>520 d<br>520 d<br>520 i<br>523 i<br>523 i<br>525 d<br>525 d<br>525 d<br>525 i<br>525 i<br>525 i<br>525 xi<br>530 d<br>530 d<br>530 d<br>530 i<br>530 i<br>530 i<br>530 xd<br>530 xd<br>530 xi<br>530 xi<br>535 d<br>535 d<br>545 i<br>550 i                 | 110<br>120<br>130<br>125<br>130<br>140<br>120<br>130<br>145<br>141<br>160<br>160<br>160<br>170<br>173<br>190<br>200<br>170<br>173<br>190<br>200<br>200<br>210<br>245<br>270                      |  | 09.05<br>07.05<br>09.07<br>06.04<br>07.05<br>03.07<br>12.04<br>05.04<br>03.07<br>05.04<br>07.05<br>07.05<br>05.04<br>07.05<br>07.05<br>03.07<br>07.05<br>07.05<br>03.07<br>03.07<br>07.05<br>03.07<br>09.04<br>03.07<br>05.04<br>07.05<br>07.05          | 05.10<br>05.10<br>05.10<br>05.10<br>03.07<br>05.10<br>05.10<br>03.07<br>05.10<br>03.05<br>05.10<br>05.10<br>08.05<br>03.07<br>05.10<br>03.07<br>03.07<br>03.07<br>03.07<br>03.07<br>03.07<br>03.07<br>03.07<br>03.07<br>08.05<br>08.05<br>05.10<br>05.10 | 24.2522-0905.3                   | 040042           |  |  | Nz 22,20         |

**BMW 5er Reihe/F10 Limousine (10-)**

|  |   |  |  |  |  |                                  |                  |   |  |                             |            |
|--|---|--|--|--|--|----------------------------------|------------------|---|--|-----------------------------|------------|
|  | 518 d<br>520 d<br>520 d ed<br>520 d xDrive<br>520 i<br>520 i<br>523 i                                       | 105<br>135<br>135<br>135<br>120<br>135<br>150        |  | 01.13<br>03.10<br>09.11<br>02.13<br>09.11<br>09.11<br>03.10                            |  | 11.0441-6008.2<br>11.0101-5402.2 | 250038<br>260009 |   |  | Dichtungssatz<br>Hülsensatz | ATE<br>ATE |
|  | 525 d<br>525 d<br>525 d xDrive<br>528 i<br>528 i<br>528 i xDrive<br>530 d<br>530 d<br>530 d xDrive<br>530 i | 150<br>180<br>190<br>180<br>180<br>190<br>190<br>200 |  | 09.11<br>03.10<br>09.11<br>09.11<br>03.10<br>09.11<br>03.10<br>09.11<br>03.11<br>09.11 |  | 11.0441-6008.2                   | 250038           |   |  | Dichtungssatz               | ATE        |
|  | 535 d<br>535 d<br>535 d xDrive<br>535 i<br>535 i xDrive<br>550 i<br>550 i xDrive                            | 220<br>230<br>230<br>225<br>225<br>300<br>300        |  | 09.10<br>09.11<br>09.11<br>03.10<br>03.11<br>03.10<br>09.10                            |  | 11.8116-0007.2                   | 390602           | 2 |  | Haltefeder                  | ATE        |
|  | 550 i xDrive<br>Active Hybrid 5   | 330<br>250   |  | 05.13<br>09.11   |  | 11.8116-0007.2                   | 390602           | 2 |  | Haltefeder                  | ATE        |



















| BMW 5er Reihe/F10 Limousine (10-)  |   |   |  |  |  |   |  |  |   |
|--|---|---|--|--|--|---|--|--|---|
|    | 550 i 330<br>M550 d xDrive 280  | 05.13<br>03.12  |  | 11.8116-0007.2   | 390602   | 2 |  | Haltefeder   | ATE   |
| BMW 5er Reihe/F11 Touring (10-)  |   |   |  |  |  |   |  |  |   |
|    | 525 d 160<br>525 d xDrive 160<br>530 d 190<br>530 d xDrive 190<br>535 d 220<br>535 d 230<br>535 d xDrive 230<br>535 i 225<br>535 i xDrive 225   | 09.11<br>09.11<br>09.11<br>03.11<br>09.10<br>09.11<br>09.11<br>09.10<br>09.11                                     | + verstärkte Bremse <sup>1)</sup><br>+ verstärkte Bremse <sup>1)</sup><br>+ verstärkte Bremse <sup>1)</sup><br>+ verstärkte Bremse <sup>1)</sup> | 11.8116-0007.2   | 390602   | 2 |  | Haltefeder   | ATE   |
|  | 550 i 300<br>550 i 330<br>M550 d xDrive 280   | 09.11<br>05.13<br>03.12   |  | 11.8116-0007.2   | 390602   | 2 |  | Haltefeder   | ATE   |
| BMW 5er Reihe/F07 GT GRAN TURISMO (09-)  |   |   |  |  |  |   |  |  |   |
|    | 520 d 135<br>530 d<br>530 d xDrive<br>535 d 220<br>535 d 230<br>535 d xDrive 220<br>535 d xDrive 230<br>535 i 225<br>535 i xDrive 225<br>550 i 300<br>550 i 330<br>550 i xDrive 300<br>550 i xDrive 330 | 10.11<br>10.09<br>09.10<br>03.10<br>02.12<br>09.10<br>02.12<br>10.09<br>09.10<br>10.09<br>05.12<br>09.10<br>05.12 |  | 24.2026-1702.3   | 010850   |   |  | Thz 26,99/22,20  | LUC   |
|    | 520 d 135<br>530 d<br>530 d xDrive<br>535 d 220<br>535 d 230<br>535 d xDrive 220<br>535 d xDrive 230<br>535 i 225<br>535 i xDrive 225<br>550 i 300<br>550 i 330<br>550 i xDrive 300<br>550 i xDrive 330 | 10.11<br>10.09<br>09.10<br>03.10<br>02.12<br>09.10<br>02.12<br>10.09<br>09.10<br>10.09<br>05.12<br>09.10<br>05.12 |  | 11.8116-0007.2<br>11.0441-6008.2   | 390602<br>250038   | 2 |  | Haltefeder<br>Dichtungssatz  | ATE<br>ATE  |
|  | 550 i 300<br>550 i 330<br>550 i xDrive 300<br>550 i xDrive 330  | 10.09<br>05.12<br>09.10<br>05.12  |  | 11.8116-0008.2   | 390603   | 2 |  | Haltefeder   | ATE   |
| BMW 6er Reihe/E63 Coupe (04-11)  |   |   |  |  |  |   |  |  |   |
|  | 630 i 190<br>630 i 200<br>635 d 210<br>645 Ci 245<br>650 i 270<br>M6 373  | 07.04<br>08.07<br>09.07<br>05.11<br>09.07<br>05.11<br>12.03<br>08.07<br>07.05<br>05.11<br>06.05<br>05.11          |  | 24.2026-1702.3   | 010850   |   |  | Thz 26,99/22,20  | LUC   |
|  | 630 i 190   | 07.04<br>08.07  |  | 11.9606-9979.2<br>11.9606-9980.2<br>24.3606-9979.5<br>24.3606-9980.5<br>11.0441-6008.2<br>11.0101-6006.2<br>11.8171-0008.1<br>11.8171-0067.1<br>11.8116-0315.2 | 220907<br>220908<br>240575<br>240576<br>250038<br>260098<br>990049<br>250153<br>390447 | 2 | <br><br><br> | D=60, - Halter<br>D=60, - Halter<br>D=60, - Halter<br>D=60, - Halter<br>Dichtungssatz<br>Hülssensatz<br>Führungsbolzen<br>Führungsbolzen<br>Haltefeder | ATE<br>ATE<br>ATE<br>ATE<br>ATE<br>ATE<br>ATE<br>ATE<br>ATE |
|  | 630 i 200<br>645 Ci 245   | 09.07<br>05.11<br>12.03<br>08.07  |  | 24.3606-9977.5<br>24.3606-9978.5<br>11.0441-6008.2<br>11.0101-6006.2<br>11.8171-0008.1<br>11.8171-0067.1<br>11.8116-0315.2                                     | 240573<br>240574<br>250038<br>260098<br>990049<br>250153<br>390447                     | 2 | <br>   | D=60, - Halter<br>D=60, - Halter<br>Dichtungssatz<br>Hülssensatz<br>Führungsbolzen<br>Führungsbolzen<br>Haltefeder                                     | ATE<br>ATE<br>ATE<br>ATE<br>ATE<br>ATE<br>ATE               |
|  | 635 d 210<br>650 i 270  | 09.07<br>05.11<br>07.05<br>05.11  |  | 11.0101-5706.2<br>11.8171-0067.1<br>11.8116-0353.2   | 260097<br>250153<br>390585   | 2 |  | Hülssensatz<br>Führungsbolzen<br>Haltefeder  | ATE<br>ATE<br>ATE   |
|  | M6 373  | 06.05<br>05.11  |  | 11.0101-5706.2<br>11.8171-0067.1<br>11.8116-0353.2   | 260097<br>250153<br>390585   | 2 |  | Hülssensatz<br>Führungsbolzen<br>Haltefeder  | ATE<br>ATE<br>ATE   |
|  | 630 i 190<br>630 i 200<br>635 d 210<br>645 Ci 245<br>650 i 270<br>M6 373  | 07.04<br>08.07<br>09.07<br>05.11<br>12.03<br>08.07<br>07.05<br>05.11<br>06.05<br>05.11                            |  | 83.6151-0552.3   | 330857   | 2 |  | L=550  |   |





<sup>1)</sup> + heavy duty brake / + freno rinforzato / + frein renforcé / + freno reforzado









































|     |  |  |  |  |  |  |  |  |                                      |                      |     |
|--|--|--|--|--|---|--|--|--|--------------------------------------|----------------------|-----|
| <b>BMW 6er Reihe/F12 Cabrio (11-)</b>  |  |  |  |  |   |  |  |  |                                      |                      |     |
|    | 640 d  | 230  |  | 06.11  |   | 11.8116-0007.2   | 390602   | 2  |                                      | Haltefeder           | ATE |
|  | 640 i  | 235  |  | 03.11  |   | 11.0441-6008.2   | 250038   |  |                                      | Dichtungssatz        | ATE |
|  | 650 i  | 300  |  | 03.11  |   |  |  |  |                                      |                      |     |
|  | 650 i  | 330  |  | 10.11  |   |  |  |  |                                      |                      |     |
|  | xDrive 640 d   | 230  |  | 03.12  |   |  |  |  |                                      |                      |     |
|  | xDrive 640 i   | 235  |  | 01.13  |   |  |  |  |                                      |                      |     |
|  | xDrive 650 i   | 300  |  | 06.11  |   |  |  |  |                                      |                      |     |
|  | xDrive 650 i   | 330  |  | 09.12  |   |  |  |  |                                      |                      |     |
| <b>BMW 6er Reihe/F13 Coupe (11-)</b>   |  |  |  |  |   |  |  |  |                                      |                      |     |
|    | 640 d  | 230  |  | 06.11  |   | 11.8116-0007.2   | 390602   | 2  |                                      | Haltefeder           | ATE |
|  | 640 i  | 235  |  | 06.11  |   | 11.0441-6008.2   | 250038   |  |                                      | Dichtungssatz        | ATE |
|  | 650 i  | 300  |  | 06.11  |   |  |  |  |                                      |                      |     |
|  | 650 i  | 330  |  | 09.12  |   |  |  |  |                                      |                      |     |
|  | xDrive 640 d   | 230  |  | 03.12  |   |  |  |  |                                      |                      |     |
|  | xDrive 640 i   | 235  |  | 01.13  |   |  |  |  |                                      |                      |     |
|  | xDrive 650 i   | 300  |  | 06.11  |   |  |  |  |                                      |                      |     |
|  | xDrive 650 i   | 330  |  | 09.12  |   |  |  |  |                                      |                      |     |
| <b>BMW 7er Reihe/E32 (86-94)</b>   |  |  |  |  |   |  |  |  |                                      |                      |     |
|    | 730 i 6  |  |  | 07.86  | 02.88   | 10.0144-4234.3   | 340014   |  |                                      | Hydraulik Verstärker |     |
|  | 730 iL 6   |  |  | 12.87  | 02.88   | 10.0504-0113.3   | 340021   |  |                                      | DS Regler            |     |
|  | 735 i  |  |  | 09.86  | 02.88   | 10.0522-4005.1   | 340029   |  |                                      | Warnschalter M10x1   |     |
|  | 735 iL   |  |  | 09.86  | 02.88   | 10.0522-4002.1   | 340028   |  |                                      | Warnschalter M12x1   |     |
|  |  |  |  |  |   | 10.0515-0515.3   | 340024   |  |                                      | Hydraulikspeicher    | ATE |
|  | 750 i  | 220  |  | 07.87  | 06.94   | 10.0522-4005.1   | 340029   |  |                                      | Warnschalter M10x1   |     |
|  | 750 iL   | 220  |  | 11.86  | 06.94   | 10.0522-4002.1   | 340028   |  |                                      | Warnschalter M12x1   |     |
|  |  |  |  |  |   | 10.0515-9002.3   | 340026   |  |                                      | Hydraulikspeicher    | ATE |
|    | 730 i 6  |  |  | 07.86  | 02.88   | 03.2125-2802.3   | 010210   |  |                                      | ThZ 25,40            | ATE |
|  | 730 iL 6   |  |  | 12.87  | 02.88   |  |  |  |                                      |                      |     |
|  | 735 i  |  |  | 09.86  | 02.88   |  |  |  |                                      |                      |     |
|  | 735 iL   |  |  | 09.86  | 02.88   |  |  |  |                                      |                      |     |
|  | 750 i  | 220  |  | 07.87  | 06.94   |  |  |  |                                      |                      |     |
|  | 750 iL   | 220  |  | 11.86  | 06.94   |  |  |  |                                      |                      |     |
|  | 730 i 6  |  |  | 03.88  | 06.94   | 03.2125-3011.3   | 010211   |  | + Unterdruckverstärker <sup>1)</sup> | ThZ 25,40            | ATE |
|  | 730 iL 6   |  |  | 03.88  | 06.94   |  |  |  |                                      |                      |     |
|  | 735 i  |  |  | 03.88  | 09.92   |  |  |  |                                      |                      |     |
|  | 735 iL   |  |  | 03.88  | 09.92   |  |  |  |                                      |                      |     |
|  | 730 i 8  | 160  |  | 03.91  | 06.94   | 24.2125-1716.3   | 010663   |  | + Unterdruckverstärker <sup>1)</sup> | ThZ 25,40            |     |
|  | 730 iL 8   | 160  |  | 06.92  | 06.94   |  |  |  |                                      |                      |     |
|  | 740 i  | 210  |  | 09.91  | 06.94   |  |  |  |                                      |                      |     |
|  | 740 iL   | 210  |  | 10.91  | 06.94   |  |  |  |                                      |                      |     |
|  | 740 iL   | 210  |  | 10.91  | 06.94   |  |  |  |                                      |                      |     |
|  | 740 iL   | 210  |  | 10.91  | 06.94   |  |  |  |                                      |                      |     |
|  | 730 i 6  |  |  | 07.86  | 10.87   | 11.3601-8503.2   | 220147   |  |                                      | D=60, - Halter       | ATE |
|  | 730 iL 6   |  |  | 12.87  | 06.94   | 11.3601-8504.2   | 220148   |  |                                      | D=60, - Halter       | ATE |
|  | 735 i  |  |  | 09.86  | 09.92   | 24.3601-8503.5   | 240535   |  |                                      | D=60, - Halter       | ATE |
|  | 735 iL   |  |  | 09.86  | 09.92   | 24.3601-8504.5   | 240536   |  |                                      | D=60, - Halter       | ATE |
|  | 740 i  | 210  |  | 09.91  | 06.94   | 11.0441-6003.2   | 250037   |  |                                      | Dichtungssatz        |     |
|  | 740 iL   | 210  |  | 10.91  | 06.94   | 11.0101-5402.2   | 260009   |  |                                      | Hülensatz            | ATE |
|  | 750 i  | 220  |  | 01.90  | 06.94   | 11.8171-0008.1   | 990049   |  |                                      | Führungsbolzen       | ATE |
|  | 750 i  | 220  |  | 07.87  | 12.89   | 11.8116-0083.1   | 390501   | 2  |                                      | Haltefeder           | ATE |
|  | 750 iL   | 220  |  | 01.90  | 06.94   |  |  |  |                                      |                      |     |
|  | 750 iL   | 220  |  | 11.86  | 12.89   |  |  |  |                                      |                      |     |
|  | 730 i 6  |  |  | 11.87  | 06.94   | 11.3601-8505.2   | 220149   |  |                                      | D=60, - Halter       | ATE |
|  | 730 i 8  | 160  |  | 03.91  | 06.94   | 11.3601-8506.2   | 220150   |  |                                      | D=60, - Halter       | ATE |
|  | 730 iL 8   | 160  |  | 06.92  | 06.94   | 24.3601-8505.5   | 240537   |  |                                      | D=60, - Halter       | ATE |
|  |  |  |  |  |   | 24.3601-8506.5   | 240538   |  |                                      | D=60, - Halter       | ATE |
|  |  |  |  |  |   | 11.0441-6003.2   | 250037   |  |                                      | Dichtungssatz        |     |
|  |  |  |  |  |   | 11.0101-5402.2   | 260009   |  |                                      | Hülensatz            | ATE |
|  |  |  |  |  |   | 11.8171-0008.1   | 990049   |  |                                      | Führungsbolzen       | ATE |
|  |  |  |  |  |   | 11.8116-0083.1   | 390501   | 2  |                                      | Haltefeder           | ATE |
|  | 730 i 6  |  |  | 07.86  | 06.94   | 83.6134-0420.3   | 330279   | 2  |                                      | L=420                |     |
|  | 730 i 8  | 160  |  | 03.91  | 06.94   |  |  |  |                                      |                      |     |
|  | 730 iL 6   |  |  | 12.87  | 06.94   |  |  |  |                                      |                      |     |
|  | 730 iL 8   | 160  |  | 06.92  | 06.94   |  |  |  |                                      |                      |     |
|  | 735 i  |  |  | 09.86  | 09.92   |  |  |  |                                      |                      |     |
|  | 735 iL   |  |  | 09.86  | 09.92   |  |  |  |                                      |                      |     |
|  | 740 i  | 210  |  | 09.91  | 06.94   |  |  |  |                                      |                      |     |
|  | 740 iL   | 210  |  | 10.91  | 06.94   |  |  |  |                                      |                      |     |
|  | 750 i  | 220  |  | 07.87  | 06.94   |  |  |  |                                      |                      |     |
|  | 750 iL   | 220  |  | 11.86  | 06.94   |  |  |  |                                      |                      |     |
|  | 730 i 6  |  |  | 07.86  | 10.87   | 11.3381-8501.2   | 220018   |  |                                      | D=38, - Halter       | ATE |
|  | 730 iL 6   |  |  | 12.87  | 06.94   | 11.3381-8502.2   | 220019   |  |                                      | D=38, - Halter       | ATE |
|  | 735 i  |  |  | 09.86  | 09.92   | 11.0441-3802.2   | 250009   |  |                                      | Dichtungssatz        | ATE |
|  | 735 iL   |  |  | 09.86  | 09.92   | 11.0101-5402.2   | 260009   |  |                                      | Hülensatz            | ATE |
|  |  |  |  |  |   | 11.8171-0008.1   | 990049   |  |                                      | Führungsbolzen       | ATE |
|  |  |  |  |  |   | 11.8116-0066.1   | 390577   | 2  |                                      | Haltefeder           | ATE |
|  | 730 i 6  |  |  | 11.87  | 06.94   | 11.3381-8503.2   | 220020   |  |                                      | D=38, - Halter       | ATE |
|  | 730 i 8  | 160  |  | 03.91  | 06.94   | 11.3381-8504.2   | 220021   |  |                                      | D=38, - Halter       | ATE |
|  | 730 iL 8   | 160  |  | 06.92  | 06.94   | 24.3381-8503.5   | 240515   |  |                                      | D=38, - Halter       | ATE |
|  |  |  |  |  |   | 24.3381-8504.5   | 240516   |  |                                      | D=38, - Halter       | ATE |
|  |  |  |  |  |   | 11.0441-3803.2   | 250010   |  |                                      | Dichtungssatz        | ATE |
|  |  |  |  |  |   | 11.0101-5402.2   | 260009   |  |                                      | Hülensatz            | ATE |
|  |  |  |  |  |   | 11.8171-0008.1   | 990049   |  |                                      | Führungsbolzen       | ATE |
|  |  |  |  |  |   | 11.8116-0066.1   | 390577   | 2  |                                      | Haltefeder           | ATE |

<sup>1)</sup> + vacuum booster / + servofreno a depressione / + amplificateur à dépression / + amplificador de depresión















<sup>2)</sup> -  / + fist type calipers / -  / + pinze flottanti / -  / + étriers à griffe / -  / + pinza de puno

|     |  |  |  |  |  |  |  |  |  |                                 |
|--|--|--|--|--|---|--|--|--|--|---------------------------------|
| <b>BMW 7er Reihe/E32 (86-94)</b>   |  |  |  |  |   |  |  |  |  |                                 |
|    | 750 i  | 220  |  | 07.87  | 12.89   | 11.0441-3802.2   | 250009   | 2  | Dichtungssatz<br>Hülzensatz<br>Führungsbolzen<br>Haltefeder                    | ATE<br>ATE<br>ATE<br>ATE        |
|  | 750 iL   | 220  |  | 11.86  | 12.89   | 11.0101-5402.2   | 260009   |  |  |                                 |
|  |  |  |  |  |   | 11.8171-0008.1   | 990049   |  |  |                                 |
|  |  |  |  |  |   | 11.8116-0066.1   | 390577   |  |  |                                 |
|  |  |  |  |  |   |  |  |  |  |                                 |
|    | 740 i  | 210  |  | 09.91  | 06.94   | 11.0441-4002.2   | 250011   | 2  | Dichtungssatz<br>Hülzensatz<br>Führungsbolzen<br>Haltefeder                    | ATE<br>ATE<br>ATE<br>ATE        |
|  | 740 iL   | 210  |  | 10.91  | 06.94   | 11.0101-5402.2   | 260009   |  |  |                                 |
|  | 750 i  | 220  |  | 01.90  | 06.94   | 11.8171-0008.1   | 990049   |  |  |                                 |
|  | 750 iL   | 220  |  | 01.90  | 06.94   | 11.8116-0066.1   | 390577   |  |  |                                 |
|  |  |  |  |  |   |  |  |  |  |                                 |
|    | 730 i 6  | 160  |  | 07.86  | 06.94   | 83.6204-0200.3   | 330306   | 2  | am Bremsattel <sup>1)</sup>  | L=200<br>L=200                  |
|  | 730 i 8  |  |  | 03.91  | 06.94   | 83.7704-0200.3   | 330825   |  |  |                                 |
|  | 730 iL 6   |  |  | 12.87  | 06.94   |  |  |  |  |                                 |
|  | 730 iL 8   | 160  |  | 06.92  | 06.94   |  |  |  |  |                                 |
|  | 735 i  |  |  | 09.86  | 09.92   |  |  |  |  |                                 |
|  | 735 iL   |  |  | 09.86  | 09.92   |  |  |  |  |                                 |
|  | 740 i  | 210  |  | 09.91  | 06.94   |  |  |  |  |                                 |
|  | 740 iL   | 210  |  | 10.91  | 06.94   |  |  |  |  |                                 |
|  | 750 i  | 220  |  | 07.87  | 06.94   |  |  |  |  |                                 |
|  | 750 iL   | 220  |  | 11.86  | 06.94   |  |  |  |  |                                 |
|    | 730 i 6  | 160  |  | 07.86  | 06.94   | 24.3727-0219.2   | 580219   | 2  |  | L=1855                          |
|  | 730 i 8  |  |  | 03.91  | 06.94   |  |  |  |  |                                 |
|  | 735 i  |  |  | 09.86  | 09.92   |  |  |  |  |                                 |
|  | 740 i  | 210  |  | 09.91  | 06.94   |  |  |  |  |                                 |
|  | 750 i  | 220  |  | 07.87  | 06.94   |  |  |  |  |                                 |
|    | 730 i 6  | 160  |  | 07.86  | 06.94   | 24.2419-0922.3   | 030051   |  |  | Gz 19,05                        |
|  | 730 i 8  |  |  | 03.91  | 06.94   |  |  |  |  |                                 |
|  | 730 iL 6   |  |  | 12.87  | 06.94   |  |  |  |  |                                 |
|  | 730 iL 8   | 160  |  | 06.92  | 06.94   |  |  |  |  |                                 |
|  | 735 i  |  |  | 09.86  | 09.92   |  |  |  |  |                                 |
|  | 730 i 6  | 160  |  | 07.86  | 06.94   | 03.2522-3601.3   | 040014   |  |  | Nz 22,20                        |
|  | 730 iL 6   |  |  | 12.87  | 06.94   |  |  |  |  |                                 |
|  | 735 i  |  |  | 09.86  | 09.92   |  |  |  |  |                                 |
|  | 735 iL   |  | 09.86  | 09.92  |   |  |  |  |  |                                 |
|  | 730 i 8  | 160  |  | 03.91  | 06.94   | 24.2522-0905.3   | 040042   |  |  |                                 |
| 730 iL 8   | 160  |  | 06.92  | 06.94  |   |  |  |  |  |                                 |
|  | 730 i 6  | 160  |  | 07.86  | 06.94   | 24.5905-0320.3   | 330058   |  |  | L=320                           |
|  | 730 iL 6   |  |  | 12.87  | 06.94   |  |  |  |  |                                 |
|  | 735 i  |  |  | 09.86  | 09.92   |  |  |  |  |                                 |
|  | 735 iL   |  | 09.86  | 09.92  |   |  |  |  |  |                                 |
|  |  |  |  |  |   |  |  |  |  |                                 |
| <b>BMW 7er Reihe/E38 (93-01)</b>   |  |  |  |  |   |  |  |  |  |                                 |
|  | 725 tds  | 105  |  | 05.96  | 08.97   | 24.2120-1721.3   | 010553   |  |  | Thz 20,64                       |
|  | 728 i  | 142  |  | 07.95  | 08.97   |  |  |  |  |                                 |
|  | 728 iL   | 142  |  | 01.96  | 08.97   |  |  |  |  |                                 |
|  | 730 i  |  |  | 07.93  | 08.97   |  |  |  |  |                                 |
|  | 730 iL   |  |  | 05.94  | 08.97   |  |  |  |  |                                 |
|  | 735 i  | 173  |  | 01.96  | 08.97   |  |  |  |  |                                 |
|  | 735 iL   | 173  |  | 01.96  | 08.97   |  |  |  |  |                                 |
|  | 740 i  | 210  |  | 07.93  | 08.97   |  |  |  |  |                                 |
|  | 740 iL   | 210  |  | 05.94  | 08.97   |  |  |  |  |                                 |
|  | 750 i  | 240  |  | 11.93  | 08.97   |  |  |  |  |                                 |
|  | 750 iL   | 240  |  | 01.94  | 08.97   |  |  |  |  |                                 |
|  | 725 tds  | 105  |  | 09.97  | 08.98   | 24.2025-1705.3   | 010624   |  |  |                                 |
|  | 728 i  | 142  |  | 09.97  | 08.98   |  |  |  |  |                                 |
|  | 728 iL   | 142  |  | 09.97  | 08.98   |  |  |  |  |                                 |
|  | 730 d  |  |  | 09.98  | 11.01   | - DSC  |  |  |  |                                 |
|  | 730 i  |  |  | 09.97  | 08.98   |  |  |  |  |                                 |
|  | 730 iL   |  |  | 09.97  | 08.98   |  |  |  |  |                                 |
| 735 i  | 173  |  | 09.97  | 08.98  |   |  |  |  |  |                                 |
| 735 iL   | 173  |  | 09.97  | 08.98  |   |  |  |  |  |                                 |
| 740 d  | 180  |  | 05.99  | 11.01  | - DSC   |  |  |  |  |                                 |
| 740 i  | 210  |  | 09.97  | 08.98  |   |  |  |  |  |                                 |
| 740 iL   | 210  |  | 09.97  | 08.98  |   |  |  |  |  |                                 |
| 750 i  | 240  |  | 09.97  | 08.98  |   |  |  |  |  |                                 |
| 750 iL   | 240  |  | 09.97  | 08.98  |   |  |  |  |  |                                 |
| 725 tds  | 105  |  | 09.98  | 11.01  | 24.2025-1704.3  | 010619   |  |  |  |                                 |
| 728 i  | 142  |  | 09.98  | 11.01  |   |  |  |  |  |                                 |
| 728 iL   | 142  |  | 09.98  | 11.01  |   |  |  |  |  |                                 |
| 730 d  |  |  | 09.98  | 11.01  | + DSC   |  |  |  |  |                                 |
| 730 i  |  |  | 09.98  | 11.01  |   |  |  |  |  |                                 |
| 730 iL   |  |  | 09.98  | 11.01  |   |  |  |  |  |                                 |
| 735 i  | 173  |  | 09.98  | 11.01  |   |  |  |  |  |                                 |
| 735 iL   | 173  |  | 09.98  | 11.01  |   |  |  |  |  |                                 |
| 740 d  | 180  |  | 05.99  | 11.01  | + DSC   |  |  |  |  |                                 |
| 740 i  | 210  |  | 09.98  | 11.01  |   |  |  |  |  |                                 |
| 740 iL   | 210  |  | 09.98  | 11.01  |   |  |  |  |  |                                 |
| 750 i  | 240  |  | 09.98  | 11.01  |   |  |  |  |  |                                 |
| 750 iL   | 240  |  | 09.98  | 11.01  |   |  |  |  |  |                                 |
|  | 740 i  | 210  |  | 07.93  | 11.01   | 24.3601-1713.5   | 240355   | 2  | D=60, - Halter<br>D=60, - Halter<br>Hülzensatz<br>Führungsbolzen<br>Haltefeder | ATE<br>ATE<br>ATE<br>ATE<br>ATE |
|  | 740 iL   | 210  |  | 05.94  | 11.01   | 24.3601-1714.5   | 240356   |  |  |                                 |
|  |  |  |  |  |   | 11.0101-5402.2   | 260009   |  |  |                                 |
|  |  |  |  |  |   | 11.8171-0008.1   | 990049   |  |  |                                 |
|  |  |  |  |  |   | 11.8116-0290.2   | 390520   |  |  |                                 |

<sup>1)</sup> on the brake caliper / sulla pinza freno / sur l'étrier de frein / a la pinza de freno

|     |    |  |  |   |  |    |  |   |  |  |
|--|--|--|--|---|---|--|--|---|--|--|
| <b>BMW 7er Reihe/E38 (93-01)</b>   |  |  |  |   |   |  |  |   |  |  |
|    | 740 d<br>750 i<br>750 iL   | 180<br>240<br>240  |  | 05.99 11.01<br>11.93 11.01<br>01.94 11.01   |   | 11.3421-8501.2 220405<br>11.3421-8502.2 220406<br>11.0101-6004.2 260014<br>11.8171-0008.1 990049<br>11.8116-0133.1 390511  | 2  | D=42, - Halter<br>D=42, - Halter<br>Hülzensatz<br>Führungsbolzen<br>Haltefeder  | ATE<br>ATE<br>ATE<br>ATE<br>ATE                      |  |
|    | 725 tds<br>728 i<br>728 iL<br>730 d<br>730 i<br>730 iL<br>735 i<br>735 iL<br>740 d<br>740 i<br>740 iL<br>750 i<br>750 iL | 105<br>142<br>142<br><br><br><br>173<br>173<br>180<br>210<br>210<br>240<br>240   |  | 05.96 11.01<br>07.95 11.01<br>01.96 11.01<br>09.98 11.01<br>07.93 11.01<br>05.94 11.01<br>01.96 11.01<br>01.96 11.01<br>05.99 11.01<br>07.93 11.01<br>05.94 11.01<br>11.93 11.01<br>01.94 11.01 |   | 83.6235-0100.3 330463<br>83.6204-0100.3 330441<br>83.6151-0356.3 330460  | 2  | + ASC<br>+ ASC<br>am Bremssattel <sup>1)</sup>  | L=100<br>L=100<br>L=355                              |  |
|    | 725 tds<br>728 i<br>728 iL<br>730 d<br>730 i<br>730 iL<br>735 i<br>735 iL<br>740 i<br>740 iL<br>740 d<br>750 i<br>750 iL | 105<br>142<br>142<br><br><br><br>173<br>173<br>210<br>210<br>240                 |  | 05.96 11.01<br>07.95 11.01<br>01.96 11.01<br>09.98 11.01<br>07.93 11.01<br>05.94 11.01<br>01.96 11.01<br>01.96 11.01<br>09.96 11.01<br>09.96 11.01<br>05.99 11.01<br>11.93 11.01<br>01.94 11.01 |   | 11.9401-9977.2 220439<br>11.9401-9978.2 220440<br>24.3401-9977.5 240523<br>24.3401-9978.5 240524<br>11.0441-4003.2 250001<br>11.0101-5402.2 260009<br>11.8171-0008.1 990049<br>11.8116-0094.1 390504 | 2  | D=40, - Halter<br>D=40, - Halter<br>D=40, - Halter<br>D=40, - Halter<br>Dichtungssatz<br>Hülzensatz<br>Führungsbolzen<br>Haltefeder | ATE<br>ATE<br>ATE<br>ATE<br>ATE<br>ATE<br>ATE<br>ATE |  |
|    | 725 tds<br>728 i<br>728 iL<br>730 d<br>730 i<br>730 iL<br>735 i<br>735 iL<br>740 d<br>740 i<br>740 iL<br>750 i<br>750 iL | 105<br>142<br>142<br><br><br><br>173<br>173<br>180<br>210<br>210<br>240<br>240   |  | 05.96 11.01<br>07.95 11.01<br>01.96 11.01<br>09.98 11.01<br>07.93 11.01<br>05.94 11.01<br>01.96 11.01<br>01.96 11.01<br>05.99 11.01<br>07.93 11.01<br>05.94 11.01<br>11.93 11.01<br>01.94 11.01 |   | 11.9401-9975.2 220495<br>11.9401-9976.2 220496<br>11.0441-4003.2 250001<br>11.0101-5402.2 260009<br>11.8171-0008.1 990049<br>11.8116-0094.1 390504   | 2  | D=40, - Halter<br>D=40, - Halter<br>Dichtungssatz<br>Hülzensatz<br>Führungsbolzen<br>Haltefeder                                     | ATE<br>ATE<br>ATE<br>ATE<br>ATE<br>ATE               |  |
|  | 725 tds<br>728 i<br>728 iL<br>730 d<br>730 i<br>730 iL<br>735 i<br>735 iL<br>740 d<br>740 i<br>740 iL<br>750 i<br>750 iL | 105<br>142<br>142<br><br><br><br>173<br>173<br>180<br>210<br>210<br>240<br>240   |  | 05.96 11.01<br>07.95 11.01<br>01.96 11.01<br>09.98 11.01<br>07.93 11.01<br>05.94 11.01<br>01.96 11.01<br>01.96 11.01<br>05.99 11.01<br>07.93 11.01<br>05.94 11.01<br>11.93 11.01<br>01.94 11.01 |   | 83.6235-0100.3 330463<br>83.6204-0100.3 330441<br>83.6124-0275.3 330458  | 2  | M12X1<br>M10X1<br>am Bremssattel <sup>1)</sup>  | L=100<br>L=100<br>L=275                              |  |
|  | 725 tds<br>728 i<br>728 iL<br>730 d<br>730 i<br>730 iL<br>735 i<br>735 iL<br>740 d<br>740 i<br>740 iL<br>750 i<br>750 iL | 105<br>142<br>142<br><br><br><br>173<br>173<br>180<br>210<br>210<br>240<br>240   |  | 05.96 11.01<br>07.95 11.01<br>01.96 11.01<br>09.98 11.01<br>07.93 11.01<br>05.94 11.01<br>01.96 11.01<br>01.96 11.01<br>05.99 11.01<br>07.93 11.01<br>05.94 11.01<br>11.93 11.01<br>01.94 11.01 |   | 24.3727-0232.2 580232<br>24.3727-0239.2 580239   |  |   | L=1265<br>L=1119                                     |  |
|  | 728 i<br>730 i<br>730 iL<br>735 i<br>740 i   | 142<br><br><br>173<br>210  |  | 07.95 04.96<br>07.93 11.01<br>05.94 11.01<br>01.96 08.96<br>07.93 08.96   |   | 24.2419-1717.3 030108  |  |   | Gz 19,05   |  |
|  | 725 tds<br>728 i   | 105<br>142   |  | 05.96 08.97<br>05.96 08.97  |   | 24.2419-1710.3 030104  |  |   | Gz 19,05   |  |
|  | 725 tds<br>728 i<br>730 i<br>730 iL<br>735 i<br>740 i  | 105<br>142<br><br><br>173<br>210   |  | 05.96 11.01<br>07.95 11.01<br>07.93 11.01<br>05.94 11.01<br>01.96 11.01<br>07.93 11.01  |   | 24.2522-0905.3 040042<br><br><br><br><br>24.2526-0902.3 040052   |  |   | Nz 22,20<br><br><br><br><br>Nz 26,99                 |  |
| <b>BMW 7er Reihe/E65/E66 (02-08)</b>   |  |  |  |   |   |  |  |   |  |  |
|  | 730 d<br>730 i,Li<br>730 Ld<br>735 i<br>735 Li<br>740 d<br>740 i,Li<br>745 d<br>745 i<br>745 Li<br>750 i<br>750 Li       | 190<br>170<br>200<br>200<br>190<br>225<br><br>245<br>245<br>270<br>270           |  | 09.02 08.08<br>07.05 08.08<br>03.05 08.08<br>11.01 08.08<br>04.02 08.08<br>09.02 08.08<br>03.05 08.08<br>03.05 08.08<br>11.01 08.08<br>04.02 08.08<br>03.05 08.08<br>03.05 08.08                |   | 24.2026-1701.3 010746  |  |   | Thz 26,99/20,64                                      |  |





























<sup>1)</sup> on the brake caliper / sulla pinza freno / sur l'étrier de frein / a la pinza de freno

|     |    |                |  |    |    |  |    |      |
|--|--|--|--|--|---|--|--|--|
| <b>BMW 7er Reihe/E65/E66 (02-08)</b>   |  |  |  |  |   |  |  |  |
|    | 760 i<br>760 Li  | 327<br>327   |  | 03.03<br>03.03   | 08.08<br>08.08  |  | 24.2026-1701.3<br>010746   | Thz 26,99/20,64  |
|    | 730 d<br>730 i<br>730 i,Li<br>730 Li<br>735 i<br>735 Li<br>740 d   | 170<br>190<br>170<br>200<br>200<br>190   |  | 09.02<br>03.03<br>07.05<br>03.03<br>11.01<br>04.02<br>09.02  | 02.05<br>08.08<br>08.08<br>08.08<br>08.08<br>08.08  |  | 11.9606-9979.2<br>11.9606-9980.2<br>24.3606-9979.5<br>24.3606-9980.5<br>11.0441-6008.2<br>11.0101-6006.2<br>11.8171-0067.1<br>11.8171-0008.1<br>11.8116-0315.2 | 220907<br>220908<br>240575<br>240576<br>250038<br>260098<br>250153<br>990049<br>390447 |
|  | 730 d<br>730 Ld<br>740 i,Li<br>745 i<br>745 Li<br>750 i<br>750 Li<br>760 i<br>760 Li   | 170<br>225<br>245<br>245<br>270<br>270<br>327<br>327   |  | 03.05<br>03.05<br>03.05<br>11.01<br>04.02<br>03.05<br>03.05<br>03.03<br>03.03  | 08.08<br>08.08<br>08.08<br>08.08<br>08.08<br>08.08<br>08.08<br>08.08<br>08.08   | - Europa 1)<br>- Europa 1)<br>- Europa 1)  | 24.3606-9977.5<br>24.3606-9978.5<br>11.0441-6008.2<br>11.0101-6006.2<br>11.8171-0067.1<br>11.8171-0008.1<br>11.8116-0315.2                                     | 240573<br>240574<br>250038<br>260098<br>250153<br>990049<br>390447                     |
|  | 745 d<br>760 i<br>760 Li   | 327<br>327   |  | 03.05<br>03.03<br>03.03  | 08.08<br>08.08<br>08.08   | + Europa 2)<br>+ Europa 2)   | 11.0101-5706.2<br>11.8171-0067.1<br>11.8116-0353.2   | 260097<br>250153<br>390585   |
|  | 750 i<br>750 Li  | 270<br>270   |  | 03.05<br>03.05   | 08.08<br>08.08  | + Europa 2)<br>+ Europa 2)   | 11.0101-5706.2<br>11.8171-0067.1<br>11.8116-0353.2   | 260097<br>250153<br>390585   |
|    | 730 d<br>730 i<br>730 i,Li<br>730 Ld<br>730 Li<br>735 i<br>735 Li<br>740 d<br>740 i,Li<br>745 d<br>745 i<br>745 Li<br>750 i<br>750 Li<br>760 i<br>760 Li | 170<br>190<br>170<br>170<br>200<br>200<br>190<br>225<br>245<br>245<br>270<br>270<br>327<br>327 |  | 09.02<br>03.03<br>07.05<br>03.03<br>11.01<br>04.02<br>09.02<br>03.05<br>03.05<br>11.01<br>04.02<br>03.05<br>03.05<br>03.03<br>03.03          | 08.08<br>08.08<br>08.08<br>08.08<br>08.08<br>08.08<br>08.08<br>08.08<br>08.08<br>08.08<br>08.08<br>08.08<br>08.08<br>08.08<br>08.08 |  | 83.6150-0556.3   | 330712   |
|  | 730 d<br>730 i<br>730 i,Li<br>730 Li<br>735 i<br>735 Li  | 170<br>190<br>170<br>200<br>200  |  | 09.02<br>03.03<br>07.05<br>03.03<br>11.01<br>04.02   | 02.05<br>08.08<br>08.08<br>08.08<br>08.08<br>08.08  |  | 11.9461-9981.2<br>11.9461-9982.2<br>24.3461-9981.5<br>24.3461-9982.5<br>11.0101-5402.2<br>11.8171-0008.1   | 220899<br>220900<br>240569<br>240570<br>260009<br>990049                               |
|  | 730 d<br>730 Ld<br>740 d<br>740 i,Li<br>745 i<br>745 Li<br>750 i<br>750 Li<br>760 i<br>760 Li  | 170<br>190<br>225<br>245<br>245<br>270<br>270<br>327<br>327                                    |  | 03.05<br>03.05<br>09.02<br>03.05<br>11.01<br>04.02<br>03.05<br>03.05<br>03.03<br>03.03   | 08.08<br>08.08<br>08.08<br>08.08<br>08.08<br>08.08<br>08.08<br>08.08<br>08.08<br>08.08  | - Europa 1)<br>- Europa 1)   | 11.0230-0176.2<br>11.0101-5402.2<br>11.8171-0008.1<br>11.8116-0296.1   | 260088<br>260009<br>990049<br>390445   |
|  | 745 d<br>760 i<br>760 Li   | 327<br>327   |  | 03.05<br>03.03<br>03.03  | 08.08<br>08.08<br>08.08   | + Europa 2)<br>+ Europa 2)   | 11.0101-5402.2<br>11.8171-0008.1<br>11.8116-0296.1   | 260009<br>990049<br>390445   |
|  | 730 d<br>730 i<br>730 i,Li<br>730 Ld<br>730 Li<br>735 i<br>735 Li<br>740 d<br>740 i,Li<br>745 d<br>745 i<br>745 Li<br>750 i<br>750 Li<br>760 i<br>760 Li | 170<br>190<br>170<br>170<br>200<br>200<br>190<br>225<br>245<br>245<br>270<br>270<br>327<br>327 |  | 09.02<br>03.03<br>07.05<br>03.05<br>03.03<br>11.01<br>04.02<br>09.02<br>03.05<br>03.05<br>11.01<br>04.02<br>03.05<br>03.05<br>03.03<br>03.03 | 08.08<br>08.08<br>08.08<br>08.08<br>08.08<br>08.08<br>08.08<br>08.08<br>08.08<br>08.08<br>08.08<br>08.08<br>08.08<br>08.08<br>08.08 |  | 83.6124-0303.3   | 330689   |
| <b>BMW 7er Reihe/F01/F02/F03/F04 (08-)</b>   |  |  |  |  |   |  |  |  |
|  | 730 d<br>730 d<br>730 d xDrive<br>730 i<br>740 d<br>740 d  | 180<br>190<br>190<br>190<br>225<br>230   |  | 09.08<br>06.12<br>06.12<br>09.08<br>09.09<br>06.12   |   |  | 11.0441-6008.2<br>11.8116-0007.2   | 250038<br>390602   |













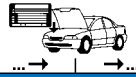









1) - Europe / - Europa / - Europe / - Europa  
2) + Europe / + Europa / + Europe / + Europa





|     |   |  |  |  |  |  |  |  |                    |                |     |
|--|---|--|--|--|---|--|--|--|--------------------|----------------|-----|
| <b>BMW 7er Reihe/F01/F02/F03/F04 (08-)</b>   |   |  |  |  |   |  |  |  |                    |                |     |
|    | 740 d xDrive  | 225  |  | 09.10  |   | 11.0441-6008.2   | 250038   |  | Dichtungssatz      | ATE            |     |
|  | 740 d xDrive  | 230  |  | 06.12  |   | 11.8116-0007.2   | 390602   | 2  | Haltefeder         | ATE            |     |
|  | 740 i   | 235  |  | 06.12  |   |  |  |  |                    |                |     |
|  | 740 i   | 240  |  | 09.08  |   |  |  |  |                    |                |     |
|  | ActiveHybrid 7  | 260  |  | 06.12  |   |  |  |  |                    |                |     |
|  | ActiveHybrid 7  | 342  |  | 03.10  |   |  |  |  |                    |                |     |
|  |   |  |  |  |   |  |  |  |                    |                |     |
|  |   |  |  |  |   |  |  |  |                    |                |     |
|  |   |  |  |  |   |  |  |  |                    |                |     |
|  |   |  |  |  |   |  |  |  |                    |                |     |
|  |   |  |  |  |   |  |  |  |                    |                |     |
|  |   | 750 i  | 300  |  | 09.08   |  | 11.0441-6008.2   | 250038   |                    | Dichtungssatz  | ATE |
| 750 i  |   | 330  |  | 06.12  |   | 11.8116-0007.2   | 390602   | 2  | Haltefeder         | ATE            |     |
| 750 i xDrive   |   | 300  |  | 09.09  |   |  |  |  |                    |                |     |
| 750 i xDrive   |   | 330  |  | 10.12  |   |  |  |  |                    |                |     |
|  |   |  |  |  |   |  |  |  |                    |                |     |
|  |   |  |  |  |   |  |  |  |                    |                |     |
|  |   |  |  |  |   |  |  |  |                    |                |     |
|  |   |  |  |  |   |  |  |  |                    |                |     |
|  |   |  |  |  |   |  |  |  |                    |                |     |
|  |   |  |  |  |   |  |  |  |                    |                |     |
|  |   |  |  |  |   |  |  |  |                    |                |     |
|    |   | 750 d xDrive   | 280  |  | 06.12   |  | 11.0441-6008.2   | 250038   |                    | Dichtungssatz  | ATE |
|  | 750 i   | 300  |  | 09.08  |   | 11.8116-0008.2   | 390603   | 2  | Haltefeder         | ATE            |     |
|  | 750 i   | 330  |  | 06.12  |   |  |  |  |                    |                |     |
|  | 750 i xDrive  | 300  |  | 09.09  |   |  |  |  |                    |                |     |
|  | 750 i xDrive  | 330  |  | 10.12  |   |  |  |  |                    |                |     |
|  | 760 i   | 400  |  | 09.09  |   |  |  |  |                    |                |     |
|  | ActiveHybrid 7  | 342  |  | 03.10  |   |  |  |  |                    |                |     |
|  |   |  |  |  |   |  |  |  |                    |                |     |
|  |   |  |  |  |   |  |  |  |                    |                |     |
|  |   |  |  |  |   |  |  |  |                    |                |     |
|  |   |  |  |  |   |  |  |  |                    |                |     |
|  |  | 730 d  | 180  |  | 09.08   |  | 11.8171-0008.1   | 990049   |                    | Führungsbolzen | ATE |
| 730 d  |   | 190  |  | 06.12  |   | 11.8116-0296.1   | 390445   | 2  | Haltefeder         | ATE            |     |
| 730 d xDrive   |   | 190  |  | 06.12  |   |  |  |  |                    |                |     |
| 730 i  |   | 190  |  | 09.08  |   |  |  |  |                    |                |     |
| 740 d  |   | 225  |  | 09.09  |   |  |  |  |                    |                |     |
| 740 d  |   | 230  |  | 06.12  |   |  |  |  |                    |                |     |
| 740 d xDrive   |   | 225  |  | 09.10  |   |  |  |  |                    |                |     |
| 740 d xDrive   |   | 230  |  | 06.12  |   |  |  |  |                    |                |     |
| 740 i  |   | 235  |  | 06.12  |   |  |  |  |                    |                |     |
| 740 i  |   | 240  |  | 09.08  |   |  |  |  |                    |                |     |
| ActiveHybrid 7   |   | 260  |  | 06.12  |   |  |  |  |                    |                |     |
|  |   |  |  |  |   |  |  |  |                    |                |     |
|  | 750 i   | 300  |  | 09.08  | 11.08   | 11.8171-0008.1   | 990049   |  | Führungsbolzen     | ATE            |     |
|  |   |  |  |  |   | 11.8116-0296.1   | 390445   | 2  | Haltefeder         | ATE            |     |
|  |   |  |  |  |   |  |  |  |                    |                |     |
|  |   |  |  |  |   |  |  |  |                    |                |     |
|  |   |  |  |  |   |  |  |  |                    |                |     |
|  |   |  |  |  |   |  |  |  |                    |                |     |
|  |   |  |  |  |   |  |  |  |                    |                |     |
|  |   |  |  |  |   |  |  |  |                    |                |     |
|  |   |  |  |  |   |  |  |  |                    |                |     |
|  |   |  |  |  |   |  |  |  |                    |                |     |
|  |   |  |  |  |   |  |  |  |                    |                |     |
|  | <b>BMW 8er Reihe/E31 (90-99)</b>  |  |  |  |   |  |  |  |                    |                |     |
|   | 840 Ci  | 210  |  | 01.96  | 08.99   | 10.0522-4005.1   | 340029   |  | Warnschalter M10x1 |                |     |
|  | 840 i   | 210  |  | 02.93  | 02.96   | 10.0522-4002.1   | 340028   |  | Warnschalter M12x1 |                |     |
|  | 850 Ci  | 240  |  | 09.94  | 12.99   | 10.0515-9002.3   | 340026   |  | Hydraulikspeicher  | ATE            |     |
|  |   |  |  |  |   |  |  |  |                    |                |     |
|  | 850 CSi   | 280  |  | 09.92  | 10.96   | 10.0522-4005.1   | 340029   |  | Warnschalter M10x1 |                |     |
|  | 850 i. Ci   | 220  |  | 04.90  | 10.94   | 10.0522-4002.1   | 340028   |  | Warnschalter M12x1 |                |     |
|  |   |  |  |  |   | 10.0515-9002.3   | 340026   |  | Hydraulikspeicher  | ATE            |     |
|  |   |  |  |  |   |  |  |  |                    |                |     |
|  | 840 i   | 210  |  | 02.93  | 02.94   | 11.3601-8511.2   | 220155   |  | D=60, - Halter     | ATE            |     |
|  | 850 Ci  | 240  |  | 09.94  | 12.99   | 11.3601-8512.2   | 220156   |  | D=60, - Halter     | ATE            |     |
|  | 850 i. Ci   | 220  |  | 04.90  | 02.94   | 11.0441-6003.2   | 250037   |  | Dichtungssatz      |                |     |
|  |   |  |  |  |   | 11.0101-5402.2   | 260009   |  | Hülzensatz         | ATE            |     |
|  |   |  |  |  |   | 11.8171-0008.1   | 990049   |  | Führungsbolzen     | ATE            |     |
|  |   |  |  |  |   | 11.8116-0092.1   | 390503   | 2  | Haltefeder         | ATE            |     |
|  |   |  |  |  |   |  |  |  |                    |                |     |
|  |   |  |  |  |   |  |  |  |                    |                |     |
|  | 840 Ci  | 210  |  | 01.96  | 08.99   | 83.6134-0420.3   | 330279   |  | L=420              |                |     |
|  | 840 i   | 210  |  | 02.93  | 02.96   | 83.6235-0100.3   | 330463   |  | L=100              |                |     |
|  | 850 Ci  | 240  |  | 09.94  | 12.99   | 83.6204-0100.3   | 330441   |  | L=100              |                |     |
|  | 850 CSi   | 280  |  | 09.92  | 10.96   |  |  |  | L=100              |                |     |
|  | 850 i. Ci   | 220  |  | 04.90  | 10.94   |  |  |  | L=100              |                |     |
|  |   |  |  |  |   |  |  |  |                    |                |     |
|  |   |  |  |  |   |  |  |  |                    |                |     |
|  |   |  |  |  |   |  |  |  |                    |                |     |
|  | 840 Ci  | 210  |  | 01.96  | 08.99   | 11.0441-4002.2   | 250011   |  | Dichtungssatz      | ATE            |     |
|  | 840 i   | 210  |  | 02.93  | 02.96   | 11.0101-5402.2   | 260009   |  | Hülzensatz         | ATE            |     |
|  | 850 Ci  | 240  |  | 09.94  | 12.99   | 11.8171-0008.1   | 990049   |  | Führungsbolzen     | ATE            |     |
|  | 850 i. Ci   | 220  |  | 04.90  | 10.94   | 11.8116-0094.1   | 390504   | 2  | Haltefeder         | ATE            |     |
|  | 850 CSi   | 280  |  | 09.92  | 10.96   | 11.0441-4002.2   | 250011   |  | Dichtungssatz      | ATE            |     |
|  |   |  |  |  |   | 11.0101-5402.2   | 260009   |  | Hülzensatz         | ATE            |     |
|  |   |  |  |  |   | 11.8116-0296.1   | 390445   | 2  | Haltefeder         | ATE            |     |
|  |   |  |  |  |   |  |  |  |                    |                |     |
|  | 840 Ci  | 210  |  | 01.96  | 08.99   | 83.6235-0100.3   | 330463   |  | L=100              |                |     |
|  | 840 i   | 210  |  | 02.93  | 02.96   | 83.6204-0100.3   | 330441   |  | L=100              |                |     |
|  | 850 Ci  | 240  |  | 09.94  | 12.99   | 83.7704-0200.3   | 330825   | 2  | L=200              |                |     |
|  | 850 i. Ci   | 220  |  | 04.90  | 10.94   |  |  |  |                    |                |     |
|  | 850 CSi   | 280  |  | 09.92  | 10.96   | 83.7724-0204.3   | 331206   | 2  | L=200              |                |     |
|  |   |  |  |  |   |  |  |  |                    |                |     |
|  |   |  |  |  |   |  |  |  |                    |                |     |
|  |   |  |  |  |   |  |  |  |                    |                |     |
|  | 840 Ci  | 210  |  | 01.96  | 08.99   | 24.2419-0922.3   | 030051   |  | Gz 19,05           |                |     |
|  | 840 i   | 210  |  | 02.93  | 02.96   |  |  |  |                    |                |     |
|  | 850 Ci  | 240  |  | 09.94  | 12.99   |  |  |  |                    |                |     |
|  | 850 CSi   | 280  |  | 09.92  | 10.96   |  |  |  |                    |                |     |
|  | 850 i. Ci   | 220  |  | 04.90  | 10.94   |  |  |  |                    |                |     |
|  |   |  |  |  |   |  |  |  |                    |                |     |
|  |   |  |  |  |   |  |  |  |                    |                |     |
|  |   |  |  |  |   |  |  |  |                    |                |     |
|  | 840 Ci  | 210  |  | 01.96  | 08.99   | 24.2526-0902.3   | 040052   |  | Nz 26,99           |                |     |
|  | 840 i   | 210  |  | 02.93  | 02.96   |  |  |  |                    |                |     |
|  | 850 Ci  | 240  |  | 09.94  | 12.99   |  |  |  |                    |                |     |
|  | 850 CSi   | 280  |  | 09.92  | 10.96   |  |  |  |                    |                |     |
|  | 850 i. Ci   | 220  |  | 04.90  | 10.94   |  |  |  |                    |                |     |
|  |   |  |  |  |   |  |  |  |                    |                |     |
|  |   |  |  |  |   |  |  |  |                    |                |     |
|  |   |  |  |  |   |  |  |  |                    |                |     |
|  | 850 Ci  | 240  |  | 09.94  | 12.99   | 24.5905-0320.3   | 330058   |  | L=320              |                |     |
|  | 850 CSi   | 280  |  | 09.92  | 10.96   |  |  |  |                    |                |     |
|  | 850 i. Ci   | 220  |  | 04.90  | 10.94   |  |  |  |                    |                |     |

1) - high-speed brake system / - impianto fr. ad alta velocità / - système fr. à haute vitesse / - sistema fr. para alta velocidad.  
2) + high-speed brake system / + impianto fr. ad alta velocità / + système de fr. à haute vitesse / + sistema fr. para alta velocidad  
3) on the brake caliper / sulla pinza freno / sur l'étrier de frein / a la pinza de freno

|     |  |  |  |  |  |  |     |  |       |
|--|--|--|--|--|---|--|---|--|-------|
| <b>BMW X1 (09-)</b>  |  |  |  |  |   |  |   |  |       |
|    | sDrive 16 d  | 85   | 07.12  |  | 03.7845-0103.4  | 300268   | - Start/Stop-Anlage <sup>1)</sup>   | 8"   | ATE   |
|  | sDrive 18 d  | 105  | 10.09  |  |   |  |   |  |       |
|  | sDrive 18 i  | 110  | 03.10  |  |   |  |   |  |       |
|  | sDrive 20 d  | 130  | 10.09  |  |   |  |   |  |       |
|  | sDrive 20 d  | 135  | 07.12  |  |   |  |   |  |       |
|  | sDrive 20 d ed   | 120  | 09.11  |  |   |  |   |  |       |
|  | sDrive 20 i  | 135  | 09.11  |  |   |  |   |  |       |
|  | xDrive 18 d  | 105  | 10.09  |  |   |  |   |  |       |
|  | xDrive 20 d  | 130  | 10.09  |  |   |  |   |  |       |
|  | xDrive 20 d  | 135  | 07.12  |  |   |  |   |  |       |
|  | xDrive 20 i  | 135  | 09.11  |  |   |  |   |  |       |
|  | xDrive 25 i  | 160  | 03.10  |  |   |  |   |  |       |
|  | xDrive 28 i  | 180  | 04.11  |  |   |  |   |  |       |
|  | xDrive 28 i  | 190  | 10.09  |  |   |  |   |  |       |
|  | xDrive 23 d  | 150  | 10.09  |  | 03.7848-5003.4  | 300236   | - Start/Stop-Anlage <sup>1)</sup>   | 8"   | ATE   |
|  | xDrive 25 d  | 160  | 07.12  |  | 03.7845-0103.4  | 300268   | + Automatikgetriebe <sup>2)</sup>   | 8"   | ATE   |
|    | sDrive 16 d  | 85   | 07.12  |  | 03.2025-1904.3  | 010797   |   | THz 25,40/22,20  | ATE   |
|  | sDrive 18 d  | 105  | 10.09  |  |   |  |   |  |       |
|  | sDrive 18 i  | 110  | 03.10  |  |   |  |   |  |       |
|  | sDrive 20 d  | 130  | 10.09  |  |   |  |   |  |       |
|  | sDrive 20 d  | 135  | 07.12  |  |   |  |   |  |       |
|  | sDrive 20 d ed   | 120  | 09.11  |  |   |  |   |  |       |
|  | sDrive 20 i  | 135  | 09.11  |  |   |  |   |  |       |
|  | xDrive 18 d  | 105  | 10.09  |  |   |  |   |  |       |
|  | xDrive 20 d  | 130  | 10.09  |  |   |  |   |  |       |
|  | xDrive 20 d  | 135  | 07.12  |  |   |  |   |  |       |
|  | xDrive 20 i  | 135  | 09.11  |  |   |  |   |  |       |
|  | xDrive 23 d  | 150  | 10.09  |  |   |  |   |  |       |
|  | xDrive 25 d  | 160  | 07.12  |  |   |  |   |  |       |
|  | xDrive 25 i  | 160  | 03.10  |  |   |  |   |  |       |
|  | xDrive 28 i  | 180  | 04.11  |  |   |  |   |  |       |
|  | xDrive 28 i  | 190  | 10.09  |  |   |  |   |  |       |
|    | sDrive 16 d  | 85   | 07.12  |  | 11.9571-9753.2  | 220929   |    | D=57, - Halter   | ATE   |
|  | sDrive 18 d  | 105  | 10.09  |  | 11.9571-9754.2  | 220930   |    | D=57, - Halter   | ATE   |
|  | sDrive 18 i  | 110  | 03.10  |  | 11.0101-5402.2  | 260009   |   | Hülsensatz   | ATE   |
|  | sDrive 20 d  | 130  | 10.09  |  | 11.8171-0008.1  | 990049   |   | Führungsbolzen   | ATE   |
|  | sDrive 20 d  | 135  | 07.12  |  | 11.8116-0339.2  | 390528   | 2   | Haltefeder   | ATE   |
|  | sDrive 20 d ed   | 120  | 09.11  |  |   |  |   |  |       |
|  | sDrive 20 i  | 135  | 09.11  |  |   |  |   |  |       |
|  | xDrive 18 d  | 105  | 10.09  |  |   |  |   |  |       |
|  | xDrive 20 d  | 130  | 10.09  |  |   |  |   |  |       |
|  | xDrive 20 d  | 135  | 07.12  |  |   |  |   |  |       |
|  | xDrive 20 i  | 135  | 09.11  |  |   |  |   |  |       |
|  | xDrive 23 d  | 150  | 10.09  | 02.12  | 11.0101-5402.2  | 260009   |   | Hülsensatz   | ATE   |
|  | xDrive 25 i  | 160  | 03.10  | 02.12  | 11.8171-0008.1  | 990049   |   | Führungsbolzen   | ATE   |
|  | xDrive 28 i  | 180  | 04.11  | 02.12  | 11.8116-0339.2  | 390528   | 2   | Haltefeder   | ATE   |
|  | xDrive 28 i  | 190  | 10.09  |  |   |  |   |  |       |
|  |  |  |  |  | 11.0101-6006.2  | 260098   |   | Hülsensatz   | ATE   |
|  |  |  |  |  | 11.8171-0008.1  | 990049   |   | Führungsbolzen   | ATE   |
|  |  |  |  |  | 11.8171-0067.1  | 250153   |   | Führungsbolzen   | ATE   |
|  |  |  |  |  | 11.8116-0315.2  | 390447   | 2   | Haltefeder   | ATE   |
|  | xDrive 23 d  | 150  | 03.12  |  | 11.9571-9753.2  | 220929   |  | D=57, - Halter   | ATE   |
|  | xDrive 25 d  | 160  | 07.12  |  | 11.9571-9754.2  | 220930   |  | D=57, - Halter   | ATE   |
|  | xDrive 25 i  | 160  | 03.12  |  | 11.0101-5402.2  | 260009   |   | Hülsensatz   | ATE   |
|  | xDrive 28 i  | 180  | 03.12  |  | 11.8171-0008.1  | 990049   |   | Führungsbolzen   | ATE   |
|  |  |  |  |  | 11.8116-0339.2  | 390528   | 2   | Haltefeder   | ATE   |
|  | sDrive 16 d  | 85   | 07.12  |  | 11.9421-9911.2  | 220825   |  | D=42, - Halter   | ATE   |
|  | sDrive 18 d  | 105  | 10.09  |  | 11.9421-9912.2  | 220826   |  | D=42, - Halter   | ATE   |
|  | sDrive 18 i  | 110  | 03.10  |  | 11.0101-5402.2  | 260009   |   | Hülsensatz   | ATE   |
|  | sDrive 20 d  | 130  | 10.09  |  | 11.8171-0008.1  | 990049   |   | Führungsbolzen   | ATE   |
|  | sDrive 20 d  | 135  | 07.12  |  | 11.8116-0066.1  | 390577   | 2   | Haltefeder   | ATE   |
|  | sDrive 20 d ed   | 120  | 09.11  |  |   |  |   |  |       |
|  | sDrive 20 i  | 135  | 09.11  |  |   |  |   |  |       |
|  | xDrive 18 d  | 105  | 10.09  |  |   |  |   |  |       |
|  | xDrive 20 d  | 130  | 10.09  |  |   |  |   |  |       |
|  | xDrive 20 d  | 135  | 07.12  |  |   |  |   |  |       |
|  | xDrive 20 i  | 135  | 09.11  |  |   |  |   |  |       |
|  | xDrive 23 d  | 150  | 10.09  |  |   |  |   |  |       |
|  | xDrive 25 d  | 160  | 07.12  |  |   |  |   |  |       |
|  | xDrive 25 i  | 160  | 03.10  |  |   |  |   |  |       |
|  | xDrive 28 i  | 180  | 04.11  |  |   |  |   |  |       |
|  | xDrive 28 i  | 190  | 10.09  |  |   |  |   |  |       |
|  |  |  |  |  | 11.9441-9957.2  | 220827   |  | D=44, - Halter   | ATE   |
|  |  |  |  |  | 11.9441-9958.2  | 220828   |  | D=44, - Halter   | ATE   |
|  |  |  |  |  | 11.0101-5402.2  | 260009   |   | Hülsensatz   | ATE   |
|  |  |  |  |  | 11.8171-0008.1  | 990049   |   | Führungsbolzen   | ATE   |
|  |  |  |  |  | 11.8116-0296.1  | 390445   | 2   | Haltefeder   | ATE   |
|  | sDrive 16 d  | 85   | 07.12  |  | 83.7850-0180.3  | 331054   | 2   |  | L=180 |
|  | sDrive 18 d  | 105  | 10.09  |  | 83.7752-0221.3  | 331053   | 2   | am Bremssattel <sup>3)</sup>   | L=220 |
|  | sDrive 18 i  | 110  | 03.10  |  | 24.5137-0221.3  | 331302   | 2   | am Bremssattel <sup>3)</sup>   | L=221 |
|  | sDrive 20 d  | 130  | 10.09  |  | 24.5125-0230.3  | 331277   | 2   | am Bremssattel <sup>3)</sup>   | L=230 |
|  | sDrive 20 d  | 135  | 07.12  |  |   |  |   |  |       |
|  | sDrive 20 d ed   | 120  | 09.11  |  |   |  |   |  |       |
|  | sDrive 20 i  | 135  | 09.11  |  |   |  |   |  |       |
|  | xDrive 18 d  | 105  | 10.09  |  |   |  |   |  |       |
|  | xDrive 20 d  | 130  | 10.09  |  |   |  |   |  |       |
|  | xDrive 20 d  | 135  | 07.12  |  |   |  |   |  |       |
|  | xDrive 20 i  | 135  | 09.11  |  |   |  |   |  |       |
|  | xDrive 23 d  | 150  | 10.09  |  |   |  |   |  |       |

1) - idling stop system / - dispositivo start/stop / - unité marche/arrêt / - unidad arranque/paro  
2) + autom.transmission / + scatola cambio automatico / + transmission automatique / + cambio automatico  
3) on the brake caliper / sulla pinza freno / sur l'étrier de frein / a la pinza de freno

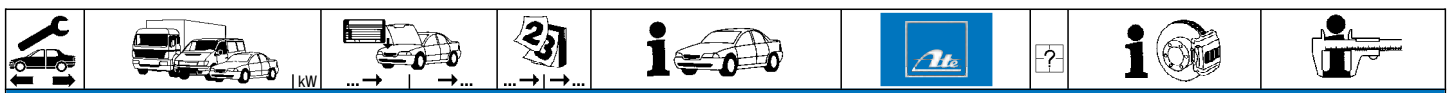























| BMW X1 (09-) |                |     |  |       |  |  |  |                |        |   |                              |          |  |
|--------------|----------------|-----|--|-------|--|--|--|----------------|--------|---|------------------------------|----------|--|
|              | xDrive 25 d    | 160 |  | 07.12 |  |  |  | 83.7850-0180.3 | 331054 | 2 |                              |          |  |
|              | xDrive 25 i    | 160 |  | 03.10 |  |  |  | 83.7752-0221.3 | 331053 | 2 | am Bremssattel <sup>1)</sup> | L=180    |  |
|              | xDrive 28 i    | 180 |  | 04.11 |  |  |  | 24.5137-0221.3 | 331302 | 2 | am Bremssattel <sup>1)</sup> | L=220    |  |
|              | xDrive 28 i    | 190 |  | 10.09 |  |  |  | 24.5125-0230.3 | 331277 | 2 | am Bremssattel <sup>1)</sup> | L=221    |  |
|              |                |     |  |       |  |  |  |                |        |   |                              | L=230    |  |
|              | sDrive 16 d    | 85  |  | 07.12 |  |  |  | 24.2419-1713.3 | 030093 |   |                              | Gz 19,05 |  |
|              | sDrive 18 d    | 105 |  | 10.09 |  |  |  |                |        |   |                              |          |  |
|              | sDrive 18 i    | 110 |  | 03.10 |  |  |  |                |        |   |                              |          |  |
|              | sDrive 20 d    | 130 |  | 10.09 |  |  |  |                |        |   |                              |          |  |
|              | sDrive 20 d    | 135 |  | 07.12 |  |  |  |                |        |   |                              |          |  |
|              | sDrive 20 d ed | 120 |  | 09.11 |  |  |  |                |        |   |                              |          |  |
|              | sDrive 20 i    | 135 |  | 09.11 |  |  |  |                |        |   |                              |          |  |
|              | xDrive 18 d    | 105 |  | 10.09 |  |  |  |                |        |   |                              |          |  |
|              | xDrive 20 d    | 130 |  | 10.09 |  |  |  |                |        |   |                              |          |  |
|              | xDrive 20 d    | 135 |  | 07.12 |  |  |  |                |        |   |                              |          |  |
|              | xDrive 20 i    | 135 |  | 09.11 |  |  |  |                |        |   |                              |          |  |
|              | xDrive 23 d    | 150 |  | 10.09 |  |  |  |                |        |   |                              |          |  |
|              | xDrive 25 d    | 160 |  | 07.12 |  |  |  |                |        |   |                              |          |  |
|              | xDrive 25 i    | 160 |  | 03.10 |  |  |  |                |        |   |                              |          |  |
|              | xDrive 28 i    | 180 |  | 04.11 |  |  |  |                |        |   |                              |          |  |
|              | xDrive 28 i    | 190 |  | 10.09 |  |  |  |                |        |   |                              |          |  |

| BMW X3 (03-10) |        |     |  |       |       |  |  |                |        |                          |  |                 |        |
|----------------|--------|-----|--|-------|-------|--|--|----------------|--------|--------------------------|--|-----------------|--------|
|                | 1.8 d  | 105 |  | 09.08 | 08.10 |  |  | 24.2025-1710.3 | 010833 |                          |  | THz 25,40/22,20 | LUC    |
|                | 2.0 d  | 110 |  | 09.07 | 08.10 |  |  |                |        |                          |  |                 |        |
|                | 2.0 d  | 110 |  | 08.04 | 08.10 |  |  |                |        |                          |  |                 |        |
|                | 2.0 i  | 110 |  | 07.05 | 08.10 |  |  |                |        |                          |  |                 |        |
|                | 2.5 i  | 141 |  | 03.04 | 08.06 |  |  |                |        |                          |  |                 |        |
|                | 2.5 si | 160 |  | 09.06 | 08.10 |  |  |                |        |                          |  |                 |        |
|                | 3.0 d  | 150 |  | 01.04 | 08.10 |  |  |                |        |                          |  |                 |        |
|                | 3.0 d  | 150 |  | 10.03 | 08.06 |  |  |                |        |                          |  |                 |        |
|                | 3.0 i  | 170 |  | 10.03 | 08.06 |  |  |                |        |                          |  |                 |        |
|                | 3.0 si | 200 |  | 09.06 | 08.10 |  |  |                |        |                          |  |                 |        |
|                | 1.8 d  | 105 |  | 09.08 | 08.10 |  |  | 24.3571-1733.5 | 240349 | <input type="checkbox"/> |  | D=57, - Halter  | ATE    |
|                | 2.0 d  | 110 |  | 09.07 | 08.10 |  |  | 24.3571-1734.5 | 240350 | <input type="checkbox"/> |  | D=57, - Halter  | ATE    |
|                | 2.0 d  | 110 |  | 08.04 | 08.10 |  |  | 11.0101-5402.2 | 260009 |                          |  | Hülzensatz      | ATE    |
|                | 2.0 i  | 110 |  | 07.05 | 08.10 |  |  | 11.8171-0008.1 | 990049 |                          |  | Führungsbolzen  | ATE    |
|                | 2.5 i  | 141 |  | 03.04 | 08.06 |  |  | 11.8116-0273.1 | 390515 | 2                        |  | Haltefeder      | ATE    |
|                | 2.5 si | 160 |  | 09.06 | 08.10 |  |  |                |        |                          |  |                 |        |
|                | 3.0 d  | 150 |  | 01.04 | 08.10 |  |  |                |        |                          |  |                 |        |
|                | 3.0 d  | 150 |  | 10.03 | 08.06 |  |  |                |        |                          |  |                 |        |
|                | 3.0 i  | 170 |  | 10.03 | 08.06 |  |  |                |        |                          |  |                 |        |
|                | 3.0 si | 200 |  | 09.06 | 08.10 |  |  |                |        |                          |  |                 |        |
|                | 3.0 sd | 210 |  | 09.06 | 08.10 |  |  | 24.3601-1713.5 | 240355 | <input type="checkbox"/> |  | D=60, - Halter  | ATE    |
|                |        |     |  |       |       |  |  | 24.3601-1714.5 | 240356 | <input type="checkbox"/> |  | D=60, - Halter  | ATE    |
|                |        |     |  |       |       |  |  | 11.0441-6007.2 | 250146 |                          |  | Dichtungssatz   | ATE    |
|                |        |     |  |       |       |  |  | 11.0101-5402.2 | 260009 |                          |  | Hülzensatz      | ATE    |
|                |        |     |  |       |       |  |  | 11.8171-0008.1 | 990049 |                          |  | Führungsbolzen  | ATE    |
|                |        |     |  |       |       |  |  | 11.8116-0290.2 | 390520 | 2                        |  | Haltefeder      | ATE    |
|                | 1.8 d  | 105 |  | 09.08 | 08.10 |  |  | 83.7751-0520.3 | 331052 | 2                        |  |                 | L=520  |
|                | 2.0 d  | 110 |  | 09.07 | 08.10 |  |  |                |        |                          |  |                 |        |
|                | 2.0 d  | 110 |  | 08.04 | 08.10 |  |  |                |        |                          |  |                 |        |
|                | 2.0 i  | 110 |  | 07.05 | 08.10 |  |  |                |        |                          |  |                 |        |
|                | 2.5 i  | 141 |  | 03.04 | 08.06 |  |  |                |        |                          |  |                 |        |
|                | 2.5 si | 160 |  | 09.06 | 08.10 |  |  |                |        |                          |  |                 |        |
|                | 3.0 d  | 150 |  | 01.04 | 08.10 |  |  |                |        |                          |  |                 |        |
|                | 3.0 d  | 150 |  | 10.03 | 08.06 |  |  |                |        |                          |  |                 |        |
|                | 3.0 i  | 170 |  | 10.03 | 08.06 |  |  |                |        |                          |  |                 |        |
|                | 3.0 si | 200 |  | 09.06 | 08.10 |  |  |                |        |                          |  |                 |        |
|                | 3.0 sd | 210 |  | 09.06 | 08.10 |  |  | 83.7751-0553.3 | 331103 | 2                        |  |                 | L=550  |
|                | 1.8 d  | 105 |  | 09.08 | 08.10 |  |  | 11.0101-5402.2 | 260009 |                          |  | Hülzensatz      | ATE    |
|                | 2.0 d  | 110 |  | 09.07 | 08.10 |  |  | 11.8171-0008.1 | 990049 |                          |  | Führungsbolzen  | ATE    |
|                | 2.0 d  | 110 |  | 08.04 | 08.10 |  |  | 11.8116-0296.1 | 390445 | 2                        |  | Haltefeder      | ATE    |
|                | 2.0 i  | 110 |  | 07.05 | 08.10 |  |  |                |        |                          |  |                 |        |
|                | 2.5 i  | 141 |  | 03.04 | 08.06 |  |  |                |        |                          |  |                 |        |
|                | 2.5 si | 160 |  | 09.06 | 08.10 |  |  |                |        |                          |  |                 |        |
|                | 3.0 d  | 150 |  | 01.04 | 08.10 |  |  |                |        |                          |  |                 |        |
|                | 3.0 d  | 150 |  | 10.03 | 08.06 |  |  |                |        |                          |  |                 |        |
|                | 3.0 i  | 170 |  | 10.03 | 08.06 |  |  |                |        |                          |  |                 |        |
|                | 3.0 sd | 210 |  | 09.06 | 08.10 |  |  |                |        |                          |  |                 |        |
|                | 3.0 si | 200 |  | 09.06 | 08.10 |  |  |                |        |                          |  |                 |        |
|                | 1.8 d  | 105 |  | 09.08 | 08.10 |  |  | 83.7750-0513.3 | 331051 | 2                        |  |                 | L=513  |
|                | 2.0 d  | 110 |  | 09.07 | 08.10 |  |  |                |        |                          |  |                 |        |
|                | 2.0 d  | 110 |  | 08.04 | 08.10 |  |  |                |        |                          |  |                 |        |
|                | 2.0 i  | 110 |  | 07.05 | 08.10 |  |  |                |        |                          |  |                 |        |
|                | 2.5 i  | 141 |  | 03.04 | 08.06 |  |  |                |        |                          |  |                 |        |
|                | 2.5 si | 160 |  | 09.06 | 08.10 |  |  |                |        |                          |  |                 |        |
|                | 3.0 d  | 150 |  | 01.04 | 08.10 |  |  |                |        |                          |  |                 |        |
|                | 3.0 d  | 150 |  | 10.03 | 08.06 |  |  |                |        |                          |  |                 |        |
|                | 3.0 i  | 170 |  | 10.03 | 08.06 |  |  |                |        |                          |  |                 |        |
|                | 3.0 sd | 210 |  | 09.06 | 08.10 |  |  |                |        |                          |  |                 |        |
|                | 3.0 si | 200 |  | 09.06 | 08.10 |  |  |                |        |                          |  |                 |        |
|                | 1.8 d  | 105 |  | 09.08 | 08.10 |  |  | 24.3727-0235.2 | 580235 | <input type="checkbox"/> |  |                 | L=1613 |
|                | 2.0 d  | 110 |  | 09.07 | 08.10 |  |  | 24.3727-0238.2 | 580238 | <input type="checkbox"/> |  |                 | L=1634 |
|                | 2.0 d  | 110 |  | 08.04 | 08.10 |  |  |                |        |                          |  |                 |        |
|                | 2.0 i  | 110 |  | 07.05 | 08.10 |  |  |                |        |                          |  |                 |        |
|                | 2.5 i  | 141 |  | 03.04 | 08.06 |  |  |                |        |                          |  |                 |        |
|                | 2.5 si | 160 |  | 09.06 | 08.10 |  |  |                |        |                          |  |                 |        |

















<sup>1)</sup> on the brake caliper / sulla pinza freno / sur l'étrier de frein / a la pinza de freno



|     |  |  |  |  |  |  |  |  |  |
|--|--|--|--|--|---|--|--|--|--|
| <b>BMW X3 (03-10)</b>  |  |  |  |  |   |  |  |  |  |
|    | 3.0 d  |  |  | 01.04  | 08.10   | 24.3727-0235.2   | 580235   | <input type="checkbox"/>   | L=1613<br>L=1634   |
|  | 3.0 d  | 150  |  | 10.03  | 08.06   | 24.3727-0238.2   | 580238   |  |  |
|  | 3.0 i  | 170  |  | 10.03  | 08.06   |  |  |  |  |
|  | 3.0 sd   | 210  |  | 09.06  | 08.10   |  |  |  |  |
|  | 3.0 si   | 200  |  | 09.06  | 08.10   |  |  |  |  |
|    | 1.8 d  | 105  |  | 09.08  | 08.10   | 24.2419-1713.3   | 030093   | <input type="checkbox"/>   | Gz 19,05   |
|  | 2.0 d  |  |  | 09.07  | 08.10   |  |  |  |  |
|  | 2.0 d  | 110  |  | 08.04  | 08.10   |  |  |  |  |
|  | 2.0 i  | 110  |  | 07.05  | 08.10   |  |  |  |  |
|  | 2.5 i  | 141  |  | 03.04  | 08.06   |  |  |  |  |
|  | 2.5 si   | 160  |  | 09.06  | 08.10   |  |  |  |  |
|  | 3.0 d  |  |  | 01.04  | 08.10   |  |  |  |  |
|  | 3.0 d  | 150  |  | 10.03  | 08.06   |  |  |  |  |
|  | 3.0 i  | 170  |  | 10.03  | 08.06   |  |  |  |  |
|  | 3.0 si   | 200  |  | 09.06  | 08.10   |  |  |  |  |
|    | 2.0 d  |  |  | 09.07  | 02.08   | 24.2522-1705.3   | 040079   | <input type="checkbox"/>   | Nz 22,20   |
|  | 2.0 d  | 110  |  | 08.04  | 02.08   |  |  |  |  |
|  | 2.0 i  | 110  |  | 07.05  | 02.08   |  |  |  |  |
|  | 2.5 i  | 141  |  | 03.04  | 08.06   |  |  |  |  |
|  | 2.5 si   | 160  |  | 09.06  | 02.08   |  |  |  |  |
|  | 3.0 d  |  |  | 01.04  | 02.08   |  |  |  |  |
|  | 3.0 d  | 150  |  | 10.03  | 08.06   |  |  |  |  |
|  | 3.0 i  | 170  |  | 10.03  | 08.06   |  |  |  |  |
|  | 3.0 si   | 200  |  | 09.06  | 02.08   |  |  |  |  |
| <b>BMW X5 (00-07)</b>  |  |  |  |  |   |  |  |  |  |
|    | 3.0 d  | 135  |  | 05.01  | 08.01   | 24.2025-1704.3   | 010619   | <input type="checkbox"/>   | Thz 25,40  |
|  | 3.0 i  | 170  |  | 04.00  | 08.01   |  |  |  |  |
|  | 4.4 i  | 210  |  | 04.00  | 08.01   |  |  |  |  |
|    | 3.0 d  |  |  | 10.03  | 12.06   | 24.2025-1707.3   | 010691   | <input type="checkbox"/>   | Thz 25,40  |
|  | 3.0 d  | 135  |  | 09.01  | 09.03   |  |  |  |  |
|  | 3.0 i  | 170  |  | 09.01  | 12.06   |  |  |  |  |
|  | 4.4 i  | 210  |  | 09.01  | 12.06   |  |  |  |  |
|  | 4.4 i  | 235  |  | 10.03  | 12.06   |  |  |  |  |
|  | 4.6 iS   | 255  |  | 12.01  | 09.03   |  |  |  |  |
|  | 4.8 iS   | 265  |  | 03.04  | 12.06   |  |  |  |  |
|    | 3.0 d  |  |  | 10.03  | 12.06   | 24.3601-1713.5   | 240355   | <input type="checkbox"/>   | D=60, - Halter<br>D=60, - Halter<br>Hülzensatz<br>Führungsbolzen<br>Haltefeder                                     |
|  | 3.0 d  | 135  |  | 05.01  | 09.03   | 24.3601-1714.5   | 240356   |  |  |
|  | 3.0 i  | 170  |  | 04.00  | 12.06   | 11.0101-5402.2   | 260009   |  |  |
|  | 4.4 i  | 210  |  | 04.00  | 09.03   | 11.8171-0008.1   | 990049   |  |  |
|  | 4.4 i  | 235  |  | 10.03  | 12.06   | 11.8116-0290.2   | 390520   |  |  |
|  | 4.4 i  | 235  |  | 10.03  | 12.06   | 11.0101-5706.2   | 260097   | 2  | Hülzensatz<br>Führungsbolzen<br>Haltefeder   |
|  | 4.6 iS   | 255  |  | 12.01  | 09.03   | 11.8171-0067.1   | 250153   |  |  |
|  | 4.8 iS   | 265  |  | 03.04  | 12.06   | 11.8116-0334.2   | 390475   |  |  |
|  |  |  |  |  |   |  |  |  |  |
|  | 3.0 d  |  |  | 10.03  | 12.06   | 83.6150-0481.3   | 330542   | 2  | L=480  |
|  | 3.0 d  | 135  |  | 05.01  | 09.03   |  |  |  |  |
|  | 3.0 i  | 170  |  | 04.00  | 12.06   |  |  |  |  |
|  | 4.4 i  | 210  |  | 04.00  | 09.03   |  |  |  |  |
|  | 4.4 i  | 235  |  | 10.03  | 12.06   |  |  |  |  |
|  | 4.6 iS   | 255  |  | 12.01  | 09.03   |  |  |  |  |
|  | 4.8 iS   | 265  |  | 03.04  | 12.06   |  |  |  |  |
|  | 3.0 d  |  |  | 10.03  | 12.06   | 11.9421-9963.2   | 220465   | <input type="checkbox"/>   | D=42, - Halter<br>D=42, - Halter<br>Haltersatz<br>Hülzensatz<br>Führungsbolzen<br>Haltefeder                       |
|  | 3.0 d  | 135  |  | 05.01  | 09.03   | 11.9421-9964.2   | 220466   |  |  |
|  | 3.0 i  | 170  |  | 04.00  | 12.06   | 11.0230-0119.2   | 260089   |  |  |
|  | 4.4 i  | 210  |  | 04.00  | 09.03   | 11.0101-5402.2   | 260009   |  |  |
|  |  |  |  |  |   | 11.8171-0008.1   | 990049   |  |  |
|  |  |  |  |  |   | 11.8116-0296.1   | 390445   |  |  |
|  | 4.4 i  | 235  |  | 10.03  | 12.06   | 24.3421-9937.5   | 240563   | 2  | D=42, - Halter<br>D=42, - Halter<br>D=42, - Halter<br>D=42, - Halter<br>Hülzensatz<br>Führungsbolzen<br>Haltefeder |
|  | 4.6 iS   | 255  |  | 12.01  | 09.03   | 24.3421-9938.5   | 240564   |  |  |
|  | 4.8 iS   | 265  |  | 03.04  | 12.06   | 11.9421-9937.2   | 220909   |  |  |
|  |  |  |  |  |   | 11.9421-9938.2   | 220910   |  |  |
|  |  |  |  |  |   | 11.0101-5402.2   | 260009   |  |  |
|  |  |  |  |  |   | 11.8171-0008.1   | 990049   |  |  |
|  | 3.0 d  |  |  | 10.03  | 12.06   | 83.1064-0050.3   | 330784   | <input type="checkbox"/>   | L=570, + Rohrleitung<br>L=570, + Rohrleitung<br>L=272, + Rohrleitung   |
|  | 3.0 d  | 135  |  | 05.01  | 09.03   | 83.1064-0060.3   | 330785   |  |  |
|  | 3.0 i  | 170  |  | 04.00  | 12.06   | 24.5157-0273.3   | 331305   |  |  |
|  | 4.4 i  | 210  |  | 04.00  | 09.03   |  |  |  |  |
|  | 4.4 i  | 235  |  | 10.03  | 12.06   |  |  |  |  |
|  | 3.0 d  |  |  | 10.03  | 12.06   | 24.3727-0231.2   | 580231   | 2  | L=1942   |
|  | 3.0 d  | 135  |  | 05.01  | 09.03   |  |  |  |  |
|  | 3.0 i  | 170  |  | 04.00  | 12.06   |  |  |  |  |
|  | 4.4 i  | 210  |  | 04.00  | 09.03   |  |  |  |  |
|  | 4.4 i  | 235  |  | 10.03  | 12.06   |  |  |  |  |
|  | 4.6 iS   | 255  |  | 12.01  | 09.03   |  |  |  |  |
|  | 3.0 d  | 135  |  | 05.01  | 08.01   | 24.2419-1713.3   | 030093   | <input type="checkbox"/>   | Gz 19,05   |
|  | 3.0 i  | 170  |  | 04.00  | 08.01   |  |  |  |  |
|  | 3.0 d  |  |  | 10.03  | 12.06   | 24.2419-1733.3   | 030125   | <input type="checkbox"/>   | Gz 19,05   |
|  | 3.0 d  | 135  |  | 09.01  | 09.03   |  |  |  |  |
|  | 3.0 i  | 170  |  | 09.01  | 12.06   |  |  |  |  |

















1) - special vehicles / - veicoli speciali / - véhicules spécial / - vehículo especial

2) + special vehicles / + veicolo speciale / + véhicule spécial / + vehículo especial





































|     |   |                |    |    |  |  |  |  |
|--|---|--|--|--|---|--|--|--|
| <b>BMW X5 (00-07)</b>  |   |  |  |  |   |  |  |  |
|    | 3.0 d<br>3.0 d<br>3.0 i   | 135  | 10.03<br>05.01<br>04.00  | 12.06<br>09.03<br>12.06  | 24.2522-0905.3  | 040042   |  | Nz 22,20   |
| <b>BMW X5 (07-13)</b>  |   |  |  |  |   |  |  |  |
|    | 3.0 d<br>3.0 sd<br>3.0 si<br>4.8 i<br>M<br>xDrive 30 d<br>xDrive 30 d<br>xDrive 30 i<br>xDrive 35 d<br>xDrive 35 i<br>xDrive 40 d<br>xDrive 48 i<br>xDrive 50 i<br>xDrive M50 d | 173<br>210<br>200<br>261<br>408<br>173<br>180<br>200<br>210<br>225<br>225<br>261<br>300<br>280 | 01.07<br>09.07<br>01.07<br>01.07<br>09.09<br>09.08<br>09.10<br>09.08<br>09.08<br>09.10<br>09.10<br>09.08<br>03.10<br>06.12 | 07.13<br>07.13<br>07.13<br>07.13<br>07.13<br>07.13<br>07.13<br>07.13<br>07.13<br>07.13<br>07.13<br>07.13<br>07.13<br>07.13 | 24.2026-1703.3  | 010910   |  | Thz 26,99/22,20 <b>LUC</b>   |
|    | 3.0 d<br>3.0 sd<br>3.0 si<br>xDrive 30 d<br>xDrive 30 d<br>xDrive 30 i<br>xDrive 35 d<br>xDrive 35 i<br>xDrive 40 d   | 173<br>210<br>200<br>173<br>180<br>200<br>210<br>225<br>225                                    | 01.07<br>10.08<br>01.07<br>09.08<br>09.10<br>09.08<br>09.08<br>09.10<br>09.10  | 07.13<br>07.13<br>07.13<br>07.13<br>07.13<br>07.13<br>07.13<br>07.13<br>07.13  | 11.0441-6008.2<br>11.0101-5402.2<br>11.8171-0008.1                                | 250038<br>260009<br>990049   |  | Dichtungssatz<br>Hülzensatz<br>Führungsbolzen <b>ATE</b>                           |
|  | 4.8 i<br>xDrive 48 i  | 261<br>261   | 01.07<br>09.08   | 07.13<br>07.13   | 11.0101-5402.2<br>11.8171-0008.1  | 260009<br>990049   |  | Hülzensatz<br>Führungsbolzen <b>ATE</b>  |
|    | 3.0 d<br>3.0 sd<br>3.0 si<br>4.8 i<br>M<br>xDrive 30 d<br>xDrive 30 d<br>xDrive 30 i<br>xDrive 35 d<br>xDrive 35 i<br>xDrive 40 d<br>xDrive 48 i<br>xDrive 50 i<br>xDrive M50 d | 173<br>210<br>200<br>261<br>408<br>173<br>180<br>200<br>210<br>225<br>225<br>261<br>300<br>280 | 01.07<br>09.07<br>01.07<br>01.07<br>09.09<br>09.08<br>09.10<br>09.08<br>09.08<br>09.10<br>09.10<br>09.08<br>03.10<br>06.12 | 07.13<br>07.13<br>07.13<br>07.13<br>07.13<br>07.13<br>07.13<br>07.13<br>07.13<br>07.13<br>07.13<br>07.13<br>07.13<br>07.13 | 83.6151-0602.3  | 330893   | 2  | L=600  |
|  | 3.0 d<br>3.0 sd<br>3.0 si<br>xDrive 30 d<br>xDrive 30 d<br>xDrive 30 i<br>xDrive 35 d<br>xDrive 35 i<br>xDrive 40 d   | 173<br>210<br>200<br>173<br>180<br>200<br>210<br>225<br>225                                    | 01.07<br>10.09<br>01.07<br>09.08<br>09.10<br>09.08<br>09.08<br>09.10<br>09.10  | 07.13<br>07.13<br>07.13<br>07.13<br>07.13<br>07.13<br>07.13<br>07.13<br>07.13  | 11.0101-5402.2<br>11.8171-0008.1<br>11.8116-0330.1                                | 260009<br>990049<br>390472   | 2  | Hülzensatz<br>Führungsbolzen<br>Haltefeder <b>ATE</b>                              |
|  | 3.0 sd<br>4.8 i<br>xDrive 48 i<br>xDrive 50 i<br>xDrive M50 d   | 210<br>261<br>261<br>300<br>280  | 09.07<br>01.07<br>09.08<br>03.10<br>06.12  | 09.09<br>07.13<br>07.13<br>07.13<br>07.13  | 11.0101-5402.2<br>11.8171-0008.1<br>11.8116-0330.1                                | 260009<br>990049<br>390472   | 2  | Hülzensatz<br>Führungsbolzen<br>Haltefeder <b>ATE</b>                              |
|  | 3.0 d<br>3.0 si<br>4.8 i  | 173<br>200<br>261  | 01.07<br>01.07<br>01.07  | 04.07<br>04.07<br>04.07  | 83.6255-0200.3<br>83.6150-0436.3  | 330896<br>330890   | 2<br>2   | am Bremssattel <sup>1)</sup><br>L=200<br>L=435                                     |
|  | 3.0 d<br>3.0 sd<br>3.0 si<br>4.8 i<br>M<br>xDrive 30 d<br>xDrive 30 d<br>xDrive 30 i<br>xDrive 35 d<br>xDrive 35 i<br>xDrive 40 d<br>xDrive 48 i<br>xDrive 50 i<br>xDrive M50 d | 173<br>210<br>200<br>261<br>408<br>173<br>180<br>200<br>210<br>225<br>225<br>261<br>300<br>280 | 05.07<br>09.07<br>05.07<br>05.07<br>09.09<br>09.08<br>09.10<br>09.08<br>09.08<br>09.10<br>09.10<br>09.08<br>03.10<br>06.12 | 07.13<br>07.13<br>07.13<br>07.13<br>07.13<br>07.13<br>07.13<br>07.13<br>07.13<br>07.13<br>07.13<br>07.13<br>07.13<br>07.13 | 83.7850-0205.3<br>83.7827-0245.3<br>83.6150-0436.3                                | 331115<br>331113<br>330890   | 2<br>2   | am Bremssattel <sup>1)</sup><br>L=205<br>L=245<br>L=435                            |
| <b>BMW X5 (13-)</b>  |   |  |  |  |   |  |  |  |
|  | xDrive 30 d<br>xDrive 50 d<br>xDrive 50 i   | 190<br>190<br>330  | 08.13<br>08.13<br>08.13  |  | 24.2026-1703.3  | 010910   |  | Thz 26,99/22,20 <b>LUC</b>   |

<sup>1)</sup> on the brake caliper / sulla pinza freno / sur l'étrier de frein / a la pinza de freno



|     |  |  |  |  |  |  |     |  |     |
|--|--|--|--|--|---|--|---|--|-----|
| <b>BMW X6 (08-)</b>  |  |  |  |  |   |  |   |  |     |
|    | 30 d   | 173  |  | 05.08  | 24.2026-1703.3  | 010910   |   | THz 26,99/22,20  | LUC |
|  | 35 d   | 210  |  | 01.08  |   |  |   |  |     |
|  | 35 i   | 225  |  | 01.08  |   |  |   |  |     |
|  | 50 i   | 300  |  | 05.08  |   |  |   |  |     |
|  | M  | 408  |  | 09.09  |   |  |   |  |     |
|  | xDrive 30 d  |  |  | 09.08  |   |  |   |  |     |
|  | xDrive 30 d  | 180  |  | 09.10  |   |  |   |  |     |
|  | xDrive 35 d  | 210  |  | 09.08  |   |  |   |  |     |
|  | xDrive 35 i  | 225  |  | 09.08  |   |  |   |  |     |
|  | xDrive 40 d  | 225  |  | 10.10  |   |  |   |  |     |
|  | xDrive 50 i  | 300  |  | 09.08  |   |  |   |  |     |
|  | xDrive M50 d   | 280  |  | 06.12  |   |  |   |  |     |
|    | 30 d   | 173  |  | 11.08  | 11.0441-6008.2  | 250038   |   | Dichtungssatz  | ATE |
|  | 35 d   | 210  |  | 11.08  | 11.0101-5402.2  | 260009   |   | Hülssensatz  | ATE |
|  | 35 i   | 225  |  | 11.08  | 11.8171-0008.1  | 990049   |   | Führungsbolzen   | ATE |
|  | xDrive 30 d  |  |  | 11.08  |   |  |   |  |     |
|  | xDrive 30 d  | 180  |  | 09.10  |   |  |   |  |     |
|  | xDrive 35 d  | 210  |  | 11.08  |   |  |   |  |     |
|  | xDrive 35 i  | 225  |  | 11.08  |   |  |   |  |     |
|  | xDrive 40 d  | 225  |  | 10.10  |   |  |   |  |     |
|  | 50 i   | 300  |  | 05.08  | 11.0441-6008.2  | 250038   |   | Dichtungssatz  | ATE |
|  | ActiveHybrid   | 357  |  | 10.10  |   |  |   |  |     |
|  | xDrive 50 i  | 300  |  | 09.08  |   |  |   |  |     |
|  | xDrive M50 d   | 280  |  | 06.12  |   |  |   |  |     |
|    | 30 d   | 173  |  | 05.08  | 83.6151-0602.3  | 330893   | 2   | L=600  |     |
|  | 35 d   | 210  |  | 01.08  |   |  |   |  |     |
|  | 35 i   | 225  |  | 01.08  |   |  |   |  |     |
|  | 50 i   | 300  |  | 05.08  |   |  |   |  |     |
|  | ActiveHybrid   | 357  |  | 10.10  |   |  |   |  |     |
|  | M  | 408  |  | 09.09  |   |  |   |  |     |
|  | xDrive 30 d  |  |  | 09.08  |   |  |   |  |     |
|  | xDrive 30 d  | 180  |  | 09.10  |   |  |   |  |     |
|  | xDrive 35 d  | 210  |  | 09.08  |   |  |   |  |     |
|  | xDrive 35 i  | 225  |  | 09.08  |   |  |   |  |     |
|  | xDrive 40 d  | 225  |  | 10.10  |   |  |   |  |     |
|  | xDrive 50 i  | 300  |  | 09.08  |   |  |   |  |     |
|  | xDrive M50 d   | 280  |  | 06.12  |   |  |   |  |     |
|    | 30 d   | 173  |  | 05.08  | 11.0101-5402.2  | 260009   |   | Hülssensatz  | ATE |
|  | xDrive 30 d  |  |  | 09.08  | 11.8171-0008.1  | 990049   |   | Führungsbolzen   | ATE |
|  | xDrive 30 d  | 180  |  | 09.10  | 11.8116-0330.1  | 390472   | 2   | Haltefeder   | ATE |
|  | xDrive 40 d  | 225  |  | 10.10  |   |  |   |  |     |
|  | 35 d   | 210  |  | 01.08  | 11.0101-5402.2  | 260009   |   | Hülssensatz  | ATE |
|  | 35 i   | 225  |  | 01.08  | 11.8171-0008.1  | 990049   |   | Führungsbolzen   | ATE |
|  | xDrive 35 d  | 210  |  | 09.08  | 11.8116-0330.1  | 390472   | 2   | Haltefeder   | ATE |
|  | xDrive 35 i  | 225  |  | 09.08  |   |  |   |  |     |
|  | xDrive M50 d   | 280  |  | 06.12  |   |  |   |  |     |
|  | 50 i   | 300  |  | 05.08  | 11.0101-5402.2  | 260009   |   | Hülssensatz  | ATE |
|  | ActiveHybrid   | 357  |  | 10.10  | 11.8171-0008.1  | 990049   |   | Führungsbolzen   | ATE |
|  | xDrive 50 i  | 300  |  | 09.08  | 11.8116-0330.1  | 390472   | 2   | Haltefeder   | ATE |
|  | 30 d   | 173  |  | 05.08  | 83.7850-0205.3  | 331115   |  | L=205  |     |
|  | 35 d   | 210  |  | 01.08  | 83.7827-0245.3  | 331113   |   | L=245  |     |
|  | 35 i   | 225  |  | 01.08  | 83.6150-0436.3  | 330890   | 2   | L=435  |     |
|  | 50 i   | 300  |  | 05.08  |   |  |   |  |     |
|  | ActiveHybrid   | 357  |  | 10.10  |   |  |   |  |     |
|  | M  | 408  |  | 09.09  |   |  |   |  |     |
|  | xDrive 30 d  |  |  | 09.08  |   |  |   |  |     |
|  | xDrive 30 d  | 180  |  | 09.10  |   |  |   |  |     |
|  | xDrive 35 d  | 210  |  | 09.08  |   |  |   |  |     |
|  | xDrive 35 i  | 225  |  | 09.08  |   |  |   |  |     |
|  | xDrive 40 d  | 225  |  | 10.10  |   |  |   |  |     |
|  | xDrive 50 i  | 300  |  | 09.08  |   |  |   |  |     |
|  | xDrive M50 d   | 280  |  | 06.12  |   |  |   |  |     |
| <b>BMW Z3 (95-02)</b>  |  |  |  |  |   |  |   |  |     |
|  | 1.8  | 85   |  | 10.95  | 10.98   | 03.7760-3102.4   | 300139  | 10"  | ATE |
|  | 1.9  |  |  | 10.95  | 12.02   |  |   |  |     |
|  | 2.0  | 110  |  | 04.99  | 08.00   |  |   |  |     |
|  | 2.2  | 125  |  | 10.00  | 12.02   |  |   |  |     |
|  | 2.8 Coupe  | 141  |  | 07.97  | 06.00   |  |   |  |     |
|  | 2.8 Roadster   | 141  |  | 05.97  | 06.00   |  |   |  |     |
|  | 3.0 Coupe  | 170  |  | 06.00  | 12.02   |  |   |  |     |
|  | 3.0 Roadster   | 170  |  | 06.00  | 12.02   |  |   |  |     |
|  | M Coupe  |  |  | 02.98  | 12.02 + S54   | 03.7860-1202.4   | 300187  | 10"  | ATE |
|  | M Roadster   |  |  | 03.97  | 12.02 + S54   |  |   |  |     |
|  | 1.8  | 85   |  | 10.95  | 10.98   | 03.2023-0987.3   | 010473  | THz 23,81/20,64  | ATE |
|  | 1.9  |  |  | 10.95  | 12.02   |  |   |  |     |
|  | 2.0  | 110  |  | 04.99  | 08.00   |  |   |  |     |
|  | 2.2  | 125  |  | 10.00  | 12.02   |  |   |  |     |
|  | 2.8 Coupe  | 141  |  | 07.97  | 06.00   |  |   |  |     |
|  | 2.8 Roadster   | 141  |  | 05.97  | 06.00   |  |   |  |     |
|  | 3.0 Coupe  | 170  |  | 06.00  | 12.02   |  |   |  |     |
|  | 3.0 Roadster   | 170  |  | 06.00  | 12.02   |  |   |  |     |
|  | 2.0  | 110  |  | 04.99  | 08.00   | 03.2023-1904.3   | 010724  | THz 23,81/20,64  | ATE |
|  | 2.8 Coupe  | 141  |  | 07.97  | 06.00   |  |   |  |     |
|  | 2.8 Roadster   | 141  |  | 05.97  | 06.00   |  |   |  |     |
|  | 3.0 Coupe  | 170  |  | 06.00  | 08.00   |  |   |  |     |













































1) on the brake caliper / sulla pinza freno / sur l'étrier de frein / a la pinza de freno

























|     |  |  |  |  |  |  |  |  |   |   |          |
|--|--|--|--|--|---|--|--|--|---|---|----------|
| <b>BMW Z3 (95-02)</b>  |  |  |  |  |   |  |  |  |   |   |          |
|    | 3.0 Roadster   | 170  |  | 06.00  | 08.00   | + DSC  | 03.2023-1904.3   | 010724   |   | THz 23,81/20,64   | ATE      |
|  | 2.2  | 125  |  | 10.00  | 12.02   | + DSC  | 03.2023-1949.3   | 010725   |   | THz 23,81/20,64   | ATE      |
|  | 3.0 Coupe  | 170  |  | 09.00  | 12.02   | + DSC  |  |  |   |   |          |
|  | 3.0 Roadster   | 170  |  | 09.00  | 12.02   | + DSC  |  |  |   |   |          |
|  | M Coupe  |  |  | 02.98  | 12.02   | + S50  | 24.2025-1701.3   | 010490   |   | THz 25,40/20,64   | LUC      |
|  | M Roadster   |  |  | 03.97  | 12.02   | + S50  |  |  |   |   |          |
|    | 1.8  | 85   |  | 10.95  | 10.98   |  | 11.9541-9667.2   | 220421   |    | D=54, - Halter  | ATE      |
|  | 1.9  |  |  | 10.95  | 12.02   |  | 11.9541-9668.2   | 220422   |    | D=54, - Halter  | ATE      |
|  |  |  |  |  |   |  | 24.3541-9667.5   | 240529   |    | D=54, - Halter  | ATE      |
|  |  |  |  |  |   |  | 24.3541-9668.5   | 240530   |    | D=54, - Halter  | ATE      |
|  |  |  |  |  |   |  | 11.0441-5402.2   | 250028   |   | Dichtungssatz   | ATE      |
|  |  |  |  |  |   |  | 11.0230-0097.2   | 260092   |   | Haltersatz  | ATE      |
|  |  |  |  |  |   |  | 11.0101-5402.2   | 260009   |   | Hülsensatz  | ATE      |
|  |  |  |  |  |   |  | 11.8171-0008.1   | 990049   |   | Führungsbolzen  | ATE      |
|  |  |  |  |  |   |  | 11.8116-0109.1   | 390495   | 2   | bis 06.96 <sup>1)</sup>   | ATE      |
|  |  |  |  |  |   |  | 11.8116-0206.1   | 390593   | 2   | ab 07.96 <sup>2)</sup>  | ATE      |
|  |  |  |  |  |   |  |  |  |   | Haltefeder  | ATE      |
|  | 2.0  | 110  |  | 04.99  | 08.00   |  | 11.9541-9587.2   | 220419   |    | D=54, - Halter  | ATE      |
|  | 2.2  | 125  |  | 10.00  | 12.02   |  | 11.9541-9588.2   | 220420   |    | D=54, - Halter  | ATE      |
|  | 2.8 Coupe  | 141  |  | 07.97  | 06.00   |  | 24.3541-9587.5   | 240527   |    | D=54, - Halter  | ATE      |
|  | 2.8 Roadster   | 141  |  | 05.97  | 06.00   |  | 24.3541-9588.5   | 240528   |    | D=54, - Halter  | ATE      |
|  |  |  |  |  |   |  | 11.0441-5402.2   | 250028   |   | Dichtungssatz   | ATE      |
|  |  |  |  |  |   |  | 11.8170-0729.1   | 260107   | 2   | Halter  | ATE      |
|  |  |  |  |  |   |  | 11.0101-5402.2   | 260009   |   | Hülsensatz  | ATE      |
|  |  |  |  |  |   |  | 11.8171-0008.1   | 990049   |   | Führungsbolzen  | ATE      |
|  |  |  |  |  |   |  | 11.8116-0109.1   | 390495   | 2   | Haltefeder  | ATE      |
|  | 3.0 Coupe  | 170  |  | 06.00  | 12.02   |  | 11.9541-9587.2   | 220419   |    | D=54, - Halter  | ATE      |
|  | 3.0 Roadster   | 170  |  | 06.00  | 12.02   |  | 11.9541-9588.2   | 220420   |    | D=54, - Halter  | ATE      |
|  |  |  |  |  |   |  | 24.3541-9587.5   | 240527   |    | D=54, - Halter  | ATE      |
|  |  |  |  |  |   |  | 24.3541-9588.5   | 240528   |    | D=54, - Halter  | ATE      |
|  |  |  |  |  |   |  | 11.0441-5402.2   | 250028   |   | Dichtungssatz   | ATE      |
|  |  |  |  |  |   |  | 11.0230-0234.2   | 260084   |   | Haltersatz  | ATE      |
|  |  |  |  |  |   |  | 11.0101-5402.2   | 260009   |   | Hülsensatz  | ATE      |
|  |  |  |  |  |   |  | 11.8171-0008.1   | 990049   |   | Führungsbolzen  | ATE      |
|  |  |  |  |  |   |  | 11.8116-0109.1   | 390495   | 2   | Haltefeder  | ATE      |
|  | M Coupe  |  |  | 02.98  | 12.02   |  | 11.3601-8515.2   | 220323   |    | D=60, - Halter  | ATE      |
|  | M Roadster   |  |  | 03.97  | 12.02   |  | 11.3601-8516.2   | 220324   |    | D=60, - Halter  | ATE      |
|  |  |  |  |  |   |  | 11.0441-6003.2   | 250037   |   | Dichtungssatz   | ATE      |
|  |  |  |  |  |   |  | 11.0101-5402.2   | 260009   |   | Hülsensatz  | ATE      |
|  |  |  |  |  |   |  | 11.8171-0008.1   | 990049   |   | Führungsbolzen  | ATE      |
|  |  |  |  |  |   |  | 11.8116-0083.1   | 390501   | 2   | Haltefeder  | ATE      |
|   | 1.8  | 85   |  | 10.95  | 10.98   |  | 83.6150-0426.3   | 330282   | 2   |   | L=425    |
|  | 1.9  |  |  | 10.95  | 12.00   |  |  |  |   |   |          |
|  | 2.0  | 110  |  | 04.99  | 08.00   |  |  |  |   |   |          |
|  | 2.2  | 125  |  | 10.00  | 12.02   |  |  |  |   |   |          |
|  | 2.8 Coupe  | 141  |  | 07.97  | 06.00   |  |  |  |   |   |          |
|  | 2.8 Roadster   | 141  |  | 05.97  | 06.00   |  |  |  |   |   |          |
|  | 3.0 Coupe  | 170  |  | 06.00  | 12.02   |  |  |  |   |   |          |
|  | 3.0 Roadster   | 170  |  | 06.00  | 12.02   |  |  |  |   |   |          |
|  | M Coupe  |  |  | 02.98  | 12.02   |  | 83.6150-0451.3   | 330283   | 2   |   | L=450    |
|  | M Roadster   |  |  | 03.97  | 12.02   |  |  |  |   |   |          |
|  | 1.8  | 85   |  | 10.95  | 10.98   |  | 11.3361-8505.2   | 220024   |  | D=36, - Halter  | ATE      |
|  | 1.9  |  |  | 10.95  | 12.02   |  | 11.3361-8506.2   | 220025   |  | D=36, - Halter  | ATE      |
|  | 2.0  | 110  |  | 04.99  | 08.00   |  | 11.0441-3602.2   | 250008   |   | Dichtungssatz   | ATE      |
|  | 2.2  | 125  |  | 10.00  | 12.02   |  | 11.0101-5402.2   | 260009   |   | Hülsensatz  | ATE      |
|  | 2.8 Coupe  | 141  |  | 07.97  | 06.00   |  | 11.8171-0008.1   | 990049   |   | Führungsbolzen  | ATE      |
|  | 2.8 Roadster   | 141  |  | 05.97  | 06.00   |  | 11.8116-0185.1   | 390592   | 2   | Haltefeder  | ATE      |
|  | 3.0 Coupe  | 170  |  | 06.00  | 12.02   |  |  |  |   |   |          |
|  | 3.0 Roadster   | 170  |  | 06.00  | 12.02   |  |  |  |   |   |          |
|  | M Coupe  |  |  | 02.98  | 12.02   |  | 11.9401-9959.2   | 220833   |  | D=40, - Halter  | ATE      |
|  | M Roadster   |  |  | 03.97  | 12.02   |  | 11.9401-9960.2   | 220834   |  | D=40, - Halter  | ATE      |
|  |  |  |  |  |   |  | 11.0441-4002.2   | 250011   |   | Dichtungssatz   | ATE      |
|  |  |  |  |  |   |  | 11.0101-5402.2   | 260009   |   | Hülsensatz  | ATE      |
|  |  |  |  |  |   |  | 11.8171-0008.1   | 990049   |   | Führungsbolzen  | ATE      |
|  | 1.8  | 85   |  | 10.95  | 10.98   |  | 83.6240-0220.3   | 330465   | 2   |   | L=220    |
|  | 1.9  |  |  | 10.95  | 12.02   |  | 83.7704-0200.3   | 330825   | 2   | am Bremsattel <sup>3)</sup>   | L=200    |
|  | 2.0  | 110  |  | 04.99  | 08.00   |  |  |  |   |   |          |
|  | 2.2  | 125  |  | 10.00  | 12.02   |  |  |  |   |   |          |
|  | 2.8 Coupe  | 141  |  | 07.97  | 06.00   |  |  |  |   |   |          |
|  | 2.8 Roadster   | 141  |  | 05.97  | 06.00   |  |  |  |   |   |          |
|  | 3.0 Coupe  | 170  |  | 06.00  | 12.02   |  |  |  |   |   |          |
|  | 3.0 Roadster   | 170  |  | 06.00  | 12.02   |  |  |  |   |   |          |
|  | 1.8  | 85   |  | 10.95  | 10.98   |  | 24.3727-0228.2   | 580228   | 2   |  | L=1255   |
|  | 1.9  |  |  | 10.95  | 12.02   |  |  |  |   |   |          |
|  | 2.0  | 110  |  | 04.99  | 08.00   |  | 24.3727-0229.2   | 580229   | 2   |  | L=1283   |
|  | 2.2  | 125  |  | 10.00  | 12.00   |  |  |  |   |   |          |
|  | 2.8 Coupe  | 141  |  | 07.97  | 06.00   |  |  |  |   |   |          |
|  | 2.8 Roadster   | 141  |  | 05.97  | 06.00   |  |  |  |   |   |          |
|  | 3.0 Coupe  | 170  |  | 06.00  | 12.00   |  |  |  |   |   |          |
|  | 3.0 Roadster   | 170  |  | 06.00  | 12.00   |  |  |  |   |   |          |
|  | M Coupe  |  |  | 02.98  | 12.00   |  |  |  |   |   |          |
|  | M Roadster   |  |  | 03.97  | 12.00   |  |  |  |   |   |          |
|  | 1.8  | 85   |  | 10.95  | 10.98   |  | 24.2419-1718.3   | 030094   |   |   | Gz 19,05 |
|  | 1.9  |  |  | 10.95  | 12.02   |  |  |  |   |   |          |
|  | 2.0  | 110  |  | 04.99  | 08.00   |  |  |  |   |   |          |
|  | 2.2  | 125  |  | 10.00  | 12.02   |  |  |  |   |   |          |
|  | 2.8 Coupe  | 141  |  | 07.97  | 06.00   |  |  |  |   |   |          |
|  | 2.8 Roadster   | 141  |  | 05.97  | 06.00   |  |  |  |   |   |          |
|  |  |  |  |  |   |  |  |  |   |   |          |

<sup>1)</sup> to 06.96 / fino 06.96 / jusqu'au 06.96 / hasta 06.96



















<sup>2)</sup> from 07.96 / dal 07.96 / du 07.96 / desde 07.96

<sup>3)</sup> on the brake caliper / sulla pinza freno / sur l'étrier de frein / a la pinza de freno

|     |               |  |  |  |  |    |      |    |  |
|--|---|--|--|--|---|--|--|--|--|
| <b>BMW Z3 (95-02)</b>  |   |  |  |  |   |  |  |  |  |
|    | 3.0 Coupe<br>3.0 Roadster<br>M Coupe<br>M Roadster  | 170<br>170   |  | 06.00<br>06.00<br>02.98<br>03.97   | 12.02<br>12.02<br>12.02<br>12.02  | 24.2419-1718.3   | 030094   | Gz 19,05   |  |
|    | 1.8<br>1.9<br>2.8 Coupe<br>2.8 Roadster   | 85<br>141<br>141   |  | 10.95<br>10.95<br>07.97<br>05.97   | 10.98<br>12.02<br>01.99<br>01.99  | 24.2520-1701.3   | 040072   | Nz 20,64   |  |
|    | 2.0<br>2.2<br>2.8 Coupe<br>2.8 Roadster<br>3.0 Coupe<br>3.0 Roadster<br>M Coupe<br>M Roadster | 110<br>125<br>141<br>141<br>170<br>170   |  | 04.99<br>10.00<br>02.99<br>02.99<br>06.00<br>06.00<br>02.98<br>03.97             | 08.00<br>12.02<br>06.00<br>06.00<br>12.02<br>12.02<br>12.02<br>12.02              | 24.2522-0905.3   | 040042   | Nz 22,20   |  |
|    | 1.8<br>1.9<br>2.0<br>2.8 Coupe<br>2.8 Roadster  | 85<br>110<br>141<br>141  |  | 10.95<br>10.95<br>04.99<br>07.97<br>05.97  | 10.98<br>12.02<br>08.00<br>06.00<br>06.00   | 24.5905-0320.3   | 330058   | L=320  |  |
| <b>BMW Z4 Roadster/E85 (03-08)</b>   |   |  |  |  |   |  |  |  |  |
|    | 2.0 i<br>2.2 i<br>2.5 i<br>2.5 i<br>2.5 si<br>3.0 i<br>3.0 si                                 | 110<br>125<br>130<br>141<br>160<br>170<br>195                                    |  | 04.05<br>10.03<br>01.06<br>12.02<br>01.06<br>12.02<br>01.06                      | 12.08<br>12.08<br>12.08<br>12.08<br>12.08<br>12.08<br>12.08                       | 03.7860-1302.4   | 300222   | 10" ATE  |  |
|    | 2.0 i<br>2.2 i<br>2.5 i<br>3.0 i  | 110<br>125<br>141<br>170   |  | 04.05<br>10.03<br>12.02<br>12.02   | 12.08<br>12.08<br>12.08<br>12.08  | 03.2023-2249.3   | 010869   | THz 23,81/22,20 ATE  |  |
|    | 2.5 i<br>2.5 si<br>3.0 si   | 130<br>160<br>195  |  | 01.06<br>01.06<br>01.06  | 12.08<br>12.08<br>12.08   | 03.2023-2256.3   | 010870   | THz 23,81/22,20 ATE  |  |
|   | 2.0 i<br>2.2 i<br>2.5 i<br>2.5 i<br>2.5 si  | 110<br>125<br>130<br>141<br>160  |  | 04.05<br>10.03<br>01.06<br>12.02<br>01.06  | 12.08<br>12.08<br>12.08<br>12.08<br>12.08   | 11.9541-9587.2<br>11.9541-9588.2<br>24.3541-9587.5<br>24.3541-9588.5<br>11.0441-5402.2<br>11.8170-0729.1<br>11.0101-5402.2<br>11.8171-0008.1<br>11.8116-0109.1 | 220419<br>220420<br>240527<br>240528<br>250028<br>260107<br>260009<br>990049<br>390495 | <br><br><br><br><br>2<br><br>2    | D=54, - Halter ATE<br>D=54, - Halter ATE<br>D=54, - Halter ATE<br>D=54, - Halter ATE<br>Dichtungssatz ATE<br>Halter ATE<br>Hülensatz ATE<br>Führungsbolzen ATE<br>Haltefeder ATE     |
|  | 3.0 i   | 170  |  | 12.02  | 12.08   | 11.9541-9587.2<br>11.9541-9588.2<br>24.3541-9587.5<br>24.3541-9588.5<br>11.0441-5402.2<br>11.0230-0234.2<br>11.0101-5402.2<br>11.8171-0008.1<br>11.8116-0109.1 | 220419<br>220420<br>240527<br>240528<br>250028<br>260084<br>260009<br>990049<br>390495 | <br><br><br><br><br>2<br><br>2 | D=54, - Halter ATE<br>D=54, - Halter ATE<br>D=54, - Halter ATE<br>D=54, - Halter ATE<br>Dichtungssatz ATE<br>Haltersatz ATE<br>Hülensatz ATE<br>Führungsbolzen ATE<br>Haltefeder ATE |
|  | 3.0 si  | 195  |  | 01.06  | 12.08   | 24.3571-1733.5<br>24.3571-1734.5<br>11.0101-5402.2<br>11.8171-0008.1<br>11.8116-0273.1   | 240349<br>240350<br>260009<br>990049<br>390515   | <br><br>2  | D=57, - Halter ATE<br>D=57, - Halter ATE<br>Hülensatz ATE<br>Führungsbolzen ATE<br>Haltefeder ATE  |
|  | M 3.2   | 252  |  | 01.06  | 12.08   | 11.0441-6003.2<br>11.0101-5402.2<br>11.8171-0008.1<br>11.8116-0083.1   | 250037<br>260009<br>990049<br>390501   | <br>2   | Dichtungssatz ATE<br>Hülensatz ATE<br>Führungsbolzen ATE<br>Haltefeder ATE   |
|  | 2.0 i<br>2.2 i<br>2.5 i<br>2.5 i<br>2.5 si<br>3.0 i<br>3.0 si                                 | 110<br>125<br>130<br>141<br>160<br>170<br>195                                    |  | 04.05<br>10.03<br>01.06<br>12.02<br>01.06<br>12.02<br>01.06                      | 12.08<br>12.08<br>12.08<br>12.08<br>12.08<br>12.08<br>12.08                       | 83.6152-0406.3   | 330789   | L=405  |  |
|  | 2.0 i<br>2.2 i<br>2.5 i<br>2.5 i  | 110<br>125<br>130<br>141   |  | 04.05<br>10.03<br>01.06<br>12.02   | 12.08<br>12.08<br>12.08<br>12.08  | 24.3401-1705.5<br>24.3401-1706.5<br>11.0441-4002.2<br>11.0101-5402.2<br>11.8171-0008.1<br>11.8116-0066.1   | 240423<br>240424<br>250011<br>260009<br>990049<br>390577                               | <br><br>2  | D=40, - Halter ATE<br>D=40, - Halter ATE<br>Dichtungssatz ATE<br>Hülensatz ATE<br>Führungsbolzen ATE<br>Haltefeder ATE   |
|  | 2.5 si<br>3.0 i<br>3.0 si   | 160<br>170<br>195  |  | 01.06<br>12.02<br>01.06  | 12.08<br>12.08<br>12.08   | 24.3401-1703.5<br>24.3401-1704.5<br>11.0441-4002.2<br>11.0101-5402.2<br>11.8171-0008.1<br>11.8116-0066.1   | 240351<br>240352<br>250011<br>260009<br>990049<br>390577                               | <br><br>2  | D=40, - Halter ATE<br>D=40, - Halter ATE<br>Dichtungssatz ATE<br>Hülensatz ATE<br>Führungsbolzen ATE<br>Haltefeder ATE   |
|  | M 3.2   | 252  |  | 01.06  | 12.08   | 11.0101-5402.2<br>11.8171-0008.1<br>11.8116-0296.1   | 260009<br>990049<br>390445   | <br>2   | Hülensatz ATE<br>Führungsbolzen ATE<br>Haltefeder ATE  |

|     |  |  |  |                                      |    |    |  |   |  |
|--|--|--|--|--|---|--|--|---|--|
| <b>BMW Z4 Roadster/E85 (03-08)</b>   |  |  |  |  |   |  |  |   |  |
|    | 2.0 i<br>2.2 i<br>2.5 i<br>2.5 i<br>2.5 si<br>3.0 i<br>3.0 si<br>M 3.2           | 110<br>125<br>130<br>141<br>160<br>170<br>195<br>252                             |  | 04.05 12.08<br>10.03 12.08<br>01.06 12.08<br>12.02 12.08<br>01.06 12.08<br>12.02 12.08<br>01.06 12.08<br>01.06 02.06 |   | 83.1294-0250.3 331267<br>83.1294-0260.3 331268<br>83.6150-0206.3 330978  | 2  | am Bremssattel <sup>1)</sup>  | L=443, + Rohrleitung<br>L=443, + Rohrleitung<br>L=205  |
|  | M 3.2  | 252  |  | 03.06 12.08  | 83.6150-0206.3 330978   | 2  | am Bremssattel <sup>1)</sup>   | L=205   |  |
|    | 2.0 i<br>2.2 i<br>2.5 i<br>2.5 i<br>2.5 si<br>3.0 i<br>3.0 si<br>M 3.2           | 110<br>125<br>130<br>141<br>160<br>170<br>195<br>252                             |  | 04.05 12.08<br>10.03 12.08<br>01.06 12.08<br>12.02 12.08<br>01.06 12.08<br>12.02 12.08<br>01.06 12.08<br>01.06 12.08 |   | 24.2419-1733.3 030125  |  |   | Gz 19,05   |
|    | 2.0 i<br>2.2 i<br>2.5 i<br>2.5 i<br>2.5 si<br>3.0 i<br>3.0 si<br>M 3.2           | 110<br>125<br>130<br>141<br>160<br>170<br>195<br>252                             |  | 04.05 12.08<br>10.03 12.08<br>01.06 12.08<br>12.02 12.08<br>01.06 12.08<br>12.02 12.08<br>01.06 12.08<br>01.06 12.08 |   | 24.2522-1705.3 040079  |  |   | Nz 22,20   |
| <b>BMW Z4 Coupe/E86 (06-08)</b>  |  |  |  |  |   |  |  |   |  |
|    | 3.0 si   | 195  |  | 03.06 09.08  | 03.7860-1302.4 300222   |  |  | 10"   | ATE  |
|    | 3.0 si   | 195  |  | 03.06 09.08  | 03.2023-2256.3 010870   |  |  | Thz 23,81/22,20   | ATE  |
|    | 3.0 si<br><br>M 3.2  | 195<br><br>252   |  | 03.06 09.08<br><br>03.06 09.08   | 24.3571-1733.5 240349<br>24.3571-1734.5 240350<br>11.0101-5402.2 260009<br>11.8171-0008.1 990049<br>11.8116-0273.1 390515<br><br>11.0441-6003.2 250037<br>11.0101-5402.2 260009<br>11.8171-0008.1 990049<br>11.8116-0083.1 390501 | 2  | <br><br>am Bremssattel <sup>1)</sup>   | D=57, - Halter ATE<br>D=57, - Halter ATE<br>Hülzensatz ATE<br>Führungsbolzen ATE<br>Haltefeder ATE<br><br>Dichtungssatz<br>Hülzensatz ATE<br>Führungsbolzen ATE<br>Haltefeder ATE     |  |
|  | 3.0 si   | 195  |  | 03.06 09.08  | 83.6152-0406.3 330789   | 2  |  | L=405   |  |
|  | 3.0 si<br><br>M 3.2  | 195<br><br>252   |  | 03.06 09.08<br><br>03.06 09.08   | 24.3401-1703.5 240351<br>24.3401-1704.5 240352<br>11.0441-4002.2 250011<br>11.0101-5402.2 260009<br>11.8171-0008.1 990049<br>11.8116-0066.1 390577<br><br>11.0101-5402.2 260009<br>11.8171-0008.1 990049<br>11.8116-0296.1 390445 | 2  | <br><br>am Bremssattel <sup>1)</sup>   | D=40, - Halter ATE<br>D=40, - Halter ATE<br>Dichtungssatz ATE<br>Hülzensatz ATE<br>Führungsbolzen ATE<br>Haltefeder ATE<br><br>Hülzensatz ATE<br>Führungsbolzen ATE<br>Haltefeder ATE |  |
|  | 3.0 si   | 195  |  | 03.06 09.08  | 83.1294-0250.3 331267<br>83.1294-0260.3 331268<br>83.6150-0206.3 330978   | 2  | am Bremssattel <sup>1)</sup>   | L=443, + Rohrleitung<br>L=443, + Rohrleitung<br>L=205   |  |
|  | 3.0 si<br>M 3.2  | 195<br>252   |  | 03.06 09.08<br>03.06 09.08   | 24.2419-1733.3 030125   |  |  | Gz 19,05  |  |
|  | 3.0 si<br>M 3.2  | 195<br>252   |  | 03.06 09.08<br>03.06 09.08   | 24.2522-1705.3 040079   |  |  | Nz 22,20  |  |
| <b>BMW Z4 Roadster/E89 (09-)</b>   |  |  |  |  |   |  |  |   |  |
|  | sDrive 18i<br>sDrive 20i<br>sDrive 23i<br>sDrive 28i<br>sDrive 30i               | 115<br>135<br>150<br>180<br>190  |  | 03.13<br>09.11<br>01.09<br>09.11<br>01.09  |   | 11.8171-0008.1 990049<br>11.0101-5402.2 260009<br>11.8116-0339.2 390528<br><br>11.8171-0008.1 990049<br>11.0101-5402.2 260009<br>11.8116-0339.2 390528 | 2  |   | Führungsbolzen ATE<br>Hülzensatz ATE<br>Haltefeder ATE<br><br>Führungsbolzen ATE<br>Hülzensatz ATE<br>Haltefeder ATE |
| <b>BMW Z8 (00-03)</b>  |  |  |  |  |   |  |  |   |  |
|  | 4.9  | 294  |  | 06.00 08.03  |   | 11.0101-6004.2 260014<br>11.8171-0008.1 990049<br>11.8116-0260.1 390597  | 2  |   | Hülzensatz ATE<br>Führungsbolzen ATE<br>Haltefeder ATE   |
|  | 4.9  | 294  |  | 06.00 08.03  |   | 11.0101-5402.2 260009<br>11.8171-0008.1 990049<br>11.8116-0296.1 390445  | 2  |   | Hülzensatz ATE<br>Führungsbolzen ATE<br>Haltefeder ATE   |
|  | 4.9  | 294  |  | 06.00 08.03  |   | 83.6124-0275.3 330458  | 2  |   | L=275  |
|  | 4.9  | 294  |  | 06.00 08.03  |   | 24.2419-1713.3 030093  |  |   | Gz 19,05   |

<sup>1)</sup> on the brake caliper / sulla pinza freno / sur l'étrier de frein / a la pinza de freno

|     |  |  |  |  |  |  |  |  |   |                |     |
|--|--|--|--|--|---|--|--|--|---|----------------|-----|
| <b>BMW Z8 (00-03)</b>  |  |  |  |  |   |  |  |  |   |                |     |
|    | 4.9  | 294  |  | 06.00  | 08.03   |  | 24.2522-0905.3   | 040042   | Nz 22,20  |                |     |
| <b>CHEVROLET AVEO (T200,T250) (04-11)</b>  |  |  |  |  |   |  |  |  |   |                |     |
|    | 1.2 i  | 53   |  | 03.06  | 07.11   |  | 24.5286-0342.3   | 331138   | 2   | L=341          |     |
|  | 1.2 i  | 55   |  | 01.08  | 07.11   |  |  |  |   |                |     |
|  | 1.2 i  | 56   |  | 03.06  | 07.11   |  |  |  |   |                |     |
|  | 1.2 i  | 62   |  | 01.08  | 07.11   |  |  |  |   |                |     |
|  | 1.2 LPG  | 62   |  | 04.08  | 07.11   |  |  |  |   |                |     |
|  | 1.4 CNG  | 69   |  | 01.10  | 07.11   |  |  |  |   |                |     |
|  | 1.4 i 16V  | 69   |  | 03.06  | 07.11   |  |  |  |   |                |     |
|  | 1.4 i 16V  | 74   |  | 01.08  | 07.11   |  |  |  |   |                |     |
|  | 1.5 i  | 62   |  | 05.05  | 07.11   |  |  |  |   |                |     |
|  | 1.6 i 16V  | 75   |  | 03.06  | 07.11   |  |  |  |   |                |     |
|  | 1.6 i 16V  | 76   |  | 05.05  | 07.11   |  |  |  |   |                |     |
|  | 1.6 i 16V  | 77   |  | 12.04  | 07.11   |  |  |  |   |                |     |
|    | 1.2 i  | 53   |  | 03.06  | 07.11   |  | 24.5247-0205.3   | 331094   | 2   | L=205          |     |
|  | 1.2 i  | 55   |  | 01.08  | 07.11   |  |  |  |   |                |     |
|  | 1.2 i  | 56   |  | 03.06  | 07.11   |  |  |  |   |                |     |
|  | 1.2 i  | 62   |  | 01.08  | 07.11   |  |  |  |   |                |     |
|  | 1.2 LPG  | 62   |  | 04.08  | 07.11   |  |  |  |   |                |     |
|  | 1.4 CNG  | 69   |  | 01.10  | 07.11   |  |  |  |   |                |     |
|  | 1.4 i 16V  | 69   |  | 03.06  | 07.11   |  |  |  |   |                |     |
|  | 1.4 i 16V  | 74   |  | 01.08  | 07.11   |  |  |  |   |                |     |
|  | 1.5 i  | 62   |  | 05.05  | 07.11   |  |  |  |   |                |     |
|  | 1.6 i 16V  | 75   |  | 03.06  | 07.11   |  |  |  |   |                |     |
|  | 1.6 i 16V  | 76   |  | 05.05  | 07.11   |  |  |  |   |                |     |
|  | 1.6 i 16V  | 77   |  | 12.04  | 07.11   |  |  |  |   |                |     |
|    | 1.2 i  | 53   |  | 03.06  | 07.11   |  | 24.3219-1751.3   | 020504   |   | Rz 19,05       |     |
|  | 1.2 i  | 55   |  | 01.08  | 07.11   |  |  |  |   |                |     |
|  | 1.2 i  | 56   |  | 03.06  | 07.11   |  |  |  |   |                |     |
|  | 1.2 i  | 62   |  | 01.08  | 07.11   |  |  |  |   |                |     |
|  | 1.2 LPG  | 62   |  | 04.08  | 07.11   |  |  |  |   |                |     |
|  | 1.4 CNG  | 69   |  | 01.10  | 07.11   |  |  |  |   |                |     |
|  | 1.4 i 16V  | 69   |  | 03.06  | 07.11   |  |  |  |   |                |     |
|  | 1.4 i 16V  | 74   |  | 01.08  | 07.11   |  |  |  |   |                |     |
|  | 1.5 i  | 62   |  | 05.05  | 07.11   |  |  |  |   |                |     |
|  | 1.6 i 16V  | 75   |  | 03.06  | 07.11   |  |  |  |   |                |     |
|  | 1.6 i 16V  | 76   |  | 05.05  | 07.11   |  |  |  |   |                |     |
|  | 1.6 i 16V  | 77   |  | 12.04  | 07.11   |  |  |  |   |                |     |
|  | 1.2 i  | 53   |  | 03.06  | 07.11   |  | 24.3728-2901.2   | 592901   |   | L=888          |     |
|  | 1.2 i  | 55   |  | 01.08  | 07.11   |  |  |  |   |                |     |
|  | 1.2 i  | 56   |  | 03.06  | 07.11   |  |  |  |   |                |     |
|  | 1.2 i  | 62   |  | 01.08  | 07.11   |  |  |  |   |                |     |
|  | 1.2 LPG  | 62   |  | 04.08  | 07.11   |  |  |  |   |                |     |
|  | 1.4 CNG  | 69   |  | 01.10  | 07.11   |  |  |  |   |                |     |
|  | 1.4 i 16V  | 69   |  | 03.06  | 07.11   |  |  |  |   |                |     |
|  | 1.4 i 16V  | 74   |  | 01.08  | 07.11   |  |  |  |   |                |     |
|  | 1.5 i  | 62   |  | 05.05  | 07.11   |  |  |  |   |                |     |
|  | 1.6 i 16V  | 75   |  | 03.06  | 07.11   |  |  |  |   |                |     |
|  | 1.6 i 16V  | 76   |  | 05.05  | 07.11   |  |  |  |   |                |     |
|  | 1.6 i 16V  | 77   |  | 12.04  | 07.11   |  |  |  |   |                |     |
| <b>CHEVROLET AVEO (T300) (11-)</b>   |  |  |  |  |   |  |  |  |   |                |     |
|  | 1.2 16V  | 51   |  | 03.11  |   |  | 11.9601-2603.2   | 220915   |  + 15" Rad <sup>1)</sup> | D=60, - Halter | ATE |
|  | 1.2 16V  | 63   |  | 03.11  |   |  |  |  |   |                |     |
|  | 1.2 LPG  | 63   |  | 11.12  |   |  |  |  |   |                |     |
|  | 1.3 D  | 55   |  | 07.11  |   |  |  |  |   |                |     |
|  | 1.3 D  | 70   |  | 07.11  |   |  |  |  |   |                |     |
|  | 1.4 16V  | 74   |  | 03.11  |   |  |  |  |   |                |     |
|  | 1.4 16V  | 76   |  | 12.12  |   |  |  |  |   |                |     |
|  | 1.6 16V  | 85   |  | 03.11  |   |  |  |  |   |                |     |
|  | 1.6 16V  | 88   |  | 06.11  |   |  |  |  |   |                |     |
|  | 1.6 16V  | 89   |  | 12.12  |   |  |  |  |   |                |     |
| <b>CHEVROLET CRUZE (09-)</b>   |  |  |  |  |   |  |  |  |   |                |     |
|  | 1.4 16V  | ≠103   |  | 08.12  |   |  | 03.7858-0732.4   | 300272   |   | 9/8" Tandem    | ATE |
|  | 1.6 16V  | ≠ 80   |  | 05.09  |   |  |  |  |   |                |     |
|  | 1.6 16V  | ≠ 83   |  | 05.09  |   |  |  |  |   |                |     |
|  | 1.6 16V  | ≠ 91   |  | 05.09  |   |  |  |  |   |                |     |
|  | 1.7 D  | ≠ 96   |  | 01.12  |   |  |  |  |   |                |     |
|  | 1.8 16V  | ≠103   |  | 11.09  |   |  |  |  |   |                |     |
|  | 1.8 16V  | ≠104   |  | 05.09  |   |  |  |  |   |                |     |
|  | 1.8 16V LPG  | ≠104   |  | 06.11  |   |  |  |  |   |                |     |
|  | 1.8 Flex   | ≠106   |  | 01.11  |   |  |  |  |   |                |     |
|  | 2.0 CDI  | ≠ 90   |  | 05.09  |   |  |  |  |   |                |     |
|  | 2.0 CDI  | ≠ 92   |  | 05.09  |   |  |  |  |   |                |     |
|  | 2.0 CDI  | ≠110   |  | 05.09  |   |  |  |  |   |                |     |
|  | 2.0 CDI  | ≠120   |  | 08.10  |   |  |  |  |   |                |     |
|  | 1.4 16V  | ≠103   |  | 08.12  |   |  | 03.2125-0421.3   | 010934   | + ESP   | THz 25,40      | ATE |
|  | 1.6 16V  | ≠ 80   |  | 05.09  |   |  |  |  |   |                |     |
|  | 1.6 16V  | ≠ 83   |  | 05.09  |   |  |  |  |   |                |     |
|  | 1.6 16V  | ≠ 91   |  | 05.09  |   |  |  |  |   |                |     |
|  | 1.7 D  | ≠ 96   |  | 01.12  |   |  |  |  |   |                |     |
|  | 1.8 16V  | ≠103   |  | 11.09  |   |  |  |  |   |                |     |
|  | 1.8 16V  | ≠104   |  | 05.09  |   |  |  |  |   |                |     |

<sup>1)</sup> + 15" wheel / + ruota 15" / + roue 15" / + rueda 15"



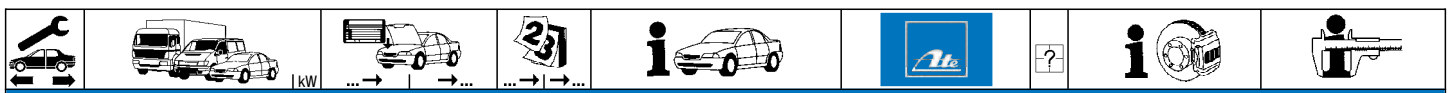























| CHEVROLET CRUZE (09-) |             |     |  |       |  |                |        |  |                         |                |     |
|-----------------------|-------------|-----|--|-------|--|----------------|--------|--|-------------------------|----------------|-----|
|                       | 1.8 16V LPG | 104 |  | 06.11 |  | 03.2125-0421.3 | 010934 |  | + ESP                   | THz 25,40      | ATE |
|                       | 1.8 Flex    | 106 |  | 01.11 |  |                |        |  |                         |                |     |
|                       | 2.0 CDI     | 90  |  | 05.09 |  |                |        |  |                         |                |     |
|                       | 2.0 CDI     | 92  |  | 05.09 |  |                |        |  |                         |                |     |
|                       | 2.0 CDI     | 110 |  | 05.09 |  |                |        |  |                         |                |     |
|                       | 2.0 CDI     | 120 |  | 08.10 |  |                |        |  |                         |                |     |
|                       | 1.4 16V     | 103 |  | 08.12 |  | 11.9601-2603.2 | 220915 |  | + 15" Rad <sup>1)</sup> | D=60, - Halter | ATE |
|                       | 1.6 16V     | 80  |  | 05.09 |  |                |        |  |                         |                |     |
|                       | 1.6 16V     | 83  |  | 05.09 |  |                |        |  |                         |                |     |
|                       | 1.6 16V     | 91  |  | 05.09 |  |                |        |  |                         |                |     |
|                       | 1.7 D       | 96  |  | 01.12 |  |                |        |  |                         |                |     |
|                       | 1.8 16V     | 103 |  | 11.09 |  |                |        |  |                         |                |     |
|                       | 1.8 16V     | 104 |  | 05.09 |  |                |        |  |                         |                |     |
|                       | 1.8 16V LPG | 104 |  | 06.11 |  |                |        |  |                         |                |     |
|                       | 1.8 Flex    | 106 |  | 01.11 |  |                |        |  |                         |                |     |
|                       | 2.0 CDI     | 90  |  | 05.09 |  |                |        |  |                         |                |     |
|                       | 2.0 CDI     | 92  |  | 05.09 |  |                |        |  |                         |                |     |
|                       | 2.0 CDI     | 110 |  | 05.09 |  |                |        |  |                         |                |     |
|                       | 2.0 CDI     | 120 |  | 08.10 |  |                |        |  |                         |                |     |
|                       | 1.4 16V     | 103 |  | 08.12 |  | 11.9601-2601.2 | 220913 |  | + 16" Rad <sup>2)</sup> | D=60, - Halter | ATE |
|                       | 1.6 16V     | 80  |  | 05.09 |  | 11.9601-2602.2 | 220914 |  | + 16" Rad <sup>2)</sup> | D=60, - Halter | ATE |
|                       | 1.6 16V     | 83  |  | 05.09 |  |                |        |  |                         |                |     |
|                       | 1.6 16V     | 91  |  | 05.09 |  |                |        |  |                         |                |     |
|                       | 1.7 D       | 96  |  | 01.12 |  |                |        |  |                         |                |     |
|                       | 1.8 16V     | 103 |  | 11.09 |  |                |        |  |                         |                |     |
|                       | 1.8 16V     | 104 |  | 05.09 |  |                |        |  |                         |                |     |
|                       | 1.8 16V LPG | 104 |  | 06.11 |  |                |        |  |                         |                |     |
|                       | 1.8 Flex    | 106 |  | 01.11 |  |                |        |  |                         |                |     |
|                       | 2.0 CDI     | 90  |  | 05.09 |  |                |        |  |                         |                |     |
|                       | 2.0 CDI     | 92  |  | 05.09 |  |                |        |  |                         |                |     |
|                       | 2.0 CDI     | 110 |  | 05.09 |  |                |        |  |                         |                |     |
|                       | 2.0 CDI     | 120 |  | 08.10 |  |                |        |  |                         |                |     |
|                       | 1.4 16V     | 103 |  | 08.12 |  | 11.9382-7001.2 | 220889 |  | + 15" Rad <sup>1)</sup> | D=38, - Halter | ATE |
|                       | 1.6 16V     | 80  |  | 05.09 |  | 11.9382-7002.2 | 220890 |  | + 15" Rad <sup>1)</sup> | D=38, - Halter | ATE |
|                       | 1.6 16V     | 83  |  | 05.09 |  |                |        |  |                         |                |     |
|                       | 1.6 16V     | 91  |  | 05.09 |  |                |        |  |                         |                |     |
|                       | 1.7 D       | 96  |  | 01.12 |  |                |        |  |                         |                |     |
|                       | 1.8 16V     | 103 |  | 11.09 |  |                |        |  |                         |                |     |
|                       | 1.8 16V     | 104 |  | 05.09 |  |                |        |  |                         |                |     |
|                       | 1.8 16V LPG | 104 |  | 06.11 |  |                |        |  |                         |                |     |
|                       | 1.8 Flex    | 106 |  | 01.11 |  |                |        |  |                         |                |     |
|                       | 2.0 CDI     | 90  |  | 05.09 |  |                |        |  |                         |                |     |
|                       | 2.0 CDI     | 92  |  | 05.09 |  |                |        |  |                         |                |     |
|                       | 2.0 CDI     | 110 |  | 05.09 |  |                |        |  |                         |                |     |
|                       | 2.0 CDI     | 120 |  | 08.10 |  |                |        |  |                         |                |     |
|                       | 1.4 16V     | 103 |  | 08.12 |  | 11.9382-7003.2 | 220891 |  | + 16" Rad <sup>2)</sup> | D=38, - Halter | ATE |
|                       | 1.6 16V     | 80  |  | 05.09 |  | 11.9382-7004.2 | 220892 |  | + 16" Rad <sup>2)</sup> | D=38, - Halter | ATE |
|                       | 1.6 16V     | 83  |  | 05.09 |  |                |        |  |                         |                |     |
|                       | 1.6 16V     | 91  |  | 05.09 |  |                |        |  |                         |                |     |
|                       | 1.7 D       | 96  |  | 01.12 |  |                |        |  |                         |                |     |
|                       | 1.8 16V     | 103 |  | 11.09 |  |                |        |  |                         |                |     |
|                       | 1.8 16V     | 104 |  | 05.09 |  |                |        |  |                         |                |     |
|                       | 1.8 16V LPG | 104 |  | 06.11 |  |                |        |  |                         |                |     |
|                       | 1.8 Flex    | 106 |  | 01.11 |  |                |        |  |                         |                |     |
|                       | 2.0 CDI     | 90  |  | 05.09 |  |                |        |  |                         |                |     |
|                       | 2.0 CDI     | 92  |  | 05.09 |  |                |        |  |                         |                |     |
|                       | 2.0 CDI     | 110 |  | 05.09 |  |                |        |  |                         |                |     |
|                       | 2.0 CDI     | 120 |  | 08.10 |  |                |        |  |                         |                |     |

| CHEVROLET KALOS (05-08) |           |    |  |       |       |                |        |   |  |          |  |
|-------------------------|-----------|----|--|-------|-------|----------------|--------|---|--|----------|--|
|                         | 1.2 i     | 53 |  | 03.05 | 05.08 | 24.5286-0342.3 | 331138 | 2 |  | L=341    |  |
|                         | 1.4 i     | 61 |  | 03.05 | 05.08 |                |        |   |  |          |  |
|                         | 1.4 i 16V | 69 |  | 03.05 | 05.08 |                |        |   |  |          |  |
|                         | 1.2 i     | 53 |  | 03.05 | 05.08 | 24.5247-0205.3 | 331094 | 2 |  | L=205    |  |
|                         | 1.4 i     | 61 |  | 03.05 | 05.08 |                |        |   |  |          |  |
|                         | 1.4 i 16V | 69 |  | 03.05 | 05.08 |                |        |   |  |          |  |
|                         | 1.2 i     | 53 |  | 03.05 | 05.08 | 24.3219-1751.3 | 020504 |   |  | Rz 19,05 |  |
|                         | 1.4 i     | 61 |  | 03.05 | 05.08 |                |        |   |  |          |  |
|                         | 1.4 i 16V | 69 |  | 03.05 | 05.08 |                |        |   |  |          |  |
|                         | 1.2 i     | 53 |  | 03.05 | 05.08 | 24.3728-2901.2 | 592901 |   |  | L=888    |  |
|                         | 1.4 i     | 61 |  | 03.05 | 05.08 |                |        |   |  |          |  |
|                         | 1.4 i 16V | 69 |  | 03.05 | 05.08 |                |        |   |  |          |  |

| CHEVROLET LANOS (05-) |           |    |  |       |  |                |        |   |  |                |     |
|-----------------------|-----------|----|--|-------|--|----------------|--------|---|--|----------------|-----|
|                       | 1.4       | 55 |  | 11.05 |  | 11.9481-9871.2 | 220681 |   |  | D=48, - Halter | ATE |
|                       | 1.5       | 63 |  | 11.05 |  | 11.9481-9872.2 | 220682 |   |  | D=48, - Halter | ATE |
|                       | 1.6 i 16V | 78 |  | 11.05 |  | 24.3521-1701.5 | 240001 |   |  | D=52, - Halter | ATE |
|                       |           |    |  |       |  | 24.3521-1702.5 | 240002 |   |  | D=52, - Halter | ATE |
|                       | 1.4       | 55 |  | 11.05 |  | 24.5233-0180.3 | 330888 | 2 |  | L=180          |     |
|                       | 1.5       | 63 |  | 11.05 |  |                |        |   |  |                |     |
|                       | 1.6 i 16V | 78 |  | 11.05 |  |                |        |   |  |                |     |
|                       | 1.4       | 55 |  | 11.05 |  | 03.3217-3512.3 | 020032 |   |  | Rz 17,46       | LUC |
|                       | 1.5       | 63 |  | 11.05 |  |                |        |   |  |                |     |

1) + 15" wheel / + ruota 15" / + roue 15" / + rueda 15"  
 2) + 16" wheel / + ruota 16" / + roue 16" / + rueda 16"



|          |  |   |  |   |  |  |                                  |                  |  |                          |  |
|--|--|---|--|---|--|--|----------------------------------|------------------|--|--------------------------|--|
| <b>CHEVROLET LANOS (05-)</b>   |  |   |  |   |  |  |                                  |                  |  |                          |  |
|    | 1.4<br>1.5<br>1.6 i 16V  | 55<br>63<br>78                                |  | 11.05<br>11.05<br>11.05   |  |  | 24.3727-2900.2<br>24.3727-2901.2 | 582900<br>582901 | <input type="checkbox"/><br><input type="checkbox"/> |                          | L=1655<br>L=1587                               |
| <b>CHEVROLET MALIBU (V300) (12-)</b>   |  |   |  |   |  |  |                                  |                  |  |                          |  |
|    | 2.0 16V<br>2.0 16V<br>2.0 LPG<br>2.0 VDCi<br>2.4 16V<br>2.4 16V<br>2.4 16V | 104<br>108<br>101<br>118<br>123<br>125<br>137 |  | 02.12<br>12.12<br>02.12<br>04.12<br>01.12<br>01.12<br>01.12   |  |  | 03.7858-0732.4                   | 300272           |  |                          | 9/8" Tandem<br>ATE                             |
|    | 2.0 16V<br>2.0 16V<br>2.0 LPG<br>2.0 VDCi<br>2.4 16V<br>2.4 16V<br>2.4 16V | 104<br>108<br>101<br>118<br>123<br>125<br>137 |  | 02.12<br>12.12<br>02.12<br>04.12<br>01.12<br>01.12<br>01.12   |  |  | 03.2125-0421.3                   | 010934           |  |                          | THz 25,40<br>ATE                               |
| <b>CHEVROLET MATIZ (05-10)</b>   |  |   |  |   |  |  |                                  |                  |  |                          |  |
|    | 0.8<br>0.8 LPG<br>1.0<br>1.0<br>1.0<br>1.0 LPG<br>1.0 LPG                  | 38<br>38<br>47<br>48<br>49<br>44<br>49        |  | 03.05 12.10<br>03.05 12.10<br>03.05 12.10<br>01.07 12.10<br>03.05 12.10<br>01.07 12.10<br>03.05 12.10 |  |  | 24.3481-1773.5<br>24.3481-1774.5 | 240377<br>240378 | <input type="checkbox"/><br><input type="checkbox"/> |                          | D=48, - Halter<br>D=48, - Halter               |
|    | 0.8<br>0.8 LPG<br>1.0<br>1.0<br>1.0<br>1.0 LPG<br>1.0 LPG                  | 38<br>38<br>47<br>48<br>49<br>44<br>49        |  | 03.05 12.10<br>03.05 12.10<br>03.05 12.10<br>01.07 12.10<br>03.05 12.10<br>01.07 12.10<br>03.05 12.10 |  |  | 24.5283-0403.3<br>24.5291-0425.3 | 331136<br>331029 | 2<br>2   | - ABS<br>+ ABS           | L=404<br>L=425                                 |
|    | 0.8<br>0.8 LPG<br>1.0<br>1.0<br>1.0<br>1.0 LPG<br>1.0 LPG                  | 38<br>38<br>47<br>48<br>49<br>44<br>49        |  | 03.05 12.10<br>03.05 12.10<br>03.05 12.10<br>01.07 12.10<br>03.05 12.10<br>01.07 12.10<br>03.05 12.10 |  |  | 24.5284-0220.3                   | 330970           | 2  |                          | L=220  |
|    | 0.8<br>0.8 LPG<br>1.0<br>1.0<br>1.0<br>1.0 LPG<br>1.0 LPG                  | 38<br>38<br>47<br>48<br>49<br>44<br>49        |  | 03.05 12.10<br>03.05 12.10<br>03.05 12.10<br>01.07 12.10<br>03.05 12.10<br>01.07 12.10<br>03.05 12.10 |  |  | 24.3217-1712.3                   | 020475           |  |                          | Rz 17,46                                       |
|    | 0.8<br>0.8 LPG<br>1.0<br>1.0<br>1.0<br>1.0 LPG<br>1.0 LPG                  | 38<br>38<br>47<br>48<br>49<br>44<br>49        |  | 03.05 12.10<br>03.05 12.10<br>03.05 12.10<br>01.07 12.10<br>03.05 12.10<br>01.07 12.10<br>03.05 12.10 |  |  | 24.3727-2902.2                   | 582902           | 1  | <input type="checkbox"/> | L=2825   |
|    | 0.8<br>0.8 LPG   | 38<br>38                                      |  | 03.05 12.10<br>03.05 12.10  |  |  | 24.3728-2900.2                   | 592900           |  |                          | L=851  |
| <b>CHEVROLET ORLANDO (11-)</b>   |  |   |  |   |  |  |                                  |                  |  |                          |  |
|    | 1.8 16V<br>1.8 LPG<br>2.0 D<br>2.0 D<br>2.0 LPG                            | 104<br>104<br>96<br>120<br>103                |  | 02.11<br>06.11<br>02.11<br>02.11<br>02.12   |  |  | 03.7858-0732.4                   | 300272           |  |                          | 9/8" Tandem<br>ATE                             |
|    | 1.8 16V<br>1.8 LPG<br>2.0 D<br>2.0 D<br>2.0 LPG                            | 104<br>104<br>96<br>120<br>103                |  | 02.11<br>06.11<br>02.11<br>02.11<br>02.12   |  |  | 03.2125-0421.3                   | 010934           |  | + ESP                    | THz 25,40<br>ATE                               |
|    | 1.4 16V  | 103   |  | 06.12   |  |  | 11.9601-2601.2<br>11.9601-2602.2 | 220913<br>220914 | <input type="checkbox"/><br><input type="checkbox"/> |                          | D=60, - Halter<br>D=60, - Halter<br>ATE<br>ATE |
|    | 1.8 16V<br>1.8 LPG<br>2.0 D<br>2.0 D<br>2.0 LPG                            | 104<br>104<br>96<br>120<br>103                |  | 02.11<br>06.11<br>02.11<br>02.11<br>02.12   |  |  | 11.9601-2601.2<br>11.9601-2602.2 | 220913<br>220914 | <input type="checkbox"/><br><input type="checkbox"/> |                          | D=60, - Halter<br>D=60, - Halter<br>ATE<br>ATE |
| <b>CHEVROLET SPARK (05-10)</b>   |  |   |  |   |  |  |                                  |                  |  |                          |  |
|    | 0.8<br>1.0 LPG<br>1.0 SX<br>1.0 SX<br>1.0 SX                               | 37<br>46<br>44<br>46<br>49                    |  | 05.05 02.10<br>05.05 02.10<br>06.09 02.10<br>05.05 02.10<br>05.05 02.10                               |  |  | 24.3481-1773.5<br>24.3481-1774.5 | 240377<br>240378 | <input type="checkbox"/><br><input type="checkbox"/> |                          | D=48, - Halter<br>D=48, - Halter               |

| <b>CHEVROLET SPARK (05-10)</b> |            |     |            |            |       |                |        |   |   |                |     |
|--------------------------------|------------|-----|------------|------------|-------|----------------|--------|---|---|----------------|-----|
|                                | 0.8        | 37  |            | 05.05      | 02.10 | 24.5283-0403.3 | 331136 | 2 |   | L=404          |     |
|                                | 1.0 LPG    | 46  |            | 05.05      | 02.10 |                |        |   |   |                |     |
|                                | 1.0 SX     | 44  |            | 06.09      | 02.10 |                |        |   |   |                |     |
|                                | 1.0 SX     | 46  |            | 05.05      | 02.10 |                |        |   |   |                |     |
|                                | 1.0 SX     | 49  |            | 05.05      | 02.10 |                |        |   |   |                |     |
|                                | 0.8        | 37  |            | 05.05      | 02.10 | 24.5284-0220.3 | 330970 | 2 |   | L=220          |     |
|                                | 1.0 LPG    | 46  |            | 05.05      | 02.10 |                |        |   |   |                |     |
|                                | 1.0 SX     | 44  |            | 06.09      | 02.10 |                |        |   |   |                |     |
|                                | 1.0 SX     | 46  |            | 05.05      | 02.10 |                |        |   |   |                |     |
|                                | 1.0 SX     | 49  |            | 05.05      | 02.10 |                |        |   |   |                |     |
|                                | 0.8        | 37  |            | 05.05      | 02.10 | 24.3217-1712.3 | 020475 |   |   | Rz 17,46       |     |
|                                | 1.0 LPG    | 46  |            | 05.05      | 02.10 |                |        |   |   |                |     |
|                                | 1.0 SX     | 44  |            | 06.09      | 02.10 |                |        |   |   |                |     |
|                                | 1.0 SX     | 46  |            | 05.05      | 02.10 |                |        |   |   |                |     |
|                                | 1.0 SX     | 49  |            | 05.05      | 02.10 |                |        |   |   |                |     |
| <b>CHEVROLET TRAX (12-)</b>    |            |     |            |            |       |                |        |   |   |                |     |
|                                | 1.4        | 103 |            | 12.12      |       | 11.9601-2601.2 | 220913 |   |   | D=60, - Halter | ATE |
|                                | 1.4 AWD    | 103 |            | 12.12      |       | 11.9601-2602.2 | 220914 |   |   | D=60, - Halter | ATE |
|                                | 1.6        | 85  |            | 12.12      |       |                |        |   |   |                |     |
|                                | 1.6 AWD    | 85  |            | 12.12      |       |                |        |   |   |                |     |
|                                | 1.7 TD     | 96  |            | 12.12      |       |                |        |   |   |                |     |
|                                | 1.7 TD AWD | 96  |            | 12.12      |       |                |        |   |   |                |     |
|                                | 1.4        | 103 |            | 12.12      |       | 11.9382-7003.2 | 220891 |   |   | D=38, - Halter | ATE |
|                                | 1.6        | 85  |            | 12.12      |       | 11.9382-7004.2 | 220892 |   |   | D=38, - Halter | ATE |
|                                | 1.7 TD     | 96  |            | 12.12      |       |                |        |   |   |                |     |
|                                | 1.4 AWD    | 103 |            | 12.12      |       | 11.9382-7003.2 | 220891 |   |   | D=38, - Halter | ATE |
|                                | 1.6 AWD    | 85  |            | 12.12      |       | 11.9382-7004.2 | 220892 |   |   | D=38, - Halter | ATE |
|                                | 1.7 TD AWD | 96  |            | 12.12      |       |                |        |   |   |                |     |
| <b>CHEVROLET VOLT (11-)</b>    |            |     |            |            |       |                |        |   |   |                |     |
|                                | EV 150     | 111 |            | 11.11      |       | 11.9601-2601.2 | 220913 |   |   | D=60, - Halter | ATE |
|                                |            |     |            |            |       | 11.9601-2602.2 | 220914 |   |   | D=60, - Halter | ATE |
|                                | EV 150     | 111 |            | 11.11      |       | 11.9382-7001.2 | 220889 |   | elektrische Feststellbremse <sup>1)</sup> | D=38, - Halter | ATE |
|                                |            |     |            |            |       | 11.9382-7002.2 | 220890 |   | elektrische Feststellbremse <sup>1)</sup> | D=38, - Halter | ATE |
| <b>CITROEN AX (86-98)</b>      |            |     |            |            |       |                |        |   |   |                |     |
|                                | 10         | 33  | ORGA 03826 |            | 12.98 | 03.2120-2031.3 | 010106 |   |   | Thz 20,64      | ATE |
|                                | 10         | 37  |            | 07.92      | 12.98 |                |        |   |   |                |     |
|                                | 10 E       | 30  | ORGA 03825 |            | 12.88 |                |        |   |   |                |     |
|                                | 11         | 40  |            | 12.86      | 06.90 |                |        |   |   |                |     |
|                                | 11         | 44  |            | 10.89      | 12.97 |                |        |   |   |                |     |
|                                | 13 Sport   |     | ORGA 04073 | 04.87      |       |                |        |   |   |                |     |
|                                | 14         | 44  |            | 12.86      | 12.88 |                |        |   |   |                |     |
|                                | 14         | 49  |            | 06.88      | 12.89 |                |        |   |   |                |     |
|                                | 14         | 55  |            | 03.89      | 12.96 |                |        |   |   |                |     |
|                                | 14 GT      | 62  | ORGA 04098 | 01.88      |       |                |        |   |   |                |     |
|                                | 14 GTI     |     |            | 06.91      | 12.96 | - ABS          |        |   |   |                |     |
|                                | 13 Sport   |     | ORGA 04074 | ORGA 05188 |       | 03.2119-3389.3 | 010057 |   |   | Thz 19,05      | ATE |
|                                | 14 D       |     |            | 09.88      | 12.97 |                |        |   |   |                |     |
|                                | 14 GT      | 62  | ORGA 04099 |            | 12.92 |                |        |   |   |                |     |
|                                | 15 D       |     |            | 08.94      | 12.97 |                |        |   |   |                |     |
|                                | 10         | 32  | ORGA 05089 | 09.86      |       | 11.0441-4501.2 | 250015 |   |   | Dichtungssatz  | ATE |
|                                | 10         | 33  | ORGA 05089 | 07.86      |       | 11.0101-4504.2 | 260004 |   |   | Tragbolzensatz | ATE |
|                                | 10 E       | 30  |            | 12.86      | 12.88 |                |        |   |   |                |     |
|                                | 11         | 40  | ORGA 05089 | 12.86      |       |                |        |   |   |                |     |
|                                | 11         | 44  | ORGA 05089 | 10.89      |       |                |        |   |   |                |     |
|                                | 13 Sport   |     | ORGA 05089 | 04.87      |       |                |        |   |   |                |     |
|                                | 14         | 44  | ORGA 05089 | 12.86      |       |                |        |   |   |                |     |
|                                | 14         | 49  | ORGA 05089 | 06.88      |       |                |        |   |   |                |     |
|                                | 14         | 55  | ORGA 05089 | 03.89      |       |                |        |   |   |                |     |
|                                | 14 D       |     | ORGA 05089 | 09.88      |       |                |        |   |   |                |     |
|                                | 14 GT      | 62  | ORGA 05089 | 01.88      |       |                |        |   |   |                |     |
|                                | 10         | 32  | ORGA 05090 |            | 06.92 | 11.0441-4501.2 | 250015 |   |   | Dichtungssatz  | ATE |
|                                | 10         | 33  | ORGA 05090 |            | 12.98 | 11.0101-4504.2 | 260004 |   |   | Tragbolzensatz | ATE |
|                                | 10         | 37  |            | 07.92      | 12.98 |                |        |   |   |                |     |
|                                | 11         | 44  | ORGA 05090 |            | 12.97 |                |        |   |   |                |     |
|                                | 14         | 55  | ORGA 05090 | ORGA 05277 |       |                |        |   |   |                |     |
|                                | 14 D       |     | ORGA 05090 | ORGA 05277 |       |                |        |   |   |                |     |
|                                | 14 GT      | 62  | ORGA 05090 |            | 12.92 |                |        |   |   |                |     |
|                                | 10         | 33  | ORGA 05105 | 07.86      |       | 83.6196-0325.3 | 330727 | 2 |   | L=325          |     |
|                                | 10         | 33  | ORGA 03825 | 07.86      |       |                |        |   |   |                |     |
|                                | 10 E       | 30  | ORGA 03825 | 12.86      |       |                |        |   |   |                |     |
|                                | 10 E       | 30  |            | 12.86      | 12.88 |                |        |   |   |                |     |
|                                | 11         | 40  | ORGA 05105 | 12.86      |       |                |        |   |   |                |     |
|                                | 11         | 44  | ORGA 05105 | 10.89      |       |                |        |   |   |                |     |
|                                | 13 Sport   |     | ORGA 05105 | 04.87      | 12.88 |                |        |   |   |                |     |
|                                | 14         | 44  | ORGA 05105 | 12.86      |       |                |        |   |   |                |     |
|                                | 14         | 49  | ORGA 05105 | 06.88      |       |                |        |   |   |                |     |
|                                | 14         | 55  | ORGA 05105 | 03.89      |       |                |        |   |   |                |     |
|                                | 14 D       |     | ORGA 05105 | 09.88      |       |                |        |   |   |                |     |
|                                | 14 GT      | 62  | ORGA 05105 | 01.88      |       |                |        |   |   |                |     |
|                                | 10         | 33  | ORGA 03826 |            | 12.98 | 24.5111-0325.3 | 330109 | 2 |   | L=325          |     |
|                                | 10         | 37  |            | 07.92      | 12.98 |                |        |   |   |                |     |

<sup>1)</sup> electric parking brake / fr.di stazionamento elettrico / frein à main électrique / freno de mano eléctrico

<sup>2)</sup> + booster unit / + servofreno / + servo-frein / + servofreno

<sup>3)</sup> - booster unit / - servofreno / - servo-frein / - servofreno

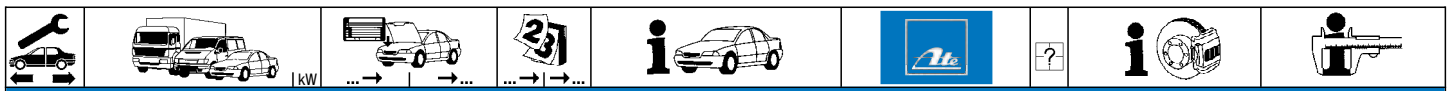

**CITROEN AX (86-98)**

|          |          |            |            |       |       |                 |                |                |        |          |           |          |
|----------|----------|------------|------------|-------|-------|-----------------|----------------|----------------|--------|----------|-----------|----------|
|          | 10 E     | 30         | ORGA 03826 |       | 12.88 |                 | 24.5111-0325.3 | 330109         | 2      |          | L=325     |          |
|          | 11       | 44         | ORGA 05106 |       | 12.97 |                 |                |                |        |          |           |          |
|          | 14       | 55         | ORGA 05106 |       | 04.91 |                 |                |                |        |          |           |          |
|          | 14 D     |            | ORGA 05106 |       | 04.91 |                 |                |                |        |          |           |          |
|          | 14 GT    | 62         | ORGA 05106 |       | 12.92 |                 |                |                |        |          |           |          |
|          | 14       | 55         | ORGA 05278 |       | 12.96 |                 | 24.5111-0290.3 | 330108         | 2      |          | L=290     |          |
|          | 14 4x4   | 55         |            | 08.91 | 12.96 |                 |                |                |        |          |           |          |
|          | 14 D     |            | ORGA 05278 |       | 12.97 |                 |                |                |        |          |           |          |
|          | 14 GTI   |            |            | 06.91 | 12.96 |                 |                |                |        |          |           |          |
|          | 15 D     |            |            | 08.94 | 12.97 |                 |                |                |        |          |           |          |
|          | 10       | 33         | ORGA 06321 |       | 07.86 | + Bremsgerät 1) | 24.5228-0200.3 | 330470         | 2      |          | L=200     |          |
|          | 10       | 33         | ORGA 03825 |       | 07.86 | - Bremsgerät 2) |                |                |        |          |           |          |
|          | 10       | 37         | ORGA 06321 |       | 07.92 |                 |                |                |        |          |           |          |
|          | 10 E     | 30         | ORGA 03825 |       | 12.86 | - Bremsgerät 2) |                |                |        |          |           |          |
|          | 10 E     | 30         |            |       | 12.86 | + Bremsgerät 1) |                |                |        |          |           |          |
|          | 11       | 40         | ORGA 06321 |       | 12.86 |                 |                |                |        |          |           |          |
|          | 11       | 44         | ORGA 06321 |       | 10.89 |                 |                |                |        |          |           |          |
|          | 13 Sport |            |            |       | 04.87 | 12.88           |                |                |        |          |           |          |
|          | 14       | 44         |            |       | 12.86 | 12.88           |                |                |        |          |           |          |
|          | 14       | 49         |            |       | 06.88 | 12.89           |                |                |        |          |           |          |
|          | 14       | 55         | ORGA 06321 |       | 03.89 |                 |                |                |        |          |           |          |
|          | 14 D     |            | ORGA 06321 |       | 09.88 |                 |                |                |        |          |           |          |
|          | 14 GT    | 62         |            |       | 01.86 | 12.92           |                |                |        |          |           |          |
| 14 GTI   |          | ORGA 06321 |            | 06.91 |       | - ABS           |                |                |        |          |           |          |
|          | 10       | 33         | ORGA 06322 |       | 12.98 |                 | 24.5229-0199.3 | 330534         | 2      |          | L=200     |          |
|          | 10       | 37         | ORGA 06322 |       | 12.98 |                 |                |                |        |          |           |          |
|          | 11       | 44         | ORGA 06322 |       | 12.97 |                 |                |                |        |          |           |          |
|          | 14       | 55         | ORGA 06322 |       | 12.96 |                 |                |                |        |          |           |          |
|          | 14 D     |            | ORGA 06322 |       | 12.97 |                 |                |                |        |          |           |          |
|          | 14 GTI   |            |            |       | 12.96 |                 |                |                |        |          |           |          |
|          | 15 D     |            |            |       | 08.94 | 12.97           |                |                |        |          |           |          |
|          | 14 4x4   | 55         |            |       | 08.91 | 12.96           | 24.5229-0265.3 | 330540         | 2      |          | L=265     |          |
|          | 14 GTI   |            | ORGA 06321 |       | 06.91 |                 | + ABS          | 24.5228-0195.3 | 330469 | 2        |           | L=202    |
|          |          | 10         | 32         |       |       | 09.86           | 06.92          | 24.3219-1119.3 | 020333 | 2        |           | Rz 19,05 |
| 10       |          | 33         |            |       | 07.86 | 12.98           | 24.3219-1603.3 | 020200         |        |          | BDX       |          |
| 10       |          | 37         |            |       | 07.92 | 12.98           | 24.3219-1604.3 | 020201         |        |          | BDX       |          |
| 10 E     |          | 30         |            |       | 12.86 | 12.88           |                |                |        |          | Rz 19,05  |          |
| 11       |          | 40         |            |       | 12.86 | 06.90           |                |                |        |          | BDX       |          |
| 11       |          | 44         |            |       | 10.89 | 12.97           |                |                |        |          |           |          |
| 13 Sport |          |            |            |       | 04.87 | 12.88           |                |                |        |          |           |          |
| 14       |          | 44         |            |       | 12.86 | 12.88           |                |                |        |          |           |          |
| 14       |          | 49         |            |       | 06.88 | 12.89           |                |                |        |          |           |          |
| 14 D     |          |            |            |       | 09.88 | 12.97           |                |                |        |          |           |          |
| 14 GT    |          | 62         |            |       | 01.88 | 12.92           |                |                |        |          |           |          |
| 15 D     |          |            |            |       | 08.94 | 12.97           |                |                |        |          |           |          |
| 14       |          | 55         |            |       | 03.89 | 12.96           | 24.3219-1609.3 | 020319         |        |          | RzR 19,05 |          |
| 14 GTI   |          |            |            |       | 06.91 | 12.96           | - ABS          | 24.3219-1610.3 | 020320 |          | RzR 19,05 |          |
| 14 4x4   |          | 55         |            |       | 08.91 | 12.96           | 24.3219-1116.3 | 020195         |        |          | Rz 19,05  |          |
| 14 GTI   |          |            |            | 06.91 | 12.96 | + ABS           | 24.3219-1117.3 | 020196         |        | Rz 19,05 |           |          |
| 14 GTI   |          |            |            | 06.91 | 12.96 |                 | 24.3220-1117.3 | 020314         |        | Rz 20,64 |           |          |
|          | 10       | 33         |            |       | 07.86 | 12.98           | 24.3727-0303.2 | 580303         | 2      |          | L=1395    |          |
|          | 10       | 37         |            |       | 07.92 | 12.98           |                |                |        |          |           |          |
|          | 10 E     | 30         |            |       | 12.86 | 12.88           |                |                |        |          |           |          |
|          | 11       | 40         |            |       | 12.86 | 06.90           |                |                |        |          |           |          |
|          | 11       | 44         |            |       | 10.89 | 12.97           |                |                |        |          |           |          |
|          | 13 Sport |            |            |       | 04.87 | 12.88           |                |                |        |          |           |          |
|          | 14       | 44         |            |       | 12.86 | 12.88           |                |                |        |          |           |          |
|          | 14       | 49         |            |       | 06.88 | 12.89           |                |                |        |          |           |          |
|          | 14       | 55         |            |       | 03.89 | 12.96           |                |                |        |          |           |          |
|          | 14 D     |            |            |       | 09.88 | 12.97           |                |                |        |          |           |          |
|          | 14 GT    | 62         |            |       | 01.88 | 12.92           |                |                |        |          |           |          |
| 14 GTI   |          |            |            | 06.91 | 12.96 |                 |                |                |        |          |           |          |
| 15 D     |          |            |            | 08.94 | 12.97 |                 |                |                |        |          |           |          |
|          | 10       | 33         |            |       | 07.86 | 12.98           | 24.6583-1502.3 | 320122         |        |          | BRL (4)   |          |
|          | 10       | 37         |            |       | 07.92 | 12.98           |                |                |        |          |           |          |
|          | 10 E     | 30         |            |       | 12.86 | 12.88           |                |                |        |          |           |          |
|          | 11       | 40         |            |       | 12.86 | 06.90           |                |                |        |          |           |          |
|          | 11       | 44         |            |       | 10.89 | 12.97           |                |                |        |          |           |          |
|          | 13 Sport |            |            |       | 04.87 | 12.88           |                |                |        |          |           |          |
|          | 14       | 44         |            |       | 12.86 | 12.88           |                |                |        |          |           |          |
|          | 14       | 49         |            |       | 06.88 | 12.89           |                |                |        |          |           |          |
|          | 14       | 55         |            |       | 03.89 | 12.96           |                |                |        |          |           |          |
|          | 14 D     |            |            |       | 09.88 | 12.97           |                |                |        |          |           |          |
| 14 GT    | 62       |            |            | 01.88 | 12.92 |                 |                |                |        |          |           |          |
| 14 GTI   |          |            |            | 06.91 | 12.96 | - ABS           |                |                |        |          |           |          |
| 15 D     |          |            |            | 08.94 | 12.97 |                 |                |                |        |          |           |          |
| 14 4x4   | 55       |            |            | 08.91 | 12.96 | 24.6042-1702.3  | 320154         |                |        | BRE 2/25 |           |          |
|          | 10       | 33         |            |       | 07.86 | 12.88           | 24.3728-0301.2 | 590301         |        |          | L=664     |          |
|          | 10 E     | 30         |            |       | 12.86 | 12.88           |                |                |        |          |           |          |
|          | 11       | 40         |            |       | 12.86 |                 |                |                |        |          |           |          |
|          | 11       | 44         |            |       | 10.89 |                 |                |                |        |          |           |          |
|          | 13 Sport |            |            |       | 04.87 | 12.88           |                |                |        |          |           |          |
|          | 14       | 44         |            |       | 12.86 |                 |                |                |        |          |           |          |
| 14       | 49       |            |            | 06.88 |       |                 |                |                |        |          |           |          |
| 14       | 55       |            |            | 03.89 |       |                 |                |                |        |          |           |          |

1) + booster unit / + servofreno / + servo-frein / + servofreno

2) - booster unit / - servofreno / - servo-frein / - servofreno

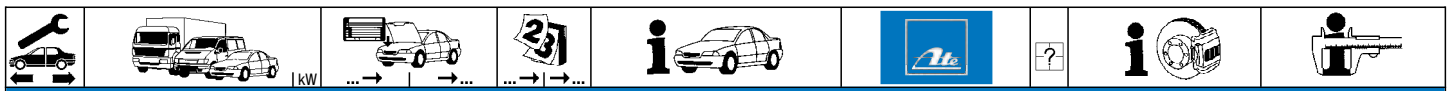

**CITROEN AX (86-98)**



















|      |       |    |            |              |              |  |                |        |  |       |
|------|-------|----|------------|--------------|--------------|--|----------------|--------|--|-------|
|      | 14 D  |    | ORGA 05047 | <b>09.88</b> |              |  | 24.3728-0301.2 | 590301 |  | L=664 |
|      | 14 GT | 62 | ORGA 05047 | <b>01.88</b> |              |  |                |        |  |       |
|      | 10    | 37 |            | <b>07.92</b> | <b>12.98</b> |  | 24.3728-0308.2 | 590308 |  | L=635 |
|      | 11    | 44 | ORGA 05048 |              | <b>12.97</b> |  |                |        |  |       |
|      | 14    | 55 | ORGA 05048 |              | <b>12.96</b> |  |                |        |  |       |
|      | 14 D  |    | ORGA 05048 |              | <b>12.97</b> |  |                |        |  |       |
|      | 14 GT | 62 | ORGA 05048 |              | <b>12.92</b> |  |                |        |  |       |
| 15 D |       |    |            | <b>08.94</b> | <b>12.97</b> |  |                |        |  |       |

**CITROEN BERLINGO (MF) Kombi (96-08)**

|              |              |            |              |              |              |              |                |                |        |       |                |            |
|--------------|--------------|------------|--------------|--------------|--------------|--------------|----------------|----------------|--------|-------|----------------|------------|
|              | 1.1 i        | 44         | ORGA 08609   | <b>07.96</b> |              | - ABS        |                | 24.2123-1710.3 | 010504 |       | THz 23,81      | <b>BOS</b> |
|              | 1.4 GNC      | 48         | ORGA 08609   | <b>11.02</b> |              | - ABS        |                |                |        |       |                |            |
|              | 1.4 Hybrid   | 54         | ORGA 08609   | <b>05.05</b> |              | - ABS        |                |                |        |       |                |            |
|              | 1.4 i        | 55         | ORGA 08609   | <b>07.96</b> |              | - ABS        |                |                |        |       |                |            |
|              | 1.8 D        | 43         | ORGA 08609   | <b>07.98</b> |              | - ABS        |                |                |        |       |                |            |
|              | 1.8 i        | 66         | ORGA 08609   | <b>05.97</b> |              | - ABS        |                |                |        |       |                |            |
|              | 1.9 D        | 50         | ORGA 08609   | <b>07.96</b> |              | - ABS        |                |                |        |       |                |            |
|              | 1.9 D        | 51         | ORGA 08609   | <b>07.98</b> |              | - ABS        |                |                |        |       |                |            |
|              | 1.1 i        | 44         | ORGA 08609   | <b>07.96</b> |              | + ABS        |                | 24.2123-1713.3 | 010505 |       | THz 23,81      | <b>BOS</b> |
|              | 1.4 GNC      | 48         | ORGA 08609   | <b>11.02</b> |              | + ABS        |                |                |        |       |                |            |
| 1.4 i        | 55           | ORGA 08609 | <b>07.96</b> |              | + ABS        |              |                |                |        |       |                |            |
| 1.8 D        | 43           | ORGA 08609 | <b>07.98</b> |              | + ABS        |              |                |                |        |       |                |            |
| 1.8 i        | 66           | ORGA 08609 | <b>05.97</b> |              | + ABS        |              |                |                |        |       |                |            |
| 1.9 D        | 50           | ORGA 08609 | <b>07.96</b> |              | + ABS        |              |                |                |        |       |                |            |
| 1.9 D        | 51           | ORGA 08609 | <b>07.98</b> |              | + ABS        |              |                |                |        |       |                |            |
| 1.1 i        | 44           | ORGA 08610 |              | <b>03.08</b> |              |              | 03.2123-2781.3 | 010631         |        | - ABS | THz 23,81      | <b>ATE</b> |
| 1.4 Bivalent |              |            |              | <b>11.02</b> | <b>03.08</b> |              | 24.2123-1714.3 | 010587         |        | - ABS | THz 23,81      | <b>BDX</b> |
| 1.4 GNC      | 48           | ORGA 08610 |              |              | <b>03.08</b> |              | 24.2123-1715.3 | 010520         |        | - ESP | THz 23,81      | <b>BDX</b> |
| 1.4 Hybrid   | 54           | ORGA 08610 |              |              | <b>03.08</b> |              |                |                |        |       |                |            |
| 1.4 i        | 55           | ORGA 08610 |              |              | <b>03.08</b> |              |                |                |        |       |                |            |
| 1.6 16V      | 80           |            |              | <b>10.00</b> | <b>03.08</b> |              |                |                |        |       |                |            |
| 1.6 HDi      | 80           |            |              | <b>08.05</b> | <b>03.08</b> |              |                |                |        |       |                |            |
| 1.6 HDi 75   | 55           |            |              | <b>07.05</b> | <b>03.08</b> |              |                |                |        |       |                |            |
| 1.6 HDi 90   | 66           |            |              | <b>07.05</b> | <b>03.08</b> |              |                |                |        |       |                |            |
| 1.8 D        | 43           | ORGA 08610 |              |              | <b>03.08</b> |              |                |                |        |       |                |            |
| 1.8 i        | 66           | ORGA 08610 |              |              | <b>03.08</b> |              |                |                |        |       |                |            |
| 1.9 D        | 50           | ORGA 08610 |              |              | <b>03.08</b> |              |                |                |        |       |                |            |
| 1.9 D        | 51           | ORGA 08610 |              |              | <b>03.08</b> |              |                |                |        |       |                |            |
| 2.0 HDi      | 66           |            |              | <b>12.99</b> | <b>03.08</b> |              |                |                |        |       |                |            |
| Electric     | 27           |            |              | <b>01.00</b> | <b>03.08</b> |              |                |                |        |       |                |            |
|              | 1.1 i        | 44         | ORGA 09428   | <b>07.96</b> |              |              | 24.3541-1777.5 | 240247         |        |       | D=54, - Halter | <b>LUC</b> |
|              | 1.4 GNC      | 48         | ORGA 09428   | <b>11.02</b> |              |              | 24.3541-1778.5 | 240248         |        |       | D=54, - Halter | <b>LUC</b> |
|              | 1.4 Hybrid   | 54         | ORGA 09428   | <b>05.05</b> |              |              |                |                |        |       |                |            |
|              | 1.4 i        | 55         | ORGA 09428   | <b>07.96</b> |              |              |                |                |        |       |                |            |
|              | Electric     | 27         |              | <b>01.00</b> | <b>03.08</b> |              |                |                |        |       |                |            |
|              | 1.1 i        | 44         | ORGA 09127   | <b>07.96</b> |              |              | 24.3541-1757.7 | 220483         |        |       | D=54, - Halter | <b>LUC</b> |
|              | 1.4 GNC      | 48         | ORGA 09127   | <b>11.02</b> |              |              | 24.3541-1758.7 | 220484         |        |       | D=54, - Halter | <b>LUC</b> |
|              | 1.4 Hybrid   | 54         | ORGA 09127   | <b>05.05</b> |              |              |                |                |        |       |                |            |
|              | 1.4 i        | 55         | ORGA 09127   | <b>07.96</b> |              |              |                |                |        |       |                |            |
|              | 1.6 16V      | 80         | ORGA 09127   | <b>10.00</b> |              |              |                |                |        |       |                |            |
| 1.8 D        | 43           | ORGA 09127 | <b>07.98</b> |              |              |              |                |                |        |       |                |            |
| 1.8 i        | 66           | ORGA 09127 | <b>05.97</b> |              |              |              |                |                |        |       |                |            |
| 1.9 D        | 50           | ORGA 09127 | <b>07.96</b> |              |              |              |                |                |        |       |                |            |
| 1.9 D        | 51           | ORGA 09127 | <b>07.98</b> |              |              |              |                |                |        |       |                |            |
| 2.0 HDi      | 66           | ORGA 09127 | <b>12.99</b> |              |              |              |                |                |        |       |                |            |
| 1.1 i        | 44           | ORGA 09429 |              |              | <b>03.08</b> |              | 24.3541-1771.5 | 240239         |        |       | D=54, - Halter | <b>BOS</b> |
| 1.1 i        | 44           | ORGA 09128 |              |              | <b>03.08</b> |              | 24.3541-1772.5 | 240240         |        |       | D=54, - Halter | <b>BOS</b> |
| 1.4 Bivalent |              |            |              | <b>11.02</b> | <b>03.08</b> |              |                |                |        |       |                |            |
| 1.4 GNC      | 48           | ORGA 09429 |              |              | <b>03.08</b> |              |                |                |        |       |                |            |
| 1.4 GNC      | 48           | ORGA 09128 |              |              | <b>03.08</b> |              |                |                |        |       |                |            |
| 1.4 Hybrid   | 54           | ORGA 09429 |              |              | <b>03.08</b> |              |                |                |        |       |                |            |
| 1.4 Hybrid   | 54           | ORGA 09128 |              |              | <b>03.08</b> |              |                |                |        |       |                |            |
| 1.4 i        | 55           | ORGA 09429 |              |              | <b>03.08</b> |              |                |                |        |       |                |            |
| 1.4 i        | 55           | ORGA 09128 |              |              | <b>03.08</b> |              |                |                |        |       |                |            |
| 1.6 16V      | 80           | ORGA 09128 |              |              | <b>03.08</b> |              |                |                |        |       |                |            |
| 1.6 HDi      | 80           |            |              | <b>08.05</b> | <b>03.08</b> |              |                |                |        |       |                |            |
| 1.6 HDi 75   | 55           |            |              | <b>07.05</b> | <b>03.08</b> |              |                |                |        |       |                |            |
| 1.6 HDi 90   | 66           |            |              | <b>07.05</b> | <b>03.08</b> |              |                |                |        |       |                |            |
| 1.8 D        | 43           | ORGA 09128 |              |              | <b>03.08</b> |              |                |                |        |       |                |            |
| 1.8 i        | 66           | ORGA 09128 |              |              | <b>03.08</b> |              |                |                |        |       |                |            |
| 1.9 D        | 50           | ORGA 09128 |              |              | <b>03.08</b> |              |                |                |        |       |                |            |
| 1.9 D        | 51           | ORGA 09128 |              |              | <b>03.08</b> |              |                |                |        |       |                |            |
| 2.0 HDi      | 66           | ORGA 09128 |              |              | <b>03.08</b> |              |                |                |        |       |                |            |
| 1.6 16V      | 80           | ORGA 09128 |              |              | <b>03.08</b> |              | 24.3541-1761.5 | 240233         |        |       | D=54, - Halter | <b>BOS</b> |
| 1.6 HDi      | 80           |            |              | <b>08.05</b> | <b>03.08</b> |              | 24.3541-1762.5 | 240234         |        |       | D=54, - Halter | <b>BOS</b> |
| 1.6 HDi 90   | 66           |            |              | <b>07.05</b> | <b>03.08</b> |              |                |                |        |       |                |            |
| 2.0 HDi      | 66           | ORGA 09128 |              |              | <b>03.08</b> |              |                |                |        |       |                |            |
|              | 1.1 i        | 44         |              | <b>07.96</b> | <b>03.08</b> |              | 24.5111-0438.3 | 330568         | 2      |       | L=445          |            |
|              | 1.4 Bivalent |            |              | <b>11.02</b> | <b>03.08</b> |              |                |                |        |       |                |            |
|              | 1.4 GNC      | 48         |              |              | <b>11.02</b> | <b>03.08</b> |                |                |        |       |                |            |
|              | 1.4 Hybrid   | 54         |              |              | <b>05.05</b> | <b>03.08</b> |                |                |        |       |                |            |
|              | 1.4 i        | 55         |              |              | <b>07.96</b> | <b>03.08</b> |                |                |        |       |                |            |
|              | 1.6 16V      | 80         |              |              | <b>10.00</b> | <b>03.08</b> |                |                |        |       |                |            |
|              | 1.6 HDi      | 80         |              |              | <b>08.05</b> | <b>03.08</b> |                |                |        |       |                |            |
|              | 1.6 HDi 75   | 55         |              |              | <b>07.05</b> | <b>03.08</b> |                |                |        |       |                |            |
| 1.6 HDi 90   | 66           |            |              | <b>07.05</b> | <b>03.08</b> |              |                |                |        |       |                |            |





|     |    |  |  |  |  |  |  |  |                          |        |
|--|--|--|--|--|---|--|--|--|--------------------------|--------|
| <b>CITROEN BERLINGO (MF) Kombi (96-08)</b>   |  |  |  |  |   |  |  |  |                          |        |
|    | 1.8 D  | 43   |  | 07.98  | 03.08   | 24.5111-0438.3   | 330568   | 2  | L=445                    |        |
|  | 1.8 i  | 66   |  | 05.97  | 03.08   |  |  |  |                          |        |
|  | 1.9 D  | 50   |  | 07.96  | 03.08   |  |  |  |                          |        |
|  | 1.9 D  | 51   |  | 07.98  | 03.08   |  |  |  |                          |        |
|  | 2.0 HDi  | 66   |  | 12.99  | 03.08   |  |  |  | - ESP                    |        |
|  | Electric   | 27   |  | 01.00  | 03.08   |  |  |  |                          |        |
|    | 1.6 16V  | 80   |  | 10.00  | 03.08   | 24.5111-0460.3   | 330603   | 2  | L=460                    |        |
|  | 1.6 HDi  | 80   |  | 08.05  | 03.08   |  |  |  | + ESP                    |        |
|  | 1.6 HDi 90   | 66   |  | 07.05  | 03.08   |  |  |  | + ESP                    |        |
|  | 2.0 HDi  | 66   |  | 12.99  | 03.08   |  |  |  | + ESP                    |        |
|    | 1.6 16V  | 80   |  | 10.00  | 03.08   | 24.3387-1711.7   | 220747   | <input type="checkbox"/>   | D=38, - Halter           |        |
|  | 1.6 HDi  | 80   |  | 08.05  | 03.08   | 24.3387-1712.7   | 220748   | <input type="checkbox"/>   | D=38, - Halter           |        |
|  | 1.6 HDi 90   | 66   |  | 07.05  | 03.08   |  |  |  | LUC                      |        |
|  | 2.0 HDi  | 66   |  | 12.99  | 03.08   |  |  |  | LUC                      |        |
|    | 1.1 i  | 44   | ORGA 09533   | 07.96  |   | 24.5229-0255.3   | 330581   | 2  | L=255                    |        |
|  | 1.4 Bivalent   | 48   | ORGA 09533   | 11.02  |   |  |  |  |                          |        |
|  | 1.4 GNC  | 48   | ORGA 09533   | 11.02  |   |  |  |  |                          |        |
|  | 1.4 Hybrid   | 54   | ORGA 09533   | 05.05  |   |  |  |  |                          |        |
|  | 1.4 i  | 55   | ORGA 09533   | 07.96  |   |  |  |  |                          |        |
|  | 1.6 16V  | 80   | ORGA 09533   | 10.00  |   |  |  |  |                          |        |
|  | 1.8 D  | 43   | ORGA 09533   | 07.98  |   |  |  |  |                          |        |
|  | 1.8 i  | 66   | ORGA 09533   | 05.97  |   |  |  |  |                          |        |
|  | 1.9 D  | 50   | ORGA 09533   | 07.96  |   |  |  |  |                          |        |
|  | 1.9 D  | 51   | ORGA 09533   | 07.98  |   |  |  |  |                          |        |
|  | 2.0 HDi  | 66   | ORGA 09533   | 12.99  |   |  |  |  |                          |        |
|  | Electric   | 27   | ORGA 09533   | 01.00  |   |  |  |  |                          |        |
|  |    | 1.1 i  | 44   | ORGA 09534   |   | 03.08  | 24.5246-0260.3   | 330782   | 2                        | L=260  |
|  |  | 1.4 Bivalent   | 48   | ORGA 09534   |   | 03.08  |  |  |                          |        |
| 1.4 GNC  |  | 48   | ORGA 09534   |  | 03.08   |  |  |  |                          |        |
| 1.4 Hybrid   |  | 54   | ORGA 09534   |  | 03.08   |  |  |  |                          |        |
| 1.4 i  |  | 55   | ORGA 09534   |  | 03.08   |  |  |  |                          |        |
| 1.6 16V  |  | 80   | ORGA 09534   |  | 03.08   |  |  |  |                          |        |
| 1.6 HDi  |  | 80   |  | 08.05  | 03.08   |  |  |  |                          |        |
| 1.6 HDi 75   |  | 55   |  | 07.05  | 03.08   |  |  |  |                          |        |
| 1.6 HDi 90   |  | 66   |  | 07.05  | 03.08   |  |  |  |                          |        |
| 1.8 D  |  | 43   | ORGA 09534   |  | 03.08   |  |  |  |                          |        |
| 1.8 i  |  | 66   | ORGA 09534   |  | 03.08   |  |  |  |                          |        |
| 1.9 D  |  | 50   | ORGA 09534   |  | 03.08   |  |  |  |                          |        |
| 1.9 D  |  | 51   | ORGA 09534   |  | 03.08   |  |  |  |                          |        |
| 2.0 HDi  |  | 66   | ORGA 09534   |  | 03.08   |  |  |  |                          |        |
| Electric   | 27   | ORGA 09534   |  | 03.08  |   |  |  |  |                          |        |
|  | 1.1 i  | 44   |  | 07.96  | 03.08   | 24.3222-1711.3   | 020413   |  | Rz 22,20                 |        |
|  | 1.4 Bivalent   | 48   |  | 11.02  | 03.08   | 24.3222-1734.3   | 020539   |  | Rz 22,20                 |        |
|  | 1.4 GNC  | 48   |  | 11.02  | 03.08   |  |  |  | LUC                      |        |
|  | 1.4 Hybrid   | 54   |  | 05.05  | 03.08   |  |  |  |                          |        |
|  | 1.4 i  | 55   |  | 07.96  | 03.08   |  |  |  |                          |        |
|  | 1.6 16V  | 80   |  | 10.00  | 03.08   |  |  |  | - ESP                    |        |
|  | 1.6 HDi  | 80   |  | 08.05  | 03.08   |  |  |  | - ESP                    |        |
|  | 1.6 HDi 75   | 55   |  | 07.05  | 03.08   |  |  |  |                          |        |
|  | 1.6 HDi 90   | 66   |  | 07.05  | 03.08   |  |  |  | - ESP                    |        |
|  | 1.8 D  | 43   |  | 07.98  | 03.08   |  |  |  |                          |        |
|  | 1.8 i  | 66   |  | 05.97  | 03.08   |  |  |  |                          |        |
|  | 1.9 D  | 50   |  | 07.96  | 03.08   |  |  |  |                          |        |
|  | 1.9 D  | 51   |  | 07.98  | 03.08   |  |  |  |                          |        |
|  | 2.0 HDi  | 66   |  | 12.99  | 03.08   |  |  |  | - ESP                    |        |
| Electric   | 27   |  | 01.00  | 03.08  |   |  |  |  |                          |        |
|  | 1.1 i  | 44   | ORGA 08393   | 07.96  |   | 24.3727-0314.2   | 580314   | <input type="checkbox"/>   | L=1745                   |        |
|  | 1.4 GNC  | 48   | ORGA 08393   | 11.02  |   | 24.3727-0315.2   | 580315   | <input type="checkbox"/>   | L=1818                   |        |
|  | 1.4 Hybrid   | 54   | ORGA 08393   | 05.05  |   |  |  |  |                          |        |
|  | 1.4 i  | 55   | ORGA 08393   | 07.96  |   |  |  |  |                          |        |
|  | 1.8 D  | 43   | ORGA 08393   | 07.98  |   |  |  |  |                          |        |
|  | 1.8 i  | 66   | ORGA 08393   | 05.97  |   |  |  |  |                          |        |
|  | 1.9 D  | 50   | ORGA 08393   | 07.96  |   |  |  |  |                          |        |
|  | 1.9 D  | 51   | ORGA 08393   | 07.98  |   |  |  |  |                          |        |
|  |  | 1.1 i  | 44   | ORGA 08394   |   | 03.08  | 24.3727-0314.2   | 580314   | <input type="checkbox"/> | L=1745 |
| 1.4 Bivalent   |  | 48   | ORGA 08394   | 11.02  | 03.08   | 24.3727-0339.2   | 580339   | <input type="checkbox"/>   | L=1850                   |        |
| 1.4 GNC  |  | 48   | ORGA 08394   |  | 03.08   |  |  |  |                          |        |
| 1.4 Hybrid   |  | 54   | ORGA 08394   |  | 03.08   |  |  |  |                          |        |
| 1.4 i  |  | 55   | ORGA 08394   |  | 03.08   |  |  |  |                          |        |
| 1.6 16V  |  | 80   | ORGA 08394   |  | 03.08   |  |  |  | - ESP                    |        |
| 1.6 HDi  |  | 80   |  | 08.05  | 03.08   |  |  |  | - ESP                    |        |
| 1.6 HDi 75   |  | 55   |  | 07.05  | 03.08   |  |  |  |                          |        |
| 1.6 HDi 90   |  | 66   |  | 07.05  | 03.08   |  |  |  | - ESP                    |        |
| 1.8 D  |  | 43   | ORGA 08394   |  | 03.08   |  |  |  |                          |        |
| 1.8 i  |  | 66   | ORGA 08394   |  | 03.08   |  |  |  |                          |        |
| 1.9 D  |  | 50   | ORGA 08394   |  | 03.08   |  |  |  |                          |        |
| 1.9 D  |  | 51   | ORGA 08394   |  | 03.08   |  |  |  |                          |        |
| 2.0 HDi  |  | 66   | ORGA 08394   |  | 03.08   |  |  |  | - ESP                    |        |
|  | 1.6 16V  | 80   |  | 10.00  | 03.08   | 24.3727-0349.2   | 580349   | <input type="checkbox"/>   | L=1820                   |        |
|  | 1.6 HDi  | 80   |  | 08.05  | 03.08   | 24.3727-0347.2   | 580347   | <input type="checkbox"/>   | L=1923                   |        |
|  | 1.6 HDi 90   | 66   |  | 07.05  | 03.08   |  |  |  | + ESP                    |        |
|  | 2.0 HDi  | 66   |  | 12.00  | 03.08   |  |  |  | + ESP                    |        |

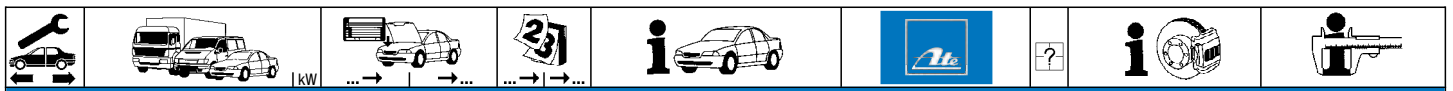

**CITROEN BERLINGO (MF) Kombi (96-08)**

|            |              |            |            |       |                                   |                                   |                |        |                                      |               |     |
|------------|--------------|------------|------------|-------|-----------------------------------|-----------------------------------|----------------|--------|--------------------------------------|---------------|-----|
|            | 1.1 i        | 44         |            | 07.96 | 03.08                             | - Mehrfunktionsdach <sup>1)</sup> | 03.6582-0010.3 | 320145 | - verstärktes Fahrwerk <sup>2)</sup> | BRL 8/1,5 (4) | ATE |
|            | 1.4 Bivalent |            |            | 11.02 | 03.08                             | + Mehrfunktionsdach <sup>1)</sup> |                |        |                                      |               |     |
|            | 1.4 GNC      | 48         |            | 11.02 | 03.08                             | - Mehrfunktionsdach <sup>1)</sup> |                |        |                                      |               |     |
|            | 1.4 Hybrid   | 54         |            | 05.05 | 03.08                             | - Mehrfunktionsdach <sup>1)</sup> |                |        |                                      |               |     |
|            | 1.4 i        | 55         |            | 07.96 | 03.08                             | - Mehrfunktionsdach <sup>1)</sup> |                |        |                                      |               |     |
|            | 1.6 16V      | 80         |            | 10.00 | 03.08                             | - Mehrfunktionsdach <sup>1)</sup> |                |        |                                      |               |     |
|            | 1.6 HDi      | 80         |            | 08.05 | 03.08                             | - Mehrfunktionsdach <sup>1)</sup> |                |        |                                      |               |     |
|            | 1.6 HDi 75   | 55         |            | 07.05 | 03.08                             | - Mehrfunktionsdach <sup>1)</sup> |                |        |                                      |               |     |
|            | 1.6 HDi 90   | 66         |            | 07.05 | 03.08                             | - Mehrfunktionsdach <sup>1)</sup> |                |        |                                      |               |     |
|            | 1.8 D        | 43         |            | 07.98 | 03.08                             | - Mehrfunktionsdach <sup>1)</sup> |                |        |                                      |               |     |
|            | 1.8 i        | 66         |            | 05.97 | 03.08                             | - Mehrfunktionsdach <sup>1)</sup> |                |        |                                      |               |     |
|            | 1.9 D        | 50         |            | 07.96 | 03.08                             | - Mehrfunktionsdach <sup>1)</sup> |                |        |                                      |               |     |
|            | 1.9 D        | 51         |            | 07.98 | 03.08                             | - Mehrfunktionsdach <sup>1)</sup> |                |        |                                      |               |     |
| 2.0 HDi    | 66           |            | 12.99      | 03.08 | - Mehrfunktionsdach <sup>1)</sup> |                                   |                |        |                                      |               |     |
| Electric   | 27           |            | 01.00      | 03.08 | - Mehrfunktionsdach <sup>1)</sup> |                                   |                |        |                                      |               |     |
|            | 1.1 i        | 44         |            | 07.96 | 03.08                             | + Mehrfunktionsdach <sup>3)</sup> | 03.6582-0015.3 | 320227 | - verstärktes Fahrwerk <sup>2)</sup> | BRL 8/1,5 (4) | ATE |
|            | 1.4 Bivalent |            |            | 11.02 | 03.08                             | + Mehrfunktionsdach <sup>3)</sup> |                |        |                                      |               |     |
|            | 1.4 GNC      | 48         |            | 11.02 | 03.08                             | + Mehrfunktionsdach <sup>3)</sup> |                |        |                                      |               |     |
|            | 1.4 Hybrid   | 54         |            | 05.05 | 03.08                             | + Mehrfunktionsdach <sup>3)</sup> |                |        |                                      |               |     |
|            | 1.4 i        | 55         |            | 07.96 | 03.08                             | + Mehrfunktionsdach <sup>3)</sup> |                |        |                                      |               |     |
|            | 1.6 16V      | 80         |            | 10.00 | 03.08                             | + Mehrfunktionsdach <sup>3)</sup> |                |        |                                      |               |     |
|            | 1.6 HDi      | 80         |            | 08.05 | 03.08                             | + Mehrfunktionsdach <sup>3)</sup> |                |        |                                      |               |     |
|            | 1.6 HDi 75   | 55         |            | 07.05 | 03.08                             | + Mehrfunktionsdach <sup>3)</sup> |                |        |                                      |               |     |
|            | 1.6 HDi 90   | 66         |            | 07.05 | 03.08                             | + Mehrfunktionsdach <sup>3)</sup> |                |        |                                      |               |     |
|            | 1.8 D        | 43         |            | 07.98 | 03.08                             | + Mehrfunktionsdach <sup>3)</sup> |                |        |                                      |               |     |
|            | 1.8 i        | 66         |            | 05.97 | 03.08                             | + Mehrfunktionsdach <sup>3)</sup> |                |        |                                      |               |     |
|            | 1.9 D        | 50         |            | 07.96 | 03.08                             | + Mehrfunktionsdach <sup>3)</sup> |                |        |                                      |               |     |
|            | 1.9 D        | 51         |            | 07.98 | 03.08                             | + Mehrfunktionsdach <sup>3)</sup> |                |        |                                      |               |     |
| 2.0 HDi    | 66           |            | 12.99      | 03.08 | + Mehrfunktionsdach <sup>3)</sup> |                                   |                |        |                                      |               |     |
| Electric   | 27           |            | 01.00      | 03.08 | + Mehrfunktionsdach <sup>3)</sup> |                                   |                |        |                                      |               |     |
|            | 1.1 i        | 44         |            | 07.96 | 03.08                             | - ABS                             | 03.6582-0011.3 | 320232 | + verstärktes Fahrwerk <sup>4)</sup> | BRL 8/1,5 (4) | ATE |
|            | 1.4 Bivalent |            |            | 11.02 | 03.08                             | - ABS                             |                |        |                                      |               |     |
|            | 1.4 GNC      | 48         |            | 11.02 | 03.08                             | - ABS                             |                |        |                                      |               |     |
|            | 1.4 Hybrid   | 54         |            | 05.05 | 03.08                             | - ABS                             |                |        |                                      |               |     |
|            | 1.4 i        | 55         |            | 07.96 | 03.08                             | - ABS                             |                |        |                                      |               |     |
|            | 1.6 16V      | 80         |            | 10.00 | 03.08                             | - ABS                             |                |        |                                      |               |     |
|            | 1.6 HDi      | 80         |            | 08.05 | 03.08                             | - ABS                             |                |        |                                      |               |     |
|            | 1.6 HDi 75   | 55         |            | 07.05 | 03.08                             | - ABS                             |                |        |                                      |               |     |
|            | 1.6 HDi 90   | 66         |            | 07.05 | 03.08                             | - ABS                             |                |        |                                      |               |     |
|            | 1.8 D        | 43         |            | 07.98 | 03.08                             | - ABS                             |                |        |                                      |               |     |
|            | 1.8 i        | 66         |            | 05.97 | 03.08                             | - ABS                             |                |        |                                      |               |     |
|            | 1.9 D        | 50         |            | 07.96 | 03.08                             | - ABS                             |                |        |                                      |               |     |
|            | 1.9 D        | 51         |            | 07.98 | 03.08                             | - ABS                             |                |        |                                      |               |     |
| 2.0 HDi    | 66           |            | 12.99      | 03.08 | - ABS                             |                                   |                |        |                                      |               |     |
| Electric   | 27           |            | 01.00      | 03.08 |                                   |                                   |                |        |                                      |               |     |
|            | 1.1 i        | 44         |            | 07.96 | 03.08                             | + ABS                             | 03.6582-0012.3 | 320233 | + verstärktes Fahrwerk <sup>4)</sup> | BRL 8/1,5 (4) | ATE |
|            | 1.4 Bivalent |            |            | 11.02 | 03.08                             | + ABS                             |                |        |                                      |               |     |
|            | 1.4 GNC      | 48         |            | 11.02 | 03.08                             | + ABS                             |                |        |                                      |               |     |
|            | 1.4 Hybrid   | 54         |            | 05.05 | 03.08                             | + ABS                             |                |        |                                      |               |     |
|            | 1.4 i        | 55         |            | 07.96 | 03.08                             | + ABS                             |                |        |                                      |               |     |
|            | 1.6 16V      | 80         |            | 10.00 | 03.08                             | + ABS                             |                |        |                                      |               |     |
|            | 1.6 HDi      | 80         |            | 08.05 | 03.08                             | + ABS                             |                |        |                                      |               |     |
|            | 1.6 HDi 75   | 55         |            | 07.05 | 03.08                             | + ABS                             |                |        |                                      |               |     |
|            | 1.6 HDi 90   | 66         |            | 07.05 | 03.08                             | + ABS                             |                |        |                                      |               |     |
|            | 1.8 D        | 43         |            | 07.98 | 03.08                             | + ABS                             |                |        |                                      |               |     |
|            | 1.8 i        | 66         |            | 05.97 | 03.08                             | + ABS                             |                |        |                                      |               |     |
|            | 1.9 D        | 50         |            | 07.96 | 03.08                             | + ABS                             |                |        |                                      |               |     |
|            | 1.9 D        | 51         |            | 07.98 | 03.08                             | + ABS                             |                |        |                                      |               |     |
| 2.0 HDi    | 66           |            | 12.99      | 03.08 | + ABS                             |                                   |                |        |                                      |               |     |
|            | 1.1 i        | 44         |            | 07.96 | 03.08                             |                                   | 24.3728-0328.2 | 590328 |                                      | L=617         |     |
|            | 1.4 Bivalent |            |            | 11.02 | 03.08                             |                                   |                |        |                                      |               |     |
|            | 1.4 GNC      | 48         |            | 11.02 | 03.08                             |                                   |                |        |                                      |               |     |
|            | 1.4 Hybrid   | 54         |            | 05.05 | 03.08                             |                                   |                |        |                                      |               |     |
|            | 1.4 i        | 55         |            | 07.96 | 03.08                             |                                   |                |        |                                      |               |     |
|            | 1.6 16V      | 80         |            | 10.00 | 03.08                             |                                   |                |        |                                      |               |     |
|            | 1.6 HDi      | 80         |            | 08.05 | 03.08                             |                                   |                |        |                                      |               |     |
|            | 1.6 HDi 75   | 55         |            | 07.05 | 03.08                             |                                   |                |        |                                      |               |     |
|            | 1.6 HDi 90   | 66         |            | 07.05 | 03.08                             |                                   |                |        |                                      |               |     |
|            | 1.6 HDi      | 80         | ORGA 11190 | 08.05 |                                   |                                   |                |        |                                      |               |     |
|            | 1.6 HDi 75   | 55         | ORGA 11190 | 07.05 |                                   |                                   |                |        |                                      |               |     |
|            | 1.6 HDi 90   | 66         | ORGA 11190 | 07.05 |                                   |                                   |                |        |                                      |               |     |
|            | 1.9 D        | 50         |            | 07.96 | 03.08                             |                                   |                |        |                                      |               |     |
| 1.9 D      | 51           |            | 07.98      | 03.08 |                                   |                                   |                |        |                                      |               |     |
| 2.0 HDi    | 66           | ORGA 11190 | 12.99      |       |                                   |                                   |                |        |                                      |               |     |
| 1.6 HDi    | 80           | ORGA 11191 |            | 03.08 |                                   |                                   |                |        |                                      |               |     |
| 1.6 HDi 75 | 55           | ORGA 11191 |            | 03.08 |                                   |                                   |                |        |                                      |               |     |
| 1.6 HDi 90 | 66           | ORGA 11191 |            | 03.08 |                                   |                                   |                |        |                                      |               |     |
| 2.0 HDi    | 66           | ORGA 11191 |            | 03.08 |                                   |                                   |                |        |                                      |               |     |
| 1.8 D      | 43           |            | 04.98      | 03.08 |                                   |                                   |                |        |                                      |               |     |
| 1.9 D      | 50           |            | 07.96      | 03.08 | + BE3-Getriebe <sup>6)</sup>      |                                   |                |        |                                      |               |     |
| 1.9 D      | 51           |            | 07.98      | 03.08 | + BE3-Getriebe <sup>6)</sup>      |                                   |                |        |                                      |               |     |
| 1.8 i      | 66           |            | 05.97      | 03.08 |                                   |                                   |                |        |                                      |               |     |

<sup>1)</sup> - multifunction roof / - tetto multifunzionale / - toit multifonctionnel / - techo multifuncional  
<sup>2)</sup> - reinforced suspension / - sospensione rinforzata / - châssis renforcé / - suspensión reforzada  
<sup>3)</sup> + multifunction roof / + tetto multifunzionale / + toit multifonctionnel / + techo multifuncional  
<sup>4)</sup> + reinforced suspension / + sospensione rinforzata / + châssis renforcé / + suspensión reforzada  
<sup>5)</sup> + BE4 transmission / + scatola cambio BE4 / + boîte de vitesse BE4 / + cambio BE4  
<sup>6)</sup> + BE3 transmission / + scatola cambio BE3 / + boîte de vitesse BE3 / + cambio BE3



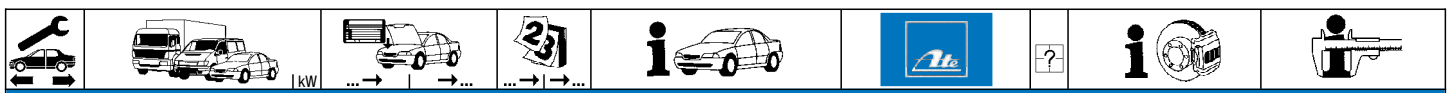

**CITROEN BERLINGO (M\_) Kasten (96-08)**

|              |               |               |            |            |                |                |                          |                          |                |            |                |        |                          |                |            |                |        |                          |                |            |                |        |                          |                |            |                |                |        |                          |                |
|--------------|---------------|---------------|------------|------------|----------------|----------------|--------------------------|--------------------------|----------------|------------|----------------|--------|--------------------------|----------------|------------|----------------|--------|--------------------------|----------------|------------|----------------|--------|--------------------------|----------------|------------|----------------|----------------|--------|--------------------------|----------------|
|              | 1.1 i         | 44            | ORGA 08609 | 07.96      | - ABS          | 24.2123-1710.3 | 010504                   |                          | THz 23,81      | <b>BOS</b> |                |        |                          |                |            |                |        |                          |                |            |                |        |                          |                |            |                |                |        |                          |                |
|              | 1.4 i         | 55            | ORGA 08609 | 07.96      | - ABS          |                |                          |                          |                |            |                |        |                          |                |            |                |        |                          |                |            |                |        |                          |                |            |                |                |        |                          |                |
|              | 1.8 D         | 43            | ORGA 08609 | 07.96      | - ABS          |                |                          |                          |                |            |                |        |                          |                |            |                |        |                          |                |            |                |        |                          |                |            |                |                |        |                          |                |
|              | 1.9 D         | 51            | ORGA 08609 | 07.96      | - ABS          |                |                          |                          |                |            |                |        |                          |                |            |                |        |                          |                |            |                |        |                          |                |            |                |                |        |                          |                |
|              | 2.0 HDi 90    | 66            | ORGA 08609 | 12.99      | - ABS          |                |                          |                          |                |            |                |        |                          |                |            |                |        |                          |                |            |                |        |                          |                |            |                |                |        |                          |                |
|              | 1.1 i         | 44            | ORGA 08609 | 07.96      | + ABS          | 24.2123-1713.3 | 010505                   |                          | THz 23,81      | <b>BOS</b> |                |        |                          |                |            |                |        |                          |                |            |                |        |                          |                |            |                |                |        |                          |                |
|              | 1.4 i         | 55            | ORGA 08609 | 07.96      | + ABS          |                |                          |                          |                |            |                |        |                          |                |            |                |        |                          |                |            |                |        |                          |                |            |                |                |        |                          |                |
|              | 1.8 D         | 43            | ORGA 08609 | 07.96      | + ABS          |                |                          |                          |                |            |                |        |                          |                |            |                |        |                          |                |            |                |        |                          |                |            |                |                |        |                          |                |
|              | 1.9 D         | 51            | ORGA 08609 | 07.96      | + ABS          |                |                          |                          |                |            |                |        |                          |                |            |                |        |                          |                |            |                |        |                          |                |            |                |                |        |                          |                |
|              | 2.0 HDi 90    | 66            | ORGA 08609 | 12.99      | + ABS          |                |                          |                          |                |            |                |        |                          |                |            |                |        |                          |                |            |                |        |                          |                |            |                |                |        |                          |                |
|              | 1.1 i         | 44 ORGA 08610 |            | 03.08      |                | 03.2123-2781.3 | 010631                   |                          | THz 23,81      | <b>ATE</b> |                |        |                          |                |            |                |        |                          |                |            |                |        |                          |                |            |                |                |        |                          |                |
|              | 1.4           | 48            |            | 11.02      | 03.08          |                |                          |                          |                |            | 24.2123-1714.3 | 010587 |                          | THz 23,81      | <b>BDX</b> |                |        |                          |                |            |                |        |                          |                |            |                |                |        |                          |                |
|              | 1.4 Bivalent  | 55            |            | 11.02      | 03.08          |                |                          |                          |                |            |                |        |                          |                |            | 24.2123-1715.3 | 010520 |                          | THz 23,81      | <b>BDX</b> |                |        |                          |                |            |                |                |        |                          |                |
|              | 1.4 i         | 55 ORGA 08610 |            |            | 03.08          |                |                          |                          |                |            |                |        |                          |                |            |                |        |                          |                |            |                |        |                          |                |            |                |                |        |                          |                |
|              | 1.6 16V       | 80            |            | 10.00      | 03.08          |                |                          |                          |                |            |                |        |                          |                |            |                |        |                          |                |            |                |        |                          |                |            |                |                |        |                          |                |
|              | 1.6 HDi 75    | 55            |            | 07.05      | 03.08          |                |                          |                          |                |            |                |        |                          |                |            |                |        |                          |                |            |                |        |                          |                |            |                |                |        |                          |                |
|              | 1.8 D         | 43 ORGA 08610 |            |            | 03.08          |                |                          |                          |                |            |                |        |                          |                |            |                |        |                          |                |            |                |        |                          |                |            |                |                |        |                          |                |
|              | 1.9 D         | 51 ORGA 08610 |            |            | 03.08          |                |                          |                          |                |            |                |        |                          |                |            |                |        |                          |                |            |                |        |                          |                |            |                |                |        |                          |                |
|              | 2.0 HDi 90    | 66 ORGA 08610 |            |            | 03.08          |                |                          |                          |                |            |                |        |                          |                |            |                |        |                          |                |            |                |        |                          |                |            |                |                |        |                          |                |
|              |               | 1.1 i         | 44         | ORGA 09428 | 07.96          |                |                          |                          |                |            |                |        |                          |                |            |                |        |                          |                |            |                |        |                          |                |            |                | 24.3541-1777.5 | 240247 | <input type="checkbox"/> | D=54, - Halter |
| 1.4 i        |               | 55            | ORGA 09428 | 07.96      |                | 24.3541-1778.5 | 240248                   | <input type="checkbox"/> | D=54, - Halter | <b>LUC</b> |                |        |                          |                |            |                |        |                          |                |            |                |        |                          |                |            |                |                |        |                          |                |
| 1.1 i        |               | 44            | ORGA 09127 | 07.96      |                |                |                          |                          |                |            | 24.3541-1757.7 | 220483 | <input type="checkbox"/> | D=54, - Halter | <b>LUC</b> |                |        |                          |                |            |                |        |                          |                |            |                |                |        |                          |                |
| 1.4 i        |               | 55            | ORGA 09127 | 07.96      |                |                |                          |                          |                |            |                |        |                          |                |            | 24.3541-1758.7 | 220484 | <input type="checkbox"/> | D=54, - Halter | <b>LUC</b> |                |        |                          |                |            |                |                |        |                          |                |
| 1.6 16V      |               | 80            | ORGA 09127 | 10.00      |                |                |                          |                          |                |            |                |        |                          |                |            |                |        |                          |                |            |                |        |                          |                |            |                |                |        |                          |                |
| 1.8 D        |               | 43            | ORGA 09127 | 07.96      |                |                |                          |                          |                |            |                |        |                          |                |            |                |        |                          |                |            |                |        |                          |                |            |                |                |        |                          |                |
| 1.9 D        |               | 51            | ORGA 09127 | 07.96      |                |                |                          |                          |                |            |                |        |                          |                |            |                |        |                          |                |            |                |        |                          |                |            |                |                |        |                          |                |
| 2.0 HDi 90   |               | 66            | ORGA 09127 | 12.99      |                |                |                          |                          |                |            |                |        |                          |                |            |                |        |                          |                |            |                |        |                          |                |            |                |                |        |                          |                |
| 1.1 i        |               | 44 ORGA 09429 |            |            | 03.08          |                |                          |                          |                |            |                |        |                          |                |            |                |        |                          |                |            | 24.3541-1771.5 | 240239 | <input type="checkbox"/> | D=54, - Halter | <b>BOS</b> |                |                |        |                          |                |
| 1.1 i        |               | 44 ORGA 09128 |            |            | 03.08          |                |                          |                          |                |            |                |        |                          |                |            |                |        |                          |                |            |                |        |                          |                |            | 24.3541-1772.5 |                |        |                          |                |
| 1.4          | 48            |               | 11.02      | 03.08      |                |                |                          |                          |                |            |                |        |                          |                |            |                |        |                          |                |            |                |        |                          |                |            |                |                |        |                          |                |
| 1.4 Bivalent | 55            |               | 11.02      | 03.08      |                |                |                          |                          |                |            |                |        |                          |                |            |                |        |                          |                |            |                |        |                          |                |            |                |                |        |                          |                |
| 1.4 i        | 55 ORGA 09429 |               |            | 03.08      |                |                |                          |                          |                |            |                |        |                          |                |            |                |        |                          |                |            |                |        |                          |                |            |                |                |        |                          |                |
| 1.4 i        | 55 ORGA 09128 |               |            | 03.08      |                |                |                          |                          |                |            |                |        |                          |                |            |                |        |                          |                |            |                |        |                          |                |            |                |                |        |                          |                |
| 1.6 16V      | 80 ORGA 09128 |               |            | 03.08      |                |                |                          |                          |                |            |                |        |                          |                |            |                |        |                          |                |            |                |        |                          |                |            |                |                |        |                          |                |
| 1.6 HDi 75   | 55            |               | 07.05      | 03.08      |                |                |                          |                          |                |            |                |        |                          |                |            |                |        |                          |                |            |                |        |                          |                |            |                |                |        |                          |                |
| 1.8 D        | 43 ORGA 09128 |               |            | 03.08      |                |                |                          |                          |                |            |                |        |                          |                |            |                |        |                          |                |            |                |        |                          |                |            |                |                |        |                          |                |
| 1.9 D        | 51 ORGA 09128 |               |            | 03.08      |                |                |                          |                          |                |            |                |        |                          |                |            |                |        |                          |                |            |                |        |                          |                |            |                |                |        |                          |                |
| 2.0 HDi 90   | 66 ORGA 09128 |               |            | 03.08      |                |                |                          |                          |                |            |                |        |                          |                |            |                |        |                          |                |            |                |        |                          |                |            |                |                |        |                          |                |
|              | 1.1 i         | 44            |            | 07.96      | 03.08          | 24.5111-0438.3 | 330568                   | 2                        | L=445          |            |                |        |                          |                |            |                |        |                          |                |            |                |        |                          |                |            |                |                |        |                          |                |
|              | 1.4           | 48            |            | 11.02      | 03.08          |                |                          |                          |                |            |                |        |                          |                |            |                |        |                          |                |            |                |        |                          |                |            |                |                |        |                          |                |
|              | 1.4 Bivalent  | 55            |            | 11.02      | 03.08          |                |                          |                          |                |            |                |        |                          |                |            |                |        |                          |                |            |                |        |                          |                |            |                |                |        |                          |                |
|              | 1.4 i         | 55            |            | 07.96      | 03.08          |                |                          |                          |                |            |                |        |                          |                |            |                |        |                          |                |            |                |        |                          |                |            |                |                |        |                          |                |
|              | 1.6 16V       | 80            |            | 10.00      | 03.08          |                |                          |                          |                |            |                |        |                          |                |            |                |        |                          |                |            |                |        |                          |                |            |                |                |        |                          |                |
|              | 1.6 HDi 75    | 55            |            | 07.05      | 03.08          |                |                          |                          |                |            |                |        |                          |                |            |                |        |                          |                |            |                |        |                          |                |            |                |                |        |                          |                |
|              | 1.8 D         | 43            |            | 07.96      | 03.08          |                |                          |                          |                |            |                |        |                          |                |            |                |        |                          |                |            |                |        |                          |                |            |                |                |        |                          |                |
|              | 1.9 D         | 51            |            | 07.96      | 03.08          |                |                          |                          |                |            |                |        |                          |                |            |                |        |                          |                |            |                |        |                          |                |            |                |                |        |                          |                |
|              | 2.0 HDi 90    | 66            |            | 12.99      | 03.08          |                |                          |                          |                |            |                |        |                          |                |            |                |        |                          |                |            |                |        |                          |                |            |                |                |        |                          |                |
|              | 2.0 HDi 90    | 66            |            | 12.99      | 03.08          |                |                          |                          |                |            | - ESP          |        |                          |                |            |                |        |                          |                |            |                |        |                          |                |            |                |                |        |                          |                |
|              | 2.0 HDi 90    | 66            |            | 12.99      | 03.08          | 24.5111-0460.3 | 330603                   | 2                        | L=460          |            |                |        |                          |                |            |                |        |                          |                |            |                |        |                          |                |            |                |                |        |                          |                |
|              | 2.0 HDi 90    | 66            |            | 12.99      | 03.08          | 24.3387-1711.7 | 220747                   | <input type="checkbox"/> | D=38, - Halter | <b>LUC</b> |                |        |                          |                |            |                |        |                          |                |            |                |        |                          |                |            |                |                |        |                          |                |
|              | 1.1 i         | 44            | ORGA 09533 | 07.96      |                | 24.5229-0255.3 | 330581                   | 2                        | L=255          |            |                |        |                          |                |            |                |        |                          |                |            |                |        |                          |                |            |                |                |        |                          |                |
|              | 1.4           | 48            | ORGA 09533 | 11.02      |                |                |                          |                          |                |            |                |        |                          |                |            |                |        |                          |                |            |                |        |                          |                |            |                |                |        |                          |                |
|              | 1.4 Bivalent  | 55            | ORGA 09533 | 11.02      |                |                |                          |                          |                |            |                |        |                          |                |            |                |        |                          |                |            |                |        |                          |                |            |                |                |        |                          |                |
|              | 1.4 i         | 55            | ORGA 09533 | 07.96      |                |                |                          |                          |                |            |                |        |                          |                |            |                |        |                          |                |            |                |        |                          |                |            |                |                |        |                          |                |
|              | 1.6 16V       | 80            | ORGA 09533 | 10.00      |                |                |                          |                          |                |            |                |        |                          |                |            |                |        |                          |                |            |                |        |                          |                |            |                |                |        |                          |                |
|              | 1.8 D         | 43            | ORGA 09533 | 07.96      |                |                |                          |                          |                |            |                |        |                          |                |            |                |        |                          |                |            |                |        |                          |                |            |                |                |        |                          |                |
|              | 1.9 D         | 51            | ORGA 09533 | 07.96      |                |                |                          |                          |                |            |                |        |                          |                |            |                |        |                          |                |            |                |        |                          |                |            |                |                |        |                          |                |
|              | 2.0 HDi 90    | 66            | ORGA 09533 | 12.99      |                |                |                          |                          |                |            |                |        |                          |                |            |                |        |                          |                |            |                |        |                          |                |            |                |                |        |                          |                |
|              | 1.1 i         | 44 ORGA 09534 |            |            | 03.08          |                |                          |                          |                |            | 24.5246-0260.3 | 330782 | 2                        | L=260          |            |                |        |                          |                |            |                |        |                          |                |            |                |                |        |                          |                |
|              | 1.4           | 48 ORGA 09534 |            |            | 03.08          |                |                          |                          |                |            |                |        |                          |                |            |                |        |                          |                |            |                |        |                          |                |            |                |                |        |                          |                |
| 1.4 Bivalent | 55 ORGA 09534 |               |            | 03.08      |                |                |                          |                          |                |            |                |        |                          |                |            |                |        |                          |                |            |                |        |                          |                |            |                |                |        |                          |                |
| 1.4 i        | 55 ORGA 09534 |               |            | 03.08      |                |                |                          |                          |                |            |                |        |                          |                |            |                |        |                          |                |            |                |        |                          |                |            |                |                |        |                          |                |
| 1.6 16V      | 80 ORGA 09534 |               |            | 03.08      |                |                |                          |                          |                |            |                |        |                          |                |            |                |        |                          |                |            |                |        |                          |                |            |                |                |        |                          |                |
| 1.6 HDi 75   | 55            |               | 07.05      | 03.08      |                |                |                          |                          |                |            |                |        |                          |                |            |                |        |                          |                |            |                |        |                          |                |            |                |                |        |                          |                |
| 1.8 D        | 43 ORGA 09534 |               |            | 03.08      |                |                |                          |                          |                |            |                |        |                          |                |            |                |        |                          |                |            |                |        |                          |                |            |                |                |        |                          |                |
| 1.9 D        | 51 ORGA 09534 |               |            | 03.08      |                |                |                          |                          |                |            |                |        |                          |                |            |                |        |                          |                |            |                |        |                          |                |            |                |                |        |                          |                |
| 2.0 HDi 90   | 66 ORGA 09534 |               |            | 03.08      |                |                |                          |                          |                |            |                |        |                          |                |            |                |        |                          |                |            |                |        |                          |                |            |                |                |        |                          |                |
|              | 1.1 i         | 44            |            | 07.96      | 03.08          | 24.3222-1711.3 | 020413                   |                          | Rz 22,20       | <b>LUC</b> |                |        |                          |                |            |                |        |                          |                |            |                |        |                          |                |            |                |                |        |                          |                |
|              | 1.4           | 48            |            | 11.02      | 03.08          |                |                          |                          |                |            | 24.3222-1734.3 | 020539 |                          | Rz 22,20       | <b>LUC</b> |                |        |                          |                |            |                |        |                          |                |            |                |                |        |                          |                |
|              | 1.4 Bivalent  | 55            |            | 11.02      | 03.08          |                |                          |                          |                |            |                |        |                          |                |            |                |        |                          |                |            |                |        |                          |                |            |                |                |        |                          |                |
|              | 1.4 i         | 55            |            | 07.96      | 03.08          |                |                          |                          |                |            |                |        |                          |                |            |                |        |                          |                |            |                |        |                          |                |            |                |                |        |                          |                |
|              | 1.6 16V       | 80            |            | 10.00      | 03.08          |                |                          |                          |                |            |                |        |                          |                |            |                |        |                          |                |            |                |        |                          |                |            |                |                |        |                          |                |
|              | 1.6 HDi 75    | 55            |            | 07.05      | 03.08          |                |                          |                          |                |            |                |        |                          |                |            |                |        |                          |                |            |                |        |                          |                |            |                |                |        |                          |                |
|              | 1.8 D         | 43            |            | 07.96      | 03.08          |                |                          |                          |                |            |                |        |                          |                |            |                |        |                          |                |            |                |        |                          |                |            |                |                |        |                          |                |
|              | 1.9 D         | 51            |            | 07.96      | 03.08          |                |                          |                          |                |            |                |        |                          |                |            |                |        |                          |                |            |                |        |                          |                |            |                |                |        |                          |                |
|              | 2.0 HDi 90    | 66            |            | 12.99      | 03.08          |                |                          |                          |                |            |                |        |                          |                |            |                |        |                          |                |            |                |        |                          |                |            |                |                |        |                          |                |
|              | 2.0 HDi 90    | 66            |            | 12.99      | 03.08          |                |                          |                          |                |            |                |        |                          |                |            | - ESP          |        |                          |                |            |                |        |                          |                |            |                |                |        |                          |                |
|              | 1.1 i         | 44            | ORGA 08393 | 07.96      |                | 24.3727-0314.2 | 580314                   | <input type="checkbox"/> | L=1745         |            |                |        |                          |                |            |                |        |                          |                |            |                |        |                          |                |            |                |                |        |                          |                |
|              | 1.4 i         | 55            | ORGA 08393 | 07.96      |                |                |                          |                          |                |            | 24.3727-0315.2 | 580315 | <input type="checkbox"/> | L=1818         |            |                |        |                          |                |            |                |        |                          |                |            |                |                |        |                          |                |
|              | 1.8 D         | 43            | ORGA 08393 | 07.96      |                |                |                          |                          |                |            |                |        |                          |                |            |                |        |                          |                |            |                |        |                          |                |            |                |                |        |                          |                |
|              | 1.9 D         | 51            | ORGA 08393 | 07.96      |                |                |                          |                          |                |            |                |        |                          |                |            |                |        |                          |                |            |                |        |                          |                |            |                |                |        |                          |                |
|              | 1.1 i         | 44 ORGA 08394 |            |            | 03.08          |                |                          |                          |                |            |                |        |                          |                |            | 24.3727-0314.2 | 580314 | <input type="checkbox"/> | L=1745         |            |                |        |                          |                |            |                |                |        |                          |                |
| 1.4          | 48            |               | 11.02      | 03.08      | 24.3727-0339.2 | 580339         | <input type="checkbox"/> | L=1850                   |                |            |                |        |                          |                |            |                |        |                          |                |            |                |        |                          |                |            |                |                |        |                          |                |
| 1.4 Bivalent | 55            |               | 11.02      | 03.08      |                |                |                          |                          |                |            |                |        |                          |                |            |                |        |                          |                |            |                |        |                          |                |            |                |                |        |                          |                |
| 1.4 i        | 55 ORGA 08394 |               |            | 03.08      |                |                |                          |                          |                |            |                |        |                          |                |            |                |        |                          |                |            |                |        |                          |                |            |                |                |        |                          |                |





**CITROEN BERLINGO (M\_) Kasten (96-08)**

|            |              |            |            |       |   |   |                |                          |                          |                  |     |                          |               |     |
|------------|--------------|------------|------------|-------|---|---|----------------|--------------------------|--------------------------|------------------|-----|--------------------------|---------------|-----|
|            | 1.6 16V      | 80         |            | 10.00 | 03.08                                       |   | 24.3727-0314.2 | 580314                   | <input type="checkbox"/> | L=1745<br>L=1850 |     |                          |               |     |
|            | 1.6 HDi 75   | 55         |            | 07.05 | 03.08                                       |   | 24.3727-0339.2 | 580339                   |                          |                  |     |                          |               |     |
|            | 1.8 D        | 43         | ORGA 08394 |       |   | 03.08   |                |                          |                          |                  |     |                          |               |     |
|            | 1.9 D        | 51         | ORGA 08394 |       |   | 03.08   |                |                          |                          |                  |     |                          |               |     |
|            | 2.0 HDi 90   | 66         | ORGA 08394 |       |   | 03.08   |                |                          |                          |                  |     |                          |               |     |
|            | 1.1 i        | 44         |            | 07.96 | 03.08                                       | + 0,5/0,6 t/-verstärktes Fahrwerk <sup>1)</sup> | 03.6582-0009.3 | 320143                   | <input type="checkbox"/> | BRL 8/1,5 (4)    | ATE |                          |               |     |
|            | 1.4          | 48         |            | 11.02 | 03.08                                       | + 0,5/0,6 t/-verstärktes Fahrwerk <sup>1)</sup> |                |                          |                          |                  |     |                          |               |     |
|            | 1.4 Bivalent | 55         |            | 11.02 | 03.08                                       | + 0,5/0,6 t/-verstärktes Fahrwerk <sup>1)</sup> |                |                          |                          |                  |     |                          |               |     |
|            | 1.4 i        | 55         |            | 07.96 | 03.08                                       | + 0,5/0,6 t/-verstärktes Fahrwerk <sup>1)</sup> |                |                          |                          |                  |     |                          |               |     |
|            | 1.6 16V      | 80         |            | 10.00 | 03.08                                       | + 0,6 t/-verstärktes Fahrwerk <sup>2)</sup>     |                |                          |                          |                  |     |                          |               |     |
|            | 1.6 HDi 75   | 55         |            | 07.05 | 03.08                                       | + 0,6 t/-verstärktes Fahrwerk <sup>2)</sup>     |                |                          |                          |                  |     |                          |               |     |
|            | 1.8 D        | 43         |            | 07.96 | 03.08                                       | + 0,6 t/-verstärktes Fahrwerk <sup>2)</sup>     |                |                          |                          |                  |     |                          |               |     |
|            | 1.9 D        | 51         |            | 07.96 | 03.08                                       | + 0,6 t/-verstärktes Fahrwerk <sup>2)</sup>     |                |                          |                          |                  |     |                          |               |     |
|            | 2.0 HDi 90   | 66         |            | 12.99 | 03.08                                       | + 0,6 t/-verstärktes Fahrwerk <sup>2)</sup>     |                |                          |                          |                  |     |                          |               |     |
|            | 1.1 i        | 44         |            | 07.96 | 03.08                                       | + 0,5/0,6 t/+verstärktes Fahrwerk <sup>3)</sup> | 03.6582-0012.3 | 320233                   |                          |                  |     | <input type="checkbox"/> | BRL 8/1,5 (4) | ATE |
|            | 1.4          | 48         |            | 11.02 | 03.08                                       | + 0,5/0,6 t/+verstärktes Fahrwerk <sup>3)</sup> |                |                          |                          |                  |     |                          |               |     |
|            | 1.4 Bivalent | 55         |            | 11.02 | 03.08                                       | + 0,5/0,6 t/+verstärktes Fahrwerk <sup>3)</sup> |                |                          |                          |                  |     |                          |               |     |
|            | 1.4 i        | 55         |            | 07.96 | 03.08                                       | + 0,5/0,6 t/+verstärktes Fahrwerk <sup>3)</sup> |                |                          |                          |                  |     |                          |               |     |
|            | 1.6 16V      | 80         |            | 10.00 | 03.08                                       | + 0,6 t/+verstärktes Fahrwerk <sup>4)</sup>     |                |                          |                          |                  |     |                          |               |     |
|            | 1.6 HDi 75   | 55         |            | 07.05 | 03.08                                       | + 0,6 t/+verstärktes Fahrwerk <sup>4)</sup>     |                |                          |                          |                  |     |                          |               |     |
| 1.8 D      | 43           |            | 07.96      | 03.08 | + 0,6 t/+verstärktes Fahrwerk <sup>4)</sup> |   |                |                          |                          |                  |     |                          |               |     |
| 1.9 D      | 51           |            | 07.96      | 03.08 | + 0,6 t/+verstärktes Fahrwerk <sup>4)</sup> |   |                |                          |                          |                  |     |                          |               |     |
| 2.0 HDi 90 | 66           |            | 12.99      | 03.08 | + 0,6 t/+verstärktes Fahrwerk <sup>4)</sup> |   |                |                          |                          |                  |     |                          |               |     |
| 1.6 16V    | 80           |            | 10.00      | 03.08 | + 0,8 t                                     | 03.6582-0015.3                                  | 320227         | <input type="checkbox"/> | BRL 8/1,5 (4)            | ATE              |     |                          |               |     |
| 1.6 HDi 75 | 55           |            | 07.05      | 03.08 | + 0,8 t                                     |   |                |                          |                          |                  |     |                          |               |     |
| 1.8 D      | 43           |            | 07.96      | 03.08 | + 0,8 t                                     |   |                |                          |                          |                  |     |                          |               |     |
| 1.9 D      | 51           |            | 07.96      | 03.08 | + 0,8 t                                     |   |                |                          |                          |                  |     |                          |               |     |
| 2.0 HDi 90 | 66           |            | 12.99      | 03.08 | + 0,8 t                                     |   |                |                          |                          |                  |     |                          |               |     |
|            | 1.1 i        | 44         |            | 07.96 | 03.08                                       |   | 24.3728-0328.2 | 590328                   | <input type="checkbox"/> | L=617            |     |                          |               |     |
|            | 1.4          | 48         |            | 11.02 | 03.08                                       |   |                |                          |                          |                  |     |                          |               |     |
|            | 1.4 Bivalent | 55         |            | 11.02 | 03.08                                       |   |                |                          |                          |                  |     |                          |               |     |
|            | 1.4 i        | 55         |            | 07.96 | 03.08                                       |   |                |                          |                          |                  |     |                          |               |     |
|            | 1.6 16V      | 80         | ORGA 11192 | 10.00 |   |   | 24.3728-0850.2 | 590850                   |                          |                  |     |                          |               |     |
|            | 1.6 HDi 75   | 55         | ORGA 11192 | 07.05 |   |   |                |                          |                          |                  |     |                          |               |     |
|            | 1.8 D        | 43         | ORGA 11192 | 07.96 |   |   |                |                          |                          |                  |     |                          |               |     |
|            | 1.9 D        | 51         | ORGA 11192 | 07.96 |   |   |                |                          |                          |                  |     |                          |               |     |
|            | 2.0 HDi 90   | 66         | ORGA 11192 | 12.99 |   |   |                |                          |                          |                  |     |                          |               |     |
|            | 1.6 16V      | 80         | ORGA 11193 |       |   | 03.08   | 24.3728-0343.2 | 590343                   |                          |                  |     | <input type="checkbox"/> | L=882, + AUT  |     |
| 1.6 HDi 75 | 55           | ORGA 11193 |            |       | 03.08                                       |   |                |                          |                          |                  |     |                          |               |     |
| 1.8 D      | 43           | ORGA 11193 |            |       | 03.08                                       |   |                |                          |                          |                  |     |                          |               |     |
| 1.9 D      | 51           | ORGA 11193 |            |       | 03.08                                       |   |                |                          |                          |                  |     |                          |               |     |
| 2.0 HDi 90 | 66           | ORGA 11193 |            |       | 03.08                                       |   |                |                          |                          |                  |     |                          |               |     |
| 1.8 D      | 43           |            | 07.96      | 03.08 | + BE3-Getriebe <sup>5)</sup>                | 24.3728-0329.2                                  | 590329         | <input type="checkbox"/> | L=653, + AUT             |                  |     |                          |               |     |
| 1.8 D      | 43           |            | 07.96      | 03.08 |   |   |                |                          |                          |                  |     |                          |               |     |
| 1.9 D      | 51           |            | 07.96      | 03.08 | + BE3-Getriebe <sup>5)</sup>                |   |                |                          |                          |                  |     |                          |               |     |

**CITROEN BERLINGO (B9) (08-)**

|             |             |       |    |       |       |  |                |                |                          |                          |           |       |
|-------------|-------------|-------|----|-------|-------|--|----------------|----------------|--------------------------|--------------------------|-----------|-------|
|             | 1.4 i       | 55    |    | 04.08 |       |  | 03.2123-3421.3 | 010933         | <input type="checkbox"/> | - ESP                    | Thz 23,81 | ATE   |
|             | 1.6 HDi 110 | 80    |    | 04.08 |       |  |                |                |                          |                          |           |       |
|             | 1.6 HDi 110 | 82    |    | 07.10 |       |  |                |                |                          |                          |           |       |
|             | 1.6 HDi 115 | 84    |    | 07.10 |       |  |                |                |                          |                          |           |       |
|             | 1.6 HDi 75  | 55    |    | 04.08 |       |  |                |                |                          |                          |           |       |
|             | 1.6 HDi 90  | 66    |    | 04.08 |       |  |                |                |                          |                          |           |       |
|             | 1.6 HDi 90  | 68    |    | 07.10 |       |  |                |                |                          |                          |           |       |
|             | 1.6 i 16V   | 66    |    | 04.08 |       |  |                |                |                          |                          |           |       |
|             | 1.6 i 16V   | 80    |    | 04.08 |       |  |                |                |                          |                          |           |       |
|             | 1.6 VTi 120 | 88    |    | 11.09 |       |  |                |                |                          |                          |           |       |
|             | 1.6 VTi 95  | 72    |    | 07.10 |       |  |                |                |                          |                          |           |       |
|             | Electric    | 42    |    | 02.13 |       |  |                |                |                          |                          |           |       |
|             |             | 1.4 i | 55 |       | 04.08 |  |                | 11.9601-9717.2 |                          |                          |           |       |
| 1.6 HDi 110 |             | 80    |    | 04.08 |       |  | 11.9601-9718.2 | 220902         |                          |                          |           |       |
| 1.6 HDi 110 |             | 82    |    | 07.10 |       |  | 11.8171-0008.1 | 990049         |                          |                          |           |       |
| 1.6 HDi 115 |             | 84    |    | 07.10 |       |  | 11.0101-5704.2 | 260095         |                          |                          |           |       |
| 1.6 HDi 75  |             | 55    |    | 04.08 |       |  | 11.0441-6008.2 | 250038         |                          |                          |           |       |
| 1.6 HDi 90  |             | 66    |    | 04.08 |       |  | 11.8116-0356.1 | 390586         |                          |                          |           |       |
| 1.6 HDi 90  |             | 68    |    | 07.10 |       |  |                |                |                          |                          |           |       |
| 1.6 i 16V   |             | 66    |    | 04.08 |       |  |                |                |                          |                          |           |       |
| 1.6 i 16V   |             | 80    |    | 04.08 |       |  |                |                |                          |                          |           |       |
| 1.6 VTi 120 |             | 88    |    | 11.09 |       |  |                |                |                          |                          |           |       |
| 1.6 VTi 95  |             | 72    |    | 07.10 |       |  |                |                |                          |                          |           |       |
| Electric    |             | 42    |    | 02.13 |       |  |                |                |                          |                          |           |       |
|             |             | 1.4 i | 55 |       | 04.08 |  |                | 24.5111-0424.3 | 331014                   | <input type="checkbox"/> | 2         | L=424 |
|             | 1.6 HDi 110 | 80    |    | 04.08 |       |  |                |                |                          |                          |           |       |
|             | 1.6 HDi 110 | 82    |    | 07.10 |       |  |                |                |                          |                          |           |       |
|             | 1.6 HDi 115 | 84    |    | 07.10 |       |  |                |                |                          |                          |           |       |
|             | 1.6 HDi 75  | 55    |    | 04.08 |       |  |                |                |                          |                          |           |       |
|             | 1.6 HDi 90  | 66    |    | 04.08 |       |  |                |                |                          |                          |           |       |
|             | 1.6 HDi 90  | 68    |    | 07.10 |       |  |                |                |                          |                          |           |       |
|             | 1.6 i 16V   | 66    |    | 04.08 |       |  |                |                |                          |                          |           |       |
|             | 1.6 i 16V   | 80    |    | 04.08 |       |  |                |                |                          |                          |           |       |
|             | 1.6 VTi 120 | 88    |    | 11.09 |       |  |                |                |                          |                          |           |       |
|             | 1.6 VTi 95  | 72    |    | 07.10 |       |  |                |                |                          |                          |           |       |
|             | Electric    | 42    |    | 02.13 |       |  |                |                |                          |                          |           |       |

<sup>1)</sup> + 0,5/0,6 t/-reinforc.suspens. / + 0,5/0,6 t/-sospensione rinforzata / + 0,5/0,6 t/-châssis renforcé / + 0,5/0,6 t/-suspensión reforzada  
<sup>2)</sup> + 0,6 t/-reinforced suspens. / + 0,6 t/-sospensione rinforzata / + 0,6 t/-châssis renforcé / + 0,6 t/-suspensión reforzada  
<sup>3)</sup> + 0,5/0,6 t/+reinforc.suspens. / + 0,5/0,6 t/+sospensione rinforzata / + 0,5/0,6 t/+châssis renforcé / + 0,5/0,6 t/+suspensión reforzada  
<sup>4)</sup> + 0,6 t/+reinforced suspens. / + 0,6 t/+sospensione rinforzata / + 0,6 t/+châssis renforcé / + 0,6 t/+suspensión reforzada  
<sup>5)</sup> + BE3 transmission / + scatola cambio BE3 / + boîte de vitesse BE3 / + cambio BE3



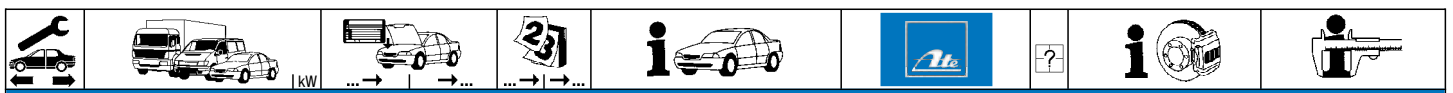

### CITROEN BERLINGO (B9) (08-)

|  |             |    |  |       |  |                |        |     |  |        |
|--|-------------|----|--|-------|--|----------------|--------|-----|--|--------|
|  | 1.4 i       | 55 |  | 04.08 |  | 24.5246-0216.3 | 331022 | 2   |  | L=216  |
|  | 1.6 HDi 110 | 80 |  | 04.08 |  |                |        |     |  |        |
|  | 1.6 HDi 110 | 82 |  | 07.10 |  |                |        |     |  |        |
|  | 1.6 HDi 115 | 84 |  | 07.12 |  |                |        |     |  |        |
|  | 1.6 HDi 75  | 55 |  | 04.08 |  |                |        |     |  |        |
|  | 1.6 HDi 90  | 66 |  | 04.08 |  |                |        |     |  |        |
|  | 1.6 HDi 90  | 68 |  | 07.10 |  |                |        |     |  |        |
|  | 1.6 i 16V   | 66 |  | 04.08 |  |                |        |     |  |        |
|  | 1.6 i 16V   | 80 |  | 04.08 |  |                |        |     |  |        |
|  | 1.6 VTi 120 | 88 |  | 11.09 |  |                |        |     |  |        |
|  | 1.6 VTi 95  | 72 |  | 07.10 |  |                |        |     |  |        |
|  | Electric    | 42 |  | 02.13 |  |                |        |     |  |        |
|  | 1.4 i       | 55 |  | 04.08 |  | 24.3727-0853.2 | 580853 | 2 ↓ |  | L=2402 |
|  | 1.6 HDi 110 | 80 |  | 04.08 |  |                |        |     |  |        |
|  | 1.6 HDi 110 | 82 |  | 07.10 |  |                |        |     |  |        |
|  | 1.6 HDi 115 | 84 |  | 07.10 |  |                |        |     |  |        |
|  | 1.6 HDi 75  | 55 |  | 04.08 |  |                |        |     |  |        |
|  | 1.6 HDi 90  | 66 |  | 04.08 |  |                |        |     |  |        |
|  | 1.6 HDi 90  | 68 |  | 07.10 |  |                |        |     |  |        |
|  | 1.6 i 16V   | 66 |  | 04.08 |  |                |        |     |  |        |
|  | 1.6 i 16V   | 80 |  | 04.08 |  |                |        |     |  |        |
|  | 1.6 VTi 120 | 88 |  | 11.09 |  |                |        |     |  |        |
|  | 1.6 VTi 95  | 72 |  | 07.10 |  |                |        |     |  |        |
|  | Electric    | 42 |  | 02.13 |  |                |        |     |  |        |

### CITROEN C1 (05-)

|  |         |    |            |       |       |                |        |   |       |           |     |
|--|---------|----|------------|-------|-------|----------------|--------|---|-------|-----------|-----|
|  | 1.0     | 50 |            | 06.05 |       | 24.4120-1701.3 | 010846 |   | - ESP | THz 20,64 | BOS |
|  | 1.4 HDi | 40 |            | 06.05 | 12.08 |                |        |   |       |           |     |
|  | 1.0     | 50 |            | 06.05 |       | 24.5295-0496.3 | 331033 |   |       | L=496     |     |
|  | 1.4 HDi | 40 |            | 06.05 | 12.08 | 24.5262-0501.3 | 331025 |   |       | L=501     |     |
|  | 1.0     | 50 | ORGA 10898 | 06.05 |       | 24.5261-0225.3 | 330909 | 2 |       | L=225     |     |
|  | 1.4 HDi | 40 | ORGA 10898 | 06.05 |       |                |        |   |       |           |     |
|  | 1.0     | 50 | ORGA 10899 | 06.05 |       | 24.5261-0225.3 | 330909 | 2 |       | L=225     |     |
|  | 1.0     | 50 | ORGA 10899 | 06.05 |       |                |        |   |       |           |     |
|  | 1.4 HDi | 40 |            | 06.05 | 12.08 |                |        |   |       |           |     |
|  | 1.4 HDi | 40 | ORGA 10899 | 12.08 |       |                |        |   |       |           |     |
|  | 1.0     | 50 |            | 06.05 |       | 24.3217-1719.3 | 020482 |   |       | Rz 17,46  | BOS |
|  | 1.4 HDi | 40 |            | 06.05 | 12.08 |                |        |   |       |           |     |
|  | 1.0     | 50 |            | 06.05 |       | 24.3728-0851.2 | 590851 |   |       | L=1596    |     |
|  | 1.4 HDi | 40 |            | 06.05 | 12.08 | 24.3728-0852.2 | 590852 |   |       | L=1479    |     |

### CITROEN C2 (03-09)

|  |         |    |            |       |       |                |        |  |       |           |     |
|--|---------|----|------------|-------|-------|----------------|--------|--|-------|-----------|-----|
|  | 1.1 i   | 44 |            | 09.03 | 12.09 | 24.2120-1741.3 | 010775 |  | - ABS | THz 20,64 |     |
|  | 1.4 16V | 65 |            | 06.06 | 12.09 |                |        |  |       |           |     |
|  | 1.4 HDi | 50 |            | 09.03 | 12.09 |                |        |  |       |           |     |
|  | 1.4 i   | 54 |            | 09.03 | 12.09 |                |        |  |       |           |     |
|  | 1.6 16V | 80 |            | 09.03 | 12.09 |                |        |  |       |           |     |
|  | 1.1 i   | 44 | ORGA 10800 | 09.03 |       | 24.2122-1766.3 | 010840 |  | - ESP | THz 22,20 | LUC |
|  | 1.4 HDi | 50 | ORGA 10800 | 09.03 |       | 24.2122-1767.3 | 010841 |  | + ESP | THz 22,20 | LUC |
|  | 1.4 i   | 54 | ORGA 10800 | 09.03 |       |                |        |  |       |           |     |
|  | 1.6 16V | 80 | ORGA 10800 | 09.03 |       |                |        |  |       |           |     |
|  | 1.6 VTS | 90 | ORGA 10800 | 01.05 |       |                |        |  |       |           |     |
|  | 1.1 i   | 44 | ORGA 10801 |       |       | 24.4122-1708.3 | 010865 |  | - ESP | THz 22,20 | BOS |
|  | 1.4 16V | 65 | ORGA 10801 |       |       |                |        |  |       |           |     |
|  | 1.4 HDi | 50 | ORGA 10801 |       |       |                |        |  |       |           |     |
|  | 1.4 i   | 54 | ORGA 10801 |       |       |                |        |  |       |           |     |
|  | 1.1 i   | 44 | ORGA 10808 |       |       | 24.4122-1704.3 | 010847 |  | - ESP | THz 22,20 | LUC |
|  | 1.4 16V | 65 | ORGA 10808 |       |       |                |        |  |       |           |     |
|  | 1.4 HDi | 50 | ORGA 10808 |       |       |                |        |  |       |           |     |
|  | 1.4 i   | 54 | ORGA 10808 |       |       |                |        |  |       |           |     |
|  | 1.6 16V | 80 | ORGA 10801 |       | 12.09 |                |        |  |       |           |     |
|  | 1.1 i   | 44 | ORGA 10811 |       |       | 24.4122-1708.3 | 010865 |  | - ESP | THz 22,20 | BOS |
|  | 1.4 16V | 65 | ORGA 10811 |       |       |                |        |  |       |           |     |
|  | 1.4 HDi | 50 | ORGA 10811 |       |       |                |        |  |       |           |     |
|  | 1.4 i   | 54 | ORGA 10811 |       |       |                |        |  |       |           |     |
|  | 1.1 i   | 44 | ORGA 10815 |       |       | 24.2122-1764.3 | 010851 |  | - ESP | THz 22,20 | BOS |
|  | 1.4 16V | 65 | ORGA 10815 |       |       |                |        |  |       |           |     |
|  | 1.4 HDi | 50 | ORGA 10815 |       |       |                |        |  |       |           |     |
|  | 1.4 i   | 54 | ORGA 10815 |       |       |                |        |  |       |           |     |
|  | 1.1 i   | 44 | ORGA 11193 |       |       | 24.4122-1708.3 | 010865 |  | - ESP | THz 22,20 | BOS |
|  | 1.4 16V | 65 | ORGA 11193 |       |       |                |        |  |       |           |     |
|  | 1.4 HDi | 50 | ORGA 11193 |       |       |                |        |  |       |           |     |
|  | 1.4 i   | 54 | ORGA 11193 |       |       |                |        |  |       |           |     |
|  | 1.1 i   | 44 | ORGA 10801 |       |       | 24.4122-1704.3 | 010847 |  | - ESP | THz 22,20 | LUC |
|  | 1.4 16V | 65 | ORGA 10801 |       |       |                |        |  |       |           |     |
|  | 1.4 HDi | 50 | ORGA 10801 |       |       |                |        |  |       |           |     |
|  | 1.4 i   | 54 | ORGA 10801 |       |       |                |        |  |       |           |     |
|  | 1.1 i   | 44 | ORGA 10801 |       |       | 24.4122-1703.3 | 010843 |  | + ESP | THz 22,20 | LUC |
|  | 1.4 16V | 65 | ORGA 10801 |       |       |                |        |  |       |           |     |
|  | 1.4 HDi | 50 | ORGA 10801 |       |       |                |        |  |       |           |     |
|  | 1.4 i   | 54 | ORGA 10801 |       |       |                |        |  |       |           |     |



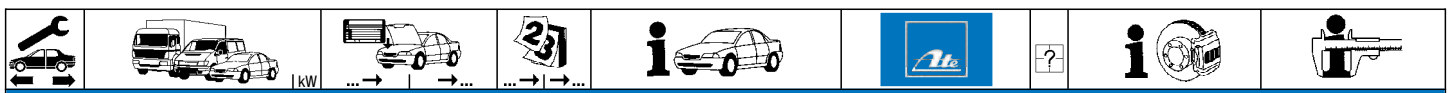

**CITROEN C2 (03-09)**

|  |   |  |  |   |  |                                  |                  |        |  |                        |            |
|--|---|--|--|---|--|----------------------------------|------------------|--------|--|------------------------|------------|
|  | 1.6 16V<br>1.6 HDi<br>1.6 VTS   | 80 ORGA 10801<br>80 ORGA 10801<br>90 ORGA 10801  |  | 12.09<br>12.09<br>12.09                                     |  | 24.4122-1703.3                   | 010843           | + ESP  | Thz 22,20  | LUC                    |            |
|  | 1.1 i<br>1.4 HDi<br>1.4 i   | 44<br>50<br>54   |  | 09.03<br>12.09<br>09.03                                     | - belüftete Scheiben <sup>1)</sup><br>- belüftete Scheiben <sup>1)</sup><br>- belüftete Scheiben <sup>1)</sup>                               | 24.3481-1761.5<br>24.3481-1762.5 | 240393<br>240394 |        | D=48, - Halter<br>D=48, - Halter   | LUC<br>LUC             |            |
|  | 1.4 16V<br>1.4 HDi<br>1.4 i<br>1.6 16V                                | 65<br>50<br>54<br>80   | ORGA 10800<br>ORGA 10800   | 06.06<br>09.03<br>09.03<br>09.03                            | + belüftete Scheiben <sup>2)</sup><br>+ belüftete Scheiben <sup>2)</sup><br>+ belüftete Scheiben <sup>2)</sup>                               | 24.3541-1803.7<br>24.3541-1804.7 | 220603<br>220604 |        | D=54, - Halter<br>D=54, - Halter   | LUC<br>LUC             |            |
|  | 1.4 HDi<br>1.6 16V<br>1.6 HDi<br>1.6 VTS                              | 50 ORGA 10801<br>80 ORGA 10801<br>80<br>90   |  | 12.09<br>12.09<br>09.05<br>12.09                            | + belüftete Scheiben <sup>2)</sup>   | 24.3541-1771.5<br>24.3541-1772.5 | 240239<br>240240 |        | D=54, - Halter<br>D=54, - Halter   | BOS<br>BOS             |            |
|  | 1.1 i<br>1.4 16V<br>1.4 HDi<br>1.4 i<br>1.6 16V<br>1.6 HDi            | 44<br>65<br>50<br>54<br>80<br>80   |  | 09.03<br>06.06<br>09.03<br>09.03<br>09.03<br>09.05          |  | 24.5111-0460.3<br>24.5111-0446.3 | 330603<br>331055 | 2<br>2 | - 16" Rad <sup>3)</sup><br>+ 16" Rad <sup>4)</sup>                                 | L=460<br>L=445         |            |
|  | 1.4 16V<br>1.4 HDi<br>1.4 i<br>1.6 16V<br>1.6 HDi<br>1.6 VTS          | 65<br>50<br>54<br>80<br>80<br>90   |  | 06.06<br>09.03<br>09.03<br>09.03<br>09.05<br>01.05          |  | 24.3387-1705.7<br>24.3387-1706.7 | 220675<br>220676 |        | D=38, - Halter<br>D=38, - Halter   | LUC<br>LUC             |            |
|  | 1.1 i<br>1.4 HDi<br>1.4 i<br>1.6 16V<br>1.6 VTS                       | 44<br>50<br>54<br>80<br>90   | ORGA 10569<br>ORGA 10569<br>ORGA 10569<br>ORGA 10569<br>ORGA 10569 | 09.03<br>09.03<br>09.03<br>09.03<br>01.05                   |  | 24.5246-0185.3                   | 330881           | 2      |  | L=185                  |            |
|  | 1.1 i<br>1.4 16V<br>1.4 HDi<br>1.4 i<br>1.6 16V<br>1.6 HDi<br>1.6 VTS | 44 ORGA 10570<br>65<br>50 ORGA 10570<br>54 ORGA 10570<br>80 ORGA 10570<br>80 ORGA 10570<br>90 ORGA 10570 |  | 06.06<br>12.09<br>12.09<br>12.09<br>12.09<br>12.09<br>12.09 |  | 24.5246-0190.3                   | 330697           | 2      |  | L=190                  |            |
|  | 1.1 i<br>1.4 16V<br>1.4 HDi<br>1.4 i                                  | 44<br>65<br>50<br>54   |  | 09.03<br>06.06<br>09.03<br>09.03                            | - ABS<br>- ABS<br>- ABS<br>- ABS   | 24.3219-1739.3<br>24.3219-1740.3 | 020472<br>020473 |        | nur paarweise austauschen <sup>5)</sup><br>nur paarweise austauschen <sup>5)</sup> | RzR 19,05<br>RzR 19,05 | LUC<br>LUC |
|  | 1.1 i<br>1.4 16V<br>1.4 HDi<br>1.4 i                                  | 44<br>65<br>50<br>54   |  | 09.03<br>06.06<br>09.03<br>09.03                            | + ABS<br>+ ABS<br>+ ABS<br>+ ABS   | 24.3220-1724.3<br>24.3220-1717.3 | 020476<br>020430 |        |  | Rz 20,64<br>Rz 20,64   | BOS<br>LUC |
|  | 1.1 i<br>1.4 16V<br>1.4 HDi<br>1.4 i                                  | 44<br>65<br>50<br>54   |  | 09.03<br>06.06<br>09.03<br>09.03                            | + HA-Trommelbremse <sup>6)</sup><br>+ HA-Trommelbremse <sup>6)</sup><br>+ HA-Trommelbremse <sup>6)</sup><br>+ HA-Trommelbremse <sup>6)</sup> | 24.3727-0843.2                   | 580843           | 2      |  | L=1612                 |            |

**CITROEN C3 (02-09)**

|  |   |  |  |  |  |                |        |       |           |     |
|--|---|--|--|--|--|----------------|--------|-------|-----------|-----|
|  | 1.1 i<br>1.4 16V<br>1.4 16V HDi 90<br>1.4 bivalent<br>1.4 HDi<br>1.4 i<br>1.6 16V   | 44<br>65<br>66<br>54<br>50<br>54<br>80   |  | 02.02<br>08.09<br>02.02<br>08.09<br>02.02<br>08.09<br>02.02<br>08.09                                     |  | 24.2120-1741.3 | 010775 | - ABS | Thz 20,64 |     |
|  | 1.1 i<br>1.4 16V<br>1.4 16V HDi 90<br>1.4 bivalent<br>1.4 HDi<br>1.4 i<br>1.6 16V<br>1.6 16V HDi 110<br>1.6 16V HDi 90                              | 44<br>65<br>66<br>54<br>50<br>54<br>80<br>80<br>66   | ORGA 10800<br>ORGA 10800<br>ORGA 10800<br>ORGA 10800<br>ORGA 10800<br>ORGA 10800<br>ORGA 10800<br>ORGA 10800<br>ORGA 10800   | 02.02<br>12.03<br>02.02<br>09.05<br>02.02<br>02.02<br>02.02<br>05.05<br>10.05                            |  | 24.2122-1766.3 | 010840 | - ESP | Thz 22,20 | LUC |
|  | 1.1 i<br>1.1 i<br>1.4 16V<br>1.4 16V HDi 90<br>1.4 bivalent<br>1.4 HDi<br>1.4 HDi<br>1.4 i<br>1.4 i<br>1.6 16V<br>1.6 16V HDi 110<br>1.6 16V HDi 90 | 44<br>44 ORGA 10815<br>65<br>66<br>66 ORGA 10815<br>54<br>50<br>50 ORGA 10815<br>54<br>54 ORGA 10815<br>80<br>80<br>66 | ORGA 10800<br>ORGA 10800<br>ORGA 10800<br>ORGA 10800<br>ORGA 10800<br>ORGA 10800<br>ORGA 10800<br>ORGA 10800<br>ORGA 10800<br>ORGA 10800<br>ORGA 10800<br>ORGA 10800 | 02.02<br>08.09<br>12.03<br>02.02<br>09.05<br>02.02<br>08.09<br>02.02<br>08.09<br>02.02<br>09.05<br>10.05 |  | 24.2122-1764.3 | 010851 | - ESP | Thz 22,20 | BOS |
|  | 1.1 i<br>1.4 16V HDi 90<br>1.4 bivalent   | 44 ORGA 10801<br>66 ORGA 10801<br>54 ORGA 10801  | ORGA 10807<br>ORGA 10807<br>ORGA 10807   |  |  | 24.4122-1708.3 | 010865 | - ESP | Thz 22,20 | BOS |

<sup>1)</sup> - ventilated discs / - dischi ventilati / - disques ventilés / - disco ventilado  
<sup>2)</sup> + ventilated discs / + dischi ventilati / + disques ventilés / + disco ventilado  
<sup>3)</sup> - 16" wheel / - ruota 16" / - roue 16" / - rueda 16"  
<sup>4)</sup> + 16" wheel / + ruota 16" / + roue 16" / + rueda 16"  
<sup>5)</sup> to change only by pairs / sostituire solo a coppie / à changer seulement par paires / cambiar solamente por parejas  
<sup>6)</sup> + RA drum brake / + P freno a tamburo / + frein à tambour essieu AR / + ET-tambores de freno



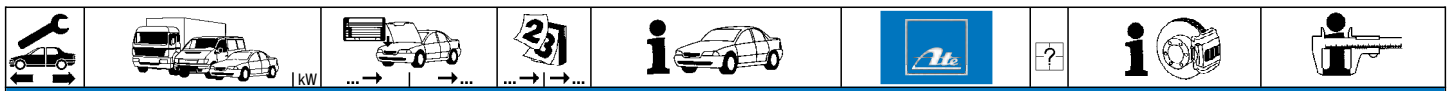

**CITROEN C3 (02-09)**

|                 |                 |               |               |       |                                   |                                |                |              |                |                |            |
|-----------------|-----------------|---------------|---------------|-------|-----------------------------------|--------------------------------|----------------|--------------|----------------|----------------|------------|
|                 | 1.4 HDi         | 50 ORGA 10801 | ORGA 10807    |       |                                   | 24.4122-1708.3                 | 010865         |              | - ESP          | THz 22,20      | <b>BOS</b> |
|                 | 1.4 i           | 54 ORGA 10801 | ORGA 10807    |       |                                   |                                |                |              |                |                |            |
|                 | 1.6 16V HDi 110 | 80 ORGA 10801 | ORGA 10807    |       |                                   |                                |                |              |                |                |            |
|                 | 1.1 i           | 44 ORGA 10808 | ORGA 10814    |       |                                   | 24.4122-1704.3                 | 010847         |              | - ESP          | THz 22,20      | <b>LUC</b> |
|                 | 1.1 i           | 44            |               | 02.02 | 08.09                             |                                |                |              |                |                |            |
|                 | 1.4 16V         | 65            |               | 12.03 | 08.09                             |                                |                |              |                |                |            |
|                 | 1.4 16V HDi 90  | 66            |               | 02.02 | 08.09                             |                                |                |              |                |                |            |
|                 | 1.4 bivalent    | 54            |               | 09.05 | 08.09                             |                                |                |              |                |                |            |
|                 | 1.4 HDi         | 50 ORGA 10808 | ORGA 10814    |       |                                   |                                |                |              |                |                |            |
|                 | 1.4 HDi         | 50            |               | 02.02 | 08.09                             |                                |                |              |                |                |            |
|                 | 1.4 i           | 54 ORGA 10808 | ORGA 10814    |       |                                   |                                |                |              |                |                |            |
|                 | 1.4 i           | 54            |               | 02.02 | 08.09                             |                                |                |              |                |                |            |
|                 | 1.6 16V         | 80            |               | 02.02 | 08.09                             |                                |                |              |                |                |            |
|                 | 1.6 16V HDi 110 | 80            |               | 09.05 | 08.09                             |                                |                |              |                |                |            |
|                 | 1.6 16V HDi 90  | 66            |               | 10.05 | 08.09                             |                                |                |              |                |                |            |
|                 | 1.1 i           | 44 ORGA 10801 | ORGA 10800    | 02.02 | 08.09                             | 24.2122-1767.3                 | 010841         |              | + ESP          | THz 22,20      | <b>LUC</b> |
|                 | 1.4 16V         | 65 ORGA 10801 | ORGA 10800    | 12.03 | 08.09                             |                                |                |              |                |                |            |
|                 | 1.4 16V HDi 90  | 66 ORGA 10801 | ORGA 10800    | 02.02 | 08.09                             |                                |                |              |                |                |            |
|                 | 1.4 bivalent    | 54 ORGA 10801 | ORGA 10800    | 09.05 | 08.09                             |                                |                |              |                |                |            |
|                 | 1.4 HDi         | 50 ORGA 10801 | ORGA 10800    | 02.02 | 08.09                             |                                |                |              |                |                |            |
|                 | 1.4 i           | 54 ORGA 10801 | ORGA 10800    | 02.02 | 08.09                             |                                |                |              |                |                |            |
|                 | 1.6 16V         | 80 ORGA 10801 | ORGA 10800    | 02.02 | 08.09                             |                                |                |              |                |                |            |
|                 | 1.6 16V HDi 110 | 80 ORGA 10801 | ORGA 10800    | 09.05 | 08.09                             |                                |                |              |                |                |            |
|                 | 1.6 16V HDi 90  | 66 ORGA 10801 | ORGA 10800    | 10.05 | 08.09                             |                                |                |              |                |                |            |
|                 |                 | 1.1 i         | 44 ORGA 10801 |       | 08.09                             | 08.09                          | 24.4122-1703.3 | 010843       |                | + ESP          | THz 22,20  |
| 1.4 16V         |                 | 65 ORGA 10801 |               | 08.09 | 08.09                             |                                |                |              |                |                |            |
| 1.4 16V HDi 90  |                 | 66 ORGA 10801 |               | 08.09 | 08.09                             |                                |                |              |                |                |            |
| 1.4 bivalent    |                 | 54 ORGA 10801 |               | 08.09 | 08.09                             |                                |                |              |                |                |            |
| 1.4 HDi         |                 | 50 ORGA 10801 |               | 08.09 | 08.09                             |                                |                |              |                |                |            |
| 1.4 i           |                 | 54 ORGA 10801 |               | 08.09 | 08.09                             |                                |                |              |                |                |            |
| 1.6 16V         |                 | 80 ORGA 10801 |               | 08.09 | 08.09                             |                                |                |              |                |                |            |
| 1.6 16V HDi 110 |                 | 80 ORGA 10801 |               | 08.09 | 08.09                             |                                |                |              |                |                |            |
| 1.6 16V HDi 90  |                 | 66 ORGA 10801 |               | 08.09 | 08.09                             |                                |                |              |                |                |            |
| 1.4 16V         |                 | 65            |               | 12.03 | 08.09                             | 24.3541-1803.7                 | 220603         |              | - 16" Rad 1)   | D=54, - Halter | <b>LUC</b> |
| 1.4 16V HDi 90  |                 | 66            |               | 02.02 | 08.09                             | 24.3541-1804.7                 | 220604         |              | - 16" Rad 1)   | D=54, - Halter | <b>LUC</b> |
| 1.6 16V         |                 | 80            |               | 02.02 | 08.09                             | + Schaltgetriebe 2)            |                |              |                |                |            |
| 1.6 16V HDi 110 | 80              |               | 09.05         | 08.09 |                                   |                                |                |              |                |                |            |
| 1.6 16V HDi 90  | 66              |               | 10.05         | 08.09 |                                   |                                |                |              |                |                |            |
| 1.6 16V         | 80              | ORGA 10800    | 02.02         | 08.09 | + Automatikgetriebe 3)            | 24.3541-1761.5                 | 240233         |              |                | D=54, - Halter | <b>BOS</b> |
| 1.6 16V HDi 110 | 80              | ORGA 10800    | 09.05         | 08.09 |                                   | 24.3541-1762.5                 | 240234         |              |                | D=54, - Halter | <b>BOS</b> |
| 1.6 16V         | 80 ORGA 10801   |               | 08.09         | 08.09 | + Automatikgetriebe 3)            | 24.3541-1761.5                 | 240233         |              |                | D=54, - Halter | <b>BOS</b> |
| 1.6 16V HDi 110 | 80 ORGA 10801   |               | 08.09         | 08.09 |                                   | 24.3541-1762.5                 | 240234         |              |                | D=54, - Halter | <b>BOS</b> |
| 1.4 16V         | 65              |               | 12.03         | 08.09 | 24.3541-1771.5                    | 240239                         |                | + 16" Rad 4) | D=54, - Halter | <b>BOS</b>     |            |
| 1.6 16V         | 80              |               | 02.02         | 08.09 | 24.3541-1772.5                    | 240240                         |                | + 16" Rad 4) | D=54, - Halter | <b>BOS</b>     |            |
| 1.6 16V HDi 90  | 66              |               | 10.05         | 08.09 |                                   |                                |                |              |                |                |            |
|                 | 1.1 i           | 44            |               | 02.02 | 08.09                             | 24.5111-0460.3                 | 330603         | 2            |                | L=460          |            |
|                 | 1.4 16V         | 65            |               | 12.03 | 08.09                             |                                |                |              |                |                |            |
|                 | 1.4 16V HDi 90  | 66            |               | 02.02 | 08.09                             |                                |                |              |                |                |            |
|                 | 1.4 bivalent    | 54            |               | 09.05 | 08.09                             |                                |                |              |                |                |            |
|                 | 1.4 HDi         | 50            |               | 02.02 | 08.09                             |                                |                |              |                |                |            |
|                 | 1.4 i           | 54            |               | 02.02 | 08.09                             |                                |                |              |                |                |            |
|                 | 1.6 16V         | 80            |               | 02.02 | 08.09                             | - 16" Rad/ + Schaltgetriebe 5) |                |              |                |                |            |
|                 | 1.6 16V HDi 110 | 80            |               | 09.05 | 08.09                             | - ABS                          |                |              |                |                |            |
| 1.6 16V HDi 90  | 66              |               | 10.05         | 08.09 |                                   |                                |                |              |                |                |            |
| 1.6 16V         | 80              |               | 02.02         | 08.09 | + 16" Rad/ + Automatikgetriebe 6) | 24.5111-0446.3                 | 331055         | 2            |                | L=445          |            |
| 1.6 16V HDi 110 | 80              |               | 09.05         | 08.09 | + ABS                             |                                |                |              |                |                |            |
|                 | 1.6 16V         | 80            |               | 02.02 | 08.09                             | 24.3387-1705.7                 | 220675         |              |                | D=38, - Halter | <b>LUC</b> |
|                 | 1.6 16V HDi 110 | 80            |               | 09.05 | 08.09                             | 24.3387-1706.7                 | 220676         |              |                | D=38, - Halter | <b>LUC</b> |
|                 | 1.6 16V HDi 90  | 66            |               | 10.05 | 08.09                             |                                |                |              |                |                |            |
|                 | 1.1 i           | 44            | ORGA 10569    | 02.02 | 08.09                             | 24.5246-0185.3                 | 330881         | 2            |                | L=185          |            |
|                 | 1.4 16V         | 65            | ORGA 10569    | 12.03 | 08.09                             |                                |                |              |                |                |            |
|                 | 1.4 16V HDi 90  | 66            | ORGA 10569    | 02.02 | 08.09                             |                                |                |              |                |                |            |
|                 | 1.4 bivalent    | 54            | ORGA 10569    | 09.05 | 08.09                             |                                |                |              |                |                |            |
|                 | 1.4 HDi         | 50            | ORGA 10569    | 02.02 | 08.09                             |                                |                |              |                |                |            |
|                 | 1.4 i           | 54            | ORGA 10569    | 02.02 | 08.09                             |                                |                |              |                |                |            |
|                 | 1.6 16V         | 80            | ORGA 10569    | 02.02 | 08.09                             |                                |                |              |                |                |            |
|                 | 1.6 16V HDi 110 | 80            | ORGA 10569    | 09.05 | 08.09                             |                                |                |              |                |                |            |
| 1.6 16V HDi 90  | 66              | ORGA 10569    | 10.05         | 08.09 |                                   |                                |                |              |                |                |            |
|                 | 1.1 i           | 44 ORGA 10570 |               | 08.09 | 08.09                             | 24.5246-0190.3                 | 330697         | 2            |                | L=190          |            |
|                 | 1.4 16V         | 65 ORGA 10570 |               | 08.09 | 08.09                             |                                |                |              |                |                |            |
|                 | 1.4 16V HDi 90  | 66 ORGA 10570 |               | 08.09 | 08.09                             |                                |                |              |                |                |            |
|                 | 1.4 bivalent    | 54 ORGA 10570 |               | 08.09 | 08.09                             |                                |                |              |                |                |            |
|                 | 1.4 HDi         | 50 ORGA 10570 |               | 08.09 | 08.09                             |                                |                |              |                |                |            |
|                 | 1.4 i           | 54 ORGA 10570 |               | 08.09 | 08.09                             |                                |                |              |                |                |            |
|                 | 1.6 16V         | 80 ORGA 10570 |               | 08.09 | 08.09                             |                                |                |              |                |                |            |
|                 | 1.6 16V HDi 110 | 80 ORGA 10570 |               | 08.09 | 08.09                             |                                |                |              |                |                |            |
| 1.6 16V HDi 90  | 66 ORGA 10570   |               | 08.09         | 08.09 |                                   |                                |                |              |                |                |            |

1) - 16" wheel / - ruota 16" / - roue 16" / - rueda 16"

2) + manual transmission / + scatola cambio velocità / + transmission mécanique / + cambio de velocidad

3) + autom.transmission / + scatola cambio automatico / + transmission automatique / + cambio automático

4) + 16" wheel / + ruota 16" / + roue 16" / + rueda 16"

5) - 16" wheel / + manual transm. / - ruota 16"/+ scatola camb.velocità / - roue 16"/ + transm.mécanique / - rueda 16"/ + cambio velocidad

6) + 16" wheel/ + autom.transm. / + ruota 16"/+ scatola camb.autom. / + roue 16"/ + transm.automatique / + rueda 16"/ + cambio automático

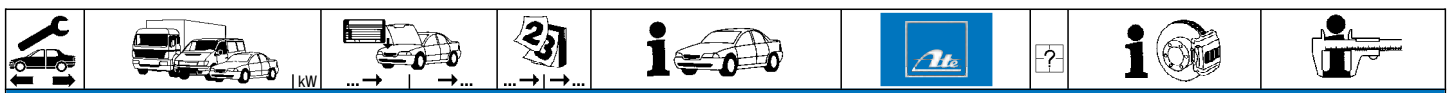

| CITROEN C3 (02-09) |                |            |            |       |       |                       |                |        |  |           |     |
|--------------------|----------------|------------|------------|-------|-------|-----------------------|----------------|--------|--|-----------|-----|
|                    | 1.1 i          | 44         |            | 02.02 | 08.09 | - ABS                 | 24.3219-1739.3 | 020472 | ☐ nur paarweise austauschen 1)<br>☐ nur paarweise austauschen 1) | RzR 19,05 | LUC |
|                    | 1.4 bivalent   | 54         |            | 09.05 | 08.09 | - ABS                 | 24.3219-1740.3 | 020473 |  | RzR 19,05 | LUC |
|                    | 1.4 HDi        | 50         |            | 02.02 | 08.09 | - ABS                 |                |        |  |           |     |
|                    | 1.4 i          | 54         |            | 02.02 | 08.09 | - ABS                 |                |        |  |           |     |
|                    | 1.1 i          | 44         |            | 02.02 | 08.09 | + ABS                 | 24.3220-1724.3 | 020476 |  | Rz 20,64  | BOS |
|                    | 1.4 16V        | 65         |            | 12.03 | 08.09 |                       | 24.3220-1717.3 | 020430 |  | Rz 20,64  | LUC |
|                    | 1.4 16V HDi 90 | 66         |            | 02.02 | 08.09 |                       |                |        |  |           |     |
|                    | 1.4 bivalent   | 54         |            | 09.05 | 08.09 | + ABS                 |                |        |  |           |     |
|                    | 1.4 HDi        | 50         |            | 02.02 | 08.09 | + ABS                 |                |        |  |           |     |
|                    | 1.4 i          | 54         |            | 02.02 | 08.09 | + ABS                 |                |        |  |           |     |
|                    | 1.6 16V HDi 90 | 66         |            | 10.05 | 08.09 |                       |                |        |  |           |     |
|                    | 1.1 i          | 44         | ORGA 10422 | 02.02 |       |                       | 24.3727-0346.2 | 580346 | 2 ↕  | L=1716    |     |
|                    | 1.4 16V        | 65         | ORGA 10422 | 12.03 |       |                       |                |        |  |           |     |
|                    | 1.4 16V HDi 90 | 66         | ORGA 10422 | 02.02 |       |                       |                |        |  |           |     |
|                    | 1.4 bivalent   | 54         | ORGA 10422 | 09.05 |       |                       |                |        |  |           |     |
|                    | 1.4 HDi        | 50         | ORGA 10422 | 02.02 |       |                       |                |        |  |           |     |
|                    | 1.4 i          | 54         | ORGA 10422 | 02.02 |       |                       |                |        |  |           |     |
|                    | 1.6 16V HDi 90 | 66         | ORGA 10422 | 10.05 |       | + HA-Trommelbremse 2) |                |        |  |           |     |
|                    | 1.1 i          | 44         | ORGA 10423 |       | 08.09 |                       | 24.3727-0352.2 | 580352 | 2 ↕  | L=1693    |     |
|                    | 1.4 16V        | 65         | ORGA 10423 |       | 08.09 |                       |                |        |  |           |     |
|                    | 1.4 16V HDi 90 | 66         | ORGA 10423 |       | 08.09 |                       |                |        |  |           |     |
|                    | 1.4 bivalent   | 54         | ORGA 10423 |       | 08.09 |                       |                |        |  |           |     |
|                    | 1.4 HDi        | 50         | ORGA 10423 |       | 08.09 |                       |                |        |  |           |     |
| 1.4 i              | 54             | ORGA 10423 |            | 08.09 |       |                       |                |        |  |           |     |
|                    | 1.6 16V HDi 90 | 66         | ORGA 10423 |       | 08.09 | + HA-Trommelbremse 2) |                |        |  |           |     |

| CITROEN C3 Picasso (09-) |                |    |  |       |  |                                  |                |        |                |                |     |
|--------------------------|----------------|----|--|-------|--|----------------------------------|----------------|--------|----------------|----------------|-----|
|                          | 1.4 VTI 95     | 70 |  | 02.09 |  |                                  | 24.4123-1705.3 | 010832 | - ESP<br>+ ESP | Thz 23,81      | LUC |
|                          | 1.4 VTI 95 LPG | 70 |  | 01.12 |  |                                  | 24.4123-1704.3 | 010828 |                | Thz 23,81      | LUC |
|                          | 1.6 Flex       | 78 |  | 11.09 |  |                                  |                |        |                |                |     |
|                          | 1.6 HDi        | 80 |  | 02.09 |  |                                  |                |        |                |                |     |
|                          | 1.6 HDi 110    | 82 |  | 05.10 |  |                                  |                |        |                |                |     |
|                          | 1.6 HDi 115    | 84 |  | 11.12 |  |                                  |                |        |                |                |     |
|                          | 1.6 HDi 90     | 66 |  | 02.09 |  |                                  |                |        |                |                |     |
|                          | 1.6 HDi 90     | 68 |  | 07.10 |  |                                  |                |        |                |                |     |
|                          | 1.6 VTI 120    | 88 |  | 02.09 |  |                                  |                |        |                |                |     |
|                          | 1.4 VTI 95     | 70 |  | 02.09 |  | + Bremsscheibendurchm. 266 mm 3) | 24.3541-1771.5 | 240239 | ☐<br>☐         | D=54, - Halter | BOS |
|                          | 1.4 VTI 95 LPG | 70 |  | 01.12 |  | + Bremsscheibendurchm. 266 mm 3) | 24.3541-1772.5 | 240240 |                | D=54, - Halter | BOS |
|                          | 1.6 Flex       | 78 |  | 11.09 |  | + Bremsscheibendurchm. 266 mm 3) |                |        |                |                |     |
|                          | 1.6 HDi        | 80 |  | 02.09 |  | + Bremsscheibendurchm. 266 mm 3) |                |        |                |                |     |
|                          | 1.6 HDi 110    | 82 |  | 05.10 |  | + Bremsscheibendurchm. 266 mm 3) |                |        |                |                |     |
|                          | 1.6 HDi 115    | 84 |  | 11.12 |  | + Bremsscheibendurchm. 266 mm 3) |                |        |                |                |     |
|                          | 1.6 HDi 90     | 66 |  | 02.09 |  | + Bremsscheibendurchm. 266 mm 3) |                |        |                |                |     |
|                          | 1.6 HDi 90     | 68 |  | 07.10 |  | + Bremsscheibendurchm. 266 mm 3) |                |        |                |                |     |
|                          | 1.6 VTI 120    | 88 |  | 02.09 |  | + Bremsscheibendurchm. 266 mm 3) |                |        |                |                |     |
|                          | 1.4 VTI 95     | 70 |  | 02.09 |  |                                  | 24.5144-0480.3 | 330961 | 2              | L=480          |     |
|                          | 1.4 VTI 95 LPG | 70 |  | 01.12 |  |                                  |                |        |                |                |     |
|                          | 1.6 Flex       | 78 |  | 11.09 |  |                                  |                |        |                |                |     |
|                          | 1.6 HDi        | 80 |  | 02.09 |  |                                  |                |        |                |                |     |
|                          | 1.6 HDi 110    | 82 |  | 05.10 |  |                                  |                |        |                |                |     |
|                          | 1.6 HDi 115    | 84 |  | 11.12 |  |                                  |                |        |                |                |     |
|                          | 1.6 HDi 90     | 66 |  | 02.09 |  |                                  |                |        |                |                |     |
|                          | 1.6 HDi 90     | 68 |  | 07.10 |  |                                  |                |        |                |                |     |
|                          | 1.6 VTI 120    | 88 |  | 02.09 |  |                                  |                |        |                |                |     |
|                          | 1.4 VTI 95     | 70 |  | 02.09 |  |                                  | 24.5239-0190.3 | 330966 | 2              | L=190          |     |
|                          | 1.4 VTI 95 LPG | 70 |  | 01.12 |  |                                  |                |        |                |                |     |
|                          | 1.6 Flex       | 78 |  | 11.09 |  |                                  |                |        |                |                |     |
|                          | 1.6 HDi        | 80 |  | 02.09 |  |                                  |                |        |                |                |     |
|                          | 1.6 HDi 110    | 82 |  | 05.10 |  |                                  |                |        |                |                |     |
|                          | 1.6 HDi 115    | 84 |  | 11.12 |  |                                  |                |        |                |                |     |
|                          | 1.6 HDi 90     | 66 |  | 02.09 |  |                                  |                |        |                |                |     |
|                          | 1.6 HDi 90     | 68 |  | 07.10 |  |                                  |                |        |                |                |     |
|                          | 1.6 VTI 120    | 88 |  | 02.09 |  |                                  |                |        |                |                |     |

| CITROEN C3 Pluriel (03-10) |            |            |            |       |       |                |                |           |     |           |     |
|----------------------------|------------|------------|------------|-------|-------|----------------|----------------|-----------|-----|-----------|-----|
|                            | 1.4 HDi    | 50         |            | 04.04 | 07.10 | - ABS          | 24.2120-1741.3 | 010775    |     | Thz 20,64 |     |
|                            | 1.4 Hybrid | 54         |            | 05.05 | 07.10 | - ABS          |                |           |     |           |     |
|                            | 1.4 i      | 54         |            | 05.03 | 07.10 | - ABS          |                |           |     |           |     |
|                            | 1.6 16V    | 80         |            | 05.03 | 07.10 | - ABS          |                |           |     |           |     |
|                            | 1.4 HDi    | 50         | ORGA 10800 | 04.04 |       | - ESP          | 24.2122-1766.3 | 010840    |     | Thz 22,20 | LUC |
|                            | 1.4 Hybrid | 54         | ORGA 10800 | 05.05 |       | - ESP          | 24.2122-1764.3 | 010851    |     | Thz 22,20 | BOS |
|                            | 1.4 i      | 54         | ORGA 10800 | 05.03 |       | - ESP          |                |           |     |           |     |
|                            | 1.6 16V    | 80         | ORGA 10800 | 05.03 |       | - ESP          |                |           |     |           |     |
|                            | 1.4 HDi    | 50         | ORGA 10801 |       | 07.10 | - ESP          | 24.4122-1704.3 | 010847    |     | Thz 22,20 | LUC |
|                            | 1.4 Hybrid | 54         | ORGA 10801 |       | 07.10 | - ESP          |                |           |     |           |     |
|                            | 1.4 i      | 54         | ORGA 10801 |       | 07.10 | - ESP          |                |           |     |           |     |
|                            | 1.6 16V    | 80         | ORGA 10801 |       | 07.10 | - ESP          |                |           |     |           |     |
| 1.4 HDi                    | 50         | ORGA 10800 | 04.04      |       | + ESP | 24.2122-1767.3 | 010841         | Thz 22,20 | LUC |           |     |
| 1.4 Hybrid                 | 54         | ORGA 10800 | 05.05      |       | + ESP |                |                |           |     |           |     |
| 1.4 i                      | 54         | ORGA 10800 | 05.03      |       | + ESP |                |                |           |     |           |     |
| 1.6 16V                    | 80         | ORGA 10800 | 05.03      |       | + ESP |                |                |           |     |           |     |
| 1.4 HDi                    | 50         | ORGA 10801 |            | 07.10 | + ESP | 24.4122-1703.3 | 010843         | Thz 22,20 | LUC |           |     |
| 1.4 Hybrid                 | 54         | ORGA 10801 |            | 07.10 | + ESP |                |                |           |     |           |     |
| 1.4 i                      | 54         | ORGA 10801 |            | 07.10 | + ESP |                |                |           |     |           |     |
| 1.6 16V                    | 80         | ORGA 10801 |            | 07.10 | + ESP |                |                |           |     |           |     |

1) to change only by pairs / sostituire solo a coppie / à changer seulement par paires / cambiar solamente por parejas

2) + RA drum brake / + P freno a tamburo / + frein à tambour essieu AR / + ET-tambores de freno

3) + brake disc diameter 266 mm / + disco fr.diam. 266mm / + disques fr.diam. 266mm / + disco fr.diam. 266mm



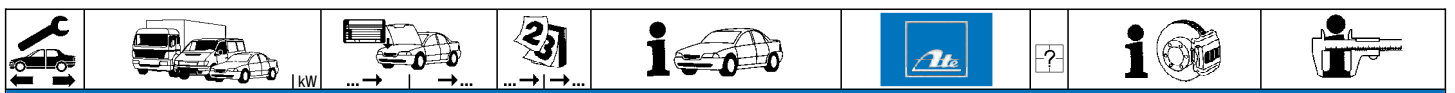

### CITROEN C3 Pluriel (03-10)

|  |   |                      |  |                                  |                                  |                         |                                  |                  |   |  |                                  |            |
|--|---|----------------------|--|----------------------------------|----------------------------------|-------------------------|----------------------------------|------------------|---|--|----------------------------------|------------|
|  | 1.4 HDi<br>1.4 Hybrid<br>1.4 i<br>1.6 16V | 50<br>54<br>54<br>80 |  | 04.04<br>05.05<br>05.03<br>05.03 | 07.10<br>07.10<br>07.10<br>07.10 |                         | 24.3541-1803.7<br>24.3541-1804.7 | 220603<br>220604 |   |  | D=54, - Halter<br>D=54, - Halter | LUC<br>LUC |
|  | 1.4 HDi<br>1.4 Hybrid<br>1.4 i<br>1.6 16V | 50<br>54<br>54<br>80 |  | 04.04<br>05.05<br>05.03<br>05.03 | 07.10<br>07.10<br>07.10<br>07.10 |                         | 24.5111-0460.3                   | 330603           | 2 |  | L=460                            |            |
|  | 1.6 16V                                   | 80                   |  | 05.03                            | 07.10                            |                         | 24.3387-1705.7<br>24.3387-1706.7 | 220675<br>220676 |   |  | D=38, - Halter<br>D=38, - Halter | LUC<br>LUC |
|  | 1.4 HDi<br>1.4 Hybrid<br>1.4 i<br>1.6 16V | 50<br>54<br>54<br>80 | ORGA 10569<br>ORGA 10569<br>ORGA 10569<br>ORGA 10569 | 04.04<br>05.05<br>05.03<br>05.03 |                                  |                         | 24.5246-0185.3                   | 330881           | 2 |  | L=185                            |            |
|  | 1.4 HDi<br>1.4 Hybrid<br>1.4 i<br>1.6 16V | 50<br>54<br>54<br>80 | ORGA 10570<br>ORGA 10570<br>ORGA 10570<br>ORGA 10570 |                                  | 07.10<br>07.10<br>07.10<br>07.10 |                         | 24.5246-0190.3                   | 330697           | 2 |  | L=190                            |            |
|  | 1.4 HDi<br>1.4 Hybrid<br>1.4 i            | 50<br>54<br>54       |  | 04.04<br>05.05<br>05.03          | 07.10<br>07.10<br>07.10          | - ABS<br>- ABS<br>- ABS | 24.3219-1739.3<br>24.3219-1740.3 | 020472<br>020473 |   | nur paarweise austauschen <sup>1)</sup><br>nur paarweise austauschen <sup>1)</sup> | RzR 19,05<br>RzR 19,05           | LUC<br>LUC |
|  | 1.4 HDi<br>1.4 Hybrid<br>1.4 i            | 50<br>54<br>54       |  | 04.04<br>05.05<br>05.03          | 07.10<br>07.10<br>07.10          | + ABS<br>+ ABS<br>+ ABS | 24.3220-1724.3<br>24.3220-1717.3 | 020476<br>020430 |   |  | Rz 20,64<br>Rz 20,64             | BOS<br>LUC |
|  | 1.4 HDi<br>1.4 Hybrid<br>1.4 i            | 50<br>54<br>54       | ORGA 10233<br>ORGA 10233<br>ORGA 10233               | 04.04<br>05.05<br>05.03          |                                  |                         | 24.3727-0346.2                   | 580346           | 2 |  | L=1716                           |            |
|  | 1.4 HDi<br>1.4 Hybrid<br>1.4 i            | 50<br>54<br>54       | ORGA 10234<br>ORGA 10234<br>ORGA 10234               |                                  | 07.10<br>07.10<br>07.10          |                         | 24.3727-0352.2                   | 580352           | 2 |  | L=1693                           |            |

### CITROEN C3 II (09-)















|  |   |  |  |   |  |  |                                  |                  |  |                |                                  |            |
|--|---|--|--|---|--|--|----------------------------------|------------------|--|----------------|----------------------------------|------------|
|  | 1.1<br>1.4<br>1.4 Flex<br>1.4 HDi 70<br>1.6 HDi<br>1.6 HDi 90   | 44 ORGA 13153<br>54 ORGA 13153<br>58 ORGA 13153<br>50 ORGA 13153<br>68 ORGA 13153<br>66 ORGA 13153 |  |   |  |  | 24.4122-1704.3<br>24.4122-1703.3 | 010847<br>010843 |  | - DSC<br>+ DSC | THz 22,20<br>THz 22,20           | LUC<br>LUC |
|  | 1.4 VTI 95<br>1.6 Flex<br>1.6 HDi<br>1.6 HDi 110<br>1.6 HDi 115<br>1.6 VTI 120                          | 70 ORGA 13153<br>81 ORGA 13153<br>68 ORGA 13153<br>82 ORGA 13153<br>84 ORGA 13153<br>88 ORGA 13153 |  |   |  |  | 24.4123-1705.3<br>24.4123-1704.3 | 010832<br>010828 |  | - DSC<br>+ DSC | THz 23,81<br>THz 23,81           | LUC<br>LUC |
|  | 1.0 VTI 68<br>1.1<br>1.2 VTI 82<br>1.4<br>1.4 Flex<br>1.4 HDi 70<br>1.4 VTI 95<br>1.6 HDi<br>1.6 HDi 90 | 50<br>44<br>60<br>54<br>58<br>50<br>70<br>68<br>66   |  | 10.12<br>09.09<br>10.12<br>09.09<br>11.09<br>11.09<br>09.09<br>11.09<br>09.09 |  |  | 24.3541-1771.5<br>24.3541-1772.5 | 240239<br>240240 |  |                | D=54, - Halter<br>D=54, - Halter | BOS<br>BOS |
|  | 1.4 VTI 95  | 70   |  | 09.09   |  |  | 24.3220-1732.3                   | 020514           |  |                | Rz 20,64                         | BOS        |

### CITROEN C4 I Limousine (LC\_) (04-10)

|  |  |  |  |  |  |  |                                  |                  |  |  |                                  |            |
|--|--|--|--|--|--|--|----------------------------------|------------------|--|--|----------------------------------|------------|
|  | 1.4 16V<br>1.6 16V<br>1.6 16V<br>1.6 16V Bio Flex<br>1.6 HDi<br>1.6 HDi<br>1.6 HDi<br>2.0 16V<br>2.0 16V<br>2.0 16V<br>2.0 16V<br>2.0 HDi<br>2.0 HDi 135 | 65<br>80<br>80<br>80<br>66<br>80<br>80<br>100<br>103<br>103<br>130<br>103<br>100                     | ORGA 11192<br>ORGA 11192<br>ORGA 11192<br>ORGA 11192<br>ORGA 11192<br>ORGA 11192<br>ORGA 11192<br>ORGA 11192<br>ORGA 11192<br>ORGA 11192<br>ORGA 11192<br>ORGA 11192<br>ORGA 11192 | 10.04<br>07.06<br>10.04<br>09.07<br>10.04<br>07.06<br>10.04<br>10.04<br>09.10<br>10.04<br>07.06<br>11.04<br>07.08<br>10.04 |  |  | 24.4123-1706.3                   | 010848           |  | + ESP  | THz 23,81                        | BOS        |
|  | 1.4 16V<br>1.4 16V<br>1.6 16V<br>1.6 16V<br>1.6 16V Bio Flex<br>1.6 16V Bio Flex<br>1.6 HDi<br>1.6 HDi<br>1.6 VTI  | 65 ORGA 10551<br>65<br>80<br>80 ORGA 10551<br>80<br>80 ORGA 10551<br>80<br>66 ORGA 10551<br>66<br>88 | ORGA 11018   | 10.04<br>07.06<br>10.04<br>09.10<br>09.10<br>09.07<br>10.04<br>07.08   |  |  | 24.3541-1771.5<br>24.3541-1772.5 | 240239<br>240240 |  | + ESP<br>- ESP<br>+ ESP<br>- ESP<br>+ ESP<br>- ESP<br>+ ESP<br>- ESP<br>+ Schaltgetriebe <sup>4)</sup> | D=54, - Halter<br>D=54, - Halter | BOS<br>BOS |
|  | 1.4 16V<br>1.6 16V<br>1.6 16V  | 65<br>80<br>80   | ORGA 10550<br>ORGA 12053<br>ORGA 10550   | 10.04<br>07.06<br>10.04  |  |  | 24.3541-1761.5<br>24.3541-1762.5 | 240233<br>240234 |  | + ESP<br>+ ESP<br>+ ESP  | D=54, - Halter<br>D=54, - Halter | BOS<br>BOS |

<sup>1)</sup> to change only by pairs / sostituire solo a coppie / à changer seulement par paires / cambiar solamente por parejas  
<sup>2)</sup> + drum brake / + freno a tamburo / + freins à tambour / + tambores de freno  
<sup>3)</sup> + disc brake / + disco freno / + disques de frein / + disco de freno  
<sup>4)</sup> + manual transmission / + scatola cambio velocità / + transmission mécanique / + cambio de velocidad

















|     |    |  |  |  |  |  |  |  |  |                          |                                  |                          |
|--|--|--|--|--|---|--|--|--|--|--------------------------|----------------------------------|--------------------------|
| <b>CITROEN C4 I Limousine (LC ) (04-10)</b>  |  |  |  |  |   |  |  |  |  |                          |                                  |                          |
|    | 1.6 16V Bio Flex   | 80   | ORGA 10550   | 09.07  | + ESP   | 24.3541-1761.5   | 240233   | D=54, - Halter<br>D=54, - Halter   | <b>BOS</b><br><b>BOS</b>                             |                          |                                  |                          |
|  | 1.6 HDi  | 66   | ORGA 10550   | 10.04  | + ESP   | 24.3541-1762.5   | 240234   |  |  |                          |                                  |                          |
|  | 1.6 HDi  | 80   | ORGA 12053   | 07.06  |   |  |  |  |  |                          |                                  |                          |
|  | 1.6 HDi  | 80   | ORGA 12053   | 10.04  | + ESP   |  |  |  |  |                          |                                  |                          |
|  | 1.6 THP 140  | 103  |  | 07.08  | 09.10   |  |  |  |  |                          |                                  |                          |
|  | 1.6 THP 150  | 110  |  | 07.08  | 09.10   |  |  |  |  |                          |                                  |                          |
|  | 1.6 VTi  | 88   |  | 07.08  | 09.10   | + Automatikgetriebe <sup>1)</sup>  |  |  |  |                          |                                  |                          |
|  | 2.0 16V  | 100  |  | 10.04  | 09.10   |  |  |  |  |                          |                                  |                          |
|  | 2.0 16V  | 103  | ORGA 12053   | 10.04  |   |  |  |  |  |                          |                                  |                          |
|  | 2.0 16V  | 103  | ORGA 12053   | 07.06  |   |  |  |  |  |                          |                                  |                          |
|  | 2.0 16V  | 130  | ORGA 10487   | 11.04  |   | 11.9571-9765.2   | 220663   |  |  |                          |                                  |                          |
|  | 2.0 HDi  | 103  | ORGA 10487   | 07.08  |   | 11.9571-9766.2   | 220664   |  |  |                          |                                  |                          |
| 2.0 HDi 135  | 100  | ORGA 10487   | 10.04  |  | 11.8116-0351.1  | 390538   |  |  |  |                          |                                  |                          |
|  |  |  |  |  | 11.8171-0008.1  | 990049   | 2  | Hältefeder<br>Führungsbolzen   | <b>ATE</b><br><b>ATE</b><br><b>ATE</b>               |                          |                                  |                          |
|  | 2.0 16V  | 130  | ORGA 10488   |  |   | 11.9571-9765.2   | 220663   | D=57, - Halter<br>D=57, - Halter   | <b>ATE</b><br><b>ATE</b><br><b>ATE</b><br><b>ATE</b> |                          |                                  |                          |
|  | 2.0 HDi  | 103  | ORGA 10488   |  |   | 11.9571-9766.2   | 220664   |  |  |                          |                                  |                          |
|  | 2.0 HDi 135  | 100  | ORGA 10488   |  |   | 11.8116-0351.1   | 390538   |  |  |                          |                                  |                          |
|  |  |  |  |  |   | 11.8171-0008.1   | 990049   |  |  |                          |                                  |                          |
|  | 2.0 16V  | 130  | ORGA 11578   |  | 09.10   | 11.0101-5704.2   | 260095   | Hülzensatz<br>Führungsbolzen   | <b>ATE</b><br><b>ATE</b><br><b>ATE</b><br><b>ATE</b> |                          |                                  |                          |
|  | 2.0 HDi  | 103  | ORGA 11578   |  | 09.10   | 11.8171-0008.1   | 990049   |  |  |                          |                                  |                          |
|  | 2.0 HDi 135  | 100  | ORGA 11578   |  | 09.10   | 11.8116-0356.1   | 390586   |  |  |                          |                                  |                          |
|  |  |  |  |  |   |  |  |  |  |                          |                                  |                          |
|    | 1.4 16V  | 65   |  | 10.04  | 09.10   | 24.5111-0420.3   | 330682   | L=420  |  |                          |                                  |                          |
|  | 1.6 16V  | 80   |  | 07.06  | 09.10   |  |  |  |  |                          |                                  |                          |
|  | 1.6 16V  | 80   |  | 10.04  | 09.10   |  |  |  |  |                          |                                  |                          |
|  | 1.6 16V Bio Flex   | 80   |  | 09.07  | 09.10   |  |  |  |  |                          |                                  |                          |
|  | 1.6 HDi  | 66   |  | 10.04  | 09.10   |  |  |  |  |                          |                                  |                          |
|  | 1.6 HDi  | 80   |  | 07.06  | 09.10   |  |  |  |  |                          |                                  |                          |
|  | 1.6 HDi  | 80   |  | 10.04  | 09.10   |  |  |  |  |                          |                                  |                          |
|  | 1.6 THP 140  | 103  |  | 07.08  | 09.10   |  |  |  |  |                          |                                  |                          |
|  | 1.6 THP 150  | 110  |  | 07.08  | 09.10   |  |  |  |  |                          |                                  |                          |
|  | 1.6 VTi  | 88   |  | 07.08  | 09.10   |  |  |  |  |                          |                                  |                          |
|  | 2.0 16V  | 100  |  | 10.04  | 09.10   |  |  |  |  |                          |                                  |                          |
|  | 2.0 16V  | 103  |  | 10.04  | 09.10   |  |  |  |  |                          |                                  |                          |
|  | 2.0 16V  | 103  |  | 07.06  | 09.10   |  |  |  |  |                          |                                  |                          |
|  | 2.0 16V  | 130  |  | 11.04  | 09.10   |  |  |  |  |                          |                                  |                          |
|  | 2.0 HDi  | 103  |  | 07.08  | 09.10   |  |  |  |  |                          |                                  |                          |
|  | 2.0 HDi 135  | 100  |  | 10.04  | 09.10   |  |  |  |  |                          |                                  |                          |
|  |   | 1.4 16V  | 65   | ORGA 11584   | 10.04   |  | 24.3387-1709.7   |  |  | 220743                   | D=38, - Halter<br>D=38, - Halter | <b>LUC</b><br><b>LUC</b> |
|  |  | 1.6 16V  | 80   | ORGA 11584   | 07.06   |  | 24.3387-1710.7   |  |  | 220744                   |                                  |                          |
| 1.6 16V  |  | 80   | ORGA 11584   | 10.04  |   |  |  |  |  |                          |                                  |                          |
| 1.6 16V Bio Flex   |  | 80   | ORGA 11584   | 09.07  |   |  |  |  |  |                          |                                  |                          |
| 1.6 HDi  |  | 66   | ORGA 11584   | 10.04  |   |  |  |  |  |                          |                                  |                          |
| 1.6 HDi  |  | 80   | ORGA 11584   | 07.06  |   |  |  |  |  |                          |                                  |                          |
| 1.6 HDi  |  | 80   | ORGA 11584   | 10.04  |   |  |  |  |  |                          |                                  |                          |
| 1.6 THP 140  |  | 103  | ORGA 11584   | 07.08  |   |  |  |  |  |                          |                                  |                          |
| 1.6 THP 150  |  | 110  | ORGA 11584   | 07.08  |   |  |  |  |  |                          |                                  |                          |
| 1.6 VTi  |  | 88   | ORGA 11584   | 07.08  |   |  |  |  |  |                          |                                  |                          |
| 2.0 16V  |  | 100  | ORGA 11584   | 10.04  |   |  |  |  |  |                          |                                  |                          |
| 2.0 16V  |  | 103  | ORGA 11584   | 10.04  |   |  |  |  |  |                          |                                  |                          |
| 2.0 16V  |  | 103  | ORGA 11584   | 07.06  |   |  |  |  |  |                          |                                  |                          |
| 2.0 16V  |  | 130  | ORGA 11584   | 11.04  |   |  |  |  |  |                          |                                  |                          |
| 2.0 HDi  |  | 103  | ORGA 11584   | 07.08  |   |  |  |  |  |                          |                                  |                          |
| 2.0 HDi 135  |  | 100  | ORGA 11584   | 10.04  |   |  |  |  |  |                          |                                  |                          |
|  |  | 1.4 16V  | 65   | ORGA 12334   |   | 09.10  | 24.3387-1709.7   | 220743   | D=38, - Halter<br>D=38, - Halter                     | <b>LUC</b><br><b>LUC</b> |                                  |                          |
|  |  | 1.6 16V  | 80   | ORGA 12334   |   | 09.10  | 24.3387-1710.7   | 220744   |  |                          |                                  |                          |
|  | 1.6 16V  | 80   | ORGA 12334   |  | 09.10   |  |  |  |  |                          |                                  |                          |
|  | 1.6 16V Bio Flex   | 80   | ORGA 12334   |  | 09.10   |  |  |  |  |                          |                                  |                          |
|  | 1.6 HDi  | 66   | ORGA 12334   |  | 09.10   |  |  |  |  |                          |                                  |                          |
|  | 1.6 HDi  | 80   | ORGA 12334   |  | 09.10   |  |  |  |  |                          |                                  |                          |
|  | 1.6 HDi  | 80   | ORGA 12334   |  | 09.10   |  |  |  |  |                          |                                  |                          |
|  | 1.6 THP 140  | 103  | ORGA 12334   |  | 09.10   |  |  |  |  |                          |                                  |                          |
|  | 1.6 THP 150  | 110  | ORGA 12334   |  | 09.10   |  |  |  |  |                          |                                  |                          |
|  | 1.6 VTi  | 88   | ORGA 12334   |  | 09.10   |  |  |  |  |                          |                                  |                          |
|  | 2.0 16V  | 100  | ORGA 12334   |  | 09.10   |  |  |  |  |                          |                                  |                          |
|  | 2.0 16V  | 103  | ORGA 12334   |  | 09.10   |  |  |  |  |                          |                                  |                          |
|  | 2.0 16V  | 103  | ORGA 12334   |  | 09.10   |  |  |  |  |                          |                                  |                          |
|  | 2.0 16V  | 130  | ORGA 12334   |  | 09.10   |  |  |  |  |                          |                                  |                          |
|  | 2.0 HDi  | 103  | ORGA 12334   |  | 09.10   |  |  |  |  |                          |                                  |                          |
|  | 2.0 HDi 135  | 100  | ORGA 12334   |  | 09.10   |  |  |  |  |                          |                                  |                          |
|  |  | 1.4 16V  | 65   |  | 10.04   | 09.10  | 24.5246-0190.3   | 330697   |  |                          | L=190                            |                          |
|  |  | 1.6 16V  | 80   |  | 07.06   | 09.10  |  |  |  |                          |                                  |                          |
| 1.6 16V  |  | 80   |  | 10.04  | 09.10   |  |  |  |  |                          |                                  |                          |
| 1.6 16V Bio Flex   |  | 80   |  | 09.07  | 09.10   |  |  |  |  |                          |                                  |                          |
| 1.6 HDi  |  | 66   |  | 10.04  | 09.10   |  |  |  |  |                          |                                  |                          |
| 1.6 HDi  |  | 80   |  | 07.06  | 09.10   |  |  |  |  |                          |                                  |                          |
| 1.6 HDi  |  | 80   |  | 10.04  | 09.10   |  |  |  |  |                          |                                  |                          |
| 1.6 THP 140  |  | 103  |  | 07.08  | 09.10   |  |  |  |  |                          |                                  |                          |
| 1.6 THP 150  |  | 110  |  | 07.08  | 09.10   |  |  |  |  |                          |                                  |                          |
| 1.6 VTi  |  | 88   |  | 07.08  | 09.10   |  |  |  |  |                          |                                  |                          |
| 2.0 16V  |  | 100  |  | 10.04  | 09.10   |  |  |  |  |                          |                                  |                          |
| 2.0 16V  |  | 103  |  | 10.04  | 09.10   |  |  |  |  |                          |                                  |                          |
| 2.0 16V  |  | 103  |  | 07.06  | 09.10   |  |  |  |  |                          |                                  |                          |
| 2.0 16V  |  | 130  |  | 11.04  | 09.10   |  |  |  |  |                          |                                  |                          |
| 2.0 HDi  |  | 103  |  | 07.08  | 09.10   |  |  |  |  |                          |                                  |                          |
| 2.0 HDi 135  |  | 100  |  | 10.04  | 09.10   |  |  |  |  |                          |                                  |                          |

<sup>1)</sup> + autom.transmission / + scatola cambio automatico / + transmission automatique / + cambio automático



































|     |    |  |  |  |  |  |  |  |                |                |     |
|--|--|--|--|--|---|--|--|--|----------------|----------------|-----|
| <b>CITROEN C4 I Limousine (LC ) (04-10)</b>  |  |  |  |  |   |  |  |  |                |                |     |
|    | 1.6 16V  | 80   |  | 07.06  | 09.10   | 24.3727-0839.2   | 580839   | 2 ↓  | L=2115         |                |     |
|  | 1.6 HDi  | 80   |  | 07.06  | 09.10   |  |  |  |                |                |     |
|  | 2.0 16V  | 103  |  | 07.06  | 09.10   |  |  |  |                |                |     |
|  | 1.4 16V  | 65   |  | 10.04  | 09.10   | 24.3727-0832.2   | 580832   | 2 ↓  | L=2035         |                |     |
|  | 1.6 16V  | 80   |  | 10.04  | 09.10   |  |  |  |                |                |     |
|  | 1.6 16V Bio Flex   | 80   |  | 09.07  | 09.10   |  |  |  |                |                |     |
|  | 1.6 HDi  | 66   |  | 10.04  | 09.10   |  |  |  |                |                |     |
|  | 1.6 HDi  | 80   |  | 10.04  | 09.10   |  |  |  |                |                |     |
|  | 1.6 THP 140  | 103  |  | 07.08  | 09.10   |  |  |  |                |                |     |
|  | 1.6 THP 150  | 110  |  | 07.08  | 09.10   |  |  |  |                |                |     |
|  | 1.6 VTi  | 88   |  | 07.08  | 09.10   |  |  |  |                |                |     |
|  | 2.0 16V  | 100  |  | 10.04  | 09.10   |  |  |  |                |                |     |
|  | 2.0 16V  | 103  |  | 10.04  | 09.10   |  |  |  |                |                |     |
|  | 2.0 16V  | 130  |  | 11.04  | 09.10   |  |  |  |                |                |     |
| 2.0 HDi  | 103  |  | 07.08  | 09.10  |   |  |  |  |                |                |     |
| 2.0 HDi 135  | 100  |  | 10.04  | 09.10  |   |  |  |  |                |                |     |
| <b>CITROEN C4 I Coupe (04-10)</b>  |  |  |  |  |   |  |  |  |                |                |     |
|    | 1.4 16V  | 65   | ORGA 11192   | 10.04  |   | 24.4123-1706.3   | 010848   | + ESP  | THz 23,81      | BOS            |     |
|  | 1.6 16V  | 80   | ORGA 11192   | 10.04  |   |  |  |  |                |                |     |
|  | 1.6 HDi 110  | 80   | ORGA 11192   | 10.04  |   |  |  |  |                |                |     |
|  | 1.6 HDi 90   | 66   | ORGA 11192   | 10.04  |   |  |  |  |                |                |     |
|  | 2.0 16V  | 100  |  | 10.04  | 07.10   |  |  |  |                |                |     |
|  | 2.0 16V  | 103  | ORGA 11192   | 12.05  |   |  |  |  |                |                |     |
|  | 2.0 16V  | 130  | ORGA 11192   | 10.04  |   |  |  |  |                |                |     |
|  | 2.0 HDi  | 103  | ORGA 11192   | 07.08  |   |  |  |  |                |                |     |
|  | 2.0 HDi 135  | 100  | ORGA 11192   | 10.04  |   |  |  |  |                |                |     |
|  |    | 1.4 16V  | 65   | ORGA 10551   |   | 07.10  | 24.3541-1771.5   | 240239   | ☐              | D=54, - Halter | BOS |
| 1.4 16V  |  | 65   |  | 10.04  | 07.10   | 24.3541-1772.5   | 240240   | ☐  | D=54, - Halter | BOS            |     |
| 1.6 16V  |  | 80   | ORGA 10551   |  | 07.10   |  |  |  |                |                |     |
| 1.6 16V  |  | 80   |  | 10.04  | 07.10   |  |  |  |                |                |     |
| 1.6 HDi 90   |  | 66   | ORGA 10551   |  | 07.10   |  |  |  |                |                |     |
| 1.6 HDi 90   |  | 66   |  | 10.04  | 07.10   |  |  |  |                |                |     |
| 1.6 VTi 120  |  | 88   |  | 07.08  | 07.10   |  |  |  |                |                |     |
| 1.6 16V  |  | 65   | ORGA 10550   | 10.04  |   | 24.3541-1761.5   | 240233   | ☐  | D=54, - Halter | BOS            |     |
| 1.6 16V  |  | 80   | ORGA 10550   | 10.04  |   | 24.3541-1762.5   | 240234   | ☐  | D=54, - Halter | BOS            |     |
| 1.6 HDi 110  |  | 80   | ORGA 12053   | 10.04  |   |  |  |  |                |                |     |
| 1.6 HDi 90   |  | 66   | ORGA 10550   | 10.04  |   |  |  |  |                |                |     |
| 1.6 THP 150  |  | 110  |  | 07.08  | 07.10   |  |  |  |                |                |     |
| 1.6 VTi 120  |  | 88   |  | 07.08  | 07.10   |  |  |  |                |                |     |
| 2.0 16V  |  | 100  |  | 10.04  | 07.10   |  |  |  |                |                |     |
| 2.0 16V  |  | 103  | ORGA 12053   | 12.05  |   |  |  |  |                |                |     |
| 2.0 16V  |  | 130  | ORGA 10487   | 10.04  |   | 11.9571-9765.2   | 220663   | ☐  | D=57, - Halter | ATE            |     |
| 2.0 HDi  |  | 103  | ORGA 10487   | 07.08  |   | 11.9571-9766.2   | 220664   | ☐  | D=57, - Halter | ATE            |     |
| 2.0 HDi 135  |  | 100  | ORGA 10487   | 10.04  |   | 11.8116-0351.1   | 390538   | 2  | Haltefeder     | ATE            |     |
|  |  |  |  |  |   | 11.8171-0008.1   | 990049   |  | Führungsbolzen | ATE            |     |
| 2.0 16V  |  | 130  | ORGA 10488   | ORGA 11577   |   | 11.9571-9765.2   | 220663   | ☐  | D=57, - Halter | ATE            |     |
| 2.0 HDi  | 103  | ORGA 10488   | ORGA 11577   |  | 11.9571-9766.2  | 220664   | ☐  | D=57, - Halter   | ATE            |                |     |
| 2.0 HDi 135  | 100  | ORGA 10488   | ORGA 11577   |  | 11.8116-0351.1  | 390538   | 2  | Haltefeder   | ATE            |                |     |
|  |  |  |  |  | 11.8171-0008.1  | 990049   |  | Führungsbolzen   | ATE            |                |     |
| 2.0 16V  | 130  | ORGA 11578   |  | 07.10  | 11.0101-5704.2  | 260095   |  | Hülzensatz   | ATE            |                |     |
| 2.0 HDi  | 103  | ORGA 11578   |  | 07.10  | 11.8171-0008.1  | 990049   |  | Führungsbolzen   | ATE            |                |     |
| 2.0 HDi 135  | 100  | ORGA 11578   |  | 07.10  | 11.8116-0356.1  | 390586   | 2  | Haltefeder   | ATE            |                |     |
|  | 1.4 16V  | 65   |  | 10.04  | 07.10   | 24.5111-0420.3   | 330682   | 2  | L=420          |                |     |
|  | 1.6 16V  | 80   |  | 10.04  | 07.10   |  |  |  |                |                |     |
|  | 1.6 HDi 110  | 80   |  | 10.04  | 07.10   |  |  |  |                |                |     |
|  | 1.6 HDi 90   | 66   |  | 10.04  | 07.10   |  |  |  |                |                |     |
|  | 1.6 THP 150  | 110  |  | 07.08  | 07.10   |  |  |  |                |                |     |
|  | 1.6 VTi 120  | 88   |  | 07.08  | 07.10   |  |  |  |                |                |     |
|  | 2.0 16V  | 100  |  | 10.04  | 07.10   |  |  |  |                |                |     |
|  | 2.0 16V  | 103  |  | 12.05  | 07.10   |  |  |  |                |                |     |
|  | 2.0 16V  | 130  |  | 10.04  | 07.10   |  |  |  |                |                |     |
|  | 2.0 HDi  | 103  |  | 07.08  | 07.10   |  |  |  |                |                |     |
|  | 2.0 HDi 135  | 100  |  | 10.04  | 07.10   |  |  |  |                |                |     |
|  |  | 1.4 16V  | 65   | ORGA 11584   | 10.04   |  | 24.3387-1709.7   | 220743   | ☐              | D=38, - Halter | LUC |
|  |  | 1.6 16V  | 80   | ORGA 11584   | 10.04   |  | 24.3387-1710.7   | 220744   | ☐              | D=38, - Halter | LUC |
|  |  | 1.6 HDi 110  | 80   | ORGA 11584   | 10.04   |  |  |  |                |                |     |
| 1.6 HDi 90   |  | 66   | ORGA 11584   | 10.04  |   |  |  |  |                |                |     |
| 1.6 THP 150  |  | 110  | ORGA 11584   | 07.08  |   |  |  |  |                |                |     |
| 1.6 VTi 120  |  | 88   | ORGA 11584   | 07.08  |   |  |  |  |                |                |     |
| 2.0 16V  |  | 100  | ORGA 11584   | 10.04  |   |  |  |  |                |                |     |
| 2.0 16V  |  | 103  | ORGA 11584   | 12.05  |   |  |  |  |                |                |     |
| 2.0 16V  |  | 130  | ORGA 11584   | 10.04  |   |  |  |  |                |                |     |
| 2.0 HDi  |  | 103  | ORGA 11584   | 07.08  |   |  |  |  |                |                |     |
| 2.0 HDi 135  |  | 100  | ORGA 11584   | 10.04  |   |  |  |  |                |                |     |
| 1.4 16V  |  | 65   | ORGA 12334   |  | 07.10   | 24.3387-1709.7   | 220743   | ☐  | D=38, - Halter | LUC            |     |
| 1.6 16V  |  | 80   | ORGA 12334   |  | 07.10   | 24.3387-1710.7   | 220744   | ☐  | D=38, - Halter | LUC            |     |
| 1.6 HDi 110  |  | 80   | ORGA 12334   |  | 07.10   |  |  |  |                |                |     |
| 1.6 HDi 90   |  | 66   | ORGA 12334   |  | 07.10   |  |  |  |                |                |     |
| 1.6 THP 150  |  | 110  | ORGA 12334   |  | 07.10   |  |  |  |                |                |     |
| 1.6 VTi 120  |  | 88   | ORGA 12334   |  | 07.10   |  |  |  |                |                |     |
| 2.0 16V  |  | 100  | ORGA 12334   |  | 07.10   |  |  |  |                |                |     |
| 2.0 16V  | 103  | ORGA 12334   |  | 07.10  |   |  |  |  |                |                |     |
| 2.0 16V  | 130  | ORGA 12334   |  | 07.10  |   |  |  |  |                |                |     |
| 2.0 HDi  | 103  | ORGA 12334   |  | 07.10  |   |  |  |  |                |                |     |
| 2.0 HDi 135  | 100  | ORGA 12334   |  | 07.10  |   |  |  |  |                |                |     |

1) + manual transmission / + scatola cambio velocità / + transmission mécanique / + cambio de velocidad  
2) + autom.transmission / + scatola cambio automatico / + transmission automatique / + cambio automático













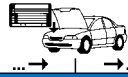









|     |    |           |  |    |                         |  |  |                                       |
|--|--|---|--|--|--|--|--|---|
| <b>CITROEN C4 I Coupe (04-10)</b>  |  |   |  |  |  |  |  |   |
|    | 1.4 16V<br>1.6 16V<br>1.6 HDi 110<br>1.6 HDi 90<br>1.6 THP 150<br>1.6 VTi 120<br>2.0 16V<br>2.0 16V<br>2.0 16V<br>2.0 HDi<br>2.0 HDi 135                           | 65<br>80<br>80<br>66<br>110<br>88<br>100<br>103<br>130<br>103<br>100                      |  | 10.04 07.10<br>10.04 07.10<br>10.04 07.10<br>10.04 07.10<br>07.08 07.10<br>07.08 07.10<br>10.04 07.10<br>12.05 07.10<br>10.04 07.10<br>07.08 07.10<br>10.04 07.10                | 24.5246-0190.3   | 330697   | 2  | L=190   |
|    | 1.4 16V<br>1.6 16V<br>1.6 HDi 110<br>1.6 HDi 90<br>1.6 THP 150<br>1.6 VTi 120<br>2.0 16V<br>2.0 16V<br>2.0 16V<br>2.0 HDi<br>2.0 HDi 135                           | 65<br>80<br>80<br>66<br>110<br>88<br>100<br>103<br>130<br>103<br>100                      |  | 10.04 07.10<br>10.04 07.10<br>10.04 07.10<br>10.04 07.10<br>07.08 07.10<br>07.08 07.10<br>10.04 07.10<br>12.05 07.10<br>10.04 07.10<br>07.08 07.10<br>10.04 07.10                | 24.3727-0832.2   | 580832   | 2 ↓  | L=2035  |
| <b>CITROEN C4 I Grand Picasso (06-13)</b>  |  |   |  |  |  |  |  |   |
|    | 1.6 HDi<br>2.0 HDi 135   | 80<br>100   | ORGA 11437<br>ORGA 11437   | 10.06<br>10.06   | 03.7860-4103.4   | 300242   |  | 10" ATE   |
|  | 1.6 16V<br>1.6 16V<br>1.6 e-HDi 110<br>1.6 HDi<br>1.6 HDi 110<br>1.6 THP 155<br>1.6 VTi 120<br>2.0 HDi 135<br>2.0 HDi 150<br>2.0 HDi 165                           | 103<br>110<br>82<br>80 ORGA 11438<br>82<br>115<br>88<br>100 ORGA 11438<br>110<br>120      |  | 07.08 07.13<br>10.08 07.13<br>11.10 07.13<br>07.13<br>09.10 07.13<br>11.10 07.13<br>07.08 07.13<br>07.13<br>07.09 07.13<br>11.10 07.13   | 03.7860-5702.4   | 300279   | - Start/Stop-Anlage <sup>1)</sup>  | 10" ATE   |
|  | 1.8 i 16V<br>2.0 i 16V   | 92<br>103   |  | 10.06 07.13<br>10.06 07.13   | 03.7870-1002.4   | 300282   |  | 11" ATE   |
|   | 1.6 16V<br>1.6 16V<br>1.6 e-HDi 110<br>1.6 HDi<br>1.6 HDi 110<br>1.6 THP 155<br>1.6 VTi 120<br>1.8 i 16V<br>2.0 HDi 135<br>2.0 HDi 150<br>2.0 HDi 165<br>2.0 i 16V | 103<br>110<br>82<br>80<br>82<br>115<br>88<br>92<br>100<br>110<br>120<br>103               |  | 07.08 07.13<br>10.08 07.13<br>11.10 07.13<br>10.06 07.13<br>09.10 07.13<br>11.10 07.13<br>07.08 07.13<br>10.06 07.13<br>10.06 07.13<br>07.09 07.13<br>11.10 07.13<br>10.06 07.13 | 03.4153-0173.3   | 010815   |  | Thz 23,81 ATE   |
|  | 1.6 HDi<br>1.6 VTi 120<br>1.8 i 16V  | 80<br>88<br>92  | ORGA 11766<br>ORGA 11766<br>ORGA 11766   | 10.06<br>07.08<br>10.06  | 11.8116-0356.1<br>11.0101-5704.2<br>11.8171-0008.1   | 390586<br>260095<br>990049   | 2  | Haltefeder<br>Hülzensatz<br>Führungsbolzen ATE  |
|  | 1.6 16V<br>1.6 16V<br>2.0 HDi 135<br>2.0 i 16V   | 103<br>110<br>100<br>103  | ORGA 11920<br>ORGA 11920<br>ORGA 11920<br>ORGA 11920                             | 07.08<br>10.08<br>10.06<br>10.06   | 11.8116-0356.1<br>11.0101-5704.2<br>11.8171-0008.1   | 390586<br>260095<br>990049   | 2  | Haltefeder<br>Hülzensatz<br>Führungsbolzen ATE  |
|  | 1.6 e-HDi 110<br>1.6 HDi<br>1.6 HDi 110<br>1.6 VTi 120<br>1.8 i 16V  | 82<br>80 ORGA 11767<br>82<br>88 ORGA 11767<br>92 ORGA 11767                               |  | 11.10 07.13<br>07.13<br>09.10 07.13<br>07.13<br>07.13  | 11.9601-9717.2<br>11.9601-9718.2<br>11.8116-0356.1<br>11.0101-5704.2<br>11.0441-6008.2<br>11.8171-0008.1 | 220901<br>220902<br>390586<br>260095<br>250038<br>990049                           | 2  | D=60, - Halter ATE<br>D=60, - Halter ATE<br>Haltefeder ATE<br>Hülzensatz ATE<br>Dichtungssatz ATE<br>Führungsbolzen ATE |
|  | 1.6 16V<br>1.6 16V<br>1.6 THP 155<br>2.0 HDi 135<br>2.0 HDi 150<br>2.0 HDi 165<br>2.0 i 16V  | 103 ORGA 11921<br>110 ORGA 11921<br>115<br>100 ORGA 11921<br>110<br>120<br>103 ORGA 11921 |  | 07.13<br>07.13<br>11.10 07.13<br>07.13<br>07.09 07.13<br>11.10 07.13<br>07.13  | 11.9601-9717.2<br>11.9601-9718.2<br>11.8116-0356.1<br>11.0441-6008.2<br>11.0101-5704.2<br>11.8171-0008.1 | 220901<br>220902<br>390586<br>250038<br>260095<br>990049                           | 2  | D=60, - Halter ATE<br>D=60, - Halter ATE<br>Haltefeder ATE<br>Dichtungssatz ATE<br>Hülzensatz ATE<br>Führungsbolzen ATE |
|  | 1.6 16V<br>1.6 16V<br>1.6 e-HDi 110<br>1.6 HDi<br>1.6 HDi 110<br>1.6 THP 155<br>1.6 VTi 120<br>1.8 i 16V<br>2.0 HDi 135<br>2.0 HDi 150<br>2.0 HDi 165<br>2.0 i 16V | 103<br>110<br>82<br>80<br>82<br>115<br>88<br>92<br>100<br>110<br>120<br>103               |  | 07.08 07.13<br>10.08 07.13<br>11.10 07.13<br>10.06 07.13<br>09.10 07.13<br>11.10 07.13<br>07.08 07.13<br>10.06 07.13<br>10.06 07.13<br>07.09 07.13<br>11.10 07.13<br>10.06 07.13 | 24.5111-0424.3   | 331014   | 2  | L=424   |
|  | 1.6 16V<br>1.6 16V<br>1.6 e-HDi 110<br>1.6 HDi   | 103<br>110<br>82<br>80  |  | 07.08 07.13<br>10.08 07.13<br>11.10 07.13<br>10.06 07.13   | 24.5246-0216.3   | 331022   | 2  | L=216   |













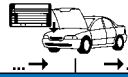













<sup>1)</sup> - idling stop system / - dispositivo start/stop / - unité marche/arrêt / - unidad arranque/paro

|     |  |  |  |  |  |  |  |  |                                   |
|--|--|--|--|--|---|--|--|--|-----------------------------------|
| <b>CITROEN C4 I Grand Picasso (06-13)</b>  |  |  |  |  |   |  |  |  |                                   |
|    | 1.6 HDi 110  | 82   |  | 09.10  | 07.13   | 24.5246-0216.3   | 331022   | 2  | L=216                             |
|  | 1.6 THP 155  | 115  |  | 11.10  | 07.13   |  |  |  |                                   |
|  | 1.6 VTi 120  | 88   |  | 07.08  | 07.13   |  |  |  |                                   |
|  | 1.8 i 16V  | 92   |  | 10.06  | 07.13   |  |  |  |                                   |
|  | 2.0 HDi 135  | 100  |  | 10.06  | 07.13   |  |  |  |                                   |
|  | 2.0 HDi 150  | 110  |  | 07.09  | 07.13   |  |  |  |                                   |
|  | 2.0 HDi 165  | 120  |  | 11.10  | 07.13   |  |  |  |                                   |
|  | 2.0 i 16V  | 103  |  | 10.06  | 07.13   |  |  |  |                                   |
| <b>CITROEN C4 I Picasso (07-13)</b>  |  |  |  |  |   |  |  |  |                                   |
|    | 1.6 HDi  | 80   | ORGA 11437   | 02.07  |   | 03.7860-4103.4   | 300242   |  | 10" ATE                           |
|  | 2.0 HDi 138  | 100  | ORGA 11437   | 02.07  |   |  |  |  |                                   |
|  | 1.6 16V  | 110  |  | 07.08  | 07.13   | 03.7860-5702.4   | 300279   |  | 10" ATE                           |
|  | 1.6 e-HDi 110  | 82   |  | 11.10  | 07.13   |  |  |  | - Start/Stop-Anlage <sup>1)</sup> |
|  | 1.6 HDi  | 80   | ORGA 11438   |  | 07.13   |  |  |  |                                   |
|  | 1.6 HDi 110  | 82   |  | 11.10  | 07.13   |  |  |  |                                   |
|  | 1.6 THP 140  | 103  |  | 07.08  | 07.13   |  |  |  |                                   |
|  | 1.6 THP 150  | 110  |  | 10.08  | 07.13   |  |  |  |                                   |
|  | 1.6 THP 155  | 115  |  | 11.10  | 07.13   |  |  |  |                                   |
|  | 1.6 VTi 120  | 88   |  | 07.08  | 07.13   |  |  |  |                                   |
|  | 2.0 HDi 138  | 100  | ORGA 11438   |  | 07.13   |  |  |  |                                   |
|  | 2.0 HDi 150  | 110  |  | 07.09  | 07.13   |  |  |  |                                   |
|  | 2.0 HDi 165  | 120  |  | 11.10  | 07.13   |  |  |  |                                   |
|  | 1.8 i 16V  | 92   |  | 02.07  | 07.13   | 03.7870-1002.4   | 300282   |  | 11" ATE                           |
|  | 2.0 i 16V  | 103  |  | 02.07  | 07.13   |  |  |  |                                   |
|    | 1.6 16V  | 110  |  | 07.08  | 07.13   | 03.4153-0173.3   | 010815   |  | THz 23,81 ATE                     |
|  | 1.6 e-HDi 110  | 82   |  | 11.10  | 07.13   |  |  |  |                                   |
|  | 1.6 HDi  | 80   |  | 02.07  | 07.13   |  |  |  |                                   |
|  | 1.6 HDi 110  | 82   |  | 11.10  | 07.13   |  |  |  |                                   |
|  | 1.6 THP 140  | 103  |  | 07.08  | 07.13   |  |  |  |                                   |
|  | 1.6 THP 150  | 110  |  | 10.08  | 07.13   |  |  |  |                                   |
|  | 1.6 THP 155  | 115  |  | 11.10  | 07.13   |  |  |  |                                   |
|  | 1.6 VTi 120  | 88   |  | 07.08  | 07.13   |  |  |  |                                   |
|  | 1.8 i 16V  | 92   |  | 02.07  | 07.13   |  |  |  |                                   |
|  | 2.0 HDi 138  | 100  |  | 02.07  | 07.13   |  |  |  |                                   |
|  | 2.0 HDi 150  | 110  |  | 07.09  | 07.13   |  |  |  |                                   |
|  | 2.0 HDi 165  | 120  |  | 11.10  | 07.13   |  |  |  |                                   |
|  | 2.0 i 16V  | 103  |  | 02.07  | 07.13   |  |  |  |                                   |
|   | 1.6 HDi  | 80   | ORGA 11766   | 02.07  |   | 11.8116-0356.1   | 390586   | 2  | Haltefeder ATE                    |
|  | 1.6 VTi 120  | 88   | ORGA 11766   | 07.08  |   | 11.0101-5704.2   | 260095   |  | Hülsensatz ATE                    |
|  | 1.8 i 16V  | 92   | ORGA 11766   | 02.07  |   | 11.8171-0008.1   | 990049   |  | Führungsbolzen ATE                |
|  |  |  |  |  |   | 11.0441-6008.2   | 250038   |  | Dichtungssatz ATE                 |
|  | 1.6 16V  | 110  | ORGA 11920   | 07.08  |   | 11.8116-0356.1   | 390586   | 2  | Haltefeder ATE                    |
|  | 1.6 THP 140  | 103  | ORGA 11920   | 07.08  |   | 11.0101-5704.2   | 260095   |  | Hülsensatz ATE                    |
|  | 1.6 THP 150  | 110  | ORGA 11920   | 10.08  |   | 11.8171-0008.1   | 990049   |  | Führungsbolzen ATE                |
|  | 2.0 HDi 138  | 100  | ORGA 11920   | 02.07  |   | 11.0441-6008.2   | 250038   |  | Dichtungssatz ATE                 |
|  | 2.0 i 16V  | 103  | ORGA 11920   | 02.07  |   |  |  |  |                                   |
|  | 1.6 e-HDi 110  | 82   |  | 11.10  | 07.13   | 11.9601-9717.2   | 220901   | 2  | D=60, - Halter ATE                |
|  | 1.6 HDi  | 80   | ORGA 11767   |  | 07.13   | 11.9601-9718.2   | 220902   |  | D=60, - Halter ATE                |
|  | 1.6 HDi 110  | 82   |  | 11.10  | 07.13   | 11.8116-0356.1   | 390586   |  | Haltefeder ATE                    |
|  | 1.6 VTi 120  | 88   | ORGA 11767   |  | 07.13   | 11.0101-5704.2   | 260095   |  | Hülsensatz ATE                    |
|  | 1.8 i 16V  | 92   | ORGA 11767   |  | 07.13   | 11.8171-0008.1   | 990049   |  | Führungsbolzen ATE                |
|  |  |  |  |  |   | 11.0441-6008.2   | 250038   |  | Dichtungssatz ATE                 |
|  | 1.6 16V  | 110  | ORGA 11921   |  | 07.13   | 11.9601-9717.2   | 220901   | 2  | D=60, - Halter ATE                |
|  | 1.6 THP 140  | 103  | ORGA 11921   |  | 07.13   | 11.9601-9718.2   | 220902   |  | D=60, - Halter ATE                |
|  | 1.6 THP 150  | 110  | ORGA 11921   |  | 07.13   | 11.8116-0356.1   | 390586   |  | Haltefeder ATE                    |
|  | 1.6 THP 155  | 115  |  | 11.10  | 07.13   | 11.0101-5704.2   | 260095   |  | Hülsensatz ATE                    |
|  | 2.0 HDi 138  | 100  | ORGA 11921   |  | 07.13   | 11.8171-0008.1   | 990049   |  | Führungsbolzen ATE                |
|  | 2.0 HDi 150  | 110  |  | 07.09  | 07.13   | 11.0441-6008.2   | 250038   |  | Dichtungssatz ATE                 |
|  | 2.0 HDi 165  | 120  |  | 11.10  | 07.13   |  |  |  |                                   |
|  | 2.0 i 16V  | 103  | ORGA 11921   |  | 07.13   |  |  |  |                                   |
|  | 1.6 16V  | 110  |  | 07.08  | 07.13   | 24.5111-0424.3   | 331014   | 2  | L=424                             |
|  | 1.6 e-HDi 110  | 82   |  | 11.10  | 07.13   |  |  |  |                                   |
|  | 1.6 HDi  | 80   |  | 02.07  | 07.13   |  |  |  |                                   |
|  | 1.6 HDi 110  | 82   |  | 11.10  | 07.13   |  |  |  |                                   |
|  | 1.6 THP 140  | 103  |  | 07.08  | 07.13   |  |  |  |                                   |
|  | 1.6 THP 150  | 110  |  | 10.08  | 07.13   |  |  |  |                                   |
|  | 1.6 THP 155  | 115  |  | 11.10  | 07.13   |  |  |  |                                   |
|  | 1.6 VTi 120  | 88   |  | 07.08  | 07.13   |  |  |  |                                   |
|  | 1.8 i 16V  | 92   |  | 02.07  | 07.13   |  |  |  |                                   |
|  | 2.0 HDi 138  | 100  |  | 02.07  | 07.13   |  |  |  |                                   |
|  | 2.0 HDi 150  | 110  |  | 07.09  | 07.13   |  |  |  |                                   |
|  | 2.0 HDi 165  | 120  |  | 11.10  | 07.13   |  |  |  |                                   |
|  | 2.0 i 16V  | 103  |  | 02.07  | 07.13   |  |  |  |                                   |
|  | 1.6 16V  | 110  |  | 07.08  | 07.13   | 24.5246-0216.3   | 331022   | 2  | L=216                             |
|  | 1.6 e-HDi 110  | 82   |  | 11.10  | 07.13   |  |  |  |                                   |
|  | 1.6 HDi  | 80   |  | 02.07  | 07.13   |  |  |  |                                   |
|  | 1.6 HDi 110  | 82   |  | 11.10  | 07.13   |  |  |  |                                   |
|  | 1.6 THP 140  | 103  |  | 07.08  | 07.13   |  |  |  |                                   |
|  | 1.6 THP 150  | 110  |  | 10.08  | 07.13   |  |  |  |                                   |
|  | 1.6 THP 155  | 115  |  | 11.10  | 07.13   |  |  |  |                                   |
|  | 1.6 VTi 120  | 88   |  | 07.08  | 07.13   |  |  |  |                                   |
|  | 1.8 i 16V  | 92   |  | 02.07  | 07.13   |  |  |  |                                   |
|  | 2.0 HDi 138  | 100  |  | 02.07  | 07.13   |  |  |  |                                   |
|  | 2.0 HDi 150  | 110  |  | 07.09  | 07.13   |  |  |  |                                   |
|  | 2.0 HDi 165  | 120  |  | 11.10  | 07.13   |  |  |  |                                   |
|  | 2.0 i 16V  | 103  |  | 11.10  | 07.13   |  |  |  |                                   |























<sup>1)</sup> - idling stop system / - dispositivo start/stop / - unité marche/arrêt / - unidad arranque/paro

|     |  |  |  |  |  |  |  |  |                          |                         |                |     |
|--|--|--|--|--|---|--|--|--|--------------------------|-------------------------|----------------|-----|
| <b>CITROEN C4 I Picasso (07-13)</b>  |  |  |  |  |   |  |  |  |                          |                         |                |     |
|    | 2.0 i 16V  | 103  |  | 02.07  | 07.13   |  | 24.5246-0216.3   | 331022   | 2                        |                         | L=216          |     |
| <b>CITROEN C4 II Limousine (B7) (10-)</b>  |  |  |  |  |   |  |  |  |                          |                         |                |     |
|    | 1.6 Flex   | 81   |  | 11.09  |   |  | 11.9601-9717.2   | 220901   | <input type="checkbox"/> |                         | D=60, - Halter | ATE |
|  | 1.6 HDi 110  | 82   |  | 11.09  |   |  | 11.9601-9718.2   | 220902   | <input type="checkbox"/> |                         | D=60, - Halter | ATE |
|  | 1.6 HDi 115  | 84   |  | 07.12  |   |  | 11.0441-6008.2   | 250038   |                          |                         | Dichtungssatz  | ATE |
|  | 1.6 HDi 90   | 68   |  | 11.09  |   | + elektrische Feststellbremse 1)   | 11.8171-0008.1   | 990049   |                          |                         | Führungsbolzen | ATE |
|  | 1.6 VTi 120  | 88   |  | 11.09  |   |  | 11.0101-5704.2   | 260095   |                          |                         | Hülssensatz    | ATE |
|  | 1.6 VTi 120 LPG  | 88   |  | 09.11  |   |  | 11.8116-0356.1   | 390586   | 2                        |                         | Haltefeder     | ATE |
|  | 2.0 Flex   | 103  |  | 11.09  |   |  |  |  |                          |                         |                |     |
|  | 1.6 THP 155  | 115  |  | 11.09  |   |  | 11.9601-9717.2   | 220901   | <input type="checkbox"/> |                         | D=60, - Halter | ATE |
|  | 2.0 HDi 150  | 110  |  | 11.09  |   |  | 11.9601-9718.2   | 220902   | <input type="checkbox"/> |                         | D=60, - Halter | ATE |
|  |  |  |  |  |   |  | 11.0441-6008.2   | 250038   |                          |                         | Dichtungssatz  | ATE |
|  |  |  |  |  |   |  | 11.8171-0008.1   | 990049   |                          |                         | Führungsbolzen | ATE |
|  |  |  |  |  |   |  | 11.0101-5704.2   | 260095   |                          |                         | Hülssensatz    | ATE |
|  |  |  |  |  |   |  | 11.8116-0356.1   | 390586   | 2                        |                         | Haltefeder     | ATE |
|    | 1.4 VTi 95   | 70   |  | 11.09  |   |  | 24.5246-0190.3   | 330697   | 2                        |                         | L=190          |     |
|  | 1.6 Flex   | 81   |  | 11.09  |   |  |  |  |                          |                         |                |     |
|  | 1.6 HDi 110  | 82   |  | 11.09  |   |  |  |  |                          |                         |                |     |
|  | 1.6 HDi 115  | 84   |  | 07.12  |   |  |  |  |                          |                         |                |     |
|  | 1.6 HDi 90   | 68   |  | 11.09  |   |  |  |  |                          |                         |                |     |
|  | 1.6 THP 155  | 115  |  | 11.09  |   |  |  |  |                          |                         |                |     |
|  | 1.6 VTi 120  | 88   |  | 11.09  |   |  |  |  |                          |                         |                |     |
|  | 1.6 VTi 120 LPG  | 88   |  | 09.11  |   |  |  |  |                          |                         |                |     |
|  | 2.0 Flex   | 103  |  | 11.09  |   |  |  |  |                          |                         |                |     |
|  | 2.0 HDi 150  | 110  |  | 11.09  |   |  |  |  |                          |                         |                |     |
| <b>CITROEN C4 II Picasso (13-)</b>   |  |  |  |  |   |  |  |  |                          |                         |                |     |
|    | 1.6 HDi 115  | 84   |  | 06.13  |   | + Bremsscheibendurchm. 283 mm 2)   | 11.0441-6008.2   | 250038   |                          |                         | Dichtungssatz  | ATE |
|  | 1.6 HDi 90   | 68   |  | 06.13  |   | + Bremsscheibendurchm. 283 mm 2)   | 11.0101-5407.2   | 260011   |                          |                         | Hülssensatz    | ATE |
|  | 1.6 THP 155  | 115  |  | 06.13  |   | + Bremsscheibendurchm. 283 mm 2)   |  |  |                          |                         |                |     |
|  | 1.6 VTi 120  | 88   |  | 06.13  |   | + Bremsscheibendurchm. 283 mm 2)   |  |  |                          |                         |                |     |
|  | 2.0 HDi 150  | 110  |  | 09.13  |   | + Bremsscheibendurchm. 283 mm 2)   |  |  |                          |                         |                |     |
|  | 1.6 HDi 115  | 84   |  | 06.13  |   | + Bremsscheibendurchm. 304 mm 3)   | 11.0441-6008.2   | 250038   |                          |                         | Dichtungssatz  | ATE |
|  | 1.6 HDi 90   | 68   |  | 06.13  |   | + Bremsscheibendurchm. 304 mm 3)   | 11.0101-5407.2   | 260011   |                          |                         | Hülssensatz    | ATE |
|  | 1.6 THP 155  | 115  |  | 06.13  |   | + Bremsscheibendurchm. 304 mm 3)   |  |  |                          |                         |                |     |
|  | 1.6 VTi 120  | 88   |  | 06.13  |   | + Bremsscheibendurchm. 304 mm 3)   |  |  |                          |                         |                |     |
|  | 2.0 HDi 150  | 110  |  | 09.13  |   | + Bremsscheibendurchm. 304 mm 3)   |  |  |                          |                         |                |     |
| <b>CITROEN C4 II Grand Picasso (13-)</b>   |  |  |  |  |   |  |  |  |                          |                         |                |     |
|  | 1.6 HDi 115  | 84   |  | 08.13  |   | + Bremsscheibendurchm. 283 mm 2)   | 11.0441-6008.2   | 250038   |                          |                         | Dichtungssatz  | ATE |
|  | 1.6 HDi 90   | 68   |  | 08.13  |   | + Bremsscheibendurchm. 283 mm 2)   | 11.0101-5407.2   | 260011   |                          |                         | Hülssensatz    | ATE |
|  | 1.6 THP 155  | 115  |  | 08.13  |   | + Bremsscheibendurchm. 283 mm 2)   |  |  |                          |                         |                |     |
|  | 1.6 VTi 120  | 88   |  | 08.13  |   | + Bremsscheibendurchm. 283 mm 2)   |  |  |                          |                         |                |     |
|  | 2.0 HDi 150  | 110  |  | 09.13  |   | + Bremsscheibendurchm. 283 mm 2)   |  |  |                          |                         |                |     |
|  | 1.6 HDi 115  | 84   |  | 08.13  |   | + Bremsscheibendurchm. 304 mm 3)   | 11.0441-6008.2   | 250038   |                          |                         | Dichtungssatz  | ATE |
|  | 1.6 HDi 90   | 68   |  | 08.13  |   | + Bremsscheibendurchm. 304 mm 3)   | 11.0101-5407.2   | 260011   |                          |                         | Hülssensatz    | ATE |
|  | 1.6 THP 155  | 115  |  | 08.13  |   | + Bremsscheibendurchm. 304 mm 3)   |  |  |                          |                         |                |     |
|  | 1.6 VTi 120  | 88   |  | 08.13  |   | + Bremsscheibendurchm. 304 mm 3)   |  |  |                          |                         |                |     |
|  | 2.0 HDi 150  | 110  |  | 09.13  |   | + Bremsscheibendurchm. 304 mm 3)   |  |  |                          |                         |                |     |
| <b>CITROEN C-ELYSEE (12-)</b>  |  |  |  |  |   |  |  |  |                          |                         |                |     |
|  | 1.6 HDi 92   | 68   |  | 11.12  |   |  | 24.4122-1703.3   | 010843   |                          | + ESP                   | Thz 22,20      | LUC |
|  | 1.2 VTi 72   | 53   |  | 11.12  |   |  | 24.3541-1771.5   | 240239   | <input type="checkbox"/> | + belüftete Scheiben 4) | D=54, - Halter | BOS |
|  | 1.6 HDi 92   | 68   |  | 11.12  |   |  | 24.3541-1772.5   | 240240   | <input type="checkbox"/> | + belüftete Scheiben 4) | D=54, - Halter | BOS |
|  | 1.6 VTi 115  | 85   |  | 11.12  |   |  |  |  |                          |                         |                |     |
|  | 1.2 VTi 72   | 53   |  | 11.12  |   |  | 24.5239-0190.3   | 330966   | 2                        |                         | L=190          |     |
|  | 1.6 HDi 92   | 68   |  | 11.12  |   |  |  |  |                          |                         |                |     |
|  | 1.6 VTi 115  | 85   |  | 11.12  |   |  |  |  |                          |                         |                |     |
|  | 1.2 VTi 72   | 53   |  | 11.12  |   |  | 24.3220-1617.3   | 020244   | <input type="checkbox"/> | - ABS                   | RzR 20,64      | BDX |
|  | 1.6 HDi 92   | 68   |  | 11.12  |   |  | 24.3220-1618.3   | 020245   | <input type="checkbox"/> | - ABS                   | RzR 20,64      | BDX |
|  | 1.6 VTi 115  | 85   |  | 11.12  |   |  |  |  |                          |                         |                |     |
| <b>CITROEN C5 I Limousine (01-04)</b>  |  |  |  |  |   |  |  |  |                          |                         |                |     |
|  | 2.0 16V  | 100  |  | 03.01  | 08.04   |  | 24.3572-1707.7   | 220619   | <input type="checkbox"/> |                         | D=57, - Halter | BOS |
|  | 2.0 16V  | 103  |  | 03.01  | 08.04   |  | 24.3572-1708.7   | 220620   | <input type="checkbox"/> |                         | D=57, - Halter | BOS |
|  | 2.0 HDi 110  | 80   |  | 03.01  | 08.04   |  |  |  |                          |                         |                |     |
|  | 2.0 HDi 90   | 66   |  | 03.01  | 08.04   |  |  |  |                          |                         |                |     |
|  | 1.8 16V  | 85   |  | 03.01  | 08.04   |  | 24.5111-0550.3   | 330665   | 2                        |                         | L=550          |     |
|  | 2.0 16V  | 100  |  | 03.01  | 08.04   |  |  |  |                          |                         |                |     |
|  | 2.0 16V  | 103  |  | 03.01  | 08.04   |  |  |  |                          |                         |                |     |
|  | 2.0 HDi 110  | 80   |  | 03.01  | 08.04   |  |  |  |                          |                         |                |     |
|  | 2.0 HDi 90   | 66   |  | 03.01  | 08.04   |  |  |  |                          |                         |                |     |
|  | 2.2 HDi  | 98   |  | 03.01  | 08.04   |  |  |  |                          |                         |                |     |
|  | 3.0 V6   | 152  |  | 03.01  | 08.04   |  |  |  |                          |                         |                |     |
|  | 1.8 16V  | 85   |  | 03.01  | 08.04   |  | 24.5229-0235.3   | 330671   | 2                        |                         | L=235          |     |
|  | 2.0 16V  | 100  |  | 03.01  | 08.04   |  |  |  |                          |                         |                |     |
|  | 2.0 16V  | 103  |  | 03.01  | 08.04   |  |  |  |                          |                         |                |     |
|  | 2.0 HDi 110  | 80   |  | 03.01  | 08.04   |  |  |  |                          |                         |                |     |
|  | 2.0 HDi 90   | 66   |  | 03.01  | 08.04   |  |  |  |                          |                         |                |     |
|  | 2.2 HDi  | 98   |  | 03.01  | 08.04   |  |  |  |                          |                         |                |     |
|  | 3.0 V6   | 152  |  | 03.01  | 08.04   |  |  |  |                          |                         |                |     |

1) + electric parking brake / + freno a mano elettrico / + frein à main électrique / + freno de mano eléctrico  
2) + brake disc diameter 283 mm / + disco fr.diam. 283mm / + disques fr.diam. 283mm / + disco fr.diam. 283mm  
3) + brake disc diameter 304 mm / + disco fr.diam. 304mm / + disques fr.diam. 304mm / + disco fr.diam. 304mm  
4) + ventilated discs / + dischi ventilati / + disques ventilés / + disco ventilado

|     |  |  |  |  |  |  |  |     |                |
|--|--|--|--|--|---|--|--|---|----------------|
| <b>CITROEN C5 I Limousine (01-04)</b>  |  |  |  |  |   |  |  |   |                |
|    | 1.8 16V  | 85   |  | 03.01  | 08.04   | 24.3727-0335.2   | 580335   | 2 ↑   | L=1840         |
|  | 2.0 16V  | 100  |  | 03.01  | 08.04   |  |  |   |                |
|  | 2.0 16V  | 103  |  | 03.01  | 08.04   |  |  |   |                |
|  | 2.0 HDi 110  | 80   |  | 03.01  | 08.04   |  |  |   |                |
|  | 2.0 HDi 90   | 66   |  | 03.01  | 08.04   |  |  |   |                |
|  | 2.2 HDi  | 98   |  | 03.01  | 08.04   |  |  |   |                |
|  | 3.0 V6   | 152  |  | 03.01  | 08.04   |  |  |   |                |
| <b>CITROEN C5 I Kombi (01-04)</b>  |  |  |  |  |   |  |  |   |                |
|    | 1.8 16V  | 85   |  | 06.01  | 08.04   | 24.3572-1707.7   | 220619   |    | D=57, - Halter |
|  | 2.0 16V  | 100  |  | 06.01  | 08.04   | 24.3572-1708.7   | 220620   |    | D=57, - Halter |
|  | 2.0 16V  | 103  |  | 06.01  | 08.04   |  |  |   |                |
|  | 2.0 HDi 110  | 80   |  | 06.01  | 08.04   |  |  |   |                |
|  | 2.0 HDi 90   | 66   |  | 06.01  | 08.04   |  |  |   |                |
|    | 1.8 16V  | 85   |  | 06.01  | 08.04   | 24.5111-0550.3   | 330665   | 2   | L=550          |
|  | 2.0 16V  | 100  |  | 06.01  | 08.04   |  |  |   |                |
|  | 2.0 16V  | 103  |  | 06.01  | 08.04   |  |  |   |                |
|  | 2.0 HDi 110  | 80   |  | 06.01  | 08.04   |  |  |   |                |
|  | 2.0 HDi 90   | 66   |  | 06.01  | 08.04   |  |  |   |                |
|  | 2.2 HDi  | 98   |  | 06.01  | 08.04   |  |  |   |                |
|  | 3.0 V6   | 152  |  | 06.01  | 08.04   |  |  |   |                |
|  | 3.0 V6 Carlsson  | 173  |  | 09.03  | 08.04   |  |  |   |                |
|    | 1.8 16V  | 85   |  | 06.01  | 08.04   | 24.5229-0235.3   | 330671   | 2   | L=235          |
|  | 2.0 16V  | 100  |  | 06.01  | 08.04   |  |  |   |                |
|  | 2.0 16V  | 103  |  | 06.01  | 08.04   |  |  |   |                |
|  | 2.0 HDi 110  | 80   |  | 06.01  | 08.04   |  |  |   |                |
|  | 2.0 HDi 90   | 66   |  | 06.01  | 08.04   |  |  |   |                |
|  | 2.2 HDi  | 98   |  | 06.01  | 08.04   |  |  |   |                |
|  | 3.0 V6   | 152  |  | 06.01  | 08.04   |  |  |   |                |
|  | 3.0 V6 Carlsson  | 173  |  | 09.03  | 08.04   |  |  |   |                |
|    | 1.8 16V  | 85   |  | 06.01  | 08.04   | 24.3727-0335.2   | 580335   | 2 ↑   | L=1840         |
|  | 2.0 16V  | 100  |  | 06.01  | 08.04   |  |  |   |                |
|  | 2.0 16V  | 103  |  | 06.01  | 08.04   |  |  |   |                |
|  | 2.0 HDi 110  | 80   |  | 06.01  | 08.04   |  |  |   |                |
|  | 2.0 HDi 90   | 66   |  | 06.01  | 08.04   |  |  |   |                |
|  | 2.2 HDi  | 98   |  | 06.01  | 08.04   |  |  |   |                |
|  | 3.0 V6   | 152  |  | 06.01  | 08.04   |  |  |   |                |
|  | 3.0 V6 Carlsson  | 173  |  | 09.03  | 08.04   |  |  |   |                |
| <b>CITROEN C5 II Limousine (04-08)</b>   |  |  |  |  |   |  |  |   |                |
|  | 1.6 HDi  | 80   |  | 09.04  | 01.08   | 24.3572-1707.7   | 220619   |  | D=57, - Halter |
|  | 2.0 16V  | 103  |  | 09.04  | 01.08   | 24.3572-1708.7   | 220620   |  | D=57, - Halter |
|  | 1.6 HDi  | 80   |  | 09.04  | 01.08   | 24.5111-0550.3   | 330665   | 2   | L=550          |
|  | 1.8 16V  | 85   |  | 09.04  | 01.08   |  |  |   |                |
|  | 1.8 16V  | 92   |  | 09.05  | 01.08   |  |  |   |                |
|  | 2.0 16V  | 103  |  | 09.04  | 01.08   |  |  |   |                |
|  | 2.0 HDi  | 100  |  | 09.04  | 01.08   |  |  |   |                |
|  | 2.2 HDi  | 98   |  | 09.04  | 01.08   |  |  |   |                |
|  | 2.2 HDi  | 125  |  | 04.06  | 01.08   |  |  |   |                |
|  | 3.0 Carlsson   | 173  |  | 09.04  | 01.08   |  |  |   |                |
|  | 3.0 V6   | 152  |  | 09.04  | 01.08   |  |  |   |                |
|  | 1.6 HDi  | 80   |  | 09.04  | 01.08   | 24.5229-0235.3   | 330671   | 2   | L=235          |
|  | 1.8 16V  | 85   |  | 09.04  | 01.08   |  |  |   |                |
|  | 1.8 16V  | 92   |  | 09.05  | 01.08   |  |  |   |                |
|  | 2.0 16V  | 103  |  | 09.04  | 01.08   |  |  |   |                |
|  | 2.0 HDi  | 100  |  | 09.04  | 01.08   |  |  |   |                |
|  | 2.2 HDi  | 98   |  | 09.04  | 01.08   |  |  |   |                |
|  | 2.2 HDi  | 125  |  | 04.06  | 01.08   |  |  |   |                |
|  | 3.0 Carlsson   | 173  |  | 09.04  | 01.08   |  |  |   |                |
|  | 3.0 V6   | 152  |  | 09.04  | 01.08   |  |  |   |                |
|  | 1.6 HDi  | 80   |  | 09.04  | 01.08   | 24.3727-0335.2   | 580335   | 2 ↑   | L=1840         |
|  | 1.8 16V  | 85   |  | 09.04  | 01.08   |  |  |   |                |
|  | 1.8 16V  | 92   |  | 09.05  | 01.08   |  |  |   |                |
|  | 2.0 16V  | 103  |  | 09.04  | 01.08   |  |  |   |                |
|  | 2.0 HDi  | 100  |  | 09.04  | 01.08   |  |  |   |                |
|  | 2.2 HDi  | 98   |  | 09.04  | 01.08   |  |  |   |                |
|  | 2.2 HDi  | 125  |  | 04.06  | 01.08   |  |  |   |                |
|  | 3.0 Carlsson   | 173  |  | 09.04  | 01.08   |  |  |   |                |
|  | 3.0 V6   | 152  |  | 09.04  | 01.08   |  |  |   |                |
| <b>CITROEN C5 II Kombi (04-08)</b>   |  |  |  |  |   |  |  |   |                |
|  | 1.6 HDi  | 80   |  | 09.04  | 01.08   | 24.3572-1707.7   | 220619   |  | D=57, - Halter |
|  | 1.8 16V  | 85   |  | 09.04  | 01.08   | 24.3572-1708.7   | 220620   |  | D=57, - Halter |
|  | 1.8 16V  | 92   |  | 09.05  | 01.08   |  |  |   |                |
|  | 2.0 16V  | 103  |  | 09.04  | 01.08   |  |  |   |                |
|  | 1.6 HDi  | 80   |  | 09.04  | 01.08   | 24.5111-0550.3   | 330665   | 2   | L=550          |
|  | 1.8 16V  | 85   |  | 09.04  | 01.08   |  |  |   |                |
|  | 1.8 16V  | 92   |  | 09.05  | 01.08   |  |  |   |                |
|  | 2.0 16V  | 103  |  | 09.04  | 01.08   |  |  |   |                |
|  | 2.0 HDi  | 100  |  | 09.04  | 01.08   |  |  |   |                |
|  | 2.2 HDi  | 98   |  | 09.04  | 01.08   |  |  |   |                |
|  | 2.2 HDi  | 120  |  | 05.06  | 01.08   |  |  |   |                |
|  | 2.2 HDi  | 125  |  | 04.06  | 01.08   |  |  |   |                |
|  | 3.0 V6   | 152  |  | 09.04  | 01.08   |  |  |   |                |



|     |  |  |  |  |  |  |  |     |                          |
|--|--|--|--|--|---|--|--|---|--------------------------|
| <b>CITROEN C5 II Kombi (04-08)</b>   |  |  |  |  |   |  |  |   |                          |
|    | 1.6 HDi  | 80   |  | 09.04  | 01.08   | 24.5229-0235.3   | 330671   | 2   | L=235                    |
|  | 1.8 16V  | 85   |  | 09.04  | 01.08   |  |  |   |                          |
|  | 1.8 16V  | 92   |  | 09.05  | 01.08   |  |  |   |                          |
|  | 2.0 16V  | 103  |  | 09.04  | 01.08   |  |  |   |                          |
|  | 2.0 HDi  | 100  |  | 09.04  | 01.08   |  |  |   |                          |
|  | 2.2 HDi  | 98   |  | 09.04  | 01.08   |  |  |   |                          |
|  | 2.2 HDi  | 120  |  | 05.06  | 01.08   |  |  |   |                          |
|  | 2.2 HDi  | 125  |  | 04.06  | 01.08   |  |  |   |                          |
|  | 3.0 V6   | 152  |  | 09.04  | 01.08   |  |  |   |                          |
|    | 1.6 HDi  | 80   |  | 09.04  | 01.08   | 24.3727-0335.2   | 580335   | 2 ↑   | L=1840                   |
|  | 1.8 16V  | 85   |  | 09.04  | 01.08   |  |  |   |                          |
|  | 1.8 16V  | 92   |  | 09.05  | 01.08   |  |  |   |                          |
|  | 2.0 16V  | 103  |  | 09.04  | 01.08   |  |  |   |                          |
|  | 2.0 HDi  | 100  |  | 09.04  | 01.08   |  |  |   |                          |
|  | 2.2 HDi  | 98   |  | 09.04  | 01.08   |  |  |   |                          |
|  | 2.2 HDi  | 120  |  | 05.06  | 01.08   |  |  |   |                          |
|  | 2.2 HDi  | 125  |  | 04.06  | 01.08   |  |  |   |                          |
|  | 3.0 V6   | 152  |  | 09.04  | 01.08   |  |  |   |                          |
| <b>CITROEN C5 III Limousine (X7) (08-)</b>   |  |  |  |  |   |  |  |   |                          |
|    | 1.6 HDi  | 80   |  | 02.08  |   | 03.7860-7802.4   | 300280   |   | 10" ATE                  |
|  | 1.6 THP 155  | 115  |  | 04.09  |   |  |  |   |                          |
|  | 1.6 VTI 120  | 88   |  | 07.10  |   |  |  |   |                          |
|  | 1.8 16V  | 92   |  | 02.08  |   |  |  |   |                          |
|  | 2.0 16V  | 103  |  | 02.08  |   |  |  |   |                          |
|  | 2.0 16V BioFlex  | 103  |  | 02.08  |   |  |  |   |                          |
|  | 2.0 HDi  | 100  |  | 02.08  |   |  |  |   |                          |
|  | 2.0 HDi 140  | 103  |  | 11.08  |   |  |  |   |                          |
|  | 2.0 HDi 165  | 120  |  | 04.09  |   |  |  |   |                          |
|  | 2.2 HDi  | 125  |  | 02.08  |   |  |  |   |                          |
|  | 2.2 HDi 200  | 150  |  | 07.10  |   |  |  |   |                          |
|  | 2.7 HDi  | 150  |  | 02.08  |   |  |  |   |                          |
|  | 3.0  | 152  |  | 02.08  |   |  |  |   |                          |
|  | 3.0 HDi 240  | 177  |  | 04.09  |   |  |  |   |                          |
|  | 3.0 V6   | 155  |  | 02.08  |   |  |  |   |                          |
|  | 1.6 HDi 110  | 82   |  | 07.10  |   | 03.7860-7802.4   | 300280   | - Start/Stop-Anlage <sup>1)</sup>   | 10" ATE                  |
|  | 1.6 HDi 115  | 84   |  | 01.12  |   |  |  |   |                          |
|    | 1.6 HDi  | 80   | ORGA 12347   | 02.08  |   | 03.2123-3123.3   | 010806   |   | THz 23,81 ATE            |
|  | 1.6 HDi 110  | 82   | ORGA 12347   | 07.10  |   |  |  |   |                          |
|  | 1.6 HDi 115  | 84   | ORGA 12347   | 01.12  |   |  |  |   |                          |
|  | 1.6 THP 155  | 115  | ORGA 12347   | 04.09  |   |  |  |   |                          |
|  | 1.8 16V  | 92   | ORGA 12347   | 02.08  |   |  |  |   |                          |
|  | 2.0 16V  | 103  | ORGA 12347   | 02.08  |   |  |  |   |                          |
|  | 2.0 16V BioFlex  | 103  | ORGA 12347   | 02.08  |   |  |  |   |                          |
|  | 2.0 HDi  | 100  | ORGA 12347   | 02.08  |   |  |  |   |                          |
|  | 2.0 HDi 140  | 103  | ORGA 12347   | 11.08  |   |  |  |   |                          |
|  | 2.0 HDi 165  | 120  | ORGA 12347   | 04.09  |   |  |  |   |                          |
|  | 2.2 HDi  | 125  | ORGA 12347   | 02.08  |   |  |  |   |                          |
|  | 2.2 HDi 200  | 150  | ORGA 12347   | 07.10  |   |  |  |   |                          |
|  | 2.7 HDi  | 150  | ORGA 12347   | 02.08  |   |  |  |   |                          |
|  | 3.0  | 152  | ORGA 12347   | 02.08  |   |  |  |   |                          |
|  | 3.0 HDi 240  | 177  | ORGA 12347   | 04.09  |   |  |  |   |                          |
|  | 3.0 V6   | 155  | ORGA 12347   | 02.08  |   |  |  |   |                          |
|  | 1.6 HDi  | 80   | ORGA 12998   | 02.08  |   | 11.9601-9731.2   | 220853   |  | D=60, - Halter ATE       |
|  | 1.6 HDi 110  | 82   | ORGA 12998   | 07.10  |   | 11.9601-9732.2   | 220854   |  | D=60, - Halter ATE       |
|  | 1.6 HDi 115  | 84   | ORGA 12998   | 01.12  |   | 11.0441-6008.2   | 250038   |   | Dichtungssatz ATE        |
|  | 1.6 VTI 120  | 88   | ORGA 12998   | 07.10  |   | 11.0101-5407.2   | 260011   |   | Hülssensatz ATE          |
|  | 1.8 16V  | 92   | ORGA 12998   | 02.08  |   | 11.8171-0008.1   | 990049   |   | Führungsbolzen ATE       |
|  | 2.0 16V  | 103  | ORGA 12998   | 02.08  |   | 11.8116-0356.1   | 390586   | 2   | Haltefeder ATE           |
|  | 2.0 16V BioFlex  | 103  | ORGA 12998   | 02.08  |   |  |  |   |                          |
|  | 2.0 HDi  | 100  | ORGA 12998   | 02.08  |   |  |  |   |                          |
|  | 2.0 HDi 140  | 103  | ORGA 12998   | 11.08  |   |  |  |   |                          |
|  | 2.0 HDi 165  | 120  | ORGA 12998   | 04.09  |   |  |  |   |                          |
|  | 1.6 HDi  | 80   | ORGA 12999   |  |   | 11.0441-6008.2   | 250038   |   | Dichtungssatz ATE        |
|  | 1.6 HDi 110  | 82   | ORGA 12999   |  |   | 11.0101-5704.2   | 260095   |   | Hülssensatz ATE          |
|  | 1.6 HDi 115  | 84   | ORGA 12999   |  |   | 11.8171-0008.1   | 990049   |   | Führungsbolzen ATE       |
|  | 1.6 VTI 120  | 88   | ORGA 12999   |  |   | 11.8116-0356.1   | 390586   | 2   | Haltefeder ATE           |
|  | 1.8 16V  | 92   | ORGA 12999   |  |   |  |  |   |                          |
|  | 2.0 16V  | 103  | ORGA 12999   |  |   |  |  |   |                          |
|  | 2.0 16V BioFlex  | 103  | ORGA 12999   |  |   |  |  |   |                          |
|  | 2.0 HDi  | 100  | ORGA 12999   |  |   |  |  |   |                          |
|  | 2.0 HDi 140  | 103  | ORGA 12999   |  |   |  |  |   |                          |
|  | 2.0 HDi 165  | 120  | ORGA 12999   |  |   |  |  |   |                          |
|  | 1.6 THP 155  | 115  |  | 04.09  |   | 24.3451-1719.7   | 220763   |  | D=45/45, - Halter LUC    |
|  | 2.2 HDi  | 125  |  | 02.08  |   | 24.3451-1720.7   | 220764   |  | D=45/45, - Halter LUC    |
|  | 2.2 HDi 200  | 150  |  | 07.10  |   |  |  |   |                          |
|  | 2.7 HDi  | 150  |  | 02.08  |   |  |  |   |                          |
|  | 3.0  | 152  |  | 02.08  |   |  |  |   |                          |
|  | 3.0 V6   | 155  |  | 02.08  |   |  |  |   |                          |
|  | 3.0 HDi 240  | 177  |  | 04.09  |   | 11.9601-9883.2   | 220917   |  | D=60, - Halter ATE       |
|  |  |  |  |  |   | 11.9601-9884.2   | 220918   |  | D=60, - Halter ATE       |
|  |  |  |  |  |   | 11.0441-6008.2   | 250038   |   | Dichtungssatz ATE        |
|  |  |  |  |  |   | 11.0101-5407.2   | 260011   |   | Hülssensatz ATE          |
|  |  |  |  |  |   | 11.8171-0008.1   | 990049   |   | Führungsbolzen ATE       |
|  | 1.6 HDi  | 80   | ORGA 12998   | 02.08  |   | 24.5161-0314.3   | 331220   |  | L=310/275, + Rohrleitung |
|  | 1.6 HDi 110  | 82   | ORGA 12998   | 07.10  |   | 24.5161-0313.3   | 331219   |  | L=310/275, + Rohrleitung |
|  | 1.6 HDi 115  | 84   | ORGA 12998   | 01.12  |   |  |  |   |                          |

<sup>1)</sup> - idling stop system / - dispositivo start/stop / - unité marche/arrêt / - unidad arranque/paro

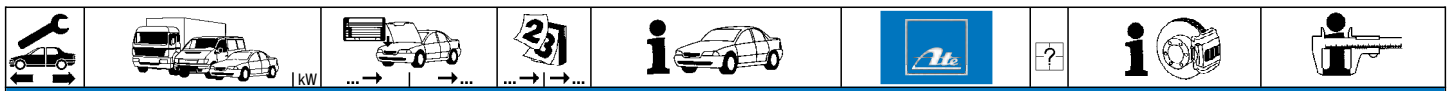

**CITROEN C5 III Limousine (X7) (08-)**

|  |                 |     |            |       |                                  |                |        |   |  |                          |     |
|--|-----------------|-----|------------|-------|----------------------------------|----------------|--------|---|--|--------------------------|-----|
|  | 1.6 THP 155     | 115 | ORGA 12998 | 04.09 |                                  | 24.5161-0314.3 | 331220 |   |  | L=310/275, + Rohrleitung |     |
|  | 1.6 VTI 120     | 88  | ORGA 12998 | 07.10 |                                  | 24.5161-0313.3 | 331219 |   |  | L=310/275, + Rohrleitung |     |
|  | 1.8 16V         | 92  | ORGA 12998 | 02.08 |                                  |                |        |   |  |                          |     |
|  | 2.0 16V         | 103 | ORGA 12998 | 02.08 |                                  |                |        |   |  |                          |     |
|  | 2.0 16V BioFlex | 103 | ORGA 12998 | 02.08 |                                  |                |        |   |  |                          |     |
|  | 2.0 HDi         | 100 | ORGA 12998 | 02.08 |                                  |                |        |   |  |                          |     |
|  | 2.0 HDi 140     | 103 | ORGA 12998 | 11.08 |                                  |                |        |   |  |                          |     |
|  | 2.0 HDi 165     | 120 | ORGA 12998 | 04.09 |                                  |                |        |   |  |                          |     |
|  | 2.2 HDi         | 125 | ORGA 12998 | 02.08 |                                  |                |        |   |  |                          |     |
|  | 2.2 HDi 200     | 150 | ORGA 12998 | 07.10 |                                  |                |        |   |  |                          |     |
|  | 2.7 HDi         | 150 | ORGA 12998 | 02.08 |                                  |                |        |   |  |                          |     |
|  | 3.0             | 152 | ORGA 12998 | 02.08 |                                  |                |        |   |  |                          |     |
|  | 3.0 V6          | 155 | ORGA 12998 | 02.08 |                                  |                |        |   |  |                          |     |
|  | 1.6 HDi         | 80  |            | 02.08 | + elektrische Feststellbremse 1) | 11.9387-7041.2 | 220865 |   |  | D=38, - Halter           | ATE |
|  | 1.6 HDi 110     | 82  |            | 07.10 | + elektrische Feststellbremse 1) | 11.9387-7042.2 | 220866 |   |  | D=38, - Halter           | ATE |
|  | 1.6 HDi 115     | 84  |            | 01.12 | + elektrische Feststellbremse 1) | 11.0101-5407.2 | 260011 |   |  | Hülzensatz               | ATE |
|  | 1.6 THP 155     | 115 |            | 04.09 | + elektrische Feststellbremse 1) | 11.8171-0008.1 | 990049 |   |  | Führungsbolzen           | ATE |
|  | 1.6 VTI 120     | 88  |            | 07.10 | + elektrische Feststellbremse 1) | 11.8116-0340.1 | 390595 | 2 |  | Haltefeder               | ATE |
|  | 1.8 16V         | 92  |            | 02.08 | + elektrische Feststellbremse 1) |                |        |   |  |                          |     |
|  | 2.0 16V         | 103 |            | 02.08 | + elektrische Feststellbremse 1) |                |        |   |  |                          |     |
|  | 2.0 16V BioFlex | 103 |            | 02.08 | + elektrische Feststellbremse 1) |                |        |   |  |                          |     |
|  | 2.0 HDi         | 100 |            | 02.08 | + elektrische Feststellbremse 1) |                |        |   |  |                          |     |
|  | 2.0 HDi 140     | 103 |            | 11.08 | + elektrische Feststellbremse 1) |                |        |   |  |                          |     |
|  | 2.0 HDi 165     | 120 |            | 04.09 | + elektrische Feststellbremse 1) |                |        |   |  |                          |     |
|  | 2.2 HDi         | 125 |            | 02.08 | + elektrische Feststellbremse 1) |                |        |   |  |                          |     |
|  | 2.2 HDi 200     | 150 |            | 07.10 | + elektrische Feststellbremse 1) |                |        |   |  |                          |     |
|  | 2.7 HDi         | 150 |            | 02.08 | + elektrische Feststellbremse 1) |                |        |   |  |                          |     |
|  | 3.0             | 152 |            | 02.08 | + elektrische Feststellbremse 1) |                |        |   |  |                          |     |
|  | 3.0 HDi 240     | 177 |            | 04.09 | + elektrische Feststellbremse 1) |                |        |   |  |                          |     |
|  | 3.0 V6          | 155 |            | 02.08 | + elektrische Feststellbremse 1) |                |        |   |  |                          |     |
|  | 1.6 HDi         | 80  |            | 02.08 | - elektrische Feststellbremse 2) | 24.3387-1707.7 | 220701 |   |  | D=38, - Halter           | LUC |
|  | 1.6 HDi 110     | 82  |            | 07.10 | - elektrische Feststellbremse 2) | 24.3387-1708.7 | 220702 |   |  | D=38, - Halter           | LUC |
|  | 1.6 HDi 115     | 84  |            | 01.12 | - elektrische Feststellbremse 2) | 24.0101-3803.2 | 260101 |   |  | Einbausatz               | LUC |
|  | 1.6 THP 155     | 115 |            | 04.09 | - elektrische Feststellbremse 2) |                |        |   |  |                          |     |
|  | 1.6 VTI 120     | 88  |            | 07.10 | - elektrische Feststellbremse 2) |                |        |   |  |                          |     |
|  | 1.8 16V         | 92  |            | 02.08 | - elektrische Feststellbremse 2) |                |        |   |  |                          |     |
|  | 2.0 16V         | 103 |            | 02.08 | - elektrische Feststellbremse 2) |                |        |   |  |                          |     |
|  | 2.0 16V BioFlex | 103 |            | 02.08 | - elektrische Feststellbremse 2) |                |        |   |  |                          |     |
|  | 2.0 HDi         | 100 |            | 02.08 | - elektrische Feststellbremse 2) |                |        |   |  |                          |     |
|  | 2.0 HDi 140     | 103 |            | 11.08 | - elektrische Feststellbremse 2) |                |        |   |  |                          |     |
|  | 2.0 HDi 165     | 120 |            | 04.09 | - elektrische Feststellbremse 2) |                |        |   |  |                          |     |
|  | 2.2 HDi         | 125 |            | 02.08 | - elektrische Feststellbremse 2) |                |        |   |  |                          |     |
|  | 2.2 HDi 200     | 150 |            | 07.10 | - elektrische Feststellbremse 2) |                |        |   |  |                          |     |
|  | 2.7 HDi         | 150 |            | 02.08 | - elektrische Feststellbremse 2) |                |        |   |  |                          |     |
|  | 3.0             | 152 |            | 02.08 | - elektrische Feststellbremse 2) |                |        |   |  |                          |     |
|  | 3.0 HDi 240     | 177 |            | 04.09 | - elektrische Feststellbremse 2) |                |        |   |  |                          |     |
|  | 3.0 V6          | 155 |            | 02.08 | - elektrische Feststellbremse 2) |                |        |   |  |                          |     |
|  | 1.6 HDi         | 80  | ORGA 11682 | 02.08 |                                  | 24.5151-0583.3 | 331019 |   |  | L=584                    |     |
|  | 1.6 HDi 110     | 82  | ORGA 11682 | 07.10 |                                  | 24.5151-0584.3 | 331020 |   |  | L=584                    |     |
|  | 1.6 HDi 115     | 84  | ORGA 11682 | 01.12 |                                  |                |        |   |  |                          |     |
|  | 1.6 THP 155     | 115 | ORGA 11682 | 04.09 |                                  |                |        |   |  |                          |     |
|  | 1.6 VTI 120     | 88  | ORGA 11682 | 07.10 |                                  |                |        |   |  |                          |     |
|  | 1.8 16V         | 92  | ORGA 11682 | 02.08 |                                  |                |        |   |  |                          |     |
|  | 2.0 16V         | 103 | ORGA 11682 | 02.08 |                                  |                |        |   |  |                          |     |
|  | 2.0 16V BioFlex | 103 | ORGA 11682 | 02.08 |                                  |                |        |   |  |                          |     |
|  | 2.0 HDi         | 100 | ORGA 11682 | 02.08 |                                  |                |        |   |  |                          |     |
|  | 2.0 HDi 140     | 103 | ORGA 11682 | 11.08 |                                  |                |        |   |  |                          |     |
|  | 2.0 HDi 165     | 120 | ORGA 11682 | 04.09 |                                  |                |        |   |  |                          |     |
|  | 2.2 HDi         | 125 | ORGA 11682 | 02.08 |                                  |                |        |   |  |                          |     |
|  | 2.2 HDi 200     | 150 | ORGA 11682 | 07.10 |                                  |                |        |   |  |                          |     |
|  | 2.7 HDi         | 150 | ORGA 11682 | 02.08 |                                  |                |        |   |  |                          |     |
|  | 3.0             | 152 | ORGA 11682 | 02.08 |                                  |                |        |   |  |                          |     |
|  | 3.0 V6          | 155 | ORGA 11682 | 02.08 |                                  |                |        |   |  |                          |     |
|  | 1.6 HDi         | 80  | ORGA 11683 |       |                                  | 24.5151-0638.3 | 331141 |   |  | L=638                    |     |
|  | 1.6 HDi 110     | 82  | ORGA 11683 |       |                                  | 24.5151-0639.3 | 331142 |   |  | L=638                    |     |
|  | 1.6 HDi 115     | 84  | ORGA 11683 |       |                                  |                |        |   |  |                          |     |
|  | 1.6 THP 155     | 115 | ORGA 11683 |       |                                  |                |        |   |  |                          |     |
|  | 1.6 VTI 120     | 88  | ORGA 11683 |       |                                  |                |        |   |  |                          |     |
|  | 1.8 16V         | 92  | ORGA 11683 |       |                                  |                |        |   |  |                          |     |
|  | 2.0 16V         | 103 | ORGA 11683 |       |                                  |                |        |   |  |                          |     |
|  | 2.0 16V BioFlex | 103 | ORGA 11683 |       |                                  |                |        |   |  |                          |     |
|  | 2.0 HDi         | 100 | ORGA 11683 |       |                                  |                |        |   |  |                          |     |
|  | 2.0 HDi 140     | 103 | ORGA 11683 |       |                                  |                |        |   |  |                          |     |
|  | 2.0 HDi 165     | 120 | ORGA 11683 |       |                                  |                |        |   |  |                          |     |
|  | 2.2 HDi         | 125 | ORGA 11683 |       |                                  |                |        |   |  |                          |     |
|  | 2.2 HDi 200     | 150 | ORGA 11682 |       |                                  |                |        |   |  |                          |     |
|  | 2.7 HDi         | 150 | ORGA 11683 |       |                                  |                |        |   |  |                          |     |
|  | 3.0             | 152 | ORGA 11683 |       |                                  |                |        |   |  |                          |     |
|  | 3.0 HDi 240     | 177 |            | 04.09 |                                  |                |        |   |  |                          |     |
|  | 3.0 V6          | 155 | ORGA 11683 |       |                                  |                |        |   |  |                          |     |

**CITROEN C5 III Kombi (X7) (08-)**

|  |             |     |  |       |  |                |        |  |  |     |     |
|--|-------------|-----|--|-------|--|----------------|--------|--|--|-----|-----|
|  | 1.6 HDi     | 80  |  | 02.08 |  | 03.7860-7802.4 | 300280 |  |  | 10" | ATE |
|  | 1.6 THP 155 | 115 |  | 04.09 |  |                |        |  |  |     |     |
|  | 1.6 VTI 120 | 88  |  | 07.10 |  |                |        |  |  |     |     |
|  | 1.8 16V     | 92  |  | 02.08 |  |                |        |  |  |     |     |
|  | 2.0 16V     | 103 |  | 02.08 |  |                |        |  |  |     |     |

1) + electric parking brake / + freno a mano elettrico / + frein à main électrique / + freno de mano eléctrico

2) - electric parking brake / - freno a mano elettrico / - frein à main électrique / - freno de mano eléctrico

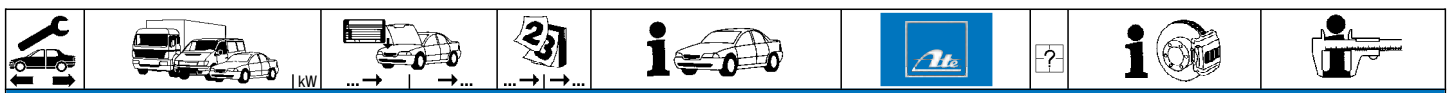



































































































**CITROEN C5 III Kombi (X7) (08-)**

























|                 |                 |                |               |       |  |                |                |            |                                   |                          |               |
|-----------------|-----------------|----------------|---------------|-------|--|----------------|----------------|------------|-----------------------------------|--------------------------|---------------|
|                 | 2.0 16V BioFlex | #103           |               | 02.08 |  | 03.7860-7802.4 | 300280         |            | 10"                               | ATE                      |               |
|                 | 2.0 HDi         | #100           |               | 02.08 |  |                |                |            |                                   |                          |               |
|                 | 2.0 HDi 140     | #103           |               | 11.08 |  |                |                |            |                                   |                          |               |
|                 | 2.0 HDi 150     | #110           |               | 04.09 |  |                |                |            |                                   |                          |               |
|                 | 2.0 HDi 165     | #120           |               | 04.09 |  |                |                |            |                                   |                          |               |
|                 | 2.2 HDi         | #125           |               | 02.08 |  |                |                |            |                                   |                          |               |
|                 | 2.2 HDi 200     | #150           |               | 07.10 |  |                |                |            |                                   |                          |               |
|                 | 2.7 HDi         | #150           |               | 02.08 |  |                |                |            |                                   |                          |               |
|                 | 3.0             | #152           |               | 02.08 |  |                |                |            |                                   |                          |               |
|                 | 3.0 HDi 240     | #177           |               | 04.09 |  |                |                |            |                                   |                          |               |
| 3.0 V6          | #155            |                | 02.08         |       |  |                |                |            |                                   |                          |               |
|                 | 1.6 HDi 110     | # 82           |               | 07.10 |  | 03.7860-7802.4 | 300280         |            | - Start/Stop-Anlage <sup>1)</sup> | 10"                      | ATE           |
|                 | 1.6 HDi 115     | # 84           |               | 01.12 |  |                |                |            |                                   |                          |               |
|                 | 1.6 HDi         | 80             | ORGA 12347    | 02.08 |  | 03.2123-3123.3 | 010806         |            |                                   | THz 23,81                | ATE           |
|                 | 1.6 HDi 110     | 82             | ORGA 12347    | 07.10 |  |                |                |            |                                   |                          |               |
|                 | 1.6 HDi 115     | 84             | ORGA 12347    | 01.12 |  |                |                |            |                                   |                          |               |
|                 | 1.6 THP 155     | 115            | ORGA 12347    | 04.09 |  |                |                |            |                                   |                          |               |
|                 | 1.6 VTI 120     | 88             | ORGA 12347    | 07.10 |  |                |                |            |                                   |                          |               |
|                 | 1.8 16V         | 92             | ORGA 12347    | 02.08 |  |                |                |            |                                   |                          |               |
|                 | 2.0 16V         | 103            | ORGA 12347    | 02.08 |  |                |                |            |                                   |                          |               |
|                 | 2.0 16V BioFlex | 103            | ORGA 12347    | 02.08 |  |                |                |            |                                   |                          |               |
|                 | 2.0 HDi         | 100            | ORGA 12347    | 02.08 |  |                |                |            |                                   |                          |               |
|                 | 2.0 HDi 140     | 103            | ORGA 12347    | 11.08 |  |                |                |            |                                   |                          |               |
|                 | 2.0 HDi 150     | 110            | ORGA 12347    | 04.09 |  |                |                |            |                                   |                          |               |
|                 | 2.0 HDi 165     | 120            | ORGA 12347    | 04.09 |  |                |                |            |                                   |                          |               |
|                 | 2.2 HDi         | 125            | ORGA 12347    | 02.08 |  |                |                |            |                                   |                          |               |
|                 | 2.2 HDi 200     | 150            | ORGA 12347    | 07.10 |  |                |                |            |                                   |                          |               |
|                 | 2.7 HDi         | 150            | ORGA 12347    | 02.08 |  |                |                |            |                                   |                          |               |
|                 | 3.0             | 152            | ORGA 12347    | 02.08 |  |                |                |            |                                   |                          |               |
|                 | 3.0 HDi 240     | 177            | ORGA 12347    | 04.09 |  |                |                |            |                                   |                          |               |
| 3.0 V6          | 155             | ORGA 12347     | 02.08         |       |  |                |                |            |                                   |                          |               |
|                 | 1.6 HDi         | 80             | ORGA 12998    | 02.08 |  | 11.9601-9731.2 | 220853         | 2          |                                   | D=60, - Halter           | ATE           |
|                 | 1.6 HDi 110     | 82             | ORGA 12998    | 07.10 |  | 11.9601-9732.2 | 220854         |            |                                   | D=60, - Halter           | ATE           |
|                 | 1.6 HDi 115     | 84             | ORGA 12998    | 01.12 |  | 11.0441-6008.2 | 250038         |            |                                   | Dichtungssatz            | ATE           |
|                 | 1.6 VTI 120     | 88             | ORGA 12998    | 07.10 |  | 11.0101-5407.2 | 260011         |            |                                   | Hülsensatz               | ATE           |
|                 | 1.8 16V         | 92             | ORGA 12998    | 02.08 |  | 11.8171-0008.1 | 990049         |            |                                   | Führungsbolzen           | ATE           |
|                 | 2.0 16V         | 103            | ORGA 12998    | 02.08 |  | 11.8116-0356.1 | 390586         |            |                                   | Haltefeder               | ATE           |
|                 | 2.0 16V BioFlex | 103            | ORGA 12998    | 02.08 |  |                |                |            |                                   |                          |               |
|                 | 2.0 HDi         | 100            | ORGA 12998    | 02.08 |  |                |                |            |                                   |                          |               |
|                 | 2.0 HDi 140     | 103            | ORGA 12998    | 11.08 |  |                |                |            |                                   |                          |               |
|                 | 2.0 HDi 150     | 110            | ORGA 12998    | 04.09 |  |                |                |            |                                   |                          |               |
|                 | 2.0 HDi 165     | 120            | ORGA 12998    | 04.09 |  |                |                |            |                                   |                          |               |
|                 | 2.0 HDi 165     | 120            | ORGA 12998    | 04.09 |  |                |                |            |                                   |                          |               |
|                 |                 | 1.6 HDi        | 80 ORGA 12999 |       |  |                | 11.0441-6008.2 | 250038     | 2                                 |                          | Dichtungssatz |
| 1.6 HDi 110     |                 | 82 ORGA 12999  |               |       |  | 11.0101-5704.2 | 260095         | Hülsensatz |                                   |                          | ATE           |
| 1.6 HDi 115     |                 | 84 ORGA 12999  |               |       |  | 11.8171-0008.1 | 990049         |            |                                   | Führungsbolzen           | ATE           |
| 1.6 VTI 120     |                 | 88 ORGA 12999  |               |       |  | 11.8116-0356.1 | 390586         |            |                                   | Haltefeder               | ATE           |
| 1.8 16V         |                 | 92 ORGA 12999  |               |       |  |                |                |            |                                   |                          |               |
| 2.0 16V         |                 | 103 ORGA 12999 |               |       |  |                |                |            |                                   |                          |               |
| 2.0 16V BioFlex |                 | 103 ORGA 12999 |               |       |  |                |                |            |                                   |                          |               |
| 2.0 HDi         |                 | 100 ORGA 12999 |               |       |  |                |                |            |                                   |                          |               |
| 2.0 HDi 140     |                 | 103 ORGA 12999 |               |       |  |                |                |            |                                   |                          |               |
| 2.0 HDi 150     |                 | 110 ORGA 12999 |               |       |  |                |                |            |                                   |                          |               |
| 2.0 HDi 165     | 120 ORGA 12999  |                |               |       |  |                |                |            |                                   |                          |               |
| 2.0 HDi 165     | 120 ORGA 12999  |                |               |       |  |                |                |            |                                   |                          |               |
|                 | 1.6 THP 155     | 115            |               | 04.09 |  | 24.3451-1719.7 | 220763         | 2          |                                   | D=45/45, - Halter        | LUC           |
|                 | 2.2 HDi         | 125            |               | 02.08 |  | 24.3451-1720.7 | 220764         |            |                                   | D=45/45, - Halter        | LUC           |
|                 | 2.2 HDi 200     | 150            |               | 07.10 |  |                |                |            |                                   |                          |               |
|                 | 2.7 HDi         | 150            |               | 02.08 |  |                |                |            |                                   |                          |               |
|                 | 3.0             | 152            |               | 02.08 |  |                |                |            |                                   |                          |               |
|                 | 3.0 V6          | 155            |               | 02.08 |  |                |                |            |                                   |                          |               |
|                 | 3.0 HDi 240     | 177            |               | 04.09 |  | 11.9601-9883.2 | 220917         |            |                                   | D=60, - Halter           | ATE           |
|                 | 1.6 HDi         | 80             | ORGA 12998    | 02.08 |  | 24.5161-0314.3 | 331220         | 2          |                                   | L=310/275, + Rohrleitung |               |
|                 | 1.6 HDi 110     | 82             | ORGA 12998    | 07.10 |  | 24.5161-0313.3 | 331219         |            |                                   | L=310/275, + Rohrleitung |               |
|                 | 1.6 HDi 115     | 84             | ORGA 12998    | 01.12 |  |                |                |            |                                   |                          |               |
|                 | 1.6 THP 155     | 115            | ORGA 12998    | 04.09 |  |                |                |            |                                   |                          |               |
|                 | 1.6 VTI 120     | 88             | ORGA 12998    | 07.10 |  |                |                |            |                                   |                          |               |
|                 | 1.8 16V         | 92             | ORGA 12998    | 02.08 |  |                |                |            |                                   |                          |               |
|                 | 2.0 16V         | 103            | ORGA 12998    | 02.08 |  |                |                |            |                                   |                          |               |
|                 | 2.0 16V BioFlex | 103            | ORGA 12998    | 02.08 |  |                |                |            |                                   |                          |               |
|                 | 2.0 HDi         | 100            | ORGA 12998    | 02.08 |  |                |                |            |                                   |                          |               |
|                 | 2.0 HDi 140     | 103            | ORGA 12998    | 11.08 |  |                |                |            |                                   |                          |               |
|                 | 2.0 HDi 150     | 110            | ORGA 12998    | 04.09 |  |                |                |            |                                   |                          |               |
|                 | 2.0 HDi 165     | 120            | ORGA 12998    | 04.09 |  |                |                |            |                                   |                          |               |
|                 | 2.2 HDi         | 125            | ORGA 12998    | 02.08 |  |                |                |            |                                   |                          |               |
|                 | 2.2 HDi 200     | 150            | ORGA 12998    | 07.10 |  |                |                |            |                                   |                          |               |
|                 | 2.7 HDi         | 150            | ORGA 12998    | 02.08 |  |                |                |            |                                   |                          |               |
| 3.0             | 152             | ORGA 12998     | 02.08         |       |  |                |                |            |                                   |                          |               |
| 3.0 V6          | 155             | ORGA 12998     | 02.08         |       |  |                |                |            |                                   |                          |               |

<sup>1)</sup> - idling stop system / - dispositivo start/stop / - unité marche/arrêt / - unidad arranque/paro



|     |    |  |  |  |  |  |  |    |  |   |
|--|--|--|--|--|---|--|--|--|--|---|
| <b>CITROEN C5 III Kombi (X7) (08-)</b>   |  |  |  |  |   |  |  |  |  |   |
|    | 1.6 HDi  | 80   |  | 02.08  | - elektrische Feststellbremse <sup>1)</sup>                                       | 24.3387-1707.7   | 220701   | <br><br><br><br><br><br><br><br><br><br><br><br><br><br><br><br><br><br><br><br><br><br><br> |  |   |
|  | 1.6 HDi 110  | 82   |  | 07.10  | - elektrische Feststellbremse <sup>1)</sup>                                       | 24.3387-1708.7   | 220702   |  |  |   |
|  | 1.6 HDi 115  | 84   |  | 01.12  | - elektrische Feststellbremse <sup>1)</sup>                                       | 24.0101-3803.2   | 260101   |  |  |   |
|  | 1.6 THP 155  | 115  |  | 04.09  | - elektrische Feststellbremse <sup>1)</sup>                                       |  |  |  |  |   |
|  | 1.6 VTI 120  | 88   |  | 07.10  | - elektrische Feststellbremse <sup>1)</sup>                                       |  |  |  |  |   |
|  | 1.8 16V  | 92   |  | 02.08  | - elektrische Feststellbremse <sup>1)</sup>                                       |  |  |  |  |   |
|  | 2.0 16V  | 103  |  | 02.08  | - elektrische Feststellbremse <sup>1)</sup>                                       |  |  |  |  |   |
|  | 2.0 16V BioFlex  | 103  |  | 02.08  | - elektrische Feststellbremse <sup>1)</sup>                                       |  |  |  |  |   |
|  | 2.0 HDi  | 100  |  | 02.08  | - elektrische Feststellbremse <sup>1)</sup>                                       |  |  |  |  |   |
|  | 2.0 HDi 140  | 103  |  | 11.08  | - elektrische Feststellbremse <sup>1)</sup>                                       |  |  |  |  |   |
|  | 2.0 HDi 150  | 110  |  | 04.09  | - elektrische Feststellbremse <sup>1)</sup>                                       |  |  |  |  |   |
|  | 2.0 HDi 165  | 120  |  | 04.09  | - elektrische Feststellbremse <sup>1)</sup>                                       |  |  |  |  |   |
|  | 2.2 HDi  | 125  |  | 02.08  | - elektrische Feststellbremse <sup>1)</sup>                                       |  |  |  |  |   |
|  | 2.2 HDi 200  | 150  |  | 07.10  | - elektrische Feststellbremse <sup>1)</sup>                                       |  |  |  |  |   |
|  | 2.7 HDi  | 150  |  | 02.08  | - elektrische Feststellbremse <sup>1)</sup>                                       |  |  |  |  |   |
|  | 3.0  | 152  |  | 02.08  | - elektrische Feststellbremse <sup>1)</sup>                                       |  |  |  |  |   |
|  | 3.0 HDi 240  | 177  |  | 04.09  | - elektrische Feststellbremse <sup>1)</sup>                                       |  |  |  |  |   |
|  | 3.0 V6   | 155  |  | 02.08  | - elektrische Feststellbremse <sup>1)</sup>                                       |  |  |  |  |   |
|  |    | 1.6 HDi  | 80   |  | 02.08   | + elektrische Feststellbremse <sup>2)</sup>  | 11.9387-7041.2   |  | 220865   | <br><br><br><br><br><br><br><br><br><br><br><br><br><br><br><br><br><br> |
|  |  | 1.6 HDi 110  | 82   |  | 07.10   | + elektrische Feststellbremse <sup>2)</sup>  | 11.9387-7042.2   |  | 220866   |   |
| 1.6 HDi 115  |  | 84   |  | 01.12  | + elektrische Feststellbremse <sup>2)</sup>                                       | 11.0101-5407.2   | 260011   |  |  |   |
| 1.6 THP 155  |  | 115  |  | 04.09  | + elektrische Feststellbremse <sup>2)</sup>                                       | 11.8116-0340.1   | 390595   |  |  |   |
| 1.6 VTI 120  |  | 88   |  | 07.10  | + elektrische Feststellbremse <sup>2)</sup>                                       | 11.8171-0008.1   | 990049   |  |  |   |
| 1.8 16V  |  | 92   |  | 02.08  | + elektrische Feststellbremse <sup>2)</sup>                                       |  |  |  |  |   |
| 2.0 16V  |  | 103  |  | 02.08  | + elektrische Feststellbremse <sup>2)</sup>                                       |  |  |  |  |   |
| 2.0 16V BioFlex  |  | 103  |  | 02.08  | + elektrische Feststellbremse <sup>2)</sup>                                       |  |  |  |  |   |
| 2.0 HDi  |  | 100  |  | 02.08  | + elektrische Feststellbremse <sup>2)</sup>                                       |  |  |  |  |   |
| 2.0 HDi 140  |  | 103  |  | 11.08  | + elektrische Feststellbremse <sup>2)</sup>                                       |  |  |  |  |   |
| 2.0 HDi 150  |  | 110  |  | 04.09  | + elektrische Feststellbremse <sup>2)</sup>                                       |  |  |  |  |   |
| 2.0 HDi 165  |  | 120  |  | 04.09  | + elektrische Feststellbremse <sup>2)</sup>                                       |  |  |  |  |   |
| 2.2 HDi  |  | 125  |  | 02.08  | + elektrische Feststellbremse <sup>2)</sup>                                       |  |  |  |  |   |
| 2.2 HDi 200  |  | 150  |  | 07.10  | + elektrische Feststellbremse <sup>2)</sup>                                       |  |  |  |  |   |
| 2.7 HDi  |  | 150  |  | 02.08  | + elektrische Feststellbremse <sup>2)</sup>                                       |  |  |  |  |   |
| 3.0  |  | 152  |  | 02.08  | + elektrische Feststellbremse <sup>2)</sup>                                       |  |  |  |  |   |
| 3.0 HDi 240  |  | 177  |  | 04.09  | + elektrische Feststellbremse <sup>2)</sup>                                       |  |  |  |  |   |
| 3.0 V6   |  | 155  |  | 02.08  | + elektrische Feststellbremse <sup>2)</sup>                                       |  |  |  |  |   |
|  |  | 1.6 HDi  | 80   | ORGA 11682   | 02.08   |  | 24.5151-0583.3   | 331019   | <br><br><br><br><br><br><br><br><br><br><br><br><br><br> |   |
|  |  | 1.6 HDi 110  | 82   | ORGA 11682   | 07.10   |  | 24.5151-0584.3   | 331020   |  |   |
|  | 1.6 HDi 115  | 84   | ORGA 11682   | 01.12  |   |  |  |  |  |   |
|  | 1.6 THP 155  | 115  | ORGA 11682   | 04.09  |   |  |  |  |  |   |
|  | 1.6 VTI 120  | 88   | ORGA 11682   | 07.10  |   |  |  |  |  |   |
|  | 1.8 16V  | 92   | ORGA 11682   | 02.08  |   |  |  |  |  |   |
|  | 2.0 16V  | 103  | ORGA 11682   | 02.08  |   |  |  |  |  |   |
|  | 2.0 16V BioFlex  | 103  | ORGA 11682   | 02.08  |   |  |  |  |  |   |
|  | 2.0 HDi  | 100  | ORGA 11682   | 02.08  |   |  |  |  |  |   |
|  | 2.0 HDi 140  | 103  | ORGA 11682   | 11.08  |   |  |  |  |  |   |
|  | 2.0 HDi 165  | 120  | ORGA 11682   | 04.09  |   |  |  |  |  |   |
|  | 2.2 HDi  | 125  | ORGA 11682   | 02.08  |   |  |  |  |  |   |
|  | 2.2 HDi 200  | 150  | ORGA 11682   | 07.10  |   |  |  |  |  |   |
|  | 2.7 HDi  | 150  | ORGA 11682   | 02.08  |   |  |  |  |  |   |
|  | 3.0  | 152  | ORGA 11682   | 02.08  |   |  |  |  |  |   |
|  | 3.0 HDi 240  | 177  | ORGA 11682   | 02.08  |   |  |  |  |  |   |
|  | 3.0 V6   | 155  | ORGA 11682   | 02.08  |   |  |  |  |  |   |
|  |  | 1.6 HDi  | 80   | ORGA 11683   |   |  | 24.5151-0638.3   | 331141   |  | <br><br><br><br><br><br><br><br><br><br>   |
|  |  | 1.6 HDi 110  | 82   | ORGA 11683   |   |  | 24.5151-0639.3   | 331142   |  |   |
|  |  | 1.6 HDi 115  | 84   | ORGA 11683   |   |  |  |  |  |   |
| 1.6 THP 155  |  | 115  | ORGA 11683   |  |   |  |  |  |  |   |
| 1.6 VTI 120  |  | 88   | ORGA 11683   |  |   |  |  |  |  |   |
| 1.8 16V  |  | 92   | ORGA 11683   |  |   |  |  |  |  |   |
| 2.0 16V  |  | 103  | ORGA 11683   |  |   |  |  |  |  |   |
| 2.0 16V BioFlex  |  | 103  | ORGA 11683   |  |   |  |  |  |  |   |
| 2.0 HDi  |  | 100  | ORGA 11683   |  |   |  |  |  |  |   |
| 2.0 HDi 140  |  | 103  | ORGA 11683   |  |   |  |  |  |  |   |
| 2.0 HDi 150  |  | 110  |  | 04.09  |   |  |  |  |  |   |
| 2.0 HDi 165  |  | 120  | ORGA 11683   |  |   |  |  |  |  |   |
| 2.2 HDi  |  | 125  | ORGA 11683   |  |   |  |  |  |  |   |
| 2.2 HDi 200  |  | 150  | ORGA 11683   |  |   |  |  |  |  |   |
| 2.7 HDi  |  | 150  | ORGA 11683   |  |   |  |  |  |  |   |
| 3.0  | 152  | ORGA 11683   |  |  |   |  |  |  |  |   |
| 3.0 HDi 240  | 177  |  | 04.09  |  |   |  |  |  |  |   |
| 3.0 V6   | 155  | ORGA 11683   |  |  |   |  |  |  |  |   |
| <b>CITROEN C6 (05-12)</b>  |  |  |  |  |   |  |  |  |  |   |
|  | 2.2 HDi  | #125   | ORGA 11192   | 06.06  |   | 03.7860-3402.4   | 300217   | <br><br>  |  |   |
|  | 2.7 HDi  | #150   | ORGA 11073   | 09.05  |   |  |  |  |  |   |
|  | 3.0 V6   | #155   | ORGA 11192   | 09.05  |   |  |  |  |  |   |
|  | 2.2 HDi  | #125   | ORGA 11193   |  |   | 03.7860-5102.4   | 300218   | <br><br>  |  |   |
|  | 2.7 HDi  | #150   | ORGA 11074   | 12.12  |   |  |  |  |  |   |
|  | 3.0 V6   | #155   | ORGA 11193   | 12.12  |   |  |  |  |  |   |
|  | 2.2 HDi  | #125   | ORGA 12047   |  |   | 03.7860-8002.4   | 300258   | <br>   |  |   |
|  | 3.0 HDi  | #177   |  | 07.09  |   |  |  |  |  |   |
|  | 2.2 HDi  | 125  | ORGA 12347   | 06.06  |   | 03.2123-3123.3   | 010806   | <br><br><br>   |  |   |
|  | 2.7 HDi  | 150  | ORGA 12347   | 09.05  |   |  |  |  |  |   |
|  | 3.0 HDi  | 177  | ORGA 12347   | 07.09  |   |  |  |  |  |   |
|  | 3.0 V6   | 155  | ORGA 12347   | 09.05  |   |  |  |  |  |   |

<sup>1)</sup> - electric parking brake / - freno a mano elettrico / - frein à main électrique / - freno de mano eléctrico  
<sup>2)</sup> + electric parking brake / + freno a mano elettrico / + frein à main électrique / + freno de mano eléctrico

|     |  |  |  |  |  |  |  |  |   |
|--|--|--|--|--|---|--|--|--|---|
| <b>CITROEN C6 (05-12)</b>  |  |  |  |  |   |  |  |  |   |
|    | 2.2 HDi  | 125  |  | 06.06  | 12.12   | 24.3451-1719.7   | 220763   | D=45/45, - Halter<br>D=45/45, - Halter   | LUC   |
|  | 2.7 HDi  | 150  |  | 09.05  | 12.12   | 24.3451-1720.7   | 220764   |  | LUC   |
|  | 3.0 V6   | 155  |  | 09.05  | 12.12   |  |  |  |   |
|  | 3.0 HDi  | 177  |  | 07.09  | 12.12   | 11.9601-9883.2   | 220917   |  | D=60, - Halter<br>D=60, - Halter<br>Hülsensatz<br>Führungsbolzen<br>Dichtungssatz |
|    | 2.2 HDi  | 125  | ORGA 11125   | 06.06  |   | 24.5161-0315.3   | 331186   | L=310/275, + Rohrleitung<br>L=310/275, + Rohrleitung                               |   |
|  | 2.7 HDi  | 150  | ORGA 11125   | 09.05  |   | 24.5161-0316.3   | 331187   |  |   |
|  | 3.0 V6   | 155  | ORGA 11125   | 09.05  |   |  |  |  |   |
|  | 2.2 HDi  | 125  | ORGA 11126   |  | 12.12   | 24.5161-0314.3   | 331220   |  | L=310/275, + Rohrleitung  |
|    | 2.7 HDi  | 150  | ORGA 11126   |  | 12.12   | 24.5161-0313.3   | 331219   | L=310/275, + Rohrleitung   |   |
|  | 3.0 V6   | 155  | ORGA 11126   |  | 12.12   |  |  |  |   |
|  | 2.2 HDi  | 125  |  | 06.06  | 12.12   | 24.3384-1769.7   | 220791   | D=38, - Halter   | LUC   |
|  | 2.7 HDi  | 150  |  | 09.05  | 12.12   | 24.3384-1770.7   | 220792   | D=38, - Halter   | LUC   |
|    | 3.0 HDi  | 177  |  | 07.09  | 12.12   | 24.0101-3802.2   | 260100   | Einbausatz   | LUC   |
|  | 3.0 V6   | 155  |  | 09.05  | 12.12   |  |  |  | LUC   |
|  | 2.2 HDi  | 125  | ORGA 11682   | 06.06  |   | 24.5151-0583.3   | 331019   | L=584<br>L=584   |   |
|  | 2.7 HDi  | 150  | ORGA 11682   | 09.05  |   | 24.5151-0584.3   | 331020   |  |   |
|    | 3.0 HDi  | 177  | ORGA 11682   | 07.09  |   |  |  |  |   |
|  | 3.0 V6   | 155  | ORGA 11682   | 09.05  |   |  |  |  |   |
|  | 2.2 HDi  | 125  | ORGA 11683   |  | 12.12   | 24.5151-0638.3   | 331141   | L=638<br>L=638   |   |
|  | 2.7 HDi  | 150  | ORGA 11683   |  | 12.12   | 24.5151-0639.3   | 331142   |  |   |
|    | 3.0 HDi  | 177  | ORGA 11683   |  | 12.12   |  |  |  |   |
|  | 3.0 V6   | 155  | ORGA 11683   |  | 12.12   |  |  |  |   |
|  | <b>CITROEN C8 (02-)</b>  |  |  |  |   |  |  |  |   |
|  |  | 2.0 16V  | #103   | ORGA 10919   | 09.05   |  | 03.7860-2002.4   | 300216   | 10"   |
| 2.0 HDi  |  | #79  | ORGA 10528   |  |   |  |  |  |   |
| 2.0 HDi 135  |  | #100   | ORGA 10919   | 03.06  |   |  |  |  |   |
| 2.2 HDi  |  | #94  | ORGA 10528   |  |   |  |  |  |   |
|    | 2.0 16V  | #103   | ORGA 10920   |  |   | 03.7860-4302.4   | 300231   | 10"  | ATE   |
|  | 2.0 HDi  | #88  |  | 02.07  |   |  |  |  |   |
|  | 2.0 HDi 135  | #100   | ORGA 10920   |  |   |  |  |  |   |
|  | 2.2 HDi  | #94  | ORGA 10528   |  |   |  |  |  |   |
|    | 2.0 16V  | 103  |  | 09.05  |   | 03.2122-2163.3   | 010800   | THz 22,20  | ATE   |
|  | 2.0 HDi  | 79   | ORGA 10528   |  |   |  |  |  |   |
|  | 2.0 HDi  | 88   |  | 02.07  |   |  |  |  |   |
|  | 2.0 HDi 135  | 100  |  | 03.06  |   |  |  |  |   |
|   | 2.2 HDi  | 94   | ORGA 10528   |  |   |  |  |  |   |
|  | 2.0 HDi 165  | 120  |  | 03.06  |   | 03.2123-3421.3   | 010933   | THz 23,81  | ATE   |
|  | 2.2 HDi  | 125  |  | 06.06  |   |  |  |  |   |
|  |  |  |  |  |   |  |  |  |   |
|  | 2.0 16V  | 100  |  | 07.02  |   | 24.3601-1711.7   | 220607   | D=60, - Halter<br>D=60, - Halter   | LUC   |
|  | 2.0 16V  | 103  |  | 09.05  |   | 24.3601-1712.7   | 220608   |  | LUC   |
|  | 2.0 HDi  | 79   |  | 07.02  |   |  |  |  |   |
|  | 2.0 HDi  | 88   |  | 02.07  |   |  |  |  |   |
|  | 2.0 HDi 135  | 100  |  | 03.06  |   |  |  |  |   |
|  | 2.2 16V  | 116  |  | 07.02  |   |  |  |  |   |
|  | 2.2 HDi  | 94   |  | 07.02  |   |  |  |  |   |
|  | 2.0 16V  | 100  |  | 07.02  |   | 24.5111-0462.3   | 330555   | L=460  |   |
|  | 2.0 16V  | 103  |  | 09.05  |   |  |  |  |   |
|  | 2.0 HDi  | 79   |  | 07.02  |   |  |  |  |   |
|  | 2.0 HDi  | 88   |  | 02.07  |   |  |  |  |   |
|  | 2.0 HDi 135  | 100  |  | 03.06  |   |  |  |  |   |
|  | 2.2 16V  | 116  |  | 07.02  |   |  |  |  |   |
|  | 2.2 HDi  | 94   |  | 07.02  |   |  |  |  |   |
|  | 2.0 HDi 165  | 120  |  | 03.06  |   | 24.5144-0500.3   | 331169   | L=500  |   |
|  | 2.2 HDi  | 125  |  | 06.06  |   |  |  |  |   |
|  |  |  |  |  |   |  |  |  |   |
|  |  |  |  |  |   |  |  |  |   |
|  | 2.0 16V  | 100  |  | 07.02  |   | 24.3384-1761.7   | 220671   | D=38, - Halter<br>D=38, - Halter   | LUC   |
|  | 2.0 16V  | 103  |  | 09.05  |   | 24.3384-1762.7   | 220672   |  | LUC   |
|  | 2.0 HDi  | 79   |  | 07.02  |   |  |  |  |   |
|  | 2.0 HDi  | 88   |  | 02.07  |   |  |  |  |   |
|  | 2.0 HDi 135  | 100  |  | 03.06  |   |  |  |  |   |
|  | 2.0 HDi 165  | 120  |  | 03.06  |   |  |  |  |   |
|  | 2.2 16V  | 116  |  | 07.02  |   |  |  |  |   |
|  | 2.2 HDi  | 94   |  | 07.02  |   |  |  |  |   |
|  | 2.2 HDi  | 125  |  | 06.06  |   |  |  |  |   |
|  | 3.0 V6   | 150  |  | 07.02  |   |  |  |  |   |
|  | 2.0 16V  | 100  |  | 07.02  |   | 24.5229-0251.3   | 330535   | L=250  |   |
|  | 2.0 16V  | 103  |  | 09.05  |   |  |  |  |   |
|  | 2.0 HDi  | 79   |  | 07.02  |   |  |  |  |   |
|  | 2.0 HDi  | 88   |  | 02.07  |   |  |  |  |   |
|  | 2.0 HDi 135  | 100  |  | 03.06  |   |  |  |  |   |
|  | 2.0 HDi 165  | 120  |  | 03.06  |   |  |  |  |   |
|  | 2.2 16V  | 116  |  | 07.02  |   |  |  |  |   |
|  | 2.2 HDi  | 94   |  | 07.02  |   |  |  |  |   |
|  | 2.2 HDi  | 125  |  | 06.06  |   |  |  |  |   |
|  | 3.0 V6   | 150  |  | 07.02  |   |  |  |  |   |
|  | 2.0 16V  | #100   | ORGA 10284   | 07.02  |   | 24.3727-0847.2   | 580847   | L=1068<br>L=2360   |   |
|  | 2.0 16V  | #103   | ORGA 10284   | 09.05  |   | 24.3727-0848.2   | 580848   |  |   |
|  | 2.0 HDi  | #79  | ORGA 10284   | 07.02  |   |  |  |  |   |
|  | 2.0 HDi  | #88  | ORGA 10284   | 02.07  |   |  |  |  |   |
|  | 2.0 HDi 135  | #100   | ORGA 10284   | 03.06  |   |  |  |  |   |
|  | 2.0 HDi 165  | #120   | ORGA 10284   | 03.06  |   |  |  |  |   |
|  | 2.2 16V  | #116   | ORGA 10284   | 07.02  |   |  |  |  |   |



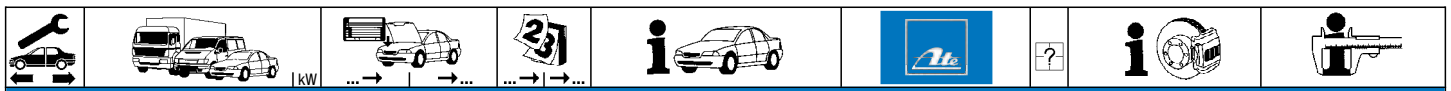

**CITROEN C8 (02-)**

|             |             |            |            |            |  |                |        |                          |  |        |
|-------------|-------------|------------|------------|------------|--|----------------|--------|--------------------------|--|--------|
|             | 2.2 HDi     | 94         | ORGA 10284 | 07.02      |  | 24.3727-0847.2 | 580847 | <input type="checkbox"/> |  | L=1068 |
|             | 2.2 HDi     | 125        | ORGA 10284 | 06.06      |  | 24.3727-0848.2 | 580848 | <input type="checkbox"/> |  | L=2360 |
|             | 3.0 V6      | 150        | ORGA 10284 | 07.02      |  |                |        | <input type="checkbox"/> |  |        |
|             | 2.0 16V     | 100        | ORGA 10285 | ORGA 11043 |  | 24.3727-0850.2 | 580850 | <input type="checkbox"/> |  | L=1041 |
|             | 2.0 16V     | 103        | ORGA 10285 | ORGA 11043 |  | 24.3727-0849.2 | 580849 | <input type="checkbox"/> |  | L=2308 |
|             | 2.0 HDi     | 79         | ORGA 10285 | ORGA 11043 |  |                |        |                          |  |        |
|             | 2.0 HDi     | 88         | ORGA 10285 | ORGA 11043 |  |                |        |                          |  |        |
|             | 2.0 HDi 135 | 100        | ORGA 10285 | ORGA 11043 |  |                |        |                          |  |        |
|             | 2.0 HDi 165 | 120        | ORGA 10285 | ORGA 11043 |  |                |        |                          |  |        |
|             | 2.2 16V     | 116        | ORGA 10285 | ORGA 11043 |  |                |        |                          |  |        |
|             | 2.2 HDi     | 94         | ORGA 10285 | ORGA 11043 |  |                |        |                          |  |        |
|             | 2.2 HDi     | 125        | ORGA 10285 | ORGA 11043 |  |                |        |                          |  |        |
| 3.0 V6      | 150         | ORGA 10285 | ORGA 11043 |            |  |                |        |                          |  |        |
| 2.0 16V     | 100         | ORGA 10284 | ORGA 10284 | 07.02      |  | 24.3727-0848.2 | 580848 | <input type="checkbox"/> |  | L=2360 |
| 2.0 16V     | 100         | ORGA 10284 | ORGA 10284 | 07.02      |  | 24.3727-0847.2 | 580847 | <input type="checkbox"/> |  | L=1068 |
| 2.0 16V     | 103         | ORGA 10284 | ORGA 10284 | 09.05      |  |                |        |                          |  |        |
| 2.0 HDi     | 79          | ORGA 10284 | ORGA 10284 | 07.02      |  |                |        |                          |  |        |
| 2.0 HDi 135 | 100         | ORGA 10284 | ORGA 10284 | 03.06      |  |                |        |                          |  |        |
| 2.0 HDi 165 | 120         | ORGA 10284 | ORGA 10284 | 03.06      |  |                |        |                          |  |        |
| 2.2 16V     | 116         | ORGA 10284 | ORGA 10284 | 07.02      |  |                |        |                          |  |        |
| 2.2 HDi     | 94          | ORGA 10284 | ORGA 10284 | 07.02      |  |                |        |                          |  |        |
| 2.2 HDi     | 125         | ORGA 10284 | ORGA 10284 | 06.06      |  |                |        |                          |  |        |
| 3.0 V6      | 150         | ORGA 10284 | ORGA 10284 | 07.02      |  |                |        |                          |  |        |
| 2.0 16V     | 100         | ORGA 10285 |            |            |  | 24.3727-0849.2 | 580849 | <input type="checkbox"/> |  | L=2308 |
| 2.0 16V     | 103         | ORGA 10285 |            |            |  | 24.3727-0850.2 | 580850 | <input type="checkbox"/> |  | L=1041 |
| 2.0 HDi     | 79          | ORGA 10285 |            |            |  |                |        |                          |  |        |
| 2.0 HDi     | 88          | ORGA 10285 |            |            |  |                |        |                          |  |        |
| 2.0 HDi 135 | 100         | ORGA 10285 |            |            |  |                |        |                          |  |        |
| 2.0 HDi 165 | 120         | ORGA 10285 |            |            |  |                |        |                          |  |        |
| 2.2 16V     | 116         | ORGA 10285 |            |            |  |                |        |                          |  |        |
| 2.2 HDi     | 94          | ORGA 10285 |            |            |  |                |        |                          |  |        |
| 2.2 HDi     | 125         | ORGA 10285 |            |            |  |                |        |                          |  |        |
| 3.0 V6      | 150         | ORGA 10285 |            |            |  |                |        |                          |  |        |

**CITROEN C-CROSSER (07-13)**

|  |         |     |            |       |       |                |        |                          |                  |       |
|--|---------|-----|------------|-------|-------|----------------|--------|--------------------------|------------------|-------|
|  | 2.2 HDi | 115 |            | 02.07 | 01.13 | 24.5286-0600.3 | 331173 | <input type="checkbox"/> |                  | L=600 |
|  | 2.4     | 125 |            | 08.08 | 01.13 | 24.5286-0601.3 | 331174 | <input type="checkbox"/> |                  | L=600 |
|  | 2.2 HDi | 115 | ORGA 12718 | 02.07 |       | 24.5112-0280.3 | 331200 | 2                        | am Bremsattel 1) | L=280 |
|  | 2.4     | 125 | ORGA 12718 | 08.08 |       | 24.5247-0275.3 | 331244 | <input type="checkbox"/> |                  | L=275 |
|  | 2.2 HDi | 115 | ORGA 12719 |       | 01.13 | 24.5247-0275.3 | 331244 | <input type="checkbox"/> |                  | L=275 |
|  | 2.4     | 125 | ORGA 12719 |       | 01.13 | 24.5247-0276.3 | 331245 | <input type="checkbox"/> |                  | L=275 |

**CITROEN DS3 (09-)**

|  |             |     |            |  |       |                |        |                          |  |                |     |
|--|-------------|-----|------------|--|-------|----------------|--------|--------------------------|--|----------------|-----|
|  | 1.6 HDi 110 | 82  | ORGA 12999 |  | 08.12 | 24.4123-1704.3 | 010828 |                          |  | Thz 23,81      | LUC |
|  | 1.6 HDi 115 | 84  |            |  |       |                |        |                          |  |                |     |
|  | 1.6 HDi 90  | 68  | ORGA 12999 |  |       |                |        |                          |  |                |     |
|  | 1.6 Racing  |     | ORGA 12999 |  |       |                |        |                          |  |                |     |
|  | 1.6 THP 150 | 115 | ORGA 12999 |  |       |                |        |                          |  |                |     |
|  | 1.6 VTi 120 | 88  | ORGA 12999 |  |       |                |        |                          |  |                |     |
|  | 1.4 VTi 95  | 70  | ORGA 12999 |  |       | 24.4122-1703.3 | 010843 |                          |  | Thz 22,20      | LUC |
|  | 1.2 VTi 82  | 60  |            |  | 10.12 | 24.3541-1771.5 | 240239 | <input type="checkbox"/> |  | D=54, - Halter | BOS |
|  | 1.4 VTi 95  | 70  |            |  | 04.10 | 24.3541-1772.5 | 240240 | <input type="checkbox"/> |  | D=54, - Halter | BOS |
|  | 1.6 HDi 90  | 68  |            |  | 11.09 |                |        |                          |  |                |     |
|  | 1.4 VTi 95  | 70  |            |  | 04.10 | 24.3220-1732.3 | 020514 |                          |  | Rz 20,64       | BOS |

**CITROEN DS3 Cabrio (13-)**

|  |                     |     |  |  |       |                |        |                          |                                 |                |     |
|--|---------------------|-----|--|--|-------|----------------|--------|--------------------------|---------------------------------|----------------|-----|
|  | 1.2 PureTech VTi 82 | 60  |  |  | 03.13 | 24.3541-1771.5 | 240239 | <input type="checkbox"/> | + Bremsscheibendurchm. 266mm 2) | D=54, - Halter | BOS |
|  | 1.6 e-HDi 90        | 68  |  |  | 03.13 | 24.3541-1772.5 | 240240 | <input type="checkbox"/> | + Bremsscheibendurchm. 266mm 2) | D=54, - Halter | BOS |
|  | 1.6 THP 155         | 115 |  |  | 03.13 |                |        |                          |                                 |                |     |
|  | 1.6 VTi 120         | 88  |  |  | 03.13 |                |        |                          |                                 |                |     |

**CITROEN DS4 (11-)**

|  |               |     |  |  |                |                |        |                          |               |                |     |
|--|---------------|-----|--|--|----------------|----------------|--------|--------------------------|---------------|----------------|-----|
|  | 1.6 e-HDi 110 | 81  |  |  | 04.11          | 11.9601-9717.2 | 220901 | <input type="checkbox"/> |               | D=60, - Halter | ATE |
|  | 1.6 HDi 110   | 82  |  |  | 04.11          | 11.9601-9718.2 | 220902 | <input type="checkbox"/> |               | D=60, - Halter | ATE |
|  | 1.6 HDi 115   | 84  |  |  | 08.12          | 11.8116-0356.1 | 390586 | 2                        |               | Haltefeder     | ATE |
|  | 1.6 HDi 90    | 68  |  |  | 05.11          | 11.8171-0008.1 | 990049 |                          |               | Führungsbolzen | ATE |
|  | 1.6 VTi 120   | 88  |  |  | 04.11          | 11.0101-5704.2 | 260095 |                          |               | Hülssensatz    | ATE |
|  |               |     |  |  |                | 11.0441-6008.2 | 250038 |                          |               | Dichtungssatz  | ATE |
|  | 1.6 THP 200   | 147 |  |  | 04.11          | 11.9601-9883.2 | 220917 | <input type="checkbox"/> |               | D=60, - Halter | ATE |
|  | 2.0 HDi 135   | 100 |  |  | 09.11          | 11.9601-9884.2 | 220918 | <input type="checkbox"/> |               | D=60, - Halter | ATE |
|  | 2.0 HDi 160   | 120 |  |  | 04.11          | 11.0101-5407.2 | 260011 |                          |               | Hülssensatz    | ATE |
|  |               |     |  |  |                | 11.8171-0008.1 | 990049 |                          |               | Führungsbolzen | ATE |
|  |               |     |  |  | 11.0101-5704.2 | 260095         |        |                          | Hülssensatz   | ATE            |     |
|  |               |     |  |  | 11.0441-6008.2 | 250038         |        |                          | Dichtungssatz | ATE            |     |
|  | 1.6 THP 155   | 115 |  |  | 04.11          | 11.9601-9717.2 | 220901 | <input type="checkbox"/> |               | D=60, - Halter | ATE |
|  | 1.6 THP 160   | 120 |  |  | 04.12          | 11.9601-9718.2 | 220902 | <input type="checkbox"/> |               | D=60, - Halter | ATE |
|  | 2.0 HDi 135   | 100 |  |  | 09.11          | 11.8116-0356.1 | 390586 | 2                        |               | Haltefeder     | ATE |
|  | 2.0 HDi 160   | 120 |  |  | 04.11          | 11.8171-0008.1 | 990049 |                          |               | Führungsbolzen | ATE |
|  |               |     |  |  |                | 11.0101-5704.2 | 260095 |                          |               | Hülssensatz    | ATE |
|  |               |     |  |  |                | 11.0441-6008.2 | 250038 |                          |               | Dichtungssatz  | ATE |
|  | 1.6 e-HDi 110 | 81  |  |  | 04.11          | 24.5246-0190.3 | 330697 | 2                        |               | L=190          |     |
|  | 1.6 HDi 110   | 82  |  |  | 04.11          |                |        |                          |               |                |     |
|  | 1.6 HDi 115   | 84  |  |  | 08.12          |                |        |                          |               |                |     |

1) on the brake caliper / sulla pinza freno / sur l'étrier de frein / a la pinza de freno  
 2) + br.disc diameter 266mm / + diametro disco fr.266mm / + diamètre disque fr.266mm / + diámetro disco fr.266mm  
 3) + 19" wheel / + ruota 19" / + roue 19" / + rueda 19"  
 4) - 19" wheel / - ruota 19" / - roue 19" / - rueda 19"



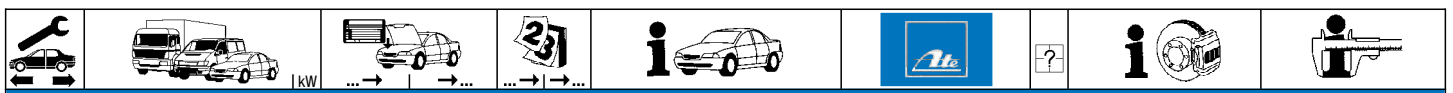

| CITROEN DS4 (11-)       |                      |     |            |       |       |                |        |   |   |                |     |
|-------------------------|----------------------|-----|------------|-------|-------|----------------|--------|---|---|----------------|-----|
|                         | 1.6 HDi 90           | 68  |            | 05.11 |       | 24.5246-0190.3 | 330697 | 2 |   | L=190          |     |
|                         | 1.6 THP 155          | 115 |            | 04.11 |       |                |        |   |   |                |     |
|                         | 1.6 THP 160          | 120 |            | 04.12 |       |                |        |   |   |                |     |
|                         | 1.6 THP 200          | 147 |            | 04.11 |       |                |        |   |   |                |     |
|                         | 1.6 VTi 120          | 88  |            | 04.11 |       |                |        |   |   |                |     |
|                         | 2.0 HDi 135          | 100 |            | 09.11 |       |                |        |   |   |                |     |
|                         | 2.0 HDi 160          | 120 |            | 04.11 |       |                |        |   |   |                |     |
| CITROEN DS5 (11-)       |                      |     |            |       |       |                |        |   |   |                |     |
|                         | 1.6 HDi 110          | 82  |            | 11.11 |       | 03.4153-0173.3 | 010815 |   | Naben D=82 <sup>1)</sup>                          | THz 23,81      | ATE |
|                         | 1.6 HDi 115          | 84  |            | 08.12 |       |                |        |   |   |                |     |
|                         | 1.6 THP 155          | 115 |            | 11.11 |       |                |        |   |   |                |     |
|                         | 1.6 THP 200          | 147 |            | 11.11 |       |                |        |   |   |                |     |
|                         | 2.0 HDi 135          | 100 |            | 11.11 |       |                |        |   |   |                |     |
|                         | 2.0 HDi 135 Hybrid4  | 100 |            | 12.11 |       |                |        |   |   |                |     |
|                         | 2.0 HDi 165          | 120 |            | 11.11 |       |                |        |   |   |                |     |
|                         | 2.0 HDi 165 Hybr.4x4 | 120 |            | 12.11 |       |                |        |   |   |                |     |
|                         | 2.0 HDi Hybrid4      | 147 |            | 11.11 |       |                |        |   |   |                |     |
|                         | 1.6 HDi 110          | 82  | ORGA 13342 | 11.11 |       | 11.9601-9717.2 | 220901 |   | <input type="checkbox"/> Naben D=82 <sup>1)</sup> | D=60, - Halter | ATE |
|                         | 1.6 HDi 115          | 84  | ORGA 13342 | 08.12 |       | 11.9601-9718.2 | 220902 |   | <input type="checkbox"/> Naben D=82 <sup>1)</sup> | D=60, - Halter | ATE |
|                         | 1.6 THP 155          | 115 |            | 11.11 |       | 11.0101-5704.2 | 260095 |   |   | Hülsensatz     | ATE |
|                         | 1.6 THP 200          | 147 |            | 11.11 |       | 11.8171-0008.1 | 990049 |   |   | Führungsbolzen | ATE |
|                         | 2.0 HDi 135          | 100 |            | 11.11 |       | 11.0441-6008.2 | 250038 |   |   | Dichtungssatz  | ATE |
|                         | 2.0 HDi 135 Hybrid4  | 100 |            | 12.11 |       | 11.8116-0356.1 | 390586 | 2 |   | Haltefeder     | ATE |
|                         | 2.0 HDi 165          | 120 |            | 11.11 |       |                |        |   |   |                |     |
|                         | 2.0 HDi 165 Hybr.4x4 | 120 |            | 12.11 |       |                |        |   |   |                |     |
|                         | 2.0 HDi Hybrid4      | 147 |            | 11.11 |       |                |        |   |   |                |     |
|                         | 1.6 HDi 110          | 82  | ORGA 13343 | 11.11 |       | 11.9601-9717.2 | 220901 |   | <input type="checkbox"/> Naben D=82 <sup>1)</sup> | D=60, - Halter | ATE |
|                         | 1.6 HDi 115          | 84  | ORGA 13343 | 08.12 |       | 11.9601-9718.2 | 220902 |   | <input type="checkbox"/> Naben D=82 <sup>1)</sup> | D=60, - Halter | ATE |
|                         | 1.6 THP 155          | 115 |            | 11.11 |       | 11.0101-5704.2 | 260095 |   |   | Hülsensatz     | ATE |
|                         | 1.6 THP 200          | 147 |            | 11.11 |       | 11.8171-0008.1 | 990049 |   |   | Führungsbolzen | ATE |
|                         | 2.0 HDi 135          | 100 |            | 11.11 |       | 11.0441-6008.2 | 250038 |   |   | Dichtungssatz  | ATE |
|                         | 2.0 HDi 135 Hybrid4  | 100 |            | 12.11 |       | 11.8116-0356.1 | 390586 | 2 |   | Haltefeder     | ATE |
|                         | 2.0 HDi 165          | 120 |            | 11.11 |       |                |        |   |   |                |     |
|                         | 2.0 HDi 165 Hybr.4x4 | 120 |            | 12.11 |       |                |        |   |   |                |     |
|                         | 2.0 HDi Hybrid4      | 147 |            | 11.11 |       |                |        |   |   |                |     |
|                         | 1.6 HDi 110          | 82  |            | 11.11 |       | 24.5246-0216.3 | 331022 | 2 | <input checked="" type="checkbox"/>               | L=216          |     |
|                         | 1.6 HDi 115          | 84  |            | 08.12 |       |                |        |   |   |                |     |
|                         | 1.6 THP 155          | 115 |            | 11.11 |       |                |        |   |   |                |     |
|                         | 2.0 HDi 135          | 100 |            | 11.11 |       |                |        |   |   |                |     |
|                         | 2.0 HDi 165          | 120 |            | 11.11 |       |                |        |   |   |                |     |
|                         | 1.6 THP 200          | 147 |            | 11.11 |       | 24.5246-0216.3 | 331022 | 2 | <input checked="" type="checkbox"/>               | L=216          |     |
| CITROEN EVASION (94-02) |                      |     |            |       |       |                |        |   |   |                |     |
|                         | 1.8                  | 73  | ORGA 08206 | 05.97 |       | 24.2122-1703.3 | 010422 |   | - ABS   | THz 22,20      |     |
|                         | 1.8                  | 76  | ORGA 08206 | 02.96 |       | 24.2122-1708.3 | 010437 |   | + ABS   | THz 22,20      |     |
|                         | 1.8                  | 73  | ORGA 08207 |       | 07.02 | 24.2122-1741.3 | 010695 |   | - ABS   | THz 22,20      |     |
|                         | 1.8                  | 76  | ORGA 08207 |       | 12.96 | 24.2122-1742.3 | 010696 |   | + ABS   | THz 22,20      |     |
|                         | 1.9 i                |     |            | 10.95 | 12.98 | 24.2123-1707.3 | 010492 |   | - ABS   | THz 23,81      |     |
|                         | 1.9 TD               |     | ORGA 08206 | 02.95 |       | 24.2123-1708.3 | 010493 |   | + ABS   | THz 23,81      |     |
|                         | 2.0 16V              |     | ORGA 08206 | 12.98 |       |                |        |   |   |                |     |
|                         | 2.0 i                |     | ORGA 08206 | 06.94 |       |                |        |   |   |                |     |
|                         | 2.0 Turbo            |     | ORGA 08206 | 06.94 |       |                |        |   |   |                |     |
|                         | 2.1 TD               |     | ORGA 08206 | 05.96 |       |                |        |   |   |                |     |
|                         | 1.9 TD               |     | ORGA 08207 |       | 07.02 | 24.2123-1738.3 | 010658 |   | - ABS   | THz 23,81      |     |
|                         | 2.0 16V              |     | ORGA 08207 |       | 07.02 | 24.2123-1733.3 | 010657 |   | + ABS   | THz 23,81      |     |
|                         | 2.0 HDi              |     |            | 08.99 | 07.02 |                |        |   |   |                |     |
|                         | 2.0 i                |     | ORGA 08207 |       | 07.02 |                |        |   |   |                |     |
|                         | 2.0 Turbo            |     | ORGA 08207 |       | 07.02 |                |        |   |   |                |     |
|                         | 2.1 TD               |     | ORGA 08207 |       | 07.02 |                |        |   |   |                |     |
|                         | 1.8                  | 73  |            | 05.97 | 07.02 | 24.3571-1711.5 | 240159 |   | <input type="checkbox"/>                          | D=57, - Halter | BDX |
|                         | 1.8                  | 76  |            | 02.96 | 12.96 | 24.3571-1712.5 | 240160 |   | <input type="checkbox"/>                          | D=57, - Halter | BDX |
|                         | 1.9 i                |     |            | 10.95 | 12.98 | 24.3571-1709.5 | 240153 |   | <input type="checkbox"/>                          | D=57, - Halter | LUC |
|                         | 1.9 TD               |     |            | 02.95 | 07.02 | 24.3571-1710.5 | 240154 |   | <input type="checkbox"/>                          | D=57, - Halter | LUC |
|                         | 2.0 16V              |     |            | 12.98 | 07.02 |                |        |   |   |                |     |
|                         | 2.0 HDi              |     |            | 08.99 | 07.02 |                |        |   |   |                |     |
|                         | 2.0 i                |     |            | 06.94 | 07.02 |                |        |   |   |                |     |
|                         | 2.0 Turbo            |     |            | 06.94 | 07.02 |                |        |   |   |                |     |
|                         | 2.1 TD               |     |            | 05.96 | 07.02 |                |        |   |   |                |     |
|                         | 1.8                  | 73  |            | 05.97 | 07.02 | 24.5118-0471.3 | 330528 | 2 |   | L=473          |     |
|                         | 1.8                  | 76  |            | 02.96 | 12.96 |                |        |   |   |                |     |
|                         | 1.9 i                |     |            | 10.95 | 12.98 |                |        |   |   |                |     |
|                         | 1.9 TD               |     |            | 02.95 | 07.02 |                |        |   |   |                |     |
|                         | 2.0 16V              |     |            | 12.98 | 07.02 |                |        |   |   |                |     |
|                         | 2.0 HDi              |     |            | 08.99 | 07.02 |                |        |   |   |                |     |
|                         | 2.0 i                |     |            | 06.94 | 07.02 |                |        |   |   |                |     |
|                         | 2.0 Turbo            |     |            | 06.94 | 07.02 |                |        |   |   |                |     |
|                         | 2.1 TD               |     |            | 05.96 | 07.02 |                |        |   |   |                |     |

<sup>1)</sup> hub diameter=82 / diametro mozzo=82 / diamètre du moyeu=82 / diámetro del buje=82

<sup>2)</sup> hub diameter=83 / diametro mozzo=83 / diamètre du moyeu=83 / diámetro del buje=83



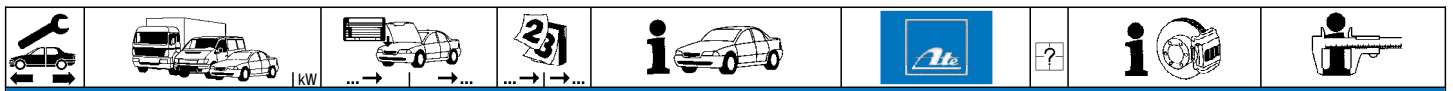

**CITROEN EVASION (94-02)**

|           |           |    |       |       |                               |                               |                |        |   |  |               |
|-----------|-----------|----|-------|-------|-------------------------------|-------------------------------|----------------|--------|---|--|---------------|
|           | 1.8       | 73 |       | 05.97 | 07.02                         | + ABS                         | 11.3361-9975.2 | 220281 | 2 | D=36, - Halter<br>ATE<br>D=36, - Halter<br>ATE<br>Dichtungssatz<br>ATE<br>Hülensatz<br>ATE<br>Haltefeder<br>ATE<br>Führungsbolzen<br>ATE<br>D=36, - Halter<br>ATE<br>D=36, - Halter<br>ATE |               |
|           | 1.8       | 76 |       | 02.96 | 12.96                         | + ABS                         | 11.3361-9976.2 | 220282 |   |  |               |
|           | 1.9 i     |    |       | 10.95 | 12.98                         | + ABS                         | 11.0441-3602.2 | 250008 |   |  |               |
|           | 1.9 TD    |    |       | 02.95 | 07.02                         | + ABS                         | 11.0101-5407.2 | 260011 |   |  |               |
|           | 2.0 16V   |    |       | 12.98 | 07.02                         |                               | 11.8116-0073.1 | 390498 |   |  |               |
|           | 2.0 HDi   |    |       | 08.99 | 07.02                         | + ABS                         | 11.8171-0008.1 | 990049 |   |  |               |
|           | 2.0 i     |    |       | 06.94 | 07.02                         | + ABS                         | 24.3361-9975.5 | 240541 |   |  |               |
| 2.0 Turbo |           |    | 06.94 | 07.02 |                               | 24.3361-9976.5                | 240542         |        |   |  |               |
| 2.1 TD    |           |    | 05.96 | 07.02 |                               |                               |                |        |   |  |               |
|           | 1.8       | 73 |       | 05.97 | 07.02                         |                               | 24.5229-0251.3 | 330535 | 2 | + HA-Trommelbremse <sup>1)</sup>   | L=250         |
|           | 1.8       | 76 |       | 02.96 | 12.96                         |                               |                |        |   |  |               |
|           | 1.9 i     |    |       | 10.95 | 12.98                         |                               |                |        |   |  |               |
|           | 1.9 TD    |    |       | 02.95 | 07.02                         |                               |                |        |   |  |               |
|           | 2.0 HDi   |    |       | 08.99 | 07.02                         |                               |                |        |   |  |               |
|           | 2.0 i     |    |       | 06.94 | 07.02                         |                               |                |        |   |  |               |
|           | 1.8       | 73 |       | 05.97 | 07.02                         |                               | 24.5229-0251.3 | 330535 | 2 | + HA-Scheibenbremse <sup>2)</sup>  | L=250         |
|           | 1.8       | 76 |       | 02.96 | 12.96                         |                               | 24.5111-0301.3 | 330499 | 2 | + HA-Scheibenbremse <sup>2)</sup>  | L=300         |
|           | 1.9 i     |    |       | 10.95 | 12.98                         |                               |                |        |   |  |               |
|           | 1.9 TD    |    |       | 02.95 | 07.02                         |                               |                |        |   |  |               |
|           | 2.0 16V   |    |       | 12.98 | 07.02                         |                               |                |        |   |  |               |
|           | 2.0 HDi   |    |       | 08.99 | 07.02                         |                               |                |        |   |  |               |
|           | 2.0 i     |    |       | 06.94 | 07.02                         |                               |                |        |   |  |               |
| 2.1 TD    |           |    | 05.96 | 07.02 |                               |                               |                |        |   |  |               |
|           | 1.8       | 73 |       | 05.97 | 07.02                         | - ABS                         | 24.3219-1704.3 | 020374 |   |  | Rz 19,05      |
|           | 1.8       | 76 |       | 02.96 | 12.96                         | - ABS                         |                |        |   |  |               |
|           | 1.9 i     |    |       | 10.95 | 12.98                         | - ABS                         |                |        |   |  |               |
|           | 1.9 TD    |    |       | 02.95 | 07.02                         | - ABS                         |                |        |   |  |               |
|           | 2.0 HDi   |    |       | 08.99 | 07.02                         | - ABS                         |                |        |   |  |               |
|           | 2.0 i     |    |       | 06.94 | 07.02                         | - ABS                         |                |        |   |  |               |
|           | 1.8       | 73 |       | 05.97 | 07.02                         |                               | 24.3727-0532.2 | 580532 |   | + HA-Trommelbremse <sup>1)</sup>   | L=1063        |
|           | 1.8       | 76 |       | 02.96 | 12.96                         |                               | 24.3727-0531.2 | 580531 |   | + HA-Trommelbremse <sup>1)</sup>   | L=2286        |
|           | 1.9 i     |    |       | 10.95 | 12.98                         |                               |                |        |   |  |               |
|           | 1.9 TD    |    |       | 02.95 | 07.02                         |                               |                |        |   |  |               |
|           | 2.0 HDi   |    |       | 08.99 | 07.02                         |                               |                |        |   |  |               |
|           | 2.0 i     |    |       | 06.94 | 07.02                         |                               |                |        |   |  |               |
|           | 2.1 TD    |    |       | 05.96 | 07.02                         |                               |                |        |   |  |               |
|           | 1.8       | 73 |       | 05.97 | 07.02                         |                               | 24.3727-0532.2 | 580532 |   | + HA-Trommelbremse <sup>1)</sup>   | L=1063        |
|           | 1.8       | 76 |       | 02.96 | 12.96                         |                               |                |        |   |  |               |
|           | 1.9 i     |    |       | 10.95 | 12.98                         |                               |                |        |   |  |               |
|           | 1.9 TD    |    |       | 02.95 | 07.02                         |                               |                |        |   |  |               |
|           | 2.0 HDi   |    |       | 08.99 | 07.02                         |                               |                |        |   |  |               |
|           | 2.0 i     |    |       | 06.94 | 07.02                         |                               |                |        |   |  |               |
|           | 2.1 TD    |    |       | 05.96 | 07.02                         |                               |                |        |   |  |               |
|           | 1.8       | 73 |       | 05.97 | 07.02                         |                               | 24.3727-0336.2 | 580336 | 1 | + HA-Scheibenbremse <sup>2)</sup>  | L=500         |
|           | 1.8       | 76 |       | 02.96 | 12.96                         |                               | 24.3727-0530.2 | 580530 |   | + HA-Scheibenbremse <sup>2)</sup>  | L=1255        |
|           | 1.9 i     |    |       | 10.95 | 12.98                         |                               | 24.3727-0529.2 | 580529 |   | + HA-Scheibenbremse <sup>2)</sup>  | L=2205        |
|           | 1.9 TD    |    |       | 02.95 | 07.02                         |                               |                |        |   |  |               |
|           | 2.0 16V   |    |       | 12.98 | 07.02                         |                               |                |        |   |  |               |
|           | 2.0 HDi   |    |       | 08.99 | 07.02                         |                               |                |        |   |  |               |
|           | 2.0 i     |    |       | 06.94 | 07.02                         |                               |                |        |   |  |               |
| 2.1 TD    |           |    | 05.96 | 07.02 |                               |                               |                |        |   |  |               |
|           | 1.8       | 73 |       | 05.97 | 07.02                         |                               | 24.6582-1715.3 | 320205 |   |  | BRL (4)       |
|           | 1.8       | 76 |       | 02.96 | 12.96                         |                               |                |        |   |  |               |
|           | 1.8       | 73 |       | 05.97 | 07.02                         |                               | 24.3728-0341.2 | 590341 |   |  | L=738, + AUT  |
|           | 1.8       | 76 |       | 02.96 | 12.96                         |                               |                |        |   |  |               |
|           | 2.0 i     |    |       | 06.94 | 07.02                         |                               |                |        |   |  |               |
|           | 2.0 i     |    |       | 05.00 | 07.02                         | + BE4-Getriebe <sup>3)</sup>  | 24.3728-0336.2 | 590336 |   |  | L=973, + AUT  |
|           | 1.9 TD    |    |       | 02.95 | 07.02                         | + ME5K-Getriebe <sup>4)</sup> | 24.3728-0342.2 | 590342 |   |  | L=863, + AUT  |
|           | 2.0 Turbo |    |       | 06.94 | 07.02                         | + ME5K-Getriebe <sup>4)</sup> |                |        |   |  |               |
|           | 1.9 TD    |    |       | 02.96 | 07.02                         | + ML5E-Getriebe <sup>5)</sup> | 24.3728-0340.2 | 590340 |   |  | L=1088, + AUT |
| 2.0 16V   |           |    | 12.98 | 07.02 |                               |                               |                |        |   |  |               |
| 2.0 Turbo |           |    | 09.95 | 07.02 | + ML5E-Getriebe <sup>5)</sup> |                               |                |        |   |  |               |
| 2.1 TD    |           |    | 05.96 | 07.02 |                               |                               |                |        |   |  |               |

**CITROEN JUMPER Bus (94-02)**

|  |                 |    |            |            |       |       |                |                |        |  |           |           |
|--|-----------------|----|------------|------------|-------|-------|----------------|----------------|--------|--|-----------|-----------|
|  | 1.9 D (10)      | 51 | S 15064995 | 01.99      |       | - ABS | 24.2122-1715.3 | 010481         |        |  | Thz 22,20 |           |
|  | 1.9 TD (10/14)  | 66 | S 15064995 | 08.94      |       | - ABS |                |                |        |  |           |           |
|  | 1.9 TD (10/14)  | 68 | S 15064995 | 02.94      |       | - ABS |                |                |        |  |           |           |
|  | 2.0 i (10)      | 80 | S 15064995 | 02.94      |       | - ABS |                |                |        |  |           |           |
|  | 2.5 D (14)      | 63 | S 15064995 | 08.94      |       | - ABS |                |                |        |  |           |           |
|  | 2.5 TD (14)     | 76 | S 15064995 | 08.94      |       | - ABS |                |                |        |  |           |           |
|  | 1.9 D (10)      | 51 | S 15064996 | S 16205754 |       |       | - ABS          | 24.2125-1703.3 | 010483 |  |           | Thz 25,40 |
|  | 1.9 TD (10/14)  | 66 | S 15064996 | S 16205754 |       |       | - ABS          |                |        |  |           |           |
|  | 1.9 TD (10/14)  | 68 | S 15064996 | S 16205754 |       |       | - ABS          |                |        |  |           |           |
|  | 2.0 i (10/14)   | 80 | S 15064996 | S 16205754 |       |       | - ABS          |                |        |  |           |           |
|  | 2.0 i (18)      | 80 |            | S 16205754 | 02.94 |       | - ABS          |                |        |  |           |           |
|  | 2.5 D (14)      | 63 | S 15064996 | S 16205754 |       |       | - ABS          |                |        |  |           |           |
|  | 2.5 D (18)      | 63 |            | S 16205754 | 08.94 |       | - ABS          |                |        |  |           |           |
|  | 2.5 TD (14)     | 76 | S 15064996 | S 16205754 |       |       | - ABS          |                |        |  |           |           |
|  | 2.5 TD (18)     | 76 |            | S 16205754 | 08.94 |       | - ABS          |                |        |  |           |           |
|  | 2.5 TDi (14/18) | 79 |            | S 16205754 | 12.96 |       | - ABS          |                |        |  |           |           |
|  | 2.8 HDi (14/18) | 94 |            | S 16205754 | 09.00 |       | - ABS          |                |        |  |           |           |
|  | 1.9 D (10)      | 51 | S 16205755 |            | 03.02 |       | - ABS          | 24.2125-1725.3 | 010717 |  |           | Thz 25,40 |
|  | 1.9 TD (10/14)  | 66 | S 16205755 |            | 03.02 |       | - ABS          |                |        |  |           |           |

1) + RA drum brake / + P freno a tamburo / + frein à tambour essieu AR / + ET-tambores de freno  
2) + RA disc brake / + P disco freno / + frein à disque essieu AR / + ET-disco de freno  
3) + BE4 transmission / + scatola cambio BE4 / + boîte de vitesse BE4 / + cambio BE4  
4) + ME5K transmission / + scatola cambio ME5K / + boîte de vitesse ME5K / + cambio ME5K  
5) + ML5E transmission / + scatola cambio ML5E / + boîte de vitesse ML5E / + cambio ML5E

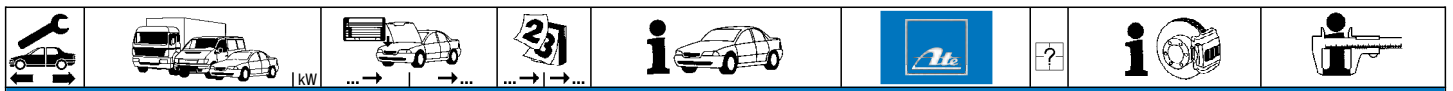

**CITROEN JUMPER Bus (94-02)**

|                  |                  |               |            |             |                |                |        |   |           |                                      |                |        |   |           |                                      |
|------------------|------------------|---------------|------------|-------------|----------------|----------------|--------|---|-----------|--------------------------------------|----------------|--------|---|-----------|--------------------------------------|
|                  | 1.9 TD (10/14)   | 68 S 16205755 |            |             | 03.02 - ABS    | 24.2125-1725.3 | 010717 |   |           | THz 25,40                            |                |        |   |           |                                      |
|                  | 2.0 i (10/14)    | 80 S 16205755 |            |             | 03.02 - ABS    |                |        |   |           |                                      |                |        |   |           |                                      |
|                  | 2.0 i (18)       | 80 S 16205353 |            |             | 03.02 - ABS    |                |        |   |           |                                      |                |        |   |           |                                      |
|                  | 2.5 D (14)       | 63 S 16205755 |            |             | 03.02 - ABS    |                |        |   |           |                                      |                |        |   |           |                                      |
|                  | 2.5 D (18)       | 63 S 16205353 |            |             | 03.02 - ABS    |                |        |   |           |                                      |                |        |   |           |                                      |
|                  | 2.5 TD (14)      | 76 S 16205755 |            |             | 03.02 - ABS    |                |        |   |           |                                      |                |        |   |           |                                      |
|                  | 2.5 TD (18)      | 76 S 16205353 |            |             | 03.02 - ABS    |                |        |   |           |                                      |                |        |   |           |                                      |
|                  | 2.5 TDi (14)     | 79 S 16205755 |            |             | 11.00 - ABS    |                |        |   |           |                                      |                |        |   |           |                                      |
|                  | 2.5 TDi (18)     | 79 S 16205353 |            |             | 11.00 - ABS    |                |        |   |           |                                      |                |        |   |           |                                      |
|                  | 2.8 HDi (14)     | 94 S 16205755 |            |             | 03.02 - ABS    |                |        |   |           |                                      |                |        |   |           |                                      |
|                  | 2.8 HDi (18)     | 94 S 16205353 |            |             | 03.02 - ABS    |                |        |   |           |                                      |                |        |   |           |                                      |
|                  | 1.9 D (10)       | 51            | S 15064995 | 01.99       | + ABS          |                |        |   |           |                                      | 24.2122-1714.3 | 010480 |   |           | THz 22,20                            |
|                  | 1.9 TD (10/14)   | 66            | S 15064995 | 08.94       | + ABS          |                |        |   |           |                                      |                |        |   |           |                                      |
|                  | 1.9 TD (10/14)   | 68            | S 15064995 | 02.94       | + ABS          |                |        |   |           |                                      |                |        |   |           |                                      |
|                  | 2.0 i (10/14)    | 80            | S 15064995 | 02.94       | + ABS          |                |        |   |           |                                      |                |        |   |           |                                      |
|                  | 2.5 D (14)       | 63            | S 15064995 | 08.94       | + ABS          |                |        |   |           |                                      |                |        |   |           |                                      |
|                  | 2.5 TD (14)      | 76            | S 15064995 | 08.94       | + ABS          |                |        |   |           |                                      |                |        |   |           |                                      |
| 1.9 D (10)       | 51               | S 15064996    | S 16206233 | + ABS       | 24.2125-1702.3 | 010482         |        |   | THz 25,40 |                                      |                |        |   |           |                                      |
| 1.9 TD (10/14)   | 66               | S 15064996    | S 16206233 | + ABS       |                |                |        |   |           |                                      |                |        |   |           |                                      |
| 1.9 TD (10/14)   | 68               | S 15064996    | S 16206233 | + ABS       |                |                |        |   |           |                                      |                |        |   |           |                                      |
| 2.0 i (10/14)    | 80               | S 15064996    | S 16206233 | + ABS       |                |                |        |   |           |                                      |                |        |   |           |                                      |
| 2.0 i (18)       | 80               | S 16194399    | 02.94      | + ABS       |                |                |        |   |           |                                      |                |        |   |           |                                      |
| 2.5 D (14)       | 63               | S 15064996    | S 16206233 | + ABS       |                |                |        |   |           |                                      |                |        |   |           |                                      |
| 2.5 D (18)       | 63               | S 16194399    | 08.94      | + ABS       |                |                |        |   |           |                                      |                |        |   |           |                                      |
| 2.5 TD (14)      | 76               | S 15064996    | S 16206233 | + ABS       |                |                |        |   |           |                                      |                |        |   |           |                                      |
| 2.5 TD (18)      | 76               | S 16194399    | 08.94      | + ABS       |                |                |        |   |           |                                      |                |        |   |           |                                      |
| 2.5 TDi (14)     | 79               | S 15064996    | S 16206233 | + ABS       |                |                |        |   |           |                                      |                |        |   |           |                                      |
| 2.5 TDi (18)     | 79               | S 16194399    | 12.96      | + ABS       |                |                |        |   |           |                                      |                |        |   |           |                                      |
| 2.8 HDi (14)     | 94               | S 16206233    | 09.00      | + ABS       |                |                |        |   |           |                                      |                |        |   |           |                                      |
| 2.8 HDi (18)     | 94               | S 16194399    | 09.00      | + ABS       |                |                |        |   |           |                                      |                |        |   |           |                                      |
| 1.9 D (10)       | 51               | S 16206234    |            | 03.02 + ABS |                |                |        |   |           | 24.2125-1726.3                       | 010718         |        |   | THz 25,40 |                                      |
| 1.9 TD (10/14)   | 66               | S 16206234    |            | 03.02 + ABS |                |                |        |   |           |                                      |                |        |   |           |                                      |
| 1.9 TD (10/14)   | 68               | S 16206234    |            | 03.02 + ABS |                |                |        |   |           |                                      |                |        |   |           |                                      |
| 2.0 i (10/14)    | 80               | S 16206234    |            | 03.02 + ABS |                |                |        |   |           |                                      |                |        |   |           |                                      |
| 2.0 i (18)       | 80               | S 16194400    |            | 03.02 + ABS |                |                |        |   |           |                                      |                |        |   |           |                                      |
| 2.5 D (14)       | 63               | S 16206234    |            | 03.02 + ABS |                |                |        |   |           |                                      |                |        |   |           |                                      |
| 2.5 D (18)       | 63               | S 16194400    |            | 03.02 + ABS |                |                |        |   |           |                                      |                |        |   |           |                                      |
| 2.5 TD (14)      | 76               | S 16206234    |            | 03.02 + ABS |                |                |        |   |           |                                      |                |        |   |           |                                      |
| 2.5 TD (18)      | 76               | S 16194400    |            | 03.02 + ABS |                |                |        |   |           |                                      |                |        |   |           |                                      |
| 2.5 TDi (14)     | 79               | S 16206234    |            | 11.00 + ABS |                |                |        |   |           |                                      |                |        |   |           |                                      |
| 2.5 TDi (18)     | 79               | S 16194400    |            | 11.00 + ABS |                |                |        |   |           |                                      |                |        |   |           |                                      |
| 2.8 HDi (14)     | 94               | S 16206234    |            | 03.02 + ABS |                |                |        |   |           |                                      |                |        |   |           |                                      |
| 2.8 HDi (18)     | 94               | S 16194400    |            | 03.02 + ABS |                |                |        |   |           |                                      |                |        |   |           |                                      |
|                  | 1.9 D (10)       | 51            |            | 01.99       | 10.01 + ABS    | 24.0101-4804.2 | 260050 |   |           |                                      |                |        |   |           | Einbausatz                           |
|                  | 1.9 TD (10/14)   | 66            |            | 08.94       | 10.01 + ABS    |                |        |   |           |                                      |                |        |   |           |                                      |
|                  | 1.9 TD (10/14)   | 68            |            | 02.94       | 10.01 + ABS    |                |        |   |           |                                      |                |        |   |           |                                      |
|                  | 2.0 i (10/14)    | 80            |            | 02.94       | 10.01 + ABS    |                |        |   |           |                                      |                |        |   |           |                                      |
|                  | 2.5 D (14)       | 63            |            | 08.94       | 10.01 + ABS    |                |        |   |           |                                      |                |        |   |           |                                      |
|                  | 1.9 D (10)       | 51            | S 15866409 | 01.99       |                | 24.5112-0466.3 | 330579 | 2 |           | L=462                                |                |        |   |           |                                      |
|                  | 1.9 TD (10/14)   | 66            | S 15866409 | 08.94       |                |                |        |   |           |                                      | 24.5112-0465.3 | 330526 | 2 |           | L=465, + Clip                        |
|                  | 1.9 TD (10/14)   | 68            | S 15866409 | 02.94       |                |                |        |   |           |                                      |                |        |   |           |                                      |
|                  | 2.0 i (10/14/18) | 80            | S 15866409 | 02.94       |                |                |        |   |           |                                      |                |        |   |           |                                      |
|                  | 2.5 D (14/18)    | 63            | S 15866409 | 08.94       |                |                |        |   |           |                                      |                |        |   |           |                                      |
|                  | 2.5 TD (14/18)   | 76            | S 15866409 | 08.94       |                |                |        |   |           |                                      |                |        |   |           |                                      |
|                  | 2.5 TDi (14/18)  | 79            | S 15866409 | 12.96       |                |                |        |   |           |                                      |                |        |   |           |                                      |
|                  | 1.9 D (10)       | 51            | S 15866410 |             | 10.01          | 24.5112-0466.3 | 330579 | 2 |           | L=462                                |                |        |   |           |                                      |
|                  | 1.9 TD (10/14)   | 66            | S 15866410 |             | 10.01          |                |        |   |           |                                      | 24.5112-0461.3 | 330616 | 2 |           | L=460, + Clip                        |
|                  | 1.9 TD (10/14)   | 68            | S 15866410 |             | 10.01          |                |        |   |           |                                      |                |        |   |           |                                      |
| 2.0 i (10/14/18) | 80               | S 15866410    |            | 10.01       |                |                |        |   |           |                                      |                |        |   |           |                                      |
| 2.5 D (14/18)    | 63               | S 15866410    |            | 10.01       |                |                |        |   |           |                                      |                |        |   |           |                                      |
| 2.5 TD (14/18)   | 76               | S 15866410    |            | 10.01       |                |                |        |   |           |                                      |                |        |   |           |                                      |
| 2.5 TDi (14/18)  | 79               | S 15866410    |            | 11.00       |                |                |        |   |           |                                      |                |        |   |           |                                      |
| 2.8 HDi (14/18)  | 94               |               | 09.00      | 10.01       |                |                |        |   |           |                                      |                |        |   |           |                                      |
| 1.9 D (10)       | 51               |               |            | 11.01       | 03.02          | 83.6401-0471.3 | 330750 | 2 |           | L=470                                |                |        |   |           |                                      |
| 1.9 TD (10/14)   | 66               |               |            | 11.01       | 03.02          |                |        |   |           |                                      | 83.6401-0469.3 | 330749 | 2 |           | L=468                                |
| 1.9 TD (10/14)   | 68               |               |            | 11.01       | 03.02          |                |        |   |           |                                      |                |        |   |           |                                      |
| 2.0 i (10/14/18) | 80               |               |            | 11.01       | 03.02          |                |        |   |           |                                      |                |        |   |           |                                      |
| 2.5 D (14/18)    | 63               |               |            | 11.01       | 03.02          |                |        |   |           |                                      |                |        |   |           |                                      |
| 2.5 TD (14/18)   | 76               |               |            | 11.01       | 03.02          |                |        |   |           |                                      |                |        |   |           |                                      |
| 2.8 HDi (14/18)  | 94               |               |            | 11.01       | 03.02          |                |        |   |           |                                      |                |        |   |           |                                      |
|                  | 1.9 D (10)       | 51            |            | 11.01       | 03.02          | 24.3461-1701.5 | 240449 |   |           | D=46, - Halter                       |                |        |   |           |                                      |
|                  | 1.9 TD (10/14)   | 66            |            | 11.01       | 03.02          |                |        |   |           |                                      | 24.3461-1702.5 | 240450 |   |           | D=46, - Halter                       |
|                  | 1.9 TD (10/14)   | 68            |            | 11.01       | 03.02          |                |        |   |           |                                      |                |        |   |           |                                      |
|                  | 2.0 i (10/14/18) | 80            |            |             | 11.01          | 03.02          |        |   |           |                                      |                |        |   |           |                                      |
|                  | 2.5 D (14/18)    | 63            |            |             | 11.01          | 03.02          |        |   |           |                                      |                |        |   |           |                                      |
|                  | 2.5 TD (14/18)   | 76            |            |             | 11.01          | 03.02          |        |   |           |                                      |                |        |   |           |                                      |
| 2.8 HDi (14/18)  | 94               |               |            | 11.01       | 03.02          |                |        |   |           |                                      |                |        |   |           |                                      |
|                  | 1.9 D (10)       | 51            |            | 01.99       | 10.01 - ABS    | 24.5112-0340.3 | 330511 | 1 |           | - verstärktes Fahrwerk <sup>1)</sup> |                |        |   |           |                                      |
|                  | 1.9 TD (10/14)   | 66            |            | 08.94       | 10.01 - ABS    |                |        |   |           |                                      | 24.5112-0361.3 | 330649 | 1 |           | + verstärktes Fahrwerk <sup>2)</sup> |
|                  | 1.9 TD (10/14)   | 68            |            | 02.94       | 10.01 - ABS    |                |        |   |           |                                      |                |        |   |           |                                      |
|                  | 2.0 i (10/14/18) | 80            |            | 02.94       | 10.01 - ABS    |                |        |   |           |                                      |                |        |   |           |                                      |
|                  | 2.5 D (14/18)    | 63            |            | 08.94       | 10.01 - ABS    |                |        |   |           |                                      |                |        |   |           |                                      |
|                  | 2.5 TD (14/18)   | 76            |            | 08.94       | 10.01 - ABS    |                |        |   |           |                                      |                |        |   |           |                                      |
|                  | 2.5 TDi (14/18)  | 79            |            | 12.96       | 11.00 - ABS    |                |        |   |           |                                      |                |        |   |           |                                      |
|                  | 2.8 HDi (14/18)  | 94            |            | 09.00       | 10.01 - ABS    |                |        |   |           |                                      |                |        |   |           |                                      |
|                  |                  |               |            |             |                |                |        |   |           |                                      |                |        |   |           |                                      |

<sup>1)</sup> - reinforced suspension / - sospensione rinforzata / - châssis renforcé / - suspensión reforzada

<sup>2)</sup> + reinforced suspension / + sospensione rinforzata / + châssis renforcé / + suspensión reforzada



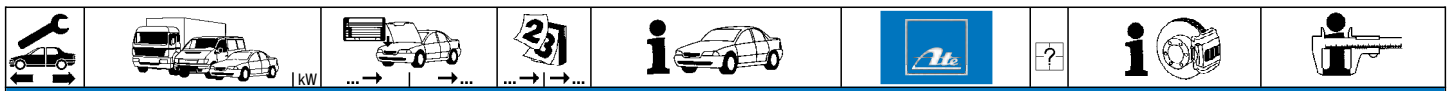

**CITROEN JUMPER Bus (94-02)**

|                      |                      |            |            |       |       |                |                |        |   |   |          |
|----------------------|----------------------|------------|------------|-------|-------|----------------|----------------|--------|---|---|----------|
|                      | 1.9 D (10)           | 51         |            | 11.01 | 03.02 | - ABS          | 24.5112-0361.3 | 330649 | 1   | + HA-Trommelbremse <sup>1)</sup>                              | L=360    |
|                      | 1.9 TD (10/14)       | 66         |            | 11.01 | 03.02 | - ABS          | 83.6401-0159.3 | 330746 | 2   | + HA-Scheibenbremse <sup>2)</sup>                             | L=160    |
|                      | 1.9 TD (10/14)       | 68         |            | 11.01 | 03.02 | - ABS          |                |        |   |   |          |
|                      | 2.0 i (10/14/18)     | 80         |            | 11.01 | 03.02 | - ABS          |                |        |   |   |          |
|                      | 2.5 D (14/18)        | 63         |            | 11.01 | 03.02 | - ABS          |                |        |   |   |          |
|                      | 2.5 TD (14/18)       | 76         |            | 11.01 | 03.02 | - ABS          |                |        |   |   |          |
|                      | 2.8 HDi (14/18)      | 94         |            | 11.01 | 03.02 | - ABS          |                |        |   |   |          |
|                      | 1.9 D (10)           | 51         |            | 01.99 | 10.01 | + ABS          | 24.5112-0315.3 | 330509 |   | <input type="checkbox"/> - verstärktes Fahrwerk <sup>3)</sup> | L=315    |
|                      | 1.9 TD (10/14)       | 66         |            | 08.94 | 10.01 | + ABS          | 24.5112-0363.3 | 330650 |   | <input type="checkbox"/> + verstärktes Fahrwerk <sup>4)</sup> | L=360    |
|                      | 1.9 TD (10/14)       | 68         |            | 02.94 | 10.01 | + ABS          |                |        |   |   |          |
| 2.0 i (10/14/18)     | 80                   |            | 02.94      | 10.01 | + ABS |                |                |        |   |   |          |
| 2.5 D (14/18)        | 63                   |            | 08.94      | 10.01 | + ABS |                |                |        |   |   |          |
| 2.5 TD (14/18)       | 76                   |            | 08.94      | 10.01 | + ABS |                |                |        |   |   |          |
| 2.5 TDi (14/18)      | 79                   |            | 12.96      | 11.00 | + ABS |                |                |        |   |   |          |
| 2.8 HDi (14/18)      | 94                   |            | 09.00      | 10.01 | + ABS |                |                |        |   |   |          |
| 1.9 D (10)           | 51                   |            | 11.01      | 03.02 | + ABS | 24.5112-0363.3 | 330650         |        | <input type="checkbox"/> + HA-Trommelbremse <sup>1)</sup> | L=360   |          |
| 1.9 TD (10/14)       | 66                   |            | 11.01      | 03.02 | + ABS | 83.6401-0159.3 | 330746         | 2      | + HA-Scheibenbremse <sup>2)</sup>                         | L=160   |          |
| 1.9 TD (10/14)       | 68                   |            | 11.01      | 03.02 | + ABS |                |                |        |   |   |          |
| 2.0 i (10/14/18)     | 80                   |            | 11.01      | 03.02 | + ABS |                |                |        |   |   |          |
| 2.5 D (14/18)        | 63                   |            | 11.01      | 03.02 | + ABS |                |                |        |   |   |          |
| 2.5 TD (14/18)       | 76                   |            | 11.01      | 03.02 | + ABS |                |                |        |   |   |          |
| 2.8 HDi (14/18)      | 94                   |            | 11.01      | 03.02 | + ABS |                |                |        |   |   |          |
|                      | 1.9 D (10)           | 51         |            | 01.99 | 10.01 |                | 24.3225-1701.3 | 020399 |   |   | Rz 25,40 |
|                      | 1.9 TD (10/14)       | 66         |            | 08.94 | 10.01 |                |                |        |   |   |          |
|                      | 1.9 TD (10/14)       | 68         |            | 02.94 | 10.01 |                |                |        |   |   |          |
|                      | 2.0 i (10/14)        | 80         |            | 02.94 | 10.01 |                |                |        |   |   |          |
|                      | 2.5 D (14)           | 63         |            | 08.94 | 10.01 |                |                |        |   |   |          |
|                      | 2.5 TD (14)          | 76         |            | 08.94 | 10.01 |                | 24.3226-1702.3 | 020469 |   |   | Rz 26,99 |
|                      | 2.5 TDi (14)         | 79         |            | 12.96 | 11.00 |                |                |        |   |   |          |
|                      | 2.8 HDi (14)         | 94         |            | 09.00 | 10.01 |                |                |        |   |   |          |
|                      | 1.9 D (10)           | 51         |            | 11.01 | 03.02 |                | 24.3226-1702.3 | 020469 |   |   | Rz 26,99 |
|                      | 1.9 TD (10/14)       | 66         |            | 11.01 | 03.02 |                |                |        |   |   |          |
| 1.9 TD (10/14)       | 68                   |            | 11.01      | 03.02 |       |                |                |        |   |   |          |
| 2.0 i (10/14)        | 80                   |            | 11.01      | 03.02 |       |                |                |        |   |   |          |
| 2.5 D (14)           | 63                   |            | 11.01      | 03.02 |       |                |                |        |   |   |          |
| 2.5 TD (14)          | 76                   |            | 11.01      | 03.02 |       |                |                |        |   |   |          |
| 2.8 HDi (14)         | 94                   |            | 11.01      | 03.02 |       |                |                |        |   |   |          |
| 2.0 i (18)           | 80                   |            | 02.94      | 10.01 |       | 24.3228-1701.3 | 020401         |        |   | Rz 28,57  |          |
| 2.5 D (18)           | 63                   |            | 08.94      | 10.01 |       |                |                |        |   |   |          |
| 2.5 TD (18)          | 76                   |            | 08.94      | 10.01 |       |                |                |        |   |   |          |
| 2.5 TDi (18)         | 79                   |            | 12.96      | 11.00 |       |                |                |        |   |   |          |
| 2.8 HDi (18)         | 94                   |            | 09.00      | 10.01 |       |                |                |        |   |   |          |
|                      | 1.9 D (10)           | 51         | S 16158427 | 01.99 |       |                | 24.3727-0345.2 | 580345 | 1   | ↓   | L=3045   |
|                      | 1.9 TD (10/14)       | 66         | S 16158427 | 08.94 |       |                |                |        |   |   |          |
|                      | 1.9 TD (10/14) 2WD   | 68         | S 16158427 | 02.94 |       |                |                |        |   |   |          |
|                      | 2.0 i (10/14/18) 2WD | 80         | S 16158427 | 02.94 |       |                |                |        |   |   |          |
|                      | 2.5 D (14/18) 2WD    | 63         | S 16158427 | 08.94 |       |                |                |        |   |   |          |
|                      | 2.5 TD (14/18) 2WD   | 76         | S 16158427 | 08.94 |       |                |                |        |   |   |          |
|                      | 2.5 TDi (14/18) 2WD  | 79         | S 16158427 | 12.96 |       |                |                |        |   |   |          |
|                      | 2.8 HDi (14/18) 2WD  | 94         | S 16158427 | 09.00 |       |                |                |        |   |   |          |
|                      | 1.9 D (10)           | 51         | S 16158428 |       | 03.02 |                | 24.3727-0350.2 | 580350 | 1   | ↓   | L=2827   |
|                      | 1.9 TD (10/14)       | 66         | S 16158428 |       | 03.02 |                |                |        |   |   |          |
| 1.9 TD (10/14) 2WD   | 68                   | S 16158428 |            | 03.02 |       |                |                |        |   |   |          |
| 2.0 i (10/14/18) 2WD | 80                   | S 16158428 |            | 03.02 |       |                |                |        |   |   |          |
| 2.5 D (14/18) 2WD    | 63                   | S 16158428 |            | 03.02 |       |                |                |        |   |   |          |
| 2.5 TD (14/18) 2WD   | 76                   | S 16158428 |            | 03.02 |       |                |                |        |   |   |          |
| 2.5 TDi (14/18) 2WD  | 79                   | S 16158428 |            | 11.00 |       |                |                |        |   |   |          |
| 2.8 HDi (14/18) 2WD  | 94                   | S 16158428 |            | 03.02 |       |                |                |        |   |   |          |
| 1.9 TD 4x4 (10/14)   | 68                   |            |            | 08.96 | 03.02 |                | 24.3727-0842.2 | 580842 | 1   | ↓   | L=4100   |
| 2.0 i 4x4 (10/14/18) | 80                   |            |            | 08.96 | 03.02 |                |                |        |   |   |          |
| 2.5 D 4x4 (14/18)    | 63                   |            |            | 08.96 | 03.02 |                |                |        |   |   |          |
| 2.5 TD 4x4 (14/18)   | 76                   |            |            | 08.96 | 03.02 |                |                |        |   |   |          |
| 2.5 TDi 4x4 (14/18)  | 79                   |            |            | 12.96 | 11.00 |                |                |        |   |   |          |
| 2.8 HDi 4x4 (14/18)  | 94                   |            |            | 09.00 | 03.02 |                |                |        |   |   |          |
|                      | 1.9 D (10)           | 51         | S 16206244 | 01.99 |       |                | 24.6512-1701.3 | 320153 |   | - ABS   | BRL (2)  |
|                      | 1.9 TD (10/14)       | 66         | S 16206244 | 08.94 |       |                |                |        |   |   |          |
|                      | 1.9 TD (10/14)       | 68         | S 16206244 | 02.94 |       |                |                |        |   |   |          |
|                      | 2.0 i (10/14/18)     | 80         | S 16206244 | 02.94 |       |                |                |        |   |   |          |
|                      | 2.5 D (14/18)        | 63         | S 16206244 | 08.94 |       |                |                |        |   |   |          |
|                      | 2.5 TD (14/18)       | 76         | S 16206244 | 08.94 |       |                |                |        |   |   |          |
|                      | 2.5 TDi (14/18)      | 79         |            | 12.96 | 11.00 |                |                |        |   |   |          |
|                      | 2.8 HDi (14/18)      | 94         | S 16206244 | 09.00 |       |                |                |        |   |   |          |
|                      | 1.9 D (10)           | 51         | S 15445357 | 01.99 |       |                | 24.6512-1703.3 | 320159 |   | + ABS   | BRL (4)  |
|                      | 1.9 TD (10/14)       | 66         | S 15445357 | 08.94 |       |                |                |        |   |   |          |
| 1.9 TD (10/14)       | 68                   | S 15445357 | 02.94      |       |       |                |                |        |   |   |          |
| 2.0 i (10/14/18)     | 80                   | S 15445357 | 02.94      |       |       |                |                |        |   |   |          |
| 2.5 D (14/18)        | 63                   | S 15445357 | 08.94      |       |       |                |                |        |   |   |          |
| 2.5 TD (14/18)       | 76                   | S 15445357 | 08.94      |       |       |                |                |        |   |   |          |
| 2.5 TDi (14/18)      | 79                   |            | 12.96      | 11.00 |       |                |                |        |   |   |          |
| 2.8 HDi (14/18)      | 94                   | S 15445357 | 09.00      |       |       |                |                |        |   |   |          |
| 1.9 D (10)           | 51                   | S 16205353 |            | 03.02 |       | 24.6512-1712.3 | 320273         |        | - ABS/ + verstärktes Fahrwerk <sup>5)</sup>               | BRL (2)   |          |
| 1.9 TD (10/14)       | 66                   | S 16205353 |            | 03.02 |       |                |                |        |   |   |          |
| 1.9 TD (10/14)       | 68                   | S 16205353 |            | 03.02 |       |                |                |        |   |   |          |
| 2.0 i (14)           | 80                   | S 16205353 |            | 03.02 |       |                |                |        |   |   |          |
| 2.5 D (14)           | 63                   | S 16205353 |            | 03.02 |       |                |                |        |   |   |          |

<sup>1)</sup> + RA drum brake / + P freno a tamburo / + frein à tambour essieu AR / + ET-tambores de freno  
<sup>2)</sup> + RA disc brake / + P disco freno / + frein à disque essieu AR / + ET-disco de freno  
<sup>3)</sup> - reinforced suspension / - sospensione rinforzata / - châssis renforcé / - suspensión reforzada  
<sup>4)</sup> + reinforced suspension / + sospensione rinforzata / + châssis renforcé / + suspensión reforzada  
<sup>5)</sup> - ABS/ + reinforced suspension / - ABS/ + sospensione rinforzata / - ABS/ + châssis renforcé / - ABS/ + suspensión reforzada





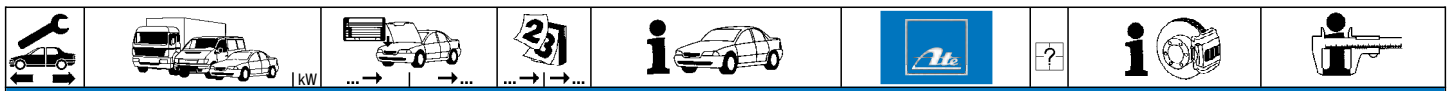

### CITROEN JUMPER Bus (94-02)

|                     |                      |               |  |              |              |                |        |   |         |
|---------------------|----------------------|---------------|--|--------------|--------------|----------------|--------|---|---------|
|                     | 2.5 TD (14)          | 76 S 16205353 |  |              | <b>03.02</b> | 24.6512-1712.3 | 320273 | - ABS/ + verstärktes Fahrwerk <sup>1)</sup> | BRL (2) |
|                     | 2.5 TDi (14)         | 79 S 16205353 |  |              | <b>03.01</b> |                |        |   |         |
|                     | 2.8 HDi (14)         | 94 S 16205353 |  |              | <b>03.02</b> |                |        |   |         |
|                     | 2.0 i (18)           | 80 S 16205353 |  |              | <b>03.02</b> | 24.6512-1709.3 | 320270 | - ABS/ + verstärktes Fahrwerk <sup>1)</sup> | BRL (2) |
|                     | 2.5 D (18)           | 63 S 16205353 |  |              | <b>03.02</b> |                |        |   |         |
|                     | 2.5 TD (18)          | 76 S 16205353 |  |              | <b>03.02</b> |                |        |   |         |
|                     | 2.5 TDi (18)         | 79 S 16205353 |  |              | <b>03.02</b> |                |        |   |         |
|                     | 2.8 HDi (18)         | 94 S 16205353 |  |              | <b>03.02</b> |                |        |   |         |
|                     |                      |               |  |              |              |                |        |   |         |
|                     | 1.9 D (10)           | 51            |  |              | <b>01.99</b> | 24.3728-0300.2 | 590300 |   | L=1478  |
|                     | 1.9 TD (10/14)       | 66            |  |              | <b>08.94</b> |                |        |   |         |
|                     | 1.9 TD (10/14) 2WD   | 68            |  |              | <b>02.94</b> |                |        |   |         |
|                     | 1.9 D (10)           | 51            |  |              | <b>01.99</b> | 24.3728-0518.2 | 590518 |   | L=1034  |
|                     | 2.0 i (10/14/18) 2WD | 80            |  |              | <b>02.94</b> |                |        |   |         |
|                     | 2.5 D (14/18) 2WD    | 63            |  |              | <b>08.94</b> |                |        |   |         |
|                     | 2.5 TD (14/18) 2WD   | 76            |  |              | <b>08.94</b> | 24.3728-0337.2 | 590337 |   | L=1058  |
|                     | 1.9 TD (10/14)       | 66            |  |              | <b>08.94</b> |                |        |   |         |
|                     | 1.9 TD (10/14) 2WD   | 68            |  |              | <b>02.94</b> |                |        |   |         |
|                     | 2.0 i (10/14/18) 2WD | 80            |  |              | <b>02.94</b> | 24.3728-0519.2 | 590519 |   | L=1090  |
|                     | 2.5 D (14/18) 2WD    | 63            |  |              | <b>08.94</b> |                |        |   |         |
|                     | 2.5 TD (14/18) 2WD   | 76            |  |              | <b>08.94</b> |                |        |   |         |
|                     | 2.8 HDi (14/18) 2WD  | 94            |  |              | <b>09.00</b> | 24.3728-0335.2 | 590335 |   | L=1435  |
|                     | 2.0 i (10/14/18) 2WD | 80            |  |              | <b>02.94</b> |                |        |   |         |
| 2.5 D (14/18) 2WD   | 63                   |               |  | <b>08.94</b> |              |                |        |   |         |
| 2.8 HDi (14/18) 2WD | 94                   |               |  | <b>09.00</b> |              |                |        |   |         |

### CITROEN JUMPER Kasten (94-02)

|                 |                    |            |            |              |              |                |        |       |           |  |                |        |           |           |
|-----------------|--------------------|------------|------------|--------------|--------------|----------------|--------|-------|-----------|--|----------------|--------|-----------|-----------|
|                 | 1.9 D (10)         | 50         | S 15064995 |              | <b>07.99</b> | 24.2122-1715.3 | 010481 | - ABS | Thz 22,20 |  |                |        |           |           |
|                 | 1.9 D (10)         | 51         | S 15064995 |              | <b>02.94</b> |                |        |       |           |  |                |        |           |           |
|                 | 1.9 TD (10/14)     | 66         | S 15064995 |              | <b>03.94</b> |                |        |       |           |  |                |        |           |           |
|                 | 1.9 TD (10/14)     | 68         | S 15064995 |              | <b>03.94</b> |                |        |       |           |  |                |        |           |           |
|                 | 2.0 i (10/14)      | 80         | S 15064995 |              | <b>03.94</b> |                |        |       |           |  |                |        |           |           |
|                 | 2.5 D (14)         | 63         | S 15064995 |              | <b>03.94</b> |                |        |       |           |  |                |        |           |           |
|                 | 2.5 TD (14)        | 76         | S 15064995 |              | <b>03.94</b> |                |        |       |           |  |                |        |           |           |
|                 | 1.9 D (10)         | 50         | S 15064996 | S 16205754   |              |                |        |       |           |  | 24.2125-1703.3 | 010483 | Thz 25,40 |           |
|                 | 1.9 D (10)         | 51         | S 15064996 | S 16205754   |              |                |        |       |           |  |                |        |           |           |
| 1.9 TD (10/14)  | 66                 | S 15064996 | S 16205754 |              |              |                |        |       |           |  |                |        |           |           |
| 1.9 TD (10/14)  | 68                 | S 15064996 | S 16205754 |              |              |                |        |       |           |  |                |        |           |           |
| 2.0 i (10/14)   | 80                 | S 15064996 | S 16205754 |              |              |                |        |       |           |  |                |        |           |           |
| 2.0 i (18)      | 80                 | S 15064996 | S 16205754 | <b>03.94</b> |              |                |        |       |           |  |                |        |           |           |
| 2.5 D (14)      | 63                 | S 15064996 | S 16205754 |              |              |                |        |       |           |  |                |        |           |           |
| 2.5 D (18)      | 63                 | S 15064996 | S 16205754 | <b>03.94</b> |              |                |        |       |           |  |                |        |           |           |
| 2.5 TD (14)     | 76                 | S 15064996 | S 16205754 |              |              |                |        |       |           |  |                |        |           |           |
| 2.5 TD (18)     | 76                 | S 15064996 | S 16205754 | <b>03.94</b> |              |                |        |       |           |  |                |        |           |           |
| 2.5 TDi (14/18) | 79                 | S 16205754 | S 16205754 |              | <b>12.96</b> |                |        |       |           |  |                |        |           |           |
| 2.8 HDi (14/18) | 94                 | S 16205754 | S 16205754 | <b>09.00</b> |              |                |        |       |           |  |                |        |           |           |
|                 | 1.9 D (10)         | 50         | S 16205755 |              |              | 24.2125-1725.3 | 010717 | - ABS | Thz 25,40 |  |                |        |           |           |
|                 | 1.9 D (10)         | 51         | S 16205755 |              |              |                |        |       |           |  |                |        |           |           |
|                 | 1.9 TD (10/14)     | 66         | S 16205755 |              |              |                |        |       |           |  |                |        |           |           |
|                 | 1.9 TD (10/14)     | 68         | S 16205755 |              |              |                |        |       |           |  |                |        |           |           |
|                 | 2.0 HDi (10/14/18) | 62         |            |              | <b>11.01</b> |                |        |       |           |  |                |        |           |           |
|                 | 2.0 i (10/14)      | 80         | S 16205755 |              |              |                |        |       |           |  |                |        |           |           |
|                 | 2.0 i (18)         | 80         | S 16205353 |              |              |                |        |       |           |  |                |        |           |           |
|                 | 2.5 D (14)         | 63         | S 16205755 |              |              |                |        |       |           |  |                |        |           |           |
|                 | 2.5 D (18)         | 63         | S 16205353 |              |              |                |        |       |           |  |                |        |           |           |
|                 | 2.5 TD (14)        | 76         | S 16205755 |              |              |                |        |       |           |  |                |        |           |           |
|                 | 2.5 TD (18)        | 76         | S 16205353 |              |              |                |        |       |           |  |                |        |           |           |
|                 | 2.5 TDi (14)       | 79         | S 16205755 |              |              |                |        |       |           |  |                |        |           |           |
|                 | 2.5 TDi (18)       | 79         | S 16205353 |              |              |                |        |       |           |  |                |        |           |           |
|                 | 2.8 HDi (14)       | 94         | S 16205755 |              |              |                |        |       |           |  |                |        |           |           |
| 2.8 HDi (18)    | 94                 | S 16205353 |            |              |              |                |        |       |           |  |                |        |           |           |
|                 | 1.9 D (10)         | 50         | S 15064995 |              | <b>07.99</b> | 24.2122-1714.3 | 010480 | + ABS | Thz 22,20 |  |                |        |           |           |
|                 | 1.9 D (10)         | 51         | S 15064995 |              | <b>02.94</b> |                |        |       |           |  |                |        |           |           |
|                 | 1.9 TD (10/14)     | 66         | S 15064995 |              | <b>03.94</b> |                |        |       |           |  |                |        |           |           |
|                 | 1.9 TD (10/14)     | 68         | S 15064995 |              | <b>03.94</b> |                |        |       |           |  |                |        |           |           |
|                 | 2.0 i (10/14)      | 80         | S 15064995 |              | <b>03.94</b> |                |        |       |           |  |                |        |           |           |
|                 | 2.5 D (14)         | 63         | S 15064995 |              | <b>03.94</b> |                |        |       |           |  |                |        |           |           |
|                 | 2.5 TD (14)        | 76         | S 15064995 |              | <b>03.94</b> |                |        |       |           |  |                |        |           |           |
|                 |                    | 1.9 D (10) | 50         | S 16206233   |              |                |        |       |           |  | 24.2125-1702.3 | 010482 | + ABS     | Thz 25,40 |
|                 |                    | 1.9 D (10) | 51         | S 16206233   |              |                |        |       |           |  |                |        |           |           |
| 1.9 TD (10/14)  |                    | 66         | S 16206233 |              |              |                |        |       |           |  |                |        |           |           |
| 1.9 TD (10/14)  |                    | 68         | S 16206233 |              |              |                |        |       |           |  |                |        |           |           |
| 2.0 i (10/14)   |                    | 80         | S 16206233 |              |              |                |        |       |           |  |                |        |           |           |
| 2.0 i (18)      |                    | 80         | S 16194399 |              | <b>03.94</b> |                |        |       |           |  |                |        |           |           |
| 2.5 D (14)      |                    | 63         | S 16206233 |              |              |                |        |       |           |  |                |        |           |           |
| 2.5 D (18)      |                    | 63         | S 16194399 |              | <b>03.94</b> |                |        |       |           |  |                |        |           |           |
| 2.5 TD (14)     |                    | 76         | S 16206233 |              |              |                |        |       |           |  |                |        |           |           |
| 2.5 TD (18)     |                    | 76         | S 16194399 |              | <b>03.94</b> |                |        |       |           |  |                |        |           |           |
| 2.5 TDi (14)    |                    | 79         | S 16206233 |              |              |                |        |       |           |  |                |        |           |           |
| 2.5 TDi (18)    |                    | 79         | S 16194399 |              | <b>12.96</b> |                |        |       |           |  |                |        |           |           |
| 2.8 HDi (14)    |                    | 94         | S 16206233 |              |              |                |        |       |           |  |                |        |           |           |
| 2.8 HDi (18)    |                    | 94         | S 16194399 |              | <b>09.00</b> |                |        |       |           |  |                |        |           |           |
|                 | 1.9 D (10)         | 50         | S 16206234 |              |              | 24.2125-1726.3 | 010718 | + ABS | Thz 25,40 |  |                |        |           |           |
|                 | 1.9 D (10)         | 51         | S 16206234 |              |              |                |        |       |           |  |                |        |           |           |
|                 | 1.9 TD (10/14)     | 66         | S 16206234 |              |              |                |        |       |           |  |                |        |           |           |
|                 | 1.9 TD (10/14)     | 68         | S 16206234 |              |              |                |        |       |           |  |                |        |           |           |
|                 | 2.0 HDi (10/14/18) | 62         |            |              | <b>11.01</b> |                |        |       |           |  |                |        |           |           |

1) - ABS/ + reinforced suspension / - ABS/ + sospensione rinforzata / - ABS/ + châssis renforcé / - ABS/ + suspensión reforzada

2) + ML5T transmission / + scatola cambio ML5T / + boîte de vitesse ML5T / + cambio ML5T

3) + ME5T transmission / + scatola cambio ME5T / + boîte de vitesse ME5T / + cambio ME5T

4) + MG5TU transmission / + scatola cambio MG5TU / + boîte de vitesse MG5TU / + cambio MG5TU





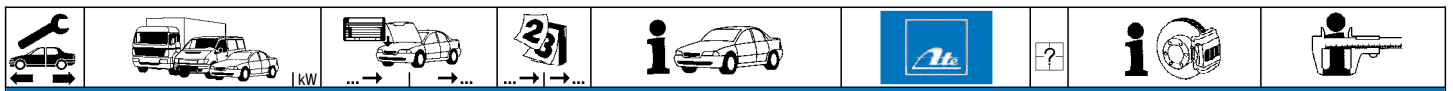

**CITROEN JUMPER Kasten (94-02)**

|  |  |  |  |  |   |                                  |                  |  |  |                                  |
|--|--|--|--|--|---|----------------------------------|------------------|--|--|----------------------------------|
|  | 2.0 i (10/14)<br>2.0 i (18)<br>2.5 D (14)<br>2.5 D (18)<br>2.5 TD (14)<br>2.5 TD (18)<br>2.5 TDi (14)<br>2.5 TDi (18)<br>2.8 HDi (14)<br>2.8 HDi (18)        | 80 S 16206234<br>80 S 16194400<br>63 S 16206234<br>63 S 16194400<br>76 S 16206234<br>76 S 16194400<br>79 S 16206234<br>79 S 16194400<br>94 S 16206234<br>94 S 16194400 |  |  | 03.02 + ABS<br>03.02 + ABS<br>03.02 + ABS<br>03.02 + ABS<br>03.02 + ABS<br>03.02 + ABS<br>11.00 + ABS<br>11.00 + ABS<br>03.02 + ABS<br>03.02 + ABS  | 24.2125-1726.3                   | 010718           |  |  | THz 25,40                        |
|  | 1.9 D (10)<br>1.9 D (10)<br>1.9 TD (10/14)<br>1.9 TD (10/14)<br>2.0 i (10/14)<br>2.5 D (14)  | 50<br>51<br>66<br>68<br>80<br>63   |  |  | 07.99 10.01 + ABS<br>02.94 10.01 + ABS<br>03.94 10.01 + ABS<br>03.94 10.01 + ABS<br>03.94 10.01 + ABS<br>03.94 10.01 + ABS  | 24.0101-4804.2                   | 260050           |  |  | Einbausatz <b>LUC</b>            |
|  | 1.9 D (10)<br>1.9 D (10)<br>1.9 TD (10/14)<br>1.9 TD (10/14)<br>2.0 i (10/14/18)<br>2.5 D (14/18)<br>2.5 TD (14/18)<br>2.5 TDi (14/18)                       | 50<br>51<br>66<br>68<br>80<br>63<br>76<br>79   | S 15866409<br>S 15866409<br>S 15866409<br>S 15866409<br>S 15866409<br>S 15866409<br>S 15866409<br>S 15866409 |  | 07.99<br>02.94<br>03.94<br>03.94<br>03.94<br>03.94<br>03.94<br>12.96  | 24.5112-0466.3<br>24.5112-0465.3 | 330579<br>330526 | 2<br>2   |  | L=462<br>L=465, + Clip           |
|  | 1.9 D (10)<br>1.9 D (10)<br>1.9 TD (10/14)<br>1.9 TD (10/14)<br>2.0 i (10/14/18)<br>2.5 D (14/18)<br>2.5 TD (14/18)<br>2.5 TDi (14/18)<br>2.8 HDi (14/18)    | 50<br>51<br>66<br>68<br>80<br>63<br>76<br>79<br>94   | S 15866410<br>S 15866410<br>S 15866410<br>S 15866410<br>S 15866410<br>S 15866410<br>S 15866410<br>S 15866410 |  | 10.01<br>10.01<br>10.01<br>10.01<br>10.01<br>10.01<br>10.01<br>11.00<br>09.00 10.01   | 24.5112-0466.3<br>24.5112-0461.3 | 330579<br>330616 | 2<br>2   |  | L=462<br>L=460, + Clip           |
|  | 1.9 D (10)<br>1.9 D (10)<br>1.9 TD (10/14)<br>1.9 TD (10/14)<br>2.0 HDi (10/14/18)<br>2.0 i (10/14/18)<br>2.5 D (14/18)<br>2.5 TD (14/18)<br>2.8 HDi (14/18) | 50<br>51<br>66<br>68<br>62<br>80<br>63<br>76<br>94   |  |  | 11.01 03.02<br>11.01 03.02<br>11.01 03.02<br>11.01 03.02<br>11.01 03.02<br>11.01 03.02<br>11.01 03.02<br>11.01 03.02<br>11.01 03.02   | 83.6401-0471.3<br>83.6401-0469.3 | 330750<br>330749 | 2<br>2   |  | L=470<br>L=468                   |
|  | 1.9 D (10)<br>1.9 D (10)<br>1.9 TD (10/14)<br>1.9 TD (10/14)<br>2.0 HDi (10/14/18)<br>2.0 i (10/14/18)<br>2.5 D (14/18)<br>2.5 TD (14/18)<br>2.8 HDi (14/18) | 50<br>51<br>66<br>68<br>62<br>80<br>63<br>76<br>94   |  |  | 11.01 03.02<br>11.01 03.02<br>11.01 03.02<br>11.01 03.02<br>11.01 03.02<br>11.01 03.02<br>11.01 03.02<br>11.01 03.02<br>11.01 03.02   | 24.3461-1701.5<br>24.3461-1702.5 | 240449<br>240450 | <input type="checkbox"/><br><input type="checkbox"/> |  | D=46, - Halter<br>D=46, - Halter |
|  | 1.9 D (10)<br>1.9 D (10)<br>1.9 TD (10/14)<br>1.9 TD (10/14)<br>2.0 i (10/14/18)<br>2.5 D (14/18)<br>2.5 TD (14/18)<br>2.5 TDi (14/18)<br>2.8 HDi (14/18)    | 50<br>51<br>66<br>68<br>80<br>63<br>76<br>79<br>94   |  |  | 07.99 10.01 - ABS<br>02.94 10.01 - ABS<br>03.94 10.01 - ABS<br>03.94 10.01 - ABS<br>03.94 10.01 - ABS<br>03.94 10.01 - ABS<br>03.94 10.01 - ABS<br>12.96 11.00 - ABS<br>09.00 10.01 - ABS | 24.5112-0340.3<br>24.5112-0361.3 | 330511<br>330649 | 1<br>1   | - verstärktes Fahrwerk <sup>1)</sup><br>+ verstärktes Fahrwerk <sup>2)</sup> | L=340<br>L=360                   |
|  | 1.9 D (10)<br>1.9 D (10)<br>1.9 TD (10/14)<br>1.9 TD (10/14)<br>2.0 HDi (10/14/18)<br>2.0 i (10/14/18)<br>2.5 D (14/18)<br>2.5 TD (14/18)<br>2.8 HDi (14/18) | 50<br>51<br>66<br>68<br>62<br>80<br>63<br>76<br>94   |  |  | 11.01 03.02 - ABS<br>11.01 03.02 - ABS<br>11.01 03.02 - ABS<br>11.01 03.02 - ABS<br>11.01 03.02 - ABS<br>11.01 03.02 - ABS<br>11.01 03.02 - ABS<br>11.01 03.02 - ABS<br>11.01 03.02 - ABS | 24.5112-0361.3<br>83.6401-0159.3 | 330649<br>330746 | 1<br>1   | + HA-Trommelbremse <sup>3)</sup><br>+ HA-Scheibenbremse <sup>4)</sup>        | L=360<br>L=160                   |
|  | 1.9 D (10)<br>1.9 D (10)<br>1.9 TD (10/14)<br>1.9 TD (10/14)<br>2.0 i (10/14/18)<br>2.5 D (14/18)<br>2.5 TD (14/18)<br>2.5 TDi (14/18)<br>2.8 HDi (14/18)    | 50<br>51<br>66<br>68<br>80<br>63<br>76<br>79<br>94   |  |  | 07.99 10.01 + ABS<br>02.94 10.01 + ABS<br>03.94 10.01 + ABS<br>03.94 10.01 + ABS<br>03.94 10.01 + ABS<br>03.94 10.01 + ABS<br>03.94 10.01 + ABS<br>12.96 11.00 + ABS<br>09.00 10.01 + ABS | 24.5112-0315.3<br>24.5112-0363.3 | 330509<br>330650 | <input type="checkbox"/><br><input type="checkbox"/> | - verstärktes Fahrwerk <sup>1)</sup><br>+ verstärktes Fahrwerk <sup>2)</sup> | L=315<br>L=360                   |
|  | 1.9 D (10)<br>1.9 D (10)<br>1.9 TD (10/14)<br>1.9 TD (10/14)<br>2.0 HDi (10/14/18)<br>2.0 i (10/14/18)<br>2.5 D (14/18)<br>2.5 TD (14/18)                    | 50<br>51<br>66<br>68<br>62<br>80<br>63<br>76   |  |  | 11.01 03.02 + ABS<br>11.01 03.02 + ABS<br>11.01 03.02 + ABS<br>11.01 03.02 + ABS<br>11.01 03.02 + ABS<br>11.01 03.02 + ABS<br>11.01 03.02 + ABS<br>11.01 03.02 + ABS                      | 24.5112-0363.3<br>83.6401-0159.3 | 330650<br>330746 | 2  | + HA-Trommelbremse <sup>3)</sup><br>+ HA-Scheibenbremse <sup>4)</sup>        | L=360<br>L=160                   |

1) - reinforced suspension / - sospensione rinforzata / - châssis renforcé / - suspensión reforzada  
 2) + reinforced suspension / + sospensione rinforzata / + châssis renforcé / + suspensión reforzada  
 3) + RA drum brake / + P freno a tamburo / + frein à tambour essieu AR / + ET-tambores de freno  
 4) + RA disc brake / + P disco freno / + frein à disque essieu AR / + ET-disco de freno

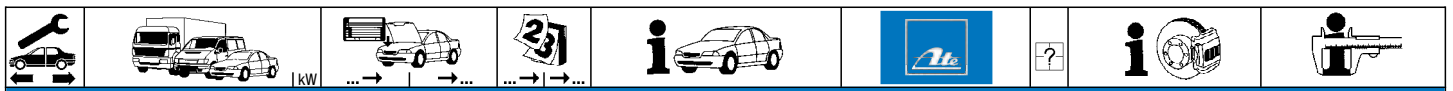

**CITROEN JUMPER Kasten (94-02)**

|  |                     |    |             |       |       |       |                                  |                  |   |   |                |
|--|---------------------|----|-------------|-------|-------|-------|----------------------------------|------------------|---|---|----------------|
|  | 2.8 HDi (14/18)     | 94 |             | 11.01 | 03.02 | + ABS | 24.5112-0363.3<br>83.6401-0159.3 | 330650<br>330746 | 2 | + HA-Trommelbremse <sup>1)</sup><br>+ HA-Scheibenbremse <sup>2)</sup> | L=360<br>L=160 |
|  | 1.9 D (10)          | 50 |             | 07.99 | 10.01 |       | 24.3225-1701.3                   | 020399           |   |   | Rz 25,40       |
|  | 1.9 D (10)          | 51 |             | 02.94 | 10.01 |       |                                  |                  |   |   |                |
|  | 1.9 TD (10/14)      | 66 |             | 03.94 | 10.01 |       |                                  |                  |   |   |                |
|  | 1.9 TD (10/14)      | 68 |             | 03.94 | 10.01 |       |                                  |                  |   |   |                |
|  | 2.0 i (10/14)       | 80 |             | 03.94 | 10.01 |       |                                  |                  |   |   |                |
|  | 2.5 D (14)          | 63 |             | 03.94 | 10.01 |       |                                  |                  |   |   |                |
|  | 2.5 TD (14)         | 76 |             | 03.94 | 10.01 |       | 24.3226-1702.3                   | 020469           |   |   | Rz 26,99       |
|  | 2.5 TDi (14)        | 79 |             | 12.96 | 11.00 |       |                                  |                  |   |   |                |
|  | 2.8 HDi (14)        | 94 |             | 09.00 | 10.01 |       |                                  |                  |   |   |                |
|  | 1.9 D (10)          | 50 |             | 11.01 | 03.02 |       | 24.3226-1702.3                   | 020469           |   |   | Rz 26,99       |
|  | 1.9 D (10)          | 51 |             | 11.01 | 03.02 |       |                                  |                  |   |   |                |
|  | 1.9 TD (10/14)      | 66 |             | 11.01 | 03.02 |       |                                  |                  |   |   |                |
|  | 1.9 TD (10/14)      | 68 |             | 11.01 | 03.02 |       |                                  |                  |   |   |                |
|  | 2.0 HDi (10/14)     | 62 |             | 11.01 | 03.02 |       |                                  |                  |   |   |                |
|  | 2.0 i (10/14)       | 80 |             | 11.01 | 03.02 |       |                                  |                  |   |   |                |
|  | 2.5 D (14)          | 63 |             | 11.01 | 03.02 |       |                                  |                  |   |   |                |
|  | 2.5 TD (14)         | 76 |             | 11.01 | 03.02 |       |                                  |                  |   |   |                |
|  | 2.8 HDi (14)        | 94 |             | 11.01 | 03.02 |       |                                  |                  |   |   |                |
|  | 2.0 i (18)          | 80 |             | 03.94 | 10.01 |       | 24.3228-1701.3                   | 020401           |   |   | Rz 28,57       |
|  | 2.5 D (18)          | 63 |             | 03.94 | 10.01 |       |                                  |                  |   |   |                |
|  | 2.5 TD (18)         | 76 |             | 03.94 | 10.01 |       |                                  |                  |   |   |                |
|  | 2.5 TDi (18)        | 79 |             | 12.96 | 11.00 |       |                                  |                  |   |   |                |
|  | 2.8 HDi (18)        | 94 |             | 09.00 | 10.01 |       |                                  |                  |   |   |                |
|  | 1.9 D (10)          | 50 | S 16158427  | 07.99 |       |       | 24.3727-0340.2                   | 580340           | 1 |   | L=3025         |
|  | 1.9 D (10)          | 51 | S 16158427  | 02.94 |       |       |                                  |                  |   |   |                |
|  | 1.9 TD (10/14)      | 66 | S 16158427  | 03.94 |       |       |                                  |                  |   |   |                |
|  | 1.9 TD (10/14)      | 68 | S 16158427  | 03.94 |       |       |                                  |                  |   |   |                |
|  | 2.0 i (10/14/18)    | 80 | S 16158427  | 03.94 |       |       |                                  |                  |   |   |                |
|  | 2.5 D (14/18)       | 63 | S 16158427  | 03.94 |       |       |                                  |                  |   |   |                |
|  | 2.5 TD (14/18)      | 76 | S 16158427  | 03.94 |       |       |                                  |                  |   |   |                |
|  | 2.5 TDi (14/18)     | 79 | S 16158427  | 12.96 |       |       |                                  |                  |   |   |                |
|  | 2.8 HDi (14/18)     | 94 | S 16158427  | 09.00 |       |       |                                  |                  |   |   |                |
|  | 1.9 D (10)          | 50 | S 16194399  |       |       |       | 24.3727-0344.2                   | 580344           | 1 |   | L=2806         |
|  | 1.9 D (10)          | 51 | S 16194399  |       |       |       |                                  |                  |   |   |                |
|  | 1.9 TD (10/14)      | 66 | S 16194399  |       |       |       |                                  |                  |   |   |                |
|  | 1.9 TD (10/14)      | 68 | S 16194399  |       |       |       |                                  |                  |   |   |                |
|  | 2.0 i (10/14/18)    | 80 | S 16194399  |       |       |       |                                  |                  |   |   |                |
|  | 2.5 D (14/18)       | 63 | S 16194399  |       |       |       |                                  |                  |   |   |                |
|  | 2.5 TD (14/18)      | 76 | S 16194399  |       |       |       |                                  |                  |   |   |                |
|  | 2.5 TDi (14/18)     | 79 | S 16194399  |       |       |       |                                  |                  |   |   |                |
|  | 2.8 HDi (14/18)     | 94 | S 16194399  |       |       |       |                                  |                  |   |   |                |
|  | 1.9 D (10)          | 50 | S 16194400  |       | 03.02 |       | 24.3727-0343.2                   | 580343           | 1 | + HA-Trommelbremse <sup>1)</sup>                                      | L=2827         |
|  | 1.9 D (10)          | 51 | S 16194400  |       | 03.02 |       | 24.3727-0348.2                   | 580348           | 1 | + HA-Scheibenbremse <sup>2)</sup>                                     | L=2715         |
|  | 1.9 TD (10/14)      | 66 | S 16194400  |       | 03.02 |       |                                  |                  |   |   |                |
|  | 1.9 TD (10/14)      | 68 | S 16194400  |       | 03.02 |       |                                  |                  |   |   |                |
|  | 2.0 HDi (10/14/18)  | 62 |             | 11.01 | 03.02 |       |                                  |                  |   |   |                |
|  | 2.0 i (10/14/18)    | 80 | S 16194400  |       | 03.02 |       |                                  |                  |   |   |                |
|  | 2.5 D (14/18)       | 63 | S 16194400  |       | 03.02 |       |                                  |                  |   |   |                |
|  | 2.5 TD (14/18)      | 76 | S 16194400  |       | 03.02 |       |                                  |                  |   |   |                |
|  | 2.5 TDi (14/18)     | 79 | S 16194400  |       | 11.00 |       |                                  |                  |   |   |                |
|  | 2.8 HDi (14/18)     | 94 | S 16194400  |       | 03.02 |       |                                  |                  |   |   |                |
|  | 2.5 D 4x4 (14/18)   | 63 |             | 03.00 | 03.02 |       | 24.3727-0842.2                   | 580842           | 1 |   | L=4100         |
|  | 2.5 TDi 4x4 (14/18) | 79 |             | 03.00 | 11.00 |       |                                  |                  |   |   |                |
|  | 2.8 HDi 4x4 (14/18) | 94 |             | 09.00 | 03.02 |       |                                  |                  |   |   |                |
|  | 1.9 D (10)          | 50 | S 16206244  | 07.99 |       |       | 24.6512-1701.3                   | 320153           |   | - ABS   | BRL (2)        |
|  | 1.9 D (10)          | 51 | S 16206244  | 02.94 |       |       |                                  |                  |   |   |                |
|  | 1.9 TD (10/14)      | 66 | S 16206244  | 03.94 |       |       |                                  |                  |   |   |                |
|  | 1.9 TD (10/14)      | 68 | S 16206244  | 03.94 |       |       |                                  |                  |   |   |                |
|  | 2.0 i (10/14/18)    | 80 | S 16206244  | 03.94 |       |       |                                  |                  |   |   |                |
|  | 2.5 D (14/18)       | 63 | S 16206244  | 03.94 |       |       |                                  |                  |   |   |                |
|  | 2.5 TD (14/18)      | 76 | S 16206244  | 03.94 |       |       |                                  |                  |   |   |                |
|  | 2.5 TDi (14/18)     | 79 | S 16206244  | 12.96 |       |       |                                  |                  |   |   |                |
|  | 2.8 HDi (14/18)     | 94 | S 16206244  | 09.00 |       |       |                                  |                  |   |   |                |
|  | 1.9 D (10)          | 50 | S 15445357  | 07.99 |       |       | 24.6512-1703.3                   | 320159           |   | + ABS   | BRL (4)        |
|  | 1.9 D (10)          | 51 | S 15445357  | 02.94 |       |       |                                  |                  |   |   |                |
|  | 1.9 TD (10/14)      | 66 | S 15445357  | 03.94 |       |       |                                  |                  |   |   |                |
|  | 1.9 TD (10/14)      | 68 | S 15445357  | 03.94 |       |       |                                  |                  |   |   |                |
|  | 2.0 i (10/14/18)    | 80 | S 15445357  | 03.94 |       |       |                                  |                  |   |   |                |
|  | 2.5 D (14/18)       | 63 | S 15445357  | 03.94 |       |       |                                  |                  |   |   |                |
|  | 2.5 TD (14/18)      | 76 | S 15445357  | 03.94 |       |       |                                  |                  |   |   |                |
|  | 2.5 TDi (14/18)     | 79 | S 15445357  | 12.96 |       |       |                                  |                  |   |   |                |
|  | 2.8 HDi (14/18)     | 94 | S 15445357  | 09.00 |       |       |                                  |                  |   |   |                |
|  | 1.9 D (10)          | 50 | S 162053353 |       | 03.02 |       | 24.6512-1712.3                   | 320273           |   | - ABS/ + verstärktes Fahrwerk <sup>3)</sup>                           | BRL (2)        |
|  | 1.9 D (10)          | 51 | S 162053353 |       | 03.02 |       |                                  |                  |   |   |                |
|  | 1.9 TD (10/14)      | 66 | S 162053353 |       | 03.02 |       |                                  |                  |   |   |                |
|  | 1.9 TD (10/14)      | 68 | S 162053353 |       | 03.02 |       |                                  |                  |   |   |                |
|  | 2.0 HDi (10/14)     | 62 |             | 11.01 | 03.02 |       |                                  |                  |   |   |                |
|  | 2.0 i (10/14)       | 80 | S 162053353 |       | 03.02 |       |                                  |                  |   |   |                |
|  | 2.5 D (14)          | 63 | S 162053353 |       | 03.02 |       |                                  |                  |   |   |                |
|  | 2.5 TD (14)         | 76 | S 162053353 |       | 03.02 |       |                                  |                  |   |   |                |
|  | 2.5 TDi (14)        | 79 | S 162053353 |       | 11.00 |       |                                  |                  |   |   |                |
|  | 2.8 HDi (14)        | 94 | S 162053353 |       | 03.02 |       |                                  |                  |   |   |                |

<sup>1)</sup> + RA drum brake / + P freno a tamburo / + frein à tambour essieu AR / + ET-tambores de freno  
<sup>2)</sup> + RA disc brake / + P disco freno / + frein à disque essieu AR / + ET-disco de freno  
<sup>3)</sup> - ABS/ + reinforced suspension / - ABS/ + sospensione rinforzata / - ABS/ + châssis renforcé / - ABS/ + suspensión reforzada



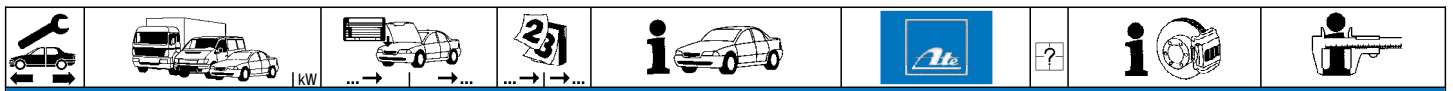

### CITROEN JUMPER Kasten (94-02)

|                 |                  |                |       |       |                               |                                |                |        |   |         |
|-----------------|------------------|----------------|-------|-------|-------------------------------|--------------------------------|----------------|--------|---|---------|
|                 | 2.0 HDi (18)     | 62             |       | 11.01 | 03.02                         |                                | 24.6512-1709.3 | 320270 | - ABS/ + verstärktes Fahrwerk <sup>1)</sup> | BRL (2) |
|                 | 2.0 i (18)       | 80 S 162053353 |       |       | 02.94                         | 03.02                          |                |        |   |         |
|                 | 2.5 D (18)       | 63 S 162053353 |       |       |                               | 03.02                          |                |        |   |         |
|                 | 2.5 TD (18)      | 76 S 162053353 |       |       |                               | 03.02                          |                |        |   |         |
|                 | 2.5 TDi (18)     | 79 S 162053353 |       |       |                               | 11.00                          |                |        |   |         |
|                 | 2.8 HDi (18)     | 94 S 162053353 |       |       |                               | 03.02                          |                |        |   |         |
|                 | 1.9 D (10)       | 50             |       | 07.99 | 03.02                         | + ML5T-Getriebe <sup>2)</sup>  | 24.3728-0300.2 | 590300 |   | L=1478  |
|                 | 1.9 D (10)       | 51             |       | 02.94 | 03.02                         | + ML5T-Getriebe <sup>2)</sup>  |                |        |   |         |
|                 | 1.9 TD (10/14)   | 66             |       | 03.94 | 03.02                         | + ML5T-Getriebe <sup>2)</sup>  |                |        |   |         |
|                 | 1.9 TD (10/14)   | 68             |       | 03.94 | 03.02                         | + ML5T-Getriebe <sup>2)</sup>  |                |        |   |         |
|                 | 1.9 D (10)       | 50             |       | 07.99 | 03.02                         | + ME5T-Getriebe <sup>3)</sup>  | 24.3728-0518.2 | 590518 |   | L=1034  |
|                 | 1.9 D (10)       | 51             |       | 02.94 | 03.02                         | + ME5T-Getriebe <sup>3)</sup>  |                |        |   |         |
|                 | 2.0 i (10/14/18) | 80             |       | 03.94 | 03.02                         | + ME5T-Getriebe <sup>3)</sup>  |                |        |   |         |
|                 | 2.5 D (14/18)    | 63             |       | 03.94 | 03.02                         | + ME5T-Getriebe <sup>3)</sup>  |                |        |   |         |
|                 | 2.5 TD (14/18)   | 76             |       | 03.94 | 03.02                         | + ME5T-Getriebe <sup>3)</sup>  |                |        |   |         |
|                 | 1.9 TD (10/14)   | 66             |       | 03.94 | 03.02                         | + ME5T-Getriebe <sup>3)</sup>  | 24.3728-0337.2 | 590337 |   | L=1058  |
| 1.9 TD (10/14)  | 68               |                | 03.94 | 03.94 | + ME5T-Getriebe <sup>3)</sup> |                                |                |        |   |         |
|                 | 2.0 i (10/14/18) | 80             |       | 03.94 | 03.02                         | + MG5TU-Getriebe <sup>4)</sup> | 24.3728-0519.2 | 590519 |   | L=1090  |
|                 | 2.5 D (14/18)    | 63             |       | 03.94 | 03.02                         | + MG5TU-Getriebe <sup>4)</sup> |                |        |   |         |
|                 | 2.5 TD (14/18)   | 76             |       | 03.94 | 03.02                         | + MG5TU-Getriebe <sup>4)</sup> |                |        |   |         |
|                 | 2.8 HDi (14/18)  | 94             |       | 09.00 | 03.02                         | + MG5TU-Getriebe <sup>4)</sup> |                |        |   |         |
|                 | 2.0 i (10/14/18) | 80             |       | 03.94 | 03.02                         | + ML5T-Getriebe <sup>2)</sup>  | 24.3728-0335.2 | 590335 |   | L=1435  |
|                 | 2.5 D (14/18)    | 63             |       | 03.94 | 03.02                         | + ML5T-Getriebe <sup>2)</sup>  |                |        |   |         |
| 2.8 HDi (14/18) | 94               |                | 09.00 | 03.02 | + ML5T-Getriebe <sup>2)</sup> |                                |                |        |   |         |

### CITROEN JUMPER Pritsche/Fahrgestell (94-02)

|              |                 |            |            |       |       |       |                |        |  |           |
|--------------|-----------------|------------|------------|-------|-------|-------|----------------|--------|--|-----------|
|              | 1.9 TD (10/14)  | 66         | S 15064995 | 03.94 |       | - ABS | 24.2122-1715.3 | 010481 |  | Thz 22,20 |
|              | 1.9 TD (10/14)  | 68         | S 15064995 | 03.94 |       | - ABS |                |        |  |           |
|              | 2.0 i (10/14)   | 80         | S 15064995 | 03.94 |       | - ABS |                |        |  |           |
|              | 2.5 D (14)      | 63         | S 15064995 | 03.94 |       | - ABS |                |        |  |           |
|              | 2.5 TD (14)     | 76         | S 15064995 | 03.94 |       | - ABS |                |        |  |           |
|              | 1.9 TD (10/14)  | 66         | S 15064996 |       |       | - ABS | 24.2125-1703.3 | 010483 |  | Thz 25,40 |
|              | 1.9 TD (10/14)  | 68         | S 15064996 |       |       | - ABS |                |        |  |           |
|              | 2.0 i (10/14)   | 80         | S 15064996 |       |       | - ABS |                |        |  |           |
|              | 2.0 i (18)      | 80         | S 16205754 | 03.94 |       | - ABS |                |        |  |           |
|              | 2.5 D (14)      | 63         | S 15064996 |       |       | - ABS |                |        |  |           |
|              | 2.5 D (18)      | 63         | S 16205754 | 03.94 |       | - ABS |                |        |  |           |
|              | 2.5 TD (14)     | 76         | S 15064996 |       |       | - ABS |                |        |  |           |
|              | 2.5 TD (18)     | 76         | S 16205754 | 03.94 |       | - ABS |                |        |  |           |
|              | 2.5 TDi (14/18) | 79         | S 16205754 | 12.96 |       | - ABS |                |        |  |           |
|              | 2.8 HDi (14/18) | 94         | S 16205754 | 09.00 |       | - ABS |                |        |  |           |
|              | 1.9 TD (10/14)  | 66         | S 16205755 |       |       | - ABS | 24.2125-1725.3 | 010717 |  | Thz 25,40 |
|              | 1.9 TD (10/14)  | 68         | S 16205755 |       |       | - ABS |                |        |  |           |
|              | 2.0 i (10/14)   | 80         | S 16205755 |       |       | - ABS |                |        |  |           |
|              | 2.0 i (18)      | 80         | S 16205353 |       |       | - ABS |                |        |  |           |
|              | 2.5 D (14)      | 63         | S 16205755 |       |       | - ABS |                |        |  |           |
|              | 2.5 D (18)      | 63         | S 16205353 |       |       | - ABS |                |        |  |           |
|              | 2.5 TD (14)     | 76         | S 16205755 |       |       | - ABS |                |        |  |           |
|              | 2.5 TD (18)     | 76         | S 16205353 |       |       | - ABS |                |        |  |           |
|              | 2.5 TDi (14)    | 79         | S 16205755 |       |       | - ABS |                |        |  |           |
|              | 2.5 TDi (18)    | 79         | S 16205353 |       |       | - ABS |                |        |  |           |
|              | 2.8 HDi (14)    | 94         | S 16205755 |       |       | - ABS |                |        |  |           |
|              | 2.8 HDi (18)    | 94         | S 16205353 |       |       | - ABS |                |        |  |           |
|              | 1.9 TD (10/14)  | 66         | S 15064995 | 03.94 |       | + ABS | 24.2122-1714.3 | 010480 |  | Thz 22,20 |
|              | 1.9 TD (10/14)  | 68         | S 15064995 | 03.94 |       | + ABS |                |        |  |           |
|              | 2.0 i (10/14)   | 80         | S 15064995 | 03.94 |       | + ABS |                |        |  |           |
| 2.5 D (14)   | 63              | S 15064995 | 03.94      |       | + ABS |       |                |        |  |           |
| 2.5 TD (14)  | 76              | S 15064995 | 03.94      |       | + ABS |       |                |        |  |           |
|              | 1.9 TD (10/14)  | 66         | S 16206233 |       |       | + ABS | 24.2125-1702.3 | 010482 |  | Thz 25,40 |
|              | 1.9 TD (10/14)  | 68         | S 16206233 |       |       | + ABS |                |        |  |           |
|              | 2.0 i (10/14)   | 80         | S 16206233 |       |       | + ABS |                |        |  |           |
|              | 2.0 i (18)      | 80         | S 16194399 | 03.94 |       | + ABS |                |        |  |           |
|              | 2.5 D (14)      | 63         | S 15064996 |       |       | + ABS |                |        |  |           |
|              | 2.5 D (18)      | 63         | S 16206233 | 03.94 |       | + ABS |                |        |  |           |
|              | 2.5 TD (14)     | 76         | S 15064996 |       |       | + ABS |                |        |  |           |
|              | 2.5 TD (18)     | 76         | S 16194399 | 03.94 |       | + ABS |                |        |  |           |
|              | 2.5 TDi (14)    | 79         | S 16206233 | 12.96 |       | + ABS |                |        |  |           |
|              | 2.5 TDi (18)    | 79         | S 16194399 | 12.96 |       | + ABS |                |        |  |           |
| 2.8 HDi (14) | 94              | S 16206233 | 09.00      |       | + ABS |       |                |        |  |           |
| 2.8 HDi (18) | 94              | S 16194399 | 09.00      |       | + ABS |       |                |        |  |           |
|              | 1.9 TD (10/14)  | 66         | S 16206234 |       |       | + ABS | 24.2125-1726.3 | 010718 |  | Thz 25,40 |
|              | 1.9 TD (10/14)  | 68         | S 16206234 |       |       | + ABS |                |        |  |           |
|              | 2.0 i (10/14)   | 80         | S 16206234 |       |       | + ABS |                |        |  |           |
|              | 2.0 i (18)      | 80         | S 16194400 |       |       | + ABS |                |        |  |           |
|              | 2.5 D (14)      | 63         | S 16206234 |       |       | + ABS |                |        |  |           |
|              | 2.5 D (18)      | 63         | S 16194400 |       |       | + ABS |                |        |  |           |
|              | 2.5 TD (14)     | 76         | S 16206234 |       |       | + ABS |                |        |  |           |
|              | 2.5 TD (18)     | 76         | S 16194400 |       |       | + ABS |                |        |  |           |
|              | 2.5 TDi (14)    | 79         | S 16206234 |       |       | + ABS |                |        |  |           |
|              | 2.5 TDi (18)    | 79         | S 16194400 |       |       | + ABS |                |        |  |           |
| 2.8 HDi (14) | 94              | S 16206234 |            |       | + ABS |       |                |        |  |           |
| 2.8 HDi (18) | 94              | S 16194400 |            |       | + ABS |       |                |        |  |           |

<sup>1)</sup> - ABS/ + reinforced suspension / - ABS/ + sospensione rinforzata / - ABS/ + châssis renforcé / - ABS/ + suspensión reforzada

<sup>2)</sup> + ML5T transmission / + scatola cambio ML5T / + boîte de vitesse ML5T / + cambio ML5T

<sup>3)</sup> + ME5T transmission / + scatola cambio ME5T / + boîte de vitesse ME5T / + cambio ME5T

<sup>4)</sup> + MG5TU transmission / + scatola cambio MG5TU / + boîte de vitesse MG5TU / + cambio MG5TU

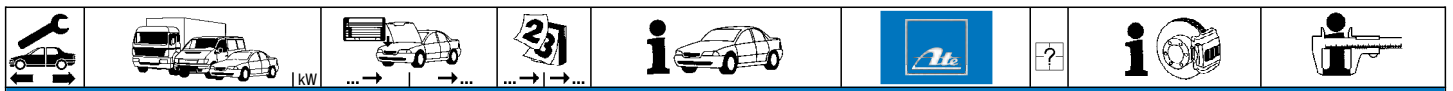

**CITROEN JUMPER Pritsche/Fahrgestell (94-02)**

|  |   |  |  |   |   |                                  |                  |  |            |  |                |
|--|---|--|--|---|---|----------------------------------|------------------|--|------------|--|----------------|
|  | 1.9 TD (10/14)<br>1.9 TD (10/14)<br>2.0 i (10/14)<br>2.5 D (14)   | 66<br>68<br>80<br>63                   |  | 03.94<br>03.94<br>03.94<br>03.94                            | 10.01 + ABS<br>10.01 + ABS<br>10.01 + ABS<br>10.01 + ABS  | 24.0101-4804.2                   | 260050           |  | Einbausatz | LUC  |                |
|  | 1.9 TD (10/14)<br>1.9 TD (10/14)<br>2.0 i (10/14/18)<br>2.5 D (14/18)<br>2.5 TD (14/18)<br>2.5 TDi (14/18)                    | 66<br>68<br>80<br>63<br>76<br>79       | S 15866409<br>S 15866409<br>S 15866409<br>S 15866409<br>S 15866409<br>S 15866409               | 03.94<br>03.94<br>03.94<br>03.94<br>03.94<br>12.96          |   | 24.5112-0466.3<br>24.5112-0465.3 | 330579<br>330526 | 2<br>2   |            | L=462<br>L=465, + Clip   |                |
|  | 1.9 TD (10/14)<br>1.9 TD (10/14)<br>2.0 i (10/14/18)<br>2.5 D (14/18)<br>2.5 TD (14/18)<br>2.5 TDi (14/18)<br>2.8 HDi (14/18) | 66<br>68<br>80<br>63<br>76<br>79<br>94 | S 15866410<br>S 15866410<br>S 15866410<br>S 15866410<br>S 15866410<br>S 15866410<br>S 15866410 | 03.94<br>03.94<br>03.94<br>03.94<br>03.94<br>03.94<br>09.00 | 10.01<br>10.01<br>10.01<br>10.01<br>10.01<br>10.01<br>10.01   | 24.5112-0466.3<br>24.5112-0461.3 | 330579<br>330616 | 2<br>2   |            | L=462<br>L=460, + Clip   |                |
|  | 1.9 TD (10/14)<br>1.9 TD (10/14)<br>2.0 i (10/14/18)<br>2.5 D (14/18)<br>2.5 TD (14/18)<br>2.5 TDi (14/18)<br>2.8 HDi (14/18) | 66<br>68<br>80<br>63<br>76<br>79<br>94 |  | 11.01<br>11.01<br>11.01<br>11.01<br>11.01<br>11.01<br>11.01 | 03.02<br>03.02<br>03.02<br>03.02<br>03.02<br>03.02<br>03.02   | 83.6401-0471.3<br>83.6401-0469.3 | 330750<br>330749 | 2<br>2   |            | L=470<br>L=468   |                |
|  | 1.9 TD (10/14)<br>1.9 TD (10/14)<br>2.0 i (10/14/18)<br>2.5 D (14/18)<br>2.5 TD (14/18)<br>2.5 TDi (14/18)<br>2.8 HDi (14/18) | 66<br>68<br>80<br>63<br>76<br>79<br>94 |  | 11.01<br>11.01<br>11.01<br>11.01<br>11.01<br>11.01<br>11.01 | 03.02<br>03.02<br>03.02<br>03.02<br>03.02<br>03.02<br>03.02   | 24.3461-1701.5<br>24.3461-1702.5 | 240449<br>240450 | <input type="checkbox"/><br><input type="checkbox"/> |            | D=46, - Halter<br>D=46, - Halter   |                |
|  | 1.9 TD (10/14)<br>1.9 TD (10/14)<br>2.0 i (10/14/18)<br>2.5 D (14/18)<br>2.5 TD (14/18)<br>2.5 TDi (14/18)<br>2.8 HDi (14/18) | 66<br>68<br>80<br>63<br>76<br>79<br>94 |  | 03.94<br>03.94<br>03.94<br>03.94<br>03.94<br>12.96<br>09.00 | 10.01 - ABS<br>10.01 - ABS<br>10.01 - ABS<br>10.01 - ABS<br>10.01 - ABS<br>10.01 - ABS<br>10.01 - ABS | 24.5112-0340.3<br>24.5112-0361.3 | 330511<br>330649 | 1<br>1   |            | - verstärktes Fahrwerk <sup>1)</sup><br>+ verstärktes Fahrwerk <sup>2)</sup> | L=340<br>L=360 |
|  | 1.9 TD (10/14)<br>1.9 TD (10/14)<br>2.0 i (10/14/18)<br>2.5 D (14/18)<br>2.5 TD (14/18)<br>2.5 TDi (14/18)<br>2.8 HDi (14/18) | 66<br>68<br>80<br>63<br>76<br>79<br>94 |  | 11.01<br>11.01<br>11.01<br>11.01<br>11.01<br>11.01<br>11.01 | 03.02 - ABS<br>03.02 - ABS<br>03.02 - ABS<br>03.02 - ABS<br>03.02 - ABS<br>03.02 - ABS<br>03.02 - ABS | 24.5112-0340.3<br>83.6401-0159.3 | 330511<br>330746 | 1<br>2   |            | + HA-Trommelbremse <sup>3)</sup><br>+ HA-Scheibenbremse <sup>4)</sup>        | L=340<br>L=160 |
|  | 1.9 TD (10/14)<br>1.9 TD (10/14)<br>2.0 i (10/14/18)<br>2.5 D (14/18)<br>2.5 TD (14/18)<br>2.5 TDi (14/18)<br>2.8 HDi (14/18) | 66<br>68<br>80<br>63<br>76<br>79<br>94 |  | 03.94<br>03.94<br>03.94<br>03.94<br>03.94<br>12.96<br>09.00 | 10.01 + ABS<br>10.01 + ABS<br>10.01 + ABS<br>10.01 + ABS<br>10.01 + ABS<br>10.01 + ABS<br>10.01 + ABS | 24.5112-0315.3<br>24.5112-0363.3 | 330509<br>330650 | <input type="checkbox"/><br><input type="checkbox"/> |            | - verstärktes Fahrwerk <sup>1)</sup><br>+ verstärktes Fahrwerk <sup>2)</sup> | L=315<br>L=360 |
|  | 1.9 TD (10/14)<br>1.9 TD (10/14)<br>2.0 i (10/14/18)<br>2.5 D (14/18)<br>2.5 TD (14/18)<br>2.5 TDi (14/18)<br>2.8 HDi (14/18) | 66<br>68<br>80<br>63<br>76<br>79<br>94 |  | 11.01<br>11.01<br>11.01<br>11.01<br>11.01<br>11.01<br>11.01 | 03.02 + ABS<br>03.02 + ABS<br>03.02 + ABS<br>03.02 + ABS<br>03.02 + ABS<br>03.02 + ABS<br>03.02 + ABS | 24.5112-0363.3<br>83.6401-0159.3 | 330650<br>330746 | <input type="checkbox"/><br><input type="checkbox"/> |            | + HA-Trommelbremse <sup>3)</sup><br>+ HA-Scheibenbremse <sup>4)</sup>        | L=360<br>L=160 |
|  | 1.9 TD (10/14)<br>1.9 TD (10/14)<br>2.0 i (10/14)<br>2.5 D (14)   | 66<br>68<br>80<br>63                   |  | 03.94<br>03.94<br>03.94<br>03.94                            | 10.01<br>10.01<br>10.01<br>10.01  | 24.3225-1701.3                   | 020399           |  |            | Rz 25,40   |                |
|  | 2.5 TD (14)<br>2.5 TDi (14)<br>2.8 HDi (14)   | 76<br>79<br>94                         |  | 03.94<br>12.96<br>09.00                                     | 10.01<br>10.01<br>10.01   | 24.3226-1702.3                   | 020469           |  |            | Rz 26,99   |                |
|  | 1.9 TD (10/14)<br>1.9 TD (10/14)<br>2.0 i (10/14)<br>2.5 D (14)<br>2.5 TD (14)<br>2.5 TDi (14)<br>2.8 HDi (14)                | 66<br>68<br>80<br>63<br>76<br>79<br>94 |  | 11.01<br>11.01<br>11.01<br>11.01<br>11.01<br>11.01<br>11.01 | 03.02<br>03.02<br>03.02<br>03.02<br>03.02<br>03.02<br>03.02   | 24.3226-1702.3                   | 020469           |  |            | Rz 26,99   |                |
|  | 2.0 i (18)<br>2.5 D (18)<br>2.5 TD (18)<br>2.5 TDi (18)<br>2.8 HDi (18)   | 80<br>63<br>76<br>79<br>94             |  | 03.94<br>03.94<br>03.94<br>12.96<br>09.00                   | 10.01<br>10.01<br>10.01<br>10.01<br>10.01   | 24.3228-1701.3                   | 020401           |  |            | Rz 28,57   |                |
|  | 1.9 TD (10/14)<br>1.9 TD (10/14)<br>2.0 i (10/14/18)<br>2.5 D (14/18)<br>2.5 TD (14/18)<br>2.5 TDi (14/18)<br>2.8 HDi (14/18) | 66<br>68<br>80<br>63<br>76<br>79<br>94 | S 16158427<br>S 16158427<br>S 16158427<br>S 16158427<br>S 16158427<br>S 16158427<br>S 16158427 | 03.94<br>03.94<br>03.94<br>03.94<br>03.94<br>12.96<br>09.00 |   | 24.3727-0340.2                   | 580340           | 1  |            | L=3025   |                |

1) - reinforced suspension / - sospensione rinforzata / - châssis renforcé / - suspensión reforzada  
 2) + reinforced suspension / + sospensione rinforzata / + châssis renforcé / + suspensión reforzada  
 3) + RA drum brake / + P freno a tamburo / + frein à tambour essieu AR / + ET-tambores de freno  
 4) + RA disc brake / + P disco freno / + frein à disque essieu AR / + ET-disco de freno



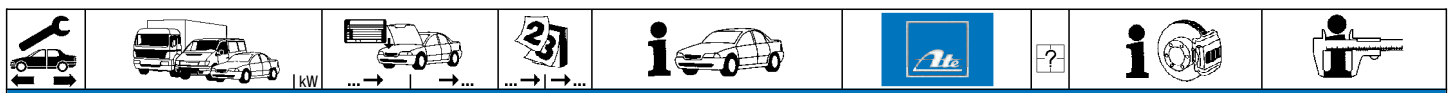

**CITROEN JUMPER Pritsche/Fahrgestell (94-02)**

|  |                     |               |            |       |       |                                |                |        |   |   |   |         |
|--|---------------------|---------------|------------|-------|-------|--------------------------------|----------------|--------|---|---|---|---------|
|  | 1.9 TD (10/14)      | 66 S 16158428 | S 16194399 |       |       | 24.3727-0344.2                 | 580344         | 1      | ↓ |   | L=2806                                      |         |
|  | 1.9 TD (10/14)      | 68 S 16158428 | S 16194399 |       |       |                                |                |        |   |   |   |         |
|  | 2.0 i (10/14/18)    | 80 S 16158428 | S 16194399 |       |       |                                |                |        |   |   |   |         |
|  | 2.5 D (14/18)       | 63 S 16158428 | S 16194399 |       |       |                                |                |        |   |   |   |         |
|  | 2.5 TD (14/18)      | 76 S 16158428 | S 16194399 |       |       |                                |                |        |   |   |   |         |
|  | 2.5 TDi (14/18)     | 79 S 16158428 | S 16194399 |       |       |                                |                |        |   |   |   |         |
|  | 2.8 HDi (14/18)     | 94 S 16158428 | S 16194399 |       |       |                                |                |        |   |   |   |         |
|  | 1.9 TD (10/14)      | 66 S 16194400 |            |       | 03.02 |                                | 24.3727-0343.2 | 580343 | 1 | ↓ | + HA-Trommelbremse <sup>1)</sup>            | L=2827  |
|  | 1.9 TD (10/14)      | 68 S 16194400 |            |       | 03.02 |                                | 24.3727-0348.2 | 580348 | 1 | ↓ | + HA-Scheibenbremse <sup>2)</sup>           | L=2715  |
|  | 2.0 i (10/14/18)    | 80 S 16194400 |            |       | 03.02 |                                |                |        |   |   |   |         |
|  | 2.5 D (14/18)       | 63 S 16194400 |            |       | 03.02 |                                |                |        |   |   |   |         |
|  | 2.5 TD (14/18)      | 76 S 16194400 |            |       | 03.02 |                                |                |        |   |   |   |         |
|  | 2.5 TDi (14/18)     | 79 S 16194400 |            |       | 03.02 |                                |                |        |   |   |   |         |
|  | 2.8 HDi (14/18)     | 94 S 16194400 |            |       | 03.02 |                                |                |        |   |   |   |         |
|  | 2.5 D 4x4 (14/18)   | 63            |            |       | 03.94 | 03.02                          | 24.3727-0842.2 | 580842 | 1 | ↓ |   | L=4100  |
|  | 2.5 TDi 4x4 (14/18) | 79            |            |       | 12.96 | 03.02                          |                |        |   |   |   |         |
|  | 1.9 TD (10/14)      | 66            | S 16206244 | 03.94 |       |                                | 24.6512-1701.3 | 320153 |   |   | - ABS                                       | BRL (2) |
|  | 1.9 TD (10/14)      | 68            | S 16206244 | 03.94 |       |                                |                |        |   |   |   |         |
|  | 2.0 i (10/14/18)    | 80            | S 16206244 | 03.94 |       |                                |                |        |   |   |   |         |
|  | 2.5 D (14/18)       | 63            | S 16206244 | 03.94 |       |                                |                |        |   |   |   |         |
|  | 2.5 TD (14/18)      | 76            | S 16206244 | 03.94 |       |                                |                |        |   |   |   |         |
|  | 2.5 TDi (14/18)     | 79            | S 16206244 | 12.96 |       |                                |                |        |   |   |   |         |
|  | 2.8 HDi (14/18)     | 94            | S 16206244 | 09.00 |       |                                |                |        |   |   |   |         |
|  | 1.9 TD (10/14)      | 66            | S 15445357 | 03.94 |       |                                | 24.6512-1701.3 | 320153 |   |   | + ABS                                       | BRL (2) |
|  | 1.9 TD (10/14)      | 68            | S 15445357 | 03.94 |       |                                |                |        |   |   |   |         |
|  | 2.0 i (10/14/18)    | 80            | S 15445357 | 03.94 |       |                                |                |        |   |   |   |         |
|  | 2.5 D (14/18)       | 63            | S 15445357 | 03.94 |       |                                |                |        |   |   |   |         |
|  | 2.5 TD (14/18)      | 76            | S 15445357 | 03.94 |       |                                |                |        |   |   |   |         |
|  | 2.5 TDi (14/18)     | 79            | S 15445357 | 12.96 |       |                                |                |        |   |   |   |         |
|  | 2.8 HDi (14/18)     | 94            | S 15445357 | 09.00 |       |                                |                |        |   |   |   |         |
|  | 1.9 TD (14)         | 66 S 16205353 |            |       | 03.02 |                                | 24.6512-1712.3 | 320273 |   |   | - ABS/ + verstärktes Fahrwerk <sup>3)</sup> | BRL (2) |
|  | 1.9 TD (14)         | 68 S 16205353 |            |       | 03.02 |                                |                |        |   |   |   |         |
|  | 2.0 i (14)          | 80 S 16205353 |            |       | 03.02 |                                |                |        |   |   |   |         |
|  | 2.5 D (14)          | 63 S 16205353 |            |       | 03.02 |                                |                |        |   |   |   |         |
|  | 2.5 TD (14)         | 76 S 16205353 |            |       | 03.02 |                                |                |        |   |   |   |         |
|  | 2.5 TDi (14)        | 79 S 16205353 |            |       | 03.02 |                                |                |        |   |   |   |         |
|  | 2.8 HDi (14)        | 94 S 16205353 |            |       | 03.02 |                                |                |        |   |   |   |         |
|  | 2.0 i (18)          | 80 S 16205353 |            |       | 03.02 |                                | 24.6512-1709.3 | 320270 |   |   | - ABS/ + verstärktes Fahrwerk <sup>3)</sup> | BRL (2) |
|  | 2.5 D (18)          | 63 S 16205353 |            |       | 03.02 |                                |                |        |   |   |   |         |
|  | 2.5 TD (18)         | 76 S 16205353 |            |       | 03.02 |                                |                |        |   |   |   |         |
|  | 2.5 TDi (18)        | 79 S 16205353 |            |       | 03.02 |                                |                |        |   |   |   |         |
|  | 2.8 HDi (18)        | 94 S 16205353 |            |       | 03.02 |                                |                |        |   |   |   |         |
|  | 1.9 TD (10/14)      | 66            |            | 03.94 | 03.02 | + ML5T-Getriebe <sup>4)</sup>  | 24.3728-0300.2 | 590300 |   |   |   | L=1478  |
|  | 1.9 TD (10/14)      | 68            |            | 03.94 | 03.02 | + ML5T-Getriebe <sup>4)</sup>  |                |        |   |   |   |         |
|  | 1.9 TD (10/14)      | 66            |            | 03.94 | 03.02 | + ME5T-Getriebe <sup>5)</sup>  | 24.3728-0337.2 | 590337 |   |   |   | L=1058  |
|  | 1.9 TD (10/14)      | 68            |            | 03.94 | 03.02 | + ME5T-Getriebe <sup>5)</sup>  |                |        |   |   |   |         |
|  | 2.0 i (10/14/18)    | 80            |            | 03.94 | 03.02 | + ME5T-Getriebe <sup>5)</sup>  | 24.3728-0518.2 | 590518 |   |   |   | L=1034  |
|  | 2.5 D (14/18)       | 63            |            | 03.94 | 03.02 | + ME5T-Getriebe <sup>5)</sup>  |                |        |   |   |   |         |
|  | 2.5 TD (14/18)      | 76            |            | 03.94 | 03.02 | + ME5T-Getriebe <sup>5)</sup>  |                |        |   |   |   |         |
|  | 2.0 i (10/14/18)    | 80            |            | 03.94 | 03.02 | + MG5TU-Getriebe <sup>6)</sup> | 24.3728-0519.2 | 590519 |   |   |   | L=1090  |
|  | 2.5 D (14/18)       | 63            |            | 03.94 | 03.02 | + MG5TU-Getriebe <sup>6)</sup> |                |        |   |   |   |         |
|  | 2.5 TD (14/18)      | 76            |            | 03.94 | 03.02 | + MG5TU-Getriebe <sup>6)</sup> |                |        |   |   |   |         |
|  | 2.8 HDi (14/18)     | 94            |            | 09.00 | 03.02 | + MG5TU-Getriebe <sup>6)</sup> |                |        |   |   |   |         |
|  | 2.0 i (10/14/18)    | 80            |            | 03.94 | 03.02 | + ML5T-Getriebe <sup>4)</sup>  | 24.3728-0335.2 | 590335 |   |   |   | L=1435  |
|  | 2.5 D (14/18)       | 63            |            | 03.94 | 03.02 | + ML5T-Getriebe <sup>4)</sup>  |                |        |   |   |   |         |
|  | 2.8 HDi (14/18)     | 94            |            | 09.00 | 03.02 | + ML5T-Getriebe <sup>4)</sup>  |                |        |   |   |   |         |

**CITROEN JUMPER (02-06)**

|  |                       |    |  |       |       |       |                |        |   |  |                                   |                                   |
|--|-----------------------|----|--|-------|-------|-------|----------------|--------|---|--|-----------------------------------|-----------------------------------|
|  | 2.0 HDi (10/14/18)    | 62 |  | 04.02 | 03.06 |       | 24.2125-1725.3 | 010717 |   |  | - ABS                             | Thz 25,40                         |
|  | 2.0 i (10/14/18)      | 81 |  | 04.02 | 03.06 |       | 24.2125-1726.3 | 010718 |   |  | + ABS                             | Thz 25,40                         |
|  | 2.2 HDi (10/14/18)    | 74 |  | 04.02 | 03.06 |       |                |        |   |  |                                   |                                   |
|  | 2.8 HDi (10/14/18)    |    |  | 04.02 | 03.06 |       |                |        |   |  |                                   |                                   |
|  | 2.8 HDi 4x4(10/14/18) |    |  | 04.02 | 03.06 |       |                |        |   |  |                                   |                                   |
|  | 2.0 HDi (10/14/18)    | 62 |  | 04.02 | 03.06 |       | 83.6401-0471.3 | 330750 | 2 |  |                                   | L=470                             |
|  | 2.0 i (10/14/18)      | 81 |  | 04.02 | 03.06 |       | 83.6401-0469.3 | 330749 | 2 |  |                                   | L=468                             |
|  | 2.2 HDi (10/14/18)    | 74 |  | 04.02 | 03.06 |       |                |        |   |  |                                   |                                   |
|  | 2.8 HDi (10/14/18)    |    |  | 04.02 | 03.06 |       |                |        |   |  |                                   |                                   |
|  | 2.8 HDi 4x4(10/14/18) |    |  | 04.02 | 03.06 |       |                |        |   |  |                                   |                                   |
|  | 2.0 HDi (10/14/18)    | 62 |  | 04.02 | 03.06 |       | 24.3461-1701.5 | 240449 |   |  | ☐                                 | D=46, - Halter                    |
|  | 2.0 i (10/14/18)      | 81 |  | 04.02 | 03.06 |       | 24.3461-1702.5 | 240450 |   |  | ☐                                 | D=46, - Halter                    |
|  | 2.2 HDi (10/14/18)    | 74 |  | 04.02 | 03.06 |       |                |        |   |  |                                   |                                   |
|  | 2.8 HDi (10/14/18)    |    |  | 04.02 | 03.06 |       |                |        |   |  |                                   |                                   |
|  | 2.8 HDi 4x4(10/14/18) |    |  | 04.02 | 03.06 |       |                |        |   |  |                                   |                                   |
|  | 2.0 HDi (10/14/18)    | 62 |  | 04.02 | 03.06 | - ABS | 24.5112-0361.3 | 330649 | 1 |  | + HA-Trommelbremse <sup>1)</sup>  | L=360                             |
|  | 2.0 i (10/14/18)      | 81 |  | 04.02 | 03.06 | - ABS | 83.6401-0159.3 | 330746 | 2 |  | + HA-Scheibenbremse <sup>2)</sup> | L=160                             |
|  | 2.2 HDi (10/14/18)    | 74 |  | 04.02 | 03.06 | - ABS |                |        |   |  |                                   |                                   |
|  | 2.8 HDi (10/14/18)    |    |  | 04.02 | 03.06 | - ABS |                |        |   |  |                                   |                                   |
|  | 2.8 HDi 4x4(10/14/18) |    |  | 04.02 | 03.06 | - ABS |                |        |   |  |                                   |                                   |
|  | 2.0 HDi (10/14/18)    | 62 |  | 04.02 | 03.06 | + ABS | 24.5112-0363.3 | 330650 |   |  | ☐                                 | + HA-Trommelbremse <sup>1)</sup>  |
|  | 2.0 i (10/14/18)      | 81 |  | 04.02 | 03.06 | + ABS | 83.6401-0159.3 | 330746 | 2 |  | ☐                                 | + HA-Scheibenbremse <sup>2)</sup> |
|  | 2.2 HDi (10/14/18)    | 74 |  | 04.02 | 03.06 | + ABS |                |        |   |  |                                   |                                   |
|  | 2.8 HDi (10/14/18)    |    |  | 04.02 | 03.06 | + ABS |                |        |   |  |                                   |                                   |
|  | 2.8 HDi 4x4(10/14/18) |    |  | 04.02 | 03.06 | + ABS |                |        |   |  |                                   |                                   |

1) + RA drum brake / + P freno a tamburo / + frein à tambour essieu AR / + ET-tambores de freno  
 2) + RA disc brake / + P disco freno / + frein à disque essieu AR / + ET-disco de freno  
 3) - ABS/ + reinforced suspension / - ABS/ + sospensione rinforzata / - ABS/ + châssis renforcé / - ABS/ + suspensión reforzada  
 4) + ML5T transmission / + scatola cambio ML5T / + boîte de vitesse ML5T / + cambio ML5T  
 5) + ME5T transmission / + scatola cambio ME5T / + boîte de vitesse ME5T / + cambio ME5T  
 6) + MG5TU transmission / + scatola cambio MG5TU / + boîte de vitesse MG5TU / + cambio MG5TU



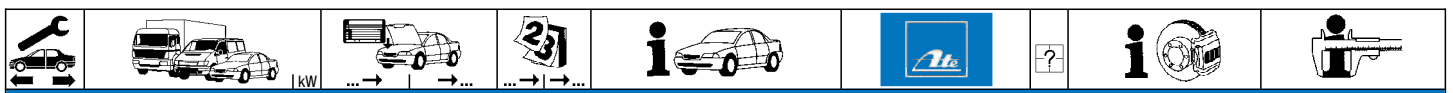













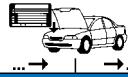



| CITROEN JUMPER (02-06) |                       |            |            |       |       |   |                |        |        |                                   |
|------------------------|-----------------------|------------|------------|-------|-------|---|----------------|--------|--------|-----------------------------------|
|                        | 2.0 HDi (10/14)       | 62         |            | 04.02 | 03.06 |   | 24.3226-1702.3 | 020469 |        | Rz 26,99                          |
|                        | 2.0 i (10/14)         | 81         |            | 04.02 | 03.06 |   |                |        |        |                                   |
|                        | 2.2 HDi (10/14)       | 74         |            | 04.02 | 03.06 |   |                |        |        |                                   |
|                        | 2.8 HDi (10/14)       |            |            | 04.02 | 03.06 |   |                |        |        |                                   |
|                        | 2.8 HDi 4x4(10/14/18) |            |            | 04.02 | 03.06 |   |                |        |        |                                   |
|                        | 2.0 HDi (10/14/18)    | 62         |            | 04.02 | 03.06 |   | 24.3727-0300.2 | 580300 | 1 ↑    | L=1078                            |
|                        | 2.0 i (10/14/18)      | 81         |            | 04.02 | 03.06 |   | 24.3727-0343.2 | 580343 | 1 ↓    | L=2827                            |
|                        | 2.2 HDi (10/14/18)    | 74         |            | 04.02 | 03.06 |   |                |        |        | + HA-Trommelbremse <sup>1)</sup>  |
|                        | 2.8 HDi (10/14/18)    |            |            | 04.02 | 03.06 |   |                |        |        |                                   |
|                        | 2.0 HDi (10/14/18)    | 62         | S 17103012 | 04.02 |       |   | 24.3727-0300.2 | 580300 | 1 ↑    | L=1078                            |
|                        | 2.0 i (10/14/18)      | 81         | S 17103012 | 04.02 |       |   | 24.3727-0348.2 | 580348 | 1 ↓    | L=2715                            |
|                        | 2.2 HDi (10/14/18)    | 74         | S 17103012 | 04.02 |       |   |                |        |        | + HA-Scheibenbremse <sup>2)</sup> |
|                        | 2.8 HDi (10/14/18)    |            | S 17103012 | 04.02 |       |   |                |        |        |                                   |
|                        | 2.0 HDi (10/14/18)    | 62         | S 17103013 |       | 03.06 |   | 24.3727-0300.2 | 580300 | 1 ↑    | L=1078                            |
|                        | 2.0 i (10/14/18)      | 81         | S 17103013 |       | 03.06 |   |                |        |        |                                   |
| 2.2 HDi (10/14/18)     | 74                    | S 17103013 |            | 03.06 |       |   |                |        |        |                                   |
| 2.8 HDi (10/14/18)     |                       | S 17103013 |            | 03.06 |       |   |                |        |        |                                   |
| 2.8 HDi 4x4(10/14/18)  |                       | S 17103012 | 04.02      |       |       | 24.3727-0562.2                              | 580562         | 1 ↑    | L=1059 |                                   |
|                        |                       |            |            |       |       | 24.3727-0348.2                              | 580348         | 1 ↓    | L=2715 |                                   |
|                        |                       | S 17103013 |            | 03.06 |       | 24.3727-0562.2                              | 580562         | 1 ↑    | L=1059 |                                   |
|                        | 2.0 HDi (10/14)       | 62         |            | 04.02 | 03.06 | - ABS/ + verstärktes Fahrwerk <sup>3)</sup> | 24.6512-1712.3 | 320273 |        | BRL (2)                           |
|                        | 2.0 i (10/14)         | 81         |            | 04.02 | 03.06 | - ABS/ + verstärktes Fahrwerk <sup>3)</sup> |                |        |        |                                   |
|                        | 2.2 HDi (10/14)       | 74         |            | 04.02 | 03.06 | - ABS/ + verstärktes Fahrwerk <sup>3)</sup> |                |        |        |                                   |
|                        | 2.8 HDi (10/14)       |            |            | 04.02 | 03.06 | - ABS/ + verstärktes Fahrwerk <sup>3)</sup> |                |        |        |                                   |
|                        | 2.0 HDi (18)          | 62         |            | 04.02 | 03.06 | - ABS/ + verstärktes Fahrwerk <sup>3)</sup> | 24.6512-1709.3 | 320270 |        | BRL (2)                           |
|                        | 2.0 i (18)            | 81         |            | 04.02 | 03.06 | - ABS/ + verstärktes Fahrwerk <sup>3)</sup> |                |        |        |                                   |
|                        | 2.2 HDi (18)          | 74         |            | 04.02 | 03.06 | - ABS/ + verstärktes Fahrwerk <sup>3)</sup> |                |        |        |                                   |
|                        | 2.8 HDi (18)          |            |            | 04.02 | 03.06 | - ABS/ + verstärktes Fahrwerk <sup>3)</sup> |                |        |        |                                   |
|                        | 2.8 HDi 4x4(10/14/18) |            |            | 04.02 | 03.06 |   | 24.6512-1701.3 | 320153 |        | BRL (2)                           |
|                        |                       |            |            |       |       |   | 24.6512-1703.3 | 320159 |        | BRL (4)                           |

| CITROEN JUMPER (06-) |             |     |  |       |  |                                |                |        |       |                          |
|----------------------|-------------|-----|--|-------|--|--------------------------------|----------------|--------|-------|--------------------------|
|                      | 2.2 HDi 100 | 74  |  | 04.06 |  | Nutzlast 120/140 <sup>4)</sup> | 24.4125-1702.3 | 010872 |       | THz 25,40 + Behälter BOS |
|                      | 2.2 HDi 110 | 81  |  | 07.11 |  | Nutzlast 120/140 <sup>4)</sup> | 24.4126-1701.3 | 010868 | - ESP | THz 26,99 + Behälter BOS |
|                      | 2.2 HDi 120 | 88  |  | 04.06 |  | Nutzlast 120/140 <sup>4)</sup> |                |        | + ESP |                          |
|                      | 2.2 HDi 130 | 96  |  | 07.11 |  | Nutzlast 120/140 <sup>4)</sup> |                |        |       |                          |
|                      | 2.2 HDi 150 | 110 |  | 07.11 |  | Nutzlast 120/140 <sup>4)</sup> |                |        |       |                          |
|                      | 3.0 HDi 145 | 107 |  | 07.10 |  | Nutzlast 120/140 <sup>4)</sup> |                |        |       |                          |
|                      | 3.0 HDi 155 | 115 |  | 07.10 |  | Nutzlast 120/140 <sup>4)</sup> |                |        |       |                          |
|                      | 3.0 HDi 160 | 116 |  | 09.06 |  | Nutzlast 120/140 <sup>4)</sup> |                |        |       |                          |
|                      | 3.0 HDi 180 | 130 |  | 07.11 |  | Nutzlast 120/140 <sup>4)</sup> |                |        |       |                          |
|                      |             |     |  | 07.11 |  | Nutzlast 120/140 <sup>4)</sup> |                |        |       |                          |
|                      | 2.2 HDi 100 | 74  |  | 04.06 |  | Nutzlast 160/200 <sup>5)</sup> | 24.4125-1701.3 | 010867 |       | THz 25,40 + Behälter BOS |
|                      | 2.2 HDi 110 | 81  |  | 07.11 |  | Nutzlast 160/200 <sup>5)</sup> |                |        | + ESP |                          |
|                      | 2.2 HDi 120 | 88  |  | 04.06 |  | Nutzlast 160/200 <sup>5)</sup> |                |        |       |                          |
|                      | 2.2 HDi 130 | 96  |  | 07.11 |  | Nutzlast 160/200 <sup>5)</sup> |                |        |       |                          |
|                      | 2.2 HDi 150 | 110 |  | 07.11 |  | Nutzlast 160/200 <sup>5)</sup> |                |        |       |                          |
|                      | 3.0 HDi 145 | 107 |  | 07.10 |  | Nutzlast 160/200 <sup>5)</sup> |                |        |       |                          |
|                      | 3.0 HDi 155 | 115 |  | 07.10 |  | Nutzlast 160/200 <sup>5)</sup> |                |        |       |                          |
|                      | 3.0 HDi 160 | 116 |  | 09.06 |  | Nutzlast 160/200 <sup>5)</sup> |                |        |       |                          |
|                      | 3.0 HDi 180 | 130 |  | 07.11 |  | Nutzlast 160/200 <sup>5)</sup> |                |        |       |                          |
|                      |             |     |  | 07.11 |  | Nutzlast 160/200 <sup>5)</sup> |                |        |       |                          |
|                      | 2.2 HDi 100 | 74  |  | 04.06 |  |                                | 24.5112-0492.3 | 331217 | 2     | L=492                    |
|                      | 2.2 HDi 110 | 81  |  | 07.11 |  |                                |                |        |       |                          |
|                      | 2.2 HDi 120 | 88  |  | 04.06 |  |                                |                |        |       |                          |
|                      | 2.2 HDi 130 | 96  |  | 07.11 |  |                                |                |        |       |                          |
|                      | 2.2 HDi 150 | 110 |  | 07.11 |  |                                |                |        |       |                          |
|                      | 3.0 HDi 145 | 107 |  | 07.10 |  |                                |                |        |       |                          |
|                      | 3.0 HDi 155 | 115 |  | 07.10 |  |                                |                |        |       |                          |
|                      | 3.0 HDi 160 | 116 |  | 09.06 |  |                                |                |        |       |                          |
|                      | 3.0 HDi 180 | 130 |  | 07.11 |  |                                |                |        |       |                          |
|                      |             |     |  | 07.11 |  |                                |                |        |       |                          |
|                      | 2.2 HDi 100 | 74  |  | 04.06 |  |                                | 83.7101-9414.3 | 330905 | 2     | L=414                    |
|                      | 2.2 HDi 110 | 81  |  | 07.11 |  |                                | 24.5112-0417.3 | 331298 | 2     | L=417                    |
|                      | 2.2 HDi 120 | 88  |  | 04.06 |  |                                | 83.7101-9489.3 | 330906 | 2     | L=489                    |
|                      | 2.2 HDi 130 | 96  |  | 07.11 |  |                                |                |        |       |                          |
|                      | 2.2 HDi 150 | 110 |  | 07.11 |  |                                |                |        |       |                          |
|                      | 3.0 HDi 145 | 107 |  | 07.10 |  |                                |                |        |       |                          |
|                      | 3.0 HDi 155 | 115 |  | 07.10 |  |                                |                |        |       |                          |
|                      | 3.0 HDi 160 | 116 |  | 09.06 |  |                                |                |        |       |                          |
|                      | 3.0 HDi 180 | 130 |  | 07.11 |  |                                |                |        |       |                          |
|                      |             |     |  | 07.11 |  |                                |                |        |       |                          |

| CITROEN JUMPY Kombi (95-06) |         |     |            |       |       |       |                |        |                |           |
|-----------------------------|---------|-----|------------|-------|-------|-------|----------------|--------|----------------|-----------|
|                             | 1.6     |     | ORGA 08206 | 10.95 |       |       | 24.2122-1703.3 | 010422 | - ABS/ + 0,8 t | THz 22,20 |
|                             | 1.9 D   | 51  | ORGA 08206 | 10.95 |       |       | 24.2122-1708.3 | 010437 | + ABS/ + 0,8 t | THz 22,20 |
|                             | 1.9 TD  | 66  | ORGA 08206 | 10.95 |       |       | 24.2123-1707.3 | 010492 | - ABS/ + 0,9 t | THz 23,81 |
|                             | 1.9 TD  | 68  | ORGA 08206 | 04.96 |       |       | 24.2123-1708.3 | 010493 | + ABS/ + 0,9 t | THz 23,81 |
|                             | 1.6     |     | ORGA 08207 |       | 12.06 |       | 24.2122-1741.3 | 010695 | - ABS/ + 0,8 t | THz 22,20 |
|                             | 1.9 D   | 51  | ORGA 08207 |       | 12.06 |       | 24.2122-1742.3 | 010696 | + ABS/ + 0,8 t | THz 22,20 |
|                             | 1.9 TD  | 66  | ORGA 08207 |       | 12.06 |       | 24.2123-1738.3 | 010658 | - ABS/ + 0,9 t | THz 23,81 |
|                             | 1.9 TD  | 68  | ORGA 08207 |       | 12.06 |       | 24.2123-1733.3 | 010657 | + ABS/ + 0,9 t | THz 23,81 |
|                             | 2.0 16V | 100 |            |       | 04.00 | 12.06 | 24.2123-1738.3 | 010658 | - ABS          | THz 23,81 |
|                             | 2.0 16V | 102 |            |       | 03.00 | 12.06 | 24.2123-1733.3 | 010657 | + ABS          | THz 23,81 |
| 2.0 HDi                     | 69      |     |            | 10.99 | 12.06 |       |                |        |                |           |
| 2.0 HDi                     | 80      |     |            | 03.00 | 12.06 |       |                |        |                |           |

<sup>1)</sup> + RA drum brake / + P freno a tamburo / + frein à tambour essieu AR / + ET-tambores de freno  
<sup>2)</sup> + RA disc brake / + P disco freno / + frein à disque essieu AR / + ET-disco de freno  
<sup>3)</sup> - ABS/ + reinforced suspension / - ABS/ + sospensione rinforzata / - ABS/ + châssis renforcé / - ABS/ + suspensión reforzada  
<sup>4)</sup> payload 120/140 / carico utile 120/140 / charge utile 120/140 / carga útil 120/140  
<sup>5)</sup> payload 160/200 / carico utile 160/200 / charge utile 160/200 / carga útil 160/200  
<sup>6)</sup> + short wheel base / + passo lungo / + empattement court / + distancia corta entre ejes  
<sup>7)</sup> + long wheel base / + passo lungo / + empattement long / + distancia larga entre ejes



|     |    |  |  |  |  |  |  |  |                                    |          |              |
|--|--|--|--|--|---|--|--|--|------------------------------------|----------|--------------|
| <b>CITROEN JUMPY Kombi (95-06)</b>   |  |  |  |  |   |  |  |  |                                    |          |              |
|    | 1.6  |  | ORGA 09792   | 10.95  |   | 24.3571-1709.5   | 240153   | D=57, - Halter<br>D=57, - Halter   | LUC<br>LUC                         |          |              |
|  | 1.9 D  | 51   | ORGA 09155   | 10.95  |   | 24.3571-1710.5   | 240154   |  |                                    |          |              |
|  | 1.9 TD   | 66   | ORGA 09792   | 10.95  |   |  |  |  |                                    |          |              |
|  | 1.9 TD   | 68   | ORGA 09792   | 04.96  |   |  |  |  |                                    |          |              |
|  | 2.0 16V  | 100  | ORGA 09792   | 04.00  |   |  |  |  |                                    |          |              |
|  | 2.0 16V  | 102  | ORGA 09792   | 03.00  |   |  |  |  |                                    |          |              |
|  | 2.0 HDi  | 69   | ORGA 09792   | 10.99  |   |  |  |  |                                    |          |              |
|  | 2.0 HDi  | 80   | ORGA 09792   | 03.00  |   |  |  |  |                                    |          |              |
|  | 1.9 D  | 51   | ORGA 09156   |  | 12.06   |  | 24.3571-1711.5   |  |                                    | 240159   |              |
|  |  |  |  |  |   |  | 24.3571-1712.5   |  |                                    | 240160   |              |
|  | 1.6  |  | ORGA 09793   |  | 12.06   |  | 24.3601-1711.7   |  |                                    | 220607   |              |
|  | 1.9 TD   | 66   | ORGA 09793   |  | 12.06   |  | 24.3601-1712.7   |  |                                    | 220608   |              |
|  | 1.9 TD   | 68   | ORGA 09793   |  | 12.06   |  |  |  |                                    |          |              |
|  | 2.0 16V  | 100  | ORGA 09793   |  | 12.06   |  |  |  |                                    |          |              |
| 2.0 16V  | 102  | ORGA 09793   |  | 12.06  |   |  |  |  |                                    |          |              |
| 2.0 HDi  | 69   | ORGA 09793   |  | 12.06  |   |  |  |  |                                    |          |              |
| 2.0 HDi  | 80   | ORGA 09793   |  | 12.06  |   |  |  |  |                                    |          |              |
|    | 1.6  |  | ORGA 09792   | 10.95  |   | 24.5118-0471.3   | 330528   | L=473  |                                    |          |              |
|  | 1.9 D  | 51   |  | 10.95  | 12.06   |  |  |  |                                    |          |              |
|  | 1.9 TD   | 66   | ORGA 09792   | 10.95  |   |  |  |  |                                    |          |              |
|  | 1.9 TD   | 68   | ORGA 09792   | 04.96  |   |  |  |  |                                    |          |              |
|  | 2.0 16V  | 100  | ORGA 09792   | 04.00  |   |  |  |  |                                    |          |              |
|  | 2.0 16V  | 102  | ORGA 09792   | 03.00  |   |  |  |  |                                    |          |              |
|  | 2.0 HDi  | 69   | ORGA 09792   | 10.99  |   |  |  |  |                                    |          |              |
|  | 2.0 HDi  | 80   | ORGA 09792   | 03.00  |   |  |  |  |                                    |          |              |
|  | 1.6  |  | ORGA 09793   |  | 12.06   |  | 24.5111-0462.3   |  | 330555                             |          |              |
|  | 1.9 TD   | 66   | ORGA 09793   |  | 12.06   |  |  |  |                                    |          |              |
|  | 1.9 TD   | 68   | ORGA 09793   |  | 12.06   |  |  |  |                                    |          |              |
|  | 2.0 16V  | 100  | ORGA 09793   |  | 12.06   |  |  |  |                                    |          |              |
|  | 2.0 16V  | 102  | ORGA 09793   |  | 12.06   |  |  |  |                                    |          |              |
|  | 2.0 HDi  | 69   | ORGA 09793   |  | 12.06   |  |  |  |                                    |          |              |
| 2.0 HDi  | 80   | ORGA 09793   |  | 12.06  |   |  |  |  |                                    |          |              |
|    | 1.6  |  |  | 10.95  | 12.06   | 24.5229-0251.3   | 330535   | L=250  |                                    |          |              |
|  | 1.9 D  | 51   |  | 10.95  | 12.06   |  |  |  |                                    |          |              |
|  | 1.9 TD   | 66   |  | 10.95  | 12.06   |  |  |  |                                    |          |              |
|  | 1.9 TD   | 68   |  | 04.96  | 12.06   |  |  |  |                                    |          |              |
|  | 2.0 16V  | 100  |  | 04.00  | 12.06   |  |  |  |                                    |          |              |
|  | 2.0 16V  | 102  |  | 03.00  | 12.06   |  |  |  |                                    |          |              |
|  | 2.0 HDi  | 69   |  | 10.99  | 12.06   |  |  |  |                                    |          |              |
|  | 2.0 HDi  | 80   |  | 03.00  | 12.06   |  |  |  |                                    |          |              |
|  |  | 1.6  |  |  | 10.95   | 12.06  | 24.3219-1704.3   |  | 020374                             | Rz 19,05 |              |
|  |  | 1.9 D  | 51   |  | 10.95   | 12.06  |  |  |                                    |          |              |
|  |  | 1.9 TD   | 66   |  | 10.95   | 12.06  |  |  |                                    |          |              |
|  |  | 1.9 TD   | 68   |  | 04.96   | 12.06  |  |  |                                    |          |              |
|  |  | 2.0 16V  | 100  |  | 04.00   | 12.06  |  |  |                                    |          |              |
|  |  | 2.0 16V  | 102  |  | 03.00   | 12.06  |  |  |                                    |          |              |
| 2.0 HDi  |  | 69   |  | 10.99  | 12.06   |  |  |  |                                    |          |              |
| 2.0 HDi  |  | 80   |  | 03.00  | 12.06   |  |  |  |                                    |          |              |
|  |  | 1.6  | ‡  |  | 10.95   | 12.06  | 24.3727-0336.2   | 580336   | L=500<br>L=900<br>L=1063<br>L=2286 |          |              |
|  |  | 1.9 D  | ‡ 51   |  | 10.95   | 12.06  | 24.3727-0341.2   | 580341   |                                    |          |              |
|  |  | 1.9 TD   | ‡ 66   |  | 10.95   | 12.06  | 24.3727-0532.2   | 580532   |                                    |          |              |
|  |  | 1.9 TD   | ‡ 68   |  | 04.96   | 12.06  | 24.3727-0531.2   | 580531   |                                    |          |              |
|  |  | 2.0 16V  | ‡100   |  | 04.00   | 12.06  |  |  |                                    |          |              |
|  |  | 2.0 16V  | ‡102   |  | 03.00   | 12.06  |  |  |                                    |          |              |
|  | 2.0 HDi  | ‡ 69   |  | 10.99  | 12.06   |  |  |  |                                    |          |              |
|  | 2.0 HDi  | ‡ 80   |  | 03.00  | 12.06   |  |  |  |                                    |          |              |
|  | 1.6  | ‡  |  | 10.95  | 12.06   | 24.3727-0336.2   | 580336   | L=500<br>L=900<br>L=1063   |                                    |          |              |
|  | 1.9 D  | ‡ 51   |  | 10.95  | 12.06   | 24.3727-0341.2   | 580341   |  |                                    |          |              |
|  | 1.9 TD   | ‡ 66   |  | 10.95  | 12.06   | 24.3727-0532.2   | 580532   |  |                                    |          |              |
|  | 1.9 TD   | ‡ 68   |  | 04.96  | 12.06   |  |  |  |                                    |          |              |
|  | 2.0 16V  | ‡100   |  | 04.00  | 12.06   |  |  |  |                                    |          |              |
|  | 2.0 16V  | ‡102   |  | 03.00  | 12.06   |  |  |  |                                    |          |              |
| 2.0 HDi  | ‡ 69   |  | 10.99  | 12.06  |   |  |  |  |                                    |          |              |
| 2.0 HDi  | ‡ 80   |  | 03.00  | 12.06  |   |  |  |  |                                    |          |              |
|  | 1.6  |  | ORGA 08420   | 10.95  | 12.06   | 24.6582-1715.3   | 320205   |  | BRL (4)                            |          |              |
|  | 1.6  |  |  | 10.95  | 12.06   |  |  |  |                                    |          |              |
|  | 1.9 D  | 51   | ORGA 08420   | 10.95  | 12.06   |  |  |  |                                    |          |              |
|  | 1.9 D  | 51   |  | 10.95  | 12.06   |  |  |  |                                    |          |              |
|  | 1.9 TD   | 66   | ORGA 08420   | 10.99  | 12.06   |  |  |  |                                    |          |              |
|  | 1.9 TD   | 66   |  | 10.99  | 12.06   |  |  |  |                                    |          |              |
|  | 1.6  | ‡  |  | 10.95  | 12.06   | 24.3728-0341.2   | 590341   | L=738, + AUT   |                                    |          |              |
|  | 2.0 16V  | ‡100   |  | 04.00  | 12.06   |  |  |  |                                    |          |              |
|  | 2.0 16V  | ‡102   |  | 03.00  | 12.06   |  |  |  |                                    |          |              |
|  | 1.9 D  | ‡ 51   |  | 10.95  | 12.06   |  |  |  |                                    |          |              |
|  | 2.0 16V  | ‡100   |  | 04.00  | 12.06   |  |  |  |                                    |          |              |
|  | 2.0 16V  | ‡102   |  | 03.00  | 12.06   |  |  |  |                                    |          |              |
|  | 2.0 HDi  | ‡ 69   |  | 10.99  | 12.06   |  |  |  |                                    |          |              |
|  | 2.0 HDi  | ‡ 80   |  | 03.00  | 12.06   |  |  |  |                                    |          |              |
|  | 1.9 TD   | ‡ 66   |  | 10.95  | 12.06   |  |  |  | 24.3728-0342.2                     | 590342   | L=863, + AUT |
|  | 1.9 TD   | ‡ 68   |  | 04.96  | 12.06   |  |  |  |                                    |          |              |

1) - long wheel base / - passo lungo / - empattement long / - distancia larga entre ejes  
2) + long wheel base / + passo lungo / + empattement long / + distancia larga entre ejes  
3) + BE3 transmission / + scatola cambio BE3 / + boîte de vitesse BE3 / + cambio BE3  
4) + BE4 transmission / + scatola cambio BE4 / + boîte de vitesse BE4 / + cambio BE4  
5) + ML5 transmission / + scatola cambio ML5 / + boîte de vitesse ML5 / + cambio ML5  
6) + ME5K transmission / + scatola cambio ME5K / + boîte de vitesse ME5K / + cambio ME5K  
7) + ML5T transmission / + scatola cambio ML5T / + boîte de vitesse ML5T / + cambio ML5T

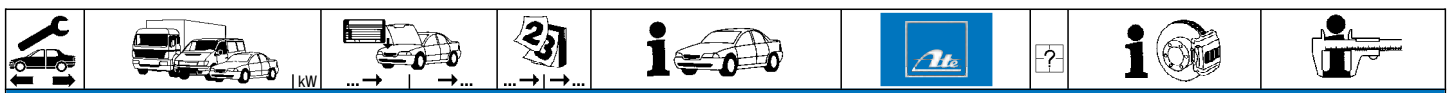









































**CITROEN JUMPY Kasten (95-06)**

|  |  |                                   |  |   |  |  |                                      |  |  |                                    |  |
|--|--|-----------------------------------|--|---|--|--|--------------------------------------|--|--|------------------------------------|--|
|  | 1.6<br>1.9 D 70<br>1.9 TD  | 51<br>66                          | ORGA 08206<br>ORGA 08206<br>ORGA 08206   | 10.95<br>04.98<br>10.95                                     |  | 24.2122-1703.3<br>24.2122-1708.3<br>24.2123-1707.3<br>24.2123-1708.3 | 010422<br>010437<br>010492<br>010493 | - ABS/ + 0,8 t<br>+ ABS/ + 0,8 t<br>- ABS/ + 0,9 t<br>+ ABS/ + 0,9 t   | THz 22,20<br>THz 22,20<br>THz 23,81<br>THz 23,81                   |                                    |  |
|  | 1.6<br>1.9 D 70<br>1.9 TD  | 51<br>66                          | ORGA 08207<br>ORGA 08207<br>ORGA 08207   | 12.06<br>12.06<br>12.06                                     |  | 24.2122-1741.3<br>24.2122-1742.3<br>24.2123-1738.3<br>24.2123-1733.3 | 010695<br>010696<br>010658<br>010657 | - ABS/ + 0,8 t<br>+ ABS/ + 0,8 t<br>- ABS/ + 0,9 t<br>+ ABS/ + 0,9 t   | THz 22,20<br>THz 22,20<br>THz 23,81<br>THz 23,81                   |                                    |  |
|  | 2.0 16V<br>2.0 HDi 110<br>2.0 HDi 95                                       | 102<br>80<br>69                   |  | 03.00<br>01.02<br>10.99                                     | 12.06<br>12.06<br>12.06  |  | 24.2123-1738.3<br>24.2123-1733.3     | 010658<br>010657   | - ABS<br>+ ABS   | THz 23,81<br>THz 23,81             |  |
|  | 1.6<br>1.9 D<br>1.9 D 70<br>1.9 TD<br>2.0 16V<br>2.0 HDi 110<br>2.0 HDi 95 | 51<br>51<br>66<br>102<br>80<br>69 | ORGA 09792<br>ORGA 09155<br>ORGA 09155<br>ORGA 09155<br>ORGA 09792<br>ORGA 09792<br>ORGA 09792 | 10.95<br>10.95<br>04.98<br>10.95<br>03.00<br>01.02<br>10.99 | + 0,8/0,9 t<br>+ 0,8/0,9 t<br>+ 0,8/0,9 t<br>+ 0,8/0,9 t<br>+ 0,8/0,9 t<br>+ 0,8/0,9 t | 24.3571-1709.5<br>24.3571-1710.5                                     | 240153<br>240154                     | <input type="checkbox"/><br><input type="checkbox"/>   | D=57, - Halter<br>D=57, - Halter                                   | LUC<br>LUC                         |  |
|  | 1.9 D<br>1.9 D 70<br>1.9 TD  | 51<br>51<br>66                    | ORGA 09156<br>ORGA 09156<br>ORGA 09156   | 12.06<br>12.06<br>12.06                                     | + 0,8/0,9 t<br>+ 0,8/0,9 t<br>+ 0,8/0,9 t  | 24.3571-1711.5<br>24.3571-1712.5                                     | 240159<br>240160                     | <input type="checkbox"/><br><input type="checkbox"/><br><input type="checkbox"/>                                 | D=57, - Halter<br>D=57, - Halter                                   | BDX<br>BDX                         |  |
|  | 1.6<br>2.0 16V<br>2.0 HDi 110<br>2.0 HDi 95                                | 102<br>80<br>69                   | ORGA 09793<br>ORGA 09793<br>ORGA 09793<br>ORGA 09793   | 12.06<br>12.06<br>12.06<br>12.06                            | + 0,8/0,9 t<br>+ 0,8/0,9 t<br>+ 0,8/0,9 t<br>+ 0,8/0,9 t                               | 24.3601-1711.7<br>24.3601-1712.7                                     | 220607<br>220608                     | <input type="checkbox"/><br><input type="checkbox"/><br><input type="checkbox"/><br><input type="checkbox"/>     | D=60, - Halter<br>D=60, - Halter                                   | LUC<br>LUC                         |  |
|  | 1.6<br>1.9 D<br>1.9 D 70<br>1.9 TD<br>2.0 16V<br>2.0 HDi 110<br>2.0 HDi 95 | 51<br>51<br>66<br>102<br>80<br>69 | ORGA 09792<br>ORGA 09792<br>ORGA 09792<br>ORGA 09792<br>ORGA 09792<br>ORGA 09792<br>ORGA 09792 | 10.95<br>10.95<br>04.98<br>10.95<br>03.00<br>01.02<br>10.99 | 12.06<br>12.06<br>12.06<br>12.06   |  | 24.5229-0251.3                       | 330535   | 2  | L=250                              |  |
|  | 1.6<br>2.0 16V<br>2.0 HDi 110<br>2.0 HDi 95                                | 102<br>80<br>69                   | ORGA 09793<br>ORGA 09793<br>ORGA 09793<br>ORGA 09793   | 12.06<br>12.06<br>12.06<br>12.06                            |  | 24.5111-0462.3   | 330555                               | 2  | L=460  |                                    |  |
|  | 1.6<br>1.9 D<br>1.9 D 70<br>1.9 TD<br>2.0 16V<br>2.0 HDi 110<br>2.0 HDi 95 | 51<br>51<br>66<br>102<br>80<br>69 |  | 10.95<br>10.95<br>04.98<br>10.95<br>03.00<br>01.02<br>10.99 | 12.06<br>12.06<br>12.06<br>12.06   |  | 24.5229-0251.3                       | 330535   | 2  | L=250                              |  |
|  | 1.6<br>1.9 D<br>1.9 D 70<br>1.9 TD<br>2.0 16V<br>2.0 HDi 110<br>2.0 HDi 95 | 51<br>51<br>66<br>102<br>80<br>69 |  | 10.95<br>10.95<br>04.98<br>10.95<br>03.00<br>01.02<br>10.99 | 12.06<br>12.06<br>12.06<br>12.06   | 24.3219-1704.3   | 020374                               |  | Rz 19,05   |                                    |  |
|  | 1.6<br>1.9 D<br>1.9 D 70<br>1.9 TD<br>2.0 16V<br>2.0 HDi 110<br>2.0 HDi 95 | 51<br>51<br>66<br>102<br>80<br>69 |  | 10.95<br>10.95<br>04.98<br>10.95<br>03.00<br>01.02<br>10.99 | 12.06<br>12.06<br>12.06<br>12.06   | 24.3727-0336.2<br>24.3727-0341.2<br>24.3727-0532.2<br>24.3727-0531.2 | 580336<br>580341<br>580532<br>580531 | 1 <input type="checkbox"/><br>1 <input type="checkbox"/><br><input type="checkbox"/><br><input type="checkbox"/> | - langer Radstand <sup>1)</sup><br>+ langer Radstand <sup>2)</sup> | L=500<br>L=900<br>L=1063<br>L=2286 |  |
|  | 1.6<br>1.9 D<br>1.9 D 70<br>1.9 TD<br>2.0 16V<br>2.0 HDi 110<br>2.0 HDi 95 | 51<br>51<br>66<br>102<br>80<br>69 |  | 10.95<br>10.95<br>04.98<br>10.95<br>03.00<br>01.02<br>10.99 | 12.06<br>12.09<br>12.06<br>12.06   | 24.3727-0336.2<br>24.3727-0341.2<br>24.3727-0532.2                   | 580336<br>580341<br>580532           | 1 <input type="checkbox"/><br>1 <input type="checkbox"/><br><input type="checkbox"/>                             | - langer Radstand <sup>1)</sup><br>+ langer Radstand <sup>2)</sup> | L=500<br>L=900<br>L=1063           |  |
|  | 1.6<br>1.6<br>1.9 D<br>1.9 D<br>1.9 D 70<br>1.9 D 70<br>1.9 TD<br>1.9 TD   | 51<br>51<br>51<br>51<br>66<br>66  | ORGA 08420<br>ORGA 08420<br>ORGA 08420<br>ORGA 08420<br>ORGA 08420                             | 10.95<br>10.95<br>10.95<br>04.98<br>04.98<br>10.95<br>10.95 | 12.06<br>12.06<br>12.06<br>12.06<br>12.06<br>12.06                                     | + ABS<br>- ABS<br>+ ABS<br>- ABS<br>+ ABS<br>+ ABS<br>- ABS          | 24.6582-1715.3                       | 320205   |  | BRL (4)                            |  |
|  | 1.6<br>2.0 16V   | 102                               |  | 10.95<br>03.00  | 12.06<br>12.06   | + BE3-Getriebe <sup>3)</sup>   | 24.3728-0341.2                       | 590341   |  | L=738, + AUT                       |  |
|  | 1.6<br>1.9 D 70<br>2.0 16V   | 51<br>51<br>102                   |  | 10.95<br>04.98<br>03.00                                     | 12.06<br>12.06<br>12.06  | + BE4-Getriebe <sup>4)</sup>   | 24.3728-0336.2                       | 590336   |  | L=973, + AUT                       |  |
|  | 2.0 HDi 110<br>2.0 HDi 95  | 80<br>69                          |  | 01.02<br>10.99  | 12.06<br>12.06   | + ME5K-Getriebe <sup>5)</sup><br>+ ML5T-Getriebe <sup>6)</sup>       | 24.3728-0342.2<br>24.3728-0340.2     | 590342<br>590340   | + ME5K-Getriebe <sup>5)</sup><br>+ ML5T-Getriebe <sup>6)</sup>     | L=863, + AUT<br>L=1088, + AUT      |  |
|  | 2.0 HDi 110<br>2.0 HDi 95  | 80<br>69                          |  | 01.02<br>10.99  | 12.06<br>12.06   | + ML5-Getriebe <sup>7)</sup>   | 24.3728-0340.2                       | 590340   | + ML5-Getriebe <sup>7)</sup>                                       | L=1088, + AUT                      |  |

1) - long wheel base / - passo lungo / - empattement long / - distancia larga entre ejes  
2) + long wheel base / + passo lungo / + empattement long / + distancia larga entre ejes  
3) + BE3 transmission / + scatola cambio BE3 / + boîte de vitesse BE3 / + cambio BE3  
4) + BE4 transmission / + scatola cambio BE4 / + boîte de vitesse BE4 / + cambio BE4  
5) + ME5K transmission / + scatola cambio ME5K / + boîte de vitesse ME5K / + cambio ME5K  
6) + ML5T transmission / + scatola cambio ML5T / + boîte de vitesse ML5T / + cambio ML5T  
7) + ML5 transmission / + scatola cambio ML5 / + boîte de vitesse ML5 / + cambio ML5



|     |  |  |  |  |  |  |  |       |                |
|--|--|--|--|--|---|--|--|---|----------------|
| <b>CITROEN JUMPY Pritsche/Fahrgestell (99-06)</b>                                  |  |  |  |  |   |  |  |   |                |
|    | 1.9 TD   | 68   |  | 10.99  | 12.06   | 24.2122-1741.3   | 010695   | - ABS/ + 0,8 t  | THz 22,20      |
|  | 2.0 HDi  | 69   |  | 10.99  | 12.06   | 24.2122-1742.3   | 010696   | + ABS/ + 0,8 t  | THz 22,20      |
|    | 1.9 TD   | 68   | ORGA 09792   | 10.99  |   | 24.2123-1738.3   | 010658   | - ABS/ + 0,9 t  | THz 23,81      |
|  | 2.0 HDi  | 69   | ORGA 09792   | 10.99  |   | 24.2123-1733.3   | 010657   | + ABS/ + 0,9 t  | THz 23,81      |
|    | 1.9 TD   | 68   | ORGA 09793   |  | 12.06   | 24.3571-1709.5   | 240153   |      | D=57, - Halter |
|  | 2.0 HDi  | 69   | ORGA 09793   |  | 12.06   | 24.3571-1710.5   | 240154   |   | D=57, - Halter |
|    | 1.9 TD   | 68   | ORGA 09792   | 10.99  |   | 24.3601-1711.7   | 220607   |      | D=60, - Halter |
|  | 2.0 HDi  | 69   | ORGA 09792   | 10.99  |   | 24.3601-1712.7   | 220608   |   | D=60, - Halter |
|    | 1.9 TD   | 68   | ORGA 09792   | 10.99  |   | 24.5118-0471.3   | 330528   | 2   | L=473          |
|  | 2.0 HDi  | 69   | ORGA 09792   | 10.99  |   |  |  |   |                |
|    | 1.9 TD   | 68   | ORGA 09793   |  | 12.06   | 24.5111-0462.3   | 330555   | 2   | L=460          |
|  | 2.0 HDi  | 69   | ORGA 09793   |  | 12.06   |  |  |   |                |
|   | 1.9 TD   | 68   |  | 10.99  | 12.06   | 24.5229-0251.3   | 330535   | 2   | L=250          |
|  | 2.0 HDi  | 69   |  | 10.99  | 12.06   |  |  |   |                |
|  | 1.9 TD   | 68   |  | 10.99  | 12.06   | 24.3219-1704.3   | 020374   |   | Rz 19,05       |
|  | 2.0 HDi  | 69   |  | 10.99  | 12.06   |  |  |   |                |
|  | 1.9 TD   | 68   |  | 10.99  | 12.06   | 24.3727-0336.2   | 580336   | 1    | L=500          |
|  | 2.0 HDi  | 69   |  | 10.99  | 12.06   | 24.3727-0341.2   | 580341   | 1    | L=900          |
|  | 1.9 TD   | 68   |  | 10.99  | 12.06   | 24.3727-0532.2   | 580532   | 1    | L=1063         |
|  | 2.0 HDi  | 69   |  | 10.99  | 12.06   | 24.3727-0531.2   | 580531   | 1    | L=2286         |
|  | 1.9 TD   | 68   | ORGA 08420   | 10.99  |   | 24.3727-0336.2   | 580336   | 1  | L=500          |
|  | 2.0 HDi  | 69   | ORGA 08420   | 10.99  |   | 24.3727-0341.2   | 580341   | 1  | L=900          |
|  | 1.9 TD   | 68   |  | 10.99  | 12.06   | 24.3727-0532.2   | 580532   | 1  | L=1063         |
|  | 2.0 HDi  | 69   |  | 10.99  | 12.06   | 24.6582-1715.3   | 320205   |   | BRL (4)        |
|  | 1.9 TD   | 68   |  | 10.99  | 12.06   | 24.3728-0342.2   | 590342   |   | L=863, + AUT   |
|  | 2.0 HDi  | 69   |  | 10.99  | 12.06   | 24.3728-0340.2   | 590340   |   | L=1088, + AUT  |
|  | 1.9 TD   | 68   |  | 10.99  | 12.06   | 24.3728-0333.2   | 590333   |   | L=1003, + AUT  |
|  | 2.0 HDi  | 69   |  | 10.99  | 12.06   |  |  |   |                |
| <b>CITROEN JUMPY (07-)</b>   |  |  |  |  |   |  |  |   |                |
|    | 1.6 HDi 90   | 66   |  | 01.07  |   | 03.2125-0298.3   | 010818   | - ESP   | THz 25,40      |
|  | 2.0 HDi 120  | 88   |  | 01.07  |   | 03.2125-0293.3   | 010817   | + ESP   | THz 25,40      |
|  | 2.0 HDi 125  | 94   |  | 07.11  |   |  |  |   |                |
|  | 2.0 HDi 140  | 100  |  | 01.07  |   |  |  |   |                |
|  | 2.0 HDi 165  | 120  |  | 07.10  |   |  |  |   |                |
|  | 2.0 HDi 95   | 72   |  | 07.11  |   |  |  |   |                |
|  | 2.0 i  | 103  |  | 01.07  |   |  |  |   |                |
|  | 1.6 HDi 90   | 66   |  | 01.07  |   | 24.5144-0455.3   | 331201   | 2   | L=455          |
|  | 2.0 HDi 120  | 88   |  | 01.07  |   |  |  |   |                |
|  | 2.0 HDi 125  | 94   |  | 07.11  |   |  |  |   |                |
|  | 2.0 HDi 140  | 100  |  | 01.07  |   |  |  |   |                |
|  | 2.0 HDi 165  | 120  |  | 07.10  |   |  |  |   |                |
|  | 2.0 HDi 95   | 72   |  | 07.11  |   |  |  |   |                |
|  | 2.0 i  | 103  |  | 01.07  |   |  |  |   |                |
|  | 1.6 HDi 90   | 66   |  | 01.07  |   | 24.3414-1715.5   | 240589   |    | D=41, - Halter |
|  | 2.0 HDi 120  | 88   |  | 01.07  |   | 24.3414-1716.5   | 240590   |   | D=41, - Halter |
|  | 2.0 HDi 125  | 94   |  | 07.11  |   |  |  |   |                |
|  | 2.0 HDi 140  | 100  |  | 01.07  |   |  |  |   |                |
|  | 2.0 HDi 165  | 120  |  | 07.10  |   |  |  |   |                |
|  | 2.0 HDi 95   | 72   |  | 07.11  |   |  |  |   |                |
|  | 2.0 i  | 103  |  | 01.07  |   |  |  |   |                |
|  | 1.6 HDi 90   | 66   | ORGA 10933   | 01.07  |   | 24.5239-0260.3   | 331171   | 2   | L=260          |
|  | 2.0 HDi 120  | 88   | ORGA 10933   | 01.07  |   | 24.5239-0365.3   | 331281   | 2   | L=365          |
|  | 2.0 HDi 140  | 100  | ORGA 10933   | 01.07  |   |  |  |   |                |
|  | 2.0 HDi 165  | 120  | ORGA 10933   | 07.10  |   |  |  |   |                |
|  | 2.0 i  | 103  | ORGA 10933   | 01.07  |   |  |  |   |                |
|  | 1.6 HDi 90   | 66   | ORGA 10934   |  |   | 24.5239-0240.3   | 331170   | 2   | L=240          |
|  | 2.0 HDi 120  | 88   | ORGA 10934   |  |   | 24.5239-0355.3   | 331243   | 2   | L=355          |
| 2.0 HDi 125  | 94   |  | 07.11  |  |   |  |  |   |                |
| 2.0 HDi 140  | 100  | ORGA 10934   |  |  |   |  |  |   |                |
| 2.0 HDi 165  | 120  | ORGA 10934   |  |  |   |  |  |   |                |
| 2.0 HDi 95   | 72   |  | 07.11  |  |   |  |  |   |                |
| 2.0 i  | 103  | ORGA 10934   |  |  |   |  |  |   |                |
|  | 1.6 HDi 90   | 66   |  | 01.07  |   | 24.3222-1726.3   | 020518   |   | Rz 22,20       |
|  |  |  |  |  |   |  |  |   | LUC            |
| <b>CITROEN NEMO (08-)</b>  |  |  |  |  |   |  |  |   |                |
|  | 1.3 HDi 75   | 55   |  | 10.10  |   | 24.5228-0181.3   | 331279   | 2   | L=180          |
|  | 1.4 HDi  | 50   |  | 02.08  |   |  |  |   |                |
|  | 1.4 i  | 54   |  | 02.08  |   |  |  |   |                |
|  | 1.3 HDi 75   | 55   |  | 10.10  |   | 24.3220-1728.3   | 020509   |   | Rz 20,64       |
|  | 1.4 HDi  | 50   |  | 02.08  |   |  |  |   |                |
|  | 1.4 i  | 54   |  | 02.08  |   |  |  |   |                |

1) - long wheel base / - passo lungo / - empattement long / - distancia larga entre ejes  
2) + long wheel base / + passo lungo / + empattement long / + distancia larga entre ejes  
3) + ME5K transmission / + scatola cambio ME5K / + boîte de vitesse ME5K / + cambio ME5K  
4) + ML5T transmission / + scatola cambio ML5T / + boîte de vitesse ML5T / + cambio ML5T  
5) + ML5 transmission / + scatola cambio ML5 / + boîte de vitesse ML5 / + cambio ML5  
6) + short wheel base / + passo lungo / + empattement court / + distancia corta entre ejes

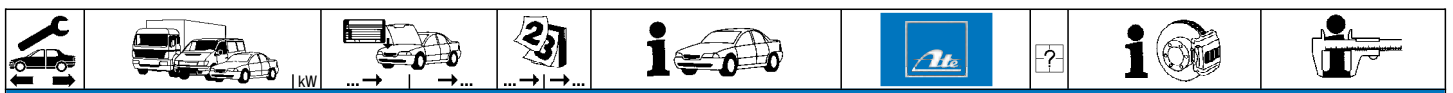

**CITROEN SAXO (96-04)**

|               |             |            |            |       |                |                |                          |                                |                                |                |        |       |           |     |
|---------------|-------------|------------|------------|-------|----------------|----------------|--------------------------|--------------------------------|--------------------------------|----------------|--------|-------|-----------|-----|
|               | 1.0 i       |            |            | 02.96 | 03.04          | 03.7740-3302.4 | 300107                   | - ABS                          | 8"                             | ATE            |        |       |           |     |
|               | 1.1 X/SX    |            |            | 02.96 | 03.04          |                |                          |                                |                                |                |        |       |           |     |
|               | 1.5 D       | 43         |            | 07.01 | 04.04          |                |                          |                                |                                |                |        |       |           |     |
|               | 1.6         | 66         |            | 02.96 | 06.03          |                |                          |                                |                                |                |        |       |           |     |
|               | 1.6         | 74         |            | 02.01 | 04.04          |                |                          |                                |                                |                |        |       |           |     |
|               | 1.6         | 88         |            | 02.96 | 04.04          |                |                          |                                |                                |                |        |       |           |     |
|               | 1.6 16V VTS | 87         |            | 07.96 | 03.04          |                |                          |                                |                                |                |        |       |           |     |
|               | 1.6 i       | 65         |            | 02.96 | 03.04          |                |                          |                                |                                |                |        |       |           |     |
|               | 1.6 i VTS   | 72         |            | 09.00 | 03.04          |                |                          |                                |                                |                |        |       |           |     |
|               | 1.6         | 66         |            | 02.96 | 06.03          |                |                          |                                |                                |                |        |       |           |     |
| 1.6           | 74          |            | 02.01      | 04.04 |                |                |                          |                                |                                |                |        |       |           |     |
| 1.6           | 88          |            | 02.96      | 04.04 |                |                |                          |                                |                                |                |        |       |           |     |
| 1.6 16V VTS   | 87          |            | 07.96      | 03.04 |                |                |                          |                                |                                |                |        |       |           |     |
| 1.6 i         | 65          |            | 02.96      | 03.04 |                |                |                          |                                |                                |                |        |       |           |     |
| 1.6 i VTS     | 72          |            | 09.00      | 03.04 |                |                |                          |                                |                                |                |        |       |           |     |
|               | 1.0 i       |            |            | 02.96 | 03.04          | 03.2120-4166.3 | 010452                   | für 3-Loch-Felge <sup>1)</sup> | THz 20,64                      | ATE            |        |       |           |     |
|               | 1.1 X/SX    |            |            | 02.96 | 03.04          |                |                          |                                |                                |                |        |       |           |     |
|               | 1.4 i VTS   | 55         |            | 02.96 | 03.04          |                |                          |                                |                                |                |        |       |           |     |
|               | 1.5 D       | 43         |            | 04.96 | 03.04          |                |                          |                                |                                |                |        |       |           |     |
|               | 1.5 D       | 66         |            | 07.01 | 04.04          |                |                          |                                |                                |                |        |       |           |     |
|               | 1.6         | 74         |            | 02.96 | 06.03          |                |                          |                                |                                |                |        |       |           |     |
|               | 1.6         | 88         |            | 02.01 | 04.04          |                |                          |                                |                                |                |        |       |           |     |
|               | 1.6         | 88         |            | 02.96 | 04.04          |                |                          |                                |                                |                |        |       |           |     |
|               | 1.6 16V VTS | 87         |            | 07.96 | 03.04          |                |                          |                                |                                |                |        |       |           |     |
|               | 1.6 i       | 65         |            | 02.96 | 03.04          |                |                          |                                |                                |                |        |       |           |     |
| 1.6 i VTS     | 72          |            | 09.00      | 03.04 |                |                |                          |                                |                                |                |        |       |           |     |
| 1.4 i VTS     | 55          |            | 02.96      | 03.04 | 03.2120-4166.3 | 010452         | - ABS                    | THz 20,64                      | ATE                            |                |        |       |           |     |
| 1.5 D         | 43          |            | 04.96      | 03.04 |                |                |                          |                                |                                |                |        |       |           |     |
| 1.5 D         | 66          |            | 07.01      | 04.04 |                |                |                          |                                |                                |                |        |       |           |     |
| 1.6           | 74          |            | 02.96      | 06.03 |                |                |                          |                                |                                |                |        |       |           |     |
| 1.6           | 88          |            | 02.01      | 04.04 |                |                |                          |                                |                                |                |        |       |           |     |
| 1.6           | 88          |            | 02.96      | 04.04 |                |                |                          |                                |                                |                |        |       |           |     |
| 1.6 16V VTS   | 87          |            | 07.96      | 03.04 |                |                |                          |                                |                                |                |        |       |           |     |
| 1.6 i         | 65          |            | 02.96      | 03.04 |                |                |                          |                                |                                |                |        |       |           |     |
| 1.6 i VTS     | 72          |            | 09.00      | 03.04 |                |                |                          |                                |                                |                |        |       |           |     |
| 1.6           | 66          |            | 02.96      | 06.03 |                |                |                          |                                |                                | 03.2122-1281.3 | 010606 | + ABS | THz 22,20 | ATE |
| 1.6           | 74          |            | 02.01      | 04.04 |                |                |                          |                                |                                |                |        |       |           |     |
| 1.6           | 88          |            | 02.96      | 04.04 |                |                |                          |                                |                                |                |        |       |           |     |
| 1.6 16V VTS   | 87          |            | 07.96      | 03.04 |                |                |                          |                                |                                |                |        |       |           |     |
| 1.6 i VTL/VTR | 65          |            | 02.96      | 03.04 |                |                |                          |                                |                                |                |        |       |           |     |
| 1.6 i VTS     | 72          |            | 09.00      | 03.04 |                |                |                          |                                |                                |                |        |       |           |     |
| 1.0 i         |             |            | 02.96      | 03.04 | 11.0441-4501.2 | 250015         |                          | Dichtungssatz                  | ATE                            |                |        |       |           |     |
| 1.1 X/SX      |             |            | 02.96      | 03.04 |                |                |                          |                                |                                |                |        |       |           |     |
| 1.4 i VTS     | 55          |            | 05.96      | 03.04 | 11.3481-9833.2 | 220561         | <input type="checkbox"/> | D=48, - Halter                 | ATE                            |                |        |       |           |     |
| 1.6           | 66          |            | 02.96      | 06.03 |                |                |                          |                                |                                |                |        |       |           |     |
| 1.6           | 74          |            | 02.01      | 04.04 | 24.3481-9833.5 | 240479         | <input type="checkbox"/> | D=48, - Halter                 | ATE                            |                |        |       |           |     |
| 1.6           | 88          |            | 02.96      | 04.04 |                |                |                          |                                |                                |                |        |       |           |     |
| 1.6 16V VTS   | 87          |            | 07.96      | 03.04 | 11.0441-4811.2 | 250024         | <input type="checkbox"/> | Dichtungssatz                  | ATE                            |                |        |       |           |     |
| 1.6 i         | 65          |            | 02.96      | 03.04 |                |                |                          |                                |                                |                |        |       |           |     |
| 1.6 i VTS     | 72          |            | 09.00      | 03.04 | 11.8171-0008.1 | 990049         | <input type="checkbox"/> | Führungsbolzen                 | ATE                            |                |        |       |           |     |
|               |             |            |            |       |                |                |                          |                                |                                |                |        |       |           |     |
|               |             |            |            |       | 11.8116-0129.1 | 390591         | 2                        | Haltefeder                     | ATE                            |                |        |       |           |     |
|               |             |            |            |       |                |                |                          |                                |                                |                |        |       |           |     |
|               | 1.0 i       |            | ORGA 08093 | 02.96 |                | 24.5111-0330.3 | 330160                   | für 3-Loch-Felge <sup>1)</sup> | L=330                          | ATE            |        |       |           |     |
|               | 1.1 X/SX    |            | ORGA 08093 | 02.96 |                |                |                          |                                |                                |                |        |       |           |     |
|               | 1.4 i VTS   | 55         | ORGA 08093 | 02.96 |                |                |                          |                                |                                |                |        |       |           |     |
|               | 1.5 D       | 43         | ORGA 08093 | 04.96 |                |                |                          |                                |                                |                |        |       |           |     |
|               | 1.5 D       | 66         | ORGA 08093 | 07.01 |                |                |                          |                                |                                |                |        |       |           |     |
|               | 1.6         | 74         | ORGA 08093 | 02.96 |                |                |                          |                                |                                |                |        |       |           |     |
|               | 1.6         | 88         | ORGA 08093 | 02.96 |                |                |                          |                                |                                |                |        |       |           |     |
|               | 1.6 16V VTS | 87         | ORGA 08093 | 07.96 |                |                |                          |                                |                                |                |        |       |           |     |
|               | 1.6 i       | 65         | ORGA 08093 | 02.96 |                |                |                          |                                |                                |                |        |       |           |     |
|               | 1.6 i VTS   | 72         | ORGA 08093 | 02.96 |                |                |                          |                                |                                |                |        |       |           |     |
| 1.0 i         |             | ORGA 08094 |            | 03.04 | 24.5111-0290.3 | 330108         | 2                        | L=290                          | ATE                            |                |        |       |           |     |
| 1.1 X/SX      |             | ORGA 08094 |            | 03.04 |                |                |                          |                                |                                |                |        |       |           |     |
| 1.4 i VTS     | 55          | ORGA 08094 |            | 03.04 |                |                |                          |                                |                                |                |        |       |           |     |
| 1.5 D         | 43          | ORGA 08094 |            | 03.04 |                |                |                          |                                |                                |                |        |       |           |     |
| 1.5 D         | 66          | ORGA 08094 |            | 04.04 |                |                |                          |                                |                                |                |        |       |           |     |
| 1.6           | 74          |            | 02.01      | 04.04 |                |                |                          |                                |                                |                |        |       |           |     |
| 1.6           | 88          | ORGA 08094 |            | 04.04 |                |                |                          |                                |                                |                |        |       |           |     |
| 1.6 16V VTS   | 87          | ORGA 08094 |            | 03.04 |                |                |                          |                                |                                |                |        |       |           |     |
| 1.6 i         | 65          | ORGA 08094 |            | 03.04 |                |                |                          |                                |                                |                |        |       |           |     |
| 1.6 i VTS     | 72          |            | 09.00      | 03.04 |                |                |                          |                                |                                |                |        |       |           |     |
|               | 1.0 i       |            |            | 02.96 | 03.04          | 24.5229-0199.3 | 330534                   | 2                              | L=200                          | ATE            |        |       |           |     |
|               | 1.1 X/SX    |            |            | 02.96 | 03.04          |                |                          |                                |                                |                |        |       |           |     |
|               | 1.4 i VTS   | 55         |            | 02.96 | 03.04          |                |                          |                                |                                |                |        |       |           |     |
|               | 1.5 D       | 43         |            | 04.96 | 03.04          |                |                          |                                |                                |                |        |       |           |     |
|               | 1.5 D       | 66         |            | 07.01 | 04.04          |                |                          |                                |                                |                |        |       |           |     |
|               | 1.6         | 74         |            | 02.96 | 06.03          |                |                          |                                |                                |                |        |       |           |     |
|               | 1.6         | 88         |            | 02.01 | 04.04          |                |                          |                                |                                |                |        |       |           |     |
|               | 1.6         | 88         |            | 02.96 | 04.04          |                |                          |                                |                                |                |        |       |           |     |
|               | 1.6 16V VTS | 87         |            | 07.96 | 03.04          |                |                          |                                |                                |                |        |       |           |     |
|               | 1.6 i       | 65         |            | 02.96 | 03.04          |                |                          |                                |                                |                |        |       |           |     |
| 1.6 i VTS     | 72          |            | 09.00      | 03.04 |                |                |                          |                                |                                |                |        |       |           |     |
|               | 1.0 i       |            |            | 02.96 | 03.04          | 24.3219-1603.3 | 020200                   | <input type="checkbox"/>       | für 3-Loch-Felge <sup>1)</sup> | RzR 19,05      |        |       |           |     |
|               | 1.1 X/SX    |            |            | 02.96 | 03.04          |                |                          |                                |                                |                |        |       |           |     |
|               |             |            |            |       |                |                |                          |                                |                                |                |        |       |           |     |
|               |             |            |            |       |                |                |                          |                                |                                |                |        |       |           |     |
|               |             |            |            |       | 24.3219-1604.3 | 020201         | <input type="checkbox"/> | für 3-Loch-Felge <sup>1)</sup> | RzR 19,05                      |                |        |       |           |     |
|               |             |            |            |       |                |                |                          |                                |                                |                |        |       |           |     |
|               |             |            |            |       |                |                |                          |                                |                                |                |        |       |           |     |
|               |             |            |            |       |                |                |                          |                                |                                |                |        |       |           |     |
|               |             |            |            |       | 24.3219-1609.3 | 020319         | <input type="checkbox"/> | für 4-Loch-Felge <sup>2)</sup> | RzR 19,05                      |                |        |       |           |     |
|               |             |            |            |       |                |                |                          |                                |                                |                |        |       |           |     |
|               |             |            |            |       | 24.3219-1610.3 | 020320         | <input type="checkbox"/> | für 4-Loch-Felge <sup>2)</sup> | RzR 19,05                      |                |        |       |           |     |
|               |             |            |            |       |                |                |                          |                                |                                |                |        |       |           |     |

<sup>1)</sup> for 3 bore wheel rim / per cerchione a 3 fori / pour jante à 3 trous / para Llantas de 3 taladros

<sup>2)</sup> for 4 bore wheel rim / per cerchione a 4 fori / pour jante à 4 trous / para Llantas de 4 taladros





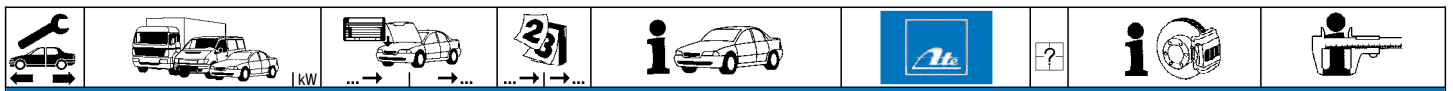

























**CITROEN SAXO (96-04)**

|          |                  |            |            |       |       |       |                |                |                          |  |           |          |
|----------|------------------|------------|------------|-------|-------|-------|----------------|----------------|--------------------------|--|-----------|----------|
|          | 1.4 i VTS        | 55         |            | 02.96 | 03.04 | - ABS | 24.3219-1609.3 | 020319         | <input type="checkbox"/> |  | RzR 19,05 |          |
|          | 1.5 D            |            |            | 04.96 | 03.04 | - ABS | 24.3219-1610.3 | 020320         | <input type="checkbox"/> |  | RzR 19,05 |          |
|          | 1.5 D            | 43         |            | 07.01 | 04.04 | - ABS |                |                |                          |  |           |          |
|          | 1.6              | 66         |            | 02.96 | 06.03 | - ABS |                |                |                          |  |           |          |
|          | 1.6 i SX/VTL/VSX | 65         |            | 02.96 | 03.04 | - ABS |                |                |                          |  |           |          |
|          | 1.0 i            |            | ORGA 08095 | 02.96 |       | + ABS | 24.3220-1711.3 | 020409         |                          |  | Rz 20,64  | LUC      |
|          | 1.1 X/SX         |            | ORGA 08095 | 02.96 |       | + ABS |                |                |                          |  |           |          |
|          | 1.4 i VTS        | 55         | ORGA 08095 | 02.96 |       | + ABS |                |                |                          |  |           |          |
|          | 1.5 D            | 43         | ORGA 08095 | 04.96 |       | + ABS |                |                |                          |  |           |          |
|          | 1.5 D            | 66         | ORGA 08095 | 07.01 |       | + ABS |                |                |                          |  |           |          |
|          | 1.6              | 66         | ORGA 08095 | 02.96 |       | + ABS |                |                |                          |  |           |          |
|          | 1.6 i SX/VTL/VSX | 65         | ORGA 08095 | 02.96 |       | + ABS |                |                |                          |  |           |          |
|          | 1.0 i            |            | ORGA 08096 |       |       | 03.04 | + ABS          | 24.3220-1717.3 | 020430                   |  |           | Rz 20,64 |
| 1.1 X/SX |                  | ORGA 08096 |            |       | 03.04 | + ABS |                |                |                          |  |           |          |
|          | 1.4 i VTS        | 55         | ORGA 08096 |       |       | 03.04 | + ABS          |                |                          |  |           |          |
|          | 1.5 D            |            | ORGA 08096 |       |       | 03.04 | + ABS          |                |                          |  |           |          |
|          | 1.5 D            | 43         | ORGA 08096 |       |       | 04.04 | + ABS          |                |                          |  |           |          |
|          | 1.6              | 66         | ORGA 08096 |       |       | 04.04 | + ABS          |                |                          |  |           |          |
|          | 1.6 i SX/VTL/VSX | 65         | ORGA 08096 |       |       | 03.04 | + ABS          |                |                          |  |           |          |
|          | 1.0 i            |            |            | 02.96 | 03.04 |       | 24.3727-0816.2 | 580816         | <input type="checkbox"/> |  | L=1442    |          |
|          | 1.1 X/SX         |            |            | 02.96 | 03.04 |       |                |                |                          |  |           |          |
|          | 1.4 i VTS        | 55         |            | 02.96 | 03.04 |       |                |                |                          |  |           |          |
|          | 1.5 D            | 43         |            | 04.96 | 03.04 |       |                |                |                          |  |           |          |
|          | 1.5 D            | 66         |            | 07.01 | 04.04 |       |                |                |                          |  |           |          |
|          | 1.6              | 66         |            | 02.96 | 06.03 |       | 24.3727-0817.2 | 580817         | <input type="checkbox"/> |  | L=1505    |          |
|          | 1.6              | 74         |            | 02.01 | 04.04 |       |                |                |                          |  |           |          |
|          | 1.6              | 88         |            | 02.96 | 04.04 |       |                |                |                          |  |           |          |
|          | 1.6 16V VTS      | 87         |            | 07.96 | 03.04 |       |                |                |                          |  |           |          |
|          | 1.6 i VTR        | 65         |            | 02.96 | 03.04 |       |                |                |                          |  |           |          |
|          | 1.6 i VTS        | 72         |            | 09.00 | 03.04 |       |                |                |                          |  |           |          |
|          | 1.0 i            |            |            | 02.96 | 03.04 |       | 24.3728-0313.2 | 590313         |                          |  | L=673     |          |
|          | 1.1 X/SX         |            |            | 02.96 | 03.04 |       |                |                |                          |  |           |          |
|          | 1.4 i VTS        | 55         |            | 02.96 | 03.04 |       |                |                |                          |  |           |          |
|          | 1.6              | 66         |            | 02.96 | 06.03 |       |                |                |                          |  |           |          |
|          | 1.6              | 88         |            | 02.96 | 04.04 |       |                |                |                          |  |           |          |
|          | 1.6 16V VTS      | 87         |            | 07.96 | 03.04 |       | 24.3728-0315.2 | 590315         |                          |  | L=673     |          |
|          | 1.6 i            | 65         |            | 02.96 | 03.04 |       |                |                |                          |  |           |          |
|          | 1.5 D            |            |            | 04.96 | 03.04 |       |                |                |                          |  |           |          |
|          | 1.5 D            | 43         |            | 07.01 | 04.04 |       |                |                |                          |  |           |          |
|          | 1.6 i VTS        | 72         |            | 02.01 | 04.04 |       |                |                |                          |  |           |          |

**CITROEN XANTIA (X1) Limousine (93-97)**

|         |           |       |            |       |       |       |                |                |                          |                          |                |        |
|---------|-----------|-------|------------|-------|-------|-------|----------------|----------------|--------------------------|--------------------------|----------------|--------|
|         | 2.0 Turbo | 108   | ORGA 06901 | 06.95 |       |       | 24.3572-1703.7 | 220375         | <input type="checkbox"/> |                          | D=57, - Halter | BDX    |
|         | 2.1 TD    | 80    | ORGA 06901 | 06.95 |       |       |                |                |                          |                          |                |        |
|         | 3.0 V6    | 140   |            | 01.97 | 12.97 |       | 24.3602-1701.7 | 220509         | <input type="checkbox"/> |                          | D=60, - Halter | BDX    |
|         | 1.6 i     | 65    |            | 03.93 | 12.97 |       | 24.5111-0355.3 | 330757         | 2                        |                          | L=360          |        |
|         | 1.8 16V   | 81    |            | 06.95 | 12.97 |       | 24.5111-0375.3 | 331128         | 2                        |                          | L=375          |        |
|         | 1.8 i     | 66    |            | 04.97 | 12.97 |       |                |                |                          |                          |                |        |
|         | 1.8 i     | 74    |            | 03.93 | 12.97 |       |                |                |                          |                          |                |        |
|         | 1.9 D     | 50    |            | 06.94 | 12.97 |       |                |                |                          |                          |                |        |
|         | 1.9 D     | 51    |            | 06.94 | 12.97 |       |                |                |                          |                          |                |        |
|         | 1.9 SD    | 55    |            | 02.96 | 12.97 |       |                |                |                          |                          |                |        |
|         | 1.9 TD    | 66    |            | 10.94 | 12.97 |       |                |                |                          |                          |                |        |
|         | 2.0       | 95    |            | 03.93 | 05.95 |       |                |                |                          |                          |                |        |
|         | 2.0 16V   | 97    |            | 06.95 | 12.97 |       |                |                |                          |                          |                |        |
|         | 2.0 16V   | 110   |            | 06.94 | 12.97 |       |                |                |                          |                          |                |        |
|         | 2.0 16V   | 112   |            | 03.93 | 12.97 |       |                |                |                          |                          |                |        |
|         | 2.0 i     | 89    |            | 03.93 | 12.97 |       |                |                |                          |                          |                |        |
|         | 2.0 Turbo | 108   |            | 06.95 | 12.97 |       |                |                |                          |                          |                |        |
|         | 2.1 TD    | 80    |            | 06.95 | 12.97 |       |                |                |                          |                          |                |        |
|         | 3.0 V6    | 140   |            | 01.97 | 12.97 |       |                |                |                          |                          |                |        |
|         |           | 1.6 i | 65         |       | 03.93 | 12.97 |                | 24.3727-0312.2 | 580312                   | <input type="checkbox"/> |                | L=1262 |
| 1.8 16V |           | 81    |            | 06.95 | 12.97 |       | 24.3727-0311.2 | 580311         | <input type="checkbox"/> |                          | L=1333         |        |
| 1.8 i   |           | 66    |            | 04.97 | 12.97 |       |                |                |                          |                          |                |        |
| 1.8 i   |           | 74    |            | 03.93 | 12.97 |       |                |                |                          |                          |                |        |
| 1.9 D   |           | 50    |            | 06.94 | 12.97 |       |                |                |                          |                          |                |        |
| 1.9 D   |           | 51    |            | 06.94 | 12.97 |       |                |                |                          |                          |                |        |
| 1.9 SD  |           | 55    |            | 02.96 | 12.97 |       |                |                |                          |                          |                |        |
| 1.9 TD  |           | 66    |            | 10.94 | 12.97 |       |                |                |                          |                          |                |        |
| 2.0     |           | 95    |            | 03.93 | 05.95 |       |                |                |                          |                          |                |        |
| 2.0 16V |           | 97    |            | 06.95 | 12.97 |       |                |                |                          |                          |                |        |
| 2.0 16V |           | 110   |            | 06.94 | 12.97 |       |                |                |                          |                          |                |        |
| 2.0 16V |           | 112   |            | 03.93 | 12.97 |       |                |                |                          |                          |                |        |
| 2.0 i   |           | 89    |            | 03.93 | 12.97 |       |                |                |                          |                          |                |        |
|         | 2.0 Turbo | 108   |            | 06.95 | 12.97 |       | 24.3727-0330.2 | 580330         | <input type="checkbox"/> |                          | L=1313         |        |
|         | 2.1 TD    | 80    |            | 06.95 | 12.97 |       | 24.3727-0311.2 | 580311         | <input type="checkbox"/> |                          | L=1333         |        |
|         | 3.0 V6    | 140   |            | 01.97 | 12.97 |       | 24.3727-0330.2 | 580330         | <input type="checkbox"/> |                          | L=1313         |        |
|         | 1.6 i     | 65    |            | 03.93 | 12.97 |       | 24.3728-0310.2 | 590310         |                          |                          | L=778          |        |
|         | 1.8 16V   | 81    |            | 06.95 | 12.97 |       |                |                |                          |                          |                |        |



|     |   |  |  |                 |                                        |  |  |  |  |                                  |                          |
|--|---|--|--|---|---|--|--|--|--|----------------------------------|--------------------------|
| <b>CITROEN XANTIA (X1) Limousine (93-97)</b>                                       |   |  |  |   |   |  |  |  |  |                                  |                          |
|    | 1.9 D<br>2.0 i  | 51<br>89   |  | 06.94<br>03.93  | 04.95<br>12.97  |  | 24.3728-0310.2   | 590310   | L=778  |                                  |                          |
| <b>CITROEN XANTIA (X1) Kombi (95-97)</b>   |   |  |  |   |   |  |  |  |  |                                  |                          |
|    | 1.8 16V<br>1.8 i<br>1.8 i<br>1.9 SD<br>1.9 TD<br>2.0 16V<br>2.0 i<br>2.0 Turbo<br>2.1 TD  | 81<br>66<br>74<br>55<br>66<br>97<br>89<br>108<br>80                              |  | 06.95<br>04.97<br>06.95<br>04.97<br>06.95<br>06.95<br>06.95<br>06.95<br>06.96                   | 12.97<br>12.97<br>12.97<br>12.97<br>12.97<br>12.97<br>12.97<br>12.97<br>12.97   |  | 24.5111-0355.3<br>24.5111-0375.3   | 330757<br>331128   | 2<br>2   | L=360<br>L=375                   |                          |
|    | 1.8 16V<br>1.8 i<br>1.8 i<br>1.9 SD<br>1.9 TD<br>2.0 16V<br>2.0 i   | 81<br>66<br>74<br>55<br>66<br>97<br>89   |  | 06.95<br>04.97<br>06.95<br>04.97<br>06.95<br>06.95<br>06.95                                     | 12.97<br>12.97<br>12.97<br>12.97<br>12.97<br>12.97<br>12.97   |  | 24.3727-0312.2<br>24.3727-0311.2   | 580312<br>580311   | <input type="checkbox"/><br><input type="checkbox"/>                             | L=1262<br>L=1333                 |                          |
|    | 2.0 Turbo<br>2.1 TD   | 108<br>80  |  | 06.95<br>06.96  | 12.97<br>12.97  |  | 24.3727-0330.2<br>24.3727-0311.2   | 580330<br>580311   | <input type="checkbox"/><br><input type="checkbox"/>                             | L=1313<br>L=1333                 |                          |
|    | 1.8 16V<br>1.8 i<br>1.8 i<br>2.0 i  | 81<br>66<br>74<br>89   |  | 06.95<br>04.97<br>06.95<br>06.95  | 12.97<br>12.97<br>12.97<br>12.97  |  | 24.3728-0310.2   | 590310   |  | L=778                            |                          |
| <b>CITROEN XANTIA (X2) Limousine (98-03)</b>                                       |   |  |  |   |   |  |  |  |  |                                  |                          |
|    | 1.9 TD<br>2.0 16V ACTIVA<br>2.0 HDi 110<br>2.0 Turbo<br>2.1 TD<br>3.0 V6  | 66<br>97 ORGA 08001<br>109<br>108 ORGA 08001<br>80 ORGA 08001<br>140             |  | 01.98<br>02.99<br>02.99<br>01.98  | 09.01 + Automatikgetriebe 1)<br>09.01<br>09.01<br>09.01<br>09.01  |  | 24.3602-1701.7<br>24.3602-1702.7   | 220509<br>220510   | <input type="checkbox"/><br><input type="checkbox"/>                             | D=60, - Halter<br>D=60, - Halter | <b>BDX</b><br><b>BDX</b> |
|    | 1.8 16V<br>1.8 i<br>1.8 i<br>1.9 SD<br>1.9 TD<br>2.0 16V<br>2.0 HDi 110<br>2.0 HDi 90<br>2.0 i<br>2.0 Turbo<br>2.1 TD<br>3.0 V6 | 81<br>66<br>74<br>55<br>66<br>97<br>109<br>66<br>89<br>108<br>80<br>140          |  | 01.98<br>01.98<br>01.98<br>01.98<br>01.98<br>02.99<br>03.99<br>01.98<br>01.98<br>01.98<br>01.98 | 09.01<br>09.01<br>09.01<br>09.01<br>09.01<br>09.01<br>09.01<br>09.01<br>09.01<br>09.01<br>02.99                         |  | 24.5111-0355.3<br>24.5111-0375.3   | 330757<br>331128   | 2<br>2   | L=360<br>L=375                   |                          |
|  | 1.8 16V<br>1.8 i<br>1.9 SD<br>1.9 TD<br>2.0 16V<br>2.0 HDi 90<br>2.0 i  | 81<br>66<br>55<br>66<br>97<br>66<br>89   |  | 01.98<br>01.98<br>01.98<br>01.98<br>01.98<br>03.99<br>01.98                                     | 09.01 + Schaltgetriebe 2)<br>09.01<br>09.01<br>09.01 + Schaltgetriebe 2)<br>09.01 + Schaltgetriebe 2)<br>09.01<br>09.01 |  | 24.3727-0312.2<br>24.3727-0311.2   | 580312<br>580311   | <input type="checkbox"/><br><input type="checkbox"/>                             | L=1262<br>L=1333                 |                          |
|  | 1.8 16V<br>1.9 TD<br>2.0 16V  | 81<br>66<br>97   |  | 01.98<br>01.98<br>01.98   | 09.01 + Automatikgetriebe 1)<br>09.01 + Automatikgetriebe 1)<br>09.01 + Automatikgetriebe 1)                            |  | 24.3727-0351.2<br>24.3727-0311.2   | 580351<br>580311   | <input type="checkbox"/><br><input type="checkbox"/><br><input type="checkbox"/> | L=1285<br>L=1333                 |                          |
|  | 2.0 HDi 110<br>2.0 HDi 90<br>2.0 Turbo<br>2.1 TD  | 109<br>66<br>108<br>80   |  | 02.99<br>03.99<br>01.98<br>01.98  | 09.01<br>09.01<br>09.01<br>02.99  |  | 24.3727-0330.2<br>24.3727-0311.2   | 580330<br>580311   | <input type="checkbox"/><br><input type="checkbox"/>                             | L=1313<br>L=1333                 |                          |
|  | 3.0 V6  | 140  |  | 01.98   | 09.01   |  | 24.3727-0330.2   | 580330   | <input type="checkbox"/>   | L=1313                           |                          |
|  | 3.0 V6  | 140  |  | 01.98   | 09.01   |  | 24.3727-0330.2   | 580330   | <input type="checkbox"/>   | L=1313                           |                          |
|  | 1.8 16V<br>1.8 i  | 81<br>66   |  | 01.98<br>01.98  | 09.01<br>09.01  |  | 24.3728-0310.2   | 590310   |  | L=778                            |                          |
| <b>CITROEN XANTIA (X2) Kombi (98-03)</b>   |   |  |  |   |   |  |  |  |  |                                  |                          |
|  | 1.9 TD<br>2.0 HDi 110<br>2.0 Turbo<br>2.1 TD<br>3.0 V6  | 66<br>109<br>108 ORGA 08001<br>80 ORGA 08001<br>140                              |  | 01.98<br>02.99<br>02.99<br>01.98  | 09.01 + Automatikgetriebe 1)<br>09.01<br>09.01<br>09.01<br>09.01  |  | 24.3602-1701.7<br>24.3602-1702.7   | 220509<br>220510   | <input type="checkbox"/><br><input type="checkbox"/>                             | D=60, - Halter<br>D=60, - Halter | <b>BDX</b><br><b>BDX</b> |
|  | 1.8 16V<br>1.8 i<br>1.9 SD<br>1.9 TD<br>2.0 16V<br>2.0 HDi 110<br>2.0 HDi 90<br>2.0 i<br>2.0 Turbo<br>2.1 TD<br>3.0 V6          | 81<br>66<br>55<br>66<br>97<br>109<br>66<br>89<br>108<br>80<br>140                |  | 01.98<br>01.98<br>01.98<br>01.98<br>01.98<br>02.99<br>03.99<br>01.98<br>01.98<br>01.98          | 09.01<br>09.01<br>09.01<br>09.01<br>09.01<br>09.01<br>09.01<br>09.01<br>09.01<br>02.99                                  |  | 24.5111-0355.3<br>24.5111-0375.3   | 330757<br>331128   | 2<br>2   | L=360<br>L=375                   |                          |

1) + autom.transmission / + scatola cambio automatico / + transmission automatique / + cambio automático

2) + manual transmission / + scatola cambio velocità / + transmission mécanique / + cambio de velocidad

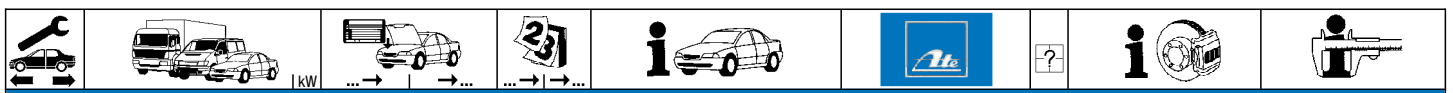

### CITROEN XANTIA (X2) Kombi (98-03)

|            |             |     |       |       |       |                                   |                |                          |                          |        |        |
|------------|-------------|-----|-------|-------|-------|-----------------------------------|----------------|--------------------------|--------------------------|--------|--------|
|            | 1.8 16V     | 81  |       | 01.98 | 09.01 | + Schaltgetriebe <sup>1)</sup>    | 24.3727-0312.2 | 580312                   | <input type="checkbox"/> |        | L=1262 |
|            | 1.8 i       | 66  |       | 01.98 | 09.01 |                                   | 24.3727-0311.2 | 580311                   | <input type="checkbox"/> |        | L=1333 |
|            | 1.9 SD      | 55  |       | 01.98 | 09.01 |                                   |                |                          |                          |        |        |
|            | 1.9 TD      | 66  |       | 01.98 | 09.01 | + Schaltgetriebe <sup>1)</sup>    |                |                          |                          |        |        |
|            | 2.0 16V     | 97  |       | 01.98 | 09.01 | + Schaltgetriebe <sup>1)</sup>    |                |                          |                          |        |        |
|            | 2.0 i       | 89  |       | 01.98 | 09.01 |                                   |                |                          |                          |        |        |
|            | 1.8 16V     | 81  |       | 01.98 | 09.01 | + Automatikgetriebe <sup>2)</sup> | 24.3727-0351.2 | 580351                   | <input type="checkbox"/> |        | L=1285 |
|            | 1.9 TD      | 66  |       | 01.98 | 09.01 | + Automatikgetriebe <sup>2)</sup> | 24.3727-0311.2 | 580311                   | <input type="checkbox"/> |        | L=1333 |
|            | 2.0 16V     | 97  |       | 01.98 | 09.01 | + Automatikgetriebe <sup>2)</sup> |                |                          |                          |        |        |
|            | 2.0 HDi 110 | 109 |       | 02.99 | 09.01 |                                   | 24.3727-0330.2 | 580330                   | <input type="checkbox"/> |        | L=1313 |
| 2.0 HDi 90 | 66          |     | 03.99 | 09.01 |       | 24.3727-0311.2                    | 580311         | <input type="checkbox"/> |                          | L=1333 |        |
| 2.0 Turbo  | 108         |     | 01.98 | 09.01 |       |                                   |                |                          |                          |        |        |
| 2.1 TD     | 80          |     | 01.98 | 02.99 |       |                                   |                |                          |                          |        |        |
| 3.0 V6     | 140         |     | 01.98 | 09.01 |       | 24.3727-0330.2                    | 580330         | <input type="checkbox"/> |                          | L=1313 |        |
| 3.0 V6     | 140         |     | 01.98 | 09.01 |       | 24.3727-0330.2                    | 580330         | <input type="checkbox"/> |                          | L=1313 |        |
|            | 1.8 16V     | 81  |       | 01.98 | 09.01 |                                   | 24.3728-0310.2 | 590310                   |                          |        | L=778  |
|            | 1.8 i       | 66  |       | 01.98 | 09.01 |                                   |                |                          |                          |        |        |

### CITROEN XM (Y3) Limousine (89-94)

|  |           |     |            |       |       |       |                |        |                          |  |                |            |
|--|-----------|-----|------------|-------|-------|-------|----------------|--------|--------------------------|--|----------------|------------|
|  | 2.0       | 84  | ORGA 05229 |       | 04.94 |       | 24.3572-1703.7 | 220375 | <input type="checkbox"/> |  | D=57, - Halter | <b>BDX</b> |
|  | 2.0 i     | 79  | ORGA 05229 |       | 04.94 |       |                |        |                          |  |                |            |
|  | 2.0 i     | 89  | ORGA 05229 |       | 06.94 |       |                |        |                          |  |                |            |
|  | 2.0 Turbo | 104 |            | 09.92 | 06.94 |       |                |        |                          |  |                |            |
|  | 2.1 D     | 60  | ORGA 05229 |       | 06.94 |       |                |        |                          |  |                |            |
|  | 2.1 TD    | 80  | ORGA 05229 |       | 06.94 |       |                |        |                          |  |                |            |
|  | 3.0 24V   | 147 | ORGA 05229 |       | 06.94 |       |                |        |                          |  |                |            |
|  | 3.0 V6    | 123 | ORGA 05229 |       | 06.94 |       |                |        |                          |  |                |            |
|  | 2.0       | 84  |            |       | 05.89 | 04.94 | 24.5411-0550.3 | 330567 | 2                        |  | L=550          |            |
|  | 2.0 i     | 79  |            |       | 05.89 | 04.94 |                |        |                          |  |                |            |
|  | 2.0 i     | 89  |            |       | 05.89 | 06.94 |                |        |                          |  |                |            |
|  | 2.0 Turbo | 104 |            | 09.92 | 06.94 |       |                |        |                          |  |                |            |
|  | 2.1 D     | 60  |            | 05.89 | 06.94 |       |                |        |                          |  |                |            |
|  | 2.1 TD    | 80  |            | 05.89 | 06.94 |       |                |        |                          |  |                |            |
|  | 3.0 24V   | 147 |            | 07.90 | 06.94 |       |                |        |                          |  |                |            |
|  | 3.0 V6    | 123 |            | 05.89 | 06.94 |       |                |        |                          |  |                |            |
|  | 2.0       | 84  |            |       | 05.89 | 04.94 | 24.3727-0309.2 | 580309 | <input type="checkbox"/> |  | L=1030         |            |
|  | 2.0 i     | 79  |            |       | 05.89 | 04.94 | 24.3727-0308.2 | 580308 | <input type="checkbox"/> |  | L=1230         |            |
|  | 2.0 i     | 89  |            |       | 05.89 | 06.94 |                |        |                          |  |                |            |
|  | 2.0 Turbo | 104 |            | 09.92 | 06.94 |       |                |        |                          |  |                |            |
|  | 2.1 D     | 60  |            | 05.89 | 06.94 |       |                |        |                          |  |                |            |
|  | 2.1 TD    | 80  |            | 05.89 | 06.94 |       |                |        |                          |  |                |            |
|  | 3.0 V6    | 123 |            | 05.89 | 06.94 |       |                |        |                          |  |                |            |
|  | 3.0 24V   | 147 |            | 07.90 | 06.94 |       | 24.3727-0308.2 | 580308 | <input type="checkbox"/> |  | L=1230         |            |

### CITROEN XM (Y3) Kombi (91-94)













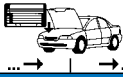

|  |           |     |            |       |       |       |                |        |                          |  |                |            |
|--|-----------|-----|------------|-------|-------|-------|----------------|--------|--------------------------|--|----------------|------------|
|  | 2.0 i     | 79  | ORGA 05229 |       | 04.94 |       | 24.3572-1703.7 | 220375 | <input type="checkbox"/> |  | D=57, - Halter | <b>BDX</b> |
|  | 2.0 i     | 89  | ORGA 05229 |       | 04.94 |       |                |        |                          |  |                |            |
|  | 2.0 Turbo | 104 |            | 09.92 | 04.94 |       |                |        |                          |  |                |            |
|  | 2.1 D     | 60  | ORGA 05229 |       | 04.94 |       |                |        |                          |  |                |            |
|  | 2.1 TD    | 80  | ORGA 05229 |       | 04.94 |       |                |        |                          |  |                |            |
|  | 3.0 V6    | 123 | ORGA 05229 |       | 04.94 |       |                |        |                          |  |                |            |
|  | 2.0 i     | 79  |            |       | 11.91 | 04.94 | 24.5411-0550.3 | 330567 | 2                        |  | L=550          |            |
|  | 2.0 i     | 89  |            |       | 11.91 | 04.94 |                |        |                          |  |                |            |
|  | 2.0 Turbo | 104 |            | 09.92 | 04.94 |       |                |        |                          |  |                |            |
|  | 2.1 D     | 60  |            | 11.91 | 04.94 |       |                |        |                          |  |                |            |
|  | 2.1 TD    | 80  |            | 11.91 | 04.94 |       |                |        |                          |  |                |            |
|  | 3.0 V6    | 123 |            | 11.91 | 04.94 |       |                |        |                          |  |                |            |
|  | 2.0 i     | 79  |            |       | 11.91 | 04.94 | 24.3727-0309.2 | 580309 | <input type="checkbox"/> |  | L=1030         |            |
|  | 2.0 i     | 89  |            |       | 11.91 | 04.94 | 24.3727-0308.2 | 580308 | <input type="checkbox"/> |  | L=1230         |            |
|  | 2.0 Turbo | 104 |            | 09.92 | 04.94 |       |                |        |                          |  |                |            |
|  | 2.1 D     | 60  |            | 11.91 | 04.94 |       |                |        |                          |  |                |            |
|  | 2.1 TD    | 80  |            | 11.91 | 04.94 |       |                |        |                          |  |                |            |
|  | 3.0 V6    | 123 |            | 11.91 | 04.94 |       | 24.3727-0308.2 | 580308 | <input type="checkbox"/> |  | L=1230         |            |

### CITROEN XM (Y4) Limousine (94-00)

|        |           |     |            |            |       |       |                |                |                          |                          |                |                |
|--------|-----------|-----|------------|------------|-------|-------|----------------|----------------|--------------------------|--------------------------|----------------|----------------|
|        | 2.0 16V   | 97  |            |            | 05.94 | 10.00 | 24.3572-1703.7 | 220375         | <input type="checkbox"/> |                          | D=57, - Halter | <b>BDX</b>     |
|        | 2.0 Turbo | 108 |            |            | 05.94 | 10.00 |                |                |                          |                          |                |                |
|        | 2.1 TD    | 80  |            |            | 05.94 | 10.00 |                |                |                          |                          |                |                |
|        | 2.5 TD    | 95  |            |            | 05.94 | 10.00 |                |                |                          |                          |                |                |
|        | 3.0 24V   | 147 |            | ORGA 07475 | 05.94 | 10.00 |                |                |                          |                          |                |                |
|        | 3.0 V6    | 123 |            |            | 05.94 | 10.00 |                |                |                          |                          |                |                |
|        | 2.5 TD    | 95  | ORGA 07476 |            |       | 10.00 |                | 24.3602-1701.7 | 220509                   | <input type="checkbox"/> |                | D=60, - Halter |
| 3.0 V6 | 140       |     |            | 04.97      | 10.00 |       | 24.3602-1702.7 | 220510         | <input type="checkbox"/> |                          | D=60, - Halter | <b>BDX</b>     |
|        | 2.0 16V   | 97  |            |            | 05.94 | 10.00 | 24.5411-0550.3 | 330567         | 2                        |                          | L=550          |                |
|        | 2.0 Turbo | 108 |            |            | 05.94 | 10.00 |                |                |                          |                          |                |                |
|        | 2.1 TD    | 80  |            |            | 05.94 | 10.00 |                |                |                          |                          |                |                |
|        | 2.5 TD    | 95  |            |            | 05.94 | 10.00 |                |                |                          |                          |                |                |
|        | 3.0 24V   | 147 |            |            | 05.94 | 10.00 |                |                |                          |                          |                |                |
|        | 3.0 V6    | 123 |            |            | 05.94 | 10.00 |                |                |                          |                          |                |                |
|        | 3.0 V6    | 140 |            |            | 04.97 | 10.00 |                |                |                          |                          |                |                |

<sup>1)</sup> + manual transmission / + scatola cambio velocità / + transmission mécanique / + cambio de velocidad  
<sup>2)</sup> + autom.transmission / + scatola cambio automatico / + transmission automatique / + cambio automático



|     |  |  |  |  |  |  |  |  |                           |
|--|--|--|--|--|---|--|--|--|---------------------------|
| <b>CITROEN XM (Y4) Limousine (94-00)</b>   |  |  |  |  |   |  |  |  |                           |
|    | 2.0 16V  | 97   |  | 05.94  | 10.00   | 24.3727-0309.2   | 580309   | <input type="checkbox"/>   | L=1030                    |
|  | 2.0 Turbo  | 108  |  | 05.94  | 10.00   | 24.3727-0308.2   | 580308   | <input type="checkbox"/>   | L=1230                    |
|  | 2.1 TD   | 80   |  | 05.94  | 10.00   |  |  |  |                           |
|  | 2.5 TD   | 95   |  | 05.94  | 10.00   |  |  |  |                           |
|  | 3.0 V6   | 123  |  | 05.94  | 10.00   |  |  |  |                           |
|  | 3.0 V6   | 140  |  | 04.97  | 10.00   |  |  |  |                           |
|  | 3.0 24V  | 147  |  | 05.94  | 10.00   | 24.3727-0308.2   | 580308   | <input type="checkbox"/>   | L=1230                    |
| <b>CITROEN XM (Y4) Kombi (94-00)</b>   |  |  |  |  |   |  |  |  |                           |
|    | 2.0 16V  | 97   |  | 05.94  | 10.00   | 24.3572-1703.7   | 220375   | <input type="checkbox"/>   | D=57, - Halter <b>BDX</b> |
|  | 2.0 Turbo  | 108  |  | 05.94  | 10.00   |  |  |  |                           |
|  | 2.1 D  | 60   |  | 07.94  | 06.96   |  |  |  |                           |
|  | 2.1 TD   | 80   |  | 05.94  | 10.00   |  |  |  |                           |
|  | 2.5 TD   | 95   | ORGA 07475   | 05.94  | 10.00   |  |  |  |                           |
|  | 3.0 V6   | 123  |  | 05.94  | 10.00   |  |  |  |                           |
|  | 2.5 TD   | 95   | ORGA 07476   |  | 10.00   | 24.3602-1701.7   | 220509   | <input type="checkbox"/>   | D=60, - Halter <b>BDX</b> |
|  | 3.0 V6   | 140  |  | 04.97  | 10.00   | 24.3602-1702.7   | 220510   | <input type="checkbox"/>   | D=60, - Halter <b>BDX</b> |
|    | 2.0 16V  | 97   |  | 05.94  | 10.00   | 24.5411-0550.3   | 330567   | 2  | L=550                     |
|  | 2.0 Turbo  | 108  |  | 05.94  | 10.00   |  |  |  |                           |
|  | 2.1 D  | 60   |  | 07.94  | 06.96   |  |  |  |                           |
|  | 2.1 TD   | 80   |  | 05.94  | 10.00   |  |  |  |                           |
|  | 2.5 TD   | 95   |  | 05.94  | 10.00   |  |  |  |                           |
|  | 3.0 V6   | 123  |  | 05.94  | 10.00   |  |  |  |                           |
|  | 3.0 V6   | 140  |  | 04.97  | 10.00   |  |  |  |                           |
| <b>CITROEN XSARA (N1) Limousine (97-05)</b>  |  |  |  |  |   |  |  |  |                           |
|    | 1.4 i  | 55   |  | 04.97  | 08.00   | 03.7750-9302.4   | 300116   |  | 9" <b>ATE</b>             |
|  | 1.5 D  | 42   |  | 04.97  | 08.00   |  |  |  |                           |
|  | 1.6 i  | 65   |  | 04.97  | 08.00   |  |  |  |                           |
|  | 1.8 D  | 43   |  | 04.97  | 08.00   |  |  |  |                           |
|  | 1.8 i  | 66   |  | 04.97  | 08.00   |  |  |  |                           |
|  | 1.8 i  | 74   |  | 04.97  | 08.00   |  |  |  |                           |
|  | 1.8 TD   | 66   |  | 10.97  | 08.00   |  |  |  |                           |
|  | 1.9 D  | 50   |  | 04.97  | 08.00   |  |  |  |                           |
|  | 1.9 D  | 51   |  | 07.98  | 08.00   |  |  |  |                           |
|  | 1.9 SD   | 55   |  | 01.98  | 08.00   |  |  |  |                           |
|  | 1.9 TD   | 66   |  | 04.97  | 08.00   |  |  |  |                           |
|  | 2.0 HDi 90   | 66   |  | 02.99  | 08.00   |  |  |  |                           |
|  | 1.4 HDi 70   | 50   |  | 01.03  | 03.05   | 03.7750-3532.4   | 300149   | - ABS  | 9" <b>ATE</b>             |
|  | 1.4 i  | 55   | ORGA 09002   |  | 03.05   | 03.7853-0902.4   | 300150   | + ABS  | 9" <b>ATE</b>             |
|  | 1.6 16V  | 80   | ORGA 09002   |  | 03.05   |  |  |  |                           |
|  | 1.9 D  | 51   | ORGA 09002   |  | 03.05   |  |  |  |                           |
|  | 2.0 16V  | 100  | ORGA 09002   |  | 03.05   |  |  |  |                           |
|  | 2.0 HDi 110  | 80   | ORGA 09002   |  | 03.05   |  |  |  |                           |
|  | 2.0 HDi 90   | 66   | ORGA 09002   |  | 03.05   |  |  |  |                           |
|  | 1.4 i  | 55   |  | 04.97  | 08.00   | 03.2122-1356.3   | 010529   | - ABS  | THz 22,20 <b>ATE</b>      |
|  | 1.5 D  | 42   |  | 04.97  | 08.00   | 24.2122-1743.3   | 010712   | - ABS  | THz 22,20 <b>ATE</b>      |
|  | 1.6 i  | 65   |  | 04.97  | 08.00   | 03.2122-1351.3   | 010528   | + ABS  | THz 22,20 <b>ATE</b>      |
|  | 1.8 D  | 43   |  | 04.97  | 08.00   | 24.2122-1733.3   | 010668   | + ABS  | THz 22,20 <b>BOS</b>      |
|  | 1.8 i  | 66   |  | 04.97  | 08.00   |  |  |  |                           |
|  | 1.8 i  | 74   |  | 04.97  | 08.00   |  |  |  |                           |
|  | 1.8 TD   | 66   |  | 10.97  | 08.00   |  |  |  |                           |
|  | 1.9 D  | 50   |  | 04.97  | 08.00   |  |  |  |                           |
|  | 1.9 D  | 51   |  | 07.98  | 08.00   |  |  |  |                           |
|  | 1.9 SD   | 55   |  | 01.98  | 08.00   |  |  |  |                           |
|  | 1.9 TD   | 66   |  | 04.97  | 08.00   |  |  |  |                           |
|  | 2.0 HDi 90   | 66   |  | 02.99  | 08.00   |  |  |  |                           |
|  | 1.4 i  | 55   | ORGA 09001   | 09.00  |   | 24.2123-1714.3   | 010587   | - ABS  | THz 23,81 <b>BDX</b>      |
|  | 1.6 16V  | 80   | ORGA 09001   | 09.00  |   | 24.2123-1715.3   | 010520   | + ABS  | THz 23,81 <b>BDX</b>      |
|  | 1.8 16V  | 81   |  | 04.97  | 08.00   |  |  |  |                           |
|  | 1.9 D  | 51   | ORGA 09001   | 09.00  |   |  |  |  |                           |
|  | 2.0 16V  | 97   |  | 07.98  | 08.00   |  |  |  |                           |
|  | 2.0 16V  | 120  |  | 04.97  | 08.00   |  |  |  |                           |
|  | 2.0 HDi 110  | 80   | ORGA 09001   | 05.01  |   |  |  |  |                           |
|  | 2.0 HDi 90   | 66   | ORGA 09001   | 09.00  |   |  |  |  |                           |
|  | 1.4 HDi 70   | 50   |  | 01.03  | 03.05   | 03.2123-2781.3   | 010631   | - ABS  | THz 23,81 <b>ATE</b>      |
|  | 1.4 i  | 55   | ORGA 09002   |  | 03.05   | 03.2123-2721.3   | 010632   | - ESP  | THz 23,81 <b>ATE</b>      |
|  | 1.6 16V  | 80   | ORGA 09002   |  | 03.05   |  |  |  |                           |
|  | 1.9 D  | 51   | ORGA 09002   |  | 03.05   |  |  |  |                           |
|  | 2.0 16V  | 100  | ORGA 09002   |  | 03.05   |  |  |  |                           |
|  | 2.0 HDi 110  | 80   | ORGA 09002   |  | 03.05   |  |  |  |                           |
|  | 2.0 HDi 90   | 66   | ORGA 09002   |  | 03.05   |  |  |  |                           |
|  | 1.4 HDi 70   | 50   |  | 01.03  | 03.05   | 03.2123-2761.3   | 010886   | + ESP  | THz 23,81 <b>ATE</b>      |
|  | 1.4 i  | 55   | ORGA 09065   |  | 03.05   |  |  |  |                           |
|  | 1.6 16V  | 80   | ORGA 09065   |  | 03.05   |  |  |  |                           |
|  | 1.9 D  | 51   | ORGA 09065   |  | 03.05   |  |  |  |                           |
|  | 2.0 16V  | 100  | ORGA 09065   |  | 03.05   |  |  |  |                           |
|  | 2.0 HDi 110  | 80   | ORGA 09065   |  | 03.05   |  |  |  |                           |
|  | 2.0 HDi 90   | 66   | ORGA 09065   |  | 03.05   |  |  |  |                           |
|  | 1.4 i  | 55   |  | 04.97  | 08.00   | 24.3481-1741.5   | 240245   | <input type="checkbox"/>   | D=48, - Halter <b>BOS</b> |
|  | 1.5 D  | 42   |  | 04.97  | 08.00   | 24.3481-1742.5   | 240246   | <input type="checkbox"/>   | D=48, - Halter <b>BOS</b> |



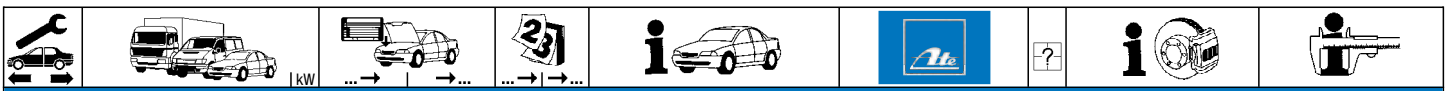









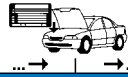





**CITROEN XSARA (N1) Limousine (97-05)**

|             |             |            |            |            |       |                |                |                |   |   |  |                |        |
|-------------|-------------|------------|------------|------------|-------|----------------|----------------|----------------|---|---|--|----------------|--------|
|             | 1.4 i       | 55         |            | 04.97      | 08.00 | + ABS          | 11.3481-9833.2 | 220561         | 2 | D=48, - Halter<br>ATE<br>D=48, - Halter<br>ATE<br>D=48, - Halter<br>ATE<br>Dichtungssatz<br>ATE<br>Hülzensatz<br>ATE<br>Führungsbolzen<br>ATE<br>Halterfeder<br>ATE | ATE<br>ATE<br>ATE<br>ATE<br>ATE<br>ATE<br>ATE<br>ATE<br>ATE<br>ATE<br>ATE<br>ATE<br>ATE<br>ATE<br>ATE<br>ATE |                |        |
|             | 1.5 D       | 42         |            | 04.97      | 08.00 | + ABS          | 11.3481-9834.2 | 220562         |   |   |  |                |        |
|             | 1.6 i       | 65         |            | 04.97      | 08.00 |                | 24.3481-9833.5 | 240479         |   |   |  |                |        |
|             | 1.8 D       | 43         |            | 04.97      | 08.00 |                | 24.3481-9834.5 | 240480         |   |   |  |                |        |
|             | 1.8 i       | 66         |            | 04.97      | 08.00 |                | 11.0441-4811.2 | 250024         |   |   |  |                |        |
|             | 1.8 i       | 74         |            | 04.97      | 08.00 | - BR           | 11.0101-5407.2 | 260011         |   |   |  |                |        |
|             | 1.8 TD      | 66         |            | 10.97      | 08.00 |                | 11.8171-0008.1 | 990049         |   |   |  |                |        |
|             | 1.9 D       | 50         |            | 04.97      | 08.00 |                | 11.8116-0129.1 | 390591         |   |   |  |                |        |
|             | 1.9 D       | 51         |            | 07.98      | 08.00 |                |                |                |   |   |  |                |        |
|             | 1.9 SD      | 55         |            | 01.98      | 08.00 |                |                |                |   |   |  |                |        |
|             | 1.9 TD      | 66         |            | 04.97      | 08.00 |                |                |                |   |   |  |                |        |
|             | 1.8 16V     | 81         |            | 04.97      | 08.00 |                | 24.3541-1767.5 | 240237         |   |   |  |                |        |
|             | 1.8 i       | 74         |            | 04.97      | 08.00 | + BR           | 24.3541-1768.5 | 240238         |   |   |  |                |        |
|             | 2.0 16V     | 97         |            | 07.98      | 08.00 |                | 24.3541-1757.7 | 220483         |   |   |  |                |        |
|             | 2.0 HDi 90  | 66         |            | 02.99      | 08.00 |                | 24.3541-1758.7 | 220484         |   |   |  |                |        |
|             | 1.4 HDi 70  | 50         |            | 01.03      | 03.05 |                | 24.3541-1771.5 | 240239         |   |   |  |                |        |
| 1.4 i       | 55          |            | 09.00      | 03.05      |       | 24.3541-1772.5 | 240240         |                |   |   |  |                |        |
| 1.6 16V     | 80          |            | 09.00      | 03.05      |       |                |                |                |   |   |  |                |        |
| 1.9 D       | 51          |            | 09.00      | 03.05      |       |                |                |                |   |   |  |                |        |
| 2.0 HDi 90  | 66          |            | 09.00      | 03.05      |       |                |                |                |   |   |  |                |        |
| 2.0 16V     | 100         | ORGA 09184 | 09.00      |            |       | 24.3571-1729.5 | 240317         |                |   |   |  |                |        |
| 2.0 16V     | 120         | ORGA 09184 | 04.97      |            |       |                |                |                |   |   |  |                |        |
| 2.0 HDi 110 | 80          | ORGA 09184 | 05.01      |            |       |                |                |                |   |   |  |                |        |
| 2.0 16V     | 100         | ORGA 09185 |            | 03.05      |       | 24.3541-1761.5 | 240233         |                |   |   |  |                |        |
| 2.0 16V     | 120         | ORGA 09185 |            | 03.05      |       | 24.3541-1762.5 | 240234         |                |   |   |  |                |        |
| 2.0 HDi 110 | 80          | ORGA 09185 |            | 03.05      |       |                |                |                |   |   |  |                |        |
|             | 1.4 i       | 55         | ORGA 08091 | 04.97      |       |                | 24.5111-0438.3 | 330568         | 2 | L=445   |  |                |        |
|             | 1.5 D       | 42         | ORGA 08091 | 04.97      |       |                |                |                |   |   |  |                |        |
|             | 1.4 i       | 55         | ORGA 08092 | ORGA 09470 |       | 08.00          |                | 24.5111-0460.3 |   |   |  | 330603         |        |
|             | 1.5 D       | 42         | ORGA 08092 |            |       |                |                |                |   |   |  |                |        |
|             | 1.6 16V     | 80         |            | ORGA 09470 | 09.00 |                |                |                |   |   |  |                |        |
|             | 1.6 i       | 65         |            |            | 04.97 | 08.00          |                |                |   |   |  |                |        |
|             | 1.8 16V     | 81         |            |            | 04.97 | 08.00          |                |                |   |   |  |                |        |
|             | 1.8 D       | 43         |            |            | 04.97 | 08.00          |                |                |   |   |  |                |        |
|             | 1.8 i       | 66         |            |            | 04.97 | 08.00          |                |                |   |   |  |                |        |
|             | 1.8 i       | 74         |            |            | 04.97 | 08.00          |                |                |   |   |  |                |        |
|             | 1.8 TD      | 66         |            |            | 10.97 | 08.00          |                |                |   |   |  |                |        |
|             | 1.9 D       | 50         |            |            | 04.97 | 08.00          |                |                |   |   |  |                |        |
|             | 1.9 D       | 51         |            | ORGA 09470 | 07.98 |                |                |                |   |   |  |                |        |
|             | 1.9 SD      | 55         |            |            | 01.98 | 08.00          |                |                |   |   |  |                |        |
|             | 1.9 TD      | 66         |            |            | 07.97 | 08.00          |                |                |   |   |  |                |        |
|             | 2.0 16V     | 97         |            |            | 07.98 | 08.00          |                |                |   |   |  |                |        |
|             | 2.0 16V     | 100        |            | ORGA 09470 | 09.00 |                | + ESP          |                |   |   |  |                |        |
|             | 2.0 16V     | 100        |            | ORGA 09184 | 09.00 |                | - ESP          |                |   |   |  |                |        |
|             | 2.0 16V     | 120        |            |            | 04.97 | 08.00          |                |                |   |   |  |                |        |
|             | 2.0 HDi 110 | 80         |            | ORGA 09470 | 05.01 |                | + ESP          |                |   |   |  |                |        |
|             | 2.0 HDi 110 | 80         |            | ORGA 09184 | 05.01 |                | - ESP          |                |   |   |  |                |        |
|             | 2.0 HDi 90  | 66         |            | ORGA 09470 | 02.99 |                |                |                |   |   |  |                |        |
|             | 1.4 HDi 70  | 50         |            |            | 01.03 | 03.05          |                | 24.5111-0459.3 |   |   |  | 330683         |        |
|             | 1.4 i       | 55         | ORGA 09471 |            |       | 03.05          |                |                |   |   |  |                |        |
| 1.9 D       | 51          | ORGA 09471 |            |            | 03.05 |                |                |                |   |   |  |                |        |
| 2.0 16V     | 100         | ORGA 09471 |            |            | 03.05 | + ESP          |                |                |   |   |  |                |        |
| 2.0 16V     | 100         | ORGA 09185 |            |            | 03.05 | - ESP          |                |                |   |   |  |                |        |
| 2.0 HDi 110 | 80          | ORGA 09471 |            |            | 03.05 | + ESP          |                |                |   |   |  |                |        |
| 2.0 HDi 110 | 80          | ORGA 09185 |            |            | 03.05 | - ESP          |                |                |   |   |  |                |        |
| 2.0 HDi 90  | 66          | ORGA 09471 |            |            | 03.05 |                |                |                |   |   |  |                |        |
|             | 1.4 i       | 55         |            | 04.97      | 08.00 | - ABS          | 24.5228-0195.3 | 330469         | 2 | L=202   |  |                |        |
|             | 1.5 D       | 42         |            | 04.97      | 08.00 | - ABS          |                |                |   |   |  |                |        |
|             | 1.6 i       | 65         |            | 04.97      | 08.00 | - ABS          |                |                |   |   |  |                |        |
|             | 1.8 D       | 43         |            | 04.97      | 08.00 | - ABS          |                |                |   |   |  |                |        |
|             | 1.8 i       | 66         |            | 04.97      | 08.00 | - ABS          |                |                |   |   |  |                |        |
|             | 1.8 i       | 74         |            | 04.97      | 08.00 | - ABS / - BR   |                |                |   |   |  |                |        |
|             | 1.8 TD      | 66         |            | 10.97      | 08.00 | - ABS          |                |                |   |   |  |                |        |
|             | 1.9 D       | 50         |            | 04.97      | 08.00 | - ABS          |                |                |   |   |  |                |        |
|             | 1.9 D       | 51         |            | 07.98      | 08.00 | - ABS          |                |                |   |   |  |                |        |
|             | 1.9 SD      | 55         |            | 01.98      | 08.00 | - ABS          |                |                |   |   |  |                |        |
|             | 1.9 TD      | 66         |            | 07.97      | 08.00 | - ABS          |                |                |   |   |  |                |        |
|             | 1.4 HDi 70  | 50         |            | 01.03      | 03.05 |                |                |                |   |   |  | 24.5228-0195.3 | 330469 |
|             | 1.4 i       | 55         |            | 09.00      | 03.05 |                |                |                |   |   |  | 24.5228-0245.3 | 330531 |
|             | 1.4 i       | 55         |            | 04.97      | 08.00 | + ABS          |                |                |   |   |  |                |        |
|             | 1.5 D       | 42         |            | 04.97      | 08.00 | + ABS          |                |                |   |   |  |                |        |
|             | 1.6 16V     | 80         |            | 09.00      | 03.05 |                |                |                |   |   |  |                |        |
|             | 1.6 i       | 65         |            | 04.97      | 08.00 | + ABS          |                |                |   |   |  |                |        |
|             | 1.8 16V     | 81         |            | 04.97      | 08.00 |                |                |                |   |   |  |                |        |
|             | 1.8 D       | 43         |            | 04.97      | 08.00 | + ABS          |                |                |   |   |  |                |        |
|             | 1.8 i       | 66         |            | 04.97      | 08.00 | + ABS          |                |                |   |   |  |                |        |
|             | 1.8 i       | 74         |            | 04.97      | 08.00 | + ABS / + BR   |                |                |   |   |  |                |        |
|             | 1.8 TD      | 66         |            | 10.97      | 08.00 | + ABS          |                |                |   |   |  |                |        |
|             | 1.9 D       | 50         |            | 04.97      | 08.00 | + ABS          |                |                |   |   |  |                |        |
|             | 1.9 D       | 51         |            | 09.00      | 03.05 |                |                |                |   |   |  |                |        |
| 1.9 D       | 51          |            | 07.98      | 08.00      | + ABS |                |                |                |   |   |  |                |        |
| 1.9 SD      | 55          |            | 01.98      | 08.00      | + ABS |                |                |                |   |   |  |                |        |
| 1.9 TD      | 66          |            | 04.97      | 08.00      | + ABS |                |                |                |   |   |  |                |        |
| 2.0 16V     | 97          |            | 07.98      | 08.00      |       |                |                |                |   |   |  |                |        |
| 2.0 16V     | 100         |            | 09.00      | 03.05      |       |                |                |                |   |   |  |                |        |
| 2.0 16V     | 120         |            | 04.97      | 08.00      |       |                |                |                |   |   |  |                |        |



| CITROEN XSARA (N1) Limousine (97-05)   |  |  |  |  |   |  |  |  |              |            |
|--|--|--|--|--|---|--|--|--|--------------|------------|
|     |  |  |  |  |  |  |  |  |              |            |
|  |  | KW   |  |  |   |  |  |  |              |            |
|    | 2.0 HDi 110  | 80   | 05.01  | 03.05  | 24.5228-0195.3  | 330469   | <input type="checkbox"/>   |  | L=202        |            |
|  | 2.0 HDi 90   | 66   | 02.99  | 03.05  | 24.5228-0245.3  | 330531   | <input type="checkbox"/>   |  | L=245        |            |
|    | 1.4 i  | 55   | 04.97  | 08.00  | 24.3220-1617.3  | 020244   | <input type="checkbox"/>   |  | RzR 20,64    | <b>BDX</b> |
|  | 1.5 D  | 42   | 04.97  | 08.00  | 24.3220-1618.3  | 020245   | <input type="checkbox"/>   |  | RzR 20,64    | <b>BDX</b> |
|  | 1.6 i  | 65   | 04.97  | 08.00  | 24.3220-1615.3  | 020242   | <input type="checkbox"/>   |  | RzR 20,64    | <b>LUC</b> |
|  | 1.8 D  | 43   | 04.97  | 08.00  | 24.3220-1616.3  | 020243   | <input type="checkbox"/>   |  | RzR 20,64    | <b>LUC</b> |
|  | 1.8 i  | 66   | 04.97  | 08.00  |   |  |  |  |              |            |
|  | 1.8 i  | 74   | 04.97  | 08.00  |   |  |  |  |              |            |
|  | 1.8 TD   | 66   | 10.97  | 08.00  |   |  |  |  |              |            |
|  | 1.9 D  | 50   | 04.97  | 08.00  |   |  |  |  |              |            |
|  | 1.9 D  | 51   | 07.98  | 08.00  |   |  |  |  |              |            |
|  | 1.4 i  | 55   | 04.97  | 08.00  | 24.3220-1711.3  | 020409   |  |  | Rz 20,64     | <b>LUC</b> |
|  | 1.5 D  | 42   | 04.97  | 08.00  |   |  |  |  |              |            |
|  | 1.6 i  | 65   | 04.97  | 08.00  |   |  |  |  |              |            |
|  | 1.8 D  | 43   | 04.97  | 08.00  |   |  |  |  |              |            |
|  | 1.8 i  | 66   | 04.97  | 08.00  |   |  |  |  |              |            |
|  | 1.8 i  | 74   | 04.97  | 08.00  |   |  |  |  |              |            |
|  | 1.8 TD   | 66   | 10.97  | 08.00  |   |  |  |  |              |            |
|  | 1.9 D  | 50   | 04.97  | 08.00  |   |  |  |  |              |            |
|  | 1.9 D  | 51   | 07.98  | 08.00  |   |  |  |  |              |            |
|  | 1.9 SD   | 55   | 01.98  | 08.00  |   |  |  |  |              |            |
|  | 1.9 TD   | 66   | 04.97  | 08.00  |   |  |  |  |              |            |
|  | 1.4 i  | 55   | ORGA 08728   | 09.00  | 24.3220-1711.3  | 020409   |  |  | Rz 20,64     | <b>LUC</b> |
|  | 1.9 D  | 51   | ORGA 08728   | 09.00  |   |  |  |  |              |            |
|  | 1.4 HDi 70   | 50   | 01.03  | 03.05  | 24.3220-1717.3  | 020430   |  |  | Rz 20,64     | <b>LUC</b> |
|  | 1.4 i  | 55   | ORGA 08729   | 03.05  |   |  |  |  |              |            |
|  | 1.9 D  | 51   | ORGA 08729   | 03.05  |   |  |  |  |              |            |
|    | 1.4 HDi 70   | 50   | 01.03  | 03.05  | 24.3727-0322.2  | 580322   | <input type="checkbox"/>   |  | L=1591       |            |
|  | 1.4 i  | 55   | 04.97  | 03.05  | 24.3727-0323.2  | 580323   | <input type="checkbox"/>   |  | L=1500       |            |
|  | 1.5 D  | 42   | 04.97  | 08.00  |   |  |  |  |              |            |
|  | 1.6 i  | 65   | 04.97  | 08.00  |   |  |  |  |              |            |
|  | 1.8 D  | 43   | 04.97  | 08.00  |   |  |  |  |              |            |
|  | 1.8 i  | 66   | 04.97  | 08.00  |   |  |  |  |              |            |
|  | 1.8 i  | 74   | 04.97  | 08.00  |   |  |  |  |              |            |
|  | 1.8 TD   | 66   | 10.97  | 08.00  |   |  |  |  |              |            |
|  | 1.9 D  | 50   | 04.97  | 08.00  |   |  |  |  |              |            |
|  | 1.9 D  | 51   | 07.98  | 03.05  |   |  |  |  |              |            |
|  | 1.9 SD   | 55   | 01.98  | 08.00  |   |  |  |  |              |            |
|  | 1.9 TD   | 66   | 04.97  | 08.00  |   |  |  |  |              |            |
|  | 1.6 16V  | 80   | 09.00  | 03.05  | 24.3727-0326.2  | 580326   | <input type="checkbox"/>   |  | L=1635       |            |
|  | 1.8 16V  | 81   | 04.97  | 08.00  | 24.3727-0327.2  | 580327   | <input type="checkbox"/>   |  | L=1545       |            |
|  | 1.8 i  | 74   | 04.97  | 08.00  |   |  |  |  |              |            |
|  | 2.0 16V  | 97   | 07.98  | 08.00  |   |  |  |  |              |            |
|  | 2.0 16V  | 100  | 09.00  | 03.05  |   |  |  |  |              |            |
|  | 2.0 16V  | 120  | 04.97  | 08.00  |   |  |  |  |              |            |
|  | 2.0 HDi 110  | 80   | 05.01  | 03.05  |   |  |  |  |              |            |
|  | 2.0 HDi 90   | 66   | 02.99  | 03.05  |   |  |  |  |              |            |
|  | 1.4 i  | 55   | 04.97  | 03.05  | 24.3728-0332.2  | 590332   |  |  | L=625        |            |
|  | 1.5 D  | 42   | 04.97  | 08.00  |   |  |  |  |              |            |
|  | 1.6 16V  | 80   | 09.00  | 03.05  |   |  |  |  |              |            |
|  | 1.6 i  | 65   | 04.97  | 08.00  |   |  |  |  |              |            |
|  | 1.8 16V  | 81   | 04.97  | 08.00  | 24.3728-0329.2  | 590329   |  |  | L=653, + AUT |            |
|  | 1.8 D  | 43   | 04.97  | 08.00  |   |  |  |  |              |            |
|  | 1.8 i  | 66   | 04.97  | 08.00  |   |  |  |  |              |            |
|  | 1.9 D  | 50   | 04.97  | 08.00  |   |  |  |  |              |            |
|  | 1.9 D  | 51   | 07.98  | 08.00  |   |  |  |  |              |            |
|  | 1.9 SD   | 55   | 01.98  | 08.00  |   |  |  |  |              |            |
|  | 1.9 TD   | 66   | 04.97  | 08.00  | 24.3728-0339.2  | 590339   |  |  | L=717, + AUT |            |
|  | 2.0 16V  | 97   | 07.98  | 08.00  |   |  |  |  |              |            |
|  | 2.0 16V  | 120  | 04.97  | 08.00  |   |  |  |  |              |            |
|  | 1.6 16V  | 80   | 09.00  | 03.05  | 24.3728-0839.2  | 590839   |  |  | L=906, + AUT |            |
|  | 2.0 16V  | 100  | 09.00  | 03.05  |   |  |  |  |              |            |
|  | 2.0 HDi 110  | 80   | 05.01  | 03.05  |   |  |  |  |              |            |
|  | 2.0 HDi 90   | 66   | 09.00  | 03.05  |   |  |  |  |              |            |
| CITROEN XSARA (N2) Kombi (97-05)   |  |  |  |  |   |  |  |  |              |            |
|  | 1.4 i  | 55   | 10.97  | 08.00  | 03.7750-9302.4  | 300116   |  | - ABS  | 9"           | <b>ATE</b> |
|  | 1.5 D  | 42   | 10.97  | 08.00  |   |  |  |  |              |            |
|  | 1.6 i  | 65   | 10.97  | 08.00  |   |  |  |  |              |            |
|  | 1.8 D  | 43   | 10.97  | 08.00  |   |  |  |  |              |            |
|  | 1.9 D  | 50   | 10.97  | 08.00  |   |  |  |  |              |            |
|  | 1.9 D  | 51   | 07.98  | 08.00  |   |  |  |  |              |            |
|  | 1.9 SD   | 55   | 01.98  | 08.00  |   |  |  |  |              |            |
|  | 1.9 TD   | 66   | 10.97  | 08.00  |   |  |  |  |              |            |
|  | 2.0 HDi 90   | 66   | 02.99  | 08.00  |   |  |  |  |              |            |
|  | 1.4 HDi 70   | 50   | 01.03  | 08.05  | 03.7750-3532.4  | 300149   |  | - ABS  | 9"           | <b>ATE</b> |
|  | 1.4 i  | 55   | ORGA 09002   | 08.05  | 03.7853-0902.4  | 300150   |  | + ABS  | 9"           | <b>ATE</b> |
|  | 1.6 16V  | 80   | ORGA 09002   | 08.05  |   |  |  |  |              |            |
|  | 1.9 D  | 51   | ORGA 09002   | 08.05  |   |  |  |  |              |            |
|  | 2.0 16V  | 100  | ORGA 09002   | 08.05  |   |  |  |  |              |            |
|  | 2.0 HDi 110  | 80   | ORGA 09002   | 08.05  |   |  |  |  |              |            |
|  | 2.0 HDi 90   | 66   | ORGA 09002   | 08.05  |   |  |  |  |              |            |

1) - driving school / - scuola guida / - auto école / - autoescuela  
2) + driving school / + scuola guida / + auto école / + autoescuela

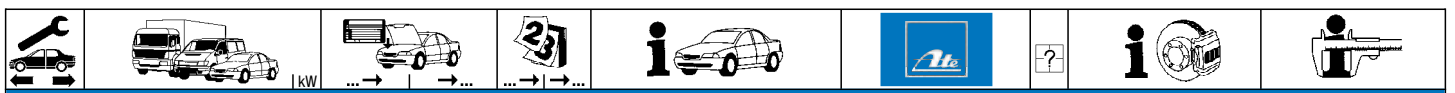













**CITROEN XSARA (N2) Kombi (97-05)**

|  |  |   |  |  |  |  |  |  |  |   |  |
|--|--|---|--|--|--|--|--|--|--|---|--|
|  | 1.4 i<br>1.5 D<br>1.6 i<br>1.8 D<br>1.9 D  | 55<br>42<br>65<br>43<br>50  |  | 10.97<br>10.97<br>10.97<br>10.97<br>10.97  | 08.00<br>08.00<br>08.00<br>08.00<br>08.00  |  | 03.2122-1356.3<br>010529   |  | - ABS  | THz 22,20   | ATE  |
|  | 1.4 i<br>1.5 D<br>1.6 16V<br>1.6 i<br>1.8 16V<br>1.8 D<br>1.8 i<br>1.8 i<br>1.9 D<br>1.9 SD<br>1.9 TD<br>2.0 16V<br>2.0 16V<br>2.0 HDi 110<br>2.0 HDi 90                         | 55<br>42<br>80<br>65<br>81<br>43<br>66<br>74<br>50<br>55<br>66<br>97<br>100<br>80<br>66                               | ORGA 09001<br>ORGA 09001<br>ORGA 09001<br>ORGA 09001<br>ORGA 09001<br>ORGA 09001<br>ORGA 09001<br>ORGA 09001<br>ORGA 09001<br>ORGA 09001<br>ORGA 09001<br>ORGA 09001<br>ORGA 09001<br>ORGA 09001   | 10.97<br>10.97<br>09.00<br>10.97<br>10.97<br>10.97<br>10.97<br>10.97<br>10.97<br>01.98<br>10.97<br>07.98<br>09.00<br>05.01<br>09.98                            | 08.00<br>08.00<br>08.00<br>08.00<br>08.00<br>08.00<br>08.00<br>08.00<br>08.00<br>08.00<br>08.00<br>08.00<br>08.00<br>08.00<br>08.00                            |  | 24.2123-1714.3<br>24.2123-1715.3<br>010587<br>010520   |  | - ABS<br>+ ABS   | THz 23,81<br>THz 23,81  | BDX<br>BDX   |
|  | 1.4 HDi 70<br>1.4 i<br>1.6 16V<br>1.9 D<br>2.0 16V<br>2.0 HDi 110<br>2.0 HDi 90  | 50<br>55 ORGA 09002<br>80 ORGA 09002<br>51 ORGA 09002<br>100 ORGA 09002<br>80 ORGA 09002<br>66 ORGA 09002             |  | 01.03<br>08.05<br>08.05<br>08.05<br>08.05<br>08.05<br>08.05  | 08.05<br>08.05<br>08.05<br>08.05<br>08.05<br>08.05<br>08.05  |  | 03.2123-2781.3<br>03.2123-2721.3<br>010631<br>010632   |  | - ABS<br>- ESP   | THz 23,81<br>THz 23,81  | ATE<br>ATE   |
|  | 1.4 HDi 70<br>1.4 i<br>1.6 16V<br>1.9 D<br>2.0 16V<br>2.0 HDi 110<br>2.0 HDi 90  | 50<br>55 ORGA 09065<br>80 ORGA 09065<br>51 ORGA 09065<br>100 ORGA 09065<br>80 ORGA 09065<br>66 ORGA 09065             |  | 01.03<br>08.05<br>08.05<br>08.05<br>08.05<br>08.05<br>08.05  | 08.05<br>08.05<br>08.05<br>08.05<br>08.05<br>08.05<br>08.05  |  | 03.2123-2761.3<br>010886   |  | + ESP  | THz 23,81   | ATE  |
|  | 1.4 i<br>1.5 D<br>1.6 i<br>1.8 D<br>1.9 D<br>1.9 D   | 55<br>42<br>65<br>43<br>50<br>51  |  | 10.97<br>10.97<br>10.97<br>10.97<br>10.97<br>07.98   | 08.00<br>08.00<br>08.00<br>08.00<br>08.00<br>08.00   | - ABS<br>- ABS<br>- ABS<br>- ABS<br>- ABS<br>- ABS                   | 11.3481-9833.2<br>11.3481-9834.2<br>24.3481-9833.5<br>24.3481-9834.5<br>11.0441-4811.2<br>11.0101-5407.2<br>11.8171-0008.1<br>11.8116-0129.1 | 220561<br>220562<br>240479<br>240480<br>250024<br>260011<br>990049<br>390591 | <input type="checkbox"/><br><input type="checkbox"/><br><input type="checkbox"/><br><input type="checkbox"/><br><input type="checkbox"/><br><input type="checkbox"/>   | D=48, - Halter<br>D=48, - Halter<br>D=48, - Halter<br>D=48, - Halter<br>Dichtungssatz<br>Hülzensatz<br>Führungsbolzen<br>Haltefeder | ATE<br>ATE<br>ATE<br>ATE<br>ATE<br>ATE<br>ATE<br>ATE |
|  | 1.4 i<br>1.5 D<br>1.6 i<br>1.8 16V<br>1.8 D<br>1.8 i<br>1.8 i<br>1.9 D<br>1.9 D<br>1.9 SD<br>1.9 TD<br>2.0 16V<br>2.0 HDi 90   | 55<br>42<br>65<br>81<br>43<br>66<br>74<br>50<br>51<br>55<br>66<br>97<br>66  |  | 10.97<br>10.97<br>10.97<br>10.97<br>10.97<br>10.97<br>10.97<br>10.97<br>07.98<br>01.98<br>10.97<br>07.98<br>09.98  | 08.00<br>08.00<br>08.00<br>08.00<br>08.00<br>08.00<br>08.00<br>08.00<br>08.00<br>08.00<br>08.00<br>08.00<br>08.00  | + ABS<br>+ ABS<br>+ ABS<br>+ ABS<br>+ ABS<br>+ ABS<br>+ ABS<br>+ ABS | 24.3541-1767.5<br>24.3541-1768.5<br>24.3541-1757.7<br>24.3541-1758.7<br>240237<br>240238<br>220483<br>220484                                 | 240237<br>240238   | <input type="checkbox"/><br><input type="checkbox"/><br><input type="checkbox"/><br><input type="checkbox"/><br><input type="checkbox"/><br><input type="checkbox"/><br><input type="checkbox"/><br><input type="checkbox"/> | D=54, - Halter<br>D=54, - Halter<br>D=54, - Halter<br>D=54, - Halter  | BOS<br>BOS<br>LUC<br>LUC                             |
|  | 1.4 HDi 70<br>1.4 i<br>1.6 16V<br>1.9 D<br>2.0 HDi 90  | 50<br>55<br>80<br>51<br>66  |  | 01.03<br>09.00<br>09.00<br>09.00<br>09.00  | 08.05<br>08.05<br>08.05<br>08.05<br>08.05  |  | 24.3541-1771.5<br>24.3541-1772.5<br>240239<br>240240   | 240239<br>240240   | <input type="checkbox"/><br><input type="checkbox"/>   | D=54, - Halter<br>D=54, - Halter  | BOS<br>BOS   |
|  | 2.0 16V<br>2.0 HDi 110   | 100<br>80   | ORGA 09184<br>ORGA 09184   | 09.00<br>05.01   |  |  | 24.3571-1729.5<br>240317   | 240317   | <input type="checkbox"/>   | D=57, - Halter  | LUC  |
|  | 2.0 16V<br>2.0 HDi 110   | 100<br>80   | ORGA 09185<br>ORGA 09185   | 08.05<br>08.05   |  |  | 24.3541-1761.5<br>24.3541-1762.5<br>240233<br>240234   | 240233<br>240234   | <input type="checkbox"/><br><input type="checkbox"/>   | D=54, - Halter<br>D=54, - Halter  | BOS<br>BOS   |
|  | 1.4 i  | 55  | ORGA 08091   | 10.97  |  |  | 24.5111-0438.3<br>330568   | 330568   | 2  |   | L=445  |
|  | 1.4 i<br>1.5 D<br>1.6 16V<br>1.6 i<br>1.8 16V<br>1.8 D<br>1.8 i<br>1.8 i<br>1.9 D<br>1.9 D<br>1.9 SD<br>1.9 TD<br>2.0 16V<br>2.0 16V<br>2.0 HDi 110<br>2.0 HDi 110<br>2.0 HDi 90 | 55 ORGA 08092<br>42<br>80<br>65<br>81<br>43<br>66<br>74<br>50<br>51<br>55<br>66<br>97<br>100<br>100<br>80<br>80<br>66 | ORGA 08092<br>ORGA 09470<br>ORGA 09470<br>ORGA 09470<br>ORGA 09470<br>ORGA 09470<br>ORGA 09470<br>ORGA 09470<br>ORGA 09470<br>ORGA 09470<br>ORGA 09470<br>ORGA 09470<br>ORGA 09470<br>ORGA 09184<br>ORGA 09470<br>ORGA 09184<br>ORGA 09470 | 10.97<br>10.97<br>09.00<br>10.97<br>10.97<br>10.97<br>10.97<br>10.97<br>10.97<br>07.98<br>01.98<br>10.97<br>07.98<br>09.00<br>09.00<br>05.01<br>05.01<br>09.98 | 08.00<br>08.00<br>08.00<br>08.00<br>08.00<br>08.00<br>08.00<br>08.00<br>08.00<br>08.00<br>08.00<br>08.00<br>08.00<br>08.00<br>08.00<br>08.00<br>08.00<br>08.00 | - ESP<br>+ ESP<br>- ESP<br>+ ESP                                     | 24.5111-0460.3<br>330603   | 330603   | 2  |   | L=460  |
|  | 1.4 HDi 70<br>1.4 i<br>1.6 16V   | 50<br>55 ORGA 09471<br>80 ORGA 09471  |  | 01.03<br>08.05<br>08.05  | 08.05<br>08.05<br>08.05  |  | 24.5111-0459.3<br>330683   | 330683   | 2  |   | L=460  |



| CITROEN XSARA (N2) Kombi (97-05) |             |     |            |                      |                      |                |        |                          |  |              |
|----------------------------------|-------------|-----|------------|----------------------|----------------------|----------------|--------|--------------------------|--|--------------|
|                                  | 1.9 D       | 51  | ORGA 09471 |                      | 08.05                | 24.5111-0459.3 | 330683 | 2                        |  | L=460        |
|                                  | 2.0 16V     | 100 | ORGA 09185 |                      | 08.05 + ESP          |                |        |                          |  |              |
|                                  | 2.0 16V     | 100 | ORGA 09471 |                      | 08.05 - ESP          |                |        |                          |  |              |
|                                  | 2.0 HDi 110 | 80  | ORGA 09185 |                      | 08.05 + ESP          |                |        |                          |  |              |
|                                  | 2.0 HDi 110 | 80  | ORGA 09471 |                      | 08.05 - ESP          |                |        |                          |  |              |
|                                  | 2.0 HDi 90  | 66  | ORGA 09471 |                      | 08.05                |                |        |                          |  |              |
|                                  | 1.4 i       | 55  |            |                      | 10.97 08.00 - ABS    | 24.5228-0195.3 | 330469 | 2                        |  | L=202        |
|                                  | 1.5 D       | 42  |            |                      | 10.97 08.00 - ABS    |                |        |                          |  |              |
|                                  | 1.6 i       | 65  |            |                      | 10.97 08.00 - ABS    |                |        |                          |  |              |
|                                  | 1.8 D       | 43  |            |                      | 10.97 08.00 - ABS    |                |        |                          |  |              |
|                                  | 1.8 i       | 66  |            |                      | 10.97 08.00 - ABS    |                |        |                          |  |              |
|                                  | 1.8 i       | 74  |            |                      | 10.97 08.00 - ABS/ - |                |        |                          |  |              |
|                                  | 1.9 D       | 50  |            |                      | 10.97 08.00 - ABS    |                |        |                          |  |              |
|                                  | 1.9 D       | 51  |            |                      | 07.98 08.00 - ABS    |                |        |                          |  |              |
|                                  | 1.9 SD      | 55  |            |                      | 01.98 08.00 - ABS    |                |        |                          |  |              |
|                                  | 1.9 TD      | 66  |            |                      | 10.97 08.00 - ABS    |                |        |                          |  |              |
|                                  | 1.4 HDi 70  | 50  |            |                      | 01.03 08.05          | 24.5228-0195.3 | 330469 | <input type="checkbox"/> |  | L=202        |
|                                  | 1.4 i       | 55  |            |                      | 09.00 08.05          | 24.5228-0245.3 | 330531 | <input type="checkbox"/> |  | L=245        |
|                                  | 1.4 i       | 55  |            |                      | 10.97 08.00 + ABS    |                |        |                          |  |              |
|                                  | 1.5 D       | 42  |            |                      | 10.97 08.00 + ABS    |                |        |                          |  |              |
|                                  | 1.6 16V     | 80  |            |                      | 09.00 08.05 + ABS    |                |        |                          |  |              |
| 1.6 i                            | 65          |     |            | 10.97 08.00 + ABS    |                      |                |        |                          |  |              |
| 1.8 16V                          | 81          |     |            | 10.97 08.00          |                      |                |        |                          |  |              |
| 1.8 D                            | 43          |     |            | 10.97 08.00 + ABS    |                      |                |        |                          |  |              |
| 1.8 i                            | 66          |     |            | 10.97 08.00 + ABS    |                      |                |        |                          |  |              |
| 1.8 i                            | 74          |     |            | 10.97 08.00 + ABS/ + |                      |                |        |                          |  |              |
| 1.9 D                            | 50          |     |            | 10.97 08.00 + ABS    |                      |                |        |                          |  |              |
| 1.9 D                            | 51          |     |            | 09.00 08.05          |                      |                |        |                          |  |              |
| 1.9 D                            | 51          |     |            | 07.98 08.00 + ABS    |                      |                |        |                          |  |              |
| 1.9 SD                           | 55          |     |            | 10.97 08.00 + ABS    |                      |                |        |                          |  |              |
| 1.9 TD                           | 66          |     |            | 10.97 08.00 + ABS    |                      |                |        |                          |  |              |
| 2.0 16V                          | 97          |     |            | 07.98 08.00          |                      |                |        |                          |  |              |
| 2.0 16V                          | 100         |     |            | 09.00 08.05          |                      |                |        |                          |  |              |
| 2.0 HDi 110                      | 80          |     |            | 05.01 08.05          |                      |                |        |                          |  |              |
| 2.0 HDi 90                       | 66          |     |            | 09.98 08.05          |                      |                |        |                          |  |              |
|                                  | 1.4 i       | 55  |            |                      | 10.97 08.00 - ABS    | 24.3220-1702.3 | 020375 |                          |  | Rz 20,64 BDX |
|                                  | 1.5 D       | 42  |            |                      | 10.97 08.00 - ABS    |                |        |                          |  |              |
|                                  | 1.6 i       | 65  |            |                      | 10.97 08.00 - ABS    |                |        |                          |  |              |
|                                  | 1.8 D       | 43  |            |                      | 10.97 08.00 - ABS    |                |        |                          |  |              |
|                                  | 1.9 D       | 50  |            |                      | 10.97 08.00 - ABS    |                |        |                          |  |              |
|                                  | 1.9 D       | 51  |            |                      | 07.98 08.00 - ABS    |                |        |                          |  |              |
|                                  | 1.4 HDi 70  | 50  |            |                      | 01.03 08.05          | 24.3222-1714.3 | 020432 |                          |  | Rz 22,00 BDX |
|                                  | 1.4 i       | 55  |            |                      | 09.00 08.05          |                |        |                          |  |              |
|                                  | 1.4 i       | 55  |            |                      | 10.97 08.00 + ABS    |                |        |                          |  |              |
|                                  | 1.5 D       | 42  |            |                      | 10.97 08.00 + ABS    |                |        |                          |  |              |
|                                  | 1.6 i       | 65  |            |                      | 10.97 08.00 + ABS    |                |        |                          |  |              |
|                                  | 1.8 D       | 43  |            |                      | 10.97 08.00 + ABS    |                |        |                          |  |              |
|                                  | 1.8 i       | 66  |            |                      | 10.97 08.00          |                |        |                          |  |              |
|                                  | 1.8 i       | 74  |            |                      | 10.97 08.00 -        |                |        |                          |  |              |
|                                  | 1.9 D       | 50  |            |                      | 10.97 08.00 + ABS    |                |        |                          |  |              |
| 1.9 D                            | 51          |     |            | 09.00 08.05          |                      |                |        |                          |  |              |
| 1.9 D                            | 51          |     |            | 07.98 08.00 + ABS    |                      |                |        |                          |  |              |
| 1.9 SD                           | 55          |     |            | 01.98 08.00          |                      |                |        |                          |  |              |
| 1.9 TD                           | 66          |     |            | 10.97 08.00          |                      |                |        |                          |  |              |
|                                  | 1.4 HDi 70  | 50  |            |                      | 01.03 08.05          | 24.3727-0337.2 | 580337 | <input type="checkbox"/> |  | L=1610       |
|                                  | 1.4 i       | 55  |            |                      | 10.97 08.05          | 24.3727-0338.2 | 580338 | <input type="checkbox"/> |  | L=1520       |
|                                  | 1.5 D       | 42  |            |                      | 10.97 08.00          |                |        |                          |  |              |
|                                  | 1.6 i       | 65  |            |                      | 10.97 08.00          |                |        |                          |  |              |
|                                  | 1.8 D       | 43  |            |                      | 10.97 08.00          |                |        |                          |  |              |
|                                  | 1.8 i       | 66  |            |                      | 10.97 08.00          |                |        |                          |  |              |
|                                  | 1.8 i       | 74  |            |                      | 10.97 08.00 -        |                |        |                          |  |              |
|                                  | 1.9 D       | 50  |            |                      | 10.97 08.00          |                |        |                          |  |              |
|                                  | 1.9 D       | 51  |            |                      | 07.98 08.05          |                |        |                          |  |              |
|                                  | 1.9 SD      | 55  |            |                      | 01.98 08.00          |                |        |                          |  |              |
|                                  | 1.9 TD      | 66  |            |                      | 10.97 08.00          |                |        |                          |  |              |
|                                  | 1.6 16V     | 80  |            |                      | 09.00 08.05          | 24.3727-0326.2 | 580326 | <input type="checkbox"/> |  | L=1635       |
|                                  | 1.8 16V     | 81  |            |                      | 10.97 08.00          | 24.3727-0327.2 | 580327 | <input type="checkbox"/> |  | L=1545       |
|                                  | 1.8 i       | 74  |            |                      | 10.97 08.00 +        |                |        |                          |  |              |
|                                  | 2.0 16V     | 97  |            |                      | 07.98 08.00          |                |        |                          |  |              |
| 2.0 16V                          | 100         |     |            | 09.00 08.05          |                      |                |        |                          |  |              |
| 2.0 HDi 110                      | 80          |     |            | 05.01 08.05          |                      |                |        |                          |  |              |
| 2.0 HDi 90                       | 66          |     |            | 09.98 08.05          |                      |                |        |                          |  |              |
|                                  | 1.4 HDi 70  | 50  |            |                      | 01.03 08.05          | 24.3728-0332.2 | 590332 |                          |  | L=625        |
|                                  | 1.4 i       | 55  |            |                      | 10.97 08.05          |                |        |                          |  |              |
|                                  | 1.5 D       | 42  |            |                      | 10.97 08.00          |                |        |                          |  |              |
|                                  | 1.6 16V     | 80  |            |                      | 09.00 08.05          |                |        |                          |  |              |
|                                  | 1.6 i       | 65  |            |                      | 10.97 08.00          |                |        |                          |  |              |
|                                  | 1.8 16V     | 81  |            |                      | 10.97 08.00          | 24.3728-0329.2 | 590329 |                          |  | L=653, + AUT |
|                                  | 1.8 D       | 43  |            |                      | 10.97 08.00          |                |        |                          |  |              |
|                                  | 1.8 i       | 66  |            |                      | 10.97 08.00          |                |        |                          |  |              |
|                                  | 1.9 D       | 50  |            |                      | 10.97 08.00          |                |        |                          |  |              |
|                                  | 1.9 SD      | 55  |            |                      | 01.98 08.00          |                |        |                          |  |              |
|                                  | 1.9 TD      | 66  |            |                      | 10.97 08.00          |                |        |                          |  |              |
|                                  | 2.0 16V     | 97  |            |                      | 07.98 08.00          | 24.3728-0339.2 | 590339 |                          |  | L=717, + AUT |
|                                  | 1.9 D       | 50  |            |                      | 09.00 08.05          | 24.3728-0839.2 | 590839 |                          |  | L=906, + AUT |
|                                  | 2.0 16V     | 100 |            |                      | 09.00 08.05          |                |        |                          |  |              |

|     |                         |    |                          |                          |  |  |  |  |
|--|---|--|--|--|---|--|--|--|
| <b>CITROEN XSARA (N2) Kombi (97-05)</b>  |   |  |  |  |   |  |  |  |
|    | 2.0 HDi 110<br>2.0 HDi 90   | 80<br>66   | 05.01<br>09.00   | 08.05<br>08.05   | 24.3728-0839.2  | 590839   |  | L=906, + AUT   |
| <b>CITROEN XSARA (N0) Coupe (97-05)</b>  |   |  |  |  |   |  |  |  |
|    | 1.4 i<br>1.6 i<br>1.8 16V<br>1.8 i<br>1.8 i<br>1.9 D<br>1.9 D<br>1.9 TD<br>2.0 HDi 90                   | 55<br>65<br>81<br>66<br>74<br>50<br>51<br>66<br>66   | 02.98<br>02.98<br>02.98<br>02.98<br>04.97<br>02.98<br>02.98<br>02.98<br>02.99                            | 08.00<br>08.00<br>08.00<br>08.00<br>08.00<br>08.00<br>08.00<br>08.00<br>08.00                            | 03.7750-9302.4  | 300116   |  | 9" ATE   |
|  | 1.4 HDi 70<br>1.4 i<br>1.6 16V<br>1.9 D<br>2.0<br>2.0 16V<br>2.0 16V<br>2.0 HDi 110<br>2.0 HDi 90       | 50<br>55 ORGA 09002<br>80 ORGA 09002<br>51 ORGA 09002<br>97 ORGA 09002<br>100 ORGA 09002<br>120 ORGA 09002<br>80 ORGA 09002<br>66 ORGA 09002 | 01.03<br>03.05<br>03.05<br>03.05<br>08.00<br>03.05<br>03.05<br>03.05<br>03.05                            | 03.05<br>03.05<br>03.05<br>03.05<br>03.05<br>03.05<br>03.05<br>03.05<br>03.05                            | 03.7750-3532.4<br>03.7853-0902.4  | 300149<br>300150   | - ABS<br>+ ABS   | 9"<br>9" ATE ATE   |
|    | 1.4 i<br>1.6 i<br>1.8 i<br>1.8 i<br>1.9 D<br>1.9 D<br>1.9 TD<br>2.0 HDi 90                              | 55<br>65<br>66<br>74<br>50<br>51<br>66<br>66   | 02.98<br>02.98<br>02.98<br>04.97<br>02.98<br>02.98<br>02.98<br>02.99                                     | 08.00<br>08.00<br>08.00<br>08.00<br>08.00<br>08.00<br>08.00<br>08.00                                     | 03.2122-1356.3<br>24.2122-1743.3<br>03.2122-1351.3<br>24.2122-1733.3              | 010529<br>010712<br>010528<br>010668   | - ABS<br>- ABS<br>+ ABS<br>+ ABS   | THz 22,20<br>THz 22,20<br>THz 22,20<br>THz 22,20<br>ATE ATE BOS                    |
|  | 1.4 i<br>1.6 16V<br>1.8 16V<br>1.9 D<br>2.0<br>2.0 16V<br>2.0 16V<br>2.0 HDi 110<br>2.0 HDi 90          | 55<br>80<br>81<br>51<br>97<br>100<br>120<br>80<br>66   | 09.00<br>09.00<br>02.98<br>08.00<br>09.00<br>08.98<br>09.00<br>02.98<br>05.01<br>09.00                   | 09.00<br>09.00<br>08.00<br>08.00<br>08.98<br>09.00<br>02.98<br>05.01<br>09.00                            | 24.2123-1714.3<br>24.2123-1715.3  | 010587<br>010520   | - ABS<br>+ ABS   | THz 23,81<br>THz 23,81<br>BDX BDX  |
|  | 1.4 HDi 70<br>1.4 i<br>1.6 16V<br>1.9 D<br>2.0<br>2.0 16V<br>2.0 16V<br>2.0 HDi 110<br>2.0 HDi 90       | 50<br>55 ORGA 09002<br>80 ORGA 09002<br>51 ORGA 09002<br>97 ORGA 09002<br>100 ORGA 09002<br>120 ORGA 09002<br>80 ORGA 09002<br>66 ORGA 09002 | 01.03<br>03.05<br>03.05<br>03.05<br>08.00<br>03.05<br>03.05<br>03.05<br>03.05                            | 03.05<br>03.05<br>03.05<br>08.00<br>03.05<br>03.05<br>03.05<br>03.05<br>03.05                            | 03.2123-2781.3<br>03.2123-2721.3  | 010631<br>010632   | - ABS<br>+ ABS   | THz 23,81<br>THz 23,81<br>ATE ATE  |
|  | 1.4 HDi 70<br>1.4 i<br>1.6 16V<br>1.9 D<br>2.0<br>2.0 16V<br>2.0 16V<br>2.0 HDi 110<br>2.0 HDi 90       | 50<br>55 ORGA 09065<br>80 ORGA 09065<br>51 ORGA 09065<br>97 ORGA 09065<br>100 ORGA 09065<br>120 ORGA 09065<br>80 ORGA 09065<br>66 ORGA 09065 | 01.03<br>03.05<br>03.05<br>03.05<br>08.00<br>03.05<br>03.05<br>03.05<br>03.05                            | 03.05<br>03.05<br>03.05<br>08.00<br>03.05<br>03.05<br>03.05<br>03.05<br>03.05                            | 03.2123-2761.3  | 010886   | + ESP  | THz 23,81<br>ATE   |
|  | 1.4 i<br>1.4 i<br>1.6 i<br>1.8 i<br>1.8 i<br>1.9 D<br>1.9 D<br>1.9 TD<br>1.8 16V<br>1.8 i<br>2.0 HDi 90 | 55<br>55<br>65<br>66<br>74<br>50<br>51<br>66<br>81<br>74<br>66   | 02.98<br>02.98<br>02.98<br>04.97<br>02.98<br>02.98<br>02.98<br>02.98<br>02.98<br>04.97<br>04.97<br>02.99 | 08.00<br>08.00<br>08.00<br>08.00<br>08.00<br>08.00<br>08.00<br>08.00<br>08.00<br>08.00<br>08.00<br>08.00 | 24.3481-1741.5<br>24.3481-1742.5  | 240245<br>240246   | - ABS<br>+ ABS   | D=48, - Halter<br>D=48, - Halter<br>BOS BOS  |
|  | 1.4 HDi 70<br>1.4 i<br>1.6 16V<br>1.9 D<br>2.0 HDi 90   | 50<br>55<br>80<br>51<br>66   | 01.03<br>09.00<br>09.00<br>09.00<br>09.00  | 03.05<br>03.05<br>03.05<br>03.05<br>03.05  | 24.3541-1771.5<br>24.3541-1772.5  | 240239<br>240240   |  | D=54, - Halter<br>D=54, - Halter<br>BOS BOS  |
|  | 2.0<br>2.0 16V<br>2.0 16V<br>2.0 HDi 110  | 97<br>100<br>120<br>80   | 08.98<br>09.00<br>02.98<br>05.01   | 08.98<br>09.00<br>02.98<br>05.01   | 24.3571-1729.5  | 240317   |  | D=57, - Halter<br>LUC  |
|  | 2.0<br>2.0 16V<br>2.0 16V<br>2.0 HDi 110  | 97 ORGA 09185<br>100 ORGA 09185<br>120 ORGA 09185<br>80 ORGA 09185   | 08.00<br>03.05<br>03.05<br>03.05   | 08.00<br>03.05<br>03.05<br>03.05   | 24.3541-1761.5<br>24.3541-1762.5  | 240233<br>240234   |  | D=54, - Halter<br>D=54, - Halter<br>BOS BOS  |

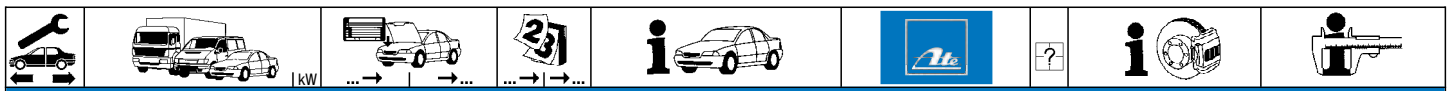

**CITROEN XSARA (N0) Coupe (97-05)**

|  |             |     |            |       |                     |                |        |                          |  |           |
|--|-------------|-----|------------|-------|---------------------|----------------|--------|--------------------------|--|-----------|
|  | 1.4 i       | 55  | ORGA 08091 | 02.98 |                     | 24.5111-0438.3 | 330568 | 2                        |  | L=445     |
|  | 1.4 i       | 55  | ORGA 08092 |       |                     | 24.5111-0460.3 | 330603 | 2                        |  | L=460     |
|  | 1.6 16V     | 80  | ORGA 09470 | 09.00 |                     |                |        |                          |  |           |
|  | 1.6 i       | 65  |            | 02.98 | 08.00               |                |        |                          |  |           |
|  | 1.8 16V     | 81  |            | 02.98 | 08.00               |                |        |                          |  |           |
|  | 1.8 i       | 66  |            | 02.98 | 08.00               |                |        |                          |  |           |
|  | 1.8 i       | 74  |            | 04.97 | 08.00               |                |        |                          |  |           |
|  | 1.9 D       | 50  |            | 02.98 | 08.00               |                |        |                          |  |           |
|  | 1.9 D       | 51  | ORGA 09470 | 02.99 |                     |                |        |                          |  |           |
|  | 1.9 TD      | 66  |            | 02.98 | 08.00               |                |        |                          |  |           |
|  | 2.0         | 97  | ORGA 09470 | 08.98 | - ESP               |                |        |                          |  |           |
|  | 2.0         | 97  | ORGA 09184 | 08.98 | + ESP               |                |        |                          |  |           |
|  | 2.0 16V     | 100 | ORGA 09470 | 09.00 | - ESP               |                |        |                          |  |           |
|  | 2.0 16V     | 100 | ORGA 09184 | 09.00 | + ESP               |                |        |                          |  |           |
|  | 2.0 16V     | 120 | ORGA 09470 | 02.98 | - ESP               |                |        |                          |  |           |
|  | 2.0 16V     | 120 | ORGA 09184 | 02.98 | + ESP               |                |        |                          |  |           |
|  | 2.0 HDi 110 | 80  | ORGA 09470 | 05.01 | - ESP               |                |        |                          |  |           |
|  | 2.0 HDi 110 | 80  | ORGA 09184 | 05.01 | + ESP               |                |        |                          |  |           |
|  | 2.0 HDi 90  | 66  | ORGA 09470 | 02.99 |                     |                |        |                          |  |           |
|  | 1.4 HDi 70  | 50  |            | 01.03 | 03.05               | 24.5111-0459.3 | 330683 | 2                        |  | L=460     |
|  | 1.4 i       | 55  | ORGA 09471 |       | 03.05               |                |        |                          |  |           |
|  | 1.9 D       | 51  | ORGA 09471 |       | 03.05               |                |        |                          |  |           |
|  | 2.0         | 97  | ORGA 09185 |       | 08.00 + ESP         |                |        |                          |  |           |
|  | 2.0         | 97  | ORGA 09471 |       | 08.00 - ESP         |                |        |                          |  |           |
|  | 2.0 16V     | 100 | ORGA 09185 |       | 03.05 + ESP         |                |        |                          |  |           |
|  | 2.0 16V     | 100 | ORGA 09471 |       | 03.05 - ESP         |                |        |                          |  |           |
|  | 2.0 16V     | 120 | ORGA 09185 |       | 03.05 + ESP         |                |        |                          |  |           |
|  | 2.0 16V     | 120 | ORGA 09471 |       | 03.05 - ESP         |                |        |                          |  |           |
|  | 2.0 HDi 110 | 80  | ORGA 09185 |       | 03.05 + ESP         |                |        |                          |  |           |
|  | 2.0 HDi 110 | 80  | ORGA 09471 |       | 03.05 - ESP         |                |        |                          |  |           |
|  | 2.0 HDi 90  | 66  | ORGA 09471 |       | 03.05               |                |        |                          |  |           |
|  | 1.4 i       | 55  |            | 02.98 | 08.00 - ABS         | 24.5228-0195.3 | 330469 | 2                        |  | L=202     |
|  | 1.6 i       | 65  |            | 02.98 | 08.00 - ABS         |                |        |                          |  |           |
|  | 1.8 i       | 66  |            | 02.98 | 08.00 - ABS         |                |        |                          |  |           |
|  | 1.8 i       | 74  |            | 04.97 | 08.00 - ABS/ - (BR) |                |        |                          |  |           |
|  | 1.9 D       | 50  |            | 02.98 | 08.00 - ABS         |                |        |                          |  |           |
|  | 1.9 D       | 51  |            | 02.99 | 08.00 - ABS         |                |        |                          |  |           |
|  | 1.9 TD      | 66  |            | 02.98 | 08.00 - ABS         |                |        |                          |  |           |
|  | 1.4 HDi 70  | 50  |            | 01.03 | 03.05               | 24.5228-0195.3 | 330469 | <input type="checkbox"/> |  | L=202     |
|  | 1.4 i       | 55  |            | 09.00 | 03.05               | 24.5228-0245.3 | 330531 | <input type="checkbox"/> |  | L=245     |
|  | 1.4 i       | 55  |            | 02.98 | 08.00 + ABS         |                |        |                          |  |           |
|  | 1.6 16V     | 80  |            | 09.00 | 03.05               |                |        |                          |  |           |
|  | 1.6 i       | 65  |            | 02.98 | 08.00               |                |        |                          |  |           |
|  | 1.8 16V     | 81  |            | 02.98 | 08.00               |                |        |                          |  |           |
|  | 1.8 i       | 66  |            | 02.98 | 08.00 + ABS         |                |        |                          |  |           |
|  | 1.8 i       | 74  |            | 04.97 | 08.00 + ABS/ + (BR) |                |        |                          |  |           |
|  | 1.9 D       | 50  |            | 02.98 | 08.00 + ABS         |                |        |                          |  |           |
|  | 1.9 D       | 51  |            | 09.00 | 03.05               |                |        |                          |  |           |
|  | 1.9 D       | 51  |            | 02.99 | 08.00 + ABS         |                |        |                          |  |           |
|  | 1.9 TD      | 66  |            | 02.98 | 08.00 + ABS         |                |        |                          |  |           |
|  | 2.0         | 97  |            | 08.98 | 08.00               |                |        |                          |  |           |
|  | 2.0 16V     | 100 |            | 09.00 | 03.05               |                |        |                          |  |           |
|  | 2.0 16V     | 120 |            | 02.98 | 03.05               |                |        |                          |  |           |
|  | 2.0 HDi 110 | 80  |            | 05.01 | 03.05               |                |        |                          |  |           |
|  | 2.0 HDi 90  | 66  |            | 02.99 | 03.05               |                |        |                          |  |           |
|  | 1.4 i       | 55  |            | 02.98 | 08.00 - ABS         | 24.3220-1617.3 | 020244 | <input type="checkbox"/> |  | RzR 20,64 |
|  | 1.6 i       | 65  |            | 02.98 | 08.00 - ABS         | 24.3220-1618.3 | 020245 | <input type="checkbox"/> |  | RzR 20,64 |
|  | 1.8 i       | 66  |            | 02.98 | 08.00 - ABS         | 24.3220-1615.3 | 020242 | <input type="checkbox"/> |  | RzR 20,64 |
|  | 1.8 i       | 74  |            | 04.97 | 08.00 - ABS/ - (BR) | 24.3220-1616.3 | 020243 | <input type="checkbox"/> |  | RzR 20,64 |
|  | 1.9 D       | 50  |            | 02.98 | 08.00 - ABS         |                |        |                          |  |           |
|  | 1.9 D       | 51  |            | 02.98 | 08.00 - ABS         |                |        |                          |  |           |
|  | 1.4 i       | 55  | ORGA 08210 | 02.98 | + ABS               | 24.3220-1711.3 | 020409 |                          |  | Rz 20,64  |
|  | 1.6 i       | 65  | ORGA 08210 | 02.98 | + ABS               |                |        |                          |  |           |
|  | 1.8 i       | 66  | ORGA 08210 | 02.98 | + ABS               |                |        |                          |  |           |
|  | 1.8 i       | 74  |            | 04.97 | 08.00 + ABS         |                |        |                          |  |           |
|  | 1.9 TD      | 66  | ORGA 08210 | 02.98 | + ABS               |                |        |                          |  |           |
|  | 1.9 TD      | 66  |            | 02.98 | 08.00 - ABS         |                |        |                          |  |           |
|  | 1.4 i       | 55  | ORGA 08211 |       | 08.00 + ABS         | 24.3220-1717.3 | 020430 |                          |  | Rz 20,64  |
|  | 1.6 i       | 65  | ORGA 08211 |       | 08.00 + ABS         |                |        |                          |  |           |
|  | 1.8 i       | 66  | ORGA 08211 |       | 08.00 + ABS         |                |        |                          |  |           |
|  | 1.8 i       | 74  |            | 04.97 | 08.00 + ABS/ - (BR) |                |        |                          |  |           |
|  | 1.9 D       | 50  |            | 02.98 | 08.00 + ABS         |                |        |                          |  |           |
|  | 1.9 D       | 51  |            | 02.99 | 08.00 + ABS         |                |        |                          |  |           |
|  | 1.9 TD      | 66  | ORGA 08211 |       | 08.00 + ABS         |                |        |                          |  |           |
|  | 1.4 i       | 55  | ORGA 08728 | 09.00 |                     | 24.3220-1711.3 | 020409 |                          |  | Rz 20,64  |
|  | 1.9 D       | 51  | ORGA 08728 | 09.00 |                     |                |        |                          |  |           |
|  | 1.4 HDi 70  | 50  |            | 01.03 | 03.05               | 24.3220-1717.3 | 020430 |                          |  | Rz 20,64  |
|  | 1.4 i       | 55  | ORGA 08729 |       | 03.05               |                |        |                          |  |           |
|  | 1.9 D       | 51  | ORGA 08729 |       | 03.05               |                |        |                          |  |           |
|  | 1.4 HDi 70  | 50  |            | 01.03 | 03.05               | 24.3727-0322.2 | 580322 | <input type="checkbox"/> |  | L=1591    |
|  | 1.4 i       | 55  |            | 02.98 | 03.05               | 24.3727-0323.2 | 580323 | <input type="checkbox"/> |  | L=1500    |
|  | 1.6 i       | 65  |            | 02.98 | 08.00               |                |        |                          |  |           |
|  | 1.8 i       | 66  |            | 02.98 | 08.00               |                |        |                          |  |           |
|  | 1.8 i       | 74  |            | 04.97 | 08.00 - (BR)        |                |        |                          |  |           |
|  | 1.9 D       | 50  |            | 02.98 | 08.00               |                |        |                          |  |           |
|  | 1.9 D       | 51  |            | 02.99 | 03.05               |                |        |                          |  |           |





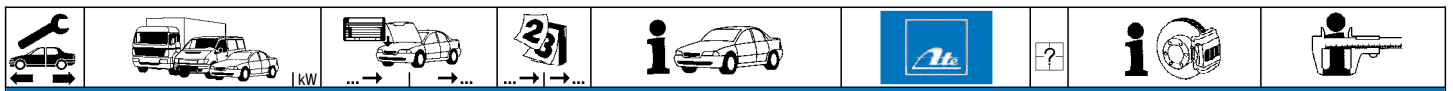

**CITROEN XSARA (N0) Coupe (97-05)**

|            |                  |     |       |       |       |      |                |        |                          |  |              |
|------------|------------------|-----|-------|-------|-------|------|----------------|--------|--------------------------|--|--------------|
|            | 1.9 TD           | 66  |       | 02.98 | 08.00 |      | 24.3727-0322.2 | 580322 | <input type="checkbox"/> |  | L=1591       |
|            |                  |     |       |       |       |      | 24.3727-0323.2 | 580323 | <input type="checkbox"/> |  | L=1500       |
|            | 1.6 16V          | 80  |       | 09.00 | 03.05 |      | 24.3727-0326.2 | 580326 | <input type="checkbox"/> |  | L=1635       |
|            | 1.8 16V          | 81  |       | 02.98 | 08.00 |      | 24.3727-0327.2 | 580327 | <input type="checkbox"/> |  | L=1545       |
|            | 1.8 i            | 74  |       | 04.97 | 08.00 | + BR |                |        |                          |  |              |
|            | 2.0              | 97  |       | 08.98 | 08.00 |      |                |        |                          |  |              |
|            | 2.0 16V          | 100 |       | 09.00 | 03.05 |      |                |        |                          |  |              |
|            | 2.0 16V          | 120 |       | 02.98 | 03.05 |      |                |        |                          |  |              |
|            | 2.0 HDi 110      | 80  |       | 05.01 | 03.05 |      |                |        |                          |  |              |
|            | 2.0 HDi 90       | 66  |       | 02.99 | 03.05 |      |                |        |                          |  |              |
|            | 1.4 HDi 70       | 50  |       | 01.03 | 03.05 |      | 24.3728-0332.2 | 590332 |                          |  | L=625        |
|            | 1.4 i            | 55  |       | 02.98 | 03.05 |      |                |        |                          |  |              |
|            | 1.6 16V X/SX/VTR | 80  |       | 09.00 | 03.05 |      |                |        |                          |  |              |
|            | 1.6 i            | 65  |       | 02.98 | 08.00 |      |                |        |                          |  |              |
|            | 1.8 i            | 66  |       | 02.98 | 08.00 |      | 24.3728-0329.2 | 590329 |                          |  | L=653, + AUT |
|            | 1.9 D            | 50  |       | 02.98 | 08.00 |      |                |        |                          |  |              |
|            | 1.9 D            | 51  |       | 02.99 | 08.00 |      |                |        |                          |  |              |
|            | 1.6 16V VTS      | 80  |       | 09.00 | 03.05 |      | 24.3728-0339.2 | 590339 |                          |  | L=717, + AUT |
|            | 1.9 TD           | 66  |       | 02.98 | 08.00 |      |                |        |                          |  |              |
|            | 2.0 16V          | 120 |       | 02.98 | 03.05 |      |                |        |                          |  |              |
|            | 1.9 D            | 51  |       | 09.00 | 03.05 |      | 24.3728-0839.2 | 590839 |                          |  | L=906, + AUT |
|            | 2.0              | 97  |       | 08.98 | 08.00 |      |                |        |                          |  |              |
|            | 2.0 16V          | 100 |       | 09.00 | 03.05 |      |                |        |                          |  |              |
|            | 2.0 HDi 110      | 80  |       | 05.01 | 03.05 |      |                |        |                          |  |              |
| 2.0 HDi 90 | 66               |     | 09.00 | 03.05 |       |      |                |        |                          |  |              |

**CITROEN XSARA Picasso (N68) (00-10)**

|  |             |     |              |       |       |                                       |                |        |                          |  |                |            |
|--|-------------|-----|--------------|-------|-------|---------------------------------------|----------------|--------|--------------------------|--|----------------|------------|
|  | 1.6         | 65  |              | 06.00 | 03.10 |                                       | 24.2123-1714.3 | 010587 | - ABS                    |  | THz 23,81      | <b>BDX</b> |
|  | 1.6         | 67  |              | 06.02 | 03.10 |                                       |                |        |                          |  |                |            |
|  | 1.6         | 70  |              | 09.00 | 03.10 |                                       |                |        |                          |  |                |            |
|  | 1.6 16V     | 80  |              | 09.05 | 03.10 |                                       |                |        |                          |  |                |            |
|  | 1.6 HDi 110 | 80  |              | 05.04 | 03.10 |                                       |                |        |                          |  |                |            |
|  | 1.6 HDi 90  | 66  |              | 09.05 | 03.10 |                                       |                |        |                          |  |                |            |
|  | 1.8 16V     | 85  |              | 02.00 | 03.10 |                                       |                |        |                          |  |                |            |
|  | 2.0 16V     | 100 |              | 01.03 | 03.10 |                                       |                |        |                          |  |                |            |
|  | 2.0 HDi     |     |              | 06.00 | 03.10 |                                       |                |        |                          |  |                |            |
|  |             |     |              |       |       |                                       |                |        |                          |  |                |            |
|  | 1.6         | 65  | ORGA 0882078 |       | 03.10 |                                       | 03.2123-2781.3 | 010631 | - ABS                    |  | THz 23,81      | <b>ATE</b> |
|  | 1.6         | 67  | ORGA 08820   |       | 03.10 |                                       |                |        |                          |  |                |            |
|  | 1.6         | 70  | ORGA 0882078 |       | 03.10 |                                       |                |        |                          |  |                |            |
|  | 1.6 16V     | 80  |              | 09.05 | 03.10 |                                       |                |        |                          |  |                |            |
|  | 1.6 HDi 110 | 80  |              | 05.04 | 03.10 |                                       |                |        |                          |  |                |            |
|  | 1.6 HDi 90  | 66  |              | 09.05 | 03.10 |                                       |                |        |                          |  |                |            |
|  | 1.8 16V     | 85  | ORGA 0882078 |       | 03.10 |                                       |                |        |                          |  |                |            |
|  | 2.0 16V     | 100 |              | 01.03 | 03.10 |                                       |                |        |                          |  |                |            |
|  | 2.0 HDi     |     | ORGA 0882078 |       | 03.10 |                                       |                |        |                          |  |                |            |
|  |             |     |              |       |       |                                       |                |        |                          |  |                |            |
|  | 1.6         | 65  |              | 06.00 | 03.10 |                                       | 24.2123-1753.3 | 010744 | + ESP                    |  | THz 23,81      |            |
|  | 1.6         | 67  |              | 06.02 | 03.10 |                                       |                |        |                          |  |                |            |
|  | 1.6         | 70  |              | 09.00 | 03.10 |                                       |                |        |                          |  |                |            |
|  | 1.6 16V     | 80  |              | 09.05 | 03.10 |                                       |                |        |                          |  |                |            |
|  | 1.6 HDi 110 | 80  |              | 05.04 | 03.10 |                                       |                |        |                          |  |                |            |
|  | 1.6 HDi 90  | 66  |              | 09.05 | 03.10 |                                       |                |        |                          |  |                |            |
|  | 1.8 16V     | 85  |              | 02.00 | 03.10 |                                       |                |        |                          |  |                |            |
|  | 2.0 16V     | 100 |              | 01.03 | 03.10 |                                       |                |        |                          |  |                |            |
|  | 2.0 HDi     |     |              | 06.00 | 03.10 |                                       |                |        |                          |  |                |            |
|  |             |     |              |       |       |                                       |                |        |                          |  |                |            |
|  | 1.6         | 65  | ORGA 11340   | 06.00 |       |                                       | 24.3541-1757.7 | 220483 | <input type="checkbox"/> |  | D=54, - Halter | <b>LUC</b> |
|  | 1.6         | 67  | ORGA 11340   | 06.02 |       |                                       | 24.3541-1758.7 | 220484 | <input type="checkbox"/> |  | D=54, - Halter | <b>LUC</b> |
|  | 1.6         | 70  | ORGA 11340   | 09.00 |       |                                       |                |        |                          |  |                |            |
|  | 1.6 16V     | 80  | ORGA 11340   | 09.05 |       |                                       |                |        |                          |  |                |            |
|  | 1.6 HDi 110 | 80  | ORGA 11340   | 05.04 |       |                                       |                |        |                          |  |                |            |
|  | 1.6 HDi 90  | 66  | ORGA 11340   | 09.05 |       |                                       |                |        |                          |  |                |            |
|  | 1.8 16V     | 85  | ORGA 11340   | 02.00 |       |                                       |                |        |                          |  |                |            |
|  | 2.0 16V     | 100 | ORGA 11340   | 01.03 |       |                                       |                |        |                          |  |                |            |
|  | 2.0 HDi     |     | ORGA 11340   | 06.00 |       |                                       |                |        |                          |  |                |            |
|  |             |     |              |       |       |                                       |                |        |                          |  |                |            |
|  | 1.6         | 65  |              | 06.00 | 03.10 | - ESP                                 | 24.3541-1771.5 | 240239 | <input type="checkbox"/> |  | D=54, - Halter | <b>BOS</b> |
|  | 1.6         | 67  |              | 06.02 | 03.10 | - ESP                                 | 24.3541-1772.5 | 240240 | <input type="checkbox"/> |  | D=54, - Halter | <b>BOS</b> |
|  | 1.6         | 70  |              | 09.00 | 03.10 | - ESP                                 |                |        |                          |  |                |            |
|  | 1.6 16V     | 80  |              | 09.05 | 03.10 | - ESP                                 |                |        |                          |  |                |            |
|  | 1.6 HDi 110 | 80  |              | 05.04 | 03.10 | - ESP                                 |                |        |                          |  |                |            |
|  | 1.6 HDi 90  | 66  |              | 09.05 | 03.10 | - ESP                                 |                |        |                          |  |                |            |
|  | 1.8 16V     | 85  |              | 02.00 | 03.10 | - ESP                                 |                |        |                          |  |                |            |
|  | 2.0 16V     | 100 |              | 01.03 | 03.10 | - ESP/ + Schaltgetriebe <sup>1)</sup> |                |        |                          |  |                |            |
|  | 2.0 16V     | 100 |              | 01.03 | 03.10 | + Automatikgetriebe <sup>2)</sup>     |                |        |                          |  |                |            |
|  | 2.0 HDi     |     |              | 06.00 | 03.10 | - ESP                                 |                |        |                          |  |                |            |
|  |             |     |              |       |       |                                       |                |        |                          |  |                |            |
|  | 1.6         | 65  |              | 06.00 | 03.10 | + ESP                                 | 24.3541-1761.5 | 240233 | <input type="checkbox"/> |  | D=54, - Halter | <b>BOS</b> |
|  | 1.6         | 67  |              | 06.02 | 03.10 | + ESP                                 | 24.3541-1762.5 | 240234 | <input type="checkbox"/> |  | D=54, - Halter | <b>BOS</b> |
|  | 1.6         | 70  |              | 09.00 | 03.10 | + ESP                                 |                |        |                          |  |                |            |
|  | 1.6 16V     | 80  |              | 09.05 | 03.10 | + ESP                                 |                |        |                          |  |                |            |
|  | 1.6 HDi 110 | 80  |              | 05.04 | 03.10 | + ESP                                 |                |        |                          |  |                |            |
|  | 1.6 HDi 90  | 66  |              | 09.05 | 03.10 | + ESP                                 |                |        |                          |  |                |            |
|  | 1.8 16V     | 85  |              | 02.00 | 03.10 | + ESP                                 |                |        |                          |  |                |            |
|  | 2.0 16V     | 100 |              | 01.03 | 03.10 | + ESP/ + Schaltgetriebe <sup>3)</sup> |                |        |                          |  |                |            |
|  | 2.0 16V     | 100 |              | 01.03 | 03.10 | + Automatikgetriebe <sup>2)</sup>     |                |        |                          |  |                |            |
|  | 2.0 HDi     |     |              | 06.00 | 03.10 | + ESP                                 |                |        |                          |  |                |            |

<sup>1)</sup> - ESP/ + manual transm. / - ESP/+ scatola cambio velocità / - ESP/ + transmission mécanique / - ESP/ + cambio de velocidad  
<sup>2)</sup> + autom.transmission / + scatola cambio automatico / + transmission automatique / + cambio automático  
<sup>3)</sup> + ESP/ + manual transm. / + ESP/+ scatola cambio velocità / + ESP/ + transmission mécanique / + ESP/ + cambio de velocidad



| <b>CITROEN XSARA Picasso (N68) (00-10)</b> |   |   |  |   |   |  |                                      |        |                |                                      |            |
|--|---|---|--|---|---|--|--------------------------------------|--------|----------------|--------------------------------------|------------|
|  | 1.6<br>1.6<br>1.6<br>1.6 16V<br>1.6 HDi 110<br>1.6 HDi 90<br>1.8 16V<br>2.0 16V<br>2.0 HDi          | 65<br>67<br>70<br>80<br>80<br>66<br>85<br>100   |  | 06.00<br>06.02<br>09.00<br>09.05<br>05.04<br>09.05<br>02.00<br>01.03<br>06.00                   | 03.10<br>03.10<br>03.10<br>03.10<br>03.10<br>03.10<br>03.10<br>03.10<br>03.10   | 24.5111-0438.3<br>24.5111-0460.3                                     | 330568<br>330603                     | 2<br>2 | - ESP<br>+ ESP | L=445<br>L=460                       |            |
|  | 1.6 16V<br>1.6 HDi 110<br>1.6 HDi 90<br>1.8 16V<br>2.0 16V<br>2.0 HDi                               | 80<br>80<br>66<br>85 ORGA 09492<br>100 ORGA 09821<br>ORGA 09492   |  | 09.05<br>05.04<br>09.05<br>03.10 + ESP<br>03.10<br>03.10 + ESP                                  | 03.10<br>03.10<br>03.10<br>03.10<br>03.10<br>03.10  | 24.3387-1711.7<br>24.3387-1712.7                                     | 220747<br>220748                     |        |                | D=38, - Halter<br>D=38, - Halter     | LUC<br>LUC |
|  | 1.6<br>1.6<br>1.6<br>1.8 16V<br>2.0 HDi   | 65<br>67<br>70<br>85  | ORGA 09526<br>ORGA 09526<br>ORGA 09526<br>ORGA 09526<br>ORGA 09526 | 06.00<br>06.02<br>09.00<br>02.00<br>06.00   |   | 24.5229-0255.3   | 330581                               | 2      |                | L=255                                |            |
|  | 1.6<br>1.6<br>1.6<br>1.6 16V<br>1.6 HDi 110<br>1.6 HDi 90<br>1.8 16V<br>2.0 16V<br>2.0 HDi          | 65 ORGA 09527<br>67 ORGA 09527<br>70 ORGA 09527<br>80<br>80<br>66<br>85 ORGA 09527<br>100<br>ORGA 09527 |  | 06.00<br>06.02<br>09.05<br>05.04<br>09.05<br>09.05<br>01.03<br>03.10                            | 03.10<br>03.10<br>03.10<br>03.10<br>03.10<br>03.10<br>03.10<br>03.10  | 24.5246-0260.3   | 330782                               | 2      |                | L=260                                |            |
|  | 1.6<br>1.6<br>1.6<br>1.8 16V<br>1.8 16V<br>2.0 HDi<br>2.0 HDi                                       | 65<br>67<br>70<br>85 ORGA 09492<br>85<br>ORGA 09492   |  | 06.00<br>06.02<br>09.00<br>03.10 - ESP<br>02.00<br>06.00  | 03.10<br>03.10<br>03.10<br>03.10<br>03.10<br>03.10 - ESP  | 24.3222-1711.3<br>24.3222-1734.3                                     | 020413<br>020539                     |        |                | Rz 22,20<br>Rz 22,20                 | LUC<br>LUC |
|  | 1.6<br>1.6<br>1.6<br>1.8 16V<br>1.8 16V<br>2.0 16V<br>2.0 HDi<br>2.0 HDi                            | 65<br>67<br>70<br>85 ORGA 09492<br>85<br>100<br>ORGA 09492  |  | 06.00<br>06.02<br>09.00<br>03.10 - ESP<br>02.00<br>01.03<br>06.00                               | 03.10<br>03.10<br>03.10<br>03.10 - ESP<br>03.10<br>03.10<br>03.10 - ESP   | 24.3727-0332.2   | 580332                               |        |                | L=1864                               |            |
|  | 1.6 16V<br>1.6 HDi 110<br>1.6 HDi 90<br>1.8 16V<br>2.0 16V<br>2.0 HDi                               | 80<br>80<br>66<br>85 ORGA 09492<br>100 ORGA 09821<br>ORGA 09492   |  | 09.05<br>05.04<br>09.05<br>03.10 + ESP<br>03.10<br>03.10 + ESP                                  | 03.10<br>03.10<br>03.10<br>03.10<br>03.10<br>03.10  | 24.3727-0333.2<br>24.3727-0334.2<br>24.3727-0353.2<br>24.3727-0354.2 | 580333<br>580334<br>580353<br>580354 |        |                | L=1860<br>L=1948<br>L=1860<br>L=1950 |            |
|  | 1.6<br>1.6<br>1.6<br>1.6 16V<br>1.6 HDi 110<br>1.6 HDi 90<br>1.8 16V<br>2.0 16V<br>2.0 HDi          | 65<br>67<br>70<br>80<br>80<br>66<br>85<br>100   |  | 06.00<br>06.02<br>09.00<br>09.05<br>05.04<br>09.05<br>02.00<br>01.03<br>06.00                   | 03.10<br>03.10 - ABS<br>03.10 - ABS<br>03.10 - ABS<br>03.10 - ABS<br>03.10 - ABS<br>03.10 - ABS<br>03.10 - ABS<br>03.10 - ABS                                     | 03.6582-0015.3   | 320227                               |        |                | BRL 8/1,5 (4)                        | ATE        |
|  | 1.6<br>1.6<br>1.6<br>1.6 16V<br>1.6 HDi 110<br>1.6 HDi 90<br>1.8 16V<br>2.0 HDi                     | 65<br>67<br>70<br>80<br>80<br>66<br>85  |  | 06.00<br>06.02<br>09.00<br>09.05<br>05.04<br>09.05<br>02.00<br>06.00                            | 03.10<br>03.10<br>03.10<br>03.10<br>03.10<br>03.10<br>03.10<br>03.10  | 24.3728-0330.2   | 590330                               |        |                | L=895, + AUT                         |            |
| <b>CITROEN ZX (N2) Limousine (91-97)</b>   |   |   |  |   |   |  |                                      |        |                |                                      |            |
|  | 1.1<br>1.1<br>1.4<br>1.4 i<br>1.6 i<br>1.8 D<br>1.8 i<br>1.9 D<br>1.9 D<br>1.9 i<br>1.9 TD<br>2.0 i | 40<br>44<br>55<br>55<br>65<br>44<br>74<br>47<br>50<br>88<br>66<br>89                                    |  | 03.91<br>03.91<br>03.91<br>03.91<br>06.93<br>07.92<br>03.91<br>06.94<br>03.91<br>07.92<br>07.92 | 06.97 - ABS<br>06.97 - ABS<br>06.97 - ABS<br>06.97 - ABS<br>06.97 - ABS<br>06.97 - ABS<br>06.97 - ABS<br>06.97 - ABS<br>06.97 - ABS<br>06.97 - ABS<br>06.97 - ABS | 03.7740-4002.4   | 300108                               |        |                | 8"                                   | ATE        |
|  | 1.1<br>1.1<br>1.4<br>1.4 i<br>1.6 i   | 40 ORGA 07070<br>44 ORGA 07070<br>55 ORGA 07070<br>55 ORGA 07070<br>65 ORGA 07070                       |  | 08.93 + ABS<br>06.97 + ABS<br>06.97 + ABS<br>06.97 + ABS<br>06.97 + ABS                         |   | 03.7750-8102.4   | 300114                               |        |                | 9"                                   | ATE        |

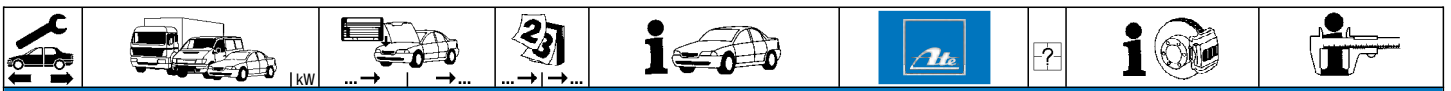

**CITROEN ZX (N2) Limousine (91-97)**

|  |  |   |  |  |   |  |  |                            |  |  |                   |
|--|--|---|--|--|---|--|--|----------------------------|--|--|-------------------|
|  | 1.8 16V<br>1.8 D<br>1.8 i<br>1.9 D<br>1.9 D<br>1.9 i<br>1.9 TD<br>2.0 i  | 81<br>44 ORGA 07070<br>74 ORGA 07070<br>47 ORGA 07070<br>50 ORGA 07070<br>88 ORGA 07070<br>66 ORGA 07070<br>89 ORGA 07070   |  | 01.96<br>06.97<br>06.97<br>06.97<br>06.97<br>06.97<br>06.97<br>06.97                                     | + ABS<br>+ ABS<br>+ ABS<br>+ ABS<br>+ ABS<br>+ ABS<br>+ ABS<br>+ ABS  | 03.7750-8102.4<br>300114                           |  | 9"                         | ATE  |  |                   |
|  | 1.1<br>1.1<br>1.4<br>1.4 i<br>1.6 i<br>1.8 16V<br>1.8 D<br>1.8 i<br>1.9 D<br>1.9 D<br>1.9 i<br>1.9 TD<br>2.0 i | 40<br>44<br>55<br>55<br>65<br>81<br>44<br>74<br>47<br>50<br>88<br>66<br>89  | ORGA 07125<br>ORGA 07125<br>ORGA 07125<br>ORGA 07125<br>ORGA 07125<br>ORGA 07125<br>ORGA 07125<br>ORGA 07125<br>ORGA 07125<br>ORGA 07125<br>ORGA 07125<br>ORGA 07125<br>ORGA 07125 | 03.91<br>03.91<br>03.91<br>03.91<br>01.96<br>06.93<br>07.92<br>03.91<br>06.94<br>03.91<br>07.92<br>07.92 | - ABS<br>- ABS<br>- ABS<br>- ABS<br>- ABS<br>- ABS<br>- ABS<br>- ABS<br>- ABS<br>- ABS<br>- ABS<br>- ABS<br>- ABS | 03.2120-2031.3<br>24.2120-1722.3                   | 010106<br>010544                                   | THz 20,64<br>THz 20,64     | ATE<br>BDX   |  |                   |
|  | 1.1<br>1.1<br>1.4<br>1.4 i<br>1.6 i<br>1.8 16V<br>1.8 D<br>1.8 i<br>1.9 D<br>1.9 D<br>1.9 i<br>1.9 TD<br>2.0 i | 40 ORGA 07126<br>44 ORGA 07126<br>55 ORGA 07126<br>55 ORGA 07126<br>65 ORGA 07126<br>81 ORGA 07126<br>44 ORGA 07126<br>74 ORGA 07126<br>47 ORGA 07126<br>50 ORGA 07126<br>88 ORGA 07126<br>66 ORGA 07126<br>89 ORGA 07126 |  | 08.93<br>06.97<br>06.97<br>06.97<br>06.97<br>06.97<br>06.97<br>06.97<br>06.97<br>06.97<br>06.97<br>06.97 | - ABS<br>- ABS<br>- ABS<br>- ABS<br>- ABS<br>- ABS<br>- ABS<br>- ABS<br>- ABS<br>- ABS<br>- ABS<br>- ABS          | 03.2120-4221.3                                     | 010605   | THz 20,64                  | ATE  |  |                   |
|  | 1.1<br>1.1<br>1.4<br>1.4 i<br>1.6 i<br>1.8 16V<br>1.8 D<br>1.8 i<br>1.9 D<br>1.9 D<br>1.9 i<br>1.9 TD<br>2.0 i | 40<br>44<br>55<br>55<br>65<br>81<br>44<br>74<br>47<br>50<br>88<br>66<br>89  | ORGA 07069<br>ORGA 07069<br>ORGA 07069<br>ORGA 07069<br>ORGA 07069<br>ORGA 07069<br>ORGA 07069<br>ORGA 07069<br>ORGA 07069<br>ORGA 07069<br>ORGA 07069<br>ORGA 07069<br>ORGA 07069 | 03.91<br>03.91<br>03.91<br>03.91<br>01.96<br>06.93<br>07.92<br>03.91<br>06.94<br>03.91<br>07.92<br>07.92 | + ABS<br>+ ABS<br>+ ABS<br>+ ABS<br>+ ABS<br>+ ABS<br>+ ABS<br>+ ABS<br>+ ABS<br>+ ABS<br>+ ABS<br>+ ABS<br>+ ABS | 24.2122-1704.3                                     | 010423   | THz 22,20                  |  |  |                   |
|  | 1.1<br>1.1<br>1.4<br>1.4 i<br>1.6 i<br>1.8 16V<br>1.8 D<br>1.8 i<br>1.9 D<br>1.9 D<br>1.9 i<br>1.9 TD<br>2.0 i | 40 ORGA 07070<br>44 ORGA 07070<br>55 ORGA 07070<br>55 ORGA 07070<br>65 ORGA 07070<br>81 ORGA 07070<br>44 ORGA 07070<br>74 ORGA 07070<br>47 ORGA 07070<br>50 ORGA 07070<br>88 ORGA 07070<br>66 ORGA 07070<br>89 ORGA 07070 |  | 08.93<br>06.97<br>06.97<br>06.97<br>06.97<br>06.97<br>06.97<br>06.97<br>06.97<br>06.97<br>06.97<br>06.97 | + ABS<br>+ ABS<br>+ ABS<br>+ ABS<br>+ ABS<br>+ ABS<br>+ ABS<br>+ ABS<br>+ ABS<br>+ ABS<br>+ ABS<br>+ ABS          | 03.2122-1331.3                                     | 010607   | THz 22,20                  | ATE  |  |                   |
|  | 1.1<br>1.1<br>1.4<br>1.4 i<br>1.6 i<br>1.8 16V<br>1.8 D<br>1.8 i<br>1.9 D<br>1.9 D<br>1.9 i<br>1.9 TD<br>2.0 i | 40 ORGA 07070<br>44 ORGA 07070<br>55 ORGA 07070<br>55 ORGA 07070<br>65 ORGA 07070<br>81 ORGA 07070<br>44 ORGA 07070<br>74 ORGA 07070<br>47 ORGA 07070<br>50 ORGA 07070<br>88 ORGA 07070<br>66 ORGA 07070<br>89 ORGA 07070 |  | 08.93<br>06.97<br>06.97<br>06.97<br>06.97<br>06.97<br>06.97<br>06.97<br>06.97<br>06.97<br>06.97<br>06.97 | + ABS<br>+ ABS<br>+ ABS<br>+ ABS<br>+ ABS<br>+ ABS<br>+ ABS<br>+ ABS<br>+ ABS<br>+ ABS<br>+ ABS<br>+ ABS          | 03.2122-1281.3                                     | 010606   | THz 22,20                  | ATE  |  |                   |
|  | 1.6 i<br>1.8 16V<br>1.8 i<br>1.9 i<br>1.9 TD<br>2.0 i  | 65<br>81<br>74<br>88<br>66<br>89  |  | 03.91<br>01.96<br>07.92<br>03.91<br>07.92<br>07.92   | 06.97<br>06.97<br>06.97<br>06.97<br>06.97<br>06.97  | + ABS<br>+ ABS<br>+ ABS<br>+ ABS<br>+ ABS<br>+ ABS | 24.3481-1615.5<br>24.3481-1616.5<br>24.0101-4806.2 | 240031<br>240032<br>260052 | <input type="checkbox"/><br><input type="checkbox"/><br><input type="checkbox"/> | D=48, - Halter<br>D=48, - Halter<br>Einbausatz | LUC<br>LUC<br>LUC |
|  | 1.8 D<br>1.9 D   | 44<br>47  | ORGA 06049<br>ORGA 06049   | 06.93<br>03.91   |   |  | 24.3481-1609.7<br>24.3481-1610.7                   | 220197<br>220198           | <input type="checkbox"/><br><input type="checkbox"/>                             | D=48, + Halter<br>D=48, + Halter               | LUC<br>LUC        |
|  | 2.0<br>2.0 16V   | 122<br>120  |  | 09.96<br>05.96   | 10.97<br>06.97  |  | 24.3571-1729.5                                     | 240317                     | <input type="checkbox"/>   | D=57, - Halter                                 | LUC               |

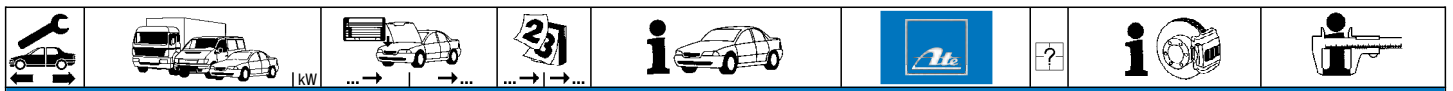

**CITROEN ZX (N2) Limousine (91-97)**

|         |         |            |            |             |                |                |        |   |          |           |                |        |   |  |           |
|---------|---------|------------|------------|-------------|----------------|----------------|--------|---|----------|-----------|----------------|--------|---|--|-----------|
|         | 1.1     | 40         |            | 03.91       | 08.93          | 24.5111-0425.3 | 330278 | 2 |          | L=425     |                |        |   |  |           |
|         | 1.1     | 44         |            | 03.91       | 06.97          |                |        |   |          |           |                |        |   |  |           |
|         | 1.4     | 55         |            | 03.91       | 06.97          |                |        |   |          |           |                |        |   |  |           |
|         | 1.4 i   | 55         |            | 03.91       | 06.97          |                |        |   |          |           |                |        |   |  |           |
|         | 1.6 i   | 65         |            | 03.91       | 06.97          |                |        |   |          |           |                |        |   |  |           |
|         | 1.8 16V | 81         |            | 01.96       | 06.97 - ABS    |                |        |   |          |           |                |        |   |  |           |
|         | 1.8 D   | 44         |            | 06.93       | 06.97          |                |        |   |          |           |                |        |   |  |           |
|         | 1.8 i   | 74         |            | 07.92       | 06.97          |                |        |   |          |           |                |        |   |  |           |
|         | 1.9 D   | 47         |            | 03.91       | 06.97          |                |        |   |          |           |                |        |   |  |           |
|         | 1.9 D   | 50         |            | 06.94       | 06.97          |                |        |   |          |           |                |        |   |  |           |
| 1.9 i   | 88      | ORGA 06748 | 03.91      |             |                |                |        |   |          |           |                |        |   |  |           |
| 1.9 i   | 88      | ORGA 06749 |            | 06.97 - ABS |                |                |        |   |          |           |                |        |   |  |           |
| 1.9 TD  | 66      | ORGA 06748 | 07.92      | 06.97 - ABS |                |                |        |   |          |           |                |        |   |  |           |
| 1.9 TD  | 66      | ORGA 06749 |            | 06.97 - ABS |                |                |        |   |          |           |                |        |   |  |           |
| 2.0 i   | 89      | ORGA 06748 | 07.92      | 06.97 - ABS |                |                |        |   |          |           |                |        |   |  |           |
| 2.0 i   | 89      | ORGA 06749 |            | 06.97 - ABS |                |                |        |   |          |           |                |        |   |  |           |
| 1.8 16V | 81      |            | 01.96      | 06.97 + ABS | 24.5111-0438.3 | 330568         | 2      |   | L=445    |           |                |        |   |  |           |
| 1.9 i   | 88      | ORGA 06749 |            | 06.97 + ABS |                |                |        |   |          |           |                |        |   |  |           |
| 1.9 TD  | 66      | ORGA 06749 |            | 06.97 + ABS |                |                |        |   |          |           |                |        |   |  |           |
| 2.0 16V | 110     |            | 06.94      | 06.97       |                |                |        |   |          |           |                |        |   |  |           |
| 2.0 16V | 112     |            | 07.92      | 10.94       |                |                |        |   |          |           |                |        |   |  |           |
| 2.0 i   | 89      | ORGA 06749 |            | 06.97 + ABS |                |                |        |   |          |           |                |        |   |  |           |
| 2.0     | 122     |            | 09.96      | 10.97       | 24.5111-0460.3 | 330603         | 2      |   | L=460    |           |                |        |   |  |           |
| 2.0 16V | 120     |            | 05.96      | 06.97       |                |                |        |   |          |           |                |        |   |  |           |
|         | 1.1     | 40         |            | 03.91       | 08.93          | 24.5228-0195.3 | 330469 | 2 |          | L=202     |                |        |   |  |           |
|         | 1.1     | 44         | ORGA 09748 | 03.91       |                |                |        |   |          |           |                |        |   |  |           |
|         | 1.4     | 55         | ORGA 06748 | 03.91       |                |                |        |   |          |           |                |        |   |  |           |
|         | 1.4 i   | 55         | ORGA 06748 | 03.91       |                |                |        |   |          |           |                |        |   |  |           |
|         | 1.6 i   | 65         | ORGA 06748 | 03.91       |                |                |        |   |          |           |                |        |   |  |           |
|         | 1.8 D   | 44         | ORGA 06748 | 06.93       |                |                |        |   |          |           |                |        |   |  |           |
|         | 1.8 i   | 74         | ORGA 06748 | 07.92       |                |                |        |   |          |           |                |        |   |  |           |
|         | 1.9 D   | 47         | ORGA 06748 | 03.91       |                |                |        |   |          |           |                |        |   |  |           |
|         | 1.9 D   | 50         | ORGA 06748 | 06.94       |                |                |        |   |          |           |                |        |   |  |           |
|         | 1.9 i   | 88         | ORGA 06748 | 03.91       | + ABS          |                |        |   |          |           |                |        |   |  |           |
|         | 1.9 i   | 88         |            | 03.91       | 06.97 - ABS    |                |        |   |          |           |                |        |   |  |           |
|         | 1.9 TD  | 66         | ORGA 09748 | 07.92       | + ABS          |                |        |   |          |           |                |        |   |  |           |
|         | 1.9 TD  | 66         |            | 07.92       | 06.97 - ABS    |                |        |   |          |           |                |        |   |  |           |
|         | 2.0 16V | 110        | ORGA 06748 | 03.91       | + ABS          |                |        |   |          |           |                |        |   |  |           |
|         | 2.0 16V | 110        |            | 06.94       | 06.97 - ABS    |                |        |   |          |           |                |        |   |  |           |
|         | 2.0 16V | 112        |            | 07.92       | 10.94          |                |        |   |          |           |                |        |   |  |           |
|         | 2.0 i   | 89         | ORGA 06748 | 07.92       | + ABS          |                |        |   |          |           |                |        |   |  |           |
| 2.0 i   | 89      |            | 07.92      | 06.97 - ABS |                |                |        |   |          |           |                |        |   |  |           |
|         | 1.1     | 44         | ORGA 06749 |             | 06.97          | 24.5228-0245.3 | 330531 | ☐ |          | L=245     |                |        |   |  |           |
|         | 1.4     | 55         | ORGA 06749 |             | 06.97          |                |        |   |          |           |                |        |   |  |           |
|         | 1.4 i   | 55         | ORGA 06749 |             | 06.97          |                |        |   |          |           |                |        |   |  |           |
|         | 1.6 i   | 65         | ORGA 06749 |             | 06.97          |                |        |   |          |           |                |        |   |  |           |
|         | 1.8 16V | 81         |            | 01.96       | 06.97          |                |        |   |          |           |                |        |   |  |           |
|         | 1.8 D   | 44         | ORGA 06749 |             | 06.97          |                |        |   |          |           |                |        |   |  |           |
|         | 1.8 i   | 74         | ORGA 06749 |             | 06.97          |                |        |   |          |           |                |        |   |  |           |
|         | 1.9 D   | 47         | ORGA 06749 |             | 06.97          |                |        |   |          |           |                |        |   |  |           |
|         | 1.9 D   | 50         | ORGA 06749 |             | 06.97          |                |        |   |          |           |                |        |   |  |           |
|         | 1.9 i   | 88         | ORGA 06749 |             | 06.97 + ABS    |                |        |   |          |           |                |        |   |  |           |
|         | 1.9 TD  | 66         | ORGA 06749 |             | 06.97 + ABS    |                |        |   |          |           |                |        |   |  |           |
|         | 2.0     | 122        |            | 09.96       | 10.97          |                |        |   |          |           |                |        |   |  |           |
|         | 2.0 16V | 110        | ORGA 06749 |             | 06.97 + ABS    |                |        |   |          |           |                |        |   |  |           |
|         | 2.0 16V | 120        |            | 05.96       | 06.97          |                |        |   |          |           |                |        |   |  |           |
|         | 2.0 i   | 89         | ORGA 06749 |             | 06.97 + ABS    |                |        |   |          |           |                |        |   |  |           |
|         | 1.1     | 40         | ORGA 05718 | 03.91       | - ABS          | 24.3220-1603.3 | 020230 | ☐ |          | RzR 20,64 |                |        |   |  |           |
|         | 1.1     | 44         | ORGA 05718 | 03.91       | - ABS          |                |        |   |          |           |                |        |   |  |           |
|         | 1.4     | 55         | ORGA 05718 | 03.91       | - ABS          |                |        |   |          |           |                |        |   |  |           |
|         | 1.4 i   | 55         | ORGA 05718 | 03.91       | - ABS          |                |        |   |          |           |                |        |   |  |           |
|         | 1.6 i   | 65         | ORGA 05718 | 03.91       | - ABS          |                |        |   |          |           |                |        |   |  |           |
|         | 1.9 D   | 47         | ORGA 05718 | 03.91       | - ABS          |                |        |   |          |           |                |        |   |  |           |
|         | 1.9 D   | 50         | ORGA 05718 | 06.94       | - ABS          |                |        |   |          |           |                |        |   |  |           |
|         | 1.1     | 40         | ORGA 05719 |             | 08.93 - ABS    |                |        |   |          |           | 24.3220-1617.3 | 020244 | ☐ |  | RzR 20,64 |
|         | 1.1     | 44         | ORGA 05719 |             | 06.97 - ABS    |                |        |   |          |           |                |        |   |  |           |
|         | 1.4     | 55         | ORGA 05719 |             | 06.97 - ABS    |                |        |   |          |           |                |        |   |  |           |
| 1.4 i   | 55      | ORGA 05719 |            | 06.97 - ABS |                |                |        |   |          |           |                |        |   |  |           |
| 1.6 i   | 65      | ORGA 05719 |            | 06.97 - ABS |                |                |        |   |          |           |                |        |   |  |           |
| 1.9 D   | 47      | ORGA 05719 |            | 06.97 - ABS |                |                |        |   |          |           |                |        |   |  |           |
| 1.9 D   | 50      | ORGA 05719 |            | 06.97 - ABS |                |                |        |   |          |           |                |        |   |  |           |
| 1.9 TD  | 66      |            | 07.92      | 06.97 - ABS |                |                |        |   |          |           |                |        |   |  |           |
| 1.1     | 44      | ORGA 06749 |            | 06.97 + ABS | 24.3220-1711.3 | 020409         |        |   | Rz 20,64 |           |                |        |   |  |           |
| 1.4     | 55      | ORGA 06749 |            | 06.97 + ABS |                |                |        |   |          |           |                |        |   |  |           |
| 1.4 i   | 55      | ORGA 06749 |            | 06.97 + ABS |                |                |        |   |          |           |                |        |   |  |           |
| 1.6 i   | 65      | ORGA 06749 |            | 06.97 + ABS |                |                |        |   |          |           |                |        |   |  |           |
| 1.8 16V | 81      |            | 01.96      | 06.97       |                |                |        |   |          |           |                |        |   |  |           |
| 1.8 D   | 44      | ORGA 06749 |            | 06.97 + ABS |                |                |        |   |          |           |                |        |   |  |           |
| 1.8 i   | 74      | ORGA 06749 |            | 06.97 + ABS |                |                |        |   |          |           |                |        |   |  |           |
| 1.9 D   | 47      | ORGA 06749 |            | 06.97 + ABS |                |                |        |   |          |           |                |        |   |  |           |
| 1.9 D   | 50      | ORGA 06749 |            | 06.97 + ABS |                |                |        |   |          |           |                |        |   |  |           |
| 1.9 TD  | 66      | ORGA 06749 |            | 06.97 + ABS |                |                |        |   |          |           |                |        |   |  |           |

<sup>1)</sup> notice length / attenzione lunghezza / faire attention longueur / atención largo



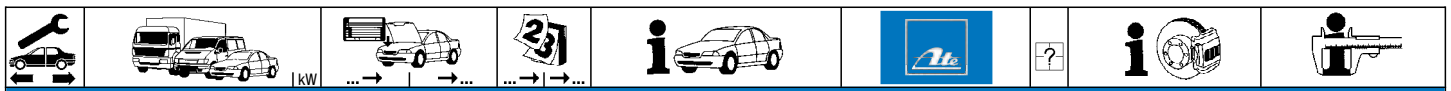

**CITROEN ZX (N2) Limousine (91-97)**

|  |         |     |            |              |              |   |                       |        |  |          |
|--|---------|-----|------------|--------------|--------------|---|-----------------------|--------|--|----------|
|  | 1.1     | 40  |            | <b>03.91</b> | <b>08.93</b> |   | <b>24.3727-0307.2</b> | 580307 | <input type="checkbox"/> + HA-Trommelbremse <sup>1)</sup>  | L=1585   |
|  | 1.1     | 44  | ORGA 07330 | <b>03.91</b> |              |   | <b>24.3727-0306.2</b> | 580306 | <input type="checkbox"/> + HA-Trommelbremse <sup>1)</sup>  | L=1493   |
|  | 1.4     | 55  | ORGA 07330 | <b>03.91</b> |              |   | <b>24.3727-0304.2</b> | 580304 | <input type="checkbox"/> + HA-Scheibenbremse <sup>2)</sup> | L=1612   |
|  | 1.4 i   | 55  | ORGA 07330 | <b>03.91</b> |              |   | <b>24.3727-0305.2</b> | 580305 | <input type="checkbox"/> + HA-Scheibenbremse <sup>2)</sup> | L=1533   |
|  | 1.6 i   | 65  | ORGA 07330 | <b>03.91</b> |              |   |                       |        |  |          |
|  | 1.8 16V | 81  | ORGA 07330 | <b>01.96</b> |              |   |                       |        |  |          |
|  | 1.8 D   | 44  | ORGA 07330 | <b>06.93</b> |              |   |                       |        |  |          |
|  | 1.8 i   | 74  | ORGA 07330 | <b>07.92</b> |              |   |                       |        |  |          |
|  | 1.9 D   | 47  | ORGA 07330 | <b>03.91</b> |              |   |                       |        |  |          |
|  | 1.9 D   | 50  | ORGA 07330 | <b>06.94</b> |              |   |                       |        |  |          |
|  | 1.9 i   | 88  | ORGA 07330 | <b>03.91</b> |              |   |                       |        |  |          |
|  | 1.9 TD  | 66  | ORGA 07330 | <b>07.92</b> |              |   |                       |        |  |          |
|  | 2.0     | 122 |            | <b>09.96</b> | <b>10.97</b> |   |                       |        |  |          |
|  | 2.0 16V | 110 | ORGA 07330 | <b>06.94</b> |              |   |                       |        |  |          |
|  | 2.0 16V | 112 |            | <b>07.92</b> | <b>10.94</b> |   |                       |        |  |          |
|  | 2.0 16V | 120 | ORGA 07330 | <b>05.96</b> |              |   |                       |        |  |          |
|  | 2.0 i   | 89  | ORGA 07330 | <b>03.91</b> |              |   |                       |        |  |          |
|  | 1.1     | 44  | ORGA 07331 |              | <b>06.97</b> |   | <b>24.3727-0316.2</b> | 580316 | <input type="checkbox"/> + HA-Trommelbremse <sup>1)</sup>  | L=1582   |
|  | 1.4     | 55  | ORGA 07331 |              | <b>06.97</b> |   | <b>24.3727-0317.2</b> | 580317 | <input type="checkbox"/> + HA-Trommelbremse <sup>1)</sup>  | L=1488   |
|  | 1.4 i   | 55  | ORGA 07331 |              | <b>06.97</b> |   |                       |        |  |          |
|  | 1.6 i   | 65  | ORGA 07331 |              | <b>06.97</b> |   |                       |        |  |          |
|  | 1.8 16V | 81  | ORGA 07331 |              | <b>06.97</b> |   |                       |        |  |          |
|  | 1.8 D   | 44  | ORGA 07331 |              | <b>06.97</b> |   |                       |        |  |          |
|  | 1.8 i   | 74  | ORGA 07331 |              | <b>06.97</b> |   |                       |        |  |          |
|  | 1.9 D   | 47  | ORGA 07331 |              | <b>06.97</b> |   |                       |        |  |          |
|  | 1.9 D   | 50  | ORGA 07331 |              | <b>06.97</b> |   |                       |        |  |          |
|  | 1.9 i   | 88  | ORGA 07331 |              | <b>06.97</b> |   |                       |        |  |          |
|  | 1.9 TD  | 66  | ORGA 07331 |              | <b>06.97</b> |   |                       |        |  |          |
|  | 2.0     | 122 | ORGA 07331 |              | <b>09.96</b> |   |                       |        |  |          |
|  | 2.0 16V | 110 | ORGA 07331 |              | <b>06.97</b> |   |                       |        |  |          |
|  | 2.0 16V | 120 | ORGA 07331 |              | <b>06.97</b> |   |                       |        |  |          |
|  | 2.0 i   | 89  | ORGA 07331 |              | <b>06.97</b> |   |                       |        |  |          |
|  | 1.1     | 40  |            | <b>03.91</b> | <b>08.93</b> | + ABS                                   | <b>24.6583-1717.3</b> | 320167 |  | BRL (4)  |
|  | 1.1     | 44  |            | <b>03.91</b> | <b>06.97</b> | + ABS                                   |                       |        |  |          |
|  | 1.4     | 55  |            | <b>03.91</b> | <b>06.97</b> | + ABS                                   |                       |        |  |          |
|  | 1.4 i   | 55  |            | <b>03.91</b> | <b>06.97</b> | + ABS                                   |                       |        |  |          |
|  | 1.6 i   | 65  |            | <b>03.91</b> | <b>06.97</b> | + ABS/ + HA-Trommelbremse <sup>3)</sup> |                       |        |  |          |
|  | 1.8 16V | 81  |            | <b>01.96</b> | <b>06.97</b> | + ABS/ + HA-Trommelbremse <sup>3)</sup> |                       |        |  |          |
|  | 1.8 D   | 44  |            | <b>06.93</b> | <b>06.97</b> | + ABS                                   |                       |        |  |          |
|  | 1.8 i   | 74  |            | <b>07.92</b> | <b>06.97</b> | + ABS/ + HA-Trommelbremse <sup>3)</sup> |                       |        |  |          |
|  | 1.9 D   | 47  |            | <b>03.91</b> | <b>06.97</b> | + ABS                                   |                       |        |  |          |
|  | 1.9 D   | 50  |            | <b>06.94</b> | <b>06.97</b> | + ABS                                   |                       |        |  |          |
|  | 1.9 TD  | 66  |            | <b>07.92</b> | <b>06.97</b> | + ABS/ + HA-Trommelbremse <sup>3)</sup> |                       |        |  |          |
|  | 1.6 i   | 65  | ORGA 06628 | <b>03.91</b> |              | + HA-Scheibenbremse <sup>2)</sup>       | <b>24.6042-1702.3</b> | 320154 |  | BRE 2/25 |
|  | 1.8 16V | 81  | ORGA 06628 | <b>01.96</b> |              | + HA-Scheibenbremse <sup>2)</sup>       |                       |        |  |          |
|  | 1.8 i   | 74  | ORGA 06628 | <b>07.92</b> |              | + HA-Scheibenbremse <sup>2)</sup>       |                       |        |  |          |
|  | 1.9 i   | 88  | ORGA 06628 | <b>03.91</b> |              |   |                       |        |  |          |
|  | 1.9 TD  | 66  | ORGA 06628 | <b>07.92</b> |              | + HA-Scheibenbremse <sup>2)</sup>       |                       |        |  |          |
|  | 2.0 i   | 89  | ORGA 06628 | <b>07.92</b> |              |   |                       |        |  |          |
|  | 1.1     | 40  |            | <b>03.91</b> | <b>08.93</b> |   | <b>24.3728-0305.2</b> | 590305 |  | L=606    |
|  | 1.1     | 44  | ORGA 06567 | <b>03.91</b> |              |   |                       |        |  |          |
|  | 1.4     | 55  | ORGA 06567 | <b>03.91</b> |              |   |                       |        |  |          |
|  | 1.4 i   | 55  | ORGA 06567 | <b>03.91</b> |              |   |                       |        |  |          |

**CITROEN ZX (N2) Kombi (93-98)**

|  |         |    |            |              |              |       |                       |        |  |           |     |
|--|---------|----|------------|--------------|--------------|-------|-----------------------|--------|--|-----------|-----|
|  | 1.4 i   | 55 | ORGA 07070 |              | <b>10.97</b> |       | <b>03.7750-8102.4</b> | 300114 |  | 9"        | ATE |
|  | 1.6 i   | 65 | ORGA 07070 |              | <b>10.97</b> |       |                       |        |  |           |     |
|  | 1.8 16V | 81 |            | <b>01.96</b> | <b>02.98</b> |       |                       |        |  |           |     |
|  | 1.8 D   | 44 | ORGA 27070 |              | <b>10.97</b> |       |                       |        |  |           |     |
|  | 1.8 i   | 74 | ORGA 07070 |              | <b>10.97</b> |       |                       |        |  |           |     |
|  | 1.9 D   | 47 | ORGA 07070 |              | <b>10.97</b> |       |                       |        |  |           |     |
|  | 1.9 D   | 50 | ORGA 07070 |              | <b>10.97</b> |       |                       |        |  |           |     |
|  | 1.9 TD  | 66 | ORGA 07070 |              | <b>10.97</b> |       |                       |        |  |           |     |
|  | 1.4 i   | 55 | ORGA 07069 | <b>10.93</b> |              | - ABS | <b>24.2122-1723.3</b> | 010547 |  | Thz 22,20 |     |
|  | 1.6 i   | 65 | ORGA 07069 | <b>10.93</b> |              | - ABS |                       |        |  |           |     |
|  | 1.8 D   | 44 | ORGA 07069 | <b>10.93</b> |              | - ABS |                       |        |  |           |     |
|  | 1.8 i   | 74 | ORGA 07069 | <b>10.93</b> |              | - ABS |                       |        |  |           |     |
|  | 1.9 D   | 47 | ORGA 07069 | <b>10.93</b> |              | - ABS |                       |        |  |           |     |
|  | 1.9 D   | 50 | ORGA 07069 | <b>06.94</b> |              | - ABS |                       |        |  |           |     |
|  | 1.9 TD  | 66 | ORGA 07069 | <b>10.93</b> |              | - ABS |                       |        |  |           |     |
|  | 1.4 i   | 55 | ORGA 07070 |              | <b>10.97</b> | - ABS | <b>03.2122-1331.3</b> | 010607 |  | Thz 22,20 | ATE |
|  | 1.6 i   | 65 | ORGA 07070 |              | <b>10.97</b> | - ABS |                       |        |  |           |     |
|  | 1.8 16V | 81 |            | <b>01.96</b> | <b>02.98</b> | - ABS |                       |        |  |           |     |
|  | 1.8 D   | 44 | ORGA 07070 |              | <b>10.97</b> | - ABS |                       |        |  |           |     |
|  | 1.8 i   | 74 | ORGA 07070 |              | <b>10.97</b> | - ABS |                       |        |  |           |     |
|  | 1.9 D   | 47 | ORGA 07070 |              | <b>10.97</b> | - ABS |                       |        |  |           |     |
|  | 1.9 D   | 50 | ORGA 07070 |              | <b>10.97</b> | - ABS |                       |        |  |           |     |
|  | 1.9 TD  | 66 | ORGA 07070 |              | <b>10.97</b> | - ABS |                       |        |  |           |     |
|  | 1.4 i   | 55 | ORGA 07070 |              | <b>10.97</b> | - ABS | <b>03.2122-1326.3</b> | 010617 |  | Thz 22,20 | ATE |
|  | 1.6 i   | 65 | ORGA 07070 |              | <b>10.97</b> | - ABS |                       |        |  |           |     |
|  | 1.8 16V | 81 |            | <b>01.96</b> | <b>02.98</b> | - ABS |                       |        |  |           |     |
|  | 1.8 D   | 44 | ORGA 07070 |              | <b>10.97</b> | - ABS |                       |        |  |           |     |
|  | 1.8 i   | 74 | ORGA 07070 |              | <b>10.97</b> | - ABS |                       |        |  |           |     |
|  | 1.9 D   | 47 | ORGA 07070 |              | <b>10.97</b> | - ABS |                       |        |  |           |     |
|  | 1.9 D   | 50 | ORGA 07070 |              | <b>10.97</b> | - ABS |                       |        |  |           |     |
|  | 1.9 TD  | 66 | ORGA 07070 |              | <b>10.97</b> | - ABS |                       |        |  |           |     |

1) + RA drum brake / + P freno a tamburo / + frein à tambour essieu AR / + ET-tambores de freno  
 2) + RA disc brake / + P disco freno / + frein à disque essieu AR / + ET-disco de freno  
 3) + ABS/ + RA drum brake / + ABS/ + P freno a tamburo / + ABS/ + fr. à tambour essieu AR / + ABS/ + ET tambores de freno





















| CITROEN ZX (N2) Kombi (93-98) |               |               |            |       |             |                |                          |                          |                          |                       |                |                |                          |                          |                        |                |                |                          |                          |                        |        |
|-------------------------------|---------------|---------------|------------|-------|-------------|----------------|--------------------------|--------------------------|--------------------------|-----------------------|----------------|----------------|--------------------------|--------------------------|------------------------|----------------|----------------|--------------------------|--------------------------|------------------------|--------|
|                               | 1.4 i         | 55            | ORGA 07069 | 10.93 | + ABS       | 24.2122-1704.3 | 010423                   |                          | Thz 22,20                |                       |                |                |                          |                          |                        |                |                |                          |                          |                        |        |
|                               | 1.6 i         | 65            | ORGA 07069 | 10.93 | + ABS       |                |                          |                          |                          |                       |                |                |                          |                          |                        |                |                |                          |                          |                        |        |
|                               | 1.8 16V       | 81            | ORGA 07069 | 01.96 | + ABS       |                |                          |                          |                          |                       |                |                |                          |                          |                        |                |                |                          |                          |                        |        |
|                               | 1.8 D         | 44            | ORGA 07069 | 10.93 | + ABS       |                |                          |                          |                          |                       |                |                |                          |                          |                        |                |                |                          |                          |                        |        |
|                               | 1.8 i         | 74            | ORGA 07069 | 10.93 | + ABS       |                |                          |                          |                          |                       |                |                |                          |                          |                        |                |                |                          |                          |                        |        |
|                               | 1.9 D         | 47            | ORGA 07069 | 10.93 | + ABS       |                |                          |                          |                          |                       |                |                |                          |                          |                        |                |                |                          |                          |                        |        |
|                               | 1.9 D         | 50            | ORGA 07069 | 06.94 | + ABS       |                |                          |                          |                          |                       |                |                |                          |                          |                        |                |                |                          |                          |                        |        |
|                               | 1.9 TD        | 66            | ORGA 07069 | 10.93 | + ABS       |                |                          |                          |                          |                       |                |                |                          |                          |                        |                |                |                          |                          |                        |        |
|                               | 1.4 i         | 55 ORGA 07070 |            | 10.97 | + ABS       | 03.2122-1331.3 | 010607                   |                          | Thz 22,20                | ATE                   |                |                |                          |                          |                        |                |                |                          |                          |                        |        |
|                               | 1.6 i         | 65 ORGA 07070 |            | 10.97 | + ABS       |                |                          |                          |                          |                       |                |                |                          |                          |                        |                |                |                          |                          |                        |        |
|                               | 1.8 16V       | 81 ORGA 07070 |            | 02.98 | + ABS       |                |                          |                          |                          |                       |                |                |                          |                          |                        |                |                |                          |                          |                        |        |
|                               | 1.8 D         | 44 ORGA 07070 |            | 10.97 | + ABS       |                |                          |                          |                          |                       |                |                |                          |                          |                        |                |                |                          |                          |                        |        |
|                               | 1.8 i         | 74 ORGA 07070 |            | 10.97 | + ABS       |                |                          |                          |                          |                       |                |                |                          |                          |                        |                |                |                          |                          |                        |        |
|                               | 1.9 D         | 47 ORGA 07070 |            | 10.97 | + ABS       |                |                          |                          |                          |                       |                |                |                          |                          |                        |                |                |                          |                          |                        |        |
|                               | 1.9 D         | 50 ORGA 07070 |            | 10.97 | + ABS       |                |                          |                          |                          |                       |                |                |                          |                          |                        |                |                |                          |                          |                        |        |
|                               | 1.9 TD        | 66 ORGA 07070 |            | 10.97 | + ABS       |                |                          |                          |                          |                       |                |                |                          |                          |                        |                |                |                          |                          |                        |        |
|                               | 1.4 i         | 55 ORGA 07070 |            | 10.97 | + ABS       | 03.2122-1281.3 | 010606                   |                          | Thz 22,20                | ATE                   |                |                |                          |                          |                        |                |                |                          |                          |                        |        |
|                               | 1.6 i         | 65 ORGA 07070 |            | 10.97 | + ABS       |                |                          |                          |                          |                       |                |                |                          |                          |                        |                |                |                          |                          |                        |        |
|                               | 1.8 16V       | 81 ORGA 07070 |            | 02.98 | + ABS       |                |                          |                          |                          |                       |                |                |                          |                          |                        |                |                |                          |                          |                        |        |
|                               | 1.8 D         | 44 ORGA 07070 |            | 10.97 | + ABS       |                |                          |                          |                          |                       |                |                |                          |                          |                        |                |                |                          |                          |                        |        |
|                               | 1.8 i         | 74 ORGA 07070 |            | 10.97 | + ABS       |                |                          |                          |                          |                       |                |                |                          |                          |                        |                |                |                          |                          |                        |        |
|                               | 1.9 D         | 47 ORGA 07070 |            | 10.97 | + ABS       |                |                          |                          |                          |                       |                |                |                          |                          |                        |                |                |                          |                          |                        |        |
|                               | 1.9 D         | 50 ORGA 07070 |            | 10.97 | + ABS       |                |                          |                          |                          |                       |                |                |                          |                          |                        |                |                |                          |                          |                        |        |
|                               | 1.9 TD        | 66 ORGA 07070 |            | 10.97 | + ABS       |                |                          |                          |                          |                       |                |                |                          |                          |                        |                |                |                          |                          |                        |        |
|                               | 1.6 i         | 65            |            | 10.93 | 10.97 + ABS | 24.3481-1615.5 | 240031                   | <input type="checkbox"/> | D=48, - Halter           | LUC                   |                |                |                          |                          |                        |                |                |                          |                          |                        |        |
|                               | 1.8 16V       | 81            |            | 01.96 | 02.98       |                |                          |                          |                          |                       | 24.3481-1616.5 | 240032         | <input type="checkbox"/> | D=48, - Halter           | LUC                    |                |                |                          |                          |                        |        |
|                               | 1.8 D         | 44            |            | 10.93 | 10.97       |                |                          |                          |                          |                       |                |                |                          |                          |                        | 24.0101-4806.2 | 260052         | <input type="checkbox"/> | Einbausatz               | LUC                    |        |
|                               | 1.8 i         | 74            |            | 10.93 | 10.97       |                |                          |                          |                          |                       |                |                |                          |                          |                        |                |                |                          |                          |                        |        |
|                               | 1.9 D         | 47            |            | 10.93 | 10.97       |                |                          |                          |                          |                       |                |                |                          |                          |                        |                |                |                          |                          |                        |        |
|                               | 1.9 D         | 50            |            | 06.94 | 10.97       |                |                          |                          |                          |                       |                |                |                          |                          |                        |                |                |                          |                          |                        |        |
|                               | 1.9 D         | 50            |            | 06.94 | 10.97       |                |                          |                          |                          |                       |                |                |                          |                          |                        |                |                |                          |                          |                        |        |
|                               | 1.9 TD        | 66            |            | 10.93 | 10.97       |                |                          |                          |                          |                       |                |                |                          |                          |                        |                |                |                          |                          |                        |        |
| 1.9 TD                        | 66 ORGA 06749 | ORGA 06748    | 10.93      | 10.97 |             |                |                          |                          |                          |                       |                |                |                          |                          |                        |                |                |                          |                          |                        |        |
| 1.9 TD                        | 66 ORGA 06749 |               | 10.97      | - ABS |             |                |                          |                          |                          |                       |                |                |                          |                          |                        |                |                |                          |                          |                        |        |
|                               | 1.4 i         | 55            |            | 10.93 | 10.97       | 24.5111-0425.3 | 330278                   | 2                        |                          | L=425                 |                |                |                          |                          |                        |                |                |                          |                          |                        |        |
|                               | 1.6 i         | 65            |            | 10.93 | 10.97       |                |                          |                          |                          |                       |                |                |                          |                          |                        |                |                |                          |                          |                        |        |
|                               | 1.8 16V       | 81            |            | 01.96 | 02.98       |                |                          |                          |                          |                       | - ABS          |                |                          |                          |                        |                |                |                          |                          |                        |        |
|                               | 1.8 D         | 44            |            | 10.93 | 10.97       |                |                          |                          |                          |                       |                |                |                          |                          |                        |                |                |                          |                          |                        |        |
|                               | 1.8 i         | 74            |            | 10.93 | 10.97       |                |                          |                          |                          |                       |                |                |                          |                          |                        |                |                |                          |                          |                        |        |
|                               | 1.9 D         | 47            |            | 10.93 | 10.97       |                |                          |                          |                          |                       |                |                |                          |                          |                        |                |                |                          |                          |                        |        |
|                               | 1.9 D         | 50            |            | 06.94 | 10.97       |                |                          |                          |                          |                       |                |                |                          |                          |                        |                |                |                          |                          |                        |        |
|                               | 1.9 D         | 50            |            | 06.94 | 10.97       |                |                          |                          |                          |                       |                |                |                          |                          |                        |                |                |                          |                          |                        |        |
| 1.9 TD                        | 66            |               | 10.93      | 10.97 |             |                |                          |                          |                          |                       |                |                |                          |                          |                        |                |                |                          |                          |                        |        |
| 1.9 TD                        | 66 ORGA 06749 |               | 10.97      | + ABS |             |                |                          |                          |                          |                       |                |                |                          |                          |                        |                |                |                          |                          |                        |        |
|                               | 1.4 i         | 55            |            | 10.93 | 10.97       | 24.5111-0438.3 | 330568                   | 2                        |                          | L=445                 |                |                |                          |                          |                        |                |                |                          |                          |                        |        |
|                               | 1.6 i         | 65            |            | 10.93 | 10.97       |                |                          |                          |                          |                       |                |                |                          |                          |                        |                |                |                          |                          |                        |        |
|                               | 1.8 16V       | 81            |            | 01.96 | 02.98       |                |                          |                          |                          |                       | + ABS          |                |                          |                          |                        |                |                |                          |                          |                        |        |
|                               | 1.8 D         | 44            |            | 10.93 | 10.97       |                |                          |                          |                          |                       |                |                |                          |                          |                        |                |                |                          |                          |                        |        |
|                               | 1.8 i         | 74            |            | 10.93 | 10.97       |                |                          |                          |                          |                       |                |                |                          |                          |                        |                |                |                          |                          |                        |        |
|                               | 1.9 D         | 47            |            | 10.93 | 10.97       |                |                          |                          |                          |                       |                |                |                          |                          |                        |                |                |                          |                          |                        |        |
|                               | 1.9 D         | 50            |            | 06.94 | 10.97       |                |                          |                          |                          |                       |                |                |                          |                          |                        |                |                |                          |                          |                        |        |
|                               | 1.9 D         | 50            |            | 06.94 | 10.97       |                |                          |                          |                          |                       |                |                |                          |                          |                        |                |                |                          |                          |                        |        |
| 1.9 TD                        | 66            |               | 10.93      | 10.97 |             |                |                          |                          |                          |                       |                |                |                          |                          |                        |                |                |                          |                          |                        |        |
| 1.9 TD                        | 66 ORGA 06749 |               | 10.97      | + ABS |             |                |                          |                          |                          |                       |                |                |                          |                          |                        |                |                |                          |                          |                        |        |
|                               | 1.4 i         | 55            |            | 10.93 | 10.97       | 24.5228-0245.3 | 330531                   | <input type="checkbox"/> |                          | L=245                 |                |                |                          |                          |                        |                |                |                          |                          |                        |        |
|                               | 1.6 i         | 65            |            | 10.93 | 10.97       |                |                          |                          |                          |                       |                |                |                          |                          |                        |                |                |                          |                          |                        |        |
|                               | 1.8 16V       | 81            |            | 01.96 | 02.98       |                |                          |                          |                          |                       | 330469         |                |                          |                          |                        |                |                |                          |                          |                        |        |
|                               | 1.8 D         | 44            |            | 10.93 | 10.97       |                |                          |                          |                          |                       |                |                |                          |                          |                        |                |                |                          |                          |                        |        |
|                               | 1.8 i         | 74            |            | 10.93 | 10.97       |                |                          |                          |                          |                       |                |                |                          |                          |                        |                |                |                          |                          |                        |        |
|                               | 1.9 D         | 47            |            | 10.93 | 10.97       |                |                          |                          |                          |                       |                |                |                          |                          |                        |                |                |                          |                          |                        |        |
|                               | 1.9 D         | 50            |            | 06.94 | 10.97       |                |                          |                          |                          |                       |                |                |                          |                          |                        |                |                |                          |                          |                        |        |
|                               | 1.9 D         | 50            |            | 06.94 | 10.97       |                |                          |                          |                          |                       |                |                |                          |                          |                        |                |                |                          |                          |                        |        |
| 1.9 TD                        | 66            |               | 10.93      | 10.97 |             |                |                          |                          |                          |                       |                |                |                          |                          |                        |                |                |                          |                          |                        |        |
| 1.9 TD                        | 66            |               | 10.93      | 10.97 |             |                |                          |                          |                          |                       |                |                |                          |                          |                        |                |                |                          |                          |                        |        |
|                               | 1.4 i         | 55            |            | 10.93 | 10.97       | 24.3220-1702.3 | 020375                   |                          |                          | Rz 20,64              | BDX            |                |                          |                          |                        |                |                |                          |                          |                        |        |
|                               | 1.6 i         | 65            |            | 10.93 | 10.97       |                |                          |                          |                          |                       |                |                |                          |                          |                        |                |                |                          |                          |                        |        |
|                               | 1.8 16V       | 81            |            | 01.96 | 02.98       |                |                          |                          |                          |                       |                |                |                          |                          |                        |                |                |                          |                          |                        |        |
|                               | 1.8 D         | 44            |            | 10.93 | 10.97       |                |                          |                          |                          |                       |                |                |                          |                          |                        |                |                |                          |                          |                        |        |
|                               | 1.8 i         | 74            |            | 10.93 | 10.97       |                |                          |                          |                          |                       |                |                |                          |                          |                        |                |                |                          |                          |                        |        |
|                               | 1.9 D         | 47            |            | 10.93 | 10.97       |                |                          |                          |                          |                       |                |                |                          |                          |                        |                |                |                          |                          |                        |        |
|                               | 1.9 D         | 50            |            | 06.94 | 10.97       |                |                          |                          |                          |                       |                |                |                          |                          |                        |                |                |                          |                          |                        |        |
|                               | 1.9 D         | 50            |            | 06.94 | 10.97       |                |                          |                          |                          |                       |                |                |                          |                          |                        |                |                |                          |                          |                        |        |
| 1.9 TD                        | 66            |               | 10.93      | 10.97 |             |                |                          |                          |                          |                       |                |                |                          |                          |                        |                |                |                          |                          |                        |        |
|                               | 1.4 i         | 55            | ORGA 07330 | 10.93 |             | 24.3727-0313.2 | 580313                   | 1                        | <input type="checkbox"/> | + HA-Trommelbremse 1) | L=1621/1531    |                |                          |                          |                        |                |                |                          |                          |                        |        |
|                               | 1.6 i         | 65            | ORGA 07330 | 10.93 |             |                |                          |                          |                          |                       |                | 24.3727-0304.2 | 580304                   | <input type="checkbox"/> | + HA-Scheibenbremse 2) | L=1612         |                |                          |                          |                        |        |
|                               | 1.8 16V       | 81            | ORGA 07330 | 01.96 |             |                |                          |                          |                          |                       |                |                |                          |                          |                        |                | 24.3727-0305.2 | 580305                   | <input type="checkbox"/> | + HA-Scheibenbremse 2) | L=1533 |
|                               | 1.8 D         | 44            | ORGA 07330 | 10.93 |             |                |                          |                          |                          |                       |                |                |                          |                          |                        |                |                |                          |                          |                        |        |
|                               | 1.8 i         | 74            | ORGA 07330 | 10.93 |             |                |                          |                          |                          |                       |                |                |                          |                          |                        |                |                |                          |                          |                        |        |
|                               | 1.9 D         | 47            | ORGA 07330 | 10.93 |             |                |                          |                          |                          |                       |                |                |                          |                          |                        |                |                |                          |                          |                        |        |
|                               | 1.9 D         | 50            | ORGA 07330 | 06.94 |             |                |                          |                          |                          |                       |                |                |                          |                          |                        |                |                |                          |                          |                        |        |
|                               | 1.9 D         | 50            | ORGA 07330 | 06.94 |             |                |                          |                          |                          |                       |                |                |                          |                          |                        |                |                |                          |                          |                        |        |
| 1.9 TD                        | 66            | ORGA 07330    | 10.93      |       |             |                |                          |                          |                          |                       |                |                |                          |                          |                        |                |                |                          |                          |                        |        |
| 1.9 TD                        | 66            | ORGA 07331    |            | 10.97 |             |                | <input type="checkbox"/> | + HA-Trommelbremse 1)    | L=1610                   |                       |                |                |                          |                          |                        |                |                |                          |                          |                        |        |
| 1.6 i                         | 65            | ORGA 07331    |            | 10.97 |             |                | <input type="checkbox"/> | + HA-Trommelbremse 1)    | L=1520                   |                       |                |                |                          |                          |                        |                |                |                          |                          |                        |        |
| 1.8 16V                       | 81            | ORGA 07331    |            | 02.98 |             |                |                          |                          |                          |                       |                |                |                          |                          |                        |                |                |                          |                          |                        |        |
| 1.8 D                         | 44            | ORGA 07331    |            | 10.97 |             |                |                          |                          |                          |                       |                |                |                          |                          |                        |                |                |                          |                          |                        |        |
| 1.8 i                         | 74            | ORGA 07331    |            | 10.97 |             |                |                          |                          |                          |                       |                |                |                          |                          |                        |                |                |                          |                          |                        |        |
| 1.9 D                         | 47            | ORGA 07331    |            | 10.97 |             |                |                          |                          |                          |                       |                |                |                          |                          |                        |                |                |                          |                          |                        |        |
| 1.9 D                         | 50            | ORGA 07331    |            | 10.97 |             |                |                          |                          |                          |                       |                |                |                          |                          |                        |                |                |                          |                          |                        |        |
| 1.9 D                         | 50            | ORGA 07331    |            | 10.97 |             |                |                          |                          |                          |                       |                |                |                          |                          |                        |                |                |                          |                          |                        |        |
| 1.9 TD                        | 66            | ORGA 07331    |            | 10.97 |             |                |                          |                          |                          |                       |                |                |                          |                          |                        |                |                |                          |                          |                        |        |
|                               | 1.4 i         | 55            |            | 10.93 | 10.97       | 24.6583-1718.3 | 320168                   |                          |                          | BRL (4)               |                |                |                          |                          |                        |                |                |                          |                          |                        |        |
|                               | 1.6 i         | 65            |            | 10.93 | 10.97       |                |                          |                          |                          |                       |                |                |                          |                          |                        |                |                |                          |                          |                        |        |
|                               | 1.8 16V       | 81            |            | 01.96 | 02.98       |                |                          |                          |                          |                       |                |                |                          |                          |                        |                |                |                          |                          |                        |        |
|                               | 1.8 D         | 44            |            | 10.93 | 10.97       |                |                          |                          |                          |                       |                |                |                          |                          |                        |                |                |                          |                          |                        |        |
|                               | 1.8 i         | 74            |            | 10.93 | 10.97       |                |                          |                          |                          |                       |                |                |                          |                          |                        |                |                |                          |                          |                        |        |
|                               | 1.9 D         | 47            |            | 10.93 | 10.97       |                |                          |                          |                          |                       |                |                |                          |                          |                        |                |                |                          |                          |                        |        |
|                               | 1.9 D         | 50            |            | 06.94 | 10.97       |                |                          |                          |                          |                       |                |                |                          |                          |                        |                |                |                          |                          |                        |        |
|                               | 1.9 D         | 50            |            | 06.94 | 10.97       |                |                          |                          |                          |                       |                |                |                          |                          |                        |                |                |                          |                          |                        |        |
| 1.9 TD                        | 66            |               | 10.93      | 10.97 |             |                |                          |                          |                          |                       |                |                |                          |                          |                        |                |                |                          |                          |                        |        |

1) + RA drum brake / + P freno a tamburo / + frein à tambour essieu AR / + ET-tambores de freno

2) + RA disc brake / + P disco freno / + frein à disque essieu AR / + ET-disco de freno



|     |  |  |  |  |  |  |  |  |
|--|--|--|--|--|---|--|--|--|
| <b>CITROEN ZX (N2) Kombi (93-98)</b>   |  |  |  |  |   |  |  |  |
|    | 1.4 l  | 55   | ORGA 06567   | 10.93  |   | 24.3728-0305.2   | 590305   | L=606  |
| <b>DACIA DOKKER (12-)</b>  |  |  |  |  |   |  |  |  |
|    | 1.5 dCi 75   | 55   |  | 11.12  | - ESP   | 24.3541-1823.5   | 240417   | D=54, - Halter   |
|  | 1.5 dCi 90   | 66   |  | 11.12  | - ESP   | 24.3541-1824.5   | 240418   | D=54, - Halter   |
|  | 1.6 16V  | 61   |  | 11.12  | - ESP   |  |  |  |
|  | 1.2 TCe 115  | 85   |  | 11.12  |   | 11.9541-9950.2   | 220843   | D=54, - Halter   |
|  | 1.5 dCi 75   | 55   |  | 11.12  | + ESP   | 11.9541-9951.2   | 220844   | D=54, - Halter   |
|  | 1.5 dCi 90   | 66   |  | 11.12  | + ESP   | 11.8116-0356.1   | 390586   | D=54, - Halter   |
|  | 1.6 16V  | 61   |  | 11.12  | + ESP   |  |  | Haltefeder   |
|  |  |  |  |  |   |  | 2  | ATE  |
| <b>DACIA DOKKER Express (12-)</b>  |  |  |  |  |   |  |  |  |
|    | 1.5 dCi  | 55   |  | 12.12  | - ESP   | 24.3541-1823.5   | 240417   | D=54, - Halter   |
|  | 1.5 dCi  | 66   |  | 12.12  | - ESP   | 24.3541-1824.5   | 240418   | D=54, - Halter   |
|  | 1.6 16V  | 61   |  | 12.12  | - ESP   | 11.9541-9950.2   | 220843   | D=54, - Halter   |
|  |  |  |  |  |   | 11.9541-9951.2   | 220844   | D=54, - Halter   |
|  |  |  |  |  |   | 11.8116-0356.1   | 390586   | D=54, - Halter   |
|  |  |  |  |  |   |  | 2  | ATE  |
|  | 1.2 TCe 115  | 85   |  | 12.12  |   | 11.9541-9950.2   | 220843   | D=54, - Halter   |
|  | 1.5 dCi  | 55   |  | 12.12  | + ESP   | 11.9541-9951.2   | 220844   | D=54, - Halter   |
|  | 1.5 dCi  | 66   |  | 12.12  | + ESP   | 11.8116-0356.1   | 390586   | D=54, - Halter   |
|  | 1.6 16V  | 61   |  | 12.12  | + ESP   |  |  | Haltefeder   |
|  |  |  |  |  |   |  | 2  | ATE  |
| <b>DACIA DUSTER (HS_) (10-)</b>  |  |  |  |  |   |  |  |  |
|    | 1.5 dCi  | 63   |  | 04.10  | + ABS/ - ESP  | 03.2122-2031.3   | 010938   | THz 22,20  |
|  | 1.5 dCi  | 66   |  | 10.10  | + ABS/ - ESP  |  |  |  |
|  | 1.5 dCi  | 79   |  | 06.10  | + ABS/ - ESP  |  |  |  |
|  | 1.5 dCi 4x4  | 66   |  | 10.10  | + ABS/ - ESP  |  |  |  |
|  | 1.5 dCi 4x4  | 79   |  | 06.10  | + ABS/ - ESP  |  |  |  |
|  | 1.5 dCi 4x4  | 81   |  | 10.10  | + ABS/ - ESP  |  |  |  |
|  | 1.6 16V  | 77   |  | 04.10  | + ABS/ - ESP  |  |  |  |
|  | 1.6 16V 4x4  | 77   |  | 06.10  | + ABS/ - ESP  |  |  |  |
|  | 1.6 16V Flexifuel  | 77   |  | 04.11  | + ABS/ - ESP  |  |  |  |
|  | 1.6 16V LPG  | 77   |  | 04.11  | + ABS/ - ESP  |  |  |  |
|    | 1.5 dCi  | 63   |  | 04.10  | - ABS   | 24.3541-1823.5   | 240417   | D=54, - Halter   |
|  | 1.5 dCi  | 66   |  | 10.10  | - ABS   | 24.3541-1824.5   | 240418   | D=54, - Halter   |
|  | 1.5 dCi  | 79   |  | 06.10  | - ABS   |  |  |  |
|  | 1.6 16V  | 77   |  | 04.10  | - ESP   |  |  |  |
|  | 1.6 16V 4x4  | 77   |  | 06.10  | - ESP   |  |  |  |
|  | 1.6 16V Flexifuel  | 77   |  | 04.11  | - ESP   |  |  |  |
|  | 1.6 16V LPG  | 77   |  | 04.11  | - ESP   |  |  |  |
|  | 1.5 dCi  | 63   |  | 04.10  | + ABS   | 11.9541-9950.2   | 220843   | D=54, - Halter   |
|  | 1.5 dCi  | 66   |  | 10.10  | + ABS   | 11.9541-9951.2   | 220844   | D=54, - Halter   |
|  | 1.5 dCi  | 79   |  | 06.10  | + ABS   | 11.8116-0356.1   | 390586   | D=54, - Halter   |
|  | 1.5 dCi 4x4  | 66   |  | 10.10  |   |  |  | Haltefeder   |
|  | 1.5 dCi 4x4  | 79   |  | 06.10  |   |  |  |  |
|  | 1.5 dCi 4x4  | 81   |  | 10.10  |   |  |  |  |
|  | 1.6 16V  | 77   |  | 04.10  | + ESP   |  |  |  |
|  | 1.6 16V 4x4  | 77   |  | 06.10  | + ESP   |  |  |  |
|  | 1.6 16V Flexifuel  | 77   |  | 04.11  | + ESP   |  |  |  |
|  | 1.6 16V LPG  | 77   |  | 04.11  | + ESP   |  |  |  |
|  | 1.5 dCi  | 63   |  | 04.10  |   | 24.5229-0285.3   | 330032   | L=285  |
|  | 1.5 dCi  | 66   |  | 10.10  |   |  |  |  |
|  | 1.5 dCi  | 79   |  | 06.10  |   |  |  |  |
|  | 1.5 dCi 4x4  | 66   |  | 10.10  |   |  |  |  |
|  | 1.5 dCi 4x4  | 79   |  | 06.10  |   |  |  |  |
|  | 1.5 dCi 4x4  | 81   |  | 10.10  |   |  |  |  |
|  | 1.6 16V  | 77   |  | 04.10  |   |  |  |  |
|  | 1.6 16V 4x4  | 77   |  | 06.10  |   |  |  |  |
|  | 1.6 16V Flexifuel  | 77   |  | 04.11  |   |  |  |  |
|  | 1.6 16V LPG  | 77   |  | 04.11  |   |  |  |  |
|  | 1.5 dCi  | 63   |  | 04.10  |   | 24.3219-1761.3   | 020536   | Rz 19,05   |
|  | 1.5 dCi  | 66   |  | 10.10  |   |  |  |  |
|  | 1.5 dCi  | 79   |  | 06.10  |   |  |  |  |
|  | 1.6 16V  | 77   |  | 04.10  |   |  |  |  |
|  | 1.6 16V Flexifuel  | 77   |  | 04.11  |   |  |  |  |
|  | 1.6 16V LPG  | 77   |  | 04.11  |   |  |  |  |
|  | 1.5 dCi 4x4  | 66   |  | 10.10  |   | 24.3219-1763.3   | 020543   | Rz 19,05   |
|  | 1.5 dCi 4x4  | 79   |  | 06.10  |   | 24.3219-1764.3   | 020544   | Rz 19,05   |
|  | 1.5 dCi 4x4  | 81   |  | 10.10  |   |  |  |  |
|  | 1.6 16V 4x4  | 77   |  | 06.10  |   |  |  |  |
| <b>DACIA LODGY (JS_) (12-)</b>   |  |  |  |  |   |  |  |  |
|  | 1.5 dCi  | 66   |  | 03.12  | - ESP   | 24.3541-1823.5   | 240417   | D=54, - Halter   |
|  | 1.6  | 61   |  | 03.12  | - ESP   | 24.3541-1824.5   | 240418   | D=54, - Halter   |
|  | 1.2 TCe  | 85   |  | 03.12  |   | 11.9541-9950.2   | 220843   | D=54, - Halter   |
|  | 1.5 dCi  | 66   |  | 03.12  | + ESP   | 11.9541-9951.2   | 220844   | D=54, - Halter   |
|  | 1.5 dCi  | 79   |  | 03.12  | + ESP   | 11.8116-0356.1   | 390586   | D=54, - Halter   |
|  | 1.6  | 61   |  | 03.12  | + ESP   |  |  | Haltefeder   |
|  |  |  |  |  |   |  | 2  | ATE  |
|  | 1.2 TCe  | 85   |  | 03.12  |   | 24.3222-1729.3   | 020526   | Rz 22,20   |
|  | 1.5 dCi  | 66   |  | 03.12  |   |  |  |  |
|  | 1.5 dCi  | 79   |  | 03.12  |   |  |  |  |
|  | 1.6  | 61   |  | 03.12  |   |  |  |  |

1) - increased payload / - carico utile maggiorato / - charge utile augmentée / - incremento de carga  
2) + increased payload / + carico utile maggiorato / + charge utile augmentée / + incremento de carga

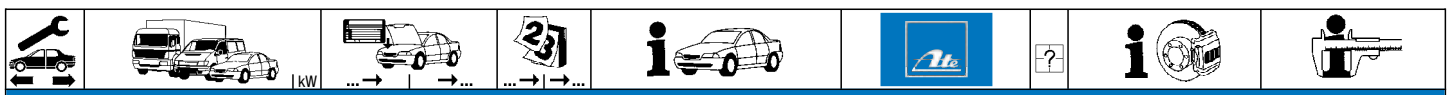

| DACIA LOGAN Express (FS_) (09-)     |                   |         |       |             |  |                |                |                          |                                    |                |        |  |
|-------------------------------------|-------------------|---------|-------|-------------|--|----------------|----------------|--------------------------|------------------------------------|----------------|--------|--|
|                                     | 1.4               | 55      |       | 03.09       |  | 03.7750-8532.4 | 300264         |                          |                                    | 9"             | ATE    |  |
|                                     | 1.5 dCi           | 50      |       | 03.09       | + ABS                                    |                |                |                          |                                    |                |        |  |
|                                     | 1.5 dCi           | 55      |       | 05.10       | + ABS                                    |                |                |                          |                                    |                |        |  |
|                                     | 1.5 dCi           | 63      |       | 03.09       | + ABS                                    |                |                |                          |                                    |                |        |  |
|                                     | 1.5 dCi           | 65      |       | 05.10       | + ABS                                    |                |                |                          |                                    |                |        |  |
|                                     | 1.6 Bifuel        | 62      |       | 05.10       | + ABS                                    |                |                |                          |                                    |                |        |  |
|                                     | 1.6 MPI 85        | 62      |       | 05.10       | + ABS                                    |                |                |                          |                                    |                |        |  |
|                                     | 1.4               | 55      |       | 03.09       | + ABS                                    | 03.2122-2031.3 | 010938         |                          |                                    | THz 22,20      | ATE    |  |
|                                     | 1.5 dCi           | 50      |       | 03.09       | + ABS                                    |                |                |                          |                                    |                |        |  |
|                                     | 1.5 dCi           | 55      |       | 05.10       | + ABS                                    |                |                |                          |                                    |                |        |  |
|                                     | 1.5 dCi           | 63      |       | 03.09       | + ABS                                    |                |                |                          |                                    |                |        |  |
|                                     | 1.5 dCi           | 65      |       | 05.10       | + ABS                                    |                |                |                          |                                    |                |        |  |
|                                     | 1.6 Bifuel        | 62      |       | 05.10       | + ABS                                    |                |                |                          |                                    |                |        |  |
|                                     | 1.6 MPI 85        | 62      |       | 05.10       | + ABS                                    |                |                |                          |                                    |                |        |  |
|                                     | 1.4               | 55      |       | 03.09       |  | 24.3541-1823.5 | 240417         | <input type="checkbox"/> | + belüftete Scheiben <sup>1)</sup> | D=54, - Halter |        |  |
|                                     | 1.5 dCi           | 50      |       | 03.09       |  | 24.3541-1824.5 | 240418         | <input type="checkbox"/> | + belüftete Scheiben <sup>1)</sup> | D=54, - Halter |        |  |
|                                     | 1.5 dCi           | 55      |       | 05.10       |  |                |                |                          |                                    |                |        |  |
|                                     | 1.5 dCi           | 63      |       | 03.09       |  |                |                |                          |                                    |                |        |  |
|                                     | 1.5 dCi           | 65      |       | 05.10       |  |                |                |                          |                                    |                |        |  |
|                                     | 1.6               | 64      |       | 03.09       |  |                |                |                          |                                    |                |        |  |
|                                     | 1.6 MPI 85        | 62      |       | 05.10       |  |                |                |                          |                                    |                |        |  |
|                                     | 1.4               | 55      |       | 03.09       |  | 24.5229-0285.3 | 330032         | 2                        |                                    | L=285          |        |  |
|                                     | 1.5 dCi           | 50      |       | 03.09       |  |                |                |                          |                                    |                |        |  |
|                                     | 1.5 dCi           | 55      |       | 05.10       |  |                |                |                          |                                    |                |        |  |
|                                     | 1.5 dCi           | 63      |       | 03.09       |  |                |                |                          |                                    |                |        |  |
|                                     | 1.5 dCi           | 65      |       | 05.10       |  |                |                |                          |                                    |                |        |  |
|                                     | 1.6               | 64      |       | 03.09       |  |                |                |                          |                                    |                |        |  |
|                                     | 1.6 MPI 85        | 62      |       | 05.10       |  |                |                |                          |                                    |                |        |  |
|                                     | 1.4               | 55      |       | 03.09       | - ABS                                    | 24.3219-1761.3 | 020536         |                          |                                    | Rz 19,05       |        |  |
|                                     | 1.5 dCi           | 50      |       | 03.09       | - ABS                                    |                |                |                          |                                    |                |        |  |
|                                     | 1.4               | 55      |       | 03.09       | + ABS                                    | 24.3222-1729.3 | 020526         |                          |                                    | Rz 22,20       |        |  |
|                                     | 1.5 dCi           | 50      |       | 03.09       | + ABS                                    |                |                |                          |                                    |                |        |  |
|                                     | 1.5 dCi           | 55      |       | 05.10       |  |                |                |                          |                                    |                |        |  |
|                                     | 1.5 dCi           | 63      |       | 03.09       |  |                |                |                          |                                    |                |        |  |
|                                     | 1.5 dCi           | 65      |       | 05.10       |  |                |                |                          |                                    |                |        |  |
|                                     | 1.6               | 64      |       | 03.09       |  |                |                |                          |                                    |                |        |  |
|                                     | 1.6 Bifuel        | 62      |       | 05.10       |  |                |                |                          |                                    |                |        |  |
|                                     | 1.6 MPI 85        | 62      |       | 05.10       |  |                |                |                          |                                    |                |        |  |
|                                     |                   | 1.6     | 64    |             | 03.09                                    |                | 24.3727-1073.2 | 581073                   | 2                                  | ↕              | L=1680 |  |
|                                     |                   | 1.4     | 55    |             | 03.09                                    |                | 24.3727-1074.2 | 581074                   | 2                                  | ↕              | L=1993 |  |
|                                     |                   | 1.5 dCi | 50    |             | 03.09                                    |                |                |                          |                                    |                |        |  |
|                                     |                   | 1.5 dCi | 55    |             | 05.10                                    |                |                |                          |                                    |                |        |  |
| 1.5 dCi                             |                   | 63      |       | 03.09       |  |                |                |                          |                                    |                |        |  |
| 1.5 dCi                             |                   | 65      |       | 05.10       |  |                |                |                          |                                    |                |        |  |
| 1.6 MPI 85                          |                   | 62      |       | 05.10       |  |                |                |                          |                                    |                |        |  |
| DACIA LOGAN Limousine (LS_) (04-13) |                   |         |       |             |  |                |                |                          |                                    |                |        |  |
|                                     | 1.2 16V           | 55      |       | 02.06       | 04.13 + ABS                              | 03.7853-4102.4 | 300271         |                          |                                    | 9"             | ATE    |  |
|                                     | 1.5 dCi           | 55      |       | 05.10       | 04.13 + ABS                              |                |                |                          |                                    |                |        |  |
|                                     | 1.5 dCi           | 65      |       | 05.10       | 04.13 + ABS                              |                |                |                          |                                    |                |        |  |
|                                     | 1.6 16V Flexifuel | 77      |       | 01.11       | 04.13 + ABS                              |                |                |                          |                                    |                |        |  |
|                                     | 1.6 Bifuel        | 62      |       | 05.10       | 04.13 + ABS                              |                |                |                          |                                    |                |        |  |
|                                     | 1.6 MPI 85        | 62      |       | 05.10       | 04.13 + ABS                              |                |                |                          |                                    |                |        |  |
|                                     | 1.5 dCi           | 63      |       | 09.07       | 04.13 + ABS                              | 03.7750-8532.4 | 300264         |                          |                                    | 9"             | ATE    |  |
| 1.6 16V                             | 64                |         | 09.04 | 04.13 + ABS |  |                |                |                          |                                    |                |        |  |
|                                     | 1.4               | 55      |       | 09.04       | 04.13 + ABS                              | 24.2120-1754.3 | 010949         |                          |                                    | THz 20,64      |        |  |
|                                     | 1.4 MPI LPG       | 55      |       | 02.06       | 04.13 + ABS                              |                |                |                          |                                    |                |        |  |
|                                     | 1.5 dCi           | 48      |       | 09.05       | 04.13 + ABS                              |                |                |                          |                                    |                |        |  |
|                                     | 1.5 dCi           | 50      |       | 01.06       | 04.13 + ABS                              |                |                |                          |                                    |                |        |  |
|                                     | 1.6 16V           | 64      |       | 09.04       | 04.13 + ABS                              |                |                |                          |                                    |                |        |  |
|                                     | 1.6 16V           | 77      |       | 02.06       | 04.13 + ABS                              |                |                |                          |                                    |                |        |  |
|                                     | 1.2 16V           | 55      |       | 02.06       | 04.13 + ABS                              | 03.2120-4611.3 | 010937         |                          |                                    | THz 20,64      | ATE    |  |
| 1.5 dCi                             | 55                |         | 05.10 | 04.13 + ABS |  |                |                |                          |                                    |                |        |  |
| 1.5 dCi                             | 63                |         | 09.07 | 04.13 + ABS |  |                |                |                          |                                    |                |        |  |
| 1.5 dCi                             | 65                |         | 05.10 | 04.13 + ABS |  |                |                |                          |                                    |                |        |  |
| 1.6 16V Flexifuel                   | 77                |         | 01.11 | 04.13 + ABS |  |                |                |                          |                                    |                |        |  |
| 1.6 Bifuel                          | 62                |         | 05.10 | 04.13 + ABS |  |                |                |                          |                                    |                |        |  |
| 1.6 MPI 85                          | 62                |         | 05.10 | 04.13 + ABS |  |                |                |                          |                                    |                |        |  |
|                                     | 1.2 16V           | 55      |       | 02.06       | 04.13 - belüftete Scheiben <sup>2)</sup> | 24.3481-1611.5 | 240029         | <input type="checkbox"/> |                                    | D=48, - Halter | LUC    |  |
|                                     | 1.4               | 55      |       | 09.04       | 04.13 - belüftete Scheiben <sup>2)</sup> | 24.3481-1612.5 | 240030         | <input type="checkbox"/> |                                    | D=48, - Halter | LUC    |  |
|                                     | 1.4 MPI LPG       | 55      |       | 02.06       | 04.13 - belüftete Scheiben <sup>2)</sup> |                |                |                          |                                    |                |        |  |
|                                     | 1.5 dCi           | 48      |       | 09.05       | 04.13 - belüftete Scheiben <sup>2)</sup> |                |                |                          |                                    |                |        |  |
|                                     | 1.5 dCi           | 50      |       | 09.05       | 04.13 - belüftete Scheiben <sup>2)</sup> |                |                |                          |                                    |                |        |  |
|                                     | 1.5 dCi           | 55      |       | 05.10       | 04.13 - belüftete Scheiben <sup>2)</sup> |                |                |                          |                                    |                |        |  |
|                                     | 1.5 dCi           | 63      |       | 09.07       | 04.13 - belüftete Scheiben <sup>2)</sup> |                |                |                          |                                    |                |        |  |
|                                     | 1.5 dCi           | 65      |       | 05.10       | 04.13 - belüftete Scheiben <sup>2)</sup> |                |                |                          |                                    |                |        |  |
|                                     | 1.6 16V           | 64      |       | 09.04       | 04.13 - belüftete Scheiben <sup>2)</sup> |                |                |                          |                                    |                |        |  |
|                                     | 1.6 16V           | 77      |       | 02.06       | 04.13 - belüftete Scheiben <sup>2)</sup> |                |                |                          |                                    |                |        |  |
|                                     | 1.6 16V Flexifuel | 77      |       | 01.11       | 04.13 - belüftete Scheiben <sup>2)</sup> |                |                |                          |                                    |                |        |  |
|                                     | 1.6 Bifuel        | 62      |       | 05.10       | 04.13 - belüftete Scheiben <sup>2)</sup> |                |                |                          |                                    |                |        |  |
|                                     | 1.6 MPI 85        | 62      |       | 05.10       | 04.13 - belüftete Scheiben <sup>2)</sup> |                |                |                          |                                    |                |        |  |























<sup>1)</sup> + ventilated discs / + dischi ventilati / + disques ventilés / + disco ventilado





















<sup>2)</sup> - ventilated discs / - dischi ventilati / - disques ventilés / - disco ventilado



















| DACIA LOGAN Limousine (LS_) (04-13) |                   |         |       |                                    |                                    |                |        |   |                                  |            |
|-------------------------------------|-------------------|---------|-------|------------------------------------|------------------------------------|----------------|--------|---|----------------------------------|------------|
|                                     | 1.2 16V           | 55      | 02.06 | 04.13                              | + belüftete Scheiben <sup>1)</sup> | 24.3481-1615.5 | 240031 |   | D=48, - Halter<br>D=48, - Halter | LUC<br>LUC |
|                                     | 1.4               | 55      | 09.04 | 04.13                              | + belüftete Scheiben <sup>1)</sup> |                | 240032 |   |                                  |            |
|                                     | 1.4 MPI LPG       | 55      | 02.06 | 04.13                              | + belüftete Scheiben <sup>1)</sup> |                |        |   |                                  |            |
|                                     | 1.5 dCi           | 48      | 09.05 | 04.13                              | + belüftete Scheiben <sup>1)</sup> |                |        |   |                                  |            |
|                                     | 1.5 dCi           | 50      | 08.06 | 04.13                              | + belüftete Scheiben <sup>1)</sup> |                |        |   |                                  |            |
|                                     | 1.5 dCi           | 55      | 05.10 | 04.13                              | + belüftete Scheiben <sup>1)</sup> |                |        |   |                                  |            |
|                                     | 1.5 dCi           | 63      | 09.07 | 04.13                              | + belüftete Scheiben <sup>1)</sup> |                |        |   |                                  |            |
|                                     | 1.5 dCi           | 65      | 05.10 | 04.13                              | + belüftete Scheiben <sup>1)</sup> |                |        |   |                                  |            |
|                                     | 1.6 16V           | 64      | 09.04 | 04.13                              | + belüftete Scheiben <sup>1)</sup> |                |        |   |                                  |            |
|                                     | 1.6 16V           | 77      | 02.06 | 04.13                              | + belüftete Scheiben <sup>1)</sup> |                |        |   |                                  |            |
|                                     | 1.6 16V Flexifuel | 77      | 01.11 | 04.13                              | + belüftete Scheiben <sup>1)</sup> |                |        |   |                                  |            |
|                                     | 1.6 Bifuel        | 62      | 05.10 | 04.13                              | + belüftete Scheiben <sup>1)</sup> |                |        |   |                                  |            |
| 1.6 MPI 85                          | 62                | 05.10   | 04.13 | + belüftete Scheiben <sup>1)</sup> |                                    |                |        |   |                                  |            |
|                                     | 1.2 16V           | 55      | 02.06 | 04.13                              |                                    | 24.5111-0300.3 | 330407 | 2 | L=300                            |            |
|                                     | 1.4               | 55      | 09.04 | 04.13                              |                                    |                |        |   |                                  |            |
|                                     | 1.4 MPI LPG       | 55      | 02.06 | 04.13                              |                                    |                |        |   |                                  |            |
|                                     | 1.5 dCi           | 48      | 09.05 | 04.13                              |                                    |                |        |   |                                  |            |
|                                     | 1.5 dCi           | 50      | 01.06 | 04.13                              |                                    |                |        |   |                                  |            |
|                                     | 1.5 dCi           | 55      | 05.10 | 04.13                              |                                    |                |        |   |                                  |            |
|                                     | 1.5 dCi           | 63      | 09.07 | 04.13                              |                                    |                |        |   |                                  |            |
|                                     | 1.5 dCi           | 65      | 05.10 | 04.13                              |                                    |                |        |   |                                  |            |
|                                     | 1.6 16V           | 64      | 09.04 | 04.13                              |                                    |                |        |   |                                  |            |
|                                     | 1.6 16V           | 77      | 02.06 | 04.13                              |                                    |                |        |   |                                  |            |
|                                     | 1.6 16V Flexifuel | 77      | 01.11 | 04.13                              |                                    |                |        |   |                                  |            |
|                                     | 1.6 Bifuel        | 62      | 05.10 | 04.13                              |                                    |                |        |   |                                  |            |
| 1.6 MPI 85                          | 62                | 05.10   | 04.13 |                                    |                                    |                |        |   |                                  |            |
|                                     | 1.2 16V           | 55      | 02.06 | 04.13                              |                                    | 24.5229-0285.3 | 330032 | 2 | L=285                            |            |
|                                     | 1.4               | 55      | 09.04 | 04.13                              |                                    |                |        |   |                                  |            |
|                                     | 1.4 MPI LPG       | 55      | 02.06 | 04.13                              |                                    |                |        |   |                                  |            |
|                                     | 1.5 dCi           | 48      | 09.05 | 04.13                              |                                    |                |        |   |                                  |            |
|                                     | 1.5 dCi           | 50      | 01.06 | 04.13                              |                                    |                |        |   |                                  |            |
|                                     | 1.5 dCi           | 55      | 05.10 | 04.13                              |                                    |                |        |   |                                  |            |
|                                     | 1.5 dCi           | 63      | 09.07 | 04.13                              |                                    |                |        |   |                                  |            |
|                                     | 1.5 dCi           | 65      | 05.10 | 04.13                              |                                    |                |        |   |                                  |            |
|                                     | 1.6 16V           | 64      | 09.04 | 04.13                              |                                    |                |        |   |                                  |            |
|                                     | 1.6 16V           | 77      | 02.06 | 04.13                              |                                    |                |        |   |                                  |            |
|                                     | 1.6 16V Flexifuel | 77      | 01.11 | 04.13                              |                                    |                |        |   |                                  |            |
|                                     | 1.6 Bifuel        | 62      | 05.10 | 04.13                              |                                    |                |        |   |                                  |            |
| 1.6 MPI 85                          | 62                | 05.10   | 04.13 |                                    |                                    |                |        |   |                                  |            |
|                                     | 1.2 16V           | 55      | 02.06 | 04.13                              | - ABS                              | 24.3219-1722.3 | 020426 |   | Rz 19,05                         | BDX        |
|                                     | 1.4               | 55      | 09.04 | 04.13                              | - ABS                              |                |        |   |                                  |            |
|                                     | 1.4 MPI LPG       | 55      | 02.06 | 04.13                              | - ABS                              |                |        |   |                                  |            |
|                                     | 1.5 dCi           | 48      | 09.05 | 04.13                              | - ABS                              |                |        |   |                                  |            |
|                                     | 1.5 dCi           | 50      | 01.06 | 04.13                              | - ABS                              |                |        |   |                                  |            |
|                                     | 1.5 dCi           | 55      | 05.10 | 04.13                              | - ABS                              |                |        |   |                                  |            |
|                                     | 1.5 dCi           | 63      | 09.07 | 04.13                              | - ABS                              |                |        |   |                                  |            |
|                                     | 1.5 dCi           | 65      | 05.10 | 04.13                              | - ABS                              |                |        |   |                                  |            |
|                                     | 1.6 16V           | 64      | 09.04 | 04.13                              | - ABS                              |                |        |   |                                  |            |
|                                     | 1.6 16V           | 77      | 02.06 | 04.13                              | - ABS                              |                |        |   |                                  |            |
|                                     | 1.6 16V Flexifuel | 77      | 01.11 | 04.13                              | - ABS                              |                |        |   |                                  |            |
|                                     | 1.6 Bifuel        | 62      | 05.10 | 04.13                              | - ABS                              |                |        |   |                                  |            |
| 1.6 MPI 85                          | 62                | 05.10   | 04.13 | - ABS                              |                                    |                |        |   |                                  |            |
|                                     | 1.2 16V           | 55      | 02.06 | 04.13                              | + ABS                              | 24.3217-1711.3 | 020449 |   | Rz 17,78                         | BOS        |
|                                     | 1.4               | 55      | 09.04 | 04.13                              | + ABS                              |                |        |   |                                  |            |
|                                     | 1.4 MPI LPG       | 55      | 02.06 | 04.13                              | + ABS                              |                |        |   |                                  |            |
|                                     | 1.5 dCi           | 48      | 09.05 | 04.13                              | + ABS                              |                |        |   |                                  |            |
|                                     | 1.5 dCi           | 50      | 01.06 | 04.13                              | + ABS                              |                |        |   |                                  |            |
|                                     | 1.5 dCi           | 55      | 05.10 | 04.13                              | + ABS                              |                |        |   |                                  |            |
|                                     | 1.5 dCi           | 63      | 09.07 | 04.13                              | + ABS                              |                |        |   |                                  |            |
|                                     | 1.5 dCi           | 65      | 05.10 | 04.13                              | + ABS                              |                |        |   |                                  |            |
|                                     | 1.6 16V           | 64      | 09.04 | 04.13                              | + ABS                              |                |        |   |                                  |            |
|                                     | 1.6 16V           | 77      | 02.06 | 04.13                              | + ABS                              |                |        |   |                                  |            |
|                                     | 1.6 16V Flexifuel | 77      | 01.11 | 04.13                              | + ABS                              |                |        |   |                                  |            |
|                                     | 1.6 MPI 85        | 62      | 05.10 | 04.13                              | + ABS                              |                |        |   |                                  |            |
|                                     | 1.2 16V           | 55      | 02.06 | 04.13                              | + ABS                              | 24.3217-1710.3 | 020420 |   | Rz 17,78                         | LUC        |
|                                     | 1.4               | 55      | 09.04 | 04.13                              | + ABS                              |                |        |   |                                  |            |
|                                     | 1.4 MPI LPG       | 55      | 02.06 | 04.13                              | + ABS                              |                |        |   |                                  |            |
|                                     | 1.5 dCi           | 48      | 09.05 | 04.13                              | + ABS                              |                |        |   |                                  |            |
|                                     | 1.5 dCi           | 50      | 01.06 | 04.13                              | + ABS                              |                |        |   |                                  |            |
|                                     | 1.5 dCi           | 63      | 09.07 | 04.13                              | + ABS                              |                |        |   |                                  |            |
|                                     | 1.5 dCi           | 65      | 05.10 | 04.13                              | + ABS                              |                |        |   |                                  |            |
|                                     | 1.6 16V           | 64      | 09.04 | 04.13                              | + ABS                              |                |        |   |                                  |            |
|                                     | 1.6 16V           | 77      | 02.06 | 04.13                              | + ABS                              |                |        |   |                                  |            |
|                                     | 1.6 Bifuel        | 62      | 05.10 | 04.13                              | + ABS                              |                |        |   |                                  |            |
|                                     | 1.6 MPI 85        | 62      | 05.10 | 04.13                              | + ABS                              |                |        |   |                                  |            |
|                                     |                   | 1.2 16V | 55    | 02.06                              | 04.13                              |                | + ABS  |   |                                  |            |
| 1.4                                 |                   | 55      | 09.04 | 04.13                              | + ABS                              |                |        |   |                                  |            |
| 1.4 MPI LPG                         |                   | 55      | 02.06 | 04.13                              | + ABS                              |                |        |   |                                  |            |
| 1.5 dCi                             |                   | 48      | 09.05 | 04.13                              | + ABS                              |                |        |   |                                  |            |
| 1.5 dCi                             |                   | 50      | 01.06 | 04.13                              | + ABS                              |                |        |   |                                  |            |
| 1.5 dCi                             |                   | 55      | 05.10 | 04.13                              | + ABS                              |                |        |   |                                  |            |
| 1.5 dCi                             |                   | 63      | 09.07 | 04.13                              | + ABS                              |                |        |   |                                  |            |
| 1.5 dCi                             |                   | 65      | 05.10 | 04.13                              | + ABS                              |                |        |   |                                  |            |
| 1.6 16V                             |                   | 64      | 09.04 | 04.13                              | + ABS                              |                |        |   |                                  |            |
| 1.6 16V                             |                   | 77      | 02.06 | 04.13                              | + ABS                              |                |        |   |                                  |            |
| 1.6 16V Flexifuel                   |                   | 77      | 01.11 | 04.13                              | + ABS                              |                |        |   |                                  |            |
| 1.6 Bifuel                          |                   | 62      | 05.10 | 04.13                              | + ABS                              |                |        |   |                                  |            |

<sup>1)</sup> + ventilated discs / + dischi ventilati / + disques ventilés / + disco ventilado



























|     |  |  |  |  |  |  |  |   |                    |
|--|--|--|--|--|---|--|--|---|--------------------|
| <b>DACIA LOGAN Limousine (LS_) (04-13)</b>   |  |  |  |  |   |  |  |   |                    |
|    | 1.6 MPI 85   | 62   |  | 05.10  | 04.13 + ABS   | 24.3727-1073.2   | 581073   | 2 ↓   | L=1680             |
|    | 1.2 16V  | 55   |  | 02.06  | 04.13   | 24.3728-1031.2   | 591031   |   | L=1033             |
|  | 1.4  | 55   |  | 09.04  | 04.13   |  |  |   |                    |
|  | 1.4 MPI LPG  | 55   |  | 02.06  | 04.13   |  |  |   |                    |
|  | 1.5 dCi  | 55   |  | 05.10  | 04.13   |  |  |   |                    |
|  | 1.6 16V  | 64   |  | 09.04  | 04.13   |  |  |   |                    |
|  | 1.6 Bifuel   | 62   |  | 05.10  | 04.13   |  |  |   |                    |
|  | 1.6 MPI 85   | 62   |  | 05.10  | 04.13   |  |  |   |                    |
| <b>DACIA LOGAN MCV Kombi (KS_) (07-13)</b>   |  |  |  |  |   |  |  |   |                    |
|    | 1.4  | 55   |  | 02.07  | 04.13   | 03.7750-8532.4   | 300264   | + ABS   | 9" ATE             |
|  | 1.5 dCi  | 50   |  | 02.07  | 04.13   |  |  |   |                    |
|  | 1.5 dCi  | 55   |  | 05.10  | 04.13   |  |  |   |                    |
|  | 1.5 dCi  | 63   |  | 09.07  | 04.13   |  |  |   |                    |
|  | 1.5 dCi  | 65   |  | 05.10  | 04.13   |  |  |   |                    |
|  | 1.6  | 64   |  | 02.07  | 04.13   |  |  |   |                    |
|  | 1.6 16V  | 77   |  | 02.07  | 04.13   |  |  |   |                    |
|  | 1.6 16V Flexifuel  | 77   |  | 11.09  | 04.13   |  |  |   |                    |
|  | 1.6 Bifuel   | 64   |  | 11.08  | 04.13   |  |  |   |                    |
|  | 1.6 MPI 85   | 62   |  | 05.10  | 04.13   |  |  |   |                    |
|    | 1.6 Bifuel   | 64   |  | 11.08  | 04.13 + ABS   | 24.2120-1754.3   | 010949   |   | THz 20,64          |
|  | 1.6 MPI 85   | 62   |  | 05.10  | 04.13 + ABS   |  |  |   |                    |
|  | 1.5 dCi  | 55   |  | 05.10  | 04.13 + ABS   | 03.2122-2031.3   | 010938   |   | THz 22,20 ATE      |
|  | 1.5 dCi  | 63   |  | 09.07  | 04.13 + ABS   |  |  |   |                    |
|  | 1.5 dCi  | 65   |  | 05.10  | 04.13 + ABS   |  |  |   |                    |
|  | 1.6 16V Flexifuel  | 77   |  | 11.09  | 04.13 + ABS   |  |  |   |                    |
|    | 1.4  | 55   |  | 02.07  | 04.13 - ABS   | 24.3481-1615.5   | 240031   |  | D=48, - Halter LUC |
|  | 1.5 dCi  | 50   |  | 02.07  | 04.13 - ABS   | 24.3481-1616.5   | 240032   |  | D=48, - Halter LUC |
|  | 1.6  | 64   |  | 02.07  | 04.13 - ABS   |  |  |   |                    |
|  | 1.5 dCi  | 50   |  | 12.08  | 04.13 + ABS   | 24.3541-1823.5   | 240417   |  | D=54, - Halter     |
|  | 1.5 dCi  | 55   |  | 05.10  | 04.13 + ABS   | 24.3541-1824.5   | 240418   |  | D=54, - Halter     |
|  | 1.6 16V  | 77   |  | 12.08  | 04.13 + ABS   |  |  |   |                    |
|  | 1.6 16V Flexifuel  | 77   |  | 11.09  | 04.13 + ABS   |  |  |   |                    |
|    | 1.4  | 55   |  | 02.07  | 04.13   | 24.5111-0300.3   | 330407   | 2   | L=300              |
|  | 1.5 dCi  | 50   |  | 02.07  | 04.13   |  |  |   |                    |
|  | 1.5 dCi  | 55   |  | 05.10  | 04.13   |  |  |   |                    |
|  | 1.5 dCi  | 63   |  | 09.07  | 04.13   |  |  |   |                    |
|  | 1.5 dCi  | 65   |  | 05.10  | 04.13   |  |  |   |                    |
|  | 1.6  | 64   |  | 02.07  | 04.13   |  |  |   |                    |
|  | 1.6 16V  | 77   |  | 02.07  | 04.13   |  |  |   |                    |
|  | 1.6 16V Flexifuel  | 77   |  | 11.09  | 04.13   |  |  |   |                    |
|  | 1.6 Bifuel   | 64   |  | 11.08  | 04.13   |  |  |   |                    |
|  | 1.6 MPI 85   | 62   |  | 05.10  | 04.13   |  |  |   |                    |
|  | 1.4  | 55   |  | 02.07  | 04.13   | 24.5229-0285.3   | 330032   | 2   | L=285              |
|  | 1.5 dCi  | 50   |  | 02.07  | 04.13   |  |  |   |                    |
|  | 1.5 dCi  | 55   |  | 05.10  | 04.13   |  |  |   |                    |
|  | 1.5 dCi  | 63   |  | 09.07  | 04.13   |  |  |   |                    |
|  | 1.5 dCi  | 65   |  | 05.10  | 04.13   |  |  |   |                    |
|  | 1.6  | 64   |  | 02.07  | 04.13   |  |  |   |                    |
|  | 1.6 16V  | 77   |  | 02.07  | 04.13   |  |  |   |                    |
|  | 1.6 16V Flexifuel  | 77   |  | 11.09  | 04.13   |  |  |   |                    |
|  | 1.6 Bifuel   | 64   |  | 11.08  | 04.13   |  |  |   |                    |
|  | 1.6 MPI 85   | 62   |  | 05.10  | 04.13   |  |  |   |                    |
|  | 1.4  | 55   |  | 02.07  | 04.13   | 24.3219-1761.3   | 020536   | - ABS   | Rz 19,05           |
|  | 1.5 dCi  | 50   |  | 02.07  | 04.13   |  |  |   |                    |
|  | 1.5 dCi  | 55   |  | 05.10  | 04.13   |  |  |   |                    |
|  | 1.5 dCi  | 63   |  | 09.07  | 04.13   |  |  |   |                    |
|  | 1.5 dCi  | 65   |  | 05.10  | 04.13   |  |  |   |                    |
|  | 1.6  | 64   |  | 02.07  | 04.13   |  |  |   |                    |
|  | 1.6 16V  | 77   |  | 02.07  | 04.13   |  |  |   |                    |
|  | 1.6 16V Flexifuel  | 77   |  | 11.09  | 04.13   |  |  |   |                    |
|  | 1.6 Bifuel   | 64   |  | 11.08  | 04.13   |  |  |   |                    |
|  | 1.6 MPI 85   | 62   |  | 05.10  | 04.13   |  |  |   |                    |
|  | 1.4  | 55   |  | 02.07  | 04.13   | 24.3222-1729.3   | 020526   | + ABS   | Rz 22,20           |
|  | 1.5 dCi  | 50   |  | 02.07  | 04.13   |  |  |   |                    |
|  | 1.5 dCi  | 55   |  | 05.10  | 04.13   |  |  |   |                    |
|  | 1.5 dCi  | 63   |  | 09.07  | 04.13   |  |  |   |                    |
|  | 1.5 dCi  | 65   |  | 05.10  | 04.13   |  |  |   |                    |
|  | 1.6  | 64   |  | 02.07  | 04.13   |  |  |   |                    |
|  | 1.6 16V  | 77   |  | 02.07  | 04.13   |  |  |   |                    |
|  | 1.6 16V Flexifuel  | 77   |  | 11.09  | 04.13   |  |  |   |                    |
|  | 1.6 Bifuel   | 64   |  | 11.08  | 04.13   |  |  |   |                    |
|  | 1.6 MPI 85   | 62   |  | 05.10  | 04.13   |  |  |   |                    |
|  | 1.4  | 55   |  | 02.07  | 04.13   | 24.3727-1074.2   | 581074   | 2 ↓   | L=1993             |
|  | 1.5 dCi  | 50   |  | 02.07  | 04.13   |  |  |   |                    |
|  | 1.5 dCi  | 55   |  | 05.10  | 04.13   |  |  |   |                    |
|  | 1.5 dCi  | 63   |  | 09.07  | 04.13   |  |  |   |                    |
|  | 1.5 dCi  | 65   |  | 05.10  | 04.13   |  |  |   |                    |
|  | 1.6 Bifuel   | 64   |  | 11.08  | 04.13   |  |  |   |                    |
|  | 1.6 MPI 85   | 62   |  | 05.10  | 04.13   |  |  |   |                    |
|  | 1.6  | 64   |  | 02.07  | 04.13   | 24.3727-1073.2   | 581073   | 2 ↓   | L=1680             |
|  | 1.6 16V  | 77   |  | 02.07  | 04.13   |  |  |   |                    |
|  | 1.6 16V Flexifuel  | 77   |  | 11.09  | 04.13   |  |  |   |                    |





























|     |   |  |  |                 |                |  |  |  |
|--|---|--|--|---|---|--|--|--|
| <b>DACIA LOGAN MCV Kombi (KS_) (07-13)</b>   |   |  |  |   |   |  |  |  |
|    | 1.6<br>1.6 Bifuel<br>1.6 MPI 85   | 64<br>64<br>62   |  | 02.07<br>11.08<br>05.10   | 04.13<br>04.13<br>04.13   | 24.3728-1031.2   | 591031   | L=1033   |
| <b>DACIA LOGAN Pick-up (US_) (08-)</b>   |   |  |  |   |   |  |  |  |
|    | 1.4<br>1.5 dCi<br>1.5 dCi<br>1.5 dCi<br>1.5 dCi<br>1.6<br>1.6 Bifuel<br>1.6 MPI 85  | 55<br>50<br>55<br>63<br>65<br>64<br>62<br>62                                     |  | 01.09<br>03.08<br>05.10<br>03.08<br>05.10<br>03.08<br>05.10<br>05.10                            | + ABS<br>+ ABS<br>+ ABS<br>+ ABS<br>+ ABS<br>+ ABS<br>+ ABS<br>+ ABS                            | 03.7750-8532.4   | 300264   | 9" ATE   |
|    | 1.4<br>1.5 dCi<br>1.5 dCi<br>1.5 dCi<br>1.5 dCi<br>1.6<br>1.6 Bifuel<br>1.6 MPI 85  | 55<br>50<br>55<br>63<br>65<br>64<br>62<br>62                                     |  | 01.09<br>03.08<br>05.10<br>03.08<br>05.10<br>03.08<br>05.10<br>05.10                            | + ABS<br>+ ABS<br>+ ABS<br>+ ABS<br>+ ABS<br>+ ABS<br>+ ABS<br>+ ABS                            | 03.2122-2031.3   | 010938   | THz 22,20 ATE  |
|    | 1.4<br>1.5 dCi<br>1.5 dCi<br>1.5 dCi<br>1.5 dCi<br>1.6<br>1.6 Bifuel<br>1.6 MPI 85  | 55<br>50<br>55<br>63<br>65<br>64<br>62<br>62                                     |  | 01.09<br>12.08<br>05.10<br>12.08<br>05.10<br>12.08<br>05.10<br>05.10                            |   | 24.3541-1823.5<br>24.3541-1824.5   | 240417<br>240418   | D=54, - Halter<br>D=54, - Halter   |
|    | 1.5 dCi<br>1.5 dCi<br>1.6   | 50<br>63<br>64   |  | 03.08<br>03.08<br>03.08   | 11.08<br>11.08<br>11.08   | 24.5111-0300.3   | 330407   | 2<br>L=300   |
|    | 1.4<br>1.5 dCi<br>1.5 dCi<br>1.5 dCi<br>1.5 dCi<br>1.6<br>1.6 Bifuel<br>1.6 MPI 85  | 55<br>50<br>55<br>63<br>65<br>64<br>62<br>62                                     |  | 01.09<br>03.08<br>05.10<br>03.08<br>05.10<br>03.08<br>05.10<br>05.10                            |   | 24.5229-0285.3   | 330032   | 2<br>L=285   |
|  | 1.4<br>1.5 dCi<br>1.5 dCi<br>1.5 dCi<br>1.5 dCi<br>1.6<br>1.6 Bifuel<br>1.6 MPI 85  | 55<br>50<br>55<br>63<br>65<br>64<br>62<br>62                                     |  | 01.09<br>03.08<br>05.10<br>03.08<br>05.10<br>03.08<br>05.10<br>05.10                            |   | 24.3222-1729.3   | 020526   | Rz 22,20   |
|  | 1.4<br>1.5 dCi<br>1.5 dCi<br>1.5 dCi<br>1.5 dCi<br>1.6<br>1.6 Bifuel<br>1.6 MPI 85  | 55<br>50<br>55<br>63<br>65<br>64<br>62<br>62                                     |  | 01.09<br>03.08<br>05.10<br>03.08<br>05.10<br>03.08<br>05.10<br>05.10                            |   | 24.3727-1074.2   | 581074   | 2 ↓<br>L=1993  |
| <b>DACIA LOGAN II Limousine (L52_) (12-)</b>                                       |   |  |  |   |   |  |  |  |
|  | 0.9 TCe 90<br>1.2 16V 75<br>1.2 16V LPG<br>1.5 dCi 75<br>1.5 dCi 90   | 66<br>55<br>55<br>55<br>66   |  | 11.12<br>11.12<br>11.12<br>11.12<br>11.12   |   | 24.3217-1711.3   | 020449   | Rz 17,78 BOS   |
|  | 0.9 TCe 90<br>1.2 16V 75<br>1.5 dCi 75<br>1.5 dCi 90  | 66<br>55<br>55<br>66   |  | 11.12<br>11.12<br>11.12<br>11.12  |   | 24.3727-1073.2   | 581073   | 2 ↓<br>L=1680  |
| <b>DACIA SANDERO (08-13)</b>   |   |  |  |   |   |  |  |  |
|  | 1.2 16V<br>1.2 16V Bifuel<br>1.4<br>1.4 MPI LPG<br>1.5 dCi<br>1.5 dCi<br>1.5 dCi<br>1.6<br>1.6 16V<br>1.6 MPI 85<br>1.5 dCi | 55<br>55<br>55<br>53<br>50<br>55<br>65<br>64<br>77<br>62<br>63                   |  | 11.08<br>11.08<br>06.08<br>01.09<br>11.08<br>05.10<br>05.10<br>06.08<br>01.11<br>05.10<br>11.08 | 02.13<br>02.13<br>02.13<br>02.13<br>02.13<br>02.13<br>02.13<br>02.13<br>02.13<br>02.13<br>02.13 | 03.7853-4102.4   | 300271   | + ABS<br>9" ATE  |
|  | 1.2 16V<br>1.2 16V Bifuel<br>1.4<br>1.4 MPI LPG<br>1.5 dCi<br>1.5 dCi   | 55<br>55<br>55<br>53<br>50<br>55   |  | 11.08<br>11.08<br>06.08<br>01.09<br>11.08<br>05.10  | 02.13<br>02.13<br>02.13<br>02.13<br>02.13<br>02.13  | 03.7750-8532.4<br>03.2120-4611.3   | 300264<br>010937   | + ABS<br>+ ABS<br>9" ATE<br>ATE  |

|     |  |  |  |  |  |  |  |  |                |            |
|--|--|--|--|--|---|--|--|--|----------------|------------|
| <b>DACIA SANDERO (08-13)</b>   |  |  |  |  |   |  |  |  |                |            |
|    | 1.5 dCi  | 65   |  | 05.10  | 02.13   | 03.2120-4611.3   | 010937   | + ABS  | THz 20,64      | <b>ATE</b> |
|  | 1.6  | 64   |  | 06.08  | 02.13   |  |  |  |                |            |
|  | 1.6 16V  | 77   |  | 01.11  | 02.13   |  |  |  |                |            |
|  | 1.6 MPI 85   | 62   |  | 05.10  | 02.13   |  |  |  |                |            |
|  | 1.5 dCi  | 63   |  | 11.08  | 02.13   | 03.2122-2031.3   | 010938   | + ABS  | THz 22,20      | <b>ATE</b> |
|    | 1.2 16V  | 55   |  | 11.08  | 02.13   | 24.3481-1611.5   | 240029   | <input type="checkbox"/> - belüftete Scheiben <sup>1)</sup>                        | D=48, - Halter | <b>LUC</b> |
|  | 1.2 16V Bifuel   | 55   |  | 11.08  | 02.13   | 24.3481-1612.5   | 240030   | <input type="checkbox"/> - belüftete Scheiben <sup>1)</sup>                        | D=48, - Halter | <b>LUC</b> |
|  | 1.4  | 55   |  | 06.08  | 02.13   |  |  |  |                |            |
|  | 1.4 MPI LPG  | 53   |  | 01.09  | 02.13   |  |  |  |                |            |
|  | 1.5 dCi  | 50   |  | 11.08  | 02.13   |  |  |  |                |            |
|  | 1.5 dCi  | 55   |  | 05.10  | 02.13   |  |  |  |                |            |
|  | 1.5 dCi  | 65   |  | 05.10  | 02.13   |  |  |  |                |            |
|  | 1.6  | 64   |  | 06.08  | 02.13   |  |  |  |                |            |
|  | 1.6 16V  | 77   |  | 01.11  | 02.13   |  |  |  |                |            |
|  | 1.6 MPI 85   | 62   |  | 05.10  | 02.13   |  |  |  |                |            |
|  | 1.2 16V  | 55   |  | 11.08  | 02.13   | 24.3481-1615.5   | 240031   | <input type="checkbox"/> + belüftete Scheiben <sup>2)</sup>                        | D=48, - Halter | <b>LUC</b> |
|  | 1.2 16V Bifuel   | 55   |  | 11.08  | 02.13   | 24.3481-1616.5   | 240032   | <input type="checkbox"/> + belüftete Scheiben <sup>2)</sup>                        | D=48, - Halter | <b>LUC</b> |
|  | 1.5 dCi  | 55   |  | 05.10  | 02.13   |  |  |  |                |            |
|  | 1.5 dCi  | 65   |  | 05.10  | 02.13   |  |  |  |                |            |
|  | 1.6 16V  | 77   |  | 01.11  | 02.13   |  |  |  |                |            |
|  | 1.6 MPI 85   | 62   |  | 05.10  | 02.13   |  |  |  |                |            |
|    | 1.2 16V  | 55   |  | 11.08  | 02.13   | 24.5111-0300.3   | 330407   | 2  | L=300          |            |
|  | 1.2 16V Bifuel   | 55   |  | 11.08  | 02.13   |  |  |  |                |            |
|  | 1.4  | 55   |  | 06.08  | 02.13   |  |  |  |                |            |
|  | 1.4 MPI LPG  | 53   |  | 01.09  | 02.13   |  |  |  |                |            |
|  | 1.5 dCi  | 50   |  | 11.08  | 02.13   |  |  |  |                |            |
|  | 1.5 dCi  | 55   |  | 05.10  | 02.13   |  |  |  |                |            |
|  | 1.5 dCi  | 63   |  | 11.08  | 02.13   |  |  |  |                |            |
|  | 1.5 dCi  | 65   |  | 05.10  | 02.13   |  |  |  |                |            |
|  | 1.6  | 64   |  | 06.08  | 02.13   |  |  |  |                |            |
|  | 1.6 16V  | 77   |  | 01.11  | 02.13   |  |  |  |                |            |
|  | 1.6 MPI 85   | 62   |  | 05.10  | 02.13   |  |  |  |                |            |
|    | 1.2 16V  | 55   |  | 11.08  | 02.13   | 24.5229-0285.3   | 330032   | 2  | L=285          |            |
|  | 1.2 16V Bifuel   | 55   |  | 11.08  | 02.13   |  |  |  |                |            |
|  | 1.4  | 55   |  | 06.08  | 02.13   |  |  |  |                |            |
|  | 1.4 MPI LPG  | 53   |  | 01.09  | 02.13   |  |  |  |                |            |
|  | 1.5 dCi  | 50   |  | 11.08  | 02.13   |  |  |  |                |            |
|  | 1.5 dCi  | 55   |  | 05.10  | 02.13   |  |  |  |                |            |
|  | 1.5 dCi  | 63   |  | 11.08  | 02.13   |  |  |  |                |            |
|  | 1.5 dCi  | 65   |  | 05.10  | 02.13   |  |  |  |                |            |
|  | 1.6  | 64   |  | 06.08  | 02.13   |  |  |  |                |            |
|  | 1.6 16V  | 77   |  | 01.11  | 02.13   |  |  |  |                |            |
|  | 1.6 MPI 85   | 62   |  | 05.10  | 02.13   |  |  |  |                |            |
|  | 1.2 16V  | 55   |  | 11.08  | 02.13   | 24.3219-1722.3   | 020426   | + 7" Bremse <sup>3)</sup>  | Rz 19,05       | <b>BDX</b> |
|  | 1.2 16V Bifuel   | 55   |  | 11.08  | 02.13   |  |  |  |                |            |
|  | 1.4  | 55   |  | 06.08  | 02.13   |  |  |  |                |            |
|  | 1.4 MPI LPG  | 53   |  | 01.09  | 02.13   |  |  |  |                |            |
|  | 1.5 dCi  | 50   |  | 11.08  | 02.13   |  |  |  |                |            |
|  | 1.5 dCi  | 55   |  | 05.10  | 02.13   |  |  |  |                |            |
|  | 1.5 dCi  | 63   |  | 11.08  | 02.13   |  |  |  |                |            |
|  | 1.5 dCi  | 65   |  | 05.10  | 02.13   |  |  |  |                |            |
|  | 1.6  | 64   |  | 06.08  | 02.13   |  |  |  |                |            |
|  | 1.6 MPI 85   | 62   |  | 05.10  | 02.13   |  |  |  |                |            |
|  | 1.2 16V  | 55   |  | 11.08  | 02.13   | 24.3217-1711.3   | 020449   | + 8" Bremse <sup>4)</sup>  | Rz 17,78       | <b>BOS</b> |
|  | 1.2 16V Bifuel   | 55   |  | 11.08  | 02.13   |  |  |  |                |            |
|  | 1.4  | 55   |  | 06.08  | 02.13   |  |  |  |                |            |
|  | 1.4 MPI LPG  | 53   |  | 01.09  | 02.13   |  |  |  |                |            |
|  | 1.5 dCi  | 50   |  | 11.08  | 02.13   |  |  |  |                |            |
|  | 1.5 dCi  | 55   |  | 05.10  | 02.13   |  |  |  |                |            |
|  | 1.5 dCi  | 63   |  | 11.08  | 02.13   |  |  |  |                |            |
|  | 1.5 dCi  | 65   |  | 05.10  | 02.13   |  |  |  |                |            |
|  | 1.6  | 64   |  | 06.08  | 02.13   |  |  |  |                |            |
|  | 1.6 16V  | 77   |  | 01.11  | 02.13   |  |  |  |                |            |
|  | 1.6 MPI 85   | 62   |  | 05.10  | 02.13   |  |  |  |                |            |
|  | 1.5 dCi  | 63   |  | 11.08  | 02.13   | 24.3222-1729.3   | 020526   | + 9" Bremse <sup>5)</sup>  | Rz 22,20       |            |
|  | 1.5 dCi  | 63   |  | 11.08  | 02.13   | 24.3727-1074.2   | 581074   | 2 ↓  | L=1993         |            |
|  | 1.2 16V  | 55   |  | 11.08  | 02.13   | 24.3728-1031.2   | 591031   |  | L=1033         |            |
|  | 1.2 16V Bifuel   | 55   |  | 11.08  | 02.13   |  |  |  |                |            |
|  | 1.4  | 55   |  | 06.08  | 02.13   |  |  |  |                |            |
|  | 1.4 MPI LPG  | 53   |  | 01.09  | 02.13   |  |  |  |                |            |
|  | 1.5 dCi  | 50   |  | 11.08  | 02.13   |  |  |  |                |            |
|  | 1.5 dCi  | 55   |  | 05.10  | 02.13   |  |  |  |                |            |
|  | 1.5 dCi  | 65   |  | 05.10  | 02.13   |  |  |  |                |            |
|  | 1.6  | 64   |  | 06.08  | 02.13   |  |  |  |                |            |
|  | 1.6 MPI 85   | 62   |  | 05.10  | 02.13   |  |  |  |                |            |
| <b>DACIA SANDERO II (B52_) (12-)</b>   |  |  |  |  |   |  |  |  |                |            |
|  | 0.9 TCe 90   | 66   |  | 11.12  |   | 24.3217-1711.3   | 020449   |  | Rz 17,78       | <b>BOS</b> |
|  | 1.2 16V  | 55   |  | 11.12  |   |  |  |  |                |            |
|  | 1.2 16V LPG  | 53   |  | 11.12  |   |  |  |  |                |            |
|  | 1.5 dCi 75   | 55   |  | 11.12  |   |  |  |  |                |            |
|  | 1.5 dCi 90   | 66   |  | 11.12  |   |  |  |  |                |            |

1) - ventilated discs / - dischi ventilati / - disques ventilés / - disco ventilado  
2) + ventilated discs / + dischi ventilati / + disques ventilés / + disco ventilado  
3) + 7" brake / + freno de 7" / + frein de 7" / + freno de 7"  
4) + 8" brake / + servofreno da 8" / + frein de 8" / + freno de 8"  
5) + 9" brake / + servofreno da 9" / + frein de 9" / + freno de 9"



|     |  |  |  |  |  |                        |  |                                       |
|--|--|--|--|--|---|--|--|---|
| <b>DAEWOO ARANOS (95-97)</b>   |  |  |  |  |   |  |  |   |
|    | 1.5<br>1.8<br>2.0  | 66<br>70<br>77   |  | 01.95<br>01.95<br>01.95  | 11.97<br>11.97<br>11.97   | 03.3219-6311.3   | 020057   | Rz 19,05 (GG) LUC   |
| <b>DAEWOO ESPERO (95-99)</b>   |  |  |  |  |   |  |  |   |
|    | 1.5 i 16V<br>1.8 i<br>2.0 i  |  |  | 02.95<br>02.95<br>02.95  | 06.99<br>06.99<br>06.99   | 24.3521-1701.5<br>24.3521-1702.5<br>11.0441-5202.2<br>11.0101-5407.2<br>11.8171-0008.1                   | 240001<br>240002<br>250026<br>260011<br>990049                                     | D=52, - Halter ATE<br>D=52, - Halter ATE<br>Dichtungssatz ATE<br>Hülzensatz ATE<br>Führungsbolzen ATE                   |
|    | 1.5 i 16V<br>1.8 i<br>2.0 i  |  |  | 02.95<br>02.95<br>02.95  | 06.99<br>06.99<br>06.99   | 03.3219-6311.3   | 020057   | Rz 19,05 (GG) LUC   |
| <b>DAEWOO KALOS (02-05)</b>  |  |  |  |  |   |  |  |   |
|    | 1.2 i<br>1.4 i<br>1.4 i 16V<br>1.6 i 16V   | 53<br>61<br>69<br>78   |  | 04.03<br>09.02<br>04.03<br>11.02   | 02.05<br>02.05<br>02.05<br>02.05  | 24.3219-1751.3   | 020504   | Rz 19,05  |
|    | 1.2 i<br>1.4 i<br>1.4 i 16V<br>1.6 i 16V   | 53<br>61<br>69<br>78   |  | 04.03<br>09.02<br>04.03<br>11.02   | 02.05<br>02.05<br>02.05<br>02.05  | 24.3728-2901.2   | 592901   | L=888   |
| <b>DAEWOO LANOS (97-02)</b>  |  |  |  |  |   |  |  |   |
|    | 1.4 i<br>1.5 i   | 55<br>63   | 447433<br>447433   | 05.97<br>05.97   |   | 11.9481-9871.2<br>11.9481-9872.2<br>11.0441-4811.2<br>11.0101-5407.2<br>11.8171-0008.1<br>11.8116-0129.1 | 220681<br>220682<br>250024<br>260011<br>990049<br>390591                           | D=48, - Halter ATE<br>D=48, - Halter ATE<br>Dichtungssatz ATE<br>Hülzensatz ATE<br>Führungsbolzen ATE<br>Haltefeder ATE |
|  | 1.6 i 16V  | 78   | 447433   | 05.97  |   | 24.3521-1701.5<br>24.3521-1702.5<br>11.0441-5202.2<br>11.0101-5407.2<br>11.8171-0008.1<br>11.8116-0097.1 | 240001<br>240002<br>250026<br>260011<br>990049<br>390590                           | D=52, - Halter ATE<br>D=52, - Halter ATE<br>Dichtungssatz ATE<br>Hülzensatz ATE<br>Führungsbolzen ATE<br>Haltefeder ATE |
|    | 1.4 i<br>1.5 i<br>1.6 i 16V  | 55<br>63<br>78   |  | 05.97<br>05.97<br>05.97  | 12.02<br>12.02<br>12.02   | 24.5233-0180.3   | 330888   | L=180   |
|  | 1.4 i<br>1.5 i   | 55<br>63   | 447433<br>447433   | 05.97<br>05.97   |   | 03.3217-3512.3   | 020032   | Rz 17,46 LUC  |
|  | 1.4 i<br>1.5 i<br>1.6 i 16V<br>1.6 i 16V   | 55<br>63<br>78<br>78   | 447434<br>447434<br>447433<br>447434   |  | 12.02<br>12.02<br>05.97<br>12.02  | 03.3219-6311.3   | 020057   | Rz 19,05 (GG) LUC   |
|  | 1.4 i<br>1.5 i<br>1.6 i 16V  | 55<br>63<br>78   |  | 05.97<br>05.97<br>05.97  | 12.02<br>12.02<br>12.02   | 24.3220-1719.3   | 020448   | Rz 20,64  |
|  | 1.4 i<br>1.5 i<br>1.6 i 16V  | 55<br>63<br>78   |  | 05.97<br>05.97<br>05.97  | 12.02<br>12.02<br>12.02   | 24.3727-2900.2<br>24.3727-2901.2   | 582900<br>582901   | L=1655<br>L=1587  |
| <b>DAEWOO MATIZ (98-05)</b>  |  |  |  |  |   |  |  |   |
|  | 0.8 (KLA4)<br>1.0 (KLA0)   | 38<br>47   |  | 07.98<br>01.03   | 02.05<br>02.05  | 24.3481-1773.5<br>24.3481-1774.5   | 240377<br>240378   | D=48, - Halter<br>D=48, - Halter  |
|  | 0.8 (KLA4)<br>1.0 (KLA0)   | 38<br>47   |  | 07.98<br>01.03   | 02.05<br>02.05  | 24.5283-0403.3<br>24.5291-0425.3   | 331136<br>331029   | L=404<br>L=425  |
|  | 0.8 (KLA4)<br>1.0 (KLA0)   | 38<br>47   |  | 07.98<br>01.03   | 02.05<br>02.05  | 24.5284-0220.3   | 330970   | L=220   |
|  | 0.8 (KLA4)<br>1.0 (KLA0)   | 38<br>47   |  | 07.98<br>01.03   | 02.05<br>02.05  | 24.3217-1712.3   | 020475   | Rz 17,46  |
|  | 0.8 (KLA4)<br>1.0 (KLA0)   | 38<br>47   |  | 07.98<br>01.03   | 02.05<br>02.05  | 24.3727-2902.2   | 582902   | L=2825  |
|  | 0.8 (KLA4)<br>1.0 (KLA0)   | 38<br>47   |  | 07.98<br>01.03   | 02.05<br>02.05  | 24.3728-2900.2   | 592900   | L=851   |
| <b>DAEWOO NEXIA (95-97)</b>  |  |  |  |  |   |  |  |   |
|  | 1.5 i  |  |  | 02.95  | 08.97   | 11.9481-9871.2<br>11.9481-9872.2<br>11.0441-4811.2<br>11.0101-5407.2<br>11.8171-0008.1<br>11.8116-0129.1 | 220681<br>220682<br>250024<br>260011<br>990049<br>390591                           | D=48, - Halter ATE<br>D=48, - Halter ATE<br>Dichtungssatz ATE<br>Hülzensatz ATE<br>Führungsbolzen ATE<br>Haltefeder ATE |
|  | 1.5 i 16V<br>1.8 i   | 66<br>74   |  | 02.95<br>10.95   | 08.97<br>08.97  | 24.3521-1701.5<br>24.3521-1702.5<br>11.0441-5202.2<br>11.0101-5407.2<br>11.8171-0008.1<br>11.8116-0097.1 | 240001<br>240002<br>250026<br>260011<br>990049<br>390590                           | D=52, - Halter ATE<br>D=52, - Halter ATE<br>Dichtungssatz ATE<br>Hülzensatz ATE<br>Führungsbolzen ATE<br>Haltefeder ATE |
|  | 1.5 i  |  |  | 02.95  | 08.97   | 03.3217-3512.3   | 020032   | Rz 17,46 LUC  |





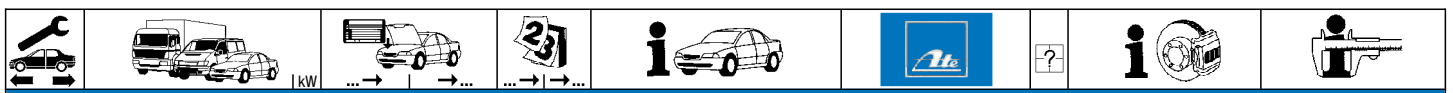































|     |                          |  |  |  |  |  |  |        |
|--|--|--|--|--|---|--|--|--|
| <b>DAEWOO NEXIA (95-97)</b>  |  |  |  |  |   |  |  |  |
|    | 1.5 i 16V<br>1.8 i   | 66<br>74   |  | 02.95<br>10.95   | 08.97<br>08.97  | 03.3219-6311.3   | 020057   | Rz 19,05 (GG) <b>LUC</b>   |
|    | 1.5 i<br>1.5 i 16V<br>1.8 i  | 66<br>74   |  | 02.95<br>02.95<br>10.95  | 08.97<br>08.97<br>08.97   | 24.3727-0730.2   | 580730   | 1 ↓<br>L=1272/1676, + Zub  |
| <b>DAEWOO NUBIRA (97-99)</b>   |  |  |  |  |   |  |  |  |
|    | 1.6 i 16V<br>1.8 i 16V   | 78<br>70   |  | 06.97<br>04.97   | 05.99<br>05.99  | 24.3220-1719.3   | 020448   | Rz 20,64   |
| <b>DAEWOO NUBIRA (99-05)</b>   |  |  |  |  |   |  |  |  |
|    | 1.6 i 16V<br>1.6 i 16V   | 76<br>78   |  | 07.00<br>06.99   | 02.05<br>02.05  | 24.3220-1719.3   | 020448   | Rz 20,64   |
| <b>DAIHATSU CHARADE (93-01)</b>  |  |  |  |  |   |  |  |  |
|    | 1.3 16V (G200)<br>1.3 16V (G200)<br>1.3 16V (G204)<br>1.5 16V (G203)<br>1.5 16V (G203)<br>1.6 GTi (G201) | 55<br>62<br>44<br>55<br>66<br>77   |  | 05.96<br>01.93<br>09.96<br>10.94<br>08.94<br>03.93                               | 11.99<br>04.01<br>04.01<br>11.99<br>11.99<br>03.96                                | 24.2119-1710.3   | 010880   | THz 19,05 + Behälter <b>LUC</b>  |
| <b>DAIHATSU CHARADE (11-)</b>  |  |  |  |  |   |  |  |  |
|    | 1.33 16V   | 73   |  | 05.11  |   | 03.7853-3203.4<br>03.7750-7132.4   | 300241<br>300255   | - ESP<br>+ ESP<br>9"<br>9" <b>ATE</b><br><b>ATE</b>                                      |
|    | 1.33 16V   | 73   |  | 05.11  |   | 11.9541-9569.2<br>11.9541-9570.2   | 220725<br>220726   | D=54, - Halter <b>ATE</b><br>D=54, - Halter <b>ATE</b>                                   |
|    | 1.33 16V   | 73   |  | 05.11  |   | 24.5286-0489.3<br>24.5286-0488.3   | 331222<br>331221   | L=488<br>L=488   |
|    | 1.33 16V   | 73   |  | 05.11  |   | 11.9347-7005.2<br>11.9347-7006.2   | 220643<br>220644   | D=34, - Halter <b>ATE</b><br>D=34, - Halter <b>ATE</b>                                   |
|   | 1.33 16V   | 73   |  | 05.11  |   | 24.5261-0195.3<br>24.5261-0255.3   | 331077<br>331078   | L=195<br>L=255   |
|  | 1.33 16V   | 73   |  | 05.11  |   | 24.3220-1728.3   | 020509   | Rz 20,64   |
|  | 1.33 16V   | 73   |  | 05.11  |   | 24.3727-1937.2<br>24.3727-1938.2   | 581937<br>581938   | + HA-Trommelbremse <sup>1)</sup><br>+ HA-Trommelbremse <sup>1)</sup><br>L=1555<br>L=1600 |
| <b>DAIHATSU CUORE (07-)</b>  |  |  |  |  |   |  |  |  |
|  | 1.0 DVVT (L276)  | 51   |  | 09.07  | + ESP   | 24.3217-1721.3<br>24.3217-1722.3   | 020489<br>020490   | Rz 17,46<br>Rz 17,46   |
| <b>DAIHATSU MATERIA (06-)</b>  |  |  |  |  |   |  |  |  |
|  | 1.3 DVVT<br>1.5 DVVT<br>1.5 DVVT 4WD   | 67<br>76<br>76   |  | 10.06<br>10.06<br>10.06  |   | 24.5235-0205.3   | 331093   | 2<br>L=205   |
|  | 1.3 DVVT<br>1.5 DVVT<br>1.5 DVVT 4WD   | 67<br>76<br>76   |  | 10.06<br>10.06<br>10.06  |   | 24.3217-1721.3<br>24.3217-1722.3   | 020489<br>020490   | Rz 17,46<br>Rz 17,46   |
| <b>DAIHATSU SIRION (05-)</b>   |  |  |  |  |   |  |  |  |
|  | 1.0 DVVT<br>1.0 DVVT 4WD<br>1.3 DVVT<br>1.3 DVVT<br>1.5 DVVT   | 51<br>51<br>64<br>67<br>76   |  | 01.05<br>04.05<br>01.05<br>03.08<br>03.08  |   | 24.5235-0205.3   | 331093   | 2<br>L=205   |
|  | 1.0 DVVT<br>1.0 DVVT 4WD<br>1.3 DVVT<br>1.3 DVVT<br>1.5 DVVT   | 51<br>51<br>64<br>67<br>76   |  | 01.05<br>04.05<br>01.05<br>03.08<br>03.08  |   | 24.3217-1721.3<br>24.3217-1722.3   | 020489<br>020490   | Rz 17,46<br>Rz 17,46   |
| <b>DAIHATSU TREVIS (06-)</b>   |  |  |  |  |   |  |  |  |
|  | 1.0 i 12V (L651)   | 43   |  | 06.06  |   | 24.3217-1724.3   | 020523   | Rz 17,46   |
| <b>FIAT 500 (07-)</b>  |  |  |  |  |   |  |  |  |
|  | 1.2 i<br>1.2 i Start-Stop<br>1.2 LPG<br>1.3 D Multijet<br>1.3 D Multijet                                 | 51<br>51<br>51<br>55<br>70   |  | 07.07<br>11.08<br>12.10<br>07.07<br>12.09  |   | 24.4120-1702.3   | 010913   | THz 20,64 - Behälter <b>LUC</b>  |

<sup>1)</sup> + RA drum brake / + P freno a tamburo / + frein à tambour essieu AR / + ET-tambores de freno













| FIAT 500 (07-)         |                       |     |  |       |       |  |                |        |   |                      |     |
|------------------------|-----------------------|-----|--|-------|-------|--|----------------|--------|---|----------------------|-----|
|                        | 0.9                   | 48  |  | 09.12 |       |  | 24.4122-1714.3 | 010914 |   | THz 22,20 - Behälter | LUC |
|                        | 0.9                   | 63  |  | 07.10 |       |  |                |        |   |                      |     |
|                        | 1.4 Abarth            | 99  |  | 07.08 |       |  |                |        |   |                      |     |
|                        | 1.4 Abarth            | 103 |  | 05.10 |       |  |                |        |   |                      |     |
|                        | 1.4 Abarth            | 118 |  | 08.08 |       |  |                |        |   |                      |     |
|                        | 1.4 Abarth Assetto C. | 140 |  | 08.08 |       |  |                |        |   |                      |     |
|                        | 1.4 Abarth Tributo F. | 132 |  | 08.08 |       |  |                |        |   |                      |     |
|                        | 1.4 i 16V             | 74  |  | 07.07 |       |  |                |        |   |                      |     |
|                        | 0.9                   | 48  |  | 09.12 |       |  | 11.9541-9831.2 | 220953 |   | D=54, - Halter       | ATE |
|                        | 0.9                   | 63  |  | 07.10 |       |  | 11.9541-9832.2 | 220954 |   | D=54, - Halter       | ATE |
|                        | 1.3 D Multijet        | 70  |  | 12.09 |       |  | 24.3541-1769.7 | 220707 |   | D=54, - Halter       | BOS |
|                        | 1.4 i 16V             | 74  |  | 07.07 |       |  | 24.3541-1770.7 | 220708 |   | D=54, - Halter       | BOS |
|                        | 0.9                   | 48  |  | 09.12 |       |  | 24.5112-0356.3 | 331129 | 2 | L=355                |     |
|                        | 0.9                   | 63  |  | 07.10 |       |  |                |        |   |                      |     |
|                        | 1.2 i                 | 51  |  | 07.07 |       |  |                |        |   |                      |     |
|                        | 1.2 i Start-Stop      | 51  |  | 11.08 |       |  |                |        |   |                      |     |
|                        | 1.2 LPG               | 51  |  | 12.10 |       |  |                |        |   |                      |     |
|                        | 1.2 LPG               | 51  |  | 07.10 |       |  |                |        |   |                      |     |
|                        | 1.3 D Multijet        | 55  |  | 07.07 |       |  |                |        |   |                      |     |
|                        | 1.3 D Multijet        | 70  |  | 08.08 |       |  |                |        |   |                      |     |
|                        | 1.4 i 16V             | 74  |  | 07.07 |       |  |                |        |   |                      |     |
|                        | 1.4 Abarth            | 99  |  | 07.08 |       |  | 24.5112-0356.3 | 331129 | 2 | L=355                |     |
|                        | 1.4 Abarth            | 103 |  | 05.10 |       |  |                |        |   |                      |     |
|                        | 1.4 Abarth            | 118 |  | 08.08 |       |  |                |        |   |                      |     |
|                        | 0.9                   | 63  |  | 07.10 |       |  | 24.5228-0165.3 | 330879 | 2 | L=165                |     |
|                        | 1.2 i                 | 51  |  | 07.07 |       |  |                |        |   |                      |     |
|                        | 1.2 i Start-Stop      | 51  |  | 11.08 |       |  |                |        |   |                      |     |
|                        | 1.2 LPG               | 51  |  | 12.10 |       |  |                |        |   |                      |     |
|                        | 1.3 D Multijet        | 55  |  | 07.07 |       |  |                |        |   |                      |     |
|                        | 1.3 D Multijet        | 70  |  | 12.09 |       |  |                |        |   |                      |     |
|                        | 1.4 Abarth            | 99  |  | 07.08 |       |  | 83.7101-9219.3 | 330903 | 2 | L=219                |     |
|                        | 1.4 Abarth            | 103 |  | 05.10 |       |  |                |        |   |                      |     |
|                        | 1.4 Abarth            | 118 |  | 08.08 |       |  |                |        |   |                      |     |
|                        | 1.4 Abarth Assetto C. | 140 |  | 08.08 |       |  |                |        |   |                      |     |
|                        | 1.4 Abarth Tributo F. | 132 |  | 08.08 |       |  |                |        |   |                      |     |
|                        | 1.4 i 16V             | 74  |  | 07.07 |       |  |                |        |   |                      |     |
|                        | 1.2 i                 | 51  |  | 07.07 | 05.10 |  | 24.3220-1108.3 | 020219 |   | Rz 20,64             | BDX |
|                        | 1.2 i Start-Stop      | 51  |  | 11.08 | 05.10 |  |                |        |   |                      |     |
|                        | 1.3 D Multijet        | 55  |  | 07.07 | 05.10 |  |                |        |   |                      |     |
|                        | 1.3 D Multijet        | 70  |  | 12.09 | 05.10 |  |                |        |   |                      |     |
|                        | 0.9                   | 48  |  | 09.12 |       |  | 24.2520-1705.3 | 040093 |   | Nz 20,64             |     |
|                        | 0.9                   | 63  |  | 07.10 |       |  |                |        |   |                      |     |
|                        | 1.2 i                 | 51  |  | 07.07 |       |  | 24.3728-0532.2 | 590532 |   | L=995                |     |
|                        | 1.2 i Start-Stop      | 51  |  | 11.08 |       |  |                |        |   |                      |     |
|                        | 1.2 LPG               | 51  |  | 12.10 |       |  |                |        |   |                      |     |
| FIAT 500C Cabrio (09-) |                       |     |  |       |       |  |                |        |   |                      |     |
|                        | 1.2                   | 51  |  | 09.09 |       |  | 24.4120-1702.3 | 010913 |   | THz 20,64 - Behälter | LUC |
|                        | 1.3 D Multijet        | 55  |  | 09.09 |       |  |                |        |   |                      |     |
|                        | 1.3 D Multijet        | 70  |  | 09.09 |       |  |                |        |   |                      |     |
|                        | 0.9                   | 63  |  | 09.09 |       |  | 24.4122-1714.3 | 010914 |   | THz 22,20 - Behälter | LUC |
|                        | 1.4                   | 74  |  | 09.09 |       |  |                |        |   |                      |     |
|                        | 1.4 Abarth            |     |  | 09.09 |       |  |                |        |   |                      |     |
|                        | 1.4 Abarth            | 118 |  | 05.11 |       |  |                |        |   |                      |     |
|                        | 0.9                   | 63  |  | 09.09 |       |  | 11.9541-9831.2 | 220953 |   | D=54, - Halter       | ATE |
|                        |                       |     |  |       |       |  | 11.9541-9832.2 | 220954 |   | D=54, - Halter       | ATE |
|                        | 1.3 D Multijet        | 70  |  | 09.09 |       |  | 24.3541-1769.7 | 220707 |   | D=54, - Halter       | BOS |
|                        | 1.4                   | 74  |  | 09.09 |       |  | 24.3541-1770.7 | 220708 |   | D=54, - Halter       | BOS |
|                        | 0.9                   | 63  |  | 09.09 |       |  | 24.5112-0356.3 | 331129 | 2 | L=355                |     |
|                        | 1.2                   | 51  |  | 09.09 |       |  |                |        |   |                      |     |
|                        | 1.3 D Multijet        | 55  |  | 09.09 |       |  |                |        |   |                      |     |
|                        | 1.3 D Multijet        | 70  |  | 09.09 |       |  |                |        |   |                      |     |
|                        | 1.4                   | 74  |  | 09.09 |       |  |                |        |   |                      |     |
|                        | 1.4 Abarth            |     |  | 09.09 |       |  |                |        |   |                      |     |
|                        | 1.4 Abarth            | 118 |  | 05.11 |       |  |                |        |   |                      |     |
|                        | 0.9                   | 63  |  | 09.09 |       |  | 24.5228-0165.3 | 330879 | 2 | L=165                |     |
|                        | 1.2                   | 51  |  | 09.09 |       |  |                |        |   |                      |     |
|                        | 1.3 D Multijet        | 55  |  | 09.09 |       |  |                |        |   |                      |     |
|                        | 1.3 D Multijet        | 70  |  | 09.09 |       |  |                |        |   |                      |     |
|                        | 1.4                   | 74  |  | 09.09 |       |  | 83.7101-9219.3 | 330903 | 2 | L=219                |     |
|                        | 1.4 Abarth            |     |  | 09.09 |       |  |                |        |   |                      |     |
|                        | 1.4 Abarth            | 118 |  | 05.11 |       |  |                |        |   |                      |     |
|                        | 0.9                   | 63  |  | 09.09 | 05.10 |  | 24.3220-1108.3 | 020219 |   | Rz 20,64             | BDX |
|                        | 1.2                   | 51  |  | 09.09 | 05.10 |  |                |        |   |                      |     |
|                        | 1.3 D Multijet        | 55  |  | 09.09 | 05.10 |  |                |        |   |                      |     |
|                        | 1.3 D Multijet        | 70  |  | 09.09 | 05.10 |  |                |        |   |                      |     |
|                        | 0.9                   | 63  |  | 09.09 |       |  | 24.2520-1705.3 | 040093 |   | Nz 20,64             |     |
|                        | 1.2                   | 51  |  | 09.09 |       |  | 24.3728-0532.2 | 590532 |   | L=995                |     |



|     |                   |  |        |   |  |  |    |  |
|--|---|--|--|---|---|--|--|--|
| <b>FIAT 500L Kombi (12-)</b>   |   |  |  |   |   |  |  |  |
|    | 0.9<br>0.9 CNG<br>1.3 D Multijet<br>1.4<br>1.6 D Multijet   | 77<br>63<br>62<br>70<br>77   | 08.12<br>03.13<br>08.12<br>08.12<br>08.12  |   | 24.5112-0402.3  | 331297   | 2  | L=402  |
|    | 0.9<br>0.9 CNG<br>1.3 D Multijet<br>1.4<br>1.6 D Multijet   | 77<br>63<br>62<br>70<br>77   | 08.12<br>03.13<br>08.12<br>08.12<br>08.12  |   | 24.5112-0142.3  | 331016   | 2 am Bremssattel 1)  | L=142  |
| <b>FIAT BARCHETTA (95-04)</b>  |   |  |  |   |   |  |  |  |
|    | 1.8 i 16V   |  | 04.95 10.04  |   | 24.2122-1716.3  | 010485   |  | Thz 22,20  |
|    | 1.8 i 16V   |  | 06.95 10.04  |   | 24.3541-1789.5<br>24.3541-1790.5  | 240291<br>240292   |   | D=54, - Halter<br>D=54, - Halter   |
|    | 1.8 i 16V   |  | 04.95 10.04  |   | 24.5112-0395.3<br>24.5112-0396.3  | 330521<br>330520   |   | L=395<br>L=397   |
|    | 1.8 i 16V   |  | 04.95 10.04  |   | 24.3344-1703.5<br>24.3344-1704.5  | 240117<br>240118   |  + GG-Sättel 2)<br> + GG-Sättel 2) | D=34, - Halter<br>D=34, - Halter   |
|    | 1.8 i 16V   |  | 04.95 10.04  |   | 24.5112-0160.3  | 330612   | 2  | L=160  |
|    | 1.8 i 16V   |  | 04.95 10.04  |   | 24.3727-0549.2  | 580549   | 2   | L=1521   |
|    | 1.8 i 16V   |  | 04.95 10.04 + ABS  |   | 24.6513-1705.3  | 320237   |   | BRL (2)  |
| <b>FIAT BRAVA (95-01)</b>  |   |  |  |   |   |  |  |  |
|    | 1.2 i 16V<br>1.4 i 12V<br>1.6 16 V<br>1.6 i 16V<br>1.8 i 16V<br>1.9 D<br>1.9 JTD<br>1.9 TD<br>2.0 | <br><br>76<br><br><br><br><br><br>113  | 12.98<br>09.95<br>01.99<br>09.95<br>09.95<br>09.95<br>12.98<br>06.96<br>09.98          | 10.01<br>10.01<br>12.02<br>10.01<br>10.01<br>10.01<br>10.01<br>10.01<br>10.01   | 24.2122-1716.3  | 010485   |  | Thz 22,20  |
|   | 1.2 i 16V<br>1.4 i 12V<br>1.6 16 V<br>1.6 i 16V<br>1.9 D<br>1.9 TD                                | <br><br>76<br><br><br>55   | 12.98<br>09.95<br>01.99<br>09.95<br>09.95<br>06.96                                     | 10.01 + Schaltgetriebe 3)<br>10.01 + Schaltgetriebe 3)<br>12.02 + Schaltgetriebe 3)<br>10.01 + Schaltgetriebe 3)<br>10.01 + Schaltgetriebe 3)<br>10.01 + Schaltgetriebe 3)  | 24.3541-1787.5<br>24.3541-1788.5  | 240289<br>240290   | <br>                            | D=54, - Halter<br>D=54, - Halter   |
|  | 1.2 i 16V<br>1.4 i 12V<br>1.6 16 V<br>1.6 i 16V<br>1.8 i 16V<br>1.9 D<br>1.9 JTD<br>1.9 TD<br>2.0 | <br><br>76<br><br><br><br><br><br>55<br>74<br>113                                | 12.98<br>09.95<br>01.99<br>09.95<br>09.95<br>09.95<br>12.98<br>06.96<br>06.96<br>09.98 | 10.01 + Automatikgetriebe 4)<br>10.01 + Automatikgetriebe 4)<br>12.02 + Automatikgetriebe 4)<br>10.01 + Automatikgetriebe 4)<br>10.01 + Automatikgetriebe 4)<br>10.01 + Automatikgetriebe 4)<br>10.01<br>10.01 + Automatikgetriebe 4)<br>10.01<br>08.00 | 24.3541-1789.5<br>24.3541-1790.5  | 240291<br>240292   | <br>                           | D=54, - Halter<br>D=54, - Halter   |
|  | 1.2 i 16V<br>1.4 i 12V<br>1.6 16 V<br>1.6 i 16V<br>1.8 i 16V<br>1.9 D<br>1.9 JTD<br>1.9 TD<br>2.0 | <br><br>76<br><br><br><br><br><br>113  | 12.98<br>09.95<br>01.99<br>09.95<br>09.95<br>09.95<br>12.98<br>06.96<br>06.96<br>09.98 | 10.01<br>10.01<br>12.02<br>10.01<br>10.01<br>10.01<br>10.01<br>10.01<br>10.01<br>08.00  | 24.5112-0387.3<br>24.5112-0388.3  | 330519<br>330518   | <br>                           | L=387<br>L=385   |
|  | 1.2 i 16V<br>1.4 i 12V<br>1.6 16 V<br>1.6 i 16V<br>1.8 i 16V<br>1.9 D<br>1.9 JTD<br>1.9 TD<br>2.0 | <br><br>76<br><br><br><br><br><br>113  | 12.98<br>09.95<br>01.99<br>09.95<br>09.95<br>09.95<br>12.98<br>06.96<br>06.96<br>09.98 | 10.01<br>10.01<br>12.02<br>10.01<br>10.01<br>10.01<br>10.01<br>10.01<br>10.01<br>08.00  | 24.5228-0223.3  | 330530   | 2  | L=223  |
|  | 1.2 i 16V<br>1.4 i 12V<br>1.9 D   |  | 12.98<br>09.95<br>09.95  | 10.01 - ABS<br>10.01 - ABS<br>10.01 - ABS   | 24.3222-1126.3<br>24.3222-1724.3  | 020358<br>020466   | + GG 5)<br>+ ALU 6)  | Rz 22,20<br>Rz 22,20   |
|  | 1.4 i 12V<br>1.6 i 16V<br>1.8 i 16V<br>1.9 D  |  | 09.95<br>09.95<br>09.95<br>09.95   | 11.98 + ABS<br>11.98<br>11.98<br>11.98 + ABS  | 24.3222-1707.3  | 020104   |  | Rz 22,20   |

1) on the brake caliper / sulla pinza freno / sur l'étrier de frein / a la pinza de freno  
2) + cast iron caliper / + pinza in ghisa / + étriers en fonte grise / + fundición gris-pinza  
3) + manual transmission / + scatola cambio velocità / + transmission mécanique / + cambio de velocidad  
4) + autom.transmission / + scatola cambio automatico / + transmission automatique / + cambio automático  
5) + cast iron / + ghisa / + fonte grise / + fundición de gris  
6) + aluminium / + alluminio / + aluminium / + aluminio

| FIAT BRAVA (95-01)   |  | 06.96 11.98 |       | 24.3222-1707.3 020104 |                | Rz 22,20 BDX   |                    |                    |
|--|--|-------------|-------|-----------------------|----------------|----------------|--------------------|--------------------|
|    | 1.9 TD   |             | 06.96 | 11.98                 | 24.3222-1707.3 | 020104         | Rz 22,20 BDX       |                    |
|  | 1.2 i 16V  |             | 12.98 | 10.01                 | 24.3222-1724.3 | 020466         | Rz 22,20           |                    |
|  | 1.4 i 12V  |             | 12.98 | 10.01                 |                |                |                    |                    |
|  | 1.6 16 V   | 76          | 01.99 | 12.02                 |                |                |                    |                    |
|  | 1.6 i 16V  |             | 12.98 | 10.01                 |                |                |                    |                    |
|  | 1.8 i 16V  |             | 12.98 | 10.01                 |                |                |                    |                    |
|  | 1.9 D  |             | 12.98 | 10.01                 |                |                |                    |                    |
|  | 1.9 JTD  |             | 12.98 | 10.01                 |                |                |                    |                    |
|  | 1.9 TD   |             | 12.98 | 10.01                 |                |                |                    |                    |
|  | 2.0  | 113         | 09.98 | 08.00                 |                |                |                    |                    |
|    | 1.2 i 16V  |             | 12.98 | 10.01                 | 24.3727-0536.2 | 580536         | L=1424             |                    |
|  | 1.4 i 12V  |             | 09.95 | 10.01                 | 24.3727-0535.2 | 580535         | L=1370             |                    |
|  | 1.9 D  |             | 09.95 | 10.01                 |                |                |                    |                    |
|  | 1.2 i 16V  |             | 12.98 | 10.01                 | 24.3727-0539.2 | 580539         | L=1428             |                    |
|  | 1.4 i 12V  |             | 09.95 | 10.01                 | 24.3727-0540.2 | 580540         | L=1383             |                    |
|  | 1.6 16 V   | 76          | 01.99 | 12.02                 |                |                |                    |                    |
|  | 1.6 i 16V  |             | 09.95 | 10.01                 |                |                |                    |                    |
|  | 1.8 i 16V  |             | 09.95 | 10.01                 |                |                |                    |                    |
|  | 1.9 D  |             | 09.95 | 10.01                 |                |                |                    |                    |
|  | 1.9 JTD  |             | 12.98 | 10.01                 |                |                |                    |                    |
| 1.9 TD   |  | 06.96       | 10.01 |                       |                |                |                    |                    |
| 2.0  | 113  | 09.98       | 08.00 |                       |                |                |                    |                    |
|    | 1.2 i 16V  |             | 12.98 | 10.01                 | 24.6584-1701.3 | 320173         | BRL (4)            |                    |
|  | 1.4 i 12V  |             | 09.95 | 10.01                 |                |                |                    |                    |
|  | 1.6 16 V   | 76          | 01.99 | 12.02                 |                |                |                    |                    |
|  | 1.6 i 16V  |             | 09.95 | 10.01                 |                |                |                    |                    |
|  | 1.8 i 16V  |             | 09.95 | 10.01                 |                |                |                    |                    |
|  | 1.9 D  |             | 09.95 | 10.01                 |                |                |                    |                    |
|  | 1.9 JTD  |             | 12.98 | 10.01                 |                |                |                    |                    |
|  | 1.9 TD   |             | 06.96 | 10.01                 |                |                |                    |                    |
|  | 2.0  | 113         | 09.98 | 08.00                 |                |                |                    |                    |
|  |    | 1.9 JTD     |       | 12.98                 | 10.01          | 24.2419-1721.3 | 030100             | Gz 19,05           |
| 1.9 JTD  |  |             | 12.98 | 10.01                 | 24.2525-1705.3 | 040083         | Nz 25,40           |                    |
|   | 1.2 i 16V  |             | 12.98 | 10.01                 | 24.3728-0523.2 | 590523         | L=937              |                    |
|  | 1.4 i 12V  |             | 09.95 | 10.01                 |                |                |                    |                    |
|  | 1.6 i 16V  |             | 09.95 | 10.01                 | 24.3728-0524.2 | 590524         | L=860              |                    |
|  | 1.8 i 16V  |             | 09.95 | 10.01                 | 24.3728-0528.2 | 590528         | L=1545             |                    |
|  | 1.9 D  |             | 09.95 | 10.01                 |                |                |                    |                    |
| 1.9 TD   | 74   | 06.96       | 10.01 |                       |                |                |                    |                    |
| FIAT BRAVO (95-01)   |  | 12.98 10.01 |       | 24.2122-1716.3 010485 |                | THz 22,20      |                    |                    |
|  | 1.2 i 16V  |             | 12.98 | 10.01                 | 24.2122-1716.3 | 010485         | THz 22,20          |                    |
|  | 1.4 i 12V  |             | 09.95 | 10.01                 |                |                |                    |                    |
|  | 1.6 i 16V  |             | 09.95 | 10.01                 |                |                |                    |                    |
|  | 1.8 i 16V  |             | 09.95 | 10.01                 |                |                |                    |                    |
|  | 1.9 D  |             | 09.95 | 10.01                 |                |                |                    |                    |
|  | 1.9 JTD  |             | 12.98 | 10.01                 |                |                |                    |                    |
|  | 1.9 TD   |             | 06.96 | 10.01                 |                |                |                    |                    |
|  | 2.0 i 20V  |             | 09.95 | 10.01                 |                |                |                    |                    |
|  |  | 1.2 i 16V   |       | 12.98                 | 10.01          | 24.3541-1787.5 | 240289             | D=54, - Halter ATE |
|  |  | 1.4 i 12V   |       | 09.95                 | 10.01          | 24.3541-1788.5 | 240290             | D=54, - Halter ATE |
| 1.6 i 16V  |  |             | 09.95 | 10.01                 |                |                |                    |                    |
| 1.9 D  |  |             | 09.95 | 10.01                 |                |                |                    |                    |
| 1.9 TD   |  | 55          | 06.96 | 10.01                 |                |                |                    |                    |
| 1.8 i 16V  |  |             | 09.95 | 10.01                 | 24.3541-1789.5 | 240291         | D=54, - Halter ATE |                    |
| 1.9 JTD  |  |             | 12.98 | 10.01                 | 24.3541-1790.5 | 240292         | D=54, - Halter ATE |                    |
| 1.9 TD   |  | 74          | 06.96 | 10.01                 |                |                |                    |                    |
| 2.0 i 20V  |  |             | 09.95 | 10.01                 | 24.3541-1791.5 | 240293         | D=54, - Halter ATE |                    |
|  |  |             |       |                       | 24.3541-1792.5 | 240294         | D=54, - Halter ATE |                    |
|  | 1.2 i 16V  |             | 12.98 | 10.01                 | 24.5112-0387.3 | 330519         | L=387              |                    |
|  | 1.4 i 12V  |             | 09.95 | 10.01                 | 24.5112-0388.3 | 330518         | L=385              |                    |
|  | 1.6 i 16V  |             | 09.95 | 10.01                 |                |                |                    |                    |
|  | 1.8 i 16V  |             | 09.95 | 10.01                 |                |                |                    |                    |
|  | 1.9 D  |             | 09.95 | 10.01                 |                |                |                    |                    |
|  | 1.9 JTD  |             | 12.98 | 10.01                 |                |                |                    |                    |
|  | 1.9 TD   |             | 06.96 | 10.01                 |                |                |                    |                    |
|  | 2.0 i 20V  |             | 09.95 | 10.01                 |                |                |                    |                    |
|  |  | 2.0 i 20V   |       | 09.95                 | 10.01          | 24.3344-1703.5 | 240117             | D=34, - Halter LUC |
|  |  |             |       |                       |                | 24.3344-1704.5 | 240118             | D=34, - Halter LUC |
|  | 1.2 i 16V  |             | 12.98 | 10.01                 | 24.5228-0223.3 | 330530         | L=223              |                    |
|  | 1.4 i 12V  |             | 09.95 | 10.01                 |                |                |                    |                    |
|  | 1.6 i 16V  |             | 09.95 | 10.01                 |                |                |                    |                    |
|  | 1.8 i 16V  |             | 09.95 | 10.01                 |                |                |                    |                    |
|  | 1.9 D  |             | 09.95 | 10.01                 |                |                |                    |                    |
|  | 1.9 JTD  |             | 12.98 | 10.01                 |                |                |                    |                    |
|  | 1.9 TD   |             | 06.96 | 10.01                 |                |                |                    |                    |
|  | 2.0 i 20V  |             | 09.95 | 10.01                 |                |                |                    |                    |

1) + cast iron caliper / + pinza in ghisa / + étriers en fonte grise / + fundición gris-pinza



### FIAT BRAVO (95-01)

|           |           |       |       |       |       |                |        |                          |          |            |
|-----------|-----------|-------|-------|-------|-------|----------------|--------|--------------------------|----------|------------|
|           | 1.2 i 16V |       | 12.98 | 10.01 | - ABS | 24.3222-1126.3 | 020358 | + GG <sup>1)</sup>       | Rz 22,20 | <b>AP</b>  |
|           | 1.4 i 12V |       | 09.95 | 10.01 | - ABS | 24.3222-1724.3 | 020466 | + ALU <sup>2)</sup>      | Rz 22,20 |            |
|           | 1.9 D     |       | 09.95 | 10.01 | - ABS |                |        |                          |          |            |
|           | 1.4 i 12V |       | 09.95 | 11.98 | + ABS | 24.3222-1707.3 | 020104 |                          | Rz 22,20 |            |
|           | 1.6 i 16V |       | 09.95 | 11.98 |       |                |        |                          |          | <b>BDX</b> |
|           | 1.8 i 16V |       | 09.95 | 11.98 |       |                |        |                          |          |            |
|           | 1.9 D     |       | 09.95 | 11.98 | + ABS |                |        |                          |          |            |
|           | 1.9 TD    |       | 06.96 | 11.98 |       |                |        |                          |          |            |
|           | 1.2 i 16V |       | 12.98 | 10.01 | + ABS | 24.3222-1724.3 | 020466 |                          | Rz 22,20 |            |
|           | 1.4 i 12V |       | 12.98 | 10.01 | + ABS |                |        |                          |          |            |
|           | 1.6 i 16V |       | 12.98 | 10.01 |       |                |        |                          |          |            |
|           | 1.8 i 16V |       | 12.98 | 10.01 |       |                |        |                          |          |            |
|           | 1.9 D     |       | 12.98 | 10.01 | + ABS |                |        |                          |          |            |
|           | 1.9 JTD   |       | 12.98 | 10.01 |       |                |        |                          |          |            |
|           | 1.9 TD    |       | 12.98 | 10.01 |       |                |        |                          |          |            |
|           | 1.2 i 16V |       | 12.98 | 10.01 | - ABS | 24.3727-0536.2 | 580536 | <input type="checkbox"/> | L=1424   |            |
|           | 1.4 i 12V |       | 09.95 | 10.01 | - ABS | 24.3727-0535.2 | 580535 | <input type="checkbox"/> | L=1370   |            |
|           | 1.9 D     |       | 09.95 | 10.01 | - ABS |                |        |                          |          |            |
|           | 1.2 i 16V |       | 12.98 | 10.01 | + ABS | 24.3727-0539.2 | 580539 | <input type="checkbox"/> | L=1428   |            |
|           | 1.4 i 12V |       | 09.95 | 10.01 | + ABS | 24.3727-0540.2 | 580540 | <input type="checkbox"/> | L=1383   |            |
|           | 1.6 i 16V |       | 09.95 | 10.01 |       |                |        |                          |          |            |
|           | 1.8 i 16V |       | 09.95 | 10.01 |       |                |        |                          |          |            |
|           | 1.9 D     |       | 09.95 | 10.01 | + ABS |                |        |                          |          |            |
|           | 1.9 JTD   |       | 12.98 | 10.01 |       |                |        |                          |          |            |
|           | 1.9 TD    |       | 06.96 | 10.01 |       |                |        |                          |          |            |
|           | 1.2 i 16V |       | 12.98 | 10.01 |       | 24.6584-1701.3 | 320173 |                          | BRL (4)  |            |
|           | 1.4 i 12V |       | 09.95 | 10.01 |       |                |        |                          |          |            |
|           | 1.6 i 16V |       | 09.95 | 10.01 |       |                |        |                          |          |            |
|           | 1.8 i 16V |       | 09.95 | 10.01 |       |                |        |                          |          |            |
|           | 1.9 D     |       | 09.95 | 10.01 |       |                |        |                          |          |            |
| 1.9 JTD   |           | 12.98 | 10.01 |       |       |                |        |                          |          |            |
| 1.9 TD    |           | 06.96 | 10.01 |       |       |                |        |                          |          |            |
| 2.0 i 20V |           | 09.95 | 10.01 |       |       |                |        |                          |          |            |
|           | 1.9 JTD   | ↕     | 12.98 | 10.01 |       | 24.2419-1721.3 | 030100 |                          | Gz 19,05 |            |
|           | 2.0 i 20V | ↕     | 09.95 | 10.01 |       |                |        |                          |          |            |
|           | 1.9 JTD   | ↕     | 12.98 | 10.01 |       | 24.2525-1705.3 | 040083 |                          | Nz 25,40 |            |
|           | 2.0 i 20V | ↕     | 09.95 | 10.01 |       |                |        |                          |          |            |
|           | 1.2 i 16V | ↕     | 12.98 | 10.01 |       | 24.3728-0523.2 | 590523 |                          | L=937    |            |
|           | 1.4 i 12V | ↕     | 09.95 | 10.01 |       |                |        |                          |          |            |
|           | 1.6 i 16V | ↕     | 09.95 | 10.01 |       | 24.3728-0524.2 | 590524 |                          | L=860    |            |
|           | 1.8 i 16V | ↕     | 09.95 | 10.01 |       | 24.3728-0528.2 | 590528 |                          | L=1545   |            |
|           | 1.9 D     | ↕     | 09.95 | 10.01 |       |                |        |                          |          |            |
|           | 1.9 TD    | ↕ 74  | 06.96 | 10.01 |       |                |        |                          |          |            |

### FIAT BRAVO (07-)





















|                |                |       |       |       |  |                |        |                          |                |            |
|----------------|----------------|-------|-------|-------|--|----------------|--------|--------------------------|----------------|------------|
|                | 1.4 i 16V      | 66    | 04.07 |       |  | 24.3541-1811.5 | 240429 | <input type="checkbox"/> | D=54, - Halter | <b>BOS</b> |
|                | 1.4 LPG        | 66    | 11.09 |       |  | 24.3541-1812.5 | 240430 | <input type="checkbox"/> | D=54, - Halter |            |
|                | 1.4 16V        | 103   | 04.08 |       |  | 24.3541-1809.7 | 220613 | <input type="checkbox"/> | D=54, - Halter |            |
|                | 1.4 T-Jet      | 88    | 09.07 |       |  |                |        |                          |                |            |
|                | 1.6 D Multijet |       | 03.08 |       |  |                |        |                          |                |            |
|                | 1.9 D Multijet |       | 04.07 |       |  |                |        |                          |                |            |
|                | 1.9 D Multijet | 66    | 04.07 | 12.08 |  |                |        |                          |                | <b>BOS</b> |
|                | 1.4 16V        | 103   | 04.08 |       |  | 24.5112-0413.3 | 331151 | 2                        | L=412          |            |
|                | 1.4 i 16V      | 66    | 04.07 |       |  |                |        |                          |                |            |
|                | 1.4 LPG        | 66    | 11.09 |       |  |                |        |                          |                |            |
|                | 1.4 T-Jet      | 88    | 09.07 |       |  |                |        |                          |                |            |
|                | 1.4 T-Jet      | 110   | 09.07 |       |  |                |        |                          |                |            |
|                | 1.6 D Multijet |       | 03.08 |       |  |                |        |                          |                |            |
|                | 1.9 D Multijet |       | 04.07 |       |  |                |        |                          |                |            |
|                | 1.9 D Multijet | 66    | 04.07 | 12.08 |  |                |        |                          |                |            |
|                | 1.9 D Multijet | 110   | 04.07 |       |  |                |        |                          |                |            |
|                | 2.0 D Multijet |       | 09.08 |       |  |                |        |                          |                |            |
|                | 1.4 16V        | 103   | 04.08 |       |  | 24.5112-0187.3 | 331150 | 2                        | L=187          |            |
|                | 1.4 i 16V      | 66    | 04.07 |       |  |                |        |                          |                |            |
|                | 1.4 LPG        | 66    | 11.09 |       |  |                |        |                          |                |            |
|                | 1.4 T-Jet      | 88    | 09.07 |       |  |                |        |                          |                |            |
|                | 1.4 T-Jet      | 110   | 09.07 |       |  |                |        |                          |                |            |
|                | 1.6 D Multijet |       | 03.08 |       |  |                |        |                          |                |            |
|                | 1.9 D Multijet |       | 04.07 |       |  |                |        |                          |                |            |
|                | 1.9 D Multijet | 66    | 04.07 | 12.08 |  |                |        |                          |                |            |
|                | 1.9 D Multijet | 110   | 04.07 |       |  |                |        |                          |                |            |
|                | 2.0 D Multijet |       | 09.08 |       |  |                |        |                          |                |            |
|                | 1.4 16V        | 103   | 04.08 |       |  | 24.3727-0553.2 | 580553 | <input type="checkbox"/> | L=1786         |            |
|                | 1.4 i 16V      | 66    | 04.07 |       |  | 24.3727-0554.2 | 580554 | <input type="checkbox"/> | L=1668         |            |
|                | 1.4 LPG        | 66    | 11.09 |       |  |                |        |                          |                |            |
|                | 1.4 T-Jet      | 88    | 09.07 |       |  |                |        |                          |                |            |
|                | 1.4 T-Jet      | 110   | 09.07 |       |  |                |        |                          |                |            |
|                | 1.6 D Multijet |       | 03.08 |       |  |                |        |                          |                |            |
|                | 1.9 D Multijet |       | 04.07 |       |  |                |        |                          |                |            |
|                | 1.9 D Multijet | 66    | 04.07 | 12.08 |  |                |        |                          |                |            |
|                | 1.9 D Multijet | 110   | 04.07 |       |  |                |        |                          |                |            |
| 2.0 D Multijet |                | 09.08 |       |       |  |                |        |                          |                |            |

<sup>1)</sup> + cast iron / + ghisa / + fonte grise / + fundición de gris

<sup>2)</sup> + aluminium / + aluminio / + aluminium / + aluminio





| FIAT CINQUECENTO (92-98)   |  |   |  |  |   |  |                                  |                  |  |                                     |                                  |                          |
|--|--|---|--|--|---|--|----------------------------------|------------------|--|-------------------------------------|----------------------------------|--------------------------|
|    | 1100 Sporting<br>700<br>900 i.e.   |   |  | 11.94<br>02.92<br>02.92  | 05.98<br>05.98<br>05.98   |  | 24.2119-0833.3                   | 010418           |  |                                     | THz 19,05                        |                          |
|    | 1100 Sporting<br>700<br>900 i.e.   |   |  | 11.94<br>02.92<br>02.92  | 05.98<br>05.98<br>05.98   |  | 24.3481-1743.5<br>24.3481-1744.5 | 240305<br>240306 | <input type="checkbox"/><br><input type="checkbox"/>   |                                     | D=48, - Halter<br>D=48, - Halter | <b>BDX</b><br><b>BDX</b> |
|    | 1100 Sporting<br>700<br>900 i.e.   |   |  | 11.94<br>02.92<br>02.92  | 05.98<br>05.98<br>05.98   |  | 24.5112-0445.3                   | 330564           | 2  |                                     | L=445                            |                          |
|    | 1100 Sporting<br>700<br>900 i.e.   |   |  | 11.94<br>02.92<br>02.92  | 05.98<br>05.98<br>05.98   |  | 24.5228-0275.3                   | 330035           | 2  |                                     | L=275                            |                          |
|    | 1100 Sporting<br>700<br>900 i.e.   |   |  | 11.94<br>02.92<br>02.92  | 05.98<br>05.98<br>05.98   |  | 24.3219-0803.3                   | 020183           |  |                                     | Rz 19,05                         |                          |
|    | 1100 Sporting<br>700<br>900 i.e.   |   |  | 11.94<br>02.92<br>02.92  | 09.97<br>09.97<br>09.97   |  | 24.3727-0523.2                   | 580523           | 1  | <input checked="" type="checkbox"/> | L=2988                           |                          |
|    | 1100 Sporting<br>700<br>900 i.e.   |   |  | 10.97<br>10.97<br>10.97  | 05.98<br>05.98<br>05.98   |  | 24.3727-0544.2                   | 580544           | 1  | <input checked="" type="checkbox"/> | L=2670                           |                          |
|    | 900 i.e.   | <input checked="" type="checkbox"/>   |  | 02.92  | 05.98   |  | 24.3728-0507.2                   | 590507           |  |                                     | L=570                            |                          |
|    | 1100 Sporting  | <input checked="" type="checkbox"/>   |  | 11.94  | 05.98   |  | 24.3728-0517.2                   | 590517           |  |                                     | L=776                            |                          |
| FIAT COUPE (94-00)   |  |   |  |  |   |  |                                  |                  |  |                                     |                                  |                          |
|    | 1.8 i 16V<br>2.0 i 16V<br>2.0 i 16V Turbo  |   |  | 07.96<br>12.93<br>12.93  | 12.00<br>06.96<br>06.96   |  | 24.2122-1716.3                   | 010485           |  |                                     | THz 22,20                        |                          |
|    | 1.8 i 16V<br>2.0 i 20V   |   |  | 07.96<br>01.97   | 12.00<br>12.00  |  | 24.3541-1791.5<br>24.3541-1792.5 | 240293<br>240294 | <input type="checkbox"/><br><input type="checkbox"/>   |                                     | D=54, - Halter<br>D=54, - Halter | <b>ATE</b><br><b>ATE</b> |
|    | 2.0 i 16V<br>2.0 i 16V Turbo   |   |  | 12.93<br>12.93   | 06.96<br>06.96  |  | 24.3344-1703.5<br>24.3344-1704.5 | 240117<br>240118 | <input type="checkbox"/> + GG-Sättel <sup>1)</sup><br><input type="checkbox"/> + GG-Sättel <sup>1)</sup> |                                     | D=34, - Halter<br>D=34, - Halter | <b>LUC</b><br><b>LUC</b> |
|   | 1.8 i 16V<br>2.0 i 16V<br>2.0 i 16V Turbo<br>2.0 i 20V<br>2.0 i 20V Turbo                            |   |  | 07.96<br>12.93<br>12.93<br>01.97<br>01.97                            | 12.00<br>06.96<br>06.96<br>12.00<br>12.00   |  | 83.6401-0159.3                   | 330746           | 2  |                                     | L=160                            |                          |
|  | 1.8 i 16V<br>2.0 i 16V<br>2.0 i 16V Turbo<br>2.0 i 20V<br>2.0 i 20V Turbo                            |   |  | 07.96<br>12.93<br>12.93<br>01.97<br>01.97                            | 12.00<br>06.96<br>06.96<br>12.00<br>12.00   |  | 24.3727-0521.2<br>24.3727-0568.2 | 580521<br>580568 | <input type="checkbox"/><br><input type="checkbox"/>   |                                     | L=1517<br>L=1473                 |                          |
|  | 1.8 i 16V<br>2.0 i 16V<br>2.0 i 16V Turbo<br>2.0 i 20V<br>2.0 i 20V Turbo                            |   |  | 07.96<br>12.93<br>12.93<br>01.97<br>01.97                            | 12.00<br>06.96<br>06.96<br>12.00<br>12.00   |  | 24.6584-1701.3                   | 320173           |  |                                     | BRL (4)                          |                          |
|  | 1.8 i 16V<br>2.0 i 16V<br>2.0 i 16V Turbo<br>2.0 i 20V<br>2.0 i 20V Turbo                            | <input checked="" type="checkbox"/><br><input checked="" type="checkbox"/><br><input checked="" type="checkbox"/><br><input checked="" type="checkbox"/><br><input checked="" type="checkbox"/> |  | 07.96<br>12.93<br>12.93<br>01.97<br>01.97                            | 12.00<br>06.96<br>06.96<br>12.00<br>12.00   |  | 24.2419-1721.3                   | 030100           |  |                                     | Gz 19,05                         |                          |
| FIAT CROMA (91-96)   |  |   |  |  |   |  |                                  |                  |  |                                     |                                  |                          |
|  | 1.6<br>1.9 TD<br>2.0<br>2.0 i.e.<br>2.0 i.e. 16V<br>2.0 i.e. Turbo<br>2.5 D<br>2.5 i.e. V6<br>2.5 TD |   |  | 11.90<br>11.90<br>11.90<br>11.90<br>12.92<br>11.90<br>04.93<br>11.90 | 12.92<br>10.96<br>12.92<br>10.96<br>10.96<br>10.96<br>10.96<br>10.96  |  | 24.2122-0802.3                   | 010374           |  |                                     | THz 22,20                        |                          |
|  | 1.6<br>1.9 TD<br>2.0<br>2.0 i.e.<br>2.0 i.e. 16V<br>2.0 i.e. Turbo<br>2.5 D<br>2.5 i.e. V6<br>2.5 TD |   |  | 11.90<br>11.90<br>11.90<br>11.90<br>12.92<br>11.90<br>04.93<br>11.90 | 12.92 + ABS<br>10.96 + ABS<br>12.92 + ABS<br>10.96 + ABS/ + gepanzerte Fzg. <sup>2)</sup><br>10.96 + ABS/ + gepanzerte Fzg. <sup>2)</sup><br>10.96 + ABS/ + gepanzerte Fzg. <sup>2)</sup><br>10.96 + ABS<br>10.96 + ABS |  | 24.3384-1608.5                   | 240168           | <input type="checkbox"/>   |                                     | D=38, - Halter                   | <b>LUC</b>               |
|  | 1.6<br>1.9 TD<br>2.0<br>2.0 i.e.<br>2.0 i.e. Turbo<br>2.5 D<br>2.5 TD                                |   |  | 11.90<br>11.90<br>11.90<br>11.90<br>11.90<br>11.90                   | 12.92<br>10.96<br>12.92<br>10.96<br>10.96<br>10.96  |  | 24.3727-0514.2                   | 580514           | 1  | <input checked="" type="checkbox"/> | L=2950                           |                          |
|  | 2.0 i.e.<br>2.0 i.e. 16V   |   | 2025078<br>2025078<br>2025078<br>2025078 | 11.90<br>11.90<br>11.90<br>11.90                                     | 12.92<br>10.96<br>10.96<br>10.96  |  | 24.3727-0545.2                   | 580545           | 1  | <input checked="" type="checkbox"/> | L=2945                           |                          |
|  | 2.0 i.e.<br>2.0 i.e. 16V   |   | 2025079                                  | 12.92<br>10.96   | 10.96<br>10.96  |  |                                  |                  |  |                                     |                                  |                          |

<sup>1)</sup> + cast iron caliper / + pinza in ghisa / + étriers en fonte grise / + fundición gris-pinza  
<sup>2)</sup> + ABS/ + armoured vehicles / + ABS/ + veicoli blindati / + ABS/ + véhicule blindé / + ABS/ + vehículo blindado

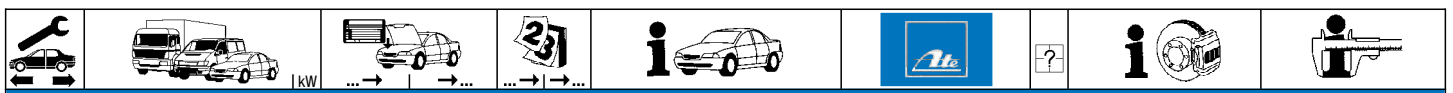

**FIAT CROMA (91-96)**

|  |                |         |       |       |       |                |        |   |  |          |
|--|----------------|---------|-------|-------|-------|----------------|--------|---|--|----------|
|  | 2.0 i.e. Turbo | 2025079 |       | 10.96 |       | 24.3727-0545.2 | 580545 | 1 |  | L=2945   |
|  | 2.5 D          | 2025079 |       | 10.96 |       |                |        |   |  |          |
|  | 2.5 i.e. V6    |         | 04.93 | 10.96 |       |                |        |   |  |          |
|  | 2.5 TD         | 2025079 |       | 10.96 |       |                |        |   |  |          |
|  | 1.6            |         |       | 11.90 | 12.92 | 03.2525-2201.3 | 040026 |   |  | Nz 25,40 |
|  | 1.9 TD         |         |       | 11.90 | 10.96 |                |        |   |  |          |
|  | 2.0            |         |       | 11.90 | 12.92 |                |        |   |  |          |
|  | 2.0 i.e.       |         |       | 11.90 | 10.96 |                |        |   |  |          |
|  | 2.0 i.e. 16V   |         |       | 12.92 | 10.96 |                |        |   |  |          |
|  | 2.0 i.e. Turbo |         |       | 11.90 | 10.96 |                |        |   |  |          |
|  | 2.5 D          |         |       | 11.90 | 10.96 |                |        |   |  |          |
|  | 2.5 i.e. V6    |         |       | 04.93 | 10.96 |                |        |   |  |          |
|  | 2.5 TD         |         |       | 11.90 | 10.96 |                |        |   |  |          |

**FIAT CROMA (05-10)**













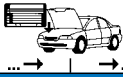

|  |                |         |  |       |       |                |        |   |                                   |                |     |
|--|----------------|---------|--|-------|-------|----------------|--------|---|-----------------------------------|----------------|-----|
|  | 1.8 i 16V      | 103     |  | 01.06 | 11.10 | 24.2125-1733.3 | 010830 |   | - Dynamic Control 1)              | THz 25,40      | LUC |
|  | 1.9 D Multijet | 85      |  | 06.05 | 11.10 | 24.2125-1732.3 | 010827 |   | + Dynamic Control 2)              | THz 25,40      | LUC |
|  | 1.9 JTD        | 88      |  | 06.05 | 11.10 |                |        |   |                                   |                |     |
|  | 1.9 JTD 16V    |         |  | 06.05 | 11.10 |                |        |   |                                   |                |     |
|  | 2.2 i 16V      | 108     |  | 06.05 | 11.10 |                |        |   |                                   |                |     |
|  | 2.4 JTD        | 147     |  | 06.05 | 11.10 |                |        |   |                                   |                |     |
|  | 1.8 i 16V      | 103     |  | 01.06 | 02.06 | 11.8116-0295.2 | 390524 | 2 |                                   | Haltefeder     | ATE |
|  | 1.9 D Multijet | 85      |  | 06.05 | 02.06 |                |        |   |                                   |                |     |
|  | 1.9 JTD        | 88      |  | 06.05 | 02.06 |                |        |   |                                   |                |     |
|  | 2.2 i 16V      | 108     |  | 06.05 | 02.06 |                |        |   |                                   |                |     |
|  | 1.8 i 16V      | 103     |  | 03.06 | 11.10 | 11.9571-9781.2 | 220659 |   | GG / nur paarweise austauschen 3) | D=57, - Halter | ATE |
|  | 1.9 D Multijet | 85      |  | 03.06 | 11.10 | 11.9571-9782.2 | 220660 |   | GG / nur paarweise austauschen 3) | D=57, - Halter | ATE |
|  | 1.9 JTD        | 88      |  | 03.06 | 11.10 | 11.8116-0356.1 | 390586 | 2 |                                   | Haltefeder     | ATE |
|  | 1.9 JTD 16V    | 2060169 |  |       | 11.10 |                |        |   |                                   |                |     |
|  | 2.2 i 16V      | 108     |  | 03.06 | 11.10 |                |        |   |                                   |                |     |
|  | 1.8 i 16V      | 103     |  | 01.06 | 11.10 | 24.5241-0401.3 | 331021 | 2 |                                   | L=401          |     |
|  | 1.9 D Multijet | 85      |  | 06.05 | 11.10 |                |        |   |                                   |                |     |
|  | 1.9 JTD        | 88      |  | 06.05 | 11.10 |                |        |   |                                   |                |     |
|  | 2.2 i 16V      | 108     |  | 06.05 | 11.10 |                |        |   |                                   |                |     |
|  | 1.9 JTD 16V    |         |  | 06.05 | 11.10 | 24.5153-0380.3 | 331044 | 2 |                                   | L=380          |     |
|  | 2.4 JTD        | 147     |  | 06.05 | 11.10 |                |        |   |                                   |                |     |
|  | 1.8 i 16V      | 103     |  | 01.06 | 11.10 | 24.3417-1709.7 | 220785 |   |                                   | D=41, - Halter | LUC |
|  | 1.9 D Multijet | 85      |  | 06.05 | 11.10 | 24.3417-1710.7 | 220786 |   |                                   | D=41, - Halter | LUC |
|  | 1.9 JTD        | 88      |  | 06.05 | 11.10 |                |        |   |                                   |                |     |
|  | 2.2 i 16V      | 108     |  | 06.05 | 11.10 |                |        |   |                                   |                |     |
|  | 1.9 JTD 16V    |         |  | 06.05 | 11.10 | 24.3417-1707.7 | 220783 |   |                                   | D=41, - Halter | LUC |
|  | 2.4 JTD        | 147     |  | 06.05 | 11.10 | 24.3417-1708.7 | 220784 |   |                                   | D=41, - Halter | LUC |
|  | 1.8 i 16V      | 103     |  | 01.06 | 11.10 | 24.5112-0295.3 | 330907 | 2 |                                   | L=295          |     |
|  | 1.9 D Multijet | 85      |  | 06.05 | 11.10 |                |        |   |                                   |                |     |
|  | 1.9 JTD        | 88      |  | 06.05 | 11.10 |                |        |   |                                   |                |     |
|  | 1.9 JTD 16V    |         |  | 06.05 | 11.10 |                |        |   |                                   |                |     |
|  | 2.2 i 16V      | 108     |  | 06.05 | 11.10 |                |        |   |                                   |                |     |

**FIAT DOBLO (01-10)**

|                   |                   |    |       |       |                                  |                                  |                |        |       |                      |                |     |
|-------------------|-------------------|----|-------|-------|----------------------------------|----------------------------------|----------------|--------|-------|----------------------|----------------|-----|
|                   | 1.2 i.e.          | 48 |       | 01.01 | 09.05                            | 24.2122-1750.3                   | 010740         |        | - ABS | THz 22,20            | ATE            |     |
|                   | 1.3 JTD           | 51 |       | 05.04 | 09.05                            | 20.5522-1128.3                   | 010747         |        | + ABS | THz 22,20            |                |     |
|                   | 1.6 i 16V         | 76 |       | 10.01 | 09.05                            |                                  |                |        |       |                      |                |     |
|                   | 1.9 D             | 46 |       | 01.01 | 09.05                            |                                  |                |        |       |                      |                |     |
|                   | 1.9 JTD           | 74 |       | 10.01 | 09.05                            |                                  |                |        |       |                      |                |     |
|                   | 1.9 JTD           | 77 |       | 07.03 | 09.05                            |                                  |                |        |       |                      |                |     |
|                   | 1.4 i             | 57 |       | 10.05 | 01.10                            | 24.4122-1707.3                   | 010864         |        | + ABS | THz 22,20 + Behälter | BOS            |     |
|                   | 1.6 16V           | 77 |       | 12.09 | 01.10                            |                                  |                |        |       |                      |                |     |
|                   | 1.6 i 16V         | 76 |       | 10.05 | 01.10                            |                                  |                |        |       |                      |                |     |
|                   | 1.6 Natural Power | 76 |       | 09.02 | 01.10                            |                                  |                |        |       |                      |                |     |
|                   | 1.3 16V           | 66 |       | 12.09 | 01.10                            | 24.4123-1710.3                   | 010866         |        | + ABS | THz 23,81 + Behälter | BOS            |     |
|                   | 1.3 D Multijet    | 55 |       | 10.05 | 01.10                            |                                  |                |        |       |                      |                |     |
|                   | 1.3 D Multijet    | 62 |       | 10.05 | 01.10                            |                                  |                |        |       |                      |                |     |
|                   | 1.3 JTD           | 55 |       | 10.05 | 01.10                            |                                  |                |        |       |                      |                |     |
|                   | 1.3 JTD           | 62 |       | 10.05 | 01.10                            |                                  |                |        |       |                      |                |     |
|                   | 1.6 Natural Power | 76 |       | 09.02 | 01.10                            |                                  |                |        |       |                      |                |     |
|                   | 1.9 D Multijet    | 88 |       | 10.05 | 01.10                            |                                  |                |        |       |                      |                |     |
|                   | 1.9 JTD           | 74 |       | 10.05 | 01.10                            |                                  |                |        |       |                      |                |     |
|                   | 1.9 JTD           | 77 |       | 10.05 | 01.10                            |                                  |                |        |       |                      |                |     |
|                   | 1.9 JTD           | 88 |       | 10.05 | 01.10                            |                                  |                |        |       |                      |                |     |
|                   | 2.0 16V           | 99 |       | 12.09 | 01.10                            |                                  |                |        |       |                      |                |     |
|                   | 1.3 16V           | 66 |       | 12.09 | 01.10                            | + Bremsscheibendurchm. 258 mm 4) | 24.3541-1769.7 | 220707 |       |                      | D=54, - Halter | BOS |
|                   | 1.3 D Multijet    | 55 |       | 10.05 | 01.10                            | + Bremsscheibendurchm. 258 mm 4) | 24.3541-1770.7 | 220708 |       |                      | D=54, - Halter | BOS |
|                   | 1.3 D Multijet    | 62 |       | 10.05 | 01.10                            | + Bremsscheibendurchm. 258 mm 4) |                |        |       |                      |                |     |
|                   | 1.3 JTD           | 55 |       | 10.05 | 01.10                            | + Bremsscheibendurchm. 258 mm 4) |                |        |       |                      |                |     |
|                   | 1.3 JTD           | 62 |       | 10.05 | 01.10                            | + Bremsscheibendurchm. 258 mm 4) |                |        |       |                      |                |     |
| 1.4 i             | 57                |    | 10.05 | 01.10 | + Bremsscheibendurchm. 258 mm 4) |                                  |                |        |       |                      |                |     |
| 1.6 16V           | 77                |    | 12.09 | 01.10 | + Bremsscheibendurchm. 258 mm 4) |                                  |                |        |       |                      |                |     |
| 1.6 i 16V         | 76                |    | 10.05 | 01.10 | + Bremsscheibendurchm. 258 mm 4) |                                  |                |        |       |                      |                |     |
| 1.6 Natural Power | 76                |    | 10.05 | 01.10 | + Bremsscheibendurchm. 258 mm 4) |                                  |                |        |       |                      |                |     |
| 1.9 D Multijet    | 88                |    | 10.05 | 01.10 | + Bremsscheibendurchm. 258 mm 4) |                                  |                |        |       |                      |                |     |
| 1.9 JTD           | 74                |    | 10.05 | 01.10 | + Bremsscheibendurchm. 258 mm 4) |                                  |                |        |       |                      |                |     |
| 1.9 JTD           | 77                |    | 10.05 | 01.10 | + Bremsscheibendurchm. 258 mm 4) |                                  |                |        |       |                      |                |     |
| 1.9 JTD           | 88                |    | 10.05 | 01.10 | + Bremsscheibendurchm. 258 mm 4) |                                  |                |        |       |                      |                |     |
| 2.0 16V           | 99                |    | 12.09 | 01.10 | + Bremsscheibendurchm. 258 mm 4) |                                  |                |        |       |                      |                |     |

1) - dynamic control / - dynamic control / - dynamic control / - Control dinámico  
 2) + dynamic control / + dynamic control / + dynamic control / + Control dinámico  
 3) GG/ replace only in pairs / GG/ sostituire solo a coppie / GG/ ne remplacer que par paires / GG/ reemplazar sólo por pares  
 4) + brake disc diameter 258mm / + diametro discos freno 258mm / + diamètre disques frein 258mm / + diámetro disco freno 258mm



|     |  |  |  |  |  |  |  |  |               |                |                |                                     |        |                |        |                          |        |
|--|--|--|--|--|---|--|--|--|---------------|----------------|----------------|-------------------------------------|--------|----------------|--------|--------------------------|--------|
| <b>FIAT DOBLO (01-10)</b>  |  |  |  |  |   |  |  |  |               |                |                |                                     |        |                |        |                          |        |
|    | 1.2 i.e.   | 48   |  | 01.01  | 09.05   | 24.5112-0475.3   | 330698   | 2  | L=475         |                |                |                                     |        |                |        |                          |        |
|  | 1.3 JTD  | 51   |  | 05.04  | 09.05   |  |  |  |               |                |                |                                     |        |                |        |                          |        |
|  | 1.6 i 16V  | 76   |  | 10.01  | 09.05   |  |  |  |               |                |                |                                     |        |                |        |                          |        |
|  | 1.9 D  | 46   |  | 01.01  | 09.05   |  |  |  |               |                |                |                                     |        |                |        |                          |        |
|  | 1.9 JTD  | 74   |  | 10.01  | 09.05   |  |  |  |               |                |                |                                     |        |                |        |                          |        |
|  | 1.9 JTD  | 77   |  | 07.03  | 09.05   |  |  |  |               |                |                |                                     |        |                |        |                          |        |
|  | 1.3 16V  | 66   |  | 12.09  | 01.10   | 24.5112-0490.3   | 330876   | 2  | L=490         |                |                |                                     |        |                |        |                          |        |
|  | 1.3 D Multijet   | 55   |  | 10.05  | 01.10   |  |  |  |               |                |                |                                     |        |                |        |                          |        |
|  | 1.3 D Multijet   | 62   |  | 10.05  | 01.10   |  |  |  |               |                |                |                                     |        |                |        |                          |        |
|  | 1.3 JTD  | 55   |  | 10.05  | 01.10   |  |  |  |               |                |                |                                     |        |                |        |                          |        |
|  | 1.3 JTD  | 62   |  | 10.05  | 01.10   |  |  |  |               |                |                |                                     |        |                |        |                          |        |
|  | 1.4 i  | 57   |  | 10.05  | 01.10   |  |  |  |               |                |                |                                     |        |                |        |                          |        |
|  | 1.6 16V  | 77   |  | 12.09  | 01.10   |  |  |  |               |                |                |                                     |        |                |        |                          |        |
|  | 1.6 i 16V  | 76   |  | 10.05  | 01.10   |  |  |  |               |                |                |                                     |        |                |        |                          |        |
|  | 1.9 JTD  | 74   |  | 10.05  | 01.10   |  |  |  |               |                |                |                                     |        |                |        |                          |        |
|  | 1.9 JTD  | 77   |  | 10.05  | 01.10   |  |  |  |               |                |                |                                     |        |                |        |                          |        |
|  | 1.9 JTD  | 88   |  | 10.05  | 01.10   |  |  |  |               |                |                |                                     |        |                |        |                          |        |
|  | 1.9 JTD  | 88   |  | 10.05  | 01.10   |  |  |  |               |                |                |                                     |        |                |        |                          |        |
|  | 2.0 16V  | 99   |  | 12.09  | 01.10   |  |  |  |               |                |                |                                     |        |                |        |                          |        |
|    | 1.2 i.e.   | 48   |  | 01.01  | 09.05   | 24.5254-0435.3   | 330763   | 2  | L=435         |                |                |                                     |        |                |        |                          |        |
|  | 1.3 16V  | 66   |  | 12.09  | 01.10   |  |  |  |               |                |                |                                     |        |                |        |                          |        |
|  | 1.3 D Multijet   | 55   |  | 10.05  | 01.10   |  |  |  |               |                |                |                                     |        |                |        |                          |        |
|  | 1.3 D Multijet   | 62   |  | 10.05  | 01.10   |  |  |  |               |                |                |                                     |        |                |        |                          |        |
|  | 1.3 JTD  | 51   |  | 05.04  | 09.05   |  |  |  |               |                |                |                                     |        |                |        |                          |        |
|  | 1.3 JTD  | 55   |  | 10.05  | 01.10   |  |  |  |               |                |                |                                     |        |                |        |                          |        |
|  | 1.3 JTD  | 62   |  | 10.05  | 01.10   |  |  |  |               |                |                |                                     |        |                |        |                          |        |
|  | 1.4 i  | 57   |  | 10.05  | 01.10   |  |  |  |               |                |                |                                     |        |                |        |                          |        |
|  | 1.6 16V  | 77   |  | 12.09  | 01.10   |  |  |  |               |                |                |                                     |        |                |        |                          |        |
|  | 1.6 i 16V  | 76   |  | 10.01  | 01.10   |  |  |  |               |                |                |                                     |        |                |        |                          |        |
|  | 1.9 D  | 46   |  | 01.01  | 01.10   |  |  |  |               |                |                |                                     |        |                |        |                          |        |
|  | 1.9 D Multijet   | 88   |  | 10.05  | 01.10   |  |  |  |               |                |                |                                     |        |                |        |                          |        |
|  | 1.9 JTD  | 74   |  | 10.01  | 01.10   |  |  |  |               |                |                |                                     |        |                |        |                          |        |
|  | 1.9 JTD  | 77   |  | 07.03  | 01.10   |  |  |  |               |                |                |                                     |        |                |        |                          |        |
|  | 1.9 JTD  | 88   |  | 10.05  | 01.10   |  |  |  |               |                |                |                                     |        |                |        |                          |        |
|  | 2.0 16V  | 99   |  | 12.09  | 01.10   |  |  |  |               |                |                |                                     |        |                |        |                          |        |
|  |  | 1.2 i.e.   | 48   |  | 01.01   |  |  |  |               | 09.05          | 24.3220-1722.3 | 020458                              |        | Rz 20,64       |        |                          |        |
|  |  | 1.3 JTD  | 51   |  | 05.04   |  |  |  |               | 09.05          |                |                                     |        |                |        |                          |        |
|  |  | 1.6 i 16V  | 76   |  | 10.01   |  |  |  |               | 09.05          |                |                                     |        |                |        |                          |        |
| 1.9 D  |  | 46   |  | 01.01  | 09.05   |  |  |  |               |                |                |                                     |        |                |        |                          |        |
| 1.9 JTD  |  | 74   |  | 10.01  | 09.05   |  |  |  |               |                |                |                                     |        |                |        |                          |        |
| 1.9 JTD  |  | 77   |  | 07.03  | 09.05   |  |  |  |               |                |                |                                     |        |                |        |                          |        |
| 1.3 16V  |  | 66   |  | 12.09  | 01.10   | 24.3220-1728.3   | 020509   |  | Rz 20,64      |                |                |                                     |        |                |        |                          |        |
| 1.3 D Multijet   |  | 55   |  | 10.05  | 01.10   |  |  |  |               |                |                |                                     |        |                |        |                          |        |
| 1.3 D Multijet   |  | 62   |  | 10.05  | 01.10   |  |  |  |               |                |                |                                     |        |                |        |                          |        |
| 1.3 JTD  |  | 55   |  | 10.05  | 01.10   |  |  |  |               |                |                |                                     |        |                |        |                          |        |
| 1.3 JTD  |  | 62   |  | 10.05  | 01.10   |  |  |  |               |                |                |                                     |        |                |        |                          |        |
| 1.4 i  |  | 57   |  | 10.05  | 01.10   |  |  |  |               |                |                |                                     |        |                |        |                          |        |
| 1.6 16V  |  | 77   |  | 12.09  | 01.10   |  |  |  |               |                |                |                                     |        |                |        |                          |        |
| 1.6 i 16V  |  | 76   |  | 10.05  | 01.10   |  |  |  |               |                |                |                                     |        |                |        |                          |        |
| 1.9 D Multijet   |  | 88   |  | 10.05  | 01.10   |  |  |  |               |                |                |                                     |        |                |        |                          |        |
| 1.9 JTD  |  | 74   |  | 10.05  | 01.10   |  |  |  |               |                |                |                                     |        |                |        |                          |        |
| 1.9 JTD  |  | 77   |  | 10.05  | 01.10   |  |  |  |               |                |                |                                     |        |                |        |                          |        |
| 1.9 JTD  |  | 88   |  | 10.05  | 01.10   |  |  |  |               |                |                |                                     |        |                |        |                          |        |
| 2.0 16V  |  | 99   |  | 12.09  | 01.10   |  |  |  |               |                |                |                                     |        |                |        |                          |        |
|  | 1.2 i.e.   | 48   |  | 01.01  | 01.10   | 24.3727-0560.2   | 580560   | <input type="checkbox"/>   | L=1741        |                |                |                                     |        |                |        |                          |        |
|  | 1.3 16V  | 66   |  | 12.09  | 01.10   |  |  |  |               | 24.3727-0558.2 | 580558         | <input type="checkbox"/>            | L=1736 |                |        |                          |        |
|  | 1.3 JTD  | 51   |  | 05.04  | 01.10   |  |  |  |               | 24.3727-0571.2 | 580571         | <input type="checkbox"/>            | L=2140 |                |        |                          |        |
|  | 1.4 i  | 57   |  | 10.05  | 01.10   |  |  |  |               | 24.3727-0570.2 | 580570         | <input type="checkbox"/>            | L=2140 |                |        |                          |        |
|  | 1.6 16V  | 77   |  | 12.09  | 01.10   |  |  |  |               | 24.3727-0572.2 | 580572         | <input checked="" type="checkbox"/> | L=2137 |                |        |                          |        |
|  | 1.6 i 16V  | 76   |  | 10.01  | 01.10   |  |  |  |               |                |                | <input type="checkbox"/>            |        |                |        |                          |        |
|  | 1.9 D  | 46   |  | 01.01  | 01.10   |  |  |  |               |                |                | <input type="checkbox"/>            |        |                |        |                          |        |
|  | 1.9 JTD  | 74   |  | 10.01  | 01.10   |  |  |  |               |                |                | <input type="checkbox"/>            |        |                |        |                          |        |
|  | 1.9 JTD  | 77   |  | 07.03  | 01.10   |  |  |  |               |                |                | <input type="checkbox"/>            |        |                |        |                          |        |
|  | 2.0 16V  | 99   |  | 12.09  | 01.10   |  |  |  |               |                |                | <input type="checkbox"/>            |        |                |        |                          |        |
|  | 1.2 i.e.   | 48   |  | 01.01  | 01.10   |  |  |  |               | 24.3727-0561.2 | 580561         | <input type="checkbox"/>            | L=1788 |                |        |                          |        |
|  | 1.3 16V  | 66   |  | 12.09  | 01.10   |  |  |  |               |                |                |                                     |        | 24.3727-0559.2 | 580559 | <input type="checkbox"/> | L=1784 |
|  | 1.3 JTD  | 51   |  | 05.04  | 01.10   |  |  |  |               |                |                |                                     |        | 24.3727-0574.2 | 580574 | <input type="checkbox"/> | L=2120 |
|  | 1.4 i  | 57   |  | 12.09  | 01.10   |  |  |  |               |                |                |                                     |        | 24.3727-0573.2 | 580573 | <input type="checkbox"/> | L=2135 |
|  | 1.6 16V  | 77   |  | 12.09  | 01.10   |  |  |  |               |                |                |                                     |        |                |        | <input type="checkbox"/> |        |
|  | 1.6 i 16V  | 76   |  | 10.01  | 01.10   |  |  |  |               |                |                |                                     |        |                |        | <input type="checkbox"/> |        |
|  | 1.9 D  | 46   |  | 01.01  | 01.10   |  |  |  |               |                |                |                                     |        |                |        | <input type="checkbox"/> |        |
|  | 1.9 JTD  | 74   |  | 10.01  | 01.10   |  |  |  |               |                |                |                                     |        |                |        | <input type="checkbox"/> |        |
|  | 1.9 JTD  | 77   |  | 07.03  | 01.10   |  |  |  |               |                |                |                                     |        |                |        | <input type="checkbox"/> |        |
| 2.0 16V  | 99   |  | 12.09  | 01.10  |   |  | <input type="checkbox"/>   |  |               |                |                |                                     |        |                |        |                          |        |
|  | 1.2 i.e. Kastenv.  | 48   |  | 01.01  | 01.10   | 03.6582-0014.3   | 320198   |  | BRL 8/1,5 (4) | ATE            |                |                                     |        |                |        |                          |        |
|  | 1.3 16V Kastenv.   | 66   |  | 12.09  | 01.10   |  |  |  |               |                |                |                                     |        |                |        |                          |        |
|  | 1.3 JTD Kastenv.   | 51   |  | 05.04  | 01.10   |  |  |  |               |                |                |                                     |        |                |        |                          |        |
|  | 1.6 i 16V Kastenv.   | 76   |  | 10.01  | 01.10   |  |  |  |               |                |                |                                     |        |                |        |                          |        |
|  | 1.9 D Kastenv.   | 46   |  | 01.01  | 01.10   |  |  |  |               |                |                |                                     |        |                |        |                          |        |
|  | 1.9 JTD Kastenv.   | 74   |  | 10.01  | 01.10   |  |  |  |               |                |                |                                     |        |                |        |                          |        |
| 1.9 JTD Kastenv.   | 77   |  | 07.03  | 01.10  |   |  |  |  |               |                |                |                                     |        |                |        |                          |        |

1) - bus / - autobus / - autobus/car / - autobús  
2) + bus / + autobus / + autobus/car / + autobús  
3) - armoured vehicles / - veicoli blindati / - vehículo blindé / - vehículo blindado



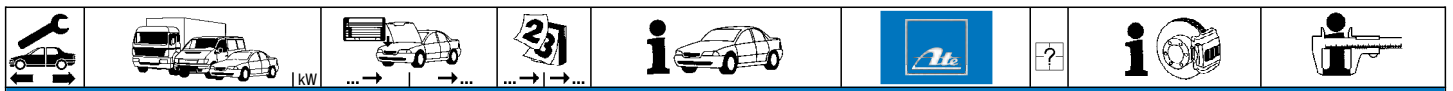

### FIAT DOBLO (10-)

























|                |                    |    |       |                            |                            |                |        |  |                                  |            |
|----------------|--------------------|----|-------|----------------------------|----------------------------|----------------|--------|--|----------------------------------|------------|
|                | 1.3 D Multijet     | 66 |       | 02.10                      |                            | 11.9571-9953.2 | 220871 |  | D=57, - Halter<br>D=57, - Halter | ATE<br>ATE |
|                | 1.4                | 70 |       | 02.10                      |                            | 11.9571-9954.2 | 220872 |  |                                  |            |
|                | 1.4                | 88 |       | 10.11                      |                            |                |        |  |                                  |            |
|                | 1.4 Natural Power  | 88 |       | 02.10                      |                            |                |        |  |                                  |            |
|                | 1.6 D 16V Multijet | 66 |       | 02.10                      |                            |                |        |  |                                  |            |
|                | 1.6 D 16V Multijet | 77 |       | 02.10                      |                            |                |        |  |                                  |            |
|                | 1.6 D Multijet     | 74 |       | 02.10                      |                            |                |        |  |                                  |            |
|                | 1.6 D Multijet     | 77 |       | 02.10                      |                            |                |        |  |                                  |            |
| 2.0 D Multijet | 99                 |    | 02.10 |                            |                            |                |        |  |                                  |            |
|                | 1.3 D Multijet     | 66 |       | 02.10                      | + 9" Bremse <sup>1)</sup>  | 24.3220-1728.3 | 020509 |  | Rz 20,64                         |            |
|                | 1.4                | 70 |       | 02.10                      | + 9" Bremse <sup>1)</sup>  |                |        |  |                                  |            |
|                | 1.4                | 88 |       | 10.11                      | + 9" Bremse <sup>1)</sup>  |                |        |  |                                  |            |
|                | 1.4 Natural Power  | 88 |       | 02.10                      | + 9" Bremse <sup>1)</sup>  |                |        |  |                                  |            |
|                | 1.6 D 16V Multijet | 66 |       | 02.10                      | + 9" Bremse <sup>1)</sup>  |                |        |  |                                  |            |
|                | 1.6 D 16V Multijet | 77 |       | 02.10                      | + 9" Bremse <sup>1)</sup>  |                |        |  |                                  |            |
|                | 1.6 D Multijet     | 74 |       | 02.10                      | + 9" Bremse <sup>1)</sup>  |                |        |  |                                  |            |
|                | 1.6 D Multijet     | 77 |       | 02.10                      | + 9" Bremse <sup>1)</sup>  |                |        |  |                                  |            |
| 2.0 D Multijet | 99                 |    | 02.10 | + 9" Bremse <sup>1)</sup>  |                            |                |        |  |                                  |            |
|                | 1.3 D Multijet     | 66 |       | 02.10                      | + 10" Bremse <sup>2)</sup> | 24.3225-1704.3 | 020541 |  | Rz 25,40                         |            |
|                | 1.4                | 70 |       | 02.10                      | + 10" Bremse <sup>2)</sup> |                |        |  |                                  |            |
|                | 1.4                | 88 |       | 10.11                      | + 10" Bremse <sup>2)</sup> |                |        |  |                                  |            |
|                | 1.4 Natural Power  | 88 |       | 02.10                      | + 10" Bremse <sup>2)</sup> |                |        |  |                                  |            |
|                | 1.6 D 16V Multijet | 66 |       | 02.10                      | + 10" Bremse <sup>2)</sup> |                |        |  |                                  |            |
|                | 1.6 D 16V Multijet | 77 |       | 02.10                      | + 10" Bremse <sup>2)</sup> |                |        |  |                                  |            |
|                | 1.6 D Multijet     | 74 |       | 02.10                      | + 10" Bremse <sup>2)</sup> |                |        |  |                                  |            |
|                | 1.6 D Multijet     | 77 |       | 02.10                      | + 10" Bremse <sup>2)</sup> |                |        |  |                                  |            |
| 2.0 D Multijet | 99                 |    | 02.10 | + 10" Bremse <sup>2)</sup> |                            |                |        |  |                                  |            |

### FIAT DUCATO (94-02)

|                  |                     |  |       |       |       |                |        |  |                |                        |     |
|------------------|---------------------|--|-------|-------|-------|----------------|--------|--|----------------|------------------------|-----|
|                  | 1.9 D (10)          |  |       | 02.94 | 10.94 | 24.2122-1715.3 | 010481 |  | - ABS<br>+ ABS | THz 22,20<br>THz 22,20 |     |
|                  | 1.9 TD (10)         |  |       | 02.94 | 10.94 | 24.2122-1714.3 | 010480 |  |                |                        |     |
|                  | 1.9 TD CAT (10)     |  |       | 02.94 | 10.94 |                |        |  |                |                        |     |
|                  | 2.0 i (10/14)       |  |       | 02.94 | 10.94 |                |        |  |                |                        |     |
|                  | 2.5 D (14)          |  |       | 02.94 | 10.94 |                |        |  |                |                        |     |
|                  | 2.5 TDI (14)        |  |       | 02.94 | 10.94 |                |        |  |                |                        |     |
| 2.5 TDI ECO (14) |                     |  | 02.94 | 10.94 |       |                |        |  |                |                        |     |
|                  | 1.9 D (10)          |  |       | 11.94 | 10.01 | 24.2125-1703.3 | 010483 |  | - ABS<br>+ ABS | THz 25,40<br>THz 25,40 |     |
|                  | 1.9 TD (10)         |  |       | 11.94 | 10.01 | 24.2125-1702.3 | 010482 |  |                |                        |     |
|                  | 1.9 TD CAT (10)     |  |       | 11.94 | 10.01 |                |        |  |                |                        |     |
|                  | 2.0 i (10/14)       |  |       | 11.94 | 10.01 |                |        |  |                |                        |     |
|                  | 2.0 i (18)          |  |       | 02.94 | 10.01 |                |        |  |                |                        |     |
|                  | 2.5 D (14)          |  |       | 11.94 | 10.01 |                |        |  |                |                        |     |
|                  | 2.5 D (18)          |  |       | 02.94 | 10.01 |                |        |  |                |                        |     |
|                  | 2.5 TDI (14)        |  |       | 11.94 | 10.01 |                |        |  |                |                        |     |
|                  | 2.5 TDI (18)        |  |       | 02.94 | 10.01 |                |        |  |                |                        |     |
|                  | 2.5 TDI ECO (14)    |  |       | 11.94 | 10.01 |                |        |  |                |                        |     |
|                  | 2.5 TDI ECO (18)    |  |       | 02.94 | 10.01 |                |        |  |                |                        |     |
|                  | 2.8 D (14)          |  |       | 02.98 | 10.01 |                |        |  |                |                        |     |
|                  | 2.8 D (18)          |  |       | 02.98 | 10.01 |                |        |  |                |                        |     |
|                  | 2.8 JTD (14)        |  |       | 11.00 | 10.01 |                |        |  |                |                        |     |
| 2.8 JTD (18)     |                     |  | 11.00 | 10.01 |       |                |        |  |                |                        |     |
| 2.8 TDI (14)     |                     |  | 10.97 | 10.01 |       |                |        |  |                |                        |     |
| 2.8 TDI (18)     |                     |  | 10.97 | 10.01 |       |                |        |  |                |                        |     |
|                  | 1.9 D (10)          |  |       | 11.01 | 03.02 | 24.2125-1725.3 | 010717 |  | - ABS<br>+ ABS | THz 25,40<br>THz 25,40 |     |
|                  | 1.9 TD (10)         |  |       | 11.01 | 03.02 | 24.2125-1726.3 | 010718 |  |                |                        |     |
|                  | 1.9 TD CAT (10)     |  |       | 11.01 | 03.02 |                |        |  |                |                        |     |
|                  | 2.0 i (10/14)       |  |       | 11.01 | 03.02 |                |        |  |                |                        |     |
|                  | 2.0 i (18)          |  |       | 11.01 | 03.02 |                |        |  |                |                        |     |
|                  | 2.0 JTD (14)        |  |       | 10.01 | 03.02 |                |        |  |                |                        |     |
|                  | 2.0 JTD (18)        |  |       | 10.01 | 03.02 |                |        |  |                |                        |     |
|                  | 2.5 D (14)          |  |       | 11.01 | 03.02 |                |        |  |                |                        |     |
|                  | 2.5 D (18)          |  |       | 11.01 | 03.02 |                |        |  |                |                        |     |
|                  | 2.5 TDI (14)        |  |       | 11.01 | 03.02 |                |        |  |                |                        |     |
|                  | 2.5 TDI (18)        |  |       | 11.01 | 03.02 |                |        |  |                |                        |     |
|                  | 2.5 TDI ECO (14)    |  |       | 11.01 | 03.02 |                |        |  |                |                        |     |
|                  | 2.5 TDI ECO (18)    |  |       | 11.01 | 03.02 |                |        |  |                |                        |     |
|                  | 2.8 D (14)          |  |       | 11.01 | 03.02 |                |        |  |                |                        |     |
| 2.8 D (18)       |                     |  | 11.01 | 03.02 |       |                |        |  |                |                        |     |
| 2.8 JTD (14)     |                     |  | 11.01 | 03.02 |       |                |        |  |                |                        |     |
| 2.8 JTD (18)     |                     |  | 11.01 | 03.02 |       |                |        |  |                |                        |     |
| 2.8 TDI (14)     |                     |  | 11.01 | 03.02 |       |                |        |  |                |                        |     |
| 2.8 TDI (18)     |                     |  | 11.01 | 03.02 |       |                |        |  |                |                        |     |
|                  | 1.9 D (10)          |  |       | 02.94 | 10.01 | 24.0101-4804.2 | 260050 |  |                | Einbausatz             | LUC |
|                  | 1.9 TD (10)         |  |       | 02.94 | 10.01 |                |        |  |                |                        |     |
|                  | 1.9 TD CAT (10)     |  |       | 02.94 | 10.01 |                |        |  |                |                        |     |
|                  | 2.0 i (10/14)       |  |       | 02.94 | 10.01 |                |        |  |                |                        |     |
|                  | 2.5 D (14)          |  |       | 02.94 | 10.01 |                |        |  |                |                        |     |
|                  | 2.8 D (14)          |  |       | 02.98 | 10.01 |                |        |  |                |                        |     |
|                  | 1.9 D (10)          |  |       | 02.94 | 01.00 | 24.5112-0466.3 | 330579 |  |                | L=462<br>L=465, + Clip |     |
|                  | 1.9 TD (10)         |  |       | 02.94 | 01.00 | 24.5112-0465.3 | 330526 |  |                |                        |     |
|                  | 1.9 TD CAT (10)     |  |       | 02.94 | 01.00 |                |        |  |                |                        |     |
|                  | 2.0 i (10/14/18)    |  |       | 02.94 | 01.00 |                |        |  |                |                        |     |
|                  | 2.5 D (14/18)       |  |       | 02.94 | 01.00 |                |        |  |                |                        |     |
|                  | 2.5 TDI (14/18)     |  |       | 02.94 | 01.00 |                |        |  |                |                        |     |
|                  | 2.5 TDI ECO (14/18) |  |       | 02.94 | 01.00 |                |        |  |                |                        |     |
|                  | 2.8 D (14/18)       |  |       | 02.98 | 01.00 |                |        |  |                |                        |     |
| 2.8 TDI (14/18)  |                     |  | 10.97 | 01.00 |       |                |        |  |                |                        |     |

<sup>1)</sup> + 9" brake / + servofreno da 9" / + frein de 9" / + freno de 9"

<sup>2)</sup> + 10" brake / + freno 10" / + frein de 10" / + freno de 10"

|     |  |  |  |  |  |  |  |       |                                  |
|--|--|--|--|--|---|--|--|---|----------------------------------|
| <b>FIAT DUCATO (94-02)</b>   |  |  |  |  |   |  |  |   |                                  |
|    | 1.9 D (10)   |  |  | 02.00  | 10.01   | 24.5112-0466.3   | 330579   | 2   | L=462<br>L=460, + Clip           |
|  | 1.9 TD (10)  |  |  | 02.00  | 10.01   | 24.5112-0461.3   | 330616   | 2   |                                  |
|  | 1.9 TD CAT (10)  |  |  | 02.00  | 10.01   |  |  |   |                                  |
|  | 2.0 i (10/14/18)   |  |  | 02.00  | 10.01   |  |  |   |                                  |
|  | 2.5 D (14/18)  |  |  | 02.00  | 10.01   |  |  |   |                                  |
|  | 2.5 TDI (14/18)  |  |  | 02.00  | 10.01   |  |  |   |                                  |
|  | 2.5 TDI ECO (14/18)  |  |  | 02.00  | 10.01   |  |  |   |                                  |
|  | 2.8 D (14/18)  |  |  | 02.00  | 10.01   |  |  |   |                                  |
|  | 2.8 JTD (14/18)  |  |  | 11.00  | 10.01   |  |  |   |                                  |
|  | 2.8 TDI (14/18)  |  |  | 02.00  | 10.01   |  |  |   |                                  |
|    | 1.9 D (10)   |  |  | 11.01  | 03.02   | 83.6401-0471.3   | 330750   | 2   | L=470<br>L=468                   |
|  | 1.9 TD (10)  |  |  | 11.01  | 03.02   | 83.6401-0469.3   | 330749   | 2   |                                  |
|  | 1.9 TD CAT (10)  |  |  | 11.01  | 03.02   |  |  |   |                                  |
|  | 2.0 i (10/14/18)   |  |  | 11.01  | 03.02   |  |  |   |                                  |
|  | 2.0 JTD (14/18)  |  |  | 10.01  | 03.02   |  |  |   |                                  |
|  | 2.5 D (14/18)  |  |  | 11.01  | 03.02   |  |  |   |                                  |
|  | 2.5 TDI (14/18)  |  |  | 11.01  | 03.02   |  |  |   |                                  |
|  | 2.5 TDI ECO (14/18)  |  |  | 11.01  | 03.02   |  |  |   |                                  |
|  | 2.8 D (14/18)  |  |  | 11.01  | 03.02   |  |  |   |                                  |
|  | 2.8 JTD (14/18)  |  |  | 11.01  | 03.02   |  |  |   |                                  |
|    | 1.9 D (10)   |  |  | 11.01  | 03.02   | 24.3461-1701.5   | 240449   |      | D=46, - Halter<br>D=46, - Halter |
|  | 1.9 TD (10)  |  |  | 11.01  | 03.02   | 24.3461-1702.5   | 240450   |      |                                  |
|  | 1.9 TD CAT (10)  |  |  | 11.01  | 03.02   |  |  |   |                                  |
|  | 2.0 i (10/14/18)   |  |  | 11.01  | 03.02   |  |  |   |                                  |
|  | 2.0 JTD (14/18)  |  |  | 10.01  | 03.02   |  |  |   |                                  |
|  | 2.5 D (14/18)  |  |  | 11.01  | 03.02   |  |  |   |                                  |
|  | 2.5 TDI (14/18)  |  |  | 11.01  | 03.02   |  |  |   |                                  |
|  | 2.5 TDI ECO (14/18)  |  |  | 11.01  | 03.02   |  |  |   |                                  |
|  | 2.8 D (14/18)  |  |  | 11.01  | 03.02   |  |  |   |                                  |
|  | 2.8 JTD (14/18)  |  |  | 11.01  | 03.02   |  |  |   |                                  |
|    | 1.9 D (10)   |  |  | 02.94  | 10.01   | 24.5112-0340.3   | 330511   | 1    | L=340                            |
|  | 1.9 TD (10)  |  |  | 02.94  | 10.01   |  |  |   |                                  |
|  | 1.9 TD CAT (10)  |  |  | 02.94  | 10.01   |  |  |   |                                  |
|  | 2.0 i (10/14/18)   |  |  | 02.94  | 10.01   |  |  |   |                                  |
|  | 2.5 D (14/18)  |  |  | 02.94  | 10.01   |  |  |   |                                  |
|  | 2.5 TDI (14/18)  |  |  | 02.94  | 10.01   |  |  |   |                                  |
|  | 2.5 TDI ECO (14/18)  |  |  | 02.94  | 10.01   |  |  |   |                                  |
|  | 2.8 D (14/18)  |  |  | 02.98  | 10.01   |  |  |   |                                  |
|  | 2.8 JTD (14/18)  |  |  | 11.00  | 10.01   |  |  |   |                                  |
|  | 2.8 TDI (14/18)  |  |  | 10.97  | 10.01   |  |  |   |                                  |
|  | 1.9 D (10)   |  |  | 11.01  | 03.02   | 83.6401-0159.3   | 330746   | 1  | L=160                            |
|  | 1.9 TD (10)  |  |  | 11.01  | 03.02   |  |  |   |                                  |
|  | 1.9 TD CAT (10)  |  |  | 11.01  | 03.02   |  |  |   |                                  |
|  | 2.0 i (10/14/18)   |  |  | 11.01  | 03.02   |  |  |   |                                  |
|  | 2.0 JTD (14/18)  |  |  | 10.01  | 03.02   |  |  |   |                                  |
|  | 2.5 D (14/18)  |  |  | 11.01  | 03.02   |  |  |   |                                  |
|  | 2.5 TDI (14/18)  |  |  | 11.01  | 03.02   |  |  |   |                                  |
|  | 2.5 TDI ECO (14/18)  |  |  | 11.01  | 03.02   |  |  |   |                                  |
|  | 2.8 D (14/18)  |  |  | 11.01  | 03.02   |  |  |   |                                  |
|  | 2.8 JTD (14/18)  |  |  | 11.01  | 03.02   |  |  |   |                                  |
|  | 1.9 D (10)   |  |  | 02.94  | 10.01   | 24.3225-1701.3   | 020399   |   | Rz 25,40                         |
|  | 1.9 TD (10)  |  |  | 02.94  | 10.01   |  |  |   |                                  |
|  | 1.9 TD CAT (10)  |  |  | 02.94  | 10.01   |  |  |   |                                  |
|  | 2.0 i (10/14)  |  |  | 02.94  | 10.01   |  |  |   |                                  |
|  | 2.5 D (14)   |  |  | 02.94  | 10.01   |  |  |   |                                  |
|  | 2.5 TDI (14)   |  |  | 02.94  | 10.01   | 24.3226-1702.3   | 020469   |   | Rz 26,99                         |
|  | 2.5 TDI ECO (14)   |  |  | 02.94  | 10.01   |  |  |   |                                  |
|  | 2.8 D (14)   |  |  | 02.98  | 10.01   |  |  |   |                                  |
|  | 2.8 JTD (14)   |  |  | 11.00  | 10.01   |  |  |   |                                  |
|  | 2.0 i (18)   |  |  | 02.94  | 10.01   | 24.3228-1701.3   | 020401   |   | Rz 28,57                         |
|  | 2.5 D (18)   |  |  | 02.94  | 10.01   |  |  |   |                                  |
|  | 2.5 TDI (18)   |  |  | 02.94  | 10.01   |  |  |   |                                  |
|  | 2.5 TDI ECO (18)   |  |  | 02.94  | 10.01   |  |  |   |                                  |
|  | 2.8 D (18)   |  |  | 02.98  | 10.01   |  |  |   |                                  |
|  | 2.8 JTD (18)   |  |  | 11.00  | 10.01   |  |  |   | Rz 26,99                         |
|  | 2.8 TDI (18)   |  |  | 10.97  | 10.01   |  |  |   |                                  |
|  | 1.9 D (10)   |  |  | 11.01  | 03.02   | 24.3226-1702.3   | 020469   |   |                                  |
|  | 1.9 TD (10)  |  |  | 11.01  | 03.02   |  |  |   |                                  |
|  | 1.9 TD CAT (10)  |  |  | 11.01  | 03.02   |  |  |   |                                  |
|  | 2.0 i (10/14)  |  |  | 11.01  | 03.02   |  |  |   |                                  |
|  | 2.0 JTD (14)   |  |  | 10.01  | 03.02   |  |  |   |                                  |
|  | 2.5 D (14)   |  |  | 11.01  | 03.02   |  |  |   |                                  |
|  | 2.5 TDI (14)   |  |  | 11.01  | 03.02   |  |  |   |                                  |
|  | 2.5 TDI ECO (14)   |  |  | 11.01  | 03.02   |  |  |   |                                  |
|  | 2.8 D (14)   |  |  | 11.01  | 03.02   |  |  |   | L=1078<br>L=3045                 |
|  | 2.8 JTD (14)   |  |  | 11.01  | 03.02   |  |  |   |                                  |
|  | 2.8 TDI (14)   |  |  | 11.01  | 03.02   |  |  |   |                                  |
|  | 1.9 D (10)   |  |  | 02.94  | 09.99   | 24.3727-0300.2   | 580300   | 1  |                                  |
|  | 1.9 TD (10)  |  |  | 02.94  | 09.99   | 24.3727-0345.2   | 580345   | 1  |                                  |
| 1.9 TD CAT (10)  |  |  | 02.94  | 09.99  |   |  |  | + HA-Trommelbremse <sup>1)</sup>  |                                  |
| 2.0 i (10/14/18)   |  |  | 02.94  | 09.99  |   |  |  |   |                                  |
| 2.5 D (14/18)  |  |  | 02.94  | 09.99  |   |  |  |   |                                  |

<sup>1)</sup> + RA drum brake / + P freno a tamburo / + frein à tambour essieu AR / + ET-tambores de freno

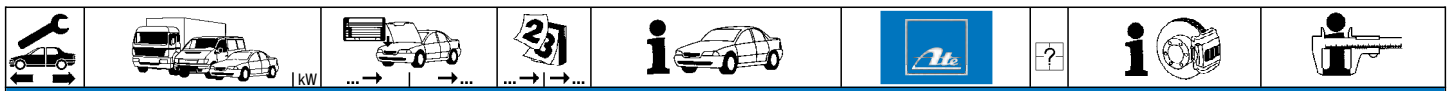

**FIAT DUCATO (94-02)**

|                     |                     |             |       |       |                |                |        |                                  |   |         |
|---------------------|---------------------|-------------|-------|-------|----------------|----------------|--------|----------------------------------|---|---------|
|                     | 2.5 TDI (14/18)     |             | 02.94 | 09.99 | 24.3727-0300.2 | 580300         | 1      | + HA-Trommelbremse <sup>1)</sup> | L=1078                                      |         |
|                     | 2.5 TDI ECO (14/18) |             | 02.94 | 09.99 | 24.3727-0345.2 | 580345         | 1      |                                  | L=3045                                      |         |
|                     | 2.8 D (14/18)       |             | 02.98 | 09.99 |                |                |        |                                  |   |         |
|                     | 2.8 TDI (14/18)     |             | 10.97 | 09.99 |                |                |        |                                  |   |         |
|                     | 1.9 D (10)          |             | 10.99 | 10.01 | 24.3727-0300.2 | 580300         | 1      | + HA-Trommelbremse <sup>1)</sup> | L=1078                                      |         |
|                     | 1.9 TD (10)         |             | 10.99 | 10.01 | 24.3727-0344.2 | 580344         | 1      |                                  | L=2806                                      |         |
|                     | 1.9 TD CAT (10)     |             | 10.99 | 10.01 |                |                |        |                                  |   |         |
|                     | 2.0 i (10/14/18)    |             | 10.99 | 10.01 |                |                |        |                                  |   |         |
|                     | 2.5 D (14/18)       |             | 10.99 | 10.01 |                |                |        |                                  |   |         |
|                     | 2.5 TDI (14/18)     |             | 10.99 | 10.01 |                |                |        |                                  |   |         |
|                     | 2.5 TDI ECO (14/18) |             | 10.99 | 10.01 |                |                |        |                                  |   |         |
|                     | 2.8 D (14/18)       |             | 10.99 | 10.01 |                |                |        |                                  |   |         |
| 2.8 JTD (14/18)     |                     | 11.00       | 10.01 |       |                |                |        |                                  |   |         |
| 2.8 TDI (14/18)     |                     | 10.99       | 10.01 |       |                |                |        |                                  |   |         |
|                     | 1.9 D (10)          |             | 11.01 | 03.02 | 24.3727-0300.2 | 580300         | 1      | + HA-Trommelbremse <sup>1)</sup> | L=1078                                      |         |
|                     | 1.9 TD (10)         |             | 11.01 | 03.02 | 24.3727-0343.2 | 580343         | 1      |                                  | L=2827                                      |         |
|                     | 1.9 TD CAT (10)     |             | 11.01 | 03.02 |                |                |        |                                  |   |         |
|                     | 2.0 i (10/14/18)    |             | 11.01 | 03.02 |                |                |        |                                  |   |         |
|                     | 2.0 JTD (14/18)     |             | 10.01 | 03.02 |                |                |        |                                  |   |         |
|                     | 2.5 D (14/18)       |             | 11.01 | 03.02 |                |                |        |                                  |   |         |
|                     | 2.5 TDI (14/18)     |             | 11.01 | 03.02 |                |                |        |                                  |   |         |
|                     | 2.5 TDI ECO (14/18) |             | 11.01 | 03.02 |                |                |        |                                  |   |         |
|                     | 2.8 D (14/18)       |             | 11.01 | 03.02 |                |                |        |                                  |   |         |
|                     | 2.8 JTD (14/18)     |             | 11.01 | 03.02 |                |                |        |                                  |   |         |
|                     | 2.8 TDI (14/18)     |             | 11.01 | 03.02 |                |                |        |                                  |   |         |
|                     |                     | 1.9 D (10)  |       | 02.94 | 03.02          | 24.3727-0300.2 | 580300 | 1                                | + HA-Scheibenbremse <sup>2)</sup>           | L=1078  |
| 1.9 TD (10)         |                     |             | 02.94 | 03.02 | 24.3727-0340.2 | 580340         | 1      | L=3025                           |   |         |
| 1.9 TD CAT (10)     |                     |             | 02.94 | 03.02 |                |                |        |                                  |   |         |
| 2.0 i (10/14/18)    |                     |             | 02.94 | 03.02 |                |                |        |                                  |   |         |
| 2.0 JTD (14/18)     |                     |             | 10.01 | 03.02 |                |                |        |                                  |   |         |
| 2.5 D (14/18)       |                     |             | 02.94 | 03.02 |                |                |        |                                  |   |         |
| 2.5 TDI (14/18)     |                     |             | 02.94 | 03.02 |                |                |        |                                  |   |         |
| 2.5 TDI ECO (14/18) |                     |             | 02.94 | 03.02 |                |                |        |                                  |   |         |
| 2.8 D (14/18)       |                     |             | 02.98 | 03.02 |                |                |        |                                  |   |         |
| 2.8 JTD (14/18)     |                     |             | 11.00 | 03.02 |                |                |        |                                  |   |         |
| 2.8 TDI (14/18)     |                     |             | 10.97 | 03.02 |                |                |        |                                  |   |         |
|                     |                     | 1.9 D (10)  |       | 02.94 | 10.01          | 24.6512-1701.3 | 320153 |                                  | - ABS                                       | BRL (2) |
|                     | 1.9 TD (10)         |             | 02.94 | 10.01 | 24.6512-1703.3 | 320159         |        | + ABS                            | BRL (4)                                     |         |
|                     | 1.9 TD CAT (10)     |             | 02.94 | 10.01 |                |                |        |                                  |   |         |
|                     | 2.0 i (10/14/18)    |             | 02.94 | 10.01 |                |                |        |                                  |   |         |
|                     | 2.5 D (14/18)       |             | 02.94 | 10.01 |                |                |        |                                  |   |         |
|                     | 2.5 TDI (14/18)     |             | 02.94 | 10.01 |                |                |        |                                  |   |         |
|                     | 2.5 TDI ECO (14/18) |             | 02.94 | 10.01 |                |                |        |                                  |   |         |
|                     | 2.8 D (14/18)       |             | 02.98 | 10.01 |                |                |        |                                  |   |         |
|                     | 2.8 JTD (14/18)     |             | 11.00 | 10.01 |                |                |        |                                  |   |         |
|                     | 2.8 TDI (14/18)     |             | 10.97 | 10.01 |                |                |        |                                  |   |         |
|                     |                     | 1.9 D (10)  |       | 11.01 | 03.02          | 24.6512-1712.3 | 320273 |                                  | - ABS/ + verstärktes Fahrwerk <sup>3)</sup> | BRL (2) |
|                     |                     | 1.9 TD (10) |       | 11.01 | 03.02          |                |        |                                  |   |         |
| 1.9 TD CAT (10)     |                     |             | 11.01 | 03.02 |                |                |        |                                  |   |         |
| 2.0 i (10/14)       |                     |             | 11.01 | 03.02 |                |                |        |                                  |   |         |
| 2.0 JTD (14)        |                     |             | 10.01 | 03.02 |                |                |        |                                  |   |         |
| 2.5 D (14)          |                     |             | 11.01 | 03.02 |                |                |        |                                  |   |         |
| 2.5 TDI (14)        |                     |             | 11.01 | 03.02 |                |                |        |                                  |   |         |
| 2.5 TDI ECO (14)    |                     |             | 11.01 | 03.02 |                |                |        |                                  |   |         |
| 2.8 D (14)          |                     |             | 11.01 | 03.02 |                |                |        |                                  |   |         |
| 2.8 JTD (14)        |                     |             | 11.01 | 03.02 |                |                |        |                                  |   |         |
| 2.8 TDI (14)        |                     |             | 11.01 | 03.02 |                |                |        |                                  |   |         |
|                     |                     | 1.9 D (10)  |       | 02.94 | 03.02          | 24.3728-0337.2 | 590337 |                                  |   | L=1058  |
|                     | 1.9 TD (10)         |             | 02.94 | 03.02 |                |                |        |                                  |   |         |
|                     | 1.9 TD CAT (10)     |             | 02.94 | 03.02 |                |                |        |                                  |   |         |
|                     | 2.0 i (10/14)       |             | 02.94 | 03.02 | 24.3728-0518.2 | 590518         |        |                                  | L=1034                                      |         |
|                     | 2.0 JTD (14)        |             | 10.01 | 03.02 | 24.3728-0534.2 | 590534         |        |                                  | L=1080                                      |         |
|                     | 2.5 D (14)          |             | 02.94 | 03.02 |                |                |        |                                  |   |         |
|                     | 2.5 TDI (14)        |             | 02.94 | 03.02 |                |                |        |                                  |   |         |
|                     | 2.5 TDI ECO (14)    |             | 02.94 | 03.02 |                |                |        |                                  |   |         |
|                     | 2.8 JTD (14)        |             | 11.00 | 03.02 |                |                |        |                                  |   |         |
|                     | 2.8 TDI (14)        |             | 10.97 | 03.02 |                |                |        |                                  |   |         |
|                     | 2.8 D (14)          |             | 02.98 | 03.02 | 24.3728-0518.2 | 590518         |        |                                  | L=1034                                      |         |
|                     |                     | 2.0 i (18)  |       | 02.94 | 03.02          | 24.3728-0519.2 | 590519 |                                  |   | L=1090  |
| 2.0 JTD (18)        |                     |             | 10.01 | 03.02 | 24.3728-0534.2 | 590534         |        |                                  | L=1080                                      |         |
| 2.5 D (18)          |                     |             | 02.94 | 03.02 |                |                |        |                                  |   |         |
| 2.5 TDI (18)        |                     |             | 02.94 | 03.02 |                |                |        |                                  |   |         |
| 2.5 TDI ECO (18)    |                     |             | 02.94 | 03.02 |                |                |        |                                  |   |         |
| 2.8 D (18)          |                     |             | 02.98 | 03.02 |                |                |        |                                  |   |         |
| 2.8 JTD (18)        |                     |             | 11.00 | 03.02 |                |                |        |                                  |   |         |
| 2.8 TDI (18)        |                     |             | 10.97 | 03.02 |                |                |        |                                  |   |         |























**FIAT DUCATO (02-06)**

|  |                       |    |       |       |                |        |  |       |           |
|--|-----------------------|----|-------|-------|----------------|--------|--|-------|-----------|
|  | 2.0 i (11/15/18)      | 81 | 04.02 | 07.06 | 24.2125-1725.3 | 010717 |  | - ABS | Thz 25,40 |
|  | 2.0 JTD (11/15/18)    | 62 | 04.02 | 07.06 | 24.2125-1726.3 | 010718 |  | + ABS | Thz 25,40 |
|  | 2.3 JTD (11/15/18)    | 81 | 04.02 | 07.06 |                |        |  |       |           |
|  | 2.8 JTD (11/15/18)    |    | 04.02 | 07.06 |                |        |  |       |           |
|  | 2.8 JTD 4x4(11/15/18) | 94 | 07.02 | 07.06 |                |        |  |       |           |

<sup>1)</sup> + RA drum brake / + P freno a tamburo / + frein à tambour essieu AR / + ET-tambores de freno  
<sup>2)</sup> + RA disc brake / + P disco freno / + frein à disque essieu AR / + ET-disco de freno  
<sup>3)</sup> - ABS/ + reinforced suspension / - ABS/ + sospensione rinforzata / - ABS/ + châssis renforcé / - ABS/ + suspensión reforzada





|     |  |  |  |  |  |  |  |  |                |
|--|--|--|--|--|---|--|--|--|----------------|
| <b>FIAT DUCATO (02-06)</b>   |  |  |  |  |   |  |  |  |                |
|    | 2.0 i (11/15/18)   | 81   |  | 04.02  | 07.06   |  |  |  |                |
|  | 2.0 JTD (11/15/18)   | 62   |  | 04.02  | 07.06   |  |  |  | L=470          |
|  | 2.3 JTD (11/15/18)   | 81   |  | 04.02  | 07.06   |  |  |  | L=468          |
|  | 2.8 JTD (11/15/18)   |  |  | 04.02  | 07.06   |  |  |  |                |
|  | 2.8 JTD 4x4(11/15/18)  | 94   |  | 07.02  | 07.06   |  |  |  |                |
|    | 2.0 i (11/15/18)   | 81   |  | 04.02  | 07.06   |  |  |  | D=46, - Halter |
|  | 2.0 JTD (11/15/18)   | 62   |  | 04.02  | 07.06   |  |  |  | D=46, - Halter |
|  | 2.3 JTD (11/15/18)   | 81   |  | 04.02  | 07.06   |  |  |  |                |
|  | 2.8 JTD (11/15/18)   |  |  | 04.02  | 07.06   |  |  |  |                |
|  | 2.8 JTD 4x4(11/15/18)  | 94   |  | 07.02  | 07.06   |  |  |  |                |
|    | 2.0 i (11/15/18)   | 81   |  | 04.02  | 07.06   |  |  |  | L=160          |
|  | 2.0 JTD (11/15/18)   | 62   |  | 04.02  | 07.06   |  |  |  |                |
|  | 2.3 JTD (11/15/18)   | 81   |  | 04.02  | 07.06   |  |  |  |                |
|  | 2.8 JTD (11/15/18)   |  |  | 04.02  | 07.06   |  |  |  |                |
|  | 2.8 JTD 4x4(11/15/18)  | 94   |  | 07.02  | 07.06   |  |  |  |                |
|    | 2.0 i (11/15)  | 81   |  | 04.02  | 07.06   |  |  |  | Rz 26,99       |
|  | 2.0 JTD (11/15)  | 62   |  | 04.02  | 07.06   |  |  |  |                |
|  | 2.3 JTD (11/15)  | 81   |  | 04.02  | 07.06   |  |  |  |                |
|  | 2.8 JTD (11/15)  |  |  | 04.02  | 07.06   |  |  |  |                |
|  | 2.8 JTD 4x4 (11/15)  | 94   |  | 07.02  | 07.06   |  |  |  |                |
|    | 2.0 i (11/15/18)   | 81   |  | 04.02  | 07.06   |  |  |  | L=1078         |
|  | 2.0 JTD (11/15/18)   | 62   |  | 04.02  | 07.06   |  |  |  | L=2827         |
|  | 2.3 JTD (11/15/18)   | 81   |  | 04.02  | 07.06   |  |  |  |                |
|  | 2.8 JTD (11/15/18)   |  |  | 04.02  | 07.06   |  |  |  |                |
|  | 2.8 JTD 4x4(11/15/18)  | 94   |  | 07.02  | 07.06   |  |  |  |                |
|    | 2.0 i (11/15)  | 81   |  | 04.02  | 07.06   |  |  |  | L=1059         |
|  | 2.0 JTD (11/15)  | 62   |  | 04.02  | 07.06   |  |  |  | L=2827         |
|  | 2.3 JTD (11/15)  | 81   |  | 04.02  | 07.06   |  |  |  |                |
|  | 2.8 JTD (11/15)  |  |  | 04.02  | 07.06   |  |  |  |                |
|  | 2.8 JTD 4x4 (11/15)  | 94   |  | 07.02  | 07.06   |  |  |  |                |
|    | 2.0 i (18)   | 81   |  | 04.02  | 07.06   |  |  |  | BRL (2)        |
|  | 2.0 JTD (18)   | 62   |  | 04.02  | 07.06   |  |  |  |                |
|  | 2.3 JTD (18)   | 81   |  | 04.02  | 07.06   |  |  |  |                |
|  | 2.8 JTD (18)   |  |  | 04.02  | 07.06   |  |  |  |                |
|  | 2.8 JTD 4x4 (18)   | 94   |  | 07.02  | 07.06   |  |  |  |                |
|   | 2.0 i (11/15/18)   | 81   |  | 04.02  | 07.06   |  |  |  | L=1478         |
|  | 2.0 JTD (11/15/18)   | 62   |  | 04.02  | 07.06   |  |  |  |                |
|  | 2.3 JTD (11/15/18)   | 81   |  | 04.02  | 07.06   |  |  |  |                |
|  | 2.8 JTD (11/15/18)   |  |  | 04.02  | 07.06   |  |  |  |                |
|  | 2.8 JTD 4x4(11/15/18)  | 94   |  | 07.02  | 07.06   |  |  |  |                |
| <b>FIAT DUCATO (06-)</b>   |  |  |  |  |   |  |  |  |                |
|  | 140 Natural Power  | 100  |  | 04.09  |   |  |  |  |                |
|  | 2.0 D 115 Multijet   | 85   |  | 06.11  |   |  |  |  |                |
|  | 2.2 D 100 Multijet   | 74   |  | 07.06  |   |  |  |  |                |
|  | 2.3 D 120 Multijet   | 88   |  | 07.06  |   |  |  |  |                |
|  | 2.3 D 130 Multijet   | 96   |  | 01.07  |   |  |  |  |                |
|  | 3.0 D 150 Multijet   | 107  |  | 04.10  |   |  |  |  |                |
|  | 3.0 D 150 Multijet   | 107  |  | 06.11  |   |  |  |  |                |
|  | 3.0 D 160 Multijet   | 116  |  | 07.06  |   |  |  |  |                |
|  | 3.0 D Multijet   | 130  |  | 06.11  |   |  |  |  |                |
|  | 140 Natural Power  | 100  |  | 04.09  |   |  |  |  |                |
| 2.0 D 115 Multijet   | 85   |  | 06.11  |  |   |  |  |  |                |
| 2.2 D 100 Multijet   | 74   |  | 07.06  |  |   |  |  |  |                |
| 2.3 D 120 Multijet   | 88   |  | 07.06  |  |   |  |  |  |                |
| 2.3 D 130 Multijet   | 96   |  | 01.07  |  |   |  |  |  |                |
| 2.3 D 150 Multijet   | 109  |  | 06.11  |  |   |  |  |  |                |
| 3.0 D 150 Multijet   | 107  |  | 04.10  |  |   |  |  |  |                |
| 3.0 D 160 Multijet   | 116  |  | 07.06  |  |   |  |  |  |                |
| 3.0 D Multijet   | 130  |  | 06.11  |  |   |  |  |  |                |
|  | 140 Natural Power  | 100  |  | 04.09  |   |  |  |  |                |
|  | 2.0 D 115 Multijet   | 85   |  | 06.11  |   |  |  |  |                |
|  | 2.2 D 100 Multijet   | 74   |  | 07.06  |   |  |  |  |                |
|  | 2.3 D 120 Multijet   | 88   |  | 07.06  |   |  |  |  |                |
|  | 2.3 D 130 Multijet   | 96   |  | 01.07  |   |  |  |  |                |
|  | 2.3 D 150 Multijet   | 109  |  | 06.11  |   |  |  |  |                |
|  | 3.0 D 150 Multijet   | 107  |  | 04.10  |   |  |  |  |                |
|  | 3.0 D 160 Multijet   | 116  |  | 07.06  |   |  |  |  |                |
|  | 3.0 D Multijet   | 130  |  | 06.11  |   |  |  |  |                |
|  | 140 Natural Power  | 100  |  | 04.09  |   |  |  |  |                |
| 2.0 D 115 Multijet   | 85   |  | 06.11  |  |   |  |  |  |                |
| 2.2 D 100 Multijet   | 74   |  | 07.06  |  |   |  |  |  |                |
| 2.3 D 120 Multijet   | 88   |  | 07.06  |  |   |  |  |  |                |
| 2.3 D 130 Multijet   | 96   |  | 01.07  |  |   |  |  |  |                |
| 2.3 D 150 Multijet   | 109  |  | 06.11  |  |   |  |  |  |                |
| 3.0 D 150 Multijet   | 107  |  | 04.10  |  |   |  |  |  |                |
| 3.0 D 160 Multijet   | 116  |  | 07.06  |  |   |  |  |  |                |
| 3.0 D Multijet   | 130  |  | 06.11  |  |   |  |  |  |                |
|  | 140 Natural Power  | 100  |  | 04.09  |   |  |  |  |                |
|  | 2.0 D 115 Multijet   | 85   |  | 06.11  |   |  |  |  |                |
|  | 2.2 D 100 Multijet   | 74   |  | 07.06  |   |  |  |  |                |
|  | 2.3 D 120 Multijet   | 88   |  | 07.06  |   |  |  |  |                |
|  | 2.3 D 130 Multijet   | 96   |  | 01.07  |   |  |  |  |                |
|  | 2.3 D 150 Multijet   | 109  |  | 06.11  |   |  |  |  |                |
|  | 3.0 D 150 Multijet   | 107  |  | 04.10  |   |  |  |  |                |
|  | 3.0 D 160 Multijet   | 116  |  | 07.06  |   |  |  |  |                |
|  | 3.0 D Multijet   | 130  |  | 06.11  |   |  |  |  |                |
|  | 140 Natural Power  | 100  |  | 04.09  |   |  |  |  |                |
| 2.0 D 115 Multijet   | 85   |  | 06.11  |  |   |  |  |  |                |
| 2.2 D 100 Multijet   | 74   |  | 07.06  |  |   |  |  |  |                |
| 2.3 D 120 Multijet   | 88   |  | 07.06  |  |   |  |  |  |                |
| 2.3 D 130 Multijet   | 96   |  | 01.07  |  |   |  |  |  |                |
| 2.3 D 150 Multijet   | 109  |  | 06.11  |  |   |  |  |  |                |
| 3.0 D 150 Multijet   | 107  |  | 04.10  |  |   |  |  |  |                |
| 3.0 D 160 Multijet   | 116  |  | 07.06  |  |   |  |  |  |                |
| 3.0 D Multijet   | 130  |  | 06.11  |  |   |  |  |  |                |
| <b>FIAT FIORINO (93-01)</b>  |  |  |  |  |   |  |  |  |                |
|  | 1.3  |  |  | 09.93  | 03.01   |  |  |  |                |
|  | 1.4  |  |  | 09.93  | 03.01   |  |  |  |                |
|  | 1.6  |  |  | 09.93  | 03.01   |  |  |  |                |
|  | 1.7 D  |  |  | 09.93  | 03.01   |  |  |  |                |
|  |  |  |  | 09.93  | 03.01   |  |  |  |                |
|  |  |  |  | 09.93  | 03.01   |  |  |  |                |
|  |  |  |  | 09.93  | 03.01   |  |  |  |                |
|  |  |  |  | 09.93  | 03.01   |  |  |  |                |

1) + RA drum brake / + P freno a tamburo / + frein à tambour essieu AR / + ET-tambores de freno  
2) - ABS/ + reinforced suspension / - ABS/ + sospensione rinforzata / - ABS/ + châssis renforcé / - ABS/ + suspensión reforzada  
3) - dynamic control / - dynamic control / - dynamic control / - Control dinámico  
4) + dynamic control / + dynamic control / + dynamic control / + Control dinámico  
5) + short wheel base / + passo lungo / + empattement court / + distancia corta entre ejes  
6) + long wheel base / + passo lungo / + empattement long / + distancia larga entre ejes

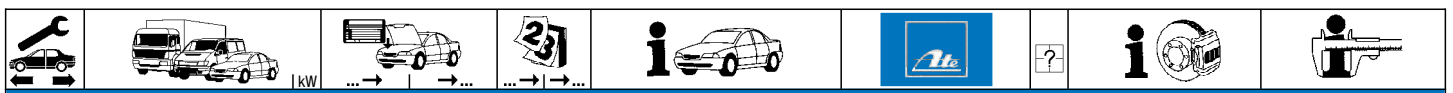

| FIAT FIORINO (93-01) |                                      |  |  |   |   |  |                |        |   |       |                |     |
|----------------------|--------------------------------------|--|--|---|---|--|----------------|--------|---|-------|----------------|-----|
|                      | 1.7 TD                               |  |  | 01.97                                     | 03.01                                     |  | 20.5522-1093.3 | 010731 |   | + ABS | THz 22,20      | ATE |
|                      | 1.3<br>1.4<br>1.6<br>1.7 D<br>1.7 TD |  |  | 09.93<br>09.93<br>09.93<br>09.93<br>01.97 | 03.01<br>03.01<br>03.01<br>03.01<br>03.01 |  | 20.5154-9450.2 | 220462 |   |       | D=54, - Halter | ATE |
|                      | 1.3<br>1.4<br>1.6<br>1.7 D<br>1.7 TD |  |  | 09.93<br>09.93<br>09.93<br>09.93<br>01.97 | 03.01<br>03.01<br>03.01<br>03.01<br>03.01 |  | 24.5112-0355.3 | 330758 | 2 |       | L=355          |     |
|                      | 1.3<br>1.4<br>1.6<br>1.7 D<br>1.7 TD |  |  | 09.93<br>09.93<br>09.93<br>09.93<br>01.97 | 03.01<br>03.01<br>03.01<br>03.01<br>03.01 |  | 24.5228-0370.3 | 330762 | 2 |       | L=370          |     |
|                      | 1.3<br>1.4<br>1.6<br>1.7 D<br>1.7 TD |  |  | 09.93<br>09.93<br>09.93<br>09.93<br>01.97 | 03.01<br>03.01<br>03.01<br>03.01<br>03.01 |  | 24.3220-1704.3 | 020097 |   |       | Rz 20,64       |     |
|                      | 1.3<br>1.4<br>1.6<br>1.7 D<br>1.7 TD |  |  | 09.93<br>09.93<br>09.93<br>09.93<br>01.97 | 03.01<br>03.01<br>03.01<br>03.01<br>03.01 |  | 24.3727-0541.2 | 580541 | 1 |       | L=3105         |     |
|                      | 1.3<br>1.4<br>1.6<br>1.7 D<br>1.7 TD |  |  | 09.93<br>09.93<br>09.93<br>09.93<br>01.97 | 03.01<br>03.01<br>03.01<br>03.01<br>03.01 |  | 24.3728-0531.2 | 590531 |   |       | L=678          |     |

| FIAT FIORINO / FIORINO QUBO (08-) |   |                            |  |   |  |  |                                  |                  |   |      |                                  |            |
|-----------------------------------|---|----------------------------|--|---|--|--|----------------------------------|------------------|---|------|----------------------------------|------------|
|                                   | 1.3 D Multijet<br>1.3 MPI<br>1.4<br>1.4 Natural Power                   | 55<br>52<br>54<br>57       |  | 09.08<br>01.07<br>09.08<br>10.09          |  |  | 24.3541-1769.7<br>24.3541-1770.7 | 220707<br>220708 |   | <br> | D=54, - Halter<br>D=54, - Halter | BOS<br>BOS |
|                                   | 1.3 D Multijet<br>1.3 D Multijet<br>1.3 MPI<br>1.4<br>1.4 Natural Power | 55<br>70<br>52<br>54<br>57 |  | 09.08<br>07.10<br>01.07<br>09.08<br>10.09 |  |  | 24.5112-0402.3                   | 331297           | 2 |      | L=402                            |            |
|                                   | 1.3 D Multijet<br>1.3 D Multijet<br>1.3 MPI<br>1.4<br>1.4 Natural Power | 55<br>70<br>52<br>54<br>57 |  | 09.08<br>07.10<br>01.07<br>09.08<br>10.09 |  |  | 24.5228-0181.3                   | 331279           | 2 |      | L=180                            |            |
|                                   | 1.3 D Multijet<br>1.3 D Multijet<br>1.3 MPI<br>1.4<br>1.4 Natural Power | 55<br>70<br>52<br>54<br>57 |  | 09.08<br>07.10<br>01.07<br>09.08<br>10.09 |  |  | 24.3220-1728.3                   | 020509           |   |      | Rz 20,64                         |            |

| FIAT IDEA (04-12) |  |  |  |   |   |  |                                  |                  |   |  |                                  |            |
|-------------------|--|--|--|---|---|--|----------------------------------|------------------|---|--|----------------------------------|------------|
|                   | 1.2 i 16V<br>1.3 D Multijet<br>1.3 JTD<br>1.4 i<br>1.4 i 16V<br>1.9 JTD  | 59<br>66<br>51<br>57<br>70<br>74                   |  | 01.04<br>11.05<br>01.04<br>11.05<br>01.04<br>01.04                            | 11.06<br>11.06<br>11.06<br>11.06<br>11.06<br>11.06                            |  | 24.2123-1763.3<br>24.2123-1769.3 | 010842<br>010863 |   | - Dynamic Control 1)<br>+ Dynamic Control 2) | THz 23,81<br>THz 23,81           | BOS        |
|                   | 1.2 i 16V<br>1.3 D Multijet<br>1.3 D Multijet<br>1.3 JTD<br>1.4 i<br>1.4 i 16V<br>1.4 LPG<br>1.6 D Multijet<br>1.9 JTD | 59<br>66<br>70<br>51<br>57<br>70<br>57<br>88<br>74 |  | 01.04<br>12.06<br>05.08<br>12.06<br>11.05<br>12.06<br>03.09<br>05.08<br>01.04 | 02.08<br>02.08<br>09.10<br>02.08<br>02.08<br>02.08<br>09.10<br>09.10<br>02.08 |  | 24.4123-1708.3                   | 010859           |   |  | THz 23,81                        | BOS        |
|                   | 1.2 i 16V<br>1.3 JTD<br>1.4 i<br>1.4 i 16V<br>1.4 LPG<br>1.3 D Multijet<br>1.3 D Multijet<br>1.6 D Multijet<br>1.9 JTD | 59<br>51<br>57<br>70<br>57<br>66<br>70<br>88<br>74 |  | 01.04<br>01.04<br>11.05<br>01.04<br>06.09<br>11.05<br>05.08<br>05.08<br>01.04 | 02.08<br>02.08<br>02.08<br>02.08<br>07.12<br>02.08<br>07.12<br>07.12<br>02.08 |  | 24.3541-1811.5<br>24.3541-1812.5 | 240429<br>240430 |   | <br>   | D=54, - Halter<br>D=54, - Halter | BOS<br>BOS |
|                   | 1.3 D Multijet<br>1.3 D Multijet<br>1.6 D Multijet<br>1.9 JTD  | 66<br>70<br>88<br>74                               |  | 11.05<br>05.08<br>05.08<br>01.04  | 02.08<br>07.12<br>07.12<br>02.08  |  | 24.3541-1831.7<br>24.3541-1832.7 | 220723<br>220724 |   | <br>   | D=54, - Halter<br>D=54, - Halter | BOS<br>BOS |
|                   | 1.2 i 16V<br>1.3 D Multijet<br>1.3 D Multijet<br>1.3 JTD<br>1.4 i  | 59<br>66<br>70<br>51<br>57                         |  | 01.04<br>11.05<br>05.08<br>01.04<br>11.05                                     | 02.08<br>02.08<br>07.12<br>02.08<br>02.08                                     |  | 24.5112-0456.3                   | 330875           | 2 |  | L=455                            |            |

1) - dynamic control / - dynamic control / - dynamic control / - Control dinámico  
2) + dynamic control / + dynamic control / + dynamic control / + Control dinámico



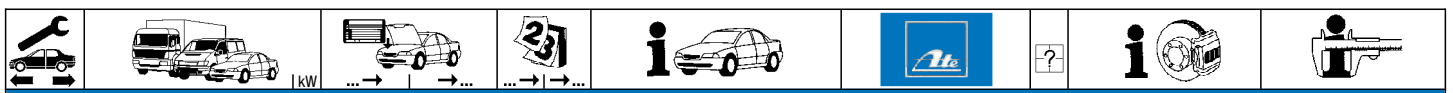

























| FIAT IDEA (04-12)  |                |    |       |       |                |                |        |   |                                 |                      |                |                |        |        |                |     |
|--------------------|----------------|----|-------|-------|----------------|----------------|--------|---|---------------------------------|----------------------|----------------|----------------|--------|--------|----------------|-----|
|                    | 1.4 i 16V      | 70 |       | 01.04 | 02.08          | 24.5112-0456.3 | 330875 | 2 |                                 | L=455                |                |                |        |        |                |     |
|                    | 1.4 LPG        | 57 |       | 03.09 | 07.12          |                |        |   |                                 |                      |                |                |        |        |                |     |
|                    | 1.6 D Multijet | 88 |       | 05.08 | 07.12          |                |        |   |                                 |                      |                |                |        |        |                |     |
|                    | 1.9 JTD        | 74 |       | 01.04 | 02.08          |                |        |   |                                 |                      |                |                |        |        |                |     |
|                    | 1.2 i 16V      | 59 |       | 01.04 | 02.08          | 83.7201-9173.3 | 330868 | 2 | □                               | L=173                |                |                |        |        |                |     |
|                    | 1.3 D Multijet | 66 |       | 11.05 | 02.08          |                |        |   |                                 |                      |                |                |        |        |                |     |
|                    | 1.3 D Multijet | 70 |       | 05.08 | 07.12          |                |        |   |                                 |                      |                |                |        |        |                |     |
|                    | 1.3 JTD        | 51 |       | 01.04 | 02.08          |                |        |   |                                 |                      |                |                |        |        |                |     |
|                    | 1.4 i          | 57 |       | 11.05 | 02.08          |                |        |   |                                 |                      |                |                |        |        |                |     |
|                    | 1.4 i 16V      | 70 |       | 01.04 | 02.08          |                |        |   |                                 |                      |                |                |        |        |                |     |
|                    | 1.4 LPG        | 57 |       | 03.09 | 07.12          |                |        |   |                                 |                      |                |                |        |        |                |     |
|                    | 1.9 JTD        | 74 |       | 01.04 | 02.08          |                |        |   |                                 |                      |                |                |        |        |                |     |
|                    | 1.6 D Multijet | 88 |       | 05.08 | 07.12          |                |        |   |                                 |                      | 83.7201-9173.3 | 330868         | 2      | □      | L=173          |     |
|                    |                |    |       |       | 24.5112-0220.3 | 330613         | 2      | ⬇ | L=220                           |                      |                |                |        |        |                |     |
|                    | 1.2 i 16V      | 59 |       | 01.04 | 05.08          | 24.3222-1724.3 | 020466 |   |                                 | Rz 22,20             |                |                |        |        |                |     |
|                    | 1.4 i          | 57 |       | 11.05 | 05.08          |                |        |   |                                 |                      |                |                |        |        |                |     |
|                    | 1.4 i 16V      | 70 |       | 01.04 | 05.08          |                |        |   |                                 |                      |                |                |        |        |                |     |
|                    | 1.2 i 16V      | 59 |       | 06.08 | 07.12          |                |        |   |                                 |                      | 24.3222-1725.3 | 020510         |        |        | Rz 22,00       |     |
|                    | 1.4 i          | 57 |       | 06.08 | 07.12          |                |        |   |                                 |                      |                |                |        |        |                |     |
|                    | 1.4 i 16V      | 70 |       | 06.08 | 07.12          |                |        |   |                                 |                      |                |                |        |        |                |     |
|                    | 1.4 LPG        | 57 |       | 03.09 | 07.12          |                |        |   |                                 |                      |                |                |        |        |                |     |
|                    | 1.3 D Multijet | 66 |       | 11.05 | 05.08          |                |        |   |                                 |                      | 24.3220-1107.3 | 020218         |        |        | Rz 20,64       |     |
|                    | 1.3 D Multijet | 70 |       | 05.08 | 05.08          |                |        |   |                                 |                      |                |                |        |        |                |     |
|                    | 1.3 JTD        | 51 |       | 01.04 | 05.08          |                |        |   |                                 |                      |                |                |        |        |                |     |
|                    | 1.9 JTD        | 74 |       | 01.04 | 06.05          |                |        |   |                                 |                      |                |                |        |        |                |     |
|                    | 1.3 D Multijet | 66 |       | 06.08 | 07.12          |                |        |   |                                 |                      | 24.3220-1728.3 | 020509         |        |        | Rz 20,64       |     |
|                    | 1.3 D Multijet | 70 |       | 06.08 | 07.12          |                |        |   |                                 |                      |                |                |        |        |                |     |
| 1.3 JTD            | 51             |    | 06.08 | 07.12 |                |                |        |   |                                 |                      |                |                |        |        |                |     |
| 1.9 JTD            | 74             |    | 06.08 | 07.12 |                |                |        |   |                                 |                      |                |                |        |        |                |     |
|                    | 1.2 i 16V      | 59 |       | 01.04 | 02.08          | 24.2520-1705.3 | 040093 |   |                                 | Nz 20,64             |                |                |        |        |                |     |
|                    | 1.4 i          | 57 |       | 11.05 | 02.08          |                |        |   |                                 |                      |                |                |        |        |                |     |
|                    | 1.4 i 16V      | 70 |       | 01.04 | 02.08          |                |        |   |                                 |                      |                |                |        |        |                |     |
|                    | 1.4 LPG        | 57 |       | 03.09 | 07.12          |                |        |   |                                 |                      |                |                |        |        |                |     |
| FIAT LINEA (07-11) |                |    |       |       |                |                |        |   |                                 |                      |                |                |        |        |                |     |
|                    | 1.3 D Multijet | 66 |       | 07.07 | 05.11          | 24.4122-1709.3 | 010871 |   | + Dynamic Control <sup>1)</sup> | Thz 22,20 + Behälter | BOS            |                |        |        |                |     |
|                    | 1.4            |    |       | 07.07 | 05.11          |                |        |   |                                 |                      |                |                |        |        |                |     |
|                    | 1.4 T-Jet      |    |       | 07.07 | 05.11          |                |        |   |                                 |                      |                |                |        |        |                |     |
|                    | 1.6            | 80 |       | 07.08 | 05.11          |                |        |   |                                 |                      |                |                |        |        |                |     |
|                    | 1.6 D Multijet | 77 |       | 01.09 | 05.11          |                |        |   |                                 |                      |                |                |        |        |                |     |
| 1.9 16V            |                |    | 07.08 | 05.11 |                |                |        |   |                                 |                      |                |                |        |        |                |     |
|                    | 1.3 D Multijet | 66 |       | 07.07 | 05.11          | 24.3541-1769.7 | 220707 | □ |                                 | D=54, - Halter       | BOS            |                |        |        |                |     |
|                    | 1.4            |    |       | 07.07 | 05.11          |                |        |   |                                 |                      |                | 24.3541-1770.7 | 220708 | □      | D=54, - Halter | BOS |
|                    | 1.3 D Multijet | 66 |       | 07.07 | 05.11          | 24.5112-0402.3 | 331297 | 2 |                                 | L=402                |                |                |        |        |                |     |
|                    | 1.4            |    |       | 07.07 | 05.11          |                |        |   |                                 |                      |                |                |        |        |                |     |
|                    | 1.4 T-Jet      |    |       | 07.07 | 05.11          |                |        |   |                                 |                      |                |                |        |        |                |     |
|                    | 1.6            | 80 |       | 07.08 | 05.11          |                |        |   |                                 |                      |                |                |        |        |                |     |
|                    | 1.6 D Multijet | 77 |       | 01.09 | 05.11          |                |        |   |                                 |                      |                |                |        |        |                |     |
| 1.9 16V            |                |    | 07.08 | 05.11 |                |                |        |   |                                 |                      |                |                |        |        |                |     |
|                    | 1.4 T-Jet      |    |       | 07.07 | 05.11          | 24.3384-1741.7 | 220599 | □ |                                 | D=38, - Halter       | LUC            |                |        |        |                |     |
|                    | 1.6            | 80 |       | 07.08 | 05.11          |                |        |   |                                 |                      |                | 24.3384-1742.7 | 220600 | □      | D=38, - Halter | LUC |
|                    | 1.6 D Multijet | 77 |       | 01.09 | 05.11          |                |        |   |                                 |                      |                |                |        |        |                |     |
|                    | 1.9 16V        |    |       | 07.08 | 05.11          |                |        |   |                                 |                      |                |                |        |        |                |     |
|                    | 1.3 D Multijet | 66 |       | 07.07 | 05.11          | 24.5228-0181.3 | 331279 | 2 |                                 | L=180                |                |                |        |        |                |     |
|                    | 1.4            |    |       | 07.07 | 05.11          |                |        |   |                                 |                      |                |                |        |        |                |     |
|                    | 1.4 T-Jet      |    |       | 07.07 | 05.11          |                |        |   |                                 |                      |                |                |        |        |                |     |
|                    | 1.6            | 80 |       | 07.08 | 05.11          |                |        |   |                                 |                      |                |                |        |        |                |     |
|                    | 1.6 D Multijet | 77 |       | 01.09 | 05.11          |                |        |   |                                 |                      |                |                |        |        |                |     |
| 1.9 16V            |                |    | 07.08 | 05.11 |                |                |        |   |                                 |                      |                |                |        |        |                |     |
|                    | 1.3 D Multijet | 66 |       | 07.07 | 05.11          | 24.3220-1728.3 | 020509 |   |                                 | Rz 20,64             |                |                |        |        |                |     |
|                    | 1.4            |    |       | 07.07 | 05.11          |                |        |   |                                 |                      |                |                |        |        |                |     |
|                    | 1.3 D Multijet | 66 |       | 07.07 | 05.11          | 24.3727-0566.2 | 580566 | □ |                                 | L=1712               |                |                |        |        |                |     |
|                    | 1.4            |    |       | 07.07 | 05.11          |                |        |   |                                 |                      | 24.3727-0567.2 | 580567         | □      | L=1725 |                |     |
|                    | 1.4 T-Jet      |    |       | 07.07 | 05.11          |                |        |   |                                 |                      | 24.3727-0564.2 | 580564         | □      | L=1520 |                |     |
|                    | 1.6            | 80 |       | 01.08 | 05.11          |                |        |   |                                 |                      | 24.3727-0565.2 | 580565         | □      | L=1528 |                |     |
|                    | 1.6 D Multijet | 77 |       | 07.09 | 05.11          |                |        |   |                                 |                      |                |                |        |        |                |     |
| 1.9 16V            |                |    | 07.08 | 05.11 |                |                |        |   |                                 |                      |                |                |        |        |                |     |
| FIAT MAREA (96-02) |                |    |       |       |                |                |        |   |                                 |                      |                |                |        |        |                |     |
|                    | 1.2 i 16V      | ⚡  |       | 04.99 | 12.02          | 24.2122-1716.3 | 010485 |   |                                 | Thz 22,20            |                |                |        |        |                |     |
|                    | 1.4 i 12V      | ⚡  |       | 09.96 | 12.02          |                |        |   |                                 |                      |                |                |        |        |                |     |
|                    | 1.6 i 16V      | ⚡  |       | 09.96 | 12.02          |                |        |   |                                 |                      |                |                |        |        |                |     |
|                    | 1.8 i 16V      | ⚡  |       | 09.96 | 12.02          |                |        |   |                                 |                      |                |                |        |        |                |     |
|                    | 1.9 JTD        | ⚡  |       | 04.99 | 12.02          |                |        |   |                                 |                      |                |                |        |        |                |     |
|                    | 1.9 TD         | ⚡  |       | 09.96 | 12.02          |                |        |   |                                 |                      |                |                |        |        |                |     |
|                    | 2.0 i 20V      | ⚡  |       | 09.96 | 12.02          |                |        |   |                                 |                      |                |                |        |        |                |     |
|                    | 2.4 JTD        | ⚡  |       | 04.99 | 12.02          |                |        |   |                                 |                      |                |                |        |        |                |     |
|                    | 2.4 TD         | ⚡  |       | 09.96 | 04.99          |                |        |   |                                 |                      |                |                |        |        |                |     |
|                    | 1.2 i 16V Lim. |    |       | 04.99 | 12.02          | 24.3541-1787.5 | 240289 | □ |                                 | D=54, - Halter       | ATE            |                |        |        |                |     |
|                    | 1.4 i 12V      |    |       | 09.96 | 12.02          |                |        |   |                                 |                      |                | 24.3541-1788.5 | 240290 | □      | D=54, - Halter | ATE |
|                    | 1.6 i 16V Lim. |    |       | 09.96 | 12.02          |                |        |   |                                 |                      |                |                |        |        |                |     |
|                    | 1.9 TD         | 55 |       | 09.96 | 12.02          |                |        |   |                                 |                      |                |                |        |        |                |     |

<sup>1)</sup> + dynamic control / + dynamic control / + dynamic control / + Control dinámico

| FIAT MAREA (96-02) |                       |      |       |       |                |                |                          |                          |                          |                |                |
|--------------------|-----------------------|------|-------|-------|----------------|----------------|--------------------------|--------------------------|--------------------------|----------------|----------------|
|                    | 1.2 i 16V Kombi       |      |       | 04.99 | 12.02          | 24.3541-1789.5 | 240291                   | <input type="checkbox"/> |                          | D=54, - Halter | ATE            |
|                    | 1.6 i 16V Kombi       |      |       | 09.96 | 12.02          | 24.3541-1790.5 | 240292                   | <input type="checkbox"/> |                          | D=54, - Halter | ATE            |
|                    | 1.8 i 16V             |      |       | 09.96 | 12.02          |                |                          |                          |                          |                |                |
|                    | 1.9 JTD               |      |       | 04.99 | 12.02          |                |                          |                          |                          |                |                |
|                    | 1.9 TD                | 74   |       | 09.96 | 12.02          |                |                          |                          |                          |                |                |
|                    | 2.0 i 20V             |      |       | 09.96 | 12.02          | 24.3541-1791.5 | 240293                   | <input type="checkbox"/> |                          | D=54, - Halter | ATE            |
|                    | 2.4 JTD               |      |       | 04.99 | 12.02          | 24.3541-1792.5 | 240294                   | <input type="checkbox"/> |                          | D=54, - Halter | ATE            |
|                    | 2.4 TD                |      |       | 09.96 | 04.99          |                |                          |                          |                          |                |                |
|                    | 1.2 i 16V             |      |       | 04.99 | 12.02          | 83.6401-0413.3 | 330748                   | 2                        |                          | L=408          |                |
|                    | 1.4 i 12V             |      |       | 09.96 | 12.02          |                |                          |                          |                          |                |                |
|                    | 1.6 i 16V             |      |       | 09.96 | 12.02          |                |                          |                          |                          |                |                |
|                    | 1.8 i 16V             |      |       | 09.96 | 12.02          |                |                          |                          |                          |                |                |
|                    | 1.9 JTD               |      |       | 04.99 | 12.02          |                |                          |                          |                          |                |                |
|                    | 1.9 TD                |      |       | 09.96 | 12.02          |                |                          |                          |                          |                |                |
|                    | 2.0 i 20V             |      |       | 09.96 | 12.02          |                |                          |                          |                          |                |                |
|                    | 2.4 JTD               |      |       | 04.99 | 12.02          |                |                          |                          |                          |                |                |
| 2.4 TD             |                       |      | 09.96 | 04.99 |                |                |                          |                          |                          |                |                |
|                    | 2.0 i 20V             |      |       | 09.96 | 04.97          | 24.3344-1715.5 | 240327                   | <input type="checkbox"/> |                          | D=34, - Halter | LUC            |
|                    | 2.4 TD                |      |       | 09.96 | 04.97          | 24.3344-1716.5 | 240328                   | <input type="checkbox"/> |                          | D=34, - Halter | LUC            |
|                    | 1.2 i 16V             |      |       | 04.99 | 12.02          | 24.5228-0223.3 | 330530                   | 2                        |                          | L=223          |                |
|                    | 1.4 i 12V             |      |       | 09.96 | 12.02          |                |                          |                          |                          |                |                |
|                    | 1.6 i 16V             |      |       | 09.96 | 12.02          |                |                          |                          |                          |                |                |
|                    | 1.8 i 16V             |      |       | 09.96 | 12.02          |                |                          |                          |                          |                |                |
|                    | 1.9 JTD               |      |       | 04.99 | 12.02          |                |                          |                          |                          |                |                |
|                    | 1.9 TD                |      |       | 09.96 | 12.02          |                |                          |                          |                          |                |                |
|                    | 2.0 i 20V             |      |       | 09.96 | 12.02          |                |                          |                          |                          |                |                |
|                    | 2.4 JTD               |      |       | 04.99 | 12.02          |                |                          |                          |                          |                |                |
| 2.4 TD             |                       |      | 09.96 | 04.99 |                |                |                          |                          |                          |                |                |
|                    | 1.4 i 12V             |      |       | 09.96 | 03.97          | 24.3222-1707.3 | 020104                   |                          |                          | Rz 22,20       | BDX            |
|                    | 1.6 i 16V Lim.        |      |       | 09.96 | 03.97          |                |                          |                          |                          |                |                |
|                    | 1.8 i 16V Lim.        |      |       | 09.96 | 03.97          |                |                          |                          |                          |                |                |
|                    | 1.9 TD Lim.           |      |       | 09.96 | 03.97          |                |                          |                          |                          |                |                |
|                    | 1.2 i 16V             |      |       | 04.99 | 12.02          | 24.3222-1126.3 | 020358                   | + GG <sup>1)</sup>       |                          | Rz 22,20       | AP             |
|                    | 1.4 i 12V             |      |       | 04.97 | 12.02          | 24.3222-1724.3 | 020466                   | + ALU <sup>2)</sup>      |                          | Rz 22,20       |                |
|                    | 1.6 i 16V Lim.        |      |       | 04.97 | 12.02          |                |                          |                          |                          |                |                |
|                    | 1.8 i 16V Lim.        |      |       | 04.97 | 12.02          |                |                          |                          |                          |                |                |
|                    | 1.9 JTD Lim.          |      |       | 04.99 | 12.02          |                |                          |                          |                          |                |                |
|                    | 1.6 i 16V Kombi       |      |       | 09.96 | 12.02          | 24.3220-1116.3 | 020313                   |                          |                          | Rz 20,64       |                |
|                    | 1.8 i 16V Kombi       |      |       | 09.96 | 12.02          |                |                          |                          |                          |                |                |
|                    | 1.9 JTD Kombi         |      |       | 04.99 | 12.02          |                |                          |                          |                          |                |                |
|                    | 1.9 TD Kombi          |      |       | 09.96 | 12.02          |                |                          |                          |                          |                |                |
|                    | 1.2 i 16V             |      |       | 04.99 | 12.02          | 24.3727-0539.2 | 580539                   | <input type="checkbox"/> |                          | L=1428         |                |
|                    | 1.4 i 12V Kombi       |      |       | 09.96 | 12.02          | 24.3727-0540.2 | 580540                   | <input type="checkbox"/> |                          | L=1383         |                |
|                    | 1.4 i 12V Lim.        |      |       | 09.96 | 12.02 + ABS    |                |                          |                          |                          |                |                |
|                    | 1.6 i 16V Lim.        |      |       | 09.96 | 12.02          |                |                          |                          |                          |                |                |
|                    | 1.8 i 16V Lim.        |      |       | 09.96 | 12.02          |                |                          |                          |                          |                |                |
|                    | 1.9 JTD               |      |       | 04.99 | 12.02          |                |                          |                          |                          |                |                |
|                    | 1.6 i 16V Kombi       |      |       | 09.96 | 12.02          | 24.3727-0543.2 | 580543                   | <input type="checkbox"/> |                          | L=1459         |                |
|                    | 1.8 i 16V Kombi       |      |       | 09.96 | 12.02          | 24.3727-0542.2 | 580542                   | <input type="checkbox"/> |                          | L=1404         |                |
|                    | 1.9 JTD Kombi         |      |       | 04.99 | 12.02          |                |                          |                          |                          |                |                |
|                    | 1.9 TD Kombi          |      |       | 09.96 | 12.02          |                |                          |                          |                          |                |                |
|                    | 1.2 i 16V             |      |       | 04.99 | 12.02          | 24.6584-1701.3 | 320173                   |                          |                          | BRL (4)        |                |
|                    | 1.4 i 12V             |      |       | 09.96 | 12.02          |                |                          |                          |                          |                |                |
|                    | 1.6 i 16V             |      |       | 09.96 | 12.02          |                |                          |                          |                          |                |                |
|                    | 1.8 i 16V             |      |       | 09.96 | 12.02          |                |                          |                          |                          |                |                |
|                    | 1.9 JTD               |      |       | 04.99 | 12.02          |                |                          |                          |                          |                |                |
|                    | 1.9 TD                |      |       | 09.96 | 12.02          |                |                          |                          |                          |                |                |
|                    | 2.0 i 20V             |      |       | 09.96 | 12.02          |                |                          |                          |                          |                |                |
|                    | 2.4 JTD               |      |       | 04.99 | 12.02          |                |                          |                          |                          |                |                |
| 2.4 TD             |                       |      | 09.96 | 04.99 |                |                |                          |                          |                          |                |                |
|                    | 1.9 JTD               | ‡    |       | 04.99 | 12.02          | 24.2419-1721.3 | 030100                   |                          |                          | Gz 19,05       |                |
|                    | 2.0 i 20V             | ‡    |       | 09.96 | 12.02          |                |                          |                          |                          |                |                |
|                    | 2.4 JTD               | ‡    |       | 04.99 | 12.02          |                |                          |                          |                          |                |                |
|                    | 1.9 JTD               | ‡    |       | 04.99 | 12.02          | 24.2525-1705.3 | 040083                   |                          |                          | Nz 25,40       |                |
|                    | 2.0 i 20V             | ‡    |       | 09.96 | 12.02          |                |                          |                          |                          |                |                |
|                    | 2.4 JTD               | ‡    |       | 04.99 | 12.02          | 24.2525-1706.3 | 040088                   |                          |                          | Nz 25,40       |                |
|                    | 1.2 i 16V             | ‡    |       | 04.99 | 12.02          | 24.3728-0523.2 | 590523                   |                          |                          | L=937          |                |
|                    | 1.4 i 12V             | ‡    |       | 09.96 | 12.02          |                |                          |                          |                          |                |                |
|                    | 1.6 i 16V             | ‡    |       | 09.96 | 12.02          | 24.3728-0528.2 | 590528                   |                          |                          | L=1545         |                |
|                    | 1.8 i 16V             | ‡    |       | 09.96 | 12.02          |                |                          |                          |                          |                |                |
|                    | 1.9 TD                | ‡ 74 |       | 09.96 | 12.02          |                |                          |                          |                          |                |                |
|                    | FIAT MULTIPLA (98-08) |      |       |       |                |                |                          |                          |                          |                |                |
|                    |                       | 1.6  |       |       | 09.00          | 02.01          | 24.3541-1791.5           | 240293                   | <input type="checkbox"/> |                | D=54, - Halter |
| 1.6 16V            |                       |      |       | 02.99 | 09.04          | 24.3541-1792.5 | 240294                   | <input type="checkbox"/> |                          | D=54, - Halter | ATE            |
| 1.6 16V Bipower    |                       |      |       | 02.99 | 03.02          |                |                          |                          |                          |                |                |
| 1.9 JTD            |                       |      |       | 02.99 | 09.04          |                |                          |                          |                          |                |                |
| 1.6 16V            |                       |      |       | 10.04 | 02.08          | 24.3541-1831.7 | 220723                   | <input type="checkbox"/> |                          | D=54, - Halter | BOS            |
| 1.6 16V Bluepower  |                       |      | 04.99 | 02.08 | 24.3541-1832.7 | 220724         | <input type="checkbox"/> |                          | D=54, - Halter           | BOS            |                |
| 1.9 JTD            |                       |      | 10.04 | 02.08 |                |                |                          |                          |                          |                |                |

1) + cast iron / + ghisa / + fonte grise / + fundición de gris

2) + aluminium / + aluminio / + aluminium / + aluminio

|          |  |          |       |       |                |                |        |                          |                                  |       |                |                |                |                          |        |       |       |  |       |       |           |     |
|--|--|----------|-------|-------|----------------|----------------|--------|--------------------------|----------------------------------|-------|----------------|----------------|----------------|--------------------------|--------|-------|-------|--|-------|-------|-----------|-----|
| <b>FIAT MULTIPLA (98-08)</b>   |  |          |       |       |                |                |        |                          |                                  |       |                |                |                |                          |        |       |       |  |       |       |           |     |
|    | 1.6  |          | 09.00 | 02.01 | 24.5112-0437.3 | 330886         | 2      |                          |                                  |       | L=435          |                |                |                          |        |       |       |  |       |       |           |     |
|  | 1.6 16V  |          | 02.99 | 02.08 |                |                |        |                          |                                  |       |                |                |                |                          |        |       |       |  |       |       |           |     |
|  | 1.6 16V Bipower  |          | 04.99 | 03.02 |                |                |        |                          |                                  |       |                |                |                |                          |        |       |       |  |       |       |           |     |
|  | 1.6 16V Bluepower  |          | 04.99 | 02.08 |                |                |        |                          |                                  |       |                |                |                |                          |        |       |       |  |       |       |           |     |
|  | 1.9 JTD  |          | 02.99 | 02.08 |                |                |        |                          |                                  |       |                |                |                |                          |        |       |       |  |       |       |           |     |
|    | 1.6  |          | 09.00 | 02.01 | 24.5228-0223.3 | 330530         | 2      |                          |                                  |       | L=223          |                |                |                          |        |       |       |  |       |       |           |     |
|  | 1.6 16V  |          | 02.99 | 02.08 |                |                |        |                          |                                  |       |                |                |                |                          |        |       |       |  |       |       |           |     |
|  | 1.6 16V Bipower  |          | 04.99 | 03.02 |                |                |        |                          |                                  |       |                |                |                |                          |        |       |       |  |       |       |           |     |
|  | 1.6 16V Bluepower  |          | 04.99 | 02.08 |                |                |        |                          |                                  |       |                |                |                |                          |        |       |       |  |       |       |           |     |
|  | 1.9 JTD  |          | 02.99 | 02.08 |                |                |        |                          |                                  |       |                |                |                |                          |        |       |       |  |       |       |           |     |
|    | 1.6  |          | 09.00 | 02.01 | 24.3220-1116.3 | 020313         |        |                          |                                  |       | Rz 20,64       |                |                |                          |        |       |       |  |       |       |           |     |
|  | 1.6 16V  |          | 02.99 | 02.08 |                |                |        |                          |                                  |       |                |                |                |                          |        |       |       |  |       |       |           |     |
|  | 1.6 16V Bipower  |          | 04.99 | 03.02 |                |                |        |                          |                                  |       |                |                |                |                          |        |       |       |  |       |       |           |     |
|  | 1.6 16V Bluepower  |          | 04.99 | 02.08 |                |                |        |                          |                                  |       |                |                |                |                          |        |       |       |  |       |       |           |     |
|  | 1.9 JTD  |          | 02.99 | 02.08 |                |                |        |                          |                                  |       |                |                |                |                          |        |       |       |  |       |       |           |     |
|    | 1.6  |          | 09.00 | 02.01 | 24.3727-0550.2 | 580550         |        | <input type="checkbox"/> |                                  |       | L=1165         |                |                |                          |        |       |       |  |       |       |           |     |
|  | 1.6 16V  |          | 02.99 | 02.02 |                |                |        |                          |                                  |       |                | 24.3727-0551.2 | 580551         | <input type="checkbox"/> |        |       |       |  |       |       |           |     |
|  | 1.9 JTD  |          | 02.99 | 02.02 |                |                |        |                          |                                  |       | L=2014         |                |                |                          |        |       |       |  |       |       |           |     |
|  | 1.6 16V Bipower  |          | 04.99 | 03.02 | 24.3727-0552.2 | 580552         |        | <input type="checkbox"/> | mit Schutzschlauch <sup>1)</sup> |       | L=1143         |                |                |                          |        |       |       |  |       |       |           |     |
|  | 1.6 16V Bluepower  |          | 04.99 | 02.08 |                |                |        |                          |                                  |       |                | 24.3727-0551.2 | 580551         | <input type="checkbox"/> |        |       |       |  |       |       |           |     |
|  |  |          |       |       |                |                |        |                          |                                  |       | L=2014         |                |                |                          |        |       |       |  |       |       |           |     |
|    | 1.6  |          | 09.00 | 02.01 | 24.6584-1701.3 | 320173         |        |                          |                                  |       | BRL (4)        |                |                |                          |        |       |       |  |       |       |           |     |
|  | 1.6 16V  |          | 02.99 | 02.08 |                |                |        |                          |                                  |       |                |                |                |                          |        |       |       |  |       |       |           |     |
|  | 1.6 16V Bipower  |          | 04.99 | 03.02 |                |                |        |                          |                                  |       |                |                |                |                          |        |       |       |  |       |       |           |     |
|  | 1.6 16V Bluepower  |          | 04.99 | 02.08 |                |                |        |                          |                                  |       |                |                |                |                          |        |       |       |  |       |       |           |     |
|  | 1.9 JTD  |          | 02.99 | 02.08 |                |                |        |                          |                                  |       |                |                |                |                          |        |       |       |  |       |       |           |     |
|    | 1.6  |          | 09.00 | 02.01 | 24.3728-0530.2 | 590530         |        |                          |                                  |       | L=866          |                |                |                          |        |       |       |  |       |       |           |     |
|  | 1.6 16V  |          | 02.99 | 02.08 |                |                |        |                          |                                  |       |                |                |                |                          |        |       |       |  |       |       |           |     |
|  | 1.6 16V Bipower  |          | 04.99 | 03.02 |                |                |        |                          |                                  |       |                |                |                |                          |        |       |       |  |       |       |           |     |
|  | 1.6 16V Bluepower  |          | 04.99 | 02.08 |                |                |        |                          |                                  |       |                |                |                |                          |        |       |       |  |       |       |           |     |
|  | 1.9 JTD  |          | 02.99 | 02.08 |                |                |        |                          |                                  |       |                |                |                |                          |        |       |       |  |       |       |           |     |
| <b>FIAT PALIO / PALIO WEEKEND EUROPA (97-06)</b>   |  |          |       |       |                |                |        |                          |                                  |       |                |                |                |                          |        |       |       |  |       |       |           |     |
|    | 1.2 (75)   |          | 10.97 | 12.06 | 20.5522-1093.3 | 010731         |        |                          |                                  |       | + ABS          | THz 22,20      | ATE            |                          |        |       |       |  |       |       |           |     |
|  | 1.6 i 16V (100)  |          | 10.97 | 12.06 |                |                |        |                          |                                  |       |                |                |                | 20.5522-1093.3           | 010731 |       |       |  |       | + ABS | THz 22,20 | ATE |
|  | 1.7 TD (70)  |          | 10.97 | 12.06 |                |                |        |                          |                                  |       |                |                |                |                          |        |       |       |  |       |       |           |     |
|  | 1.9 D  |          | 03.01 | 12.06 |                |                |        |                          |                                  |       |                |                |                |                          |        |       |       |  |       |       |           |     |
|   | 1.2 (75)   |          | 10.97 | 12.06 | 24.5112-0460.3 | 330599         | 2      |                          |                                  |       | L=460          |                |                |                          |        |       |       |  |       |       |           |     |
|  | 1.6 i 16V (100)  |          | 10.97 | 12.06 |                |                |        |                          |                                  |       |                |                |                |                          |        |       |       |  |       |       |           |     |
|  | 1.7 TD (70)  |          | 10.97 | 12.06 |                |                |        |                          |                                  |       |                |                |                |                          |        |       |       |  |       |       |           |     |
|  | 1.9 D  |          | 03.01 | 12.06 |                |                |        |                          |                                  |       |                |                |                |                          |        |       |       |  |       |       |           |     |
|  |  | 1.2 (75) |       | 10.97 |                |                |        |                          |                                  |       |                | 12.06          | 24.5112-0220.3 | 330613                   | 2      |       |       |  | L=220 |       |           |     |
| 1.6 i 16V (100)  |  |          | 10.97 | 12.06 |                |                |        |                          |                                  |       |                |                |                |                          |        |       |       |  |       |       |           |     |
| 1.7 TD (70)  |  |          | 10.97 | 12.06 |                |                |        |                          |                                  |       |                |                |                |                          |        |       |       |  |       |       |           |     |
| 1.9 D  |  |          | 03.01 | 12.06 |                |                |        |                          |                                  |       |                |                |                |                          |        |       |       |  |       |       |           |     |
|    |  | 1.2 (75) |       | 10.97 | 12.06          | 24.3220-1116.3 | 020313 |                          |                                  |       |                | Rz 20,64       |                |                          |        |       |       |  |       |       |           |     |
|  | 1.6 i 16V (100)  |          | 10.97 | 12.06 |                |                |        |                          |                                  |       |                |                |                |                          |        |       |       |  |       |       |           |     |
|  | 1.7 TD (70)  |          | 10.97 | 12.06 |                |                |        |                          |                                  |       |                |                |                |                          |        |       |       |  |       |       |           |     |
|  | 1.9 D  |          | 03.01 | 12.06 |                |                |        |                          |                                  |       |                |                |                |                          |        |       |       |  |       |       |           |     |
|  |  | 1.2 (75) |       | 10.97 | 03.99          |                |        |                          |                                  |       |                |                | 24.3728-0533.2 | 590533                   |        |       |       |  | L=684 |       |           |     |
| 1.6 i 16V (100)  |  |          | 10.97 | 12.06 | 24.3728-0535.2 | 590535         |        |                          |                                  | L=678 |                |                |                |                          |        |       |       |  |       |       |           |     |
|  |  |          |       |       |                |                |        |                          |                                  |       | 24.3728-0533.2 | 590533         |                |                          |        | L=684 |       |  |       |       |           |     |
| <b>FIAT PALIO SW / SIENA (PL) (98-06)</b>  |  |          |       |       |                |                |        |                          |                                  |       |                |                |                |                          |        |       |       |  |       |       |           |     |
|    | 1.4  |          | 02.98 | 12.06 | 24.3728-0533.2 | 590533         |        |                          |                                  |       | L=684          |                |                |                          |        |       |       |  |       |       |           |     |
|  | 1.6 i 16V  |          | 02.98 | 12.06 |                |                |        |                          |                                  |       |                | 24.3728-0535.2 | 590535         |                          |        |       | L=678 |  |       |       |           |     |
| <b>FIAT PANDA (86-02)</b>  |  |          |       |       |                |                |        |                          |                                  |       |                |                |                |                          |        |       |       |  |       |       |           |     |
|    | 1000   | +        | 01.86 | 12.92 | 24.2119-0826.3 | 010349         |        |                          |                                  |       | THz 19,05      |                |                |                          |        |       |       |  |       |       |           |     |
|  | 1000 i.e.  | +        | 10.87 | 12.02 |                |                |        |                          |                                  |       |                |                |                |                          |        |       |       |  |       |       |           |     |
|  | 1100   | +        | 02.91 | 12.02 |                |                |        |                          |                                  |       |                |                |                |                          |        |       |       |  |       |       |           |     |
|  | 750  | +        | 01.86 | 12.97 |                |                |        |                          |                                  |       |                |                |                |                          |        |       |       |  |       |       |           |     |
|  | 900  | +        | 04.92 | 12.96 |                |                |        |                          |                                  |       |                |                |                |                          |        |       |       |  |       |       |           |     |
|  | 4x4  | +        | 01.86 | 12.02 |                |                |        |                          |                                  |       |                |                |                |                          |        |       |       |  |       |       |           |     |
|    | 1000   |          | 01.86 | 12.92 | 24.5112-0433.3 | 330522         | 2      |                          |                                  |       | L=434          |                |                |                          |        |       |       |  |       |       |           |     |
|  | 1000 i.e.  |          | 10.87 | 12.02 |                |                |        |                          |                                  |       |                |                |                |                          |        |       |       |  |       |       |           |     |
|  | 1100   |          | 02.91 | 12.02 |                |                |        |                          |                                  |       |                |                |                |                          |        |       |       |  |       |       |           |     |
|  | 4x4  |          | 01.86 | 12.02 |                |                |        |                          |                                  |       |                |                |                |                          |        |       |       |  |       |       |           |     |
|  | 750  |          | 01.86 | 12.97 |                |                |        |                          |                                  |       |                |                |                |                          |        |       |       |  |       |       |           |     |
|  | 900  |          | 04.92 | 12.96 |                |                |        |                          |                                  |       |                |                |                |                          |        |       |       |  |       |       |           |     |
|  |  | 1000     |       | 01.86 |                |                |        |                          |                                  |       |                | 12.92          | 24.5112-0185.3 | 330654                   | 2      |       |       |  | L=185 |       |           |     |
| 1000 i.e.  |  |          | 10.87 | 12.02 |                |                |        |                          |                                  |       |                |                |                |                          |        |       |       |  |       |       |           |     |
| 1100   |  |          | 02.91 | 12.02 |                |                |        |                          |                                  |       |                |                |                |                          |        |       |       |  |       |       |           |     |
| 4x4  |  |          | 01.86 | 12.02 |                |                |        |                          |                                  |       |                |                |                |                          |        |       |       |  |       |       |           |     |
| 750  |  |          | 01.86 | 12.97 |                |                |        |                          |                                  |       |                |                |                |                          |        |       |       |  |       |       |           |     |
| 900  |  |          | 04.92 | 12.96 |                |                |        |                          |                                  |       |                |                |                |                          |        |       |       |  |       |       |           |     |
|    |  | 1000     |       | 01.86 | 12.92          | 24.3219-0803.3 | 020183 |                          |                                  |       |                | Rz 19,05       |                |                          |        |       |       |  |       |       |           |     |
|  | 1000 i.e.  |          | 10.87 | 12.02 |                |                |        |                          |                                  |       |                |                |                |                          |        |       |       |  |       |       |           |     |
|  | 1100   |          | 02.91 | 12.02 |                |                |        |                          |                                  |       |                |                |                |                          |        |       |       |  |       |       |           |     |
|  | 4x4  |          | 01.86 | 12.02 |                |                |        |                          |                                  |       |                |                |                |                          |        |       |       |  |       |       |           |     |
|  | 750  |          | 01.86 | 12.97 |                |                |        |                          |                                  |       |                |                |                |                          |        |       |       |  |       |       |           |     |
|  | 900  |          | 04.92 | 12.96 |                |                |        |                          |                                  |       |                |                |                |                          |        |       |       |  |       |       |           |     |

<sup>1)</sup> with protecting cover / con flessibile di protezione / avec gaine protectrice / con manguera de protección

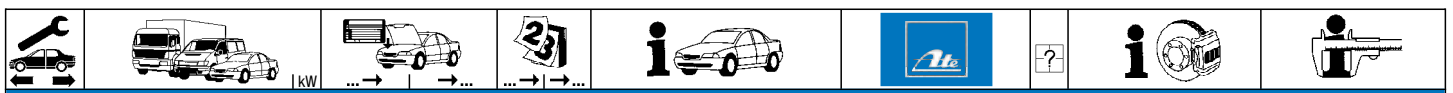

| FIAT PANDA (86-02) |  |  |  |  |  |  |                |        |     |            |
|--------------------|--|--|--|--|--|--|----------------|--------|-----|------------|
|                    | 1000<br>1000 i.e.<br>1100<br>4x4<br>750<br>900 |  |  | 01.86<br>10.87<br>02.91<br>01.86<br>01.86<br>04.92 | 12.92<br>12.02<br>12.02<br>12.02<br>12.97<br>12.96 |  | 24.3727-0519.2 | 580519 | 1 ↓ | L=2385     |
|                    | 4x4  |  |  | 01.86  | 12.02  |  | 24.6046-0801.3 | 320116 |     | BR 4/6 (2) |
|                    | 1000<br>1000 i.e.<br>1100<br>4x4<br>750<br>900 |  |  | 01.86<br>10.87<br>02.91<br>01.86<br>01.86<br>04.92 | 12.92<br>12.02<br>12.02<br>12.02<br>12.97<br>12.96 |  | 24.3728-0505.2 | 590505 |     | L=560      |

| FIAT PANDA (03-13) |  |  |  |   |   |  |  |                            |  |  |                   |
|--------------------|--|--|--|---|---|--|--|----------------------------|--|--|-------------------|
|                    | 1.1 i<br>1.2<br>1.2 Bi-Power<br>1.2 i<br>1.2 LPG<br>1.2 LPG<br>1.3 D Multijet<br>1.3 JTD<br>1.3 JTD<br>1.4 Bi-/Natural Power<br>1.4<br>1.2 4x4<br>1.2 i 4x4<br>1.3 D Multijet 4x4  | 40<br>51<br>44<br>44<br>44<br>51<br>51<br>55<br>55<br>74<br>51<br>44<br>44                               |  | 09.03<br>03.10<br>01.07<br>09.03<br>04.09<br>11.10<br>09.03<br>09.03<br>06.06<br>01.07<br>11.06<br>10.10<br>10.04<br>10.04  | 06.13<br>06.13<br>06.13<br>06.13<br>06.13<br>06.13<br>06.13<br>06.13<br>06.13<br>06.13<br>06.13<br>06.13<br>06.13<br>06.13<br>06.13                                     |  | 24.2120-1744.3<br>24.2120-1747.3<br>24.2120-1746.3 | 010820<br>010836<br>010835 | - ABS<br>+ ABS<br>+ Dynamic Control <sup>1)</sup>                                | THz 20,64<br>THz 20,64<br>THz 20,64                | BOS<br>BOS        |
|                    | 1.1 i<br>1.2 i<br>1.1 i<br>1.2<br>1.2 i<br>1.3 D Multijet 4x4<br>1.4   | 40<br>44<br>40<br>51<br>44<br>74<br>74   |  | 09.03<br>09.03<br>07.07<br>03.10<br>07.07<br>10.04<br>11.06   | 06.07<br>06.07<br>06.13<br>06.13<br>06.13<br>06.13<br>06.13   |  | 24.3481-1743.5<br>24.3481-1744.5<br>24.3481-1744.5 | 240305<br>240306<br>240306 | <input type="checkbox"/><br><input type="checkbox"/><br><input type="checkbox"/> | D=48, - Halter<br>D=48, - Halter<br>D=48, - Halter | BDX<br>BDX<br>BDX |
|                    | 1.1 i<br>1.2<br>1.2 Bi-Power<br>1.2 i<br>1.2 LPG<br>1.2 LPG<br>1.3 D Multijet<br>1.3 JTD<br>1.3 JTD<br>1.4<br>1.4 Bi-/Natural Power<br>1.2 4x4<br>1.2 i 4x4<br>1.3 D Multijet 4x4  | 40<br>51<br>44<br>44<br>44<br>51<br>51<br>55<br>74<br>74<br>51<br>44<br>44                               |  | 09.03<br>03.10<br>01.07<br>09.03<br>04.09<br>11.10<br>09.03<br>09.03<br>06.06<br>11.06<br>01.07<br>10.10<br>10.04<br>10.04  | 06.13<br>06.13<br>06.13<br>06.13<br>06.13<br>06.13<br>06.13<br>06.13<br>06.13<br>06.13<br>06.13<br>06.13<br>06.13<br>06.13  |  | 24.5112-0440.3                                     | 330887                     | 2  |  | L=440             |
|                    | 1.1 i<br>1.2<br>1.2 Bi-Power<br>1.2 i<br>1.2 LPG<br>1.2 LPG<br>1.3 D Multijet<br>1.3 JTD<br>1.3 JTD<br>1.4<br>1.4 Bi-/Natural Power<br>1.2 4x4<br>1.2 i 4x4<br>1.3 D Multijet 4x4  | 40<br>51<br>44<br>44<br>44<br>51<br>51<br>55<br>74<br>74<br>51<br>44<br>44                               |  | 09.03<br>03.10<br>01.07<br>09.03<br>04.09<br>11.10<br>09.03<br>09.03<br>06.06<br>11.06<br>01.07<br>10.10<br>10.04<br>10.04  | 06.13<br>06.13<br>06.13<br>06.13<br>06.13<br>06.13<br>06.13<br>06.13<br>06.13<br>06.13<br>06.13<br>06.13<br>06.13<br>06.13  |  | 24.5228-0165.3                                     | 330879                     | 2  |  | L=165             |
|                    | 1.1 i<br>1.2<br>1.2 Bi-Power<br>1.2 i<br>1.3 D Multijet<br>1.3 JTD<br>1.3 JTD<br>1.4 Bi-/Natural Power<br>1.1 i<br>1.2<br>1.2 Bi-Power<br>1.2 i<br>1.3 D Multijet<br>1.3 JTD<br>1.3 JTD<br>1.4 Bi-/Natural Power<br>1.2 LPG<br>1.2 LPG | 40<br>51<br>44<br>44<br>44<br>51<br>55<br>74<br>40<br>51<br>44<br>44<br>44<br>51<br>55<br>74<br>44<br>51 |  | 09.03<br>03.10<br>01.07<br>09.03<br>09.03<br>06.06<br>01.07<br>10.10<br>10.04<br>10.04<br>09.03<br>03.10<br>01.07<br>09.03<br>09.03<br>06.06<br>01.07<br>04.09<br>11.10 | 06.13<br>06.13<br>06.13<br>06.13<br>06.13<br>06.13<br>06.13<br>06.13<br>06.13<br>06.13<br>06.13<br>05.10<br>05.10<br>05.10<br>05.10<br>05.10<br>05.10<br>06.13<br>06.13 |  | 24.3220-1107.3                                     | 020218                     | - ABS  | Rz 20,64   | AP                |
|                    | 1.1 i<br>1.2<br>1.2 Bi-Power<br>1.2 i<br>1.3 D Multijet<br>1.3 JTD<br>1.3 JTD<br>1.4 Bi-/Natural Power<br>1.2 LPG<br>1.2 LPG   | 40<br>51<br>44<br>44<br>44<br>51<br>55<br>74<br>44<br>51   |  | 09.03<br>03.10<br>01.07<br>09.03<br>09.03<br>06.06<br>01.07<br>10.10<br>10.04<br>11.10  | 06.13<br>06.13<br>06.13<br>06.13<br>06.13<br>06.13<br>06.13<br>06.13<br>06.13<br>06.13  |  | 24.3220-1108.3                                     | 020219                     | + ABS  | Rz 20,64   | BDX               |
|                    | 1.2 LPG<br>1.2 LPG   | 44<br>51   |  | 04.09<br>11.10  | 06.13<br>06.13  |  | 24.3220-1728.3                                     | 020509                     |  |  | Rz 20,64          |

1) + dynamic control / + dynamic control / + dynamic control / + Control dinámico  
 2) - dynamic control / - dynamic control / - dynamic control / - Control dinámico  
 3) - differential lock / - differenziale autobloccante / - blocage de différentiel / - bloqueo diferencial  
 4) + differential lock / + differenziale autobloccante / + blocage de différentiel / + bloqueo diferencial





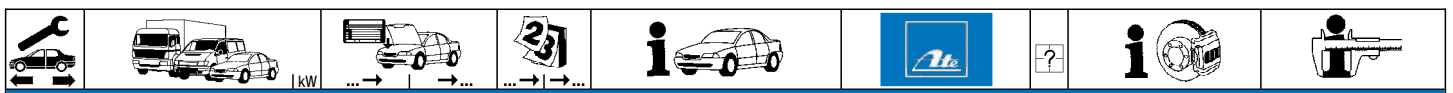

| FIAT PANDA (03-13)    |                |    |       |       |       |                |        |                          |        |
|-----------------------|----------------|----|-------|-------|-------|----------------|--------|--------------------------|--------|
|                       | 1.1 i          | 40 |       | 09.03 | 06.13 | 24.3727-0556.2 | 580556 | <input type="checkbox"/> | L=1405 |
|                       | 1.2            | 51 |       | 03.10 | 06.13 |                | 580557 |                          |        |
|                       | 1.2 i          | 44 |       | 09.03 | 06.13 |                |        |                          |        |
|                       | 1.2 LPG        | 44 |       | 04.09 | 06.13 |                |        |                          |        |
|                       | 1.2 LPG        | 51 |       | 11.10 | 06.13 |                |        |                          |        |
|                       | 1.3 D Multijet |    |       | 09.03 | 06.13 |                |        |                          |        |
|                       | 1.3 JTD        | 51 |       | 09.03 | 06.13 |                |        |                          |        |
|                       | 1.3 JTD        | 55 |       | 06.06 | 06.13 |                |        |                          |        |
| 1.4 Bi-/Natural Power |                |    | 01.07 | 06.13 |       |                |        |                          |        |
|                       | 1.1 i          | 40 |       | 09.03 | 06.13 | 24.3728-0532.2 | 590532 | <input type="checkbox"/> | L=995  |
|                       | 1.2 Bi-Power   | 44 |       | 01.07 | 06.13 |                |        |                          |        |
|                       | 1.2 i          | 44 |       | 09.03 | 06.13 |                |        |                          |        |
|                       | 1.2 LPG        | 44 |       | 04.09 | 06.13 |                |        |                          |        |

| FIAT PANDA SUV (06-) |                   |    |  |       |  |                |                |                          |                      |        |
|----------------------|-------------------|----|--|-------|--|----------------|----------------|--------------------------|----------------------|--------|
|                      | 1.3 JTD 4x4 Cross | 51 |  | 04.06 |  | 24.2120-1744.3 | 010820         | <input type="checkbox"/> | THz 20,64            |        |
|                      |                   |    |  |       |  |                | 24.2120-1747.3 |                          |                      | 010836 |
|                      |                   |    |  |       |  |                | 24.2120-1746.3 |                          |                      | 010835 |
|                      | 1.3 JTD 4x4 Cross | 51 |  | 04.06 |  | 24.4122-1714.3 | 010914         |                          | THz 22,20 - Behälter |        |
|                      | 1.3 JTD 4x4 Cross | 51 |  | 04.06 |  | 24.3541-1769.7 | 220707         | <input type="checkbox"/> | D=54, - Halter       |        |
|                      |                   |    |  |       |  |                | 24.3541-1770.7 |                          |                      | 220708 |
|                      | 1.3 JTD 4x4 Cross | 51 |  | 04.06 |  | 24.5119-0477.3 | 330991         | 2                        | L=477                |        |
|                      |                   |    |  |       |  |                |                |                          |                      |        |
|                      | 1.3 JTD 4x4 Cross | 51 |  | 04.06 |  | 83.7101-9219.3 | 330903         | 2                        | L=219                |        |
|                      |                   |    |  |       |  |                |                |                          |                      |        |

| FIAT PANDA (12-) |                      |    |  |       |  |                |        |                          |                |
|------------------|----------------------|----|--|-------|--|----------------|--------|--------------------------|----------------|
|                  | 0.9                  | 48 |  | 02.12 |  | 11.9541-9831.2 | 220953 | <input type="checkbox"/> | D=54, - Halter |
|                  | 1.2                  | 51 |  | 02.12 |  |                | 220954 |                          |                |
|                  | 1.2 LPG              | 51 |  | 02.12 |  |                |        |                          |                |
|                  | 0.9                  | 48 |  | 02.12 |  | 24.5112-0356.3 | 331129 | 2                        | L=355          |
|                  | 0.9                  | 57 |  | 02.12 |  |                |        |                          |                |
|                  | 0.9                  | 63 |  | 02.12 |  |                |        |                          |                |
|                  | 0.9 4x4              | 63 |  | 09.12 |  |                |        |                          |                |
|                  | 0.9 CNG              | 63 |  | 07.12 |  |                |        |                          |                |
|                  | 0.9 Twinair Turbo NP | 59 |  | 02.12 |  |                |        |                          |                |
|                  | 1.2                  | 51 |  | 02.12 |  |                |        |                          |                |
|                  | 1.2 LPG              | 51 |  | 02.12 |  |                |        |                          |                |
|                  | 1.3 D Multijet       | 55 |  | 02.12 |  |                |        |                          |                |
|                  | 1.3 D Multijet 4x4   | 55 |  | 06.12 |  |                |        |                          |                |
|                  | 0.9                  | 48 |  | 02.12 |  | 24.3220-1728.3 | 020509 | <input type="checkbox"/> | Rz 20,64       |
|                  | 0.9                  | 57 |  | 02.12 |  |                |        |                          |                |
|                  | 0.9                  | 63 |  | 02.12 |  |                |        |                          |                |
|                  | 0.9 CNG              | 63 |  | 07.12 |  |                |        |                          |                |
|                  | 0.9 Twinair Turbo NP | 59 |  | 02.12 |  |                |        |                          |                |
|                  | 1.2                  | 51 |  | 02.12 |  |                |        |                          |                |
|                  | 1.2 LPG              | 51 |  | 02.12 |  |                |        |                          |                |
|                  | 1.3 D Multijet       | 55 |  | 02.12 |  |                |        |                          |                |
|                  | 0.9                  | 48 |  | 02.12 |  | 24.2520-1705.3 | 040093 | <input type="checkbox"/> | Nz 20,64       |
|                  | 0.9                  | 57 |  | 02.12 |  |                |        |                          |                |
|                  | 0.9                  | 63 |  | 02.12 |  |                |        |                          |                |
|                  | 0.9 4x4              | 63 |  | 09.12 |  |                |        |                          |                |
|                  | 0.9 CNG              | 63 |  | 07.12 |  |                |        |                          |                |
|                  | 0.9 Twinair Turbo NP | 59 |  | 02.12 |  |                |        |                          |                |
|                  | 1.2                  | 51 |  | 02.12 |  |                |        |                          |                |
|                  | 1.2 LPG              | 51 |  | 02.12 |  |                |        |                          |                |
|                  | 1.3 D Multijet       | 55 |  | 02.12 |  |                |        |                          |                |
|                  | 1.3 D Multijet 4x4   | 55 |  | 06.12 |  |                |        |                          |                |

| FIAT PUNTO (93-00)  |                       |  |       |       |                |                |                          |                          |                |        |                          |                |
|---------------------|-----------------------|--|-------|-------|----------------|----------------|--------------------------|--------------------------|----------------|--------|--------------------------|----------------|
|                     | 1.1 i (55)            |  |       | 11.93 | 09.99          | 24.2120-1710.3 | 010468                   | <input type="checkbox"/> | THz 20,64      |        |                          |                |
|                     | 1.2 i (60) Cabrio     |  |       | 03.94 | 06.00          |                |                          |                          |                |        |                          |                |
|                     | 1.2 i (60/75) Lim.    |  |       | 11.93 | 09.99          |                |                          |                          |                |        |                          |                |
|                     | 1.2 i 16V (85) Cabrio |  |       | 06.97 | 06.00          |                |                          |                          |                |        |                          |                |
|                     | 1.2 i 16V (85) Lim.   |  |       | 06.97 | 09.99          |                |                          |                          |                |        |                          |                |
|                     | 1.4 GT                |  |       | 06.97 | 09.99          |                |                          |                          |                |        |                          |                |
|                     | 1.6 i (90) Cabrio     |  |       | 03.94 | 05.97          |                |                          |                          |                |        |                          |                |
|                     | 1.6 i (90) Lim.       |  |       | 03.94 | 05.97          |                |                          |                          |                |        |                          |                |
|                     | 1.7 D                 |  |       | 01.95 | 05.97          |                |                          |                          |                |        |                          |                |
|                     | 1.7 TD                |  |       | 11.93 | 09.99          |                |                          |                          |                |        |                          |                |
| 1.4 GT              |                       |  | 11.93 | 05.97 | 24.2122-1716.3 | 010485         |                          | THz 22,20                |                |        |                          |                |
|                     | 1.1 i (55)            |  |       | 11.93 | 09.99          | 24.3481-1743.5 | 240305                   | <input type="checkbox"/> | D=48, - Halter |        |                          |                |
|                     | 1.2 i (60) Cabrio     |  |       | 03.94 | 06.00          |                | 24.3481-1744.5           |                          |                | 240306 |                          |                |
|                     | 1.2 i (60/75) Lim.    |  |       | 11.93 | 09.99          |                |                          |                          |                |        |                          |                |
|                     | 1.7 D                 |  |       | 01.95 | 05.97          |                |                          |                          |                |        |                          |                |
|                     | 1.2 i (60) Cabrio     |  |       | 03.94 | 06.00          |                | 24.3481-1703.5           |                          |                | 240051 | <input type="checkbox"/> | D=48, - Halter |
|                     | 1.2 i (60/75) Lim.    |  |       | 11.93 | 09.99          |                | 24.3481-1704.5           |                          |                | 240052 | <input type="checkbox"/> | D=48, - Halter |
|                     | 1.6 i (90) Cabrio     |  |       | 03.94 | 05.97          |                | 24.0101-4301.2           |                          |                | 260047 |                          | Einbausatz     |
|                     | 1.6 i (90) Lim.       |  |       | 03.94 | 05.97          |                |                          |                          |                |        |                          |                |
|                     | 1.7 TD                |  |       | 11.93 | 05.97          |                |                          |                          |                |        |                          |                |
|                     | 1.2 i 16V (85) Cabrio |  |       | 06.97 | 06.00          |                | 24.3481-1751.5           |                          |                | 240285 | <input type="checkbox"/> | D=48, - Halter |
| 1.2 i 16V (85) Lim. |                       |  | 06.97 | 09.99 | 24.3481-1752.5 | 240286         | <input type="checkbox"/> | D=48, - Halter           |                |        |                          |                |

1) + dynamic control / + dynamic control / + dynamic control / + Control dinámico

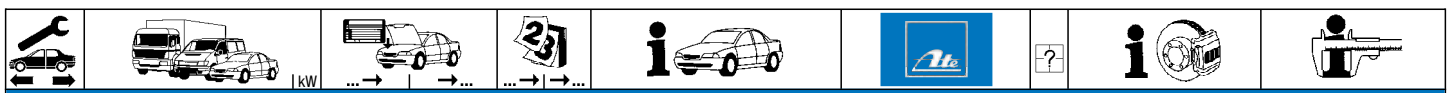

| FIAT PUNTO (93-00) |  |                                 |  |  |  |   |  |                                      |              |  |  |
|--------------------|--|---------------------------------|--|--|--|---|--|--------------------------------------|--------------|--|--|
|                    | 1.7 TD   |                                 |  | 06.97  | 09.99  |   | 24.3481-1751.5   | 240285                               |              | D=48, - Halter<br>D=48, - Halter   | <b>BDX</b><br><b>BDX</b>                             |
|                    | 1.1 i (55)<br>1.2 i (60) Cabrio<br>1.2 i (60/75) Lim.<br>1.2 i 16V (85) Cabrio<br>1.2 i 16V (85) Lim.<br>1.4 GT<br>1.6 i (90) Cabrio<br>1.6 i (90) Lim.<br>1.7 D<br>1.7 TD |                                 |  | 11.93<br>03.94<br>11.93<br>06.97<br>06.97<br>11.93<br>03.94<br>03.94<br>01.95<br>11.93 | 09.99<br>06.00<br>09.99<br>06.00<br>09.99<br>06.00<br>05.97<br>05.97<br>05.97<br>09.99 |   | 24.5112-0376.3<br>24.5112-0370.3<br>24.5112-0395.3<br>24.5112-0396.3 | 330514<br>330515<br>330521<br>330520 | <br><br><br> | Länge beachten/Schaltgetriebe <sup>1)</sup><br>Länge beachten/Schaltgetriebe <sup>1)</sup><br>Länge beachten/Automatikgetr. <sup>2)</sup><br>Länge beachten/Automatikgetr. <sup>2)</sup> | L=362<br>L=372<br>L=395<br>L=397                     |
|                    | 1.1 i (55)<br>1.2 i (60) Cabrio<br>1.2 i (60/75) Lim.<br>1.2 i 16V (85) Cabrio<br>1.2 i 16V (85) Lim.<br>1.6 i (90) Cabrio<br>1.6 i (90) Lim.<br>1.7 D<br>1.7 TD           |                                 |  | 11.93<br>03.94<br>11.93<br>06.97<br>06.97<br>03.94<br>03.94<br>01.95<br>11.93          | 09.99<br>06.00<br>09.99<br>06.00<br>09.99<br>05.97<br>05.97<br>05.97<br>09.99          |   | 24.3220-1108.3<br>24.3220-1107.3                                     | 020219<br>020218                     |              | Rz 20,64<br>Rz 20,64   | <b>BDX</b><br><b>AP</b>                              |
|                    | 1.1 i (55)<br>1.2 i (60) Cabrio<br>1.2 i (60/75) Lim.<br>1.2 i 16V (85) Cabrio<br>1.2 i 16V (85) Lim.<br>1.6 i (90) Cabrio<br>1.6 i (90) Lim.<br>1.7 D<br>1.7 TD           |                                 |  | 11.93<br>03.94<br>11.93<br>06.97<br>06.97<br>03.94<br>03.94<br>01.95<br>11.93          | 09.99<br>06.00<br>09.99<br>06.00<br>09.99<br>05.97<br>05.97<br>05.97<br>09.99          |   | 24.3727-0526.2<br>24.3727-0525.2                                     | 580526<br>580525                     | <br>         | L=1456<br>L=1469   |  |
|                    | 1.1 i (55)<br>1.1 i (55)<br>1.2 i (60) Cabrio<br>1.2 i (60) Lim.<br>1.2 i (60/75) Lim.<br>1.2 i 16V (85) Lim.<br>1.4 GT  |                                 |  | 06.97<br>11.93<br>03.94<br>06.97<br>11.93<br>06.97<br>06.97                            | 09.99<br>05.97<br>05.95<br>09.99<br>05.97<br>- ABS<br>- ABS                            |   | 24.6513-1705.3   | 320237                               |              | BRL (2)  |  |
|                    | 1.1 i (55)<br>1.2 i (60) Cabrio<br>1.2 i (60/75) Lim.<br>1.6 i (90) Cabrio<br>1.6 i (90) Lim.  | ↑<br>↑<br>↑<br>↑<br>↑           |  | 11.93<br>03.94<br>11.93<br>03.94<br>03.94  | 08.94<br>08.94<br>08.94<br>08.94<br>08.94  |   | 24.3728-0521.2   | 590521                               |              | L=854  |  |
|                    | 1.1 i (55)<br>1.2 i (60) Cabrio<br>1.2 i (60/75) Lim.<br>1.2 i 16V (85) Cabrio<br>1.2 i 16V (85) Lim.<br>1.6 i (90) Cabrio<br>1.6 i (90) Lim.                              | ↑<br>↑<br>↑<br>↑<br>↑<br>↑<br>↑ |  | 09.94<br>09.94<br>09.94<br>06.97<br>06.97<br>09.94<br>09.94                            | 09.99<br>06.00<br>09.99<br>06.00<br>09.99<br>05.97<br>05.97                            |   | 24.3728-0516.2   | 590516                               |              | L=856  |  |
| FIAT PUNTO (00-03) |  |                                 |  |  |  |   |  |                                      |              |  |  |
|                    | 1.2 i<br>1.2 i 16V<br>1.8 i 16V<br>1.9 D<br>1.9 JTD  |                                 |  | 10.99<br>10.99<br>10.99<br>10.99<br>10.99  | 06.03<br>06.03<br>06.03<br>06.03<br>06.03  |   | 24.2120-1742.3   | 010776                               |              | Thz 20,64  |  |
|                    | 1.2 i<br>1.2 i 16V<br>1.2 i 16V<br>1.9 D<br>1.9 JTD  |                                 |  | 10.99<br>10.99<br>10.99<br>10.99<br>10.99  | 06.03<br>06.03<br>06.03<br>06.03<br>06.03  |   | 24.3481-1743.5<br>24.3481-1744.5                                     | 240305<br>240306                     | <br>         | D=48, - Halter<br>D=48, - Halter   | <b>BDX</b><br><b>BDX</b>                             |
|                    | 1.2 i 16V<br>1.2 i 16V<br>1.9 D<br>1.9 JTD   |                                 |  | 10.99<br>10.99<br>10.99<br>10.99   | 06.03<br>06.03<br>06.03<br>06.03   | + Schaltgetriebe <sup>3)</sup><br>+ Automatikgetriebe <sup>4)</sup> | 24.3481-1751.5<br>24.3481-1752.5<br>24.3541-1787.5<br>24.3541-1788.5 | 240285<br>240286<br>240289<br>240290 | <br><br><br> | D=48, - Halter<br>D=48, - Halter<br>D=54, - Halter<br>D=54, - Halter   | <b>BDX</b><br><b>BDX</b><br><b>ATE</b><br><b>ATE</b> |
|                    | 1.2 i<br>1.2 i 16V<br>1.8 i 16V<br>1.9 D<br>1.9 JTD  |                                 |  | 10.99<br>10.99<br>10.99<br>10.99<br>10.99  | 06.03<br>06.03<br>06.03<br>06.03<br>06.03  |   | 83.6401-0454.3   | 330860                               | 2            | L=453  |  |
|                    | 1.2 i<br>1.2 i 16V<br>1.8 i 16V<br>1.9 D<br>1.9 JTD  |                                 |  | 10.99<br>10.99<br>10.99<br>10.99<br>10.99  | 06.03<br>06.03<br>06.03<br>06.03<br>06.03  |   | 83.7201-9173.3   | 330868                               | 2            | L=173  |  |
|                    | 1.2 i<br>1.2 i 16V<br>1.2 i 16V<br>1.9 D<br>1.9 JTD  |                                 |  | 10.99<br>10.99<br>10.99<br>10.99<br>10.99  | 06.03<br>06.03<br>06.03<br>06.03<br>06.03  | + Schaltgetriebe <sup>3)</sup><br>+ Automatikgetriebe <sup>4)</sup> | 24.3220-1720.3<br>24.3222-1723.3                                     | 020455<br>020459                     |              | Rz 20,64<br>Rz 22,00   |  |
|                    | 1.2 i<br>1.2 i 16V<br>1.9 D<br>1.9 JTD   |                                 |  | 10.99<br>10.99<br>10.99<br>10.99   | 06.03<br>06.03<br>06.03<br>06.03   |   | 24.3727-0538.2   | 580538                               | 2 ↓          | L=1456, - Zub  |  |

<sup>1)</sup> notice length/ manual transm. / attenz.lunghezza/cambio veloc. / fair.att.longueur/trans.mécan. / atención largo/ camb.velocidad  
<sup>2)</sup> notice length/ autom.transm. / attenz.lunghezza/cambio autom. / fair.att.longueur/trans.autom. / atención largo/ cambio autom.  
<sup>3)</sup> + manual transmission / + scatola cambio velocità / + transmission mécanique / + cambio de velocidad  
<sup>4)</sup> + autom.transmission / + scatola cambio automatico / + transmission automatique / + cambio automático



| FIAT PUNTO (00-03)           |  | 10.99  |  | 06.03  |   | 03.0101-0032.2   |                                      | 320231 |   | - ABS  |  | BRES 3/25  |                          | ATE |  |
|------------------------------|--|--|--|--|---|--|--------------------------------------|--------|---|--|--|--|--------------------------|-----|--|
|                              | 1.2 i<br>1.2 i 16V<br>1.8 i 16V<br>1.9 D<br>1.9 JTD  |  |  | 10.99<br>10.99<br>10.99<br>10.99   | 06.03<br>06.03<br>06.03<br>06.03                            |  |                                      |        |   |  |  |  |                          |     |  |
| FIAT PUNTO (03-06)           |  | 07.03  |  | 11.05  |   | 24.2120-1742.3   |                                      | 010776 |   | - ABS  |  | THz 20,64  |                          |     |  |
|                              | 1.2 i<br>1.2 i 16V<br>1.3 JTD 16V<br>1.4 i 16V<br>1.9 JTD  |  |  | 07.03<br>07.03<br>07.03<br>07.03   | 11.05<br>11.05<br>11.05<br>11.05                            | 24.2120-1742.3<br>24.2120-1743.3                                     | 010776<br>010777                     |        |   | - ABS<br>+ ABS   |  | THz 20,64<br>THz 20,64   |                          |     |  |
|                              | 1.3 JTD 16V<br>1.4 i 16V<br>1.8 i 16V<br>1.9 JTD   | 63   |  | 07.03<br>07.03<br>07.03<br>07.03   | 11.05<br>11.05<br>11.05<br>11.05                            | 24.2122-1760.3<br>24.2122-1763.3                                     | 010821<br>010838                     |        |   | - ABS<br>+ ABS   |  | THz 22,20<br>THz 22,20   |                          |     |  |
|                              | 1.3 JTD 16V<br>1.4 i 16V<br>1.8 i 16V<br>1.9 JTD   |  |  | 07.03<br>07.03<br>07.03<br>07.03   | 11.05<br>11.05<br>11.05<br>11.05                            | 24.2122-1768.3   | 010853                               |        |   | + Dynamic Control <sup>1)</sup>  |  | THz 22,20  |                          |     |  |
|                              | 1.2 i 16V<br>1.3 JTD 16V<br>1.4 i 16V<br>1.9 JTD   |  |  | 07.03<br>07.03<br>07.03<br>07.03   | 11.05<br>11.05<br>11.05<br>11.05                            | 24.3481-1751.5<br>24.3481-1752.5<br>24.3541-1787.5<br>24.3541-1788.5 | 240285<br>240286<br>240289<br>240290 |        |   | + Schaltgetriebe <sup>2)</sup><br>+ Schaltgetriebe <sup>2)</sup><br>+ Automatikgetriebe <sup>3)</sup><br>+ Automatikgetriebe <sup>3)</sup> |  | D=48, - Halter<br>D=48, - Halter<br>D=54, - Halter<br>D=54, - Halter | BDX<br>BDX<br>ATE<br>ATE |     |  |
|                              | 1.3 JTD 16V<br>1.4 i 16V<br>1.9 JTD  | 63   |  | 07.03<br>07.03<br>07.03  | 11.05<br>11.05<br>11.05                                     | 24.3541-1789.5<br>24.3541-1790.5                                     | 240291<br>240292                     |        |   |  |  | D=54, - Halter<br>D=54, - Halter                                     | ATE<br>ATE               |     |  |
|                              | 1.2 i<br>1.2 i 16V<br>1.3 JTD 16V<br>1.4 i 16V<br>1.8 i 16V<br>1.9 JTD<br>1.9 JTD  |  |  | 07.03<br>07.03<br>07.03<br>07.03<br>07.03<br>07.03<br>07.03  | 11.05<br>11.05<br>11.05<br>11.05<br>11.05<br>11.05<br>11.05 | 83.6401-0454.3   | 330860                               | 2      |   |  |  | L=453  |                          |     |  |
|                              | 1.2 i<br>1.2 i 16V<br>1.3 JTD 16V<br>1.4 i 16V<br>1.8 i 16V<br>1.9 JTD<br>1.9 JTD  |  |  | 07.03<br>07.03<br>07.03<br>07.03<br>07.03<br>07.03<br>07.03  | 11.05<br>11.05<br>11.05<br>11.05<br>11.05<br>11.05<br>11.05 | 24.5112-0220.3   | 330613                               | 2      |   |  |  | L=220  |                          |     |  |
|                              | 1.2 i<br>1.2 i 16V<br>1.3 JTD 16V<br>1.9 JTD   |  |  | 07.03<br>07.03<br>07.03<br>07.03   | 11.05<br>11.05<br>11.05<br>11.05                            | 24.3220-1720.3   | 020455                               |        |   | - ABS<br>- ABS   |  | Rz 20,64   |                          |     |  |
|                              | 1.2 i<br>1.2 i 16V<br>1.3 JTD 16V<br>1.9 JTD   | 63   |  | 07.03<br>07.03<br>07.03<br>07.03   | 11.05<br>11.05<br>11.05<br>11.05                            | 24.3222-1723.3   | 020459                               |        |   | + ABS<br>+ ABS   |  | Rz 22,00   |                          |     |  |
|                              | 1.4 i 16V  |  |  | 07.03  | 11.05   | 24.3220-1723.3   | 020468                               |        |   |  |  | Rz 20,64   |                          |     |  |
|                              | 1.2 i<br>1.2 i 16V<br>1.3 JTD 16V<br>1.9 JTD   |  |  | 07.03<br>07.03<br>07.03<br>07.03   | 11.05<br>11.05<br>11.05<br>11.05                            | 24.3727-0538.2   | 580538                               | 2      | ↓ |  |  | L=1456, - Zub  |                          |     |  |
|                              | 1.4 i 16V  | 63   |  | 07.03  | 11.05   | 24.3727-0563.2   | 580563                               | 2      | ↓ |  |  | L=1467   |                          |     |  |
|                              | 1.2 i<br>1.2 i 16V<br>1.3 JTD 16V<br>1.4 i 16V<br>1.8 i 16V<br>1.9 JTD   |  |  | 07.03<br>07.03<br>07.03<br>07.03<br>07.03<br>07.03   | 11.05<br>11.05<br>11.05<br>11.05<br>11.05<br>11.05          | 24.2415-1709.3   | 030123                               |        |   |  |  | Gz 15,87   |                          |     |  |
|                              | 1.2 i<br>1.4 i 16V   | 63   |  | 07.03<br>07.03   | 11.05<br>11.05  | 24.2520-1705.3   | 040093                               |        |   |  |  | Nz 20,64   |                          |     |  |
| FIAT PUNTO / PUNTO EVO (09-) |  | 03.12  |  | 10.09  |   | 24.4122-1709.3   |                                      | 010871 |   | + Schaltgetriebe <sup>2)</sup>   |  | THz 22,20 + Behälter   |                          | BOS |  |
|                              | 0.9 Bifuel<br>0.9 Twinair Turbo<br>1.2<br>1.2<br>1.3 D Multijet<br>1.3 D Multijet<br>1.3 D Multijet<br>1.3 D Multijet<br>1.3 D Multijet<br>1.4<br>1.4 16V<br>1.4 16V<br>1.4 LPG<br>1.4 MultiAir<br>1.4 MultiAir<br>1.4 Natural Power<br>1.6 D Multijet | 63<br>63<br>48<br>51<br>51<br>55<br>62<br>66<br>70<br>77<br>99<br>57<br>77<br>99<br>57<br>88 |  | 03.12<br>03.12<br>10.09<br>10.09<br>07.08<br>10.09<br>10.09<br>10.09<br>10.09<br>10.09<br>10.09<br>06.09<br>03.12<br>03.12<br>10.09<br>10.09 |   | 24.4122-1709.3   | 010871                               |        |   | + Schaltgetriebe <sup>2)</sup>   |  | THz 22,20 + Behälter   | BOS                      |     |  |
|                              | 0.9 Bifuel<br>0.9 Twinair Turbo<br>1.2<br>1.2<br>1.3 D Multijet  | 63<br>63<br>48<br>51<br>51   |  | 03.12<br>03.12<br>10.09<br>10.09<br>07.08  |   | 24.3541-1769.7<br>24.3541-1770.7                                     | 220707<br>220708                     |        |   |  |  | D=54, - Halter<br>D=54, - Halter                                     | BOS<br>BOS               |     |  |

<sup>1)</sup> + dynamic control / + dynamic control / + dynamic control / + Control dinámico  
<sup>2)</sup> + manual transmission / + scatola cambio velocità / + transmission mécanique / + cambio de velocidad  
<sup>3)</sup> + automatic transmission / + scatola cambio automatico / + transm. automatique / + cambio automático

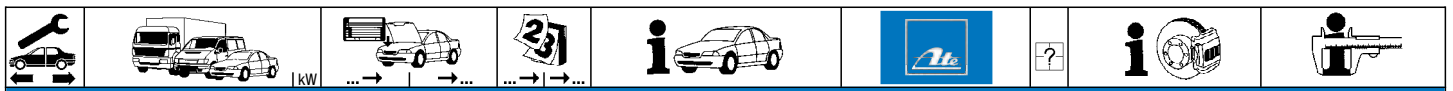

**FIAT PUNTO / PUNTO EVO (09-)**

|  |                   |     |  |       |                                   |                |        |                          |                              |          |
|--|-------------------|-----|--|-------|-----------------------------------|----------------|--------|--------------------------|------------------------------|----------|
|  | 0.9 Bifuel        | 63  |  | 03.12 |                                   | 24.5112-0402.3 | 331297 | 2                        |                              | L=402    |
|  | 0.9 Twinair Turbo | 63  |  | 03.12 |                                   |                |        |                          |                              |          |
|  | 1.2               | 48  |  | 10.09 |                                   |                |        |                          |                              |          |
|  | 1.2               | 51  |  | 10.09 |                                   |                |        |                          |                              |          |
|  | 1.3 D Multijet    | 51  |  | 07.08 |                                   |                |        |                          |                              |          |
|  | 1.3 D Multijet    | 55  |  | 10.09 |                                   |                |        |                          |                              |          |
|  | 1.3 D Multijet    | 62  |  | 10.09 |                                   |                |        |                          |                              |          |
|  | 1.3 D Multijet    | 66  |  | 10.09 |                                   |                |        |                          |                              |          |
|  | 1.3 D Multijet    | 70  |  | 10.09 |                                   |                |        |                          |                              |          |
|  | 1.4               |     |  | 10.09 |                                   |                |        |                          |                              |          |
|  | 1.4 16V           | 77  |  | 10.09 |                                   |                |        |                          |                              |          |
|  | 1.4 16V           | 99  |  | 10.09 |                                   |                |        |                          |                              |          |
|  | 1.4 LPG           | 57  |  | 06.09 |                                   |                |        |                          |                              |          |
|  | 1.4 MultiAir      | 77  |  | 03.12 |                                   |                |        |                          |                              |          |
|  | 1.4 MultiAir      | 99  |  | 03.12 |                                   |                |        |                          |                              |          |
|  | 1.4 Natural Power | 57  |  | 10.09 |                                   |                |        |                          |                              |          |
|  | 1.6 D Multijet    | 88  |  | 10.09 |                                   |                |        |                          |                              |          |
|  | 0.9 Bifuel        | 63  |  | 03.12 |                                   | 24.5112-0142.3 | 331016 | 2                        | am Bremssattel <sup>1)</sup> | L=142    |
|  | 0.9 Twinair Turbo | 63  |  | 03.12 |                                   | 24.5228-0216.3 | 330908 | 2                        |                              | L=216    |
|  | 1.2               | 48  |  | 10.09 |                                   |                |        |                          |                              |          |
|  | 1.2               | 51  |  | 10.09 |                                   |                |        |                          |                              |          |
|  | 1.3 D Multijet    | 55  |  | 10.09 |                                   |                |        |                          |                              |          |
|  | 1.3 D Multijet    | 55  |  | 10.09 |                                   |                |        |                          |                              |          |
|  | 1.3 D Multijet    | 62  |  | 10.09 |                                   |                |        |                          |                              |          |
|  | 1.3 D Multijet    | 66  |  | 10.09 |                                   |                |        |                          |                              |          |
|  | 1.3 D Multijet    | 70  |  | 10.09 |                                   |                |        |                          |                              |          |
|  | 1.4               |     |  | 10.09 |                                   |                |        |                          |                              |          |
|  | 1.4 16V           | 77  |  | 10.09 |                                   |                |        |                          |                              |          |
|  | 1.4 16V           | 99  |  | 10.09 |                                   |                |        |                          |                              |          |
|  | 1.4 Abarth        |     |  | 10.09 |                                   |                |        |                          |                              |          |
|  | 1.4 LPG           | 57  |  | 06.09 |                                   |                |        |                          |                              |          |
|  | 1.4 MultiAir      | 77  |  | 03.12 |                                   |                |        |                          |                              |          |
|  | 1.4 MultiAir      | 99  |  | 03.12 |                                   |                |        |                          |                              |          |
|  | 1.4 Natural Power | 57  |  | 10.09 |                                   |                |        |                          |                              |          |
|  | 1.6 D Multijet    | 88  |  | 10.09 |                                   |                |        |                          |                              |          |
|  | 2.0 Abarth        | 199 |  | 10.09 |                                   |                |        |                          |                              |          |
|  | 0.9 Bifuel        | 63  |  | 03.12 |                                   | 24.3220-1728.3 | 020509 |                          |                              | Rz 20,64 |
|  | 0.9 Twinair Turbo | 63  |  | 03.12 |                                   |                |        |                          |                              |          |
|  | 1.2               | 48  |  | 10.09 |                                   |                |        |                          |                              |          |
|  | 1.3 D Multijet    | 51  |  | 07.08 |                                   |                |        |                          |                              |          |
|  | 1.3 D Multijet    | 55  |  | 10.09 |                                   |                |        |                          |                              |          |
|  | 1.3 D Multijet    | 62  |  | 10.09 |                                   |                |        |                          |                              |          |
|  | 1.3 D Multijet    | 66  |  | 10.09 |                                   |                |        |                          |                              |          |
|  | 1.3 D Multijet    | 70  |  | 10.09 |                                   |                |        |                          |                              |          |
|  | 1.4               |     |  | 10.09 |                                   |                |        |                          |                              |          |
|  | 1.4 16V           | 77  |  | 10.09 |                                   |                |        |                          |                              |          |
|  | 1.4 16V           | 99  |  | 10.09 |                                   |                |        |                          |                              |          |
|  | 1.4 MultiAir      | 77  |  | 03.12 |                                   |                |        |                          |                              |          |
|  | 1.4 MultiAir      | 99  |  | 03.12 |                                   |                |        |                          |                              |          |
|  | 0.9 Bifuel        | 63  |  | 03.12 |                                   | 24.3727-0575.2 | 580575 | <input type="checkbox"/> |                              | L=1642   |
|  | 0.9 Twinair Turbo | 63  |  | 03.12 |                                   | 24.3727-0576.2 | 580576 | <input type="checkbox"/> |                              | L=1660   |
|  | 1.2               | 48  |  | 10.09 |                                   |                |        |                          |                              |          |
|  | 1.3 D Multijet    | 51  |  | 07.08 | + HA-Trommelbremse <sup>2)</sup>  | 24.3727-0577.2 | 580577 | <input type="checkbox"/> |                              | L=1674   |
|  | 1.3 D Multijet    | 55  |  | 10.09 | + HA-Trommelbremse <sup>2)</sup>  | 24.3727-0578.2 | 580578 | <input type="checkbox"/> |                              | L=1689   |
|  | 1.3 D Multijet    | 62  |  | 10.09 | + HA-Trommelbremse <sup>2)</sup>  |                |        |                          |                              |          |
|  | 1.3 D Multijet    | 66  |  | 10.09 | + HA-Trommelbremse <sup>2)</sup>  |                |        |                          |                              |          |
|  | 1.3 D Multijet    | 70  |  | 10.09 | + HA-Trommelbremse <sup>2)</sup>  |                |        |                          |                              |          |
|  | 1.4               |     |  | 10.09 | + HA-Trommelbremse <sup>2)</sup>  |                |        |                          |                              |          |
|  | 1.4 16V           | 77  |  | 10.09 | + HA-Trommelbremse <sup>2)</sup>  |                |        |                          |                              |          |
|  | 1.4 16V           | 99  |  | 10.09 | + HA-Trommelbremse <sup>2)</sup>  |                |        |                          |                              |          |
|  | 1.4 MultiAir      | 77  |  | 03.12 | + HA-Trommelbremse <sup>2)</sup>  |                |        |                          |                              |          |
|  | 1.4 MultiAir      | 99  |  | 03.12 | + HA-Trommelbremse <sup>2)</sup>  |                |        |                          |                              |          |
|  | 1.2               | 51  |  | 10.09 | + HA-Scheibenbremse <sup>3)</sup> | 24.3727-0579.2 | 580579 | <input type="checkbox"/> |                              | L=1654   |
|  | 1.3 D Multijet    | 51  |  | 07.08 | + HA-Scheibenbremse <sup>3)</sup> | 24.3727-0580.2 | 580580 | <input type="checkbox"/> |                              | L=1673   |
|  | 1.3 D Multijet    | 55  |  | 10.09 | + HA-Scheibenbremse <sup>3)</sup> |                |        |                          |                              |          |
|  | 1.3 D Multijet    | 62  |  | 10.09 | + HA-Scheibenbremse <sup>3)</sup> |                |        |                          |                              |          |
|  | 1.3 D Multijet    | 66  |  | 10.09 | + HA-Scheibenbremse <sup>3)</sup> |                |        |                          |                              |          |
|  | 1.3 D Multijet    | 70  |  | 10.09 | + HA-Scheibenbremse <sup>3)</sup> |                |        |                          |                              |          |
|  | 1.4               |     |  | 10.09 | + HA-Scheibenbremse <sup>3)</sup> |                |        |                          |                              |          |
|  | 1.4 16V           | 77  |  | 10.09 | + HA-Scheibenbremse <sup>3)</sup> |                |        |                          |                              |          |
|  | 1.4 16V           | 99  |  | 10.09 | + HA-Scheibenbremse <sup>3)</sup> |                |        |                          |                              |          |
|  | 1.4 Abarth        |     |  | 10.09 |                                   |                |        |                          |                              |          |
|  | 1.4 LPG           | 57  |  | 06.09 |                                   |                |        |                          |                              |          |
|  | 1.4 MultiAir      | 77  |  | 03.12 | + HA-Scheibenbremse <sup>3)</sup> |                |        |                          |                              |          |
|  | 1.4 MultiAir      | 99  |  | 03.12 | + HA-Scheibenbremse <sup>3)</sup> |                |        |                          |                              |          |
|  | 1.4 Natural Power | 57  |  | 10.09 |                                   |                |        |                          |                              |          |
|  | 1.6 D Multijet    | 88  |  | 10.09 |                                   |                |        |                          |                              |          |
|  | 2.0 Abarth        | 199 |  | 10.09 |                                   |                |        |                          |                              |          |

**FIAT GRANDE PUNTO (06-11)**

|  |                |    |  |       |       |                |        |  |                                 |                          |
|--|----------------|----|--|-------|-------|----------------|--------|--|---------------------------------|--------------------------|
|  | 1.2            |    |  | 10.05 | 08.10 | 24.4122-1709.3 | 010871 |  | + Dynamic Control <sup>4)</sup> | THz 22,20 + Behälter BOS |
|  | 1.3 D Multijet | 51 |  | 10.05 | 08.10 |                |        |  |                                 |                          |
|  | 1.3 D Multijet | 55 |  | 04.08 | 08.10 |                |        |  |                                 |                          |
|  | 1.3 D Multijet | 62 |  | 04.10 | 08.10 |                |        |  |                                 |                          |
|  | 1.3 D Multijet | 66 |  | 10.05 | 08.10 |                |        |  |                                 |                          |
|  | 1.4            |    |  | 10.05 | 08.10 |                |        |  |                                 |                          |
|  | 1.4 16V        |    |  | 10.05 | 08.10 |                |        |  |                                 |                          |

















<sup>1)</sup> on the brake caliper / sulla pinza freno / sur l'étrier de frein / a la pinza de freno

<sup>2)</sup> + RA drum brake / + P freno a tamburo / + frein à tambour essieu AR / + ET-tambores de freno

<sup>3)</sup> + RA disc brake / + P disco freno / + frein à disque essieu AR / + ET-disco de freno

<sup>4)</sup> + dynamic control / + dynamic control / + dynamic control / + Control dinámico



|     |  |  |  |  |  |  |  |  |                                 |
|--|--|--|--|--|---|--|--|--|---------------------------------|
| <b>FIAT GRANDE PUNTO (06-11)</b>   |  |  |  |  |   |  |  |  |                                 |
|    | 1.4 LPG  | 57   |  | 12.08  | 08.10   | 24.4122-1709.3   | 010871   | + Dynamic Control <sup>1)</sup>  | THz 22,20 + Behälter <b>BOS</b> |
|  | 1.4 Natural Power  | 57   |  | 07.08  | 08.10   |  |  |  |                                 |
|  | 1.4 T-Jet  | 88   |  | 07.07  | 08.10   |  |  |  |                                 |
|  | 1.6 D Multijet   | 88   |  | 07.08  | 08.10   |  |  |  |                                 |
|  | 1.9 JTD  |  |  | 10.05  | 08.10   |  |  |  |                                 |
|  | 1.9 JTD  | 96   |  | 02.06  | 08.10   |  |  |  |                                 |
|    | 1.2  |  |  | 10.05  | 01.11   | 24.3541-1837.7   | 220745   | <input type="checkbox"/>   | D=54, - Halter <b>BOS</b>       |
|  | 1.2  | 51   |  | 09.10  | 01.11   | 24.3541-1838.7   | 220746   | <input type="checkbox"/>   | D=54, - Halter <b>BOS</b>       |
|  | 1.3 D Multijet   | 51   |  | 10.05  | 01.11   | 24.3541-1769.7   | 220707   | <input type="checkbox"/>   | D=54, - Halter <b>BOS</b>       |
|  | 1.3 D Multijet   | 55   |  | 04.08  | 01.11   | 24.3541-1770.7   | 220708   | <input type="checkbox"/>   | D=54, - Halter <b>BOS</b>       |
|  | 1.4  |  |  | 10.05  | 01.11   |  |  |  |                                 |
|  | 1.4 16V  |  |  | 10.05  | 01.11   |  |  |  |                                 |
|  | 1.4 LPG  | 57   |  | 12.08  | 01.11   |  |  |  |                                 |
|  | 1.4 Natural Power  | 57   |  | 07.08  | 01.11   |  |  |  |                                 |
|    | 1.2  |  |  | 10.05  | 01.11   | 24.5112-0402.3   | 331297   | 2  | L=402                           |
|  | 1.2  | 51   |  | 09.10  | 01.11   |  |  |  |                                 |
|  | 1.3 D Multijet   | 51   |  | 10.05  | 01.11   |  |  |  |                                 |
|  | 1.3 D Multijet   | 55   |  | 04.08  | 01.11   |  |  |  |                                 |
|  | 1.3 D Multijet   | 62   |  | 04.10  | 01.11   |  |  |  |                                 |
|  | 1.3 D Multijet   | 66   |  | 10.05  | 01.11   |  |  |  |                                 |
|  | 1.4  |  |  | 10.05  | 01.11   |  |  |  |                                 |
|  | 1.4 16V  |  |  | 10.05  | 01.11   |  |  |  |                                 |
|  | 1.4 LPG  | 57   |  | 12.08  | 01.11   |  |  |  |                                 |
|  | 1.4 Natural Power  | 57   |  | 07.08  | 01.11   |  |  |  |                                 |
|  | 1.4 T-Jet  | 88   |  | 07.07  | 01.11   |  |  |  |                                 |
|  | 1.6 D Multijet   | 88   |  | 07.08  | 01.11   |  |  |  |                                 |
|  | 1.9 JTD  |  |  | 10.05  | 01.11   |  |  |  |                                 |
|  | 1.9 JTD  | 96   |  | 02.06  | 01.11   |  |  |  |                                 |
|    | 1.2  |  |  | 10.05  | 01.11   | 24.5112-0142.3   | 331016   | 2  | am Bremsattel <sup>2)</sup>     |
|  | 1.2  | 51   |  | 09.10  | 01.11   | 24.5228-0216.3   | 330908   | 2  | L=142<br>L=216                  |
|  | 1.3 D Multijet   | 51   |  | 10.05  | 01.11   |  |  |  |                                 |
|  | 1.3 D Multijet   | 55   |  | 04.08  | 01.11   |  |  |  |                                 |
|  | 1.3 D Multijet   | 62   |  | 04.10  | 01.11   |  |  |  |                                 |
|  | 1.3 D Multijet   | 66   |  | 10.05  | 01.11   |  |  |  |                                 |
|  | 1.4  |  |  | 10.05  | 01.11   |  |  |  |                                 |
|  | 1.4 16V  |  |  | 10.05  | 01.11   |  |  |  |                                 |
|  | 1.4 Abarth   | 114  |  | 10.07  | 01.11   |  |  |  |                                 |
|  | 1.4 Abarth   | 132  |  | 12.07  | 01.11   |  |  |  |                                 |
|  | 1.4 LPG  | 57   |  | 12.08  | 01.11   |  |  |  |                                 |
|  | 1.4 Natural Power  | 57   |  | 07.08  | 01.11   |  |  |  |                                 |
|  | 1.4 T-Jet  | 88   |  | 07.07  | 01.11   |  |  |  |                                 |
|  | 1.6 D Multijet   | 88   |  | 07.08  | 01.11   |  |  |  |                                 |
|  | 1.9 JTD  |  |  | 10.05  | 01.11   |  |  |  |                                 |
|  | 1.9 JTD  | 96   |  | 02.06  | 01.11   |  |  |  |                                 |
|  | 1.2  |  |  | 10.05  | 01.11   | 24.3220-1728.3   | 020509   |  | Rz 20,64                        |
|  | 1.2  | 51   |  | 09.10  | 01.11   |  |  |  |                                 |
|  | 1.3 D Multijet   | 51   |  | 10.05  | 01.11   |  |  |  |                                 |
|  | 1.3 D Multijet   | 55   |  | 04.08  | 01.11   |  |  |  |                                 |
|  | 1.3 D Multijet   | 62   |  | 04.10  | 01.11   |  |  |  |                                 |
|  | 1.3 D Multijet   | 66   |  | 10.05  | 01.11   |  |  |  |                                 |
|  | 1.4  |  |  | 10.05  | 01.11   |  |  |  |                                 |
|  | 1.4 16V  |  |  | 10.05  | 01.11   |  |  |  |                                 |
|  | 1.4 LPG  | 57   |  | 12.08  | 01.11   |  |  |  |                                 |
|  | 1.4 Natural Power  | 57   |  | 07.08  | 01.11   |  |  |  |                                 |
|  | 1.2  |  |  | 10.05  | 01.11   | 24.3727-0575.2   | 580575   | <input type="checkbox"/>   | L=1642                          |
|  | 1.2  | 51   |  | 09.10  | 01.11   | 24.3727-0576.2   | 580576   | <input type="checkbox"/>   | L=1660                          |
|  | 1.3 D Multijet   | 51   |  | 10.05  | 01.11   | 24.3727-0577.2   | 580577   | <input type="checkbox"/>   | L=1674                          |
|  | 1.3 D Multijet   | 55   |  | 04.08  | 01.11   | 24.3727-0578.2   | 580578   | <input type="checkbox"/>   | L=1689                          |
|  | 1.3 D Multijet   | 62   |  | 04.10  | 01.11   |  |  |  |                                 |
|  | 1.3 D Multijet   | 66   |  | 10.05  | 01.11   |  |  |  |                                 |
|  | 1.4  |  |  | 10.05  | 01.11   |  |  |  |                                 |
|  | 1.4 16V  |  |  | 10.05  | 01.11   |  |  |  |                                 |
|  | 1.4 LPG  | 57   |  | 12.08  | 01.11   |  |  |  |                                 |
|  | 1.4 Natural Power  | 57   |  | 07.08  | 01.11   |  |  |  |                                 |
|  | 1.4 Abarth   | 114  |  | 10.07  | 01.11   | 24.3727-0579.2   | 580579   | <input type="checkbox"/>   | L=1654                          |
|  | 1.4 Abarth   | 132  |  | 12.07  | 01.11   | 24.3727-0580.2   | 580580   | <input type="checkbox"/>   | L=1673                          |
|  | 1.4 T-Jet  | 88   |  | 07.07  | 01.11   |  |  |  |                                 |
|  | 1.6 D Multijet   | 88   |  | 07.08  | 01.11   |  |  |  |                                 |
|  | 1.9 JTD  |  |  | 10.05  | 01.11   |  |  |  |                                 |
|  | 1.9 JTD  | 96   |  | 02.06  | 01.11   |  |  |  |                                 |
| <b>FIAT SCUDO (95-06)</b>  |  |  |  |  |   |  |  |  |                                 |
|  | 1.6 i.e.   |  |  | 11.95  | 12.06   | 24.2122-1703.3   | 010422   | - ABS  | THz 22,20                       |
|  | 1.9 D  |  |  | 11.95  | 12.06   | 24.2122-1708.3   | 010437   | + ABS  | THz 22,20                       |
|  | 1.9 TD   |  |  | 11.95  | 12.06   |  |  |  |                                 |
|  | 2.0 i 16V  |  |  | 06.00  | 12.06   |  |  |  |                                 |
|  | 2.0 JTD  |  |  | 12.99  | 12.06   |  |  |  |                                 |
|  | 1.6 i.e.   |  |  | 11.95  | 12.06   | 24.3571-1711.5   | 240159   | <input type="checkbox"/>   | D=57, - Halter <b>BDX</b>       |
|  | 1.9 D  |  |  | 11.95  | 12.06   | 24.3571-1712.5   | 240160   | <input type="checkbox"/>   | D=57, - Halter <b>BDX</b>       |
|  | 1.9 TD   |  |  | 11.95  | 12.06   |  |  |  |                                 |
|  | 2.0 i 16V  |  |  | 06.00  | 12.06   |  |  |  |                                 |
|  | 2.0 JTD  |  |  | 12.99  | 12.06   |  |  |  |                                 |
|  | 1.6 i.e.   |  |  | 11.95  | 09.03   | 24.3571-1709.5   | 240153   | <input type="checkbox"/>   | D=57, - Halter <b>LUC</b>       |
|  | 1.9 D  |  |  | 11.95  | 09.03   | 24.3571-1710.5   | 240154   | <input type="checkbox"/>   | D=57, - Halter <b>LUC</b>       |
|  | 1.9 TD   |  |  | 11.95  | 09.03   |  |  |  |                                 |

<sup>1)</sup> + dynamic control / + dynamic control / + dynamic control / + Control dinámico

















<sup>2)</sup> on the brake caliper / sulla pinza freno / sur l'étrier de frein / a la pinza de freno

| <b>FIAT SCUDO (95-06)</b> |                    |     |  |       |       |  |  |                |        |   |  |  |  |  |  |  |                |           |     |
|---------------------------|--------------------|-----|--|-------|-------|--|--|----------------|--------|---|--|--|--|--|--|--|----------------|-----------|-----|
|                           | 2.0 i 16V          |     |  | 06.00 | 09.03 |  |  | 24.3571-1709.5 | 240153 |   |  |  |  |  |  |  | D=57, - Halter | LUC       |     |
|                           | 2.0 JTD            |     |  | 12.99 | 09.03 |  |  | 24.3571-1710.5 | 240154 |   |  |  |  |  |  |  | D=57, - Halter | LUC       |     |
|                           | 1.6 i.e.           |     |  | 10.03 | 12.06 |  |  | 24.3601-1711.7 | 220607 |   |  |  |  |  |  |  | D=60, - Halter | LUC       |     |
|                           | 1.9 D              |     |  | 10.03 | 12.06 |  |  | 24.3601-1712.7 | 220608 |   |  |  |  |  |  |  | D=60, - Halter | LUC       |     |
|                           | 1.9 TD             |     |  | 10.03 | 12.06 |  |  |                |        |   |  |  |  |  |  |  |                |           |     |
|                           | 2.0 i 16V          |     |  | 10.03 | 12.06 |  |  |                |        |   |  |  |  |  |  |  |                |           |     |
|                           | 2.0 JTD            |     |  | 10.03 | 12.06 |  |  |                |        |   |  |  |  |  |  |  |                |           |     |
|                           | 1.6 i.e.           |     |  | 11.95 | 12.06 |  |  | 24.5118-0471.3 | 330528 | 2 |  |  |  |  |  |  | L=473          |           |     |
|                           | 1.9 D              |     |  | 11.95 | 12.06 |  |  |                |        |   |  |  |  |  |  |  |                |           |     |
|                           | 1.9 TD             |     |  | 11.95 | 12.06 |  |  |                |        |   |  |  |  |  |  |  |                |           |     |
|                           | 2.0 i 16V          |     |  | 06.00 | 12.06 |  |  |                |        |   |  |  |  |  |  |  |                |           |     |
|                           | 2.0 JTD            |     |  | 12.99 | 12.06 |  |  | 24.5111-0462.3 | 330555 | 2 |  |  |  |  |  |  | L=460          |           |     |
|                           | 1.6 i.e.           |     |  | 11.95 | 12.06 |  |  | 24.5229-0251.3 | 330535 | 2 |  |  |  |  |  |  | L=250          |           |     |
|                           | 1.9 D              |     |  | 11.95 | 12.06 |  |  |                |        |   |  |  |  |  |  |  |                |           |     |
|                           | 1.9 TD             |     |  | 11.95 | 12.06 |  |  |                |        |   |  |  |  |  |  |  |                |           |     |
|                           | 2.0 i 16V          |     |  | 06.00 | 12.06 |  |  |                |        |   |  |  |  |  |  |  |                |           |     |
|                           | 2.0 JTD            |     |  | 12.99 | 12.06 |  |  |                |        |   |  |  |  |  |  |  |                |           |     |
|                           | 1.6 i.e.           |     |  | 11.95 | 12.06 |  |  | 24.3219-1704.3 | 020374 |   |  |  |  |  |  |  | Rz 19,05       |           |     |
|                           | 1.9 D              |     |  | 11.95 | 12.06 |  |  |                |        |   |  |  |  |  |  |  |                |           |     |
|                           | 1.9 TD             |     |  | 11.95 | 12.06 |  |  |                |        |   |  |  |  |  |  |  |                |           |     |
|                           | 2.0 i 16V          |     |  | 06.00 | 12.06 |  |  |                |        |   |  |  |  |  |  |  |                |           |     |
|                           | 2.0 JTD            |     |  | 12.99 | 12.06 |  |  |                |        |   |  |  |  |  |  |  |                |           |     |
|                           | 1.6 i.e.           |     |  | 11.95 | 12.06 |  |  | 24.3727-0336.2 | 580336 | 1 | <br>- langer Radstand <sup>1)</sup><br>+ langer Radstand <sup>2)</sup> |  |  |  |  |  | L=500          |           |     |
|                           | 1.9 D              |     |  | 11.95 | 12.06 |  |  | 24.3727-0341.2 | 580341 | 1 |  |  |  |  |  |  | L=900          |           |     |
|                           | 1.9 TD             |     |  | 11.95 | 12.06 |  |  | 24.3727-0532.2 | 580532 |   |  |  |  |  |  |  | L=1063         |           |     |
|                           | 2.0 i 16V          |     |  | 06.00 | 12.06 |  |  | 24.3727-0531.2 | 580531 |   |  |  |  |  |  |  | L=2286         |           |     |
|                           | 2.0 JTD            |     |  | 12.99 | 12.06 |  |  |                |        |   |  |  |  |  |  |  |                |           |     |
|                           | 1.6 i.e.           |     |  | 11.95 | 12.06 |  |  | 24.6582-1715.3 | 320205 |   |  |  |  |  |  |  | BRL (4)        |           |     |
|                           | 1.9 D              |     |  | 11.95 | 12.06 |  |  |                |        |   |  |  |  |  |  |  |                |           |     |
|                           | 1.9 TD             |     |  | 11.95 | 12.06 |  |  |                |        |   |  |  |  |  |  |  |                |           |     |
|                           | 2.0 i 16V          |     |  | 06.00 | 12.06 |  |  |                |        |   |  |  |  |  |  |  |                |           |     |
|                           | 2.0 JTD            |     |  | 12.99 | 12.06 |  |  |                |        |   |  |  |  |  |  |  |                |           |     |
|                           | 1.6 i.e.           |     |  | 11.95 | 12.06 |  |  | 24.3728-0341.2 | 590341 |   |  |  |  |  |  |  | L=738, + AUT   |           |     |
|                           | 1.9 D              |     |  | 11.95 | 12.06 |  |  | 24.3728-0342.2 | 590342 |   |  |  |  |  |  |  | L=863, + AUT   |           |     |
|                           | 2.0 i 16V          |     |  | 06.00 | 12.06 |  |  | 24.3728-0336.2 | 590336 |   |  |  |  |  |  |  | L=973, + AUT   |           |     |
| <b>FIAT SCUDO (07-)</b>   |                    |     |  |       |       |  |  |                |        |   |  |  |  |  |  |  |                |           |     |
|                           | 1.6 D Multijet     | 66  |  | 01.07 |       |  |  | 03.2125-0298.3 | 010818 |   | - ESP<br>+ ESP   |  |  |  |  |  | THz 25,40      | ATE       |     |
|                           | 2.0                | 103 |  | 03.07 |       |  |  | 03.2125-0293.3 | 010817 |   |  |  |  |  |  |  |                | THz 25,40 | ATE |
|                           | 2.0 D Multijet     | 88  |  | 01.07 |       |  |  |                |        |   |  |  |  |  |  |  |                |           |     |
|                           | 2.0 D Multijet     | 94  |  | 04.11 |       |  |  |                |        |   |  |  |  |  |  |  |                |           |     |
|                           | 2.0 D Multijet     | 100 |  | 01.07 |       |  |  |                |        |   |  |  |  |  |  |  |                |           |     |
|                           | 2.0 D Multijet     | 120 |  | 07.10 |       |  |  |                |        |   |  |  |  |  |  |  |                |           |     |
|                           | 2.0 D Multijet 4x4 | 94  |  | 04.11 |       |  |  |                |        |   |  |  |  |  |  |  |                |           |     |
|                           | 1.6 D Multijet     | 66  |  | 01.07 |       |  |  | 24.5144-0455.3 | 331201 | 2 |  |  |  |  |  |  | L=455          |           |     |
|                           | 2.0                | 103 |  | 03.07 |       |  |  |                |        |   |  |  |  |  |  |  |                |           |     |
|                           | 2.0 D Multijet     | 88  |  | 01.07 |       |  |  |                |        |   |  |  |  |  |  |  |                |           |     |
|                           | 2.0 D Multijet     | 94  |  | 04.11 |       |  |  |                |        |   |  |  |  |  |  |  |                |           |     |
|                           | 2.0 D Multijet     | 100 |  | 01.07 |       |  |  |                |        |   |  |  |  |  |  |  |                |           |     |
|                           | 2.0 D Multijet     | 120 |  | 07.10 |       |  |  |                |        |   |  |  |  |  |  |  |                |           |     |
|                           | 2.0 D Multijet 4x4 | 94  |  | 04.11 |       |  |  |                |        |   |  |  |  |  |  |  |                |           |     |
|                           | 1.6 D Multijet     | 66  |  | 06.07 |       |  |  | 24.5239-0240.3 | 331170 | 2 | - langer Radstand <sup>1)</sup><br>+ langer Radstand <sup>2)</sup>     |  |  |  |  |  | L=240          |           |     |
|                           | 2.0                | 103 |  | 03.07 |       |  |  | 24.5239-0355.3 | 331243 | 2 |  |  |  |  |  |  |                | L=355     |     |
|                           | 2.0 D Multijet     | 88  |  | 06.07 |       |  |  |                |        |   |  |  |  |  |  |  |                |           |     |
|                           | 2.0 D Multijet     | 94  |  | 04.11 |       |  |  |                |        |   |  |  |  |  |  |  |                |           |     |
|                           | 2.0 D Multijet     | 100 |  | 06.07 |       |  |  |                |        |   |  |  |  |  |  |  |                |           |     |
|                           | 2.0 D Multijet     | 120 |  | 07.10 |       |  |  |                |        |   |  |  |  |  |  |  |                |           |     |
|                           | 2.0 D Multijet 4x4 | 94  |  | 04.11 |       |  |  |                |        |   |  |  |  |  |  |  |                |           |     |
|                           | 1.6 D Multijet     | 66  |  | 01.07 |       |  |  | 24.3222-1726.3 | 020518 |   |  |  |  |  |  |  | Rz 22,20       | LUC       |     |
|                           | 2.0 D Multijet     | 120 |  | 07.10 |       |  |  |                |        |   |  |  |  |  |  |  |                |           |     |
| <b>FIAT SEDICI (06-)</b>  |                    |     |  |       |       |  |  |                |        |   |  |  |  |  |  |  |                |           |     |
|                           | 1.6 16V            | 79  |  | 06.06 |       |  |  | 24.5273-0375.3 | 331147 | 2 |  |  |  |  |  |  | L=375          |           |     |
|                           | 1.6 16V            | 88  |  | 06.06 |       |  |  |                |        |   |  |  |  |  |  |  |                |           |     |
|                           | 1.6 16V 4x4        | 79  |  | 06.06 |       |  |  |                |        |   |  |  |  |  |  |  |                |           |     |
|                           | 1.6 16V 4x4        | 88  |  | 06.06 |       |  |  |                |        |   |  |  |  |  |  |  |                |           |     |
|                           | 1.9 D Multijet     | 88  |  | 06.06 |       |  |  |                |        |   |  |  |  |  |  |  |                |           |     |
|                           | 1.9 D Multijet 4x4 | 88  |  | 06.06 |       |  |  |                |        |   |  |  |  |  |  |  |                |           |     |
|                           | 2.0 D Multijet     | 99  |  | 06.06 |       |  |  |                |        |   |  |  |  |  |  |  |                |           |     |
|                           | 2.0 D Multijet 4x4 | 99  |  | 06.06 |       |  |  |                |        |   |  |  |  |  |  |  |                |           |     |
|                           | 1.6 16V            | 79  |  | 06.06 |       |  |  | 24.5279-0300.3 | 331135 | 2 |  |  |  |  |  |  | L=300          |           |     |
|                           | 1.6 16V            | 88  |  | 06.06 |       |  |  |                |        |   |  |  |  |  |  |  |                |           |     |
|                           | 1.6 16V 4x4        | 79  |  | 06.06 |       |  |  |                |        |   |  |  |  |  |  |  |                |           |     |
|                           | 1.6 16V 4x4        | 88  |  | 06.06 |       |  |  |                |        |   |  |  |  |  |  |  |                |           |     |
|                           | 1.9 D Multijet     | 88  |  | 06.06 |       |  |  |                |        |   |  |  |  |  |  |  |                |           |     |
|                           | 1.9 D Multijet 4x4 | 88  |  | 06.06 |       |  |  |                |        |   |  |  |  |  |  |  |                |           |     |
|                           | 2.0 D Multijet     | 99  |  | 06.06 |       |  |  |                |        |   |  |  |  |  |  |  |                |           |     |
|                           | 2.0 D Multijet 4x4 | 99  |  | 06.06 |       |  |  |                |        |   |  |  |  |  |  |  |                |           |     |
|                           | 1.6 16V            | 79  |  | 06.06 |       |  |  | 24.3219-1756.3 | 020511 |   |  |  |  |  |  |  | Rz 19,05       | BOS       |     |
|                           | 1.6 16V            | 88  |  | 06.06 |       |  |  |                |        |   |  |  |  |  |  |  |                |           |     |
|                           | 1.6 16V 4x4        | 79  |  | 06.06 |       |  |  |                |        |   |  |  |  |  |  |  |                |           |     |
|                           | 1.6 16V 4x4        | 88  |  | 06.06 |       |  |  |                |        |   |  |  |  |  |  |  |                |           |     |
|                           | 1.9 D Multijet     | 88  |  | 06.06 |       |  |  |                |        |   |  |  |  |  |  |  |                |           |     |

1) - long wheel base / - passo lungo / - empattement long / - distancia larga entre ejes  
 2) + long wheel base / + passo lungo / + empattement long / + distancia larga entre ejes





| FIAT SEDICI (06-)  |   |                  |  |   |   |  |                                  |                  |   |                                  |                          |
|--|---|------------------|--|---|---|--|----------------------------------|------------------|---|----------------------------------|--------------------------|
|    | 1.9 D Multijet 4x4<br>2.0 D Multijet<br>2.0 D Multijet 4x4  | 88<br>99<br>99   |  | 06.06<br>06.06<br>06.06   |   |  | 24.3219-1756.3                   | 020511           |   | Rz 19,05                         | <b>BOS</b>               |
| FIAT SEICENTO (98-08)  |   |                  |  |   |   |  |                                  |                  |   |                                  |                          |
|    | 1100 i.e.<br>900 i.e.   |                  |  | 04.98<br>04.98  | 03.08<br>03.08  |  | 24.2119-0833.3                   | 010418           |   | THz 19,05                        |                          |
|    | 1100 i.e.<br>900 i.e.   |                  |  | 04.98<br>04.98  | 03.08<br>03.08  |  | 24.3481-1743.5<br>24.3481-1744.5 | 240305<br>240306 | <input type="checkbox"/><br><input type="checkbox"/>                                | D=48, - Halter<br>D=48, - Halter | <b>BDX</b><br><b>BDX</b> |
|    | 1100 i.e.<br>900 i.e.   |                  |  | 04.98<br>04.98  | 03.08<br>03.08  |  | 24.5112-0445.3                   | 330564           | 2   | L=445                            |                          |
|    | 1100 i.e.<br>900 i.e.   |                  |  | 04.98<br>04.98  | 03.08<br>03.08  |  | 24.5228-0275.3                   | 330035           | 2   | L=275                            |                          |
|    | 1100 i.e.<br>900 i.e.   |                  |  | 04.98<br>04.98  | 03.08<br>03.08  |  | 24.3219-0803.3                   | 020183           |   | Rz 19,05                         |                          |
|    | 1100 i.e.<br>900 i.e.   |                  |  | 04.98<br>04.98  | 03.08<br>03.08  |  | 24.3727-0544.2                   | 580544           | 1  | L=2670                           |                          |
|    | 900 i.e.<br>1100 i.e.   |                  |  | 04.98<br>04.98  | 03.08<br>03.08  |  | 24.3728-0507.2<br>24.3728-0517.2 | 590507<br>590517 |   | L=570<br>L=776                   |                          |
| FIAT STILO / STILO Multi Wagon (01-08)   |   |                  |  |   |   |  |                                  |                  |   |                                  |                          |
|    | 1.2 i 16V<br>1.4 i 16V<br>1.6 16V<br>1.8 16V<br>1.9 D Multijet<br>1.9 JTD<br>1.9 JTD  | 59               |  | 02.02<br>01.04<br>10.01<br>10.01<br>09.05<br>02.02<br>10.01                                     | 03.08<br>03.08<br>03.08<br>03.08<br>03.08<br>03.08<br>03.08                                     |  | 24.2122-1754.3                   | 010755           | + Dynamic Control <sup>1)</sup>   | THz 22,20                        |                          |
|    | 1.6 16V<br>1.9 D Multijet<br>1.9 JTD<br>2.4 20V   | 100<br>110       |  | 04.05<br>09.05<br>01.04<br>10.01  | 03.08<br>03.08<br>03.08<br>03.08  |  | 24.2123-1769.3                   | 010863           |   | THz 23,81                        | <b>BOS</b>               |
|   | 1.2 i 16V<br>1.4 i 16V<br>1.6 16V<br>1.8 16V<br>1.9 D Multijet<br>1.9 JTD<br>1.9 JTD  | 59               |  | 02.02<br>01.04<br>10.01<br>10.01<br>09.05<br>02.02<br>10.01                                     | 03.08<br>03.08<br>03.08<br>03.08<br>03.08<br>03.08<br>03.08                                     |  | 24.3541-1811.5<br>24.3541-1812.5 | 240429<br>240430 | <input type="checkbox"/><br><input type="checkbox"/>                                | D=54, - Halter<br>D=54, - Halter | <b>BOS</b><br><b>BOS</b> |
|  | 1.8 16V<br>1.9 D Multijet<br>1.9 JTD<br>1.9 JTD   |                  |  | 10.01<br>09.05<br>02.02<br>10.01  | 03.08<br>03.08<br>03.08<br>03.08  |  | 24.3541-1809.7                   | 220613           | <input type="checkbox"/>  | D=54, - Halter                   | <b>BOS</b>               |
|  | 1.2 i 16V<br>1.4 i 16V<br>1.6 16V<br>1.6 16V<br>1.8 16V<br>1.9 D Multijet<br>1.9 D Multijet<br>1.9 JTD<br>1.9 JTD<br>1.9 JTD<br>2.4 20V | 59<br>100<br>110 |  | 02.02<br>01.04<br>10.01<br>04.05<br>10.01<br>09.05<br>09.05<br>02.02<br>01.04<br>10.01<br>10.01 | 03.08<br>03.08<br>03.08<br>03.08<br>03.08<br>03.08<br>03.08<br>03.08<br>03.08<br>03.08<br>03.08 |  | 83.6401-0413.3                   | 330748           | 2   | L=408                            |                          |
|  | 1.2 i 16V<br>1.4 i 16V<br>1.6 16V<br>1.6 16V<br>1.8 16V<br>1.9 D Multijet<br>1.9 D Multijet<br>1.9 JTD<br>1.9 JTD<br>1.9 JTD<br>2.4 20V | 59<br>100<br>110 |  | 02.02<br>01.04<br>10.01<br>04.05<br>10.01<br>09.05<br>09.05<br>02.02<br>01.04<br>10.01<br>10.01 | 03.08<br>03.08<br>03.08<br>03.08<br>03.08<br>03.08<br>03.08<br>03.08<br>03.08<br>03.08<br>03.08 |  | 24.5112-0185.3<br>83.6501-0282.3 | 330654<br>330769 | 2<br>2  | am Bremssattel <sup>2)</sup>     | L=185<br>L=287           |
|  | 1.2 i 16V<br>1.4 i 16V<br>1.6 16V<br>1.6 16V<br>1.8 16V<br>1.9 D Multijet<br>1.9 D Multijet<br>1.9 JTD<br>1.9 JTD<br>1.9 JTD<br>2.4 20V | 59<br>100<br>110 |  | 02.02<br>01.04<br>10.01<br>04.05<br>10.01<br>09.05<br>09.05<br>02.02<br>01.04<br>10.01<br>10.01 | 03.08<br>03.08<br>03.08<br>03.08<br>03.08<br>03.08<br>03.08<br>03.08<br>03.08<br>03.08<br>03.08 |  | 24.3727-0553.2<br>24.3727-0554.2 | 580553<br>580554 | <input type="checkbox"/><br><input type="checkbox"/>                                | L=1786<br>L=1668                 |                          |

<sup>1)</sup> + dynamic control / + dynamic control / + dynamic control / + Control dinámico











<sup>2)</sup> on the brake caliper / sulla pinza freno / sur l'étrier de frein / a la pinza de freno

| <b>FIAT STRADA / PICK-UP (99-)</b> |   |                      |  |   |  |  |  |  |  |  |                            |        |  |  |  |  |                          |  |
|------------------------------------|---|----------------------|--|---|--|--|--|--|--|--|----------------------------|--------|--|--|--|--|--------------------------|--|
|                                    | 1.2<br>1.3 JTD<br>1.7 TD<br>1.9 D<br>1.9 JTD  | 62<br>51<br>46<br>59 |  | 05.99<br>05.06<br>05.99<br>12.00<br>04.03                   |  |  |  |  |  | 20.5522-1093.3                                     | 010731                     |        | + ABS  |  | THz 22,20                                      |  | <b>ATE</b>               |  |
|                                    | 1.2<br>1.3 JTD<br>1.7 TD<br>1.9 D<br>1.9 JTD  | 62<br>51<br>46<br>59 |  | 05.99<br>05.06<br>05.99<br>12.00<br>04.03                   |  |  |  |  |  | 24.5112-0475.3                                     | 330698                     | 2      |  |  | L=475  |  |                          |  |
|                                    | 1.2<br>1.3 JTD<br>1.7 TD<br>1.9 D<br>1.9 JTD  | 62<br>51<br>46<br>59 |  | 05.99<br>05.06<br>05.99<br>12.00<br>04.03                   |  |  |  |  |  | 24.5228-0375.3                                     | 330699                     | 2      |  |  | L=375  |  |                          |  |
|                                    | 1.2   |                      |  | 05.99   |  |  |  |  |  | 24.3728-0533.2<br>24.3728-0535.2                   | 590533<br>590535           |        |  |  | L=684<br>L=678                                 |  |                          |  |
| <b>FIAT STRADA II (11-)</b>        |   |                      |  |   |  |  |  |  |  |  |                            |        |  |  |  |  |                          |  |
|                                    | 1.3 D Multijet  | 70                   |  | 01.11   |  |  |  |  |  | 24.5228-0375.3                                     | 330699                     | 2      |  |  | L=375  |  |                          |  |
|                                    | 1.3 D Multijet  | 70                   |  | 01.11   |  |  |  |  |  | 24.3220-1722.3                                     | 020458                     |        |  |  | Rz 20,64                                       |  |                          |  |
| <b>FIAT TALENTO (88-94)</b>        |   |                      |  |   |  |  |  |  |  |  |                            |        |  |  |  |  |                          |  |
|                                    | 1.9 D<br>2.0  |                      |  | 10.88<br>07.90  | 12.94<br>12.94   |  |  |  |  | 24.2122-0801.3                                     | 010373                     |        |  |  | THz 22,20                                      |  |                          |  |
|                                    | 1.9 D<br>2.0  |                      |  | 10.88<br>07.90  | 12.94<br>12.94   |  |  |  |  | 24.5112-0435.3<br>24.5112-0436.3                   | 330524<br>330574           | 2<br>2 |  |  | L=435, + Clip<br>L=435, - Clip                 |  |                          |  |
|                                    | 1.9 D<br>2.0  |                      |  | 10.88<br>07.90  | 12.94<br>12.94   |  |  |  |  | 24.5112-0315.3                                     | 330509                     | 1      |  |  | L=315  |  |                          |  |
|                                    | 1.9 D<br>2.0  |                      |  | 10.90<br>10.90  | 12.94<br>12.94   |  |  |  |  | 24.3728-0515.2                                     | 590515                     |        |  |  | L=1200   |  |                          |  |
| <b>FIAT TEMPRA (93-96)</b>         |   |                      |  |   |  |  |  |  |  |  |                            |        |  |  |  |  |                          |  |
|                                    | 1.4 i.e. Kombi<br>1.4 i.e. Lim.<br>1.6 i.e. Kombi<br>1.6 i.e. Lim.<br>1.8 i.e. Lim.<br>1.9 D Kombi<br>1.9 D Lim.<br>1.9 TD Lim. |                      |  | 05.93<br>05.93<br>05.93<br>05.93<br>05.93<br>05.93<br>05.93 | 09.96<br>09.96 + ABS<br>09.96<br>09.96 + ABS/ + Automatikgetriebe 1)<br>09.96<br>09.96 + ABS<br>09.96          |  |  |  |  | 24.3541-1748.5                                     | 240222                     |        | <input checked="" type="checkbox"/>  |  | D=54, - Halter                                 |  | <b>LUC</b>               |  |
|                                    | 1.4 i.e.<br>1.6 i.e.<br>1.8 i.e.<br>1.9 D<br>1.9 TD<br>2.0 i.e.<br>2.0 i.e. 4x4   |                      |  | 05.93<br>05.93<br>05.93<br>05.93<br>05.93<br>05.93          | 09.96 + ABS<br>09.96 + ABS<br>09.96 + ABS<br>09.96 + ABS<br>09.96 + ABS<br>09.96<br>09.96                      |  |  |  |  | 24.3344-1703.5<br>24.3344-1704.5<br>24.0101-3601.2 | 240117<br>240118<br>260044 |        | <input checked="" type="checkbox"/><br><input checked="" type="checkbox"/> |  | D=34, - Halter<br>D=34, - Halter<br>Einbausatz |  | <b>LUC</b><br><b>LUC</b> |  |
|                                    | 1.8 i.e.<br>2.0 i.e.<br>2.0 i.e. 4x4  |                      |  | 05.93<br>05.93<br>05.93                                     | 09.96<br>09.96<br>09.96  |  |  |  |  | 24.5228-0223.3                                     | 330530                     | 2      |  |  | L=223  |  |                          |  |
|                                    | 1.4 i.e.<br>1.6 i.e.<br>1.9 D   |                      |  | 05.93<br>05.93<br>05.93                                     | 09.96 - ABS<br>09.96 - ABS/ + Schaltgetriebe 2)<br>09.96 - ABS   |  |  |  |  | 24.3222-1701.3                                     | 020376                     |        |  |  | Rz 22,20                                       |  |                          |  |
|                                    | 1.6 i.e.<br>1.8 i.e.<br>1.9 TD  |                      |  | 05.93<br>05.93<br>05.93                                     | 09.96 - ABS/ + Automatikgetriebe 3)<br>09.96 - ABS<br>09.96 - ABS  |  |  |  |  | 24.3220-1116.3                                     | 020313                     |        |  |  | Rz 20,64                                       |  |                          |  |
|                                    | 1.4 i.e. Lim.<br>1.6 i.e. Lim.  |                      |  | 05.93<br>05.93  | 09.96 - ABS<br>09.96 - ABS/ + Schaltgetriebe 2)  |  |  |  |  | 24.3727-0511.2<br>24.3727-0510.2                   | 580511<br>580510           |        | <input type="checkbox"/><br><input checked="" type="checkbox"/>            |  | L=1415<br>L=1375                               |  |                          |  |
|                                    | 1.4 i.e. Kombi<br>1.6 i.e. Kombi<br>1.6 i.e. Lim.<br>1.8 i.e.<br>1.9 D<br>1.9 TD  |                      |  | 05.93<br>05.93<br>05.93<br>05.93<br>05.93<br>05.93          | 09.96 - ABS<br>09.96 - ABS<br>09.96 - ABS/ + Automatikgetriebe 3)<br>09.96 - ABS<br>09.96 - ABS<br>09.96 - ABS |  |  |  |  | 24.3727-0513.2                                     | 580513                     |        | <input type="checkbox"/>   |  | L=1445   |  |                          |  |
|                                    | 1.4 i.e.<br>1.6 i.e.<br>1.8 i.e.<br>1.9 D<br>1.9 TD<br>2.0 i.e.   |                      |  | 05.93<br>05.93<br>05.93<br>05.93<br>05.93                   | 09.96 + ABS<br>09.96 + ABS<br>09.96 + ABS<br>09.96 + ABS<br>09.96 + ABS  |  |  |  |  | 24.3727-0521.2<br>24.3727-0006.2                   | 580521<br>580006           |        | <input type="checkbox"/><br><input checked="" type="checkbox"/>            |  | L=1517<br>L=1460                               |  |                          |  |
|                                    | 1.4 i.e.<br>1.6 i.e.<br>1.8 i.e.<br>1.9 D   |                      |  | 05.93<br>05.93<br>05.93<br>05.93                            | 09.96<br>09.96<br>09.96<br>09.96   |  |  |  |  | 24.6584-1701.3                                     | 320173                     |        |  |  | BRL (4)  |  |                          |  |

1) + ABS/ + autom.transmission / + ABS/ + scatola cambio autom. / + ABS/ + transmission automatique / + ABS/ + cambio automático

























2) - ABS/ + manual transmission / - ABS/ + scatola camb.velocità / - ABS/ + transmission mécanique / - ABS/ + cambio de velocidad

3) - ABS/ + autom.transmission / - ABS/ + scatola cambio autom. / - ABS/ + transmission automatique / - ABS/ + cambio automático

| FIAT TEMPRA (93-96)  |  |  |  |                            |  |   |
|--|--|--|--|----------------------------|--|---|
|    | 1.9 TD<br>2.0 i.e.<br>2.0 i.e. 4x4   | 05.93 09.96<br>05.93 09.96<br>05.93 09.96  | 24.6584-1701.3                                     | 320173                     |  | BRL (4)   |
|    | 1.4 i.e.<br>1.6 i.e.<br>1.8 i.e.<br>1.9 TD<br>2.0 i.e.<br>2.0 i.e. 4x4                   | 05.93 09.96<br>05.93 09.96<br>05.93 09.96<br>05.93 09.96<br>05.93 09.96<br>05.93 09.96   | 24.3728-0503.2                                     | 590503                     |  | L=729<br>L=764  |
| FIAT TIPO (93-95)  |  |  |  |                            |  |   |
|    | 1.4 i.e.<br>1.6 i.e.<br>1.8 i.e.<br>1.9 TD   | 05.93 09.95 + ABS<br>05.93 09.95 + ABS<br>05.93 09.95<br>05.93 09.95   | 24.3541-1748.5                                     | 240222                     | <input type="checkbox"/>                             | D=54, - Halter <b>LUC</b>   |
|    | 1.4 i.e.<br>1.6 i.e.<br>1.7 D<br>1.8 i.e.<br>1.9 D<br>1.9 TD<br>2.0 i.e.<br>2.0 i.e. 16V | 05.93 09.95 + ABS<br>05.93 09.95 + ABS<br>05.93 09.95 + ABS<br>05.93 09.95 + ABS<br>05.93 09.95 + ABS<br>05.93 09.95 + ABS<br>05.93 09.95<br>05.93 09.95   | 24.3344-1703.5<br>24.3344-1704.5<br>24.0101-3601.2 | 240117<br>240118<br>260044 | <input type="checkbox"/><br><input type="checkbox"/> | D=34, - Halter<br>D=34, - Halter<br>Einbausatz <b>LUC</b><br><b>LUC</b> |
|    | 1.4 i.e.<br>1.6 i.e.<br>1.7 D<br>1.8 i.e.<br>1.9 D<br>1.9 TD<br>2.0 i.e.<br>2.0 i.e. 16V | 05.93 09.95<br>05.93 09.95<br>05.93 09.95<br>05.93 09.95<br>05.93 09.95<br>05.93 09.95<br>05.93 09.95<br>05.93 09.95   | 83.6401-0159.3                                     | 330746                     | 2  | L=160   |
|    | 1.4 i.e.<br>1.6 i.e.<br>1.7 D<br>1.9 D   | 05.93 09.95 - ABS<br>05.93 09.95 - ABS/ + Schaltgetriebe <sup>1)</sup><br>05.93 09.95 - ABS<br>05.93 09.95 - ABS   | 24.3222-1701.3                                     | 020376                     |  | Rz 22,20  |
|  | 1.6 i.e.<br>1.8 i.e.<br>1.9 TD   | 05.93 09.95 - ABS/ + Automatikgetriebe <sup>2)</sup><br>05.93 09.95 - ABS<br>05.93 09.95 - ABS   | 24.3220-1116.3                                     | 020313                     |  | Rz 20,64  |
|   | 1.4 i.e.<br>1.6 i.e.<br>1.7 D<br>1.9 D<br>1.6 i.e.<br>1.8 i.e.<br>1.9 TD                 | 05.93 09.95 - ABS<br>05.93 09.95 - ABS/ + Schaltgetriebe <sup>1)</sup><br>05.93 09.95 - ABS<br>05.93 09.95 - ABS<br>05.93 09.95 - ABS/ + Automatikgetriebe <sup>2)</sup><br>05.93 09.95 - ABS<br>05.93 09.95 - ABS | 24.3727-0511.2<br>24.3727-0510.2                   | 580511<br>580510           | <input type="checkbox"/><br><input type="checkbox"/> | L=1415<br>L=1375<br>L=1445  |
|  | 1.4 i.e.<br>1.6 i.e.<br>1.7 D<br>1.8 i.e.<br>1.9 D<br>1.9 TD<br>2.0 i.e.<br>2.0 i.e. 16V | 05.93 09.95 + ABS<br>05.93 09.95 + ABS<br>05.93 09.95 + ABS<br>05.93 09.95 + ABS<br>05.93 09.95 + ABS<br>05.93 09.95 + ABS<br>05.93 09.95<br>05.93 09.95   | 24.3727-0521.2<br>24.3727-0006.2                   | 580521<br>580006           | <input type="checkbox"/><br><input type="checkbox"/> | L=1517<br>L=1460  |
|  | 1.4 i.e.<br>1.6 i.e.<br>1.7 D<br>1.8 i.e.<br>1.9 D<br>1.9 TD<br>2.0 i.e.<br>2.0 i.e. 16V | 05.93 09.95<br>05.93 09.95<br>05.93 09.95<br>05.93 09.95<br>05.93 09.95<br>05.93 09.95<br>05.93 09.95<br>05.93 09.95   | 24.6584-1701.3                                     | 320173                     |  | BRL (4)   |
|  | 1.4 i.e.<br>1.6 i.e.<br>1.7 D<br>1.8 i.e.<br>1.9 D<br>1.9 TD<br>2.0 i.e.<br>2.0 i.e. 16V | 05.93 09.95<br>05.93 09.95<br>05.93 09.95<br>05.93 09.95<br>05.93 09.95<br>05.93 09.95<br>05.93 09.95<br>05.93 09.95   | 24.3728-0503.2                                     | 590503                     |  | L=729<br>L=764  |
| FIAT ULYSSE (94-02)  |  |  |  |                            |  |   |
|  | 1.8 i.e.<br>1.9 TD<br>2.0  | 06.96 04.99 - ABS<br>01.95 04.99 - ABS<br>06.94 04.99 - ABS  | 24.2123-1707.3                                     | 010492                     |  | Thz 23,81   |
|  | 1.8 i.e.<br>1.9 TD<br>2.0  | 05.99 07.02 - ABS<br>05.99 07.02 - ABS<br>05.99 07.02 - ABS  | 24.2123-1738.3                                     | 010658                     |  | Thz 23,81   |
|  | 1.8 i.e.<br>1.9 TD<br>2.0<br>2.0 16V<br>2.0 Turbo<br>2.1 TD                              | 06.96 04.99 + ABS<br>01.95 04.99 + ABS<br>06.94 04.99 + ABS<br>06.94 04.99<br>06.94 04.99<br>06.96 04.99   | 24.2123-1708.3                                     | 010493                     |  | Thz 23,81   |
|  | 1.8 i.e.<br>1.9 TD   | 05.99 07.02 + ABS<br>05.99 07.02 + ABS   | 24.2123-1733.3                                     | 010657                     |  | Thz 23,81   |

<sup>1)</sup> - ABS/ + manual transmission / - ABS/ + scatola camb.velocità / - ABS/ + transmission mécanique / - ABS/ + cambio de velocidad

<sup>2)</sup> - ABS/ + autom.transmission / - ABS/ + scatola cambio autom. / - ABS/ + transmission automatique / - ABS/ + cambio automático

|          |   |  |  |  |  |  |  |  |  |   |  |
|--|---|--|--|--|--|--|--|--|--|---|--|
| <b>FIAT ULYSSE (94-02)</b>   |   |  |  |  |  |  |  |  |  |   |  |
|    | 2.0<br>2.0 16V<br>2.0 JTD<br>2.0 Turbo<br>2.1 TD  | 89<br><br><br>108                                |  | 05.99<br>05.99<br>05.99<br>05.99                                     | 07.02<br>07.02<br>07.02<br>07.02                                     | + ABS  | 24.2123-1733.3   | 010657   |  | THz 23,81   |  |
|    | 1.8 i.e.<br><br>1.9 TD<br>2.0<br>2.0 16V<br>2.0 JTD<br>2.0 Turbo<br>2.1 TD                                  | <br><br>89<br><br><br>108                        |  | 06.96<br><br>01.95<br>06.94<br>06.94<br>06.94<br>06.96               | 07.02<br><br>07.02<br>07.02<br>07.02<br>07.02<br>10.99               |  | 24.3571-1711.5<br>24.3571-1712.5   | 240159<br>240160   | <input type="checkbox"/><br><input type="checkbox"/>   | D=57, - Halter<br>D=57, - Halter  | <b>BDX</b><br><b>BDX</b>   |
|    | 1.9 TD<br>2.0<br>2.0 16V<br>2.0 JTD<br>2.0 Turbo<br>2.1 TD  | 89<br><br><br><br>108                            |  | 01.95<br>06.94<br>06.94<br>10.99<br>06.94<br>06.96                   | 07.02<br>07.02<br>07.02<br>07.02<br>07.02<br>10.99                   |  | 24.3571-1709.5<br>24.3571-1710.5   | 240153<br>240154   | <input type="checkbox"/><br><input type="checkbox"/><br><input type="checkbox"/>   | D=57, - Halter<br>D=57, - Halter  | <b>LUC</b><br><b>LUC</b>   |
|    | 1.8 i.e.<br>1.9 TD<br>2.0<br>2.0 16V<br>2.0 JTD<br>2.0 Turbo<br>2.1 TD                                      | <br><br>89<br><br><br>108                        |  | 06.96<br>01.95<br>06.94<br>06.94<br>10.99<br>06.94<br>06.96          | 07.02<br>07.02<br>07.02<br>07.02<br>07.02<br>07.02<br>10.99          |  | 24.5118-0471.3   | 330528   | 2  |   | L=473  |
|    | 1.8 i.e.<br>1.9 TD<br>2.0<br>2.0 16V<br>2.0 JTD<br>2.0 Turbo<br>2.1 TD                                      | <br><br>89<br><br><br>108                        |  | 06.96<br>01.95<br>06.94<br>06.94<br>10.99<br>06.94<br>06.96          | 07.02<br>07.02<br>07.02<br>07.02<br>07.02<br>07.02<br>10.99          | + ABS<br>+ ABS<br>+ ABS<br>+ ABS<br>+ ABS<br>+ ABS | 11.3361-9975.2<br>11.3361-9976.2<br>11.0441-3602.2<br>11.0101-5407.2<br>11.8171-0008.1<br>11.8116-0073.1<br>24.3361-9975.5<br>24.3361-9976.5 | 220281<br>220282<br>250008<br>260011<br>990049<br>390498<br>240541<br>240542 | <input type="checkbox"/><br><input type="checkbox"/><br><input type="checkbox"/><br><input type="checkbox"/><br><input type="checkbox"/><br><input type="checkbox"/><br><input type="checkbox"/><br><input type="checkbox"/> | D=36, - Halter<br>D=36, - Halter<br>Dichtungssatz<br>Hülzensatz<br>Führungsbolzen<br>Haltefeder<br>D=36, - Halter<br>D=36, - Halter | <b>ATE</b><br><b>ATE</b><br><b>ATE</b><br><b>ATE</b><br><b>ATE</b><br><b>ATE</b><br><b>ATE</b> |
|    | 1.8 i.e.<br>1.9 TD<br>2.0<br>2.0 16V<br>2.0 JTD<br>2.0 Turbo<br>2.1 TD                                      | <br><br>89<br><br><br>108                        |  | 06.96<br>01.95<br>06.94<br>06.94<br>10.99<br>06.94<br>06.96          | 07.02<br>07.02<br>07.02<br>07.02<br>07.02<br>07.02<br>10.99          |  | 24.5229-0251.3<br>24.5111-0301.3   | 330535<br>330499   | 2<br>2   | Länge beachten <sup>1)</sup><br>Länge beachten <sup>1)</sup>  | L=250<br>L=300   |
|    | 1.8 i.e.<br>1.9 TD<br>2.0<br>2.0 JTD<br>2.1 TD  | <br><br>89                                       |  | 06.96<br>01.95<br>06.94<br>10.99<br>06.96                            | 07.02<br>07.02<br>07.02<br>07.02<br>10.99                            | - ABS<br>- ABS<br>- ABS<br>- ABS                   | 24.3219-1704.3   | 020374   |  |   | Rz 19,05   |
|    | 1.8 i.e.<br>2.0   | <br>89   |  | 06.96<br>06.94   | 07.02<br>07.02   |  | 24.3727-0336.2<br>24.3727-0532.2<br>24.3727-0531.2   | 580336<br>580532<br>580531   | 1<br>1   | <input type="checkbox"/><br><input type="checkbox"/><br><input type="checkbox"/>  | L=500<br>L=1063<br>L=2286  |
|    | 1.9 TD<br>2.0 16V<br>2.0 JTD<br>2.0 Turbo<br>2.1 TD   | <br><br><br>108                                  |  | 01.95<br>06.94<br>10.99<br>06.94<br>06.96                            | 07.02<br>07.02<br>07.02<br>07.02<br>10.99                            |  | 24.3727-0336.2<br>24.3727-0530.2<br>24.3727-0529.2   | 580336<br>580530<br>580529   | 1  | <input type="checkbox"/><br><input type="checkbox"/><br><input type="checkbox"/>  | L=500<br>L=1255<br>L=2205  |
|    | 1.8 i.e.  |  |  | 06.96  | 07.02  |  | 24.6582-1715.3   | 320205   |  |   | BRL (4)  |
|    | 1.8 i.e.<br>2.0   | <br>89   |  | 06.96<br>06.94   | 07.02<br>07.02   |  | 24.3728-0341.2   | 590341   |  |   | L=738, + AUT   |
|    | 1.9 TD<br>2.0 JTD<br>2.0 Turbo  | <br><br>108                                      |  | 01.95<br>10.99<br>06.94  | 07.02<br>07.02<br>07.02  |  | 24.3728-0342.2   | 590342   |  |   | L=863, + AUT   |
|    | 2.0 16V<br>2.1 TD   | <br>108  |  | 06.94<br>06.96   | 07.02<br>10.99   |  | 24.3728-0336.2<br>24.3728-0340.2   | 590336<br>590340   |  |   | L=973, + AUT<br>L=1088, + AUT  |
| <b>FIAT ULYSSE (02-11)</b>   |   |  |  |  |  |  |  |  |  |   |  |
|    | 2.0 D Multijet<br>2.0 D Multijet<br>2.0 i 16V<br>2.0 JTD<br>2.0 JTD<br>2.2 D Multijet<br>2.2 JTD<br>2.2 JTD | 88<br>100<br>100<br>79<br>80<br>125<br>94<br>120 |  | 05.06<br>05.06<br>08.02<br>05.03<br>08.02<br>03.08<br>08.02<br>03.08 | 01.11<br>01.11<br>01.11<br>01.11<br>01.11<br>01.11<br>01.11<br>01.11 |  | 03.2122-2163.3   | 010800   |  | THz 22,20   | <b>ATE</b>   |
|    | 2.0 D Multijet<br>2.0 D Multijet<br>2.0 i 16V<br>2.0 JTD<br>2.0 JTD<br>2.2 JTD<br>2.2 JTD                   | 88<br>100<br>100<br>79<br>80<br>94<br>120        |  | 05.06<br>05.06<br>08.02<br>05.03<br>08.02<br>08.02<br>03.08          | 01.11<br>01.11<br>01.11<br>01.11<br>01.11<br>01.11<br>01.11          |  | 24.3601-1711.7<br>24.3601-1712.7   | 220607<br>220608   | <input type="checkbox"/><br><input type="checkbox"/>   | D=60, - Halter<br>D=60, - Halter  | <b>LUC</b><br><b>LUC</b>   |
|    | 2.0 D Multijet<br>2.0 D Multijet<br>2.0 i 16V<br>2.0 JTD<br>2.0 JTD<br>2.2 JTD<br>2.2 JTD<br>3.0 i V6       | 88<br>100<br>100<br>79<br>80<br>94<br>120<br>150 |  | 05.06<br>05.06<br>08.02<br>05.03<br>08.02<br>08.02<br>03.08<br>08.02 | 01.11<br>01.11<br>01.11<br>01.11<br>01.11<br>01.11<br>01.11<br>01.11 |  | 24.5111-0462.3   | 330555   | 2  |   | L=460  |

<sup>1)</sup> notice length / attenzione lunghezza / faire attention longueur / atención largo

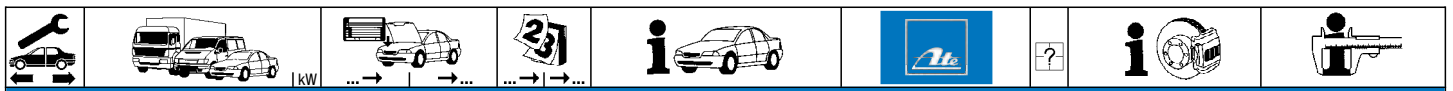



















### FIAT ULYSSE (02-11)

|                |                |     |       |       |       |  |                |        |        |                                  |            |   |        |  |
|----------------|----------------|-----|-------|-------|-------|--|----------------|--------|--------|----------------------------------|------------|---|--------|--|
|                | 2.0 D Multijet | 88  |       | 05.06 | 01.11 |  | 24.3384-1761.7 | 220671 | ☐<br>☐ | D=38, - Halter<br>D=38, - Halter | LUC<br>LUC |   |        |  |
|                | 2.0 D Multijet | 100 |       | 05.06 | 01.11 |  | 24.3384-1762.7 | 220672 |        |                                  |            |   |        |  |
|                | 2.0 i 16V      | 100 |       | 08.02 | 01.11 |  |                |        |        |                                  |            |   |        |  |
|                | 2.0 JTD        | 79  |       | 05.03 | 01.11 |  |                |        |        |                                  |            |   |        |  |
|                | 2.0 JTD        | 80  |       | 08.02 | 01.11 |  |                |        |        |                                  |            |   |        |  |
|                | 2.2 D Multijet | 125 |       | 03.08 | 01.11 |  |                |        |        |                                  |            |   |        |  |
|                | 2.2 JTD        | 94  |       | 08.02 | 01.11 |  |                |        |        |                                  |            |   |        |  |
|                | 2.2 JTD        | 120 |       | 03.08 | 01.11 |  |                |        |        |                                  |            |   |        |  |
| 3.0 i V6       | 150            |     | 08.02 | 01.11 |       |  |                |        |        |                                  |            |   |        |  |
|                | 2.0 D Multijet | 88  |       | 05.06 | 01.11 |  | 24.5229-0251.3 | 330535 | 2      | L=250                            |            |   |        |  |
|                | 2.0 D Multijet | 100 |       | 05.06 | 01.11 |  |                |        |        |                                  |            |   |        |  |
|                | 2.0 i 16V      | 100 |       | 08.02 | 01.11 |  |                |        |        |                                  |            |   |        |  |
|                | 2.0 JTD        | 79  |       | 05.03 | 01.11 |  |                |        |        |                                  |            |   |        |  |
|                | 2.0 JTD        | 80  |       | 08.02 | 01.11 |  |                |        |        |                                  |            |   |        |  |
|                | 2.2 D Multijet | 125 |       | 03.08 | 01.11 |  |                |        |        |                                  |            |   |        |  |
|                | 2.2 JTD        | 94  |       | 08.02 | 01.11 |  |                |        |        |                                  |            |   |        |  |
|                | 2.2 JTD        | 120 |       | 03.08 | 01.11 |  |                |        |        |                                  |            |   |        |  |
| 3.0 i V6       | 150            |     | 08.02 | 01.11 |       |  |                |        |        |                                  |            |   |        |  |
|                | 2.0 i 16V      | 100 |       | 08.02 | 01.11 |  | 24.3727-0847.2 | 580847 | ☐<br>☐ | L=1068<br>L=2360                 |            |   |        |  |
|                | 2.0 JTD        | 79  |       | 05.03 | 01.11 |  | 24.3727-0848.2 | 580848 |        |                                  |            |   |        |  |
|                | 2.0 JTD        | 80  |       | 08.02 | 01.11 |  |                |        |        |                                  |            |   |        |  |
|                | 2.2 JTD        | 94  |       | 08.02 | 01.11 |  |                |        |        |                                  |            |   |        |  |
|                | 2.2 JTD        | 120 |       | 03.08 | 01.11 |  |                |        |        |                                  |            |   |        |  |
|                | 3.0 i V6       | 150 |       | 08.02 | 01.11 |  |                |        |        |                                  |            |   |        |  |
|                | 2.0 D Multijet | 88  |       | 05.06 | 01.11 |  | 24.3727-0569.2 | 580569 |        |                                  |            | 2 | L=1255 |  |
|                | 2.0 D Multijet | 100 |       | 05.06 | 01.11 |  |                |        |        |                                  |            |   |        |  |
| 2.2 D Multijet | 125            |     | 03.08 | 01.11 |       |  |                |        |        |                                  |            |   |        |  |























### FORD C-MAX I (07-10)

|  |           |     |  |       |       |  |                |        |                  |  |                          |
|--|-----------|-----|--|-------|-------|--|----------------|--------|------------------|--|--------------------------|
|  | 1.6 i 16V | 74  |  | 03.07 | 04.07 |  | 03.7863-0332.4 | 300203 |                  | 10"  | ATE                      |
|  | 1.6 TDCi  |     |  | 03.07 | 04.07 |  |                |        |                  |  |                          |
|  | 1.6 TDCi  | 66  |  | 03.07 | 04.07 |  |                |        |                  |  |                          |
|  | 1.8 i 16V |     |  | 03.07 | 04.07 |  |                |        |                  |  |                          |
|  | 1.8 TDCi  | 85  |  | 03.07 | 04.07 |  |                |        |                  |  |                          |
|  | 2.0 i 16V | 107 |  | 03.07 | 04.07 |  |                |        |                  |  |                          |
|  | 2.0 TDCi  |     |  | 03.07 | 04.07 |  |                |        |                  |  |                          |
|  | 2.0 TDCi  |     |  | 03.07 | 04.07 |  |                |        |                  |  |                          |
|  | 1.6 i 16V | 74  |  | 05.07 | 10.10 |  | 03.7863-3932.4 | 300288 |                  | 10"  | ATE                      |
|  | 1.6 TDCi  |     |  | 05.07 | 10.10 |  |                |        |                  |  |                          |
|  | 1.6 TDCi  | 66  |  | 05.07 | 10.10 |  |                |        |                  |  |                          |
|  | 1.8 i 16V |     |  | 05.07 | 10.10 |  |                |        |                  |  |                          |
|  | 1.8 TDCi  | 85  |  | 05.07 | 10.10 |  |                |        |                  |  |                          |
|  | 2.0 i 16V | 107 |  | 05.07 | 10.10 |  |                |        |                  |  |                          |
|  | 2.0 TDCi  |     |  | 05.07 | 10.10 |  |                |        |                  |  |                          |
|  | 2.0 TDCi  | 81  |  | 02.08 | 10.10 |  |                |        |                  |  |                          |
|  | 1.6 i 16V | 74  |  | 03.07 | 05.07 |  | 03.2123-3103.3 | 010781 |                  | Thz 23,81  | ATE                      |
|  | 1.6 TDCi  |     |  | 03.07 | 05.07 |  |                |        |                  |  |                          |
|  | 1.6 TDCi  | 66  |  | 03.07 | 05.07 |  |                |        |                  |  |                          |
|  | 1.8 i 16V |     |  | 03.07 | 05.07 |  |                |        |                  |  |                          |
|  | 1.8 TDCi  | 85  |  | 03.07 | 05.07 |  |                |        |                  |  |                          |
|  | 2.0 i 16V | 107 |  | 03.07 | 05.07 |  |                |        |                  |  |                          |
|  | 2.0 TDCi  |     |  | 03.07 | 05.07 |  |                |        |                  |  |                          |
|  | 2.0 TDCi  |     |  | 03.07 | 05.07 |  |                |        |                  |  |                          |
|  | 1.6 i 16V | 74  |  | 06.07 | 10.08 |  | 03.2125-0483.3 | 010783 |                  | Thz 25,40  | ATE                      |
|  | 1.6 TDCi  |     |  | 06.07 | 10.08 |  |                |        |                  |  |                          |
|  | 1.6 TDCi  | 66  |  | 06.07 | 10.08 |  |                |        |                  |  |                          |
|  | 1.8 i 16V |     |  | 06.07 | 10.08 |  |                |        |                  |  |                          |
|  | 1.8 TDCi  | 85  |  | 06.07 | 10.08 |  |                |        |                  |  |                          |
|  | 2.0 i 16V | 107 |  | 06.07 | 10.08 |  |                |        |                  |  |                          |
|  | 2.0 TDCi  |     |  | 06.07 | 10.08 |  |                |        |                  |  |                          |
|  | 2.0 TDCi  | 81  |  | 02.08 | 10.08 |  |                |        |                  |  |                          |
|  | 1.6 i 16V | 74  |  | 11.08 | 10.10 |  | 03.2125-0661.3 | 010917 |                  | Thz 25,40  | ATE                      |
|  | 1.6 TDCi  |     |  | 11.08 | 10.10 |  |                |        |                  |  |                          |
|  | 1.6 TDCi  | 66  |  | 11.08 | 10.10 |  |                |        |                  |  |                          |
|  | 1.8 i 16V |     |  | 11.08 | 10.10 |  |                |        |                  |  |                          |
|  | 1.8 TDCi  | 85  |  | 11.08 | 10.10 |  |                |        |                  |  |                          |
|  | 2.0 i 16V | 107 |  | 11.08 | 10.10 |  |                |        |                  |  |                          |
|  | 2.0 TDCi  |     |  | 11.08 | 10.10 |  |                |        |                  |  |                          |
|  | 2.0 TDCi  | 81  |  | 11.08 | 10.10 |  |                |        |                  |  |                          |
|  | 1.6 i 16V | 74  |  | 03.07 | 10.10 |  | 11.9571-9813.2 | 220647 | ☐<br>☐<br>☐<br>☐ | D=57, - Halter<br>D=57, - Halter<br>D=57, - Halter<br>D=57, - Halter | ATE<br>ATE<br>ATE<br>ATE |
|  | 1.6 TDCi  |     |  | 03.07 | 10.10 |  | 11.9571-9814.2 | 220648 |                  |  |                          |
|  | 1.6 TDCi  | 66  |  | 03.07 | 10.10 |  | 24.3571-9813.5 | 240557 |                  |  |                          |
|  | 1.8 i 16V |     |  | 03.07 | 10.10 |  | 24.3571-9814.5 | 240558 |                  |  |                          |
|  |           |     |  |       |       |  | 11.0101-5407.2 | 260011 |                  |  |                          |
|  |           |     |  |       |       |  | 11.8171-0008.1 | 990049 |                  |  |                          |
|  |           |     |  |       |       |  | 11.8116-0356.1 | 390586 |                  |  |                          |
|  |           |     |  |       |       |  |                |        |                  |  |                          |
|  | 1.8 TDCi  | 85  |  | 03.07 | 10.10 |  | 11.9571-9813.2 | 220647 | ☐<br>☐<br>☐<br>☐ | D=57, - Halter<br>D=57, - Halter<br>D=57, - Halter<br>D=57, - Halter | ATE<br>ATE<br>ATE<br>ATE |
|  | 2.0 i 16V | 107 |  | 03.07 | 10.10 |  | 11.9571-9814.2 | 220648 |                  |  |                          |
|  | 2.0 TDCi  |     |  | 03.07 | 10.10 |  | 24.3571-9813.5 | 240557 |                  |  |                          |
|  | 2.0 TDCi  | 81  |  | 02.08 | 10.10 |  | 24.3571-9814.5 | 240558 |                  |  |                          |
|  |           |     |  |       |       |  | 11.0101-5407.2 | 260011 |                  |  | ATE<br>ATE<br>ATE<br>ATE |
|  |           |     |  |       |       |  | 11.8171-0008.1 | 990049 |                  |  |                          |
|  |           |     |  |       |       |  | 11.8116-0356.1 | 390586 |                  |  |                          |
|  |           |     |  |       |       |  |                |        |                  |  |                          |
|  | 1.6 i 16V | 74  |  | 03.07 | 10.10 |  | 83.7716-0397.3 | 330790 | 2                | L=395  |                          |
|  | 1.6 TDCi  |     |  | 03.07 | 10.10 |  |                |        |                  |  |                          |
|  | 1.6 TDCi  | 66  |  | 03.07 | 10.10 |  |                |        |                  |  |                          |
|  | 1.8 i 16V |     |  | 03.07 | 10.10 |  |                |        |                  |  |                          |
|  | 1.8 TDCi  | 85  |  | 03.07 | 10.10 |  |                |        |                  |  |                          |
|  | 2.0 i 16V | 107 |  | 03.07 | 10.10 |  |                |        |                  |  |                          |

|     |    |       |  |    |  |                        |  |  |  |  |
|--|--|---|--|--|---|--|--|--|--|--|
| <b>FORD C-MAX I (07-10)</b>  |  |   |  |  |   |  |  |  |  |  |
|    | 2.0 TDCi<br>2.0 TDCi   | 81  |  | 03.07<br>02.08   | 10.10<br>10.10  | 83.7716-0397.3   | 330790   | 2  | L=395  |  |
|    | 1.6 i 16V<br>1.6 TDCi<br>1.6 TDCi<br>1.8 i 16V   | 74<br>66  |  | 03.07<br>03.07<br>03.07<br>03.07   | 10.10<br>10.10<br>10.10<br>10.10  | 11.9387-7015.2<br>11.9387-7016.2<br>11.0101-5407.2<br>11.8171-0008.1<br>11.8116-0340.1                   | 220627<br>220628<br>260011<br>990049<br>390595                                     | 2  | D=38, - Halter<br>D=38, - Halter<br>Hülsensatz<br>Führungsbolzen<br>Haltefeder           | ATE<br>ATE<br>ATE<br>ATE<br>ATE        |
|    | 1.8 TDCi<br>2.0 i 16V<br>2.0 TDCi<br>2.0 TDCi  | 85<br>107<br>81   |  | 03.07<br>03.07<br>03.07<br>02.08   | 10.10<br>10.10<br>10.10<br>10.10  | 11.9387-7015.2<br>11.9387-7016.2<br>11.0230-0698.2<br>11.0101-5407.2<br>11.8171-0008.1<br>11.8116-0340.1 | 220627<br>220628<br>260091<br>260011<br>990049<br>390595                           | 2  | D=38, - Halter<br>D=38, - Halter<br>Halter<br>Hülsensatz<br>Führungsbolzen<br>Haltefeder | ATE<br>ATE<br>ATE<br>ATE<br>ATE<br>ATE |
|    | 1.6 i 16V<br>1.6 TDCi<br>1.6 TDCi<br>1.6 TDCi<br>1.8 i 16V<br>1.8 TDCi<br>2.0 i 16V<br>2.0 TDCi<br>2.0 TDCi  | 74<br>66<br>85<br>107<br>81   |  | 03.07<br>03.07<br>03.07<br>03.07<br>03.07<br>03.07<br>03.07<br>02.08   | 10.10<br>10.10<br>10.10<br>10.10<br>10.10<br>10.10<br>10.10<br>10.10              | 83.7788-0416.3   | 330884   | 2  | L=415  |  |
|    | 1.6 i 16V<br>1.6 TDCi<br>1.6 TDCi<br>1.8 i 16V<br>1.8 TDCi<br>2.0 i 16V<br>2.0 TDCi<br>2.0 TDCi  | 74<br>66<br>85<br>107<br>81   |  | 03.07<br>03.07<br>03.07<br>03.07<br>03.07<br>03.07<br>02.08  | 10.10<br>10.10<br>10.10<br>10.10<br>10.10<br>10.10<br>10.10                       | 24.3727-0678.2<br>24.3727-0659.2   | 580678<br>580659   | 1<br>1   | L=341<br>L=1816/1860   |  |
| <b>FORD C-MAX II (10-)</b>   |  |   |  |  |   |  |  |  |  |  |
|    | 1.0 EcoBoost<br>1.0 EcoBoost<br>1.6 Flexifuel<br>1.6 LPG<br>1.6 TDCi<br>1.6 TDCi<br>1.6 Ti-VCT<br>1.6 Ti-VCT<br>1.6 Ti-VCT   | 74<br>92<br>88<br>88<br>70<br>85<br>63<br>77<br>92                                    |  | 09.12<br>09.12<br>02.11<br>02.12<br>12.10<br>12.10<br>12.10<br>12.10<br>12.10  |   | 11.9571-9813.2<br>24.3571-9813.5<br>11.9571-9814.2<br>24.3571-9814.5<br>11.8116-0356.1                   | 220647<br>240557<br>220648<br>240558<br>390586                                     | 2  | D=57, - Halter<br>D=57, - Halter<br>D=57, - Halter<br>D=57, - Halter<br>Haltefeder       | ATE<br>ATE<br>ATE<br>ATE<br>ATE        |
|    | 1.6 EcoBoost<br>1.6 EcoBoost<br>2.0 TDCi<br>2.0 TDCi<br>2.0 TDCi   | 110<br>134<br>85<br>103<br>120  |  | 12.10<br>12.10<br>12.10<br>12.10<br>12.10  |   | 11.9571-9813.2<br>24.3571-9813.5<br>11.9571-9814.2<br>24.3571-9814.5<br>11.8116-0356.1                   | 220647<br>240557<br>220648<br>240558<br>390586                                     | 2  | D=57, - Halter<br>D=57, - Halter<br>D=57, - Halter<br>D=57, - Halter<br>Haltefeder       | ATE<br>ATE<br>ATE<br>ATE<br>ATE        |
|  | 1.0 EcoBoost<br>1.0 EcoBoost<br>1.6 EcoBoost<br>1.6 EcoBoost<br>1.6 Flexifuel<br>1.6 LPG<br>1.6 TDCi<br>1.6 TDCi<br>1.6 Ti-VCT<br>1.6 Ti-VCT<br>1.6 Ti-VCT<br>2.0 TDCi<br>2.0 TDCi<br>2.0 TDCi | 74<br>92<br>110<br>134<br>88<br>88<br>70<br>85<br>63<br>77<br>92<br>85<br>103<br>120  |  | 09.12<br>09.12<br>12.10<br>12.10<br>02.11<br>02.12<br>12.10<br>12.10<br>12.10<br>12.10<br>12.10<br>12.10<br>12.10<br>12.10 |   | 24.3727-0678.2   | 580678   | 1  | - Mittelkonsole <sup>1)</sup>  | L=341                                  |
| <b>FORD GRAND C-MAX (10-)</b>  |  |   |  |  |   |  |  |  |  |  |
|  | 1.0 EcoBoost<br>1.0 EcoBoost<br>1.6 EcoBoost<br>1.6 EcoBoost<br>1.6 Flexifuel<br>1.6 LPG<br>1.6 TDCi<br>1.6 TDCi<br>1.6 Ti-VCT<br>1.6 Ti-VCT<br>2.0 TDCi<br>2.0 TDCi<br>2.0 TDCi<br>2.0 TDCi   | 74<br>92<br>110<br>134<br>88<br>86<br>70<br>85<br>77<br>92<br>85<br>100<br>103<br>120 |  | 09.12<br>09.12<br>12.10<br>12.10<br>02.11<br>02.12<br>12.10<br>12.10<br>12.10<br>12.10<br>12.10<br>12.10<br>12.10<br>12.10 |   | 11.9571-9813.2<br>24.3571-9813.5<br>11.9571-9814.2<br>24.3571-9814.5<br>11.8116-0356.1                   | 220647<br>240557<br>220648<br>240558<br>390586                                     | 2  | D=57, - Halter<br>D=57, - Halter<br>D=57, - Halter<br>D=57, - Halter<br>Haltefeder       | ATE<br>ATE<br>ATE<br>ATE<br>ATE        |
|  | 1.0 EcoBoost<br>1.0 EcoBoost<br>1.6 EcoBoost<br>1.6 Flexifuel<br>1.6 LPG<br>1.6 TDCi<br>1.6 TDCi<br>1.6 Ti-VCT<br>1.6 Ti-VCT<br>2.0 TDCi<br>2.0 TDCi<br>2.0 TDCi                               | 74<br>92<br>134<br>88<br>86<br>70<br>85<br>77<br>92<br>85<br>100<br>103               |  | 09.12<br>09.12<br>12.10<br>02.11<br>02.12<br>12.10<br>12.10<br>12.10<br>12.10<br>12.10<br>12.10<br>12.10                   |   | 24.3727-0678.2   | 580678   | 1  | - Mittelkonsole <sup>1)</sup>  | L=341                                  |

<sup>1)</sup> - centre console / - consolle centrale / - consola central / - consola central



|     |            |  |  |  |   |  |  |   |
|--|--|--|--|--|--|--|--|---|
| <b>FORD GRAND C-MAX (10-)</b>  |  |  |  |  |  |  |  |   |
|    | 2.0 TDCi<br>2.0 TDCi   | 103<br>120   | 12.10<br>12.10   |  | 24.3727-0678.2   | 580678   | 1 ↑ - Mittelkonsole <sup>1)</sup>  | L=341   |
| <b>FORD COUGAR (98-00)</b>   |  |  |  |  |  |  |  |   |
|    | 2.0 i 16V<br>2.5 i V6  |  | 09.98<br>09.98   | 12.00<br>12.00   | 24.2125-1709.3   | 010499   |  | Thz 25,40   |
|    | 2.0 i 16V  |  | 09.98  | 12.00  | 24.3601-8527.5<br>24.3601-8528.5<br>11.0441-6005.2<br>11.0230-0170.2<br>11.0101-5407.2<br>11.8171-0008.1<br>11.8116-0301.1 | 240503<br>240504<br>250150<br>260078<br>260011<br>990049<br>390610                 | 2<br>☐<br>☐  | D=60, - Halter<br>D=60, - Halter<br>Dichtungssatz<br>Haltersatz<br>Hülsensatz<br>Führungsbolzen<br>Haltefeder<br>ATE<br>ATE<br>ATE<br>ATE<br>ATE<br>ATE |
|  | 2.5 i V6   |  | 09.98  | 12.00  | 24.3601-8527.5<br>24.3601-8528.5<br>11.0441-6005.2<br>11.0101-5407.2<br>11.8171-0008.1<br>11.8116-0301.1                   | 240503<br>240504<br>250150<br>260011<br>990049<br>390610                           | 2<br>☐<br>☐  | D=60, - Halter<br>D=60, - Halter<br>Dichtungssatz<br>Hülsensatz<br>Führungsbolzen<br>Haltefeder<br>ATE<br>ATE<br>ATE<br>ATE<br>ATE                      |
|    | 2.0 i 16V<br>2.5 i V6  |  | 09.98<br>09.98   | 12.00<br>12.00   | 83.7114-0376.3   | 330373   | 2  | L=370   |
|    | 2.0 i 16V<br>2.5 i V6  |  | 09.98<br>09.98   | 12.00<br>12.00   | 24.3364-1703.5<br>24.3364-1704.5   | 240309<br>240310   | ☐<br>☐   | D=36, - Halter<br>D=36, - Halter<br>BOS<br>BOS  |
|    | 2.0 i 16V<br>2.5 i V6  |  | 09.98<br>09.98   | 12.00<br>12.00   | 83.6362-0542.3   | 330485   | 2  | L=540   |
|    | 2.0 i 16V<br>2.5 i V6  |  | 09.98<br>09.98   | 12.00<br>12.00   | 24.3727-0638.2<br>24.3727-0644.2   | 580638<br>580644   | 1 ↑<br>2 ↓   | L=270<br>L=1462   |
|    | 2.0 i 16V<br>2.5 i V6  |  | 09.98<br>09.98   | 12.00<br>12.00   | 24.2419-1723.3   | 030112   |  | Gz 19,05  |
| <b>FORD ESCORT / ORION (91-94)</b>   |  |  |  |  |  |  |  |   |
|   | alle Typen   |  | 09.90  | 01.95  | - ABS / - 1,8 i-16V <sup>2)</sup>  | 24.2123-1606.3   | 010386   | Thz 23,81   |
|  | 1.8 i 16V  |  | 09.91  | 01.95  | - ABS  | 24.2125-1701.3   | 010456   | Thz 25,40   |
|  | alle Typen   |  | 09.90  | 01.95  | - Cosworth-Turbo   | 10.6125-0124.3   | 010560   | + ABS<br>Thz 25,40  |
|  | 1.1<br>1.3 Kastenw.<br>1.3 Kombi<br>1.3 Lim.<br>1.4<br>1.6<br>1.8 D<br>1.8 i 16V<br>1.8 TD | 77   | 09.90<br>09.90<br>09.90<br>09.90<br>09.90<br>09.90<br>09.90<br>01.92<br>02.93    | 01.95<br>01.95<br>01.95<br>01.95<br>01.95<br>01.95<br>01.95<br>01.95<br>01.95    | + ABS<br>+ ABS<br>+ ABS  | 24.3541-1707.5<br>24.3541-1708.5<br>24.0101-5401.2                                 | 240067<br>240068<br>260059   | ☐<br>☐<br>☐<br>D=54, - Halter<br>D=54, - Halter<br>Einbausatz<br>BDX<br>BDX<br>BDX  |
|  | 1.8 i 16V<br>RS 2000   | 96   | 01.92<br>05.91   | 01.95<br>01.95   |  | 11.0441-6005.2<br>11.0101-5407.2<br>11.8171-0008.1                                 | 250150<br>260011<br>990049   | Dichtungssatz<br>Hülsensatz<br>Führungsbolzen<br>ATE<br>ATE<br>ATE  |
|  | 2.0 RS Cosworth T.   |  | 09.92  | 01.95  |  | 11.0441-6005.2<br>11.0101-5407.2<br>11.8171-0008.1<br>11.8116-0073.1               | 250150<br>260011<br>990049<br>390498   | 2<br>☐<br>☐<br>Dichtungssatz<br>Hülsensatz<br>Führungsbolzen<br>Haltefeder<br>ATE<br>ATE<br>ATE<br>ATE  |
|  | alle Typen   |  | 09.90  | 01.95  |  | 24.5129-0395.3<br>24.5129-0396.3   | 330582<br>330583   | ☐<br>☐<br>L=395<br>L=395  |
|  | 1.6<br>1.8 D<br>1.8 i 16V<br>1.8 TD<br>RS 2000   |  | 09.90<br>09.90<br>01.92<br>02.93<br>05.91  | 01.95<br>01.95<br>01.95<br>01.95<br>01.95  | + ABS<br>+ ABS<br>+ ABS<br>+ ABS   | 13.2331-8007.2   | 210143   | ☐<br>D=33<br>ATE  |
|  | alle Typen   |  | 09.90  | 01.95  |  | 24.5303-0455.3   | 330588   | 2<br>L=455  |
|  | 1.1<br>1.3 Lim.<br>1.4 Lim.  |  | 09.90<br>09.90<br>09.90  | 01.95<br>01.95<br>01.95  | - ABS<br>- ABS<br>- ABS/ + Schaltgetriebe <sup>3)</sup>  | 24.3220-1112.3   | 020223   | Rz 20,64  |
|  | 1.3 Kombi<br>1.4 Cabrio<br>1.4 Kombi<br>1.4 Lim.<br>1.6<br>1.8 D<br>1.8 i 16V<br>1.8 TD    | 77   | 09.90<br>09.90<br>09.90<br>09.90<br>09.90<br>01.92<br>02.93                      | 01.95<br>01.95<br>01.95<br>01.95<br>01.95<br>01.95<br>01.95                      | - ABS<br>- ABS<br>- ABS/ + Automatikgetriebe <sup>5)</sup><br>- ABS/ - Kastenwagen <sup>6)</sup><br>- ABS<br>- ABS         | 24.3219-1107.3   | 020338   | nur paarweise austauschen <sup>4)</sup><br>Rz 19,05<br>LUC  |
|  | 1.1<br>1.3<br>1.4<br>1.4 Kastenw.<br>1.8 D Kastenw.  |  | 09.90<br>09.90<br>09.90<br>09.90<br>09.90  | 01.95<br>01.95<br>01.95<br>01.95<br>01.95  | + ABS<br>+ ABS<br>+ ABS<br>- ABS   | 24.3222-1117.3   | 020272   | Rz 22,20  |

<sup>1)</sup> - centre console / - consolle centrale / - consola central / - consola central

<sup>2)</sup> - ABS / - 1,8 i-16V / - ABS / - 1,8 i-16V / - ABS / - 1,8 i-16V / - ABS / - 1,8 i 16V

<sup>3)</sup> - ABS / + manual transmission / - ABS / + scatola camb.velocità / - ABS / + transmission mécanique / - ABS / + cambio de velocidad

<sup>4)</sup> to change only by pairs / sostituire solo a coppie / à changer seulement par paires / cambiar solamente por parejas

<sup>5)</sup> - ABS / + autom.transmission / - ABS / + scatola cambio autom. / - ABS / + transmission automatique / - ABS / + cambio automático

<sup>6)</sup> - ABS / - Van / - ABS / - furgone / - ABS / - fourgonnette / - ABS / - furgón

| FORD ESCORT / ORION (91-94) |                    |    |       |       |                                    |                |        |       |                      |
|-----------------------------|--------------------|----|-------|-------|------------------------------------|----------------|--------|-------|----------------------|
|                             | alle Typen         |    | 09.90 | 01.95 | 24.3727-0628.2                     | 580628         | 1      | ↑     | L=151                |
|                             | alle Typen         |    | 09.90 | 01.95 | - Kastenwagen/-Cosworth/-RS2000 1) | 24.3727-0627.2 | 580627 | 1     | ↓                    |
| FORD ESCORT VII (95-00)     |                    |    |       |       |                                    |                |        |       |                      |
|                             | 1.3 i              |    | 02.95 | 07.95 | 03.7750-5802.4                     | 300170         |        | + ABS | 9" ATE               |
|                             | 1.4 i              |    | 02.95 | 07.95 |                                    |                |        |       |                      |
|                             | 1.6 i 16V          |    | 02.95 | 07.95 |                                    |                |        |       |                      |
|                             | 1.8 D              |    | 02.95 | 07.95 |                                    |                |        |       |                      |
|                             | 1.8 i 16V          |    | 02.95 | 07.95 |                                    |                |        |       |                      |
|                             | 1.8 TD             |    | 02.95 | 07.95 |                                    |                |        |       |                      |
|                             | 1.3 i              |    | 02.95 | 02.99 | 24.2123-1732.3                     | 010625         |        | - ABS | THz 23,81 - Behälter |
|                             | 1.4 i              |    | 02.95 | 02.99 |                                    |                |        |       |                      |
|                             | 1.6 i 16V          |    | 02.95 | 02.99 |                                    |                |        |       |                      |
|                             | 1.8 D              |    | 02.95 | 02.99 |                                    |                |        |       |                      |
|                             | 1.8 i 16V          | 77 | 02.95 | 02.99 |                                    |                |        |       |                      |
|                             | 1.8 i 16V          | 85 | 02.95 | 02.99 |                                    |                |        |       |                      |
|                             | 1.8 TD             |    | 02.95 | 02.99 |                                    |                |        |       |                      |
|                             | 1.8 i 16V          | 96 | 02.95 | 02.99 | 24.2125-1715.3                     | 010655         |        | - ABS | THz 25,40            |
|                             | 1.3 i              |    | 02.95 | 07.95 | 10.6125-0124.3                     | 010560         |        | + ABS | THz 25,40            |
|                             | 1.4 i              |    | 02.95 | 07.95 |                                    |                |        |       |                      |
|                             | 1.6 i 16V          |    | 02.95 | 07.95 |                                    |                |        |       |                      |
|                             | 1.8 D              |    | 02.95 | 07.95 |                                    |                |        |       |                      |
|                             | 1.8 i 16V          |    | 02.95 | 07.95 |                                    |                |        |       |                      |
|                             | 1.8 TD             |    | 02.95 | 07.95 |                                    |                |        |       |                      |
|                             | 1.3 i              |    | 08.95 | 02.99 | 03.2123-1581.3                     | 010487         |        | + ABS | THz 23,81 (MKIV) ATE |
|                             | 1.4 i              |    | 08.95 | 02.99 |                                    |                |        |       |                      |
|                             | 1.6 i 16V          |    | 08.95 | 07.00 |                                    |                |        |       |                      |
|                             | 1.8 D              |    | 08.95 | 02.99 |                                    |                |        |       |                      |
|                             | 1.8 i 16V          |    | 08.95 | 02.99 |                                    |                |        |       |                      |
|                             | 1.8 TD             |    | 08.95 | 07.00 |                                    |                |        |       |                      |
|                             | 1.3 i              |    | 02.95 | 02.99 | 24.3541-1707.5                     | 240067         |        |       | D=54, - Halter BDX   |
|                             | 1.4 i              |    | 02.95 | 02.99 | 24.3541-1708.5                     | 240068         |        |       | D=54, - Halter BDX   |
|                             | 1.6 i 16V          |    | 02.95 | 07.00 | 24.0101-5401.2                     | 260059         |        |       | Einbausatz BDX       |
|                             | 1.8 D              |    | 02.95 | 02.99 |                                    |                |        |       |                      |
|                             | 1.8 i 16V          | 77 | 02.95 | 02.99 |                                    |                |        |       |                      |
|                             | 1.8 i 16V          | 85 | 02.95 | 02.99 |                                    |                |        |       |                      |
|                             | 1.8 TD             |    | 02.95 | 07.00 |                                    |                |        |       |                      |
|                             | 1.8 i 16V          | 96 | 02.95 | 02.99 | 11.0441-6005.2                     | 250150         |        |       | Dichtungssatz ATE    |
|                             | RS 2000            |    | 02.95 | 02.99 | 11.0101-5407.2                     | 260011         |        |       | Hülssensatz ATE      |
|                             |                    |    |       |       | 11.8171-0008.1                     | 990049         |        |       | Führungsbolzen ATE   |
|                             | 2.0 i 16V Cosworth |    | 02.95 | 12.95 | 11.0441-6005.2                     | 250150         |        |       | Dichtungssatz ATE    |
|                             |                    |    |       |       | 11.0101-5407.2                     | 260011         |        |       | Hülssensatz ATE      |
|                             |                    |    |       |       | 11.8171-0008.1                     | 990049         |        |       | Führungsbolzen ATE   |
|                             |                    |    |       |       | 11.8116-0073.1                     | 390498         | 2      |       | Haltefeder ATE       |
|                             | 1.6 i 16V          |    | 02.95 | 07.00 | + ABS                              | 13.2331-8007.2 | 210143 |       | D=33 ATE             |
|                             | 1.8 D              |    | 02.95 | 02.99 | + ABS                              |                |        |       |                      |
|                             | 1.8 i 16V          |    | 02.95 | 02.99 | + ABS                              |                |        |       |                      |
|                             | 1.8 TD             |    | 02.95 | 07.00 | + ABS                              |                |        |       |                      |
|                             | 1.3 i              |    | 02.95 | 02.99 | - ABS                              | 24.5305-0300.3 | 330658 | 2     | L=300                |
|                             | 1.4 i Cabrio       |    | 02.95 | 02.99 | - ABS                              |                |        |       |                      |
|                             | 1.4 i Lim.         |    | 02.95 | 02.99 | - ABS                              |                |        |       |                      |
|                             | 1.6 i 16V Cabrio   |    | 02.95 | 02.99 | - ABS                              |                |        |       |                      |
|                             | 1.6 i 16V Lim.     |    | 02.95 | 02.99 | - ABS                              |                |        |       |                      |
|                             | 1.8 D Cabrio       |    | 02.95 | 02.99 | - ABS                              |                |        |       |                      |
|                             | 1.8 D Lim.         |    | 02.95 | 02.99 | - ABS                              |                |        |       |                      |
|                             | 1.8 i 16V Cabrio   |    | 02.95 | 02.99 | - ABS                              |                |        |       |                      |
|                             | 1.8 i 16V Lim.     |    | 02.95 | 02.99 | - ABS                              |                |        |       |                      |
|                             | 1.8 TD Cabrio      |    | 02.95 | 02.99 | - ABS                              |                |        |       |                      |
|                             | 1.8 TD Lim.        |    | 02.95 | 02.99 | - ABS                              |                |        |       |                      |
|                             | 1.3 i              |    | 02.95 | 02.99 | + ABS                              | 24.5305-0420.3 | 330661 | 2     | L=420                |
|                             | 1.4 i Cabrio       |    | 02.95 | 02.99 | + ABS                              |                |        |       |                      |
|                             | 1.4 i Lim.         |    | 02.95 | 02.99 | + ABS                              |                |        |       |                      |
|                             | 1.6 i 16V Cabrio   |    | 02.95 | 02.99 | + ABS                              |                |        |       |                      |
|                             | 1.6 i 16V Lim.     |    | 02.95 | 02.99 | + ABS                              |                |        |       |                      |
|                             | 1.8 D Cabrio       |    | 02.95 | 02.99 | + ABS                              |                |        |       |                      |
|                             | 1.8 D Lim.         |    | 02.95 | 02.99 | + ABS                              |                |        |       |                      |
|                             | 1.8 i 16V Cabrio   |    | 02.95 | 02.99 | + ABS                              |                |        |       |                      |
|                             | 1.8 i 16V Lim.     |    | 02.95 | 02.99 | + ABS                              |                |        |       |                      |
|                             | 1.8 TD Cabrio      |    | 02.95 | 02.99 | + ABS                              |                |        |       |                      |
|                             | 1.8 TD Lim.        |    | 02.95 | 02.99 | + ABS                              |                |        |       |                      |
|                             | 2.0 i 16V Cosworth |    | 02.95 | 12.95 |                                    |                |        |       |                      |
|                             | 1.4 i Kombi        |    | 08.95 | 02.99 | 24.5305-0320.3                     | 330764         | 2      |       | L=322                |
|                             | 1.6 i 16V Kombi    |    | 08.95 | 02.99 |                                    |                |        |       |                      |
|                             | 1.8 D Kombi        |    | 08.95 | 02.99 |                                    |                |        |       |                      |
|                             | 1.8 i 16V Kombi    |    | 08.95 | 02.99 |                                    |                |        |       |                      |
|                             | 1.8 TD Kombi       |    | 08.95 | 02.99 |                                    |                |        |       |                      |
|                             | 1.4 i Kastenw.     |    | 02.95 | 02.99 | 24.5306-0380.3                     | 330783         | 2      |       | L=380                |
|                             | 1.8 D Kastenw.     |    | 02.95 | 02.99 |                                    |                |        |       |                      |
|                             | 1.3 i              |    | 02.95 | 07.95 | - ABS                              | 24.3220-1112.3 | 020223 |       | Rz 20,64             |
|                             | 1.4 i Cabrio       |    | 02.95 | 07.95 | - ABS                              |                |        |       |                      |
|                             | 1.4 i Lim.         |    | 02.95 | 07.95 | - ABS                              |                |        |       |                      |
|                             | 1.6 i 16V          |    | 02.95 | 07.00 | - ABS                              |                |        |       |                      |
|                             | 1.8 D              |    | 08.95 | 02.99 |                                    |                |        |       |                      |
|                             | 1.8 D              |    | 02.95 | 07.95 | - ABS                              |                |        |       |                      |

1) - Van/ -Cosworth/ -RS2000 / - furgone/ - Cosworth/ - RS2000 / - fourgonn./ - Cosworth/ - RS2000 / - furgón/ - Cosworth/ - RS2000



**FORD ESCORT VII (95-00)**

|  |  |                                 |   |   |   |                |        |   |                      |            |
|--|--|---------------------------------|---|---|---|----------------|--------|---|----------------------|------------|
|  | 1.8 i 16V<br>1.8 TD  |                                 | 08.95<br>02.95  | 02.99<br>07.00  | - ABS   | 24.3220-1112.3 | 020223 |   | Rz 20,64             |            |
|  | 1.4 i Kombi<br>1.6 i 16V<br>1.8 D<br>1.8 i 16V Cabrio<br>1.8 TD  |                                 | 02.95<br>02.95<br>02.95<br>02.95<br>02.95   | 07.95<br>07.95<br>07.95<br>07.95<br>07.95   | - ABS<br>- ABS<br>- ABS<br>- ABS  | 24.3219-1107.3 | 020338 | nur paarweise austauschen <sup>1)</sup> | Rz 19,05             | <b>LUC</b> |
|  | 1.3 i<br>1.3 i<br>1.4 i Cabrio<br>1.4 i Kastenw.<br>1.4 i Kombi<br>1.4 i Lim.<br>1.6 i 16V<br>1.8 D<br>1.8 D Kastenw.<br>1.8 i 16V<br>1.8 TD |                                 | 02.95<br>08.95<br>08.95<br>02.95<br>08.95<br>08.95<br>08.95<br>02.95<br>02.95<br>02.95<br>08.95 | 02.99<br>02.99<br>02.99<br>02.99<br>02.99<br>02.99<br>07.00<br>07.95<br>02.99<br>02.99<br>07.00 | + ABS<br>- ABS<br><br><br><br><br><br>+ ABS   | 24.3222-1117.3 | 020272 |   | Rz 22,20             |            |
|  | 1.3 i<br>1.4 i<br>1.6 i 16V<br>1.8 D<br>1.8 i 16V<br>1.8 TD<br>2.0 i 16V Cosworth  | ↑<br>↑<br>↑<br>↑<br>↑<br>↑<br>↑ | 02.95<br>02.95<br>02.95<br>02.95<br>02.95<br>02.95<br>02.95                                     | 02.99<br>02.99<br>07.00<br>02.99<br>02.99<br>07.00<br>12.95                                     |   | 24.3727-0661.2 | 580661 | 1 ↑<br>1 ↓                              | L=281<br>L=1670/1705 |            |
|  | 1.3 i<br>1.4 i<br>1.6 i 16V<br>1.8 D<br>1.8 i 16V<br>1.8 TD<br>2.0 i 16V Cosworth  | ↑<br>↑<br>↑<br>↑<br>↑<br>↑<br>↑ | 02.95<br>02.95<br>02.95<br>02.95<br>02.95<br>02.95<br>02.95                                     | 02.99<br>02.99<br>07.00<br>02.99<br>02.99<br>07.00<br>12.95                                     |   | 24.3727-0661.2 | 580661 | 1 ↑                                     | L=281                |            |
|  | 1.3 i<br>1.4 i<br>1.6 i 16V<br>1.8 D<br>1.8 i 16V<br>1.8 TD<br>2.0 i 16V Cosworth  | ↑<br>↑<br>↑<br>↑<br>↑<br>↑<br>↑ | 02.95<br>02.95<br>02.95<br>02.95<br>02.95<br>02.95<br>02.95                                     | 04.98<br>04.98<br>04.98<br>04.98<br>04.98<br>04.98<br>04.98                                     | + Lieferwagen <sup>2)</sup><br>+ Lieferwagen <sup>2)</sup><br>+ Lieferwagen <sup>2)</sup><br>+ Lieferwagen <sup>2)</sup><br>+ Lieferwagen <sup>2)</sup><br>+ Lieferwagen <sup>2)</sup><br>+ Lieferwagen <sup>2)</sup> | 24.3727-0661.2 | 580661 | 1 ↑                                     | L=281                |            |
|  | 1.3 i<br>1.4 i<br>1.6 i 16V<br>1.8 D<br>1.8 i 16V<br>1.8 TD<br>2.0 i 16V Cosworth  | ↑<br>↑<br>↑<br>↑<br>↑<br>↑<br>↑ | 05.98<br>05.98<br>05.98<br>05.98<br>05.98<br>05.98<br>05.98                                     | 02.99<br>02.99<br>02.99<br>02.99<br>02.99<br>02.99<br>02.99                                     | + Lieferwagen <sup>2)</sup><br>+ Lieferwagen <sup>2)</sup><br>+ Lieferwagen <sup>2)</sup><br>+ Lieferwagen <sup>2)</sup><br>+ Lieferwagen <sup>2)</sup><br>+ Lieferwagen <sup>2)</sup><br>+ Lieferwagen <sup>2)</sup> | 24.3727-0661.2 | 580661 | 1 ↑                                     | L=281                |            |
|  | 1.3 i<br>1.4 i<br>1.6 i 16V<br>1.8 D<br>1.8 i 16V<br>1.8 TD<br>2.0 i 16V Cosworth  | ↑<br>↑<br>↑<br>↑<br>↑<br>↑<br>↑ | 02.95<br>02.95<br>02.95<br>02.95<br>02.95<br>02.95<br>02.95                                     | 04.98<br>04.98<br>04.98<br>04.98<br>04.98<br>04.98<br>04.98                                     | + Lieferwagen <sup>2)</sup><br>+ Lieferwagen <sup>2)</sup><br>+ Lieferwagen <sup>2)</sup><br>+ Lieferwagen <sup>2)</sup><br>+ Lieferwagen <sup>2)</sup><br>+ Lieferwagen <sup>2)</sup><br>+ Lieferwagen <sup>2)</sup> | 24.3727-0661.2 | 580661 | 1 ↑                                     | L=281                |            |
|  | 1.3 i<br>1.4 i<br>1.6 i 16V<br>1.8 D<br>1.8 i 16V<br>1.8 TD<br>2.0 i 16V Cosworth  | ↑<br>↑<br>↑<br>↑<br>↑<br>↑<br>↑ | 05.98<br>05.98<br>05.98<br>05.98<br>05.98<br>05.98<br>05.98                                     | 02.99<br>02.99<br>02.99<br>02.99<br>02.99<br>02.99<br>02.99                                     | + Lieferwagen <sup>2)</sup><br>+ Lieferwagen <sup>2)</sup><br>+ Lieferwagen <sup>2)</sup><br>+ Lieferwagen <sup>2)</sup><br>+ Lieferwagen <sup>2)</sup><br>+ Lieferwagen <sup>2)</sup><br>+ Lieferwagen <sup>2)</sup> | 24.3727-0661.2 | 580661 | 1 ↑                                     | L=281                |            |







































































**FORD FIESTA III (89-96)**

|  |   |    |  |  |  |                |        |  |                      |            |
|--|---|----|--|--|--|----------------|--------|--|----------------------|------------|
|  | 1.1<br>1.3<br>1.4<br>1.8 D                                      |    | 05.89<br>03.89<br>03.89<br>05.89                   | 04.91<br>04.91<br>04.91<br>04.91                   | - SCS<br>- SCS<br>- SCS<br>- SCS                   | 24.2120-1739.3 | 010762 |  | Thz 20,64 - Behälter | <b>LUC</b> |
|  | 1.1<br>1.3<br>1.3 Kastenw.<br>1.4<br>1.8 D<br>1.8 D Kastenw.    |    | 05.91<br>05.91<br>09.91<br>05.91<br>05.91<br>09.91 | 01.94<br>01.94<br>01.94<br>01.94<br>01.94<br>01.94 | - SCS<br>- SCS<br>- SCS<br>- SCS<br>- SCS<br>- SCS | 24.2120-1604.3 | 010370 |  | Thz 20,64            |            |
|  | 1.1<br>1.3<br>1.3 Kastenw.<br>1.4<br>1.8 D<br>1.8 D Kastenw.    |    | 02.94<br>02.94<br>02.94<br>02.94<br>02.94<br>02.94 | 11.96<br>11.96<br>11.96<br>11.96<br>11.96<br>11.96 | - SCS<br>- SCS<br>- SCS<br>- SCS<br>- SCS<br>- SCS | 24.2120-1606.3 | 010582 |  | Thz 20,64 + Behälter |            |
|  | 1.6<br>1.6 Turbo<br>1.6 XR2i<br>1.6i 16V<br>1.8 16V<br>1.8 XR2i |    | 01.89<br>03.90<br>03.89<br>01.94<br>02.92<br>02.92 | 11.96<br>10.92<br>11.96<br>11.96<br>11.96<br>11.96 | - SCS<br>- SCS<br>- SCS<br>- SCS<br>- SCS<br>- SCS | 24.2122-1755.3 | 010763 |  | Thz 22,20 + Behälter | <b>LUC</b> |
|  | 1.0   | 33 | 03.89  | 12.95  | + SCS  | 24.2122-1603.3 | 010381 |  | Thz 22,20            |            |

<sup>1)</sup> to change only by pairs / sostituire solo a coppie / à changer seulement par paires / cambiar solamente por parejas

<sup>2)</sup> + delivery van / + furgone / + voiture de livraison / + furgoneta



|          |  |              |       |       |                |        |   |                |  |                |                |     |       |       |       |                |                |        |  |                |     |       |       |       |       |  |                |        |  |               |       |              |       |       |       |  |                |         |  |                |       |       |  |       |       |  |                |        |  |                |       |     |  |       |       |           |                |        |  |                |     |           |    |       |          |    |                |        |  |                |     |          |    |          |       |       |                |        |  |                |     |          |         |       |       |       |                |        |  |               |     |                |    |       |       |       |                |        |   |                |                |                |       |       |       |  |                |        |  |            |     |                |       |       |       |  |  |  |  |  |  |          |    |       |       |  |  |  |  |  |  |
|--|--|--------------|-------|-------|----------------|--------|---|----------------|--|----------------|----------------|-----|-------|-------|-------|----------------|----------------|--------|--|----------------|-----|-------|-------|-------|-------|--|----------------|--------|--|---------------|-------|--------------|-------|-------|-------|--|----------------|---------|--|----------------|-------|-------|--|-------|-------|--|----------------|--------|--|----------------|-------|-----|--|-------|-------|-----------|----------------|--------|--|----------------|-----|-----------|----|-------|----------|----|----------------|--------|--|----------------|-----|----------|----|----------|-------|-------|----------------|--------|--|----------------|-----|----------|---------|-------|-------|-------|----------------|--------|--|---------------|-----|----------------|----|-------|-------|-------|----------------|--------|---|----------------|----------------|----------------|-------|-------|-------|--|----------------|--------|--|------------|-----|----------------|-------|-------|-------|--|--|--|--|--|--|----------|----|-------|-------|--|--|--|--|--|--|
| FORD FIESTA III (89-96)  |  |              |       |       |                |        |   |                |  |                |                |     |       |       |       |                |                |        |  |                |     |       |       |       |       |  |                |        |  |               |       |              |       |       |       |  |                |         |  |                |       |       |  |       |       |  |                |        |  |                |       |     |  |       |       |           |                |        |  |                |     |           |    |       |          |    |                |        |  |                |     |          |    |          |       |       |                |        |  |                |     |          |         |       |       |       |                |        |  |               |     |                |    |       |       |       |                |        |   |                |                |                |       |       |       |  |                |        |  |            |     |                |       |       |       |  |  |  |  |  |  |          |    |       |       |  |  |  |  |  |  |
|    | <table border="1"> <tr><td>1.1</td><td>44</td><td>05.89</td><td>11.96</td><td>+ SCS</td><td>24.2122-1603.3</td><td>010381</td><td></td><td>Thz 22,20</td></tr> <tr><td>1.3</td><td></td><td>03.89</td><td>11.96</td><td>+ SCS</td><td></td><td></td><td></td><td></td></tr> <tr><td>1.3 Kastenw.</td><td></td><td>09.91</td><td>11.96</td><td>+ SCS</td><td></td><td></td><td></td><td></td></tr> <tr><td>1.4</td><td></td><td>03.89</td><td>11.96</td><td>+ SCS</td><td></td><td></td><td></td><td></td></tr> <tr><td>1.6</td><td></td><td>01.89</td><td>11.96</td><td>+ SCS</td><td></td><td></td><td></td><td></td></tr> <tr><td>1.6 Turbo</td><td>96</td><td>03.90</td><td>10.92</td><td>+ SCS</td><td></td><td></td><td></td><td></td></tr> <tr><td>1.6 XR2i</td><td></td><td>03.89</td><td>11.96</td><td>+ SCS</td><td></td><td></td><td></td><td></td></tr> <tr><td>1.6i 16V</td><td>65</td><td>01.94</td><td>11.96</td><td>+ SCS</td><td></td><td></td><td></td><td></td></tr> <tr><td>1.8 16V</td><td>77</td><td>02.92</td><td>11.96</td><td>+ SCS</td><td></td><td></td><td></td><td></td></tr> <tr><td>1.8 D</td><td>44</td><td>05.89</td><td>11.96</td><td>+ SCS</td><td></td><td></td><td></td><td></td></tr> <tr><td>1.8 D Kastenw.</td><td></td><td>09.91</td><td>11.96</td><td>+ SCS</td><td></td><td></td><td></td><td></td></tr> <tr><td>1.8 XR2i</td><td>96</td><td>02.92</td><td>12.95</td><td>+ SCS</td><td></td><td></td><td></td><td></td></tr> </table>  | 1.1          | 44    | 05.89 | 11.96          | + SCS  | 24.2122-1603.3  | 010381         |  | Thz 22,20      | 1.3            |     | 03.89 | 11.96 | + SCS |                |                |        |  | 1.3 Kastenw.   |     | 09.91 | 11.96 | + SCS |       |  |                |        | 1.4  |               | 03.89 | 11.96        | + SCS |       |       |  |                | 1.6     |  | 01.89          | 11.96 | + SCS |  |       |       |  | 1.6 Turbo      | 96     | 03.90  | 10.92          | + SCS |     |  |       |       | 1.6 XR2i  |                | 03.89  | 11.96  | + SCS          |     |           |    |       | 1.6i 16V | 65 | 01.94          | 11.96  | + SCS  |                |     |          |    | 1.8 16V  | 77    | 02.92 | 11.96          | + SCS  |  |                |     |          | 1.8 D   | 44    | 05.89 | 11.96 | + SCS          |        |  |               |     | 1.8 D Kastenw. |    | 09.91 | 11.96 | + SCS |                |        |   |                | 1.8 XR2i       | 96             | 02.92 | 12.95 | + SCS |  |                |        |  |            |     |                |       |       |       |  |  |  |  |  |  |          |    |       |       |  |  |  |  |  |  |
| 1.1  | 44   | 05.89        | 11.96 | + SCS | 24.2122-1603.3 | 010381 |   | Thz 22,20      |  |                |                |     |       |       |       |                |                |        |  |                |     |       |       |       |       |  |                |        |  |               |       |              |       |       |       |  |                |         |  |                |       |       |  |       |       |  |                |        |  |                |       |     |  |       |       |           |                |        |  |                |     |           |    |       |          |    |                |        |  |                |     |          |    |          |       |       |                |        |  |                |     |          |         |       |       |       |                |        |  |               |     |                |    |       |       |       |                |        |   |                |                |                |       |       |       |  |                |        |  |            |     |                |       |       |       |  |  |  |  |  |  |          |    |       |       |  |  |  |  |  |  |
| 1.3  |  | 03.89        | 11.96 | + SCS |                |        |   |                |  |                |                |     |       |       |       |                |                |        |  |                |     |       |       |       |       |  |                |        |  |               |       |              |       |       |       |  |                |         |  |                |       |       |  |       |       |  |                |        |  |                |       |     |  |       |       |           |                |        |  |                |     |           |    |       |          |    |                |        |  |                |     |          |    |          |       |       |                |        |  |                |     |          |         |       |       |       |                |        |  |               |     |                |    |       |       |       |                |        |   |                |                |                |       |       |       |  |                |        |  |            |     |                |       |       |       |  |  |  |  |  |  |          |    |       |       |  |  |  |  |  |  |
| 1.3 Kastenw.   |  | 09.91        | 11.96 | + SCS |                |        |   |                |  |                |                |     |       |       |       |                |                |        |  |                |     |       |       |       |       |  |                |        |  |               |       |              |       |       |       |  |                |         |  |                |       |       |  |       |       |  |                |        |  |                |       |     |  |       |       |           |                |        |  |                |     |           |    |       |          |    |                |        |  |                |     |          |    |          |       |       |                |        |  |                |     |          |         |       |       |       |                |        |  |               |     |                |    |       |       |       |                |        |   |                |                |                |       |       |       |  |                |        |  |            |     |                |       |       |       |  |  |  |  |  |  |          |    |       |       |  |  |  |  |  |  |
| 1.4  |  | 03.89        | 11.96 | + SCS |                |        |   |                |  |                |                |     |       |       |       |                |                |        |  |                |     |       |       |       |       |  |                |        |  |               |       |              |       |       |       |  |                |         |  |                |       |       |  |       |       |  |                |        |  |                |       |     |  |       |       |           |                |        |  |                |     |           |    |       |          |    |                |        |  |                |     |          |    |          |       |       |                |        |  |                |     |          |         |       |       |       |                |        |  |               |     |                |    |       |       |       |                |        |   |                |                |                |       |       |       |  |                |        |  |            |     |                |       |       |       |  |  |  |  |  |  |          |    |       |       |  |  |  |  |  |  |
| 1.6  |  | 01.89        | 11.96 | + SCS |                |        |   |                |  |                |                |     |       |       |       |                |                |        |  |                |     |       |       |       |       |  |                |        |  |               |       |              |       |       |       |  |                |         |  |                |       |       |  |       |       |  |                |        |  |                |       |     |  |       |       |           |                |        |  |                |     |           |    |       |          |    |                |        |  |                |     |          |    |          |       |       |                |        |  |                |     |          |         |       |       |       |                |        |  |               |     |                |    |       |       |       |                |        |   |                |                |                |       |       |       |  |                |        |  |            |     |                |       |       |       |  |  |  |  |  |  |          |    |       |       |  |  |  |  |  |  |
| 1.6 Turbo  | 96   | 03.90        | 10.92 | + SCS |                |        |   |                |  |                |                |     |       |       |       |                |                |        |  |                |     |       |       |       |       |  |                |        |  |               |       |              |       |       |       |  |                |         |  |                |       |       |  |       |       |  |                |        |  |                |       |     |  |       |       |           |                |        |  |                |     |           |    |       |          |    |                |        |  |                |     |          |    |          |       |       |                |        |  |                |     |          |         |       |       |       |                |        |  |               |     |                |    |       |       |       |                |        |   |                |                |                |       |       |       |  |                |        |  |            |     |                |       |       |       |  |  |  |  |  |  |          |    |       |       |  |  |  |  |  |  |
| 1.6 XR2i   |  | 03.89        | 11.96 | + SCS |                |        |   |                |  |                |                |     |       |       |       |                |                |        |  |                |     |       |       |       |       |  |                |        |  |               |       |              |       |       |       |  |                |         |  |                |       |       |  |       |       |  |                |        |  |                |       |     |  |       |       |           |                |        |  |                |     |           |    |       |          |    |                |        |  |                |     |          |    |          |       |       |                |        |  |                |     |          |         |       |       |       |                |        |  |               |     |                |    |       |       |       |                |        |   |                |                |                |       |       |       |  |                |        |  |            |     |                |       |       |       |  |  |  |  |  |  |          |    |       |       |  |  |  |  |  |  |
| 1.6i 16V   | 65   | 01.94        | 11.96 | + SCS |                |        |   |                |  |                |                |     |       |       |       |                |                |        |  |                |     |       |       |       |       |  |                |        |  |               |       |              |       |       |       |  |                |         |  |                |       |       |  |       |       |  |                |        |  |                |       |     |  |       |       |           |                |        |  |                |     |           |    |       |          |    |                |        |  |                |     |          |    |          |       |       |                |        |  |                |     |          |         |       |       |       |                |        |  |               |     |                |    |       |       |       |                |        |   |                |                |                |       |       |       |  |                |        |  |            |     |                |       |       |       |  |  |  |  |  |  |          |    |       |       |  |  |  |  |  |  |
| 1.8 16V  | 77   | 02.92        | 11.96 | + SCS |                |        |   |                |  |                |                |     |       |       |       |                |                |        |  |                |     |       |       |       |       |  |                |        |  |               |       |              |       |       |       |  |                |         |  |                |       |       |  |       |       |  |                |        |  |                |       |     |  |       |       |           |                |        |  |                |     |           |    |       |          |    |                |        |  |                |     |          |    |          |       |       |                |        |  |                |     |          |         |       |       |       |                |        |  |               |     |                |    |       |       |       |                |        |   |                |                |                |       |       |       |  |                |        |  |            |     |                |       |       |       |  |  |  |  |  |  |          |    |       |       |  |  |  |  |  |  |
| 1.8 D  | 44   | 05.89        | 11.96 | + SCS |                |        |   |                |  |                |                |     |       |       |       |                |                |        |  |                |     |       |       |       |       |  |                |        |  |               |       |              |       |       |       |  |                |         |  |                |       |       |  |       |       |  |                |        |  |                |       |     |  |       |       |           |                |        |  |                |     |           |    |       |          |    |                |        |  |                |     |          |    |          |       |       |                |        |  |                |     |          |         |       |       |       |                |        |  |               |     |                |    |       |       |       |                |        |   |                |                |                |       |       |       |  |                |        |  |            |     |                |       |       |       |  |  |  |  |  |  |          |    |       |       |  |  |  |  |  |  |
| 1.8 D Kastenw.   |  | 09.91        | 11.96 | + SCS |                |        |   |                |  |                |                |     |       |       |       |                |                |        |  |                |     |       |       |       |       |  |                |        |  |               |       |              |       |       |       |  |                |         |  |                |       |       |  |       |       |  |                |        |  |                |       |     |  |       |       |           |                |        |  |                |     |           |    |       |          |    |                |        |  |                |     |          |    |          |       |       |                |        |  |                |     |          |         |       |       |       |                |        |  |               |     |                |    |       |       |       |                |        |   |                |                |                |       |       |       |  |                |        |  |            |     |                |       |       |       |  |  |  |  |  |  |          |    |       |       |  |  |  |  |  |  |
| 1.8 XR2i   | 96   | 02.92        | 12.95 | + SCS |                |        |   |                |  |                |                |     |       |       |       |                |                |        |  |                |     |       |       |       |       |  |                |        |  |               |       |              |       |       |       |  |                |         |  |                |       |       |  |       |       |  |                |        |  |                |       |     |  |       |       |           |                |        |  |                |     |           |    |       |          |    |                |        |  |                |     |          |    |          |       |       |                |        |  |                |     |          |         |       |       |       |                |        |  |               |     |                |    |       |       |       |                |        |   |                |                |                |       |       |       |  |                |        |  |            |     |                |       |       |       |  |  |  |  |  |  |          |    |       |       |  |  |  |  |  |  |
|    | <table border="1"> <tr><td>1.0</td><td>33</td><td>03.89</td><td>10.95</td><td></td><td>11.3481-8511.2</td><td>220337</td><td> - belüftete Scheiben <sup>1)</sup></td><td>D=48, - Halter</td><td>ATE</td></tr> <tr><td>1.1</td><td></td><td>05.89</td><td>10.95</td><td></td><td>11.3481-8512.2</td><td>220338</td><td> - belüftete Scheiben <sup>1)</sup></td><td>D=48, - Halter</td><td>ATE</td></tr> <tr><td>1.3</td><td>44</td><td>03.89</td><td>10.95</td><td></td><td>11.0441-4805.2</td><td>250020</td><td> - belüftete Scheiben <sup>1)</sup></td><td>Dichtungssatz</td><td>ATE</td></tr> <tr><td>1.3 Kastenw.</td><td></td><td>09.91</td><td>10.95</td><td></td><td>24.3541-1701.5</td><td>240005</td><td> + belüftete Scheiben <sup>2)</sup></td><td>D=54, - Halter</td><td>ATE</td></tr> <tr><td>1.4</td><td></td><td>03.89</td><td>10.95</td><td></td><td>24.3541-1702.5</td><td>240006</td><td> + belüftete Scheiben <sup>2)</sup></td><td>D=54, - Halter</td><td>ATE</td></tr> <tr><td>1.6</td><td></td><td>01.89</td><td>10.95</td><td></td><td>11.0441-5402.2</td><td>250028</td><td> + belüftete Scheiben <sup>2)</sup></td><td>Dichtungssatz</td><td>ATE</td></tr> <tr><td>1.6 Turbo</td><td>96</td><td>03.90</td><td>10.92</td><td></td><td>11.8171-0008.1</td><td>990049</td><td> + belüftete Scheiben <sup>2)</sup></td><td>Führungsbolzen</td><td>ATE</td></tr> <tr><td>1.6 XR2i</td><td></td><td>03.89</td><td>10.95</td><td></td><td>11.0101-5407.2</td><td>260011</td><td></td><td>Hülsensatz</td><td>ATE</td></tr> <tr><td>1.6i 16V</td><td>65</td><td>01.94</td><td>10.95</td><td></td><td></td><td></td><td></td><td></td><td></td></tr> <tr><td>1.8 16V</td><td>77</td><td>02.92</td><td>10.95</td><td></td><td></td><td></td><td></td><td></td><td></td></tr> <tr><td>1.8 D</td><td>44</td><td>05.89</td><td>10.95</td><td></td><td></td><td></td><td></td><td></td><td></td></tr> <tr><td>1.8 D Kastenw.</td><td></td><td>09.91</td><td>10.95</td><td></td><td></td><td></td><td></td><td></td><td></td></tr> <tr><td>1.8 XR2i</td><td>96</td><td>02.92</td><td>10.95</td><td></td><td></td><td></td><td></td><td></td><td></td></tr> </table>  | 1.0          | 33    | 03.89 | 10.95          |        | 11.3481-8511.2  | 220337         |  - belüftete Scheiben <sup>1)</sup> | D=48, - Halter | ATE            | 1.1 |       | 05.89 | 10.95 |                | 11.3481-8512.2 | 220338 |  - belüftete Scheiben <sup>1)</sup> | D=48, - Halter | ATE | 1.3   | 44    | 03.89 | 10.95 |  | 11.0441-4805.2 | 250020 |  - belüftete Scheiben <sup>1)</sup> | Dichtungssatz | ATE   | 1.3 Kastenw. |       | 09.91 | 10.95 |  | 24.3541-1701.5 | 240005  |  + belüftete Scheiben <sup>2)</sup> | D=54, - Halter | ATE   | 1.4   |  | 03.89 | 10.95 |  | 24.3541-1702.5 | 240006 |  + belüftete Scheiben <sup>2)</sup> | D=54, - Halter | ATE   | 1.6 |  | 01.89 | 10.95 |           | 11.0441-5402.2 | 250028 |  + belüftete Scheiben <sup>2)</sup> | Dichtungssatz  | ATE | 1.6 Turbo | 96 | 03.90 | 10.92    |    | 11.8171-0008.1 | 990049 |  + belüftete Scheiben <sup>2)</sup> | Führungsbolzen | ATE | 1.6 XR2i |    | 03.89    | 10.95 |       | 11.0101-5407.2 | 260011 |  | Hülsensatz     | ATE | 1.6i 16V | 65      | 01.94 | 10.95 |       |                |        |  |               |     | 1.8 16V        | 77 | 02.92 | 10.95 |       |                |        |   |                |                | 1.8 D          | 44    | 05.89 | 10.95 |  |                |        |  |            |     | 1.8 D Kastenw. |       | 09.91 | 10.95 |  |  |  |  |  |  | 1.8 XR2i | 96 | 02.92 | 10.95 |  |  |  |  |  |  |
| 1.0  | 33   | 03.89        | 10.95 |       | 11.3481-8511.2 | 220337 |  - belüftete Scheiben <sup>1)</sup>  | D=48, - Halter | ATE  |                |                |     |       |       |       |                |                |        |  |                |     |       |       |       |       |  |                |        |  |               |       |              |       |       |       |  |                |         |  |                |       |       |  |       |       |  |                |        |  |                |       |     |  |       |       |           |                |        |  |                |     |           |    |       |          |    |                |        |  |                |     |          |    |          |       |       |                |        |  |                |     |          |         |       |       |       |                |        |  |               |     |                |    |       |       |       |                |        |   |                |                |                |       |       |       |  |                |        |  |            |     |                |       |       |       |  |  |  |  |  |  |          |    |       |       |  |  |  |  |  |  |
| 1.1  |  | 05.89        | 10.95 |       | 11.3481-8512.2 | 220338 |  - belüftete Scheiben <sup>1)</sup>  | D=48, - Halter | ATE  |                |                |     |       |       |       |                |                |        |  |                |     |       |       |       |       |  |                |        |  |               |       |              |       |       |       |  |                |         |  |                |       |       |  |       |       |  |                |        |  |                |       |     |  |       |       |           |                |        |  |                |     |           |    |       |          |    |                |        |  |                |     |          |    |          |       |       |                |        |  |                |     |          |         |       |       |       |                |        |  |               |     |                |    |       |       |       |                |        |   |                |                |                |       |       |       |  |                |        |  |            |     |                |       |       |       |  |  |  |  |  |  |          |    |       |       |  |  |  |  |  |  |
| 1.3  | 44   | 03.89        | 10.95 |       | 11.0441-4805.2 | 250020 |  - belüftete Scheiben <sup>1)</sup>  | Dichtungssatz  | ATE  |                |                |     |       |       |       |                |                |        |  |                |     |       |       |       |       |  |                |        |  |               |       |              |       |       |       |  |                |         |  |                |       |       |  |       |       |  |                |        |  |                |       |     |  |       |       |           |                |        |  |                |     |           |    |       |          |    |                |        |  |                |     |          |    |          |       |       |                |        |  |                |     |          |         |       |       |       |                |        |  |               |     |                |    |       |       |       |                |        |   |                |                |                |       |       |       |  |                |        |  |            |     |                |       |       |       |  |  |  |  |  |  |          |    |       |       |  |  |  |  |  |  |
| 1.3 Kastenw.   |  | 09.91        | 10.95 |       | 24.3541-1701.5 | 240005 |  + belüftete Scheiben <sup>2)</sup>  | D=54, - Halter | ATE  |                |                |     |       |       |       |                |                |        |  |                |     |       |       |       |       |  |                |        |  |               |       |              |       |       |       |  |                |         |  |                |       |       |  |       |       |  |                |        |  |                |       |     |  |       |       |           |                |        |  |                |     |           |    |       |          |    |                |        |  |                |     |          |    |          |       |       |                |        |  |                |     |          |         |       |       |       |                |        |  |               |     |                |    |       |       |       |                |        |   |                |                |                |       |       |       |  |                |        |  |            |     |                |       |       |       |  |  |  |  |  |  |          |    |       |       |  |  |  |  |  |  |
| 1.4  |  | 03.89        | 10.95 |       | 24.3541-1702.5 | 240006 |  + belüftete Scheiben <sup>2)</sup>  | D=54, - Halter | ATE  |                |                |     |       |       |       |                |                |        |  |                |     |       |       |       |       |  |                |        |  |               |       |              |       |       |       |  |                |         |  |                |       |       |  |       |       |  |                |        |  |                |       |     |  |       |       |           |                |        |  |                |     |           |    |       |          |    |                |        |  |                |     |          |    |          |       |       |                |        |  |                |     |          |         |       |       |       |                |        |  |               |     |                |    |       |       |       |                |        |   |                |                |                |       |       |       |  |                |        |  |            |     |                |       |       |       |  |  |  |  |  |  |          |    |       |       |  |  |  |  |  |  |
| 1.6  |  | 01.89        | 10.95 |       | 11.0441-5402.2 | 250028 |  + belüftete Scheiben <sup>2)</sup>  | Dichtungssatz  | ATE  |                |                |     |       |       |       |                |                |        |  |                |     |       |       |       |       |  |                |        |  |               |       |              |       |       |       |  |                |         |  |                |       |       |  |       |       |  |                |        |  |                |       |     |  |       |       |           |                |        |  |                |     |           |    |       |          |    |                |        |  |                |     |          |    |          |       |       |                |        |  |                |     |          |         |       |       |       |                |        |  |               |     |                |    |       |       |       |                |        |   |                |                |                |       |       |       |  |                |        |  |            |     |                |       |       |       |  |  |  |  |  |  |          |    |       |       |  |  |  |  |  |  |
| 1.6 Turbo  | 96   | 03.90        | 10.92 |       | 11.8171-0008.1 | 990049 |  + belüftete Scheiben <sup>2)</sup>  | Führungsbolzen | ATE  |                |                |     |       |       |       |                |                |        |  |                |     |       |       |       |       |  |                |        |  |               |       |              |       |       |       |  |                |         |  |                |       |       |  |       |       |  |                |        |  |                |       |     |  |       |       |           |                |        |  |                |     |           |    |       |          |    |                |        |  |                |     |          |    |          |       |       |                |        |  |                |     |          |         |       |       |       |                |        |  |               |     |                |    |       |       |       |                |        |   |                |                |                |       |       |       |  |                |        |  |            |     |                |       |       |       |  |  |  |  |  |  |          |    |       |       |  |  |  |  |  |  |
| 1.6 XR2i   |  | 03.89        | 10.95 |       | 11.0101-5407.2 | 260011 |   | Hülsensatz     | ATE  |                |                |     |       |       |       |                |                |        |  |                |     |       |       |       |       |  |                |        |  |               |       |              |       |       |       |  |                |         |  |                |       |       |  |       |       |  |                |        |  |                |       |     |  |       |       |           |                |        |  |                |     |           |    |       |          |    |                |        |  |                |     |          |    |          |       |       |                |        |  |                |     |          |         |       |       |       |                |        |  |               |     |                |    |       |       |       |                |        |   |                |                |                |       |       |       |  |                |        |  |            |     |                |       |       |       |  |  |  |  |  |  |          |    |       |       |  |  |  |  |  |  |
| 1.6i 16V   | 65   | 01.94        | 10.95 |       |                |        |   |                |  |                |                |     |       |       |       |                |                |        |  |                |     |       |       |       |       |  |                |        |  |               |       |              |       |       |       |  |                |         |  |                |       |       |  |       |       |  |                |        |  |                |       |     |  |       |       |           |                |        |  |                |     |           |    |       |          |    |                |        |  |                |     |          |    |          |       |       |                |        |  |                |     |          |         |       |       |       |                |        |  |               |     |                |    |       |       |       |                |        |   |                |                |                |       |       |       |  |                |        |  |            |     |                |       |       |       |  |  |  |  |  |  |          |    |       |       |  |  |  |  |  |  |
| 1.8 16V  | 77   | 02.92        | 10.95 |       |                |        |   |                |  |                |                |     |       |       |       |                |                |        |  |                |     |       |       |       |       |  |                |        |  |               |       |              |       |       |       |  |                |         |  |                |       |       |  |       |       |  |                |        |  |                |       |     |  |       |       |           |                |        |  |                |     |           |    |       |          |    |                |        |  |                |     |          |    |          |       |       |                |        |  |                |     |          |         |       |       |       |                |        |  |               |     |                |    |       |       |       |                |        |   |                |                |                |       |       |       |  |                |        |  |            |     |                |       |       |       |  |  |  |  |  |  |          |    |       |       |  |  |  |  |  |  |
| 1.8 D  | 44   | 05.89        | 10.95 |       |                |        |   |                |  |                |                |     |       |       |       |                |                |        |  |                |     |       |       |       |       |  |                |        |  |               |       |              |       |       |       |  |                |         |  |                |       |       |  |       |       |  |                |        |  |                |       |     |  |       |       |           |                |        |  |                |     |           |    |       |          |    |                |        |  |                |     |          |    |          |       |       |                |        |  |                |     |          |         |       |       |       |                |        |  |               |     |                |    |       |       |       |                |        |   |                |                |                |       |       |       |  |                |        |  |            |     |                |       |       |       |  |  |  |  |  |  |          |    |       |       |  |  |  |  |  |  |
| 1.8 D Kastenw.   |  | 09.91        | 10.95 |       |                |        |   |                |  |                |                |     |       |       |       |                |                |        |  |                |     |       |       |       |       |  |                |        |  |               |       |              |       |       |       |  |                |         |  |                |       |       |  |       |       |  |                |        |  |                |       |     |  |       |       |           |                |        |  |                |     |           |    |       |          |    |                |        |  |                |     |          |    |          |       |       |                |        |  |                |     |          |         |       |       |       |                |        |  |               |     |                |    |       |       |       |                |        |   |                |                |                |       |       |       |  |                |        |  |            |     |                |       |       |       |  |  |  |  |  |  |          |    |       |       |  |  |  |  |  |  |
| 1.8 XR2i   | 96   | 02.92        | 10.95 |       |                |        |   |                |  |                |                |     |       |       |       |                |                |        |  |                |     |       |       |       |       |  |                |        |  |               |       |              |       |       |       |  |                |         |  |                |       |       |  |       |       |  |                |        |  |                |       |     |  |       |       |           |                |        |  |                |     |           |    |       |          |    |                |        |  |                |     |          |    |          |       |       |                |        |  |                |     |          |         |       |       |       |                |        |  |               |     |                |    |       |       |       |                |        |   |                |                |                |       |       |       |  |                |        |  |            |     |                |       |       |       |  |  |  |  |  |  |          |    |       |       |  |  |  |  |  |  |
|    | <table border="1"> <tr><td>1.0</td><td>33</td><td>11.95</td><td>11.96</td><td></td><td>11.3481-8513.2</td><td>220335</td><td> - belüftete Scheiben <sup>1)</sup></td><td>D=48, - Halter</td><td>ATE</td></tr> <tr><td>1.1</td><td></td><td>11.95</td><td>11.96</td><td></td><td>11.3481-8514.2</td><td>220336</td><td> - belüftete Scheiben <sup>1)</sup></td><td>D=48, - Halter</td><td>ATE</td></tr> <tr><td>1.3</td><td>44</td><td>11.95</td><td>11.96</td><td></td><td>11.0230-0165.2</td><td>260073</td><td> - belüftete Scheiben <sup>1)</sup></td><td>Haltersatz</td><td>ATE</td></tr> <tr><td>1.3 Kastenw.</td><td></td><td>11.95</td><td>11.96</td><td></td><td>11.0441-4805.2</td><td>250020</td><td> - belüftete Scheiben <sup>1)</sup></td><td>Dichtungssatz</td><td>ATE</td></tr> <tr><td>1.4</td><td></td><td>11.95</td><td>11.96</td><td></td><td>11.3541-8529.2</td><td>220341</td><td> + belüftete Scheiben <sup>2)</sup></td><td>D=54, - Halter</td><td>ATE</td></tr> <tr><td>1.6</td><td></td><td>11.95</td><td>11.96</td><td></td><td>11.3541-8530.2</td><td>220342</td><td> + belüftete Scheiben <sup>2)</sup></td><td>D=54, - Halter</td><td>ATE</td></tr> <tr><td>1.6 XR2i</td><td></td><td>11.95</td><td>11.96</td><td></td><td>24.3541-8529.5</td><td>240553</td><td> + belüftete Scheiben <sup>2)</sup></td><td>D=54, - Halter</td><td>ATE</td></tr> <tr><td>1.6i 16V</td><td>65</td><td>11.95</td><td>11.96</td><td></td><td>24.3541-8530.5</td><td>240554</td><td> + belüftete Scheiben <sup>2)</sup></td><td>D=54, - Halter</td><td>ATE</td></tr> <tr><td>1.8 16V</td><td>77</td><td>11.95</td><td>11.96</td><td></td><td>11.0441-5402.2</td><td>250028</td><td> + belüftete Scheiben <sup>2)</sup></td><td>Dichtungssatz</td><td>ATE</td></tr> <tr><td>1.8 D</td><td>44</td><td>11.95</td><td>11.96</td><td></td><td>11.8171-0008.1</td><td>990049</td><td> + belüftete Scheiben <sup>2)</sup></td><td>Führungsbolzen</td><td>ATE</td></tr> <tr><td>1.8 D Kastenw.</td><td></td><td>11.95</td><td>11.96</td><td></td><td>11.0101-5407.2</td><td>260011</td><td></td><td>Hülsensatz</td><td>ATE</td></tr> <tr><td>1.8 XR2i</td><td>96</td><td>11.95</td><td>11.96</td><td></td><td></td><td></td><td></td><td></td><td></td></tr> </table> | 1.0          | 33    | 11.95 | 11.96          |        | 11.3481-8513.2  | 220335         |  - belüftete Scheiben <sup>1)</sup> | D=48, - Halter | ATE            | 1.1 |       | 11.95 | 11.96 |                | 11.3481-8514.2 | 220336 |  - belüftete Scheiben <sup>1)</sup> | D=48, - Halter | ATE | 1.3   | 44    | 11.95 | 11.96 |  | 11.0230-0165.2 | 260073 |  - belüftete Scheiben <sup>1)</sup> | Haltersatz    | ATE   | 1.3 Kastenw. |       | 11.95 | 11.96 |  | 11.0441-4805.2 | 250020  |  - belüftete Scheiben <sup>1)</sup> | Dichtungssatz  | ATE   | 1.4   |  | 11.95 | 11.96 |  | 11.3541-8529.2 | 220341 |  + belüftete Scheiben <sup>2)</sup> | D=54, - Halter | ATE   | 1.6 |  | 11.95 | 11.96 |           | 11.3541-8530.2 | 220342 |  + belüftete Scheiben <sup>2)</sup> | D=54, - Halter | ATE | 1.6 XR2i  |    | 11.95 | 11.96    |    | 24.3541-8529.5 | 240553 |  + belüftete Scheiben <sup>2)</sup> | D=54, - Halter | ATE | 1.6i 16V | 65 | 11.95    | 11.96 |       | 24.3541-8530.5 | 240554 |  + belüftete Scheiben <sup>2)</sup> | D=54, - Halter | ATE | 1.8 16V  | 77      | 11.95 | 11.96 |       | 11.0441-5402.2 | 250028 |  + belüftete Scheiben <sup>2)</sup> | Dichtungssatz | ATE | 1.8 D          | 44 | 11.95 | 11.96 |       | 11.8171-0008.1 | 990049 |  + belüftete Scheiben <sup>2)</sup> | Führungsbolzen | ATE            | 1.8 D Kastenw. |       | 11.95 | 11.96 |  | 11.0101-5407.2 | 260011 |  | Hülsensatz | ATE | 1.8 XR2i       | 96    | 11.95 | 11.96 |  |  |  |  |  |  |          |    |       |       |  |  |  |  |  |  |
| 1.0  | 33   | 11.95        | 11.96 |       | 11.3481-8513.2 | 220335 |  - belüftete Scheiben <sup>1)</sup>  | D=48, - Halter | ATE  |                |                |     |       |       |       |                |                |        |  |                |     |       |       |       |       |  |                |        |  |               |       |              |       |       |       |  |                |         |  |                |       |       |  |       |       |  |                |        |  |                |       |     |  |       |       |           |                |        |  |                |     |           |    |       |          |    |                |        |  |                |     |          |    |          |       |       |                |        |  |                |     |          |         |       |       |       |                |        |  |               |     |                |    |       |       |       |                |        |   |                |                |                |       |       |       |  |                |        |  |            |     |                |       |       |       |  |  |  |  |  |  |          |    |       |       |  |  |  |  |  |  |
| 1.1  |  | 11.95        | 11.96 |       | 11.3481-8514.2 | 220336 |  - belüftete Scheiben <sup>1)</sup>  | D=48, - Halter | ATE  |                |                |     |       |       |       |                |                |        |  |                |     |       |       |       |       |  |                |        |  |               |       |              |       |       |       |  |                |         |  |                |       |       |  |       |       |  |                |        |  |                |       |     |  |       |       |           |                |        |  |                |     |           |    |       |          |    |                |        |  |                |     |          |    |          |       |       |                |        |  |                |     |          |         |       |       |       |                |        |  |               |     |                |    |       |       |       |                |        |   |                |                |                |       |       |       |  |                |        |  |            |     |                |       |       |       |  |  |  |  |  |  |          |    |       |       |  |  |  |  |  |  |
| 1.3  | 44   | 11.95        | 11.96 |       | 11.0230-0165.2 | 260073 |  - belüftete Scheiben <sup>1)</sup>  | Haltersatz     | ATE  |                |                |     |       |       |       |                |                |        |  |                |     |       |       |       |       |  |                |        |  |               |       |              |       |       |       |  |                |         |  |                |       |       |  |       |       |  |                |        |  |                |       |     |  |       |       |           |                |        |  |                |     |           |    |       |          |    |                |        |  |                |     |          |    |          |       |       |                |        |  |                |     |          |         |       |       |       |                |        |  |               |     |                |    |       |       |       |                |        |   |                |                |                |       |       |       |  |                |        |  |            |     |                |       |       |       |  |  |  |  |  |  |          |    |       |       |  |  |  |  |  |  |
| 1.3 Kastenw.   |  | 11.95        | 11.96 |       | 11.0441-4805.2 | 250020 |  - belüftete Scheiben <sup>1)</sup>  | Dichtungssatz  | ATE  |                |                |     |       |       |       |                |                |        |  |                |     |       |       |       |       |  |                |        |  |               |       |              |       |       |       |  |                |         |  |                |       |       |  |       |       |  |                |        |  |                |       |     |  |       |       |           |                |        |  |                |     |           |    |       |          |    |                |        |  |                |     |          |    |          |       |       |                |        |  |                |     |          |         |       |       |       |                |        |  |               |     |                |    |       |       |       |                |        |   |                |                |                |       |       |       |  |                |        |  |            |     |                |       |       |       |  |  |  |  |  |  |          |    |       |       |  |  |  |  |  |  |
| 1.4  |  | 11.95        | 11.96 |       | 11.3541-8529.2 | 220341 |  + belüftete Scheiben <sup>2)</sup>  | D=54, - Halter | ATE  |                |                |     |       |       |       |                |                |        |  |                |     |       |       |       |       |  |                |        |  |               |       |              |       |       |       |  |                |         |  |                |       |       |  |       |       |  |                |        |  |                |       |     |  |       |       |           |                |        |  |                |     |           |    |       |          |    |                |        |  |                |     |          |    |          |       |       |                |        |  |                |     |          |         |       |       |       |                |        |  |               |     |                |    |       |       |       |                |        |   |                |                |                |       |       |       |  |                |        |  |            |     |                |       |       |       |  |  |  |  |  |  |          |    |       |       |  |  |  |  |  |  |
| 1.6  |  | 11.95        | 11.96 |       | 11.3541-8530.2 | 220342 |  + belüftete Scheiben <sup>2)</sup>  | D=54, - Halter | ATE  |                |                |     |       |       |       |                |                |        |  |                |     |       |       |       |       |  |                |        |  |               |       |              |       |       |       |  |                |         |  |                |       |       |  |       |       |  |                |        |  |                |       |     |  |       |       |           |                |        |  |                |     |           |    |       |          |    |                |        |  |                |     |          |    |          |       |       |                |        |  |                |     |          |         |       |       |       |                |        |  |               |     |                |    |       |       |       |                |        |   |                |                |                |       |       |       |  |                |        |  |            |     |                |       |       |       |  |  |  |  |  |  |          |    |       |       |  |  |  |  |  |  |
| 1.6 XR2i   |  | 11.95        | 11.96 |       | 24.3541-8529.5 | 240553 |  + belüftete Scheiben <sup>2)</sup>  | D=54, - Halter | ATE  |                |                |     |       |       |       |                |                |        |  |                |     |       |       |       |       |  |                |        |  |               |       |              |       |       |       |  |                |         |  |                |       |       |  |       |       |  |                |        |  |                |       |     |  |       |       |           |                |        |  |                |     |           |    |       |          |    |                |        |  |                |     |          |    |          |       |       |                |        |  |                |     |          |         |       |       |       |                |        |  |               |     |                |    |       |       |       |                |        |   |                |                |                |       |       |       |  |                |        |  |            |     |                |       |       |       |  |  |  |  |  |  |          |    |       |       |  |  |  |  |  |  |
| 1.6i 16V   | 65   | 11.95        | 11.96 |       | 24.3541-8530.5 | 240554 |  + belüftete Scheiben <sup>2)</sup>  | D=54, - Halter | ATE  |                |                |     |       |       |       |                |                |        |  |                |     |       |       |       |       |  |                |        |  |               |       |              |       |       |       |  |                |         |  |                |       |       |  |       |       |  |                |        |  |                |       |     |  |       |       |           |                |        |  |                |     |           |    |       |          |    |                |        |  |                |     |          |    |          |       |       |                |        |  |                |     |          |         |       |       |       |                |        |  |               |     |                |    |       |       |       |                |        |   |                |                |                |       |       |       |  |                |        |  |            |     |                |       |       |       |  |  |  |  |  |  |          |    |       |       |  |  |  |  |  |  |
| 1.8 16V  | 77   | 11.95        | 11.96 |       | 11.0441-5402.2 | 250028 |  + belüftete Scheiben <sup>2)</sup>  | Dichtungssatz  | ATE  |                |                |     |       |       |       |                |                |        |  |                |     |       |       |       |       |  |                |        |  |               |       |              |       |       |       |  |                |         |  |                |       |       |  |       |       |  |                |        |  |                |       |     |  |       |       |           |                |        |  |                |     |           |    |       |          |    |                |        |  |                |     |          |    |          |       |       |                |        |  |                |     |          |         |       |       |       |                |        |  |               |     |                |    |       |       |       |                |        |   |                |                |                |       |       |       |  |                |        |  |            |     |                |       |       |       |  |  |  |  |  |  |          |    |       |       |  |  |  |  |  |  |
| 1.8 D  | 44   | 11.95        | 11.96 |       | 11.8171-0008.1 | 990049 |  + belüftete Scheiben <sup>2)</sup> | Führungsbolzen | ATE  |                |                |     |       |       |       |                |                |        |  |                |     |       |       |       |       |  |                |        |  |               |       |              |       |       |       |  |                |         |  |                |       |       |  |       |       |  |                |        |  |                |       |     |  |       |       |           |                |        |  |                |     |           |    |       |          |    |                |        |  |                |     |          |    |          |       |       |                |        |  |                |     |          |         |       |       |       |                |        |  |               |     |                |    |       |       |       |                |        |   |                |                |                |       |       |       |  |                |        |  |            |     |                |       |       |       |  |  |  |  |  |  |          |    |       |       |  |  |  |  |  |  |
| 1.8 D Kastenw.   |  | 11.95        | 11.96 |       | 11.0101-5407.2 | 260011 |   | Hülsensatz     | ATE  |                |                |     |       |       |       |                |                |        |  |                |     |       |       |       |       |  |                |        |  |               |       |              |       |       |       |  |                |         |  |                |       |       |  |       |       |  |                |        |  |                |       |     |  |       |       |           |                |        |  |                |     |           |    |       |          |    |                |        |  |                |     |          |    |          |       |       |                |        |  |                |     |          |         |       |       |       |                |        |  |               |     |                |    |       |       |       |                |        |   |                |                |                |       |       |       |  |                |        |  |            |     |                |       |       |       |  |  |  |  |  |  |          |    |       |       |  |  |  |  |  |  |
| 1.8 XR2i   | 96   | 11.95        | 11.96 |       |                |        |   |                |  |                |                |     |       |       |       |                |                |        |  |                |     |       |       |       |       |  |                |        |  |               |       |              |       |       |       |  |                |         |  |                |       |       |  |       |       |  |                |        |  |                |       |     |  |       |       |           |                |        |  |                |     |           |    |       |          |    |                |        |  |                |     |          |    |          |       |       |                |        |  |                |     |          |         |       |       |       |                |        |  |               |     |                |    |       |       |       |                |        |   |                |                |                |       |       |       |  |                |        |  |            |     |                |       |       |       |  |  |  |  |  |  |          |    |       |       |  |  |  |  |  |  |
|    | <table border="1"> <tr><td>1.0</td><td>33</td><td>03.89</td><td>12.95</td><td></td><td>24.5303-0400.3</td><td>330404</td><td>2</td><td>L=400</td></tr> <tr><td>1.1</td><td></td><td>05.89</td><td>11.96</td><td></td><td></td><td></td><td></td><td></td></tr> <tr><td>1.3</td><td>44</td><td>03.89</td><td>11.96</td><td></td><td></td><td></td><td></td><td></td></tr> <tr><td>1.3 Kastenw.</td><td></td><td>09.91</td><td>11.96</td><td></td><td></td><td></td><td></td><td></td></tr> <tr><td>1.4</td><td></td><td>03.89</td><td>11.96</td><td></td><td></td><td></td><td></td><td></td></tr> <tr><td>1.6</td><td></td><td>01.89</td><td>11.96</td><td></td><td></td><td></td><td></td><td></td></tr> <tr><td>1.6 Turbo</td><td>96</td><td>03.90</td><td>10.92</td><td></td><td></td><td></td><td></td><td></td></tr> <tr><td>1.6 XR2i</td><td></td><td>03.89</td><td>11.96</td><td></td><td></td><td></td><td></td><td></td></tr> <tr><td>1.6i 16V</td><td>65</td><td>01.94</td><td>11.96</td><td></td><td></td><td></td><td></td><td></td></tr> <tr><td>1.8 16V</td><td>77</td><td>02.92</td><td>11.96</td><td></td><td></td><td></td><td></td><td></td></tr> <tr><td>1.8 D</td><td>44</td><td>05.89</td><td>11.96</td><td></td><td></td><td></td><td></td><td></td></tr> <tr><td>1.8 D Kastenw.</td><td></td><td>09.91</td><td>11.96</td><td></td><td></td><td></td><td></td><td></td></tr> <tr><td>1.8 XR2i</td><td>96</td><td>02.92</td><td>12.95</td><td></td><td></td><td></td><td></td><td></td></tr> </table>   | 1.0          | 33    | 03.89 | 12.95          |        | 24.5303-0400.3  | 330404         | 2  | L=400          | 1.1            |     | 05.89 | 11.96 |       |                |                |        |  | 1.3            | 44  | 03.89 | 11.96 |       |       |  |                |        | 1.3 Kastenw.   |               | 09.91 | 11.96        |       |       |       |  |                | 1.4     |  | 03.89          | 11.96 |       |  |       |       |  | 1.6            |        | 01.89  | 11.96          |       |     |  |       |       | 1.6 Turbo | 96             | 03.90  | 10.92  |                |     |           |    |       | 1.6 XR2i |    | 03.89          | 11.96  |  |                |     |          |    | 1.6i 16V | 65    | 01.94 | 11.96          |        |  |                |     |          | 1.8 16V | 77    | 02.92 | 11.96 |                |        |  |               |     | 1.8 D          | 44 | 05.89 | 11.96 |       |                |        |   |                | 1.8 D Kastenw. |                | 09.91 | 11.96 |       |  |                |        |  | 1.8 XR2i   | 96  | 02.92          | 12.95 |       |       |  |  |  |  |  |  |          |    |       |       |  |  |  |  |  |  |
| 1.0  | 33   | 03.89        | 12.95 |       | 24.5303-0400.3 | 330404 | 2   | L=400          |  |                |                |     |       |       |       |                |                |        |  |                |     |       |       |       |       |  |                |        |  |               |       |              |       |       |       |  |                |         |  |                |       |       |  |       |       |  |                |        |  |                |       |     |  |       |       |           |                |        |  |                |     |           |    |       |          |    |                |        |  |                |     |          |    |          |       |       |                |        |  |                |     |          |         |       |       |       |                |        |  |               |     |                |    |       |       |       |                |        |   |                |                |                |       |       |       |  |                |        |  |            |     |                |       |       |       |  |  |  |  |  |  |          |    |       |       |  |  |  |  |  |  |
| 1.1  |  | 05.89        | 11.96 |       |                |        |   |                |  |                |                |     |       |       |       |                |                |        |  |                |     |       |       |       |       |  |                |        |  |               |       |              |       |       |       |  |                |         |  |                |       |       |  |       |       |  |                |        |  |                |       |     |  |       |       |           |                |        |  |                |     |           |    |       |          |    |                |        |  |                |     |          |    |          |       |       |                |        |  |                |     |          |         |       |       |       |                |        |  |               |     |                |    |       |       |       |                |        |   |                |                |                |       |       |       |  |                |        |  |            |     |                |       |       |       |  |  |  |  |  |  |          |    |       |       |  |  |  |  |  |  |
| 1.3  | 44   | 03.89        | 11.96 |       |                |        |   |                |  |                |                |     |       |       |       |                |                |        |  |                |     |       |       |       |       |  |                |        |  |               |       |              |       |       |       |  |                |         |  |                |       |       |  |       |       |  |                |        |  |                |       |     |  |       |       |           |                |        |  |                |     |           |    |       |          |    |                |        |  |                |     |          |    |          |       |       |                |        |  |                |     |          |         |       |       |       |                |        |  |               |     |                |    |       |       |       |                |        |   |                |                |                |       |       |       |  |                |        |  |            |     |                |       |       |       |  |  |  |  |  |  |          |    |       |       |  |  |  |  |  |  |
| 1.3 Kastenw.   |  | 09.91        | 11.96 |       |                |        |   |                |  |                |                |     |       |       |       |                |                |        |  |                |     |       |       |       |       |  |                |        |  |               |       |              |       |       |       |  |                |         |  |                |       |       |  |       |       |  |                |        |  |                |       |     |  |       |       |           |                |        |  |                |     |           |    |       |          |    |                |        |  |                |     |          |    |          |       |       |                |        |  |                |     |          |         |       |       |       |                |        |  |               |     |                |    |       |       |       |                |        |   |                |                |                |       |       |       |  |                |        |  |            |     |                |       |       |       |  |  |  |  |  |  |          |    |       |       |  |  |  |  |  |  |
| 1.4  |  | 03.89        | 11.96 |       |                |        |   |                |  |                |                |     |       |       |       |                |                |        |  |                |     |       |       |       |       |  |                |        |  |               |       |              |       |       |       |  |                |         |  |                |       |       |  |       |       |  |                |        |  |                |       |     |  |       |       |           |                |        |  |                |     |           |    |       |          |    |                |        |  |                |     |          |    |          |       |       |                |        |  |                |     |          |         |       |       |       |                |        |  |               |     |                |    |       |       |       |                |        |   |                |                |                |       |       |       |  |                |        |  |            |     |                |       |       |       |  |  |  |  |  |  |          |    |       |       |  |  |  |  |  |  |
| 1.6  |  | 01.89        | 11.96 |       |                |        |   |                |  |                |                |     |       |       |       |                |                |        |  |                |     |       |       |       |       |  |                |        |  |               |       |              |       |       |       |  |                |         |  |                |       |       |  |       |       |  |                |        |  |                |       |     |  |       |       |           |                |        |  |                |     |           |    |       |          |    |                |        |  |                |     |          |    |          |       |       |                |        |  |                |     |          |         |       |       |       |                |        |  |               |     |                |    |       |       |       |                |        |   |                |                |                |       |       |       |  |                |        |  |            |     |                |       |       |       |  |  |  |  |  |  |          |    |       |       |  |  |  |  |  |  |
| 1.6 Turbo  | 96   | 03.90        | 10.92 |       |                |        |   |                |  |                |                |     |       |       |       |                |                |        |  |                |     |       |       |       |       |  |                |        |  |               |       |              |       |       |       |  |                |         |  |                |       |       |  |       |       |  |                |        |  |                |       |     |  |       |       |           |                |        |  |                |     |           |    |       |          |    |                |        |  |                |     |          |    |          |       |       |                |        |  |                |     |          |         |       |       |       |                |        |  |               |     |                |    |       |       |       |                |        |   |                |                |                |       |       |       |  |                |        |  |            |     |                |       |       |       |  |  |  |  |  |  |          |    |       |       |  |  |  |  |  |  |
| 1.6 XR2i   |  | 03.89        | 11.96 |       |                |        |   |                |  |                |                |     |       |       |       |                |                |        |  |                |     |       |       |       |       |  |                |        |  |               |       |              |       |       |       |  |                |         |  |                |       |       |  |       |       |  |                |        |  |                |       |     |  |       |       |           |                |        |  |                |     |           |    |       |          |    |                |        |  |                |     |          |    |          |       |       |                |        |  |                |     |          |         |       |       |       |                |        |  |               |     |                |    |       |       |       |                |        |   |                |                |                |       |       |       |  |                |        |  |            |     |                |       |       |       |  |  |  |  |  |  |          |    |       |       |  |  |  |  |  |  |
| 1.6i 16V   | 65   | 01.94        | 11.96 |       |                |        |   |                |  |                |                |     |       |       |       |                |                |        |  |                |     |       |       |       |       |  |                |        |  |               |       |              |       |       |       |  |                |         |  |                |       |       |  |       |       |  |                |        |  |                |       |     |  |       |       |           |                |        |  |                |     |           |    |       |          |    |                |        |  |                |     |          |    |          |       |       |                |        |  |                |     |          |         |       |       |       |                |        |  |               |     |                |    |       |       |       |                |        |   |                |                |                |       |       |       |  |                |        |  |            |     |                |       |       |       |  |  |  |  |  |  |          |    |       |       |  |  |  |  |  |  |
| 1.8 16V  | 77   | 02.92        | 11.96 |       |                |        |   |                |  |                |                |     |       |       |       |                |                |        |  |                |     |       |       |       |       |  |                |        |  |               |       |              |       |       |       |  |                |         |  |                |       |       |  |       |       |  |                |        |  |                |       |     |  |       |       |           |                |        |  |                |     |           |    |       |          |    |                |        |  |                |     |          |    |          |       |       |                |        |  |                |     |          |         |       |       |       |                |        |  |               |     |                |    |       |       |       |                |        |   |                |                |                |       |       |       |  |                |        |  |            |     |                |       |       |       |  |  |  |  |  |  |          |    |       |       |  |  |  |  |  |  |
| 1.8 D  | 44   | 05.89        | 11.96 |       |                |        |   |                |  |                |                |     |       |       |       |                |                |        |  |                |     |       |       |       |       |  |                |        |  |               |       |              |       |       |       |  |                |         |  |                |       |       |  |       |       |  |                |        |  |                |       |     |  |       |       |           |                |        |  |                |     |           |    |       |          |    |                |        |  |                |     |          |    |          |       |       |                |        |  |                |     |          |         |       |       |       |                |        |  |               |     |                |    |       |       |       |                |        |   |                |                |                |       |       |       |  |                |        |  |            |     |                |       |       |       |  |  |  |  |  |  |          |    |       |       |  |  |  |  |  |  |
| 1.8 D Kastenw.   |  | 09.91        | 11.96 |       |                |        |   |                |  |                |                |     |       |       |       |                |                |        |  |                |     |       |       |       |       |  |                |        |  |               |       |              |       |       |       |  |                |         |  |                |       |       |  |       |       |  |                |        |  |                |       |     |  |       |       |           |                |        |  |                |     |           |    |       |          |    |                |        |  |                |     |          |    |          |       |       |                |        |  |                |     |          |         |       |       |       |                |        |  |               |     |                |    |       |       |       |                |        |   |                |                |                |       |       |       |  |                |        |  |            |     |                |       |       |       |  |  |  |  |  |  |          |    |       |       |  |  |  |  |  |  |
| 1.8 XR2i   | 96   | 02.92        | 12.95 |       |                |        |   |                |  |                |                |     |       |       |       |                |                |        |  |                |     |       |       |       |       |  |                |        |  |               |       |              |       |       |       |  |                |         |  |                |       |       |  |       |       |  |                |        |  |                |       |     |  |       |       |           |                |        |  |                |     |           |    |       |          |    |                |        |  |                |     |          |    |          |       |       |                |        |  |                |     |          |         |       |       |       |                |        |  |               |     |                |    |       |       |       |                |        |   |                |                |                |       |       |       |  |                |        |  |            |     |                |       |       |       |  |  |  |  |  |  |          |    |       |       |  |  |  |  |  |  |
|    | <table border="1"> <tr><td>1.0</td><td>33</td><td>03.89</td><td>12.95</td><td></td><td>24.5302-0295.3</td><td>330403</td><td>2</td><td>L=295</td></tr> <tr><td>1.1</td><td></td><td>05.89</td><td>11.96</td><td></td><td>24.5306-0295.3</td><td>330662</td><td>2</td><td>L=295</td></tr> <tr><td>1.3</td><td>44</td><td>03.89</td><td>11.96</td><td></td><td></td><td></td><td></td><td></td></tr> <tr><td>1.4</td><td></td><td>03.89</td><td>11.96</td><td></td><td></td><td></td><td></td><td></td></tr> <tr><td>1.6</td><td></td><td>01.89</td><td>11.96</td><td></td><td></td><td></td><td></td><td></td></tr> <tr><td>1.6 Turbo</td><td>96</td><td>03.90</td><td>10.92</td><td></td><td></td><td></td><td></td><td></td></tr> <tr><td>1.6 XR2i</td><td></td><td>03.89</td><td>11.96</td><td></td><td></td><td></td><td></td><td></td></tr> <tr><td>1.6i 16V</td><td>65</td><td>01.94</td><td>11.96</td><td></td><td></td><td></td><td></td><td></td></tr> <tr><td>1.8 16V</td><td>77</td><td>02.92</td><td>11.96</td><td></td><td></td><td></td><td></td><td></td></tr> <tr><td>1.8 D</td><td>44</td><td>05.89</td><td>11.96</td><td></td><td></td><td></td><td></td><td></td></tr> <tr><td>1.8 XR2i</td><td>96</td><td>02.92</td><td>12.95</td><td></td><td></td><td></td><td></td><td></td></tr> </table>   | 1.0          | 33    | 03.89 | 12.95          |        | 24.5302-0295.3  | 330403         | 2  | L=295          | 1.1            |     | 05.89 | 11.96 |       | 24.5306-0295.3 | 330662         | 2      | L=295  | 1.3            | 44  | 03.89 | 11.96 |       |       |  |                |        | 1.4  |               | 03.89 | 11.96        |       |       |       |  |                | 1.6     |  | 01.89          | 11.96 |       |  |       |       |  | 1.6 Turbo      | 96     | 03.90  | 10.92          |       |     |  |       |       | 1.6 XR2i  |                | 03.89  | 11.96  |                |     |           |    |       | 1.6i 16V | 65 | 01.94          | 11.96  |  |                |     |          |    | 1.8 16V  | 77    | 02.92 | 11.96          |        |  |                |     |          | 1.8 D   | 44    | 05.89 | 11.96 |                |        |  |               |     | 1.8 XR2i       | 96 | 02.92 | 12.95 |       |                |        |   |                |                |                |       |       |       |  |                |        |  |            |     |                |       |       |       |  |  |  |  |  |  |          |    |       |       |  |  |  |  |  |  |
| 1.0  | 33   | 03.89        | 12.95 |       | 24.5302-0295.3 | 330403 | 2   | L=295          |  |                |                |     |       |       |       |                |                |        |  |                |     |       |       |       |       |  |                |        |  |               |       |              |       |       |       |  |                |         |  |                |       |       |  |       |       |  |                |        |  |                |       |     |  |       |       |           |                |        |  |                |     |           |    |       |          |    |                |        |  |                |     |          |    |          |       |       |                |        |  |                |     |          |         |       |       |       |                |        |  |               |     |                |    |       |       |       |                |        |   |                |                |                |       |       |       |  |                |        |  |            |     |                |       |       |       |  |  |  |  |  |  |          |    |       |       |  |  |  |  |  |  |
| 1.1  |  | 05.89        | 11.96 |       | 24.5306-0295.3 | 330662 | 2   | L=295          |  |                |                |     |       |       |       |                |                |        |  |                |     |       |       |       |       |  |                |        |  |               |       |              |       |       |       |  |                |         |  |                |       |       |  |       |       |  |                |        |  |                |       |     |  |       |       |           |                |        |  |                |     |           |    |       |          |    |                |        |  |                |     |          |    |          |       |       |                |        |  |                |     |          |         |       |       |       |                |        |  |               |     |                |    |       |       |       |                |        |   |                |                |                |       |       |       |  |                |        |  |            |     |                |       |       |       |  |  |  |  |  |  |          |    |       |       |  |  |  |  |  |  |
| 1.3  | 44   | 03.89        | 11.96 |       |                |        |   |                |  |                |                |     |       |       |       |                |                |        |  |                |     |       |       |       |       |  |                |        |  |               |       |              |       |       |       |  |                |         |  |                |       |       |  |       |       |  |                |        |  |                |       |     |  |       |       |           |                |        |  |                |     |           |    |       |          |    |                |        |  |                |     |          |    |          |       |       |                |        |  |                |     |          |         |       |       |       |                |        |  |               |     |                |    |       |       |       |                |        |   |                |                |                |       |       |       |  |                |        |  |            |     |                |       |       |       |  |  |  |  |  |  |          |    |       |       |  |  |  |  |  |  |
| 1.4  |  | 03.89        | 11.96 |       |                |        |   |                |  |                |                |     |       |       |       |                |                |        |  |                |     |       |       |       |       |  |                |        |  |               |       |              |       |       |       |  |                |         |  |                |       |       |  |       |       |  |                |        |  |                |       |     |  |       |       |           |                |        |  |                |     |           |    |       |          |    |                |        |  |                |     |          |    |          |       |       |                |        |  |                |     |          |         |       |       |       |                |        |  |               |     |                |    |       |       |       |                |        |   |                |                |                |       |       |       |  |                |        |  |            |     |                |       |       |       |  |  |  |  |  |  |          |    |       |       |  |  |  |  |  |  |
| 1.6  |  | 01.89        | 11.96 |       |                |        |   |                |  |                |                |     |       |       |       |                |                |        |  |                |     |       |       |       |       |  |                |        |  |               |       |              |       |       |       |  |                |         |  |                |       |       |  |       |       |  |                |        |  |                |       |     |  |       |       |           |                |        |  |                |     |           |    |       |          |    |                |        |  |                |     |          |    |          |       |       |                |        |  |                |     |          |         |       |       |       |                |        |  |               |     |                |    |       |       |       |                |        |   |                |                |                |       |       |       |  |                |        |  |            |     |                |       |       |       |  |  |  |  |  |  |          |    |       |       |  |  |  |  |  |  |
| 1.6 Turbo  | 96   | 03.90        | 10.92 |       |                |        |   |                |  |                |                |     |       |       |       |                |                |        |  |                |     |       |       |       |       |  |                |        |  |               |       |              |       |       |       |  |                |         |  |                |       |       |  |       |       |  |                |        |  |                |       |     |  |       |       |           |                |        |  |                |     |           |    |       |          |    |                |        |  |                |     |          |    |          |       |       |                |        |  |                |     |          |         |       |       |       |                |        |  |               |     |                |    |       |       |       |                |        |   |                |                |                |       |       |       |  |                |        |  |            |     |                |       |       |       |  |  |  |  |  |  |          |    |       |       |  |  |  |  |  |  |
| 1.6 XR2i   |  | 03.89        | 11.96 |       |                |        |   |                |  |                |                |     |       |       |       |                |                |        |  |                |     |       |       |       |       |  |                |        |  |               |       |              |       |       |       |  |                |         |  |                |       |       |  |       |       |  |                |        |  |                |       |     |  |       |       |           |                |        |  |                |     |           |    |       |          |    |                |        |  |                |     |          |    |          |       |       |                |        |  |                |     |          |         |       |       |       |                |        |  |               |     |                |    |       |       |       |                |        |   |                |                |                |       |       |       |  |                |        |  |            |     |                |       |       |       |  |  |  |  |  |  |          |    |       |       |  |  |  |  |  |  |
| 1.6i 16V   | 65   | 01.94        | 11.96 |       |                |        |   |                |  |                |                |     |       |       |       |                |                |        |  |                |     |       |       |       |       |  |                |        |  |               |       |              |       |       |       |  |                |         |  |                |       |       |  |       |       |  |                |        |  |                |       |     |  |       |       |           |                |        |  |                |     |           |    |       |          |    |                |        |  |                |     |          |    |          |       |       |                |        |  |                |     |          |         |       |       |       |                |        |  |               |     |                |    |       |       |       |                |        |   |                |                |                |       |       |       |  |                |        |  |            |     |                |       |       |       |  |  |  |  |  |  |          |    |       |       |  |  |  |  |  |  |
| 1.8 16V  | 77   | 02.92        | 11.96 |       |                |        |   |                |  |                |                |     |       |       |       |                |                |        |  |                |     |       |       |       |       |  |                |        |  |               |       |              |       |       |       |  |                |         |  |                |       |       |  |       |       |  |                |        |  |                |       |     |  |       |       |           |                |        |  |                |     |           |    |       |          |    |                |        |  |                |     |          |    |          |       |       |                |        |  |                |     |          |         |       |       |       |                |        |  |               |     |                |    |       |       |       |                |        |   |                |                |                |       |       |       |  |                |        |  |            |     |                |       |       |       |  |  |  |  |  |  |          |    |       |       |  |  |  |  |  |  |
| 1.8 D  | 44   | 05.89        | 11.96 |       |                |        |   |                |  |                |                |     |       |       |       |                |                |        |  |                |     |       |       |       |       |  |                |        |  |               |       |              |       |       |       |  |                |         |  |                |       |       |  |       |       |  |                |        |  |                |       |     |  |       |       |           |                |        |  |                |     |           |    |       |          |    |                |        |  |                |     |          |    |          |       |       |                |        |  |                |     |          |         |       |       |       |                |        |  |               |     |                |    |       |       |       |                |        |   |                |                |                |       |       |       |  |                |        |  |            |     |                |       |       |       |  |  |  |  |  |  |          |    |       |       |  |  |  |  |  |  |
| 1.8 XR2i   | 96   | 02.92        | 12.95 |       |                |        |   |                |  |                |                |     |       |       |       |                |                |        |  |                |     |       |       |       |       |  |                |        |  |               |       |              |       |       |       |  |                |         |  |                |       |       |  |       |       |  |                |        |  |                |       |     |  |       |       |           |                |        |  |                |     |           |    |       |          |    |                |        |  |                |     |          |    |          |       |       |                |        |  |                |     |          |         |       |       |       |                |        |  |               |     |                |    |       |       |       |                |        |   |                |                |                |       |       |       |  |                |        |  |            |     |                |       |       |       |  |  |  |  |  |  |          |    |       |       |  |  |  |  |  |  |
|    | <table border="1"> <tr><td>1.3 Kastenw.</td><td></td><td>09.91</td><td>11.96</td><td></td><td>24.5304-0280.3</td><td>330589</td><td>2</td><td>L=280</td></tr> <tr><td>1.8 D Kastenw.</td><td></td><td>09.91</td><td>11.96</td><td></td><td></td><td></td><td></td><td></td></tr> </table>  | 1.3 Kastenw. |       | 09.91 | 11.96          |        | 24.5304-0280.3  | 330589         | 2  | L=280          | 1.8 D Kastenw. |     | 09.91 | 11.96 |       |                |                |        |  |                |     |       |       |       |       |  |                |        |  |               |       |              |       |       |       |  |                |         |  |                |       |       |  |       |       |  |                |        |  |                |       |     |  |       |       |           |                |        |  |                |     |           |    |       |          |    |                |        |  |                |     |          |    |          |       |       |                |        |  |                |     |          |         |       |       |       |                |        |  |               |     |                |    |       |       |       |                |        |   |                |                |                |       |       |       |  |                |        |  |            |     |                |       |       |       |  |  |  |  |  |  |          |    |       |       |  |  |  |  |  |  |
| 1.3 Kastenw.   |  | 09.91        | 11.96 |       | 24.5304-0280.3 | 330589 | 2   | L=280          |  |                |                |     |       |       |       |                |                |        |  |                |     |       |       |       |       |  |                |        |  |               |       |              |       |       |       |  |                |         |  |                |       |       |  |       |       |  |                |        |  |                |       |     |  |       |       |           |                |        |  |                |     |           |    |       |          |    |                |        |  |                |     |          |    |          |       |       |                |        |  |                |     |          |         |       |       |       |                |        |  |               |     |                |    |       |       |       |                |        |   |                |                |                |       |       |       |  |                |        |  |            |     |                |       |       |       |  |  |  |  |  |  |          |    |       |       |  |  |  |  |  |  |
| 1.8 D Kastenw.   |  | 09.91        | 11.96 |       |                |        |   |                |  |                |                |     |       |       |       |                |                |        |  |                |     |       |       |       |       |  |                |        |  |               |       |              |       |       |       |  |                |         |  |                |       |       |  |       |       |  |                |        |  |                |       |     |  |       |       |           |                |        |  |                |     |           |    |       |          |    |                |        |  |                |     |          |    |          |       |       |                |        |  |                |     |          |         |       |       |       |                |        |  |               |     |                |    |       |       |       |                |        |   |                |                |                |       |       |       |  |                |        |  |            |     |                |       |       |       |  |  |  |  |  |  |          |    |       |       |  |  |  |  |  |  |
|    | <table border="1"> <tr><td>1.0</td><td>33</td><td>03.89</td><td>12.93</td><td>- SCS</td><td>24.3217-1601.3</td><td>020180</td><td></td><td>Rz 17,46</td></tr> <tr><td>1.1</td><td></td><td>05.89</td><td>12.93</td><td>- SCS</td><td></td><td></td><td></td><td></td></tr> <tr><td>1.3</td><td>44</td><td>03.89</td><td>12.93</td><td>- SCS</td><td></td><td></td><td></td><td></td></tr> <tr><td>1.4</td><td>44</td><td>03.89</td><td>12.93</td><td>- SCS</td><td></td><td></td><td></td><td></td></tr> <tr><td>1.8 D</td><td>44</td><td>05.89</td><td>11.96</td><td>- SCS</td><td></td><td></td><td></td><td></td></tr> </table>   | 1.0          | 33    | 03.89 | 12.93          | - SCS  | 24.3217-1601.3  | 020180         |  | Rz 17,46       | 1.1            |     | 05.89 | 12.93 | - SCS |                |                |        |  | 1.3            | 44  | 03.89 | 12.93 | - SCS |       |  |                |        | 1.4  | 44            | 03.89 | 12.93        | - SCS |       |       |  |                | 1.8 D   | 44   | 05.89          | 11.96 | - SCS |  |       |       |  |                |        |  |                |       |     |  |       |       |           |                |        |  |                |     |           |    |       |          |    |                |        |  |                |     |          |    |          |       |       |                |        |  |                |     |          |         |       |       |       |                |        |  |               |     |                |    |       |       |       |                |        |   |                |                |                |       |       |       |  |                |        |  |            |     |                |       |       |       |  |  |  |  |  |  |          |    |       |       |  |  |  |  |  |  |
| 1.0  | 33   | 03.89        | 12.93 | - SCS | 24.3217-1601.3 | 020180 |   | Rz 17,46       |  |                |                |     |       |       |       |                |                |        |  |                |     |       |       |       |       |  |                |        |  |               |       |              |       |       |       |  |                |         |  |                |       |       |  |       |       |  |                |        |  |                |       |     |  |       |       |           |                |        |  |                |     |           |    |       |          |    |                |        |  |                |     |          |    |          |       |       |                |        |  |                |     |          |         |       |       |       |                |        |  |               |     |                |    |       |       |       |                |        |   |                |                |                |       |       |       |  |                |        |  |            |     |                |       |       |       |  |  |  |  |  |  |          |    |       |       |  |  |  |  |  |  |
| 1.1  |  | 05.89        | 12.93 | - SCS |                |        |   |                |  |                |                |     |       |       |       |                |                |        |  |                |     |       |       |       |       |  |                |        |  |               |       |              |       |       |       |  |                |         |  |                |       |       |  |       |       |  |                |        |  |                |       |     |  |       |       |           |                |        |  |                |     |           |    |       |          |    |                |        |  |                |     |          |    |          |       |       |                |        |  |                |     |          |         |       |       |       |                |        |  |               |     |                |    |       |       |       |                |        |   |                |                |                |       |       |       |  |                |        |  |            |     |                |       |       |       |  |  |  |  |  |  |          |    |       |       |  |  |  |  |  |  |
| 1.3  | 44   | 03.89        | 12.93 | - SCS |                |        |   |                |  |                |                |     |       |       |       |                |                |        |  |                |     |       |       |       |       |  |                |        |  |               |       |              |       |       |       |  |                |         |  |                |       |       |  |       |       |  |                |        |  |                |       |     |  |       |       |           |                |        |  |                |     |           |    |       |          |    |                |        |  |                |     |          |    |          |       |       |                |        |  |                |     |          |         |       |       |       |                |        |  |               |     |                |    |       |       |       |                |        |   |                |                |                |       |       |       |  |                |        |  |            |     |                |       |       |       |  |  |  |  |  |  |          |    |       |       |  |  |  |  |  |  |
| 1.4  | 44   | 03.89        | 12.93 | - SCS |                |        |   |                |  |                |                |     |       |       |       |                |                |        |  |                |     |       |       |       |       |  |                |        |  |               |       |              |       |       |       |  |                |         |  |                |       |       |  |       |       |  |                |        |  |                |       |     |  |       |       |           |                |        |  |                |     |           |    |       |          |    |                |        |  |                |     |          |    |          |       |       |                |        |  |                |     |          |         |       |       |       |                |        |  |               |     |                |    |       |       |       |                |        |   |                |                |                |       |       |       |  |                |        |  |            |     |                |       |       |       |  |  |  |  |  |  |          |    |       |       |  |  |  |  |  |  |
| 1.8 D  | 44   | 05.89        | 11.96 | - SCS |                |        |   |                |  |                |                |     |       |       |       |                |                |        |  |                |     |       |       |       |       |  |                |        |  |               |       |              |       |       |       |  |                |         |  |                |       |       |  |       |       |  |                |        |  |                |       |     |  |       |       |           |                |        |  |                |     |           |    |       |          |    |                |        |  |                |     |          |    |          |       |       |                |        |  |                |     |          |         |       |       |       |                |        |  |               |     |                |    |       |       |       |                |        |   |                |                |                |       |       |       |  |                |        |  |            |     |                |       |       |       |  |  |  |  |  |  |          |    |       |       |  |  |  |  |  |  |
|    | <table border="1"> <tr><td>1.6</td><td></td><td>01.89</td><td>11.96</td><td>- SCS</td><td>24.3219-1106.3</td><td>020192</td><td></td><td>Rz 19,05</td></tr> <tr><td>1.6 Turbo</td><td>96</td><td>03.90</td><td>10.92</td><td>- SCS</td><td></td><td></td><td></td><td></td></tr> <tr><td>1.6 XR2i</td><td></td><td>03.89</td><td>11.96</td><td>- SCS</td><td></td><td></td><td></td><td></td></tr> <tr><td>1.6i 16V</td><td>65</td><td>01.94</td><td>11.96</td><td>- SCS</td><td></td><td></td><td></td><td></td></tr> <tr><td>1.8 16V</td><td>77</td><td>02.92</td><td>11.96</td><td>- SCS</td><td></td><td></td><td></td><td></td></tr> <tr><td>1.8 XR2i</td><td>96</td><td>02.92</td><td>12.95</td><td>- SCS</td><td></td><td></td><td></td><td></td></tr> </table>   | 1.6          |       | 01.89 | 11.96          | - SCS  | 24.3219-1106.3  | 020192         |  | Rz 19,05       | 1.6 Turbo      | 96  | 03.90 | 10.92 | - SCS |                |                |        |  | 1.6 XR2i       |     | 03.89 | 11.96 | - SCS |       |  |                |        | 1.6i 16V   | 65            | 01.94 | 11.96        | - SCS |       |       |  |                | 1.8 16V | 77   | 02.92          | 11.96 | - SCS |  |       |       |  | 1.8 XR2i       | 96     | 02.92  | 12.95          | - SCS |     |  |       |       |           |                |        |  |                |     |           |    |       |          |    |                |        |  |                |     |          |    |          |       |       |                |        |  |                |     |          |         |       |       |       |                |        |  |               |     |                |    |       |       |       |                |        |   |                |                |                |       |       |       |  |                |        |  |            |     |                |       |       |       |  |  |  |  |  |  |          |    |       |       |  |  |  |  |  |  |
| 1.6  |  | 01.89        | 11.96 | - SCS | 24.3219-1106.3 | 020192 |   | Rz 19,05       |  |                |                |     |       |       |       |                |                |        |  |                |     |       |       |       |       |  |                |        |  |               |       |              |       |       |       |  |                |         |  |                |       |       |  |       |       |  |                |        |  |                |       |     |  |       |       |           |                |        |  |                |     |           |    |       |          |    |                |        |  |                |     |          |    |          |       |       |                |        |  |                |     |          |         |       |       |       |                |        |  |               |     |                |    |       |       |       |                |        |   |                |                |                |       |       |       |  |                |        |  |            |     |                |       |       |       |  |  |  |  |  |  |          |    |       |       |  |  |  |  |  |  |
| 1.6 Turbo  | 96   | 03.90        | 10.92 | - SCS |                |        |   |                |  |                |                |     |       |       |       |                |                |        |  |                |     |       |       |       |       |  |                |        |  |               |       |              |       |       |       |  |                |         |  |                |       |       |  |       |       |  |                |        |  |                |       |     |  |       |       |           |                |        |  |                |     |           |    |       |          |    |                |        |  |                |     |          |    |          |       |       |                |        |  |                |     |          |         |       |       |       |                |        |  |               |     |                |    |       |       |       |                |        |   |                |                |                |       |       |       |  |                |        |  |            |     |                |       |       |       |  |  |  |  |  |  |          |    |       |       |  |  |  |  |  |  |
| 1.6 XR2i   |  | 03.89        | 11.96 | - SCS |                |        |   |                |  |                |                |     |       |       |       |                |                |        |  |                |     |       |       |       |       |  |                |        |  |               |       |              |       |       |       |  |                |         |  |                |       |       |  |       |       |  |                |        |  |                |       |     |  |       |       |           |                |        |  |                |     |           |    |       |          |    |                |        |  |                |     |          |    |          |       |       |                |        |  |                |     |          |         |       |       |       |                |        |  |               |     |                |    |       |       |       |                |        |   |                |                |                |       |       |       |  |                |        |  |            |     |                |       |       |       |  |  |  |  |  |  |          |    |       |       |  |  |  |  |  |  |
| 1.6i 16V   | 65   | 01.94        | 11.96 | - SCS |                |        |   |                |  |                |                |     |       |       |       |                |                |        |  |                |     |       |       |       |       |  |                |        |  |               |       |              |       |       |       |  |                |         |  |                |       |       |  |       |       |  |                |        |  |                |       |     |  |       |       |           |                |        |  |                |     |           |    |       |          |    |                |        |  |                |     |          |    |          |       |       |                |        |  |                |     |          |         |       |       |       |                |        |  |               |     |                |    |       |       |       |                |        |   |                |                |                |       |       |       |  |                |        |  |            |     |                |       |       |       |  |  |  |  |  |  |          |    |       |       |  |  |  |  |  |  |
| 1.8 16V  | 77   | 02.92        | 11.96 | - SCS |                |        |   |                |  |                |                |     |       |       |       |                |                |        |  |                |     |       |       |       |       |  |                |        |  |               |       |              |       |       |       |  |                |         |  |                |       |       |  |       |       |  |                |        |  |                |       |     |  |       |       |           |                |        |  |                |     |           |    |       |          |    |                |        |  |                |     |          |    |          |       |       |                |        |  |                |     |          |         |       |       |       |                |        |  |               |     |                |    |       |       |       |                |        |   |                |                |                |       |       |       |  |                |        |  |            |     |                |       |       |       |  |  |  |  |  |  |          |    |       |       |  |  |  |  |  |  |
| 1.8 XR2i   | 96   | 02.92        | 12.95 | - SCS |                |        |   |                |  |                |                |     |       |       |       |                |                |        |  |                |     |       |       |       |       |  |                |        |  |               |       |              |       |       |       |  |                |         |  |                |       |       |  |       |       |  |                |        |  |                |       |     |  |       |       |           |                |        |  |                |     |           |    |       |          |    |                |        |  |                |     |          |    |          |       |       |                |        |  |                |     |          |         |       |       |       |                |        |  |               |     |                |    |       |       |       |                |        |   |                |                |                |       |       |       |  |                |        |  |            |     |                |       |       |       |  |  |  |  |  |  |          |    |       |       |  |  |  |  |  |  |
|    | <table border="1"> <tr><td>1.0</td><td>33</td><td>01.94</td><td>12.95</td><td>- SCS</td><td>24.3219-1717.3</td><td>020415</td><td></td><td>Rz 19,05</td></tr> <tr><td>1.1</td><td></td><td>01.94</td><td>11.96</td><td>- SCS</td><td></td><td></td><td></td><td></td></tr> <tr><td>1.3</td><td>44</td><td>01.94</td><td>11.96</td><td>- SCS</td><td></td><td></td><td></td><td></td></tr> <tr><td>1.4</td><td></td><td>01.94</td><td>11.96</td><td>- SCS</td><td></td><td></td><td></td><td></td></tr> </table>  | 1.0          | 33    | 01.94 | 12.95          | - SCS  | 24.3219-1717.3  | 020415         |  | Rz 19,05       | 1.1            |     | 01.94 | 11.96 | - SCS |                |                |        |  | 1.3            | 44  | 01.94 | 11.96 | - SCS |       |  |                |        | 1.4  |               | 01.94 | 11.96        | - SCS |       |       |  |                |         |  |                |       |       |  |       |       |  |                |        |  |                |       |     |  |       |       |           |                |        |  |                |     |           |    |       |          |    |                |        |  |                |     |          |    |          |       |       |                |        |  |                |     |          |         |       |       |       |                |        |  |               |     |                |    |       |       |       |                |        |   |                |                |                |       |       |       |  |                |        |  |            |     |                |       |       |       |  |  |  |  |  |  |          |    |       |       |  |  |  |  |  |  |
| 1.0  | 33   | 01.94        | 12.95 | - SCS | 24.3219-1717.3 | 020415 |   | Rz 19,05       |  |                |                |     |       |       |       |                |                |        |  |                |     |       |       |       |       |  |                |        |  |               |       |              |       |       |       |  |                |         |  |                |       |       |  |       |       |  |                |        |  |                |       |     |  |       |       |           |                |        |  |                |     |           |    |       |          |    |                |        |  |                |     |          |    |          |       |       |                |        |  |                |     |          |         |       |       |       |                |        |  |               |     |                |    |       |       |       |                |        |   |                |                |                |       |       |       |  |                |        |  |            |     |                |       |       |       |  |  |  |  |  |  |          |    |       |       |  |  |  |  |  |  |
| 1.1  |  | 01.94        | 11.96 | - SCS |                |        |   |                |  |                |                |     |       |       |       |                |                |        |  |                |     |       |       |       |       |  |                |        |  |               |       |              |       |       |       |  |                |         |  |                |       |       |  |       |       |  |                |        |  |                |       |     |  |       |       |           |                |        |  |                |     |           |    |       |          |    |                |        |  |                |     |          |    |          |       |       |                |        |  |                |     |          |         |       |       |       |                |        |  |               |     |                |    |       |       |       |                |        |   |                |                |                |       |       |       |  |                |        |  |            |     |                |       |       |       |  |  |  |  |  |  |          |    |       |       |  |  |  |  |  |  |
| 1.3  | 44   | 01.94        | 11.96 | - SCS |                |        |   |                |  |                |                |     |       |       |       |                |                |        |  |                |     |       |       |       |       |  |                |        |  |               |       |              |       |       |       |  |                |         |  |                |       |       |  |       |       |  |                |        |  |                |       |     |  |       |       |           |                |        |  |                |     |           |    |       |          |    |                |        |  |                |     |          |    |          |       |       |                |        |  |                |     |          |         |       |       |       |                |        |  |               |     |                |    |       |       |       |                |        |   |                |                |                |       |       |       |  |                |        |  |            |     |                |       |       |       |  |  |  |  |  |  |          |    |       |       |  |  |  |  |  |  |
| 1.4  |  | 01.94        | 11.96 | - SCS |                |        |   |                |  |                |                |     |       |       |       |                |                |        |  |                |     |       |       |       |       |  |                |        |  |               |       |              |       |       |       |  |                |         |  |                |       |       |  |       |       |  |                |        |  |                |       |     |  |       |       |           |                |        |  |                |     |           |    |       |          |    |                |        |  |                |     |          |    |          |       |       |                |        |  |                |     |          |         |       |       |       |                |        |  |               |     |                |    |       |       |       |                |        |   |                |                |                |       |       |       |  |                |        |  |            |     |                |       |       |       |  |  |  |  |  |  |          |    |       |       |  |  |  |  |  |  |
|    | <table border="1"> <tr><td>1.0</td><td>33</td><td>03.89</td><td>12.95</td><td>+ SCS</td><td>24.3222-1111.3</td><td>020266</td><td></td><td>Rz 22,20</td></tr> <tr><td>1.1</td><td></td><td>05.89</td><td>11.96</td><td>+ SCS</td><td></td><td></td><td></td><td></td></tr> <tr><td>1.3</td><td>44</td><td>03.89</td><td>11.96</td><td>+ SCS</td><td></td><td></td><td></td><td></td></tr> <tr><td>1.3 Kastenw.</td><td></td><td>09.91</td><td>01.94</td><td></td><td></td><td></td><td></td><td></td></tr> <tr><td>1.4</td><td></td><td>03.89</td><td>11.96</td><td>+ SCS</td><td></td><td></td><td></td><td></td></tr> <tr><td>1.6</td><td></td><td>01.89</td><td>11.96</td><td>+ SCS</td><td></td><td></td><td></td><td></td></tr> <tr><td>1.6 Turbo</td><td>96</td><td>03.90</td><td>10.92</td><td>+ SCS</td><td></td><td></td><td></td><td></td></tr> <tr><td>1.6 XR2i</td><td></td><td>03.89</td><td>11.96</td><td>+ SCS</td><td></td><td></td><td></td><td></td></tr> </table>   | 1.0          | 33    | 03.89 | 12.95          | + SCS  | 24.3222-1111.3  | 020266         |  | Rz 22,20       | 1.1            |     | 05.89 | 11.96 | + SCS |                |                |        |  | 1.3            | 44  | 03.89 | 11.96 | + SCS |       |  |                |        | 1.3 Kastenw.   |               | 09.91 | 01.94        |       |       |       |  |                | 1.4     |  | 03.89          | 11.96 | + SCS |  |       |       |  | 1.6            |        | 01.89  | 11.96          | + SCS |     |  |       |       | 1.6 Turbo | 96             | 03.90  | 10.92  | + SCS          |     |           |    |       | 1.6 XR2i |    | 03.89          | 11.96  | + SCS  |                |     |          |    |          |       |       |                |        |  |                |     |          |         |       |       |       |                |        |  |               |     |                |    |       |       |       |                |        |   |                |                |                |       |       |       |  |                |        |  |            |     |                |       |       |       |  |  |  |  |  |  |          |    |       |       |  |  |  |  |  |  |
| 1.0  | 33   | 03.89        | 12.95 | + SCS | 24.3222-1111.3 | 020266 |   | Rz 22,20       |  |                |                |     |       |       |       |                |                |        |  |                |     |       |       |       |       |  |                |        |  |               |       |              |       |       |       |  |                |         |  |                |       |       |  |       |       |  |                |        |  |                |       |     |  |       |       |           |                |        |  |                |     |           |    |       |          |    |                |        |  |                |     |          |    |          |       |       |                |        |  |                |     |          |         |       |       |       |                |        |  |               |     |                |    |       |       |       |                |        |   |                |                |                |       |       |       |  |                |        |  |            |     |                |       |       |       |  |  |  |  |  |  |          |    |       |       |  |  |  |  |  |  |
| 1.1  |  | 05.89        | 11.96 | + SCS |                |        |   |                |  |                |                |     |       |       |       |                |                |        |  |                |     |       |       |       |       |  |                |        |  |               |       |              |       |       |       |  |                |         |  |                |       |       |  |       |       |  |                |        |  |                |       |     |  |       |       |           |                |        |  |                |     |           |    |       |          |    |                |        |  |                |     |          |    |          |       |       |                |        |  |                |     |          |         |       |       |       |                |        |  |               |     |                |    |       |       |       |                |        |   |                |                |                |       |       |       |  |                |        |  |            |     |                |       |       |       |  |  |  |  |  |  |          |    |       |       |  |  |  |  |  |  |
| 1.3  | 44   | 03.89        | 11.96 | + SCS |                |        |   |                |  |                |                |     |       |       |       |                |                |        |  |                |     |       |       |       |       |  |                |        |  |               |       |              |       |       |       |  |                |         |  |                |       |       |  |       |       |  |                |        |  |                |       |     |  |       |       |           |                |        |  |                |     |           |    |       |          |    |                |        |  |                |     |          |    |          |       |       |                |        |  |                |     |          |         |       |       |       |                |        |  |               |     |                |    |       |       |       |                |        |   |                |                |                |       |       |       |  |                |        |  |            |     |                |       |       |       |  |  |  |  |  |  |          |    |       |       |  |  |  |  |  |  |
| 1.3 Kastenw.   |  | 09.91        | 01.94 |       |                |        |   |                |  |                |                |     |       |       |       |                |                |        |  |                |     |       |       |       |       |  |                |        |  |               |       |              |       |       |       |  |                |         |  |                |       |       |  |       |       |  |                |        |  |                |       |     |  |       |       |           |                |        |  |                |     |           |    |       |          |    |                |        |  |                |     |          |    |          |       |       |                |        |  |                |     |          |         |       |       |       |                |        |  |               |     |                |    |       |       |       |                |        |   |                |                |                |       |       |       |  |                |        |  |            |     |                |       |       |       |  |  |  |  |  |  |          |    |       |       |  |  |  |  |  |  |
| 1.4  |  | 03.89        | 11.96 | + SCS |                |        |   |                |  |                |                |     |       |       |       |                |                |        |  |                |     |       |       |       |       |  |                |        |  |               |       |              |       |       |       |  |                |         |  |                |       |       |  |       |       |  |                |        |  |                |       |     |  |       |       |           |                |        |  |                |     |           |    |       |          |    |                |        |  |                |     |          |    |          |       |       |                |        |  |                |     |          |         |       |       |       |                |        |  |               |     |                |    |       |       |       |                |        |   |                |                |                |       |       |       |  |                |        |  |            |     |                |       |       |       |  |  |  |  |  |  |          |    |       |       |  |  |  |  |  |  |
| 1.6  |  | 01.89        | 11.96 | + SCS |                |        |   |                |  |                |                |     |       |       |       |                |                |        |  |                |     |       |       |       |       |  |                |        |  |               |       |              |       |       |       |  |                |         |  |                |       |       |  |       |       |  |                |        |  |                |       |     |  |       |       |           |                |        |  |                |     |           |    |       |          |    |                |        |  |                |     |          |    |          |       |       |                |        |  |                |     |          |         |       |       |       |                |        |  |               |     |                |    |       |       |       |                |        |   |                |                |                |       |       |       |  |                |        |  |            |     |                |       |       |       |  |  |  |  |  |  |          |    |       |       |  |  |  |  |  |  |
| 1.6 Turbo  | 96   | 03.90        | 10.92 | + SCS |                |        |   |                |  |                |                |     |       |       |       |                |                |        |  |                |     |       |       |       |       |  |                |        |  |               |       |              |       |       |       |  |                |         |  |                |       |       |  |       |       |  |                |        |  |                |       |     |  |       |       |           |                |        |  |                |     |           |    |       |          |    |                |        |  |                |     |          |    |          |       |       |                |        |  |                |     |          |         |       |       |       |                |        |  |               |     |                |    |       |       |       |                |        |   |                |                |                |       |       |       |  |                |        |  |            |     |                |       |       |       |  |  |  |  |  |  |          |    |       |       |  |  |  |  |  |  |
| 1.6 XR2i   |  | 03.89        | 11.96 | + SCS |                |        |   |                |  |                |                |     |       |       |       |                |                |        |  |                |     |       |       |       |       |  |                |        |  |               |       |              |       |       |       |  |                |         |  |                |       |       |  |       |       |  |                |        |  |                |       |     |  |       |       |           |                |        |  |                |     |           |    |       |          |    |                |        |  |                |     |          |    |          |       |       |                |        |  |                |     |          |         |       |       |       |                |        |  |               |     |                |    |       |       |       |                |        |   |                |                |                |       |       |       |  |                |        |  |            |     |                |       |       |       |  |  |  |  |  |  |          |    |       |       |  |  |  |  |  |  |

1) - ventilated discs / - dischi ventilati / - disques ventilés / - disco ventilado  
2) + ventilated discs / + dischi ventilati / + disques ventilés / + disco ventilado

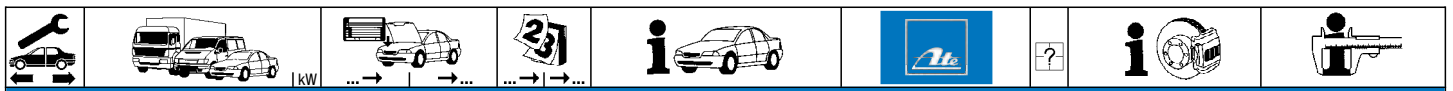

**FORD FIESTA III (89-96)**



















|                |                |       |       |       |                |                |        |   |          |                |                |        |   |        |        |
|----------------|----------------|-------|-------|-------|----------------|----------------|--------|---|----------|----------------|----------------|--------|---|--------|--------|
|                | 1.6i 16V       | 65    | 01.94 | 11.96 | + SCS          | 24.3222-1111.3 | 020266 |   |          | Rz 22,20       |                |        |   |        |        |
|                | 1.8 16V        | 77    | 02.92 | 11.96 | + SCS          |                |        |   |          |                |                |        |   |        |        |
|                | 1.8 D          | 44    | 05.89 | 11.96 | + SCS          |                |        |   |          |                |                |        |   |        |        |
|                | 1.8 D Kastenw. |       | 09.91 | 01.94 |                |                |        |   |          |                |                |        |   |        |        |
|                | 1.8 XR2i       | 96    | 02.92 | 12.95 | + SCS          |                |        |   |          |                |                |        |   |        |        |
| 1.3 Kastenw.   |                | 02.94 | 11.96 |       | 24.3222-1117.3 | 020272         |        |   | Rz 22,20 |                |                |        |   |        |        |
| 1.8 D Kastenw. |                | 02.94 | 11.96 |       |                |                |        |   |          |                |                |        |   |        |        |
|                | 1.0            | 33    | 03.89 | 12.95 |                | 24.3727-0628.2 | 580628 | 1 | ↕        | L=151          |                |        |   |        |        |
|                | 1.1            |       | 05.89 | 11.96 |                |                |        |   |          |                |                |        |   |        |        |
|                | 1.3            | 44    | 03.89 | 11.96 |                |                |        |   |          |                |                |        |   |        |        |
|                | 1.4            |       | 03.89 | 11.96 |                |                |        |   |          |                |                |        |   |        |        |
|                | 1.6            |       | 01.89 | 11.96 |                |                |        |   |          |                |                |        |   |        |        |
|                | 1.6 Turbo      | 96    | 03.90 | 10.92 |                |                |        |   |          |                |                |        |   |        |        |
|                | 1.6 XR2i       |       | 03.89 | 11.96 |                |                |        |   |          |                |                |        |   |        |        |
|                | 1.6i 16V       | 65    | 01.94 | 11.96 |                |                |        |   |          |                |                |        |   |        |        |
|                | 1.8 16V        | 77    | 02.92 | 11.96 |                |                |        |   |          |                |                |        |   |        |        |
|                | 1.8 D          | 44    | 05.89 | 11.96 |                |                |        |   |          |                |                |        |   |        |        |
|                | 1.8 XR2i       | 96    | 02.92 | 12.95 |                |                |        |   |          |                |                |        |   |        |        |
|                | 1.0            | 33    | 03.89 | 07.91 |                |                |        |   |          |                | 24.3727-0623.2 | 580623 | 1 | ↕      | L=3268 |
|                | 1.1            |       | 05.89 | 07.91 |                |                |        |   |          |                |                |        |   |        |        |
|                | 1.3            | 44    | 03.89 | 07.91 |                |                |        |   |          |                |                |        |   |        |        |
|                | 1.4            |       | 03.89 | 07.91 |                |                |        |   |          |                |                |        |   |        |        |
| 1.6            |                | 01.89 | 07.91 |       |                |                |        |   |          |                |                |        |   |        |        |
| 1.6 Turbo      | 96             | 03.90 | 07.91 |       |                |                |        |   |          |                |                |        |   |        |        |
| 1.6 XR2i       |                | 03.89 | 07.91 |       |                |                |        |   |          |                |                |        |   |        |        |
| 1.8 D          | 44             | 05.89 | 07.91 |       |                |                |        |   |          |                |                |        |   |        |        |
| 1.0            | 33             | 08.91 | 01.94 |       | 24.3727-0626.2 | 580626         | 1      | ↕ | L=3242   |                |                |        |   |        |        |
| 1.1            |                | 08.91 | 01.94 |       |                |                |        |   |          |                |                |        |   |        |        |
| 1.3            | 44             | 08.91 | 01.94 |       |                |                |        |   |          |                |                |        |   |        |        |
| 1.4            |                | 08.91 | 01.94 |       |                |                |        |   |          |                |                |        |   |        |        |
| 1.6            |                | 08.91 | 01.94 |       |                |                |        |   |          |                |                |        |   |        |        |
| 1.6 Turbo      | 96             | 08.91 | 10.92 |       |                |                |        |   |          |                |                |        |   |        |        |
| 1.6 XR2i       |                | 08.91 | 01.94 |       |                |                |        |   |          |                |                |        |   |        |        |
| 1.8 16V        | 77             | 02.92 | 01.94 |       |                |                |        |   |          |                |                |        |   |        |        |
| 1.8 D          | 44             | 08.91 | 01.94 |       |                |                |        |   |          |                |                |        |   |        |        |
| 1.8 XR2i       | 96             | 02.92 | 01.94 |       |                |                |        |   |          |                |                |        |   |        |        |
| 1.0            | 33             | 02.94 | 12.95 |       |                |                |        |   |          | 24.3727-0662.2 | 580662         | 1      | ↕ | L=3255 |        |
| 1.1            |                | 02.94 | 11.96 |       |                |                |        |   |          |                |                |        |   |        |        |
| 1.3            | 44             | 02.94 | 11.96 |       |                |                |        |   |          |                |                |        |   |        |        |
| 1.4            |                | 02.94 | 11.96 |       |                |                |        |   |          |                |                |        |   |        |        |
| 1.6            |                | 02.94 | 11.96 |       |                |                |        |   |          |                |                |        |   |        |        |
| 1.6 XR2i       |                | 02.94 | 11.96 |       |                |                |        |   |          |                |                |        |   |        |        |
| 1.6i 16V       | 65             | 01.94 | 11.96 |       |                |                |        |   |          |                |                |        |   |        |        |
| 1.8 16V        | 77             | 02.94 | 11.96 |       |                |                |        |   |          |                |                |        |   |        |        |
| 1.8 D          | 44             | 02.94 | 11.96 |       |                |                |        |   |          |                |                |        |   |        |        |
| 1.8 XR2i       | 96             | 02.94 | 12.95 |       |                |                |        |   |          |                |                |        |   |        |        |
| 1.3 Kastenw.   |                | 09.91 | 11.96 |       | 24.3727-0633.2 | 580633         | 1      | ↕ | L=3930   |                |                |        |   |        |        |
| 1.8 D Kastenw. |                | 09.91 | 11.96 |       |                |                |        |   |          |                |                |        |   |        |        |
|                | 1.0            | ↕ 33  | 03.89 | 12.93 |                | 24.3728-0601.2 | 590601 |   |          |                |                |        |   |        | L=673  |
|                | 1.1            | ↕     | 05.89 | 12.93 |                |                |        |   |          |                |                |        |   |        |        |
|                | 1.3            | ↕ 44  | 03.89 | 12.93 |                |                |        |   |          |                |                |        |   |        |        |
|                | 1.3 Kastenw.   | ↕     | 09.91 | 12.93 |                |                |        |   |          |                |                |        |   |        |        |
|                | 1.4            | ↕     | 03.89 | 12.93 |                |                |        |   |          |                |                |        |   |        |        |
|                | 1.6            | ↕     | 01.89 | 12.93 |                |                |        |   |          |                |                |        |   |        |        |
|                | 1.6 Turbo      | ↕ 96  | 03.90 | 10.92 |                |                |        |   |          |                |                |        |   |        |        |
|                | 1.6 XR2i       | ↕     | 03.89 | 12.93 |                |                |        |   |          |                |                |        |   |        |        |
|                | 1.8 16V        | ↕ 77  | 02.92 | 12.93 |                |                |        |   |          |                |                |        |   |        |        |
|                | 1.8 D          | ↕ 44  | 05.89 | 12.93 |                |                |        |   |          |                |                |        |   |        |        |
|                | 1.8 D Kastenw. | ↕     | 09.91 | 12.93 |                |                |        |   |          |                |                |        |   |        |        |
|                | 1.8 XR2i       | ↕ 96  | 02.92 | 12.93 |                |                |        |   |          |                |                |        |   |        |        |

**FORD FIESTA IV (96-02)**

|                |                |       |       |       |  |                |        |  |           |           |                |        |  |  |           |                |        |  |  |           |
|----------------|----------------|-------|-------|-------|--|----------------|--------|--|-----------|-----------|----------------|--------|--|--|-----------|----------------|--------|--|--|-----------|
|                | 1.25 i 16V     | ↕     | 02.00 | 03.02 | - ABS                                    | 03.7750-2332.4 | 300113 |  |           | 9"        | ATE            |        |  |  |           |                |        |  |  |           |
|                | 1.3 i          | ↕     | 02.00 | 03.02 | - ABS                                    |                |        |  |           |           |                |        |  |  |           |                |        |  |  |           |
|                | 1.4 i 16V      | ↕     | 02.00 | 03.02 | - ABS                                    |                |        |  |           |           |                |        |  |  |           |                |        |  |  |           |
|                | 1.6            | ↕ 65  | 02.00 | 03.02 | - ABS                                    |                |        |  |           |           |                |        |  |  |           |                |        |  |  |           |
|                | 1.6 i 16V      | ↕     | 02.00 | 03.02 | - ABS                                    |                |        |  |           |           |                |        |  |  |           |                |        |  |  |           |
|                | 1.8 D          | ↕     | 02.00 | 03.02 | - ABS                                    |                |        |  |           |           |                |        |  |  |           |                |        |  |  |           |
| 1.8 DI         | ↕              | 03.00 | 03.02 | - ABS |  |                |        |  |           |           |                |        |  |  |           |                |        |  |  |           |
|                | 1.25 i 16V     |       | 01.96 | 01.00 | - ABS/ + Schaltgetriebe <sup>1)</sup>    | 24.2122-1730.3 | 010651 |  |           | THz 22,20 |                |        |  |  |           |                |        |  |  |           |
|                | 1.3 i Lim.     |       | 01.96 | 03.02 | - ABS                                    |                |        |  |           |           |                |        |  |  |           |                |        |  |  |           |
|                | 1.8 D Lim.     |       | 01.96 | 03.02 | - ABS                                    |                |        |  |           |           |                |        |  |  |           |                |        |  |  |           |
|                | 1.8 DI         |       | 03.00 | 03.02 | - ABS                                    |                |        |  |           |           |                |        |  |  |           |                |        |  |  |           |
|                | 1.25 i 16V     |       | 01.96 | 01.00 | - ABS/ + Automatikgetriebe <sup>2)</sup> |                |        |  |           |           | 24.2123-1735.3 | 010652 |  |  | THz 23,81 |                |        |  |  |           |
|                | 1.4 i 16V      |       | 02.96 | 03.02 | - ABS                                    |                |        |  |           |           |                |        |  |  |           |                |        |  |  |           |
|                | 1.6            | ↕ 65  | 02.00 | 03.02 | - ABS                                    |                |        |  |           |           |                |        |  |  |           |                |        |  |  |           |
|                | 1.6 i 16V      |       | 10.99 | 03.02 | - ABS                                    |                |        |  |           |           |                |        |  |  |           |                |        |  |  |           |
|                | 1.3 i Kastenw. |       | 01.96 | 01.00 | - ABS                                    |                |        |  |           |           |                |        |  |  |           | 24.2123-1737.3 | 010654 |  |  | THz 23,81 |
|                | 1.8 D Kastenw. |       | 01.96 | 01.00 | - ABS                                    |                |        |  |           |           |                |        |  |  |           |                |        |  |  |           |
|                | 1.25 i 16V     |       | 02.00 | 03.02 | - ABS                                    |                |        |  |           |           |                |        |  |  |           | 03.2122-1588.3 | 010733 |  |  | THz 22,20 |
|                | 1.3 i Kastenw. |       | 02.00 | 03.02 | - ABS                                    |                |        |  |           |           |                |        |  |  |           |                |        |  |  |           |
| 1.8 D Kastenw. |                | 02.00 | 03.02 | - ABS |  |                |        |  |           |           |                |        |  |  |           |                |        |  |  |           |
| 1.25 i 16V     |                | 01.96 | 01.00 | + ABS | 24.2122-1720.3                           | 010531         |        |  | THz 22,20 |           |                |        |  |  |           |                |        |  |  |           |
| 1.3 i Lim.     |                | 01.96 | 01.00 | + ABS |  |                |        |  |           |           |                |        |  |  |           |                |        |  |  |           |
| 1.4 i 16V      |                | 02.96 | 01.00 | + ABS |  |                |        |  |           |           |                |        |  |  |           |                |        |  |  |           |

<sup>1)</sup> - ABS/ + manual transmission / - ABS/ + scatola camb.velocità / - ABS/ + transmission mécanique / - ABS/ + cambio de velocidad

<sup>2)</sup> - ABS/ + autom.transmission / - ABS/ + scatola cambio autom. / - ABS/ + transmission automatique / - ABS/ + cambio automático

|     |        |  |  |  |  |    |  |   |
|--|--|--|--|--|---|--|--|---|
| <b>FORD FIESTA IV (96-02)</b>  |  |  |  |  |   |  |  |   |
|    | 1.6 i 16V<br>1.8 D Lim.  |  | 10.99<br>01.96   | 01.00<br>01.00   | + ABS<br>+ ABS  | 24.2122-1720.3   | 010531   | THz 22,20   |
|  | 1.25 i 16V<br>1.3 i Lim.<br>1.4 i 16V<br>1.6<br>1.6 i 16V<br>1.8 D Lim.<br>1.8 DI      | 65   | 02.00<br>02.00<br>02.00<br>02.00<br>02.00<br>02.00<br>03.00                      | 03.02<br>03.02<br>03.02<br>03.02<br>03.02<br>03.02<br>03.02                      | + ABS<br>+ ABS<br>+ ABS<br>+ ABS<br>+ ABS<br>+ ABS<br>+ ABS                       | 03.2123-2243.3   | 010748   | THz 23,81<br><b>ATE</b>   |
|  | 1.3 i Kastenw.<br>1.8 D Kastenw.   |  | 01.96<br>01.96   | 01.00<br>01.00   | + ABS<br>+ ABS  | 24.2123-1736.3   | 010653   | THz 23,81   |
|  | 1.3 i Kastenw.<br>1.8 D Kastenw.   |  | 02.00<br>02.00   | 03.02<br>03.02   | + ABS<br>+ ABS  | 03.2122-1564.3   | 010594   | THz 22,20<br><b>ATE</b>   |
|    | 1.25 i 16V<br>1.3 i Lim.<br>1.8 D Lim.   |  | 01.96<br>01.96<br>01.96  | 01.00<br>01.00<br>01.00  | + Schaltgetriebe <sup>1)</sup>  | 11.3481-8513.2<br>11.3481-8514.2<br>11.0441-4805.2<br>11.0230-0165.2<br>11.0101-5407.2<br>11.8171-0008.1<br>11.8116-0264.1                   | 220335<br>220336<br>250020<br>260073<br>260011<br>990049<br>390594                 | D=48, - Halter<br>D=48, - Halter<br>Dichtungssatz<br>Haltersatz<br>Hülsensatz<br>Führungsbolzen<br>Haltefeder<br><b>ATE</b><br><b>ATE</b><br><b>ATE</b><br><b>ATE</b><br><b>ATE</b><br><b>ATE</b><br><b>ATE</b>                       |
|  | 1.25 i 16V<br>1.3 i Kastenw.<br>1.4 i 16V<br>1.6 i 16V<br>1.8 D Kastenw.               |  | 01.96<br>01.96<br>02.96<br>10.99<br>01.96  | 01.00<br>01.00<br>01.00<br>01.00<br>01.00  | + Automatikgetriebe <sup>2)</sup>   | 11.3541-8529.2<br>11.3541-8530.2<br>24.3541-8529.5<br>24.3541-8530.5<br>11.0441-5402.2<br>11.0101-5407.2<br>11.8171-0008.1<br>11.8116-0264.1 | 220341<br>220342<br>240553<br>240554<br>250028<br>260011<br>990049<br>390594       | D=54, - Halter<br>D=54, - Halter<br>D=54, - Halter<br>D=54, - Halter<br>Dichtungssatz<br>Hülsensatz<br>Führungsbolzen<br>Haltefeder<br><b>ATE</b><br><b>ATE</b><br><b>ATE</b><br><b>ATE</b><br><b>ATE</b><br><b>ATE</b><br><b>ATE</b> |
|  | 1.25 i 16V<br>1.3 i<br>1.4 i 16V<br>1.6<br>1.6 i 16V<br>1.8 D<br>1.8 DI                | 65   | 02.00<br>02.00<br>02.00<br>02.00<br>02.00<br>02.00<br>03.00                      | 03.02<br>03.02<br>03.02<br>03.02<br>03.02<br>03.02<br>03.02                      | - ABS<br>- ABS<br>- ABS<br>- ABS<br>- ABS<br>- ABS<br>- ABS                       | 11.3481-8515.2<br>11.3481-8516.2<br>24.3481-8515.5<br>24.3481-8516.5<br>11.0101-5407.2<br>11.8171-0008.1<br>11.8116-0264.1                   | 220365<br>220366<br>240477<br>240478<br>260011<br>990049<br>390594                 | D=48, - Halter<br>D=48, - Halter<br>D=48, - Halter<br>D=48, - Halter<br>Hülsensatz<br>Führungsbolzen<br>Haltefeder<br><b>ATE</b><br><b>ATE</b><br><b>ATE</b><br><b>ATE</b><br><b>ATE</b><br><b>ATE</b>                                |
|  | 1.25 i 16V<br>1.3 i<br>1.4 i 16V<br>1.6<br>1.6 i 16V<br>1.8 D<br>1.8 DI                | 65   | 02.00<br>02.00<br>02.00<br>02.00<br>02.00<br>02.00<br>03.00                      | 03.02<br>03.02<br>03.02<br>03.02<br>03.02<br>03.02<br>03.02                      | + ABS<br>+ ABS<br>+ ABS<br>+ ABS<br>+ ABS<br>+ ABS<br>+ ABS                       | 11.3541-8531.2<br>11.3541-8532.2<br>11.0101-5407.2<br>11.8171-0008.1<br>11.8116-0264.1   | 220367<br>220368<br>260011<br>990049<br>390594                                     | D=54, - Halter<br>D=54, - Halter<br>Hülsensatz<br>Führungsbolzen<br>Haltefeder<br><b>ATE</b><br><b>ATE</b><br><b>ATE</b><br><b>ATE</b><br><b>ATE</b>  |
|  | 1.25 i 16V<br>1.3 i Lim.<br>1.4 i 16V<br>1.6 i 16V<br>1.8 D Lim.                       |  | 01.96<br>01.96<br>02.96<br>10.99<br>01.96  | 02.00<br>02.00<br>02.00<br>02.00<br>02.00  |   | 24.5305-0295.3   | 330657   | 2<br>L=297  |
|  | 1.3 i Kastenw.<br>1.8 D Kastenw.   |  | 01.96<br>01.96   | 03.02<br>03.02   |   | 24.5304-0280.3   | 330589   | 2<br>L=280  |
|  | 1.25 i 16V<br>1.3 i Lim.<br>1.8 D Lim.   |  | 01.96<br>01.96<br>01.96  | 01.00<br>01.00<br>01.00  | + Schaltgetriebe <sup>1)</sup>  | 24.3217-1715.3   | 020463   | nur paarweise austauschen <sup>3)</sup><br>Rz 17,78<br><b>LUC</b>   |
|  | 1.25 i 16V<br>1.3 i Lim.<br>1.8 D Lim.<br>1.8 DI Lim.                                  |  | 02.00<br>02.00<br>02.00<br>03.00   | 03.02<br>03.02<br>03.02<br>03.02   | + Schaltgetriebe <sup>1)</sup>  | 24.3219-1735.3   | 020464   | Rz 19,05  |
|  | 1.25 i 16V<br>1.4 i 16V<br>1.6<br>1.6 i 16V  | 65   | 01.96<br>02.96<br>02.00<br>10.99   | 03.02<br>03.02<br>03.02<br>03.02   | + Automatikgetriebe <sup>2)</sup>   | 24.3219-1107.3   | 020338   | nur paarweise austauschen <sup>3)</sup><br>Rz 19,05<br><b>LUC</b>   |
|  | 1.3 i Kastenw.<br>1.8 D Kastenw.<br>1.8 DI Kastenw.                                    |  | 01.96<br>01.96<br>03.00  | 03.02<br>03.02<br>03.02  |   | 24.3222-1117.3   | 020272   | Rz 22,20  |
|  | 1.25 i 16V<br>1.3 i Lim.<br>1.4 i 16V<br>1.6<br>1.6 i 16V<br>1.8 D Lim.<br>1.8 DI Lim. | 65   | 01.96<br>01.96<br>02.96<br>02.00<br>10.99<br>01.96<br>03.00                      | 03.02<br>03.02<br>03.02<br>03.02<br>03.02<br>03.02<br>03.02                      |   | 24.3727-1800.2<br>24.3727-0660.2   | 581800<br>580660   | 1 <br>1 <br>L=312<br>L=1575/1627                                |
|  | 1.3 i Kastenw.<br>1.8 D Kastenw.<br>1.8 DI Kastenw.                                    |  | 01.96<br>01.96<br>03.00  | 03.02<br>03.02<br>03.02  |   | 24.3727-0634.2   | 580634   | 1 <br>L=1875/1930  |
|  | 1.25 i 16V<br>1.3 i<br>1.4 i 16V<br>1.8 D  |  | 01.96<br>01.96<br>02.96<br>01.96   | 08.98<br>08.98<br>08.98<br>08.98   |   | 24.2419-1734.3   | 030126   | Gz 19,05  |
|  | 1.25 i 16V<br>1.3 i<br>1.4 i 16V<br>1.6<br>1.6 i 16V<br>1.8 D<br>1.8 DI                | 65   | 09.98<br>09.98<br>09.98<br>02.00<br>10.99<br>09.98<br>03.00                      | 03.02<br>03.02<br>03.02<br>03.02<br>03.02<br>03.02<br>03.02                      |   | 24.2419-1736.3   | 030128   | Gz 19,05  |

<sup>1)</sup> + manual transmission / + scatola cambio velocità / + transmission mécanique / + cambio de velocidad

<sup>2)</sup> + autom.transmission / + scatola cambio automatico / + transmission automatique / + cambio automático

<sup>3)</sup> to change only by pairs / sostituire solo a coppie / à changer seulement par paires / cambiar solamente por parejas



| FORD FIESTA V (02-08) |                 |     |       |       |                |        |  |                      |             |                |        |                |            |     |
|-----------------------|-----------------|-----|-------|-------|----------------|--------|--|----------------------|-------------|----------------|--------|----------------|------------|-----|
|                       | 1.25 i 16V      | 51  | 03.03 | 08.08 | 03.7750-8732.4 | 300199 | - Bremsassistent 1)<br>+ Bremsassistent 2) | 9"                   | 9"          | ATE            |        |                |            |     |
|                       | 1.25 i 16V      | 55  | 05.02 | 08.08 |                |        |  |                      |             | 300201         | ATE    |                |            |     |
|                       | 1.3 i           | 44  | 04.02 | 08.08 |                |        |  |                      |             |                |        |                |            |     |
|                       | 1.3 i           | 51  | 04.02 | 08.08 |                |        |  |                      |             |                |        |                |            |     |
|                       | 1.4 i 16V       | 59  | 04.02 | 08.08 |                |        |  |                      |             |                |        |                |            |     |
|                       | 1.4 TDCi        | 50  | 04.02 | 08.08 |                |        |  |                      |             |                |        |                |            |     |
|                       | 1.6 i 16V       | 74  | 04.02 | 08.08 |                |        |  |                      |             |                |        |                |            |     |
|                       | 1.6 TDCi        | 66  | 10.04 | 08.08 |                |        |  |                      |             |                |        |                |            |     |
|                       | 1.25 i 16V      | 51  | 03.03 | 08.08 | 03.4153-0015.4 | 010784 | - ABS<br>+ ABS<br>+ ESP                    | THz 23,81 + Behälter | ATE         |                |        |                |            |     |
|                       | 1.25 i 16V      | 55  | 05.02 | 08.08 |                |        |  |                      |             | 010786         | ATE    |                |            |     |
|                       | 1.3 i           | 44  | 04.02 | 08.08 |                |        |  |                      |             | 010785         | ATE    |                |            |     |
|                       | 1.3 i           | 51  | 04.02 | 08.08 |                |        |  |                      |             |                |        |                |            |     |
|                       | 1.4 i 16V       | 59  | 04.02 | 08.08 |                |        |  |                      |             |                |        |                |            |     |
|                       | 1.4 TDCi        | 50  | 04.02 | 08.08 |                |        |  |                      |             |                |        |                |            |     |
|                       | 1.6 i 16V       | 74  | 04.02 | 08.08 |                |        |  |                      |             |                |        |                |            |     |
|                       | 1.6 TDCi        | 66  | 10.04 | 08.08 |                |        |  |                      |             |                |        |                |            |     |
|                       | 1.25 i 16V      | 51  | 03.03 | 08.08 | 11.3541-8531.2 | 220367 | ☐<br>☐                                     | D=54, - Halter       | ATE         |                |        |                |            |     |
|                       | 1.25 i 16V      | 55  | 05.02 | 08.08 |                |        |  |                      |             | 220368         | ATE    |                |            |     |
|                       | 1.3 i           | 44  | 04.02 | 08.08 |                |        |  |                      |             | 11.0101-5407.2 | 260011 | Hülzensatz     | ATE        |     |
|                       | 1.3 i           | 51  | 04.02 | 08.08 |                |        |  |                      |             | 11.8171-0008.1 | 990049 | Führungsbolzen | ATE        |     |
|                       | 1.4 i 16V       | 59  | 04.02 | 08.08 |                |        |  |                      |             | 11.8116-0264.1 | 390594 | Haltefeder     | ATE        |     |
|                       | 1.4 TDCi        | 50  | 04.02 | 08.08 |                |        |  |                      |             |                |        |                |            |     |
|                       | 1.6 i 16V       | 74  | 04.02 | 08.08 |                |        |  |                      |             |                |        |                |            |     |
|                       | 1.6 TDCi        | 66  | 10.04 | 08.08 |                |        |  |                      |             |                |        |                |            |     |
|                       | ST 150          | 110 | 11.04 | 04.08 |                |        |  |                      |             | 11.8116-0301.1 | 390610 | 2              | Haltefeder | ATE |
|                       | ST 150          | 110 | 05.08 | 08.08 |                |        |  |                      |             | 11.8116-0301.1 | 390610 | 2              | Haltefeder | ATE |
|                       | 1.25 i 16V      | 51  | 03.03 | 08.08 | 24.5141-0473.3 | 331303 | 2  | L=473                |             |                |        |                |            |     |
|                       | 1.25 i 16V      | 55  | 05.02 | 08.08 |                |        |  |                      |             |                |        |                |            |     |
|                       | 1.3 i           | 44  | 04.02 | 08.08 |                |        |  |                      |             |                |        |                |            |     |
|                       | 1.3 i           | 51  | 04.02 | 08.08 |                |        |  |                      |             |                |        |                |            |     |
|                       | 1.4 i 16V       | 59  | 04.02 | 08.08 |                |        |  |                      |             |                |        |                |            |     |
|                       | 1.4 TDCi        | 50  | 04.02 | 08.08 |                |        |  |                      |             |                |        |                |            |     |
|                       | 1.6 i 16V       | 74  | 04.02 | 08.08 |                |        |  |                      |             |                |        |                |            |     |
|                       | 1.6 TDCi        | 66  | 10.04 | 08.08 |                |        |  |                      |             |                |        |                |            |     |
|                       | 1.25 i 16V      | 51  | 03.03 | 08.08 | 83.7827-0300.3 | 330902 | 2  | L=300                |             |                |        |                |            |     |
|                       | 1.25 i 16V      | 55  | 05.02 | 08.08 |                |        |  |                      |             |                |        |                |            |     |
|                       | 1.3 i           | 44  | 04.02 | 08.08 |                |        |  |                      |             |                |        |                |            |     |
|                       | 1.3 i           | 51  | 04.02 | 08.08 |                |        |  |                      |             |                |        |                |            |     |
|                       | 1.4 i 16V       | 59  | 04.02 | 08.08 |                |        |  |                      |             |                |        |                |            |     |
|                       | 1.4 TDCi        | 50  | 04.02 | 08.08 |                |        |  |                      |             |                |        |                |            |     |
|                       | 1.6 i 16V       | 74  | 04.02 | 08.08 |                |        |  |                      |             |                |        |                |            |     |
|                       | 1.6 TDCi        | 66  | 10.04 | 08.08 |                |        |  |                      |             |                |        |                |            |     |
|                       | 1.25 i 16V      | 51  | 03.03 | 08.08 | 24.3219-1735.3 | 020464 |  | Rz 19,05             |             |                |        |                |            |     |
|                       | 1.25 i 16V      | 55  | 05.02 | 08.08 |                |        |  |                      |             |                |        |                |            |     |
|                       | 1.3 i           | 44  | 04.02 | 08.08 |                |        |  |                      |             |                |        |                |            |     |
|                       | 1.3 i           | 51  | 04.02 | 08.08 |                |        |  |                      |             |                |        |                |            |     |
|                       | 1.4 i 16V       | 59  | 04.02 | 08.08 |                |        |  |                      |             |                |        |                |            |     |
|                       | 1.4 TDCi        | 50  | 04.02 | 08.08 |                |        |  |                      |             |                |        |                |            |     |
|                       | 1.6 i 16V       | 74  | 04.02 | 08.08 |                |        |  |                      |             |                |        |                |            |     |
|                       | 1.6 TDCi        | 66  | 10.04 | 08.08 |                |        |  |                      |             |                |        |                |            |     |
|                       | 1.25 i 16V      | 51  | 03.03 | 08.08 | 24.3727-0658.2 | 580658 | 1 ↑<br>1 ↓                                 | L=300                | L=1305/1445 |                |        |                |            |     |
|                       | 1.25 i 16V      | 55  | 05.02 | 08.08 |                |        |  |                      |             | 580653         |        |                |            |     |
|                       | 1.3 i           | 44  | 04.02 | 08.08 |                |        |  |                      |             |                |        |                |            |     |
|                       | 1.3 i           | 51  | 04.02 | 08.08 |                |        |  |                      |             |                |        |                |            |     |
|                       | 1.4 i 16V       | 59  | 04.02 | 08.08 |                |        |  |                      |             |                |        |                |            |     |
|                       | 1.4 TDCi        | 50  | 04.02 | 08.08 |                |        |  |                      |             |                |        |                |            |     |
|                       | 1.6 i 16V       | 74  | 04.02 | 08.08 |                |        |  |                      |             |                |        |                |            |     |
|                       | 1.6 TDCi        | 66  | 10.04 | 08.08 |                |        |  |                      |             |                |        |                |            |     |
|                       | 1.4 i 16V       | 59  | 04.02 | 08.08 | 24.2419-1735.3 | 030127 |  | Gz 19,05             |             |                |        |                |            |     |
|                       | 1.4 TDCi        | 50  | 04.02 | 08.08 |                |        |  |                      |             |                |        |                |            |     |
|                       | 1.6 i 16V       | 74  | 04.02 | 08.08 |                |        |  |                      |             |                |        |                |            |     |
|                       | 1.6 TDCi        | 66  | 10.04 | 08.08 |                |        |  |                      |             |                |        |                |            |     |
| FORD FIESTA VI (08-)  |                 |     |       |       |                |        |  |                      |             |                |        |                |            |     |
|                       | 1.25 i 16V      | 44  | 09.08 |       | 83.7838-0371.3 | 331123 | ☐<br>☐                                     | L=366                |             |                |        |                |            |     |
|                       | 1.25 i 16V      | 60  | 09.08 |       |                |        |  |                      |             | 83.7838-0370.3 | 331122 | L=366          |            |     |
|                       | 1.4 Duratec LPG |     | 06.09 |       |                |        |  |                      |             |                |        |                |            |     |
|                       | 1.4 i 16V       | 71  | 09.08 |       |                |        |  |                      |             |                |        |                |            |     |
|                       | 1.4 TDCi        | 50  | 01.09 |       |                |        |  |                      |             |                |        |                |            |     |
|                       | 1.4 TDCi        | 51  | 07.10 |       |                |        |  |                      |             |                |        |                |            |     |
|                       | 1.6 TDCi        | 55  | 09.08 |       |                |        |  |                      |             |                |        |                |            |     |
|                       | 1.6 TDCi        | 66  | 09.08 |       |                |        |  |                      |             |                |        |                |            |     |
|                       | 1.6 TDCi        | 70  | 02.10 |       |                |        |  |                      |             |                |        |                |            |     |
|                       | 1.6 Ti-VCT      | 88  | 09.08 |       |                |        |  |                      |             |                |        |                |            |     |
|                       | 1.6 Ti-VCT      | 99  | 12.10 |       |                |        |  |                      |             |                |        |                |            |     |
|                       | 1.0             | 48  | 10.12 |       | 24.3219-1760.3 | 020529 |  | Rz 19,05             |             |                |        |                |            |     |
|                       | 1.0             | 59  | 10.12 |       |                |        |  |                      |             |                |        |                |            |     |
|                       | 1.0 EcoBoost    | 74  | 10.12 |       |                |        |  |                      |             |                |        |                |            |     |
|                       | 1.0 EcoBoost    | 92  | 10.12 |       |                |        |  |                      |             |                |        |                |            |     |
|                       | 1.25 i 16V      | 44  | 09.08 |       |                |        |  |                      |             |                |        |                |            |     |
|                       | 1.25 i 16V      | 60  | 09.08 |       |                |        |  |                      |             |                |        |                |            |     |
|                       | 1.4 Duratec LPG |     | 06.09 |       |                |        |  |                      |             |                |        |                |            |     |
|                       | 1.4 i 16V       | 71  | 09.08 |       |                |        |  |                      |             |                |        |                |            |     |
|                       | 1.4 TDCi        | 50  | 01.09 |       |                |        |  |                      |             |                |        |                |            |     |
|                       | 1.4 TDCi        | 51  | 07.10 |       |                |        |  |                      |             |                |        |                |            |     |
|                       | 1.5 TDCi        | 55  | 10.12 |       |                |        |  |                      |             |                |        |                |            |     |

1) - electr. brake actuator / - BAS / - assistance de freinage / - asistente de freno  
2) + electr. brake actuator / + BAS / + assistance de freinage / + asistente de freno

| <b>FORD FIESTA VI (08-)</b> |                    |    |  |       |       |  |  |                |        |   |   |                                   |  |  |  |  |                          |
|-----------------------------|--------------------|----|--|-------|-------|--|--|----------------|--------|---|---|-----------------------------------|--|--|--|--|--------------------------|
|                             | 1.6 TDCi           | 55 |  | 09.08 |       |  |  | 24.3219-1760.3 | 020529 |   |   |                                   |  |  |  |  | Rz 19,05                 |
|                             | 1.6 TDCi           | 66 |  | 09.08 |       |  |  |                |        |   |   |                                   |  |  |  |  |                          |
|                             | 1.6 TDCi           | 70 |  | 02.10 |       |  |  |                |        |   |   |                                   |  |  |  |  |                          |
|                             | 1.6 Ti-VCT         | 77 |  | 10.12 |       |  |  |                |        |   |   |                                   |  |  |  |  |                          |
|                             | 1.6 Ti-VCT         | 88 |  | 09.08 |       |  |  |                |        |   |   |                                   |  |  |  |  |                          |
|                             | 1.6 Ti-VCT         | 99 |  | 12.10 |       |  |  |                |        |   |   |                                   |  |  |  |  |                          |
| <b>FORD FOCUS I (98-04)</b> |                    |    |  |       |       |  |  |                |        |   |   |                                   |  |  |  |  |                          |
|                             | 1.4 i 16V          |    |  | 10.98 | 09.04 |  |  | 24.2123-1750.3 | 010714 |   | - ABS                                   |                                   |  |  |  |  | THz 23,81                |
|                             | 1.6 i 16V          |    |  | 10.98 | 09.04 |  |  | 24.4123-1713.3 | 010905 |   | + ABS                                   |                                   |  |  |  |  | THz 23,81 - Behälter BOS |
|                             | 1.8 i 16V          |    |  | 10.98 | 09.04 |  |  |                |        |   |   |                                   |  |  |  |  |                          |
|                             | 1.8 TDCi           |    |  | 03.01 | 09.04 |  |  |                |        |   |   |                                   |  |  |  |  |                          |
|                             | 1.8 Turbo DI       |    |  | 10.98 | 09.04 |  |  |                |        |   |   |                                   |  |  |  |  |                          |
|                             | 2.0 i 16V          |    |  | 10.98 | 09.04 |  |  |                |        |   |   |                                   |  |  |  |  |                          |
|                             | 1.4 i 16V          |    |  | 06.99 | 10.01 |  |  | 03.4123-0019.3 | 010584 |   | + ESP                                   |                                   |  |  |  |  | THz 23,81 ATE            |
|                             | 1.6 i 16V          |    |  | 06.99 | 10.01 |  |  |                |        |   |   |                                   |  |  |  |  |                          |
|                             | 1.8 i 16V          |    |  | 06.99 | 10.01 |  |  |                |        |   |   |                                   |  |  |  |  |                          |
|                             | 1.8 TDCi           |    |  | 03.01 | 10.01 |  |  |                |        |   |   |                                   |  |  |  |  |                          |
|                             | 1.8 Turbo DI       |    |  | 06.99 | 10.01 |  |  |                |        |   |   |                                   |  |  |  |  |                          |
|                             | 2.0 i 16V          |    |  | 06.99 | 10.01 |  |  |                |        |   |   |                                   |  |  |  |  |                          |
|                             | 1.4 i 16V          |    |  | 11.01 | 09.04 |  |  | 03.4123-0153.3 | 010659 |   | + ESP                                   |                                   |  |  |  |  | THz 23,81 ATE            |
|                             | 1.6 i 16V          |    |  | 11.01 | 09.04 |  |  |                |        |   |   |                                   |  |  |  |  |                          |
|                             | 1.8 i 16V          |    |  | 11.01 | 09.04 |  |  |                |        |   |   |                                   |  |  |  |  |                          |
|                             | 1.8 TDCi           |    |  | 11.01 | 09.04 |  |  |                |        |   |   |                                   |  |  |  |  |                          |
|                             | 1.8 Turbo DI       |    |  | 11.01 | 09.04 |  |  |                |        |   |   |                                   |  |  |  |  |                          |
|                             | 2.0 i 16V          |    |  | 11.01 | 09.04 |  |  |                |        |   |   |                                   |  |  |  |  |                          |
|                             | 1.4 i 16V          |    |  | 10.98 | 09.04 |  |  | 11.3541-8105.2 | 220339 |   |   |                                   |  |  |  |  | D=54, - Halter ATE       |
|                             | 1.6 i 16V          |    |  | 10.98 | 09.04 |  |  | 11.3541-8106.2 | 220340 |   |   |                                   |  |  |  |  | D=54, - Halter ATE       |
|                             | 1.8 i 16V          |    |  | 10.98 | 09.04 |  |  | 24.3541-8105.5 | 240485 |   |   |                                   |  |  |  |  | D=54, - Halter ATE       |
|                             | 1.8 TDCi           |    |  | 03.01 | 09.04 |  |  | 24.3541-8106.5 | 240486 |   |   |                                   |  |  |  |  | D=54, - Halter ATE       |
|                             | 1.8 Turbo DI       |    |  | 10.98 | 09.04 |  |  | 11.0101-5407.2 | 260011 |   |   |                                   |  |  |  |  | Hülzensatz ATE           |
|                             | 2.0 i 16V          |    |  | 10.98 | 09.04 |  |  | 11.8171-0008.1 | 990049 |   |   |                                   |  |  |  |  | Führungsbolzen ATE       |
|                             | 1.4 i 16V          |    |  | 10.98 | 09.04 |  |  | 24.5112-0341.3 | 330655 | 2 |   |                                   |  |  |  |  | L=340                    |
|                             | 1.6 i 16V          |    |  | 10.98 | 09.04 |  |  |                |        |   |   |                                   |  |  |  |  |                          |
|                             | 1.8 i 16V          |    |  | 10.98 | 09.04 |  |  |                |        |   |   |                                   |  |  |  |  |                          |
|                             | 1.8 TDCi           |    |  | 03.01 | 09.04 |  |  |                |        |   |   |                                   |  |  |  |  |                          |
|                             | 1.8 Turbo DI       |    |  | 10.98 | 09.04 |  |  |                |        |   |   |                                   |  |  |  |  |                          |
|                             | 2.0 i 16V          |    |  | 10.98 | 09.04 |  |  |                |        |   |   |                                   |  |  |  |  |                          |
|                             | ST 170             |    |  | 03.02 | 09.04 |  |  |                |        |   |   |                                   |  |  |  |  |                          |
|                             | 1.4 i 16V          |    |  | 10.98 | 09.04 |  |  | 24.3344-1705.5 | 240273 |   |   |                                   |  |  |  |  | D=34, - Halter LUC       |
|                             | 1.6 i 16V          |    |  | 10.98 | 09.04 |  |  | 24.3344-1706.5 | 240274 |   |   |                                   |  |  |  |  | D=34, - Halter LUC       |
|                             | 1.8 i 16V          |    |  | 10.98 | 09.04 |  |  |                |        |   |   |                                   |  |  |  |  |                          |
|                             | 1.8 TDCi           |    |  | 03.01 | 09.04 |  |  |                |        |   |   |                                   |  |  |  |  |                          |
|                             | 1.8 Turbo DI       |    |  | 10.98 | 09.04 |  |  |                |        |   |   |                                   |  |  |  |  |                          |
|                             | 2.0 i 16V          |    |  | 10.98 | 09.04 |  |  |                |        |   |   |                                   |  |  |  |  |                          |
|                             | RS 2.0             |    |  | 10.02 | 09.04 |  |  |                |        |   |   |                                   |  |  |  |  |                          |
|                             | ST 170             |    |  | 03.02 | 09.04 |  |  |                |        |   |   |                                   |  |  |  |  |                          |
|                             | 1.4 i 16V          |    |  | 10.98 | 08.00 |  |  | 24.5228-0196.3 | 330656 | 2 |   |                                   |  |  |  |  | L=195                    |
|                             | 1.6 i 16V          |    |  | 10.98 | 08.00 |  |  |                |        |   |   |                                   |  |  |  |  |                          |
|                             | 1.8 i 16V          |    |  | 10.98 | 08.00 |  |  |                |        |   |   |                                   |  |  |  |  |                          |
|                             | 1.8 Turbo DI       |    |  | 10.98 | 08.00 |  |  |                |        |   |   |                                   |  |  |  |  |                          |
|                             | 2.0 i 16V          |    |  | 10.98 | 08.00 |  |  |                |        |   |   |                                   |  |  |  |  |                          |
|                             | 1.4 i 16V          |    |  | 09.00 | 04.01 |  |  | 24.5124-0410.3 | 330760 | 2 |   |                                   |  |  |  |  | L=410                    |
|                             | 1.6 i 16V          |    |  | 09.00 | 04.01 |  |  |                |        |   |   |                                   |  |  |  |  |                          |
|                             | 1.8 i 16V          |    |  | 09.00 | 04.01 |  |  |                |        |   |   |                                   |  |  |  |  |                          |
|                             | 1.8 Turbo DI       |    |  | 09.00 | 04.01 |  |  |                |        |   |   |                                   |  |  |  |  |                          |
|                             | 2.0 i 16V          |    |  | 09.00 | 04.01 |  |  |                |        |   |   |                                   |  |  |  |  |                          |
|                             | 1.4 i 16V          |    |  | 05.01 | 09.04 |  |  | 24.5124-0411.3 | 330774 | 2 |   |                                   |  |  |  |  | L=410                    |
|                             | 1.6 i 16V          |    |  | 05.01 | 09.04 |  |  |                |        |   |   |                                   |  |  |  |  |                          |
|                             | 1.8 i 16V          |    |  | 05.01 | 09.04 |  |  |                |        |   |   |                                   |  |  |  |  |                          |
|                             | 1.8 TDCi           |    |  | 03.01 | 09.04 |  |  |                |        |   |   |                                   |  |  |  |  |                          |
|                             | 1.8 Turbo DI       |    |  | 05.01 | 09.04 |  |  |                |        |   |   |                                   |  |  |  |  |                          |
|                             | 2.0 i 16V          |    |  | 05.01 | 09.04 |  |  |                |        |   |   |                                   |  |  |  |  |                          |
|                             | RS 2.0             |    |  | 10.02 | 09.04 |  |  |                |        |   |   |                                   |  |  |  |  |                          |
|                             | ST 170             |    |  | 03.02 | 09.04 |  |  |                |        |   |   |                                   |  |  |  |  |                          |
|                             | 1.4 i 16V Lim.     |    |  | 10.98 | 09.04 |  |  | 24.3220-1112.3 | 020223 |   |   |                                   |  |  |  |  | Rz 20,64                 |
|                             | 1.6 i 16V Lim.     |    |  | 10.98 | 09.04 |  |  |                |        |   |   |                                   |  |  |  |  |                          |
|                             | 1.8 i 16V Lim.     |    |  | 10.98 | 09.04 |  |  |                |        |   |   |                                   |  |  |  |  |                          |
|                             | 1.8 Turbo DI Kombi |    |  | 10.98 | 09.04 |  |  |                |        |   |   |                                   |  |  |  |  |                          |
|                             | 1.4 i 16V Kombi    |    |  | 10.98 | 09.04 |  |  | 24.3222-1117.3 | 020272 |   |   |                                   |  |  |  |  | Rz 22,20                 |
|                             | 1.6 i 16V Kombi    |    |  | 10.98 | 09.04 |  |  |                |        |   |   |                                   |  |  |  |  |                          |
|                             | 1.8 i 16V Kombi    |    |  | 10.98 | 09.04 |  |  |                |        |   |   |                                   |  |  |  |  |                          |
|                             | 1.8 Turbo DI Lim.  |    |  | 10.98 | 09.04 |  |  | 24.3219-1107.3 | 020338 |   | nur paarweise austauschen <sup>1)</sup> |                                   |  |  |  |  | Rz 19,05 LUC             |
|                             | 1.4 i 16V          |    |  | 10.98 | 08.01 |  |  | 24.3727-0650.2 | 580650 | 1 |   |                                   |  |  |  |  | L=326                    |
|                             | 1.6 i 16V          |    |  | 10.98 | 08.01 |  |  | 24.3727-0649.2 | 580649 | 1 |   | + HA-Trommelbremse <sup>2)</sup>  |  |  |  |  | L=1483/1483              |
|                             | 1.8 i 16V          |    |  | 10.98 | 08.01 |  |  | 24.3727-0656.2 | 580656 | 1 |   | + HA-Scheibenbremse <sup>3)</sup> |  |  |  |  | L=1770/1770              |
|                             | 1.8 TDCi           |    |  | 03.01 | 08.01 |  |  | 24.3727-0663.2 | 580663 | 2 |   | Verlängerung <sup>4)</sup>        |  |  |  |  | L=175                    |
|                             | 1.8 Turbo DI       |    |  | 10.98 | 08.01 |  |  |                |        |   |   |                                   |  |  |  |  |                          |
|                             | 2.0 i 16V          |    |  | 10.98 | 08.01 |  |  |                |        |   |   |                                   |  |  |  |  |                          |
|                             | 1.4 i 16V          |    |  | 09.01 | 09.04 |  |  | 24.3727-0654.2 | 580654 | 1 |   |                                   |  |  |  |  | L=330                    |
|                             | 1.6 i 16V          |    |  | 09.01 | 09.04 |  |  | 24.3727-0651.2 | 580651 | 1 |   | + HA-Trommelbremse <sup>2)</sup>  |  |  |  |  | L=1483/1483              |
|                             | 1.8 i 16V          |    |  | 09.01 | 09.04 |  |  | 24.3727-0655.2 | 580655 | 1 |   | + HA-Scheibenbremse <sup>3)</sup> |  |  |  |  | L=1770/1770              |
|                             | 1.8 TDCi           |    |  | 09.01 | 09.04 |  |  | 24.3727-0663.2 | 580663 | 2 |   | Verlängerung <sup>4)</sup>        |  |  |  |  | L=175                    |
|                             | 1.8 Turbo DI       |    |  | 09.01 | 09.04 |  |  |                |        |   |   |                                   |  |  |  |  |                          |
|                             | 2.0 i 16V          |    |  | 09.01 | 09.04 |  |  |                |        |   |   |                                   |  |  |  |  |                          |

<sup>1)</sup> to change only by pairs / sostituire solo a coppie / à changer seulement par paires / cambiar solamente por parejas

<sup>2)</sup> + RA drum brake / + P freno a tamburo / + frein à tambour essieu AR / + ET-tambores de freno

<sup>3)</sup> + RA disc brake / + P disco freno / + frein à disque essieu AR / + ET-disco de freno

<sup>4)</sup> extension only / solo prolunga / rallonge seulement / solamente prolongador



| FORD FOCUS I (98-04) |  |  |  |   |   |  |  |   |  |
|----------------------|--|--|--|---|---|--|--|---|--|
|                      | RS 2.0<br>ST 170   |  |  | 10.02<br>03.02  | 09.04<br>09.04  |  | 24.3727-0654.2 580654<br>24.3727-0651.2 580651<br>24.3727-0655.2 580655<br>24.3727-0663.2 580663 | 1 ↑<br>1 ↓ + HA-Trommelbremse 1)<br>1 ↓ + HA-Scheibenbremse 2)<br>2 ↓ Verlängerung 3) | L=330<br>L=1483/1483<br>L=1770/1770<br>L=175 |
|                      | 1.4 i 16V<br>1.6 i 16V<br>1.8 i 16V<br>1.8 TDCi<br>1.8 Turbo DI<br>2.0 i 16V<br>ST 170 |  |  | 10.98<br>10.98<br>10.98<br>03.01<br>10.98<br>10.98<br>03.02 | 09.04<br>09.04<br>09.04<br>09.04<br>09.04<br>09.04<br>09.04 |  | 24.2419-1733.3 030125  |   | Gz 19,05                                     |

















| FORD FOCUS II (05-11) |  |  |  |   |   |  |  |  |             |            |
|-----------------------|--|--|--|---|---|--|--|--|-------------|------------|
|                       | 1.4 i 16V<br>1.6 i 16V<br>1.6 TDCi<br>1.6 TDCi<br>1.6 Ti VCT<br>1.8 i 16V<br>1.8 TDCi<br>2.0 i 16V<br>2.0 TDCi                       | 59<br>74<br><br>66<br>85<br>92<br>85<br>107              |  | 10.04<br>10.04<br>10.04<br>01.05<br>10.04<br>01.06<br>01.05<br>10.04<br>10.04                   | 04.07<br>04.07<br>04.07<br>04.07<br>04.07<br>04.07<br>04.07<br>04.07<br>04.07                   |  | 03.7863-0332.4 300203<br>03.7760-8103.4 300240 | + Bremsassistent 4)<br>- Bremsassistent 5) | 10"<br>10"  | ATE<br>ATE |
|                       | 1.4 i 16V<br>1.6 i 16V<br>1.6 TDCi<br>1.6 TDCi<br>1.6 Ti VCT<br>1.8 i 16V<br>1.8 TDCi<br>2.0 i 16V<br>2.0 TDCi<br>2.0 TDCi           | 59<br>74<br><br>66<br>85<br>92<br>85<br>107<br>81        |  | 05.07<br>05.07<br>05.07<br>05.07<br>05.07<br>05.07<br>05.07<br>05.07<br>05.07<br>02.08          | 02.11<br>02.11<br>02.11<br>02.11<br>02.11<br>02.11<br>02.11<br>02.11<br>02.11<br>02.11          |  | 03.7760-2232.4 300266<br>03.7863-3932.4 300288 | - Bremsassistent 5)<br>+ Bremsassistent 4) | 10"<br>10"  | ATE<br>ATE |
|                       | 1.4 i 16V<br>1.6 i 16V<br>1.6 TDCi<br>1.6 TDCi<br>1.6 Ti VCT<br>1.8 i 16V<br>1.8 TDCi<br>2.0 i 16V<br>2.0 TDCi<br>2.0 TDCi           | 59<br>74<br><br>66<br>85<br>92<br>85<br>107<br>81        |  | 10.04<br>10.04<br>10.04<br>01.05<br>10.04<br>01.06<br>01.05<br>10.04<br>10.04<br>10.04          | 02.11<br>02.11<br>02.11<br>02.11<br>02.11<br>02.11<br>02.11<br>02.11<br>02.11<br>02.11          |  | 03.7760-2332.4 300267                          | - ABS                                      | 10"         | ATE        |
|                       | 2.5 RS<br>2.5 RS 500   | 224<br>257   |  | 01.09<br>05.10  | 02.11<br>02.11  |  | 03.7755-7703.4 300247                          |  | 9/8" Tandem | ATE        |
|                       | 1.4 i 16V<br>1.6 i 16V<br>1.6 TDCi<br>1.6 TDCi<br>1.6 Ti VCT<br>1.8 i 16V<br>1.8 TDCi<br>2.0 i 16V<br>2.0 TDCi<br>2.0 TDCi<br>2.5 ST | 59<br>74<br><br>66<br>85<br>92<br>85<br>107<br>81<br>166 |  | 10.04<br>10.04<br>10.04<br>01.05<br>10.04<br>01.06<br>01.05<br>10.04<br>10.04<br>10.04<br>10.05 | 02.11<br>02.11<br>02.11<br>02.11<br>02.11<br>02.11<br>02.11<br>02.11<br>02.11<br>02.11<br>02.11 |  | 03.2123-3041.3 010887                          | - ABS                                      | Thz 23,81   | ATE        |
|                       | 1.4 i 16V<br>1.6 i 16V<br>1.6 TDCi<br>1.6 TDCi<br>1.6 Ti VCT<br>1.8 i 16V<br>1.8 TDCi<br>2.0 i 16V<br>2.0 TDCi<br>2.0 TDCi<br>2.5 ST | 59<br>74<br><br>66<br>85<br>92<br>85<br>107<br>81<br>166 |  | 10.04<br>10.04<br>10.04<br>01.05<br>10.04<br>01.06<br>01.05<br>10.04<br>10.04<br>10.04<br>10.05 | 04.07<br>04.07<br>04.07<br>04.07<br>04.07<br>04.07<br>04.07<br>04.07<br>04.07<br>04.07<br>04.07 |  | 03.2123-3103.3 010781                          | + ABS/ + ESP                               | Thz 23,81   | ATE        |
|                       | 1.4 i 16V<br>1.6 i 16V<br>1.6 TDCi<br>1.6 TDCi<br>1.6 Ti VCT<br>1.8 i 16V<br>1.8 TDCi<br>2.0 i 16V<br>2.0 TDCi<br>2.0 TDCi<br>2.5 ST | 59<br>74<br><br>66<br>85<br>92<br>85<br>107<br>81<br>166 |  | 05.07<br>05.07<br>05.07<br>05.07<br>05.07<br>05.07<br>05.07<br>05.07<br>05.07<br>02.08<br>05.07 | 10.08<br>10.08<br>10.08<br>10.08<br>10.08<br>10.08<br>10.08<br>10.08<br>10.08<br>10.08<br>10.08 |  | 03.2125-0483.3 010783                          | + ABS/ + ESP                               | Thz 25,40   | ATE        |
|                       | 1.4 i 16V<br>1.6 i 16V<br>1.6 TDCi<br>1.6 TDCi<br>1.6 Ti VCT<br>1.8 i 16V<br>1.8 TDCi<br>2.0 i 16V<br>2.0 TDCi<br>2.0 TDCi           | 59<br>74<br><br>66<br>85<br>92<br>85<br>107<br>81        |  | 11.08<br>11.08<br>11.08<br>11.08<br>11.08<br>11.08<br>11.08<br>11.08<br>11.08<br>11.08          | 02.11<br>02.11<br>02.11<br>02.11<br>02.11<br>02.11<br>02.11<br>02.11<br>02.11<br>02.11          |  | 03.2125-0661.3 010917                          | + ABS/ + ESP                               | Thz 25,40   | ATE        |

1) + RA drum brake / + P freno a tamburo / + frein à tambour essieu AR / + ET-tambores de freno  
 2) + RA disc brake / + P disco freno / + frein à disque essieu AR / + ET-disco de freno  
 3) extension only / solo prolunga / rallonge seulement / solamente prolongador  
 4) + electr. brake actuator / + BAS / + assistance de freinage / + asistente de freno  
 5) - electr. brake actuator / - BAS / - assistance de freinage / - asistente de freno



| FORD FOCUS II (05-11) |              |     |  |       |       |                                   |                |        |              |   |       |
|-----------------------|--------------|-----|--|-------|-------|-----------------------------------|----------------|--------|--------------|---|-------|
|                       | 2.5 ST       | 166 |  | 11.08 | 02.11 |                                   | 03.2125-0661.3 | 010917 | + ABS/ + ESP | THz 25,40                                   | ATE   |
|                       | 2.5 RS       | 224 |  | 01.09 | 02.11 |                                   | 03.2125-0651.3 | 010935 |              | THz 25,40                                   | ATE   |
|                       | 2.5 RS 500   | 257 |  | 05.10 | 02.11 |                                   |                |        |              |   |       |
|                       | 1.4 i 16V    | 59  |  | 10.04 | 02.11 |                                   | 11.9571-9813.2 | 220647 |              | D=57, - Halter                              | ATE   |
|                       | 1.6 i 16V    | 74  |  | 10.04 | 02.11 |                                   | 11.9571-9814.2 | 220648 |              | D=57, - Halter                              | ATE   |
|                       | 1.6 TDCi     |     |  | 10.04 | 02.11 |                                   | 24.3571-9813.5 | 240557 |              | D=57, - Halter                              | ATE   |
|                       | 1.6 TDCi     | 66  |  | 01.05 | 02.11 |                                   | 24.3571-9814.5 | 240558 |              | D=57, - Halter                              | ATE   |
|                       | 1.6 Ti VCT   | 85  |  | 10.04 | 02.11 |                                   | 11.0101-5407.2 | 260011 |              | Hülsensatz                                  | ATE   |
|                       | 1.8 i 16V    | 92  |  | 01.06 | 02.11 |                                   | 11.8171-0008.1 | 990049 |              | Führungsbolzen                              | ATE   |
|                       |              |     |  |       |       |                                   | 11.8116-0356.1 | 390586 | 2            | Haltefeder                                  | ATE   |
|                       | 1.8 TDCi     | 85  |  | 01.05 | 02.11 |                                   | 11.9571-9813.2 | 220647 |              | D=57, - Halter                              | ATE   |
|                       | 2.0 i 16V    | 107 |  | 10.04 | 02.11 |                                   | 11.9571-9814.2 | 220648 |              | D=57, - Halter                              | ATE   |
|                       | 2.0 TDCi     |     |  | 10.04 | 02.11 |                                   | 24.3571-9813.5 | 240557 |              | D=57, - Halter                              | ATE   |
|                       | 2.0 TDCi     | 81  |  | 02.08 | 02.11 |                                   | 24.3571-9814.5 | 240558 |              | D=57, - Halter                              | ATE   |
|                       |              |     |  |       |       |                                   | 11.0101-5407.2 | 260011 |              | Hülsensatz                                  | ATE   |
|                       |              |     |  |       |       |                                   | 11.8171-0008.1 | 990049 |              | Führungsbolzen                              | ATE   |
|                       |              |     |  |       |       |                                   | 11.8116-0356.1 | 390586 | 2            | Haltefeder                                  | ATE   |
|                       | 2.5 ST       | 166 |  | 10.05 | 02.11 |                                   | 11.9576-9975.2 | 220649 |              | D=57, - Halter                              | ATE   |
|                       |              |     |  |       |       |                                   | 11.9576-9976.2 | 220650 |              | D=57, - Halter                              | ATE   |
|                       |              |     |  |       |       |                                   | 11.8116-0345.2 | 390596 | 2            | Haltefeder                                  | ATE   |
|                       |              |     |  |       |       |                                   | 11.8171-0008.1 | 990049 |              | Führungsbolzen                              | ATE   |
|                       |              |     |  |       |       |                                   | 11.0101-5407.2 | 260011 |              | Hülsensatz                                  | ATE   |
|                       | 1.4 i 16V    | 59  |  | 10.04 | 02.11 |                                   | 83.7716-0397.3 | 330790 | 2            | L=395                                       |       |
|                       | 1.6 i 16V    | 74  |  | 10.04 | 02.11 |                                   |                |        |              |   |       |
|                       | 1.6 TDCi     |     |  | 10.04 | 02.11 |                                   |                |        |              |   |       |
|                       | 1.6 TDCi     | 66  |  | 01.05 | 02.11 |                                   |                |        |              |   |       |
|                       | 1.6 Ti VCT   | 85  |  | 10.04 | 02.11 |                                   |                |        |              |   |       |
|                       | 1.8 i 16V    | 92  |  | 01.06 | 02.11 |                                   |                |        |              |   |       |
|                       | 1.8 TDCi     | 85  |  | 01.05 | 02.11 |                                   |                |        |              |   |       |
|                       | 2.0 i 16V    | 107 |  | 10.04 | 02.11 |                                   |                |        |              |   |       |
|                       | 2.0 TDCi     |     |  | 10.04 | 02.11 |                                   |                |        |              |   |       |
|                       | 2.0 TDCi     | 81  |  | 02.08 | 02.11 |                                   |                |        |              |   |       |
|                       | 2.5 ST       | 166 |  | 10.05 | 02.11 |                                   |                |        |              |   |       |
|                       | 1.4 i 16V    | 59  |  | 10.04 | 02.11 |                                   | 11.9387-7015.2 | 220627 |              | D=38, - Halter                              | ATE   |
|                       | 1.6 i 16V    | 74  |  | 10.04 | 02.11 |                                   | 11.9387-7016.2 | 220628 |              | D=38, - Halter                              | ATE   |
|                       | 1.6 TDCi     |     |  | 10.04 | 02.11 |                                   | 11.0101-5407.2 | 260011 |              | Hülsensatz                                  | ATE   |
|                       | 1.6 TDCi     | 66  |  | 01.05 | 02.11 |                                   | 11.8171-0008.1 | 990049 |              | Führungsbolzen                              | ATE   |
|                       | 1.6 Ti VCT   | 85  |  | 10.04 | 02.11 |                                   | 11.8116-0340.1 | 390595 | 2            | Haltefeder                                  | ATE   |
|                       | 1.8 i 16V    | 92  |  | 01.06 | 02.11 |                                   |                |        |              |   |       |
|                       | 1.8 TDCi     | 85  |  | 01.05 | 02.11 |                                   | 11.9387-7015.2 | 220627 |              | D=38, - Halter                              | ATE   |
|                       | 2.0 i 16V    | 107 |  | 10.04 | 02.11 |                                   | 11.9387-7016.2 | 220628 |              | D=38, - Halter                              | ATE   |
|                       | 2.0 TDCi     |     |  | 10.04 | 02.11 |                                   | 11.0230-0698.2 | 260091 |              | Halter                                      | ATE   |
|                       | 2.0 TDCi     | 81  |  | 02.08 | 02.11 |                                   | 11.0101-5407.2 | 260011 |              | Hülsensatz                                  | ATE   |
|                       | 2.5 ST       | 166 |  | 10.05 | 02.11 |                                   | 11.8171-0008.1 | 990049 |              | Führungsbolzen                              | ATE   |
|                       |              |     |  |       |       |                                   | 11.8116-0340.1 | 390595 | 2            | Haltefeder                                  | ATE   |
|                       | 1.4 i 16V    | 59  |  | 10.04 | 02.11 |                                   | 83.7788-0382.3 | 330971 | 2            | L=380                                       |       |
|                       | 1.4 i 16V    | 59  |  | 10.04 | 02.11 | + HA-Trommelbremse <sup>1)</sup>  | 83.7788-0416.3 | 330884 | 2            | + mechanische Feststellbremse <sup>3)</sup> | L=415 |
|                       | 1.6 i 16V    | 74  |  | 10.04 | 02.11 | + HA-Scheibenbremse <sup>2)</sup> | 83.7714-0391.3 | 330980 | 2            | + elektrische Feststellbremse <sup>4)</sup> | L=390 |
|                       | 1.6 TDCi     |     |  | 10.04 | 02.11 |                                   | 83.7788-0409.3 | 330981 | 2            | + Turnier                                   | L=410 |
|                       | 1.6 TDCi     | 66  |  | 01.05 | 02.11 |                                   |                |        |              |   |       |
|                       | 1.6 Ti VCT   | 85  |  | 10.04 | 02.11 |                                   |                |        |              |   |       |
|                       | 1.8 i 16V    | 92  |  | 01.06 | 02.11 |                                   |                |        |              |   |       |
|                       | 1.8 TDCi     | 85  |  | 01.05 | 02.11 |                                   |                |        |              |   |       |
|                       | 2.0 i 16V    | 107 |  | 10.04 | 02.11 |                                   |                |        |              |   |       |
|                       | 2.0 TDCi     |     |  | 10.04 | 02.11 |                                   |                |        |              |   |       |
|                       | 2.0 TDCi     | 81  |  | 02.08 | 02.11 |                                   |                |        |              |   |       |
|                       | 2.5 ST       | 166 |  | 10.05 | 02.11 |                                   |                |        |              |   |       |
|                       | 1.4 i 16V    | 59  |  | 10.04 | 02.11 |                                   | 24.3220-1721.3 | 020467 |              | Rz 20,64                                    |       |
|                       | 1.4 i 16V    | 59  |  | 10.04 | 02.11 | + HA-Trommelbremse <sup>1)</sup>  | 24.3727-0664.2 | 580664 | 1            | L=1440/1490                                 |       |
|                       | 1.4 i 16V    | 59  |  | 10.04 | 02.11 | + HA-Scheibenbremse <sup>2)</sup> | 24.3727-0678.2 | 580678 | 1            | L=341                                       |       |
|                       | 1.6 i 16V    | 74  |  | 10.04 | 02.11 |                                   | 24.3727-0659.2 | 580659 | 1            | L=1816/1860                                 |       |
|                       | 1.6 TDCi     |     |  | 10.04 | 02.11 |                                   |                |        |              |   |       |
|                       | 1.6 TDCi     | 66  |  | 01.05 | 02.11 |                                   |                |        |              |   |       |
|                       | 1.6 Ti VCT   | 85  |  | 10.04 | 02.11 |                                   |                |        |              |   |       |
|                       | 1.8 i 16V    | 92  |  | 01.06 | 02.11 |                                   |                |        |              |   |       |
|                       | 1.8 TDCi     | 85  |  | 01.05 | 02.11 |                                   |                |        |              |   |       |
|                       | 2.0 i 16V    | 107 |  | 10.04 | 02.11 |                                   |                |        |              |   |       |
|                       | 2.0 TDCi     |     |  | 10.04 | 02.11 |                                   |                |        |              |   |       |
|                       | 2.0 TDCi     | 81  |  | 02.08 | 02.11 |                                   |                |        |              |   |       |
|                       | 2.5 ST       | 166 |  | 10.05 | 02.11 |                                   |                |        |              |   |       |
|                       | 2.5 RS       | 224 |  | 01.09 | 02.11 |                                   | 24.3727-0672.2 | 580672 | 1            | L=1848/1933                                 |       |
|                       | 2.5 RS 500   | 257 |  | 05.10 | 02.11 |                                   |                |        |              |   |       |
| FORD FOCUS III (11-)  |              |     |  |       |       |                                   |                |        |              |   |       |
|                       | 1.6 EcoBoost | 110 |  | 03.11 |       |                                   | 11.9571-9813.2 | 220647 |              | D=57, - Halter                              | ATE   |
|                       | 1.6 EcoBoost | 134 |  | 03.11 |       |                                   | 11.9571-9814.2 | 220648 |              | D=57, - Halter                              | ATE   |
|                       | 2.0 TDCi     | 85  |  | 03.11 |       |                                   | 24.3571-9813.5 | 240557 |              | D=57, - Halter                              | ATE   |
|                       | 2.0 TDCi     | 100 |  | 03.11 |       |                                   | 24.3571-9814.5 | 240558 |              | D=57, - Halter                              | ATE   |
|                       | 2.0 TDCi     | 103 |  | 03.11 |       |                                   | 11.8116-0356.1 | 390586 | 2            | Haltefeder                                  | ATE   |
|                       | 2.0 TDCi     | 120 |  | 03.11 |       |                                   |                |        |              |   |       |
|                       | 1.6 LPG      | 88  |  | 02.12 |       |                                   | 11.9571-9813.2 | 220647 |              | D=57, - Halter                              | ATE   |
|                       | 1.6 TDCi     | 70  |  | 03.11 |       |                                   | 11.9571-9814.2 | 220648 |              | D=57, - Halter                              | ATE   |
|                       | 1.6 TDCi     | 85  |  | 03.11 |       |                                   | 24.3571-9813.5 | 240557 |              | D=57, - Halter                              | ATE   |
|                       | 1.6 Ti-VCT   | 63  |  | 08.11 |       |                                   | 24.3571-9814.5 | 240558 |              | D=57, - Halter                              | ATE   |
|                       | 1.6 Ti-VCT   | 77  |  | 03.11 |       |                                   | 11.8116-0356.1 | 390586 | 2            | Haltefeder                                  | ATE   |























1) + RA drum brake / + P freno a tamburo / + frein à tambour essieu AR / + ET-tambores de freno  
2) + RA disc brake / + P disco freno / + frein à disque essieu AR / + ET-disco de freno  
3) + mechanical parking brake / + fr. stazionamento meccanico / + frein à main mécanique / + freno de mano mecánica  
4) + electric parking brake / + freno a mano elettrico / + frein à main électrique / + freno de mano eléctrico

|     |    |  |  |  |  |  |  |                                     |  |   |                |
|--|--|--|--|--|---|--|--|---|--|---|----------------|
| <b>FORD FOCUS III (11-)</b>  |  |  |  |  |   |  |  |   |  |   |                |
|    | 1.6 Ti-VCT   | 92   |  | 03.11  |   | 11.9571-9813.2   | 220647   | 2<br>- Bremssattel lackiert 1)<br>- Bremssattel lackiert 1)<br>- Bremssattel lackiert 1)<br>- Bremssattel lackiert 1) | D=57, - Halter                             | ATE   |                |
|  | 1.6 Ti-VCT Flexifuel   | 88   |  | 03.11  |   | 11.9571-9814.2   | 220648   |   | D=57, - Halter                             | ATE   |                |
|  |  |  |  |  |   | 24.3571-9813.5   | 240557   |   | D=57, - Halter                             | ATE   |                |
|  |  |  |  |  |   | 24.3571-9814.5   | 240558   |   | D=57, - Halter                             | ATE   |                |
|  |  |  |  |  |   | 11.8116-0356.1   | 390586   |   | Haltefeder                                 | ATE   |                |
|    | 1.0 EcoBoost   | 74   |  | 02.12  |   | 11.9571-9813.2   | 220647   | 2<br>- Bremssattel lackiert 1)<br>- Bremssattel lackiert 1)<br>- Bremssattel lackiert 1)<br>- Bremssattel lackiert 1) | D=57, - Halter                             | ATE   |                |
|  | 1.0 EcoBoost   | 92   |  | 02.12  |   | 11.9571-9814.2   | 220648   |   | D=57, - Halter                             | ATE   |                |
|  | 1.6 Flexifuel  | 110  |  | 07.13  |   | 24.3571-9813.5   | 240557   |   | D=57, - Halter                             | ATE   |                |
|  | 1.6 TDCi ECOnetic  | 77   |  | 04.12  |   | 24.3571-9814.5   | 240558   |   | D=57, - Halter                             | ATE   |                |
|  |  |  |  |  |   | 11.8116-0356.1   | 390586   |   | Haltefeder                                 | ATE   |                |
|    | 1.0 EcoBoost   | 74   |  | 02.12  |   | 11.8116-0340.1   | 390595   | 2   | Haltefeder                                 | ATE   |                |
|  | 1.0 EcoBoost   | 92   |  | 02.12  |   |  |  |   |  |   |                |
|  | 1.6 Flexifuel  | 110  |  | 07.13  |   |  |  |   |  |   |                |
|  | 1.6 TDCi ECOnetic  | 77   |  | 04.12  |   |  |  |   |  |   |                |
|  | 2.0 EcoBoost ST  | 184  |  | 06.12  |   |  |  |   |  |   |                |
| <b>FORD FOCUS C-MAX (03-07)</b>  |  |  |  |  |   |  |  |   |  |   |                |
|    | 1.6 i 16V  | 74   |  | 08.03  | 08.06   | 03.7863-0332.4   | 300203   | + Bremsassistent 2)<br>- Bremsassistent 3)  | 10"  | ATE   |                |
|  | 1.6 TDCi   | 66   |  | 01.05  | 08.06   | 03.7760-8103.4   | 300240   |   | 10"  | ATE   |                |
|  | 1.6 TDCi   | 80   |  | 08.03  | 08.06   |  |  |   |  |   |                |
|  | 1.6 Ti VCT   | 85   |  | 08.04  | 08.06   |  |  |   |  |   |                |
|  | 1.8 i 16V  | 88   |  | 08.03  | 08.06   |  |  |   |  |   |                |
|  | 1.8 i 16V  | 92   |  | 04.04  | 08.06   |  |  |   |  |   |                |
|  | 1.8 TDCi   | 85   |  | 01.05  | 08.06   |  |  |   |  |   |                |
|  | 2.0 i 16V  | 107  |  | 04.04  | 08.06   |  |  |   |  |   |                |
|  | 2.0 TDCi   | 100  |  | 08.03  | 08.06   |  |  |   |  |   |                |
|  | 1.6 i 16V  | 74   |  | 09.06  | 03.07   | 03.7863-3932.4   | 300288   |   | + Bremsassistent 2)<br>- Bremsassistent 3) | 10"   | ATE            |
|  | 1.6 TDCi   | 66   |  | 09.06  | 03.07   | 03.7760-2232.4   | 300266   |   |  | 10"   | ATE            |
|  | 1.6 TDCi   | 80   |  | 09.06  | 03.07   |  |  |   |  |   |                |
|  | 1.6 Ti VCT   | 85   |  | 09.06  | 03.07   |  |  |   |  |   |                |
|  | 1.8 i 16V  | 88   |  | 09.06  | 03.07   |  |  |   |  |   |                |
|  | 1.8 i 16V  | 92   |  | 09.06  | 03.07   |  |  |   |  |   |                |
| 1.8 TDCi   | 85   |  | 09.06  | 03.07  |   |  |  |   |  |   |                |
| 2.0 i 16V  | 107  |  | 09.06  | 03.07  |   |  |  |   |  |   |                |
| 2.0 TDCi   | 100  |  | 09.06  | 03.07  |   |  |  |   |  |   |                |
| 1.6 i 16V  | 74   |  | 08.03  | 03.07  | 03.7760-2332.4  | 300267   | - ABS  | 10"   |  | ATE   |                |
| 1.6 TDCi   | 66   |  | 01.05  | 03.07  |   |  |  |   |  |   |                |
| 1.6 TDCi   | 80   |  | 08.03  | 03.07  |   |  |  |   |  |   |                |
| 1.6 Ti VCT   | 85   |  | 08.04  | 03.07  |   |  |  |   |  |   |                |
| 1.8 i 16V  | 88   |  | 08.03  | 03.07  |   |  |  |   |  |   |                |
| 1.8 i 16V  | 92   |  | 04.04  | 03.07  |   |  |  |   |  |   |                |
| 1.8 TDCi   | 85   |  | 01.05  | 03.07  |   |  |  |   |  |   |                |
| 2.0 i 16V  | 107  |  | 04.04  | 03.07  |   |  |  |   |  |   |                |
| 2.0 TDCi   | 100  |  | 08.03  | 03.07  |   |  |  |   |  |   |                |
|  | 1.6 i 16V  | 74   |  | 08.03  | 03.07   | 03.2123-3041.3   |  | 010887  | - ABS<br>+ ABS/ - ESP<br>+ ESP             | Thz 23,81   | ATE            |
|  | 1.6 TDCi   | 66   |  | 01.05  | 03.07   | 03.2125-0483.3   |  | 010783  |  | Thz 25,40   | ATE            |
|  | 1.6 TDCi   | 80   |  | 08.03  | 03.07   | 03.2123-3103.3   |  | 010781  |  | Thz 23,81   | ATE            |
|  | 1.6 Ti VCT   | 85   |  | 08.04  | 03.07   |  |  |   |  |   |                |
|  | 1.8 i 16V  | 88   |  | 08.03  | 03.07   |  |  |   |  |   |                |
|  | 1.8 i 16V  | 92   |  | 04.04  | 03.07   |  |  |   |  |   |                |
|  | 1.8 TDCi   | 85   |  | 01.05  | 03.07   |  |  |   |  |   |                |
|  | 2.0 i 16V  | 107  |  | 04.04  | 03.07   |  |  |   |  |   |                |
|  | 2.0 TDCi   | 100  |  | 08.03  | 03.07   |  |  |   |  |   |                |
|  |  | 1.6 i 16V  | 74   |  | 08.03   | 03.07  | 11.9571-9813.2   | 220647  |  | 2<br>- Bremssattel lackiert 1)<br>- Bremssattel lackiert 1)<br>- Bremssattel lackiert 1)<br>- Bremssattel lackiert 1) | D=57, - Halter |
| 1.6 TDCi   |  | 66   |  | 01.05  | 03.07   | 11.9571-9814.2   | 220648   | D=57, - Halter  | ATE  |   |                |
| 1.6 TDCi   |  | 80   |  | 08.03  | 03.07   | 24.3571-9813.5   | 240557   | D=57, - Halter  | ATE  |   |                |
| 1.6 Ti VCT   |  | 85   |  | 08.04  | 03.07   | 24.3571-9814.5   | 240558   | D=57, - Halter  | ATE  |   |                |
| 1.8 i 16V  |  | 88   |  | 08.03  | 03.07   | 11.0101-5407.2   | 260011   | Hülzensatz  | ATE  |   |                |
| 1.8 i 16V  |  | 92   |  | 04.04  | 03.07   | 11.8171-0008.1   | 990049   | Führungsbolzen  | ATE  |   |                |
|  |  |  |  |  |   | 11.8116-0356.1   | 390586   | Haltefeder  | ATE  |   |                |
| 1.8 TDCi   |  | 85   |  | 01.05  | 03.07   | 11.9571-9813.2   | 220647   | D=57, - Halter  | ATE  |   |                |
| 2.0 i 16V  |  | 107  |  | 04.04  | 03.07   | 11.9571-9814.2   | 220648   | D=57, - Halter  | ATE  |   |                |
| 2.0 TDCi   |  | 100  |  | 08.03  | 03.07   | 24.3571-9813.5   | 240557   | D=57, - Halter  | ATE  |   |                |
|  | 1.6 i 16V  | 74   |  | 08.03  | 03.07   | 83.7716-0397.3   | 330790   | 2   | L=395                                      |   |                |
|  | 1.6 TDCi   | 66   |  | 01.05  | 03.07   |  |  |   |  |   |                |
|  | 1.6 TDCi   | 80   |  | 08.03  | 03.07   |  |  |   |  |   |                |
|  | 1.6 Ti VCT   | 85   |  | 08.04  | 03.07   |  |  |   |  |   |                |
|  | 1.8 i 16V  | 88   |  | 08.03  | 03.07   |  |  |   |  |   |                |
|  | 1.8 i 16V  | 92   |  | 04.04  | 03.07   |  |  |   |  |   |                |
|  | 1.8 TDCi   | 85   |  | 01.05  | 03.07   |  |  |   |  |   |                |
|  | 2.0 i 16V  | 107  |  | 04.04  | 03.07   |  |  |   |  |   |                |
|  | 2.0 TDCi   | 100  |  | 08.03  | 03.07   |  |  |   |  |   |                |
|  |  | 1.6 i 16V  | 74   |  | 08.03   | 03.07  | 11.9387-7015.2   |   | 220627                                     | 2<br>- Bremssattel lackiert 1)<br>- Bremssattel lackiert 1)   | D=38, - Halter |
| 1.6 Ti VCT   |  | 85   |  | 08.04  | 03.07   | 11.9387-7016.2   | 220628   | D=38, - Halter  | ATE  |   |                |
| 1.8 i 16V  |  | 88   |  | 08.03  | 03.07   | 11.0101-5407.2   | 260011   | Hülzensatz  | ATE  |   |                |
| 1.8 i 16V  |  | 92   |  | 04.04  | 03.07   | 11.8171-0008.1   | 990049   | Führungsbolzen  | ATE  |   |                |
|  |  |  |  |  |   | 11.8116-0340.1   | 390595   | Haltefeder  | ATE  |   |                |
| 1.6 TDCi   |  | 66   |  | 01.05  | 03.07   | 11.9387-7015.2   | 220627   | D=38, - Halter  | ATE  |   |                |
| 1.6 TDCi   |  | 80   |  | 08.03  | 03.07   | 11.9387-7016.2   | 220628   | D=38, - Halter  | ATE  |   |                |
| 1.8 TDCi   |  | 85   |  | 01.05  | 03.07   | 11.0230-0698.2   | 260091   | Halter  | ATE  |   |                |
| 2.0 i 16V  |  | 107  |  | 04.04  | 03.07   | 11.0101-5407.2   | 260011   | Hülzensatz  | ATE  |   |                |
| 2.0 TDCi   |  | 100  |  | 08.03  | 03.07   | 11.8171-0008.1   | 990049   | Führungsbolzen  | ATE  |   |                |
|  |  |  |  |  | 11.8116-0340.1  | 390595   | Haltefeder   | ATE   |  |   |                |

1) - brake caliper, painted / - pinza freno, verniciata / - étrier de frein, verni / - pinza de freno, pintada

2) + electr. brake actuator / + BAS / + assistance de freinage / + asistente de freno

3) - electr. brake actuator / - BAS / - assistance de freinage / - asistente de freno

|     |                                |  |  |   |  |   |  |    |  |                                 |            |
|--|--|--|--|---|---|---|--|--|--|---------------------------------|------------|
| <b>FORD FOCUS C-MAX (03-07)</b>  |  |  |  |   |   |   |  |  |  |                                 |            |
|    | 1.6 i 16V<br>1.6 TDCi<br>1.6 TDCi<br>1.6 Ti VCT<br>1.8 i 16V<br>1.8 i 16V<br>1.8 TDCi<br>2.0 i 16V<br>2.0 TDCi | 74<br>66<br>80<br>85<br>88<br>92<br>85<br>107<br>100                             |  | 08.03 03.07<br>01.05 03.07<br>08.03 03.07<br>08.04 03.07<br>08.03 03.07<br>04.04 03.07<br>01.05 03.07<br>04.04 03.07<br>08.03 03.07 |   | 83.7788-0416.3 330884<br>24.5124-0420.3 331276<br>24.5167-0420.3 331278<br>83.7714-0391.3 330980                          | 2<br>2<br>2<br>2   | + mechanische Feststellbremse <sup>1)</sup><br>+ elektrische Feststellbremse <sup>2)</sup><br>+ elektrische Feststellbremse <sup>2)</sup><br>+ elektrische Feststellbremse <sup>2)</sup> | L=415<br>L=420<br>L=400<br>L=390   |                                 |            |
|    | 1.6 i 16V<br>1.6 TDCi<br>1.6 TDCi<br>1.6 Ti VCT<br>1.8 i 16V<br>1.8 i 16V<br>1.8 TDCi<br>2.0 i 16V<br>2.0 TDCi | 74<br>66<br>80<br>85<br>88<br>92<br>85<br>107<br>100                             |  | 08.03 03.07<br>01.05 03.07<br>08.03 03.07<br>08.04 03.07<br>08.03 03.07<br>04.04 03.07<br>01.05 03.07<br>04.04 03.07<br>08.03 03.07 |   | 24.3727-0678.2 580678<br>24.3727-0659.2 580659  | 1 ↑<br>1 ↓   |  | L=341<br>L=1816/1860   |                                 |            |
| <b>FORD FUSION (02-12)</b>   |  |  |  |   |   |   |  |  |  |                                 |            |
|    | 1.25 i 16V<br>1.4 i 16V<br>1.4 TDCi<br>1.6 i 16V<br>1.6 TDCi   | 55<br>59<br>50<br>74<br>66   |  | 08.04 09.12<br>07.02 09.12<br>07.02 09.12<br>07.02 09.12<br>10.04 09.12   |   | 03.7750-8732.4 300199<br>03.7853-2102.4 300201  |  | - Bremsassistent <sup>3)</sup><br>+ Bremsassistent <sup>4)</sup>   | 9"<br>9"   | ATE<br>ATE                      |            |
|    | 1.25 i 16V<br>1.4 i 16V<br>1.4 TDCi<br>1.6 i 16V<br>1.6 TDCi   | 55<br>59<br>50<br>74<br>66   |  | 08.04 09.12<br>07.02 09.12<br>07.02 09.12<br>07.02 09.12<br>10.04 09.12   |   | 03.4153-0015.4 010784<br>03.4153-0029.4 010786<br>03.4153-0025.4 010785   |  | - ABS<br>+ ABS<br>+ ESP  | THz 23,81 + Behälter<br>THz 23,81 + Behälter<br>THz 23,81 + Behälter           | ATE<br>ATE<br>ATE               |            |
|    | 1.25 i 16V<br>1.4 i 16V<br>1.4 TDCi<br>1.6 i 16V<br>1.6 TDCi   | 55<br>59<br>50<br>74<br>66   |  | 08.04 09.12<br>07.02 09.12<br>07.02 09.12<br>07.02 09.12<br>10.04 09.12   |   | 11.3541-8531.2 220367<br>11.3541-8532.2 220368<br>11.0101-5407.2 260011<br>11.8171-0008.1 990049<br>11.8116-0264.1 390594 | 2  |  | D=54, - Halter<br>D=54, - Halter<br>Hülzensatz<br>Führungsbolzen<br>Haltefeder | ATE<br>ATE<br>ATE<br>ATE<br>ATE |            |
|    | 1.25 i 16V<br>1.4 i 16V<br>1.4 TDCi<br>1.6 i 16V<br>1.6 TDCi   | 55<br>59<br>50<br>74<br>66   |  | 08.04 09.12<br>07.02 09.12<br>07.02 09.12<br>07.02 09.12<br>10.04 09.12   |   | 83.7769-0493.3 330861   | 2  |  |  | L=491                           |            |
|  | 1.25 i 16V<br>1.4 i 16V<br>1.4 TDCi<br>1.6 i 16V<br>1.6 TDCi   | 55<br>59<br>50<br>74<br>66   |  | 08.04 09.12<br>07.02 09.12<br>07.02 09.12<br>07.02 09.12<br>10.04 09.12   |   | 83.7827-0321.3 330862   | 2  |  |  | L=320                           |            |
|  | 1.25 i 16V<br>1.4 i 16V<br>1.4 TDCi<br>1.6 i 16V<br>1.6 TDCi   | 55<br>59<br>50<br>74<br>66   |  | 08.04 09.12<br>07.02 09.12<br>07.02 09.12<br>07.02 09.12<br>10.04 09.12   |   | 24.3219-1735.3 020464   |  |  |  | Rz 19,05                        |            |
|  | 1.25 i 16V<br>1.4 i 16V<br>1.4 TDCi<br>1.6 i 16V<br>1.6 TDCi   | 55<br>59<br>50<br>74<br>66   |  | 08.04 09.12<br>07.02 09.12<br>07.02 09.12<br>07.02 09.12<br>10.04 09.12   |   | 24.3727-0658.2 580658<br>24.3727-0653.2 580653  | 1 ↑<br>1 ↓   |  |  | L=300<br>L=1305/1445            |            |
|  | 1.25 i 16V<br>1.4 i 16V<br>1.4 TDCi<br>1.6 i 16V<br>1.6 TDCi   | 55<br>59<br>50<br>74<br>66   |  | 08.04 09.12<br>07.02 09.12<br>07.02 09.12<br>07.02 09.12<br>10.04 09.12   |   | 24.2419-1735.3 030127   |  |  |  | Gz 19,05                        |            |
| <b>FORD GALAXY I (95-06)</b>   |  |  |  |   |   |   |  |  |  |                                 |            |
|  | 1.9 TDI<br>2.0 i<br>2.3 i 16V<br>2.8 i V6  | 66<br>66<br>128<br>128   |  | 01.96 08.97<br>09.95 08.97<br>01.97 08.97<br>09.95 08.97  |   | 03.7760-3002.4 300120   |  |  |  | 10"                             | ATE        |
|  | 1.9 TDI<br>1.9 TDI<br>2.0 i<br>2.3 i 16V<br>2.8 i V6   | 66<br>81<br>66<br>66<br>128  |  | 09.97 03.00<br>10.97 03.00<br>09.97 03.00<br>09.97 03.00<br>09.97 03.00   |   | 03.7755-1902.4 300138   |  |  |  | 9" Tandem                       | ATE        |
|  | 1.9 TDI<br>1.9 TDI<br>2.0 i<br>2.3 i 16V<br>2.8 i V6   | 66<br>85<br>66<br>66<br>150  |  | 04.00 10.02<br>04.00 10.02<br>04.00 10.02<br>04.00 10.02<br>04.00 10.02   |   | 03.7755-6302.4 300221<br>03.7858-3302.4 300122  |  | - ESP<br>+ ESP   |  | 9/8" Tandem<br>9/8" Tandem      | ATE<br>ATE |
|  | 1.9 TDI<br>1.9 TDI<br>1.9 TDI<br>2.0 i<br>2.3 i 16V<br>2.8 i V6  | 66<br>85<br>96<br>66<br>66<br>150  |  | 04.00 04.06<br>04.00 04.06<br>02.03 04.06<br>04.00 04.06<br>04.00 04.06<br>04.00 04.06  |   | 03.7755-6302.4 300221   |  | - ESP  |  | 9/8" Tandem                     | ATE        |

























<sup>1)</sup> + mechanical parking brake / + fr. stazionamento meccanico / + frein à main mécanique / + freno de mano mecánica

<sup>2)</sup> + electric parking brake / + freno a mano elettrico / + frein à main électrique / + freno de mano eléctrico













<sup>3)</sup> - electr. brake actuator / - BAS / - assistance de freinage / - asistente de freno

<sup>4)</sup> + electr. brake actuator / + BAS / + assistance de freinage / + asistente de freno



































|     |  |  |  |  |  |  |     |       |                   |          |
|--|--|--|--|--|---|--|---|---|-------------------|----------|
| <b>FORD GALAXY I (95-06)</b>   |  |  |  |  |   |  |   |   |                   |          |
|    | 1.9 TDI  | 66   |  | 01.96  | 08.97   | 03.2123-1548.3   | 010478  | - ABS   | THz 23,81         | ATE      |
|  | 2.0 i  |  |  | 09.95  | 08.97   | 03.2123-1526.3   | 010477  | + ABS   | THz 23,81         | ATE      |
|  | 2.3 i 16V  |  |  | 01.97  | 08.97   | 03.3517-5100.1   | 390326  | - ABS   | Verschlußschraube | ATE      |
|  | 2.8 i V6   | 128  |  | 09.95  | 08.97   |  |   |   |                   |          |
|  | 1.9 TDI  | 66   |  | 09.97  | 03.00   | 03.2125-8404.3   | 010583  | - ABS   | THz 25,40         | ATE      |
|  | 1.9 TDI  | 81   |  | 10.97  | 03.00   | 03.2125-0343.3   | 010896  | + ABS   | THz 25,40         | ATE      |
|  | 2.0 i  |  |  | 09.97  | 03.00   |  |   |   |                   |          |
|  | 2.3 i 16V  |  |  | 09.97  | 03.00   |  |   |   |                   |          |
|  | 2.8 i V6   | 128  |  | 09.97  | 03.00   |  |   |   |                   |          |
|  | 1.9 TDI  | 66   |  | 04.00  | 04.06   | 03.2125-0343.3   | 010896  | - ESP   | THz 25,40         | ATE      |
|  | 1.9 TDI  | 85   |  | 04.00  | 04.06   | 03.2125-9604.3   | 010581  | + ESP   | THz 25,40         | ATE      |
|  | 1.9 TDI  | 96   |  | 02.03  | 04.06   |  |   |   |                   |          |
|  | 1.9 TDI  | 110  |  | 05.05  | 04.06   |  |   |   |                   |          |
|  | 2.0 i  |  |  | 04.00  | 04.06   |  |   |   |                   |          |
| 2.3 i 16V  |  |  | 04.00  | 04.06  |   |  |   |   |                   |          |
| 2.8 i V6   | 150  |  | 04.00  | 04.06  |   |  |   |   |                   |          |
|    | 1.9 TDI  | 66   |  | 01.96  | 03.00   | 11.0441-5704.2   | 250034  |   | Dichtungssatz     | ATE      |
|  | 1.9 TDI  | 81   |  | 10.97  | 03.00   | 11.0101-5407.2   | 260011  |   | Hülzensatz        | ATE      |
|  | 2.0 i  |  |  | 09.95  | 03.00   | 11.8171-0008.1   | 990049  |   | Führungsbolzen    | ATE      |
|  | 2.3 i 16V  |  |  | 01.97  | 03.00   | 11.8116-0143.1   | 390513  | 2   | Haltefeder        | ATE      |
|  | 2.8 i V6   | 128  |  | 09.95  | 03.00   |  |   |   |                   |          |
|  | 1.9 TDI  | 66   |  | 04.00  | 04.01   | 11.0441-5704.2   | 250034  |   | Dichtungssatz     | ATE      |
|  | 1.9 TDI  | 85   |  | 04.00  | 04.01   | 11.0101-5407.2   | 260011  |   | Hülzensatz        | ATE      |
|  | 2.0 i  |  |  | 04.00  | 04.01   | 11.8171-0008.1   | 990049  |   | Führungsbolzen    | ATE      |
|  | 2.3 i 16V  |  |  | 04.00  | 04.01   | 11.8116-0143.1   | 390513  | 2   | Haltefeder        | ATE      |
|  | 1.9 TDI  | 66   |  | 05.01  | 04.06   | 11.9571-9811.2   | 220485  |      | D=57, - Halter    | ATE      |
|  | 1.9 TDI  | 85   |  | 05.01  | 04.06   | 11.9571-9812.2   | 220486  |      | D=57, - Halter    | ATE      |
|  | 1.9 TDI  | 96   |  | 02.03  | 04.06   | 11.0441-5704.2   | 250034  |   | Dichtungssatz     | ATE      |
|  | 2.0 i  |  |  | 05.01  | 04.06   | 11.0101-5407.2   | 260011  |   | Hülzensatz        | ATE      |
|  | 2.3 i 16V  |  |  | 05.01  | 04.06   | 11.8171-0008.1   | 990049  |   | Führungsbolzen    | ATE      |
| 2.8 i V6   | 150  |  | 05.01  | 04.06  | 11.8116-0326.1  | 390471   | 2   | Haltefeder  | ATE               |          |
| 1.9 TDI  | 110  |  | 05.05  | 04.06  | 11.9571-9819.2  | 220469   |    | D=57, - Halter  | ATE               |          |
| 2.8 i V6   | 150  |  | 04.00  | 04.06  | 11.9571-9820.2  | 220470   |    | D=57, - Halter  | ATE               |          |
| 1.9 TDI  | 66   |  | 01.96  | 04.01  | 83.7717-0450.3  | 330807   | 2   |   | L=450             |          |
| 1.9 TDI  | 81   |  | 10.97  | 03.00  | 24.5166-0454.3  | 331306   | 2   |   | L=454             |          |
| 2.0 i  |  |  | 09.95  | 04.01  |   |  |   |   |                   |          |
| 2.3 i 16V  |  |  | 01.97  | 04.01  |   |  |   |   |                   |          |
| 2.8 i V6   | 128  |  | 09.95  | 04.01  |   |  |   |   |                   |          |
| 1.9 TDI  | 66   |  | 05.01  | 04.06  | 83.6219-0455.3  | 330592   | 2   |   | L=455             |          |
| 1.9 TDI  | 85   |  | 05.01  | 04.06  |   |  |   |   |                   |          |
| 1.9 TDI  | 96   |  | 05.01  | 04.06  |   |  |   |   |                   |          |
| 1.9 TDI  | 110  |  | 05.05  | 04.06  |   |  |   |   |                   |          |
| 2.0 i  |  |  | 05.01  | 04.06  |   |  |   |   |                   |          |
| 2.3 i 16V  |  |  | 05.01  | 04.06  |   |  |   |   |                   |          |
| 2.8 i V6   | 150  |  | 05.01  | 04.06  |   |  |   |   |                   |          |
|  | 1.9 TDI  | 66   |  | 01.96  | 04.06   | 24.3384-1707.5   | 240171  |    | D=38, - Halter    | LUC      |
|  | 1.9 TDI  | 81   |  | 10.97  | 03.00   | 24.3384-1708.5   | 240172  |    | D=38, - Halter    | LUC      |
|  | 1.9 TDI  | 85   |  | 04.00  | 04.06   |  |   |   |                   |          |
|  | 1.9 TDI  | 96   |  | 02.03  | 04.06   |  |   |   |                   |          |
|  | 2.0 i  |  |  | 09.95  | 04.06   |  |   |   |                   |          |
|  | 2.3 i 16V  |  |  | 01.97  | 04.06   |  |   |   |                   |          |
| 2.8 i V6   | 128  |  | 09.95  | 04.06  |   |  |   |   |                   |          |
| 1.9 TDI  | 110  |  | 05.05  | 04.06  | 24.3384-1715.5  | 240265   |  | D=38, - Halter  | LUC               |          |
| 2.8 i V6   | 150  |  | 04.00  | 04.06  | 24.3384-1716.5  | 240266   |  | D=38, - Halter  | LUC               |          |
|  | 1.9 TDI  | 66   |  | 01.96  | 04.06   | 83.6225-0370.3   | 330768  | 2   |                   | L=370    |
|  | 1.9 TDI  | 81   |  | 10.97  | 03.00   | 83.6113-0140.3   | 330482  | 2   | am Bremssattel 1) | L=140    |
|  | 1.9 TDI  | 85   |  | 04.00  | 04.06   |  |   |   |                   |          |
|  | 1.9 TDI  | 96   |  | 02.03  | 04.06   |  |   |   |                   |          |
|  | 1.9 TDI  | 110  |  | 05.05  | 04.06   |  |   |   |                   |          |
|  | 2.0 i  |  |  | 09.95  | 04.06   |  |   |   |                   |          |
|  | 2.3 i 16V  |  |  | 01.97  | 04.06   |  |   |   |                   |          |
|  | 2.8 i V6   | 128  |  | 09.95  | 03.00   |  |   |   |                   |          |
|  | 1.9 TDI  | 66   |  | 01.96  | 04.06   | 24.3727-0163.2   | 580163  | 2  |                   | L=1293   |
|  | 1.9 TDI  | 81   |  | 10.97  | 03.00   |  |   |   |                   |          |
|  | 1.9 TDI  | 85   |  | 04.00  | 04.06   |  |   |   |                   |          |
|  | 1.9 TDI  | 96   |  | 02.03  | 04.06   |  |   |   |                   |          |
|  | 1.9 TDI  | 110  |  | 05.05  | 04.06   |  |   |   |                   |          |
|  | 2.0 i  |  |  | 09.95  | 04.06   |  |   |   |                   |          |
|  | 2.3 i 16V  |  |  | 01.97  | 04.06   |  |   |   |                   |          |
|  | 2.8 i V6   | 128  |  | 09.95  | 03.00   |  |   |   |                   |          |
| 2.8 i V6   | 150  |  | 04.00  | 04.06  |   |  |   |   |                   |          |
|  | 1.9 TDI  | 66   |  | 01.96  | 04.06   | 24.2419-1722.3   | 030111  |   |                   | Gz 19,05 |
|  | 1.9 TDI  | 81   |  | 10.97  | 03.00   |  |   |   |                   |          |
|  | 1.9 TDI  | 85   |  | 04.00  | 04.06   |  |   |   |                   |          |
|  | 1.9 TDI  | 96   |  | 02.03  | 04.06   |  |   |   |                   |          |
|  | 1.9 TDI  | 110  |  | 05.05  | 04.06   |  |   |   |                   |          |
|  | 2.0 i  |  |  | 09.95  | 04.06   |  |   |   |                   |          |
|  | 2.3 i 16V  |  |  | 01.97  | 04.06   |  |   |   |                   |          |
|  | 2.8 i V6   | 128  |  | 09.95  | 03.00   |  |   |   |                   |          |

1) on the brake caliper / sulla pinza freno / sur l'étrier de frein / a la pinza de freno

|     |    |                  |   |  |       |  |  |                                 |
|--|--|--|---|--|--|--|--|---|
| <b>FORD GALAXY II (06-)</b>  |  |  |   |  |  |  |  |   |
|    | 1.6 EcoBoost<br>1.6 TDCi<br>1.8 TDCi<br>1.8 TDCi<br>2.0 Flexifuel<br>2.0 i 16V<br>2.0 SCTi EcoBoost<br>2.0 TDCi<br>2.0 TDCi<br>2.0 TDCi<br>2.0 TDCi<br>2.0 TDCi<br>2.2 TDCi<br>2.2 TDCi<br>2.3 i 16V | 118<br>85<br>74<br>92<br>107<br>107<br>149<br>85<br>96<br>100<br>103<br>120<br>129<br>147<br>118 | 02.11<br>02.11<br>04.06<br>04.06<br>05.06<br>04.06<br>03.10<br>10.07<br>04.06<br>05.06<br>04.06<br>03.10<br>04.08<br>07.10<br>07.07 |  | 03.7755-9403.4   | 300238   |  | 9/8" Tandem<br>ATE  |
|    | 1.6 EcoBoost<br>1.6 TDCi<br>1.8 TDCi<br>1.8 TDCi<br>2.0 Flexifuel<br>2.0 i 16V<br>2.0 TDCi<br>2.0 TDCi<br>2.0 TDCi<br>2.0 TDCi<br>2.0 TDCi<br>2.2 TDCi<br>2.2 TDCi<br>2.3 i 16V                      | 118<br>85<br>74<br>92<br>107<br>107<br>85<br>96<br>100<br>103<br>120<br>129<br>147<br>118        | 02.11<br>02.11<br>04.06<br>04.06<br>05.06<br>04.06<br>10.07<br>04.06<br>05.06<br>04.06<br>03.10<br>11.08<br>07.10<br>07.07          |  | 11.9601-9711.2<br>11.9601-9712.2<br>11.8116-0206.1<br>11.0101-5407.2<br>11.8171-0008.1 | 220873<br>220874<br>390593<br>260011<br>990049                                     | 2  | D=60, - Halter<br>ATE<br>D=60, - Halter<br>ATE<br>Haltefeder<br>ATE<br>Hülzensatz<br>ATE<br>Führungsbolzen<br>ATE |
|  | 2.0 SCTi EcoBoost<br>2.2 TDCi  | 149<br>129   | 03.10<br>04.08  | 10.08  | 11.9606-9949.2<br>11.9606-9950.2<br>11.0101-5704.2<br>11.8171-0008.1<br>11.8116-0388.2 | 220879<br>220880<br>260095<br>990049<br>390588                                     | 2  | D=60, - Halter<br>ATE<br>D=60, - Halter<br>ATE<br>Hülzensatz<br>ATE<br>Führungsbolzen<br>ATE<br>Haltefeder<br>ATE |
|    | 1.6 EcoBoost<br>1.6 TDCi<br>1.8 TDCi<br>1.8 TDCi<br>2.0 Flexifuel<br>2.0 i 16V<br>2.0 SCTi EcoBoost<br>2.0 TDCi<br>2.0 TDCi<br>2.0 TDCi<br>2.0 TDCi<br>2.2 TDCi<br>2.2 TDCi<br>2.3 i 16V             | 118<br>85<br>74<br>92<br>107<br>107<br>149<br>85<br>96<br>100<br>103<br>120<br>129<br>147<br>118 | 02.11<br>02.11<br>04.06<br>04.06<br>05.06<br>04.06<br>11.11<br>10.07<br>04.06<br>05.06<br>04.06<br>03.10<br>10.08<br>07.10<br>07.07 |  | 24.5162-0390.3   | 331199   | 2  | L=390   |
|  | 1.6 EcoBoost<br>1.6 TDCi<br>1.8 TDCi<br>1.8 TDCi<br>2.0 Flexifuel<br>2.0 i 16V<br>2.0 SCTi EcoBoost<br>2.0 TDCi<br>2.0 TDCi<br>2.0 TDCi<br>2.0 TDCi<br>2.2 TDCi<br>2.2 TDCi<br>2.3 i 16V             | 118<br>85<br>74<br>92<br>107<br>107<br>149<br>85<br>96<br>100<br>103<br>120<br>129<br>147<br>118 | 02.11<br>02.11<br>12.06<br>12.06<br>12.06<br>12.06<br>03.10<br>10.07<br>12.06<br>12.06<br>03.10<br>04.08<br>07.10<br>07.07          |  | 24.5163-0155.3   | 331204   | 2  | - elektrische Feststellbremse <sup>1)</sup> L=155   |
|  | 1.6 EcoBoost<br>1.6 TDCi<br>1.8 TDCi<br>1.8 TDCi<br>2.0 Flexifuel<br>2.0 i 16V<br>2.0 SCTi EcoBoost<br>2.0 TDCi<br>2.0 TDCi<br>2.0 TDCi<br>2.0 TDCi<br>2.2 TDCi<br>2.2 TDCi<br>2.3 i 16V             | 118<br>85<br>74<br>92<br>107<br>107<br>149<br>85<br>96<br>100<br>103<br>120<br>129<br>147<br>118 | 02.11<br>02.11<br>04.06<br>04.06<br>05.06<br>04.06<br>03.10<br>10.07<br>04.06<br>05.06<br>04.06<br>03.10<br>04.08<br>07.10<br>07.07 |  | 24.5133-0310.3   | 331197   | 2  | + elektrische Feststellbremse <sup>2)</sup> L=310   |
|  | 1.8 TDCi<br>1.8 TDCi<br>2.0 Flexifuel<br>2.0 i 16V<br>2.0 TDCi<br>2.0 TDCi<br>2.0 TDCi   | 74<br>92<br>107<br>107<br>85<br>96<br>100<br>103   | 04.06<br>04.06<br>05.06<br>04.06<br>10.07<br>04.06<br>05.06<br>04.06  | 06.09<br>06.09<br>06.09<br>06.09<br>06.09<br>06.09<br>06.09                      | 24.5133-0311.3   | 331198   | 2  | + elektrische Feststellbremse <sup>2)</sup> L=310   |

<sup>1)</sup> - electric parking brake / - freno a mano elettrico / - frein à main électrique / - freno de mano eléctrico  
<sup>2)</sup> + electric parking brake / + freno a mano elettrico / + frein à main électrique / + freno de mano eléctrico













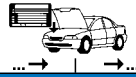













|     |    |                  |  |   |  |  |    |  |        |  |   |  |
|--|--|--|--|---|---|--|--|--|--------|--|---|--|
| <b>FORD GALAXY II (06-)</b>  |  |  |  |   |   |  |  |  |        |  |   |  |
|    | 2.2 TDCi<br>2.3 i 16V  | 129<br>118   |  | 04.08<br>07.07  | 06.09<br>06.09  |  | 24.5133-0311.3   | 331198   | 2      | + elektrische Feststellbremse <sup>1)</sup>  | L=310   |  |
|    | 1.6 EcoBoost<br>1.6 TDCi<br>1.8 TDCi<br>1.8 TDCi<br>2.0 Flexifuel<br>2.0 i 16V<br>2.0 SCTi EcoBoost<br>2.0 TDCi<br>2.0 TDCi<br>2.0 TDCi<br>2.0 TDCi<br>2.0 TDCi<br>2.2 TDCi<br>2.2 TDCi<br>2.3 i 16V | 118<br>85<br>74<br>92<br>107<br>107<br>149<br>85<br>96<br>100<br>103<br>120<br>129<br>147<br>118 |  | 02.11<br>02.11<br>02.07<br>02.07<br>02.07<br>02.07<br>03.10<br>10.07<br>02.07<br>02.07<br>02.07<br>03.10<br>04.08<br>07.10<br>07.07 |   |  | 24.3727-0676.2<br>24.3727-0677.2   | 580676<br>580677   |        | + mechanische Feststellbremse <sup>2)</sup><br>+ mechanische Feststellbremse <sup>2)</sup>                           | L=2078<br>L=2071  |  |
| <b>FORD KA I (96-08)</b>   |  |  |  |   |   |  |  |  |        |  |   |  |
|    | 1.6 i  | 70   |  | 08.03   | 09.08   |  | 03.7750-5432.4   | 300248   |        |  | 9"  | ATE                                    |
|    | 1.0 i<br>1.3 i   |  |  | 11.96<br>11.96  | 08.99<br>08.99  | - ABS<br>- ABS   | 24.2120-1720.3   | 010530   |        |  | THz 20,64   |  |
|    | 1.0 i<br>1.3 i   |  |  | 11.96<br>11.96  | 09.08<br>09.08  | + ABS<br>+ ABS   | 24.2122-1729.3   | 010650   |        |  | THz 22,20   |  |
|    | 1.0 i<br>1.3 i   |  |  | 11.96<br>11.96  | 01.00<br>01.00  |  | 11.3481-8513.2<br>11.3481-8514.2<br>11.0441-4805.2<br>11.0230-0165.2<br>11.0101-5407.2<br>11.8171-0008.1<br>11.8116-0264.1 | 220335<br>220336<br>250020<br>260073<br>260011<br>990049<br>390594                 | 2      | <input type="checkbox"/> -<br><input type="checkbox"/> -   | D=48, - Halter<br>D=48, - Halter<br>Dichtungssatz<br>Haltersatz<br>Hülzensatz<br>Führungsbolzen<br>Halterfeder      | ATE<br>ATE<br>ATE<br>ATE<br>ATE<br>ATE |
|    | 1.0 i<br>1.3 i   |  |  | 02.00<br>02.00  | 09.08<br>09.08  |  | 11.3481-8515.2<br>11.3481-8516.2<br>24.3481-8515.5<br>24.3481-8516.5<br>11.0101-5407.2<br>11.8171-0008.1<br>11.8116-0264.1 | 220365<br>220366<br>240477<br>240478<br>260011<br>990049<br>390594                 | 2      | <input type="checkbox"/> -<br><input type="checkbox"/> -<br><input type="checkbox"/> -<br><input type="checkbox"/> - | D=48, - Halter<br>D=48, - Halter<br>D=48, - Halter<br>D=48, - Halter<br>Hülzensatz<br>Führungsbolzen<br>Halterfeder | ATE<br>ATE<br>ATE<br>ATE<br>ATE<br>ATE |
|  | 1.6 i  | 70   |  | 08.03   | 09.08   |  | 11.3541-8531.2<br>11.3541-8532.2<br>11.0101-5407.2<br>11.8171-0008.1<br>11.8116-0264.1                                     | 220367<br>220368<br>260011<br>990049<br>390594                                     | 2      | <input type="checkbox"/> -<br><input type="checkbox"/> -   | D=54, - Halter<br>D=54, - Halter<br>Hülzensatz<br>Führungsbolzen<br>Halterfeder                                     | ATE<br>ATE<br>ATE<br>ATE               |
|  | 1.0 i<br>1.3 i   |  |  | 11.96<br>11.96  | 09.08<br>09.08  |  | 24.5308-0488.3<br>24.5308-0489.3   | 330776<br>330777   |        | <input type="checkbox"/> - ABS<br><input type="checkbox"/> - ABS   | L=488<br>L=488  |  |
|  | 1.0 i<br>1.3 i   |  |  | 11.96<br>11.96  | 09.98<br>09.98  |  | 24.5305-0350.3   | 330660   | 2      |  | L=352   |  |
|  | 1.0 i<br>1.3 i   |  |  | 10.98<br>10.98  | 01.00<br>01.00  |  | 24.5305-0340.3   | 330659   | 2      |  | L=340   |  |
|  | 1.0 i<br>1.3 i   |  |  | 02.00<br>02.00  | 09.08<br>09.08  |  | 24.5305-0351.3   | 330687   | 2      |  | L=350   |  |
|  | 1.6 i  | 70   |  | 08.03   | 09.08   |  | 24.5305-0352.3   | 331041   | 2      |  | L=352   |  |
|  | 1.0 i<br>1.3 i   |  |  | 11.96<br>11.96  | 01.00<br>01.00  |  | 24.3219-1107.3   | 020338   |        | nur paarweise austauschen <sup>3)</sup>  | Rz 19,05  | LUC                                    |
|  | 1.0 i<br>1.3 i   |  |  | 02.00<br>02.00  | 09.08<br>09.08  |  | 24.3219-1735.3   | 020464   |        |  | Rz 19,05  |  |
|  | 1.6 i  | 70   |  | 08.03   | 09.08   |  | 24.3219-1735.3   | 020464   |        |  | Rz 19,05  |  |
|  | 1.0 i<br>1.3 i   |  |  | 11.96<br>11.96  | 11.06<br>11.06  |  | 24.3727-1800.2<br>24.3727-0660.2   | 581800<br>580660   | 1<br>1 | <input type="checkbox"/> ↑<br><input type="checkbox"/> ↓   | L=312<br>L=1575/1627  |  |
|  | 1.0 i<br>1.3 i   |  |  | 12.06<br>12.06  | 09.08<br>09.08  |  | 24.3727-0668.2<br>24.3727-0666.2   | 580668<br>580666   | 1<br>1 | <input type="checkbox"/> ↑<br><input type="checkbox"/> ↓   | L=333<br>L=1575/1627  |  |
|  | 1.6 i  | 70   |  | 08.03   | 09.08   |  | 24.3727-0668.2<br>24.3727-0665.2   | 580668<br>580665   | 1<br>1 | <input type="checkbox"/> ↑<br><input type="checkbox"/> ↓   | L=333<br>L=1575/1627  |  |
|  | 1.0 i<br>1.3 i   |  |  | 11.96<br>11.96  | 08.98<br>08.98  |  | 24.2419-1737.3   | 030129   |        |  | Gz 19,05  |  |
|  | 1.0 i<br>1.3 i   |  |  | 09.98<br>09.98  | 09.08<br>09.08  |  | 24.2419-1736.3   | 030128   |        |  | Gz 19,05  |  |
| <b>FORD KA II (08-)</b>  |  |  |  |   |   |  |  |  |        |  |   |  |
|  | 1.2 i 16V<br>1.3 TDCi  | 51<br>55   |  | 10.08<br>10.08  |   |  | 24.5112-0356.3   | 331129   | 2      |  | L=355   |  |
|  | 1.2 i 16V<br>1.3 TDCi  | 51<br>55   |  | 10.08<br>10.08  |   |  | 24.5228-0165.3   | 330879   | 2      |  | L=165   |  |
|  | 1.2 i 16V<br>1.3 TDCi  | 51<br>55   |  | 10.08<br>10.08  | 05.10<br>05.10  |  | 24.3220-1108.3   | 020219   |        |  | Rz 20,64  | BDX                                    |

<sup>1)</sup> + electric parking brake / + freno a mano elettrico / + frein à main électrique / + freno de mano eléctrico

<sup>2)</sup> + mechanical parking brake / + fr. stazionamento meccanico / + frein à main mécanique / + freno de mano mecánica

<sup>3)</sup> to change only by pairs / sostituire solo a coppie / à changer seulement par paires / cambiar solamente por parejas

|     |            |  |  |    |  |   |    |   |
|--|--|--|--|--|---|---|--|---|
| <b>FORD KA II (08-)</b>  |  |  |  |  |   |   |  |   |
|    | 1.2 i 16V<br>1.3 TDCi  | 51<br>55   |  | 10.08<br>10.08   |   | 24.3727-0670.2 580670<br>24.3727-0671.2 580671  | <input type="checkbox"/>   | L=1402<br>L=1450  |
|    | 1.2 i 16V<br>1.3 TDCi  | 51<br>55   |  | 10.08<br>10.08   |   | 24.3728-0532.2 590532<br>24.3728-0628.2 590628  |  | L=995<br>L=1028   |
| <b>FORD KUGA I (08-12)</b>   |  |  |  |  |   |   |  |   |
|    | 2.0 TDCi<br>2.0 TDCi<br>2.0 TDCi 4x4<br>2.0 TDCi 4x4<br>2.0 TDCi 4x4<br>2.5 i<br>2.5 i 4x4 | 1100<br>1103<br>1100<br>1103<br>1120<br>1147<br>1147                             |  | 04.08 12.12<br>03.10 12.12<br>04.08 12.12<br>03.10 12.12<br>03.10 12.12<br>03.09 12.12<br>11.08 12.12  |   | 03.7755-7703.4 300247   |  | 9/8" Tandem <b>ATE</b>  |
|  | 2.0 TDCi<br>2.0 TDCi<br>2.0 TDCi 4x4<br>2.0 TDCi 4x4<br>2.0 TDCi 4x4                       | 1100<br>1103<br>1100<br>1103<br>1120   |  | 04.08 12.12<br>03.10 12.12<br>04.08 12.12<br>03.10 12.12<br>03.10 12.12  |   | 03.7760-2232.4 300266   |  | 10" <b>ATE</b>  |
|    | 2.0 TDCi<br>2.0 TDCi<br>2.0 TDCi 4x4<br>2.0 TDCi 4x4<br>2.0 TDCi 4x4<br>2.5 i<br>2.5 i 4x4 | 1100<br>1103<br>1100<br>1103<br>1120<br>1147<br>1147                             |  | 11.08 12.12<br>03.10 12.12<br>11.08 12.12<br>03.10 12.12<br>03.10 12.12<br>03.09 12.12<br>11.08 12.12  |   | 03.2125-0651.3 010935   |  | THz 25,40 <b>ATE</b>  |
|  | 2.0 TDCi<br>2.0 TDCi 4x4   | 1100<br>1100   |  | 04.08 10.08<br>04.08 10.08   |   | 03.2125-0483.3 010783   |  | THz 25,40 <b>ATE</b>  |
|  | 2.0 TDCi<br>2.0 TDCi 4x4   | 1100<br>1100   |  | 11.08 12.12<br>11.08 12.12   |   | 03.2125-0661.3 010917   |  | THz 25,40 <b>ATE</b>  |
|    | 2.0 TDCi<br>2.0 TDCi<br>2.0 TDCi 4x4<br>2.0 TDCi 4x4<br>2.0 TDCi 4x4<br>2.5 i<br>2.5 i 4x4 | 100<br>103<br>100<br>103<br>120<br>147<br>147                                    |  | 04.08 12.12<br>03.10 12.12<br>04.08 12.12<br>03.10 12.12<br>03.10 12.12<br>03.09 12.12<br>11.08 12.12  |   | 11.9571-9813.2 220647<br>11.9571-9814.2 220648<br>24.3571-9813.5 240557<br>24.3571-9814.5 240558<br>11.0101-5407.2 260011<br>11.8171-0008.1 990049<br>11.8116-0356.1 390586 | <input type="checkbox"/><br><input type="checkbox"/><br><input type="checkbox"/><br><input type="checkbox"/>   | D=57, - Halter <b>ATE</b><br>D=57, - Halter <b>ATE</b><br>D=57, - Halter <b>ATE</b><br>D=57, - Halter <b>ATE</b><br>Hülzensatz <b>ATE</b><br>Führungsbolzen <b>ATE</b><br>Haltefeder <b>ATE</b> |
|   | 2.0 TDCi<br>2.0 TDCi<br>2.0 TDCi 4x4<br>2.0 TDCi 4x4<br>2.0 TDCi 4x4<br>2.5 i<br>2.5 i 4x4 | 100<br>103<br>100<br>103<br>120<br>147<br>147                                    |  | 04.08 12.12<br>03.10 12.12<br>04.08 12.12<br>03.10 12.12<br>03.10 12.12<br>03.09 12.12<br>11.08 12.12  |   | 83.7788-0435.3 331119   | 2  | L=435   |
|  | 2.0 TDCi<br>2.0 TDCi<br>2.0 TDCi 4x4<br>2.0 TDCi 4x4<br>2.0 TDCi 4x4<br>2.5 i<br>2.5 i 4x4 | 100<br>103<br>100<br>103<br>120<br>147<br>147                                    |  | 04.08 12.12<br>03.10 12.12<br>04.08 12.12<br>03.10 12.12<br>03.10 12.12<br>03.09 12.12<br>11.08 12.12  |   | 83.7788-0472.3 331120   | 2  | L=472   |
|  | 2.0 TDCi<br>2.0 TDCi<br>2.0 TDCi 4x4<br>2.0 TDCi 4x4<br>2.0 TDCi 4x4<br>2.5 i<br>2.5 i 4x4 | 100<br>103<br>100<br>103<br>120<br>147<br>147                                    |  | 04.08 12.12<br>03.10 12.12<br>04.08 12.12<br>03.10 12.12<br>03.10 12.12<br>03.09 12.12<br>11.08 12.12  |   | 24.3727-0667.2 580667<br>24.3727-0672.2 580672  | 1 <br>1  | L=360<br>L=1848/1933  |
| <b>FORD KUGA II (13-)</b>  |  |  |  |  |   |   |  |   |
|  | 1.6 EcoBoost   | 110  |  | 01.13  |   | 11.9571-9813.2 220647<br>24.3571-9813.5 240557<br>11.9571-9814.2 220648<br>24.3571-9814.5 240558  | <input type="checkbox"/><br><input type="checkbox"/><br><input type="checkbox"/><br><input type="checkbox"/>   | D=57, - Halter <b>ATE</b><br>D=57, - Halter <b>ATE</b><br>D=57, - Halter <b>ATE</b><br>D=57, - Halter <b>ATE</b>  |
|  | 1.6 EcoBoost<br>1.6 EcoBoost 4x4<br>2.0 TDCi<br>2.0 TDCi                                   | 110<br>134<br>103<br>120   |  | 01.13<br>01.13<br>01.13<br>01.13   |   | 11.8116-0340.1 390595   | 2  | Haltefeder <b>ATE</b>   |
| <b>FORD MAVERICK (93-96)</b>   |  |  |  |  |   |   |  |   |
|  | 2.4 i<br>2.7 TD  |  |  | 02.93 09.96<br>02.93 09.96   |   | 24.2123-1726.3 010557   |  | THz 23,81 - Behälter  |
|  | 2.4 i<br>2.7 TD<br>2.4 i<br>2.7 TD   |  |  | 02.93 09.96 + 2 türig <sup>1)</sup><br>02.93 09.96 + 2 türig <sup>1)</sup><br>02.93 09.96 + 4 türig <sup>2)</sup><br>02.93 09.96 + 4 türig <sup>2)</sup> |   | 24.3222-1717.3 020443<br>24.3223-1709.3 020444  |  | Rz 22,20<br>Rz 23,81  |
| <b>FORD MAVERICK (97-98)</b>   |  |  |  |  |   |   |  |   |
|  | 2.4 i<br>2.7 TD  |  |  | 10.96 03.98<br>10.96 03.98   |   | 24.2125-1738.3 010931   |  | THz 25,40 <b>LUC</b>  |

1) + 2 door / + 2 porte / + 2 portes / + 2 puertas  
2) + 4 door / + 4 porte / + 4 portes / + 4 puertas

| <b>FORD MAVERICK (97-98)</b> |  |                                |  |   |   |                                  |  |  |  |        |   |  |  |  |  |  |  |  |
|------------------------------|--|--------------------------------|--|---|---|----------------------------------|--|--|--|--------|---|--|--|--|--|--|--|--|
|                              | 2.4 i<br>2.7 TD  |                                |  | 10.96<br>10.96                            | 03.98<br>03.98                            | + 2 türg 1)<br>+ 2 türg 1)       |  | 24.3223-1709.3   | 020444   |        |   |  |  |  |  |  |  | Rz 23,81   |
| <b>FORD MAVERICK (01-07)</b> |  |                                |  |   |   |                                  |  |  |  |        |   |  |  |  |  |  |  |  |
|                              | 2.0 i 16V<br>2.3 i 16V<br>3.0 i V6<br>3.0 i 24V<br>3.0 i 24V                             | 91<br>110<br>145<br>149<br>149 |  | 02.01<br>03.04<br>02.01<br>03.04<br>05.06 | 06.07<br>06.07<br>06.07<br>04.06<br>06.07 |                                  |  | 24.3727-0673.2<br>24.3727-0674.2   | 580673<br>580674   | 1<br>1 | + Ganzbodenkonsole 2)<br>- Ganzbodenkonsole 3)  |  |  |  |  |  |  | L=819<br>L=988<br>L=1081<br>L=1081   |
| <b>FORD MONDEO I (93-96)</b> |  |                                |  |   |   |                                  |  |  |  |        |   |  |  |  |  |  |  |  |
|                              | 1.6 i 16V<br>1.8 i 16V<br>1.8 TD<br>2.0 i 16V  |                                |  | 01.93<br>01.93<br>01.93<br>01.93          | 12.95<br>12.95<br>12.95<br>12.95          | - ABS<br>- ABS<br>- ABS<br>- ABS |  | 24.2125-1705.3   | 010495   |        |   |  |  |  |  |  |  | Thz 25,40  |
|                              | 1.6 i 16V<br>1.8 i 16V<br>1.8 TD<br>2.0 i 16V  |                                |  | 01.96<br>01.96<br>01.96<br>01.96          | 09.96<br>09.96<br>09.96<br>09.96          | - ABS<br>- ABS<br>- ABS<br>- ABS |  | 24.2125-1706.3   | 010496   |        |   |  |  |  |  |  |  | Thz 25,40  |
|                              | 1.6 i 16V<br>1.8 i 16V<br>1.8 TD<br>2.0 i 16V<br>2.5 i 24V                               |                                |  | 01.93<br>01.93<br>01.93<br>01.93<br>08.94 | 12.95<br>12.95<br>12.95<br>12.95<br>12.95 | + ABS<br>+ ABS<br>+ ABS<br>+ ABS |  | 24.2125-1707.3   | 010497   |        |   |  |  |  |  |  |  | Thz 25,40  |
|                              | 1.6 i 16V<br>1.8 i 16V<br>1.8 TD<br>2.0 i 16V<br>2.5 i 24V                               |                                |  | 01.96<br>01.96<br>01.96<br>01.96<br>01.96 | 09.96<br>09.96<br>09.96<br>09.96<br>09.96 | + ABS<br>+ ABS<br>+ ABS<br>+ ABS |  | 24.2125-1708.3   | 010498   |        |   |  |  |  |  |  |  | Thz 25,40  |
|                              | 1.6 i 16V<br>1.8 i 16V<br>1.8 TD<br>2.0 i 16V  |                                |  | 01.93<br>01.93<br>01.93<br>01.93          | 09.96<br>09.96<br>09.96<br>09.96          |                                  |  | 24.3601-8527.5<br>24.3601-8528.5<br>11.0441-6005.2<br>11.0230-0170.2<br>11.0101-5407.2<br>11.8171-0008.1<br>11.8116-0301.1 | 240503<br>240504<br>250150<br>260078<br>260011<br>990049<br>390610 | 2      |   |  |  |  |  |  |  | D=60, - Halter<br>D=60, - Halter<br>Dichtungssatz<br>Haltersatz<br>Hülensatz<br>Führungsbolzen<br>Haltefeder |
|                              | 2.0 i 16V 4x4<br>2.5 i 24V   |                                |  | 01.95<br>08.94                            | 09.96<br>09.96                            |                                  |  | 11.0441-6005.2<br>11.0101-5407.2<br>11.8171-0008.1<br>11.8116-0143.1   | 250150<br>260011<br>990049<br>390513                               | 2      |   |  |  |  |  |  |  | Dichtungssatz<br>Hülensatz<br>Führungsbolzen<br>Haltefeder   |
|                              | 1.6 i 16V<br>1.8 i 16V<br>1.8 TD<br>2.0 i 16V<br>2.5 i 24V                               |                                |  | 01.93<br>01.93<br>01.93<br>01.93<br>08.94 | 09.96<br>09.96<br>09.96<br>09.96<br>09.96 |                                  |  | 83.7114-0376.3   | 330373   | 2      |   |  |  |  |  |  |  | L=370  |
|                              | 1.8 i 16V Lim.<br>1.8 TD Lim.<br>2.0 i 16V Lim.<br>2.5 i 24V Lim.                        |                                |  | 01.93<br>01.93<br>01.93<br>08.94          | 09.96<br>09.96<br>09.96<br>09.96          |                                  |  | 24.3364-1703.5<br>24.3364-1704.5   | 240309<br>240310   |        |   |  |  |  |  |  |  | D=36, - Halter<br>D=36, - Halter   |
|                              | 1.8 i 16V Kombi<br>1.8 TD Kombi<br>2.0 i 16V Kombi<br>2.5 i 24V Kombi                    |                                |  | 01.93<br>01.93<br>01.93<br>08.94          | 09.96<br>09.96<br>09.96<br>09.96          |                                  |  | 24.3364-1705.5<br>24.3364-1706.5   | 240311<br>240312   |        |   |  |  |  |  |  |  | D=36, - Halter<br>D=36, - Halter   |
|                              | 1.6 i 16V Lim.<br>1.8 i 16V Lim.<br>1.8 TD Lim.<br>2.0 i 16V Lim.<br>2.5 i 24V Lim.      |                                |  | 01.93<br>01.93<br>01.93<br>01.93<br>08.94 | 12.95<br>12.95<br>12.95<br>12.95<br>12.95 |                                  |  | 83.6227-0281.3   | 330424   | 2      | + HA-Trommelbremse 4)                           |  |  |  |  |  |  | L=280  |
|                              | 1.6 i 16V Lim.<br>1.8 i 16V Lim.<br>1.8 TD Lim.<br>2.0 i 16V Lim.<br>2.5 i 24V Lim.      |                                |  | 01.96<br>01.96<br>01.96<br>01.96<br>01.96 | 09.96<br>09.96<br>09.96<br>09.96<br>09.96 |                                  |  | 83.6118-0281.3<br>83.6362-0542.3   | 330483<br>330485   | 2<br>2 | + HA-Trommelbremse 4)<br>+ HA-Scheibenbremse 5) |  |  |  |  |  |  | L=280<br>L=540   |
|                              | 1.6 i 16V Kombi<br>1.8 i 16V Kombi<br>1.8 TD Kombi<br>2.0 i 16V Kombi<br>2.5 i 24V Kombi |                                |  | 01.93<br>01.93<br>01.93<br>01.93<br>08.94 | 09.96<br>09.96<br>09.96<br>09.96<br>09.96 |                                  |  | 83.6114-0300.3<br>24.5164-0315.3   | 330258<br>331209   | 2<br>2 | + HA-Trommelbremse 4)<br>+ HA-Scheibenbremse 5) |  |  |  |  |  |  | L=300<br>L=315   |
|                              | 1.6 i 16V Lim.<br>1.8 i 16V Lim.<br>1.8 TD Lim.<br>2.0 i 16V Lim.                        |                                |  | 01.93<br>01.93<br>01.93<br>01.93          | 05.94<br>05.94<br>05.94<br>05.94          |                                  |  | 24.3220-1111.3   | 020222   |        |   |  |  |  |  |  |  | Rz 20,64   |
|                              | 1.6 i 16V Lim.<br>1.8 i 16V Lim.<br>1.8 TD Lim.<br>2.0 i 16V Lim.                        |                                |  | 06.94<br>06.94<br>06.94<br>06.94          | 09.96<br>09.96<br>09.96<br>09.96          |                                  |  | 24.3222-1114.3   | 020269   |        |   |  |  |  |  |  |  | Rz 22,20   |
|                              | 1.6 i 16V Kombi<br>1.8 i 16V Kombi<br>1.8 TD Kombi<br>2.0 i 16V Kombi                    |                                |  | 01.93<br>01.93<br>01.93<br>01.93          | 09.96<br>09.96<br>09.96<br>09.96          |                                  |  | 24.3222-1116.3   | 020271   |        |   |  |  |  |  |  |  | Rz 22,20   |

1) + 2 door / + 2 porte / + 2 portes / + 2 puertas

2) + center console / + mensola per pianale,sull'intera lunghezza / + console de plancher sur toute la longueur / + consola total de suelo

3) - center console / - mensola per pianale,sull'intera lunghezza / - console de plancher sur toute la longueur / - consola total de suelo

4) + RA drum brake / + P freno a tamburo / + frein à tambour essieu AR / + ET-tambores de freno

5) + RA disc brake / + P disco freno / + frein à disque essieu AR / + ET-disco de freno

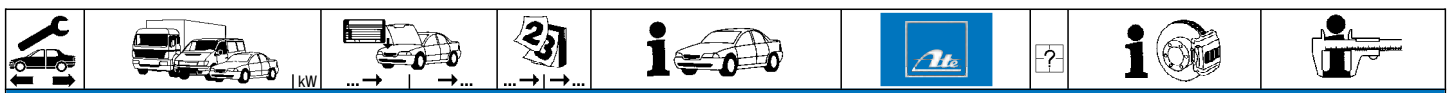

**FORD MONDEO I (93-96)**

|                 |                 |       |                |                |        |                       |  |                           |                       |
|-----------------|-----------------|-------|----------------|----------------|--------|-----------------------|--|---------------------------|-----------------------|
|                 | 1.6 i 16V Lim.  | 01.93 | 09.96          | 24.3727-0638.2 | 580638 | 1 ↑                   |  | L=270<br>L=1611<br>L=1462 |                       |
|                 | 1.8 i 16V Lim.  | 01.93 | 09.96          | 24.3727-0639.2 | 580639 | 2 ↓                   |  |                           | + HA-Trommelbremse 1) |
|                 | 1.8 TD Lim.     | 01.93 | 09.96          | 24.3727-0644.2 | 580644 | 2 ↓                   | + HA-Scheibenbremse 2)   |                           |                       |
|                 | 2.0 i 16V Lim.  | 01.93 | 09.96          |                |        |                       |  |                           |                       |
|                 | 2.5 i 24V Lim.  | 08.94 | 09.96          |                |        |                       |  |                           |                       |
|                 | 1.6 i 16V Kombi | 01.93 | 09.96          | 24.3727-0638.2 | 580638 | 1 ↑                   |  | L=270<br>L=1611<br>L=1647 |                       |
| 1.8 i 16V Kombi | 01.93           | 09.96 | 24.3727-0639.2 | 580639         | 2 ↓    | + HA-Trommelbremse 1) |  |                           |                       |
|                 | 1.8 TD Kombi    | 01.93 | 09.96          | 24.3727-0641.2 | 580641 | 2 ↓                   | + HA-Scheibenbremse 2)   |                           |                       |
|                 | 2.0 i 16V Kombi | 01.93 | 09.96          |                |        |                       |  |                           |                       |
|                 | 2.5 i 24V Kombi | 08.94 | 09.96          |                |        |                       |  |                           |                       |
|                 | 1.6 i 16V Lim.  | 01.93 | 12.95          | 03.6043-1774.3 | 320031 |                       | THz primär Anschluß M10x1 3)<br>THz sekundär Anschluß M12x1 4) | BRE 3/30                  | ATE                   |
| 1.8 i 16V Lim.  | 01.93           | 12.95 | 03.6043-1784.3 | 320034         |        | BRE 3/30              |  | ATE                       |                       |
|                 | 2.0 i 16V Lim.  | 01.93 | 12.95          |                |        |                       |  |                           |                       |
|                 | 1.6 i 16V Lim.  | 01.96 | 09.96          | 03.6043-1954.3 | 320226 | 2                     |  | BRE 3/30                  | ATE                   |
|                 | 1.8 i 16V Lim.  | 01.96 | 09.96          |                |        |                       |  |                           |                       |
|                 | 2.0 i 16V Lim.  | 01.96 | 09.96          |                |        |                       |  |                           |                       |
|                 | 1.6 i 16V Kombi | 01.93 | 12.95          | 03.6043-1773.3 | 320030 |                       | THz primär Anschluß M10x1 3)<br>THz sekundär Anschluß M12x1 4) | BRE 3/25                  | ATE                   |
|                 | 1.8 i 16V Kombi | 01.93 | 12.95          | 03.6043-1783.3 | 320033 |                       |  | BRE 3/25                  | ATE                   |
|                 | 1.8 TD          | 01.93 | 12.95          |                |        |                       |  |                           |                       |
|                 | 2.0 i 16V Kombi | 01.93 | 12.95          |                |        |                       |  |                           |                       |
|                 | 1.6 i 16V Kombi | 01.96 | 09.96          | 03.6043-1953.3 | 320201 | 2                     |  | BRE 3/45                  | ATE                   |
|                 | 1.8 i 16V Kombi | 01.96 | 09.96          |                |        |                       |  |                           |                       |
|                 | 1.8 TD Kombi    | 01.96 | 09.96          |                |        |                       |  |                           |                       |
|                 | 2.0 i 16V Kombi | 01.96 | 09.96          |                |        |                       |  |                           |                       |
|                 | 1.6 i 16V       | 01.93 | 12.95          | 03.6043-1776.3 | 320032 |                       | THz primär Anschluß M10x1 3)<br>THz sekundär Anschluß M12x1 4) | BRE 3/40                  | ATE                   |
|                 | 1.8 i 16V       | 01.93 | 12.95          | 03.6043-1786.3 | 320035 |                       |  | BRE 3/40                  | ATE                   |
|                 | 1.8 TD          | 01.93 | 12.95          |                |        |                       |  |                           |                       |
|                 | 2.0 i 16V       | 01.93 | 12.95          |                |        |                       |  |                           |                       |
|                 | 2.5 i 24V       | 08.94 | 12.95          |                |        |                       |  |                           |                       |
|                 | 1.6 i 16V       | 01.96 | 09.96          | 03.6043-1956.3 | 320202 | 2                     |  | BRE 3/40                  | ATE                   |
|                 | 1.8 i 16V       | 01.96 | 09.96          |                |        |                       |  |                           |                       |
|                 | 1.8 TD          | 01.96 | 09.96          |                |        |                       |  |                           |                       |
|                 | 2.0 i 16V       | 01.96 | 09.96          |                |        |                       |  |                           |                       |
|                 | 2.5 i 24V       | 01.96 | 09.96          |                |        |                       |  |                           |                       |
|                 | 1.6 i 16V       | 08.94 | 09.96          | 24.2419-1723.3 | 030112 |                       |  | Gz 19,05                  |                       |
|                 | 1.8 i 16V       | 08.94 | 09.96          |                |        |                       |  |                           |                       |
|                 | 1.8 TD          | 08.94 | 09.96          |                |        |                       |  |                           |                       |
|                 | 2.0 i 16V       | 08.94 | 09.96          |                |        |                       |  |                           |                       |
|                 | 2.5 i 24V       | 08.94 | 09.96          |                |        |                       |  |                           |                       |

**FORD MONDEO II (96-00)**

|                |                 |       |                |                |        |   |   |           |
|----------------|-----------------|-------|----------------|----------------|--------|---|---|-----------|
|                | 1.6 i 16V       | 10.96 | 09.00          | 24.2125-1706.3 | 010496 |   |   | THz 25,40 |
|                | 1.8 i 16V       | 10.96 | 09.00          |                |        |   |   |           |
|                | 1.8 TD          | 10.96 | 09.00          |                |        |   |   |           |
|                | 2.0 i 16V       | 10.96 | 09.00          |                |        |   |   |           |
|                | 2.5 i 24V       | 10.96 | 09.00          |                |        |   |   |           |
|                | 2.5 ST 200      | 05.99 | 09.00          |                |        |   |   |           |
|                | 1.6 i 16V       | 10.96 | 09.00          | 24.2125-1709.3 | 010499 |   |   | THz 25,40 |
|                | 1.8 i 16V       | 10.96 | 09.00          |                |        |   |   |           |
|                | 1.8 TD          | 10.96 | 09.00          |                |        |   |   |           |
|                | 2.0 i 16V       | 10.96 | 09.00          |                |        |   |   |           |
|                | 2.5 i 24V       | 10.96 | 09.00          |                |        |   |   |           |
|                | 2.5 ST 200      | 05.99 | 09.00          |                |        |   |   |           |
|                | 1.6 i 16V       | 10.96 | 09.00          | 24.3601-8527.5 | 240503 | 2 | D=60, - Halter<br>D=60, - Halter<br>Dichtungssatz<br>Haltersatz<br>Hülzensatz<br>Führungsbolzen<br>Haltefeder | ATE       |
|                | 1.8 i 16V       | 10.96 | 09.00          | 24.3601-8528.5 | 240504 |   |   | ATE       |
|                | 1.8 TD          | 10.96 | 09.00          | 11.0441-6005.2 | 250150 |   |   | ATE       |
|                | 2.0 i 16V       | 10.96 | 09.00          | 11.0230-0170.2 | 260078 |   |   | ATE       |
|                | 2.5 i 24V       | 12.97 | 09.00          | 11.0101-5407.2 | 260011 |   |   | ATE       |
|                | 2.5 ST 200      | 05.99 | 09.00          | 11.8171-0008.1 | 990049 |   |   | ATE       |
|                | 2.5 i 24V       | 10.96 | 11.97          | 11.8116-0301.1 | 390610 |   |   | ATE       |
|                |                 |       |                | 11.0441-6005.2 | 250150 |   |   | ATE       |
|                |                 |       |                | 11.0101-5407.2 | 260011 |   |   | ATE       |
|                |                 |       |                | 11.8171-0008.1 | 990049 |   |   | ATE       |
|                |                 |       |                | 11.8116-0143.1 | 390513 |   |   | ATE       |
|                |                 |       |                |                |        |   |   |           |
|                | 1.6 i 16V       | 10.96 | 09.00          | 83.7114-0376.3 | 330373 | 2 |   | L=370     |
|                | 1.8 i 16V       | 10.96 | 09.00          |                |        |   |   |           |
|                | 1.8 TD          | 10.96 | 09.00          |                |        |   |   |           |
|                | 2.0 i 16V       | 10.96 | 09.00          |                |        |   |   |           |
|                | 2.5 i 24V       | 10.96 | 09.00          |                |        |   |   |           |
|                | 1.6 i 16V Lim.  | 10.96 | 09.00          | 24.3364-1703.5 | 240309 | 2 | D=36, - Halter<br>D=36, - Halter  | BOS       |
| 1.8 i 16V Lim. | 10.96           | 09.00 | 24.3364-1704.5 | 240310         | BOS    |   |   |           |
|                | 1.8 TD Lim.     | 10.96 | 09.00          |                |        |   |   |           |
|                | 2.0 i 16V Lim.  | 10.96 | 09.00          |                |        |   |   |           |
|                | 2.5 i 24V Lim.  | 10.96 | 09.00          |                |        |   |   |           |
|                | 2.5 ST 200      | 05.99 | 09.00          |                |        |   |   |           |
|                | 1.6 i 16V Kombi | 10.96 | 09.00          | 24.3364-1705.5 | 240311 | 2 | D=36, - Halter<br>D=36, - Halter  | BOS       |
|                | 1.8 i 16V Kombi | 10.96 | 09.00          | 24.3364-1706.5 | 240312 |   |   | BOS       |
|                | 1.8 TD Kombi    | 10.96 | 09.00          |                |        |   |   |           |
|                | 2.0 i 16V Kombi | 10.96 | 09.00          |                |        |   |   |           |
|                | 2.5 i 24V Kombi | 10.96 | 09.00          |                |        |   |   |           |
|                | 2.5 ST 200      | 05.99 | 09.00          |                |        |   |   |           |
|                | 1.6 i 16V Lim.  | 10.96 | 09.00          | 83.6118-0281.3 | 330483 | 2 | + HA-Trommelbremse 1)<br>+ HA-Scheibenbremse 2)   | L=280     |
|                | 1.8 i 16V Lim.  | 10.96 | 09.00          | 83.6362-0542.3 | 330485 |   |   | L=540     |
|                | 1.8 TD Lim.     | 10.96 | 09.00          |                |        |   |   |           |
|                | 2.0 i 16V Lim.  | 10.96 | 09.00          |                |        |   |   |           |
|                | 2.5 i 24V Lim.  | 10.96 | 09.00          |                |        |   |   |           |

1) + RA drum brake / + P freno a tamburo / + frein à tambour essieu AR / + ET-tambores de freno  
2) + RA disc brake / + P disco freno / + frein à disque essieu AR / + ET-disco de freno  
3) TMC primary: connection M10x1 / PFT primario: attacco M10x1 / MCT raccordement primaire M10x1 / CMT primario: conexión M10x1  
4) TMC secondary: connection M12x1 / PFT secundario: attacco M12x1 / MCT raccordement secondaire M12x1 / CMT secundario: conexión M12x1  
5) + Saloon / + Berlina / + Berline / + Berlina  
6) + Estate / + Station Wagon / + Break / + Break





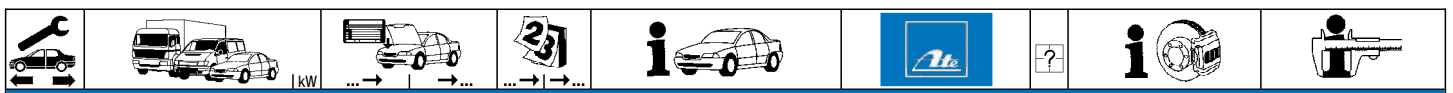

**FORD MONDEO II (96-00)**

















|  |                 |  |       |       |                 |                |        |   |   |                     |
|--|-----------------|--|-------|-------|-----------------|----------------|--------|---|---|---------------------|
|  | 2.5 ST 200      |  | 05.99 | 09.00 | + Limousine 1)  | 83.6118-0281.3 | 330483 | 2 | + HA-Trommelbremse 2)<br>+ HA-Scheibenbremse 3) | L=280<br>L=540      |
|  | 1.6 i 16V Kombi |  | 10.96 | 04.97 |                 | 83.6114-0300.3 | 330258 | 2 | + HA-Trommelbremse 2)                           | L=300               |
|  | 1.8 i 16V Kombi |  | 10.96 | 04.97 |                 | 24.5164-0315.3 | 331209 | 2 | + HA-Scheibenbremse 3)                          | L=315               |
|  | 1.8 TD Kombi    |  | 10.96 | 04.97 |                 |                |        |   |   |                     |
|  | 2.0 i 16V Kombi |  | 10.96 | 04.97 |                 |                |        |   |   |                     |
|  | 2.5 i 24V Kombi |  | 10.96 | 04.97 |                 |                |        |   |   |                     |
|  | 1.6 i 16V Kombi |  | 05.97 | 09.00 |                 | 83.6114-0300.3 | 330258 | 2 | + HA-Trommelbremse 2)                           | L=300               |
|  | 1.8 i 16V Kombi |  | 05.97 | 09.00 |                 | 24.5164-0316.3 | 331210 |   | + HA-Scheibenbremse 3)                          | L=315               |
|  | 1.8 TD Kombi    |  | 05.97 | 09.00 |                 | 24.5164-0317.3 | 331211 |   | + HA-Scheibenbremse 3)                          | L=315               |
|  | 2.0 i 16V Kombi |  | 05.97 | 09.00 |                 |                |        |   |   |                     |
|  | 2.5 i 24V Kombi |  | 05.97 | 09.00 |                 |                |        |   |   |                     |
|  | 2.5 ST 200      |  | 05.99 | 09.00 | + Kombiwagen 4) |                |        |   |   |                     |
|  | 1.6 i 16V Lim.  |  | 10.96 | 09.00 |                 | 24.3222-1114.3 | 020269 |   |   | Rz 22,20            |
|  | 1.8 i 16V Lim.  |  | 10.96 | 09.00 |                 |                |        |   |   |                     |
|  | 1.8 TD Lim.     |  | 10.96 | 09.00 |                 |                |        |   |   |                     |
|  | 2.0 i 16V Lim.  |  | 10.96 | 09.00 |                 | 24.3220-1111.3 | 020222 |   |   | Rz 20,64            |
|  | 1.6 i 16V Kombi |  | 10.96 | 09.00 |                 | 24.3222-1116.3 | 020271 |   |   | Rz 22,20            |
|  | 1.8 i 16V Kombi |  | 10.96 | 09.00 |                 |                |        |   |   |                     |
|  | 1.6 i 16V Lim.  |  | 10.96 | 09.00 |                 | 24.3727-0638.2 | 580638 | 1 | ↑   | L=270               |
|  | 1.8 i 16V Lim.  |  | 10.96 | 09.00 |                 | 24.3727-0639.2 | 580639 | 2 | ↓ + HA-Trommelbremse 2)                         | L=1611              |
|  | 1.8 TD Lim.     |  | 10.96 | 09.00 |                 | 24.3727-0644.2 | 580644 | 2 | ↓ + HA-Scheibenbremse 3)                        | L=1462              |
|  | 2.0 i 16V Lim.  |  | 10.96 | 09.00 |                 |                |        |   |   |                     |
|  | 2.5 i 24V Lim.  |  | 10.96 | 09.00 |                 |                |        |   |   |                     |
|  | 2.5 ST 200      |  | 05.99 | 09.00 | + Limousine 1)  |                |        |   |   |                     |
|  | 1.6 i 16V Kombi |  | 10.96 | 09.00 |                 | 24.3727-0638.2 | 580638 | 1 | ↑   | L=270               |
|  | 1.8 i 16V Kombi |  | 10.96 | 09.00 |                 | 24.3727-0639.2 | 580639 | 2 | ↓ + HA-Trommelbremse 2)                         | L=1611              |
|  | 1.8 TD Kombi    |  | 10.96 | 09.00 |                 | 24.3727-0641.2 | 580641 | 2 | ↓ + HA-Scheibenbremse 3)                        | L=1647              |
|  | 2.0 i 16V Kombi |  | 10.96 | 09.00 |                 |                |        |   |   |                     |
|  | 2.5 i 24V Kombi |  | 10.96 | 09.00 |                 |                |        |   |   |                     |
|  | 2.5 ST 200      |  | 05.99 | 09.00 | + Kombiwagen 4) |                |        |   |   |                     |
|  | 1.6 i 16V Lim.  |  | 10.96 | 09.00 | - ABS           | 03.6043-1954.3 | 320226 |   | + HA-Scheibenbremse 3)                          | BRE 3/30            |
|  | 1.8 i 16V Lim.  |  | 10.96 | 09.00 | - ABS           | 03.6583-0165.3 | 320285 |   | + HA-Trommelbremse 2)                           | BRL 8/3 (4) schwarz |
|  | 1.8 TD Lim.     |  | 10.96 | 09.00 | - ABS           |                |        |   |   | ATE                 |
|  | 2.0 i 16V Lim.  |  | 10.96 | 09.00 | - ABS           |                |        |   |   | ATE                 |
|  | 1.6 i 16V Kombi |  | 10.96 | 09.00 | - ABS           | 03.6043-1953.3 | 320201 | 2 |   | BRE 3/45            |
|  | 1.8 i 16V Kombi |  | 10.96 | 09.00 | - ABS           |                |        |   |   | ATE                 |
|  | 1.8 TD Kombi    |  | 10.96 | 09.00 | - ABS           |                |        |   |   |                     |
|  | 2.0 i 16V Kombi |  | 10.96 | 09.00 | - ABS           |                |        |   |   |                     |
|  | 1.8 i 16V       |  | 10.96 | 09.00 | + ABS/ASR       | 03.6043-1956.3 | 320202 | 2 |   | BRE 3/40            |
|  | 1.8 TD          |  | 10.96 | 09.00 | + ABS           |                |        |   |   | ATE                 |
|  | 2.0 i 16V       |  | 10.96 | 09.00 | + ABS/ASR       |                |        |   |   |                     |
|  | 2.5 i 24V       |  | 10.96 | 09.00 |                 |                |        |   |   |                     |
|  | 2.5 ST 200      |  | 05.99 | 09.00 |                 |                |        |   |   |                     |
|  | 1.6 i 16V       |  | 10.96 | 09.00 |                 | 24.2419-1723.3 | 030112 |   |   | Gz 19,05            |
|  | 1.8 i 16V       |  | 10.96 | 09.00 |                 |                |        |   |   |                     |
|  | 1.8 TD          |  | 10.96 | 09.00 |                 |                |        |   |   |                     |
|  | 2.0 i 16V       |  | 10.96 | 09.00 |                 |                |        |   |   |                     |
|  | 2.5 i 24V       |  | 10.96 | 09.00 |                 |                |        |   |   |                     |
|  | 2.5 ST 200      |  | 05.99 | 09.00 |                 |                |        |   |   |                     |

**FORD MONDEO III (00-07)**

|  |                 |  |       |       |  |                |        |   |  |                |     |
|--|-----------------|--|-------|-------|--|----------------|--------|---|--|----------------|-----|
|  | 1.8 i 16V       |  | 10.00 | 03.07 |  | 24.3571-1735.5 | 240385 |   |  | D=57, - Halter | BOS |
|  | 1.8 SCi         |  | 06.03 | 03.07 |  | 24.3571-1736.5 | 240386 |   |  | D=57, - Halter | BOS |
|  | 2.0 DI          |  | 10.00 | 03.07 |  |                |        |   |  |                |     |
|  | 2.0 i 16V       |  | 10.00 | 03.07 |  |                |        |   |  |                |     |
|  | 2.0 TDCi        |  | 10.01 | 03.07 |  |                |        |   |  |                |     |
|  | 2.2 TDCi        |  | 09.04 | 03.07 |  |                |        |   |  |                |     |
|  | 2.5 i V6        |  | 10.00 | 03.07 |  |                |        |   |  |                |     |
|  | 3.0 i V6        |  | 09.04 | 03.07 |  |                |        |   |  |                |     |
|  | ST 220          |  | 04.02 | 03.07 |  |                |        |   |  |                |     |
|  | 1.8 i 16V       |  | 10.00 | 03.07 |  | 83.7188-0446.3 | 330664 | 2 |  | L=470          |     |
|  | 1.8 SCi         |  | 06.03 | 03.07 |  |                |        |   |  |                |     |
|  | 2.0 DI          |  | 10.00 | 03.07 |  |                |        |   |  |                |     |
|  | 2.0 i 16V       |  | 10.00 | 03.07 |  |                |        |   |  |                |     |
|  | 2.0 TDCi        |  | 10.01 | 03.07 |  |                |        |   |  |                |     |
|  | 2.2 TDCi        |  | 09.04 | 03.07 |  |                |        |   |  |                |     |
|  | 2.5 i V6        |  | 10.00 | 03.07 |  |                |        |   |  |                |     |
|  | 3.0 i V6        |  | 09.04 | 03.07 |  |                |        |   |  |                |     |
|  | ST 220          |  | 04.02 | 03.07 |  |                |        |   |  |                |     |
|  | 1.8 i 16V Lim.  |  | 10.00 | 08.04 |  | 24.3384-1713.5 | 240431 |   |  | D=38, - Halter | BOS |
|  | 1.8 SCi Lim.    |  | 06.03 | 08.04 |  | 24.3384-1714.5 | 240432 |   |  | D=38, - Halter | BOS |
|  | 2.0 DI Lim.     |  | 10.00 | 08.04 |  |                |        |   |  |                |     |
|  | 2.0 i 16V Lim.  |  | 10.00 | 08.04 |  |                |        |   |  |                |     |
|  | 2.0 TDCi Lim.   |  | 10.01 | 08.04 |  |                |        |   |  |                |     |
|  | 2.5 i V6 Lim.   |  | 10.00 | 08.04 |  |                |        |   |  |                |     |
|  | ST 220 Lim.     |  | 04.02 | 08.04 |  |                |        |   |  |                |     |
|  | 1.8 i 16V Kombi |  | 10.00 | 08.04 |  | 24.3384-1757.5 | 240473 |   |  | D=38, - Halter | LUC |
|  | 1.8 SCi Kombi   |  | 06.03 | 08.04 |  | 24.3384-1758.5 | 240474 |   |  | D=38, - Halter | LUC |
|  | 2.0 DI Kombi    |  | 10.00 | 08.04 |  |                |        |   |  |                |     |
|  | 2.0 i 16V Kombi |  | 10.00 | 08.04 |  |                |        |   |  |                |     |
|  | 2.0 TDCi Kombi  |  | 10.01 | 08.04 |  |                |        |   |  |                |     |
|  | 2.5 i V6 Kombi  |  | 10.00 | 08.04 |  |                |        |   |  |                |     |
|  | ST 220 Kombi    |  | 04.02 | 08.04 |  |                |        |   |  |                |     |

1) + Saloon / + Berlina / + Berline / + Berlina  
 2) + RA drum brake / + P freno a tamburo / + frein à tambour essieu AR / + ET-tambores de freno  
 3) + RA disc brake / + P disco freno / + frein à disque essieu AR / + ET-disco de freno  
 4) + Estate / + Station Wagon / + Break / + Break



| FORD MONDEO III (00-07)  |  |  |  |  |   |  |  |  |   |  |                |       |
|--|--|--|--|--|---|--|--|--|---|--|----------------|-------|
|     |  |  |  |  |  |  |  |  |   |  |                |       |
|    | 1.8 i 16V  |  |  | 10.00  | 03.07   | 83.7788-0280.3   | 330836   | 2  |   |  | L=280          |       |
|  | 1.8 SCi  |  |  | 06.03  | 03.07   |  |  |  |   |  |                |       |
|  | 2.0 DI   |  |  | 10.00  | 03.07   |  |  |  |   |  |                |       |
|  | 2.0 i 16V  |  |  | 10.00  | 03.07   |  |  |  |   |  |                |       |
|  | 2.0 TDCi   |  |  | 10.01  | 03.07   |  |  |  |   |  |                |       |
|  | 2.2 TDCi   |  |  | 09.04  | 03.07   |  |  |  |   |  |                |       |
|  | 2.5 i V6   |  |  | 10.00  | 03.07   |  |  |  |   |  |                |       |
|  | 3.0 i V6   |  |  | 09.04  | 03.07   |  |  |  |   |  |                |       |
|  | ST 220   |  |  | 04.02  | 03.07   |  |  |  |   |  |                |       |
|    | 1.8 i 16V Lim.   |  |  | 10.00  | 03.07   | 24.3727-0647.2   | 580647   | 2 ↓  |   |  | L=1735         |       |
|  | 1.8 SCi Lim.   |  |  | 06.03  | 03.07   |  |  |  |   |  |                |       |
|  | 2.0 DI Lim.  |  |  | 10.00  | 03.07   |  |  |  |   |  |                |       |
|  | 2.0 i 16V Lim.   |  |  | 10.00  | 03.07   |  |  |  |   |  |                |       |
|  | 2.0 TDCi Lim.  |  |  | 10.01  | 03.07   |  |  |  |   |  |                |       |
|  | 2.2 TDCi Lim.  |  |  | 09.04  | 03.07   |  |  |  |   |  |                |       |
|  | 2.5 i V6 Lim.  |  |  | 10.00  | 03.07   |  |  |  |   |  |                |       |
|  | 3.0 i V6 Lim.  |  |  | 09.04  | 03.07   |  |  |  |   |  |                |       |
|  | ST 220 Lim.  |  |  | 04.02  | 03.07   |  |  |  |   |  |                |       |
|  | 1.8 i 16V Kombi  |  |  | 10.00  | 03.07   | 24.3727-0648.2   | 580648   | 2 ↓  |   |  | L=1722         |       |
|  | 1.8 SCi Kombi  |  |  | 06.03  | 03.07   |  |  |  |   |  |                |       |
|  | 2.0 DI Kombi   |  |  | 10.00  | 03.07   |  |  |  |   |  |                |       |
|  | 2.0 i 16V Kombi  |  |  | 10.00  | 03.07   |  |  |  |   |  |                |       |
|  | 2.0 TDCi Kombi   |  |  | 10.01  | 03.07   |  |  |  |   |  |                |       |
|  | 2.2 TDCi Kombi   |  |  | 09.04  | 03.07   |  |  |  |   |  |                |       |
|  | 2.5 i V6 Kombi   |  |  | 10.00  | 03.07   |  |  |  |   |  |                |       |
|  | 3.0 i V6 Kombi   |  |  | 09.04  | 03.07   |  |  |  |   |  |                |       |
|  | ST 220 Kombi   |  |  | 04.02  | 03.07   |  |  |  |   |  |                |       |
| FORD MONDEO IV (07-)   |  |  |  |  |   |  |  |  |   |  |                |       |
|    | 1.6 EcoBoost   | 118  |  | 02.11  |   | 03.7755-9403.4   | 300238   |  |   |  | 9/8" Tandem    | ATE   |
|  | 1.6 TDCi   | 85   |  | 02.11  |   |  |  |  |   |  |                |       |
|  | 1.6 Ti VCT   | 81   |  | 04.07  |   |  |  |  |   |  |                |       |
|  | 1.6 Ti VCT   | 88   |  | 07.10  |   |  |  |  |   |  |                |       |
|  | 1.6 Ti VCT   | 92   |  | 04.07  |   |  |  |  |   |  |                |       |
|  | 1.8 TDCi   | 74   |  | 04.07  |   |  |  |  |   |  |                |       |
|  | 1.8 TDCi   | 92   |  | 06.07  |   |  |  |  |   |  |                |       |
|  | 2.0 EcoBoost   | 176  |  | 07.10  |   |  |  |  |   |  |                |       |
|  | 2.0 Flexifuel  | 107  |  | 03.07  |   |  |  |  |   |  |                |       |
|  | 2.0 i 16V  | 107  |  | 04.07  |   |  |  |  |   |  |                |       |
|  | 2.0 LPG  | 107  |  | 07.09  |   |  |  |  |   |  |                |       |
|  | 2.0 SCTi   | 149  |  | 03.10  |   |  |  |  |   |  |                |       |
|  | 2.0 TDCi   | 85   |  | 10.07  |   |  |  |  |   |  |                |       |
|  | 2.0 TDCi   | 96   |  | 04.07  |   |  |  |  |   |  |                |       |
|  | 2.0 TDCi   | 100  |  | 03.09  |   |  |  |  |   |  |                |       |
|  | 2.0 TDCi   | 103  |  | 04.07  |   |  |  |  |   |  |                |       |
|  | 2.0 TDCi   | 120  |  | 03.10  |   |  |  |  |   |  |                |       |
|  | 2.2 TDCi   | 129  |  | 04.08  |   |  |  |  |   |  |                |       |
|  | 2.2 TDCi   | 147  |  | 11.10  |   |  |  |  |   |  |                |       |
|  | 2.3 i 16V  | 118  |  | 07.07  |   |  |  |  |   |  |                |       |
|  | 2.5 i 20V  | 162  |  | 04.07  |   |  |  |  |   |  |                |       |
|  | 1.6 EcoBoost   | 118  |  | 02.11  |   | 11.9601-9711.2   | 220873   |  |  |  | D=60, - Halter | ATE   |
|  | 1.6 TDCi   | 85   |  | 02.11  |   | 11.9601-9712.2   | 220874   |  |  |  | D=60, - Halter | ATE   |
|  | 1.6 Ti VCT   | 81   |  | 04.07  |   | 11.0101-5407.2   | 260011   |  |   |  | Hülsensatz     | ATE   |
|  | 1.6 Ti VCT   | 88   |  | 07.10  |   | 11.8171-0008.1   | 990049   |  |   |  | Führungsbolzen | ATE   |
|  | 1.6 Ti VCT   | 92   |  | 04.07  |   | 11.8116-0206.1   | 390593   | 2  |   |  | Haltefeder     | ATE   |
|  | 1.8 TDCi   | 74   |  | 04.07  |   |  |  |  |   |  |                |       |
|  | 1.8 TDCi   | 92   |  | 06.07  |   |  |  |  |   |  |                |       |
|  | 2.0 EcoBoost   | 176  |  | 07.10  |   |  |  |  |   |  |                |       |
|  | 2.0 Flexifuel  | 107  |  | 03.07  |   |  |  |  |   |  |                |       |
|  | 2.0 i 16V  | 107  |  | 04.07  |   |  |  |  |   |  |                |       |
|  | 2.0 LPG  | 107  |  | 07.09  |   |  |  |  |   |  |                |       |
|  | 2.0 SCTi   | 149  |  | 03.10  |   |  |  |  |   |  |                |       |
|  | 2.0 TDCi   | 85   |  | 10.07  |   |  |  |  |   |  |                |       |
|  | 2.0 TDCi   | 96   |  | 04.07  |   |  |  |  |   |  |                |       |
|  | 2.0 TDCi   | 100  |  | 03.09  |   |  |  |  |   |  |                |       |
|  | 2.0 TDCi   | 103  |  | 04.07  |   |  |  |  |   |  |                |       |
|  | 2.0 TDCi   | 120  |  | 03.10  |   |  |  |  |   |  |                |       |
|  | 2.2 TDCi   | 129  |  | 04.08  |   |  |  |  |   |  |                |       |
|  | 2.2 TDCi   | 147  |  | 11.10  |   |  |  |  |   |  |                |       |
|  | 2.3 i 16V  | 118  |  | 07.07  |   |  |  |  |   |  |                |       |
|  | 2.5 i 20V  | 162  |  | 04.07  |   |  |  |  |   |  |                |       |
|  | 1.6 EcoBoost   | 118  |  | 02.11  |   | 24.5162-0390.3   | 331199   | 2  |   |  |                | L=390 |
|  | 1.6 TDCi   | 85   |  | 02.11  |   |  |  |  |   |  |                |       |
|  | 1.6 Ti VCT   | 81   |  | 04.07  |   |  |  |  |   |  |                |       |
|  | 1.6 Ti VCT   | 88   |  | 07.10  |   |  |  |  |   |  |                |       |
|  | 1.6 Ti VCT   | 92   |  | 04.07  |   |  |  |  |   |  |                |       |
|  | 1.8 TDCi   | 74   |  | 04.07  |   |  |  |  |   |  |                |       |
|  | 1.8 TDCi   | 92   |  | 06.07  |   |  |  |  |   |  |                |       |
|  | 2.0 EcoBoost   | 176  |  | 07.10  |   |  |  |  |   |  |                |       |
|  | 2.0 Flexifuel  | 107  |  | 03.07  |   |  |  |  |   |  |                |       |
|  | 2.0 i 16V  | 107  |  | 04.07  |   |  |  |  |   |  |                |       |
|  | 2.0 LPG  | 107  |  | 07.09  |   |  |  |  |   |  |                |       |
|  | 2.0 SCTi   | 149  |  | 03.10  |   |  |  |  |   |  |                |       |
|  | 2.0 TDCi   | 85   |  | 10.07  |   |  |  |  |   |  |                |       |
|  | 2.0 TDCi   | 96   |  | 04.07  |   |  |  |  |   |  |                |       |
|  | 2.0 TDCi   | 100  |  | 03.09  |   |  |  |  |   |  |                |       |
|  | 2.0 TDCi   | 103  |  | 04.07  |   |  |  |  |   |  |                |       |





























| FORD MONDEO IV (07-) |               |     |       |       |  |                |        |   |                                  |        |
|----------------------|---------------|-----|-------|-------|--|----------------|--------|---|----------------------------------|--------|
|                      | 2.0 TDCi      | 120 |       | 03.10 |  | 24.5162-0390.3 | 331199 | 2 |                                  | L=390  |
|                      | 2.2 TDCi      | 129 |       | 04.08 |  |                |        |   |                                  |        |
|                      | 2.2 TDCi      | 147 |       | 11.10 |  |                |        |   |                                  |        |
|                      | 2.3 i 16V     | 118 |       | 07.07 |  |                |        |   |                                  |        |
|                      | 2.5 i 20V     | 162 |       | 04.07 |  |                |        |   |                                  |        |
|                      | 1.6 EcoBoost  | 118 |       | 02.11 |  | 24.5163-0155.3 | 331204 | 2 | + mechanische Feststellbremse 1) | L=155  |
|                      | 1.6 TDCi      | 85  |       | 02.11 |  |                |        |   |                                  |        |
|                      | 1.6 Ti VCT    | 81  |       | 04.07 |  |                |        |   |                                  |        |
|                      | 1.6 Ti VCT    | 88  |       | 07.10 |  |                |        |   |                                  |        |
|                      | 1.6 Ti VCT    | 92  |       | 04.07 |  |                |        |   |                                  |        |
|                      | 1.8 TDCi      | 74  |       | 04.07 |  |                |        |   |                                  |        |
|                      | 1.8 TDCi      | 92  |       | 06.07 |  |                |        |   |                                  |        |
|                      | 2.0 EcoBoost  | 176 |       | 07.10 |  |                |        |   |                                  |        |
|                      | 2.0 Flexifuel | 107 |       | 03.07 |  |                |        |   |                                  |        |
|                      | 2.0 i 16V     | 107 |       | 04.07 |  |                |        |   |                                  |        |
|                      | 2.0 LPG       | 107 |       | 07.09 |  |                |        |   |                                  |        |
|                      | 2.0 SCTi      | 149 |       | 03.10 |  |                |        |   |                                  |        |
|                      | 2.0 TDCi      | 85  |       | 10.07 |  |                |        |   |                                  |        |
|                      | 2.0 TDCi      | 96  |       | 04.07 |  |                |        |   |                                  |        |
|                      | 2.0 TDCi      | 100 |       | 03.09 |  |                |        |   |                                  |        |
|                      | 2.0 TDCi      | 103 |       | 04.07 |  |                |        |   |                                  |        |
|                      | 2.0 TDCi      | 120 |       | 03.10 |  |                |        |   |                                  |        |
| 2.2 TDCi             | 129           |     | 04.08 |       |  |                |        |   |                                  |        |
| 2.2 TDCi             | 147           |     | 11.10 |       |  |                |        |   |                                  |        |
| 2.3 i 16V            | 118           |     | 07.07 |       |  |                |        |   |                                  |        |
| 2.5 i 20V            | 162           |     | 04.07 |       |  |                |        |   |                                  |        |
|                      | 1.6 EcoBoost  | 118 |       | 02.11 |  | 24.3727-0676.2 | 580676 |   | + mechanische Feststellbremse 1) | L=2078 |
|                      | 1.6 TDCi      | 85  |       | 02.11 |  | 24.3727-0677.2 | 580677 |   | + mechanische Feststellbremse 1) | L=2071 |
|                      | 1.6 Ti VCT    | 81  |       | 04.07 |  |                |        |   |                                  |        |
|                      | 1.6 Ti VCT    | 88  |       | 07.10 |  |                |        |   |                                  |        |
|                      | 1.6 Ti VCT    | 92  |       | 04.07 |  |                |        |   |                                  |        |
|                      | 1.8 TDCi      | 74  |       | 04.07 |  |                |        |   |                                  |        |
|                      | 1.8 TDCi      | 92  |       | 06.07 |  |                |        |   |                                  |        |
|                      | 2.0 EcoBoost  | 176 |       | 07.10 |  |                |        |   |                                  |        |
|                      | 2.0 Flexifuel | 107 |       | 03.07 |  |                |        |   |                                  |        |
|                      | 2.0 i 16V     | 107 |       | 04.07 |  |                |        |   |                                  |        |
|                      | 2.0 LPG       | 107 |       | 07.09 |  |                |        |   |                                  |        |
|                      | 2.0 SCTi      | 149 |       | 03.10 |  |                |        |   |                                  |        |
|                      | 2.0 TDCi      | 85  |       | 10.07 |  |                |        |   |                                  |        |
|                      | 2.0 TDCi      | 96  |       | 04.07 |  |                |        |   |                                  |        |
|                      | 2.0 TDCi      | 100 |       | 03.09 |  |                |        |   |                                  |        |
|                      | 2.0 TDCi      | 103 |       | 04.07 |  |                |        |   |                                  |        |
|                      | 2.0 TDCi      | 120 |       | 03.10 |  |                |        |   |                                  |        |
| 2.2 TDCi             | 129           |     | 04.08 |       |  |                |        |   |                                  |        |
| 2.2 TDCi             | 147           |     | 11.10 |       |  |                |        |   |                                  |        |
| 2.3 i 16V            | 118           |     | 07.07 |       |  |                |        |   |                                  |        |
| 2.5 i 20V            | 162           |     | 04.07 |       |  |                |        |   |                                  |        |

### FORD PUMA (97-01)

|           |           |  |       |       |       |                |                |        |                |                              |     |
|-----------|-----------|--|-------|-------|-------|----------------|----------------|--------|----------------|------------------------------|-----|
|           | 1.4 i 16V |  |       | 02.98 | 01.00 | - ABS          | 24.2123-1735.3 | 010652 |                | THz 23,81                    |     |
|           | 1.7 i 16V |  |       | 01.98 | 01.00 | - ABS          |                |        |                |                              |     |
|           | 1.4 i 16V |  |       | 02.98 | 01.00 | + ABS          | 24.2123-1736.3 | 010653 |                | THz 23,81                    |     |
|           | 1.7 i 16V |  |       | 06.97 | 01.00 | + ABS          |                |        |                |                              |     |
|           | 1.4 i 16V |  |       | 02.00 | 10.00 | + ABS          | 03.2123-2243.3 | 010748 |                | THz 23,81                    |     |
|           | 1.6 i 16V |  |       | 08.00 | 12.01 | + ABS          |                |        |                | ATE                          |     |
|           | 1.7 i 16V |  |       | 02.00 | 12.01 | + ABS          |                |        |                |                              |     |
|           |           |  |       |       |       |                |                |        |                |                              |     |
|           | 1.4 i 16V |  |       | 02.98 | 01.00 |                | 11.3541-8529.2 | 220341 |                | D=54, - Halter               | ATE |
|           | 1.7 i 16V |  |       | 06.97 | 01.00 |                | 11.3541-8530.2 | 220342 |                | D=54, - Halter               | ATE |
|           | ST 160    |  |       | 06.99 | 01.00 |                | 24.3541-8529.5 | 240553 |                | D=54, - Halter               | ATE |
|           |           |  |       |       |       |                | 24.3541-8530.5 | 240554 |                | D=54, - Halter               | ATE |
|           |           |  |       |       |       |                | 11.0441-5402.2 | 250028 |                | Dichtungssatz                | ATE |
|           |           |  |       |       |       |                | 11.0101-5407.2 | 260011 |                | Hülensatz                    | ATE |
|           |           |  |       |       |       |                | 11.8171-0008.1 | 990049 |                | Führungsbolzen               | ATE |
|           |           |  |       |       |       |                | 11.8116-0264.1 | 390594 | 2              | Haltefeder                   | ATE |
|           | 1.4 i 16V |  |       | 02.00 | 10.00 |                | 11.3541-8531.2 | 220367 |                | D=54, - Halter               | ATE |
|           | 1.6 i 16V |  |       | 08.00 | 12.01 |                | 11.3541-8532.2 | 220368 |                | D=54, - Halter               | ATE |
| 1.7 i 16V |           |  | 02.00 | 12.01 |       | 11.0101-5407.2 | 260011         |        | Hülensatz      | ATE                          |     |
| ST 160    |           |  | 02.00 | 12.01 |       | 11.8171-0008.1 | 990049         |        | Führungsbolzen | ATE                          |     |
|           |           |  |       |       |       | 11.8116-0264.1 | 390594         | 2      | Haltefeder     | ATE                          |     |
|           | 1.7 i 16V |  |       | 06.97 | 01.98 |                | 24.5305-0350.3 | 330660 | 2              | L=352                        |     |
|           | 1.4 i 16V |  |       | 02.98 | 12.99 |                | 24.5305-0295.3 | 330657 | 2              | L=297                        |     |
|           | 1.7 i 16V |  |       | 02.98 | 12.99 |                |                |        |                |                              |     |
|           | 1.4 i 16V |  |       | 01.00 | 10.00 |                | 24.5305-0355.3 | 330688 | 2              | L=355                        |     |
|           | 1.6 i 16V |  |       | 08.00 | 12.01 |                |                |        |                |                              |     |
|           | 1.7 i 16V |  |       | 01.00 | 12.01 |                |                |        |                |                              |     |
|           |           |  |       |       |       |                |                |        |                |                              |     |
|           |           |  |       |       |       |                |                |        |                |                              |     |
|           | 1.4 i 16V |  |       | 02.98 | 01.00 |                | 24.3217-1715.3 | 020463 |                | nur paarweise austauschen 2) |     |
|           | 1.7 i 16V |  |       | 06.97 | 01.00 |                |                |        |                | Rz 17,78                     |     |
|           | ST 160    |  |       | 06.99 | 01.00 |                |                |        |                | LUC                          |     |
|           |           |  |       |       |       |                |                |        |                |                              |     |
|           | 1.4 i 16V |  |       | 02.00 | 10.00 |                | 24.3219-1735.3 | 020464 |                | Rz 19,05                     |     |
|           | 1.6 i 16V |  |       | 08.00 | 12.01 |                |                |        |                |                              |     |
|           | 1.7 i 16V |  |       | 02.00 | 12.01 |                |                |        |                |                              |     |
|           | ST 160    |  |       | 02.00 | 12.01 |                |                |        |                |                              |     |
|           | 1.4 i 16V |  |       | 02.98 | 11.98 |                | 24.3727-1800.2 | 581800 | 1              | L=312                        |     |
|           | 1.7 i 16V |  |       | 06.97 | 11.98 |                | 24.3727-0660.2 | 580660 | 1              | L=1575/1627                  |     |

1) + mechanical parking brake / + fr. stazionamento meccanico / + frein à main mécanique / + freno de mano mecánica

2) to change only by pairs / sostituire solo a coppie / à changer seulement par paires / cambiar solamente por parejas

|     |   |                         |    |  |                         |  |   |                             |
|--|---|---|--|--|--|--|---|---|
| <b>FORD PUMA (97-01)</b>   |   |   |  |  |  |  |   |   |
|    | 1.4 i 16V<br>1.6 i 16V<br>1.7 i 16V   |   | 12.98<br>08.00<br>12.98  | 10.00<br>12.01<br>12.01  | 24.3727-1800.2<br>24.3727-0660.2   | 581800<br>580660   | 1 ↑<br>1 ↓  | L=312<br>L=1575/1627  |
|    | 1.4 i 16V<br>1.7 i 16V  |   | 02.98<br>06.97   | 08.98<br>08.98   | 24.2419-1734.3   | 030126   |   | Gz 19,05  |
|  | 1.4 i 16V<br>1.6 i 16V<br>1.7 i 16V   |   | 09.98<br>08.00<br>09.98  | 10.00<br>12.01<br>12.01  | 24.2419-1736.3   | 030128   |   | Gz 19,05  |
| <b>FORD RANGER (11-)</b>   |   |   |  |  |  |  |   |   |
|    | 2.2 TDCi<br>2.2 TDCi 4x4<br>2.2 TDCi 4x4<br>3.2 TDCi 4x4  | 92<br>110<br>147  | 11.11<br>11.11<br>11.11<br>11.11   |  | 24.2520-1706.3   | 040094   |   | Nz 20,40  |
| <b>FORD SCORPIO / GRANADA (GB) (95-98)</b>   |   |   |  |  |  |  |   |   |
|    | 2.0 i<br>2.3 i 16V<br>2.5 TD<br>2.9 i<br>2.9 i 24V  |   | 10.94<br>05.96<br>10.94<br>01.95<br>10.94  | 08.98<br>08.98<br>08.98<br>08.98<br>08.98  | 03.2125-8811.3   | 010563   |   | THz 25,40 ATE   |
|    | 2.0 i<br>2.3 i 16V<br>2.5 TD<br>2.9 i   |   | 10.94<br>05.96<br>10.94<br>01.95   | 08.98<br>08.98<br>08.98<br>08.98   | 24.3601-8527.5<br>24.3601-8528.5<br>11.0441-6005.2<br>11.0230-0170.2<br>11.8171-0008.1<br>11.8116-0301.1 | 240503<br>240504<br>250150<br>260011<br>990049<br>390610                           | <br><br>2     | D=60, - Halter<br>D=60, - Halter<br>Dichtungssatz<br>Haltersatz<br>Hülzensatz<br>Führungsbolzen<br>Haltefeder |
|  | 2.9 i 24V   |   | 10.94  | 08.98  | 11.0441-6005.2<br>11.0101-5407.2<br>11.8171-0008.1<br>11.8116-0143.1                                     | 250150<br>260011<br>990049<br>390513   | 2   | Dichtungssatz<br>Hülzensatz<br>Führungsbolzen<br>Haltefeder   |
|    | 2.0 i<br>2.3 i 16V<br>2.5 TD<br>2.9 i<br>2.9 i 24V  |   | 10.94<br>05.96<br>10.94<br>01.95<br>10.94  | 08.98<br>08.98<br>08.98<br>08.98<br>08.98  | 83.6188-0311.3   | 330291   | 2   | L=310   |
|   | 2.0 i Lim.<br>2.3 i 16V Lim.<br>2.5 TD Lim.<br>2.9 i Lim.   |   | 10.94<br>05.96<br>10.94<br>01.95   | 08.98<br>08.98<br>08.98<br>08.98   | 24.3434-1601.5<br>24.3434-1602.5<br>24.0101-4301.2   | 240019<br>240020<br>260047   | <br>         | D=43, - Halter<br>D=43, - Halter<br>Einbausatz  |
|  | 2.0 i<br>2.3 i 16V<br>2.5 TD<br>2.9 i<br>2.9 i 24V  |   | 10.94<br>05.96<br>10.94<br>01.95<br>10.94  | 08.98<br>08.98<br>08.98<br>08.98<br>08.98  | 83.6327-0180.3   | 330740   | 2   | am Bremsattel <sup>1)</sup><br>L=180  |
|  | 2.0 i<br>2.5 TD<br>2.9 i<br>2.9 i 24V   |   | 10.94<br>10.94<br>01.95<br>10.94   | 12.95<br>12.95<br>12.95<br>12.95   | 24.3727-0642.2   | 580642   | 1 ↓   | L=3760  |
|  | 2.0 i<br>2.3 i 16V<br>2.5 TD<br>2.9 i<br>2.9 i 24V  |   | 01.96<br>05.96<br>01.96<br>01.96<br>01.96  | 08.98<br>08.98<br>08.98<br>08.98<br>08.98  | 24.3727-0643.2   | 580643   | 1 ↓   | L=3800  |
| <b>FORD S-MAX (06-)</b>  |   |   |  |  |  |  |   |   |
|  | 1.6 EcoBoost<br>1.6 TDCi<br>1.8 TDCi<br>1.8 TDCi<br>2.0 EcoBoost<br>2.0 i 16V<br>2.0 SCTi EcoBoost<br>2.0 TDCi<br>2.0 TDCi<br>2.0 TDCi<br>2.0 TDCi<br>2.0 TDCi<br>2.0 TDCi<br>2.2 TDCi<br>2.2 TDCi<br>2.3 i 16V<br>2.5 ST | 118<br>85<br>74<br>92<br>176<br>107<br>149<br>85<br>96<br>100<br>103<br>120<br>129<br>147<br>118<br>162 | 02.11<br>02.11<br>01.07<br>04.06<br>07.10<br>04.06<br>03.10<br>10.07<br>04.06<br>05.06<br>04.06<br>03.10<br>04.08<br>07.10<br>07.07<br>04.06 |  | 03.7755-9403.4   | 300238   |   | 9/8" Tandem ATE   |
|  | 1.6 EcoBoost<br>1.6 TDCi<br>1.8 TDCi<br>1.8 TDCi<br>2.0 i 16V<br>2.0 TDCi<br>2.0 TDCi<br>2.0 TDCi<br>2.0 TDCi<br>2.0 TDCi<br>2.2 TDCi<br>2.2 TDCi<br>2.3 i 16V  | 118<br>85<br>74<br>92<br>107<br>85<br>96<br>100<br>103<br>120<br>129<br>147<br>118                      | 02.11<br>02.11<br>01.07<br>04.06<br>04.06<br>10.07<br>04.06<br>05.06<br>04.06<br>03.10<br>11.08<br>07.10<br>07.07                            |  | 11.9601-9711.2<br>11.9601-9712.2<br>11.0101-5407.2<br>11.8171-0008.1<br>11.8116-0206.1                   | 220873<br>220874<br>260011<br>990049<br>390593                                     | <br><br>2 | D=60, - Halter<br>D=60, - Halter<br>Hülzensatz<br>Führungsbolzen<br>Haltefeder                                |

<sup>1)</sup> on the brake caliper / sulla pinza freno / sur l'étrier de frein / a la pinza de freno

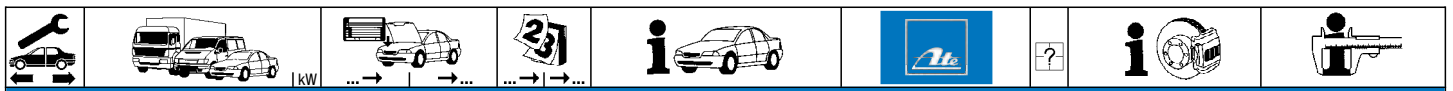

### FORD S-MAX (06-)

























|  |   |   |  |  |  |                            |  |  |                   |
|--|---|---|--|--|--|----------------------------|--|--|-------------------|
|  | 2.0 EcoBoost<br>2.0 SCTi EcoBoost<br>2.2 TDCi<br>2.5 ST   | 176<br>149<br>129<br>162  | 07.10<br>03.10<br>04.08<br>04.06   | 10.08  | 11.9606-9949.2<br>11.9606-9950.2<br>11.8116-0388.2 | 220879<br>220880<br>390588 | <br>2  | D=60, - Halter<br>D=60, - Halter<br>Haltefeder | ATE<br>ATE<br>ATE |
|  | 1.6 EcoBoost<br>1.6 TDCi<br>1.8 TDCi<br>1.8 TDCi<br>2.0 i 16V<br>2.0 TDCi<br>2.0 TDCi<br>2.0 TDCi<br>2.0 TDCi<br>2.2 TDCi<br>2.2 TDCi<br>2.3 i 16V  | 118<br>85<br>74<br>92<br>107<br>85<br>96<br>100<br>103<br>120<br>129<br>147<br>118                      | 02.11<br>02.11<br>01.07<br>04.06<br>04.06<br>10.07<br>04.06<br>05.06<br>04.06<br>03.10<br>04.08<br>07.10<br>07.07                            |  | 24.5162-0390.3                                     | 331199                     | 2  | L=390  |                   |
|  | 1.6 EcoBoost<br>1.6 TDCi<br>1.8 TDCi<br>1.8 TDCi<br>2.0 EcoBoost<br>2.0 i 16V<br>2.0 SCTi EcoBoost<br>2.0 TDCi<br>2.0 TDCi<br>2.0 TDCi<br>2.0 TDCi<br>2.0 TDCi<br>2.2 TDCi<br>2.2 TDCi<br>2.3 i 16V<br>2.5 ST | 118<br>85<br>74<br>92<br>176<br>107<br>149<br>85<br>96<br>100<br>103<br>120<br>129<br>147<br>118<br>162 | 02.11<br>02.11<br>01.07<br>12.06<br>07.10<br>12.06<br>03.10<br>10.07<br>12.06<br>12.06<br>03.10<br>03.10<br>04.08<br>07.10<br>07.07<br>12.06 |  | 24.5163-0155.3                                     | 331204                     | 2  | + mechanische Feststellbremse <sup>1)</sup>    | L=155             |
|  | 1.6 EcoBoost<br>1.6 TDCi<br>1.8 TDCi<br>1.8 TDCi<br>2.0 EcoBoost<br>2.0 i 16V<br>2.0 SCTi EcoBoost<br>2.0 TDCi<br>2.0 TDCi<br>2.0 TDCi<br>2.0 TDCi<br>2.0 TDCi<br>2.2 TDCi<br>2.2 TDCi<br>2.3 i 16V<br>2.5 ST | 118<br>85<br>74<br>92<br>176<br>107<br>149<br>85<br>96<br>100<br>103<br>120<br>129<br>147<br>118<br>162 | 02.11<br>02.11<br>01.07<br>04.06<br>07.10<br>04.06<br>03.10<br>10.07<br>04.06<br>05.06<br>04.06<br>03.10<br>04.08<br>07.10<br>07.07<br>04.06 |  | 24.5133-0310.3                                     | 331197                     | 2  | + elektrische Feststellbremse <sup>2)</sup>    | L=310             |
|  | 1.8 TDCi<br>1.8 TDCi<br>2.0 i 16V<br>2.0 TDCi<br>2.0 TDCi<br>2.0 TDCi<br>2.0 TDCi<br>2.2 TDCi<br>2.3 i 16V<br>2.5 ST  | 74<br>92<br>107<br>85<br>96<br>100<br>103<br>129<br>118<br>162  | 01.07<br>04.06<br>04.06<br>10.07<br>04.06<br>05.06<br>04.06<br>04.08<br>07.07<br>04.06   | 06.09<br>06.09<br>06.09<br>06.09<br>06.09<br>06.09<br>06.09<br>06.09<br>06.09<br>06.09 | 24.5133-0311.3                                     | 331198                     | 2  | + elektrische Feststellbremse <sup>2)</sup>    | L=310             |
|  | 1.6 EcoBoost<br>1.6 TDCi<br>1.8 TDCi<br>1.8 TDCi<br>2.0 EcoBoost<br>2.0 i 16V<br>2.0 SCTi EcoBoost<br>2.0 TDCi<br>2.0 TDCi<br>2.0 TDCi<br>2.0 TDCi<br>2.2 TDCi<br>2.2 TDCi<br>2.3 i 16V<br>2.5 ST             | 118<br>85<br>74<br>92<br>176<br>107<br>149<br>85<br>96<br>100<br>103<br>120<br>129<br>147<br>118<br>162 | 02.11<br>02.11<br>02.07<br>02.07<br>07.10<br>02.07<br>03.10<br>10.07<br>02.07<br>02.07<br>02.07<br>03.10<br>04.08<br>07.10<br>07.07<br>02.07 |  | 24.3727-0676.2<br>24.3727-0677.2                   | 580676<br>580677           | <input type="checkbox"/> + mechanische Feststellbremse <sup>1)</sup><br><input type="checkbox"/> + mechanische Feststellbremse <sup>1)</sup> | L=2078<br>L=2071                               |                   |

### FORD STREET KA (03-06)

|  |       |    |       |       |  |                                      |  |  |                          |
|--|-------|----|-------|-------|--|--------------------------------------|--|--|--------------------------|
|  | 1.6 i | 70 | 02.03 | 02.06 | 03.7750-5432.4   | 300248                               |  | 9"   | ATE                      |
|  | 1.6 i | 70 | 02.03 | 02.06 | 11.3541-8531.2<br>11.3541-8532.2<br>11.0101-5407.2<br>11.8171-0008.1 | 220367<br>220368<br>260011<br>990049 | <input type="checkbox"/><br><input type="checkbox"/> | D=54, - Halter<br>D=54, - Halter<br>Hülzensatz<br>Führungsbolzen | ATE<br>ATE<br>ATE<br>ATE |
|  | 1.6 i | 70 | 02.03 | 02.06 | 24.5305-0352.3   | 331041                               | 2  | L=352  |                          |

<sup>1)</sup> + mechanical parking brake / + fr. stazionamento meccanico / + frein à main mécanique / + freno de mano mecánica

<sup>2)</sup> + electric parking brake / + freno a mano elettrico / + frein à main électrique / + freno de mano eléctrico

|     |    |                           |  |   |   |  |  |    |  |                          |
|--|--|---|--|---|--|--|--|--|--|--------------------------|
| <b>FORD STREET KA (03-06)</b>  |  |   |  |   |  |  |  |  |  |                          |
|    | 1.6 i  | 70  |  | 02.03   | 02.06  | 24.3219-1735.3   | 020464   | Rz 19,05   |  |                          |
|    | 1.6 i  | 70  |  | 02.03   | 02.06  | 24.3727-1800.2<br>24.3727-0660.2   | 581800<br>580660   | 1 <br>1  | L=312<br>L=1575/1627   |                          |
| <b>FORD TOURNEO (94-00)</b>  |  |   |  |   |  |  |  |  |  |                          |
|    | 2.0<br>2.5 D<br>2.5 TD   |   |  | 07.94<br>07.94<br>07.94   | 03.97<br>03.97<br>03.97  | 24.2123-1724.3<br>10.6123-0154.3   | 010566<br>010578   | - ABS<br>+ ABS   | THz 23,81<br>THz 23,81   | <b>BDX</b><br><b>ATE</b> |
|    | 2.0<br>2.5 D<br>2.5 TD   |   |  | 04.97<br>04.97<br>04.97   | 03.00<br>03.00<br>03.00  | 24.2123-1749.3<br>24.2123-1742.3   | 010713<br>010671   | - ABS<br>+ ABS   | THz 23,81<br>THz 23,81   |                          |
|    | 2.0<br>2.5 D<br>2.5 TD   |   |  | 07.94<br>07.94<br>07.94   | 03.00<br>03.00<br>03.00  | 24.3222-1124.3<br>24.3220-1121.3   | 020344<br>020343   |  | Rz 22,20<br>Rz 20,64   |                          |
|    | 2.0<br>2.5 D<br>2.5 TD   |   |  | 07.94<br>07.94<br>07.94   | 03.00<br>03.00<br>03.00  | 24.3727-0636.2<br>24.3727-0637.2   | 580636<br>580637   | 1 <br>1  | + Einfachbereifung <sup>1)</sup><br>+ Doppelbereifung <sup>2)</sup>      | L=2823<br>L=2730         |
| <b>FORD TRANSIT (92-94)</b>  |  |   |  |   |  |  |  |  |  |                          |
|    | 2.0 Bus<br>2.0 i Bus<br>2.0 i Kasten<br>2.0 Kasten<br>2.0 Pritsche/Fahrg.<br>2.5 DI Bus<br>2.5 DI Bus<br>2.5 DI Kasten<br>2.5 DI Kasten<br>2.5 DI Kasten<br>2.5 DI Prits./Fahrg.<br>2.5 DI Prits./Fahrg.<br>2.5 TD Bus<br>2.5 TD Bus<br>2.5 TD Kasten<br>2.5 TD Prits./Fahrg.<br>2.5 TD Prits./Fahrg.<br>2.9 i Bus | 66<br>72<br>72<br>66<br>72<br>51<br>59<br>51<br>59<br>63<br>51<br>59<br>63<br>74<br>74<br>63<br>74<br>107 |  | 09.91<br>09.91<br>09.91<br>09.91<br>08.91<br>09.91<br>05.91<br>05.91<br>10.92<br>09.91<br>09.91<br>10.92<br>09.91<br>05.91<br>11.92<br>09.91<br>01.91 | 09.94<br>07.94<br>06.94<br>06.94<br>08.94<br>07.94<br>06.94<br>06.94<br>06.94<br>08.94<br>08.94<br>07.94<br>07.94<br>06.94<br>07.94<br>08.94<br>08.94<br>08.94 | 10.6350-0603.4   | 300159   | + Wegsensor <sup>3)</sup>  | 9"   | <b>ATE</b>               |
|  | 2.0 Bus<br>2.0 i Bus<br>2.0 i Kasten<br>2.0 Kasten<br>2.0 Pritsche/Fahrg.<br>2.5 DI Bus<br>2.5 DI Bus<br>2.5 DI Kasten<br>2.5 DI Kasten<br>2.5 DI Kasten<br>2.5 DI Prits./Fahrg.<br>2.5 DI Prits./Fahrg.<br>2.5 TD Bus<br>2.5 TD Bus<br>2.5 TD Kasten<br>2.5 TD Prits./Fahrg.<br>2.5 TD Prits./Fahrg.<br>2.9 i Bus | 66<br>72<br>72<br>66<br>72<br>51<br>59<br>51<br>59<br>63<br>51<br>59<br>63<br>74<br>74<br>63<br>74<br>107 |  | 09.91<br>09.91<br>09.91<br>09.91<br>08.91<br>09.91<br>05.91<br>05.91<br>10.92<br>09.91<br>09.91<br>10.92<br>09.91<br>05.91<br>11.92<br>09.91<br>01.91 | 09.94<br>07.94<br>06.94<br>06.94<br>08.94<br>07.94<br>06.94<br>06.94<br>08.94<br>08.94<br>07.94<br>07.94<br>06.94<br>07.94<br>08.94<br>08.94<br>08.94          | 24.2123-1724.3<br>10.6123-0154.3   | 010566<br>010578   | - ABS<br>+ ABS   | THz 23,81<br>THz 23,81   | <b>BDX</b><br><b>ATE</b> |
|  | 2.0 Bus<br>2.0 i Bus<br>2.0 i Kasten<br>2.0 Kasten<br>2.0 Pritsche/Fahrg.<br>2.5 DI Bus<br>2.5 DI Bus<br>2.5 DI Kasten<br>2.5 DI Kasten<br>2.5 DI Kasten<br>2.5 DI Prits./Fahrg.<br>2.5 DI Prits./Fahrg.<br>2.5 TD Bus<br>2.5 TD Bus<br>2.5 TD Kasten<br>2.5 TD Prits./Fahrg.<br>2.5 TD Prits./Fahrg.<br>2.9 i Bus | 66<br>72<br>72<br>66<br>72<br>51<br>59<br>51<br>59<br>63<br>51<br>59<br>63<br>74<br>74<br>63<br>74<br>107 |  | 09.91<br>09.91<br>09.91<br>09.91<br>08.91<br>09.91<br>05.91<br>05.91<br>10.92<br>09.91<br>09.91<br>10.92<br>09.91<br>05.91<br>11.92<br>09.91<br>01.91 | 09.94<br>07.94<br>06.94<br>06.94<br>08.94<br>07.94<br>06.94<br>06.94<br>08.94<br>08.94<br>07.94<br>07.94<br>06.94<br>07.94<br>08.94<br>08.94<br>08.94          | 24.5236-0430.3<br>24.5236-0429.3   | 330587<br>330586   | <br> | L=429<br>L=429   |                          |
|  | 2.0 Bus<br>2.0 i Bus<br>2.0 i Kasten<br>2.0 Kasten<br>2.0 Pritsche/Fahrg.<br>2.5 DI Bus<br>2.5 DI Bus<br>2.5 DI Kasten<br>2.5 DI Kasten<br>2.5 DI Kasten   | 66<br>72<br>72<br>66<br>72<br>51<br>59<br>51<br>59<br>63  |  | 09.91<br>09.91<br>09.91<br>09.91<br>08.91<br>09.91<br>05.91<br>05.91<br>10.92   | 09.94<br>07.94<br>06.94<br>06.94<br>08.94<br>07.94<br>06.94<br>06.94<br>08.94<br>08.94   | 24.5245-0405.3<br>24.5245-0398.3   | 330686<br>331188   | 2<br>2   | vertikal Bremssystem <sup>4)</sup><br>diagonal Bremssystem <sup>5)</sup> | L=405<br>L=398           |

<sup>1)</sup> + single tyre / + ruota singola / + roue simple / + cubierta simple

<sup>2)</sup> + twin tyres / + ruote gemellate / + roue jumelée / + cubierta doble

<sup>3)</sup> + travel sensor / + sensore di corsa / + capteur de course / + sensor de recorrido

<sup>4)</sup> vertical brake system / sistema del freno verticale / système de freinage vertical / sistema de freno vertical

<sup>5)</sup> diagonal brake system / sistema freno diagonalmente / système de freinage en diagonal / sistema de freno en diagonal



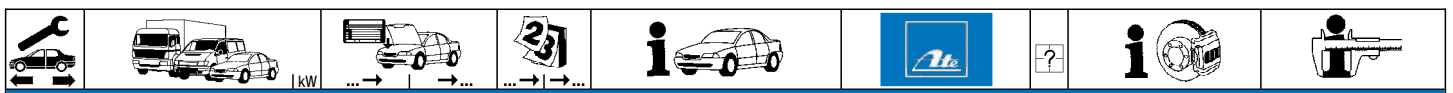

**FORD TRANSIT (92-94)**

|  |   |  |  |  |        |  |                  |
|--|---|--|--|--|--------|--|------------------|
|  | 2.5 DI Prits./Fahrg. 51<br>2.5 DI Prits./Fahrg. 59<br>2.5 TD Bus 63<br>2.5 TD Bus 74<br>2.5 TD Kasten 74<br>2.5 TD Prits./Fahrg. 63<br>2.5 TD Prits./Fahrg. 74<br>2.9 i Bus 107   |  | 09.91 08.94<br>09.91 08.94<br>10.92 07.94<br>09.91 07.94<br>05.91 06.94<br>11.92 08.94<br>09.91 08.94<br>01.91 08.94   | 24.5245-0405.3 330686<br>24.5245-0398.3 331188 | 2<br>2 | vertikal Bremssystem <sup>1)</sup><br>diagonal Bremssystem <sup>2)</sup> | L=405<br>L=398   |
|  | 2.0 Bus 66<br>2.0 i Bus 72<br>2.0 i Kasten 72<br>2.0 Kasten 66<br>2.0 Pritsche/Fahrg. 72<br>2.9 i Bus 107   |  | 09.91 09.94 FT80/100S/100L/115/120<br>09.91 07.94 FT80/100S/100L/115/120<br>09.91 06.94 FT80/100S/100L/115/120<br>09.91 06.94 FT80/100S/100L/115/120<br>09.91 08.94 FT80/100S/100L/115/120<br>09.91 08.94 FT80/100S/100L/115/120<br>01.91 08.94 FT80/100S/100L/115/120   | 24.3222-1124.3 020344                          |        |  | Rz 22,20         |
|  | 2.5 DI Bus 51<br>2.5 DI Bus 59<br>2.5 DI Kasten 51<br>2.5 DI Kasten 59<br>2.5 DI Kasten 63<br>2.5 DI Prits./Fahrg. 51<br>2.5 DI Prits./Fahrg. 59<br>2.5 TD Bus 63<br>2.5 TD Bus 74<br>2.5 TD Kasten 74<br>2.5 TD Prits./Fahrg. 63<br>2.5 TD Prits./Fahrg. 74  |  | 08.91 07.94 FT80/100S/100L/115/120<br>09.91 07.94 FT80/100S/100L/115/120<br>05.91 06.94 FT80/100S/100L/115/120<br>05.91 06.94 FT80/100S/100L/115/120<br>10.92 06.94 FT80/100S/100L/115/120<br>09.91 08.94 FT80/100S/100L/115/120<br>09.91 08.94 FT80/100S/100L/115/120<br>10.92 07.94 FT80/100S/100L/115/120<br>09.91 07.94 FT80/100S/100L/115/120<br>05.91 06.94 FT80/100S/100L/115/120<br>11.92 08.94 FT80/100S/100L/115/120<br>09.91 08.94 FT80/100S/100L/115/120   | 24.3220-1121.3 020343                          |        |  | Rz 20,64         |
|  | 2.0 Bus 66<br>2.0 i Bus 72<br>2.0 i Kasten 72<br>2.0 Kasten 66<br>2.0 Pritsche/Fahrg. 72<br>2.5 DI Bus 51<br>2.5 DI Bus 59<br>2.5 DI Kasten 51<br>2.5 DI Kasten 59<br>2.5 DI Kasten 63<br>2.5 DI Prits./Fahrg. 51<br>2.5 DI Prits./Fahrg. 59<br>2.5 TD Bus 63<br>2.5 TD Bus 74<br>2.5 TD Kasten 74<br>2.5 TD Prits./Fahrg. 63<br>2.5 TD Prits./Fahrg. 74<br>2.9 i Bus 107 |  | 09.91 09.94 FT130/150S/150L<br>09.91 07.94 FT130/150S/150L<br>09.91 06.94 FT130/150S/150L<br>09.91 06.94 FT130/150S/150L<br>09.91 08.94 FT130/150S/150L<br>08.91 07.94 FT130/150S/150L<br>09.91 07.94 FT130/150S/150L<br>05.91 06.94 FT130/150S/150L<br>05.91 06.94 FT130/150S/150L<br>10.92 06.94 FT130/150S/150L<br>09.91 08.94 FT130/150S/150L<br>09.91 08.94 FT130/150S/150L<br>10.92 07.94 FT130/150S/150L<br>09.91 07.94 FT130/150S/150L<br>05.91 06.94 FT130/150S/150L<br>11.92 08.94 FT130/150S/150L<br>09.91 08.94 FT130/150S/150L<br>01.91 08.94 FT130/150S/150L                   | 24.3220-1121.3 020343                          |        |  | Rz 20,64         |
|  | 2.0 Bus 66<br>2.0 i Bus 72<br>2.0 i Kasten 72<br>2.0 Kasten 66<br>2.0 Pritsche/Fahrg. 72<br>2.5 DI Bus 51<br>2.5 DI Bus 59<br>2.5 DI Kasten 51<br>2.5 DI Kasten 59<br>2.5 DI Kasten 63<br>2.5 DI Prits./Fahrg. 51<br>2.5 DI Prits./Fahrg. 59<br>2.5 TD Bus 63<br>2.5 TD Bus 74<br>2.5 TD Kasten 74<br>2.5 TD Prits./Fahrg. 63<br>2.5 TD Prits./Fahrg. 74<br>2.9 i Bus 107 |  | 09.91 09.94 FT190/190A/190EF<br>09.91 07.94 FT190/190A/190EF<br>09.91 06.94 FT190/190A/190EF<br>09.91 06.94 FT190/190A/190EF<br>09.91 08.94 FT190/190A/190EF<br>08.91 07.94 FT190/190A/190EF<br>09.91 07.94 FT190/190A/190EF<br>05.91 06.94 FT190/190A/190EF<br>05.91 06.94 FT190/190A/190EF<br>10.92 06.94 FT190/190A/190EF<br>09.91 08.94 FT190/190A/190EF<br>09.91 08.94 FT190/190A/190EF<br>10.92 07.94 FT190/190A/190EF<br>09.91 07.94 FT190/190A/190EF<br>05.91 06.94 FT190/190A/190EF<br>11.92 08.94 FT190/190A/190EF<br>09.91 08.94 FT190/190A/190EF<br>01.91 08.94 FT190/190A/190EF | 24.3225-1103.3 020346                          |        |  | Rz 25,40         |
|  | 2.0 Bus 66<br>2.0 i Bus 72<br>2.0 i Kasten 72<br>2.0 Kasten 66<br>2.0 Pritsche/Fahrg. 72<br>2.5 DI Bus 51<br>2.5 DI Bus 59<br>2.5 DI Kasten 51<br>2.5 DI Kasten 59<br>2.5 DI Kasten 63<br>2.5 DI Prits./Fahrg. 51<br>2.5 DI Prits./Fahrg. 59<br>2.5 TD Bus 63<br>2.5 TD Bus 74<br>2.5 TD Kasten 74<br>2.5 TD Prits./Fahrg. 63<br>2.5 TD Prits./Fahrg. 74<br>2.9 i Bus 107 |  | 09.91 09.94<br>09.91 07.94<br>09.91 06.94<br>09.91 06.94<br>09.91 08.94<br>08.91 07.94<br>09.91 07.94<br>05.91 06.94<br>05.91 06.94<br>10.92 06.94<br>09.91 08.94<br>09.91 08.94<br>10.92 07.94<br>09.91 07.94<br>05.91 06.94<br>11.92 08.94<br>09.91 08.94<br>01.91 08.94   | 24.3727-0636.2 580636<br>24.3727-0637.2 580637 | 1<br>1 | + Einfachbereifung <sup>3)</sup><br>+ Doppelbereifung <sup>4)</sup>      | L=2823<br>L=2730 |
|  | 2.0 Bus 66<br>2.0 i Bus 72<br>2.0 i Kasten 72<br>2.0 Kasten 66<br>2.0 Pritsche/Fahrg. 72<br>2.5 DI Bus 51<br>2.5 DI Bus 59<br>2.5 DI Kasten 51<br>2.5 DI Kasten 59<br>2.5 DI Kasten 63<br>2.5 DI Prits./Fahrg. 51<br>2.5 DI Prits./Fahrg. 59<br>2.5 TD Bus 63<br>2.5 TD Bus 74<br>2.5 TD Kasten 74<br>2.5 TD Prits./Fahrg. 63<br>2.5 TD Prits./Fahrg. 74<br>2.9 i Bus 107 |  | 09.91 09.94<br>09.91 07.94<br>09.91 06.94<br>09.91 06.94<br>09.91 08.94<br>08.91 07.94<br>09.91 07.94<br>05.91 06.94<br>05.91 06.94<br>10.92 06.94<br>09.91 08.94<br>09.91 08.94<br>10.92 07.94<br>09.91 07.94<br>05.91 06.94<br>11.92 08.94<br>09.91 08.94<br>01.91 08.94   | 24.3728-0627.2 590627                          |        |  | L=1376           |

<sup>1)</sup> vertical brake system / sistema del freno verticale / système de freinage vertical / sistema de freno vertical  
<sup>2)</sup> diagonal brake system / sistema freno diagonalmente / système de freinage en diagonal / sistema de freno en diagonal  
<sup>3)</sup> + single tyre / + ruota singola / + roue simple / + cubierta simple  
<sup>4)</sup> + twin tyres / + ruote gemellate / + roue jumelée / + cubierta doble

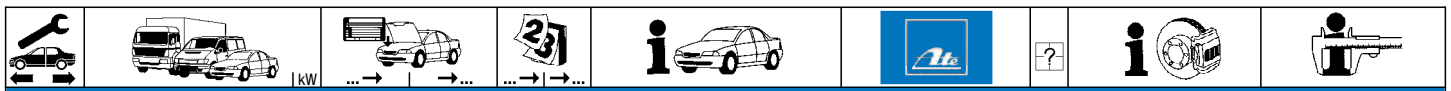

| FORD TRANSIT (92-94) |                      |     |  |       |       |                |        |  |  |        |
|----------------------|----------------------|-----|--|-------|-------|----------------|--------|--|--|--------|
|                      | 2.5 DI Kasten        | 51  |  | 05.91 | 06.94 | 24.3728-0627.2 | 590627 |  |  | L=1376 |
|                      | 2.5 DI Kasten        | 59  |  | 05.91 | 06.94 |                |        |  |  |        |
|                      | 2.5 DI Kasten        | 63  |  | 10.92 | 06.94 |                |        |  |  |        |
|                      | 2.5 DI Prits./Fahrg. | 51  |  | 09.91 | 08.94 |                |        |  |  |        |
|                      | 2.5 DI Prits./Fahrg. | 59  |  | 09.91 | 08.94 |                |        |  |  |        |
|                      | 2.5 TD Bus           | 63  |  | 10.92 | 07.94 |                |        |  |  |        |
|                      | 2.5 TD Bus           | 74  |  | 09.91 | 07.94 |                |        |  |  |        |
|                      | 2.5 TD Kasten        | 74  |  | 05.91 | 06.94 |                |        |  |  |        |
|                      | 2.5 TD Prits./Fahrg. | 63  |  | 11.92 | 08.94 |                |        |  |  |        |
|                      | 2.5 TD Prits./Fahrg. | 74  |  | 09.91 | 08.94 |                |        |  |  |        |
|                      | 2.9 i Bus            | 107 |  | 01.91 | 08.94 |                |        |  |  |        |

| FORD TRANSIT (95-00) |                      |    |  |       |       |                |        |       |  |           |
|----------------------|----------------------|----|--|-------|-------|----------------|--------|-------|--|-----------|
|                      | 2.0 Bus              | 84 |  | 09.95 | 03.97 | 10.6360-1302.4 | 300286 | + ABS |  | 10" ATE   |
|                      | 2.0 CNG Bus          | 84 |  | 06.94 | 03.97 |                |        |       |  |           |
|                      | 2.0 Kasten           | 84 |  | 06.94 | 03.97 |                |        |       |  |           |
|                      | 2.0 Pritsche/Fahrg.  | 84 |  | 08.94 | 03.97 |                |        |       |  |           |
|                      | 2.5 DI Bus           | 51 |  | 08.94 | 03.97 |                |        |       |  |           |
|                      | 2.5 DI Bus           | 56 |  | 07.94 | 03.97 |                |        |       |  |           |
|                      | 2.5 DI Kasten        | 51 |  | 06.94 | 03.97 |                |        |       |  |           |
|                      | 2.5 DI Kasten        | 56 |  | 06.94 | 03.97 |                |        |       |  |           |
|                      | 2.5 DI Prits./Fahrg. | 51 |  | 08.94 | 03.97 |                |        |       |  |           |
|                      | 2.5 DI Prits./Fahrg. | 56 |  | 08.94 | 03.97 |                |        |       |  |           |
|                      | 2.5 TD Bus           | 55 |  | 08.94 | 03.97 |                |        |       |  |           |
|                      | 2.5 TD Bus           | 63 |  | 01.95 | 03.97 |                |        |       |  |           |
|                      | 2.5 TD Bus           | 74 |  | 07.94 | 03.97 |                |        |       |  |           |
|                      | 2.5 TD Kasten        | 63 |  | 06.94 | 03.97 |                |        |       |  |           |
|                      | 2.5 TD Kasten        | 74 |  | 06.94 | 03.97 |                |        |       |  |           |
|                      | 2.5 TD Prits./Fahrg. | 63 |  | 08.94 | 03.97 |                |        |       |  |           |
|                      | 2.5 TD Prits./Fahrg. | 74 |  | 08.94 | 03.97 |                |        |       |  |           |
|                      | 2.0 Bus              | 84 |  | 09.95 | 03.97 | 24.2123-1724.3 | 010566 | - ABS |  | THz 23,81 |
|                      | 2.0 CNG Bus          | 84 |  | 06.94 | 03.97 | 10.6123-0154.3 | 010578 | + ABS |  | THz 23,81 |
|                      | 2.0 Kasten           | 84 |  | 06.94 | 03.97 |                |        |       |  |           |
|                      | 2.0 Pritsche/Fahrg.  | 84 |  | 08.94 | 03.97 |                |        |       |  |           |
|                      | 2.5 DI Bus           | 51 |  | 08.94 | 03.97 |                |        |       |  |           |
|                      | 2.5 DI Bus           | 56 |  | 07.94 | 03.97 |                |        |       |  |           |
|                      | 2.5 DI Kasten        | 51 |  | 06.94 | 03.97 |                |        |       |  |           |
|                      | 2.5 DI Kasten        | 56 |  | 06.94 | 03.97 |                |        |       |  |           |
|                      | 2.5 DI Prits./Fahrg. | 51 |  | 08.94 | 03.97 |                |        |       |  |           |
|                      | 2.5 DI Prits./Fahrg. | 56 |  | 08.94 | 03.97 |                |        |       |  |           |
|                      | 2.5 TD Bus           | 55 |  | 08.94 | 03.97 |                |        |       |  |           |
|                      | 2.5 TD Bus           | 63 |  | 01.95 | 03.97 |                |        |       |  |           |
|                      | 2.5 TD Bus           | 74 |  | 07.94 | 03.97 |                |        |       |  |           |
|                      | 2.5 TD Kasten        | 63 |  | 06.94 | 03.97 |                |        |       |  |           |
|                      | 2.5 TD Kasten        | 74 |  | 06.94 | 03.97 |                |        |       |  |           |
|                      | 2.5 TD Prits./Fahrg. | 63 |  | 08.94 | 03.97 |                |        |       |  |           |
|                      | 2.5 TD Prits./Fahrg. | 74 |  | 08.94 | 03.97 |                |        |       |  |           |
|                      | 2.0 Bus              | 84 |  | 04.97 | 03.00 | 24.2123-1749.3 | 010713 | - ABS |  | THz 23,81 |
|                      | 2.0 CNG Bus          | 84 |  | 04.97 | 03.00 | 24.2123-1742.3 | 010671 | + ABS |  | THz 23,81 |
|                      | 2.0 Kasten           | 84 |  | 04.97 | 03.00 |                |        |       |  |           |
|                      | 2.0 Pritsche/Fahrg.  | 84 |  | 04.97 | 03.00 |                |        |       |  |           |
|                      | 2.5 DI Bus           | 51 |  | 04.97 | 03.00 |                |        |       |  |           |
|                      | 2.5 DI Bus           | 56 |  | 04.97 | 03.00 |                |        |       |  |           |
|                      | 2.5 DI Bus           | 85 |  | 08.97 | 03.00 |                |        |       |  |           |
|                      | 2.5 DI Kasten        | 51 |  | 04.97 | 03.00 |                |        |       |  |           |
|                      | 2.5 DI Kasten        | 56 |  | 04.97 | 03.00 |                |        |       |  |           |
|                      | 2.5 DI Kasten        | 85 |  | 05.99 | 03.00 |                |        |       |  |           |
|                      | 2.5 DI Prits./Fahrg. | 51 |  | 04.97 | 03.00 |                |        |       |  |           |
|                      | 2.5 DI Prits./Fahrg. | 56 |  | 04.97 | 03.00 |                |        |       |  |           |
|                      | 2.5 DI Prits./Fahrg. | 85 |  | 05.99 | 03.00 |                |        |       |  |           |
|                      | 2.5 TD Bus           | 55 |  | 04.97 | 03.00 |                |        |       |  |           |
|                      | 2.5 TD Bus           | 63 |  | 04.97 | 03.00 |                |        |       |  |           |
|                      | 2.5 TD Bus           | 74 |  | 04.97 | 03.00 |                |        |       |  |           |
|                      | 2.5 TD Kasten        | 55 |  | 10.98 | 03.00 |                |        |       |  |           |
|                      | 2.5 TD Kasten        | 63 |  | 04.97 | 03.00 |                |        |       |  |           |
|                      | 2.5 TD Kasten        | 74 |  | 04.97 | 03.00 |                |        |       |  |           |
|                      | 2.5 TD Prits./Fahrg. | 55 |  | 10.98 | 03.00 |                |        |       |  |           |
|                      | 2.5 TD Prits./Fahrg. | 63 |  | 04.97 | 03.00 |                |        |       |  |           |
|                      | 2.5 TD Prits./Fahrg. | 74 |  | 04.97 | 03.00 |                |        |       |  |           |
|                      | 2.0 Bus              | 84 |  | 09.95 | 03.00 | 24.5236-0430.3 | 330587 |       |  | L=429     |
|                      | 2.0 CNG Bus          | 84 |  | 06.94 | 03.00 | 24.5236-0429.3 | 330586 |       |  | L=429     |
|                      | 2.0 Kasten           | 84 |  | 06.94 | 03.00 |                |        |       |  |           |
|                      | 2.0 Pritsche/Fahrg.  | 84 |  | 08.94 | 03.00 |                |        |       |  |           |
|                      | 2.5 DI Bus           | 51 |  | 08.94 | 03.00 |                |        |       |  |           |
|                      | 2.5 DI Bus           | 56 |  | 07.94 | 03.00 |                |        |       |  |           |
|                      | 2.5 DI Bus           | 85 |  | 08.97 | 03.00 |                |        |       |  |           |
|                      | 2.5 DI Kasten        | 51 |  | 06.94 | 03.00 |                |        |       |  |           |
|                      | 2.5 DI Kasten        | 56 |  | 06.94 | 03.00 |                |        |       |  |           |
|                      | 2.5 DI Kasten        | 85 |  | 05.99 | 03.00 |                |        |       |  |           |
|                      | 2.5 DI Prits./Fahrg. | 51 |  | 08.94 | 03.00 |                |        |       |  |           |
|                      | 2.5 DI Prits./Fahrg. | 56 |  | 08.94 | 03.00 |                |        |       |  |           |
|                      | 2.5 DI Prits./Fahrg. | 85 |  | 05.99 | 03.00 |                |        |       |  |           |
|                      | 2.5 TD Bus           | 55 |  | 08.94 | 03.00 |                |        |       |  |           |
|                      | 2.5 TD Bus           | 63 |  | 01.95 | 03.00 |                |        |       |  |           |
|                      | 2.5 TD Bus           | 74 |  | 07.94 | 03.00 |                |        |       |  |           |
|                      | 2.5 TD Kasten        | 55 |  | 10.98 | 03.00 |                |        |       |  |           |
|                      | 2.5 TD Kasten        | 63 |  | 06.94 | 03.00 |                |        |       |  |           |





**FORD TRANSIT (95-00)**























|                      |                      |    |       |       |       |                |        |  |        |  |                  |
|----------------------|----------------------|----|-------|-------|-------|----------------|--------|--|--------|--|------------------|
|                      | 2.5 TD Kasten        | 74 |       | 06.94 | 03.00 | 24.5236-0430.3 | 330587 |  |        | L=429<br>L=429   |                  |
|                      | 2.5 TD Prits./Fahrg. | 55 |       | 10.98 | 03.00 | 24.5236-0429.3 | 330586 |  |        |  |                  |
|                      | 2.5 TD Prits./Fahrg. | 63 |       | 08.94 | 03.00 |                |        |  |        |  |                  |
|                      | 2.5 TD Prits./Fahrg. | 74 |       | 08.94 | 03.00 |                |        |  |        |  |                  |
|                      | 2.0 Bus              | 84 |       | 09.95 | 03.00 | 24.5245-0405.3 | 330686 |  | 2<br>2 | vertikal Bremssystem <sup>1)</sup><br>diagonal Bremssystem <sup>2)</sup> | L=405<br>L=398   |
|                      | 2.0 CNG Bus          | 84 |       | 06.94 | 03.00 | 24.5245-0398.3 | 331188 |  |        |  |                  |
|                      | 2.0 Kasten           | 84 |       | 06.94 | 03.00 |                |        |  |        |  |                  |
|                      | 2.0 Pritsche/Fahrg.  | 84 |       | 08.94 | 03.00 |                |        |  |        |  |                  |
|                      | 2.5 DI Bus           | 51 |       | 08.94 | 03.00 |                |        |  |        |  |                  |
|                      | 2.5 DI Bus           | 56 |       | 07.94 | 03.00 |                |        |  |        |  |                  |
|                      | 2.5 DI Bus           | 85 |       | 08.97 | 03.00 |                |        |  |        |  |                  |
|                      | 2.5 DI Kasten        | 51 |       | 06.94 | 03.00 |                |        |  |        |  |                  |
|                      | 2.5 DI Kasten        | 56 |       | 06.94 | 03.00 |                |        |  |        |  |                  |
|                      | 2.5 DI Kasten        | 85 |       | 05.99 | 03.00 |                |        |  |        |  |                  |
|                      | 2.5 DI Prits./Fahrg. | 51 |       | 08.94 | 03.00 |                |        |  |        |  |                  |
|                      | 2.5 DI Prits./Fahrg. | 56 |       | 08.94 | 03.00 |                |        |  |        |  |                  |
|                      | 2.5 DI Prits./Fahrg. | 85 |       | 05.99 | 03.00 |                |        |  |        |  |                  |
|                      | 2.5 TD Bus           | 55 |       | 08.94 | 03.00 |                |        |  |        |  |                  |
|                      | 2.5 TD Bus           | 63 |       | 01.95 | 03.00 |                |        |  |        |  |                  |
|                      | 2.5 TD Bus           | 74 |       | 07.94 | 03.00 |                |        |  |        |  |                  |
|                      | 2.5 TD Kasten        | 55 |       | 10.98 | 03.00 |                |        |  |        |  |                  |
|                      | 2.5 TD Kasten        | 63 |       | 06.94 | 03.00 |                |        |  |        |  |                  |
|                      | 2.5 TD Kasten        | 74 |       | 06.94 | 03.00 |                |        |  |        |  |                  |
|                      | 2.5 TD Prits./Fahrg. | 55 |       | 10.98 | 03.00 |                |        |  |        |  |                  |
| 2.5 TD Prits./Fahrg. | 63                   |    | 08.94 | 03.00 |       |                |        |  |        |  |                  |
| 2.5 TD Prits./Fahrg. | 74                   |    | 08.94 | 03.00 |       |                |        |  |        |  |                  |
|                      | 2.0 Bus              | 84 |       | 09.95 | 03.00 | 24.3222-1124.3 | 020344 |  |        | Rz 22,20   |                  |
|                      | 2.0 CNG Bus          | 84 |       | 06.94 | 03.00 |                |        |  |        |  |                  |
|                      | 2.0 Kasten           | 84 |       | 06.94 | 03.00 |                |        |  |        |  |                  |
|                      | 2.0 Pritsche/Fahrg.  | 84 |       | 08.94 | 03.00 |                |        |  |        |  |                  |
|                      | 2.5 DI Bus           | 51 |       | 08.94 | 03.00 | 24.3220-1121.3 | 020343 |  |        |  |                  |
|                      | 2.5 DI Bus           | 56 |       | 07.94 | 03.00 |                |        |  |        |  |                  |
|                      | 2.5 DI Bus           | 85 |       | 08.97 | 03.00 |                |        |  |        |  |                  |
|                      | 2.5 DI Kasten        | 51 |       | 06.94 | 03.00 |                |        |  |        |  |                  |
|                      | 2.5 DI Kasten        | 56 |       | 06.94 | 03.00 |                |        |  |        |  |                  |
|                      | 2.5 DI Kasten        | 85 |       | 05.99 | 03.00 |                |        |  |        |  |                  |
|                      | 2.5 DI Prits./Fahrg. | 51 |       | 08.94 | 03.00 |                |        |  |        |  |                  |
|                      | 2.5 DI Prits./Fahrg. | 56 |       | 08.94 | 03.00 |                |        |  |        |  |                  |
|                      | 2.5 DI Prits./Fahrg. | 85 |       | 05.99 | 03.00 |                |        |  |        |  |                  |
|                      | 2.5 TD Bus           | 55 |       | 08.94 | 03.00 |                |        |  |        |  |                  |
|                      | 2.5 TD Bus           | 63 |       | 01.95 | 03.00 |                |        |  |        |  |                  |
|                      | 2.5 TD Bus           | 74 |       | 07.94 | 03.00 |                |        |  |        |  |                  |
|                      | 2.5 TD Kasten        | 55 |       | 10.98 | 03.00 |                |        |  |        |  |                  |
|                      | 2.5 TD Kasten        | 63 |       | 06.94 | 03.00 |                |        |  |        |  |                  |
|                      | 2.5 TD Kasten        | 74 |       | 06.94 | 03.00 |                |        |  |        |  |                  |
|                      | 2.5 TD Prits./Fahrg. | 55 |       | 10.98 | 03.00 |                |        |  |        |  |                  |
| 2.5 TD Prits./Fahrg. | 63                   |    | 08.94 | 03.00 |       |                |        |  |        |  |                  |
| 2.5 TD Prits./Fahrg. | 74                   |    | 08.94 | 03.00 |       |                |        |  |        |  |                  |
|                      | 2.0 Bus              | 84 |       | 09.95 | 03.00 | 24.3225-1103.3 | 020346 |  |        | Rz 25,40   |                  |
|                      | 2.0 CNG Bus          | 84 |       | 06.94 | 03.00 |                |        |  |        |  |                  |
|                      | 2.0 Kasten           | 84 |       | 06.94 | 03.00 |                |        |  |        |  |                  |
|                      | 2.0 Pritsche/Fahrg.  | 84 |       | 08.94 | 03.00 |                |        |  |        |  |                  |
|                      | 2.5 DI Bus           | 51 |       | 08.94 | 03.00 |                |        |  |        |  |                  |
|                      | 2.5 DI Bus           | 56 |       | 07.94 | 03.00 |                |        |  |        |  |                  |
|                      | 2.5 DI Bus           | 85 |       | 08.97 | 03.00 |                |        |  |        |  |                  |
|                      | 2.5 DI Kasten        | 51 |       | 06.94 | 03.00 |                |        |  |        |  |                  |
|                      | 2.5 DI Kasten        | 56 |       | 06.94 | 03.00 |                |        |  |        |  |                  |
|                      | 2.5 DI Kasten        | 85 |       | 05.99 | 03.00 |                |        |  |        |  |                  |
|                      | 2.5 DI Prits./Fahrg. | 51 |       | 08.94 | 03.00 |                |        |  |        |  |                  |
|                      | 2.5 DI Prits./Fahrg. | 56 |       | 08.94 | 03.00 |                |        |  |        |  |                  |
|                      | 2.5 DI Prits./Fahrg. | 85 |       | 05.99 | 03.00 |                |        |  |        |  |                  |
|                      | 2.5 TD Bus           | 55 |       | 08.94 | 03.00 |                |        |  |        |  |                  |
|                      | 2.5 TD Bus           | 63 |       | 01.95 | 03.00 |                |        |  |        |  |                  |
|                      | 2.5 TD Bus           | 74 |       | 07.94 | 03.00 |                |        |  |        |  |                  |
|                      | 2.5 TD Kasten        | 55 |       | 10.98 | 03.00 |                |        |  |        |  |                  |
|                      | 2.5 TD Kasten        | 63 |       | 06.94 | 03.00 |                |        |  |        |  |                  |
|                      | 2.5 TD Kasten        | 74 |       | 06.94 | 03.00 |                |        |  |        |  |                  |
|                      | 2.5 TD Prits./Fahrg. | 55 |       | 10.98 | 03.00 |                |        |  |        |  |                  |
| 2.5 TD Prits./Fahrg. | 63                   |    | 08.94 | 03.00 |       |                |        |  |        |  |                  |
| 2.5 TD Prits./Fahrg. | 74                   |    | 08.94 | 03.00 |       |                |        |  |        |  |                  |
|                      | 2.0 Bus              | 84 |       | 09.95 | 03.00 | 24.3727-0636.2 | 580636 |  | 1<br>1 | + Einfachbereifung <sup>3)</sup><br>+ Doppelbereifung <sup>4)</sup>      | L=2823<br>L=2730 |
|                      | 2.0 CNG Bus          | 84 |       | 06.94 | 03.00 | 24.3727-0637.2 | 580637 |  |        |  |                  |
|                      | 2.0 Kasten           | 84 |       | 06.94 | 03.00 |                |        |  |        |  |                  |
|                      | 2.0 Pritsche/Fahrg.  | 84 |       | 08.94 | 03.00 |                |        |  |        |  |                  |
|                      | 2.5 DI Bus           | 51 |       | 08.94 | 03.00 |                |        |  |        |  |                  |
|                      | 2.5 DI Bus           | 56 |       | 07.94 | 03.00 |                |        |  |        |  |                  |
|                      | 2.5 DI Bus           | 85 |       | 08.97 | 03.00 |                |        |  |        |  |                  |
|                      | 2.5 DI Kasten        | 51 |       | 06.94 | 03.00 |                |        |  |        |  |                  |
|                      | 2.5 DI Kasten        | 56 |       | 06.94 | 03.00 |                |        |  |        |  |                  |
|                      | 2.5 DI Kasten        | 85 |       | 05.99 | 03.00 |                |        |  |        |  |                  |
|                      | 2.5 DI Prits./Fahrg. | 51 |       | 08.94 | 03.00 |                |        |  |        |  |                  |
|                      | 2.5 DI Prits./Fahrg. | 56 |       | 08.94 | 03.00 |                |        |  |        |  |                  |
|                      | 2.5 DI Prits./Fahrg. | 85 |       | 05.99 | 03.00 |                |        |  |        |  |                  |
|                      | 2.5 TD Bus           | 55 |       | 08.94 | 03.00 |                |        |  |        |  |                  |
| 2.5 TD Bus           | 63                   |    | 01.95 | 03.00 |       |                |        |  |        |  |                  |
| 2.5 TD Bus           | 74                   |    | 07.94 | 03.00 |       |                |        |  |        |  |                  |
| 2.5 TD Kasten        | 55                   |    | 10.98 | 03.00 |       |                |        |  |        |  |                  |

<sup>1)</sup> vertical brake system / sistema del freno verticale / système de freinage vertical / sistema de freno vertical  
<sup>2)</sup> diagonal brake system / sistema freno diagonalmente / système de freinage en diagonal / sistema de freno en diagonal  
<sup>3)</sup> + single tyre / + ruota singola / + roue simple / + cubierta simple  
<sup>4)</sup> + twin tyres / + ruote gemellate / + roue jumelée / + cubierta doble













































































| <b>FORD TRANSIT (95-00)</b>                         |                      |     |  |       |       |  |  |                |        |   |                                  |                |     |
|---|----------------------|-----|--|-------|-------|--|--|----------------|--------|---|----------------------------------|----------------|-----|
|   | 2.5 TD Kasten        | 63  |  | 06.94 | 03.00 |  |  | 24.3727-0636.2 | 580636 | 1 | + Einfachbereifung <sup>1)</sup> | L=2823         |     |
|   | 2.5 TD Kasten        | 74  |  | 06.94 | 03.00 |  |  | 24.3727-0637.2 | 580637 | 1 | + Doppelbereifung <sup>2)</sup>  | L=2730         |     |
|   | 2.5 TD Prits./Fahrg. | 55  |  | 10.98 | 03.00 |  |  |                |        |   |                                  |                |     |
|   | 2.5 TD Prits./Fahrg. | 63  |  | 08.94 | 03.00 |  |  |                |        |   |                                  |                |     |
|   | 2.5 TD Prits./Fahrg. | 74  |  | 08.94 | 03.00 |  |  |                |        |   |                                  |                |     |
| <b>FORD TRANSIT (00-06)</b>                         |                      |     |  |       |       |  |  |                |        |   |                                  |                |     |
|   | 2.0 DI               |     |  | 08.00 | 04.06 |  |  | 24.5299-0449.3 | 331039 |   |                                  | L=449          |     |
|   | 2.0 TDCi             |     |  | 08.02 | 04.06 |  |  | 24.5299-0452.3 | 331040 |   |                                  | L=452          |     |
|   | 2.3 16V RWD          |     |  | 08.00 | 04.06 |  |  |                |        |   |                                  |                |     |
|   | 2.3 i 16V            |     |  | 04.01 | 04.06 |  |  |                |        |   |                                  |                |     |
|   | 2.4 DI               |     |  | 01.00 | 04.06 |  |  |                |        |   |                                  |                |     |
|   | 2.4 DI RWD           |     |  | 01.00 | 04.06 |  |  |                |        |   |                                  |                |     |
|   | 2.4 TD Allrad        | 55  |  | 08.00 | 04.06 |  |  |                |        |   |                                  |                |     |
|   | 2.4 TDCi             |     |  | 03.04 | 04.06 |  |  |                |        |   |                                  |                |     |
|   | 2.4 TDCi RWD         | 101 |  | 03.04 | 04.06 |  |  |                |        |   |                                  |                |     |
|   | 2.4 TDE              |     |  | 11.01 | 04.06 |  |  |                |        |   |                                  |                |     |
|   | 2.4 TDE RWD          |     |  | 11.01 | 04.06 |  |  |                |        |   |                                  |                |     |
|   | 2.0 DI               |     |  | 08.00 | 04.06 |  |  | 24.5294-0463.3 | 331032 | 2 |                                  | L=425          |     |
|   | 2.0 TDCi             |     |  | 08.02 | 04.06 |  |  |                |        |   |                                  |                |     |
|   | 2.3 16V RWD          |     |  | 08.00 | 04.06 |  |  |                |        |   |                                  |                |     |
|   | 2.3 i 16V            |     |  | 04.01 | 04.06 |  |  |                |        |   |                                  |                |     |
|   | 2.4 DI               |     |  | 01.00 | 04.06 |  |  |                |        |   |                                  |                |     |
|   | 2.4 DI RWD           |     |  | 01.00 | 04.06 |  |  |                |        |   |                                  |                |     |
|   | 2.4 TD Allrad        | 55  |  | 08.00 | 04.06 |  |  |                |        |   |                                  |                |     |
|   | 2.4 TDCi             |     |  | 03.04 | 04.06 |  |  |                |        |   |                                  |                |     |
|   | 2.4 TDCi RWD         | 101 |  | 03.04 | 04.06 |  |  |                |        |   |                                  |                |     |
|   | 2.4 TDE              |     |  | 11.01 | 04.06 |  |  |                |        |   |                                  |                |     |
|   | 2.4 TDE RWD          |     |  | 11.01 | 04.06 |  |  |                |        |   |                                  |                |     |
|   | 2.0 DI               |     |  | 08.00 | 04.06 |  |  | 24.3225-1103.3 | 020346 |   |                                  | Rz 25,40       |     |
|   | 2.0 TDCi             |     |  | 08.02 | 04.06 |  |  |                |        |   |                                  |                |     |
|   | 2.3 16V RWD          |     |  | 08.00 | 04.06 |  |  |                |        |   |                                  |                |     |
|   | 2.3 i 16V            |     |  | 04.01 | 04.06 |  |  |                |        |   |                                  |                |     |
|   | 2.4 DI               |     |  | 01.00 | 04.06 |  |  |                |        |   |                                  |                |     |
|   | 2.4 DI RWD           |     |  | 01.00 | 04.06 |  |  |                |        |   |                                  |                |     |
|   | 2.4 TD Allrad        | 55  |  | 08.00 | 04.06 |  |  |                |        |   |                                  |                |     |
|   | 2.4 TDCi             |     |  | 03.04 | 04.06 |  |  |                |        |   |                                  |                |     |
|   | 2.4 TDCi RWD         | 101 |  | 03.04 | 04.06 |  |  |                |        |   |                                  |                |     |
|   | 2.4 TDE              |     |  | 11.01 | 04.06 |  |  |                |        |   |                                  |                |     |
|   | 2.4 TDE RWD          |     |  | 11.01 | 04.06 |  |  |                |        |   |                                  |                |     |
|   | 2.0 DI               |     |  | 08.00 | 04.06 |  |  | 24.2520-1706.3 | 040094 |   |                                  | Nz 20,40       |     |
|   | 2.0 TDCi             |     |  | 08.02 | 04.06 |  |  |                |        |   |                                  |                |     |
|   | 2.3 16V RWD          |     |  | 08.00 | 04.06 |  |  |                |        |   |                                  |                |     |
|   | 2.3 i 16V            |     |  | 04.01 | 04.06 |  |  |                |        |   |                                  |                |     |
|   | 2.4 DI               |     |  | 01.00 | 04.06 |  |  |                |        |   |                                  |                |     |
|   | 2.4 DI RWD           |     |  | 01.00 | 04.06 |  |  |                |        |   |                                  |                |     |
|   | 2.4 TD Allrad        | 55  |  | 08.00 | 04.06 |  |  |                |        |   |                                  |                |     |
|   | 2.4 TDCi             |     |  | 03.04 | 04.06 |  |  |                |        |   |                                  |                |     |
|   | 2.4 TDCi RWD         | 101 |  | 03.04 | 04.06 |  |  |                |        |   |                                  |                |     |
|   | 2.4 TDE              |     |  | 11.01 | 04.06 |  |  |                |        |   |                                  |                |     |
|   | 2.4 TDE RWD          |     |  | 11.01 | 04.06 |  |  |                |        |   |                                  |                |     |
| <b>FORD TRANSIT (06-)</b>                           |                      |     |  |       |       |  |  |                |        |   |                                  |                |     |
|   | 2.2 TDCi 4x4         |     |  | 10.11 |       |  |  | 24.5141-0320.3 | 330949 | 2 |                                  | L=320          |     |
|   | 2.2 TDCi FWD         |     |  | 05.06 |       |  |  |                |        |   |                                  |                |     |
|   | 2.2 TDCi RWD         |     |  | 10.11 |       |  |  |                |        |   |                                  |                |     |
|   | 2.3 16V RWD          |     |  | 05.06 |       |  |  |                |        |   |                                  |                |     |
|   | 2.4 TDCi 4x4         |     |  | 05.06 |       |  |  |                |        |   |                                  |                |     |
|   | 2.4 TDCi RWD         |     |  | 05.06 |       |  |  |                |        |   |                                  |                |     |
|   | 3.2 TDCi RWD         |     |  | 09.07 |       |  |  |                |        |   |                                  |                |     |
|   | 2.2 TDCi 4x4         |     |  | 10.11 |       |  |  | 24.5124-0252.3 | 331218 | 2 | + Einfachbereifung <sup>1)</sup> | L=252          |     |
|   | 2.2 TDCi FWD         |     |  | 05.06 |       |  |  |                |        |   |                                  |                |     |
|   | 2.2 TDCi RWD         |     |  | 10.11 |       |  |  |                |        |   |                                  |                |     |
|   | 2.3 16V RWD          |     |  | 05.06 |       |  |  |                |        |   |                                  |                |     |
|   | 2.4 TDCi 4x4         |     |  | 05.06 |       |  |  |                |        |   |                                  |                |     |
|   | 2.4 TDCi RWD         |     |  | 05.06 |       |  |  |                |        |   |                                  |                |     |
|   | 3.2 TDCi RWD         |     |  | 09.07 |       |  |  |                |        |   |                                  |                |     |
|   | 2.2 TDCi FWD         |     |  | 05.06 |       |  |  | 24.3225-1103.3 | 020346 |   |                                  | Rz 25,40       |     |
|   | 2.2 TDCi 4x4         |     |  | 10.11 |       |  |  | 24.2520-1706.3 | 040094 |   |                                  | Nz 20,40       |     |
|   | 2.2 TDCi FWD         |     |  | 05.06 |       |  |  |                |        |   |                                  |                |     |
|   | 2.2 TDCi RWD         |     |  | 10.11 |       |  |  |                |        |   |                                  |                |     |
|   | 2.3 16V RWD          |     |  | 05.06 |       |  |  |                |        |   |                                  |                |     |
|   | 2.4 TDCi 4x4         |     |  | 05.06 |       |  |  |                |        |   |                                  |                |     |
|   | 2.4 TDCi RWD         |     |  | 05.06 |       |  |  |                |        |   |                                  |                |     |
|   | 3.2 TDCi RWD         |     |  | 09.07 |       |  |  |                |        |   |                                  |                |     |
| <b>FORD TRANSIT CONNECT / TOURNEO CONNECT (03-)</b> |                      |     |  |       |       |  |  |                |        |   |                                  |                |     |
|   | 1.8 16V              | 85  |  | 06.02 |       |  |  | 11.9367-7001.2 | 220733 |   |                                  | D=36, - Halter | ATE |
|   | 1.8 Di               | 55  |  | 06.02 |       |  |  | 11.9367-7002.2 | 220734 |   |                                  | D=36, - Halter | ATE |
|   | 1.8 TDCi             | 66  |  | 06.02 |       |  |  | 11.0101-5407.2 | 260011 |   |                                  | Hülsensatz     | ATE |
|   | 1.8 TDCi             | 81  |  | 08.06 |       |  |  | 11.8171-0008.1 | 990049 |   |                                  | Führungsbolzen | ATE |
|   |                      |     |  |       |       |  |  | 11.8116-0340.1 | 390595 | 2 |                                  | Haltefeder     | ATE |























1) + single tyre / + ruota singola / + roue simple / + cubierta simple  
2) + twin tyres / + ruote gemellate / + roue jumelée / + cubierta doble  
3) - rear axle C / - asse posteriore C / - essieu arrière C / - eje trasero C









































|     |    |  |   |  |  |  |  |  |   |
|--|--|--|---|--|---|--|--|--|---|
| <b>FORD TRANSIT CONNECT / TOURNEO CONNECT (03-)</b>                                |  |  |   |  |   |  |  |  |   |
|    | 1.8 16V<br>1.8 Di<br>1.8 TDCi<br>1.8 TDCi  | 85<br>55<br>66<br>81   | 06.02<br>06.02<br>06.02<br>08.06  |  | 24.5148-0354.3  | 330992   | 2  | + Trommelbremse <sup>1)</sup>  | L=354   |
|    | 1.8 16V<br>1.8 Di<br>1.8 TDCi<br>1.8 TDCi  | 85<br>55<br>66<br>81   | 06.02<br>06.02<br>06.02<br>08.06  |  | 24.3220-1721.3  | 020467   |  |  | Rz 20,64  |
|    | 1.8 16V<br>1.8 Di<br>1.8 TDCi<br>1.8 TDCi  | 85<br>55<br>66<br>81   | 06.02<br>06.02<br>06.02<br>08.06  |  | 03.6582-0118.3  | 320281   |  |  | BRL 8/1,5 (4) <b>ATE</b>  |
|    | 1.8 16V<br>1.8 Di<br>1.8 TDCi<br>1.8 TDCi  | 85<br>55<br>66<br>81   | 06.02<br>06.02<br>06.02<br>08.06  |  | 24.2419-1733.3  | 030125   |  |  | Gz 19,05  |
| <b>HONDA ACCORD (90-93)</b>  |  |  |   |  |   |  |  |  |   |
|    | 2.0 i 16V (CB3)  |  | 01.90 12.93 - ABS   |  | 24.3219-1723.3<br>24.3219-1724.3  | 020427<br>020428   |  |  | Rz 19,05<br>Rz 19,05  |
| <b>HONDA ACCORD (98-02)</b>  |  |  |   |  |   |  |  |  |   |
|    | 1.6 i 16V (CG7)<br>1.6 i 16V (CH5)<br>1.8 VTEC (CG8)<br>1.8 VTEC (CH6)<br>2.0 TDiC (CH2)<br>2.0 TDiC (CH8)<br>2.0 VTEC (CG9)<br>2.0 VTEC (CH7)<br>2.2 Type R (CH1)<br>2.3 VTEC (CL3)<br>2.3 VTEC (CL4) | 85<br>85<br>100<br>100<br>77<br>77<br>108<br>108<br>156<br>113<br>113            | 10.98 12.02<br>10.98 12.02<br>10.98 12.02<br>10.98 12.02<br>02.99 10.00<br>02.99 10.00<br>10.98 01.01<br>10.98 01.01<br>02.99 12.02<br>01.01 12.02<br>01.01 12.02 |  | 24.5287-0452.3<br>24.5287-0451.3  | 331011<br>331010   |  |  | L=451<br>L=451  |
|    | 1.6 i 16V (CG7)<br>1.6 i 16V (CH5)   | 85<br>85   | 10.98 12.02<br>10.98 12.02  |  | 24.3220-1731.3  | 020503   |  |  | Rz 20,64  |
| <b>HONDA ACCORD Limousine (03-08)</b>  |  |  |   |  |   |  |  |  |   |
|  | 2.0 16V (CL7)<br>2.0 16V (CL8) Allrad<br>2.2 i-CTDi (CN1)<br>2.4 16V (CL9)<br>2.4 16V (CM5)<br>2.4 VTEC (CM5)  | 114<br>114<br>103<br>140<br>113<br>122   | 01.06 05.08<br>01.06 05.08<br>01.06 05.08<br>01.06 05.08<br>09.06 05.08<br>04.06 07.08  |  | 24.2120-1752.3  | 010928   |  |  | Thz 20,64 + Behälter <b>LUC</b>   |
|  | 2.0 16V (CL7)<br>2.0 16V (CL8) Allrad<br>2.4 16V (CL9)<br>2.4 16V (CM5)<br>2.4 16V (CM5)<br>2.4 VTEC (CM5)<br>2.4 VTEC E (CM5)   | 114<br>114<br>140<br>113<br>113<br>122<br>118                                    | 02.03 05.08<br>02.03 05.08<br>02.03 05.08<br>09.06 05.08<br>01.04 05.08<br>04.06 07.08<br>02.03 09.05   |  | 11.0101-5407.2<br>11.8171-0008.1<br>11.8116-0356.1                                | 260011<br>990049<br>390586   | 2  |  | Hülsensatz<br>Führungsbolzen<br>Haltefeder <b>ATE</b><br><b>ATE</b><br><b>ATE</b> |
|  | 2.0 16V (CL7)<br>2.0 16V (CL8) Allrad<br>2.2 i-CTDi (CN1)<br>2.4 16V (CL9)<br>2.4 16V (CM5)<br>2.4 VTEC (CM5)<br>2.4 VTEC E (CM5)  | 114<br>114<br>103<br>140<br>113<br>122<br>118                                    | 02.03 05.08<br>02.03 05.08<br>01.04 05.08<br>02.03 05.08<br>09.06 05.08<br>04.06 07.08<br>02.03 09.05   |  | 24.5270-0457.3<br>24.5270-0456.3  | 330997<br>330996   |  |  | L=456<br>L=456  |
|  | 2.0 16V (CL7)<br>2.0 16V (CL8) Allrad<br>2.2 i-CTDi (CN1)<br>2.4 16V (CL9)<br>2.4 16V (CM5)<br>2.4 VTEC (CM5)<br>2.4 VTEC E (CM5)  | 114<br>114<br>103<br>140<br>113<br>122<br>118                                    | 02.03 05.08<br>02.03 05.08<br>01.04 05.08<br>02.03 05.08<br>09.06 05.08<br>04.06 07.08<br>02.03 09.05   |  | 24.5270-0461.3<br>24.5270-0462.3  | 330998<br>330999   |  |  | L=461<br>L=461  |
| <b>HONDA ACCORD Kombi (03-08)</b>  |  |  |   |  |   |  |  |  |   |
|  | 2.0 i 16V (CM1)<br>2.2 CTDi (CM2)<br>2.4 i 16V (CM2)<br>2.4 VTEC T   | 114<br>103<br>140<br>147   | 01.06 05.08<br>01.06 05.08<br>01.06 05.08<br>01.06 05.08  |  | 24.2120-1752.3  | 010928   |  |  | Thz 20,64 + Behälter <b>LUC</b>   |
|  | 2.0 i 16V (CM1)<br>2.2 CTDi (CM2)<br>2.4 i 16V (CM2)<br>2.4 VTEC E<br>2.4 VTEC T   | 114<br>103<br>140<br>118<br>147  | 04.03 05.08<br>01.04 05.08<br>04.03 05.08<br>09.03 09.05<br>09.03 05.08   |  | 11.0101-5407.2<br>11.8171-0008.1<br>11.8116-0356.1                                | 260011<br>990049<br>390586   | 2  |  | Hülsensatz<br>Führungsbolzen<br>Haltefeder <b>ATE</b><br><b>ATE</b><br><b>ATE</b> |
|  | 2.0 i 16V (CM1)<br>2.2 CTDi (CM2)<br>2.4 i 16V (CM2)<br>2.4 VTEC E<br>2.4 VTEC T   | 114<br>103<br>140<br>118<br>147  | 04.03 05.08<br>01.04 05.08<br>04.03 05.08<br>09.03 09.05<br>09.03 05.08   |  | 24.5270-0457.3<br>24.5270-0456.3  | 330997<br>330996   |  |  | L=456<br>L=456  |

<sup>1)</sup> + drum brake / + freno a tamburo / + freins à tambour / + tambores de freno

|     |  |  |  |  |  |  |  |   |  |
|--|--|--|--|--|---|--|--|---|--|
| <b>HONDA ACCORD Kombi (03-08)</b>  |  |  |  |  |   |  |  |   |  |
|    | 2.0 i 16V (CM1)<br>2.2 CTDi (CM2)<br>2.4 i 16V (CM2)<br>2.4 VTEC E<br>2.4 VTEC T | 114<br>103<br>140<br>118<br>147  |  | 04.03<br>01.04<br>04.03<br>09.03<br>09.03  | 05.08<br>05.08<br>05.08<br>09.05<br>05.08   | 24.5270-0461.3<br>24.5270-0462.3   | 330998<br>330999   | <br>  | L=461<br>L=461                                 |
| <b>HONDA CITY (08-)</b>  |  |  |  |  |   |  |  |   |  |
|    | 1.4 i VTEC   | 73   |  | 09.08  |   | 24.2122-1771.3   | 010901   |    | Thz 22,20 + Behälter <b>LUC</b>                |
|    | 1.4 i VTEC   | 73   |  | 09.08  |   | 24.3511-1717.7<br>24.3511-1718.7   | 220887<br>220888   | <br>  | D=51, - Halter<br>D=51, - Halter               |
|    | 1.4 i VTEC   | 73   |  | 09.08  |   | 24.5268-0495.3<br>24.5268-0496.3   | 330933<br>330934   | <br>  | L=495<br>L=495                                 |
|    | 1.4 i VTEC   | 73   |  | 09.08  |   | 24.3304-1713.7<br>24.3304-1714.7   | 220885<br>220886   | <br>  | D=30, - Halter<br>D=30, - Halter               |
|    | 1.4 i VTEC   | 73   |  | 09.08  |   | 24.5297-0332.3<br>24.5297-0272.3   | 331037<br>331036   | <br>  | L=332<br>L=272                                 |
| <b>HONDA CIVIC (3-türig) (91-95)</b>   |  |  |  |  |   |  |  |   |  |
|    | 1.3 16V (EG3)<br>1.5 16V (EG4)   |  |  | 09.91<br>09.91   | 10.95<br>10.95  | 24.3219-1723.3<br>24.3219-1724.3   | 020427<br>020428   | <br>  | Rz 19,05<br>Rz 19,05                           |
| <b>HONDA CIVIC (4-türig) (91-95)</b>   |  |  |  |  |   |  |  |   |  |
|    | 1.5 16V (EG8)<br>1.6 16V 4WD VTEC(EH1)   | 92   |  | 09.91<br>09.91   | 10.95<br>10.95  | 24.3219-1723.3<br>24.3219-1724.3   | 020427<br>020428   | <br>  | Rz 19,05<br>Rz 19,05                           |
| <b>HONDA CIVIC (3/4-türig) (95-01)</b>   |  |  |  |  |   |  |  |   |  |
|    | 1.4 i (EJ9)<br>1.4 i (EJ9)   | 55<br>66   |  | 11.95<br>11.95   | 01.01<br>01.01  | 24.2120-1751.3   | 010909   |    | Thz 20,64                                      |
|   | 1.4 i (EJ9)<br>1.4 i (EJ9)   | 55<br>66   |  | 11.95<br>11.95   | 01.01<br>01.01  | 24.3511-1709.5<br>24.3511-1710.5   | 240333<br>240334   | <br>   | D=51, - Halter<br>D=51, - Halter               |
|  | 1.4 i (EJ9)<br>1.4 i (EJ9)<br>1.5 VTEC (EK3)<br>1.6 VTEC (EK1)<br>1.6 VTEC (EK4) | 55<br>66<br>84<br>83<br>118  |  | 11.95<br>11.95<br>11.95<br>11.95<br>11.95  | 01.01<br>01.01<br>01.01<br>01.01<br>01.01   | 24.3541-1805.5<br>24.3541-1806.5   | 240323<br>240324   | <br><br><br><br> | D=54, - Halter<br>D=54, - Halter               |
|  | 1.4 i (EJ9)<br>1.4 i (EJ9)<br>1.5 VTEC (EK3)<br>1.6 VTEC (EK1)                   | 55<br>66<br>84<br>83   |  | 11.95<br>11.95<br>11.95<br>11.95   | 01.01<br>01.01<br>01.01<br>01.01  | 24.3219-1723.3<br>24.3219-1724.3   | 020427<br>020428   | <br><br><br>  | Rz 19,05<br>Rz 19,05                           |
| <b>HONDA CIVIC (3-türig) (01-05)</b>   |  |  |  |  |   |  |  |   |  |
|  | 1.4 i 16V<br>1.6 i 16V<br>1.7 CTDi   | 66<br>81<br>74   |  | 02.01<br>02.01<br>01.02  | 12.05<br>12.05<br>12.05   | 24.3541-1825.7<br>24.3541-1826.7   | 220721<br>220722   | <br><br>   | D=54, - Halter<br>D=54, - Halter               |
|  | 1.4 i 16V<br>1.6 i 16V   | 66<br>81   |  | 02.01<br>02.01   | 12.05<br>12.05  | 24.5289-0277.3   | 331013   | 2   | L=277  |
| <b>HONDA CIVIC (4-türig) (01-05)</b>   |  |  |  |  |   |  |  |   |  |
|  | 1.4 i 16V<br>1.6 i 16V   | 66<br>81   |  | 02.01<br>02.01   | 12.05<br>12.05  | 24.3541-1733.7<br>24.3541-1734.7   | 220705<br>220706   | <br>  | D=54, - Halter<br>D=54, - Halter               |
|  | 1.4 i 16V<br>1.6 i 16V   | 66<br>81   |  | 02.01<br>02.01   | 12.05<br>12.05  | 24.5289-0277.3   | 331013   | 2   | L=277  |
| <b>HONDA CIVIC (5-türig) (94-96)</b>   |  |  |  |  |   |  |  |   |  |
|  | 1.4 i (MA8)<br>1.5 VTEC E (MA9)<br>1.6 i (MB1)<br>1.6 VTEC (MB1)                 |  |  | 09.94<br>09.94<br>09.94<br>09.94   | 12.96<br>12.96<br>12.96<br>12.96  | 24.3541-1813.5<br>24.3541-1814.5   | 240381<br>240382   | <br><br><br>  | D=54, - Halter<br>D=54, - Halter               |
|  | 1.4 i (MA8)<br>1.5 VTEC E (MA9)<br>1.6 i (MB1)<br>1.6 VTEC (MB1)                 |  |  | 09.94<br>09.94<br>09.94<br>09.94   | 12.96 + ABS<br>12.96 + ABS<br>12.96<br>12.96                                      | 24.3304-1701.5<br>24.3304-1702.5<br>24.0101-3004.2                                 | 240113<br>240114<br>260042   | <br><br><br>  | D=30, - Halter<br>D=30, - Halter<br>Einbausatz |
|  | 1.4 i (MA8)<br>1.5 VTEC E (MA9)  |  |  | 09.94<br>09.94   | 12.95 - ABS<br>12.95 - ABS  | 24.3219-1710.3   | 020386   |    | Rz 19,05                                       |
|  | 1.4 i (MA8)<br>1.5 VTEC E (MA9)  |  |  | 01.96<br>01.96   | 12.96 - ABS<br>12.96 - ABS  | 24.3219-1743.3   | 020485   |    | Rz 19,05                                       |
| <b>HONDA CIVIC (5-türig) (01-05)</b>   |  |  |  |  |   |  |  |   |  |
|  | 1.4 i 16V (EU7)<br>1.6 VTEC (EU8)<br>1.7 CTDi (EU9)                              | 66<br>81<br>74   |  | 02.01<br>02.01<br>01.02  | 12.05<br>12.05<br>12.05   | 24.3541-1733.7<br>24.3541-1734.7   | 220705<br>220706   | <br><br>   | D=54, - Halter<br>D=54, - Halter               |



































































|     |    |  |  |  |  |  |  |  |  |  |  |
|--|--|--|--|--|---|--|--|--|--|--|--|
| <b>HONDA CIVIC (5-türig) (01-05)</b>   |  |  |  |  |   |  |  |  |  |  |  |
|    | 1.4 i 16V (EU7)<br>1.6 VTEC (EU8)  | 66<br>81   |  | 02.01<br>12.05   | 12.05   |  | 24.5289-0277.3   | 331013   | 2  |  | L=277  |
| <b>HONDA CIVIC Hatchback (FK/FN) (05-)</b>   |  |  |  |  |   |  |  |  |  |  |  |
|    | 1.4 i-VTEC (FK1/FN4)<br>1.6 i 16V (FK4)  | 73<br>84   |  | 10.08<br>09.05   |   |  | 24.2119-1709.3   | 010876   |  |  | Thz 19,05 + Behälter <b>LUC</b>                                      |
|    | 1.4 i-VTEC (FK1/FN4)<br>1.6 i 16V (FK4)  | 73<br>84   |  | 10.08<br>09.05   |   |  | 24.5270-0515.3<br>24.5270-0516.3   | 331145<br>331146   | <input type="checkbox"/><br><input type="checkbox"/>   |  | L=515<br>L=515   |
|    | 1.4 i-VTEC (FK1)<br>1.8 i-VTEC (FK2/FN1)   | 61<br>103  |  | 01.06<br>01.06   |   |  | 24.5268-0510.3<br>24.5268-0511.3   | 331143<br>331144   | <input type="checkbox"/><br><input type="checkbox"/>   |  | L=510<br>L=510   |
|    | 1.4 i-VTEC (FK1)<br>1.8 i-VTEC (FK2/FN1)<br>2.0 i-VTEC (FN2)<br>2.0 Type R (FN2)<br>2.2 CTDi (FK3/FN3)                                 | 61<br>103<br>110<br>148<br>103   |  | 01.06<br>01.06<br>12.06<br>09.06<br>01.06  |   |  | 24.5270-0200.3<br>24.5270-0201.3   | 331247<br>331248   | <input type="checkbox"/><br><input type="checkbox"/><br><input type="checkbox"/><br><input type="checkbox"/><br><input type="checkbox"/>   |  | L=200/290, (Satz)<br>L=200/230, (Satz)                               |
| <b>HONDA CIVIC Stufenheck (FD) (05-)</b>   |  |  |  |  |   |  |  |  |  |  |  |
|    | 1.6 16V (FD4)<br>1.6 16V (FD4/FD6)<br>1.8 16V (FD1)<br>1.8 16V (FD1)<br>1.8 FlexFuel (FD1)<br>1.8 i-VTEC (FD1/FD7)                     | 92<br>84<br>97<br>103<br>103<br>103  |  | 09.05<br>01.06<br>01.06<br>02.06<br>11.06<br>09.05                               |   |  | 24.2119-1709.3   | 010876   |  |  | Thz 19,05 + Behälter <b>LUC</b>                                      |
|    | 1.3 (FD3)<br>1.3 Hybrid (FD3)  | 85<br>70   |  | 02.06<br>01.06   |   |  | 24.3541-1733.7<br>24.3541-1734.7   | 220705<br>220706   | <input type="checkbox"/><br><input type="checkbox"/>   |  | D=54, - Halter<br>D=54, - Halter <b>NIS</b>                          |
|    | 1.3 Hybrid (FD3)<br>1.6 16V (FD4)<br>1.6 16V (FD4/FD6)<br>1.8 16V (FD1)<br>1.8 16V (FD1)<br>1.8 FlexFuel (FD1)<br>1.8 i-VTEC (FD1/FD7) | 85<br>92<br>84<br>97<br>103<br>103<br>103  |  | 01.10<br>09.05<br>09.05<br>01.06<br>02.06<br>11.06<br>09.05                      |   |  | 24.5270-0515.3<br>24.5270-0516.3   | 331145<br>331146   | <input type="checkbox"/><br><input type="checkbox"/><br><input type="checkbox"/><br><input type="checkbox"/><br><input type="checkbox"/><br><input type="checkbox"/><br><input type="checkbox"/> |  | L=515<br>L=515   |
|    | 1.3 (FD3)<br>1.3 Hybrid (FD3)<br>2.0 16V (FD2)   | 85<br>70<br>114  |  | 02.06<br>01.06<br>02.06  |   |  | 24.5289-0277.3<br>24.5270-0200.3<br>24.5270-0201.3                                 | 331013<br>331247<br>331248   | 2<br><input type="checkbox"/><br><input type="checkbox"/>  |  | L=277<br>L=200/290, (Satz)<br>L=200/230, (Satz)                      |
| <b>HONDA CIVIC AERODECK (98-01)</b>  |  |  |  |  |   |  |  |  |  |  |  |
|  | 1.4 i 16V (MB8)<br>1.4 i 16V (MB8)<br>1.5 VTEC (MB9)<br>1.6 i 16V (MC1)<br>2.0 TDiC (MC3)  | 55<br>66<br>84<br>85<br>77   |  | 02.98<br>02.98<br>02.98<br>02.98<br>02.01  | 02.01<br>02.01  |  | 24.3541-1813.5<br>24.3541-1814.5   | 240381<br>240382   | <input type="checkbox"/><br><input type="checkbox"/>   |  | D=54, - Halter<br>D=54, - Halter <b>LUC</b>                          |
|  | 1.4 i 16V (MB8)<br>1.4 i 16V (MB8)<br>1.5 VTEC (MB9)   | 55<br>66<br>84   |  | 02.98<br>02.98<br>02.98  | 02.01<br>02.01<br>02.01   | - ABS<br>- ABS<br>- ABS  | 24.3219-1743.3   | 020485   |  |  | Rz 19,05   |
| <b>HONDA CIVIC COUPE (94-95)</b>   |  |  |  |  |   |  |  |  |  |  |  |
|  | 1.6 i (EJ6)  | 77   |  | 01.94<br>12.95   | - ABS   |  | 24.2120-1751.3   | 010909   |  |  | Thz 20,64  |
|  | 1.5 i (EJ2)<br>1.6 i (EJ6)<br>1.6 VTEC (EJ1)   | 74<br>77<br>92   |  | 01.94<br>01.94<br>01.94  | 12.95<br>12.95<br>12.95   |  | 24.3219-1723.3<br>24.3219-1724.3   | 020427<br>020428   | <input type="checkbox"/><br><input type="checkbox"/>   |  | Rz 19,05<br>Rz 19,05   |
| <b>HONDA CIVIC COUPE (96-01)</b>   |  |  |  |  |   |  |  |  |  |  |  |
|  | 1.6 i (EJ6)  | 77   |  | 01.96<br>12.98   | - ABS   |  | 24.2120-1751.3   | 010909   |  |  | Thz 20,64  |
|  | 1.6 i (EJ6)<br>1.6 VTEC (EJ8)<br>1.6 VTEC (EM1)  | 77<br>92<br>118  |  | 01.96<br>01.96<br>04.99  | 01.01<br>01.01<br>01.01   |  | 24.3511-1709.5<br>24.3511-1710.5<br>24.3541-1805.5<br>24.3541-1806.5               | 240333<br>240334<br>240323<br>240324   | <input type="checkbox"/><br><input type="checkbox"/><br><input type="checkbox"/><br><input type="checkbox"/>   |  | D=51, - Halter<br>D=51, - Halter<br>D=54, - Halter<br>D=54, - Halter |
|  | 1.6 i (EJ6)<br>1.6 VTEC (EJ8)  | 77<br>92   |  | 01.96<br>01.96   | 01.01<br>01.01  |  | 24.3219-1723.3<br>24.3219-1724.3   | 020427<br>020428   | <input type="checkbox"/><br><input type="checkbox"/>   |  | Rz 19,05<br>Rz 19,05   |
| <b>HONDA CIVIC COUPE (01-04)</b>   |  |  |  |  |   |  |  |  |  |  |  |
|  | 1.6 i 16V (EM6)<br>1.7 i 16V (EM2)<br>1.7 VTEC (EM2)   | 81<br>88<br>92   |  | 02.01<br>02.01<br>02.01  | 10.04<br>10.04<br>10.04   |  | 24.3541-1733.7<br>24.3541-1734.7   | 220705<br>220706   | <input type="checkbox"/><br><input type="checkbox"/>   |  | D=54, - Halter<br>D=54, - Halter <b>NIS</b>                          |
| <b>HONDA CONCERTO (90-95)</b>  |  |  |  |  |   |  |  |  |  |  |  |
|  | 1.5 i (HW)<br>1.6 i 16V (HW)<br>1.6 i 16V (HW)   | 66<br>82<br>90   |  | 01.90<br>01.90<br>01.90  | 01.95<br>01.95<br>01.95   |  | 24.3541-1813.5<br>24.3541-1814.5   | 240381<br>240382   | <input type="checkbox"/><br><input type="checkbox"/>   |  | D=54, - Halter<br>D=54, - Halter <b>LUC</b>                          |
|  | 1.6 i 16V (HW)<br>1.6 i 16V (HW)   | 82<br>90   |  | 01.90<br>01.90   | 01.95<br>01.95  |  | 24.3304-1701.5<br>24.3304-1702.5<br>24.0101-3004.2                                 | 240113<br>240114<br>260042   | <input type="checkbox"/><br><input type="checkbox"/>   |  | D=30, - Halter<br>D=30, - Halter<br>Einbausatz <b>LUC</b>            |

|     |  |  |  |  |  |  |  |     |                                 |
|--|--|--|--|--|---|--|--|---|---------------------------------|
| <b>HONDA CONCERTO (90-95)</b>  |  |  |  |  |   |  |  |   |                                 |
|    | 1.5 i (HW)   | 66   |  | 01.90  | 01.95   | 24.3219-1710.3   | 020386   |    | Rz 19,05                        |
| <b>HONDA CR-V I (97-02)</b>  |  |  |  |  |   |  |  |   |                                 |
|    | 2.0 i 16V (RD1)  | 94   |  | 01.98  | 04.99   | 24.2123-1774.3   | 010877   |   | THz 23,81 + Behälter <b>LUC</b> |
|  | 2.0 i 16V (RD1)  | 98   |  | 04.99  | 12.01   |  |  |   | - ABS                           |
|  | 2.0 i 16V (RD1)  | 108  |  | 04.99  | 12.01   |  |  |   | - ABS                           |
|    | 2.0 i 16V (RD1)  | 94   |  | 01.97  | 04.99   | 24.5287-0442.3   | 331009   |    | L=441                           |
|  | 2.0 i 16V (RD1)  | 98   |  | 04.99  | 02.02   | 24.5287-0441.3   | 331008   |    | L=441                           |
|  | 2.0 i 16V (RD1)  | 108  |  | 04.99  | 02.02   |  |  |   |                                 |
|    | 2.0 i 16V (RD1)  | 94   |  | 01.97  | 04.99   | 24.3220-1733.3   | 020515   |    | Rz 20,64                        |
|  | 2.0 i 16V (RD1)  | 98   |  | 04.99  | 02.02   | 24.3220-1734.3   | 020516   |    | Rz 20,64                        |
|  | 2.0 i 16V (RD1)  | 108  |  | 04.99  | 02.02   |  |  |   |                                 |
| <b>HONDA CR-V II (02-06)</b>   |  |  |  |  |   |  |  |   |                                 |
|    | 2.0 16V  | 110  |  | 07.02  | 09.06   | 24.5270-0582.3   | 331001   |    | L=581                           |
|  | 2.0 16V  | 112  |  | 03.02  | 09.06   | 24.5270-0581.3   | 331000   |    | L=581                           |
|  | 2.2 CTDi   | 103  |  | 02.05  | 09.06   |  |  |   |                                 |
|  | 2.4 VTEC Allrad  | 118  |  | 03.02  | 09.06   |  |  |   |                                 |
|    | 2.0 16V  | 110  |  | 07.02  | 12.04   | 24.3381-1707.7   | 220831   |    | D=38, + Halter <b>LUC</b>       |
|  | 2.0 16V  | 112  |  | 03.02  | 09.06   | 24.3381-1708.7   | 220832   |    | D=38, + Halter <b>LUC</b>       |
|  | 2.4 VTEC Allrad  | 118  |  | 03.02  | 12.04   |  |  |   |                                 |
|    | 2.0 16V  | 110  |  | 07.02  | 12.04   | 24.5270-0435.3   | 331134   | 2   | L=435                           |
|  | 2.0 16V  | 112  |  | 03.02  | 09.06   |  |  |   |                                 |
|  | 2.4 VTEC Allrad  | 118  |  | 03.02  | 12.04   |  |  |   |                                 |
|  | 2.0 16V  | 110  |  | 01.05  | 09.06   | 24.5270-0490.3   | 331079   | 2   | L=490                           |
|  | 2.2 CTDi   | 103  |  | 02.05  | 09.06   |  |  |   |                                 |
|  | 2.4 VTEC Allrad  | 118  |  | 01.05  | 09.06   | 24.5270-0450.3   | 331183   | 2   | L=450                           |
| <b>HONDA CR-V III (07-12)</b>  |  |  |  |  |   |  |  |   |                                 |
|    | 2.0 i-VTEC   | 105  |  | 11.09  | 09.12   | 24.5270-0410.3   | 331181   |    | L=410                           |
|  | 2.0 i-VTEC   | 110  |  | 01.07  | 09.10   | 24.5270-0411.3   | 331182   |    | L=410                           |
|  | 2.0 i-VTEC 4WD   | 110  |  | 01.07  | 09.10   |  |  |   |                                 |
|  | 2.2 CTDi 4WD   | 103  |  | 01.07  | 09.12   |  |  |   |                                 |
|  | 2.2 i-DTEC 4WD   | 110  |  | 01.07  | 09.12   |  |  |   |                                 |
|  | 2.4 i-VTEC   | 118  |  | 01.07  | 09.12   |  |  |   |                                 |
|  | 2.4 i-VTEC   | 125  |  | 04.07  | 09.12   |  |  |   |                                 |
|  | 2.4 i-VTEC   | 134  |  | 01.07  | 09.12   |  |  |   |                                 |
|  | 2.4 i-VTEC 4WD   | 118  |  | 01.07  | 09.12   |  |  |   |                                 |
|  | 2.4 i-VTEC 4WD   | 122  |  | 09.09  | 09.12   |  |  |   |                                 |
|  | 2.4 i-VTEC 4WD   | 124  |  | 09.07  | 09.12   |  |  |   |                                 |
|  | 2.4 i-VTEC 4WD   | 125  |  | 04.07  | 09.12   |  |  |   |                                 |
|  | 2.0 i-VTEC   | 105  |  | 11.09  | 09.12   | 24.5270-0450.3   | 331183   | 2   | L=450                           |
|  | 2.0 i-VTEC   | 110  |  | 01.07  | 09.10   |  |  |   |                                 |
|  | 2.0 i-VTEC 4WD   | 110  |  | 01.07  | 09.10   |  |  |   |                                 |
|  | 2.2 CTDi 4WD   | 103  |  | 01.07  | 09.12   |  |  |   |                                 |
|  | 2.2 i-DTEC 4WD   | 110  |  | 01.07  | 09.12   |  |  |   |                                 |
|  | 2.4 i-VTEC   | 118  |  | 01.07  | 09.12   |  |  |   |                                 |
|  | 2.4 i-VTEC   | 125  |  | 04.07  | 09.12   |  |  |   |                                 |
|  | 2.4 i-VTEC   | 134  |  | 01.07  | 09.12   |  |  |   |                                 |
|  | 2.4 i-VTEC 4WD   | 118  |  | 01.07  | 09.12   |  |  |   |                                 |
|  | 2.4 i-VTEC 4WD   | 122  |  | 09.09  | 09.12   |  |  |   |                                 |
|  | 2.4 i-VTEC 4WD   | 124  |  | 09.07  | 09.12   |  |  |   |                                 |
|  | 2.4 i-VTEC 4WD   | 125  |  | 04.07  | 09.12   |  |  |   |                                 |
| <b>HONDA CRX (92-98)</b>   |  |  |  |  |   |  |  |   |                                 |
|  | 1.6 i 16V VTEC (EG2)   | 118  |  | 01.92  | 12.98   | 24.3541-1805.5   | 240323   |  | D=54, - Halter                  |
|  | 1.6 i 16V VTEC (EH6)   | 92   |  | 01.92  | 12.98   | 24.3541-1806.5   | 240324   |  | D=54, - Halter                  |
|  | 1.6 i 16V VTEC (EH6)   | 92   |  | 01.92  | 12.98   | 24.3219-1723.3   | 020427   |  | Rz 19,05                        |
|  |  |  |  |  |   | 24.3219-1724.3   | 020428   |  | Rz 19,05                        |
| <b>HONDA HR-V (99-05)</b>  |  |  |  |  |   |  |  |   |                                 |
|  | 1.6 i 16V  | 77   |  | 02.99  | 09.05   | 24.3219-1723.3   | 020427   |  | Rz 19,05                        |
|  | 1.6 i 16V 4WD  | 77   |  | 02.99  | 09.05   | 24.3219-1724.3   | 020428   |  | Rz 19,05                        |
|  | 1.6 i 16V 4WD  | 91   |  | 10.99  | 09.05   |  |  |   | + 3 türig <sup>1)</sup>         |
|  | 1.6 i 16V  | 77   |  | 02.99  | 09.05   | 24.3220-1733.3   | 020515   |  | Rz 20,64                        |
|  | 1.6 i 16V 4WD  | 77   |  | 02.99  | 09.05   | 24.3220-1734.3   | 020516   |  | Rz 20,64                        |
|  | 1.6 i 16V 4WD  | 91   |  | 10.99  | 09.05   |  |  |   | + 5 türig <sup>2)</sup>         |
| <b>HONDA JAZZ (02-08)</b>  |  |  |  |  |   |  |  |   |                                 |
|  | 1.2 (GD5)  | 57   |  | 01.04  | 10.08   | 24.2122-1771.3   | 010901   |   | THz 22,20 + Behälter <b>LUC</b> |
|  | 1.2 (GE2)  | 59   |  | 10.05  | 10.08   |  |  |   | - ESP                           |
|  | 1.4 (GD1)  | 61   |  | 01.04  | 10.08   |  |  |   | - ESP                           |
|  | 1.4 (GE3)  | 65   |  | 04.05  | 10.08   |  |  |   | - ESP                           |
|  | 1.4 (GE3)  | 67   |  | 09.05  | 10.08   |  |  |   | - ESP                           |
|  | 1.7 (GD3)  | 92   |  | 01.04  | 10.08   |  |  |   | - ESP                           |
|  | 1.2 (GD5)  | 57   |  | 01.04  | 10.08   | 24.2122-1772.3   | 010902   |   | THz 22,20 + Behälter <b>LUC</b> |
|  | 1.2 (GE2)  | 59   |  | 10.05  | 10.08   |  |  |   | + ESP                           |
|  | 1.4 (GD1)  | 61   |  | 01.04  | 10.08   |  |  |   | + ESP                           |
|  | 1.4 (GE3)  | 65   |  | 04.05  | 10.08   |  |  |   | + ESP                           |
|  | 1.4 (GE3)  | 67   |  | 09.05  | 10.08   |  |  |   | + ESP                           |
|  | 1.7 (GD3)  | 92   |  | 01.04  | 10.08   |  |  |   | + ESP                           |

<sup>1)</sup> + 3 door / + 3 porte / + 3 portes / + 3 puertas







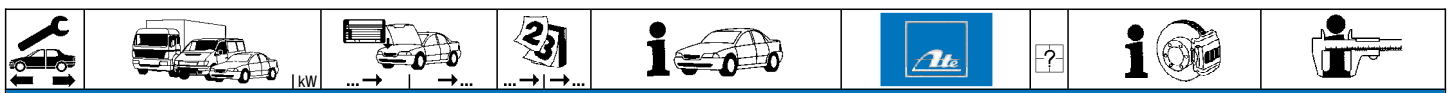



<sup>2)</sup> + 5 door / + 5 porte / + 5 portes / + 5 puertas

|     |  |  |  |  |  |  |  |   |   |                      |            |
|--|--|--|--|--|---|--|--|---|---|----------------------|------------|
| <b>HONDA JAZZ (02-08)</b>  |  |  |  |  |   |  |  |   |   |                      |            |
|    | 1.2 (GD5)  | 57   |  | 03.02  | 12.03   | 24.3511-1719.7   | 220937   |  | D=51, - Halter  | <b>LUC</b>           |            |
|  | 1.4 (GD1)  | 61   |  | 03.02  | 12.03   | 24.3511-1720.7   | 220938   |  | D=51, - Halter  | <b>LUC</b>           |            |
|    | 1.2 (GD5)  | 57   |  | 01.04  | 10.08   | 24.3511-1717.7   | 220887   |  | D=51, - Halter  |                      |            |
|  | 1.2 (GE2)  | 59   |  | 10.05  | 10.08   | 24.3511-1718.7   | 220888   |  | D=51, - Halter  |                      |            |
|  | 1.4 (GD1)  | 61   |  | 01.04  | 10.08   |  |  |   |   |                      |            |
|  | 1.4 (GE3)  | 65   |  | 04.05  | 10.08   |  |  |   |   |                      |            |
|  | 1.4 (GE3)  | 67   |  | 09.05  | 10.08   |  |  |   |   |                      |            |
|  | 1.7 (GD3)  | 92   |  | 01.04  | 10.08   |  |  |   |   |                      |            |
|    | 1.2 (GD5)  | 57   |  | 03.02  | 10.08   | 24.5268-0495.3   | 330933   |  | L=495   |                      |            |
|  | 1.2 (GE2)  | 59   |  | 10.05  | 10.08   | 24.5268-0496.3   | 330934   |  | L=495   |                      |            |
|  | 1.4 (GD1)  | 61   |  | 03.02  | 10.08   |  |  |   |   |                      |            |
|  | 1.4 (GE3)  | 65   |  | 04.05  | 10.08   |  |  |   |   |                      |            |
|  | 1.4 (GE3)  | 67   |  | 09.05  | 10.08   |  |  |   |   |                      |            |
|  | 1.7 (GD3)  | 92   |  | 01.04  | 10.08   |  |  |   |   |                      |            |
|    | 1.2 (GD5)  | 57   |  | 01.04  | 10.08   | 24.3304-1713.7   | 220885   |  | D=30, - Halter  |                      |            |
|  | 1.2 (GE2)  | 59   |  | 10.05  | 10.08   | 24.3304-1714.7   | 220886   |  | D=30, - Halter  |                      |            |
|  | 1.4 (GD1)  | 61   |  | 01.04  | 10.08   |  |  |   |   |                      |            |
|  | 1.4 (GE3)  | 65   |  | 04.05  | 10.08   |  |  |   |   |                      |            |
|  | 1.4 (GE3)  | 67   |  | 09.05  | 10.08   |  |  |   |   |                      |            |
|  | 1.7 (GD3)  | 92   |  | 01.04  | 10.08   |  |  |   |   |                      |            |
|    | 1.2 (GD5)  | 57   |  | 03.02  | 10.08   | 24.5297-0332.3   | 331037   |  | L=332   |                      |            |
|  | 1.2 (GE2)  | 59   |  | 10.05  | 10.08   | 24.5297-0272.3   | 331036   |  | L=272   |                      |            |
|  | 1.4 (GD1)  | 61   |  | 03.02  | 10.08   |  |  |   |   |                      |            |
|  | 1.4 (GE3)  | 65   |  | 04.05  | 10.08   |  |  |   |   |                      |            |
|  | 1.4 (GE3)  | 67   |  | 09.05  | 10.08   |  |  |   |   |                      |            |
|  | 1.7 (GD3)  | 92   |  | 01.04  | 10.08   |  |  |   |   |                      |            |
|  | 1.2 (GD5)  | 57   |  | 03.02  | 12.03   | 24.3217-1717.3   | 020477   |   | Rz 17,46  |                      |            |
|  | 1.4 (GD1)  | 61   |  | 03.02  | 12.03   |  |  |   |   |                      |            |
| <b>HONDA JAZZ (08-)</b>  |  |  |  |  |   |  |  |   |   |                      |            |
|  | 1.2 i-VTEC   | 66   |  | 07.08  | 12.08   | - ESP  | 24.2122-1771.3   | 010901  |   | THz 22,20 + Behälter | <b>LUC</b> |
|  | 1.4 i 16V  | 73   |  | 07.08  | 12.08   | - ESP  |  |   |   |                      |            |
|  | 1.5 Flexfuel   | 88   |  | 07.08  | 12.08   | - ESP  |  |   |   |                      |            |
|  | 1.5 i 16V  | 88   |  | 07.08  | 12.08   | - ESP  |  |   |   |                      |            |
|  | 1.2 i-VTEC   | 66   |  | 07.08  | 12.08   | + ESP  | 24.2122-1772.3   | 010902  |   | THz 22,20 + Behälter | <b>LUC</b> |
|  | 1.4 i 16V  | 73   |  | 07.08  | 12.08   | + ESP  |  |   |   |                      |            |
|  | 1.5 Flexfuel   | 88   |  | 07.08  | 12.08   | + ESP  |  |   |   |                      |            |
|  | 1.5 i 16V  | 88   |  | 07.08  | 12.08   | + ESP  |  |   |   |                      |            |
|  | 1.2 i-VTEC   | 66   |  | 07.08  | 12.08   |  | 24.3511-1717.7   | 220887  |  | D=51, - Halter       |            |
|  | 1.4 i 16V  | 73   |  | 07.08  | 12.08   |  | 24.3511-1718.7   | 220888  |  | D=51, - Halter       |            |
|  | 1.5 Flexfuel   | 88   |  | 07.08  | 12.08   |  |  |   |   |                      |            |
|  | 1.5 i 16V  | 88   |  | 07.08  | 12.08   |  |  |   |   |                      |            |
|  | 1.2 i-VTEC   | 66   |  | 07.08  | 12.08   |  | 24.5268-0495.3   | 330933  |  | L=495                |            |
|  | 1.4 i 16V  | 73   |  | 07.08  | 12.08   |  | 24.5268-0496.3   | 330934  |  | L=495                |            |
|  | 1.5 Flexfuel   | 88   |  | 07.08  | 12.08   |  |  |   |   |                      |            |
|  | 1.5 i 16V  | 88   |  | 07.08  | 12.08   |  |  |   |   |                      |            |
|  | 1.2 i-VTEC   | 66   |  | 07.08  | 12.08   |  | 24.3304-1713.7   | 220885  |  | D=30, - Halter       |            |
|  | 1.5 Flexfuel   | 88   |  | 07.08  | 12.08   |  | 24.3304-1714.7   | 220886  |  | D=30, - Halter       |            |
|  | 1.5 i 16V  | 88   |  | 07.08  | 12.08   |  |  |   |   |                      |            |
|  | 1.5 i 16V  | 88   |  | 07.08  | 12.08   |  |  |   |   |                      |            |
|  | 1.2 i-VTEC   | 66   |  | 07.08  | 12.08   |  | 24.5297-0332.3   | 331037  |  | L=332                |            |
|  | 1.4 i 16V  | 73   |  | 07.08  | 12.08   |  | 24.5297-0272.3   | 331036  |  | L=272                |            |
|  | 1.5 Flexfuel   | 88   |  | 07.08  | 12.08   |  |  |   |   |                      |            |
|  | 1.5 i 16V  | 88   |  | 07.08  | 12.08   |  |  |   |   |                      |            |
| <b>HONDA LOGO (99-02)</b>  |  |  |  |  |   |  |  |   |   |                      |            |
|  | 1.3 i  | 48   |  | 02.99  | 03.02   |  | 24.3511-1709.5   | 240333  |  | D=51, - Halter       |            |
|  |  |  |  |  |   |  | 24.3511-1710.5   | 240334  |  | D=51, - Halter       |            |
| <b>HONDA PRELUDE (96-00)</b>   |  |  |  |  |   |  |  |   |   |                      |            |
|  | 2.0 i 16V (BB9)  | 98   |  | 10.96  | 10.00   |  | 24.5270-0395.3   | 330937  |  | L=395                |            |
|  | 2.2 i 16V  | 147  |  | 10.96  | 10.00   |  | 24.5270-0390.3   | 330936  |  | L=390                |            |
|  | 2.2 i 16V (BB6/BB8)  | 136  |  | 10.96  | 10.00   |  |  |   |   |                      |            |
| <b>HYUNDAI ACCENT I (94-99)</b>  |  |  |  |  |   |  |  |   |   |                      |            |
|  | 1.3 i  |  |  | 10.94  | 12.99   |  | 24.3219-1747.3   | 020498  |  | Rz 19,05             |            |
|  | 1.3 i 12V  | 62   |  | 10.94  | 12.99   |  | 24.3219-1748.3   | 020499  |  | Rz 19,05             |            |
|  | 1.5 i 12V  | 65   |  | 10.94  | 12.99   |  |  |   |   |                      |            |
|  | 1.5 i 16V  | 73   |  | 10.95  | 12.99   |  |  |   |   |                      |            |
|  | 1.3 i  |  |  | 06.96  | 12.99   |  | 24.3727-3103.2   | 583103  |  | L=1485               |            |
|  | 1.3 i 12V  | 62   |  | 06.96  | 12.99   |  | 24.3727-3102.2   | 583102  |  | L=1485               |            |
|  | 1.5 i 12V  | 65   |  | 06.96  | 12.99   |  |  |   |   |                      |            |
|  | 1.5 i 16V  | 73   |  | 06.96  | 12.99   |  |  |   |   |                      |            |
| <b>HYUNDAI ACCENT II (00-05)</b>   |  |  |  |  |   |  |  |   |   |                      |            |
|  | 1.3 i 12V  | 55   |  | 01.00  | 09.05   |  | 24.3541-1807.5   | 240335  |  | D=54, - Halter       | <b>AKE</b> |
|  | 1.3 i 12V  | 61   |  | 01.00  | 09.05   |  | 24.3541-1808.5   | 240336  |  | D=54, - Halter       | <b>AKE</b> |
|  | 1.3 i 12V  | 62   |  | 08.02  | 09.05   |  |  |   |   |                      |            |
|  | 1.3 i 12V  | 63   |  | 01.00  | 09.05   |  |  |   |   |                      |            |
|  | 1.5 CRDi   | 60   |  | 04.02  | 09.05   |  |  |   |   |                      |            |
|  | 1.5 i 12V  | 66   |  | 01.00  | 09.05   |  |  |   |   |                      |            |
|  | 1.5 i 16V  | 75   |  | 09.00  | 09.05   |  |  |   |   |                      |            |
|  | 1.6 i 16V  | 77   |  | 10.02  | 09.05   |  |  |   |   |                      |            |



























|     |                     |  |  |  |                      |  |  |  |                      |
|--|---|--|--|--|---|--|--|--|----------------------|
| <b>HYUNDAI ACCENT II (00-05)</b>   |   |  |  |  |   |  |  |  |                      |
|    | 1.3 i 12V<br>1.3 i 12V<br>1.3 i 12V<br>1.3 i 12V<br>1.5 CRDi<br>1.5 i 12V<br>1.5 i 16V<br>1.6 i 16V | 55<br>61<br>62<br>63<br>60<br>66<br>75<br>77                                     |  | 01.00<br>01.00<br>08.02<br>01.00<br>04.02<br>01.00<br>09.00<br>10.02             | 09.05 + ABS<br>09.05 + ABS<br>09.05 + ABS<br>09.05 + ABS<br>09.05 + ABS<br>09.05 + ABS<br>09.05 + ABS | 24.5298-0485.3<br>24.5298-0486.3   | 331064<br>331065   | <input type="checkbox"/><br><input type="checkbox"/>                               | L=485<br>L=485       |
|    | 1.3 i 12V<br>1.3 i 12V<br>1.3 i 12V<br>1.3 i 12V<br>1.5 CRDi<br>1.5 i 12V<br>1.5 i 16V<br>1.6 i 16V | 55<br>61<br>62<br>63<br>60<br>66<br>75<br>77                                     |  | 01.00<br>01.00<br>08.02<br>01.00<br>04.02<br>01.00<br>09.00<br>10.02             | 09.05<br>09.05<br>09.05<br>09.05<br>09.05<br>09.05<br>09.05   | 24.5261-0256.3   | 331246   | 2  | L=255                |
|    | 1.3 i 12V<br>1.3 i 12V<br>1.3 i 12V<br>1.5 CRDi<br>1.5 i 12V<br>1.5 i 16V                           | 55<br>61<br>63<br>60<br>66<br>75   |  | 01.00<br>01.00<br>01.00<br>04.02<br>01.00<br>09.00                               | 07.02<br>07.02<br>09.05<br>07.02<br>07.02   | 24.3219-1743.3   | 020485   |  | Rz 19,05             |
|    | 1.3 i 12V<br>1.3 i 12V<br>1.3 i 12V<br>1.5 CRDi<br>1.5 i 12V<br>1.5 i 16V<br>1.6 i 16V              | 55<br>61<br>62<br>60<br>66<br>75<br>77   |  | 08.02<br>08.02<br>08.02<br>08.02<br>08.02<br>08.02<br>10.02                      | 09.05<br>09.05<br>09.05<br>09.05<br>09.05<br>09.05  | 24.3217-1723.3   | 020502   |  | Rz 17,78             |
|    | 1.3 i 12V<br>1.3 i 12V<br>1.3 i 12V<br>1.5 CRDi<br>1.5 i 12V<br>1.5 i 16V<br>1.6 i 16V              | 55<br>61<br>62<br>60<br>66<br>75<br>77   |  | 08.02<br>08.02<br>08.02<br>08.02<br>08.02<br>08.02<br>10.02                      | 09.05<br>09.05<br>09.05<br>09.05<br>09.05<br>09.05  | 24.3727-3105.2<br>24.3727-3104.2   | 583105<br>583104   | <input type="checkbox"/><br><input type="checkbox"/>                               | L=1493<br>L=1493     |
| <b>HYUNDAI ATOS (98-08)</b>  |   |  |  |  |   |  |  |  |                      |
|   | 0.8<br>1.0 i 12V<br>1.0 i 12V   | 38<br>40<br>43   |  | 04.99<br>02.98<br>03.01  | 07.03<br>03.02<br>07.03   | 24.5286-0340.3<br>24.5286-0341.3   | 330977<br>330989   | <input type="checkbox"/><br><input type="checkbox"/>                               | L=340<br>L=340       |
|  | 0.8<br>1.0 i 12V<br>1.0 i 12V<br>1.1 i 12V<br>1.1 i 12V   | 38<br>40<br>43<br>43<br>46   |  | 04.99<br>02.98<br>03.01<br>08.03<br>03.04  | 07.03<br>03.02<br>07.03<br>05.05 + ABS<br>01.06 + ABS   | 24.3217-1723.3   | 020502   |  | Rz 17,78             |
|  | 0.8<br>1.0 i 12V<br>1.0 i 12V<br>1.1 i 12V<br>1.1 i 12V   | 38<br>40<br>43<br>43<br>46   |  | 04.99<br>02.98<br>03.01<br>08.03<br>03.04  | 07.03<br>03.02<br>07.03<br>05.05<br>02.08   | 24.3727-3101.2<br>24.3727-3100.2   | 583101<br>583100   | <input type="checkbox"/><br><input type="checkbox"/>                               | L=1504<br>L=1520     |
|  | 0.8<br>1.0 i 12V<br>1.0 i 12V<br>1.1 i 12V<br>1.1 i 12V   | 38<br>40<br>43<br>43<br>46   |  | 04.99<br>02.98<br>03.01<br>08.03<br>03.04  | 07.03<br>03.02<br>07.03<br>05.05  | 24.3728-3100.2   | 593100   |  | L=795                |
| <b>HYUNDAI ATOS PRIME (99-08)</b>  |   |  |  |  |   |  |  |  |                      |
|  | 1.0 i 12V   | 40   |  | 08.99  | 02.01   | 24.5286-0340.3<br>24.5286-0341.3   | 330977<br>330989   | <input type="checkbox"/><br><input type="checkbox"/>                               | L=340<br>L=340       |
|  | 1.0 i 12V<br>1.0 i 12V<br>1.1 i 12V<br>1.1 i 12V  | 40<br>43<br>43<br>46   |  | 08.99<br>03.01<br>06.03<br>09.05   | 02.01<br>12.05<br>01.07 + ABS<br>02.06 + ABS  | 24.3217-1723.3   | 020502   |  | Rz 17,78             |
|  | 1.0 i 12V<br>1.0 i 12V<br>1.1 i 12V<br>1.1 i 12V  | 40<br>43<br>43<br>46   |  | 08.99<br>03.01<br>06.03<br>09.05   | 02.01<br>12.05<br>01.07<br>08.08  | 24.3727-3101.2<br>24.3727-3100.2   | 583101<br>583100   | <input type="checkbox"/><br><input type="checkbox"/>                               | L=1504<br>L=1520     |
|  | 1.0 i 12V<br>1.0 i 12V<br>1.1 i 12V<br>1.1 i 12V  | 40<br>43<br>43<br>46   |  | 08.99<br>03.01<br>06.03<br>09.05   | 02.01<br>12.05<br>01.07<br>08.08  | 24.3728-3100.2   | 593100   |  | L=795                |
| <b>HYUNDAI COUPE (RD) (96-02)</b>  |   |  |  |  |   |  |  |  |                      |
|  | 1.6 i 16V<br>1.6 i 16V<br>1.6 i 16V   | 79<br>84<br>85   |  | 08.00<br>12.96<br>03.98  | 04.02 - ABS<br>04.02 - ABS<br>04.02 - ABS   | 24.3219-1731.3<br>24.3219-1732.3   | 020453<br>020454   | <input type="checkbox"/><br><input type="checkbox"/>                               | Rz 19,05<br>Rz 19,05 |
| <b>HYUNDAI ELANTRA (00-06)</b>   |   |  |  |  |   |  |  |  |                      |
|  | 1.6 i 16V<br>1.6 i 16V<br>1.6 i 16V<br>1.6 i 16V<br>1.8 i 16V<br>1.8 i 16V                          | 66<br>77<br>79<br>82<br>79<br>93   |  | 11.01<br>08.03<br>11.01<br>08.03<br>11.01<br>09.04                               | 05.06<br>05.06<br>05.06<br>05.06<br>07.03<br>05.06  | 24.3219-1743.3   | 020485   | - ABS  | Rz 19,05             |























































| HYUNDAI ELANTRA (00-06)  |                    |     |  |       |       |       |                |        |                          |       |                   |
|--------------------------|--------------------|-----|--|-------|-------|-------|----------------|--------|--------------------------|-------|-------------------|
|                          | 1.8 i 16V          | 97  |  | 11.01 | 05.06 |       | 24.3219-1743.3 | 020485 |                          | - ABS | Rz 19,05          |
|                          | 2.0 CRDi           | 83  |  | 11.01 | 05.06 |       |                |        |                          |       |                   |
|                          | 2.0 i 16V          | 102 |  | 11.01 | 05.06 |       |                |        |                          |       |                   |
|                          | 2.0 i 16V          | 104 |  | 11.01 | 05.06 |       |                |        |                          |       |                   |
|                          | 2.0 i 16V          | 105 |  | 10.03 | 05.06 |       |                |        |                          |       |                   |
|                          | 1.6 i 16V          | 66  |  | 06.00 | 10.03 |       | 24.3727-3110.2 | 583110 | <input type="checkbox"/> | + ABS | L=1593            |
|                          | 1.6 i 16V          | 77  |  | 08.03 | 10.03 |       | 24.3727-3111.2 | 583111 | <input type="checkbox"/> | + ABS | L=1578            |
|                          | 1.6 i 16V          | 79  |  | 06.00 | 10.03 |       |                |        |                          |       |                   |
|                          | 1.8 i 16V          | 79  |  | 06.00 | 07.03 |       |                |        |                          |       |                   |
|                          | 1.8 i 16V          | 97  |  | 06.00 | 10.03 |       |                |        |                          |       |                   |
|                          | 2.0 CRDi           | 83  |  | 04.01 | 10.03 |       |                |        |                          |       |                   |
|                          | 2.0 i 16V          | 102 |  | 06.00 | 10.03 |       |                |        |                          |       |                   |
|                          | 2.0 i 16V          | 104 |  | 06.00 | 10.03 |       |                |        |                          |       |                   |
|                          | 1.6 i 16V          | 66  |  | 11.03 | 05.06 |       | 24.3727-3112.2 | 583112 | <input type="checkbox"/> | + ABS | L=1578            |
|                          | 1.6 i 16V          | 77  |  | 11.03 | 05.06 |       | 24.3727-3113.2 | 583113 | <input type="checkbox"/> | + ABS | L=1562            |
|                          | 1.6 i 16V          | 79  |  | 11.03 | 05.06 |       |                |        |                          |       |                   |
|                          | 1.6 i 16V          | 82  |  | 08.03 | 05.06 |       |                |        |                          |       |                   |
|                          | 1.8 i 16V          | 93  |  | 06.04 | 05.06 |       |                |        |                          |       |                   |
|                          | 1.8 i 16V          | 97  |  | 11.03 | 05.06 |       |                |        |                          |       |                   |
|                          | 2.0 CRDi           | 83  |  | 11.03 | 05.06 |       |                |        |                          |       |                   |
|                          | 2.0 i 16V          | 102 |  | 11.03 | 05.06 |       |                |        |                          |       |                   |
|                          | 2.0 i 16V          | 104 |  | 11.03 | 05.06 |       |                |        |                          |       |                   |
|                          | 2.0 i 16V          | 105 |  | 10.03 | 05.06 |       |                |        |                          |       |                   |
| HYUNDAI ELANTRA (06-11)  |                    |     |  |       |       |       |                |        |                          |       |                   |
|                          | 1.6 CRDi           | 85  |  | 06.06 | 06.11 | + ABS | 24.3727-3115.2 | 583115 | <input type="checkbox"/> |       | L=1672            |
|                          | 1.6 i 16V          | 90  |  | 06.06 | 06.11 | + ABS | 24.3727-3114.2 | 583114 | <input type="checkbox"/> |       | L=1674            |
|                          | 2.0 CVT            | 105 |  | 06.06 | 06.11 | + ABS |                |        |                          |       |                   |
| HYUNDAI GALLOPER (98-03) |                    |     |  |       |       |       |                |        |                          |       |                   |
|                          | 2.5 Tci D          | 77  |  | 08.98 | 12.03 |       | 24.3431-1705.5 | 240365 | <input type="checkbox"/> |       | D=43/43, - Halter |
|                          | 2.5 TD             | 65  |  | 08.98 | 12.03 |       | 24.3431-1706.5 | 240366 | <input type="checkbox"/> |       | D=43/43, - Halter |
|                          | 2.5 TD Intercooler | 73  |  | 08.98 | 12.03 |       |                |        |                          |       |                   |
|                          | 3.0 i V6           | 104 |  | 08.98 | 12.03 |       |                |        |                          |       |                   |
|                          | 2.5 Tci D          | 77  |  | 08.98 | 12.03 |       | 24.5290-0439.3 | 331176 | <input type="checkbox"/> |       | L=439             |
|                          | 2.5 TD             | 65  |  | 08.98 | 12.03 |       | 24.5290-0440.3 | 331177 | <input type="checkbox"/> |       | L=439             |
|                          | 2.5 TD Intercooler | 73  |  | 08.98 | 12.03 |       |                |        |                          |       |                   |
|                          | 3.0 i V6           | 104 |  | 08.98 | 12.03 |       |                |        |                          |       |                   |
|                          | 2.6 TD Allrad      | 63  |  | 08.98 | 06.03 |       | 24.5260-0155.3 | 331156 | 2                        |       | L=155             |
| HYUNDAI GETZ (02-09)     |                    |     |  |       |       |       |                |        |                          |       |                   |
|                          | 1.1 i 12V          | 46  |  | 09.02 | 07.05 |       | 24.2122-1761.3 | 010822 |                          | - ABS | THz 22,20         |
|                          | 1.3 i 12V          | 60  |  | 09.02 | 04.05 |       | 24.2122-1765.3 | 010839 |                          | + ABS | THz 22,20         |
|                          | 1.3 i 12V          | 63  |  | 09.03 | 04.05 |       |                |        |                          |       |                   |
|                          | 1.5 i GL           | 73  |  | 08.02 | 07.05 | - ⊕   |                |        |                          |       |                   |
|                          | 1.6 i 16V          | 77  |  | 09.02 | 07.05 |       |                |        |                          |       |                   |
|                          | 1.1 i 12V          | 46  |  | 09.02 | 07.05 |       | 24.3541-1807.5 | 240335 | <input type="checkbox"/> |       | D=54, - Halter    |
|                          | 1.1 i 12V          | 49  |  | 08.05 | 02.09 |       | 24.3541-1808.5 | 240336 | <input type="checkbox"/> |       | D=54, - Halter    |
|                          | 1.3 i 12V          | 60  |  | 09.02 | 04.05 |       |                |        |                          |       |                   |
|                          | 1.3 i 12V          | 63  |  | 09.03 | 04.05 |       |                |        |                          |       |                   |
|                          | 1.4 i 16V          | 71  |  | 08.05 | 02.09 |       |                |        |                          |       |                   |
|                          | 1.5 CRDi           | 60  |  | 03.03 | 04.05 |       |                |        |                          |       |                   |
|                          | 1.5 CRDi           | 65  |  | 08.05 | 02.09 |       |                |        |                          |       |                   |
|                          | 1.5 CRDi GLS       | 75  |  | 07.04 | 07.05 |       |                |        |                          |       |                   |
|                          | 1.5 CRDi GLS       | 81  |  | 08.05 | 02.09 |       |                |        |                          |       |                   |
|                          | 1.5 i GL           | 73  |  | 08.02 | 07.05 | - ⊕   |                |        |                          |       |                   |
|                          | 1.6 i 16V          | 77  |  | 09.02 | 07.05 |       |                |        |                          |       |                   |
|                          | 1.6 i 16V          | 78  |  | 08.05 | 02.09 |       |                |        |                          |       |                   |
|                          | 1.1 i 12V          | 46  |  | 09.02 | 07.05 |       | 24.5248-0466.3 | 330920 | <input type="checkbox"/> |       | L=466             |
|                          | 1.1 i 12V          | 49  |  | 08.05 | 02.09 |       | 24.5248-0467.3 | 330921 | <input type="checkbox"/> |       | L=466             |
|                          | 1.3 i 12V          | 60  |  | 09.02 | 04.05 |       |                |        |                          |       |                   |
|                          | 1.3 i 12V          | 63  |  | 09.03 | 04.05 |       |                |        |                          |       |                   |
|                          | 1.4 i 16V          | 71  |  | 08.05 | 02.09 |       |                |        |                          |       |                   |
|                          | 1.5 CRDi           | 60  |  | 03.03 | 04.05 |       |                |        |                          |       |                   |
|                          | 1.5 CRDi           | 65  |  | 08.05 | 02.09 |       |                |        |                          |       |                   |
|                          | 1.5 CRDi GLS       | 75  |  | 07.04 | 07.05 |       |                |        |                          |       |                   |
|                          | 1.5 CRDi GLS       | 81  |  | 08.05 | 02.09 |       |                |        |                          |       |                   |
|                          | 1.5 i GL           | 73  |  | 08.02 | 07.05 | - ⊕   |                |        |                          |       |                   |
|                          | 1.6 i 16V          | 77  |  | 09.02 | 07.05 |       |                |        |                          |       |                   |
|                          | 1.6 i 16V          | 78  |  | 08.05 | 02.09 |       |                |        |                          |       |                   |
|                          | 1.1 i 12V          | 46  |  | 09.02 | 07.05 |       | 24.5272-0258.3 | 330939 | <input type="checkbox"/> |       | L=258             |
|                          | 1.1 i 12V          | 49  |  | 08.05 | 02.09 |       | 24.5272-0205.3 | 330975 | <input type="checkbox"/> |       | L=205             |
|                          | 1.5 CRDi           | 65  |  | 08.05 | 02.09 | - ABS |                |        |                          |       |                   |
|                          | 1.6 i 16V          | 77  |  | 09.02 | 07.05 | - ABS |                |        |                          |       |                   |
|                          | 1.6 i 16V          | 78  |  | 08.05 | 02.09 | - ABS |                |        |                          |       |                   |
|                          | 1.3 i 12V          | 60  |  | 09.02 | 04.05 |       | 24.5298-0469.3 | 331191 | <input type="checkbox"/> |       | L=469             |
|                          | 1.3 i 12V          | 63  |  | 09.03 | 04.05 |       | 24.5298-0470.3 | 331192 | <input type="checkbox"/> |       | L=469             |
|                          | 1.4 i 16V          | 71  |  | 08.05 | 02.09 |       |                |        |                          |       |                   |
|                          | 1.5 CRDi           | 60  |  | 03.03 | 04.05 |       |                |        |                          |       |                   |
|                          | 1.5 CRDi           | 65  |  | 08.05 | 02.09 | + ABS |                |        |                          |       |                   |
|                          | 1.5 CRDi GLS       | 75  |  | 07.04 | 07.05 |       |                |        |                          |       |                   |
|                          | 1.5 CRDi GLS       | 81  |  | 08.05 | 02.09 |       |                |        |                          |       |                   |
|                          | 1.5 i GL           | 73  |  | 08.02 | 07.05 | - ⊕   |                |        |                          |       |                   |
|                          | 1.6 i 16V          | 77  |  | 09.02 | 07.05 | + ABS |                |        |                          |       |                   |
|                          | 1.6 i 16V          | 78  |  | 08.05 | 02.09 | + ABS |                |        |                          |       |                   |



















| HYUNDAI GETZ (02-09)   |              |     |  |       |       |       |   |                |        |                          |  |  |                |
|--|--------------|-----|--|-------|-------|-------|---|----------------|--------|--------------------------|--|--|----------------|
|    | 1.1 i 12V    | 46  |  | 09.02 | 07.05 |       |   | 24.3217-1723.3 | 020502 |                          |  |  | Rz 17,78       |
|  | 1.1 i 12V    | 49  |  | 08.05 | 02.09 |       |   |                |        |                          |  |  |                |
|  | 1.3 i 12V    | 60  |  | 09.02 | 04.05 |       |   |                |        |                          |  |  |                |
|  | 1.3 i 12V    | 63  |  | 09.03 | 04.05 |       |   |                |        |                          |  |  |                |
|  | 1.4 i 16V    | 71  |  | 08.05 | 02.09 |       |   |                |        |                          |  |  |                |
|  | 1.5 CRDi     | 60  |  | 03.03 | 04.05 |       |   |                |        |                          |  |  |                |
|  | 1.5 CRDi     | 65  |  | 08.05 | 02.09 |       |   |                |        |                          |  |  |                |
|  | 1.5 CRDi GLS | 75  |  | 07.04 | 07.05 |       |   |                |        |                          |  |  |                |
|  | 1.5 CRDi GLS | 81  |  | 08.05 | 02.09 |       |   |                |        |                          |  |  |                |
|  | 1.5 i GL     | 73  |  | 08.02 | 07.05 |       | ⊖ |                |        |                          |  |  |                |
|  | 1.6 i 16V    | 77  |  | 09.02 | 07.05 |       |   |                |        |                          |  |  |                |
|  | 1.6 i 16V    | 78  |  | 08.05 | 02.09 |       |   |                |        |                          |  |  |                |
| HYUNDAI i10 (08-)  |              |     |  |       |       |       |   |                |        |                          |  |  |                |
|    | 1.0 12V      | 51  |  | 01.11 |       |       |   | 24.5286-0265.3 | 331046 | 2                        |  |  | L=265          |
|  | 1.1 12V      | 48  |  | 01.08 |       |       |   |                |        |                          |  |  |                |
|  | 1.1 12V      | 49  |  | 01.08 |       |       |   |                |        |                          |  |  |                |
|  | 1.1 12V      | 51  |  | 04.11 |       |       |   |                |        |                          |  |  |                |
|  | 1.1 CRDi     | 55  |  | 01.08 |       |       |   |                |        |                          |  |  |                |
|  | 1.1 LPG      | 51  |  | 04.11 |       |       |   |                |        |                          |  |  |                |
|  | 1.2 12V      | 57  |  | 11.08 |       |       |   |                |        |                          |  |  |                |
|  | 1.2 16V      | 59  |  | 01.08 |       |       |   |                |        |                          |  |  |                |
|  | 1.2 16V      | 63  |  | 04.11 |       |       |   |                |        |                          |  |  |                |
| HYUNDAI i30 (07-11)  |              |     |  |       |       |       |   |                |        |                          |  |  |                |
|    | 1.4 16V      | 77  |  | 10.07 | 10.11 |       |   | 24.3727-3115.2 | 583115 | <input type="checkbox"/> |  |  | L=1672         |
|  | 1.4 16V      | 80  |  | 10.07 | 10.11 |       |   | 24.3727-3114.2 | 583114 | <input type="checkbox"/> |  |  | L=1674         |
|  | 1.6 16V      | 85  |  | 10.07 | 10.11 |       |   |                |        |                          |  |  |                |
|  | 1.6 16V      | 88  |  | 01.10 | 10.11 |       |   |                |        |                          |  |  |                |
|  | 1.6 16V      | 90  |  | 10.07 | 10.11 |       |   |                |        |                          |  |  |                |
|  | 1.6 16V      | 93  |  | 02.08 | 10.11 |       |   |                |        |                          |  |  |                |
|  | 1.6 CRDi     | 66  |  | 10.07 | 10.11 |       |   |                |        |                          |  |  |                |
|  | 1.6 CRDi     | 85  |  | 10.07 | 10.11 |       |   |                |        |                          |  |  |                |
|  | 1.6 CRDi     | 94  |  | 02.08 | 10.11 |       |   |                |        |                          |  |  |                |
|  | 2.0 16V      | 100 |  | 01.10 | 10.11 |       |   |                |        |                          |  |  |                |
|  | 2.0 16V      | 105 |  | 10.07 | 10.11 |       |   |                |        |                          |  |  |                |
|  | 2.0 CRDi     | 100 |  | 02.08 | 10.11 |       |   |                |        |                          |  |  |                |
|  | 2.0 CRDi     | 103 |  | 10.07 | 10.11 |       |   |                |        |                          |  |  |                |
| HYUNDAI i30 CW Kombi (08-12)   |              |     |  |       |       |       |   |                |        |                          |  |  |                |
|   | 1.4 16V      | 77  |  | 02.08 | 06.12 |       |   | 24.3727-3116.2 | 583116 | <input type="checkbox"/> |  |  | L=1715         |
|  | 1.4 16V      | 80  |  | 11.09 | 06.12 |       |   | 24.3727-3117.2 | 583117 | <input type="checkbox"/> |  |  | L=1705         |
|  | 1.6 16V      | 85  |  | 02.08 | 06.12 |       |   |                |        |                          |  |  |                |
|  | 1.6 16V      | 88  |  | 01.10 | 06.12 |       |   |                |        |                          |  |  |                |
|  | 1.6 16V      | 90  |  | 02.08 | 06.12 |       |   |                |        |                          |  |  |                |
|  | 1.6 16V      | 93  |  | 02.08 | 06.12 |       |   |                |        |                          |  |  |                |
|  | 1.6 CRDi     | 66  |  | 02.08 | 06.12 |       |   |                |        |                          |  |  |                |
|  | 1.6 CRDi     | 85  |  | 02.08 | 06.12 |       |   |                |        |                          |  |  |                |
|  | 1.6 CRDi     | 94  |  | 02.08 | 06.12 |       |   |                |        |                          |  |  |                |
|  | 2.0 16V      | 100 |  | 01.10 | 06.12 |       |   |                |        |                          |  |  |                |
|  | 2.0 16V      | 105 |  | 02.08 | 06.12 |       |   |                |        |                          |  |  |                |
|  | 2.0 CRDi     | 100 |  | 01.10 | 06.12 |       |   |                |        |                          |  |  |                |
|  | 2.0 CRDi     | 103 |  | 02.08 | 06.12 |       |   |                |        |                          |  |  |                |
| HYUNDAI LANTRA/ELANTRA (90-95)   |              |     |  |       |       |       |   |                |        |                          |  |  |                |
|  | 1.5          |     |  | 12.90 | 04.95 |       |   | 24.3541-1807.5 | 240335 | <input type="checkbox"/> |  |  | D=54, - Halter |
|  |              |     |  |       |       |       |   | 24.3541-1808.5 | 240336 | <input type="checkbox"/> |  |  | AKE            |
|  |              |     |  |       |       |       |   |                |        |                          |  |  | AKE            |
|  |              |     |  |       |       |       |   |                |        |                          |  |  |                |
| HYUNDAI LANTRA/ELANTRA (95-00)   |              |     |  |       |       |       |   |                |        |                          |  |  |                |
|  | 1.5 12V      |     |  | 08.95 | 05.00 | + ABS |   | 24.3727-3107.2 | 583107 | <input type="checkbox"/> |  |  | L=1436         |
|  | 1.6 16V      |     |  | 08.95 | 05.00 |       |   | 24.3727-3106.2 | 583106 | <input type="checkbox"/> |  |  | L=1428         |
|  | 1.8 16V      |     |  | 08.95 | 05.00 |       |   |                |        |                          |  |  |                |
|  | 1.9 D        |     |  | 03.98 | 09.00 |       |   |                |        |                          |  |  |                |
|  | 2.0 16V      |     |  | 08.95 | 05.00 |       |   |                |        |                          |  |  |                |
| HYUNDAI LANTRA (00-03)   |              |     |  |       |       |       |   |                |        |                          |  |  |                |
|  | 1.6 i 16V    | 79  |  | 11.01 | 07.03 | - ABS |   | 24.3219-1743.3 | 020485 |                          |  |  | Rz 19,05       |
|  | 1.8 i 16V    | 97  |  | 11.01 | 07.03 | - ABS |   |                |        |                          |  |  |                |
|  | 2.0 CRDi     | 83  |  | 11.01 | 07.03 | - ABS |   |                |        |                          |  |  |                |
|  | 2.0 i 16V    | 104 |  | 11.01 | 07.03 | - ABS |   |                |        |                          |  |  |                |
|  | 1.6 i 16V    | 79  |  | 06.00 | 07.03 | + ABS |   | 24.3727-3110.2 | 583110 | <input type="checkbox"/> |  |  | L=1593         |
|  | 1.8 i 16V    | 97  |  | 06.00 | 07.03 | + ABS |   | 24.3727-3111.2 | 583111 | <input type="checkbox"/> |  |  | L=1578         |
|  | 2.0 CRDi     | 83  |  | 04.01 | 07.03 | + ABS |   |                |        |                          |  |  |                |
|  | 2.0 i 16V    | 104 |  | 06.00 | 07.03 | + ABS |   |                |        |                          |  |  |                |
| HYUNDAI MATRIX (01-08)   |              |     |  |       |       |       |   |                |        |                          |  |  |                |
|  | 1.5 CRDi     | 60  |  | 10.01 | 07.03 | - ABS |   | 24.2123-1762.3 | 010823 |                          |  |  | Thz 23,81      |
|  | 1.6 i 16V    | 76  |  | 06.01 | 07.03 | - ABS |   |                |        |                          |  |  |                |
|  | 1.8 i 16V    | 90  |  | 06.01 | 07.03 |       |   |                |        |                          |  |  |                |
|  | 1.5 CRDi     | 60  |  | 10.01 | 02.05 |       |   | 24.5298-0514.3 | 331088 | <input type="checkbox"/> |  |  | L=514          |
|  | 1.5 CRDi     | 75  |  | 12.04 | 04.08 |       |   | 24.5298-0515.3 | 331166 | <input type="checkbox"/> |  |  | L=514          |
|  | 1.5 CRDi VGT | 81  |  | 08.05 | 04.08 |       |   |                |        |                          |  |  |                |
|  | 1.6 i 16V    | 76  |  | 06.01 | 04.08 |       |   |                |        |                          |  |  |                |
|  | 1.8 i 16V    | 90  |  | 06.01 | 04.08 |       |   |                |        |                          |  |  |                |





























| KW   |                  | ... |        | ...   |       | ...   |  | ...            |        | ...   |  | ... |  | ...            |            |
|--|------------------|-----|--------|-------|-------|-------|--|----------------|--------|---|--|-----|--|----------------|------------|
| <b>HYUNDAI MATRIX (01-08)</b>  |                  |     |        |       |       |       |  |                |        |   |  |     |  |                |            |
|    | 1.5 CRDi         | 60  |        | 10.01 | 02.05 | + ABS |  | 24.3341-1701.5 | 240435 |    |  |     |  | D=34, - Halter |            |
|  | 1.5 CRDi         | 75  |        | 12.04 | 04.08 | + ABS |  | 24.3341-1702.5 | 240436 |    |  |     |  | D=34, - Halter |            |
|  | 1.5 CRDi VGT     | 81  |        | 08.05 | 04.08 | + ABS |  |                |        |   |  |     |  |                |            |
|  | 1.6 i 16V        | 76  |        | 06.01 | 04.08 | + ABS |  |                |        |   |  |     |  |                |            |
|  | 1.8 i 16V        | 90  |        | 06.01 | 04.08 |       |  |                |        |   |  |     |  |                |            |
|    | 1.5 CRDi         | 60  |        | 10.01 | 02.05 | - ABS |  | 24.3219-1743.3 | 020485 |   |  |     |  | Rz 19,05       |            |
|  | 1.5 CRDi         | 75  |        | 12.04 | 04.08 | - ABS |  |                |        |   |  |     |  |                |            |
|  | 1.5 CRDi VGT     | 81  |        | 08.05 | 04.08 | - ABS |  |                |        |   |  |     |  |                |            |
|  | 1.6 i 16V        | 76  |        | 06.01 | 04.08 | - ABS |  |                |        |   |  |     |  |                |            |
| <b>HYUNDAI PONY/EXCEL (89-94)</b>  |                  |     |        |       |       |       |  |                |        |   |  |     |  |                |            |
|    | 1.3              |     |        | 08.89 | 06.94 |       |  | 24.3541-1807.5 | 240335 |    |  |     |  | D=54, - Halter | <b>AKE</b> |
|  | 1.5              |     |        | 08.89 | 06.94 |       |  | 24.3541-1808.5 | 240336 |    |  |     |  | D=54, - Halter | <b>AKE</b> |
| <b>HYUNDAI S-COUPE (90-96)</b>   |                  |     |        |       |       |       |  |                |        |   |  |     |  |                |            |
|    | 1.5 (G4DJ)       |     |        | 03.90 | 05.92 |       |  | 24.3541-1807.5 | 240335 |    |  |     |  | D=54, - Halter | <b>AKE</b> |
|  | 1.5 (G4EK)       |     |        | 06.92 | 04.96 |       |  | 24.3541-1808.5 | 240336 |    |  |     |  | D=54, - Halter | <b>AKE</b> |
| <b>HYUNDAI SANTA FE I (SM) (01-06)</b>   |                  |     |        |       |       |       |  |                |        |   |  |     |  |                |            |
|    | 2.0 CRDi         | 83  |        | 08.01 | 07.03 | + ABS |  | 24.3727-3109.2 | 583109 |    |  |     |  | L=1741         |            |
|  | 2.0 CRDi         | 92  |        | 08.03 | 02.06 | + ABS |  | 24.3727-3108.2 | 583108 |    |  |     |  | L=1775         |            |
|  | 2.0 CRDi         | 107 |        | 11.03 | 02.06 | + ABS |  |                |        |   |  |     |  |                |            |
|  | 2.0 CRDi 4x4     | 83  |        | 04.01 | 07.03 | + ABS |  |                |        |   |  |     |  |                |            |
|  | 2.0 CRDi 4x4     | 92  |        | 08.03 | 02.06 | + ABS |  |                |        |   |  |     |  |                |            |
|  | 2.0 CRDi 4x4     | 107 |        | 11.03 | 02.06 | + ABS |  |                |        |   |  |     |  |                |            |
|  | 2.0 i 16V        | 99  |        | 02.01 | 02.06 | + ABS |  |                |        |   |  |     |  |                |            |
|  | 2.2 CRDi         | 110 |        | 10.05 | 02.06 | + ABS |  |                |        |   |  |     |  |                |            |
|  | 2.2 CRDi 4x4     | 110 |        | 10.05 | 02.06 | + ABS |  |                |        |   |  |     |  |                |            |
|  | 2.4 i 16V        | 107 |        | 02.01 | 02.06 | + ABS |  |                |        |   |  |     |  |                |            |
|  | 2.4 i 16V 4x4    | 107 |        | 02.01 | 02.06 | + ABS |  |                |        |   |  |     |  |                |            |
|  | 2.7 i V6         | 139 |        | 10.05 | 02.06 | + ABS |  |                |        |   |  |     |  |                |            |
|  | 2.7 i V6 4x4     | 127 |        | 02.01 | 02.06 | + ABS |  |                |        |   |  |     |  |                |            |
|  | 2.7 i V6 4x4     | 139 |        | 10.05 | 02.06 | + ABS |  |                |        |   |  |     |  |                |            |
| <b>HYUNDAI SONATA (93-98)</b>  |                  |     |        |       |       |       |  |                |        |   |  |     |  |                |            |
|    | 1.8 i            | 72  |        | 07.93 | 05.98 | - ABS |  | 24.3219-1731.3 | 020453 |    |  |     |  | Rz 19,05       |            |
|  | 2.0 i 16V        |     |        | 07.93 | 05.98 | - ABS |  | 24.3219-1732.3 | 020454 |    |  |     |  | Rz 19,05       |            |
| <b>HYUNDAI TUCSON (04-10)</b>  |                  |     |        |       |       |       |  |                |        |   |  |     |  |                |            |
|  | 2.0 CRDi         | 83  |        | 08.04 | 03.10 |       |  | 24.5286-0405.3 | 331061 |  |  |     |  | L=405          |            |
|  | 2.0 CRDi         | 88  |        | 01.07 | 03.10 |       |  |                |        |   |  |     |  |                |            |
|  | 2.0 CRDi         | 100 |        | 01.06 | 03.10 |       |  |                |        |   |  |     |  |                |            |
|  | 2.0 CRDi         | 103 |        | 01.06 | 03.10 |       |  |                |        |   |  |     |  |                |            |
|  | 2.0 CRDi         | 110 |        | 01.09 | 03.10 |       |  |                |        |   |  |     |  |                |            |
|  | 2.0 CRDi Allrad  | 83  |        | 08.04 | 03.10 |       |  |                |        |   |  |     |  |                |            |
|  | 2.0 CRDi Allrad  | 88  |        | 01.07 | 03.10 |       |  |                |        |   |  |     |  |                |            |
|  | 2.0 CRDi Allrad  | 100 |        | 01.06 | 03.10 |       |  |                |        |   |  |     |  |                |            |
|  | 2.0 CRDi Allrad  | 103 |        | 01.06 | 03.10 |       |  |                |        |   |  |     |  |                |            |
|  | 2.0 CRDi Allrad  | 110 |        | 01.09 | 03.10 |       |  |                |        |   |  |     |  |                |            |
|  | 2.0 i 16V        | 104 |        | 08.04 | 03.10 |       |  |                |        |   |  |     |  |                |            |
|  | 2.0 i 16V Allrad | 104 |        | 08.04 | 03.10 |       |  |                |        |   |  |     |  |                |            |
|  | 2.7 i 24V Allrad | 129 |        | 08.04 | 03.10 |       |  |                |        |   |  |     |  |                |            |
| <b>ISUZU D-MAX (8DH) (02-)</b>   |                  |     |        |       |       |       |  |                |        |   |  |     |  |                |            |
|  | 2.5 D            | 74  |        | 10.02 | 05.03 |       |  | 24.3601-1715.5 | 240389 |  |  |     |  | D=60, - Halter | <b>AKE</b> |
|  | 2.5 D 4x4        | 74  |        | 05.02 | 05.03 |       |  | 24.3601-1716.5 | 240390 |  |  |     |  | D=60, - Halter | <b>AKE</b> |
|  | 3.0 DiTD         | 96  |        | 10.02 | 05.03 |       |  |                |        |   |  |     |  |                |            |
|  | 3.0 DiTD 4x4     | 96  |        | 05.02 | 05.03 |       |  |                |        |   |  |     |  |                |            |
|  | 2.5 D            | 74  |        | 10.02 | 05.03 |       |  | 24.3225-1702.3 | 020425 |   |  |     |  | Rz 25,40       |            |
|  | 2.5 D 4x4        | 74  |        | 05.02 | 05.03 |       |  |                |        |   |  |     |  |                |            |
|  | 3.0 DiTD         | 96  |        | 10.02 | 05.03 |       |  |                |        |   |  |     |  |                |            |
|  | 3.0 DiTD 4x4     | 96  |        | 05.02 | 05.03 |       |  |                |        |   |  |     |  |                |            |
| <b>IVECO DAILY I / GRINTA (78-99)</b>  |                  |     |        |       |       |       |  |                |        |   |  |     |  |                |            |
|  | 35 F 8           |     |        | 01.78 | 05.81 |       |  | 24.3217-1113.3 | 020176 |   |  |     |  | Rz 17,46       |            |
|  | 35.8             |     |        | 06.81 | 04.99 |       |  |                |        |   |  |     |  |                |            |
|  | 40 F 8           |     |        | 01.78 | 05.81 |       |  |                |        |   |  |     |  |                |            |
|  | 40.8             |     |        | 06.81 | 04.99 |       |  |                |        |   |  |     |  |                |            |
|  | 45.10            |     |        | 06.86 | 04.99 |       |  | 24.3220-1106.3 | 020217 |   |  |     |  | Rz 20,64       |            |
|  | 49.10            |     |        | 06.86 | 04.99 |       |  |                |        |   |  |     |  |                |            |
| <b>JAGUAR X-Type (CF1) Limousine (01-09)</b>                                       |                  |     |        |       |       |       |  |                |        |   |  |     |  |                |            |
|  | 2.0 D            | 96  | J04730 | 07.03 |       |       |  | 24.3571-1735.5 | 240385 |  |  |     |  | D=57, - Halter | <b>BOS</b> |
|  | 2.0 V6           | 115 |        | 03.02 | 10.05 |       |  | 24.3571-1736.5 | 240386 |  |  |     |  | D=57, - Halter | <b>BOS</b> |
|  | 2.2 D            | 107 | J04730 | 01.07 |       |       |  |                |        |   |  |     |  |                |            |
|  | 2.2 D            | 110 | J04730 | 10.05 |       |       |  |                |        |   |  |     |  |                |            |
|  | 2.2 D            | 114 | J04730 | 10.05 |       |       |  |                |        |   |  |     |  |                |            |
|  | 2.5 V6           | 144 |        | 06.01 | 11.09 |       |  |                |        |   |  |     |  |                |            |
|  | 3.0 V6           | 169 |        | 06.01 | 11.07 |       |  |                |        |   |  |     |  |                |            |
|  | 2.0 D            | 96  |        | 07.03 | 11.09 |       |  | 83.7188-0446.3 | 330664 | 2   |  |     |  | L=470          |            |
|  | 2.0 V6           | 115 |        | 03.02 | 10.05 |       |  |                |        |   |  |     |  |                |            |
|  | 2.2 D            | 107 |        | 01.07 | 11.09 |       |  |                |        |   |  |     |  |                |            |
|  | 2.2 D            | 110 |        | 10.05 | 11.09 |       |  |                |        |   |  |     |  |                |            |
|  | 2.2 D            | 114 |        | 10.05 | 11.09 |       |  |                |        |   |  |     |  |                |            |

















|     |   |  |  |                          |  |  |                            |    |
|--|---|--|--|--|---|--|--|--|
| <b>JAGUAR X-Type (CF1) Limousine (01-09)</b>                                       |   |  |  |  |   |  |  |  |
|    | 2.5 V6<br>3.0 V6  | 144<br>169   |  | 06.01<br>06.01   | 11.09<br>11.07  |  | 83.7188-0446.3<br>330664   | 2<br>L=470   |
|    | 2.0 D<br>2.0 V6<br>2.2 D<br>2.2 D<br>2.2 D<br>2.5 V6<br>3.0 V6  | 96<br>115<br>107<br>110<br>114<br>144<br>169                                     |  | 07.03<br>03.02<br>01.07<br>10.05<br>10.05<br>06.01<br>06.01  | 11.09<br>10.05<br>11.09<br>11.09<br>11.09<br>11.09<br>11.07                       |  | 83.7856-0369.3<br>331237   | 2<br>L=368   |
| <b>JAGUAR X-Type (CF1) Kombi (03-09)</b>   |   |  |  |  |   |  |  |  |
|    | 2.0 D<br>2.0 V6<br>2.2 D<br>2.2 D<br>2.2 D<br>2.5 V6<br>3.0 V6  | 96<br>115<br>107<br>110<br>114<br>144<br>169                                     | J04730<br>J04730<br>J04730<br>J04730   | 02.04<br>11.03<br>01.07<br>10.05<br>10.05<br>02.04<br>02.04  | 03.09   |  | 24.3571-1735.5<br>24.3571-1736.5<br>240385<br>240386   | <br>D=57, - Halter<br>D=57, - Halter<br><b>BOS</b><br><b>BOS</b>  |
|    | 2.0 D<br>2.0 V6<br>2.2 D<br>2.2 D<br>2.2 D<br>2.5 V6<br>3.0 V6  | 96<br>115<br>107<br>110<br>114<br>144<br>169                                     |  | 02.04<br>11.03<br>01.07<br>10.05<br>10.05<br>02.04<br>02.04  | 12.09<br>03.09<br>12.09<br>12.09<br>12.09<br>12.09<br>12.09                       |  | 83.7188-0446.3<br>330664   | 2<br>L=470   |
|    | 2.0 D<br>2.0 V6<br>2.2 D<br>2.2 D<br>2.2 D<br>2.5 V6<br>3.0 V6  | 96<br>115<br>107<br>110<br>114<br>144<br>169                                     |  | 02.04<br>11.03<br>01.07<br>10.05<br>10.05<br>02.04<br>02.04  | 12.09<br>03.09<br>12.09<br>12.09<br>12.09<br>12.09<br>12.09                       |  | 83.7856-0369.3<br>331237   | 2<br>L=368   |
| <b>JAGUAR XJ (X300) (94-97)</b>  |   |  |  |  |   |  |  |  |
|    | 12 6.0<br>6 3.2<br>6 Sovereign 4.0<br>R Super Charged 4.0   | 229<br>155<br>177<br>235   |  | 11.94<br>11.94<br>11.94<br>11.94   | 07.97<br>07.97<br>07.97<br>07.97  |  | 11.0441-6003.2<br>11.8116-0073.1<br>11.8171-0008.1<br>11.0101-5407.2<br>250037<br>390498<br>990049<br>260011 | 2<br>Dichtungssatz<br>Haltefeder<br>Führungsbolzen<br>Hülssensatz<br><b>ATE</b><br><b>ATE</b><br><b>ATE</b>  |
|   | 6 3.2<br>6 Sovereign 4.0<br>R Super Charged 4.0   | 155<br>177<br>235  |  | 11.94<br>11.94<br>11.94  | 07.97<br>07.97<br>07.97   |  | 83.6314-0375.3<br>330558   | 2<br>L=375   |
|  | 12 6.0<br>6 3.2<br>6 Sovereign 4.0<br>R Super Charged 4.0   | 229<br>155<br>177<br>235   |  | 11.94<br>11.94<br>11.94<br>11.94   | 07.97<br>07.97<br>07.97<br>07.97  |  | 11.9481-9871.2<br>11.9481-9872.2<br>220681<br>220682   | <br>D=48, - Halter<br>D=48, - Halter<br><b>ATE</b><br><b>ATE</b>  |
| <b>KIA CARENS II (02-06)</b>   |   |  |  |  |   |  |  |  |
|  | 1.6 i 16V<br>1.8 i 16V<br>2.0 CRDi<br>2.0 CRDi<br>2.0 CVVT  | 77<br>93<br>83<br>103<br>102   |  | 07.02<br>07.02<br>07.02<br>11.05<br>08.04  | 04.06<br>04.06<br>04.06<br>04.06<br>04.06   | - ABS<br>- ABS<br>- ABS<br>- ABS<br>- ABS  | 24.5285-0240.3<br>330976   | 2<br>L=240   |
| <b>KIA CARNIVAL I (99-01)</b>  |   |  |  |  |   |  |  |  |
|  | 2.5 i<br>2.5 V6<br>2.9 TDi  | 132<br>121<br>93   |  | 10.00<br>06.00<br>06.00  | 10.01<br>10.01<br>10.01   | + ABS<br>+ ABS<br>+ ABS  | 24.3222-1731.3<br>020531   | Rz 22,20   |
| <b>KIA CARNIVAL II (01-06)</b>   |   |  |  |  |   |  |  |  |
|  | 2.5 V6<br>2.5 V6<br>2.9 CRDi<br>2.9 TD  | 110<br>132<br>106<br>93  |  | 10.01<br>10.01<br>10.01<br>10.01   | 08.06<br>08.06<br>08.06<br>08.06  | + ABS<br>+ ABS<br>+ ABS<br>+ ABS   | 24.3222-1731.3<br>020531   | Rz 22,20   |
| <b>KIA CEE'D Limousine (06-)</b>   |   |  |  |  |   |  |  |  |
|  | 1.4 16V<br>1.4 16V<br>1.4 16V<br>1.6 16V<br>1.6 16V<br>1.6 16V<br>1.6 16V<br>1.6 CRDi 115<br>1.6 CRDi 128<br>1.6 CRDi 90<br>2.0 16V<br>2.0 CRDi | 66<br>77<br>80<br>85<br>90<br>92<br>93<br>85<br>94<br>66<br>105<br>103           |  | 06.10<br>12.06<br>12.06<br>09.07<br>12.06<br>10.10<br>02.08<br>12.06<br>10.10<br>12.06<br>12.06<br>09.07 |   |  | 24.5286-0524.3<br>24.5286-0525.3<br>331223<br>331224   | <br><br>L=535<br>L=535 |
|  | 1.4 16V<br>1.4 16V<br>1.4 16V<br>1.6 16V<br>1.6 16V<br>1.6 16V<br>1.6 16V<br>1.6 CRDi 115   | 66<br>77<br>80<br>85<br>90<br>92<br>93<br>85                                     |  | 06.10<br>12.06<br>12.06<br>09.07<br>12.06<br>10.10<br>02.08<br>12.06                                     |   |  | 24.5298-0270.3<br>24.5298-0271.3<br>331086<br>331087   | <br><br>L=270<br>L=270 |

|     |   |  |  |                          |  |  |  |  |                  |
|--|---|--|--|--|---|--|--|--|------------------|
| <b>KIA CEE'D Limousine (06-)</b>   |   |  |  |  |   |  |  |  |                  |
|    | 1.6 CRDi 128<br>1.6 CRDi 90<br>2.0 16V<br>2.0 CRDi  | 94<br>66<br>105<br>103   |  | 10.10<br>12.06<br>12.06<br>09.07   |   | 24.5298-0270.3<br>24.5298-0271.3   | 331086<br>331087   | <input type="checkbox"/><br><input type="checkbox"/>                               | L=270<br>L=270   |
|    | 1.6 CRDi 128  | 94   |  | 10.10  |   | 24.3727-3204.2<br>24.3727-3205.2   | 583204<br>583205   | <input type="checkbox"/><br><input type="checkbox"/>                               | L=1673<br>L=1673 |
| <b>KIA CEE'D Kombi (07-)</b>   |   |  |  |  |   |  |  |  |                  |
|    | 1.4 16V<br>1.4 16V<br>1.4 16V<br>1.6 16V<br>1.6 16V<br>1.6 16V<br>1.6 16V<br>1.6 CRDi 115<br>1.6 CRDi 128<br>1.6 CRDi 90<br>2.0 16V<br>2.0 CRDi     | 66<br>77<br>80<br>85<br>90<br>92<br>93<br>85<br>94<br>66<br>105<br>103           |  | 10.10<br>10.10<br>09.07<br>09.07<br>09.07<br>06.09<br>09.07<br>09.07<br>10.10<br>09.07<br>09.07<br>09.07 |   | 24.5286-0524.3<br>24.5286-0525.3   | 331223<br>331224   | <input type="checkbox"/><br><input type="checkbox"/>                               | L=535<br>L=535   |
|    | 1.4 16V<br>1.4 16V<br>1.4 16V<br>1.6 16V<br>1.6 16V<br>1.6 16V<br>1.6 16V<br>1.6 CRDi 115<br>1.6 CRDi 128<br>1.6 CRDi 90<br>2.0 16V<br>2.0 CRDi     | 66<br>77<br>80<br>85<br>90<br>92<br>93<br>85<br>94<br>66<br>105<br>103           |  | 10.10<br>10.10<br>09.07<br>09.07<br>09.07<br>06.09<br>09.07<br>09.07<br>10.10<br>09.07<br>09.07<br>09.07 |   | 24.5298-0270.3<br>24.5298-0271.3   | 331086<br>331087   | <input type="checkbox"/><br><input type="checkbox"/>                               | L=270<br>L=270   |
|    | 1.6 CRDi 128  | 94   |  | 10.10  |   | 24.3727-3204.2<br>24.3727-3205.2   | 583204<br>583205   | <input type="checkbox"/><br><input type="checkbox"/>                               | L=1673<br>L=1673 |
| <b>KIA MENTOR II (GB) (01-04)</b>  |   |  |  |  |   |  |  |  |                  |
|   | 1.6 i 16V   | 75   |  | 05.01 08.04  |   | 24.5285-0240.3   | 330976   | 2  | L=240            |
|  | 1.6 i 16V   | 75   |  | 05.01 08.04  | - ABS   | 24.3217-1120.3   | 020360   |  | Rz 17,46         |
| <b>KIA PICANTO (BA) (04-11)</b>  |   |  |  |  |   |  |  |  |                  |
|  | 1.0<br>1.0<br>1.1<br>1.1 CRDi   | 45<br>46<br>48<br>55   |  | 09.05 04.11<br>11.09 04.11<br>04.04 04.11<br>11.05 04.11   |   | 24.5286-0265.3   | 331046   | 2  | L=265            |
|  | 1.0<br>1.1<br>1.1 CRDi  | 45<br>48<br>55   |  | 09.05 09.06<br>04.04 09.06<br>11.05 09.06  |   | 24.3215-1703.3   | 020530   | - ABS  | Rz 15,87         |
|  | 1.0<br>1.0<br>1.1<br>1.1 CRDi   | 45<br>46<br>48<br>55   |  | 09.05 04.11<br>11.09 04.11<br>04.04 04.11<br>11.05 04.11   | - ABS<br>- ABS<br>- ABS<br>- ABS  | 24.3727-3202.2<br>24.3727-3203.2   | 583202<br>583203   | <input type="checkbox"/><br><input type="checkbox"/>                               | L=1487<br>L=1487 |
|  | 1.0<br>1.0<br>1.1<br>1.1 CRDi   | 45<br>46<br>48<br>55   |  | 09.05 04.11<br>11.09 04.11<br>04.04 04.11<br>11.05 04.11   | + ABS<br>+ ABS<br>+ ABS<br>+ ABS  | 24.3727-3206.2<br>24.3727-3207.2   | 583206<br>583207   | <input type="checkbox"/><br><input type="checkbox"/>                               | L=1515<br>L=1515 |
|  | 1.0<br>1.0<br>1.1<br>1.1 CRDi   | 45<br>46<br>48<br>55   |  | 09.05 04.11<br>11.09 04.11<br>09.05 04.11<br>11.05 04.11   |   | 24.3728-3201.2   | 593201   |  | L=840            |
| <b>KIA PRO CEE'D (08-)</b>   |   |  |  |  |   |  |  |  |                  |
|  | 1.4 16V<br>1.4 16V<br>1.4 16V<br>1.6 16V<br>1.6 16V<br>1.6 16V<br>1.6 16V<br>1.6 CRDi 115<br>1.6 CRDi 128<br>1.6 CRDi 90<br>2.0 16V<br>2.0 CRDi 140 | 66<br>77<br>80<br>85<br>90<br>92<br>93<br>85<br>94<br>66<br>105<br>103           |  | 06.10<br>02.08<br>02.08<br>02.08<br>02.08<br>10.10<br>02.08<br>02.08<br>10.10<br>02.08<br>02.08<br>02.08 |   | 24.5286-0524.3<br>24.5286-0525.3   | 331223<br>331224   | <input type="checkbox"/><br><input type="checkbox"/>                               | L=535<br>L=535   |
|  | 1.4 16V<br>1.4 16V<br>1.4 16V<br>1.6 16V<br>1.6 16V<br>1.6 16V  | 66<br>77<br>80<br>85<br>90<br>92   |  | 06.10<br>02.08<br>02.08<br>02.08<br>02.08<br>10.10   |   | 24.5298-0270.3<br>24.5298-0271.3   | 331086<br>331087   | <input type="checkbox"/><br><input type="checkbox"/>                               | L=270<br>L=270   |
|  |   |  |  |  |   |  |  |  |                  |

|     |    |  |  |    |  |  |  |  |                              |            |
|--|--|--|--|--|---|--|--|--|------------------------------|------------|
| <b>KIA PRO CEE'D (08-)</b>   |  |  |  |  |   |  |  |  |                              |            |
|    | 1.6 16V<br>1.6 CRDi 115<br>1.6 CRDi 128<br>1.6 CRDi 90<br>2.0 16V<br>2.0 CRDi 140  | 93<br>85<br>94<br>66<br>105<br>103   |  | 02.08<br>02.08<br>10.10<br>02.08<br>02.08<br>02.08   |   | 24.5298-0270.3<br>24.5298-0271.3   | 331086<br>331087   | <input type="checkbox"/><br><input type="checkbox"/>                               | L=270<br>L=270               |            |
|    | 1.6 CRDi 128   | 94   |  | 10.10  |   | 24.3727-3204.2<br>24.3727-3205.2   | 583204<br>583205   | <input type="checkbox"/><br><input type="checkbox"/>                               | L=1673<br>L=1673             |            |
| <b>KIA RIO I (DC) (00-05)</b>  |  |  |  |  |   |  |  |  |                              |            |
|    | 1.3 i<br>1.3 i<br>1.5 i 16V  | 55<br>60<br>72   |  | 08.00 06.02<br>08.00 06.02<br>08.00 06.02  |   | 24.3217-1120.3   | 020360   |  | Rz 17,46                     |            |
|    | 1.3 i<br>1.3 i<br>1.5 i 16V<br>1.5 i 16V<br>1.5 i 16V  | 55<br>60<br>70<br>71<br>72   |  | 07.02 02.05<br>07.02 02.05<br>09.02 02.05<br>09.02 02.05<br>07.02 02.05  |   | 24.3217-1729.3   | 020535   |  | Rz 17,46                     |            |
|    | 1.3 i<br>1.3 i<br>1.5 i 16V<br>1.5 i 16V<br>1.5 i 16V  | 55<br>60<br>70<br>71<br>72   |  | 08.00 02.05<br>08.00 02.05<br>09.02 02.05<br>09.02 02.05<br>08.00 02.05  |   | 24.3727-3200.2<br>24.3727-3201.2   | 583200<br>583201   | <input type="checkbox"/><br><input type="checkbox"/>                               | L=1584<br>L=1584             |            |
|    | 1.3 i<br>1.3 i<br>1.5 i 16V<br>1.5 i 16V<br>1.5 i 16V  | 55<br>60<br>70<br>71<br>72   |  | 08.00 02.05<br>08.00 02.05<br>09.02 02.05<br>09.02 02.05<br>08.00 02.05  |   | 24.3728-3200.2   | 593200   |  | L=733                        |            |
| <b>KIA SEDONA I (GB) (99-01)</b>   |  |  |  |  |   |  |  |  |                              |            |
|    | 2.5 i V6<br>2.9 TDi  | 121<br>93  |  | 06.00 09.01 + ABS<br>06.00 09.01 + ABS   |   | 24.3222-1731.3   | 020531   |  | Rz 22,20                     |            |
| <b>KIA SEDONA II (GB) (01-06)</b>  |  |  |  |  |   |  |  |  |                              |            |
|    | 2.5 i V6<br>2.9 CRDi   | 110<br>106   |  | 10.01 10.06 + ABS<br>10.01 10.06 + ABS   |   | 24.3222-1731.3   | 020531   |  | Rz 22,20                     |            |
| <b>KIA SEPHIA I (93-98)</b>  |  |  |  |  |   |  |  |  |                              |            |
|  | 1.5 16V<br>1.6 i<br>1.8 16V  |  |  | 02.96 12.98<br>10.93 06.96<br>01.95 12.98  |   | 11.0101-5407.2<br>11.8171-0008.1   | 260011<br>990049   |  | Hülsensatz<br>Führungsbolzen | ATE<br>ATE |
|  | 1.6 i  |  |  | 10.93 03.95  |   | 03.0101-0014.2   | 320004   |  | BRES 3/25                    | ATE        |
| <b>KIA SEPHIA II (01-04)</b>   |  |  |  |  |   |  |  |  |                              |            |
|  | 1.6 i 16V  | 75   |  | 05.01 08.04  |   | 24.5285-0240.3   | 330976   | 2  | L=240                        |            |
|  | 1.6 i 16V  | 75   |  | 05.01 08.04 - ABS  |   | 24.3217-1120.3   | 020360   |  | Rz 17,46                     |            |
| <b>KIA SHUMA I (97-01)</b>   |  |  |  |  |   |  |  |  |                              |            |
|  | 1.5 i 16V<br>1.8 i 16V   | 65<br>81   |  | 10.97 04.01 - ABS<br>10.97 04.01 - ABS   |   | 24.5285-0240.3   | 330976   | 2  | L=240                        |            |
| <b>KIA SHUMA II (01-04)</b>  |  |  |  |  |   |  |  |  |                              |            |
|  | 1.6 i 16V<br>1.8 i 16V   | 75<br>84   |  | 05.01 08.04<br>04.03 08.04   |   | 24.5285-0240.3   | 330976   | 2  | L=240                        |            |
|  | 1.6 i 16V<br>1.8 i 16V   | 75<br>84   |  | 05.01 08.04 - ABS<br>04.03 08.04 - ABS   |   | 24.3217-1120.3   | 020360   |  | Rz 17,46                     |            |
| <b>KIA SORENTO (JC) (02-09)</b>  |  |  |  |  |   |  |  |  |                              |            |
|  | 2.5 CRDi<br>3.5 i V6   | 103<br>143   |  | 08.02 11.06 + ABS<br>08.02 11.06 + ABS/ + Automatikgetriebe <sup>1)</sup>  |   | 24.2126-1702.3   | 010950   |  | Thz 26,99                    |            |
| <b>KIA SPORTAGE (04-10)</b>  |  |  |  |  |   |  |  |  |                              |            |
|  | 2.0 CRDi<br>2.0 CRDi<br>2.0 CRDi<br>2.0 CRDi<br>2.0 CRDi 4WD<br>2.0 CRDi 4WD<br>2.0 CRDi 4WD<br>2.0 CRDi 4WD<br>2.0 i 16V<br>2.0 i 16V 4WD | 83<br>100<br>103<br>110<br>83<br>100<br>103<br>110<br>104<br>104                 |  | 02.05 05.10<br>01.06 05.10<br>01.06 05.10<br>09.08 05.10<br>09.04 05.10<br>01.06 05.10<br>01.06 05.10<br>09.08 05.10<br>09.04 05.10<br>09.04 05.10 |   | 24.5286-0405.3   | 331061   | <input type="checkbox"/>   | L=405                        |            |

<sup>1)</sup> + ABS/ + autom.transmission / + ABS/ + scatola cambio autom. / + ABS/ + transmission automatique / + ABS/ + cambio automático











|     |  |  |  |  |  |  |  |  |           |
|--|--|--|--|--|---|--|--|--|-----------|
| <b>KIA SPORTAGE (04-10)</b>  |  |  |  |  |   |  |  |  |           |
|    | 2.7 i V6 4WD   | 129  |  | 09.04  | 05.10   |  | 24.5286-0405.3   | 331061   | L=405     |
| <b>LADA 110 Stufenheck (2110) (95-07)</b>  |  |  |  |  |   |  |  |  |           |
|    | 1.5  | 54   |  | 01.95  | 08.07   |  | 24.2120-0803.3   | 010415   | THz 20,64 |
|  | 1.5  | 57   |  | 01.95  | 08.07   |  |  |  |           |
|  | 1.5 i 16V  | 70   |  | 01.95  | 08.07   |  |  |  |           |
|  | 1.6  | 60   |  | 01.00  | 08.07   |  |  |  |           |
|  | 1.6  | 66   |  | 01.00  | 08.07   |  |  |  |           |
|  | 2.0 i  | 110  |  | 08.96  | 08.07   |  |  |  |           |
|  | Wankel   | 88   |  | 06.97  | 08.07   |  |  |  |           |
|    | 1.5  | 54   |  | 01.95  | 08.07   |  | 24.3220-1103.3   | 020214   | Rz 20,64  |
|  | 1.5  | 57   |  | 01.95  | 08.07   |  |  |  |           |
|  | 1.5 i 16V  | 70   |  | 01.95  | 08.07   |  |  |  |           |
|  | 1.6  | 60   |  | 01.00  | 08.07   |  |  |  |           |
|  | 1.6  | 66   |  | 01.00  | 08.07   |  |  |  |           |
|  | 2.0 i  | 110  |  | 08.96  | 08.07   |  |  |  |           |
|  | Wankel   | 88   |  | 06.97  | 08.07   |  |  |  |           |
| <b>LADA 111 Kombi (2111) (95-08)</b>   |  |  |  |  |   |  |  |  |           |
|    | 1.5  | 57   |  | 01.95  | 12.08   |  | 24.2120-0803.3   | 010415   | THz 20,64 |
|  | 1.5 i 16V  | 70   |  | 01.95  | 12.08   |  |  |  |           |
|  | 1.6  | 60   |  | 01.05  | 12.08   |  |  |  |           |
|  | 1.6  | 66   |  | 03.06  | 12.08   |  |  |  |           |
|    | 1.5  | 57   |  | 01.95  | 12.08   |  | 24.3220-1103.3   | 020214   | Rz 20,64  |
|  | 1.5 i 16V  | 70   |  | 01.95  | 12.08   |  |  |  |           |
|  | 1.6  | 60   |  | 01.05  | 12.08   |  |  |  |           |
|  | 1.6  | 66   |  | 03.06  | 12.08   |  |  |  |           |
| <b>LADA 112 Fließheck (2112) (95-08)</b>   |  |  |  |  |   |  |  |  |           |
|    | 1.5  | 54   |  | 01.95  | 12.08   |  | 24.2120-0803.3   | 010415   | THz 20,64 |
|  | 1.5  | 57   |  | 01.95  | 12.08   |  |  |  |           |
|  | 1.5 i 16V  | 70   |  | 01.95  | 12.08   |  |  |  |           |
|  | 1.6  | 60   |  | 01.05  | 12.08   |  |  |  |           |
|  | 1.6  | 66   |  | 03.06  | 12.08   |  |  |  |           |
|    | 1.5  | 54   |  | 01.95  | 12.08   |  | 24.3220-1103.3   | 020214   | Rz 20,64  |
|  | 1.5  | 57   |  | 01.95  | 12.08   |  |  |  |           |
|  | 1.5 i 16V  | 70   |  | 01.95  | 12.08   |  |  |  |           |
|  | 1.6  | 60   |  | 01.05  | 12.08   |  |  |  |           |
|  | 1.6  | 66   |  | 03.06  | 12.08   |  |  |  |           |
| <b>LADA FORMA (2108) (89-95)</b>   |  |  |  |  |   |  |  |  |           |
|  | 1100   |  |  | 07.91  | 12.95   |  | 24.2120-0803.3   | 010415   | THz 20,64 |
|  | 1300   |  |  | 05.89  | 12.95   |  |  |  |           |
|  | 1500   |  |  | 07.91  | 12.95   |  |  |  |           |
|  | 1100   |  |  | 07.91  | 12.95   |  | 24.5127-0305.3   | 330578   | L=305     |
|  | 1300   |  |  | 05.89  | 12.95   |  |  |  |           |
|  | 1500   |  |  | 07.91  | 12.95   |  |  |  |           |
|  | 1100   |  |  | 07.91  | 12.95   |  | 24.3220-1103.3   | 020214   | Rz 20,64  |
|  | 1300   |  |  | 05.89  | 12.95   |  |  |  |           |
|  | 1500   |  |  | 07.91  | 12.95   |  |  |  |           |
|  | 1100   |  |  | 07.91  | 12.95   |  | 24.3727-2403.2   | 582403   | L=1617    |
|  | 1300   |  |  | 05.89  | 12.95   |  |  |  |           |
|  | 1500   |  |  | 07.91  | 12.95   |  |  |  |           |
| <b>LADA KALINA (1117/1118/1119) (04-)</b>  |  |  |  |  |   |  |  |  |           |
|  | 1.4 16V  | 66   |  | 11.08  |   |  | 24.3220-1103.3   | 020214   | Rz 20,64  |
|  | 1.4 16V LPG  | 65   |  | 11.08  |   |  |  |  |           |
|  | 1.6 16V  | 60   |  | 10.04  |   |  |  |  |           |
|  | 1.6 16V  | 62   |  | 01.10  |   |  |  |  |           |
|  | 1.6 16V  | 66   |  | 10.04  |   |  |  |  |           |
| <b>LADA PRIORA (2170/2172) (08-)</b>   |  |  |  |  |   |  |  |  |           |
|  | 1.6 i 16V  | 60   |  | 12.08  |   |  | 24.3220-1103.3   | 020214   | Rz 20,64  |
|  | 1.6 i 16V  | 72   |  | 12.08  |   |  |  |  |           |
|  | 1.6 LPG  | 71   |  | 12.08  |   |  |  |  |           |
| <b>LADA SAMARA (2108/2109) (86-99)</b>   |  |  |  |  |   |  |  |  |           |
|  | 1100   |  |  | 09.88  | 12.99   |  | 24.2120-0803.3   | 010415   | THz 20,64 |
|  | 1300   |  |  | 07.86  | 12.99   |  |  |  |           |
|  | 1500   |  |  | 07.87  | 12.99   |  |  |  |           |
|  | 1100   |  |  | 09.88  | 12.99   |  | 24.5127-0305.3   | 330578   | L=305     |
|  | 1300   |  |  | 07.86  | 12.99   |  |  |  |           |
|  | 1500   |  |  | 07.87  | 12.99   |  |  |  |           |
|  | 1100   |  |  | 09.88  | 12.99   |  | 24.3220-1103.3   | 020214   | Rz 20,64  |
|  | 1300   |  |  | 07.86  | 12.99   |  |  |  |           |
|  | 1500   |  |  | 07.87  | 12.99   |  |  |  |           |
|  | 1100   |  |  | 09.88  | 12.99   |  | 24.3727-2403.2   | 582403   | L=1617    |
|  | 1300   |  |  | 07.86  | 12.99   |  |  |  |           |
|  | 1500   |  |  | 07.87  | 12.99   |  |  |  |           |

| LADA TOSCANA (2107) (83-96)  |  |  |  |  |  |                   |
|--|--|--|--|--|--|-------------------|
|  1300<br>1500  | 09.85 12.96<br>09.83 02.93   | 24.3220-1103.3   | 020214   |  | Rz 20,64                                       |                   |
|  1300<br>1500  | 09.85 12.96<br>09.83 02.93   | 24.3727-2402.2   | 582402   | 1 ↓  | L=2503   |                   |
| LADA NIVA II (2123) (02-)  |  |  |  |  |  |                   |
|  1.7 i 4x4<br>1.7 i 4x4<br>1.7 LPG   | 59<br>61<br>57   | 09.02<br>08.04<br>09.02  | 24.3220-1103.3                                     | 020214   | Rz 20,64                                       |                   |
| LANCIA DEDRA (94-99)   |  |  |  |  |  |                   |
|  1.8 GT 16V<br>1.8 i.e.<br>1.9 TD<br>2.0 i.e.<br>2.0 i.e. 16V  | 03.96 08.99<br>11.93 08.99<br>11.93 08.99<br>11.93 08.99<br>11.93 08.99                | 24.3344-1703.5<br>24.3344-1704.5<br>24.0101-3601.2   | 240117<br>240118<br>260044                         | <input type="checkbox"/><br><input type="checkbox"/> | D=34, - Halter<br>D=34, - Halter<br>Einbausatz | LUC<br>LUC<br>LUC |
|  1.6   | 11.93 08.99  | 24.3222-1701.3   | 020376   |  | Rz 22,20                                       |                   |
|  1.6   | 11.93 08.99  | 24.3727-0511.2<br>24.3727-0510.2   | 580511<br>580510                                   | <input type="checkbox"/><br><input type="checkbox"/> | L=1415<br>L=1375                               |                   |
|  1.6<br>1.8 i.e.<br>1.9 TD<br>2.0 i.e.<br>2.0 i.e. 16V   | 11.93 08.99<br>11.93 08.99<br>11.93 08.99<br>11.93 08.99<br>11.93 08.99                | 24.3727-0521.2<br>24.3727-0006.2   | 580521<br>580006                                   | <input type="checkbox"/><br><input type="checkbox"/> | L=1517<br>L=1460                               |                   |
|  1.6<br>1.8 GT 16V<br>1.8 i.e.<br>1.9 TD<br>2.0 i.e.<br>2.0 i.e. 16V   | 11.93 08.99<br>03.96 08.99<br>11.93 08.99<br>11.93 08.99<br>11.93 08.99<br>11.93 08.99 | 24.6584-1701.3   | 320173   |  | BRL (4)  |                   |
| LANCIA DELTA (94-99)   |  |  |  |  |  |                   |
|  1.4 i.e.<br>1.6 i.e.<br>1.8<br>1.8 i.e.<br>2.0 HF Turbo<br>2.0 i.e. 16V   | 66   | 11.93 08.99<br>11.93 08.99<br>02.96 09.99<br>11.93 08.99<br>11.93 08.99<br>11.93 08.99                               | 24.2122-1716.3                                     | 010485   | THz 22,20                                      |                   |
|  1.8<br>1.8 i.e.<br>2.0 HF Turbo<br>2.0 i.e. 16V<br>2.0 TD   | 66   | 02.96 09.99<br>11.93 08.99<br>11.93 08.99<br>11.93 08.99<br>07.94 08.99  | 24.3344-1703.5<br>24.3344-1704.5<br>24.0101-3601.2 | 240117<br>240118<br>260044                           | D=34, - Halter<br>D=34, - Halter<br>Einbausatz | LUC<br>LUC<br>LUC |
|  1.4 i.e.<br>1.6 i.e.<br>1.8<br>1.8 i.e.<br>2.0 HF Integrale<br>2.0 HF Turbo<br>2.0 i.e. 16V<br>2.0 i.e. 16V Integrale<br>2.0 TD         | 66   | 11.93 08.99<br>11.93 08.99<br>02.96 09.99<br>11.93 08.99<br>11.93 08.99<br>11.93 08.99<br>11.93 08.99<br>07.94 08.99 | 83.6401-0159.3                                     | 330746   | 2  | L=160             |
|  1.4 i.e.<br>1.6 i.e.  |  | 11.93 08.99<br>11.93 08.99   | 24.3222-1701.3                                     | 020376   | Rz 22,20                                       |                   |
|  1.4 i.e.<br>1.6 i.e.  |  | 11.93 08.99<br>11.93 08.99   | 24.3727-0511.2<br>24.3727-0510.2                   | 580511<br>580510                                     | L=1415<br>L=1375                               |                   |
|  1.8<br>1.8 i.e.<br>2.0 HF Turbo<br>2.0 i.e. 16V<br>2.0 TD   | 66   | 02.96 09.99<br>11.93 08.99<br>11.93 08.99<br>11.93 08.99<br>07.94 08.99  | 24.3727-0521.2<br>24.3727-0006.2                   | 580521<br>580006                                     | L=1517<br>L=1460                               |                   |
| LANCIA DELTA (08-)   |  |  |  |  |  |                   |
|  1.8 Di 16V<br>1.9 D Multijet<br>2.0 D Multijet  | 147<br>140<br>121  | 01.09<br>08.08<br>08.08  | 11.9571-9953.2<br>11.9571-9954.2                   | 220871<br>220872                                     | D=57, - Halter<br>D=57, - Halter               | ATE<br>ATE        |
|  1.4 16V<br>1.4 16V<br>1.4 16V Turbo<br>1.4 Bifuel<br>1.6 D Multijet<br>1.6 D Multijet<br>1.8 Di 16V<br>1.9 D Multijet<br>2.0 D Multijet | 88<br>103<br>110<br>88<br>77<br>88<br>147<br>140<br>121                                | 08.08<br>07.10<br>08.08<br>07.11<br>04.11<br>08.08<br>01.09<br>08.08<br>08.08  | 83.6401-0413.3                                     | 330748   | 2  | L=408             |
|  1.4 16V<br>1.4 16V<br>1.4 16V Turbo<br>1.4 Bifuel<br>1.6 D Multijet   | 88<br>103<br>110<br>88<br>77   | 08.08<br>07.10<br>08.08<br>07.11<br>04.11  | 24.5112-0187.3                                     | 331150   | 2  | L=187             |



























1) - air conditioning / - aria condizionata / - air conditionné / - aire acondicionado

2) + air conditioning / + aria condizionata / + air conditionné / + aire acondicionado



| LANCIA DELTA (08-)   |                    |     |  |       |       |                |        |                          |                                 |  |  |                |     |
|--|--------------------|-----|--|-------|-------|----------------|--------|--------------------------|---------------------------------|--|--|----------------|-----|
|     | 1.6 D Multijet     | 88  |  | 08.08 |       | 24.5112-0187.3 | 331150 | 2                        |                                 |  |  | L=187          |     |
|  | 1.8 Di 16V         | 147 |  | 01.09 |       |                |        |                          |                                 |  |  |                |     |
|  | 1.9 D Multijet     | 140 |  | 08.08 |       |                |        |                          |                                 |  |  |                |     |
|  | 2.0 D Multijet     | 121 |  | 08.08 |       |                |        |                          |                                 |  |  |                |     |
|    | 1.4 16V            | 88  |  | 08.08 |       | 24.3727-3001.2 | 583001 | <input type="checkbox"/> |                                 |  |  | L=1902         |     |
|  | 1.4 16V            | 103 |  | 07.10 |       | 24.3727-3002.2 | 583002 | <input type="checkbox"/> |                                 |  |  | L=1760         |     |
|  | 1.4 16V Turbo      | 110 |  | 08.08 |       |                |        |                          |                                 |  |  |                |     |
|  | 1.4 Bifuel         | 88  |  | 07.11 |       |                |        |                          |                                 |  |  |                |     |
|  | 1.6 D Multijet     | 77  |  | 04.11 |       |                |        |                          |                                 |  |  |                |     |
|  | 1.6 D Multijet     | 88  |  | 08.08 |       |                |        |                          |                                 |  |  |                |     |
|  | 1.8 Di 16V         | 147 |  | 01.09 |       |                |        |                          |                                 |  |  |                |     |
|  | 1.9 D Multijet     | 140 |  | 08.08 |       |                |        |                          |                                 |  |  |                |     |
|  | 2.0 D Multijet     | 121 |  | 08.08 |       |                |        |                          |                                 |  |  |                |     |
| LANCIA KAPPA (95-01)   |                    |     |  |       |       |                |        |                          |                                 |  |  |                |     |
|    | 2.0 i.e.           |     |  | 01.95 | 10.01 | 24.2123-1718.3 | 010507 |                          |                                 |  |  | THz 23,81      |     |
|  | 2.0 i.e. 16V Turbo |     |  | 07.95 | 10.01 |                |        |                          |                                 |  |  |                |     |
|  | 2.0 i.e. 20V Turbo |     |  | 06.98 | 10.01 |                |        |                          |                                 |  |  |                |     |
|  | 2.4 i.e.           |     |  | 01.95 | 10.01 |                |        |                          |                                 |  |  |                |     |
|  | 2.4 JTD            |     |  | 06.98 | 10.01 |                |        |                          |                                 |  |  |                |     |
|  | 2.4 TD             |     |  | 01.95 | 10.01 |                |        |                          |                                 |  |  |                |     |
|  | 3.0 i.e. V6        |     |  | 01.95 | 10.01 |                |        |                          |                                 |  |  |                |     |
|    | 2.0 i.e. 16V Turbo |     |  | 07.95 | 10.01 | 24.3571-1719.5 | 240303 | <input type="checkbox"/> |                                 |  |  | D=57, - Halter | ATE |
|  | 2.0 i.e. 20V Turbo |     |  | 06.98 | 10.01 |                |        |                          |                                 |  |  |                |     |
|  | 2.4 JTD            |     |  | 06.98 | 10.01 |                |        |                          |                                 |  |  |                |     |
| LANCIA LYBRA (99-05)   |                    |     |  |       |       |                |        |                          |                                 |  |  |                |     |
|    | 1.8 i 16V          |     |  | 10.99 | 12.05 | 24.3541-1791.5 | 240293 | <input type="checkbox"/> |                                 |  |  | D=54, - Halter | ATE |
|  | 1.9 JTD            |     |  | 10.99 | 12.05 | 24.3541-1792.5 | 240294 | <input type="checkbox"/> |                                 |  |  | D=54, - Halter | ATE |
|  | 2.0 i 20V          |     |  | 10.99 | 12.05 |                |        |                          |                                 |  |  |                |     |
|  | 2.4 JTD            |     |  | 10.99 | 12.05 |                |        |                          |                                 |  |  |                |     |
|    | 1.6                |     |  | 10.00 | 10.05 | 83.6401-0413.3 | 330748 | 2                        |                                 |  |  | L=408          |     |
|  | 1.6 i 16V          |     |  | 10.99 | 12.05 |                |        |                          |                                 |  |  |                |     |
|  | 1.8 i 16V          |     |  | 10.99 | 12.05 |                |        |                          |                                 |  |  |                |     |
|  | 1.9 JTD            |     |  | 10.99 | 12.05 |                |        |                          |                                 |  |  |                |     |
|  | 2.0 i 20V          |     |  | 10.99 | 12.05 |                |        |                          |                                 |  |  |                |     |
|  | 2.4 JTD            |     |  | 10.99 | 12.05 |                |        |                          |                                 |  |  |                |     |
|   | 1.6                |     |  | 10.00 | 10.05 | 24.3384-1741.7 | 220599 | <input type="checkbox"/> |                                 |  |  | D=38, - Halter | LUC |
|  | 1.6 i 16V          |     |  | 10.99 | 12.05 | 24.3384-1742.7 | 220600 | <input type="checkbox"/> |                                 |  |  | D=38, - Halter | LUC |
|  | 1.8 i 16V          |     |  | 10.99 | 12.05 |                |        |                          |                                 |  |  |                |     |
|  | 1.9 JTD            |     |  | 10.99 | 12.05 |                |        |                          |                                 |  |  |                |     |
|  | 2.0 i 20V          |     |  | 10.99 | 12.05 |                |        |                          |                                 |  |  |                |     |
|  | 2.4 JTD            |     |  | 10.99 | 12.05 |                |        |                          |                                 |  |  |                |     |
| LANCIA MUSA (04-12)  |                    |     |  |       |       |                |        |                          |                                 |  |  |                |     |
|  | 1.3 D Multijet     | 51  |  | 10.04 | 11.06 | 24.2123-1763.3 | 010842 |                          | - Dynamic Control <sup>1)</sup> |  |  | THz 23,81      |     |
|  | 1.3 D Multijet     | 66  |  | 09.06 | 11.06 | 24.2123-1769.3 | 010863 |                          | + Dynamic Control <sup>2)</sup> |  |  | THz 23,81      | BOS |
|  | 1.4                | 57  |  | 07.05 | 11.06 |                |        |                          |                                 |  |  |                |     |
|  | 1.4                | 70  |  | 10.04 | 11.06 |                |        |                          |                                 |  |  |                |     |
|  | 1.9 D Multijet     | 74  |  | 10.04 | 11.06 |                |        |                          |                                 |  |  |                |     |
|  | 1.3 D Multijet     | 51  |  | 12.06 | 07.12 | 24.4123-1708.3 | 010859 |                          |                                 |  |  | THz 23,81      | BOS |
|  | 1.3 D Multijet     | 66  |  | 12.06 | 07.12 |                |        |                          |                                 |  |  |                |     |
|  | 1.3 D Multijet     | 70  |  | 08.09 | 07.12 |                |        |                          |                                 |  |  |                |     |
|  | 1.4                | 57  |  | 12.06 | 07.12 |                |        |                          |                                 |  |  |                |     |
|  | 1.4                | 66  |  | 10.07 | 07.12 |                |        |                          |                                 |  |  |                |     |
|  | 1.4                | 70  |  | 12.06 | 07.12 |                |        |                          |                                 |  |  |                |     |
|  | 1.4 LPG            | 57  |  | 11.10 | 07.12 |                |        |                          |                                 |  |  |                |     |
|  | 1.6 D Multijet     | 85  |  | 07.08 | 07.12 |                |        |                          |                                 |  |  |                |     |
|  | 1.6 D Multijet     | 88  |  | 06.08 | 07.12 |                |        |                          |                                 |  |  |                |     |
|  | 1.9 D Multijet     | 74  |  | 12.06 | 07.12 |                |        |                          |                                 |  |  |                |     |
|  | 1.4                | 57  |  | 07.05 | 07.12 | 24.3541-1811.5 | 240429 | <input type="checkbox"/> |                                 |  |  | D=54, - Halter | BOS |
|  | 1.4                | 66  |  | 10.07 | 07.12 | 24.3541-1812.5 | 240430 | <input type="checkbox"/> |                                 |  |  | D=54, - Halter | BOS |
|  | 1.4                | 70  |  | 10.04 | 07.12 |                |        |                          |                                 |  |  |                |     |
|  | 1.4 LPG            | 57  |  | 11.10 | 07.12 |                |        |                          |                                 |  |  |                |     |
|  | 1.3 D Multijet     | 51  |  | 10.04 | 07.12 | 24.3541-1831.7 | 220723 | <input type="checkbox"/> |                                 |  |  | D=54, - Halter | BOS |
|  | 1.3 D Multijet     | 66  |  | 09.06 | 07.12 | 24.3541-1832.7 | 220724 | <input type="checkbox"/> |                                 |  |  | D=54, - Halter | BOS |
|  | 1.3 D Multijet     | 70  |  | 08.09 | 07.12 |                |        |                          |                                 |  |  |                |     |
|  | 1.6 D Multijet     | 85  |  | 07.08 | 07.12 |                |        |                          |                                 |  |  |                |     |
|  | 1.6 D Multijet     | 88  |  | 06.08 | 07.12 |                |        |                          |                                 |  |  |                |     |
|  | 1.9 D Multijet     | 74  |  | 10.04 | 07.12 |                |        |                          |                                 |  |  |                |     |
|  | 1.3 D Multijet     | 51  |  | 10.04 | 07.12 | 24.5112-0456.3 | 330875 | 2                        |                                 |  |  | L=455          |     |
|  | 1.3 D Multijet     | 66  |  | 09.06 | 07.12 |                |        |                          |                                 |  |  |                |     |
|  | 1.3 D Multijet     | 70  |  | 08.09 | 07.12 |                |        |                          |                                 |  |  |                |     |
|  | 1.4                | 57  |  | 07.05 | 07.12 |                |        |                          |                                 |  |  |                |     |
|  | 1.4                | 66  |  | 10.07 | 07.12 |                |        |                          |                                 |  |  |                |     |
|  | 1.4                | 70  |  | 10.04 | 07.12 |                |        |                          |                                 |  |  |                |     |
|  | 1.4 LPG            | 57  |  | 11.10 | 07.12 |                |        |                          |                                 |  |  |                |     |
|  | 1.6 D Multijet     | 85  |  | 07.08 | 07.12 |                |        |                          |                                 |  |  |                |     |
|  | 1.6 D Multijet     | 88  |  | 06.08 | 07.12 |                |        |                          |                                 |  |  |                |     |
|  | 1.9 D Multijet     | 74  |  | 10.04 | 07.12 |                |        |                          |                                 |  |  |                |     |
|  | 1.3 D Multijet     | 51  |  | 10.04 | 07.12 | 83.7201-9173.3 | 330868 | 2                        |                                 |  |  | L=173          |     |
|  | 1.3 D Multijet     | 66  |  | 09.06 | 07.12 |                |        |                          |                                 |  |  |                |     |
|  | 1.3 D Multijet     | 70  |  | 08.09 | 07.12 |                |        |                          |                                 |  |  |                |     |
|  | 1.4                | 57  |  | 07.05 | 07.12 |                |        |                          |                                 |  |  |                |     |
|  | 1.4                | 66  |  | 10.07 | 07.12 |                |        |                          |                                 |  |  |                |     |
|  | 1.4                | 70  |  | 10.04 | 07.12 |                |        |                          |                                 |  |  |                |     |

<sup>1)</sup> - dynamic control / - dynamic control / - dynamic control / - Control dinámico  
<sup>2)</sup> + dynamic control / + dynamic control / + dynamic control / + Control dinámico

|     |            |  |  |                       |  |  |  |  |   |
|--|--|--|--|---|---|--|--|--|---|
| <b>LANCIA MUSA (04-12)</b>   |  |  |  |   |   |  |  |  |   |
|    | 1.4 LPG<br>1.6 D Multijet<br>1.6 D Multijet<br>1.9 D Multijet                              | 57<br>85<br>88<br>74   |  | 11.10 07.12<br>07.08 07.12<br>06.08 07.12<br>10.04 07.12  |   | 83.7201-9173.3   | 330868   | 2  | L=173                                       |
|    | 1.3 D Multijet<br>1.4  | 51<br>70   |  | 10.04 06.05<br>10.04 06.05  |   | 24.3222-1724.3   | 020466   |  | Rz 22,20                                    |
|    | 1.4<br>1.4<br>1.4<br>1.4 LPG   | 57<br>66<br>70<br>57   |  | 07.05 07.12<br>10.07 07.12<br>07.05 07.12<br>11.10 07.12  |   | 24.3222-1725.3   | 020510   |  | Rz 22,00 <b>AP</b>                          |
|    | 1.9 D Multijet   | 74   |  | 10.04 06.05   |   | 24.3220-1107.3   | 020218   |  | Rz 20,64 <b>AP</b>                          |
|    | 1.3 D Multijet<br>1.3 D Multijet<br>1.3 D Multijet<br>1.9 D Multijet                       | 51<br>66<br>70<br>74   |  | 07.05 07.12<br>09.06 07.12<br>08.09 07.12<br>07.05 07.12  |   | 24.3220-1728.3   | 020509   |  | Rz 20,64                                    |
|    | 1.4<br>1.4<br>1.4<br>1.4 LPG   | 57<br>66<br>70<br>57   |  | 07.05 07.12<br>10.07 07.12<br>10.04 07.12<br>11.10 07.12  |   | 24.2520-1705.3   | 040093   |  | Nz 20,64                                    |
| <b>LANCIA PHEDRA (02-10)</b>   |  |  |  |   |   |  |  |  |   |
|    | 2.0 D Multijet<br>2.0 i 16V<br>2.0 JTD<br>2.2 D Multijet<br>2.2 JTD<br>2.2 JTD             | 100<br>100<br>80<br>125<br>94<br>120   |  | 07.06 09.10<br>08.02 09.10<br>08.02 09.10<br>03.08 09.10<br>08.02 09.10<br>04.06 09.10                |   | 03.2122-2163.3   | 010800   |  | Thz 22,20 <b>ATE</b>                        |
|    | 2.0 D Multijet<br>2.0 i 16V<br>2.0 JTD<br>2.2 JTD  | 100<br>100<br>80<br>94   |  | 07.06 09.10<br>08.02 09.10<br>08.02 09.10<br>08.02 09.10  |   | 24.3601-1711.7<br>24.3601-1712.7   | 220607<br>220608   | <input type="checkbox"/><br><input type="checkbox"/>                               | D=60, - Halter<br>D=60, - Halter <b>LUC</b> |
|    | 2.0 D Multijet<br>2.0 i 16V<br>2.0 JTD<br>2.2 JTD<br>3.0 i V6                              | 100<br>100<br>80<br>94<br>150  |  | 07.06 09.10<br>08.02 09.10<br>08.02 09.10<br>08.02 09.10<br>08.02 09.10                               |   | 24.5111-0462.3   | 330555   | 2  | L=460                                       |
|    | 2.0 D Multijet<br>2.0 i 16V<br>2.0 JTD<br>2.2 D Multijet<br>2.2 JTD<br>2.2 JTD<br>3.0 i V6 | 100<br>100<br>80<br>125<br>94<br>120<br>150                                      |  | 07.06 09.10<br>08.02 09.10<br>08.02 09.10<br>03.08 09.10<br>08.02 09.10<br>04.06 09.10<br>08.02 09.10 |   | 24.3384-1761.7<br>24.3384-1762.7   | 220671<br>220672   | <input type="checkbox"/><br><input type="checkbox"/>                               | D=38, - Halter<br>D=38, - Halter <b>LUC</b> |
|  | 2.0 D Multijet<br>2.0 i 16V<br>2.0 JTD<br>2.2 D Multijet<br>2.2 JTD<br>2.2 JTD<br>3.0 i V6 | 100<br>100<br>80<br>125<br>94<br>120<br>150                                      |  | 07.06 09.10<br>08.02 09.10<br>08.02 09.10<br>03.08 09.10<br>08.02 09.10<br>04.06 09.10<br>08.02 09.10 |   | 24.5229-0251.3   | 330535   | 2  | L=250                                       |
|  | 2.0 i 16V<br>2.0 JTD<br>2.2 D Multijet<br>2.2 JTD<br>2.2 JTD<br>3.0 i V6                   | 100<br>80<br>125<br>94<br>120<br>150   |  | 08.02 09.10<br>08.02 09.10<br>03.08 09.10<br>08.02 09.10<br>04.06 09.10<br>08.02 09.10                |   | 24.3727-0847.2<br>24.3727-0848.2   | 580847<br>580848   | <input type="checkbox"/><br><input type="checkbox"/>                               | L=1068<br>L=2360                            |
|  | 2.0 D Multijet   | 100  |  | 07.06 09.10   |   | 24.3727-0569.2   | 580569   | 2 ↓  | L=1255                                      |
| <b>LANCIA THEMA (92-94)</b>  |  |  |  |   |   |  |  |  |   |
|  | 2.0 i.e.<br>2.0 i.e. 16V<br>2.0 i.e. 16V Turbo<br>2.5 TD<br>3.0 i.e. V6                    |  |  | 10.92 12.94<br>10.92 12.94<br>10.92 12.94<br>10.92 12.94<br>10.92 12.94                               |   | 24.2122-0802.3   | 010374   |  | Thz 22,20                                   |
|  | 2.0 i.e.<br>2.0 i.e. 16V<br>2.0 i.e. 16V Turbo<br>2.5 TD<br>3.0 i.e. V6                    |  |  | 10.92 12.94<br>10.92 12.94<br>10.92 12.94<br>10.92 12.94<br>10.92 12.94                               |   | 24.3384-1608.5   | 240168   | <input type="checkbox"/>   | D=38, - Halter <b>LUC</b>                   |
|  | 2.0 i.e.<br>2.0 i.e. 16V<br>2.0 i.e. 16V Turbo<br>2.5 TD<br>3.0 i.e. V6                    |  |  | 10.92 12.94<br>10.92 12.94<br>10.92 12.94<br>10.92 12.94<br>10.92 12.94                               |   | 24.3727-0545.2   | 580545   | 1 ↓  | L=2945                                      |
| <b>LANCIA Y 10 (85-95)</b>   |  |  |  |   |   |  |  |  |   |
|  | 1.0 Fire<br>1.0 Fire 4WD<br>1.0 Turbo<br>1.1 4WD<br>1.1 Fire<br>1.3 Fire                   |  |  | 06.85 02.92<br>06.85 02.92<br>06.85 02.89<br>12.86 12.92<br>01.90 12.92<br>02.89 12.92                |   | 24.2120-0801.3   | 010362   |  | Thz 20,64                                   |
|  | 1.1 4WD<br>1.1 Fire<br>1.3 Fire  |  |  | 01.93 12.95<br>01.93 12.95<br>01.93 12.95   |   | 24.2120-1733.3   | 010686   |  | Thz 20,64                                   |

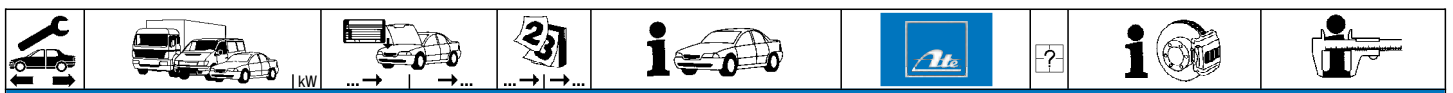

| LANCIA Y 10 (85-95) |  |  |  |  |  |  |                |        |     |             |
|---------------------|--|--|--|--|--|--|----------------|--------|-----|-------------|
|                     | 1.0 Fire<br>1.0 Fire 4WD<br>1.0 Turbo<br>1.1 4WD<br>1.1 Fire<br>1.3 Fire |  |  | 06.85<br>12.86<br>06.85<br>01.90<br>01.90<br>02.89 | 12.95<br>12.95<br>12.95<br>12.95<br>12.95<br>12.95 |  | 24.3219-0803.3 | 020183 |     | Rz 19,05    |
|                     | 1.0 Fire<br>1.0 Turbo<br>1.1 Fire<br>1.3 Fire                            |  |  | 06.85<br>06.85<br>01.90<br>02.89                   | 12.92<br>12.92<br>12.92<br>12.92                   |  | 24.3727-0519.2 | 580519 | 1 ↓ | L=2385      |
|                     | 1.0 Fire 4WD<br>1.1 4WD  |  |  | 12.86<br>01.90                                     | 12.95<br>12.95                                     |  | 24.3727-0503.2 | 580503 | 1 ↓ | L=2670      |
|                     | 1.0 Fire<br>1.0 Fire 4WD<br>1.0 Turbo<br>1.1 4WD<br>1.1 Fire<br>1.3 Fire |  |  | 06.85<br>12.86<br>06.85<br>01.90<br>01.90<br>02.89 | 12.95<br>12.95<br>12.95<br>12.95<br>12.95<br>12.95 |  | 24.6513-0801.3 | 320117 |     | BRL 1/3 (2) |

| LANCIA Y (96-03) |   |                      |  |   |   |                                  |                                  |                  |  |                                  |                          |
|------------------|---|----------------------|--|---|---|----------------------------------|----------------------------------|------------------|--|----------------------------------|--------------------------|
|                  | 1.1 i<br>1.2 i<br>1.2 i 16V<br>1.2 i 16V<br>1.4 i |                      |  | 05.97<br>01.96<br>10.00<br>05.97<br>01.96 | 12.98<br>07.03<br>07.03<br>09.00<br>12.98 |                                  | 24.2120-1710.3                   | 010468           |  | THz 20,64                        |                          |
|                  | 1.1 i<br>1.2 i<br>1.2 i                           | 44<br>44<br>44       |  | 05.97<br>10.00<br>01.96                   | 12.98<br>07.03<br>09.00                   | - ABS                            | 24.3481-1743.5<br>24.3481-1744.5 | 240305<br>240306 | <input type="checkbox"/><br><input type="checkbox"/> | D=48, - Halter<br>D=48, - Halter | <b>BDX</b><br><b>BDX</b> |
|                  | 1.2 i<br>1.2 i 16V<br>1.2 i 16V<br>1.4 i          | 44<br>59<br>63<br>44 |  | 10.00<br>10.00<br>05.97<br>01.99          | 07.03<br>07.03<br>09.00<br>07.03          | + ABS                            | 24.3481-1751.5<br>24.3481-1752.5 | 240285<br>240286 | <input type="checkbox"/><br><input type="checkbox"/> | D=48, - Halter<br>D=48, - Halter | <b>BDX</b><br><b>BDX</b> |
|                  | 1.1 i<br>1.2 i<br>1.2 i<br>1.2 i<br>1.4 i         |                      |  | 05.97<br>10.00<br>01.96                   | 12.98<br>07.03<br>09.00                   | - ABS                            | 24.5112-0376.3<br>24.5112-0370.3 | 330514<br>330515 | <input type="checkbox"/><br><input type="checkbox"/> | L=362<br>L=372                   |                          |
|                  | 1.2 i<br>1.2 i 16V<br>1.2 i 16V<br>1.4 i          | 44<br>44<br>59<br>63 |  | 10.00<br>10.00<br>05.97<br>01.96          | 07.03<br>07.03<br>09.00<br>12.98          | + ABS                            | 24.5112-0395.3<br>24.5112-0396.3 | 330521<br>330520 | <input type="checkbox"/><br><input type="checkbox"/> | L=395<br>L=397                   |                          |
|                  | 1.1 i<br>1.2 i<br>1.2 i 16V<br>1.2 i 16V<br>1.4 i | 44<br>44<br>59<br>63 |  | 05.97<br>01.96<br>10.00<br>05.97<br>01.96 | 12.98<br>07.03<br>07.03<br>09.00<br>12.98 |                                  | 24.3220-1108.3<br>24.3220-1107.3 | 020219<br>020218 |  | Rz 20,64<br>Rz 20,64             | <b>BDX</b><br><b>AP</b>  |
|                  | 1.1 i<br>1.2 i<br>1.2 i 16V<br>1.2 i 16V<br>1.4 i | 44<br>59<br>63       |  | 05.97<br>01.96<br>10.00<br>05.97<br>01.96 | 12.98<br>07.03<br>07.03<br>09.00<br>12.98 |                                  | 24.3727-0534.2<br>24.3727-0533.2 | 580534<br>580533 | <input type="checkbox"/><br><input type="checkbox"/> | L=1392<br>L=1414                 |                          |
|                  | 1.1 i<br>1.2 i<br>1.2 i 16V<br>1.2 i 16V<br>1.4 i | 44<br>44<br>59<br>63 |  | 05.97<br>01.96<br>10.00<br>05.97<br>01.96 | 12.98<br>07.03<br>07.03<br>09.00<br>12.98 | - ABS<br>- ABS<br>- ABS<br>- ABS | 24.6513-1705.3                   | 320237           | <input type="checkbox"/>                             | BRL (2)                          |                          |
|                  | 1.1 i<br>1.2 i<br>1.2 i 16V<br>1.2 i 16V<br>1.4 i | 44<br>59<br>63       |  | 05.97<br>01.96<br>10.00<br>05.97<br>01.96 | 12.98<br>07.03<br>07.03<br>09.00<br>12.98 |                                  | 24.3728-0516.2                   | 590516           |  | L=856                            |                          |

| LANCIA YPSILON (03-11) |  |  |  |   |  |  |  |                            |  |  |  |
|------------------------|--|--|--|---|--|--|--|----------------------------|--|--|--|
|                        | 1.2 i<br>1.2 i 16V<br>1.3 JTD<br>1.3 JTD<br>1.3 JTD<br>1.3 JTD<br>1.4 i<br>1.4 i 16V                   | 44<br>59<br>51<br>55<br>66<br>77<br>57<br>70             |  | 06.03<br>06.03<br>06.03<br>10.06<br>10.06<br>07.07<br>02.06<br>06.03          | 06.11<br>06.11<br>06.11<br>06.11<br>06.11<br>06.11<br>06.11<br>06.11                   |  | 24.2120-1745.3                                     | 010834                     |  | THz 20,64                                      |  |
|                        | 1.2 i<br>1.4 i<br>1.2 i<br>1.4 i<br>1.2 i 16V<br>1.3 JTD<br>1.3 JTD<br>1.3 JTD<br>1.3 JTD<br>1.4 i 16V | 44<br>57<br>44<br>57<br>59<br>51<br>55<br>66<br>77<br>70 |  | 06.03<br>02.06<br>08.06<br>08.06<br>06.03<br>06.03<br>10.06<br>07.07<br>06.03 | 07.06<br>07.06<br>06.11<br>06.11<br>06.11<br>06.11<br>06.11<br>06.11<br>06.11<br>06.11 |  | 24.2122-1762.3<br>24.2122-1768.3                   | 010837<br>010853           | - Dynamic Control <sup>1)</sup><br>+ Dynamic Control <sup>2)</sup>               | THz 22,20<br>THz 22,20                         |  |
|                        | 1.2 i<br>1.4 i<br>1.2 i<br>1.4 i<br>1.2 i 16V<br>1.3 JTD<br>1.3 JTD<br>1.3 JTD<br>1.3 JTD<br>1.4 i 16V | 44<br>57<br>44<br>57<br>59<br>51<br>55<br>66<br>77<br>70 |  | 06.03<br>02.06<br>08.06<br>08.06<br>06.03<br>06.03<br>10.06<br>07.07<br>06.03 | 07.06<br>07.06<br>06.11<br>06.11<br>06.11<br>06.11<br>06.11<br>06.11<br>06.11<br>06.11 |  | 24.3481-1807.7<br>24.3481-1806.7                   | 220777<br>220766           | <input type="checkbox"/><br><input type="checkbox"/>                             | D=48, - Halter<br>D=48, - Halter               | <b>LUC</b><br><b>LUC</b>               |
|                        | 1.2 i<br>1.4 i<br>1.2 i 16V<br>1.3 JTD<br>1.3 JTD<br>1.3 JTD<br>1.3 JTD<br>1.4 i 16V                   | 44<br>57<br>59<br>51<br>55<br>66<br>77<br>70             |  | 08.06<br>08.06<br>06.03<br>06.03<br>10.06<br>07.07<br>06.03                   | 06.11<br>06.11<br>06.11<br>06.11<br>06.11<br>06.11<br>06.11<br>06.11                   |  | 24.3481-1805.7<br>24.3481-1806.7<br>24.0101-3802.2 | 220765<br>220766<br>260100 | <input type="checkbox"/><br><input type="checkbox"/><br><input type="checkbox"/> | D=48, - Halter<br>D=48, - Halter<br>Einbausatz | <b>LUC</b><br><b>LUC</b><br><b>LUC</b> |
|                        | 1.2 i 16V<br>1.3 JTD<br>1.3 JTD<br>1.3 JTD<br>1.3 JTD<br>1.4 i 16V                                     | 59<br>51<br>55<br>66<br>77<br>70                         |  | 06.03<br>06.03<br>10.06<br>07.07<br>06.03                                     | 06.11<br>06.11<br>06.11<br>06.11<br>06.11  |  | 24.3541-1833.5<br>24.3541-1834.5                   | 240403<br>240404           | <input type="checkbox"/><br><input type="checkbox"/>                             | D=54, - Halter<br>D=54, - Halter               | <b>LUC</b><br><b>LUC</b>               |

<sup>1)</sup> - dynamic control / - dynamic control / - dynamic control / - Control dinámico  
<sup>2)</sup> + dynamic control / + dynamic control / + dynamic control / + Control dinámico



| <b>LANCIA YPSILON (03-11)</b> |                |    |       |       |                |                |        |   |  |  |  |  |  |  |  |  |  |  |                |                |                |
|-------------------------------|----------------|----|-------|-------|----------------|----------------|--------|---|--|--|--|--|--|--|--|--|--|--|----------------|----------------|----------------|
|                               | 1.2 i          | 44 |       | 06.03 | 06.11          | 24.5119-0447.3 | 330990 | 2 |  |  |  |  |  |  |  |  |  |  | L=447          |                |                |
|                               | 1.2 i 16V      | 59 |       | 06.03 | 06.11          |                |        |   |  |  |  |  |  |  |  |  |  |  |                |                |                |
|                               | 1.3 JTD        | 51 |       | 06.03 | 06.11          |                |        |   |  |  |  |  |  |  |  |  |  |  |                |                |                |
|                               | 1.3 JTD        | 55 |       | 10.06 | 06.11          |                |        |   |  |  |  |  |  |  |  |  |  |  |                |                |                |
|                               | 1.3 JTD        | 66 |       | 10.06 | 06.11          |                |        |   |  |  |  |  |  |  |  |  |  |  |                |                |                |
|                               | 1.3 JTD        | 77 |       | 07.07 | 06.11          |                |        |   |  |  |  |  |  |  |  |  |  |  |                |                |                |
|                               | 1.4 i          | 57 |       | 02.06 | 06.11          |                |        |   |  |  |  |  |  |  |  |  |  |  |                |                |                |
| 1.4 i 16V                     | 70             |    | 06.03 | 06.11 |                |                |        |   |  |  |  |  |  |  |  |  |  |  |                |                |                |
|                               | 1.2 i          | 44 |       | 06.03 | 06.11          | 83.7201-9173.3 | 330868 | 2 |  |  |  |  |  |  |  |  |  |  | L=173          |                |                |
|                               | 1.2 i 16V      | 59 |       | 06.03 | 06.11          |                |        |   |  |  |  |  |  |  |  |  |  |  |                |                |                |
|                               | 1.3 JTD        | 51 |       | 06.03 | 06.11          |                |        |   |  |  |  |  |  |  |  |  |  |  |                |                |                |
|                               | 1.3 JTD        | 55 |       | 10.06 | 06.11          |                |        |   |  |  |  |  |  |  |  |  |  |  |                |                |                |
|                               | 1.3 JTD        | 66 |       | 10.06 | 06.11          |                |        |   |  |  |  |  |  |  |  |  |  |  |                |                |                |
|                               | 1.3 JTD        | 77 |       | 07.07 | 06.11          |                |        |   |  |  |  |  |  |  |  |  |  |  |                |                |                |
|                               | 1.4 i          | 57 |       | 02.06 | 06.11          |                |        |   |  |  |  |  |  |  |  |  |  |  |                |                |                |
| 1.4 i 16V                     | 70             |    | 06.03 | 06.11 |                |                |        |   |  |  |  |  |  |  |  |  |  |  |                |                |                |
|                               | 1.2 i          | 44 |       | 06.03 | 06.11          | 24.3219-1756.3 | 020511 |   |  |  |  |  |  |  |  |  |  |  | Rz 19,05       |                |                |
|                               | 1.4 i          | 57 |       | 02.06 | 06.11          |                |        |   |  |  |  |  |  |  |  |  |  |  |                |                |                |
|                               | 1.2 i 16V      | 59 |       | 06.03 | 06.11          |                |        |   |  |  |  |  |  |  |  |  |  |  |                |                |                |
|                               | 1.3 JTD        | 51 |       | 06.03 | 06.11          |                |        |   |  |  |  |  |  |  |  |  |  |  |                |                |                |
|                               | 1.3 JTD        | 55 |       | 10.06 | 06.11          |                |        |   |  |  |  |  |  |  |  |  |  |  |                |                |                |
|                               | 1.3 JTD        | 66 |       | 10.06 | 06.11          |                |        |   |  |  |  |  |  |  |  |  |  |  |                |                |                |
|                               | 1.3 JTD        | 77 |       | 07.07 | 06.11          |                |        |   |  |  |  |  |  |  |  |  |  |  |                |                |                |
| 1.4 i 16V                     | 70             |    | 06.03 | 06.11 |                |                |        |   |  |  |  |  |  |  |  |  |  |  |                |                |                |
|                               | 1.2 i          | 44 |       | 06.03 | 06.11          | 24.3220-1727.3 | 020480 |   |  |  |  |  |  |  |  |  |  |  | Rz 20,64       |                |                |
|                               | 1.2 i 16V      | 59 |       | 06.03 | 06.11          |                |        |   |  |  |  |  |  |  |  |  |  |  |                |                |                |
|                               | 1.3 JTD        | 51 |       | 06.03 | 06.11          |                |        |   |  |  |  |  |  |  |  |  |  |  |                |                |                |
|                               | 1.3 JTD        | 55 |       | 10.06 | 06.11          |                |        |   |  |  |  |  |  |  |  |  |  |  |                |                |                |
|                               | 1.3 JTD        | 66 |       | 10.06 | 06.11          |                |        |   |  |  |  |  |  |  |  |  |  |  |                |                |                |
|                               | 1.3 JTD        | 77 |       | 07.07 | 06.11          |                |        |   |  |  |  |  |  |  |  |  |  |  |                |                |                |
|                               | 1.4 i 16V      | 70 |       | 06.03 | 06.11          |                |        |   |  |  |  |  |  |  |  |  |  |  |                |                |                |
|                               | 1.2 i          | 44 |       | 06.03 | 06.11          | 24.3727-3000.2 | 583000 | 2 |  |  |  |  |  |  |  |  |  |  | L=1430         |                |                |
|                               | 1.2 i 16V      | 59 |       | 06.03 | 06.11          |                |        |   |  |  |  |  |  |  |  |  |  |  |                |                |                |
|                               | 1.3 JTD        | 51 |       | 06.03 | 06.11          |                |        |   |  |  |  |  |  |  |  |  |  |  |                |                |                |
|                               | 1.3 JTD        | 55 |       | 10.06 | 06.11          |                |        |   |  |  |  |  |  |  |  |  |  |  |                |                |                |
|                               | 1.3 JTD        | 66 |       | 10.06 | 06.11          |                |        |   |  |  |  |  |  |  |  |  |  |  |                |                |                |
|                               | 1.3 JTD        | 77 |       | 07.07 | 06.11          |                |        |   |  |  |  |  |  |  |  |  |  |  |                |                |                |
|                               | 1.4 i          | 57 |       | 02.06 | 06.11          |                |        |   |  |  |  |  |  |  |  |  |  |  |                |                |                |
| 1.4 i 16V                     | 70             |    | 06.03 | 06.11 |                |                |        |   |  |  |  |  |  |  |  |  |  |  |                |                |                |
|                               | 1.2 i          | 44 |       | 06.03 | 06.11          | 24.2520-1705.3 | 040093 |   |  |  |  |  |  |  |  |  |  |  | Nz 20,64       |                |                |
|                               | 1.4 i          | 57 |       | 02.06 | 06.11          |                |        |   |  |  |  |  |  |  |  |  |  |  |                |                |                |
| <b>LANCIA YPSILON (11-)</b>   |                |    |       |       |                |                |        |   |  |  |  |  |  |  |  |  |  |  |                |                |                |
|                               | 1.2            | 51 |       | 07.11 |                | 11.9541-9831.2 | 220953 |   |  |  |  |  |  |  |  |  |  |  | D=54, - Halter | ATE            |                |
|                               | 1.2 Bifuel     | 49 |       | 07.11 |                |                |        |   |  |  |  |  |  |  |  |  |  |  |                |                | 11.9541-9832.2 |
|                               | 0.9            | 63 |       | 07.11 |                | 24.5112-0356.3 | 331129 | 2 |  |  |  |  |  |  |  |  |  |  |                | L=355          |                |
|                               | 1.2            | 51 |       | 07.11 |                |                |        |   |  |  |  |  |  |  |  |  |  |  |                |                |                |
|                               | 1.2 Bifuel     | 49 |       | 07.11 |                |                |        |   |  |  |  |  |  |  |  |  |  |  |                |                |                |
|                               | 1.3 D Multijet | 70 |       | 07.11 |                |                |        |   |  |  |  |  |  |  |  |  |  |  |                |                |                |
|                               | 0.9            | 63 |       | 07.11 |                | 24.3220-1728.3 | 020509 |   |  |  |  |  |  |  |  |  |  |  |                | Rz 20,64       |                |
|                               | 1.2            | 51 |       | 07.11 |                |                |        |   |  |  |  |  |  |  |  |  |  |  |                |                |                |
|                               | 1.2 Bifuel     | 49 |       | 07.11 |                |                |        |   |  |  |  |  |  |  |  |  |  |  |                |                |                |
|                               | 1.3 D Multijet | 70 |       | 07.11 |                |                |        |   |  |  |  |  |  |  |  |  |  |  |                |                |                |
| <b>LANCIA ZETA (94-02)</b>    |                |    |       |       |                |                |        |   |  |  |  |  |  |  |  |  |  |  |                |                |                |
|                               | 2.0 i.e. 16V   |    |       | 05.98 | 04.99          | 24.2123-1708.3 | 010493 |   |  |  |  |  |  |  |  |  |  |  |                | THz 23,81      |                |
|                               | 2.0 i.e. Turbo |    |       | 06.94 | 04.99          |                |        |   |  |  |  |  |  |  |  |  |  |  |                |                |                |
|                               | 2.1 TD         |    |       | 06.96 | 04.99          |                |        |   |  |  |  |  |  |  |  |  |  |  |                |                |                |
|                               | 2.0 i.e. 16V   |    |       | 05.99 | 09.02          | 24.2123-1733.3 | 010657 |   |  |  |  |  |  |  |  |  |  |  |                | THz 23,81      |                |
|                               | 2.0 i.e. Turbo |    |       | 05.99 | 09.02          |                |        |   |  |  |  |  |  |  |  |  |  |  |                |                |                |
|                               | 2.0 JTD        |    |       | 05.99 | 09.02          |                |        |   |  |  |  |  |  |  |  |  |  |  |                |                |                |
|                               | 2.1 TD         |    |       | 05.99 | 09.99          |                |        |   |  |  |  |  |  |  |  |  |  |  |                |                |                |
|                               | 2.0 i.e. 16V   |    |       | 05.98 | 09.02          | 24.3571-1709.5 | 240153 |   |  |  |  |  |  |  |  |  |  |  | D=57, - Halter | LUC            |                |
|                               | 2.0 i.e. Turbo |    |       | 06.94 | 09.02          |                |        |   |  |  |  |  |  |  |  |  |  |  |                |                |                |
|                               | 2.0 JTD        |    |       | 09.99 | 09.02          |                |        |   |  |  |  |  |  |  |  |  |  |  |                |                |                |
|                               | 2.1 TD         |    |       | 06.96 | 09.99          |                |        |   |  |  |  |  |  |  |  |  |  |  |                |                |                |
|                               | 2.0 i.e. 16V   |    |       | 05.98 | 09.02          | 24.5118-0471.3 | 330528 | 2 |  |  |  |  |  |  |  |  |  |  |                | L=473          |                |
|                               | 2.0 i.e. Turbo |    |       | 06.94 | 09.02          |                |        |   |  |  |  |  |  |  |  |  |  |  |                |                |                |
|                               | 2.0 JTD        |    |       | 09.99 | 09.02          |                |        |   |  |  |  |  |  |  |  |  |  |  |                |                |                |
|                               | 2.1 TD         |    |       | 06.96 | 09.99          |                |        |   |  |  |  |  |  |  |  |  |  |  |                |                |                |
|                               | 2.0 i.e. 16V   |    |       | 05.98 | 09.02 + ABS    | 11.3361-9975.2 | 220281 |   |  |  |  |  |  |  |  |  |  |  |                | D=36, - Halter | ATE            |
|                               | 2.0 i.e. Turbo |    |       | 06.94 | 09.02          |                |        |   |  |  |  |  |  |  |  |  |  |  |                |                |                |
|                               | 2.0 JTD        |    |       | 09.99 | 09.02 + ABS    |                |        |   |  |  |  |  |  |  |  |  |  |  |                |                |                |
|                               | 2.1 TD         |    |       | 06.96 | 09.99          |                |        |   |  |  |  |  |  |  |  |  |  |  |                |                |                |
|                               |                |    |       |       |                |                |        |   |  |  |  |  |  |  |  |  |  |  |                |                |                |
|                               |                |    |       |       | 11.0101-5407.2 | 260011         |        |   |  |  |  |  |  |  |  |  |  |  |                |                |                |
|                               |                |    |       |       | 11.8171-0008.1 | 990049         |        |   |  |  |  |  |  |  |  |  |  |  |                |                |                |
|                               |                |    |       |       | 11.8116-0073.1 | 390498         |        |   |  |  |  |  |  |  |  |  |  |  |                |                |                |
|                               |                |    |       |       | 24.3361-9975.5 | 240541         |        |   |  |  |  |  |  |  |  |  |  |  |                |                |                |
|                               |                |    |       |       | 24.3361-9976.5 | 240542         |        |   |  |  |  |  |  |  |  |  |  |  |                |                |                |
|                               | 2.0 i.e. 16V   |    |       | 05.98 | 09.02          | 24.5229-0251.3 | 330535 | 2 |  |  |  |  |  |  |  |  |  |  |                | L=250          |                |
|                               | 2.0 i.e. Turbo |    |       | 06.94 | 09.02          |                |        |   |  |  |  |  |  |  |  |  |  |  |                |                |                |
|                               | 2.0 JTD        |    |       | 09.99 | 09.02          |                |        |   |  |  |  |  |  |  |  |  |  |  |                |                |                |
|                               | 2.1 TD         |    |       | 06.96 | 09.99          |                |        |   |  |  |  |  |  |  |  |  |  |  |                |                |                |
|                               | 2.0 i.e. 16V   |    |       | 05.98 | 09.02 - ABS    | 24.3219-1704.3 | 020374 |   |  |  |  |  |  |  |  |  |  |  |                | Rz 19,05       |                |
|                               | 2.0 JTD        |    |       | 09.99 | 09.02 - ABS    |                |        |   |  |  |  |  |  |  |  |  |  |  |                |                |                |
|                               | 2.0 i.e. 16V   |    |       | 05.98 | 09.02          | 24.3727-0336.2 | 580336 | 1 |  |  |  |  |  |  |  |  |  |  |                | L=500          |                |
|                               | 2.0 i.e. Turbo |    |       | 06.94 | 09.02          |                |        |   |  |  |  |  |  |  |  |  |  |  |                |                |                |
|                               | 2.0 JTD        |    |       | 09.99 | 09.02          |                |        |   |  |  |  |  |  |  |  |  |  |  |                |                |                |
|                               | 2.1 TD         |    |       | 06.96 | 09.99          |                |        |   |  |  |  |  |  |  |  |  |  |  |                |                |                |
|                               |                |    |       |       | 24.3727-0530.2 | 580530         |        |   |  |  |  |  |  |  |  |  |  |  |                |                |                |
|                               |                |    |       |       | 24.3727-0529.2 | 580529         |        |   |  |  |  |  |  |  |  |  |  |  |                |                |                |

1) notice length / attenzione lunghezza / faire attention longueur / atención largo

| LANCIA ZETA (94-02)                |                |          |          |       |                |                |        |                          |                          |        |                |     |
|------------------------------------|----------------|----------|----------|-------|----------------|----------------|--------|--------------------------|--------------------------|--------|----------------|-----|
|                                    | 2.0 i.e. Turbo |          |          | 06.94 | 09.02          | 24.3728-0342.2 | 590342 |                          |                          |        | L=863, + AUT   |     |
|                                    | 2.0 JTD        |          |          | 09.99 | 09.02          |                |        |                          |                          |        |                |     |
|                                    | 2.0 i.e. 16V   |          |          | 05.98 | 09.02          | 24.3728-0336.2 | 590336 |                          |                          |        | L=973, + AUT   |     |
|                                    | 2.1 TD         |          |          | 06.96 | 09.99          | 24.3728-0340.2 | 590340 |                          |                          |        | L=1088, + AUT  |     |
| LAND ROVER DISCOVERY I (89-98)     |                |          |          |       |                |                |        |                          |                          |        |                |     |
|                                    | 2.0 16V        | 99       | LA061991 | 09.93 |                | 24.2125-1710.3 | 010559 |                          | -ABS                     |        | Thz 25,40      |     |
|                                    | 2.5 D 4x4      | 90       | LA061991 | 07.94 |                |                |        |                          |                          |        |                |     |
|                                    | 2.5 TDI        | 83       | LA061991 | 09.89 |                |                |        |                          |                          |        |                |     |
|                                    | 3.5 V8         | 113      | LA061991 | 09.89 |                |                |        |                          |                          |        |                |     |
|                                    | 3.9 V8         | 134      | LA061991 | 09.93 |                |                |        |                          |                          |        |                |     |
| 3.9 V8                             | 136            | LA061991 | 07.94    |       |                |                |        |                          |                          |        |                |     |
|                                    | 2.0 16V        | 99       | KA034314 |       | 10.98          | 24.5297-0385.3 | 331047 | 2                        |                          |        | L=385          |     |
|                                    | 2.5 D 4x4      | 90       | KA034314 |       | 10.98          |                |        |                          |                          |        |                |     |
|                                    | 2.5 TDI        | 83       | KA034314 |       | 10.98          |                |        |                          |                          |        |                |     |
|                                    | 3.5 V8         | 113      | KA034314 |       | 06.94          |                |        |                          |                          |        |                |     |
|                                    | 3.9 V8         | 134      |          | 09.93 | 10.98          | 24.5226-0489.3 | 331049 |                          | <input type="checkbox"/> |        | L=489          |     |
| 3.9 V8                             | 136            |          | 07.94    | 10.98 | 24.5226-0485.3 | 331048         |        | <input type="checkbox"/> |                          | L=485  |                |     |
| LAND ROVER DISCOVERY II (94-04)    |                |          |          |       |                |                |        |                          |                          |        |                |     |
|                                    | 2.0 16V        | 99       | LA061991 | 01.94 |                | 24.2125-1710.3 | 010559 |                          | -ABS                     |        | Thz 25,40      |     |
|                                    | 2.0 16V        | 99       | KA034314 |       | 11.98          | 24.5297-0385.3 | 331047 | 2                        |                          |        | L=385          |     |
|                                    | 2.5 Td5        | 102      |          | 01.99 | 06.04          | 24.5226-0485.3 | 331048 |                          | <input type="checkbox"/> |        | L=485          |     |
|                                    | 4.0 V8         | 136      |          | 11.98 | 06.04          | 24.5226-0489.3 | 331049 |                          | <input type="checkbox"/> |        | L=489          |     |
| LAND ROVER FREELANDER (LN) (98-06) |                |          |          |       |                |                |        |                          |                          |        |                |     |
|                                    | 1.8 i 16V      | 86       | 1A000001 |       | 10.06          | 24.3571-1753.7 | 220789 |                          | <input type="checkbox"/> |        | D=57, - Halter | LUC |
|                                    | 2.0 TD4        | 80       | 1A000001 |       | 10.06          | 24.3571-1754.7 | 220790 |                          | <input type="checkbox"/> |        | D=57, - Halter | LUC |
|                                    | 2.0 TD4        | 82       | 1A000001 |       | 10.06          |                |        |                          |                          |        |                |     |
|                                    | 2.5 V6         | 130      | 1A000001 |       | 10.06          |                |        |                          |                          |        |                |     |
|                                    | 1.8 i 16V      | 86       | 2A393451 |       | 10.06          | 24.5149-0431.3 | 330993 | 2                        |                          |        | L=431          |     |
|                                    | 1.8 i 16V      | 88       |          | 02.98 | 11.00          |                |        |                          |                          |        |                |     |
|                                    | 2.0 DI         | 72       |          | 02.98 | 11.00          |                |        |                          |                          |        |                |     |
|                                    | 2.0 TD4        | 80       | 2A393451 |       | 10.06          |                |        |                          |                          |        |                |     |
|                                    | 2.0 TD4        | 82       | 2A393451 |       | 10.06          |                |        |                          |                          |        |                |     |
| 2.5 V6                             | 130            | 2A393451 |          | 10.06 |                |                |        |                          |                          |        |                |     |
|                                    | 1.8 i 16V      | 86       | YA999999 | 11.00 |                | 24.3220-1112.3 | 020223 |                          |                          |        | Rz 20,64       |     |
|                                    | 1.8 i 16V      | 88       |          | 02.98 | 11.00          |                |        |                          |                          |        |                |     |
|                                    | 2.0 DI         | 72       |          | 02.98 | 11.00          |                |        |                          |                          |        |                |     |
|                                    | 2.0 TD4        | 80       | YA999999 | 11.01 |                |                |        |                          |                          |        |                |     |
|                                    | 2.0 TD4        | 82       | YA999999 | 11.00 |                |                |        |                          |                          |        |                |     |
| 2.5 V6                             | 130            | YA999999 | 11.00    |       |                |                |        |                          |                          |        |                |     |
|                                    | 1.8 i 16V      | 86       | 1A000001 |       | 10.06          | 24.3219-1746.3 | 020497 |                          |                          |        | Rz 19,05       |     |
|                                    | 2.0 TD4        | 80       | 1A000001 |       | 10.06          |                |        |                          |                          |        |                |     |
|                                    | 2.0 TD4        | 82       | 1A000001 |       | 10.06          |                |        |                          |                          |        |                |     |
|                                    | 2.5 V6         | 130      | 1A000001 |       | 10.06          |                |        |                          |                          |        |                |     |
|                                    | 1.8 i 16V      | 86       | YA999999 | 11.00 |                | 24.3727-3300.2 | 583300 |                          | <input type="checkbox"/> |        | L=1568         |     |
|                                    | 1.8 i 16V      | 88       |          | 02.98 | 11.00          | 24.3727-3301.2 | 583301 |                          | <input type="checkbox"/> |        | L=1568         |     |
|                                    | 2.0 DI         | 72       |          | 02.98 | 11.00          |                |        |                          |                          |        |                |     |
|                                    | 2.0 TD4        | 80       | YA999999 | 11.01 |                |                |        |                          |                          |        |                |     |
|                                    | 2.0 TD4        | 82       | YA999999 | 11.00 |                |                |        |                          |                          |        |                |     |
| 2.5 V6                             | 130            | YA999999 | 11.00    |       |                |                |        |                          |                          |        |                |     |
| LAND ROVER FREELANDER 2 (FA) (07-) |                |          |          |       |                |                |        |                          |                          |        |                |     |
|                                    | 2.2 SD4        | 140      |          | 08.10 |                | 03.7755-1232.4 | 300260 |                          |                          |        | 9/8" Tandem    | ATE |
|                                    | 2.2 TD4        | 110      |          | 08.10 |                |                |        |                          |                          |        |                |     |
|                                    | 2.2 TD4        | 112      |          | 01.07 |                |                |        |                          |                          |        |                |     |
|                                    | 2.2 TD4        | 118      |          | 10.06 |                |                |        |                          |                          |        |                |     |
|                                    | 2.2 TD4 4x4    | 110      |          | 10.06 |                |                |        |                          |                          |        |                |     |
|                                    | 2.2 TD4 4x4    | 115      |          | 10.06 |                |                |        |                          |                          |        |                |     |
|                                    | 3.2            | 171      |          | 01.07 |                |                |        |                          |                          |        |                |     |
|                                    | 2.2 SD4        | 140      |          | 08.10 |                | 11.9601-9711.2 | 220873 |                          | <input type="checkbox"/> |        | D=60, - Halter | ATE |
|                                    | 2.2 TD4        | 110      |          | 08.10 |                | 11.9601-9712.2 | 220874 |                          | <input type="checkbox"/> |        | D=60, - Halter | ATE |
|                                    | 2.2 TD4        | 112      |          | 01.07 |                | 11.8116-0206.1 | 390593 | 2                        |                          |        | Haltefeder     | ATE |
|                                    | 2.2 TD4        | 118      |          | 10.06 |                | 11.0101-5407.2 | 260011 |                          |                          |        | Hülzensatz     | ATE |
|                                    | 2.2 TD4 4x4    | 110      |          | 10.06 |                | 11.8171-0008.1 | 990049 |                          |                          |        | Führungsbolzen | ATE |
|                                    | 2.2 TD4 4x4    | 115      |          | 10.06 |                |                |        |                          |                          |        |                |     |
|                                    | 3.2            | 171      |          | 01.07 |                | 11.9601-9711.2 | 220873 |                          | <input type="checkbox"/> |        | D=60, - Halter | ATE |
|                                    | 2.2 SD4        | 140      |          | 08.10 |                | 11.9601-9712.2 | 220874 |                          | <input type="checkbox"/> |        | D=60, - Halter | ATE |
|                                    | 2.2 TD4        | 110      |          | 08.10 |                | 11.8116-0206.1 | 390593 | 2                        |                          |        | Haltefeder     | ATE |
|                                    | 2.2 TD4        | 112      |          | 01.07 |                | 11.0101-5407.2 | 260011 |                          |                          |        | Hülzensatz     | ATE |
|                                    | 2.2 TD4        | 118      |          | 10.06 |                | 11.8171-0008.1 | 990049 |                          |                          |        | Führungsbolzen | ATE |
|                                    | 2.2 TD4 4x4    | 110      |          | 10.06 |                |                |        |                          |                          |        |                |     |
|                                    | 2.2 TD4 4x4    | 115      |          | 10.06 |                |                |        |                          |                          |        |                |     |
|                                    | 3.2            | 171      |          | 01.07 |                | 24.3727-3303.2 | 583303 |                          | <input type="checkbox"/> |        | L=1578         |     |
|                                    |                |          |          |       |                | 583302         |        | <input type="checkbox"/> |                          | L=1573 |                |     |

| LAND ROVER RANGE ROVER II (LP) (94-02)    |                     |     |          |       |       |                                      |                |        |   |   |                          |
|---|---------------------|-----|----------|-------|-------|--------------------------------------|----------------|--------|---|---|--------------------------|
|   | 2.5 D               | 83  |          | 07.94 | 03.02 |                                      | 24.2125-1710.3 | 010559 |   |   | THz 25,40                |
|   | 2.5 TD              | 100 |          | 07.94 | 03.02 |                                      |                |        |   |   |                          |
|   | 3.9                 | 140 |          | 07.94 | 03.02 |                                      |                |        |   |   |                          |
|   | 4.0                 | 136 |          | 06.98 | 03.02 |                                      |                |        |   |   |                          |
|   | 4.6                 | 160 |          | 06.98 | 03.02 |                                      |                |        |   |   |                          |
|   | 4.6                 | 165 |          | 07.94 | 03.02 |                                      |                |        |   |   |                          |
| LAND ROVER RANGE ROVER III (LM) (02-12)   |                     |     |          |       |       |                                      |                |        |   |   |                          |
|   | 3.0 TD 6            | 130 | 5A999999 | 03.02 |       | - gepanzerte Fahrzeuge <sup>1)</sup> | 11.8116-0283.2 | 390609 | 2 |   | Haltefeder ATE           |
|   | 3.6 TD 8            | 200 | 5A999999 | 04.06 |       | - gepanzerte Fahrzeuge <sup>1)</sup> |                |        |   |   |                          |
|   | 4.2                 | 291 | 5A999999 | 05.05 |       | - gepanzerte Fahrzeuge <sup>1)</sup> |                |        |   |   |                          |
|   | 4.4                 | 210 | 5A999999 | 03.02 |       | - gepanzerte Fahrzeuge <sup>1)</sup> |                |        |   |   |                          |
|   | 4.4                 | 225 | 5A999999 | 05.05 |       | - gepanzerte Fahrzeuge <sup>1)</sup> |                |        |   |   |                          |
| LAND ROVER RANGE ROVER EVOQUE (SAL) (11-) |                     |     |          |       |       |                                      |                |        |   |   |                          |
|   | 2.0 16V             | 177 |          | 06.11 |       |                                      | 11.9601-9711.2 | 220873 |   |   | D=60, - Halter ATE       |
|   | 2.2 eD4             | 110 |          | 06.11 |       |                                      | 11.9601-9712.2 | 220874 |   |   | D=60, - Halter ATE       |
|   | 2.2 SD4             | 140 |          | 06.11 |       |                                      |                |        |   |   |                          |
|   | 2.2 TD4             | 110 |          | 06.11 |       |                                      |                |        |   |   |                          |
| LEXUS LX 470 (98-08)                      |                     |     |          |       |       |                                      |                |        |   |   |                          |
|   | 4.7 V8 4x4 (UZJ100) | 170 |          | 05.98 | 03.08 |                                      | 24.5235-0360.3 | 331058 |   |   | L=360                    |
|   | 4.7 V8 4x4 (UZJ100) | 173 |          | 09.01 | 03.08 |                                      |                |        |   |   |                          |
|   | 4.7 V8 4x4 (UZJ100) | 197 |          | 05.98 | 10.02 |                                      |                |        |   |   |                          |
|   | 4.7 V8 4x4 (UZJ100) | 202 |          | 08.02 | 03.08 |                                      |                |        |   |   |                          |
| MAZDA 121 (96-03)                         |                     |     |          |       |       |                                      |                |        |   |   |                          |
|   | 1.2 i 16V           | 55  |          | 03.96 | 01.00 | + Schaltgetriebe <sup>2)</sup>       | 11.3481-8513.2 | 220335 |   |   | D=48, - Halter ATE       |
|   | 1.3 i               |     |          | 03.96 | 01.00 |                                      | 11.3481-8514.2 | 220336 |   |   | D=48, - Halter ATE       |
|   | 1.8 D               | 44  |          | 03.96 | 01.00 |                                      | 11.0441-4805.2 | 250020 |   |   | Dichtungssatz ATE        |
|   |                     |     |          |       |       |                                      | 11.0230-0165.2 | 260073 |   |   | Haltersatz ATE           |
|   |                     |     |          |       |       |                                      | 11.0101-5407.2 | 260011 |   |   | Hülzensatz ATE           |
|   |                     |     |          |       |       |                                      | 11.8171-0008.1 | 990049 |   |   | Führungsbolzen ATE       |
|   |                     |     |          |       |       |                                      | 11.8116-0264.1 | 390594 | 2 |   | Haltefeder ATE           |
|   | 1.2 i 16V           | 55  |          | 03.96 | 01.00 | + Automatikgetriebe <sup>3)</sup>    | 11.3541-8529.2 | 220341 |   |   | D=54, - Halter ATE       |
|   |                     |     |          |       |       |                                      | 11.3541-8530.2 | 220342 |   |   | D=54, - Halter ATE       |
|   |                     |     |          |       |       |                                      | 11.0441-5402.2 | 250028 |   |   | Dichtungssatz ATE        |
|   |                     |     |          |       |       |                                      | 11.0101-5407.2 | 260011 |   |   | Hülzensatz ATE           |
|   |                     |     |          |       |       |                                      | 11.8171-0008.1 | 990049 |   |   | Führungsbolzen ATE       |
|   |                     |     |          |       |       |                                      | 11.8116-0264.1 | 390594 | 2 |   | Haltefeder ATE           |
|   | 1.2 i 16V           | 55  |          | 02.00 | 03.03 | - ABS                                | 11.3481-8515.2 | 220365 |   |   | D=48, - Halter ATE       |
|   | 1.3 i               |     |          | 02.00 | 03.03 | - ABS                                | 11.3481-8516.2 | 220366 |   |   | D=48, - Halter ATE       |
|   | 1.8 D               | 44  |          | 02.00 | 03.03 | - ABS                                | 24.3481-8515.5 | 240477 |   |   | D=48, - Halter ATE       |
|   |                     |     |          |       |       |                                      | 24.3481-8516.5 | 240478 |   |   | D=48, - Halter ATE       |
|   |                     |     |          |       |       |                                      | 11.0101-5407.2 | 260011 |   |   | Hülzensatz ATE           |
|   |                     |     |          |       |       |                                      | 11.8171-0008.1 | 990049 |   |   | Führungsbolzen ATE       |
|   |                     |     |          |       |       |                                      | 11.8116-0264.1 | 390594 | 2 |   | Haltefeder ATE           |
|   | 1.2 i 16V           | 55  |          | 02.00 | 03.03 | + ABS                                | 11.3541-8531.2 | 220367 |   |   | D=54, - Halter ATE       |
|   | 1.3 i               |     |          | 02.00 | 03.03 | + ABS                                | 11.3541-8532.2 | 220368 |   |   | D=54, - Halter ATE       |
|   | 1.8 D               | 44  |          | 02.00 | 03.03 | + ABS                                | 11.0101-5407.2 | 260011 |   |   | Hülzensatz ATE           |
|   |                     |     |          |       |       |                                      | 11.8171-0008.1 | 990049 |   |   | Führungsbolzen ATE       |
|   |                     |     |          |       |       |                                      | 11.8116-0264.1 | 390594 | 2 |   | Haltefeder ATE           |
|   | 1.2 i 16V           | 55  |          | 03.96 | 01.00 | + Schaltgetriebe <sup>2)</sup>       | 24.3217-1715.3 | 020463 |   | nur paarweise austauschen <sup>4)</sup> | Rz 17,78 LUC             |
|   | 1.3 i               |     |          | 03.96 | 01.00 |                                      |                |        |   |   |                          |
|   | 1.8 D               | 44  |          | 03.96 | 01.00 |                                      |                |        |   |   |                          |
|   | 1.2 i 16V           | 55  |          | 02.00 | 03.03 | + Schaltgetriebe <sup>2)</sup>       | 24.3219-1735.3 | 020464 |   |   | Rz 19,05                 |
|   | 1.3 i               |     |          | 02.00 | 03.03 |                                      |                |        |   |   |                          |
|   | 1.8 D               | 44  |          | 02.00 | 03.03 |                                      |                |        |   |   |                          |
|   | 1.2 i 16V           | 55  |          | 03.96 | 03.03 | + Automatikgetriebe <sup>3)</sup>    | 24.3219-1107.3 | 020338 |   | nur paarweise austauschen <sup>4)</sup> | Rz 19,05 LUC             |
|   | 1.2 i 16V           | 55  |          | 03.96 | 11.98 |                                      | 24.3727-1800.2 | 581800 | 1 | ↑                                       | L=312                    |
|   | 1.3 i               |     |          | 03.96 | 11.98 |                                      | 24.3727-0660.2 | 580660 | 1 | ↓                                       | L=1575/1627              |
|   | 1.8 D               | 44  |          | 03.96 | 11.98 |                                      |                |        |   |   |                          |
|   | 1.2 i 16V           | 55  |          | 12.98 | 03.03 |                                      | 24.3727-0660.2 | 580660 | 1 | ↓                                       | L=1575/1627              |
|   | 1.3 i               |     |          | 12.98 | 03.03 |                                      |                |        |   |   |                          |
|   | 1.8 D               | 44  |          | 12.98 | 03.03 |                                      |                |        |   |   |                          |
|   | 1.2 i 16V           | 55  |          | 03.96 | 08.98 |                                      | 24.2419-1734.3 | 030126 |   |   | Gz 19,05                 |
|   | 1.3 i               |     |          | 03.96 | 08.98 |                                      |                |        |   |   |                          |
|   | 1.8 D               | 44  |          | 03.96 | 08.98 |                                      |                |        |   |   |                          |
|   | 1.2 i 16V           | 55  |          | 09.98 | 03.03 |                                      | 24.2419-1736.3 | 030128 |   |   | Gz 19,05                 |
|   | 1.3 i               |     |          | 09.98 | 03.03 |                                      |                |        |   |   |                          |
|   | 1.8 D               | 44  |          | 09.98 | 03.03 |                                      |                |        |   |   |                          |
| MAZDA 2 (DY) (03-07)                      |                     |     |          |       |       |                                      |                |        |   |   |                          |
|   | 1.2 16V             | 55  |          | 04.03 | 09.07 | - ABS                                | 03.4153-0015.4 | 010784 |   |   | THz 23,81 + Behälter ATE |
|   | 1.25 16V            | 55  |          | 04.03 | 09.07 | - ABS                                |                |        |   |   |                          |
|   | 1.3 16V             | 67  |          | 04.03 | 09.07 | - ABS                                |                |        |   |   |                          |
|   | 1.4 16V             | 59  |          | 02.03 | 09.07 | - ABS                                |                |        |   |   |                          |
|   | 1.4 CD              | 50  |          | 04.03 | 09.07 | - ABS                                |                |        |   |   |                          |
|   | 1.6 16V             | 74  |          | 02.03 | 09.07 | - ABS                                |                |        |   |   |                          |
|   | 1.2 16V             | 55  |          | 04.03 | 09.07 | + ABS                                | 03.4153-0029.4 | 010786 |   |   | THz 23,81 + Behälter ATE |
|   | 1.25 16V            | 55  |          | 04.03 | 09.07 | + ABS                                |                |        |   |   |                          |
|   | 1.3 16V             | 67  |          | 04.03 | 09.07 | + ABS                                |                |        |   |   |                          |
|   | 1.4 16V             | 59  |          | 02.03 | 09.07 | + ABS                                |                |        |   |   |                          |
|   | 1.4 CD              | 50  |          | 04.03 | 09.07 | + ABS                                |                |        |   |   |                          |
|   | 1.6 16V             | 74  |          | 02.03 | 09.07 | + ABS                                |                |        |   |   |                          |
|   | 1.2 16V             | 55  |          | 06.04 | 09.07 | + ESP                                | 03.4153-0025.4 | 010785 |   |   | THz 23,81 + Behälter ATE |
|   | 1.25 16V            | 55  |          | 06.04 | 09.07 | + ESP                                |                |        |   |   |                          |

1) - armoured vehicles / - veicoli blindati / - véhicules blindés / - vehículo blindado

2) + manual transmission / + scatola cambio velocità / + transmission mécanique / + cambio de velocidad

3) + autom.transmission / + scatola cambio automatico / + transmission automatique / + cambio automático

4) to change only by pairs / sostituire solo a coppie / à changer seulement par paires / cambiar solamente por parejas



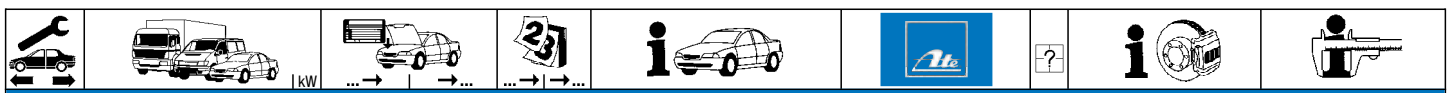

**MAZDA 2 (DY) (03-07)**

|  |  |                                  |  |  |  |  |  |      |        |  |                                 |
|--|--|----------------------------------|--|--|--|--|--|------|--------|--|---------------------------------|
|  | 1.3 16V<br>1.4 16V<br>1.4 CD<br>1.6 16V                        | 67<br>59<br>50<br>74             |  | 06.04<br>06.04<br>06.04<br>06.04                   | 09.07<br>09.07<br>+ ESP<br>+ ESP                   | 03.4153-0025.4   | 010785   |      |        | Thz 23,81 + Behälter   | ATE                             |
|  | 1.2 16V<br>1.25 16V<br>1.3 16V<br>1.4 16V<br>1.4 CD<br>1.6 16V | 55<br>55<br>67<br>59<br>50<br>74 |  | 04.03<br>04.03<br>04.03<br>02.03<br>04.03<br>02.03 | 09.07<br>09.07<br>09.07<br>09.07<br>09.07<br>09.07 | 11.3541-8531.2<br>11.3541-8532.2<br>11.0101-5407.2<br>11.8171-0008.1<br>11.8116-0356.1 | 220367<br>220368<br>260011<br>990049<br>390586 | <br> | 2      | D=54, - Halter<br>D=54, - Halter<br>Hülzensatz<br>Führungsbolzen<br>Haltefeder | ATE<br>ATE<br>ATE<br>ATE<br>ATE |
|  | 1.2 16V<br>1.25 16V<br>1.3 16V<br>1.4 16V<br>1.4 CD<br>1.6 16V | 55<br>55<br>67<br>59<br>50<br>74 |  | 04.03<br>04.03<br>04.03<br>02.03<br>04.03<br>02.03 | 09.07<br>09.07<br>09.07<br>09.07<br>09.07<br>09.07 | 24.5141-0472.3   | 330915   |      | 2      | L=470  |                                 |
|  | 1.2 16V<br>1.25 16V<br>1.3 16V<br>1.4 16V<br>1.4 CD<br>1.6 16V | 55<br>55<br>67<br>59<br>50<br>74 |  | 04.03<br>04.03<br>04.03<br>02.03<br>04.03<br>02.03 | 09.07<br>09.07<br>09.07<br>09.07<br>09.07<br>09.07 | 24.5271-0303.3   | 330938   |      | 2      | L=300  |                                 |
|  | 1.2 16V<br>1.25 16V<br>1.3 16V<br>1.4 16V<br>1.4 CD<br>1.6 16V | 55<br>55<br>67<br>59<br>50<br>74 |  | 04.03<br>04.03<br>04.03<br>02.03<br>04.03<br>02.03 | 09.07<br>09.07<br>09.07<br>09.07<br>09.07<br>09.07 | 24.3219-1735.3   | 020464   |      |        | Rz 19,05   |                                 |
|  | 1.2 16V<br>1.25 16V<br>1.3 16V<br>1.4 16V<br>1.4 CD<br>1.6 16V | 55<br>55<br>67<br>59<br>50<br>74 |  | 04.03<br>04.03<br>04.03<br>02.03<br>04.03<br>02.03 | 09.07<br>09.07<br>09.07<br>09.07<br>09.07<br>09.07 | 24.3727-0653.2<br>24.3727-0663.2   | 580653<br>580663                               | <br> | 1<br>2 | Verlängerung <sup>1)</sup>   | L=1305/1445<br>L=175            |
|  | 1.2 16V<br>1.25 16V<br>1.3 16V<br>1.4 16V<br>1.4 CD<br>1.6 16V | 55<br>55<br>67<br>59<br>50<br>74 |  | 04.03<br>04.03<br>04.03<br>02.03<br>04.03<br>02.03 | 09.07<br>09.07<br>09.07<br>09.07<br>09.07<br>09.07 | 24.2419-1735.3   | 030127   |      |        | Gz 19,05   |                                 |

**MAZDA 2 (DE) (07-)**





















|  |   |  |  |  |  |                                  |                  |      |   |                |  |
|--|---|--|--|--|--|----------------------------------|------------------|------|---|----------------|--|
|  | 1.3 16V<br>1.3 16V<br>1.3 MZR<br>1.4 MZR-CD<br>1.5 16V<br>1.5 MZR<br>1.6 MZ-CD<br>1.6 MZ-CD | 55<br>63<br>62<br>50<br>76<br>75<br>66<br>70 |  | 10.07<br>10.07<br>01.10<br>01.08<br>10.07<br>06.11<br>10.08<br>06.11 |  | 24.5265-0365.3<br>24.5265-0366.3 | 331159<br>331160 | <br> |   | L=365<br>L=365 |  |
|  | 1.3 16V<br>1.3 16V<br>1.3 MZR<br>1.4 MZR-CD<br>1.5 16V<br>1.5 MZR<br>1.6 MZ-CD<br>1.6 MZ-CD | 55<br>63<br>62<br>50<br>76<br>75<br>66<br>70 |  | 10.07<br>10.07<br>01.10<br>01.08<br>10.07<br>06.11<br>10.08<br>06.11 |  | 24.5285-0265.3                   | 331184           |      | 2 | L=265          |  |
|  | 1.3 16V<br>1.3 16V<br>1.3 MZR<br>1.4 MZR-CD<br>1.5 16V<br>1.5 MZR<br>1.6 MZ-CD<br>1.6 MZ-CD | 55<br>63<br>62<br>50<br>76<br>75<br>66<br>70 |  | 10.07<br>10.07<br>01.10<br>01.08<br>10.07<br>06.11<br>10.08<br>06.11 |  | 24.3219-1752.3                   | 020505           |      |   | Rz 19,05       |  |

**MAZDA 3 (BK) (03-09)**

|  |   |   |  |   |   |  |  |                                  |  |  |  |
|--|---|---|--|---|---|--|--|----------------------------------|--|--|--|
|  | 1.4 i 16V<br>1.4 i 16V<br>1.6 CiTD<br>1.6 i 16V<br>2.0 i 16V<br>2.0 MZR-CD<br>2.3 i 16V<br>2.3 i 16V Sport            | 59<br>62<br>80<br>77<br>110<br>105<br>118<br>126        |  | 10.03<br>10.03<br>06.04<br>10.03<br>10.03<br>12.06<br>10.03<br>10.03          | 05.09<br>03.06<br>05.09<br>05.09<br>05.09<br>05.09<br>09.04<br>05.09          | 03.2125-0483.3   | 010783   |                                  |  | Thz 25,40  | ATE  |
|  | 1.4 i 16V<br>1.4 i 16V<br>1.6 CiTD<br>1.6 i 16V<br>2.0 i 16V<br>2.0 MZR-CD<br>2.3 i 16V<br>2.3 i 16V Sport<br>2.3 MPS | 59<br>62<br>80<br>77<br>110<br>105<br>118<br>126<br>191 |  | 10.03<br>10.03<br>06.04<br>10.03<br>10.03<br>12.06<br>10.03<br>10.03<br>12.06 | 05.09<br>03.06<br>05.09<br>05.09<br>05.09<br>05.09<br>09.04<br>05.09<br>05.09 | 11.9571-9785.2<br>11.9571-9786.2<br>11.0101-5407.2<br>11.8171-0008.1<br>11.8116-0356.1<br>11.9571-9785.2<br>11.9571-9786.2<br>11.0101-5407.2<br>11.8171-0008.1<br>11.8116-0356.1 | 220595<br>220596<br>260011<br>990049<br>390586<br>220595<br>220596<br>260011<br>990049<br>390586 | <br><br><br><br><br><br><br><br> | 2<br><br><br><br><br><br><br><br><br><br>2 | D=57, - Halter<br>D=57, - Halter<br>Hülzensatz<br>Führungsbolzen<br>Haltefeder<br>D=57, - Halter<br>D=57, - Halter<br>Hülzensatz<br>Führungsbolzen<br>Haltefeder | ATE<br>ATE<br>ATE<br>ATE<br>ATE<br>ATE<br>ATE<br>ATE<br>ATE<br>ATE |

<sup>1)</sup> extension only / solo prolonga / rallonge seulement / solamente prolongador



|     |  |  |  |  |  |  |  |                                 |
|--|--|--|--|--|---|--|--|---|
| <b>MAZDA 3 (BK) (03-09)</b>  |  |  |  |  |   |  |  |   |
|    | 1.4 i 16V  | 59   | 10.03  | 05.09  | 11.9387-7015.2  | 220627   | 2  | D=38, - Halter<br>ATE<br>D=38, - Halter<br>ATE<br>Hülzensatz<br>ATE<br>Führungsbolzen<br>ATE<br>Haltefeder<br>ATE |
|  | 1.4 i 16V  | 62   | 10.03  | 03.06  | 11.9387-7016.2  | 220628   |  |   |
|  | 1.6 CiTD   | 80   | 06.04  | 05.09  | 11.0101-5407.2  | 260011   |  |   |
|  | 1.6 i 16V  | 77   | 10.03  | 05.09  | 11.8171-0008.1  | 990049   |  |   |
|  |  |  |  |  | 11.8116-0340.1  | 390595   |  |   |
|  | 2.0 i 16V  | 110  | 10.03  | 05.09  | 11.9387-7015.2  | 220627   |  |   |
|  | 2.0 MZR-CD   | 105  | 12.06  | 05.09  | 11.9387-7016.2  | 220628   |  |   |
|  | 2.3 i 16V  | 118  | 10.03  | 09.04  | 11.0230-0698.2  | 260091   |  |   |
|  | 2.3 i 16V Sport  | 126  | 10.03  | 05.09  | 11.0101-5407.2  | 260011   |  |   |
|  | 2.3 MPS  | 191  | 12.06  | 05.09  | 11.8171-0008.1  | 990049   |  |   |
|  |  |  |  | 11.8116-0340.1   | 390595  |  |  |   |
|    | 1.4 i 16V  | 59   | 10.03  | 05.09  | 83.7788-0383.3  | 330972   | 2  | L=382   |
|  | 1.4 i 16V  | 62   | 10.03  | 03.06  |   |  |  |   |
|  | 1.6 CiTD   | 80   | 06.04  | 05.09  |   |  |  |   |
|  | 1.6 i 16V  | 77   | 10.03  | 05.09  |   |  |  |   |
|  | 2.0 i 16V  | 110  | 10.03  | 05.09  |   |  |  |   |
|  | 2.0 MZR-CD   | 105  | 12.06  | 05.09  |   |  |  |   |
|  | 2.3 i 16V  | 118  | 10.03  | 09.04  |   |  |  |   |
|  | 2.3 i 16V Sport  | 126  | 10.03  | 05.09  |   |  |  |   |
|  | 2.3 MPS  | 191  | 12.06  | 05.09  |   |  |  |   |
|  |  |  |  |  |   |  |  |   |
|    | 1.4 i 16V  | 59   | 10.03  | 05.09  | 24.3727-1813.2  | 581813   | 2  | L=345<br>L=1831<br>L=1875   |
|  | 1.4 i 16V  | 62   | 10.03  | 03.06  | 24.3727-1815.2  | 581815   |  |   |
|  | 1.6 CiTD   | 80   | 06.04  | 05.09  | 24.3727-1814.2  | 581814   |  |   |
|  | 1.6 i 16V  | 77   | 10.03  | 05.09  |   |  |  |   |
|  | 2.0 i 16V  | 110  | 10.03  | 05.09  |   |  |  |   |
|  | 2.0 MZR-CD   | 105  | 12.06  | 05.09  |   |  |  |   |
|  | 2.3 i 16V  | 118  | 10.03  | 09.04  |   |  |  |   |
|  | 2.3 i 16V Sport  | 126  | 10.03  | 05.09  |   |  |  |   |
|  | 2.3 MPS  | 191  | 12.06  | 05.09  |   |  |  |   |
|  |  |  |  |  |   |  |  |   |
| <b>MAZDA 3 (BL) (09-)</b>  |  |  |  |  |   |  |  |   |
|    | 1.6 MZR  | 77   | 06.09  |  | 03.2125-0483.3  | 010783   | 2  | Thz 25,40<br>ATE  |
|  | 1.6 MZR-CD   | 80   | 06.09  |  |   |  |  |   |
|  | 1.6 MZR-CD   | 85   | 11.10  |  |   |  |  |   |
|  | 2.0 MZR  | 110  | 06.09  |  |   |  |  |   |
|  | 2.0 MZR DISI   | 111  | 06.09  |  |   |  |  |   |
|  | 2.2 MZR-CD   | 110  | 06.09  |  |   |  |  |   |
|  | 2.2 MZR-CD   | 136  | 06.09  |  |   |  |  |   |
|   | 1.6 MZR  | 77   | 06.09  |  | 11.9571-9785.2  | 220595   | 2  | D=57, - Halter<br>ATE<br>D=57, - Halter<br>ATE  |
|  | 1.6 MZR-CD   | 80   | 06.09  |  | 11.9571-9786.2  | 220596   |  |   |
|  | 1.6 MZR-CD   | 85   | 11.10  |  |   |  |  |   |
|  | 2.0 MZR  | 110  | 06.09  |  |   |  |  |   |
|  | 2.0 MZR DISI   | 111  | 06.09  |  |   |  |  |   |
|  | 2.2 MZR-CD   | 110  | 06.09  |  | 11.9571-9785.2  | 220595   |  |   |
|  | 2.2 MZR-CD   | 136  | 06.09  |  | 11.9571-9786.2  | 220596   |  |   |
|  | 1.6 MZR  | 77   | 06.09  |  | 83.7788-0383.3  | 330972   | 2  | L=382   |
|  | 1.6 MZR-CD   | 80   | 06.09  |  |   |  |  |   |
|  | 1.6 MZR-CD   | 85   | 11.10  |  |   |  |  |   |
|  | 2.0 MZR  | 110  | 06.09  |  |   |  |  |   |
|  | 2.0 MZR DISI   | 111  | 06.09  |  |   |  |  |   |
|  | 2.2 MZR-CD   | 110  | 06.09  |  |   |  |  |   |
|  | 2.2 MZR-CD   | 136  | 06.09  |  |   |  |  |   |
| 2.3 MPS Turbo  | 191  | 06.09  |  |  |   |  |  |   |
|  |  |  |  |  |   |  |  |   |
| <b>MAZDA 323 Limousine/323 F (89-94)</b>   |  |  |  |  |   |  |  |   |
|  | 1.3 i (BG)   |  | 09.89  | 12.94  | 24.3217-1120.3  | 020360   | 2  | Rz 17,46  |
|  | 1.6 i (BG)   |  | 09.89  | 12.94  |   |  |  |   |
|  | 1.7 D (BG)   |  | 09.89  | 12.94  |   |  |  |   |
|  | 1.8 i 16V (BG)   |  | 09.89  | 12.94  |   |  |  |   |
|  | 1.3 i (BG)   |  | 09.89  | 12.94  | 24.3727-1811.2  | 581811   | 2  | L=1503<br>L=1466  |
|  | 1.3 i (BG)   |  | 09.89  | 12.94  | 24.3727-1810.2  | 581810   |  |   |
|  | 1.6 i (BG)   |  | 09.89  | 12.94  |   |  |  |   |
|  | 1.6 i (BG)   |  | 09.89  | 12.94  |   |  |  |   |
|  | 1.7 D (BG)   |  | 09.89  | 12.94  |   |  |  |   |
|  | 1.7 D (BG)   |  | 09.89  | 12.94  |   |  |  |   |
|  | 1.8 i 16V (BG)   |  | 09.89  | 12.94  |   |  |  |   |
|  | 1.8 i 16V (BG)   |  | 09.89  | 12.94  |   |  |  |   |
| <b>MAZDA 323 Limousine/323 C/323 F/323 S (94-98)</b>                               |  |  |  |  |   |  |  |   |
|  | 1.3 i 16V (BA1)  |  | 05.94  | 08.98  | 24.0101-5102.2  | 260056   | 2  | Einbausatz<br>SUM   |
|  |  |  |  |  |   |  |  |   |
|  | 1.3 i 16V (BA1)  |  | 05.94  | 08.98  | 24.3219-1725.3  | 020429   | 2  | Rz 19,05<br>LUC   |
|  | 1.5 i 16V (BA1)  |  | 05.94  | 08.98  |   |  |  |   |
|  | 1.7 D (BA1)  |  | 05.94  | 08.98  |   |  |  |   |
|  | 1.8 i (BA1)  |  | 05.94  | 08.98  |   |  |  |   |
|  | 2.0 D  |  | 10.96  | 08.98  |   |  |  |   |
|  | 1.3 i 16V (BA1)  |  | 05.94  | 08.98  | 24.3727-1819.2  | 581819   | 2  | L=1553<br>L=1553  |
|  | 1.5 i 16V (BA1)  |  | 05.94  | 08.98  | 24.3727-1818.2  | 581818   |  |   |
|  | 1.8 i (BA1)  |  | 05.94  | 08.98  |   |  |  |   |
|  | 1.3 i 16V (BA1)  |  | 05.94  | 08.98  | 24.3727-1817.2  | 581817   |  |   |
|  | 1.5 i 16V (BA1)  |  | 05.94  | 08.98  | 24.3727-1816.2  | 581816   |  |   |
|  | 1.5 i 16V (BA1)  |  | 05.94  | 08.98  |   |  |  |   |
|  | 1.7 D (BA1)  |  | 05.94  | 08.98  |   |  |  |   |
| 1.8 i (BA1)  |  | 05.94  | 08.98  |  |   |  |  |   |
| 1.8 i (BA1)  |  | 05.94  | 08.98  |  |   |  |  |   |

























1) + RA drum brake/ + 5 door / + P freno a tamburo/ + 5 porte / + fr.à tambour essieu AR/ + 5 portes / + ET tambores de freno/ + 5 puertas

2) + RA drum brake/ + 4 door / + P freno a tamburo/ + 4 porte / + fr.à tambour essieu AR/ + 4 portes / + ET tambores de freno/ + 4 puertas

3) + 3 door / + 3 porte / + 3 portes / + 3 puertas





















4) + 4 door / + 4 porte / + 4 portes / + 4 puertas



























5) + 5 door / + 5 porte / + 5 portes / + 5 puertas





































|     |  |  |  |  |  |  |  |  |                         |
|--|--|--|--|--|---|--|--|--|-------------------------|
| <b>MAZDA 323 Limousine/323 C/323 F/323 S (94-98)</b>                               |  |  |  |  |   |  |  |  |                         |
|    | 2.0 D  |  |  | 10.96  | 08.98   | 24.3727-1817.2   | 581817   | <input type="checkbox"/>   | L=1653                  |
|  |  |  |  |  |   | 24.3727-1816.2   | 581816   | <input type="checkbox"/>   | L=1653                  |
| <b>MAZDA 323 Limousine/323 F/323 P/323 S (98-03)</b>                               |  |  |  |  |   |  |  |  |                         |
|    | 1.3 i 16V (BJ)   | 53   |  | 01.01  | 10.03   | 24.5288-0375.3   | 331012   | 2  | L=375                   |
|  | 1.3 i 16V (BJ)   | 54   |  | 08.98  | 12.00   |  |  |  |                         |
|  | 1.5 i 16V (BJ)   | 65   |  | 08.98  | 12.00   |  |  |  |                         |
|    | 1.6 i 16V (BJ)   | 70   |  | 01.01  | 10.03   | 24.3354-1701.5   | 240347   | <input type="checkbox"/>   | D=35, - Halter          |
|  | 1.6 i 16V (BJ)   | 72   |  | 01.01  | 10.03   | 24.3354-1702.5   | 240348   | <input type="checkbox"/>   | D=35, - Halter          |
|  | 1.8 i 16V (BJ)   | 84   |  | 08.98  | 12.00   |  |  |  | <b>AKE</b>              |
|  | 2.0 D (BJ)   | 52   |  | 08.98  | 12.00   |  |  |  | <b>AKE</b>              |
|  | 2.0 DiTD (BJ)  | 74   |  | 01.01  | 10.03   |  |  |  |                         |
|  | 2.0 i 16V (BJ)   | 96   |  | 01.01  | 10.03   |  |  |  |                         |
|  | 2.0 TD (BJ)  | 66   |  | 08.98  | 12.00   |  |  |  |                         |
|    | 1.3 i 16V (BJ)   | 53   |  | 01.01  | 10.03   | 24.3217-1716.3   | 020474   |  | Rz 17,46                |
|  | 1.3 i 16V (BJ)   | 54   |  | 08.98  | 12.00   |  |  |  |                         |
|  | 1.5 i 16V (BJ)   | 65   |  | 08.98  | 12.00   |  |  |  |                         |
|  | 2.0 TD (BJ)  | 66   |  | 08.98  | 12.00   |  |  |  |                         |
|    | 1.3 i 16V (BJ)   | 53   |  | 01.01  | 10.03   | 24.3727-1812.2   | 581812   | <input type="checkbox"/>   | L=252                   |
|  | 1.3 i 16V (BJ)   | 54   |  | 08.98  | 12.00   |  |  |  |                         |
|  | 1.5 i 16V (BJ)   | 65   |  | 08.98  | 12.00   |  |  |  |                         |
|  | 1.6 i 16V (BJ)   | 70   |  | 01.01  | 10.03   | 24.3727-1812.2   | 581812   | <input type="checkbox"/>   | L=252                   |
|  | 1.6 i 16V (BJ)   | 72   |  | 01.01  | 10.03   | 24.3727-1823.2   | 581823   | <input type="checkbox"/>   | L=1693                  |
|  | 1.8 i 16V (BJ)   | 84   |  | 08.98  | 12.00   | 24.3727-1824.2   | 581824   | <input type="checkbox"/>   | L=1715                  |
|  | 2.0 D (BJ)   | 52   |  | 08.98  | 12.00   |  |  |  |                         |
|  | 2.0 DiTD (BJ)  | 74   |  | 01.01  | 10.03   |  |  |  |                         |
|  | 2.0 i 16V (BJ)   | 96   |  | 01.01  | 10.03   |  |  |  |                         |
|  | 2.0 TD (BJ)  | 66   |  | 08.98  | 12.00   |  |  |  |                         |
| <b>MAZDA 323 Kombi (86-94)</b>   |  |  |  |  |   |  |  |  |                         |
|    | 1.5 (BW)   |  |  | 05.86  | 12.94   | 24.0101-5102.2   | 260056   |  | Einbausatz              |
|  | 1.6 i (BW)   |  |  | 05.86  | 12.94   |  |  |  | <b>SUM</b>              |
|  | 1.6 i 4x4 (BW)   |  |  | 09.89  | 12.94   |  |  |  |                         |
|  | 1.7 D (BW)   |  |  | 05.86  | 12.94   |  |  |  |                         |
|    | 1.5 (BW)   |  |  | 05.86  | 12.94   | 24.3217-1703.3   | 020380   |  | Rz 17,46                |
|  | 1.6 i (BW)   |  |  | 05.86  | 12.94   |  |  |  |                         |
|  | 1.7 D (BW)   |  |  | 05.86  | 12.94   |  |  |  |                         |
| <b>MAZDA 5 (CR) (05-10)</b>  |  |  |  |  |   |  |  |  |                         |
|  | 1.8 16V  | 85   |  | 03.05  | 05.10   | 03.4152-0020.3   | 010929   |  | Thz 22,20 + Behälter    |
|  | 2.0 16V  | 107  |  | 03.05  | 05.10   |  |  |  | <b>ATE</b>              |
|  | 2.0 CiTD   | 81   |  | 03.05  | 05.10   |  |  |  |                         |
|  | 2.0 CiTD   | 105  |  | 06.05  | 05.10   |  |  |  |                         |
|  | 1.8 16V  | 85   |  | 03.05  | 11.06   | 11.9571-9785.2   | 220595   | <input type="checkbox"/>   | D=57, - Halter          |
|  | 2.0 16V  | 107  |  | 03.05  | 11.06   | 11.9571-9786.2   | 220596   | <input type="checkbox"/>   | D=57, - Halter          |
|  | 2.0 CiTD   | 81   |  | 03.05  | 11.06   | 11.0101-5407.2   | 260011   |  | Hülzensatz              |
|  | 2.0 CiTD   | 105  |  | 06.05  | 11.06   | 11.8171-0008.1   | 990049   |  | Führungsbolzen          |
|  |  |  |  |  |   | 11.8116-0356.1   | 390586   | 2  | Haltefeder              |
|  | 1.8 16V  | 85   |  | 12.06  | 05.10   | 11.9571-9785.2   | 220595   | <input type="checkbox"/>   | D=57, - Halter          |
|  | 2.0 16V  | 107  |  | 12.06  | 05.10   | 11.9571-9786.2   | 220596   | <input type="checkbox"/>   | D=57, - Halter          |
|  | 2.0 CiTD   | 81   |  | 12.06  | 05.10   | 11.0101-5407.2   | 260011   |  | Hülzensatz              |
|  | 2.0 CiTD   | 105  |  | 12.06  | 05.10   | 11.8171-0008.1   | 990049   |  | Führungsbolzen          |
|  |  |  |  |  |   | 11.8116-0356.1   | 390586   | 2  | Haltefeder              |
|  | 1.8 16V  | 85   |  | 03.05  | 05.10   | 11.0230-0698.2   | 260091   |  | + 15" Rad <sup>1)</sup> |
|  | 2.0 16V  | 107  |  | 03.05  | 05.10   | 11.0101-5407.2   | 260011   |  | Halter                  |
|  | 2.0 CiTD   | 81   |  | 03.05  | 05.10   | 11.8171-0008.1   | 990049   |  | Hülzensatz              |
|  | 2.0 CiTD   | 105  |  | 06.05  | 05.10   | 11.8116-0340.1   | 390595   | 2  | Führungsbolzen          |
|  |  |  |  |  |   |  |  |  | Haltefeder              |
|  | 1.8 16V  | 85   |  | 03.05  | 05.10   | 83.7788-0383.3   | 330972   | 2  | + 15" Rad <sup>1)</sup> |
|  | 2.0 16V  | 107  |  | 03.05  | 05.10   | 24.5124-0390.3   | 331050   | 2  | + 16" Rad <sup>2)</sup> |
|  | 2.0 CiTD   | 81   |  | 03.05  | 05.10   |  |  |  | L=382                   |
|  | 2.0 CiTD   | 105  |  | 06.05  | 05.10   |  |  |  | L=390                   |
|  | 1.8 16V  | 85   |  | 03.05  | 05.10   | 24.3727-1812.2   | 581812   | <input type="checkbox"/>   | L=252                   |
|  | 2.0 16V  | 107  |  | 03.05  | 05.10   | 24.3727-1822.2   | 581822   | <input type="checkbox"/>   | L=1828                  |
|  | 2.0 CiTD   | 81   |  | 03.05  | 05.10   | 24.3727-1820.2   | 581820   | <input type="checkbox"/>   | L=1810                  |
|  | 2.0 CiTD   | 105  |  | 06.05  | 05.10   |  |  |  |                         |
| <b>MAZDA 5 (CW) (10-)</b>  |  |  |  |  |   |  |  |  |                         |
|  | 1.6 CD   | 85   |  | 09.10  |   | 11.9571-9785.2   | 220595   | <input type="checkbox"/>   | D=57, - Halter          |
|  | 1.8 16V  | 85   |  | 09.10  |   | 11.9571-9786.2   | 220596   | <input type="checkbox"/>   | D=57, - Halter          |
|  | 2.0 16V  | 106  |  | 01.11  |   | 11.0101-5407.2   | 260011   |  | Hülzensatz              |
|  | 2.0 16V  | 110  |  | 09.10  |   | 11.8171-0008.1   | 990049   |  | Führungsbolzen          |
|  |  |  |  |  |   | 11.8116-0356.1   | 390586   | 2  | Haltefeder              |
|  | 1.6 CD   | 85   |  | 09.10  |   | 83.7788-0383.3   | 330972   | 2  | + 15" Rad <sup>1)</sup> |
|  | 1.8 16V  | 85   |  | 09.10  |   | 24.5124-0390.3   | 331050   | 2  | + 16" Rad <sup>2)</sup> |
|  | 2.0 16V  | 106  |  | 01.11  |   |  |  |  | L=382                   |
|  | 2.0 16V  | 110  |  | 09.10  |   |  |  |  | L=390                   |
|  | 1.6 CD   | 85   |  | 09.10  |   | 24.3727-1812.2   | 581812   | <input type="checkbox"/>   | L=252                   |
|  | 1.8 16V  | 85   |  | 09.10  |   |  |  |  |                         |
|  | 2.0 16V  | 106  |  | 01.11  |   |  |  |  |                         |
|  | 2.0 16V  | 110  |  | 09.10  |   |  |  |  |                         |

<sup>1)</sup> + 15" wheel / + ruota 15" / + roue 15" / + rueda 15"

<sup>2)</sup> + 16" wheel / + ruota 16" / + roue 16" / + rueda 16"

|     |  |  |  |  |  |  |  |  |                |     |
|--|--|--|--|--|---|--|--|--|----------------|-----|
| <b>MAZDA 6 Limousine (GG) (02-07)</b>  |  |  |  |  |   |  |  |  |                |     |
|    | 1.8 16V  | 88   |  | 08.02  | 07.07   | 24.5288-0270.3   | 331227   | 2  | L=270          |     |
|  | 2.0 16V  | 104  |  | 06.02  | 07.07   |  |  |  |                |     |
|  | 2.0 16V  | 108  |  | 03.05  | 07.07   |  |  |  |                |     |
|  | 2.0 DI   | 89   |  | 08.02  | 07.07   |  |  |  |                |     |
|  | 2.0 DI   | 100  |  | 06.02  | 07.07   |  |  |  |                |     |
|  | 2.0 DI   | 105  |  | 06.05  | 07.07   |  |  |  |                |     |
|  | 2.3 16V  | 118  |  | 07.03  | 02.05   |  |  |  |                |     |
|  | 2.3 16V  | 120  |  | 03.05  | 07.07   |  |  |  |                |     |
|  | 2.3 16V  | 122  |  | 06.02  | 07.07   |  |  |  |                |     |
|  | 2.3 MPS Turbo  | 191  |  | 12.05  | 07.07   | 24.5288-0265.3   | 331062   | 2  | L=265          |     |
|    | 1.8 16V  | 88   |  | 08.02  | 07.07   | 24.3727-1821.2   | 581821   | ↓  | L=1635/1640    |     |
|  | 2.0 16V  | 104  |  | 06.02  | 07.07   |  |  |  |                |     |
|  | 2.0 16V  | 108  |  | 03.05  | 07.07   |  |  |  |                |     |
|  | 2.0 DI   | 89   |  | 08.02  | 07.07   |  |  |  |                |     |
|  | 2.0 DI   | 100  |  | 06.02  | 07.07   |  |  |  |                |     |
|  | 2.0 DI   | 105  |  | 06.05  | 07.07   |  |  |  |                |     |
|  | 2.3 16V  | 118  |  | 07.03  | 02.05   |  |  |  |                |     |
|  | 2.3 16V  | 120  |  | 03.05  | 07.07   |  |  |  |                |     |
|  | 2.3 16V  | 122  |  | 06.02  | 07.07   |  |  |  |                |     |
| <b>MAZDA 6 Kombi (GY) (02-07)</b>  |  |  |  |  |   |  |  |  |                |     |
|    | 1.8 16V  | 88   |  | 08.02  | 07.07   | 24.5288-0270.3   | 331227   | 2  | L=270          |     |
|  | 2.0 16V  | 104  |  | 08.02  | 07.07   |  |  |  |                |     |
|  | 2.0 16V  | 108  |  | 03.05  | 07.07   |  |  |  |                |     |
|  | 2.0 CiTD 4x4   | 89   |  | 10.02  | 02.05   |  |  |  |                |     |
|  | 2.0 CiTD 4x4   | 100  |  | 10.02  | 02.05   |  |  |  |                |     |
|  | 2.0 DI   | 89   |  | 08.02  | 07.07   |  |  |  |                |     |
|  | 2.0 DI   | 100  |  | 08.02  | 07.07   |  |  |  |                |     |
|  | 2.0 DI   | 105  |  | 06.05  | 07.07   |  |  |  |                |     |
|  | 2.3 16V  | 122  |  | 08.02  | 07.07   |  |  |  |                |     |
|  | 2.3 16V AWD  | 119  |  | 11.02  | 07.07   |  |  |  |                |     |
|    | 1.8 16V  | 88   |  | 08.02  | 07.07   | 24.3727-1821.2   | 581821   | ↓  | L=1635/1640    |     |
|  | 2.0 16V  | 104  |  | 08.02  | 07.07   |  |  |  |                |     |
|  | 2.0 16V  | 108  |  | 03.05  | 07.07   |  |  |  |                |     |
|  | 2.0 CiTD 4x4   | 89   |  | 10.02  | 02.05   |  |  |  |                |     |
|  | 2.0 CiTD 4x4   | 100  |  | 10.02  | 02.05   |  |  |  |                |     |
|  | 2.0 DI   | 89   |  | 08.02  | 07.07   |  |  |  |                |     |
|  | 2.0 DI   | 100  |  | 08.02  | 07.07   |  |  |  |                |     |
|  | 2.0 DI   | 105  |  | 06.05  | 07.07   |  |  |  |                |     |
|  | 2.3 16V  | 122  |  | 08.02  | 07.07   |  |  |  |                |     |
|  | 2.3 16V AWD  | 119  |  | 11.02  | 07.07   |  |  |  |                |     |
| <b>MAZDA 6 (GH) (07-)</b>  |  |  |  |  |   |  |  |  |                |     |
|  | 1.8 MZR  | 88   |  | 08.07  |   | 24.5288-0295.3   | 331185   | 2  | L=295          |     |
|  | 2.0 MZR  | 108  |  | 08.07  |   |  |  |  |                |     |
|  | 2.0 MZR  | 114  |  | 01.10  |   |  |  |  |                |     |
|  | 2.0 MZR-CD   | 103  |  | 08.07  |   |  |  |  |                |     |
|  | 2.2 MZR-CD   | 92   |  | 01.09  |   |  |  |  |                |     |
|  | 2.2 MZR-CD   | 95   |  | 01.10  |   |  |  |  |                |     |
|  | 2.2 MZR-CD   | 120  |  | 01.09  |   |  |  |  |                |     |
|  | 2.2 MZR-CD   | 132  |  | 01.10  |   |  |  |  |                |     |
|  | 2.2 MZR-CD   | 136  |  | 01.09  |   |  |  |  |                |     |
|  | 2.5 MZR  | 125  |  | 08.07  |   |  |  |  |                |     |
| <b>MAZDA 626 (91-97)</b>   |  |  |  |  |   |  |  |  |                |     |
|  | 1.8 i (GE1)  |  |  | 09.91  | 04.94   | 24.3571-1703.5   | 240099   | ☐  | D=57, - Halter | AKE |
|  | 2.0 D (GE1)  |  |  | 09.91  | 04.94   | 24.3571-1704.5   | 240100   | ☐  | D=57, - Halter | AKE |
|  | 2.0 i (GE1)  |  |  | 09.91  | 04.94   | 24.0101-5701.2   | 260065   |  | Einbausatz     | AKE |
|  | 2.0 i 4WD (GE8)  |  |  | 09.91  | 04.94   |  |  |  |                |     |
|  | 2.5 i V6 (GE1/GE7)   |  |  | 09.91  | 04.94   |  |  |  |                |     |
|  | 1.8 i (GE1)  |  |  | 09.91  | 04.94   | 24.0101-3001.2   | 260039   |  | Einbausatz     | AKE |
|  | 2.0 D (GE1)  |  |  | 09.91  | 04.94   |  |  |  |                |     |
|  | 2.0 i (GE1)  |  |  | 09.91  | 04.94   |  |  |  |                |     |
|  | 2.5 i V6 (GE1/GE7)   |  |  | 09.91  | 04.94   |  |  |  |                |     |
|  | 1.8 i (GE1)  |  |  | 09.91  | 04.97   | 24.3727-1812.2   | 581812   | ☐  | L=252          |     |
|  | 2.0 D (GE1)  |  |  | 09.91  | 04.97   | 24.3727-1809.2   | 581809   | ☐  | L=1657         |     |
|  | 2.0 i (GE1)  |  |  | 09.91  | 04.97   | 24.3727-1808.2   | 581808   | ☐  | L=1657         |     |
|  | 2.5 i V6 (GE1/GE7)   |  |  | 09.91  | 04.97   |  |  |  |                |     |
| <b>MAZDA 626 (97-02)</b>   |  |  |  |  |   |  |  |  |                |     |
|  | 1.8 i 16V (GF)   | 66   |  | 05.97  | 11.99   | 24.3220-1737.3   | 020540   |  | Rz 20,64       |     |
|  | 1.8 i 16V (GF)   | 74   |  | 12.99  | 04.02   |  |  |  |                |     |
|  | 1.8 i 16V (GF)   | 66   | 115108   | 419982   |   | 24.3727-1812.2   | 581812   | ☐  | L=252          |     |
|  | 2.0 DiTD (GF)  |  | 115108   | 419982   |   |  |  |  |                |     |
|  | 1.8 i 16V (GF)   | 66   | 419983   |  | 11.99   | 24.3727-1812.2   | 581812   | ☐  | L=252          |     |
|  | 1.8 i 16V (GF)   | 74   |  | 12.99  | 04.02   |  |  |  |                |     |
|  | 2.0 DiTD (GF)  |  | 419983   |  | 04.02   |  |  |  |                |     |
|  | 2.0 i 16V (GF)   | 85   |  | 05.97  | 04.02   | 24.3727-1812.2   | 581812   | ☐  | L=252          |     |
|  | 2.0 i 16V (GF)   | 100  |  | 02.98  | 04.02   | 24.3727-1823.2   | 581823   | ☐  | L=1693         |     |
|  |  |  |  |  |   | 24.3727-1824.2   | 581824   | ☐  | L=1715         |     |

|     |                                      |  |  |  |       |  |  |   |
|--|--|--|--|--|--|--|--|---|
| <b>MAZDA 626 Kombi (88-92)</b>   |  |  |  |  |  |  |  |   |
|    | 1.8 (GV1)<br>2.0 (GV1)<br>2.0 D (GV1)<br>2.2 12V (GV1)   | 72<br>44<br>85   | 03.88<br>03.88<br>03.88<br>03.88   | 02.92<br>02.92<br>07.91<br>10.90   | 24.3727-1812.2   | 581812   | ↑  | L=252   |
| <b>MAZDA 626 Kombi (92-98)</b>   |  |  |  |  |  |  |  |   |
|    | 2.0 D (GV1)<br>2.0 D (GV1)<br>2.0 i (GV1)<br>2.0 i 16V (GV1)<br>2.2 i 12V (GV1)                                      | 55<br>60<br>66<br>86<br>85   | 04.92<br>11.94<br>04.92<br>04.92<br>04.92  | 01.98<br>04.96<br>01.98<br>02.95<br>01.98  | 24.3727-1812.2   | 581812   | ↑  | L=252   |
| <b>MAZDA 626 Kombi (98-02)</b>   |  |  |  |  |  |  |  |   |
|    | 1.8 i 16V (GW)<br>2.0 DiTD (GW)<br>2.0 DiTD (GW)<br>2.0 i 16V (GW)<br>2.0 i 16V (GW)                                 | 66<br>74<br>81<br>85<br>100  | 02.98<br>04.98<br>10.00<br>02.98<br>02.98  | 12.99<br>06.02<br>06.02<br>09.99<br>09.99  | 24.3354-1701.5<br>24.3354-1702.5   | 240347<br>240348   | ☐<br>☐   | D=35, - Halter<br>D=35, - Halter<br><b>AKE</b><br><b>AKE</b>  |
|    | 1.8 i 16V (GW)<br>1.8 i 16V (GW)<br>2.0 DiTD (GW)<br>2.0 DiTD (GW)<br>2.0 i 16V (GW)<br>2.0 i 16V (GW)               | 66<br>74<br>74<br>81<br>85<br>100  | 02.98<br>01.00<br>04.98<br>10.00<br>02.98<br>02.98                               | 12.99<br>06.02<br>06.02<br>06.02<br>06.02<br>06.02                               | 24.3727-1812.2   | 581812   | ↑  | L=252   |
| <b>MAZDA DEMIO (98-02)</b>   |  |  |  |  |  |  |  |   |
|    | 1.3 i 16V<br>1.3 i 16V<br>1.5 i 16V  | 46<br>53<br>55   | 08.98<br>08.98<br>04.00  | 10.02<br>03.00<br>10.02  | 24.5265-0445.3   | 331071   | 2  | L=445   |
|    | 1.3 i 16V<br>1.3 i 16V<br>1.5 i 16V  | 46<br>53<br>55   | 08.98<br>08.98<br>04.00  | 10.02<br>03.00<br>10.02  | 24.5285-0250.3<br>24.5285-0269.3   | 331074<br>331137   | ☐<br>☐   | L=250<br>L=269  |
|    | 1.3 i 16V<br>1.3 i 16V<br>1.5 i 16V  | 46<br>53<br>55   | 08.98<br>08.98<br>04.00  | 10.02<br>03.00<br>10.02  | 24.3217-1718.3   | 020478   |  | Rz 17,46  |
| <b>MAZDA DEMIO (03-)</b>   |  |  |  |  |  |  |  |   |
|   | 1.2 i 16V<br>1.4 CD<br>1.4 i 16V<br>1.6 i 16V  | 55<br>50<br>58<br>74   | 04.03<br>04.03<br>02.03<br>02.03   |  | 11.3541-8531.2<br>11.3541-8532.2<br>11.0101-5407.2<br>11.8171-0008.1<br>11.8116-0264.1 | 220367<br>220368<br>260011<br>990049<br>390594                                     | ☐<br>☐<br>2  | D=54, - Halter<br>D=54, - Halter<br>Hülensatz<br>Führungsbolzen<br>Haltefeder<br><b>ATE</b><br><b>ATE</b><br><b>ATE</b><br><b>ATE</b> |
|  | 1.2 i 16V<br>1.4 CD<br>1.4 i 16V<br>1.6 i 16V  | 55<br>50<br>58<br>74   | 04.03<br>04.03<br>02.03<br>02.03   |  | 24.3219-1735.3   | 020464   |  | Rz 19,05  |
|  | 1.2 i 16V<br>1.4 CD<br>1.4 i 16V<br>1.6 i 16V  | 55<br>50<br>58<br>74   | 04.03<br>04.03<br>02.03<br>02.03   |  | 24.3727-0653.2   | 580653   | 1 ↓  | L=1305/1445   |
| <b>MAZDA MX-3 (91-98)</b>  |  |  |  |  |  |  |  |   |
|  | 1.6 i (EC)   |  | 07.91  | 12.98 - ABS  | 24.3217-1120.3   | 020360   |  | Rz 17,46  |
| <b>MAZDA MX-5 (98-05)</b>  |  |  |  |  |  |  |  |   |
|  | 1.6 i 16V (NB1)<br>1.6 i 16V (NB18)<br>1.8 i 16V (NB1)<br>1.8 i 16V (NB18)<br>1.8 i 16V (NB18)                       | 66<br>81<br>103<br>102<br>107  | 05.98<br>05.98<br>05.98<br>08.00<br>08.00  | 07.00<br>07.00<br>07.00<br>10.05 - ABS<br>10.05 - ABS                            | 24.5265-0335.3   | 331070   | ☐  | L=335   |
|  | 1.6 i Sport (NB18)<br>1.8 i 16V (NB18)<br>1.8 i 16V (NB18)   | 81<br>102<br>107   | 08.00<br>08.00<br>08.00  | 10.05<br>10.05 + ABS<br>10.05 + ABS  | 24.5265-0345.3<br>24.5265-0346.3   | 331091<br>331092   | ☐<br>☐   | L=345<br>L=345  |
|  | 1.6 i 16V (NB1)<br>1.6 i 16V (NB18)<br>1.6 i Sport (NB18)<br>1.8 i 16V (NB1)<br>1.8 i 16V (NB18)<br>1.8 i 16V (NB18) | 66<br>81<br>81<br>103<br>102<br>107  | 05.98<br>05.98<br>08.02<br>05.98<br>08.00<br>08.00                               | 07.00<br>10.05<br>10.05<br>07.00<br>10.05<br>10.05                               | 24.5265-0275.3<br>24.5268-0270.3   | 331069<br>331072   | ☐<br>☐   | L=275<br>L=270  |
| <b>MAZDA MX-6 (91-97)</b>  |  |  |  |  |  |  |  |   |
|  | 2.0 i (GE1)<br>2.5 i V6 (GE1/GE7)  | 85   | 07.91<br>07.91   | 08.97<br>08.97   | 24.3571-1703.5<br>24.3571-1704.5<br>24.0101-5701.2                                     | 240099<br>240100<br>260065   | ☐<br>☐   | D=57, - Halter<br>D=57, - Halter<br>Einbausatz<br><b>AKE</b><br><b>AKE</b><br><b>AKE</b>  |
|  | 2.0 i (GE1)<br>2.5 i V6 (GE1/GE7)  | 85   | 07.91<br>07.91   | 08.97<br>08.97   | 24.0101-3001.2   | 260039   |  | Einbausatz<br><b>AKE</b>  |
| <b>MAZDA PREMACY (CP) (99-05)</b>  |  |  |  |  |  |  |  |   |
|  | 1.8 i 16V<br>1.9 i 16V<br>2.0 DiTD<br>2.0 DiTD<br>2.0 i 16V  | 74<br>84<br>66<br>74<br>96   | 07.99<br>07.99<br>10.99<br>07.00<br>11.01  | 03.05<br>03.05<br>06.00<br>03.05<br>03.05  | 24.5288-0375.3   | 331012   | 2  | L=375   |

|     |                |  |  |  |               |      |  |    |  |
|--|--|--|--|--|--|--|--|--|--|
| <b>MAZDA PREMACY (CP) (99-05)</b>  |  |  |  |  |  |  |  |  |  |
|    | 1.8 i 16V<br>2.0 DiTD<br>2.0 i 16V   | 74<br>74<br>96   |  | 07.99<br>07.00<br>11.01  | 03.05 + ABS<br>03.05 + ABS<br>03.05  | 24.3354-1701.5<br>24.3354-1702.5   | 240347<br>240348   | <br>D=35, - Halter<br>D=35, - Halter  | <b>AKE</b><br><b>AKE</b>   |
|    | 1.8 i 16V<br>1.9 i 16V<br>2.0 DiTD<br>2.0 DiTD   | 74<br>84<br>66<br>74   |  | 07.99<br>07.99<br>10.99<br>07.00   | 07.01<br>07.01<br>06.00<br>07.01   | 24.3220-1737.3   | 020540   | - ABS<br>Rz 20,64  |  |
|    | 1.8 i 16V<br>1.9 i 16V<br>2.0 DiTD<br>2.0 DiTD   | 74<br>84<br>66<br>74   | 131754<br>131754<br>131754<br>131754   | 07.99<br>07.99<br>10.99<br>07.00   | - ABS<br>- ABS   | 24.3727-1812.2   | 581812   | <br>L=252   |  |
|    | 1.8 i 16V<br>1.9 i 16V<br>2.0 DiTD<br>2.0 DiTD   | 74<br>84<br>66<br>74   | 131755<br>131755<br>131755<br>131755   | 03.05<br>03.05<br>06.00<br>03.05   | - ABS<br>- ABS   | 24.3727-1812.2   | 581812   | <br>L=252   |  |
|    | 1.8 i 16V<br>2.0 DiTD<br>2.0 i 16V   | 74<br>74<br>96   |  | 07.99<br>07.00<br>11.01  | 03.05 + ABS<br>03.05 + ABS   | 24.3727-1812.2   | 581812   | <br>L=252   |  |
| <b>MAZDA PREMACY (CR) (05-10)</b>  |  |  |  |  |  |  |  |  |  |
|    | 1.8 i 16V<br>2.0 CiTD<br>2.0 CiTD<br>2.0 CiTD<br>2.0 i 16V                                     | 85<br>81<br>105<br>107<br>107  |  | 03.05<br>03.05<br>06.05<br>03.05<br>03.05  | 11.06 + ⊕<br>11.06 + ⊕<br>11.06 + ⊕<br>11.06 + ⊕<br>11.06 + ⊕                                  | 11.9571-9785.2<br>11.9571-9786.2<br>11.0101-5407.2<br>11.8171-0008.1<br>11.8116-0356.1 | 220595<br>220596<br>260011<br>990049<br>390586                                     | <br>D=57, - Halter<br>D=57, - Halter<br>Hülensatz<br>Führungsbolzen<br>Haltefeder | <b>ATE</b><br><b>ATE</b><br><b>ATE</b><br><b>ATE</b><br><b>ATE</b> |
|    | 1.8 i 16V<br>2.0 CiTD<br>2.0 CiTD<br>2.0 CiTD<br>2.0 i 16V                                     | 85<br>81<br>105<br>107<br>107  |  | 12.06<br>12.06<br>12.06<br>12.06<br>12.06  | 05.10 + ⊕<br>05.10 + ⊕<br>05.10 + ⊕<br>05.10 + ⊕<br>05.10 + ⊕                                  | 11.9571-9785.2<br>11.9571-9786.2<br>11.0101-5407.2<br>11.8171-0008.1<br>11.8116-0356.1 | 220595<br>220596<br>260011<br>990049<br>390586                                     | <br>D=57, - Halter<br>D=57, - Halter<br>Hülensatz<br>Führungsbolzen<br>Haltefeder | <b>ATE</b><br><b>ATE</b><br><b>ATE</b><br><b>ATE</b><br><b>ATE</b> |
|    | 1.8 i 16V<br>2.0 CiTD<br>2.0 CiTD<br>2.0 CiTD<br>2.0 i 16V                                     | 85<br>81<br>105<br>107<br>107  |  | 03.05<br>03.05<br>06.05<br>03.05<br>03.05  | 05.10 + ⊕<br>05.10 + ⊕<br>05.10 + ⊕<br>05.10 + ⊕<br>05.10 + ⊕                                  | 11.0230-0698.2<br>11.0101-5407.2<br>11.8171-0008.1<br>11.8116-0340.1                   | 260091<br>260011<br>990049<br>390595   | + 15" Rad <sup>1)</sup><br>Halter<br>Hülensatz<br>Führungsbolzen<br>Haltefeder   | <b>ATE</b><br><b>ATE</b><br><b>ATE</b><br><b>ATE</b>               |
|    | 1.8 i 16V<br>2.0 CiTD<br>2.0 CiTD<br>2.0 CiTD<br>2.0 i 16V                                     | 85<br>81<br>105<br>107<br>107  |  | 03.05<br>03.05<br>06.05<br>03.05<br>03.05  | 05.10 + ⊕<br>05.10 + ⊕<br>05.10 + ⊕<br>05.10 + ⊕<br>05.10 + ⊕                                  | 83.7788-0383.3<br>24.5124-0390.3   | 330972<br>331050   | + 15" Rad <sup>1)</sup><br>+ 16" Rad <sup>2)</sup><br>L=382<br>L=390   |  |
|   | 1.8 i 16V<br>2.0 CiTD<br>2.0 CiTD<br>2.0 CiTD<br>2.0 i 16V                                     | 85<br>81<br>105<br>107<br>107  |  | 03.05<br>03.05<br>06.05<br>03.05<br>03.05  | 05.10 + ⊕<br>05.10 + ⊕<br>05.10 + ⊕<br>05.10 + ⊕<br>05.10 + ⊕                                  | 24.3727-1812.2<br>24.3727-1822.2<br>24.3727-1820.2                                     | 581812<br>581822<br>581820   | <br>L=252<br>L=1828<br>L=1810  |  |
| <b>MAZDA XEDOS 6 (92-00)</b>   |  |  |  |  |  |  |  |  |  |
|  | 1.6 i 16V (CA1)<br>2.0 i V6 (CA1)  |  |  | 06.92<br>06.92   | 09.99<br>10.00   | 24.3571-1703.5<br>24.3571-1704.5<br>24.0101-5701.2                                     | 240099<br>240100<br>260065   | <br>D=57, - Halter<br>D=57, - Halter<br>Einbausatz                              | <b>AKE</b><br><b>AKE</b><br><b>AKE</b>                             |
|  | 1.6 i 16V (CA1)<br>2.0 i V6 (CA1)  |  |  | 06.92<br>06.92   | 09.99<br>10.00   | 24.0101-3001.2   | 260039   | Einbausatz   | <b>AKE</b>   |
| <b>MERCEDES BENZ A-Klasse (W168) (97-04)</b>                                       |  |  |  |  |  |  |  |  |  |
|  | A 140<br>A 160<br>A 160 CDI<br>A 160 CDI<br>A 170 CDI<br>A 170 CDI<br>A 190<br>A 210 Evolution | 60<br>75<br>44<br>55<br>66<br>70<br>92<br>103                                    |  | 09.97<br>09.97<br>08.98<br>02.01<br>03.98<br>02.01<br>05.99<br>03.02             | 08.04<br>08.04<br>01.01<br>08.04<br>01.01<br>08.04<br>08.04<br>08.04                           | 24.4122-1701.3   | 010533   | THz 22,20  |  |
|  | A 140<br>A 160 CDI<br>A 160 CDI  | 60<br>44<br>55   |  | 09.97<br>08.98<br>02.01  | 08.04 + kurzer Radstand <sup>3)</sup><br>01.01<br>08.04  | 24.3541-1759.7<br>24.3541-1760.7   | 220491<br>220492   | <br>D=54, - Halter<br>D=54, - Halter  | <b>LUC</b><br><b>LUC</b>   |
|  | A 140<br>A 160<br>A 170 CDI<br>A 170 CDI   | 60<br>75<br>66<br>70   |  | 09.97<br>09.97<br>03.98<br>02.01   | 08.04 - kurzer Radstand <sup>4)</sup><br>08.04 - (BR)<br>01.01<br>08.04                        | 24.3541-1753.7<br>24.3541-1754.7   | 220479<br>220480   | <br>D=54, - Halter<br>D=54, - Halter  | <b>LUC</b><br><b>LUC</b>   |
|  | A 140<br>A 160<br>A 160 CDI<br>A 160 CDI<br>A 170 CDI<br>A 170 CDI<br>A 190<br>A 210 Evolution | 60<br>75<br>44<br>55<br>66<br>70<br>92<br>103                                    |  | 09.97<br>09.97<br>08.98<br>02.01<br>03.98<br>02.01<br>05.99<br>03.02             | 08.04<br>08.04<br>01.01<br>08.04<br>01.01<br>08.04<br>08.04<br>08.04                           | 83.7715-0280.3   | 330806   | 2<br>L=280   |  |
|  | A 160<br>A 170 CDI<br>A 190  | 75<br>70<br>92   |  | 09.97<br>02.01<br>05.99  | 08.04 + langer Radstand <sup>5)</sup><br>08.04 + langer Radstand <sup>5)</sup><br>08.04 - (BR) | 24.3281-1701.5<br>24.3281-1702.5   | 240433<br>240434   | <br>D=28, - Halter<br>D=28, - Halter  | <b>LUC</b><br><b>LUC</b>   |

<sup>1)</sup> + 15" wheel / + ruota 15" / + roue 15" / + rueda 15"

<sup>2)</sup> + 16" wheel / + ruota 16" / + roue 16" / + rueda 16"

<sup>3)</sup> + short wheel base / + passo lungo / + empattement court / + distancia corta entre ejes

<sup>4)</sup> - short wheel base / - passo corto / - empattement court / - distancia corta entre ejes

<sup>5)</sup> + long wheel base / + passo lungo / + empattement long / + distancia larga entre ejes



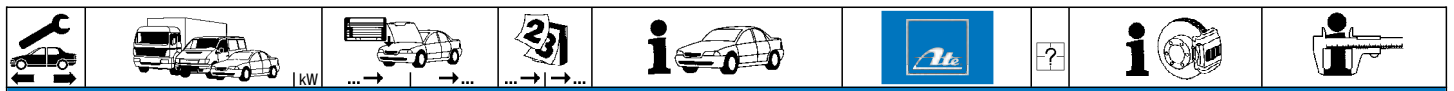

### MERCEDES BENZ A-Klasse (W168) (97-04)

|                 |                 |         |         |         |  |  |                |                |        |        |          |                                |                |
|-----------------|-----------------|---------|---------|---------|--|--|----------------|----------------|--------|--------|----------|--------------------------------|----------------|
|                 | A 140           | 60      |         | 09.97   | 08.04                                    | + Trommelbremse <sup>1)</sup>            | 83.6212-0340.3 | 330626         | 2      |        | L=340    |                                |                |
|                 | A 160           | 75      |         | 09.97   | 08.04                                    | + Trommelbremse <sup>1)</sup>            |                |                |        |        |          |                                |                |
|                 | A 160 CDI       | 44      |         | 08.98   | 01.01                                    | + Trommelbremse <sup>1)</sup>            |                |                |        |        |          |                                |                |
|                 | A 160 CDI       | 55      |         | 02.01   | 08.04                                    | + Trommelbremse <sup>1)</sup>            |                |                |        |        |          |                                |                |
|                 | A 170 CDI       | 66      |         | 03.98   | 01.01                                    | + Trommelbremse <sup>1)</sup>            |                |                |        |        |          |                                |                |
|                 | A 170 CDI       | 70      |         | 02.01   | 08.04                                    | + Trommelbremse <sup>1)</sup>            |                |                |        |        |          |                                |                |
|                 | A 190           | 92      |         | 05.99   | 08.04                                    | + Trommelbremse <sup>1)</sup>            |                |                |        |        |          |                                |                |
|                 | A 210 Evolution | 103     |         | 03.02   | 08.04                                    | + Trommelbremse <sup>1)</sup>            |                |                |        |        |          |                                |                |
|                 |                 | A 140   | 60      |         | 09.97                                    | 08.04                                    |                |                |        |        |          | + Scheibenbremse <sup>2)</sup> | 83.6212-0340.3 |
| A 160           |                 | 75      |         | 09.97   | 08.04                                    | + Scheibenbremse <sup>2)</sup>           |                |                |        |        |          |                                |                |
| A 160 CDI       |                 | 44      |         | 08.98   | 01.01                                    | + Scheibenbremse <sup>2)</sup>           |                |                |        |        |          |                                |                |
| A 160 CDI       |                 | 55      |         | 02.01   | 08.04                                    | + Scheibenbremse <sup>2)</sup>           |                |                |        |        |          |                                |                |
| A 170 CDI       |                 | 66      |         | 03.98   | 01.01                                    | + Scheibenbremse <sup>2)</sup>           |                |                |        |        |          |                                |                |
| A 170 CDI       |                 | 70      |         | 02.01   | 08.04                                    | + Scheibenbremse <sup>2)</sup>           |                |                |        |        |          |                                |                |
| A 190           |                 | 92      |         | 05.99   | 08.04                                    | + Scheibenbremse <sup>2)</sup>           |                |                |        |        |          |                                |                |
| A 210 Evolution |                 | 103     |         | 03.02   | 08.04                                    | + Scheibenbremse <sup>2)</sup>           |                |                |        |        |          |                                |                |
|                 |                 | A 140   | 60      | J078973 | 09.97                                    |  |                | 24.3219-1718.3 | 020421 |        |          | Rz 19,05                       |                |
|                 | A 160           | 75      | J078973 | 09.97   |  | + kurzer Radstand/ - (BR) <sup>4)</sup>  |                |                |        |        |          |                                |                |
|                 | A 170 CDI       | 66      | J078973 | 03.98   |  |  |                |                |        |        |          |                                |                |
|                 | A 140           | 60      | J078974 |         | 08.04                                    | + kurzer Radstand/ - (BR) <sup>4)</sup>  | 24.3217-1709.3 | 020419         |        |        | Rz 17,78 | LUC                            |                |
|                 | A 160           | 75      | J078974 |         | 08.04                                    | + kurzer Radstand/ - (BR) <sup>4)</sup>  |                |                |        |        |          |                                |                |
|                 | A 160 CDI       | 44      |         | 08.98   | 01.01                                    |  |                |                |        |        |          |                                |                |
|                 | A 160 CDI       | 55      |         | 02.01   | 08.04                                    |  |                |                |        |        |          |                                |                |
|                 | A 170 CDI       | 66      | J078974 |         | 01.01                                    |  |                |                |        |        |          |                                |                |
|                 | A 170 CDI       | 70      |         | 02.01   | 08.04                                    | + kurzer Radstand <sup>5)</sup>          |                |                |        |        |          |                                |                |
|                 | A 190           | 92      |         |         |  |  |                |                |        |        |          |                                |                |
|                 | A 140           | 60      | J306886 | 09.97   |  | - langer Radstand <sup>6)</sup>          | 24.3727-0440.2 | 580440         | 1      |        | L=987    | L=1062                         | L=739          |
|                 | A 160           | 75      | J306886 | 09.97   |  | - langer Radstand <sup>6)</sup>          |                |                |        |        |          |                                |                |
|                 | A 160 CDI       | 44      | J306886 | 08.98   |  | - langer Radstand <sup>6)</sup>          |                |                |        |        |          |                                |                |
|                 | A 160 CDI       | 55      | J306886 | 02.01   |  | - langer Radstand <sup>6)</sup>          |                |                |        |        |          |                                |                |
|                 | A 170 CDI       | 66      | J306886 | 03.98   |  | - langer Radstand <sup>6)</sup>          |                |                |        |        |          |                                |                |
|                 | A 170 CDI       | 70      | J306886 | 02.01   |  | - langer Radstand <sup>6)</sup>          |                |                |        |        |          |                                |                |
|                 | A 190           | 92      | J306886 | 05.99   |  | + (BR) / - langer Radstand <sup>7)</sup> |                |                |        |        |          |                                |                |
|                 | A 140           | 60      | J306887 |         | 08.04                                    | - langer Radstand <sup>6)</sup>          | 24.3727-0400.2 | 580400         | 1      |        | L=987    | L=1056                         | L=739          |
|                 | A 160           | 75      | J306887 |         | 08.04                                    | - langer Radstand <sup>6)</sup>          |                |                |        |        |          |                                |                |
|                 | A 160 CDI       | 44      | J306887 |         | 01.01                                    | - langer Radstand <sup>6)</sup>          |                |                |        |        |          |                                |                |
|                 | A 160 CDI       | 55      | J306887 |         | 08.04                                    | - langer Radstand <sup>6)</sup>          |                |                |        |        |          |                                |                |
|                 | A 170 CDI       | 66      | J306887 |         | 01.01                                    | - langer Radstand <sup>6)</sup>          |                |                |        |        |          |                                |                |
|                 | A 170 CDI       | 70      | J306887 |         | 08.04                                    | - langer Radstand <sup>6)</sup>          |                |                |        |        |          |                                |                |
| A 190           | 92              | J306887 |         | 08.04   | + (BR) / - langer Radstand <sup>7)</sup> |  |                |                |        |        |          |                                |                |
| A 190           | 92              | J306886 | 05.99   |         | - (BR)                                   | 24.3727-0440.2                           | 580440         | 1              |        | L=987  | L=685    |                                |                |
| A 190           | 92              | J306887 |         | 08.04   | - (BR)                                   |  |                |                |        |        |          |                                |                |
| A 160           | 75              |         | 09.97   | 08.04   | + langer Radstand <sup>8)</sup>          | 24.3727-0431.2                           | 580431         | 1              |        | L=1170 | L=1038   | L=685                          |                |
| A 170 CDI       | 70              |         | 02.01   | 08.04   | + langer Radstand <sup>8)</sup>          |  |                |                |        |        |          |                                |                |
| A 190           | 92              |         | 05.99   | 08.04   | + langer Radstand <sup>8)</sup>          |  |                |                |        |        |          |                                |                |
|                 | A 140           | 60      | J094989 | 09.97   |  |  | 24.2415-1707.3 | 030110         |        |        | Gz 15,87 |                                |                |
|                 | A 160           | 75      | J094989 | 09.97   |  |  |                |                |        |        |          |                                |                |
|                 | A 160 CDI       | 44      | J094989 | 08.98   |  |  |                |                |        |        |          |                                |                |
|                 | A 170 CDI       | 66      | J094989 | 03.98   |  |  |                |                |        |        |          |                                |                |
|                 | A 170 CDI       | 70      | J094989 | 03.98   |  |  |                |                |        |        |          |                                |                |

### MERCEDES BENZ A-Klasse (W169) (04-11)

|             |               |          |          |       |                                   |                                   |                |        |   |  |                |     |
|-------------|---------------|----------|----------|-------|-----------------------------------|-----------------------------------|----------------|--------|---|--|----------------|-----|
|             | A 150 / A 160 | 70       |          | 08.04 | 10.11                             |                                   | 24.2123-1776.3 | 010926 |   |  | Thz 23,81      | LUC |
|             | A 160 CDI     | 60       |          | 08.04 | 10.11                             |                                   |                |        |   |  |                |     |
|             | A 170         | 85       |          | 08.04 | 10.11                             |                                   |                |        |   |  |                |     |
|             | A 180         | 85       |          | 04.09 | 10.11                             |                                   |                |        |   |  |                |     |
|             | A 180 CDI     | 80       |          | 08.04 | 10.11                             |                                   |                |        |   |  |                |     |
|             | A 200         | 100      |          | 08.04 | 10.11                             |                                   |                |        |   |  |                |     |
|             | A 200 CDI     |          |          | 08.04 | 10.11                             |                                   |                |        |   |  |                |     |
|             | A 200 Turbo   | 142      |          | 03.05 | 10.11                             |                                   |                |        |   |  |                |     |
|             | E-Cell        | 50       |          | 12.10 | 10.11                             |                                   |                |        |   |  |                |     |
|             | A 150 / A 160 | 70       | J 215300 | 08.04 |                                   | - erhöhte Zuladung <sup>9)</sup>  | 24.3571-1751.7 | 220709 |   |  | D=57, - Halter | LUC |
|             | A 160 CDI     | 60       | J 215300 | 08.04 |                                   | - erhöhte Zuladung <sup>9)</sup>  |                |        |   |  |                |     |
|             | A 150 / A 160 | 70       | J 215301 |       | 10.11                             | - erhöhte Zuladung <sup>9)</sup>  |                |        |   |  |                |     |
|             | A 160 CDI     | 60       | J 215301 |       | 10.11                             | - erhöhte Zuladung <sup>9)</sup>  |                |        |   |  |                |     |
|             | A 170         | 85       | J 474115 |       | 10.11                             | - erhöhte Zuladung <sup>9)</sup>  | 24.3571-1749.7 | 220693 |   |  | D=57, - Halter | LUC |
|             | A 180         | 85       | J 474115 |       | 10.11                             | + erhöhte Zuladung <sup>10)</sup> |                |        |   |  |                |     |
|             | A 180 CDI     | 80       | J 474115 |       | 10.11                             | + erhöhte Zuladung <sup>10)</sup> |                |        |   |  |                |     |
|             | A 180 CDI     | 80       | J 474114 | 04.09 | 10.11                             | + erhöhte Zuladung <sup>10)</sup> |                |        |   |  |                |     |
|             | A 200         | 100      | J 474114 | 08.04 | 10.11                             | + erhöhte Zuladung <sup>10)</sup> |                |        |   |  |                |     |
|             | A 200 CDI     |          | J 474114 | 08.04 | 10.11                             | + erhöhte Zuladung <sup>10)</sup> | 24.3571-1750.7 | 220694 |   |  | D=57, - Halter | LUC |
|             | A 200 Turbo   | 142      | J 474114 | 03.05 | 10.11                             | + erhöhte Zuladung <sup>10)</sup> |                |        |   |  |                |     |
|             | A 200         | 100      | J 474114 | 08.04 | 10.11                             | + erhöhte Zuladung <sup>10)</sup> | 24.0101-3802.2 | 260100 |   |  | D=57, - Halter | LUC |
|             | A 200 CDI     |          | J 474114 | 08.04 | 10.11                             | + erhöhte Zuladung <sup>10)</sup> |                |        |   |  |                |     |
| A 200 Turbo | 142           | J 474114 | 03.05    | 10.11 | + erhöhte Zuladung <sup>10)</sup> |                                   |                |        |   |  |                |     |
|             | A 150 / A 160 | 70       |          | 08.04 | 10.11                             |                                   | 24.5126-0474.3 | 331017 | 2 |  | L=474          |     |
|             | A 160 CDI     | 60       |          | 08.04 | 10.11                             |                                   |                |        |   |  |                |     |
|             | A 170         | 85       |          | 08.04 | 10.11                             |                                   |                |        |   |  |                |     |
|             | A 180         | 85       |          | 04.09 | 10.11                             |                                   |                |        |   |  |                |     |
|             | A 180 CDI     | 80       |          | 08.04 | 10.11                             |                                   |                |        |   |  |                |     |
|             | A 200         | 100      |          | 08.04 | 10.11                             |                                   |                |        |   |  |                |     |

1) + drum brake / + freno a tamburo / + freins à tambour / + tambores de freno  
2) + disc brake / + disco freno / + disques de frein / + disco de freno  
3) on the brake caliper / sulla pinza freno / sur l'étrier de frein / a la pinza de freno  
4) + short wheel base / - (BR) / + passo corto / - (BR) / + empattement court / - (BR) / + distanc.corta entre ejes / - (BR)  
5) + short wheel base / + passo lungo / + empattement long / + distancia corta entre ejes  
6) - long wheel base / - passo lungo / - empattement long / - distancia larga entre ejes  
7) + (BR) / - long wheel base / + (BR) / - passo lungo / + (BR) / - empattement long / + (BR) / - distancia larga entre ejes

8) + long wheel base / + passo lungo / + empattement long / + distancia larga entre ejes  
9) - increased payload / - carico utile maggiorato / - charge utile augmentée / - incremento de carga  
10) + increased payload / + carico utile maggiorato / + charge utile augmentée / + incremento de carga



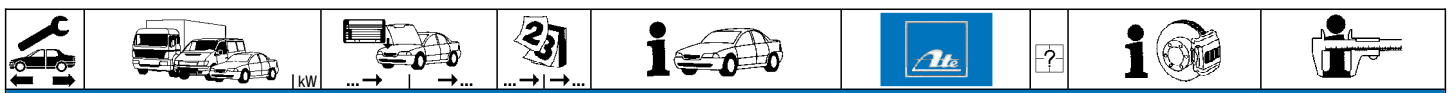

**MERCEDES BENZ A-Klasse (W169) (04-11)**

|  |  |  |  |  |   |  |                            |  |  |  |                   |
|--|--|--|--|--|---|--|----------------------------|--|--|--|-------------------|
|  | A 200 CDI<br>A 200 Turbo<br>E-Cell   | 142<br>50                                      |  | 08.04<br>03.05<br>12.10  | 10.11<br>10.11<br>10.11                                     | 24.5126-0474.3                                     | 331017                     | 2  |  | L=474  |                   |
|  | A 150 / A 160<br>A 160 CDI<br>A 170<br>A 180<br>A 180 CDI<br>A 200<br>A 200 CDI<br>A 200 Turbo           | 70<br>60<br>85<br>85<br>80<br>100<br>142       | J 474114<br>J 474114<br>J 474114<br>J 474114<br>J 474114<br>J 474114<br>J 474114 | 08.04<br>08.04<br>08.04<br>04.09<br>08.04<br>08.04<br>08.04          |   | 24.3301-1703.7<br>24.3301-1704.7<br>24.0101-3802.2 | 220683<br>220684<br>260100 | <input type="checkbox"/><br><input type="checkbox"/> |  | D=30, - Halter<br>D=30, - Halter<br>Einbausatz | LUC<br>LUC<br>LUC |
|  | A 150 / A 160<br>A 160 CDI<br>A 170<br>A 180<br>A 180 CDI<br>A 200<br>A 200 CDI<br>A 200 Turbo<br>E-Cell | 70<br>60<br>85<br>85<br>80<br>100<br>142<br>50 | J 474115<br>J 474115<br>J 474115<br>J 474115<br>J 474115<br>J 474115<br>J 474115 | 08.04<br>10.11<br>10.11<br>10.11<br>10.11<br>10.11<br>10.11          |   | 24.3301-1703.7<br>24.3301-1704.7<br>24.0101-3802.2 | 220683<br>220684<br>260100 | <input type="checkbox"/><br><input type="checkbox"/> |  | D=30, - Halter<br>D=30, - Halter<br>Einbausatz | LUC<br>LUC<br>LUC |
|  | A 150 / A 160<br>A 160 CDI<br>A 170<br>A 180<br>A 180 CDI<br>A 200<br>A 200 CDI<br>A 200 Turbo<br>E-Cell | 70<br>60<br>85<br>85<br>80<br>100<br>142<br>50 |  | 08.04<br>08.04<br>08.04<br>04.09<br>08.04<br>08.04<br>03.05<br>12.10 | 10.11<br>10.11<br>10.11<br>10.11<br>10.11<br>10.11<br>10.11 | 24.5238-0230.3                                     | 330673                     | 2  |  | L=230  |                   |
|  | A 150 / A 160<br>A 160 CDI<br>A 170<br>A 180<br>A 180 CDI<br>A 200<br>A 200 CDI<br>A 200 Turbo<br>E-Cell | 70<br>60<br>85<br>85<br>80<br>100<br>142<br>50 |  | 08.04<br>08.04<br>08.04<br>04.09<br>08.04<br>08.04<br>03.05<br>12.10 | 10.11<br>10.11<br>10.11<br>10.11<br>10.11<br>10.11<br>10.11 | 24.3727-0452.2<br>24.3727-0451.2                   | 580452<br>580451           | <input type="checkbox"/><br><input type="checkbox"/> |  | L=587<br>L=1215                                |                   |

**MERCEDES BENZ B-Klasse (W245) (05-11)**

|  |  |   |  |  |  |  |                            |  |  |  |                   |
|--|--|---|--|--|--|--|----------------------------|--|--|--|-------------------|
|  | B 150 / B 160<br>B 160 BlueEfficiency<br>B 170 / B 180<br>B 170 NGT<br>B 180 BlueEfficiency<br>B 180 CDI<br>B 180 NGT<br>B 200<br>B 200 CDI<br>B 200 Turbo | 70<br>85<br>85<br>85<br>80<br>85<br>100<br>103<br>142 |  | 03.05<br>04.09<br>03.05<br>04.08<br>04.09<br>03.05<br>04.09<br>03.05<br>03.05<br>03.05 | 04.11<br>04.11<br>04.11<br>04.09<br>04.11<br>04.11<br>04.11<br>04.11<br>04.11<br>04.11 | 24.2123-1776.3                                     | 010926                     |  |  | THz 23,81                                      | LUC               |
|  | B 150 / B 160<br>B 160 BlueEfficiency<br>B 170 / B 180<br>B 180 BlueEfficiency<br>B 170 NGT<br>B 180 CDI<br>B 180 NGT<br>B 200<br>B 200 CDI<br>B 200 Turbo | 70<br>85<br>85<br>85<br>80<br>85<br>100<br>103<br>142 |  | 03.05<br>04.09<br>03.05<br>04.08<br>04.09<br>03.05<br>04.09<br>03.05<br>03.05<br>03.05 | 04.11<br>04.11<br>04.11<br>04.11<br>04.09<br>04.11<br>04.11<br>04.11<br>04.11<br>04.11 | 24.3571-1749.7<br>24.3571-1750.7<br>24.0101-3802.2 | 220693<br>220694<br>260100 | <input type="checkbox"/><br><input type="checkbox"/> |  | D=57, - Halter<br>D=57, - Halter<br>Einbausatz | LUC<br>LUC<br>LUC |
|  | B 150 / B 160<br>B 160 BlueEfficiency<br>B 170 / B 180<br>B 170 NGT<br>B 180 BlueEfficiency<br>B 180 CDI<br>B 180 NGT<br>B 200<br>B 200 CDI<br>B 200 Turbo | 70<br>85<br>85<br>85<br>80<br>85<br>100<br>103<br>142 |  | 03.05<br>04.09<br>03.05<br>04.08<br>04.09<br>03.05<br>04.09<br>03.05<br>03.05<br>03.05 | 04.11<br>04.11<br>04.11<br>04.09<br>04.11<br>04.11<br>04.11<br>04.11<br>04.11<br>04.11 | 24.5126-0474.3                                     | 331017                     | 2  |  | L=474  |                   |
|  | B 150 / B 160<br>B 160 BlueEfficiency<br>B 170 / B 180<br>B 170 NGT<br>B 180 BlueEfficiency<br>B 180 CDI<br>B 180 NGT<br>B 200<br>B 200 CDI<br>B 200 Turbo | 70<br>85<br>85<br>85<br>80<br>85<br>100<br>103<br>142 |  | 03.05<br>04.09<br>03.05<br>04.08<br>04.09<br>03.05<br>04.09<br>03.05<br>03.05<br>03.05 | 04.11<br>04.11<br>04.11<br>04.09<br>04.11<br>04.11<br>04.11<br>04.11<br>04.11<br>04.11 | 24.3301-1703.7<br>24.3301-1704.7<br>24.0101-3802.2 | 220683<br>220684<br>260100 | <input type="checkbox"/><br><input type="checkbox"/> |  | D=30, - Halter<br>D=30, - Halter<br>Einbausatz | LUC<br>LUC<br>LUC |
|  | B 150 / B 160<br>B 160 BlueEfficiency<br>B 170 / B 180<br>B 170 NGT<br>B 180 BlueEfficiency<br>B 180 CDI<br>B 180 NGT                                      | 70<br>85<br>85<br>85<br>80<br>85                      |  | 03.05<br>04.09<br>03.05<br>04.08<br>04.09<br>03.05<br>04.09                            | 04.11<br>04.11<br>04.11<br>04.09<br>04.11<br>04.11<br>04.11                            | 24.5238-0230.3                                     | 330673                     | 2  |  | L=230  |                   |



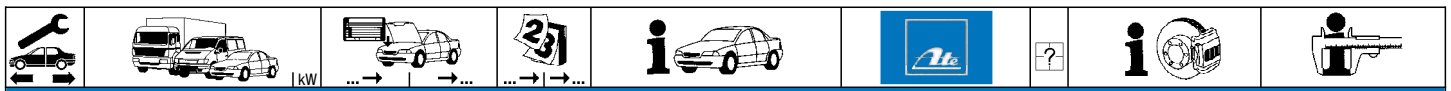





















**MERCEDES BENZ B-Klasse (W245) (05-11)**











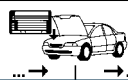

|  |                      |     |  |       |       |                |        |                          |  |        |
|--|----------------------|-----|--|-------|-------|----------------|--------|--------------------------|--|--------|
|  | B 200                | 100 |  | 03.05 | 04.11 | 24.5238-0230.3 | 330673 | 2                        |  | L=230  |
|  | B 200 CDI            | 103 |  | 03.05 | 04.11 |                |        |                          |  |        |
|  | B 200 Turbo          | 142 |  | 03.05 | 04.11 |                |        |                          |  |        |
|  | B 150 / B 160        | 70  |  | 03.05 | 04.11 | 24.3727-0452.2 | 580452 | <input type="checkbox"/> |  | L=587  |
|  | B 160 BlueEfficiency |     |  | 04.09 | 04.11 | 24.3727-0451.2 | 580451 | <input type="checkbox"/> |  | L=1215 |
|  | B 170 / B 180        | 85  |  | 03.05 | 04.11 |                |        |                          |  |        |
|  | B 170 NGT            | 85  |  | 04.08 | 04.09 |                |        |                          |  |        |
|  | B 180 BlueEfficiency |     |  | 04.09 | 04.11 |                |        |                          |  |        |
|  | B 180 CDI            | 80  |  | 03.05 | 04.11 |                |        |                          |  |        |
|  | B 180 NGT            | 85  |  | 04.09 | 04.11 |                |        |                          |  |        |
|  | B 200                | 100 |  | 03.05 | 04.11 |                |        |                          |  |        |
|  | B 200 CDI            | 103 |  | 03.05 | 04.11 |                |        |                          |  |        |
|  | B 200 Turbo          | 142 |  | 03.05 | 04.11 |                |        |                          |  |        |

**MERCEDES BENZ C-Klasse (W202) Limousine (93-00)**

|  |                  |         |         |       |       |                |        |  |  |                 |       |
|--|------------------|---------|---------|-------|-------|----------------|--------|--|--|-----------------|-------|
|  | C 180            | F011180 | F619720 |       |       | 03.7760-2702.4 | 300090 |  |  | 10"             | ATE   |
|  | C 180            | A021677 | A519673 |       |       |                |        |  |  |                 |       |
|  | C 200            |         | F619720 | 01.94 |       |                |        |  |  |                 |       |
|  | C 200            |         | A519673 | 01.94 |       |                |        |  |  |                 |       |
|  | C 200 D          | F060570 | F619720 |       |       |                |        |  |  |                 |       |
|  | C 200 D          | A072908 | A519673 |       |       |                |        |  |  |                 |       |
|  | C 200 Kompressor |         | F619720 | 10.95 |       |                |        |  |  |                 |       |
|  | C 200 Kompressor |         | A519673 | 10.95 |       |                |        |  |  |                 |       |
|  | C 220            |         |         | 03.93 | 08.96 |                |        |  |  |                 |       |
|  | C 220 D          | F060570 | F619720 |       |       |                |        |  |  |                 |       |
|  | C 220 D          | A072908 | A519673 |       |       |                |        |  |  |                 |       |
|  | C 230            |         |         | 07.96 | 06.97 |                |        |  |  |                 |       |
|  | C 230 Kompressor |         | F619720 | 09.95 |       |                |        |  |  |                 |       |
|  | C 230 Kompressor |         | A519673 | 09.95 |       |                |        |  |  |                 |       |
|  | C 250 D          | F060570 |         |       | 08.95 |                |        |  |  |                 |       |
|  | C 250 D          | A072908 |         |       | 08.95 |                |        |  |  |                 |       |
|  | C 250 TD         |         | F619720 | 09.95 |       |                |        |  |  |                 |       |
|  | C 250 TD         |         | A519673 | 09.95 |       |                |        |  |  |                 |       |
|  | C 280            |         |         | 06.93 | 05.97 |                |        |  |  |                 |       |
|  | C 36 AMG         |         |         | 05.94 | 08.97 |                |        |  |  |                 |       |
|  | C 180            |         | F011179 | 03.93 |       | 24.2022-1601.3 | 010340 |  |  | Thz 22,20/17,46 |       |
|  | C 180            |         | A021676 | 03.93 |       |                |        |  |  |                 |       |
|  | C 200 D          |         | F060569 | 03.93 |       |                |        |  |  |                 |       |
|  | C 200 D          |         | A072907 | 03.93 |       |                |        |  |  |                 |       |
|  | C 220 D          |         | F060569 | 06.93 |       |                |        |  |  |                 |       |
|  | C 220 D          |         | A072907 | 06.93 |       |                |        |  |  |                 |       |
|  | C 250 D          |         | F050569 | 06.93 |       |                |        |  |  |                 |       |
|  | C 250 D          |         | A072907 | 06.93 |       |                |        |  |  |                 |       |
|  | C 180            | A021677 | A136773 |       |       | 03.2023-0825.3 | 010028 |  |  | Thz 23,81/19,05 | ATE   |
|  | C 180            | F011180 |         | 05.00 |       |                |        |  |  |                 |       |
|  | C 200            |         | F110261 | 01.94 |       |                |        |  |  |                 |       |
|  | C 200            |         | A136773 | 01.94 |       |                |        |  |  |                 |       |
|  | C 200 D          | F060570 |         |       | 05.00 |                |        |  |  |                 |       |
|  | C 200 D          | A072908 |         |       | 05.00 |                |        |  |  |                 |       |
|  | C 220            |         | F110261 | 06.93 |       |                |        |  |  |                 |       |
|  | C 220            |         | A136773 | 06.93 |       |                |        |  |  |                 |       |
|  | C 220 D          | F060570 |         |       | 05.00 |                |        |  |  |                 |       |
|  | C 220 D          | A072908 |         |       | 05.00 |                |        |  |  |                 |       |
|  | C 250 D          | F060570 |         |       | 08.95 |                |        |  |  |                 |       |
|  | C 250 D          | A072908 |         |       | 08.95 |                |        |  |  |                 |       |
|  | C 280            |         | F110261 | 06.93 |       |                |        |  |  |                 |       |
|  | C 280            |         | A136773 | 06.93 |       |                |        |  |  |                 |       |
|  | C 36 AMG         |         | F110261 | 05.94 |       |                |        |  |  |                 |       |
|  | C 36 AMG         |         | A136773 | 05.94 |       |                |        |  |  |                 |       |
|  | C 180            | A136774 |         | 05.00 |       | 24.2023-1701.3 | 010514 |  |  | Thz 23,81/19,05 | LUC   |
|  | C 200            | F110262 |         | 05.00 |       |                |        |  |  |                 |       |
|  | C 200            | A136774 |         | 05.00 |       |                |        |  |  |                 |       |
|  | C 200 Kompressor |         | F619720 | 10.95 |       |                |        |  |  |                 |       |
|  | C 200 Kompressor |         | A519673 | 10.95 |       |                |        |  |  |                 |       |
|  | C 220            | F110262 |         |       | 08.96 |                |        |  |  |                 |       |
|  | C 220            | A136774 |         |       | 08.96 |                |        |  |  |                 |       |
|  | C 230            |         |         | 07.96 | 06.97 |                |        |  |  |                 |       |
|  | C 230 Kompressor |         | F619720 | 09.95 |       |                |        |  |  |                 |       |
|  | C 230 Kompressor |         | A519673 | 09.95 |       |                |        |  |  |                 |       |
|  | C 250 TD         |         | F619720 | 09.95 |       |                |        |  |  |                 |       |
|  | C 250 TD         |         | A519673 | 09.95 |       |                |        |  |  |                 |       |
|  | C 280            | F110262 |         |       | 05.97 |                |        |  |  |                 |       |
|  | C 280            | A136774 |         |       | 05.97 |                |        |  |  |                 |       |
|  | C 36 AMG         | F110262 |         |       | 08.97 |                |        |  |  |                 |       |
|  | C 36 AMG         | A136774 |         |       | 08.97 |                |        |  |  |                 |       |
|  | C 200 CDI        |         | F619721 | 03.98 | 05.00 | 24.2023-1702.3 | 010534 |  |  | Thz 23,81/19,05 | LUC   |
|  | C 200 Kompressor |         | A519674 |       | 05.00 |                |        |  |  |                 |       |
|  | C 220 CDI        |         |         | 09.97 | 05.00 |                |        |  |  |                 |       |
|  | C 230 Kompressor |         | F619721 |       | 05.00 |                |        |  |  |                 |       |
|  | C 230 Kompressor |         | A519674 |       | 05.00 |                |        |  |  |                 |       |
|  | C 240            |         |         | 06.97 | 05.00 |                |        |  |  |                 | - ESP |
|  | C 250 TD         |         | F619721 |       | 05.00 |                |        |  |  |                 |       |
|  | C 250 TD         |         | A519674 |       | 05.00 |                |        |  |  |                 |       |
|  | C 280            |         |         | 06.97 | 05.00 |                |        |  |  |                 | - ESP |
|  | C 240            |         |         | 06.97 | 05.00 | 24.2023-1704.3 | 010635 |  |  | Thz 23,81       | LUC   |
|  | C 280            |         |         | 06.97 | 05.00 |                |        |  |  |                 | + ESP |



| MERCEDES BENZ C-Klasse (W202) Limousine (93-00)                                    |                  |         |         |       |       |  |                |        |   |                |     |
|--|------------------|---------|---------|-------|-------|--|----------------|--------|---|----------------|-----|
|    | C 43 AMG         |         |         | 09.97 | 05.00 |  | 24.2023-1704.3 | 010635 |   | Thz 23,81      | LUC |
|    | C 180            | F331441 |         |       | 05.00 |  | 24.3541-1755.7 | 220481 |    | D=54, - Halter | LUC |
|  | C 180            | A344661 |         |       | 05.00 |  | 24.3541-1756.7 | 220482 |    | D=54, - Halter | LUC |
|  | C 220 D          | F331441 |         |       | 05.00 |  |                |        |   |                |     |
|  | C 220 D          | A344661 |         |       | 05.00 |  |                |        |   |                |     |
|  | C 250 D          | F331441 |         |       | 08.95 |  |                |        |   |                |     |
|  | C 250 D          | A344661 |         |       | 08.95 |  |                |        |   |                |     |
|  | C 200            |         | F331440 | 01.94 |       |  | 24.3541-1617.7 | 220227 |    | D=54, - Halter | LUC |
|  | C 200            |         | A344660 | 01.94 |       |  | 24.3541-1618.7 | 220228 |    | D=54, - Halter | LUC |
|  | C 220            |         | F331440 | 03.93 |       |  |                |        |   |                |     |
|  | C 220            |         | A344660 | 03.93 |       |  |                |        |   |                |     |
|  | C 280            |         | F331440 | 06.93 |       |  |                |        |   |                |     |
|  | C 280            |         | A344660 | 06.93 |       |  |                |        |   |                |     |
|  | C 200            | F331441 |         |       | 05.00 |  | 24.3541-1751.7 | 220477 |    | D=54, - Halter | LUC |
|  | C 200            | A344661 |         |       | 05.00 |  | 24.3541-1752.7 | 220478 |    | D=54, - Halter | LUC |
|  | C 200 CDI        |         |         | 03.98 | 05.00 |  |                |        |   |                |     |
|  | C 220            | F331441 |         |       | 08.96 |  |                |        |   |                |     |
|  | C 220            | A344661 |         |       | 08.96 |  |                |        |   |                |     |
|  | C 220 CDI        |         |         | 09.97 | 05.00 |  |                |        |   |                |     |
|  | C 230            |         |         | 07.96 | 06.97 |  |                |        |   |                |     |
|  | C 200 Kompressor |         |         | 10.95 | 05.00 |  | 11.3571-8511.2 | 220315 |    | D=57, - Halter | ATE |
|  | C 230 Kompressor |         |         | 09.95 | 05.00 |  | 11.3571-8512.2 | 220316 |    | D=57, - Halter | ATE |
|  | C 240            |         |         | 06.97 | 05.00 |  | 24.3571-8511.5 | 240491 |    | D=57, - Halter | ATE |
|  | C 250 TD         |         |         | 09.95 | 05.00 |  | 24.3571-8512.5 | 240492 |    | D=57, - Halter | ATE |
|  | C 280            | F331441 |         |       | 05.00 |  | 11.0441-5703.2 | 250145 |   | Dichtungssatz  | ATE |
|  | C 280            | A344661 |         |       | 05.00 |  | 11.0230-0096.2 | 260033 |   | Haltersatz     | ATE |
|  |                  |         |         |       |       |  | 11.0101-5407.2 | 260011 |   | Hülsensatz     | ATE |
|  |                  |         |         |       |       |  | 11.8171-0008.1 | 990049 |   | Führungsbolzen | ATE |
|  |                  |         |         |       |       |  | 11.8116-0253.1 | 390512 | 2   | Haltefeder     | ATE |
|  | C 36 AMG         |         | F331440 | 05.94 |       |  | 13.0441-4214.2 | 250091 |   | Dichtungssatz  | ATE |
|  | C 36 AMG         |         | A344660 | 05.94 |       |  |                |        |   |                |     |
|  | C 36 AMG         | F331441 |         |       | 08.97 |  | 13.4421-8009.2 | 210228 |    | D=42/38        | ATE |
|  | C 36 AMG         | A344661 |         |       | 08.97 |  | 13.4421-8010.2 | 210229 |    | D=42/38        | ATE |
|  |                  |         |         |       |       |  | 13.0441-4214.2 | 250091 |   | Dichtungssatz  | ATE |
|  | C 43 AMG         |         |         | 09.97 | 05.00 |  | 11.8116-0133.1 | 390511 | 2   | Haltefeder     | ATE |
|    | C 180            |         | F331440 | 03.93 |       |  | 83.6115-0480.3 | 330385 | 2   | L=480          |     |
|  | C 180            |         | A344660 | 03.93 |       |  |                |        |   |                |     |
|  | C 200            |         | F331440 | 01.94 |       |  |                |        |   |                |     |
|  | C 200            |         | A344660 | 01.94 |       |  |                |        |   |                |     |
|  | C 200 D          |         | F331440 | 03.93 |       |  |                |        |   |                |     |
|  | C 200 D          |         | A344660 | 03.93 |       |  |                |        |   |                |     |
|  | C 220            |         | F331440 | 03.93 |       |  |                |        |   |                |     |
|  | C 220            |         | A344660 | 03.93 |       |  |                |        |   |                |     |
|  | C 220 D          |         | F331440 | 06.93 |       |  |                |        |   |                |     |
|  | C 220 D          |         | A344660 | 06.93 |       |  |                |        |   |                |     |
|  | C 250 D          |         | F331440 | 06.93 |       |  |                |        |   |                |     |
|  | C 250 D          |         | A344660 | 06.93 |       |  |                |        |   |                |     |
|  | C 280            |         | F331440 | 06.93 |       |  |                |        |   |                |     |
|  | C 280            |         | A344660 | 06.93 |       |  |                |        |   |                |     |
|  | C 36 AMG         |         | F331440 | 05.94 |       |  |                |        |   |                |     |
|  | C 36 AMG         |         | A344660 | 05.94 |       |  |                |        |   |                |     |
|  | C 180            | F331441 |         |       | 05.00 |  | 83.7705-0386.3 | 330828 | 2   | L=385          |     |
|  | C 180            | A344661 |         |       | 05.00 |  |                |        |   |                |     |
|  | C 200            | F331441 |         |       | 05.00 |  |                |        |   |                |     |
|  | C 200            | A344661 |         |       | 05.00 |  |                |        |   |                |     |
|  | C 200 CDI        |         |         | 03.98 | 05.00 |  |                |        |   |                |     |
|  | C 200 D          | F331441 |         |       | 05.00 |  |                |        |   |                |     |
|  | C 200 D          | A344661 |         |       | 05.00 |  |                |        |   |                |     |
|  | C 200 Kompressor |         |         | 10.95 | 05.00 |  |                |        |   |                |     |
|  | C 220            | F331441 |         |       | 08.96 |  |                |        |   |                |     |
|  | C 220            | A344661 |         |       | 08.96 |  |                |        |   |                |     |
|  | C 220 CDI        |         |         | 09.97 | 05.00 |  |                |        |   |                |     |
|  | C 220 D          | F331441 |         |       | 05.00 |  |                |        |   |                |     |
|  | C 220 D          | A344661 |         |       | 05.00 |  |                |        |   |                |     |
|  | C 230            |         |         | 07.96 | 06.97 |  |                |        |   |                |     |
|  | C 230 Kompressor |         |         | 09.95 | 05.00 |  |                |        |   |                |     |
|  | C 240            |         |         | 06.97 | 05.00 |  |                |        |   |                |     |
|  | C 250 D          | F331441 |         |       | 08.95 |  |                |        |   |                |     |
|  | C 250 D          | A344661 |         |       | 08.95 |  |                |        |   |                |     |
|  | C 250 TD         |         |         | 09.95 | 05.00 |  |                |        |   |                |     |
|  | C 280            | F331441 |         |       | 05.00 |  |                |        |   |                |     |
|  | C 280            | A344661 |         |       | 05.00 |  |                |        |   |                |     |
|  | C 36 AMG         | F331441 |         |       | 08.97 |  |                |        |   |                |     |
|  | C 36 AMG         | A344661 |         |       | 08.97 |  |                |        |   |                |     |
|  | C 43 AMG         |         |         | 09.97 | 05.00 |  |                |        |   |                |     |
|  | C 180            |         | F443892 | 03.93 |       |  | 13.2351-8005.2 | 210014 |  | D=35           | ATE |
|  | C 180            |         | A419828 | 03.93 |       |  | 13.2351-8006.2 | 210015 |  | D=35           | ATE |
|  | C 200            |         | F443892 | 01.94 |       |  | 24.9235-8005.5 | 230023 |  | D=35           | ATE |
|  | C 200            |         | A419828 | 01.94 |       |  | 24.9235-8006.5 | 230024 |  | D=35           | ATE |
|  | C 200 D          |         | F443892 | 03.93 |       |  | 13.0441-3505.2 | 250051 |   | Dichtungssatz  | ATE |
|  | C 200 D          |         | A419828 | 03.93 |       |  |                |        |   |                |     |
|  | C 220            |         | F443892 | 03.93 |       |  |                |        |   |                |     |
|  | C 220            |         | A419828 | 03.93 |       |  |                |        |   |                |     |
|  | C 220 D          |         | F443892 | 06.93 |       |  |                |        |   |                |     |

|     |  |  |  |  |  |  |  |  |                          |               |
|--|--|--|--|--|---|--|--|--|--------------------------|---------------|
| <b>MERCEDES BENZ C-Klasse (W202) Limousine (93-00)</b>                             |  |  |  |  |   |  |  |  |                          |               |
|    | C 220 D  |  | A419828  | 06.93  |   | 13.2351-8005.2   | 210014   | <input type="checkbox"/>   | D=35                     | ATE           |
|  | C 250 D  |  | F443892  | 06.93  |   | 13.2351-8006.2   | 210015   | <input type="checkbox"/>   | D=35                     | ATE           |
|  | C 250 D  |  | A419828  | 06.93  |   | 24.9235-8005.5   | 230023   | <input type="checkbox"/>   | D=35                     | ATE           |
|  |  |  |  |  |   | 24.9235-8006.5   | 230024   | <input type="checkbox"/>   | D=35                     | ATE           |
|  |  |  |  |  |   | 13.0441-3505.2   | 250051   | <input type="checkbox"/>   | Dichtungssatz            | ATE           |
|  | C 180  | F443893  |  | 05.00  |   | 13.2351-8019.2   | 210139   | <input type="checkbox"/>   | D=35                     | ATE           |
|  | C 180  | A419829  |  | 05.00  |   | 13.2351-8020.2   | 210140   | <input type="checkbox"/>   | D=35                     | ATE           |
|  | C 200  | F443893  |  | 05.00  |   | 13.0441-3507.2   | 250053   |  | Dichtungssatz            | ATE           |
|  | C 200  | A419829  |  | 05.00  |   |  |  |  |                          |               |
|  | C 200 CDI  |  |  | 03.98  | 05.00   |  |  |  |                          |               |
|  | C 200 D  | F443893  |  | 05.00  |   |  |  |  |                          |               |
|  | C 200 D  | A419829  |  | 05.00  |   |  |  |  |                          |               |
|  | C 220  | F443893  |  | 08.96  |   |  |  |  |                          |               |
|  | C 220  | A419829  |  | 08.96  |   |  |  |  |                          |               |
|  | C 220 CDI  |  |  | 09.97  | 05.00   |  |  |  |                          |               |
|  | C 220 D  | F443893  |  | 05.00  |   |  |  |  |                          |               |
|  | C 220 D  | A419829  |  | 05.00  |   |  |  |  |                          |               |
|  | C 230  |  |  | 07.96  | 06.97   |  |  |  |                          |               |
|  | C 250 D  | F443893  |  | 08.95  |   |  |  |  |                          |               |
|  | C 250 D  | A419829  |  | 08.95  |   |  |  |  |                          |               |
|  | C 280  | 142  | F331440  | 06.93  | - ASR   |  |  |  |                          |               |
|  | C 280  | 142  | A344660  | 06.93  | - ASR   |  |  |  |                          |               |
|  | C 200 Kompressor   |  | F576240  | 10.95  |   | 13.2381-8035.2   | 210037   | <input type="checkbox"/>   | D=38                     | ATE           |
|  | C 200 Kompressor   |  | A487047  | 10.95  |   | 13.2381-8036.2   | 210038   | <input type="checkbox"/>   | D=38                     | ATE           |
|  | C 230 Kompressor   |  | F576240  | 09.95  |   | 24.9238-8035.5   | 230025   | <input type="checkbox"/>   | D=38                     | ATE           |
|  | C 230 Kompressor   |  | A487047  | 09.95  |   | 24.9238-8036.5   | 230026   | <input type="checkbox"/>   | D=38                     | ATE           |
|  | C 240  |  | F576240  | 06.97  |   | 13.0441-3817.2   | 250071   | <input type="checkbox"/>   | Dichtungssatz            | ATE           |
|  | C 240  |  | A487047  | 06.97  |   |  |  |  |                          |               |
|  | C 250 TD   |  | F576240  | 09.95  |   |  |  |  |                          |               |
|  | C 250 TD   |  | A487047  | 09.95  |   |  |  |  |                          |               |
|  | C 280  | 142  | F331441  | 05.97  | - ASR   |  |  |  |                          |               |
|  | C 280  | 142  | A344661  | 05.97  | - ASR   |  |  |  |                          |               |
|  | C 280  | 145  | F576240  | 06.97  |   |  |  |  |                          |               |
|  | C 280  | 145  | A487047  | 06.97  |   |  |  |  |                          |               |
|  | C 200 Kompressor   | F576241  |  | 05.00  |   | 13.2361-8003.2   | 210220   | <input type="checkbox"/>   | D=36                     | ATE           |
|  | C 200 Kompressor   | A487048  |  | 05.00  |   | 13.2361-8004.2   | 210221   | <input type="checkbox"/>   | D=36                     | ATE           |
|  | C 230 Kompressor   | F576241  |  | 05.00  |   | 13.0441-3609.2   | 250057   |  | Dichtungssatz            | ATE           |
|  | C 230 Kompressor   | A487048  |  | 05.00  |   |  |  |  |                          |               |
|  | C 240  | F576241  |  | 05.00  |   |  |  |  |                          |               |
|  | C 240  | A487048  |  | 05.00  |   |  |  |  |                          |               |
|  | C 250 TD   | F576241  |  | 05.00  |   |  |  |  |                          |               |
|  | C 250 TD   | A487048  |  | 05.00  |   |  |  |  |                          |               |
|  | C 280  | 145  | F576241  | 05.00  |   |  |  |  |                          |               |
|  | C 280  | 145  | A487048  | 05.00  |   |  |  |  |                          |               |
|  | C 280  |  |  | 06.93  | 05.97   | + ASR  | 13.2351-8017.2   | 210218   | <input type="checkbox"/> | D=35          |
|  |  |  |  |  |   |  | 13.2351-8018.2   | 210219   | <input type="checkbox"/> | D=35          |
|  |  |  |  |  |   |  | 13.0441-3817.2   | 250071   |                          | Dichtungssatz |
|  | C 36 AMG   |  | F331440  | 05.94  |   | 13.2381-8033.2   | 210222   | <input type="checkbox"/>   | D=38                     | ATE           |
|  | C 36 AMG   |  | A344660  | 05.94  |   | 13.2381-8034.2   | 210223   | <input type="checkbox"/>   | D=38                     | ATE           |
|  |  |  |  |  |   | 24.9238-8033.5   | 230015   | <input type="checkbox"/>   | D=38                     | ATE           |
|  |  |  |  |  |   | 24.9238-8034.5   | 230016   | <input type="checkbox"/>   | D=38                     | ATE           |
|  |  |  |  |  |   | 13.0441-3817.2   | 250071   |  | Dichtungssatz            | ATE           |
|  | C 36 AMG   | F331441  |  | 08.97  |   | 13.2361-8001.2   | 210214   | <input type="checkbox"/>   | D=36                     | ATE           |
|  | C 36 AMG   | A344661  |  | 08.97  |   | 13.2361-8002.2   | 210215   | <input type="checkbox"/>   | D=36                     | ATE           |
|  |  |  |  |  |   | 24.9236-8001.5   | 230007   | <input type="checkbox"/>   | D=36                     | ATE           |
|  |  |  |  |  |   | 24.9236-8002.5   | 230008   | <input type="checkbox"/>   | D=36                     | ATE           |
|  |  |  |  |  |   | 13.0441-3606.2   | 250147   |  | Dichtungssatz            | ATE           |
|  | C 43 AMG   |  |  | 09.97  | 05.00   |  |  | <input type="checkbox"/>   | D=42                     | ATE           |
|  |  |  |  |  |   | 13.2421-8025.2   | 210061   | <input type="checkbox"/>   | D=42                     | ATE           |
|  |  |  |  |  |   | 13.2421-8026.2   | 210062   | <input type="checkbox"/>   | D=42                     | ATE           |
|  |  |  |  |  |   | 13.0441-3606.2   | 250147   |  | Dichtungssatz            | ATE           |
|  | C 180  |  |  | 03.93  | 08.95   | 83.7704-0281.3   | 330804   | 2  |                          | L=280         |
|  | C 200  |  |  | 01.94  | 08.95   |  |  |  |                          |               |
|  | C 200 D  |  |  | 03.93  | 08.95   |  |  |  |                          |               |
|  | C 220  |  |  | 03.93  | 08.95   |  |  |  |                          |               |
|  | C 220 D  |  |  | 06.93  | 08.95   |  |  |  |                          |               |
|  | C 250 D  |  |  | 06.93  | 08.95   |  |  |  |                          |               |
|  | C 280  |  |  | 06.93  | 08.95   |  |  |  |                          |               |
|  | C 180  |  |  | 09.95  | 05.00   | 83.7715-0280.3   | 330806   | 2  |                          | L=280         |
|  | C 200  |  |  | 09.95  | 05.00   |  |  |  |                          |               |
|  | C 200 CDI  |  |  | 03.98  | 05.00   |  |  |  |                          |               |
|  | C 200 D  |  |  | 09.95  | 05.00   |  |  |  |                          |               |
|  | C 200 Kompressor   |  |  | 10.95  | 05.00   |  |  |  |                          |               |
|  | C 220  |  |  | 09.95  | 08.96   |  |  |  |                          |               |
|  | C 220 CDI  |  |  | 09.97  | 05.00   |  |  |  |                          |               |
|  | C 220 D  |  |  | 09.95  | 05.00   |  |  |  |                          |               |
|  | C 230  |  |  | 07.96  | 06.97   |  |  |  |                          |               |
|  | C 230 Kompressor   |  |  | 09.95  | 05.00   |  |  |  |                          |               |
|  | C 240  |  |  | 06.97  | 05.00   |  |  |  |                          |               |
|  | C 250 TD   |  |  | 09.95  | 05.00   |  |  |  |                          |               |
|  | C 280  |  |  | 09.95  | 05.00   |  |  |  |                          |               |
|  | C 36 AMG   |  |  | 05.94  | 08.97   |  |  |  |                          |               |
|  | C 43 AMG   |  |  | 09.97  | 05.00   |  |  |  |                          |               |
|  | C 180  |  |  | 03.93  | 05.00   | 24.3727-0423.2   | 580423   | 1  | <input type="checkbox"/> | L=2554        |
|  | C 200  |  |  | 01.94  | 05.00   | 24.3727-0418.2   | 580418   | <input type="checkbox"/>   | <input type="checkbox"/> | L=960         |
|  | C 200 CDI  |  |  | 03.98  | 05.00   | 24.3727-0419.2   | 580419   | <input type="checkbox"/>   | <input type="checkbox"/> | L=925         |
|  | C 200 D  |  |  | 03.93  | 05.00   |  |  |  |                          |               |
|  | C 200 Kompressor   |  |  | 10.95  | 05.00   |  |  |  |                          |               |

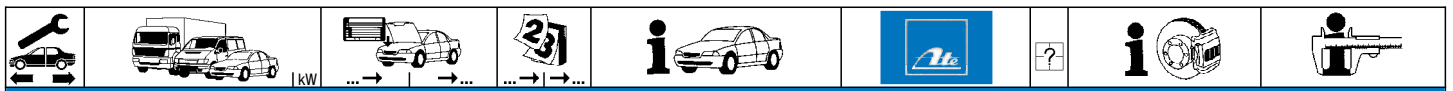

**MERCEDES BENZ C-Klasse (W202) Limousine (93-00)**

|                  |                  |       |       |                |                |                |                     |          |                          |       |
|------------------|------------------|-------|-------|----------------|----------------|----------------|---------------------|----------|--------------------------|-------|
|                  | C 220            |       | 03.93 | 08.96          | 24.3727-0423.2 | 580423         | 1                   |          | L=2554<br>L=960<br>L=925 |       |
|                  | C 220 CDI        |       | 09.97 | 05.00          | 24.3727-0418.2 | 580418         |                     |          |                          |       |
|                  | C 220 D          |       | 06.93 | 05.00          | 24.3727-0419.2 | 580419         |                     |          |                          |       |
|                  | C 230            |       | 07.96 | 06.97          |                |                |                     |          |                          |       |
|                  | C 230 Kompressor |       | 09.95 | 05.00          |                |                |                     |          |                          |       |
|                  | C 240            |       | 06.97 | 05.00          |                |                |                     |          |                          |       |
|                  | C 250 D          |       | 06.93 | 08.95          |                |                |                     |          |                          |       |
|                  | C 250 TD         |       | 09.95 | 05.00          |                |                |                     |          |                          |       |
|                  | C 280            |       | 06.93 | 05.00          |                |                |                     |          |                          |       |
|                  | C 36 AMG         |       | 05.94 | 08.97          |                |                |                     |          |                          |       |
|                  | C 43 AMG         |       | 09.97 | 05.00          | 24.3727-0418.2 | 580418         |                     |          |                          | L=960 |
|                  |                  |       |       |                | 24.3727-0419.2 | 580419         |                     |          |                          | L=925 |
|                  | C 180            |       | 03.93 | 05.00          | 24.3727-0418.2 | 580418         |                     |          |                          | L=960 |
|                  | C 200            |       | 01.94 | 05.00          | 24.3727-0419.2 | 580419         |                     |          |                          | L=925 |
|                  | C 200 CDI        |       | 03.98 | 05.00          |                |                |                     |          |                          |       |
| C 200 D          |                  | 03.93 | 05.00 |                |                |                |                     |          |                          |       |
| C 200 Kompressor |                  | 10.95 | 05.00 |                |                |                |                     |          |                          |       |
| C 220            |                  | 03.93 | 08.96 |                |                |                |                     |          |                          |       |
| C 220 CDI        |                  | 09.97 | 05.00 |                |                |                |                     |          |                          |       |
| C 220 D          |                  | 06.93 | 05.00 |                |                |                |                     |          |                          |       |
| C 230            |                  | 07.96 | 06.97 |                |                |                |                     |          |                          |       |
| C 230 Kompressor |                  | 09.95 | 05.00 |                |                |                |                     |          |                          |       |
| C 240            |                  | 06.97 | 05.00 |                |                |                |                     |          |                          |       |
| C 250 D          |                  | 06.93 | 08.95 |                |                |                |                     |          |                          |       |
| C 250 TD         |                  | 06.93 | 05.00 |                |                |                |                     |          |                          |       |
| C 280            |                  | 06.93 | 05.00 |                |                |                |                     |          |                          |       |
| C 36 AMG         |                  | 05.94 | 08.97 |                |                |                |                     |          |                          |       |
| C 43 AMG         |                  | 09.97 | 05.00 | 24.3727-0418.2 | 580418         |                | L=960               |          |                          |       |
|                  |                  |       |       | 24.3727-0419.2 | 580419         |                | L=925               |          |                          |       |
|                  | C 180            |       | 03.93 | 05.00          | 24.2419-0915.3 | 030045         | + GG <sup>1)</sup>  | Gz 19,05 |                          |       |
|                  | C 200            |       | 01.94 | 05.00          | 24.2419-1703.3 | 030097         | + ALU <sup>2)</sup> | Gz 19,05 |                          |       |
|                  | C 200 CDI        |       | 03.98 | 05.00          |                |                |                     |          |                          |       |
|                  | C 200 D          |       | 03.93 | 05.00          |                |                |                     |          |                          |       |
|                  | C 220            |       | 03.93 | 08.96          |                |                |                     |          |                          |       |
|                  | C 220 CDI        |       | 09.97 | 05.00          |                |                |                     |          |                          |       |
|                  | C 220 D          |       | 06.93 | 05.00          |                |                |                     |          |                          |       |
|                  | C 230            |       | 07.96 | 06.97          |                |                |                     |          |                          |       |
|                  | C 240            |       | 06.97 | 05.00          |                |                |                     |          |                          |       |
|                  | C 250 D          |       | 06.93 | 08.95          |                |                |                     |          |                          |       |
|                  | C 250 TD         |       | 09.95 | 05.00          |                |                |                     |          |                          |       |
|                  | C 280            |       | 06.93 | 05.00          |                |                |                     |          |                          |       |
|                  | C 36 AMG         |       | 05.94 | 08.97          |                |                |                     |          |                          |       |
|                  |                  | C 180 |       | 03.93          | 05.00          | 03.2523-1310.3 | 040022              |          | Nz 23,81                 |       |
|                  |                  | C 200 |       | 01.94          | 05.00          |                |                     |          |                          |       |
| C 200 D          |                  |       | 03.93 | 05.00          |                |                |                     |          |                          |       |
| C 220            |                  |       | 03.93 | 08.96          |                |                |                     |          |                          |       |
| C 220 D          |                  |       | 06.93 | 05.00          |                |                |                     |          |                          |       |
| C 250 D          |                  |       | 06.93 | 08.95          |                |                |                     |          |                          |       |
| C 250 TD         |                  |       | 09.95 | 05.00          |                |                |                     |          |                          |       |
| C 280            |                  |       | 06.93 | 05.00          |                |                |                     |          |                          |       |
| C 36 AMG         |                  |       | 05.94 | 08.97          |                |                |                     |          |                          |       |

**MERCEDES BENZ C-Klasse (S202) Kombi (96-01)**

|                  |                  |         |         |       |                |        |  |                 |     |
|------------------|------------------|---------|---------|-------|----------------|--------|--|-----------------|-----|
|                  | C 180            |         | F619720 | 06.96 | 03.7760-2702.4 | 300090 |  | 10"             | ATE |
|                  | C 200            |         | F619720 | 06.96 |                |        |  |                 |     |
|                  | C 200 D          |         | F619720 | 07.96 |                |        |  |                 |     |
|                  | C 200 Kompressor |         | F619720 | 11.96 |                |        |  |                 |     |
|                  | C 220 D          |         | F619720 | 06.96 |                |        |  |                 |     |
|                  | C 230            |         | F619720 | 06.96 |                |        |  |                 |     |
|                  | C 250 TD         |         | F619720 | 06.96 |                |        |  |                 |     |
|                  | C 180            |         | F619720 | 06.96 | 24.2023-1701.3 | 010514 |  | Thz 23,81/19,05 | LUC |
|                  | C 200            |         | F619720 | 06.96 |                |        |  |                 |     |
|                  | C 200 D          |         | F619720 | 07.96 |                |        |  |                 |     |
|                  | C 200 Kompressor |         | F619720 | 11.96 |                |        |  |                 |     |
|                  | C 220 D          |         | F619720 | 06.96 |                |        |  |                 |     |
|                  | C 230            |         | F619720 | 06.96 |                |        |  |                 |     |
|                  | C 250 TD         |         | F619720 | 06.96 |                |        |  |                 |     |
|                  | C 180            | F619721 |         | 04.01 | 24.2023-1702.3 | 010534 |  | Thz 23,81/19,05 | LUC |
|                  | C 200            | F619721 |         | 04.01 |                |        |  |                 |     |
|                  | C 200 CDI        |         | 03.98   | 04.01 |                |        |  |                 |     |
| C 200 D          | F619721          |         | 04.01   |       |                |        |  |                 |     |
| C 200 Kompressor | F619621          |         | 04.01   |       |                |        |  |                 |     |
| C 220 CDI        |                  | 09.97   | 04.01   |       |                |        |  |                 |     |
| C 220 D          | F619721          |         | 04.01   |       |                |        |  |                 |     |
| C 230            | F619721          |         | 06.97   |       |                |        |  |                 |     |
| C 230 Kompressor |                  | 06.97   | 04.01   |       |                |        |  |                 |     |
| C 240            |                  | 06.97   | 04.01   | - ESP |                |        |  |                 |     |
| C 250 TD         | F619721          |         | 04.01   |       |                |        |  |                 |     |
| C 280            |                  | 06.97   | 04.01   | - ESP |                |        |  |                 |     |
| C 240            |                  | 06.97   | 04.01   | + ESP | 24.2023-1704.3 | 010635 |  | Thz 23,81       | LUC |
| C 280            |                  | 06.97   | 04.01   | + ESP |                |        |  |                 |     |
| C 43 AMG         |                  | 09.97   | 04.01   |       |                |        |  |                 |     |
|                  | C 180            |         | 06.96   | 04.01 | 24.3541-1751.7 | 220477 |  | D=54, - Halter  | LUC |
|                  | C 200            |         | 06.96   | 04.01 | 24.3541-1752.7 | 220478 |  | D=54, - Halter  | LUC |
|                  | C 200 CDI        |         | 03.98   | 04.01 |                |        |  |                 |     |
|                  | C 200 D          |         | 07.96   | 04.01 |                |        |  |                 |     |

1) + cast iron / + ghisa / + fonte grise / + fundición de gris  
2) + aluminium / + alluminio / + aluminium / + aluminio





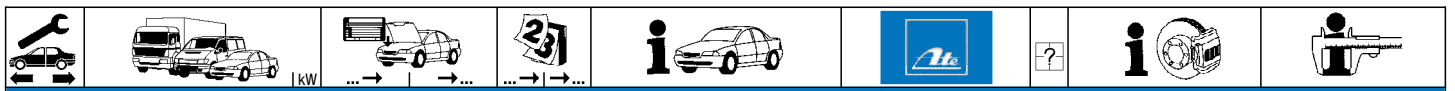

**MERCEDES BENZ C-Klasse (S202) Kombi (96-01)**

|                  |                  |          |         |       |                |                |                |        |                |                |        |  |
|------------------|------------------|----------|---------|-------|----------------|----------------|----------------|--------|----------------|----------------|--------|--|
|                  | C 220 CDI        |          |         | 09.97 | 04.01          | 24.3541-1751.7 | 220477         |        |                | D=54, - Halter | LUC    |  |
|                  | C 220 D          |          |         | 06.96 | 04.01          | 24.3541-1752.7 | 220478         |        |                | D=54, - Halter | LUC    |  |
|                  | C 230            |          |         | 06.96 | 06.97          |                |                |        |                |                |        |  |
|                  | C 200 Kompressor |          |         | 11.96 | 04.01          | 11.3571-8511.2 | 220315         |        |                | D=57, - Halter | ATE    |  |
|                  | C 230 Kompressor |          |         | 06.97 | 04.01          | 11.3571-8512.2 | 220316         |        |                | D=57, - Halter | ATE    |  |
|                  | C 240            |          |         | 06.97 | 04.01          | 24.3571-8511.5 | 240491         |        |                | D=57, - Halter | ATE    |  |
|                  | C 250 TD         |          |         | 06.96 | 04.01          | 24.3571-8512.5 | 240492         |        |                | D=57, - Halter | ATE    |  |
|                  | C 280            |          |         | 06.97 | 04.01          | 11.0441-5703.2 | 250145         |        |                | Dichtungssatz  | ATE    |  |
|                  |                  |          |         |       |                | 11.0230-0096.2 | 260033         |        |                | Haltersatz     | ATE    |  |
|                  |                  |          |         |       |                | 11.0101-5407.2 | 260011         |        |                | Hülsensatz     | ATE    |  |
|                  |                  |          |         |       | 11.8171-0008.1 | 990049         |                |        | Führungsbolzen | ATE            |        |  |
|                  |                  |          |         |       | 11.8116-0253.1 | 390512         |                |        | Haltefeder     | ATE            |        |  |
|                  | C 43 AMG         |          |         | 09.97 | 04.01          | 11.8116-0133.1 | 390511         | 2      |                | Haltefeder     | ATE    |  |
|                  | C 180            |          |         | 06.96 | 04.01          | 83.7705-0386.3 | 330828         | 2      |                | L=385          |        |  |
|                  | C 200            |          |         | 06.96 | 04.01          |                |                |        |                |                |        |  |
|                  | C 200 CDI        |          |         | 03.98 | 04.01          |                |                |        |                |                |        |  |
|                  | C 200 D          |          |         | 07.96 | 04.01          |                |                |        |                |                |        |  |
|                  | C 200 Kompressor |          |         | 11.96 | 04.01          |                |                |        |                |                |        |  |
|                  | C 220 CDI        |          |         | 09.97 | 04.01          |                |                |        |                |                |        |  |
|                  | C 220 D          |          |         | 06.96 | 04.01          |                |                |        |                |                |        |  |
|                  | C 230            |          |         | 06.96 | 06.97          |                |                |        |                |                |        |  |
|                  | C 230 Kompressor |          |         | 06.97 | 04.01          |                |                |        |                |                |        |  |
|                  | C 240            |          |         | 06.97 | 04.01          |                |                |        |                |                |        |  |
|                  | C 250 TD         |          |         | 06.96 | 04.01          |                |                |        |                |                |        |  |
|                  | C 280            |          |         | 06.97 | 04.01          |                |                |        |                |                |        |  |
|                  | C 43 AMG         |          |         | 09.97 | 04.01          |                |                |        |                |                |        |  |
|                  | C 180            |          | F576240 | 06.96 |                | 13.2381-8035.2 | 210037         |        |                | D=38           | ATE    |  |
|                  | C 200            |          | F576240 | 06.96 |                | 13.2381-8036.2 | 210038         |        |                | D=38           | ATE    |  |
|                  | C 200 CDI        |          | F576240 | 03.98 |                | 24.9238-8035.5 | 230025         |        |                | D=38           | ATE    |  |
|                  | C 200 D          |          | F576240 | 07.96 |                | 24.9238-8036.5 | 230026         |        |                | D=38           | ATE    |  |
|                  | C 200 Kompressor |          | F576240 | 11.96 |                | 13.0441-3817.2 | 250071         |        |                | Dichtungssatz  | ATE    |  |
|                  | C 220 CDI        |          | F576240 | 09.97 |                |                |                |        |                |                |        |  |
|                  | C 220 D          |          | F576240 | 06.96 |                |                |                |        |                |                |        |  |
|                  | C 230            |          | F576240 | 06.96 |                |                |                |        |                |                |        |  |
|                  | C 250 TD         |          | F576240 | 06.96 |                |                |                |        |                |                |        |  |
|                  | C 280            |          | F576240 | 06.96 |                |                |                |        |                |                |        |  |
|                  | C 180            | F576241  |         | 04.01 |                | 13.2361-8003.2 | 210220         |        |                | D=36           | ATE    |  |
|                  | C 200            | F576241  |         | 04.01 |                | 13.2361-8004.2 | 210221         |        |                | D=36           | ATE    |  |
|                  | C 200 CDI        | F576241  |         | 04.01 |                | 13.0441-3609.2 | 250057         |        |                | Dichtungssatz  | ATE    |  |
|                  | C 200 D          | F576241  |         | 04.01 |                |                |                |        |                |                |        |  |
|                  | C 200 Kompressor | F576241  |         | 04.01 |                |                |                |        |                |                |        |  |
|                  | C 220 CDI        | F576241  |         | 04.01 |                |                |                |        |                |                |        |  |
|                  | C 220 D          | F576241  |         | 04.01 |                |                |                |        |                |                |        |  |
|                  | C 230            | F576241  |         | 06.97 |                |                |                |        |                |                |        |  |
|                  | C 230 Kompressor |          | 06.97   | 04.01 |                |                |                |        |                |                |        |  |
|                  | C 240            |          | 06.97   | 04.01 |                |                |                |        |                |                |        |  |
|                  | C 250 TD         | F576241  |         | 04.01 |                |                |                |        |                |                |        |  |
|                  | C 280            |          | 06.97   | 04.01 |                |                |                |        |                |                |        |  |
|                  | C 43 AMG         |          | 09.97   | 04.01 |                | 13.2421-8025.2 | 210061         |        |                | D=42           | ATE    |  |
|                  |                  |          |         |       |                | 13.2421-8026.2 | 210062         |        |                | D=42           | ATE    |  |
|                  |                  |          |         |       |                | 13.0441-3606.2 | 250147         |        |                | Dichtungssatz  | ATE    |  |
|                  | C 180            |          |         | 06.96 | 04.01          | 83.7715-0280.3 | 330806         | 2      |                | L=280          |        |  |
|                  | C 200            |          |         | 06.96 | 04.01          |                |                |        |                |                |        |  |
|                  | C 200 CDI        |          |         | 03.98 | 04.01          |                |                |        |                |                |        |  |
|                  | C 200 D          |          |         | 07.96 | 04.01          |                |                |        |                |                |        |  |
|                  | C 200 Kompressor |          |         | 11.96 | 04.01          |                |                |        |                |                |        |  |
|                  | C 220 CDI        |          |         | 09.97 | 04.01          |                |                |        |                |                |        |  |
|                  | C 220 D          |          |         | 06.96 | 04.01          |                |                |        |                |                |        |  |
|                  | C 230            |          |         | 06.96 | 06.97          |                |                |        |                |                |        |  |
|                  | C 230 Kompressor |          |         | 06.97 | 04.01          |                |                |        |                |                |        |  |
|                  | C 240            |          |         | 06.97 | 04.01          |                |                |        |                |                |        |  |
|                  | C 250 TD         |          |         | 06.96 | 04.01          |                |                |        |                |                |        |  |
|                  | C 280            |          |         | 06.97 | 04.01          |                |                |        |                |                |        |  |
|                  | C 43 AMG         |          |         | 09.97 | 04.01          |                |                |        |                |                |        |  |
|                  |                  | C 180    |         |       | 06.96          | 04.01          | 24.3727-0423.2 | 580423 | 1              |                | L=2554 |  |
| C 200            |                  |          |         | 06.96 | 04.01          | 24.3727-0418.2 | 580418         |        |                | L=960          |        |  |
| C 200 CDI        |                  |          |         | 03.98 | 04.01          | 24.3727-0419.2 | 580419         |        |                | L=925          |        |  |
| C 200 D          |                  |          |         | 07.96 | 04.01          |                |                |        |                |                |        |  |
| C 200 Kompressor |                  |          |         | 11.96 | 04.01          |                |                |        |                |                |        |  |
| C 220 CDI        |                  |          |         | 09.97 | 04.01          |                |                |        |                |                |        |  |
| C 220 D          |                  |          |         | 06.96 | 04.01          |                |                |        |                |                |        |  |
| C 230            |                  |          |         | 06.96 | 06.97          |                |                |        |                |                |        |  |
| C 230 Kompressor |                  |          |         | 06.97 | 04.01          |                |                |        |                |                |        |  |
| C 240            |                  |          |         | 06.97 | 04.01          |                |                |        |                |                |        |  |
| C 250 TD         |                  |          |         | 06.96 | 04.01          |                |                |        |                |                |        |  |
| C 280            |                  |          |         | 06.97 | 04.01          |                |                |        |                |                |        |  |
|                  |                  | C 43 AMG |         |       | 09.97          | 04.01          | 24.3727-0418.2 | 580418 |                |                | L=960  |  |
|                  |                  |          |         |       |                |                | 24.3727-0419.2 | 580419 |                |                | L=925  |  |
|                  | C 180            |          |         | 06.96 | 04.01          | 24.3727-0418.2 | 580418         |        |                | L=960          |        |  |
|                  | C 200            |          |         | 06.96 | 04.01          | 24.3727-0419.2 | 580419         |        |                | L=925          |        |  |
|                  | C 200 CDI        |          |         | 03.98 | 04.01          |                |                |        |                |                |        |  |
|                  | C 200 D          |          |         | 07.96 | 04.01          |                |                |        |                |                |        |  |
|                  | C 200 Kompressor |          |         | 11.96 | 04.01          |                |                |        |                |                |        |  |
|                  | C 220 CDI        |          |         | 09.97 | 04.01          |                |                |        |                |                |        |  |
|                  | C 220 D          |          |         | 06.96 | 04.01          |                |                |        |                |                |        |  |
|                  | C 230            |          |         | 06.96 | 06.97          |                |                |        |                |                |        |  |
|                  | C 230 Kompressor |          |         | 06.97 | 04.01          |                |                |        |                |                |        |  |



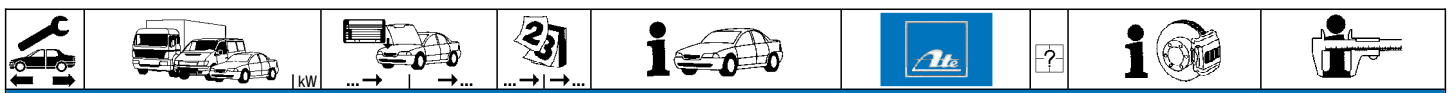

**MERCEDES BENZ C-Klasse (S202) Kombi (96-01)**

|  |                  |  |  |       |       |                |        |                          |                     |          |
|--|------------------|--|--|-------|-------|----------------|--------|--------------------------|---------------------|----------|
|  | C 240            |  |  | 06.97 | 04.01 | 24.3727-0418.2 | 580418 | <input type="checkbox"/> |                     | L=960    |
|  | C 250 TD         |  |  | 06.96 | 04.01 | 24.3727-0419.2 | 580419 | <input type="checkbox"/> |                     | L=925    |
|  | C 280            |  |  | 06.97 | 04.01 |                |        |                          |                     |          |
|  | C 43 AMG         |  |  | 09.97 | 04.01 | 24.3727-0418.2 | 580418 | <input type="checkbox"/> |                     | L=960    |
|  | C 180            |  |  | 06.96 | 04.01 | 24.2419-0915.3 | 030045 | <input type="checkbox"/> | + GG <sup>1)</sup>  | Gz 19,05 |
|  | C 200            |  |  | 06.96 | 04.01 | 24.2419-1703.3 | 030097 |                          | + ALU <sup>2)</sup> | Gz 19,05 |
|  | C 200 CDI        |  |  | 03.98 | 04.01 |                |        |                          |                     |          |
|  | C 200 D          |  |  | 07.96 | 04.01 |                |        |                          |                     |          |
|  | C 200 Kompressor |  |  | 11.96 | 04.01 |                |        |                          |                     |          |
|  | C 220 CDI        |  |  | 09.97 | 04.01 |                |        |                          |                     |          |
|  | C 220 D          |  |  | 06.96 | 04.01 |                |        |                          |                     |          |
|  | C 230            |  |  | 06.96 | 06.97 |                |        |                          |                     |          |
|  | C 230 Kompressor |  |  | 06.97 | 04.01 |                |        |                          |                     |          |
|  | C 240            |  |  | 06.97 | 04.01 |                |        |                          |                     |          |
|  | C 250 TD         |  |  | 06.96 | 04.01 |                |        |                          |                     |          |
|  | C 280            |  |  | 06.97 | 04.01 |                |        |                          |                     |          |

**MERCEDES BENZ C-Klasse (W203) Limousine (00-07)**

|                     |                      |                     |                     |       |       |                |        |                          |  |                 |     |
|---------------------|----------------------|---------------------|---------------------|-------|-------|----------------|--------|--------------------------|--|-----------------|-----|
|                     | C 180                |                     |                     | 04.00 | 04.07 | 03.7848-2002.4 | 300166 |                          |  | 7/8" Tandem     | ATE |
|                     | C 180 Kompressor     |                     |                     | 05.02 | 04.07 |                |        |                          |  |                 |     |
|                     | C 200 CDI            |                     |                     | 04.00 | 04.07 |                |        |                          |  |                 |     |
|                     | C 200 CDI            | 90                  |                     | 04.03 | 04.07 |                |        |                          |  |                 |     |
|                     | C 200 CGI Kompressor |                     |                     | 07.03 | 04.07 |                |        |                          |  |                 |     |
|                     | C 200 Kompressor     |                     |                     | 04.00 | 04.07 |                |        |                          |  |                 |     |
|                     | C 200 Kompressor     | 120                 |                     | 05.00 | 05.02 |                |        |                          |  |                 |     |
|                     | C 220 CDI            |                     |                     | 04.00 | 04.07 |                |        |                          |  |                 |     |
|                     | C 220 CDI            | 110                 |                     | 02.04 | 04.07 |                |        |                          |  |                 |     |
|                     | C 230                |                     |                     | 06.05 | 04.07 |                |        |                          |  |                 |     |
|                     | C 230 Kompressor     |                     |                     | 02.04 | 04.07 |                |        |                          |  |                 |     |
|                     | C 240                |                     |                     | 04.00 | 04.07 |                |        |                          |  |                 |     |
|                     | C 240 4-matic        |                     |                     | 07.02 | 04.07 |                |        |                          |  |                 |     |
|                     | C 270 CDI            |                     |                     | 08.00 | 04.07 |                |        |                          |  |                 |     |
|                     | C 280                |                     |                     | 06.05 | 04.07 |                |        |                          |  |                 |     |
|                     | C 280 4-matic        |                     |                     | 06.05 | 04.07 |                |        |                          |  |                 |     |
|                     | C 30 CDI AMG         |                     |                     | 01.03 | 04.07 |                |        |                          |  |                 |     |
|                     | C 32 AMG Kompressor  |                     |                     | 03.01 | 04.07 |                |        |                          |  |                 |     |
|                     | C 320                |                     |                     | 04.00 | 04.07 |                |        |                          |  |                 |     |
|                     | C 320 4-matic        |                     |                     | 07.02 | 04.07 |                |        |                          |  |                 |     |
| C 320 CDI           |                      |                     | 02.05               | 04.07 |       |                |        |                          |  |                 |     |
| C 350               |                      |                     | 06.05               | 04.07 |       |                |        |                          |  |                 |     |
| C 350 4-matic       |                      |                     | 06.05               | 04.07 |       |                |        |                          |  |                 |     |
| C 55 AMG            |                      |                     | 02.04               | 04.07 |       |                |        |                          |  |                 |     |
|                     | C 180                |                     |                     | 04.00 | 04.07 | 03.2023-1741.3 | 010703 |                          |  | Thz 23,81/20,64 |     |
|                     | C 180 Kompressor     |                     |                     | 05.02 | 04.07 |                |        |                          |  |                 |     |
|                     | C 200 CDI            |                     |                     | 04.00 | 04.07 |                |        |                          |  |                 |     |
|                     | C 200 CDI            | 90                  |                     | 04.03 | 04.07 |                |        |                          |  |                 |     |
|                     | C 200 CGI Kompressor |                     |                     | 07.03 | 04.07 |                |        |                          |  |                 |     |
|                     | C 200 Kompressor     |                     |                     | 04.00 | 04.07 |                |        |                          |  |                 |     |
|                     | C 200 Kompressor     | 120                 |                     | 05.00 | 05.02 |                |        |                          |  |                 |     |
|                     | C 220 CDI            |                     |                     | 04.00 | 04.07 |                |        |                          |  |                 |     |
|                     | C 220 CDI            | 110                 |                     | 02.04 | 04.07 |                |        |                          |  |                 |     |
|                     | C 230 Kompressor     |                     |                     | 02.04 | 04.07 |                |        |                          |  |                 |     |
|                     | C 240                |                     |                     | 04.00 | 04.07 |                |        |                          |  |                 |     |
|                     | C 230                |                     |                     | 06.05 | 04.07 | 03.2025-1741.3 | 010705 |                          |  | Thz 25,40/20,64 | ATE |
|                     | C 240 4-matic        |                     |                     | 07.02 | 04.07 |                |        |                          |  |                 |     |
| C 270 CDI           |                      |                     | 08.00               | 04.07 |       |                |        |                          |  |                 |     |
| C 280               |                      |                     | 06.05               | 04.07 |       |                |        |                          |  |                 |     |
| C 280 4-matic       |                      |                     | 06.05               | 04.07 |       |                |        |                          |  |                 |     |
| C 30 CDI AMG        |                      |                     | 01.03               | 04.07 |       |                |        |                          |  |                 |     |
| C 32 AMG Kompressor |                      |                     | 03.01               | 04.07 |       |                |        |                          |  |                 |     |
| C 320               |                      |                     | 04.00               | 04.07 |       |                |        |                          |  |                 |     |
| C 320 4-matic       |                      |                     | 07.02               | 04.07 |       |                |        |                          |  |                 |     |
| C 320 CDI           |                      |                     | 02.05               | 04.07 |       |                |        |                          |  |                 |     |
| C 350               |                      |                     | 06.05               | 04.07 |       |                |        |                          |  |                 |     |
| C 350 4-matic       |                      |                     | 06.05               | 04.07 |       |                |        |                          |  |                 |     |
| C 55 AMG            |                      |                     | 02.04               | 04.07 |       |                |        |                          |  |                 |     |
|                     | C 180                |                     |                     | 04.00 | 04.07 | 24.3571-1739.7 | 220667 | <input type="checkbox"/> |  | D=57, - Halter  | LUC |
|                     | C 180 Kompressor     |                     |                     | 05.02 | 04.07 | 24.3571-1740.7 | 220668 | <input type="checkbox"/> |  | D=57, - Halter  | LUC |
|                     | C 200 CDI            |                     |                     | 04.00 | 04.07 | 24.0101-3803.2 | 260101 |                          |  | Einbausatz      | LUC |
|                     | C 200 CDI            | 90                  |                     | 04.03 | 04.07 |                |        |                          |  |                 |     |
|                     | C 200 CGI Kompressor |                     |                     | 07.03 | 04.07 |                |        |                          |  |                 |     |
|                     | C 200 Kompressor     |                     |                     | 04.00 | 04.07 |                |        |                          |  |                 |     |
|                     | C 200 Kompressor     | 120                 |                     | 05.00 | 05.02 |                |        |                          |  |                 |     |
|                     | C 220 CDI            |                     |                     | 04.00 | 04.07 |                |        |                          |  |                 |     |
|                     | C 220 CDI            | 110                 |                     | 02.04 | 04.07 |                |        |                          |  |                 |     |
|                     | C 180 Kompressor     |                     | A 660226 / F 565688 | 05.02 | 04.07 | 24.0101-3803.2 | 260101 |                          |  | Einbausatz      | LUC |
|                     | C 200 CDI            |                     | A 660226 / F 565688 | 04.00 | 04.07 |                |        |                          |  |                 |     |
|                     | C 200 CDI            | 90                  | A 660226 / F 565688 | 04.03 | 04.07 |                |        |                          |  |                 |     |
|                     | C 200 CGI Kompressor |                     | A 660226 / F 565688 | 07.03 | 04.07 |                |        |                          |  |                 |     |
| C 200 Kompressor    |                      | A 660226 / F 565688 | 04.00               | 04.07 |       |                |        |                          |  |                 |     |
| C 220 CDI           |                      | A 660226 / F 565688 | 04.00               | 04.07 |       |                |        |                          |  |                 |     |
| C 220 CDI           | 110                  | A 660226 / F 565688 | 02.04               | 04.07 |       |                |        |                          |  |                 |     |
| C 230 Kompressor    |                      | A 660226 / F 565688 | 02.04               | 04.07 |       |                |        |                          |  |                 |     |
| C 240               |                      | A 660226 / F 565688 | 04.00               | 04.07 |       |                |        |                          |  |                 |     |
| C 270 CDI           |                      | A 660226 / F 565688 | 08.00               | 04.07 |       |                |        |                          |  |                 |     |
| C 320               |                      | A 660226 / F 565688 | 04.00               | 04.07 |       |                |        |                          |  |                 |     |

<sup>1)</sup> + cast iron / + ghisa / + fonte grise / + fundición de gris

<sup>2)</sup> + aluminium / + alluminio / + aluminium / + aluminio

<sup>3)</sup> - sport package/- sport package AMG / - pacchetto sportivo/- pacchetto sport.AMG / - version sport/- version sport AMG / - kit deportivo/- kit deportivo AMG

<sup>4)</sup> + sports package/+ sports package AMG / + pacchetto sportivo/+ pacchetto sport.AMG / + version sport/+ version sport AMG / + kit deportivo/+ kit deportivo AMG





**MERCEDES BENZ C-Klasse (W203) Limousine (00-07)**

|                      |                      |       |   |   |   |                |  |                   |                               |                   |   |   |        |        |
|----------------------|----------------------|-------|---|---|---|----------------|--|-------------------|-------------------------------|-------------------|---|---|--------|--------|
|                      | C 180 Kompressor     | 90    | A 660227 / F 565689                           | 04.07   | + Sportpaket / + Sportpaket AMG <sup>1)</sup> | 24.0101-3803.2 | 260101   |                   |                               | Einbausatz        | LUC   |   |        |        |
|                      | C 200 CDI            |       |   | 04.07   | + Sportpaket / + Sportpaket AMG <sup>1)</sup> |                |  |                   |                               |                   |   |   |        |        |
|                      | C 200 CGI Kompressor |       |   | 04.07   | + Sportpaket / + Sportpaket AMG <sup>1)</sup> |                |  |                   |                               |                   |   |   |        |        |
|                      | C 200 Kompressor     |       |   | 04.07   | + Sportpaket / + Sportpaket AMG <sup>1)</sup> |                |  |                   |                               |                   |   |   |        |        |
|                      | C 220 CDI            |       |   | 04.07   | + Sportpaket / + Sportpaket AMG <sup>1)</sup> |                |  |                   |                               |                   |   |   |        |        |
|                      | C 230                |       |   | 06.05   | 04.07   |                |  |                   |                               |                   |   | + Sportpaket / + Sportpaket AMG <sup>1)</sup> |        |        |
|                      | C 230 Kompressor     |       |   | 04.07   | + Sportpaket / + Sportpaket AMG <sup>1)</sup> |                |  |                   |                               |                   |   |   |        |        |
|                      | C 240                |       |   | 04.07   | + Sportpaket / + Sportpaket AMG <sup>1)</sup> |                |  |                   |                               |                   |   |   |        |        |
|                      | C 270 CDI            |       |   | 04.07   | + Sportpaket / + Sportpaket AMG <sup>1)</sup> |                |  |                   |                               |                   |   |   |        |        |
|                      | C 280                |       |   | 06.05   | 04.07   |                |  |                   |                               |                   |   | + Sportpaket / + Sportpaket AMG <sup>1)</sup> |        |        |
| C 280 4-matic        | 06.05                | 04.07 | + Sportpaket / + Sportpaket AMG <sup>1)</sup> |   |   |                |  |                   |                               |                   |   |   |        |        |
| C 320                | A 660227 / F 565689  | 04.07 | + Sportpaket / + Sportpaket AMG <sup>1)</sup> |   |   |                |  |                   |                               |                   |   |   |        |        |
| C 320 CDI            | 02.05                | 04.07 | - Sportpaket / - Sportpaket AMG <sup>2)</sup> |   |   |                |  |                   |                               |                   |   |   |        |        |
| C 350                | 06.05                | 04.07 | - Sportpaket / - Sportpaket AMG <sup>2)</sup> |   |   |                |  |                   |                               |                   |   |   |        |        |
| C 230                | 06.05                | 04.07 | - Sportpaket / - Sportpaket AMG <sup>2)</sup> | 24.3571-1721.7                                | 220555  | ☐<br>☐         | D=57, - Halter<br>D=57, - Halter<br>Einbausatz | LUC<br>LUC<br>LUC |                               |                   |   |   |        |        |
| C 230 Kompressor     | 02.04                | 04.07 | - Sportpaket / - Sportpaket AMG <sup>2)</sup> | 24.3571-1722.7                                | 220556  |                |  |                   |                               |                   |   |   |        |        |
| C 240                | 04.00                | 04.07 | - Sportpaket / - Sportpaket AMG <sup>2)</sup> | 24.0101-3803.2                                | 260101  |                |  |                   |                               |                   |   |   |        |        |
| C 270 CDI            | 08.00                | 04.07 | - Sportpaket / - Sportpaket AMG <sup>2)</sup> |   |   |                |  |                   |                               |                   |   |   |        |        |
| C 280                | 06.05                | 04.07 | - Sportpaket / - Sportpaket AMG <sup>2)</sup> |   |   |                |  |                   |                               |                   |   |   |        |        |
| C 320                | 04.00                | 04.07 | - Sportpaket / - Sportpaket AMG <sup>2)</sup> |   |   |                |  |                   |                               |                   |   |   |        |        |
| C 240 4-matic        | 07.02                | 04.07 |   | 24.0101-3803.2                                | 260101  | 2              | Einbausatz                                     | LUC               |                               |                   |   |   |        |        |
| C 280 4-matic        | 06.05                | 04.07 | - Sportpaket / - Sportpaket AMG <sup>2)</sup> | 13.8190-0330.1                                | 990134  |                |  |                   |                               |                   |   |   |        |        |
| C 320 4-matic        | 07.02                | 04.07 |   |   |   |                |  |                   |                               |                   |   |   |        |        |
| C 350 4-matic        | 06.05                | 04.07 | - Sportpaket / - Sportpaket AMG <sup>2)</sup> | 13.8190-0330.1                                | 990134  | 2              | Halterschraube                                 |                   |                               |                   |   |   |        |        |
|                      | C 180                | 90    |   | 04.00   | 04.07   | 83.7705-0386.3 | 330828   | 2                 |                               | L=385             |   |   |        |        |
|                      | C 180 Kompressor     |       |   | 05.02   | 04.07   |                |  |                   |                               |                   |   |   |        |        |
|                      | C 200 CDI            |       |   | 04.00   | 04.07   |                |  |                   |                               |                   |   |   |        |        |
|                      | C 200 CDI            |       |   | 04.03   | 04.07   |                |  |                   |                               |                   |   |   |        |        |
|                      | C 200 CGI Kompressor |       |   | 07.03   | 04.07   |                |  |                   |                               |                   |   |   |        |        |
|                      | C 200 Kompressor     |       |   | 04.00   | 04.07   |                |  |                   |                               |                   |   |   |        |        |
|                      | C 200 Kompressor     |       |   | 120   | 05.00   |                |  |                   |                               |                   |   | 05.02   |        |        |
|                      | C 220 CDI            |       |   | 04.00   | 04.07   |                |  |                   |                               |                   |   |   |        |        |
|                      | C 220 CDI            |       |   | 110   | 02.04   |                |  |                   |                               |                   |   | 04.07   |        |        |
|                      | C 230                |       |   | 06.05   | 04.07   |                |  |                   |                               |                   |   |   |        |        |
|                      | C 230 Kompressor     |       |   | 02.04   | 04.07   |                |  |                   |                               |                   |   |   |        |        |
|                      | C 240                |       |   | 04.00   | 04.07   |                |  |                   |                               |                   |   |   |        |        |
|                      | C 270 CDI            |       |   | 08.00   | 04.07   |                |  |                   |                               |                   |   |   |        |        |
|                      | C 280                |       |   | 06.05   | 04.07   |                |  |                   |                               |                   |   |   |        |        |
|                      | C 30 CDI AMG         |       |   | 01.03   | 04.07   |                |  |                   |                               |                   |   |   |        |        |
| C 32 AMG Kompressor  | 03.01                | 04.07 |   |   |   |                |  |                   |                               |                   |   |   |        |        |
| C 320                | 04.00                | 04.07 |   |   |   |                |  |                   |                               |                   |   |   |        |        |
| C 320 CDI            | 02.05                | 04.07 |   |   |   |                |  |                   |                               |                   |   |   |        |        |
| C 350                | 06.05                | 04.07 |   |   |   |                |  |                   |                               |                   |   |   |        |        |
| C 55 AMG             | 02.04                | 04.07 |   |   |   |                |  |                   |                               |                   |   |   |        |        |
|                      | C 180                | 90    |   | 04.00   | 04.07   | 13.9361-0023.2 | 210241   | ☐<br>☐            | D=36<br>D=36<br>Dichtungssatz | ATE<br>ATE<br>ATE |   |   |        |        |
|                      | C 180 Kompressor     |       |   | 05.02   | 04.07   |                |  |                   |                               |                   | - Sportpaket / - Sportpaket AMG <sup>2)</sup> | 13.9361-0024.2                                | 210242 |        |
|                      | C 200 CDI            |       |   | 04.00   | 04.07   |                |  |                   |                               |                   | - Sportpaket / - Sportpaket AMG <sup>2)</sup> | 13.0441-3609.2                                | 250057 |        |
|                      | C 200 CDI            |       |   | 04.03   | 04.07   |                |  |                   |                               |                   | - Sportpaket / - Sportpaket AMG <sup>2)</sup> |   |        |        |
|                      | C 200 CGI Kompressor |       |   | 07.03   | 04.07   |                |  |                   |                               |                   | - Sportpaket / - Sportpaket AMG <sup>2)</sup> |   |        |        |
|                      | C 200 Kompressor     |       |   | 04.00   | 04.07   |                |  |                   |                               |                   | - Sportpaket / - Sportpaket AMG <sup>2)</sup> |   |        |        |
|                      | C 200 Kompressor     |       |   | 120   | 05.00   |                |  |                   |                               |                   | 05.02   |   |        |        |
|                      | C 220 CDI            |       |   | 04.00   | 04.07   |                |  |                   |                               |                   | - Sportpaket / - Sportpaket AMG <sup>2)</sup> |   |        |        |
|                      | C 220 CDI            |       |   | 110   | 02.04   |                |  |                   |                               |                   | 04.07   | - Sportpaket / - Sportpaket AMG <sup>2)</sup> |        |        |
|                      | C 180 Kompressor     |       |   | 05.02   | 04.07   |                |  |                   |                               |                   | + Sportpaket / + Sportpaket AMG <sup>1)</sup> | 13.9361-0035.2                                | 210253 | ☐<br>☐ |
| C 200 CDI            | 04.00                | 04.07 | + Sportpaket / + Sportpaket AMG <sup>1)</sup> | 13.9361-0036.2                                | 210254  |                |  |                   |                               |                   |   |   |        |        |
| C 200 CDI            | 90                   | 04.03 | 04.07   | + Sportpaket / + Sportpaket AMG <sup>1)</sup> | 13.0441-3609.2                                | 250057         |  |                   |                               |                   |   |   |        |        |
| C 200 CGI Kompressor | 07.03                | 04.07 | + Sportpaket / + Sportpaket AMG <sup>1)</sup> |   |   |                |  |                   |                               |                   |   |   |        |        |
| C 200 Kompressor     | 04.00                | 04.07 | + Sportpaket / + Sportpaket AMG <sup>1)</sup> |   |   |                |  |                   |                               |                   |   |   |        |        |
| C 220 CDI            | 04.00                | 04.07 | + Sportpaket / + Sportpaket AMG <sup>1)</sup> |   |   |                |  |                   |                               |                   |   |   |        |        |
| C 220 CDI            | 110                  | 02.04 | 04.07   | + Sportpaket / + Sportpaket AMG <sup>1)</sup> |   |                |  |                   |                               |                   |   |   |        |        |
| C 230                | 06.05                | 04.07 |   |   |   |                |  |                   |                               |                   |   |   |        |        |
| C 230 Kompressor     | 02.04                | 04.07 |   |   |   |                |  |                   |                               |                   |   |   |        |        |
| C 240                | 04.00                | 04.07 |   |   |   |                |  |                   |                               |                   |   |   |        |        |
| C 240 4-matic        | 07.02                | 04.07 |   |   |   |                |  |                   |                               |                   |   |   |        |        |
| C 270 CDI            | 08.00                | 04.07 |   |   |   |                |  |                   |                               |                   |   |   |        |        |
| C 280                | 06.05                | 04.07 |   |   |   |                |  |                   |                               |                   |   |   |        |        |
| C 280 4-matic        | 06.05                | 04.07 |   |   |   |                |  |                   |                               |                   |   |   |        |        |
| C 320                | 04.00                | 04.07 |   |   |   |                |  |                   |                               |                   |   |   |        |        |
| C 320 4-matic        | 07.02                | 04.07 |   |   |   |                |  |                   |                               |                   |   |   |        |        |
| C 320 CDI            | 02.05                | 04.07 |   |   |   |                |  |                   |                               |                   |   |   |        |        |
| C 350                | 06.05                | 04.07 |   |   |   |                |  |                   |                               |                   |   |   |        |        |
| C 350 4-matic        | 06.05                | 04.07 |   |   |   |                |  |                   |                               |                   |   |   |        |        |
| C 30 CDI AMG         | 01.03                | 04.07 |   | 13.0441-4216.2                                | 250093  |                | Dichtungssatz                                  | ATE               |                               |                   |   |   |        |        |
| C 32 AMG Kompressor  | 03.01                | 04.07 |   |   |   |                |  |                   |                               |                   |   |   |        |        |
| C 55 AMG             | 02.04                | 04.07 |   |   |   |                |  |                   |                               |                   |   |   |        |        |
|                      | C 180                | 90    |   | 04.00   | 04.07   | 83.7715-0280.3 | 330806   | 2                 |                               | L=280             |   |   |        |        |
|                      | C 180 Kompressor     |       |   | 05.02   | 04.07   |                |  |                   |                               |                   |   |   |        |        |
|                      | C 200 CDI            |       |   | 04.00   | 04.07   |                |  |                   |                               |                   |   |   |        |        |
|                      | C 200 CDI            |       |   | 04.03   | 04.07   |                |  |                   |                               |                   |   |   |        |        |
|                      | C 200 CGI Kompressor |       |   | 07.03   | 04.07   |                |  |                   |                               |                   |   |   |        |        |
|                      | C 200 Kompressor     |       |   | 04.00   | 04.07   |                |  |                   |                               |                   |   |   |        |        |
|                      | C 200 Kompressor     |       |   | 120   | 05.00   |                |  |                   |                               |                   |   | 05.02   |        |        |
|                      | C 220 CDI            |       |   | 04.00   | 04.07   |                |  |                   |                               |                   |   |   |        |        |
|                      | C 220 CDI            |       |   | 110   | 02.04   |                |  |                   |                               |                   |   | 04.07   |        |        |
|                      | C 230                |       |   | 06.05   | 04.07   |                |  |                   |                               |                   |   |   |        |        |
| C 230 Kompressor     | 02.04                | 04.07 |   |   |   |                |  |                   |                               |                   |   |   |        |        |

<sup>1)</sup> + sports package/+ sports package AMG / + pacchetto sportivo/+ pacchetto sport.AMG / + version sport/+ version sport AMG / + kit sportivo/+ kit sportivo AMG

<sup>2)</sup> - sport package/- sport package AMG / - pacchetto sportivo/- pacchetto sport.AMG / - version sport/- version sport AMG / - kit sportivo/- kit sportivo AMG

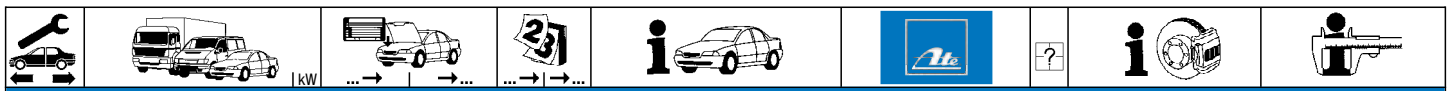

**MERCEDES BENZ C-Klasse (W203) Limousine (00-07)**

|  |   |                  |  |  |   |  |                            |   |                          |       |
|--|---|------------------|--|--|---|--|----------------------------|---|--------------------------|-------|
|  | C 240<br>C 240 4-matic<br>C 270 CDI<br>C 280<br>C 280 4-matic<br>C 30 CDI AMG<br>C 32 AMG Kompressor<br>C 320<br>C 320 4-matic<br>C 320 CDI<br>C 350<br>C 350 4-matic<br>C 55 AMG   |                  |  | 04.00<br>07.02<br>08.00<br>06.05<br>06.05<br>01.03<br>03.01<br>04.00<br>07.02<br>02.05<br>06.05<br>06.05<br>02.04  | 04.07<br>04.07<br>04.07<br>04.07<br>04.07<br>04.07<br>04.07<br>04.07<br>04.07<br>04.07<br>04.07<br>04.07<br>04.07   | 83.7715-0280.3                                     | 330806                     | 2   |                          | L=280 |
|  | C 180<br>C 180 Kompressor<br>C 200 CDI<br>C 200 CDI<br>C 200 CGI Kompressor<br>C 200 Kompressor<br>C 200 Kompressor<br>C 220 CDI<br>C 220 CDI<br>C 230<br>C 230 Kompressor<br>C 240<br>C 240 4-matic<br>C 270 CDI<br>C 280<br>C 280 4-matic<br>C 30 CDI AMG<br>C 32 AMG Kompressor<br>C 320<br>C 320 4-matic<br>C 320 CDI<br>C 350<br>C 350 4-matic<br>C 55 AMG | 90<br>120<br>110 |  | 04.00<br>05.02<br>04.00<br>04.03<br>07.03<br>04.00<br>05.00<br>04.00<br>02.04<br>06.05<br>02.04<br>04.00<br>07.02<br>08.00<br>06.05<br>06.05<br>01.03<br>03.01<br>04.00<br>07.02<br>02.05<br>06.05<br>06.05<br>02.04 | 04.07<br>04.07<br>04.07<br>04.07<br>04.07<br>04.07<br>05.02<br>04.07<br>04.07<br>04.07<br>04.07<br>04.07<br>04.07<br>04.07<br>04.07<br>04.07<br>04.07<br>04.07<br>04.07<br>04.07<br>04.07<br>04.07<br>04.07<br>04.07<br>04.07 | 24.3727-0429.2<br>24.3727-0430.2<br>24.3727-0436.2 | 580429<br>580430<br>580436 | 1<br><input type="checkbox"/><br><input type="checkbox"/> | L=2735<br>L=925<br>L=900 |       |
|  | C 180<br>C 180 Kompressor<br>C 200 CDI<br>C 200 CDI<br>C 200 CGI Kompressor<br>C 200 Kompressor<br>C 200 Kompressor<br>C 220 CDI<br>C 220 CDI<br>C 230<br>C 230 Kompressor<br>C 240<br>C 240 4-matic<br>C 270 CDI<br>C 280<br>C 30 CDI AMG<br>C 32 AMG Kompressor<br>C 320<br>C 320 4-matic<br>C 320 CDI<br>C 350<br>C 350 4-matic<br>C 55 AMG                  | 90<br>120<br>110 |  | 04.00<br>05.02<br>04.00<br>04.03<br>07.03<br>04.00<br>05.00<br>04.00<br>02.04<br>06.05<br>02.04<br>04.00<br>07.02<br>08.00<br>06.05<br>06.05<br>01.03<br>03.01<br>04.00<br>07.02<br>02.05<br>06.05<br>06.05<br>02.04 | 04.07<br>04.07<br>04.07<br>04.07<br>04.07<br>04.07<br>05.02<br>04.07<br>04.07<br>04.07<br>04.07<br>04.07<br>04.07<br>04.07<br>04.07<br>04.07<br>04.07<br>04.07<br>04.07<br>04.07<br>04.07<br>04.07<br>04.07<br>04.07          | 24.3727-0430.2<br>24.3727-0436.2                   | 580430<br>580436           | <input type="checkbox"/><br><input type="checkbox"/>      | L=925<br>L=900           |       |

**MERCEDES BENZ C-Klasse (S203) Kombi (01-07)**

|  |   |                  |  |  |  |                |        |  |             |     |
|--|---|------------------|--|--|--|----------------|--------|--|-------------|-----|
|  | C 180<br>C 180 Kompressor<br>C 200 CDI<br>C 200 CDI<br>C 200 CGI Kompressor<br>C 200 Kompressor<br>C 200 Kompressor<br>C 220 CDI<br>C 220 CDI<br>C 230<br>C 230 Kompressor<br>C 240<br>C 240 4-matic<br>C 270 CDI<br>C 280<br>C 280 4-matic<br>C 30 CDI AMG<br>C 32 Kompressor AMG<br>C 320<br>C 320 4-matic<br>C 320 CDI<br>C 350<br>C 350 4-matic<br>C 55 AMG | 90<br>120<br>110 |  | 03.01<br>05.02<br>03.01<br>04.03<br>07.03<br>05.02<br>03.01<br>03.01<br>02.04<br>06.05<br>02.04<br>03.01<br>07.02<br>03.01<br>06.05<br>06.05<br>01.03<br>03.01<br>03.01<br>07.02<br>02.05<br>06.05<br>06.05<br>02.04 | 09.07<br>09.07<br>09.07<br>09.07<br>09.07<br>09.07<br>04.02<br>09.07<br>09.07<br>09.07<br>09.07<br>09.07<br>09.07<br>09.07<br>09.07<br>09.07<br>09.07<br>09.07<br>09.07<br>09.07<br>09.07<br>09.07<br>09.07<br>09.07 | 03.7848-2002.4 | 300166 |  | 7/8" Tandem | ATE |
|--|---|------------------|--|--|--|----------------|--------|--|-------------|-----|



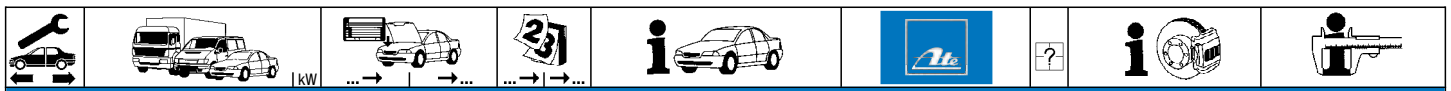

**MERCEDES BENZ C-Klasse (S203) Kombi (01-07)**

|  |   |                  |  |   |  |  |                            |   |  |                   |  |
|--|---|------------------|--|---|--|--|----------------------------|---|--|-------------------|--|
|  | C 180<br>C 180 Kompressor<br>C 200 CDI<br>C 200 CDI<br>C 200 CGI Kompressor<br>C 200 Kompressor<br>C 200 Kompressor<br>C 220 CDI<br>C 220 CDI<br>C 230 Kompressor<br>C 240  |                  |  | 03.01 09.07<br>05.02 09.07<br>03.01 09.07<br>04.03 09.07<br>07.03 09.07<br>05.02 09.07<br>03.01 04.02<br>03.01 09.07<br>02.04 09.07<br>02.04 09.07<br>03.01 09.07   |  | 03.2023-1741.3<br>010703                           |                            |   | Thz 23,81/20,64                                | ATE               |  |
|  | C 230<br>C 240 4-matic<br>C 270 CDI<br>C 280<br>C 280 4-matic<br>C 30 CDI AMG<br>C 32 Kompressor AMG<br>C 320<br>C 320 4-matic<br>C 320 CDI<br>C 350<br>C 350 4-matic<br>C 55 AMG   |                  |  | 06.05 09.07<br>07.02 09.07<br>03.01 09.07<br>06.05 09.07<br>06.05 09.07<br>01.03 09.07<br>03.01 09.07<br>03.01 09.07<br>07.02 09.07<br>02.05 09.07<br>06.05 09.07<br>06.05 09.07<br>02.04 09.07   |  | 03.2025-1741.3<br>010705                           |                            |   | Thz 25,40/20,64                                | ATE               |  |
|  | C 180<br>C 180 Kompressor<br>C 200 CDI<br>C 200 CDI<br>C 200 CGI Kompressor<br>C 200 Kompressor<br>C 200 Kompressor<br>C 220 CDI<br>C 220 CDI   | 90<br>120<br>110 |  | 03.01 09.07<br>05.02 09.07<br>03.01 09.07<br>04.03 09.07<br>07.03 09.07<br>05.02 09.07<br>03.01 04.02<br>03.01 09.07<br>02.04 09.07   | - Sportpaket / - Sportpaket AMG <sup>1)</sup><br>- Sportpaket / - Sportpaket AMG <sup>1)</sup><br>- Sportpaket / - Sportpaket AMG <sup>1)</sup><br>- Sportpaket / - Sportpaket AMG <sup>1)</sup><br>- Sportpaket / - Sportpaket AMG <sup>1)</sup>  | 24.3571-1739.7<br>24.3571-1740.7<br>24.0101-3803.2 | 220667<br>220668<br>260101 |   | D=57, - Halter<br>D=57, - Halter<br>Einbausatz | LUC<br>LUC<br>LUC |  |
|  | C 180 Kompressor<br>C 200 CDI<br>C 200 CDI<br>C 200 CGI Kompressor<br>C 200 Kompressor<br>C 220 CDI<br>C 220 CDI<br>C 230 Kompressor<br>C 240<br>C 270 CDI<br>C 320   | 90<br>110        | A 660226 / F 565688<br>A 660226 / F 565688<br>A 660226 / F 565688<br>A 660226 / F 565688<br>A 660226 / F 565688<br>A 660226 / F 565688<br>A 660226 / F 565688<br>A 660226 / F 565688<br>A 660226 / F 565688<br>A 660226 / F 565688 | 05.02<br>03.01<br>04.03<br>07.03<br>05.02<br>03.01<br>02.04<br>02.04<br>03.01<br>03.01<br>03.01   | + Sportpaket / + Sportpaket AMG <sup>2)</sup><br>+ Sportpaket / + Sportpaket AMG <sup>2)</sup><br>+ Sportpaket / + Sportpaket AMG <sup>2)</sup><br>+ Sportpaket / + Sportpaket AMG <sup>2)</sup><br>+ Sportpaket / + Sportpaket AMG <sup>2)</sup><br>+ Sportpaket / + Sportpaket AMG <sup>2)</sup><br>+ Sportpaket / + Sportpaket AMG <sup>2)</sup><br>+ Sportpaket / + Sportpaket AMG <sup>2)</sup><br>+ Sportpaket / + Sportpaket AMG <sup>2)</sup><br>+ Sportpaket / + Sportpaket AMG <sup>2)</sup>   | 24.0101-3803.2                                     | 260101                     |   | Einbausatz                                     | LUC               |  |
|  | C 180 Kompressor<br>C 200 CDI<br>C 200 CGI Kompressor<br>C 200 Kompressor<br>C 220 CDI<br>C 230<br>C 230 Kompressor<br>C 240<br>C 270 CDI<br>C 280<br>C 280 4-matic<br>C 320<br>C 320 CDI<br>C 350  | 90<br>110        | A 660227 / F 565689<br>A 660227 / F 565689<br>A 660227 / F 565689<br>A 660227 / F 565689<br>A 660227 / F 565689<br>A 660227 / F 565689<br>A 660227 / F 565689<br>A 660227 / F 565689<br>A 660227 / F 565689<br>A 660227 / F 565689 | 09.07<br>09.07<br>09.07<br>09.07<br>09.07<br>06.05<br>09.07<br>09.07<br>09.07<br>09.07<br>06.05<br>06.05<br>09.07<br>02.05<br>06.05   | + Sportpaket / + Sportpaket AMG <sup>2)</sup><br>+ Sportpaket / + Sportpaket AMG <sup>2)</sup><br>+ Sportpaket / + Sportpaket AMG <sup>2)</sup><br>+ Sportpaket / + Sportpaket AMG <sup>2)</sup><br>+ Sportpaket / + Sportpaket AMG <sup>2)</sup><br>+ Sportpaket / + Sportpaket AMG <sup>2)</sup><br>+ Sportpaket / + Sportpaket AMG <sup>2)</sup><br>+ Sportpaket / + Sportpaket AMG <sup>2)</sup><br>+ Sportpaket / + Sportpaket AMG <sup>2)</sup><br>+ Sportpaket / + Sportpaket AMG <sup>2)</sup><br>+ Sportpaket / + Sportpaket AMG <sup>2)</sup><br>+ Sportpaket / + Sportpaket AMG <sup>2)</sup><br>+ Sportpaket / + Sportpaket AMG <sup>2)</sup><br>+ Sportpaket / + Sportpaket AMG <sup>2)</sup> | 24.0101-3803.2                                     | 260101                     |   | Einbausatz                                     | LUC               |  |
|  | C 230<br>C 230 Kompressor<br>C 240<br>C 270 CDI<br>C 280<br>C 320   |                  |  | 06.05 09.07<br>02.04 09.07<br>03.01 09.07<br>03.01 09.07<br>06.05 09.07<br>03.01 09.07  | - Sportpaket / - Sportpaket AMG <sup>1)</sup><br>- Sportpaket / - Sportpaket AMG <sup>1)</sup><br>- Sportpaket / - Sportpaket AMG <sup>1)</sup><br>- Sportpaket / - Sportpaket AMG <sup>1)</sup><br>- Sportpaket / - Sportpaket AMG <sup>1)</sup><br>- Sportpaket / - Sportpaket AMG <sup>1)</sup>   | 24.3571-1721.7<br>24.3571-1722.7<br>24.0101-3803.2 | 220555<br>220556<br>260101 |   | D=57, - Halter<br>D=57, - Halter<br>Einbausatz | LUC<br>LUC<br>LUC |  |
|  | C 240 4-matic<br>C 280 4-matic<br>C 320 4-matic   |                  |  | 07.02 09.07<br>06.05 09.07<br>07.02 09.07   | - Sportpaket / - Sportpaket AMG <sup>1)</sup>  | 24.0101-3803.2<br>13.8190-0330.1                   | 260101<br>990134           | 2 | Einbausatz<br>Halterschraube                   | LUC               |  |
|  | C 180<br>C 180 Kompressor<br>C 200 CDI<br>C 200 CDI<br>C 200 CGI Kompressor<br>C 200 Kompressor<br>C 200 Kompressor<br>C 220 CDI<br>C 220 CDI<br>C 230<br>C 230 Kompressor<br>C 240<br>C 270 CDI<br>C 280<br>C 30 CDI AMG<br>C 32 Kompressor AMG<br>C 320<br>C 320 CDI<br>C 350 | 90<br>120<br>110 |  | 03.01 09.07<br>05.02 09.07<br>03.01 09.07<br>04.03 09.07<br>07.03 09.07<br>05.02 09.07<br>03.01 04.02<br>03.01 09.07<br>02.04 09.07<br>06.05 09.07<br>02.04 09.07<br>03.01 09.07<br>03.01 09.07<br>06.05 09.07<br>01.03 09.07<br>03.01 09.07<br>03.01 09.07<br>02.05 09.07<br>06.05 09.07 |  | 83.7705-0386.3                                     | 330828                     | 2 |  | L=385             |  |

<sup>1)</sup> - sport package/- sport package AMG / - pacchetto sportivo/- pacchetto sport.AMG / - version sport/- version sport AMG / - kit sportivo/- kit sportivo AMG  
<sup>2)</sup> + sports package/+ sports package AMG / + pacchetto sportivo/+ pacchetto sport.AMG / + version sport/+ version sport AMG / + kit sportivo/+ kit sportivo AMG



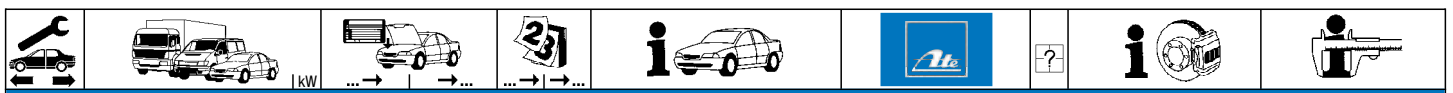

**MERCEDES BENZ C-Klasse (S203) Kombi (01-07)**

|  |                      |      |       |       |   |                |                          |                          |               |
|--|----------------------|------|-------|-------|---|----------------|--------------------------|--------------------------|---------------|
|  | C 55 AMG             |      | 02.04 | 09.07 | 83.7705-0386.3                                | 330828         | 2                        |                          | L=385         |
|  | C 180                |      | 03.01 | 09.07 | 13.9361-0035.2                                | 210253         | <input type="checkbox"/> |                          | D=36          |
|  | C 180 Kompressor     |      | 05.02 | 09.07 | 13.9361-0036.2                                | 210254         | <input type="checkbox"/> |                          | D=36          |
|  | C 200 CDI            |      | 03.01 | 09.07 | 13.0441-3609.2                                | 250057         |                          |                          | Dichtungssatz |
|  | C 200 CDI            | 90   | 04.03 | 09.07 |   |                |                          |                          |               |
|  | C 200 CGI Kompressor |      | 07.03 | 09.07 |   |                |                          |                          |               |
|  | C 200 Kompressor     |      | 05.02 | 09.07 |   |                |                          |                          |               |
|  | C 200 Kompressor     | 120  | 03.01 | 04.02 |   |                |                          |                          |               |
|  | C 220 CDI            |      | 03.01 | 09.07 |   |                |                          |                          |               |
|  | C 220 CDI            | 110  | 02.04 | 09.07 |   |                |                          |                          |               |
|  | C 230                |      | 06.05 | 09.07 |   |                |                          |                          |               |
|  | C 230 Kompressor     |      | 02.04 | 09.07 |   |                |                          |                          |               |
|  | C 240                |      | 03.01 | 09.07 |   |                |                          |                          |               |
|  | C 240 4-matic        |      | 07.02 | 09.07 |   |                |                          |                          |               |
|  | C 270 CDI            |      | 03.01 | 09.07 |   |                |                          |                          |               |
|  | C 280                |      | 06.05 | 09.07 |   |                |                          |                          |               |
|  | C 280 4-matic        |      | 06.05 | 09.07 |   |                |                          |                          |               |
|  | C 320                |      | 03.01 | 09.07 |   |                |                          |                          |               |
|  | C 320 4-matic        |      | 07.02 | 09.07 |   |                |                          |                          |               |
|  | C 320 CDI            |      | 02.05 | 09.07 |   |                |                          |                          |               |
|  | C 350                |      | 06.05 | 09.07 |   |                |                          |                          |               |
|  | C 350 4-matic        |      | 06.05 | 09.07 |   |                |                          |                          |               |
|  | C 30 CDI AMG         |      | 01.03 | 09.07 | 13.0441-4216.2                                | 250093         |                          |                          | Dichtungssatz |
|  | C 32 Kompressor AMG  |      | 03.01 | 09.07 |   |                |                          |                          |               |
|  | C 55 AMG             |      | 02.04 | 09.07 |   |                |                          |                          |               |
|  | C 350 4-matic        |      | 06.05 | 09.07 | - Sportpaket / - Sportpaket AMG <sup>2)</sup> | 13.2421-8025.2 | 210061                   | <input type="checkbox"/> | D=42          |
|  |                      |      |       |       |   |                |                          | <input type="checkbox"/> | D=42          |
|  |                      |      |       |       |   |                |                          |                          | Dichtungssatz |
|  |                      |      |       |       |   |                |                          |                          |               |
|  | C 180                |      | 03.01 | 09.07 | 83.7715-0280.3                                | 330806         | 2                        |                          | L=280         |
|  | C 180 Kompressor     |      | 05.02 | 09.07 |   |                |                          |                          |               |
|  | C 200 CDI            |      | 03.01 | 09.07 |   |                |                          |                          |               |
|  | C 200 CDI            | 90   | 04.03 | 09.07 |   |                |                          |                          |               |
|  | C 200 CGI Kompressor |      | 07.03 | 09.07 |   |                |                          |                          |               |
|  | C 200 Kompressor     |      | 05.02 | 09.07 |   |                |                          |                          |               |
|  | C 200 Kompressor     | 120  | 03.01 | 04.02 |   |                |                          |                          |               |
|  | C 220 CDI            |      | 03.01 | 09.07 |   |                |                          |                          |               |
|  | C 220 CDI            | 110  | 02.04 | 09.07 |   |                |                          |                          |               |
|  | C 230                |      | 06.05 | 09.07 |   |                |                          |                          |               |
|  | C 230 Kompressor     |      | 02.04 | 09.07 |   |                |                          |                          |               |
|  | C 240                |      | 03.01 | 09.07 |   |                |                          |                          |               |
|  | C 240 4-matic        |      | 07.02 | 09.07 |   |                |                          |                          |               |
|  | C 270 CDI            |      | 03.01 | 09.07 |   |                |                          |                          |               |
|  | C 280                |      | 06.05 | 09.07 |   |                |                          |                          |               |
|  | C 280 4-matic        |      | 06.05 | 09.07 |   |                |                          |                          |               |
|  | C 30 CDI AMG         |      | 01.03 | 09.07 |   |                |                          |                          |               |
|  | C 32 Kompressor AMG  |      | 03.01 | 09.07 |   |                |                          |                          |               |
|  | C 320                |      | 03.01 | 09.07 |   |                |                          |                          |               |
|  | C 320 4-matic        |      | 07.02 | 09.07 |   |                |                          |                          |               |
|  | C 320 CDI            |      | 02.05 | 09.07 |   |                |                          |                          |               |
|  | C 350                |      | 06.05 | 09.07 |   |                |                          |                          |               |
|  | C 350 4-matic        |      | 06.05 | 09.07 |   |                |                          |                          |               |
|  | C 55 AMG             |      | 02.04 | 09.07 |   |                |                          |                          |               |
|  | C 180                | ↑    | 03.01 | 09.07 | 24.3727-0429.2                                | 580429         | 1                        | <input type="checkbox"/> | L=2735        |
|  | C 180 Kompressor     | ↑    | 05.02 | 09.07 | 24.3727-0430.2                                | 580430         |                          | <input type="checkbox"/> | L=925         |
|  | C 200 CDI            | ↑    | 03.01 | 09.07 | 24.3727-0436.2                                | 580436         |                          | <input type="checkbox"/> | L=900         |
|  | C 200 CDI            | ↑ 90 | 04.03 | 09.07 |   |                |                          |                          |               |
|  | C 200 CGI Kompressor | ↑    | 07.03 | 09.07 |   |                |                          |                          |               |
|  | C 200 Kompressor     | ↑    | 05.02 | 09.07 |   |                |                          |                          |               |
|  | C 200 Kompressor     | ↑120 | 03.01 | 04.02 |   |                |                          |                          |               |
|  | C 220 CDI            | ↑    | 03.01 | 09.07 |   |                |                          |                          |               |
|  | C 220 CDI            | ↑110 | 02.04 | 09.07 |   |                |                          |                          |               |
|  | C 230                | ↑    | 06.05 | 09.07 |   |                |                          |                          |               |
|  | C 230 Kompressor     | ↑    | 02.04 | 09.07 |   |                |                          |                          |               |
|  | C 240                | ↑    | 03.01 | 09.07 |   |                |                          |                          |               |
|  | C 240 4-matic        | ↑    | 07.02 | 09.07 |   |                |                          |                          |               |
|  | C 270 CDI            | ↑    | 03.01 | 09.07 |   |                |                          |                          |               |
|  | C 280                | ↑    | 06.05 | 09.07 |   |                |                          |                          |               |
|  | C 280 4-matic        | ↑    | 06.05 | 09.07 |   |                |                          |                          |               |
|  | C 30 CDI AMG         | ↑    | 01.03 | 09.07 |   |                |                          |                          |               |
|  | C 32 Kompressor AMG  | ↑    | 03.01 | 09.07 |   |                |                          |                          |               |
|  | C 320                | ↑    | 03.01 | 09.07 |   |                |                          |                          |               |
|  | C 320 4-matic        | ↑    | 07.02 | 09.07 |   |                |                          |                          |               |
|  | C 320 CDI            | ↑    | 02.05 | 09.07 |   |                |                          |                          |               |
|  | C 350                | ↑    | 06.05 | 09.07 |   |                |                          |                          |               |
|  | C 350 4-matic        | ↑    | 06.05 | 09.07 |   |                |                          |                          |               |
|  | C 55 AMG             | ↑    | 02.04 | 09.07 |   |                |                          |                          |               |
|  | C 180                | ↑    | 03.01 | 09.07 | 24.3727-0430.2                                | 580430         |                          | <input type="checkbox"/> | L=925         |
|  | C 180 Kompressor     | ↑    | 05.02 | 09.07 | 24.3727-0436.2                                | 580436         |                          | <input type="checkbox"/> | L=900         |
|  | C 200 CDI            | ↑    | 03.01 | 09.07 |   |                |                          |                          |               |
|  | C 200 CDI            | ↑ 90 | 04.03 | 09.07 |   |                |                          |                          |               |
|  | C 200 CGI Kompressor | ↑    | 07.03 | 09.07 |   |                |                          |                          |               |
|  | C 200 Kompressor     | ↑    | 05.02 | 09.07 |   |                |                          |                          |               |
|  | C 200 Kompressor     | ↑120 | 03.01 | 04.02 |   |                |                          |                          |               |
|  | C 220 CDI            | ↑    | 03.01 | 09.07 |   |                |                          |                          |               |
|  | C 220 CDI            | ↑110 | 02.04 | 09.07 |   |                |                          |                          |               |

<sup>1)</sup> + sports package/+ sports package AMG / + pacchetto sportivo/+ pacchetto sport.AMG / + version sport/+ version sport AMG / + kit sportivo/+ kit sportivo AMG

<sup>2)</sup> - sport package/- sport package AMG / - pacchetto sportivo/- pacchetto sport.AMG / - version sport/- version sport AMG / - kit sportivo/- kit sportivo AMG

























**MERCEDES BENZ C-Klasse (S203) Kombi (01-07)**

|  |                     |  |  |       |       |  |                |        |                          |  |       |
|--|---------------------|--|--|-------|-------|--|----------------|--------|--------------------------|--|-------|
|  | C 230               |  |  | 06.05 | 09.07 |  | 24.3727-0430.2 | 580430 | <input type="checkbox"/> |  | L=925 |
|  | C 230 Kompressor    |  |  | 02.04 | 09.07 |  | 24.3727-0436.2 | 580436 | <input type="checkbox"/> |  | L=900 |
|  | C 240               |  |  | 03.01 | 09.07 |  |                |        |                          |  |       |
|  | C 240 4-matic       |  |  | 07.02 | 09.07 |  |                |        |                          |  |       |
|  | C 270 CDI           |  |  | 03.01 | 09.07 |  |                |        |                          |  |       |
|  | C 280               |  |  | 06.05 | 09.07 |  |                |        |                          |  |       |
|  | C 30 CDI AMG        |  |  | 01.03 | 09.07 |  |                |        |                          |  |       |
|  | C 32 Kompressor AMG |  |  | 03.01 | 09.07 |  |                |        |                          |  |       |
|  | C 320               |  |  | 03.01 | 09.07 |  |                |        |                          |  |       |
|  | C 320 4-matic       |  |  | 07.02 | 09.07 |  |                |        |                          |  |       |
|  | C 320 CDI           |  |  | 02.05 | 09.07 |  |                |        |                          |  |       |
|  | C 350               |  |  | 06.05 | 09.07 |  |                |        |                          |  |       |
|  | C 350 4-matic       |  |  | 06.05 | 09.07 |  |                |        |                          |  |       |
|  | C 55 AMG            |  |  | 02.04 | 09.07 |  |                |        |                          |  |       |

**MERCEDES BENZ C-Klasse (CL203) Sportcoupe (01-08)**

|  |                      |  |          |       |       |  |                |        |                          |       |                 |     |
|--|----------------------|--|----------|-------|-------|--|----------------|--------|--------------------------|-------|-----------------|-----|
|  | C 160 Kompressor     |  |          | 04.05 | 05.08 |  | 03.7848-2002.4 | 300166 |                          |       | 7/8" Tandem     | ATE |
|  | C 180                |  |          | 03.01 | 05.08 |  |                |        |                          |       |                 |     |
|  | C 180 Kompressor     |  |          | 05.02 | 05.08 |  |                |        |                          |       |                 |     |
|  | C 200 CDI            |  |          | 07.03 | 05.08 |  |                |        |                          |       |                 |     |
|  | C 200 CGI Kompressor |  |          | 07.03 | 05.08 |  |                |        |                          |       |                 |     |
|  | C 200 Kompressor     |  |          | 03.01 | 05.08 |  |                |        |                          |       |                 |     |
|  | C 220 CDI            |  |          | 03.01 | 05.08 |  |                |        |                          |       |                 |     |
|  | C 230                |  |          | 06.05 | 05.08 |  |                |        |                          |       |                 |     |
|  | C 230 Kompressor     |  |          | 03.01 | 05.08 |  |                |        |                          |       |                 |     |
|  | C 30 CDI AMG         |  |          | 09.02 | 05.08 |  |                |        |                          |       |                 |     |
|  | C 320                |  |          | 09.02 | 05.08 |  |                |        |                          |       |                 |     |
|  | C 350                |  |          | 06.05 | 05.08 |  |                |        |                          |       |                 |     |
|  | C 160 Kompressor     |  |          | 04.05 | 05.08 |  | 03.2023-1741.3 | 010703 |                          |       | THz 23,81/20,64 | ATE |
|  | C 180                |  |          | 03.01 | 05.08 |  |                |        |                          |       |                 |     |
|  | C 180 Kompressor     |  |          | 05.02 | 05.08 |  |                |        |                          |       |                 |     |
|  | C 200 CDI            |  |          | 07.03 | 05.08 |  |                |        |                          |       |                 |     |
|  | C 200 CGI Kompressor |  |          | 07.03 | 05.08 |  |                |        |                          |       |                 |     |
|  | C 200 Kompressor     |  |          | 03.01 | 05.08 |  |                |        |                          |       |                 |     |
|  | C 220 CDI            |  |          | 03.01 | 05.08 |  |                |        |                          |       |                 |     |
|  | C 230 Kompressor     |  |          | 03.01 | 05.08 |  |                |        |                          |       |                 |     |
|  | C 230                |  |          | 06.05 | 05.08 |  | 03.2025-1741.3 | 010705 |                          |       | THz 25,40/20,64 | ATE |
|  | C 30 CDI AMG         |  |          | 09.02 | 05.08 |  |                |        |                          |       |                 |     |
|  | C 320                |  |          | 09.02 | 05.08 |  |                |        |                          |       |                 |     |
|  | C 350                |  |          | 06.05 | 05.08 |  |                |        |                          |       |                 |     |
|  | C 160 Kompressor     |  |          | 04.05 | 05.08 |  | 24.3571-1739.7 | 220667 | <input type="checkbox"/> |       | D=57, - Halter  | LUC |
|  | C 180                |  |          | 03.01 | 05.08 |  | 24.3571-1740.7 | 220668 | <input type="checkbox"/> |       | D=57, - Halter  | LUC |
|  | C 180 Kompressor     |  |          | 05.02 | 05.08 |  | 24.0101-3803.2 | 260101 | <input type="checkbox"/> |       | Einbausatz      | LUC |
|  | C 200 CDI            |  |          | 07.03 | 05.08 |  |                |        |                          |       |                 |     |
|  | C 200 CGI Kompressor |  |          | 07.03 | 05.08 |  |                |        |                          |       |                 |     |
|  | C 200 Kompressor     |  |          | 03.01 | 05.08 |  |                |        |                          |       |                 |     |
|  | C 220 CDI            |  |          | 03.01 | 05.08 |  |                |        |                          |       |                 |     |
|  | C 230 Kompressor     |  |          | 03.01 | 05.08 |  | 24.3571-1721.7 | 220555 | <input type="checkbox"/> |       | D=57, - Halter  | LUC |
|  |                      |  |          |       |       |  | 24.3571-1722.7 | 220556 | <input type="checkbox"/> |       | D=57, - Halter  | LUC |
|  |                      |  |          |       |       |  | 24.3571-1739.7 | 220667 | <input type="checkbox"/> | + AUS | J USA           | LUC |
|  |                      |  |          |       |       |  | 24.3571-1740.7 | 220668 | <input type="checkbox"/> | + AUS | J USA           | LUC |
|  |                      |  |          |       |       |  | 24.0101-3803.2 | 260101 | <input type="checkbox"/> |       | Einbausatz      | LUC |
|  | C 230                |  |          | 06.05 | 05.08 |  | 24.3571-1721.7 | 220555 | <input type="checkbox"/> |       | D=57, - Halter  | LUC |
|  | C 320                |  |          | 09.02 | 05.08 |  | 24.3571-1722.7 | 220556 | <input type="checkbox"/> |       | D=57, - Halter  | LUC |
|  |                      |  |          |       |       |  | 24.0101-3803.2 | 260101 | <input type="checkbox"/> |       | Einbausatz      | LUC |
|  | C 160 Kompressor     |  |          | 04.05 | 05.08 |  | 83.7705-0386.3 | 330828 | 2                        |       | L=385           |     |
|  | C 180                |  |          | 03.01 | 05.08 |  |                |        |                          |       |                 |     |
|  | C 180 Kompressor     |  |          | 05.02 | 05.08 |  |                |        |                          |       |                 |     |
|  | C 200 CDI            |  |          | 07.03 | 05.08 |  |                |        |                          |       |                 |     |
|  | C 200 CGI Kompressor |  |          | 07.03 | 05.08 |  |                |        |                          |       |                 |     |
|  | C 200 Kompressor     |  |          | 03.01 | 05.08 |  |                |        |                          |       |                 |     |
|  | C 220 CDI            |  |          | 03.01 | 05.08 |  |                |        |                          |       |                 |     |
|  | C 230                |  |          | 06.05 | 05.08 |  |                |        |                          |       |                 |     |
|  | C 230 Kompressor     |  |          | 03.01 | 05.08 |  |                |        |                          |       |                 |     |
|  | C 30 CDI AMG         |  |          | 09.02 | 05.08 |  |                |        |                          |       |                 |     |
|  | C 320                |  |          | 09.02 | 05.08 |  |                |        |                          |       |                 |     |
|  | C 350                |  |          | 06.05 | 05.08 |  |                |        |                          |       |                 |     |
|  | C 160 Kompressor     |  |          | 04.05 | 05.08 |  | 13.9361-0023.2 | 210241 | <input type="checkbox"/> |       | D=36            | ATE |
|  | C 180                |  |          | 03.01 | 05.08 |  | 13.9361-0024.2 | 210242 | <input type="checkbox"/> |       | D=36            | ATE |
|  | C 180 Kompressor     |  |          | 05.02 | 05.08 |  | 13.0441-3609.2 | 250057 | <input type="checkbox"/> |       | Dichtungssatz   | ATE |
|  | C 200 CDI            |  |          | 07.03 | 05.08 |  |                |        |                          |       |                 |     |
|  | C 200 CGI Kompressor |  |          | 07.03 | 05.08 |  |                |        |                          |       |                 |     |
|  | C 200 Kompressor     |  |          | 03.01 | 05.08 |  |                |        |                          |       |                 |     |
|  | C 220 CDI            |  |          | 03.01 | 05.08 |  |                |        |                          |       |                 |     |
|  | C 230 Kompressor     |  |          | 03.01 | 05.08 |  | 13.9361-0035.2 | 210253 | <input type="checkbox"/> |       | D=36            | ATE |
|  |                      |  |          |       |       |  | 13.9361-0036.2 | 210254 | <input type="checkbox"/> |       | D=36            | ATE |
|  |                      |  |          |       |       |  | 13.9361-0023.2 | 210241 | <input type="checkbox"/> | + AUS | J USA           | ATE |
|  |                      |  |          |       |       |  | 13.9361-0024.2 | 210242 | <input type="checkbox"/> | + AUS | J USA           | ATE |
|  |                      |  |          |       |       |  | 13.0441-3609.2 | 250057 | <input type="checkbox"/> |       | Dichtungssatz   | ATE |
|  | C 230                |  |          | 06.05 | 05.08 |  | 13.9361-0035.2 | 210253 | <input type="checkbox"/> |       | D=36            | ATE |
|  | C 320                |  |          | 09.02 | 05.08 |  | 13.9361-0036.2 | 210254 | <input type="checkbox"/> |       | D=36            | ATE |
|  | C 350                |  |          | 06.05 | 05.08 |  | 13.0441-3609.2 | 250057 | <input type="checkbox"/> |       | Dichtungssatz   | ATE |
|  | C 30 CDI AMG         |  | A 556572 | 09.02 |       |  | 13.9361-0035.2 | 210253 | <input type="checkbox"/> |       | D=36            | ATE |
|  |                      |  |          |       |       |  | 13.9361-0036.2 | 210254 | <input type="checkbox"/> |       | D=36            | ATE |
|  |                      |  |          |       |       |  | 13.0441-3609.2 | 250057 | <input type="checkbox"/> |       | Dichtungssatz   | ATE |
|  | C 30 CDI AMG         |  | A 556573 |       | 05.08 |  | 13.0441-4216.2 | 250093 | <input type="checkbox"/> |       | Dichtungssatz   | ATE |



|     |    |  |                          |                          |  |  |  |  |   |
|--|--|--|--|--|---|--|--|--|---|
| <b>MERCEDES BENZ C-Klasse (CL203) Sportcoupe (01-08)</b>                           |  |  |  |  |   |  |  |  |   |
|    | C 160 Kompressor<br>C 180<br>C 180 Kompressor<br>C 200 CDI<br>C 200 CGI Kompressor<br>C 200 Kompressor<br>C 220 CDI<br>C 230<br>C 230 Kompressor<br>C 30 CDI AMG<br>C 320<br>C 350 |  | 04.05<br>03.01<br>05.02<br>07.03<br>07.03<br>03.01<br>03.01<br>06.05<br>03.01<br>09.02<br>09.02<br>06.05 | 05.08<br>05.08<br>05.08<br>05.08<br>05.08<br>05.08<br>05.08<br>05.08<br>05.08<br>05.08<br>05.08<br>05.08 |   | 83.7715-0280.3<br>330806   | 2  |  | L=280   |
|    | C 160 Kompressor<br>C 180<br>C 180 Kompressor<br>C 200 CDI<br>C 200 CGI Kompressor<br>C 200 Kompressor<br>C 220 CDI<br>C 230<br>C 230 Kompressor<br>C 30 CDI AMG<br>C 320<br>C 350 | ↑<br>↓<br>↓<br>↓<br>↓<br>↓<br>↓<br>↓<br>↓<br>↓<br>↓<br>↓<br>↓                    | 04.05<br>03.01<br>05.02<br>07.03<br>07.03<br>03.01<br>03.01<br>06.05<br>03.01<br>09.02<br>09.02<br>06.05 | 05.08<br>05.08<br>05.08<br>05.08<br>05.08<br>05.08<br>05.08<br>05.08<br>05.08<br>05.08<br>05.08<br>05.08 |   | 24.3727-0429.2<br>24.3727-0430.2<br>24.3727-0436.2                                 | 580429<br>580430<br>580436   | 1<br>↑<br>↓<br>↓   | L=2735<br>L=925<br>L=900  |
|  | C 160 Kompressor<br>C 180<br>C 180 Kompressor<br>C 200 CDI<br>C 200 CGI Kompressor<br>C 200 Kompressor<br>C 220 CDI<br>C 230<br>C 230 Kompressor<br>C 30 CDI AMG<br>C 320<br>C 350 | ↑<br>↑<br>↑<br>↑<br>↑<br>↑<br>↑<br>↑<br>↑<br>↑<br>↑<br>↑                         | 04.05<br>03.01<br>05.02<br>07.03<br>07.03<br>03.01<br>03.01<br>06.05<br>03.01<br>09.02<br>09.02<br>06.05 | 05.08<br>05.08<br>05.08<br>05.08<br>05.08<br>05.08<br>05.08<br>05.08<br>05.08<br>05.08<br>05.08<br>05.08 |   | 24.3727-0430.2<br>24.3727-0436.2   | 580430<br>580436   | ↓<br>↓   | L=925<br>L=900  |
| <b>MERCEDES BENZ C-Klasse (CLC203) Coupe (08-10)</b>                               |  |  |  |  |   |  |  |  |   |
|   | CLC 160<br>CLC 180 Kompressor<br>CLC 200 CDI<br>CLC 200 Kompressor<br>CLC 220 CDI<br>CLC 230<br>CLC 350  | ↑<br>↑<br>↑<br>↑<br>↑<br>↑<br>↑  | 01.09<br>05.08<br>05.08<br>05.08<br>05.08<br>05.08<br>05.08  | 10.10<br>10.10<br>10.10<br>10.10<br>10.10<br>10.10<br>10.10  |   | 03.7848-2002.4   | 300166   |  | 7/8" Tandem<br>ATE  |
|  | CLC 160<br>CLC 180 Kompressor<br>CLC 200 CDI<br>CLC 200 Kompressor<br>CLC 220 CDI  | ↑<br>↑<br>↑<br>↑<br>↑  | 01.09<br>05.08<br>05.08<br>05.08<br>05.08  | 10.10<br>10.10<br>10.10<br>10.10<br>10.10  |   | 03.2023-1741.3   | 010703   |  | THz 23,81/20,64<br>ATE  |
|  | CLC 230<br>CLC 350   | ↑<br>↑   | 05.08<br>05.08   | 10.10<br>10.10   |   | 03.2025-1741.3   | 010705   |  | THz 25,40/20,64<br>ATE  |
|  | CLC 160<br>CLC 180 Kompressor<br>CLC 200 CDI<br>CLC 220 CDI<br>CLC 200 Kompressor<br>CLC 230   | ↑<br>↑<br>↑<br>↑<br>↑<br>↑   | 01.09<br>05.08<br>05.08<br>05.08<br>05.08<br>05.08   | 10.10<br>10.10<br>10.10<br>10.10<br>10.10<br>10.10   |   | 24.0101-3803.2   | 260101   |  | Einbausatz<br>LUC   |
|  | CLC 180 Kompressor<br>CLC 200 CDI<br>CLC 220 CDI   | ↑<br>↑<br>↑  | 05.08<br>05.08<br>05.08  | 10.10<br>10.10<br>10.10  |   | 24.3571-1739.7<br>24.3571-1740.7<br>24.0101-3803.2                                 | 220667<br>220668<br>260101   | ☒<br>☒<br>☒  | D=57, - Halter<br>D=57, - Halter<br>Einbausatz<br>LUC<br>LUC<br>LUC |
|  | CLC 200 Kompressor<br>CLC 230  | ↑<br>↑   | 05.08<br>05.08   | 10.10<br>10.10   |   | 24.0101-3803.2   | 260101   |  | Einbausatz<br>LUC   |
|  | CLC 230  | ↑  | 05.08  | 10.10  |   | 24.3571-1721.7<br>24.3571-1722.7<br>24.0101-3803.2                                 | 220555<br>220556<br>260101   | ☒<br>☒<br>☒  | D=57, - Halter<br>D=57, - Halter<br>Einbausatz<br>LUC<br>LUC<br>LUC |
|  | CLC 160<br>CLC 180 Kompressor<br>CLC 200 CDI<br>CLC 200 Kompressor<br>CLC 220 CDI<br>CLC 230<br>CLC 350  | ↑<br>↑<br>↑<br>↑<br>↑<br>↑<br>↑  | 01.09<br>05.08<br>05.08<br>05.08<br>05.08<br>05.08<br>05.08  | 10.10<br>10.10<br>10.10<br>10.10<br>10.10<br>10.10<br>10.10  |   | 83.7705-0386.3   | 330828   | 2  | L=385   |
|  | CLC 160<br>CLC 180 Kompressor<br>CLC 200 CDI<br>CLC 220 CDI  | ↑<br>↑<br>↑<br>↑   | 01.09<br>05.08<br>05.08<br>05.08   | 10.10<br>10.10<br>10.10<br>10.10   |   | 13.9361-0023.2<br>13.9361-0024.2<br>13.0441-3609.2                                 | 210241<br>210242<br>250057   | ☒<br>☒<br>☒  | D=36<br>D=36<br>Dichtungssatz<br>ATE<br>ATE<br>ATE                  |
|  | CLC 200 Kompressor<br>CLC 230<br>CLC 350   | ↑<br>↑<br>↑  | 05.08<br>05.08<br>05.08  | 10.10<br>10.10<br>10.10  |   | 13.9361-0035.2<br>13.9361-0036.2<br>13.0441-3609.2                                 | 210253<br>210254<br>250057   | ☒<br>☒<br>☒  | D=36<br>D=36<br>Dichtungssatz<br>ATE<br>ATE<br>ATE                  |
|  | CLC 160<br>CLC 180 Kompressor<br>CLC 200 CDI<br>CLC 200 Kompressor<br>CLC 220 CDI<br>CLC 230<br>CLC 350  | ↑<br>↑<br>↑<br>↑<br>↑<br>↑<br>↑  | 01.09<br>05.08<br>05.08<br>05.08<br>05.08<br>05.08<br>05.08  | 10.10<br>10.10<br>10.10<br>10.10<br>10.10<br>10.10<br>10.10  |   | 83.7715-0280.3   | 330806   | 2  | L=280   |
|  | CLC 160<br>CLC 180 Kompressor<br>CLC 200 CDI<br>CLC 200 Kompressor   | ↑<br>↑<br>↑<br>↑   | 01.09<br>05.08<br>05.08<br>05.08   | 10.10<br>10.10<br>10.10<br>10.10   |   | 24.3727-0429.2<br>24.3727-0430.2<br>24.3727-0436.2                                 | 580429<br>580430<br>580436   | 1<br>↑<br>↓<br>↓   | L=2735<br>L=925<br>L=900  |



**MERCEDES BENZ C-Klasse (CLC203) Coupe (08-10)**

|  |                    |     |       |       |                |        |                          |  |                          |
|--|--------------------|-----|-------|-------|----------------|--------|--------------------------|--|--------------------------|
|  | CLC 220 CDI        | 88  | 05.08 | 10.10 | 24.3727-0429.2 | 580429 | 1                        |  | L=2735<br>L=925<br>L=900 |
|  | CLC 230            | 115 | 05.08 | 10.10 | 24.3727-0430.2 | 580430 | <input type="checkbox"/> |  |                          |
|  | CLC 350            | 115 | 05.08 | 10.10 | 24.3727-0436.2 | 580436 | <input type="checkbox"/> |  |                          |
|  | CLC 160            | 100 | 01.09 | 10.10 | 24.3727-0430.2 | 580430 | <input type="checkbox"/> |  |                          |
|  | CLC 180 Kompressor | 115 | 05.08 | 10.10 | 24.3727-0436.2 | 580436 | <input type="checkbox"/> |  |                          |
|  | CLC 200 CDI        | 135 | 05.08 | 10.10 |                |        |                          |  |                          |
|  | CLC 200 Kompressor | 135 | 05.08 | 10.10 |                |        |                          |  |                          |
|  | CLC 220 CDI        | 125 | 05.08 | 10.10 |                |        |                          |  |                          |
|  | CLC 230            | 150 | 05.08 | 10.10 |                |        |                          |  |                          |
|  | CLC 350            | 150 | 05.08 | 10.10 |                |        |                          |  |                          |

**MERCEDES BENZ C-Klasse (W204) Limousine (07-)**

|                   |                      |       |                        |                        |                |        |   |                 |     |
|-------------------|----------------------|-------|------------------------|------------------------|----------------|--------|---|-----------------|-----|
|                   | C 180 CDI            | 88    | 01.11                  |                        | 03.7745-6302.4 | 300261 |   | 8"              | ATE |
|                   | C 180 CGI            | 115   | 04.09                  |                        |                |        |   |                 |     |
|                   | C 180 Kompressor     | 115   | 05.07                  |                        |                |        |   |                 |     |
|                   | C 180 Kompressor Eco | 100   | 01.09                  |                        |                |        |   |                 |     |
|                   | C 200 CDI            | 135   | 05.07                  |                        |                |        |   |                 |     |
|                   | C 200 CGI            | 135   | 04.09                  |                        |                |        |   |                 |     |
|                   | C 200 Kompressor     | 135   | 05.07                  |                        |                |        |   |                 |     |
|                   | C 220 CDI            | 120   | 05.07                  |                        |                |        |   |                 |     |
|                   | C 220 CDI            | 125   | 05.07                  |                        |                |        |   |                 |     |
|                   | C 220 CDI 4-matic    | 125   | 02.13                  | - Start/Stop-Anlage 1) |                |        |   |                 |     |
|                   | C 230                | 150   | 05.07                  |                        |                |        |   |                 |     |
|                   | C 230 4-matic        | 150   | 07.07                  |                        |                |        |   |                 |     |
|                   | C 250 CDI            | 150   | 10.08                  |                        |                |        |   |                 |     |
|                   | C 250 CDI 4-matic    | 150   | 01.11                  |                        |                |        |   |                 |     |
|                   | C 250 CGI            | 150   | 04.09                  |                        |                |        |   |                 |     |
|                   | C 280                | 170   | 05.07                  |                        |                |        |   |                 |     |
|                   | C 280 4-matic        | 170   | 07.07                  |                        |                |        |   |                 |     |
|                   | C 300                | 170   | 07.09                  | - Start/Stop-Anlage 1) |                |        |   |                 |     |
|                   | C 300 4-matic        | 170   | 04.09                  |                        |                |        |   |                 |     |
|                   | C 300 CDI 4-matic    | 170   | 01.11                  |                        |                |        |   |                 |     |
|                   | C 300 CGI            | 185   | 02.11                  | - Start/Stop-Anlage 1) |                |        |   |                 |     |
|                   | C 300 CGI 4-matic    | 185   | 02.11                  | - Start/Stop-Anlage 1) |                |        |   |                 |     |
|                   | C 320 CDI            | 165   | 05.07                  |                        |                |        |   |                 |     |
|                   | C 320 CDI 4-matic    | 165   | 07.07                  |                        |                |        |   |                 |     |
|                   | C 350                | 200   | 05.07                  |                        |                |        |   |                 |     |
|                   | C 350                | 225   | 01.11                  | - Start/Stop-Anlage 1) |                |        |   |                 |     |
|                   | C 350 4-matic        | 200   | 07.07                  |                        |                |        |   |                 |     |
|                   | C 350 4-matic        | 225   | 01.11                  | - Start/Stop-Anlage 1) |                |        |   |                 |     |
|                   | C 350 CDI            | 165   | 04.09                  |                        |                |        |   |                 |     |
|                   | C 350 CDI            | 170   | 10.09                  | - Start/Stop-Anlage 1) |                |        |   |                 |     |
|                   | C 350 CDI            | 195   | 06.11                  | - Start/Stop-Anlage 1) |                |        |   |                 |     |
| C 350 CDI 4-matic | 165                  | 07.09 | - Start/Stop-Anlage 1) |                        |                |        |   |                 |     |
| C 350 CDI 4-matic | 170                  | 10.09 |                        |                        |                |        |   |                 |     |
| C 350 CGI         | 215                  | 09.08 |                        |                        |                |        |   |                 |     |
| C 63 AMG          | 100                  | 09.07 |                        |                        |                |        |   |                 |     |
|                   | C 180 CDI            | 88    | 01.11                  |                        | 03.2025-2301.3 | 010895 |   | THz 25,40/22,20 | ATE |
|                   | C 180 CGI            | 115   | 04.09                  |                        |                |        |   |                 |     |
|                   | C 180 Kompressor     | 115   | 03.07                  |                        |                |        |   |                 |     |
|                   | C 180 Kompressor Eco | 100   | 01.09                  |                        |                |        |   |                 |     |
|                   | C 200 CDI            | 135   | 03.07                  |                        |                |        |   |                 |     |
|                   | C 200 CGI            | 135   | 04.09                  |                        |                |        |   |                 |     |
|                   | C 200 Kompressor     | 135   | 03.07                  |                        |                |        |   |                 |     |
|                   | C 220 CDI            | 120   | 03.07                  |                        |                |        |   |                 |     |
|                   | C 220 CDI            | 125   | 03.07                  |                        |                |        |   |                 |     |
|                   | C 220 CDI 4-matic    | 125   | 02.13                  |                        |                |        |   |                 |     |
|                   | C 230                | 150   | 03.07                  |                        |                |        |   |                 |     |
|                   | C 230 4-matic        | 150   | 07.07                  |                        |                |        |   |                 |     |
|                   | C 250 CDI            | 150   | 10.08                  |                        |                |        |   |                 |     |
|                   | C 250 CDI 4-matic    | 150   | 01.11                  |                        |                |        |   |                 |     |
|                   | C 250 CGI            | 150   | 04.09                  |                        |                |        |   |                 |     |
|                   | C 280                | 170   | 03.07                  |                        |                |        |   |                 |     |
|                   | C 280 4-matic        | 170   | 07.07                  |                        |                |        |   |                 |     |
|                   | C 300                | 170   | 07.09                  |                        |                |        |   |                 |     |
|                   | C 300 4-matic        | 170   | 04.09                  |                        |                |        |   |                 |     |
|                   | C 300 CDI 4-matic    | 170   | 01.11                  |                        |                |        |   |                 |     |
|                   | C 300 CGI            | 185   | 02.11                  |                        |                |        |   |                 |     |
|                   | C 300 CGI 4-matic    | 185   | 02.11                  |                        |                |        |   |                 |     |
|                   | C 320 CDI            | 165   | 03.07                  |                        |                |        |   |                 |     |
|                   | C 320 CDI 4-matic    | 165   | 07.07                  |                        |                |        |   |                 |     |
|                   | C 350                | 200   | 03.07                  |                        |                |        |   |                 |     |
|                   | C 350                | 225   | 01.11                  |                        |                |        |   |                 |     |
|                   | C 350 4-matic        | 200   | 07.07                  |                        |                |        |   |                 |     |
|                   | C 350 4-matic        | 225   | 01.11                  |                        |                |        |   |                 |     |
|                   | C 350 CDI            | 165   | 04.09                  |                        |                |        |   |                 |     |
|                   | C 350 CDI            | 170   | 10.09                  |                        |                |        |   |                 |     |
|                   | C 350 CDI            | 195   | 06.11                  |                        |                |        |   |                 |     |
| C 350 CDI 4-matic | 165                  | 07.09 |                        |                        |                |        |   |                 |     |
| C 350 CDI 4-matic | 170                  | 10.09 |                        |                        |                |        |   |                 |     |
| C 350 CGI         | 215                  | 09.08 |                        |                        |                |        |   |                 |     |
| C 63 AMG          | 100                  | 09.07 |                        |                        |                |        |   |                 |     |
|                   | C 180 CDI            | 88    | 01.11                  |                        | 83.7705-0386.3 | 330828 | 2 | L=385           |     |
|                   | C 180 CGI            | 115   | 04.09                  |                        |                |        |   |                 |     |
|                   | C 180 Kompressor     | 115   | 03.07                  |                        |                |        |   |                 |     |
|                   | C 180 Kompressor Eco | 100   | 01.09                  |                        |                |        |   |                 |     |
|                   | C 200 CDI            | 100   | 03.07                  |                        |                |        |   |                 |     |

1) - idling stop system / - dispositivo start/stop / - unité marche/arrêt / - unidad arranque/paro



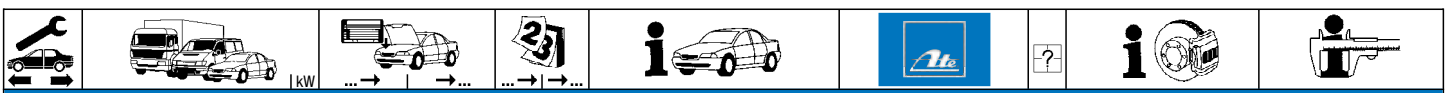

**MERCEDES BENZ C-Klasse (W204) Limousine (07-)**

|  |   |  |   |   |  |  |        |  |  |                                 |  |
|--|---|--|---|---|--|--|--------|--|--|---------------------------------|--|
|  | C 200 CGI 135<br>C 200 Kompressor 135<br>C 220 CDI 120<br>C 220 CDI 125<br>C 230 150<br>C 250 CDI 150<br>C 250 CGI 150<br>C 280 170<br>C 300 170<br>C 300 CGI 185<br>C 320 CDI 165<br>C 350 200<br>C 350 225<br>C 350 CDI 165<br>C 350 CDI 170<br>C 350 CDI 195<br>C 350 CGI 215              |  | 04.09<br>03.07<br>03.07<br>03.07<br>03.07<br>10.08<br>04.09<br>03.07<br>07.09<br>02.11<br>03.07<br>03.07<br>01.11<br>04.09<br>10.09<br>06.11<br>09.08 |   | 83.7705-0386.3   | 330828   | 2      |  | L=385  |                                 |  |
|  | C 180 CDI 88<br>C 180 CGI 115<br>C 180 Kompressor 115<br>C 180 Kompressor Eco 100<br>C 200 CDI 135<br>C 200 CGI 135<br>C 220 CDI 120<br>C 220 CDI 125<br>C 230 150<br>C 230 4-matic 150<br>C 250 CGI 150<br>C 280 170<br>C 280 4-matic 170<br>C 300 4-matic 170<br>C 300 CDI 4-matic 170      |  | 01.11<br>04.09<br>03.07<br>01.09<br>03.07<br>04.09<br>03.07<br>03.07<br>03.07<br>07.07<br>04.09<br>03.07<br>07.07<br>07.07<br>04.09<br>01.11          |   | 11.0101-5407.2<br>11.8171-0008.1<br>11.8116-0340.1                                     | 260011<br>990049<br>390595                     | 2      |  | Hülzensatz<br>Führungsbolzen<br>Haltefeder                                     | ATE<br>ATE<br>ATE               |  |
|  | C 250 CDI 150<br>C 250 CDI 4-matic 150<br>C 320 CDI 165<br>C 320 CDI 4-matic 165<br>C 350 200<br>C 350 4-matic 200<br>C 350 CDI 165<br>C 350 CDI 4-matic 170<br>C 350 CGI 215   |  | 10.08<br>01.11<br>03.07<br>07.07<br>03.07<br>07.07<br>04.09<br>10.09<br>09.08   |   | 11.0101-5407.2<br>11.8171-0008.1<br>11.8116-0340.1                                     | 260011<br>990049<br>390595                     | 2      |  | Hülzensatz<br>Führungsbolzen<br>Haltefeder                                     | ATE<br>ATE<br>ATE               |  |
|  | C 220 CDI 4-matic 125   |  | 02.13   |   | 11.9386-9991.2<br>11.9386-9992.2<br>11.0101-5407.2<br>11.8171-0008.1<br>11.8116-0340.1 | 220949<br>220950<br>260011<br>990049<br>390595 | 2      | <input type="checkbox"/> + ALU-Sättel <sup>1)</sup><br><input type="checkbox"/> + ALU-Sättel <sup>1)</sup> | D=38, - Halter<br>D=38, - Halter<br>Hülzensatz<br>Führungsbolzen<br>Haltefeder | ATE<br>ATE<br>ATE<br>ATE<br>ATE |  |
|  | C 300 170<br>C 300 CGI 185<br>C 300 CGI 4-matic 185<br>C 350 225<br>C 350 4-matic 225<br>C 350 CDI 170<br>C 350 CDI 195<br>C 350 CDI 4-matic 165  |  | 07.09<br>02.11<br>02.11<br>01.11<br>01.11<br>10.09<br>06.11<br>07.09  |   | 11.9406-9961.2<br>11.9406-9962.2<br>11.0101-5407.2<br>11.8171-0008.1<br>11.8116-0340.1 | 220951<br>220952<br>260011<br>990049<br>390595 | 2      | <input type="checkbox"/><br><input type="checkbox"/>   | D=40, - Halter<br>D=40, - Halter<br>Hülzensatz<br>Führungsbolzen<br>Haltefeder | ATE<br>ATE<br>ATE<br>ATE<br>ATE |  |
|  | C 180 Kompressor 115<br>C 200 CDI 100<br>C 200 Kompressor 135<br>C 220 CDI 120<br>C 220 CDI 125<br>C 230 150<br>C 230 4-matic 150<br>C 250 CDI 150<br>C 280 170<br>C 280 4-matic 170<br>C 320 CDI 165<br>C 320 CDI 4-matic 165<br>C 350 200<br>C 350 4-matic 200<br>C 350 CGI 215<br>C 63 AMG |  | 03.07<br>03.07<br>03.07<br>03.07<br>03.07<br>03.07<br>07.07<br>10.08<br>03.07<br>07.07<br>03.07<br>07.07<br>03.07<br>07.07<br>09.08<br>09.07          | 10.08<br>10.08<br>10.08<br>10.08<br>10.08<br>10.08<br>10.08<br>10.08<br>10.08<br>10.08<br>10.08<br>10.08<br>10.08<br>10.08<br>10.08 |  | 83.7715-0299.3                                 | 331117 | 2  |  | L=300                           |  |
|  | C 180 CDI 88<br>C 180 CGI 115<br>C 180 Kompressor 115<br>C 180 Kompressor Eco 100<br>C 200 CDI 135<br>C 200 CGI 135<br>C 220 CDI 120<br>C 220 CDI 125<br>C 220 CDI 4-matic 125<br>C 230 150<br>C 230 4-matic 150<br>C 250 CDI 150<br>C 250 CDI 4-matic 150<br>C 250 CGI 150<br>C 280 170      |  | 01.11<br>04.09<br>11.08<br>01.09<br>11.08<br>04.09<br>11.08<br>11.08<br>02.13<br>11.08<br>11.08<br>11.08<br>01.11<br>04.09<br>11.08                   |   | 83.7715-0299.3   | 331117   | 2      |  |  | L=300                           |  |

<sup>1)</sup> + aluminium calipers / + pinze in alluminio / + étriers en aluminium / + pinzas de aluminio



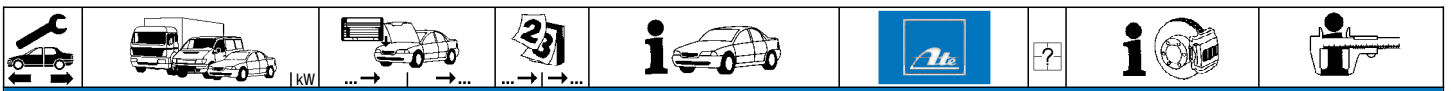















**MERCEDES BENZ C-Klasse (W204) Limousine (07-)**

|  |                          |  |       |                |        |     |  |        |
|--|--------------------------|--|-------|----------------|--------|-----|--|--------|
|  | C 280 4-matic 170        |  | 11.08 | 83.7715-0299.3 | 331117 | 2   |  | L=300  |
|  | C 300 170                |  | 07.09 |                |        |     |  |        |
|  | C 300 4-matic 170        |  | 04.09 |                |        |     |  |        |
|  | C 300 CDI 4-matic 170    |  | 01.11 |                |        |     |  |        |
|  | C 300 CGI 185            |  | 02.11 |                |        |     |  |        |
|  | C 300 CGI 4-matic 185    |  | 02.11 |                |        |     |  |        |
|  | C 320 CDI 165            |  | 11.08 |                |        |     |  |        |
|  | C 320 CDI 4-matic 165    |  | 11.08 |                |        |     |  |        |
|  | C 350 200                |  | 11.08 |                |        |     |  |        |
|  | C 350 225                |  | 01.11 |                |        |     |  |        |
|  | C 350 4-matic 200        |  | 11.08 |                |        |     |  |        |
|  | C 350 4-matic 225        |  | 01.11 |                |        |     |  |        |
|  | C 350 CDI 165            |  | 04.09 |                |        |     |  |        |
|  | C 350 CDI 170            |  | 10.09 |                |        |     |  |        |
|  | C 350 CDI 195            |  | 06.11 |                |        |     |  |        |
|  | C 350 CDI 4-matic 165    |  | 07.09 |                |        |     |  |        |
|  | C 350 CDI 4-matic 170    |  | 10.09 |                |        |     |  |        |
|  | C 350 CGI 215            |  | 11.08 |                |        |     |  |        |
|  | C 63 AMG 11.08           |  |       |                |        |     |  |        |
|  | C 180 CDI 88             |  | 01.11 | 24.3727-0465.2 | 580465 | 1 ↑ |  | L=2057 |
|  | C 180 CGI 115            |  | 04.09 | 24.3727-0470.2 | 580470 | 1 ↓ |  | L=1152 |
|  | C 180 Kompressor 115     |  | 03.07 | 24.3727-0467.2 | 580467 | 2 ↓ |  | L=728  |
|  | C 180 Kompressor Eco 115 |  | 01.09 |                |        |     |  |        |
|  | C 200 CDI 100            |  | 03.07 |                |        |     |  |        |
|  | C 200 CGI 135            |  | 04.09 |                |        |     |  |        |
|  | C 200 Kompressor 135     |  | 03.07 |                |        |     |  |        |
|  | C 220 CDI 120            |  | 03.07 |                |        |     |  |        |
|  | C 220 CDI 125            |  | 03.07 |                |        |     |  |        |
|  | C 220 CDI 4-matic 125    |  | 02.13 |                |        |     |  |        |
|  | C 230 150                |  | 03.07 |                |        |     |  |        |
|  | C 230 4-matic 150        |  | 07.07 |                |        |     |  |        |
|  | C 250 CDI 150            |  | 10.08 |                |        |     |  |        |
|  | C 250 CDI 4-matic 150    |  | 01.11 |                |        |     |  |        |
|  | C 250 CGI 150            |  | 04.09 |                |        |     |  |        |
|  | C 280 170                |  | 03.07 |                |        |     |  |        |
|  | C 280 4-matic 170        |  | 07.07 |                |        |     |  |        |
|  | C 300 170                |  | 07.09 |                |        |     |  |        |
|  | C 300 4-matic 170        |  | 04.09 |                |        |     |  |        |
|  | C 300 CDI 4-matic 170    |  | 01.11 |                |        |     |  |        |
|  | C 300 CGI 185            |  | 02.11 |                |        |     |  |        |
|  | C 300 CGI 4-matic 185    |  | 02.11 |                |        |     |  |        |
|  | C 320 CDI 165            |  | 03.07 |                |        |     |  |        |
|  | C 320 CDI 4-matic 165    |  | 07.07 |                |        |     |  |        |
|  | C 350 200                |  | 03.07 |                |        |     |  |        |
|  | C 350 225                |  | 01.11 |                |        |     |  |        |
|  | C 350 4-matic 200        |  | 07.07 |                |        |     |  |        |
|  | C 350 4-matic 225        |  | 01.11 |                |        |     |  |        |
|  | C 350 CDI 165            |  | 04.09 |                |        |     |  |        |
|  | C 350 CDI 170            |  | 10.09 |                |        |     |  |        |
|  | C 350 CDI 195            |  | 06.11 |                |        |     |  |        |
|  | C 350 CDI 4-matic 165    |  | 07.09 |                |        |     |  |        |
|  | C 350 CDI 4-matic 170    |  | 10.09 |                |        |     |  |        |
|  | C 350 CGI 215            |  | 09.08 |                |        |     |  |        |
|  | C 63 AMG 115             |  | 09.07 |                |        |     |  |        |
|  | C 180 CDI 88             |  | 01.11 | 24.3727-0470.2 | 580470 | 1 ↓ |  | L=1152 |
|  | C 180 CGI 115            |  | 04.09 | 24.3727-0467.2 | 580467 | 2 ↓ |  | L=728  |
|  | C 180 Kompressor 115     |  | 03.07 |                |        |     |  |        |
|  | C 180 Kompressor Eco 115 |  | 01.09 |                |        |     |  |        |
|  | C 200 CDI 100            |  | 03.07 |                |        |     |  |        |
|  | C 200 CGI 135            |  | 04.09 |                |        |     |  |        |
|  | C 200 Kompressor 135     |  | 03.07 |                |        |     |  |        |
|  | C 220 CDI 120            |  | 03.07 |                |        |     |  |        |
|  | C 220 CDI 125            |  | 03.07 |                |        |     |  |        |
|  | C 220 CDI 4-matic 125    |  | 02.13 |                |        |     |  |        |
|  | C 230 150                |  | 03.07 |                |        |     |  |        |
|  | C 230 4-matic 150        |  | 07.07 |                |        |     |  |        |
|  | C 250 CDI 150            |  | 10.08 |                |        |     |  |        |
|  | C 250 CDI 4-matic 150    |  | 01.11 |                |        |     |  |        |
|  | C 250 CGI 150            |  | 04.09 |                |        |     |  |        |
|  | C 280 170                |  | 03.07 |                |        |     |  |        |
|  | C 280 4-matic 170        |  | 07.07 |                |        |     |  |        |
|  | C 300 170                |  | 07.09 |                |        |     |  |        |
|  | C 300 4-matic 170        |  | 04.09 |                |        |     |  |        |
|  | C 300 CDI 4-matic 170    |  | 01.11 |                |        |     |  |        |
|  | C 300 CGI 185            |  | 02.11 |                |        |     |  |        |
|  | C 300 CGI 4-matic 185    |  | 02.11 |                |        |     |  |        |
|  | C 320 CDI 165            |  | 03.07 |                |        |     |  |        |
|  | C 320 CDI 4-matic 165    |  | 07.07 |                |        |     |  |        |
|  | C 350 200                |  | 03.07 |                |        |     |  |        |
|  | C 350 225                |  | 01.11 |                |        |     |  |        |
|  | C 350 4-matic 200        |  | 07.07 |                |        |     |  |        |
|  | C 350 4-matic 225        |  | 01.11 |                |        |     |  |        |
|  | C 350 CDI 165            |  | 04.09 |                |        |     |  |        |
|  | C 350 CDI 170            |  | 10.09 |                |        |     |  |        |
|  | C 350 CDI 195            |  | 06.11 |                |        |     |  |        |
|  | C 350 CDI 4-matic 165    |  | 07.09 |                |        |     |  |        |
|  | C 350 CDI 4-matic 170    |  | 10.09 |                |        |     |  |        |



|     |   |    |   |  |       |  |                          |                   |
|--|---|--|---|--|--|--|--|---|
| <b>MERCEDES BENZ C-Klasse (W204) Limousine (07-)</b>                               |   |  |   |  |  |  |  |   |
|    | C 350 CGI<br>C 63 AMG   | 215<br>215   | 09.08<br>09.07  |  | 24.3727-0470.2<br>24.3727-0467.2   | 580470<br>580467   | 1<br>2   | L=1152<br>L=728   |
| <b>MERCEDES BENZ C-Klasse (S204) Kombi (07-)</b>                                   |   |  |   |  |  |  |  |   |
|    | C 180 CDI BE<br>C 220 CDI 4-matic<br>C 350 CDI<br>C 350 CGI   | 88<br>125<br>195<br>225  | 01.11<br>02.13<br>06.11<br>06.11  |  | 03.7745-6302.4   | 300261   | - Start/Stop-Anlage <sup>1)</sup>  | 8"<br>ATE   |
|    | C 180 CGI<br>C 180 Kompressor<br>C 200 CDI<br>C 200 CGI<br>C 200 Kompressor<br>C 220 CDI<br>C 230<br>C 250 CDI<br>C 250 CDI 4matic<br>C 250 CGI<br>C 280<br>C 320 CDI<br>C 320 CDI 4-matic<br>C 350<br>C 350 CDI 4-matic<br>C 350 CDI BlueEff.<br>C 63 AMG  | 115<br>115<br>135<br>150<br>150<br>150<br>150<br>150<br>150<br>150<br>170<br>165<br>165<br>200<br>170<br>170<br>170<br>170                     | 04.09<br>09.07<br>09.07<br>04.09<br>09.07<br>09.07<br>09.07<br>04.09<br>04.09<br>04.09<br>09.07<br>09.07<br>09.07<br>09.07<br>10.09<br>04.09<br>09.07                                     |  | 03.7745-6302.4   | 300261   |  | 8"<br>ATE   |
|    | C 180 CDI BE<br>C 180 CGI<br>C 180 Kompressor<br>C 200 CDI<br>C 200 CGI<br>C 200 Kompressor<br>C 220 CDI<br>C 220 CDI 4-matic<br>C 230<br>C 250 CDI<br>C 250 CDI 4matic<br>C 250 CGI<br>C 280<br>C 320 CDI<br>C 320 CDI 4-matic<br>C 350<br>C 350 CDI<br>C 350 CDI 4-matic<br>C 350 CDI BlueEff.<br>C 350 CGI<br>C 63 AMG | 88<br>115<br>115<br>135<br>150<br>150<br>150<br>125<br>150<br>150<br>150<br>150<br>170<br>165<br>165<br>200<br>195<br>170<br>170<br>225<br>170 | 01.11<br>04.09<br>09.07<br>09.07<br>04.09<br>09.07<br>09.07<br>02.13<br>09.07<br>04.09<br>04.09<br>04.09<br>09.07<br>09.07<br>09.07<br>09.07<br>06.11<br>10.09<br>04.09<br>06.11<br>09.07 |  | 03.2025-2301.3   | 010895   |  | Thz 25,40/22,20<br>ATE  |
|  | C 180 CDI BE<br>C 180 CGI<br>C 180 Kompressor<br>C 200 CDI<br>C 200 CGI<br>C 200 Kompressor<br>C 220 CDI<br>C 230<br>C 250 CDI<br>C 250 CGI<br>C 280<br>C 320 CDI<br>C 350<br>C 350 CDI<br>C 350 CDI BlueEff.<br>C 350 CGI  | 88<br>115<br>115<br>135<br>150<br>150<br>150<br>150<br>150<br>150<br>170<br>165<br>200<br>195<br>170<br>225                                    | 01.11<br>04.09<br>09.07<br>09.07<br>04.09<br>09.07<br>09.07<br>09.07<br>04.09<br>04.09<br>09.07<br>09.07<br>09.07<br>06.11<br>04.09<br>06.11  |  | 83.7705-0386.3   | 330828   | 2  | L=385   |
|  | C 180 CGI<br>C 180 Kompressor<br>C 200 CDI<br>C 200 CGI<br>C 200 Kompressor<br>C 220 CDI<br>C 230<br>C 250 CGI<br>C 280   | 115<br>115<br>135<br>150<br>150<br>150<br>150<br>170   | 04.09<br>09.07<br>09.07<br>04.09<br>09.07<br>09.07<br>09.07<br>04.09<br>09.07   |  | 11.0101-5407.2<br>11.8171-0008.1<br>11.8116-0340.1                                     | 260011<br>990049<br>390595   | 2  | Hülsensatz<br>Führungsbolzen<br>Haltefeder<br>ATE<br>ATE<br>ATE                                     |
|  | C 180 CDI BE  | 88   | 01.11   |  | 11.9386-9991.2<br>11.9386-9992.2<br>11.0101-5407.2<br>11.8171-0008.1<br>11.8116-0340.1 | 220949<br>220950<br>260011<br>990049<br>390595                                     | <input type="checkbox"/> + Sportpaket <sup>2)</sup><br><input type="checkbox"/> + Sportpaket <sup>2)</sup> | D=38, - Halter<br>D=38, - Halter<br>Hülsensatz<br>Führungsbolzen<br>Haltefeder<br>ATE<br>ATE<br>ATE |
|  | C 250 CDI<br>C 320 CDI<br>C 320 CDI 4-matic<br>C 350<br>C 350 CDI 4-matic<br>C 350 CDI BlueEff.   | 150<br>165<br>165<br>200<br>170<br>170   | 04.09<br>09.07<br>09.07<br>09.07<br>10.09<br>04.09  |  | 11.0101-5407.2<br>11.8171-0008.1<br>11.8116-0340.1                                     | 260011<br>990049<br>390595   | 2  | Hülsensatz<br>Führungsbolzen<br>Haltefeder<br>ATE<br>ATE<br>ATE                                     |



















<sup>1)</sup> - idling stop system / - dispositivo start/stop / - unité marche/arrêt / - unidad arranque/paro

<sup>2)</sup> + sports package / + pacchetto sportivo / + version sport / + kit deportivo















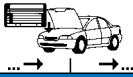



































































| MERCEDES BENZ C-Klasse (S204) Kombi (07-) |                    |     |       |       |       |  |   |   |  |  |                                 |  |
|---|--------------------|-----|-------|-------|-------|--|---|---|--|--|---------------------------------|--|
|   | C 350 CDI          | 195 |       | 06.11 |       |  | 11.9406-9961.2 220951<br>11.9406-9962.2 220952<br>11.0101-5407.2 260011<br>11.8171-0008.1 990049<br>11.8116-0340.1 390595 | 2 | + ALU-Sättel <sup>1)</sup><br>+ ALU-Sättel <sup>1)</sup> | D=40, - Halter<br>D=40, - Halter<br>Hülzensatz<br>Führungsbolzen<br>Haltefeder | ATE<br>ATE<br>ATE<br>ATE<br>ATE |  |
|   | C 350 CGI          | 225 |       | 06.11 |       |  | 11.9406-9961.2 220951<br>11.9406-9962.2 220952<br>11.0101-5407.2 260011<br>11.8171-0008.1 990049<br>11.8116-0340.1 390595 | 2 |  | D=40, - Halter<br>D=40, - Halter<br>Hülzensatz<br>Führungsbolzen<br>Haltefeder | ATE<br>ATE<br>ATE<br>ATE<br>ATE |  |
|   | C 250 CDI 4matic   | 150 |       | 04.09 |       |  | 11.0101-5407.2 260011<br>11.8171-0008.1 990049<br>11.8116-0340.1 390595   | 2 |  | Hülzensatz<br>Führungsbolzen<br>Haltefeder                                     | ATE<br>ATE<br>ATE               |  |
|   | C 180 Kompressor   |     |       | 09.07 | 10.08 |  | 83.7715-0299.3 331117   | 2 |  |  | L=300                           |  |
|   | C 200 CDI          |     |       | 09.07 | 10.08 |  |   |   |  |  |                                 |  |
|   | C 200 Kompressor   | 135 |       | 09.07 | 10.08 |  |   |   |  |  |                                 |  |
|   | C 220 CDI          |     |       | 09.07 | 10.08 |  |   |   |  |  |                                 |  |
|   | C 230              | 150 |       | 09.07 | 10.08 |  |   |   |  |  |                                 |  |
|   | C 280              | 170 |       | 09.07 | 10.08 |  |   |   |  |  |                                 |  |
|   | C 320 CDI          | 165 |       | 09.07 | 10.08 |  |   |   |  |  |                                 |  |
|   | C 320 CDI 4-matic  | 165 |       | 09.07 | 10.08 |  |   |   |  |  |                                 |  |
|   | C 350              | 200 |       | 09.07 | 10.08 |  |   |   |  |  |                                 |  |
|   | C 63 AMG           |     |       | 09.07 | 10.08 |  |   |   |  |  |                                 |  |
|   | C 180 CDI BE       | 88  |       | 01.11 |       |  | 83.7715-0299.3 331117   | 2 |  |  | L=300                           |  |
|   | C 180 CGI          | 115 |       | 04.09 |       |  |   |   |  |  |                                 |  |
|   | C 180 Kompressor   |     |       | 11.08 |       |  |   |   |  |  |                                 |  |
| C 200 CDI                                 |                    |     | 11.08 |       |       |  |   |   |  |  |                                 |  |
| C 200 CGI                                 |                    |     | 04.09 |       |       |  |   |   |  |  |                                 |  |
| C 200 Kompressor                          | 135                |     | 11.08 |       |       |  |   |   |  |  |                                 |  |
| C 220 CDI                                 |                    |     | 11.08 |       |       |  |   |   |  |  |                                 |  |
| C 220 CDI 4-matic                         | 125                |     | 02.13 |       |       |  |   |   |  |  |                                 |  |
| C 230                                     | 150                |     | 11.08 |       |       |  |   |   |  |  |                                 |  |
| C 250 CDI                                 | 150                |     | 04.09 |       |       |  |   |   |  |  |                                 |  |
| C 250 CDI 4matic                          | 150                |     | 04.09 |       |       |  |   |   |  |  |                                 |  |
| C 250 CGI                                 | 150                |     | 04.09 |       |       |  |   |   |  |  |                                 |  |
| C 280                                     | 170                |     | 11.08 |       |       |  |   |   |  |  |                                 |  |
| C 320 CDI                                 | 165                |     | 11.08 |       |       |  |   |   |  |  |                                 |  |
| C 320 CDI 4-matic                         | 165                |     | 11.08 |       |       |  |   |   |  |  |                                 |  |
| C 350                                     | 200                |     | 11.08 |       |       |  |   |   |  |  |                                 |  |
| C 350 CDI                                 | 195                |     | 06.11 |       |       |  |   |   |  |  |                                 |  |
| C 350 CDI 4-matic                         | 170                |     | 10.09 |       |       |  |   |   |  |  |                                 |  |
| C 350 CDI BlueEff.                        | 170                |     | 04.09 |       |       |  |   |   |  |  |                                 |  |
| C 350 CGI                                 | 225                |     | 06.11 |       |       |  |   |   |  |  |                                 |  |
| C 63 AMG                                  |                    |     | 11.08 |       |       |  |   |   |  |  |                                 |  |
|   | C 180 CDI BE       | 88  |       | 01.11 |       |  | 24.3727-0465.2 580465   | 1 | ↑  |  | L=2057                          |  |
|   | C 180 CGI          | 115 |       | 04.09 |       |  | 24.3727-0470.2 580470   | 1 | ↓  |  | L=1152                          |  |
|   | C 180 Kompressor   |     |       | 09.07 |       |  | 24.3727-0467.2 580467   | 2 | ↓  |  | L=728                           |  |
|   | C 200 CDI          |     |       | 09.07 |       |  |   |   |  |  |                                 |  |
|   | C 200 CGI          |     |       | 04.09 |       |  |   |   |  |  |                                 |  |
|   | C 200 Kompressor   | 135 |       | 09.07 |       |  |   |   |  |  |                                 |  |
|   | C 220 CDI          |     |       | 09.07 |       |  |   |   |  |  |                                 |  |
|   | C 220 CDI 4-matic  | 125 |       | 02.13 |       |  |   |   |  |  |                                 |  |
|   | C 230              | 150 |       | 09.07 |       |  |   |   |  |  |                                 |  |
|   | C 250 CDI          | 150 |       | 04.09 |       |  |   |   |  |  |                                 |  |
|   | C 250 CDI 4matic   | 150 |       | 04.09 |       |  |   |   |  |  |                                 |  |
|   | C 250 CGI          | 150 |       | 04.09 |       |  |   |   |  |  |                                 |  |
|   | C 280              | 170 |       | 09.07 |       |  |   |   |  |  |                                 |  |
|   | C 320 CDI          | 165 |       | 09.07 |       |  |   |   |  |  |                                 |  |
|   | C 320 CDI 4-matic  | 165 |       | 09.07 |       |  |   |   |  |  |                                 |  |
|   | C 350              | 200 |       | 09.07 |       |  |   |   |  |  |                                 |  |
|   | C 350 CDI          | 195 |       | 06.11 |       |  |   |   |  |  |                                 |  |
| C 350 CDI 4-matic                         | 170                |     | 10.09 |       |       |  |   |   |  |  |                                 |  |
| C 350 CDI BlueEff.                        | 170                |     | 04.09 |       |       |  |   |   |  |  |                                 |  |
| C 350 CGI                                 | 225                |     | 06.11 |       |       |  |   |   |  |  |                                 |  |
| C 63 AMG                                  |                    |     | 09.07 |       |       |  |   |   |  |  |                                 |  |
|   | C 180 CGI          | 115 |       | 04.09 |       |  | 24.3727-0470.2 580470   | 1 | ↓  |  | L=1152                          |  |
|   | C 180 Kompressor   |     |       | 09.07 |       |  | 24.3727-0467.2 580467   | 2 | ↓  |  | L=728                           |  |
|   | C 200 CDI          |     |       | 09.07 |       |  |   |   |  |  |                                 |  |
|   | C 200 CGI          |     |       | 04.09 |       |  |   |   |  |  |                                 |  |
|   | C 200 Kompressor   | 135 |       | 09.07 |       |  |   |   |  |  |                                 |  |
|   | C 220 CDI          |     |       | 09.07 |       |  |   |   |  |  |                                 |  |
|   | C 230              | 150 |       | 09.07 |       |  |   |   |  |  |                                 |  |
|   | C 250 CDI          | 150 |       | 04.09 |       |  |   |   |  |  |                                 |  |
|   | C 250 CDI 4matic   | 150 |       | 04.09 |       |  |   |   |  |  |                                 |  |
|   | C 250 CGI          | 150 |       | 04.09 |       |  |   |   |  |  |                                 |  |
|   | C 280              | 170 |       | 09.07 |       |  |   |   |  |  |                                 |  |
|   | C 320 CDI          | 165 |       | 09.07 |       |  |   |   |  |  |                                 |  |
|   | C 320 CDI 4-matic  | 165 |       | 09.07 |       |  |   |   |  |  |                                 |  |
|   | C 350              | 200 |       | 09.07 |       |  |   |   |  |  |                                 |  |
|   | C 350 CDI          | 195 |       | 06.11 |       |  |   |   |  |  |                                 |  |
|   | C 350 CDI 4-matic  | 170 |       | 10.09 |       |  |   |   |  |  |                                 |  |
|   | C 350 CDI BlueEff. | 170 |       | 04.09 |       |  |   |   |  |  |                                 |  |
| C 350 CGI                                 | 225                |     | 06.11 |       |       |  |   |   |  |  |                                 |  |
| C 63 AMG                                  |                    |     | 09.07 |       |       |  |   |   |  |  |                                 |  |

<sup>1)</sup> + aluminium calipers / + pinze in alluminio / + étriers en aluminium / + pinzas de aluminio

|     |                                      |  |  |  |       |  |    |  |                                 |
|--|--|--|--|--|--|--|--|--|---------------------------------|
| <b>MERCEDES BENZ C-Klasse (C204) Coupe (11-)</b>                                   |  |  |  |  |  |  |  |  |                                 |
|    | C 180<br>C 180 CGI<br>C 200 CGI<br>C 220 CDI<br>C 250 CDI<br>C 250 CGI<br>C 350<br>C 63 AMG<br>C 63 AMG Black Series | 115<br>115<br>135<br>125<br>150<br>150<br>225<br>336<br>380                      | 01.13<br>06.11<br>06.11<br>06.11<br>06.11<br>06.11<br>06.11<br>06.11<br>01.12    |  | 03.7745-6302.4   | 300261   | - Start/Stop-Anlage <sup>1)</sup>  | 8" ATE   |                                 |
|    | C 180<br>C 180 CGI<br>C 200 CGI<br>C 220 CDI<br>C 250 CDI<br>C 250 CGI<br>C 350<br>C 63 AMG<br>C 63 AMG Black Series | 115<br>115<br>135<br>125<br>150<br>150<br>225<br>336<br>380                      | 01.13<br>06.11<br>06.11<br>06.11<br>06.11<br>06.11<br>06.11<br>06.11<br>01.12    |  | 03.2025-2301.3   | 010895   |  | Thz 25,40/22,20 ATE  |                                 |
|    | C 180<br>C 180 CGI<br>C 200 CGI<br>C 220 CDI<br>C 250 CDI<br>C 250 CGI<br>C 350                                      | 115<br>115<br>135<br>125<br>150<br>150<br>225                                    | 01.13<br>06.11<br>06.11<br>06.11<br>06.11<br>06.11<br>06.11                      |  | 83.7705-0386.3   | 330828   | 2  | L=385  |                                 |
|    | C 180<br>C 180 CGI   | 115<br>115   | 01.13<br>06.11   |  | 11.9386-9991.2<br>11.9386-9992.2   | 220949<br>220950   | <input type="checkbox"/><br><input type="checkbox"/>   | D=38, - Halter<br>D=38, - Halter   | ATE<br>ATE                      |
|  | C 200 CGI<br>C 220 CDI<br>C 250 CGI  | 135<br>125<br>150  | 06.11<br>06.11<br>06.11  |  | 11.0101-5407.2<br>11.8171-0008.1<br>11.8116-0340.1                                     | 260011<br>990049<br>390595   | <input type="checkbox"/><br><input type="checkbox"/><br>2  | Hülensatz<br>Führungsbolzen<br>Haltefeder  | ATE<br>ATE<br>ATE<br>ATE        |
|  | C 250 CDI<br>C 350   | 150<br>225   | 06.11<br>06.11   |  | 11.9406-9961.2<br>11.9406-9962.2   | 220951<br>220952   | <input type="checkbox"/><br><input type="checkbox"/>   | D=40, - Halter<br>D=40, - Halter   | ATE<br>ATE                      |
|  |  |  |  |  | 11.0101-5407.2<br>11.8171-0008.1<br>11.8116-0340.1                                     | 260011<br>990049<br>390595   | <input type="checkbox"/><br><input type="checkbox"/><br>2  | Hülensatz<br>Führungsbolzen<br>Haltefeder  | ATE<br>ATE<br>ATE               |
|  | C 180<br>C 180 CGI<br>C 200 CGI<br>C 220 CDI<br>C 250 CDI<br>C 250 CGI<br>C 350<br>C 63 AMG                          | 115<br>115<br>135<br>125<br>150<br>150<br>225<br>336                             | 01.13<br>06.11<br>06.11<br>06.11<br>06.11<br>06.11<br>06.11<br>06.11             |  | 83.7715-0299.3   | 331117   | 2  | L=300  |                                 |
|  | C 180<br>C 180 CGI<br>C 200 CGI<br>C 220 CDI<br>C 250 CDI<br>C 250 CGI<br>C 350<br>C 63 AMG                          | 115<br>115<br>135<br>125<br>150<br>150<br>225<br>336                             | 01.13<br>06.11<br>06.11<br>06.11<br>06.11<br>06.11<br>06.11<br>06.11             |  | 24.3727-0465.2<br>24.3727-0470.2<br>24.3727-0467.2                                     | 580465<br>580470<br>580467   | 1 <input type="checkbox"/><br>1 <input type="checkbox"/><br>2 <input type="checkbox"/>   | L=2057<br>L=1152<br>L=728  |                                 |
|  | C 180<br>C 180 CGI<br>C 200 CGI<br>C 220 CDI<br>C 250 CDI<br>C 250 CGI<br>C 350<br>C 63 AMG                          | 115<br>115<br>135<br>125<br>150<br>150<br>225<br>336                             | 01.13<br>06.11<br>06.11<br>06.11<br>06.11<br>06.11<br>06.11<br>06.11             |  | 24.3727-0470.2<br>24.3727-0467.2   | 580470<br>580467   | 1 <input type="checkbox"/><br>2 <input type="checkbox"/>   | L=1152<br>L=728  |                                 |
|  | C 63 AMG Black Series  | 380  | 01.12  |  | 24.3727-0465.2<br>24.3727-0470.2   | 580465<br>580470   | 1 <input type="checkbox"/><br>1 <input type="checkbox"/>   | L=2057<br>L=1152   |                                 |
|  | C 63 AMG Black Series  | 380  | 01.12  |  | 24.3727-0470.2   | 580470   | 1 <input type="checkbox"/>   | L=1152   |                                 |
| <b>MERCEDES BENZ CL-Klasse (C140) Coupe (96-99)</b>                                |  |  |  |  |  |  |  |  |                                 |
|  | CL 420<br>CL 500<br>CL 600   | 115<br>115<br>135  | 06.96<br>06.96<br>06.96  | 02.99<br>02.99<br>02.99  | 03.2026-0462.3   | 010728   |  | Thz 26,99/25,40 ATE  |                                 |
|  | CL 420<br>CL 500<br>CL 600   | 115<br>115<br>135  | 06.96<br>06.96<br>06.96  | 02.99<br>02.99<br>02.99  | 03.2026-0562.3   | 010729   |  | Thz 26,99/25,40 ATE  |                                 |
|  | CL 420<br>CL 500<br>CL 600   | 115<br>115<br>135  | 06.96<br>06.96<br>06.96  | 02.99<br>02.99<br>02.99  | 83.6115-0480.3   | 330385   | 2  | L=480  |                                 |
|  | CL 420<br>CL 500<br>CL 600   | 115<br>115<br>135  | 06.96<br>06.96<br>06.96  | 02.99<br>02.99<br>02.99  | 13.2461-8001.2<br>13.2461-8002.2<br>24.9246-8001.5<br>24.9246-8002.5<br>13.0441-4601.2 | 210226<br>210227<br>230021<br>230022<br>250099                                     | <input type="checkbox"/><br><input type="checkbox"/><br><input type="checkbox"/><br><input type="checkbox"/><br><input type="checkbox"/> | D=46<br>D=46<br>D=46<br>D=46<br>Dichtungssatz                                      | ATE<br>ATE<br>ATE<br>ATE<br>ATE |
|  | CL 420<br>CL 500<br>CL 600   | 115<br>115<br>135  | 06.96<br>06.96<br>06.96  | 02.99<br>02.99<br>02.99  | 83.7715-0280.3   | 330806   | 2  | L=280  |                                 |



















<sup>1)</sup> - idling stop system / - dispositivo start/stop / - unité marche/arrêt / - unidad arranque/paro

| MERCEDES BENZ CL-Klasse (C140) Coupe (96-99)  |                       |     |          |       |                |                |        |   |   |  |       |                 |     |
|---|-----------------------|-----|----------|-------|----------------|----------------|--------|---|---|--|-------|-----------------|-----|
|   | CL 420                |     |          | 06.96 | 02.99          | 24.3727-0462.2 | 580462 | 1 | ↑ |  |       | L=2622          |     |
|   | CL 500                |     |          | 06.96 | 02.99          | 24.3727-0456.2 | 580456 |   | □ |  |       | L=1134          |     |
|   | CL 600                |     |          | 06.96 | 02.99          | 24.3727-0455.2 | 580455 |   | □ |  |       | L=1109          |     |
|   | CL 420                |     |          | 06.96 | 02.99          | 24.3727-0456.2 | 580456 |   | □ |  |       | L=1134          |     |
|   | CL 500                |     |          | 06.96 | 02.99          | 24.3727-0455.2 | 580455 |   | □ |  |       | L=1109          |     |
|   | CL 600                |     |          | 06.96 | 02.99          |                |        |   |   |  |       |                 |     |
| MERCEDES BENZ CL-Klasse (C215) Coupe (99-06)  |                       |     |          |       |                |                |        |   |   |  |       |                 |     |
|   | CL 500                |     |          | 03.99 | 08.06          | 24.4025-1701.3 | 010719 |   |   |  |       | Thz 25,40       |     |
|   | CL 55 AMG             |     |          | 10.99 | 08.06          |                |        |   |   |  |       |                 |     |
|   | CL 55 Kompressor AMG  |     |          | 06.02 | 08.06          |                |        |   |   |  |       |                 |     |
|   | CL 600                |     |          | 03.99 | 08.06          |                |        |   |   |  |       |                 |     |
|   | CL 65 AMG             |     |          | 09.03 | 08.06          |                |        |   |   |  |       |                 |     |
|   | CL 500                |     |          | 03.99 | 08.06          | 83.6105-0360.3 | 330635 | 2 |   |  |       | L=360           |     |
|   | CL 55 AMG             |     |          | 10.99 | 08.06          |                |        |   |   |  |       |                 |     |
|   | CL 55 Kompressor AMG  |     |          | 06.02 | 08.06          |                |        |   |   |  |       |                 |     |
|   | CL 600                |     |          | 03.99 | 08.06          |                |        |   |   |  |       |                 |     |
|   | CL 65 AMG             |     |          | 09.03 | 08.06          |                |        |   |   |  |       |                 |     |
|   | CL 500                |     |          | 03.99 | 08.06          | 11.0101-4202.2 | 260094 |   |   |  |       | Hülsensatz      |     |
|   | CL 55 AMG             |     |          | 10.99 | 08.06          |                |        |   |   |  |       |                 |     |
|   | CL 55 Kompressor AMG  |     |          | 06.02 | 08.06          |                |        |   |   |  |       |                 |     |
|   | CL 600                |     |          | 03.99 | 08.06          |                |        |   |   |  |       |                 |     |
|   | CL 65 AMG             |     |          | 09.03 | 08.06          |                |        |   |   |  |       |                 |     |
|   | CL 500                |     |          | 03.99 | 08.06          | 24.5123-0240.3 | 330759 | 2 |   |  |       | L=240           |     |
|   | CL 55 AMG             |     |          | 10.99 | 08.06          |                |        |   |   |  |       |                 |     |
|   | CL 55 Kompressor AMG  |     |          | 06.02 | 08.06          |                |        |   |   |  |       |                 |     |
|   | CL 600                |     |          | 03.99 | 08.06          |                |        |   |   |  |       |                 |     |
|   | CL 65 AMG             |     |          | 09.03 | 08.06          |                |        |   |   |  |       |                 |     |
|   | CL 500                |     |          | 03.99 | 08.06          | 83.7715-0299.3 | 331117 | 2 |   |  |       | L=300           |     |
|   | CL 55 AMG             |     |          | 10.99 | 08.06          | 24.3727-0461.2 | 580461 | 1 | ↑ |  |       | L=2742          |     |
|   | CL 55 Kompressor AMG  |     |          | 06.02 | 08.06          | 24.3727-0458.2 | 580458 |   | □ |  |       | L=990           |     |
|   | CL 600                |     |          | 03.99 | 08.06          | 24.3727-0457.2 | 580457 |   | □ |  |       | L=980           |     |
|   | CL 55 Kompressor AMG  |     |          | 06.02 | 08.06          | 24.3727-0461.2 | 580461 | 1 | ↑ |  |       | L=2742          |     |
|   | CL 65 AMG             |     |          | 09.03 | 08.06          | 24.3727-0461.2 | 580461 | 1 | ↑ |  |       | L=2742          |     |
|   | CL 500                |     |          | 03.99 | 08.06          | 24.3727-0458.2 | 580458 |   | □ |  |       | L=990           |     |
| CL 55 AMG                                     |                       |     | 10.99    | 08.06 | 24.3727-0457.2 | 580457         |        | □ |   |  | L=980 |                 |     |
| CL 600  |                       |     | 03.99    | 08.06 |                |                |        |   |   |  |       |                 |     |
| MERCEDES BENZ CL-Klasse (C216) Coupe (06-)    |                       |     |          |       |                |                |        |   |   |  |       |                 |     |
|   | CL 500                | 285 | A 024306 | 07.06 |                | 03.7858-1932.4 | 300263 |   |   |  |       | 9/8" Tandem     | ATE |
|   | CL 500                | 320 | A 024306 | 02.11 |                |                |        |   |   |  |       |                 |     |
|   | CL 500 4-matic        | 285 | A 024306 | 03.08 |                |                |        |   |   |  |       |                 |     |
|   | CL 500 4-matic        | 320 | A 024306 | 02.11 |                |                |        |   |   |  |       |                 |     |
|   | CL 500 BlueEfficiency |     | A 024306 | 10.10 |                |                |        |   |   |  |       |                 |     |
|   | CL 600                | 380 | A 024306 | 07.06 |                |                |        |   |   |  |       |                 |     |
|   | CL 63 AMG             | 386 | A 024306 | 01.07 |                |                |        |   |   |  |       |                 |     |
|   | CL 63 AMG             | 400 | A 024306 | 02.11 |                |                |        |   |   |  |       |                 |     |
|   | CL 63 AMG             | 420 | A 024306 | 01.10 |                |                |        |   |   |  |       |                 |     |
|   | CL 65 AMG             | 450 | A 024306 | 01.07 |                |                |        |   |   |  |       |                 |     |
|   | CL 65 AMG             | 463 | A 024306 | 02.11 |                |                |        |   |   |  |       |                 |     |
|   | CL 500                | 285 | A 024016 | 07.06 |                | 03.4055-0013.3 | 010793 |   |   |  |       | Thz 25,40       | ATE |
|   | CL 500 4-matic        | 285 | A 024016 | 03.08 |                |                |        |   |   |  |       |                 |     |
|   | CL 500 BlueEfficiency |     | A 024016 | 10.10 |                |                |        |   |   |  |       |                 |     |
|   | CL 600                | 380 | A 024016 | 07.06 |                |                |        |   |   |  |       |                 |     |
|   | CL 63 AMG             | 386 | A 024016 | 01.07 |                |                |        |   |   |  |       |                 |     |
|   | CL 65 AMG             | 450 | A 024016 | 01.07 |                |                |        |   |   |  |       |                 |     |
|   | CL 500                | 285 |          | 07.06 |                | 11.9426-9959.2 | 220801 |   | □ |  |       | D=42, - Halter  | ATE |
|   | CL 500 4-matic        | 285 |          | 03.08 |                | 11.9426-9960.2 | 220802 |   | □ |  |       | D=42, - Halter  | ATE |
|   | CL 500 BlueEfficiency |     |          | 10.10 |                | 11.8116-0086.2 | 390606 | 2 |   |  |       | Haltefeder      | ATE |
|   |                       |     |          |       |                | 11.8171-0008.1 | 990049 | 2 |   |  |       | Führungsbolzen  | ATE |
|   |                       |     |          |       |                | 11.0101-5407.2 | 260011 |   |   |  |       | Hülsensatz      | ATE |
|   | CL 500                | 285 |          | 02.11 |                | 11.9426-9959.2 | 220801 |   | □ |  |       | D=42, - Halter  | ATE |
|   | CL 500 4-matic        | 320 |          | 02.11 |                | 11.9426-9960.2 | 220802 |   | □ |  |       | D=42, - Halter  | ATE |
|   |                       |     |          |       |                | 11.8171-0008.1 | 990049 |   |   |  |       | Führungsbolzen  | ATE |
|   |                       |     |          |       |                | 11.0101-5407.2 | 260011 |   |   |  |       | Hülsensatz      | ATE |
|   |                       |     |          |       |                | 11.8116-0086.2 | 390606 | 2 |   |  |       | Haltefeder      | ATE |
|   | CL 500                | 285 |          | 07.06 |                | 24.5123-0350.3 | 330963 | 2 |   |  |       | L=350           |     |
|   | CL 500                | 320 |          | 02.11 |                |                |        |   |   |  |       |                 |     |
|   | CL 500 4-matic        | 285 |          | 03.08 |                |                |        |   |   |  |       |                 |     |
|   | CL 500 4-matic        | 320 |          | 02.11 |                |                |        |   |   |  |       |                 |     |
|   | CL 500 BlueEfficiency |     |          | 10.10 |                |                |        |   |   |  |       |                 |     |
|   | CL 600                | 380 |          | 07.06 |                |                |        |   |   |  |       |                 |     |
|   | CL 63 AMG             | 386 |          | 01.07 |                |                |        |   |   |  |       |                 |     |
|   | CL 63 AMG             | 400 |          | 02.11 |                |                |        |   |   |  |       |                 |     |
|   | CL 63 AMG             | 420 |          | 01.10 |                |                |        |   |   |  |       |                 |     |
|   | CL 65 AMG             | 450 |          | 01.07 |                |                |        |   |   |  |       |                 |     |
| CL 65 AMG                                     | 463                   |     | 02.11    |       |                |                |        |   |   |  |       |                 |     |
| MERCEDES BENZ CLK-Klasse (C208) Coupe (97-02) |                       |     |          |       |                |                |        |   |   |  |       |                 |     |
|   | CLK 200               |     |          | 06.97 | 06.02          | 03.7863-0903.4 | 300244 |   |   |  |       | 10"             | ATE |
|   | CLK 200 Kompressor    |     |          | 06.97 | 06.02          |                |        |   |   |  |       |                 |     |
|   | CLK 230 Kompressor    |     |          | 06.97 | 06.02          |                |        |   |   |  |       |                 |     |
|   | CLK 200               |     |          | 06.97 | 06.02          | 24.2023-1702.3 | 010534 |   |   |  |       | Thz 23,81/19,05 | LUC |
|   | CLK 200 Kompressor    |     |          | 06.97 | 06.02          |                |        |   |   |  |       |                 |     |
|   | CLK 230 Kompressor    |     |          | 06.97 | 06.02          |                |        |   |   |  |       |                 |     |
|   | CLK 320               |     |          | 06.97 | 06.02          |                |        |   |   |  |       |                 |     |
|   | CLK 200               |     |          | 06.97 | 06.02          | 03.2023-2004.3 | 010788 |   |   |  |       | Thz 23,81/19,05 | ATE |
|   |                       |     |          |       |                |                |        |   |   |  |       |                 |     |

| MERCEDES BENZ CLK-Klasse (C208) Coupe (97-02)                                      |   |  |  |  |   |  |  |  |   |  |   |
|--|---|--|--|--|---|--|--|--|---|--|---|
|     |         |  |  |  |  |    |      |    |   |  |   |
|    | CLK 200 Kompressor<br>CLK 230 Kompressor  |  | 06.97<br>06.97   | 06.02<br>06.02   | + ESP<br>+ ESP  | 03.2023-2004.3   | 010788   |  |   | Thz 23,81/19,05  | ATE   |
|  | CLK 320   |  | 06.97  | 06.02  | + ESP   | 24.2023-1704.3   | 010635   |  |   | Thz 23,81  | LUC   |
|  | CLK 430<br>CLK 55 AMG   |  | 03.98<br>08.99   | 06.02<br>06.02   |   | 24.2025-1709.3   | 010693   |  |   | Thz 25,40  |   |
|    | CLK 200<br>CLK 200 Kompressor<br>CLK 230 Kompressor                                     |  | 06.97<br>06.97<br>06.97  | 06.02<br>06.02<br>06.02  |   | 11.3571-8511.2<br>11.3571-8512.2<br>24.3571-8511.5<br>24.3571-8512.5<br>11.0441-5703.2<br>11.0230-0096.2<br>11.0101-5407.2<br>11.8171-0008.1<br>11.8116-0253.1 | 220315<br>220316<br>240491<br>240492<br>250145<br>260033<br>260011<br>990049<br>390512 | <br><br><br><br><br><br><br><br><br> |   | D=57, - Halter<br>D=57, - Halter<br>D=57, - Halter<br>D=57, - Halter<br>Dichtungssatz<br>Haltersatz<br>Hülensatz<br>Führungsbolzen<br>Haltefeder | ATE<br>ATE<br>ATE<br>ATE<br>ATE<br>ATE<br>ATE<br>ATE<br>ATE |
|  | CLK 320<br>CLK 430  |  | 06.97<br>03.98   | 06.02<br>06.02   | + ABS   | 11.3571-8509.2<br>11.3571-8510.2<br>11.0441-5703.2<br>11.0101-5407.2<br>11.8171-0008.1<br>11.8116-0253.1   | 220313<br>220314<br>250145<br>260011<br>990049<br>390512                               | <br><br><br><br><br>   |   | D=57, - Halter<br>D=57, - Halter<br>Dichtungssatz<br>Hülensatz<br>Führungsbolzen<br>Haltefeder   | ATE<br>ATE<br>ATE<br>ATE<br>ATE<br>ATE                      |
|  | CLK 430   | F129678  | 03.98  |  | - ABS   | 13.4421-8009.2<br>13.4421-8010.2<br>13.0441-4214.2   | 210228<br>210229<br>250091   | <br><br>  |   | D=42/38<br>D=42/38<br>Dichtungssatz  | ATE<br>ATE<br>ATE   |
|  | CLK 430   | F129679  |  | 06.02  | - ABS   | 11.9441-9971.2<br>11.9441-9972.2<br>11.8116-0133.1   | 220839<br>220840<br>390511   | <br><br>  |   | D=44, - Halter<br>D=44, - Halter<br>Haltefeder   | ATE<br>ATE<br>ATE   |
|  | CLK 55 AMG  |  | 08.99  | 06.02  |   | 11.8116-0133.1   | 390511   |   | 2 | Haltefeder   | ATE   |
|    | CLK 200<br>CLK 200 Kompressor<br>CLK 230 Kompressor<br>CLK 320<br>CLK 430<br>CLK 55 AMG |  | 06.97<br>06.97<br>06.97<br>06.97<br>03.98<br>08.99                               | 06.02<br>06.02<br>06.02<br>06.02<br>06.02<br>06.02                               |   | 83.7705-0386.3   | 330828   | <br><br><br><br><br>  | 2 | L=385  |   |
|    | CLK 200<br>CLK 200 Kompressor<br>CLK 230 Kompressor                                     |  | 06.97<br>06.97<br>06.97  | 06.02<br>06.02<br>06.02  |   | 13.2361-8003.2<br>13.2361-8004.2<br>13.0441-3609.2   | 210220<br>210221<br>250057   | <br><br>   |   | D=36<br>D=36<br>Dichtungssatz  | ATE<br>ATE<br>ATE   |
|  | CLK 320<br>CLK 430  | F129678  | 06.97<br>03.98   | 06.02<br>06.02   |   | 13.2361-8001.2<br>13.2361-8002.2<br>24.9236-8001.5<br>24.9236-8002.5<br>13.0441-3606.2   | 210214<br>210215<br>230007<br>230008<br>250147   | <br><br><br><br>   |   | D=36<br>D=36<br>D=36<br>D=36<br>Dichtungssatz  | ATE<br>ATE<br>ATE<br>ATE<br>ATE                             |
|  | CLK 430<br>CLK 55 AMG   | F126679  |  | 06.02<br>08.99   |   | 13.2421-8025.2<br>13.2421-8026.2<br>13.0441-4216.2   | 210061<br>210062<br>250093   | <br><br>  |   | D=42<br>D=42<br>Dichtungssatz  | ATE<br>ATE<br>ATE   |
|  | CLK 200<br>CLK 200 Kompressor<br>CLK 230 Kompressor<br>CLK 320<br>CLK 430<br>CLK 55 AMG |  | 06.97<br>06.97<br>06.97<br>06.97<br>03.98<br>08.99                               | 06.02<br>06.02<br>06.02<br>06.02<br>06.02<br>06.02                               |   | 83.7715-0280.3   | 330806   | <br><br><br><br><br>   | 2 | L=280  |   |
|  | CLK 200<br>CLK 200 Kompressor<br>CLK 230 Kompressor<br>CLK 320<br>CLK 430<br>CLK 55 AMG |  | 06.97<br>06.97<br>06.97<br>06.97<br>03.98<br>08.99                               | 06.02<br>06.02<br>06.02<br>06.02<br>06.02<br>06.02                               |   | 24.3727-0418.2<br>24.3727-0419.2   | 580418<br>580419   | <br><br><br><br><br>   |   | L=960<br>L=925   |   |
|  | CLK 200<br>CLK 230 Kompressor<br>CLK 320  |  | 06.97<br>06.97<br>06.97  | 06.02<br>06.02<br>06.02  |   | 24.3727-0418.2<br>24.3727-0419.2   | 580418<br>580419   | <br><br>  |   | L=960<br>L=925   |   |
|  | CLK 200<br>CLK 200 Kompressor<br>CLK 230 Kompressor                                     |  | 06.97<br>06.97<br>06.97  | 06.02<br>06.02<br>06.02  |   | 24.2419-0915.3<br>24.2419-1703.3   | 030045<br>030097   | <br><br>  |   | + GG <sup>1)</sup><br>+ ALU <sup>2)</sup>  | Gz 19,05<br>Gz 19,05  |
|  | CLK 200<br>CLK 200 Kompressor<br>CLK 230 Kompressor                                     |  | 06.97<br>06.97<br>06.97  | 06.02<br>06.02<br>06.02  |   | 03.2523-1310.3   | 040022   | <br><br>  |   |  | Nz 23,81  |
| MERCEDES BENZ CLK-Klasse (A208) Cabrio (98-03)                                     |   |  |  |  |   |  |  |  |   |  |   |
|  | CLK 200<br>CLK 200 Kompressor<br>CLK 230 Kompressor                                     |  | 06.98<br>06.98<br>06.98  | 06.03<br>06.03<br>06.03  | + ESP<br>+ ESP<br>+ ESP   | 03.7863-0903.4   | 300244   |  |   | 10"  | ATE   |
|  | CLK 200<br>CLK 200 Kompressor<br>CLK 230 Kompressor<br>CLK 320                          |  | 06.98<br>06.98<br>06.98<br>06.98   | 06.03<br>06.03<br>06.03<br>06.03   | - ESP<br>- ESP<br>- ESP<br>- ESP  | 24.2023-1702.3   | 010534   |  |   | Thz 23,81/19,05  | LUC   |
|  | CLK 200<br>CLK 200 Kompressor<br>CLK 230 Kompressor                                     |  | 06.98<br>06.98<br>06.98  | 06.03<br>06.03<br>06.03  | + ESP<br>+ ESP<br>+ ESP   | 03.2023-2004.3   | 010788   |  |   | Thz 23,81/19,05  | ATE   |
|  | CLK 320<br>CLK 430<br>CLK 55 AMG  |  | 06.98<br>06.99<br>01.00  | 06.03<br>06.03<br>06.03  | + ESP<br>+ ESP<br>+ ESP   | 24.2023-1704.3<br>24.2025-1709.3   | 010635<br>010693   |  |   | Thz 23,81<br>Thz 25,40   | LUC   |

1) + cast iron / + ghisa / + fonte grise / + fundición de gris

2) + aluminium / + alluminio / + aluminium / + aluminio

|     |  |  |  |  |  |  |  |  |     |
|--|--|--|--|--|---|--|--|--|-----|
| <b>MERCEDES BENZ CLK-Klasse (A208) Cabrio (98-03)</b>                              |  |  |  |  |   |  |  |  |     |
|    | CLK 200  |  | 06.98  | 06.03  | 11.3571-8511.2  | 220315   | 2  | D=57, - Halter   | ATE |
|  |  |  |  |  | 11.3571-8512.2  | 220316   |  | D=57, - Halter   | ATE |
|  |  |  |  |  | 24.3571-8511.5  | 240491   |  | D=57, - Halter   | ATE |
|  |  |  |  |  | 24.3571-8512.5  | 240492   |  | D=57, - Halter   | ATE |
|  |  |  |  |  | 11.0441-5703.2  | 250145   |  | Dichtungssatz  | ATE |
|  |  |  |  |  | 11.0230-0096.2  | 260033   |  | Haltersatz   | ATE |
|  |  |  |  |  | 11.0101-5407.2  | 260011   |  | Hülsensatz   | ATE |
|  |  |  |  |  | 11.8171-0008.1  | 990049   |  | Führungsbolzen   | ATE |
|  |  |  |  |  | 11.8116-0253.1  | 390512   |  | Haltefeder   | ATE |
|  | CLK 200 Kompressor   |  | 06.98  | 06.03  | 11.3571-8509.2  | 220313   | 2  | D=57, - Halter   | ATE |
|  | CLK 230 Kompressor   |  | 06.98  | 06.03  | 11.3571-8510.2  | 220314   |  | D=57, - Halter   | ATE |
|  | CLK 320  |  | 06.98  | 06.03  | 11.0441-5703.2  | 250145   |  | Dichtungssatz  | ATE |
|  |  |  |  |  | 11.0101-5407.2  | 260011   |  | Hülsensatz   | ATE |
|  |  |  |  |  | 11.8171-0008.1  | 990049   |  | Führungsbolzen   | ATE |
|  |  |  |  |  | 11.8116-0253.1  | 390512   |  | Haltefeder   | ATE |
|  | CLK 430  |  | 06.99  | 06.03  | 11.9441-9971.2  | 220839   | 2  | D=44, - Halter   | ATE |
|  |  |  |  |  | 11.9441-9972.2  | 220840   |  | D=44, - Halter   | ATE |
|  |  |  |  |  | 11.8171-0008.1  | 990049   |  | Führungsbolzen   | ATE |
|  |  |  |  |  | 11.8116-0133.1  | 390511   |  | Haltefeder   | ATE |
|  | CLK 55 AMG   |  | 01.00  | 06.03  | 11.8116-0133.1  | 390511   | 2  | Haltefeder   | ATE |
|    | CLK 200  |  | 06.98  | 06.03  | 83.7705-0386.3  | 330828   | 2  | L=385  |     |
|  | CLK 200 Kompressor   |  | 06.98  | 06.03  |   |  |  |  |     |
|  | CLK 230 Kompressor   |  | 06.98  | 06.03  |   |  |  |  |     |
|  | CLK 320  |  | 06.98  | 06.03  |   |  |  |  |     |
|  | CLK 430  |  | 06.99  | 06.03  |   |  |  |  |     |
|  | CLK 55 AMG   |  | 01.00  | 06.03  |   |  |  |  |     |
|    | CLK 200  |  | 06.98  | 06.03  | 13.2361-8003.2  | 210220   | 2  | D=36   | ATE |
|  |  |  |  |  | 13.2361-8004.2  | 210221   |  | D=36   | ATE |
|  |  |  |  |  | 13.0441-3609.2  | 250057   |  | Dichtungssatz  | ATE |
|  |  |  |  |  |   |  |  |  |     |
|  | CLK 200 Kompressor   |  | 06.98  | 06.03  | 13.2361-8001.2  | 210214   |  | D=36   | ATE |
|  | CLK 230 Kompressor   |  | 06.98  | 06.03  | 13.2361-8002.2  | 210215   |  | D=36   | ATE |
|  | CLK 320  |  | 06.98  | 06.03  | 24.9236-8001.5  | 230007   |  | D=36   | ATE |
|  |  |  |  |  | 24.9236-8002.5  | 230008   |  | D=36   | ATE |
|  |  |  |  |  | 13.0441-3606.2  | 250147   |  | Dichtungssatz  | ATE |
|  | CLK 430  |  | 06.99  | 06.03  | 13.2421-8025.2  | 210061   | 2  | D=42   | ATE |
|  | CLK 55 AMG   |  | 01.00  | 06.03  | 13.2421-8026.2  | 210062   |  | D=42   | ATE |
|  |  |  |  |  | 13.0441-4216.2  | 250093   |  | Dichtungssatz  | ATE |
|   | CLK 200  |  | 06.98  | 06.03  | 83.7715-0280.3  | 330806   | 2  | L=280  |     |
|  | CLK 200 Kompressor   |  | 06.98  | 06.03  |   |  |  |  |     |
|  | CLK 230 Kompressor   |  | 06.98  | 06.03  |   |  |  |  |     |
|  | CLK 320  |  | 06.98  | 06.03  |   |  |  |  |     |
|  | CLK 430  |  | 06.99  | 06.03  |   |  |  |  |     |
|  | CLK 55 AMG   |  | 01.00  | 06.03  |   |  |  |  |     |
|  | CLK 200  | ⚙  | 06.98  | 06.03  | 24.3727-0418.2  | 580418   | 2  | L=960  |     |
|  | CLK 200 Kompressor   | ⚙  | 06.98  | 06.03  | 24.3727-0419.2  | 580419   |  | L=925  |     |
|  | CLK 230 Kompressor   | ⚙  | 06.98  | 06.03  |   |  |  |  |     |
|  | CLK 320  | ⚙  | 06.98  | 06.03  |   |  |  |  |     |
|  | CLK 430  | ⚙  | 06.99  | 06.03  |   |  |  |  |     |
|  | CLK 55 AMG   | ⚙  | 01.00  | 06.03  |   |  |  |  |     |
|  | CLK 200  | ⚙  | 06.98  | 06.03  | 24.3727-0418.2  | 580418   | 2  | L=960  |     |
|  | CLK 230 Kompressor   | ⚙  | 06.98  | 06.03  | 24.3727-0419.2  | 580419   |  | L=925  |     |
|  | CLK 320  | ⚙  | 06.98  | 06.03  |   |  |  |  |     |
|  | CLK 200  |  | 06.98  | 06.03  | 24.2419-0915.3  | 030045   | 2  | Gz 19,05   |     |
|  | CLK 200 Kompressor   |  | 06.98  | 06.03  | 24.2419-1703.3  | 030097   |  | + GG <sup>1)</sup>   |     |
|  | CLK 230 Kompressor   |  | 06.98  | 06.03  |   |  |  | + ALU <sup>2)</sup>  |     |
|  | CLK 200  |  | 06.98  | 06.03  | 03.2523-1310.3  | 040022   | 2  | Nz 23,81   |     |
|  | CLK 200 Kompressor   |  | 06.98  | 06.03  |   |  |  |  |     |
|  | CLK 230 Kompressor   |  | 06.98  | 06.03  |   |  |  |  |     |
| <b>MERCEDES BENZ CLK-Klasse (C209) Coupe (02-09)</b>                               |  |  |  |  |   |  |  |  |     |
|  | CLK 200 CGI  | ⚙  | 09.02  | 04.09  | 03.7848-2002.4  | 300166   | 2  | 7/8" Tandem  | ATE |
|  | CLK 200 Kompressor   | ⚙  | 09.02  | 04.09  |   |  |  |  |     |
|  | CLK 200 Kompressor   | ⚙  | 10.06  | 04.09  |   |  |  |  |     |
|  | CLK 220 CDI  | ⚙  | 05.05  | 04.09  |   |  |  |  |     |
|  | CLK 240  | ⚙  | 05.02  | 04.09  |   |  |  |  |     |
|  | CLK 270 CDI  | ⚙  | 10.02  | 04.09  |   |  |  |  |     |
|  | CLK 280  | ⚙  | 05.05  | 04.09  |   |  |  |  |     |
|  | CLK 320  | ⚙  | 05.02  | 04.09  |   |  |  |  |     |
|  | CLK 320 CDI  | ⚙  | 05.05  | 04.09  |   |  |  |  |     |
|  | CLK 350  | ⚙  | 05.05  | 04.09  |   |  |  |  |     |
|  | CLK 500  | ⚙  | 05.02  | 04.09  |   |  |  |  |     |
|  | CLK 500  | ⚙  | 06.06  | 04.09  |   |  |  |  |     |
|  | CLK 55 AMG   | ⚙  | 09.02  | 04.09  |   |  |  |  |     |
|  | CLK 63 AMG   | ⚙  | 04.06  | 04.09  |   |  |  |  |     |
|  | CLK 200 CGI  | ⚙  | 09.02  | 04.09  | 03.2023-1741.3  | 010703   | 2  | 7/8" Tandem  | ATE |
|  | CLK 200 Kompressor   | ⚙  | 09.02  | 04.09  |   |  |  |  |     |
|  | CLK 200 Kompressor   | ⚙  | 10.06  | 04.09  |   |  |  |  |     |
|  | CLK 270 CDI  | ⚙  | 10.02  | 04.09  |   |  |  |  |     |
|  | CLK 200 CGI  | ⚙  | 09.02  | 04.09  |   |  |  |  |     |
|  | CLK 200 Kompressor   | ⚙  | 09.02  | 04.09  |   |  |  |  |     |
|  | CLK 200 Kompressor   | ⚙  | 10.06  | 04.09  |   |  |  |  |     |
|  | CLK 220 CDI  | ⚙  | 05.05  | 04.09  |   |  |  |  |     |
|  | CLK 240  | ⚙  | 05.02  | 04.09  |   |  |  |  |     |
|  | CLK 270 CDI  | ⚙  | 10.02  | 04.09  |   |  |  |  |     |
|  | CLK 280  | ⚙  | 05.05  | 04.09  |   |  |  |  |     |
|  | CLK 320  | ⚙  | 05.02  | 04.09  |   |  |  |  |     |
|  |  |  |  |  |   |  |  |  |     |
|  |  |  |  |  |   |  |  |  |     |

1) + cast iron / + ghisa / + fonte grise / + fundición de gris

2) + aluminium / + alluminio / + aluminium / + aluminio

3) - sport package/- sport package AMG / - pacchetto sportivo/- pacchetto sport.AMG / - version sport/- version sport AMG / - kit sportivo/- kit sportivo AMG

4) + sports package/+ sports package AMG / + pacchetto sportivo/+ pacchetto sport.AMG / + version sport/+ version sport AMG / + kit sportivo/+ kit sportivo AMG

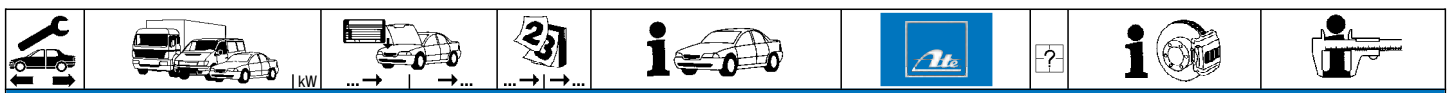

















**MERCEDES BENZ CLK-Klasse (C209) Coupe (02-09)**

|  |  |          |   |  |  |  |  |  |                                 |     |
|--|--|----------|---|--|--|--|--|--|---------------------------------|-----|
|  | CLK 320 CDI #165<br>CLK 350 #200<br>CLK 500 #225<br>CLK 500 #285<br>CLK 55 AMG #270<br>CLK 63 AMG #  |          | 05.05 04.09<br>05.05 04.09<br>05.02 04.09<br>06.06 04.09<br>09.02 04.09<br>04.06 04.09  |  | 03.2025-1741.3   | 010705   |  |  | ThZ 25,40/20,64                 | ATE |
|  | CLK 200 CGI 125<br>CLK 200 Kompressor 120<br>CLK 220 CDI<br>CLK 240<br>CLK 320 160<br>CLK 200 Kompressor 135<br>CLK 270 CDI<br>CLK 280 170   |          | 09.02 04.09<br>09.02 04.09<br>05.05 04.09<br>05.02 04.09<br>05.02 04.09<br>10.06 04.09<br>10.02 04.09<br>05.05 04.09  |  | 24.3571-1739.7<br>24.3571-1740.7<br>24.0101-3803.2                                     | 220667<br>220668<br>260101                     | <input type="checkbox"/> - Sportpaket / - Sportpaket AMG 1)<br><input type="checkbox"/> - Sportpaket / - Sportpaket AMG 1)   | D=57, - Halter<br>D=57, - Halter<br>Einbausatz | LUC<br>LUC<br>LUC               |     |
|  | CLK 200 CGI 125<br>CLK 200 Kompressor 120<br>CLK 200 Kompressor 135<br>CLK 220 CDI<br>CLK 240<br>CLK 270 CDI<br>CLK 280 170<br>CLK 320 160<br>CLK 320 CDI 165<br>CLK 350 200<br>CLK 500 225<br>CLK 500 285<br>CLK 55 AMG 270<br>CLK 63 AMG   |          | 09.02 04.09<br>09.02 04.09<br>10.06 04.09<br>05.05 04.09<br>05.02 04.09<br>10.02 04.09<br>05.05 04.09<br>05.02 04.09<br>05.05 04.09<br>05.05 04.09<br>05.05 04.09<br>05.02 04.09<br>06.06 04.09<br>09.02 04.09<br>04.06 04.09 |  | 83.7705-0386.3   | 330828   | 2  |  | L=385                           |     |
|  | CLK 200 CGI 125<br>CLK 200 Kompressor 120<br>CLK 220 CDI<br>CLK 200 Kompressor 135<br>CLK 240<br>CLK 270 CDI<br>CLK 280 170<br>CLK 320 160<br>CLK 320 CDI 165<br>CLK 350 200<br>CLK 500 225<br>CLK 500 285<br>CLK 55 AMG 270                 |          | 09.02 04.09<br>09.02 04.09<br>05.05 04.09<br>10.06 04.09<br>05.02 04.09<br>10.02 04.09<br>05.05 04.09<br>05.02 04.09<br>05.05 04.09<br>05.05 04.09<br>05.02 04.09<br>06.06 04.09<br>09.02 04.09<br>04.06 04.09                |  | 13.9361-0023.2<br>13.9361-0024.2<br>13.9361-0035.2<br>13.9361-0036.2<br>13.0441-3609.2 | 210241<br>210242<br>210253<br>210254<br>250057 | <input type="checkbox"/> - Sportpaket / - Sportpaket AMG 1)<br><input type="checkbox"/> - Sportpaket / - Sportpaket AMG 1)<br><input type="checkbox"/> + Sportpaket / + Sportpaket AMG 2)<br><input type="checkbox"/> + Sportpaket / + Sportpaket AMG 2) | D=36<br>D=36<br>D=36<br>D=36<br>Dichtungssatz  | ATE<br>ATE<br>ATE<br>ATE<br>ATE |     |
|  | CLK 500 225<br>CLK 500 285<br>CLK 55 AMG 270   | F 123374 | 05.02 04.09<br>06.06 04.09<br>09.02 04.09   |  | 13.0441-4216.2   | 250093   |  |  | Dichtungssatz                   | ATE |
|  | CLK 200 CGI 125<br>CLK 200 Kompressor 120<br>CLK 200 Kompressor 135<br>CLK 220 CDI<br>CLK 240<br>CLK 270 CDI<br>CLK 280 170<br>CLK 320 160<br>CLK 320 CDI 165<br>CLK 350 200<br>CLK 500 225<br>CLK 500 285<br>CLK 55 AMG 270<br>CLK 63 AMG   |          | 09.02 04.09<br>09.02 04.09<br>10.06 04.09<br>05.05 04.09<br>05.02 04.09<br>10.02 04.09<br>05.05 04.09<br>05.02 04.09<br>05.05 04.09<br>05.05 04.09<br>05.02 04.09<br>06.06 04.09<br>09.02 04.09<br>04.06 04.09                |  | 83.7715-0280.3   | 330806   | 2  |  | L=280                           |     |
|  | CLK 200 CGI #125<br>CLK 200 Kompressor #120<br>CLK 200 Kompressor #135<br>CLK 220 CDI #<br>CLK 240 #<br>CLK 270 CDI #<br>CLK 280 #170<br>CLK 320 #160<br>CLK 320 CDI #165<br>CLK 350 #200<br>CLK 500 #225<br>CLK 500 #285<br>CLK 55 AMG #270 |          | 09.02 04.09<br>09.02 04.09<br>10.06 04.09<br>05.05 04.09<br>05.02 04.09<br>10.02 04.09<br>05.05 04.09<br>05.02 04.09<br>05.05 04.09<br>05.05 04.09<br>05.02 04.09<br>06.06 04.09<br>09.02 04.09                               |  | 24.3727-0429.2<br>24.3727-0430.2<br>24.3727-0436.2                                     | 580429<br>580430<br>580436                     | <input checked="" type="checkbox"/><br><input type="checkbox"/><br><input type="checkbox"/>  | L=2735<br>L=925<br>L=900                       |                                 |     |
|  | CLK 200 CGI #125<br>CLK 200 Kompressor #120<br>CLK 200 Kompressor #135<br>CLK 220 CDI #<br>CLK 240 #<br>CLK 270 CDI #<br>CLK 280 #170<br>CLK 320 #160<br>CLK 320 CDI #165<br>CLK 350 #200<br>CLK 500 #225<br>CLK 500 #285<br>CLK 55 AMG #270 |          | 09.02 04.09<br>09.02 04.09<br>10.06 04.09<br>05.05 04.09<br>05.02 04.09<br>10.02 04.09<br>05.05 04.09<br>05.02 04.09<br>05.05 04.09<br>05.05 04.09<br>05.02 04.09<br>06.06 04.09<br>09.02 04.09                               |  | 24.3727-0430.2<br>24.3727-0436.2   | 580430<br>580436                               | <input type="checkbox"/><br><input type="checkbox"/>   | L=925<br>L=900                                 |                                 |     |
|  | CLK 63 AMG #   |          | 04.06 04.09   |  | 24.3727-0429.2   | 580429   | <input checked="" type="checkbox"/>  | L=2735   |                                 |     |

1) - sport package/- sport package AMG / - pacchetto sportivo/- pacchetto sport.AMG / - version sport/- version sport AMG / - kit sportivo/- kit sportivo AMG  
 2) + sports package/+ sports package AMG / + pacchetto sportivo/+ pacchetto sport.AMG / + version sport/+ version sport AMG / + kit sportivo/+ kit sportivo AMG





|     |  |  |  |  |  |  |  |  |     |
|--|--|--|--|--|---|--|--|--|-----|
| <b>MERCEDES BENZ CLK-Klasse (A209) Cabrio (03-09)</b>                              |  |  |  |  |   |  |  |  |     |
|    | CLK 200 CGI  | 125  | 05.03  | 12.09  | 03.7848-2002.4  | 300166   |  | 7/8" Tandem  | ATE |
|  | CLK 200 Kompressor   | 120  | 05.03  | 12.09  |   |  |  |  |     |
|  | CLK 200 Kompressor   | 135  | 10.06  | 12.09  |   |  |  |  |     |
|  | CLK 240  | 125  | 05.03  | 12.09  |   |  |  |  |     |
|  | CLK 280  | 170  | 05.05  | 12.09  |   |  |  |  |     |
|  | CLK 320  | 160  | 05.03  | 12.09  |   |  |  |  |     |
|  | CLK 320 CDI  | 165  | 05.05  | 12.09  |   |  |  |  |     |
|  | CLK 350  | 200  | 05.05  | 12.09  |   |  |  |  |     |
|  | CLK 500  | 225  | 05.03  | 12.09  |   |  |  |  |     |
|  | CLK 500  | 285  | 06.06  | 12.09  |   |  |  |  |     |
| CLK 55 AMG   | 270  | 05.03  | 12.09  |  |   |  |  |  |     |
| CLK 63 AMG   | 354  | 04.06  | 12.09  |  |   |  |  |  |     |
|    | CLK 200 CGI  | 125  | 05.03  | 12.09  | 03.2023-1741.3  | 010703   |  | THz 23,81/20,64  | ATE |
|  | CLK 200 Kompressor   | 120  | 05.03  | 12.09  | 03.2025-1741.3  | 010705   |  | THz 25,40/20,64  | ATE |
|  | CLK 200 Kompressor   | 135  | 10.06  | 12.09  |   |  |  |  |     |
|  | CLK 240  | 125  | 05.03  | 12.09  |   |  |  |  |     |
|  | CLK 280  | 170  | 05.05  | 12.09  |   |  |  |  |     |
|  | CLK 320  | 160  | 05.03  | 12.09  |   |  |  |  |     |
|  | CLK 320 CDI  | 165  | 05.05  | 12.09  |   |  |  |  |     |
|  | CLK 350  | 200  | 05.05  | 12.09  |   |  |  |  |     |
|  | CLK 500  | 225  | 05.03  | 12.09  |   |  |  |  |     |
|  | CLK 500  | 285  | 06.06  | 12.09  |   |  |  |  |     |
| CLK 55 AMG   | 270  | 05.03  | 12.09  |  |   |  |  |  |     |
| CLK 63 AMG   | 354  | 04.06  | 12.09  |  |   |  |  |  |     |
|    | CLK 200 CGI  | 125  | 05.03  | 12.09  | 24.3571-1739.7  | 220667   | <input type="checkbox"/>   | D=57, - Halter   | LUC |
|  |  |  |  |  | 24.3571-1740.7  | 220668   | <input type="checkbox"/>   | D=57, - Halter   | LUC |
|  |  |  |  |  | 24.0101-3803.2  | 260101   | <input type="checkbox"/>   | Einbausatz   | LUC |
|  | CLK 240  | 125  | 05.03  | 12.09  | 24.3571-1721.7  | 220555   | <input type="checkbox"/>   | D=57, - Halter   | LUC |
|  | CLK 320  | 160  | 05.03  | 12.09  | 24.3571-1722.7  | 220556   | <input type="checkbox"/>   | D=57, - Halter   | LUC |
|  | CLK 200 Kompressor   | 120  | 05.03  | 12.09  | 24.3571-1721.7  | 220555   | <input type="checkbox"/>   | D=57, - Halter   | LUC |
|  | CLK 200 Kompressor   | 135  | 10.06  | 12.09  | 24.3571-1722.7  | 220556   | <input type="checkbox"/>   | D=57, - Halter   | LUC |
|  | CLK 280  | 170  | 05.05  | 12.09  |   |  |  |  |     |
|  |  |  |  |  |   |  |  |  |     |
|  |  |  |  |  |   |  |  |  |     |
|    | CLK 200 CGI  | 125  | 05.03  | 12.09  | 83.7705-0386.3  | 330828   | 2  | L=385  |     |
|  | CLK 200 Kompressor   | 120  | 05.03  | 12.09  |   |  |  |  |     |
|  | CLK 200 Kompressor   | 135  | 10.06  | 12.09  |   |  |  |  |     |
|  | CLK 240  | 125  | 05.03  | 12.09  |   |  |  |  |     |
|  | CLK 280  | 170  | 05.05  | 12.09  |   |  |  |  |     |
|  | CLK 320  | 160  | 05.03  | 12.09  |   |  |  |  |     |
|  | CLK 320 CDI  | 165  | 05.05  | 12.09  |   |  |  |  |     |
|  | CLK 350  | 200  | 05.05  | 12.09  |   |  |  |  |     |
|  | CLK 500  | 225  | 05.03  | 12.09  |   |  |  |  |     |
|  | CLK 500  | 285  | 06.06  | 12.09  |   |  |  |  |     |
| CLK 55 AMG   | 270  | 05.03  | 12.09  |  |   |  |  |  |     |
| CLK 63 AMG   | 354  | 04.06  | 12.09  |  |   |  |  |  |     |
|  | CLK 200 CGI  | 125  | 05.03  | 12.09  | 13.9361-0023.2  | 210241   | <input type="checkbox"/>   | D=36   | ATE |
|  |  |  |  |  | 13.9361-0024.2  | 210242   | <input type="checkbox"/>   | D=36   | ATE |
|  |  |  |  |  | 13.0441-3609.2  | 250057   | <input type="checkbox"/>   | Dichtungssatz  | ATE |
|  | CLK 200 Kompressor   | 120  | 05.03  | 12.09  | 13.9361-0035.2  | 210253   | <input type="checkbox"/>   | D=36   | ATE |
|  | CLK 200 Kompressor   | 135  | 10.06  | 12.09  | 13.9361-0036.2  | 210254   | <input type="checkbox"/>   | D=36   | ATE |
|  | CLK 240  | 125  | 05.03  | 12.09  | 13.0441-3609.2  | 250057   | <input type="checkbox"/>   | Dichtungssatz  | ATE |
|  | CLK 280  | 170  | 05.05  | 12.09  |   |  |  |  |     |
|  | CLK 320  | 160  | 05.03  | 12.09  |   |  |  |  |     |
|  | CLK 320 CDI  | 165  | 05.05  | 12.09  |   |  |  |  |     |
|  | CLK 350  | 200  | 05.05  | 12.09  |   |  |  |  |     |
| CLK 500  | 225  | 05.03  | 12.09  | 13.0441-4216.2   | 250093  |  | Dichtungssatz  | ATE  |     |
| CLK 500  | 285  | 06.06  | 12.09  |  |   |  |  |  |     |
| CLK 55 AMG   | 270  | 05.03  | 12.09  |  |   |  |  |  |     |
|  | CLK 200 CGI  | 125  | 05.03  | 12.09  | 83.7715-0280.3  | 330806   | 2  | L=280  |     |
|  | CLK 200 Kompressor   | 120  | 05.03  | 12.09  |   |  |  |  |     |
|  | CLK 200 Kompressor   | 135  | 10.06  | 12.09  |   |  |  |  |     |
|  | CLK 240  | 125  | 05.03  | 12.09  |   |  |  |  |     |
|  | CLK 280  | 170  | 05.05  | 12.09  |   |  |  |  |     |
|  | CLK 320  | 160  | 05.03  | 12.09  |   |  |  |  |     |
|  | CLK 320 CDI  | 165  | 05.05  | 12.09  |   |  |  |  |     |
|  | CLK 350  | 200  | 05.05  | 12.09  |   |  |  |  |     |
|  | CLK 500  | 225  | 05.03  | 12.09  |   |  |  |  |     |
|  | CLK 500  | 285  | 06.06  | 12.09  |   |  |  |  |     |
| CLK 55 AMG   | 270  | 05.03  | 12.09  |  |   |  |  |  |     |
| CLK 63 AMG   | 354  | 04.06  | 12.09  |  |   |  |  |  |     |
|  | CLK 200 CGI  | 125  | 05.03  | 12.09  | 24.3727-0429.2  | 580429   | 1 <input type="checkbox"/>   | L=2735   |     |
|  | CLK 200 Kompressor   | 120  | 05.03  | 12.09  | 24.3727-0430.2  | 580430   | <input type="checkbox"/>   | L=925  |     |
|  | CLK 200 Kompressor   | 135  | 10.06  | 12.09  | 24.3727-0436.2  | 580436   | <input type="checkbox"/>   | L=900  |     |
|  | CLK 240  | 125  | 05.03  | 12.09  |   |  |  |  |     |
|  | CLK 280  | 170  | 05.05  | 12.09  |   |  |  |  |     |
|  | CLK 320  | 160  | 05.03  | 12.09  |   |  |  |  |     |
|  | CLK 320 CDI  | 165  | 05.05  | 12.09  |   |  |  |  |     |
|  | CLK 350  | 200  | 05.05  | 12.09  |   |  |  |  |     |
|  | CLK 500  | 225  | 05.03  | 12.09  |   |  |  |  |     |
|  | CLK 500  | 285  | 06.06  | 12.09  |   |  |  |  |     |
| CLK 55 AMG   | 270  | 05.03  | 12.09  |  |   |  |  |  |     |
| CLK 200 CGI  | 125  | 05.03  | 12.09  | 24.3727-0430.2   | 580430  | <input type="checkbox"/>   | L=925  |  |     |
| CLK 200 Kompressor   | 120  | 05.03  | 12.09  | 24.3727-0436.2   | 580436  | <input type="checkbox"/>   | L=900  |  |     |
| CLK 200 Kompressor   | 135  | 10.06  | 12.09  |  |   |  |  |  |     |
| CLK 240  | 125  | 05.03  | 12.09  |  |   |  |  |  |     |
| CLK 280  | 170  | 05.05  | 12.09  |  |   |  |  |  |     |

1) - sport package/- sport package AMG / - pacchetto sportivo/- pacchetto sport.AMG / - version sport/- version sport AMG / - kit deportivo/- kit deportivo AMG

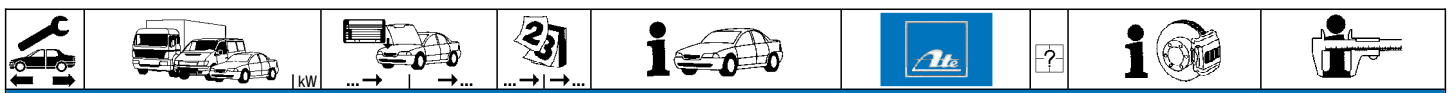

**MERCEDES BENZ CLK-Klasse (A209) Cabrio (03-09)**

|  |             |     |       |       |                |        |                          |                |
|--|-------------|-----|-------|-------|----------------|--------|--------------------------|----------------|
|  | CLK 320     | 160 | 05.03 | 12.09 | 24.3727-0430.2 | 580430 | <input type="checkbox"/> | L=925<br>L=900 |
|  | CLK 320 CDI | 165 | 05.05 | 12.09 | 24.3727-0436.2 | 580436 | <input type="checkbox"/> |                |
|  | CLK 350     | 200 | 05.05 | 12.09 |                |        |                          |                |
|  | CLK 500     | 225 | 05.03 | 12.09 |                |        |                          |                |
|  | CLK 500     | 285 | 06.06 | 12.09 |                |        |                          |                |
|  | CLK 55 AMG  | 270 | 05.03 | 12.09 |                |        |                          |                |
|  | CLK 63 AMG  | 354 | 04.06 | 12.09 | 24.3727-0429.2 | 580429 | 1                        |                |













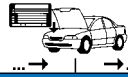



**MERCEDES BENZ CLS-Klasse (C219) Coupe (04-10)**













































|            |                   |       |       |       |                |        |                          |   |
|------------|-------------------|-------|-------|-------|----------------|--------|--------------------------|---|
|            | CLS 280 / CLS 300 | 170   | 10.07 | 10.10 | 24.5123-0380.3 | 331256 | 2                        | L=380   |
|            | CLS 320 CDI       | 155   | 05.05 | 10.10 |                |        |                          |   |
|            | CLS 320 CDI       | 165   | 05.05 | 10.10 |                |        |                          |   |
|            | CLS 350           | 200   | 08.04 | 10.10 |                |        |                          |   |
|            | CLS 350 CDI       | 165   | 04.09 | 10.10 |                |        |                          |   |
|            | CLS 350 CGI       | 215   | 04.09 | 10.10 |                |        |                          |   |
|            | CLS 350 CGI       | 215   | 04.06 | 10.10 |                |        |                          |   |
|            | CLS 500           | 225   | 08.04 | 10.10 |                |        |                          |   |
|            | CLS 500           | 285   | 04.06 | 10.10 |                |        |                          |   |
|            | CLS 55 AMG        | 350   | 01.05 | 10.10 |                |        |                          |   |
| CLS 63 AMG | 378               | 04.06 | 10.10 |       |                |        |                          |   |
|            | CLS 280 / CLS 300 | 170   | 10.07 | 10.10 | 11.9426-9991.2 | 220641 | <input type="checkbox"/> | D=42, - Halter<br>D=42, - Halter<br>Hülensatz<br>Dichtungssatz<br>Haltefeder<br>ATE |
|            | CLS 320 CDI       | 155   | 05.05 | 10.10 | 11.9426-9992.2 | 220642 | <input type="checkbox"/> |   |
|            | CLS 320 CDI       | 165   | 05.05 | 10.10 | 11.0101-4202.2 | 260094 |                          |   |
|            | CLS 350 CDI       | 165   | 04.09 | 10.10 | 11.0441-4203.2 | 250013 |                          |   |
|            |                   |       |       |       | 11.8116-0323.1 | 390459 | 2                        |   |
|            | CLS 350           | 200   | 08.04 | 10.10 | 11.9426-9991.2 | 220641 | <input type="checkbox"/> |   |
|            | CLS 350 CGI       | 215   | 04.09 | 10.10 | 11.9426-9992.2 | 220642 | <input type="checkbox"/> |   |
|            | CLS 350 CGI       | 215   | 04.06 | 10.10 | 11.0101-5407.2 | 260011 |                          |   |
|            | CLS 500           | 225   | 08.04 | 10.10 | 11.8171-0008.1 | 990049 |                          |   |
|            |                   |       |       |       | 11.8116-0323.1 | 390459 | 2                        |   |
|            | CLS 280 / CLS 300 | 170   | 10.07 | 10.10 | 24.5238-0255.3 | 330674 | 2                        | L=255   |
|            | CLS 320 CDI       | 155   | 05.05 | 10.10 |                |        |                          |   |
|            | CLS 320 CDI       | 165   | 05.05 | 10.10 |                |        |                          |   |
|            | CLS 350           | 200   | 08.04 | 10.10 |                |        |                          |   |
|            | CLS 350 CDI       | 165   | 04.09 | 10.10 |                |        |                          |   |
|            | CLS 350 CGI       | 215   | 04.09 | 10.10 |                |        |                          |   |
|            | CLS 350 CGI       | 215   | 04.06 | 10.10 |                |        |                          |   |
|            | CLS 500           | 225   | 08.04 | 10.10 |                |        |                          |   |
|            | CLS 500           | 285   | 04.06 | 10.10 |                |        |                          |   |
|            | CLS 55 AMG        | 350   | 01.05 | 10.10 |                |        |                          |   |
| CLS 63 AMG | 378               | 04.06 | 10.10 |       |                |        |                          |   |
|            | CLS 280 / CLS 300 | 170   | 10.07 | 10.10 | 24.3727-0447.2 | 580447 | 1                        | L=1952<br>L=1742<br>L=1726  |
|            | CLS 350           | 200   | 08.04 | 10.10 | 24.3727-0449.2 | 580449 | <input type="checkbox"/> |   |
|            | CLS 350 CGI       | 215   | 04.09 | 10.10 | 24.3727-0448.2 | 580448 | <input type="checkbox"/> |   |
|            | CLS 350 CGI       | 215   | 04.06 | 10.10 |                |        |                          |   |
|            | CLS 500           | 225   | 08.04 | 10.10 |                |        |                          |   |
|            | CLS 500           | 285   | 04.06 | 10.10 |                |        |                          |   |
|            | CLS 55 AMG        | 350   | 01.05 | 10.10 |                |        |                          |   |
|            | CLS 63 AMG        | 378   | 04.06 | 10.10 |                |        |                          |   |
|            | CLS 280 / CLS 300 | 170   | 10.07 | 10.10 | 24.3727-0449.2 | 580449 | <input type="checkbox"/> |   |
|            | CLS 350           | 200   | 08.04 | 10.10 | 24.3727-0448.2 | 580448 | <input type="checkbox"/> |   |

**MERCEDES BENZ CLS-Klasse (C218) Coupe (10-)**

























|                     |                      |       |       |                |                |        |                          |   |
|---------------------|----------------------|-------|-------|----------------|----------------|--------|--------------------------|---|
|                     | CLS 250 CDI          | 150   | 11.10 |                | 03.2126-3146.3 | 010936 |                          | Thz 26,99<br>ATE                                      |
|                     | CLS 350 BlueTec      | 185   | 01.13 |                |                |        |                          |   |
|                     | CLS 350 BT 4-matic   | 185   | 01.13 |                |                |        |                          |   |
|                     | CLS 350 CDI          | 195   | 11.10 |                |                |        |                          |   |
|                     | CLS 350 CDI 4-matic  | 195   | 09.11 |                |                |        |                          |   |
|                     | CLS 350 CGI          | 225   | 11.10 |                |                |        |                          |   |
|                     | CLS 500              | 300   | 11.10 |                |                |        |                          |   |
|                     | CLS 500 4-matic      | 300   | 11.10 |                |                |        |                          |   |
|                     | CLS 63 AMG           | 386   | 03.11 |                |                |        |                          |   |
|                     | CLS 63 AMG           | 412   | 01.11 |                |                |        |                          |   |
|                     | CLS 63 AMG 4-matic   | 410   | 01.13 |                |                |        |                          |   |
|                     | CLS 63 AMG S         | 430   | 01.13 |                |                |        |                          |   |
|                     | CLS 63 AMG S 4-matic | 430   | 01.13 |                |                |        |                          |   |
|                     | CLS 250 CDI          | 150   | 11.10 |                | 11.9426-9990.2 | 220640 | <input type="checkbox"/> | D=42, - Halter<br>D=42, - Halter<br>Haltefeder<br>ATE |
|                     |                      |       |       |                | 11.9426-9989.2 | 220639 | <input type="checkbox"/> |   |
|                     |                      |       |       |                | 11.8116-0087.2 | 390607 | 2                        |   |
|                     | CLS 350 BlueTec      | 185   | 01.13 |                | 11.9426-9992.2 | 220642 | <input type="checkbox"/> |   |
|                     | CLS 350 BT 4-matic   | 185   | 01.13 |                | 11.9426-9991.2 | 220641 | <input type="checkbox"/> |   |
|                     | CLS 350 CDI          | 195   | 11.10 |                | 11.0101-5407.2 | 260011 |                          |   |
| CLS 350 CDI 4-matic | 195                  | 09.11 |       | 11.8171-0008.1 | 990049         |        |                          |   |
| CLS 350 CGI         | 225                  | 11.10 |       | 11.8116-0087.2 | 390607         | 2      |                          |   |



|     |    |      |    |                                   |  |      |  |  |  |                                 |
|--|--|--|--|---|---|--|--|--|--|---------------------------------|
| <b>MERCEDES BENZ CLS-Klasse (C218) Coupe (10-)</b>                                 |  |  |  |   |   |  |  |  |  |                                 |
|    | CLS 500<br>CLS 500 4-matic   | 300<br>300   |  | 11.10<br>11.10  |   |  |  | D=42, - Halter<br>D=42, - Halter<br>Hülzensatz<br>Führungsbolzen<br>Haltefeder     | ATE<br>ATE<br>ATE<br>ATE<br>ATE  |                                 |
| <b>MERCEDES BENZ CLS-Klasse (X218) Shooting Brake (12-)</b>                        |  |  |  |   |   |  |  |  |  |                                 |
|    | CLS 250 CDI<br>CLS 350<br>CLS 350 CDI<br>CLS 350 CDI 4-matic   | 150<br>225<br>195<br>195   | A 26541<br>A 26541<br>A 26541<br>A 26541   | 09.12<br>09.12<br>09.12<br>09.12  |   | 03.7858-1932.4   | 300263   |  | 9/8" Tandem  | ATE                             |
|    | CLS 250 CDI<br>CLS 350<br>CLS 350 CDI<br>CLS 350 CDI 4-matic<br>CLS 500<br>CLS 500 4-matic<br>CLS 63 AMG<br>CLS 63 AMG 4-matic<br>CLS 63 AMG S<br>CLS 63 AMG S 4-matic | 150<br>225<br>195<br>195<br>300<br>300<br>386<br>410<br>410<br>430<br>430            |  | 09.12<br>09.12<br>09.12<br>09.12<br>09.12<br>09.12<br>09.12<br>01.13<br>01.13<br>01.13<br>01.13                   |   | 03.2126-3146.3   | 010936   |  | THz 26,99  | ATE                             |
|    | CLS 250 CDI  | 150  |  | 09.12   |   | 11.9426-9990.2<br>11.9426-9989.2<br>11.0101-5407.2<br>11.8171-0008.1<br>11.8116-0087.2 | 220640<br>220639<br>260011<br>990049<br>390607                                     | 2  | D=42, - Halter<br>D=42, - Halter<br>Hülzensatz<br>Führungsbolzen<br>Haltefeder | ATE<br>ATE<br>ATE<br>ATE<br>ATE |
|  | CLS 350<br>CLS 350 CDI<br>CLS 350 CDI 4-matic  | 225<br>195<br>195  |  | 09.12<br>09.12<br>09.12   |   | 11.9426-9992.2<br>11.9426-9991.2<br>11.0101-5407.2<br>11.8171-0008.1<br>11.8116-0087.2 | 220642<br>220641<br>260011<br>990049<br>390607                                     | 2  | D=42, - Halter<br>D=42, - Halter<br>Hülzensatz<br>Führungsbolzen<br>Haltefeder | ATE<br>ATE<br>ATE<br>ATE<br>ATE |
|  | CLS 500<br>CLS 500 4-matic   | 300<br>300   |  | 09.12<br>09.12  |   | 11.9426-9959.2<br>11.9426-9960.2<br>11.0101-5407.2<br>11.8171-0008.1<br>11.8116-0087.2 | 220801<br>220802<br>260011<br>990049<br>390607                                     | 2  | D=42, - Halter<br>D=42, - Halter<br>Hülzensatz<br>Führungsbolzen<br>Haltefeder | ATE<br>ATE<br>ATE<br>ATE<br>ATE |
| <b>MERCEDES BENZ E-Klasse (W124) Limousine (93-95)</b>                             |  |  |  |   |   |  |  |  |  |                                 |
|   | E 200<br>E 200 D<br>E 220<br>E 250 D<br>E 250 Turbo-D<br>E 280<br>E 300 4-matic<br>E 300 D<br>E 300 Turbo-D<br>E 300 Turbo-D 4-matic<br>E 320<br>E 36 AMG              | 100<br>55<br>110<br>83<br>93<br>145<br>132<br>100<br>108<br>108<br>162<br>200        |  | 06.93<br>06.93<br>06.93<br>07.93<br>06.93<br>06.93<br>06.93<br>07.93<br>06.93<br>06.93<br>06.93<br>06.93<br>05.94 | 06.95   | 03.7760-2702.4   | 300090   |  | 10"  | ATE                             |
|  | E 200<br>E 200 D<br>E 220<br>E 250 D<br>E 250 Turbo-D<br>E 280<br>E 280<br>E 300 4-matic<br>E 300 D<br>E 300 Turbo-D<br>E 300 Turbo-D 4-matic<br>E 320<br>E 36 AMG     | 100<br>55<br>110<br>83<br>93<br>142<br>145<br>132<br>100<br>108<br>108<br>162<br>200 | C 164263<br>C 164263<br>C 164263<br>C 164263<br>C 164263<br>C 164263<br>C 164263<br>C 164263<br>C 164263<br>C 164263<br>C 164263<br>C 164263<br>C 164263 | 06.93<br>06.93<br>06.93<br>07.93<br>06.93<br>06.93<br>06.93<br>06.93<br>07.93<br>06.93<br>06.93<br>06.93<br>07.94 | 06.95   | 03.2023-0825.3   | 010028   |  | THz 23,81/19,05  | ATE                             |
|  | E 320<br>E 420<br>E 500<br>E 60 AMG  | 162<br>205<br>235<br>280   | C 164263<br>C 164263<br>B 927760<br>B 927760   | 06.93<br>06.93<br>06.93<br>05.94  |   | 03.2025-0211.3   | 010034   |  | THz 25,40/19,05  | ATE                             |
|  | E 200<br>E 220<br>E 250 Turbo-D<br>E 280<br>E 300 D<br>E 300 Turbo-D   | 100<br>110<br>93<br>145<br>100<br>108  |  | 06.93<br>06.93<br>06.93<br>06.93<br>07.93<br>06.93  | 06.95   | 24.3541-1603.5<br>24.3541-1604.5<br>24.0101-3601.2<br>11.0101-5403.2                   | 240037<br>240038<br>260044<br>260010   | 2  | D=54, - Halter<br>D=54, - Halter<br>Einbausatz<br>Fallenbalgsatz               | LUC<br>LUC<br>LUC<br>LUC        |
|  | E 200 D<br>E 250 D   | 55<br>83   |  | 06.93<br>07.93  | 06.95   | 24.3541-1725.5<br>24.3541-1726.5<br>11.0441-5404.2<br>11.0101-5403.2                   | 240003<br>240004<br>250029<br>260010   | 2  | D=54, - Halter<br>D=54, - Halter<br>Dichtungssatz<br>Fallenbalgsatz            | LUC<br>LUC<br>LUC<br>LUC        |
|  | E 280<br>E 320   | 142<br>162   | B 864307<br>B 864307   | 06.93<br>06.93  |   | 13.0441-4214.2   | 250091   |  | Dichtungssatz  | ATE                             |
|  | E 280<br>E 320<br>E 420  | 142<br>162<br>205  | B 864308<br>B 864308<br>B 938568   | 06.95<br>06.95<br>06.93   |   | 13.0441-4214.2   | 250091   |  | Dichtungssatz  | ATE                             |
|  | E 300 4-matic<br>E 300 Turbo-D 4-matic   | 132<br>108   |  | 06.93<br>06.93  | 06.95   | 11.0441-5404.2<br>11.0101-5403.2   | 250029<br>260010   |  | Dichtungssatz<br>Fallenbalgsatz  | LUC<br>LUC                      |
|  | E 36 AMG   | 200  |  | 07.94   | 06.95   | 13.0441-4214.2   | 250091   |  | Dichtungssatz  | ATE                             |

|     |    |                           |  |    |       |  |    |       |
|--|--|---|--|--|--|--|--|---|
| <b>MERCEDES BENZ E-Klasse (W124) Limousine (93-95)</b>                             |  |   |  |  |  |  |  |   |
|    | E 420<br>E 500<br>E 60 AMG   | 205 B 938569<br>235 B 927761<br>280   |  | 06.95<br>06.95<br>05.94 06.95  | 13.0441-4214.2   | 250091   |  | Dichtungssatz<br>ATE  |
|  | E 500  | 235   | B 927760   | 06.93  | 24.9442-8003.5<br>24.9442-8004.5   | 230053<br>230054   | <br>   | D=42/38<br>D=42/38<br>ATE<br>ATE  |
|    | E 200<br>E 200 D<br>E 220<br>E 250 D<br>E 250 Turbo-D<br>E 280<br>E 280<br>E 300 D<br>E 300 Turbo-D<br>E 320<br>E 36 AMG<br>E 420<br>E 500<br>E 60 AMG   | 100<br>55<br>110<br>83<br>93<br>142<br>145<br>100<br>108<br>162<br>200<br>205<br>235<br>280               |  | 06.93 06.95<br>06.93 06.95<br>06.93 06.95<br>07.93 06.95<br>06.93 06.95<br>06.93 06.95<br>06.93 06.95<br>07.93 06.95<br>06.93 06.95<br>06.93 06.95<br>07.94 06.95<br>06.93 06.95<br>06.93 06.95<br>05.94 06.95                               | 83.7754-0340.3   | 330794   | 2  | L=340   |
|  | E 300 4-matic<br>E 300 Turbo-D 4-matic   | 132<br>108  |  | 06.93 06.95<br>06.93 06.95   | 83.6154-0526.3   | 330285   | 2  | L=525   |
|    | E 200<br>E 200 D<br>E 220<br>E 250 D<br>E 250 Turbo-D<br>E 280<br>E 300 4-matic<br>E 300 D<br>E 300 Turbo-D<br>E 300 Turbo-D 4-matic   | 100<br>55<br>110<br>83<br>93<br>145<br>132<br>100<br>108<br>108   |  | 06.93 06.95<br>06.93 06.95<br>06.93 06.95<br>07.93 06.95<br>06.93 06.95<br>06.93 06.95<br>06.93 06.95<br>07.93 06.95<br>06.93 06.95<br>06.93 06.95   | 13.2351-8005.2<br>13.2351-8006.2<br>24.9235-8005.5<br>24.9235-8006.5<br>13.0441-3505.2 | 210014<br>210015<br>230023<br>230024<br>250051                                     | <br><br><br><br><br><br><br><br><br> | D=35<br>D=35<br>D=35<br>D=35<br>Dichtungssatz<br>ATE<br>ATE<br>ATE<br>ATE<br>ATE<br>ATE |
|  | E 280  | 145   |  | 06.93 06.95<br>06.93 06.95 + ASR   | 13.2351-8017.2<br>13.2351-8018.2<br>13.0441-3505.2                                     | 210218<br>210219<br>250051   | <br><br>  | D=35<br>D=35<br>Dichtungssatz<br>ATE<br>ATE<br>ATE                                      |
|  | E 320<br>E 36 AMG  | 162<br>200  |  | 06.93 06.95<br>07.94 06.95   | 13.2381-8035.2<br>13.2381-8036.2<br>24.9238-8035.5<br>24.9238-8036.5<br>13.0441-3817.2 | 210037<br>210038<br>230025<br>230026<br>250071                                     | <br><br><br><br>   | D=38<br>D=38<br>D=38<br>D=38<br>Dichtungssatz<br>ATE<br>ATE<br>ATE<br>ATE               |
|  | E 420<br>E 500<br>E 60 AMG   | 205<br>235<br>280   | B 927760<br>B 927760   | 06.93 06.95<br>06.93<br>05.94  | 13.2381-8033.2<br>13.2381-8034.2<br>24.9238-8033.5<br>24.9238-8034.5<br>13.0441-3817.2 | 210222<br>210223<br>230015<br>230016<br>250071                                     | <br><br><br><br>   | D=38<br>D=38<br>D=38<br>D=38<br>Dichtungssatz<br>ATE<br>ATE<br>ATE<br>ATE               |
|  | E 500<br>E 60 AMG  | 235 B 927761<br>280 B 927761  |  | 06.95<br>06.95   | 13.2421-8025.2<br>13.2421-8026.2<br>13.0441-4216.2                                     | 210061<br>210062<br>250093   | <br><br>  | D=42<br>D=42<br>Dichtungssatz<br>ATE<br>ATE<br>ATE                                      |
|  | E 200<br>E 200 D<br>E 220<br>E 250 D<br>E 250 Turbo-D<br>E 280<br>E 280<br>E 300 4-matic<br>E 300 D<br>E 300 Turbo-D<br>E 300 Turbo-D 4-matic<br>E 320<br>E 36 AMG<br>E 420<br>E 500<br>E 60 AMG | 100<br>55<br>110<br>83<br>93<br>142<br>145<br>132<br>100<br>108<br>108<br>162<br>200<br>205<br>235<br>280 |  | 06.93 06.95<br>06.93 06.95<br>06.93 06.95<br>07.93 06.95<br>06.93 06.95<br>06.93 06.95<br>06.93 06.95<br>07.93 06.95<br>06.93 06.95<br>06.93 06.95<br>06.93 06.95<br>06.93 06.95<br>07.94 06.95<br>06.93 06.95<br>06.93 06.95<br>05.94 06.95 | 83.7704-0281.3   | 330804   | 2  | L=280   |
|  | E 200<br>E 200 D<br>E 220<br>E 250 D<br>E 250 Turbo-D<br>E 280<br>E 280<br>E 300 4-matic<br>E 300 D<br>E 300 Turbo-D<br>E 300 Turbo-D 4-matic<br>E 320<br>E 36 AMG<br>E 420<br>E 500<br>E 60 AMG | 100<br>55<br>110<br>83<br>93<br>142<br>145<br>132<br>100<br>108<br>108<br>162<br>200<br>205<br>235<br>280 |  | 06.93 06.95<br>06.93 06.95<br>06.93 06.95<br>07.93 06.95<br>06.93 06.95<br>06.93 06.95<br>06.93 06.95<br>07.93 06.95<br>06.93 06.95<br>06.93 06.95<br>06.93 06.95<br>06.93 06.95<br>07.94 06.95<br>06.93 06.95<br>06.93 06.95<br>05.94 06.95 | 24.3727-0411.2<br>24.3727-0409.2   | 580411<br>580409   | 1 <br>2    | L=2496<br>L=1060  |
|  | E 200<br>E 200 D<br>E 220<br>E 250 D<br>E 250 Turbo-D<br>E 280<br>E 280  | 100<br>55<br>110<br>83<br>93<br>142<br>145  |  | 06.93 06.95<br>06.93 06.95<br>06.93 06.95<br>07.93 06.95<br>06.93 06.95<br>06.93 06.95<br>06.93 06.95  | 24.2419-0915.3<br>24.2419-1703.3   | 030045<br>030097   | + GG <sup>1)</sup><br>+ ALU <sup>2)</sup>  | Gz 19,05<br>Gz 19,05  |























1) + cast iron / + ghisa / + fonte grise / + fundición de gris  
2) + aluminium / + alluminio / + aluminium / + aluminio

|     |   |  |    |                          |                         |      |  |    |  |                                 |
|--|---|--|--|--|--|--|--|--|--|---------------------------------|
| <b>MERCEDES BENZ E-Klasse (W124) Limousine (93-95)</b>                             |   |  |  |  |  |  |  |  |  |                                 |
|    | E 300 D<br>E 320<br>E 36 AMG  | 100<br>162<br>200  |  | 07.93<br>06.93<br>07.94  | 06.95<br>06.95<br>06.95  | 24.2419-0915.3<br>24.2419-1703.3   | 030045<br>030097   | + GG <sup>1)</sup><br>+ ALU <sup>2)</sup>  | Gz 19,05<br>Gz 19,05   |                                 |
|    | E 200<br>E 200 D<br>E 220<br>E 250 D<br>E 250 Turbo-D<br>E 280<br>E 280<br>E 300 D<br>E 320<br>E 36 AMG   | 100<br>55<br>110<br>83<br>93<br>142<br>145<br>100<br>162<br>200                  |  | 06.93<br>06.93<br>06.93<br>07.93<br>06.93<br>06.93<br>06.93<br>07.93<br>06.93<br>07.94                   | 06.95<br>06.95<br>06.95<br>06.95<br>06.95<br>06.95<br>06.95<br>06.95<br>06.95<br>06.95                   | 03.2523-1210.3<br>03.2523-1310.3<br>03.2523-1310.3                                     | 040021<br>040022<br>040022   |  | Nz 23,81<br>Nz 23,81<br>Nz 23,81                                     |                                 |
| <b>MERCEDES BENZ E-Klasse (S124) Kombi (93-96)</b>                                 |   |  |  |  |  |  |  |  |  |                                 |
|    | E 200<br>E 220<br>E 250 D<br>E 250 Turbo D<br>E 280<br>E 300 4-matic<br>E 300 D<br>E 300 TE-24<br>E 300 Turbo D<br>E 300 Turbo D 4-matic<br>E 320<br>E 36 AMG | 100<br>110<br>83<br>93<br>145<br>132<br>100<br>162<br>108<br>108<br>162<br>200   |  | 06.93<br>06.93<br>06.93<br>06.93<br>06.93<br>06.93<br>06.93<br>06.93<br>06.93<br>06.93<br>06.93<br>05.94 | 06.96<br>06.96<br>06.96<br>06.96<br>06.96<br>06.96<br>06.96<br>06.96<br>06.96<br>06.96<br>06.96<br>06.96 | 03.7760-2702.4   | 300090   |  | 10" ATE  |                                 |
|    | E 200<br>E 220<br>E 250 D<br>E 250 Turbo D<br>E 280<br>E 300 4-matic<br>E 300 D<br>E 300 TE-24<br>E 300 Turbo D<br>E 300 Turbo D 4-matic<br>E 320<br>E 36 AMG | 100<br>110<br>83<br>93<br>145<br>132<br>100<br>162<br>108<br>108<br>162<br>200   | F 298225<br>F 298225<br>F 298225<br>F 298225<br>F 298225<br>F 298225<br>C 164263<br>C 164263<br>F 298225<br>F 298225<br>F 298225<br>F 298225 | 06.93<br>06.93<br>06.93<br>06.93<br>06.93<br>06.93<br>06.93<br>06.93<br>06.93<br>06.93<br>06.93<br>05.94 | 06.96<br>06.96<br>06.96<br>06.96<br>06.96<br>06.96<br>06.96<br>06.96<br>06.96<br>06.96<br>06.96<br>06.96 | 03.2023-0825.3   | 010028   |  | Thz 23,81/19,05 ATE  |                                 |
|   | E 200<br>E 220<br>E 250 Turbo D<br>E 280<br>E 300 D<br>E 300 Turbo D<br>E 250 D<br>E 300 TE-24<br>E 320<br>E 320  | 100<br>110<br>93<br>145<br>100<br>108<br>83<br>162<br>162<br>162                 |  | 06.93<br>06.93<br>06.93<br>06.93<br>06.93<br>06.93<br>06.93<br>06.93<br>06.93<br>06.93                   | 06.96<br>06.96<br>06.96<br>06.96<br>06.96<br>06.96<br>06.96<br>06.96<br>06.96<br>06.96                   | 24.3541-1603.5<br>24.3541-1604.5<br>24.0101-3601.2                                     | 240037<br>240038<br>260044   | <br>  | D=54, - Halter<br>D=54, - Halter<br>Einbausatz                       | LUC<br>LUC<br>LUC               |
|  | E 250 D<br>E 300 TE-24<br>E 320<br>E 320  | 83<br>162<br>162<br>162  |  | 06.93<br>06.93<br>06.93<br>06.93   | 06.96<br>06.96<br>06.96<br>06.96   | 24.3541-1725.5<br>24.3541-1726.5<br>11.0441-5404.2<br>11.0101-5403.2                   | 240003<br>240004<br>250029<br>260010   | <br>   | D=54, - Halter<br>D=54, - Halter<br>Dichtungssatz<br>Fallenbalgssatz | LUC<br>LUC<br>LUC<br>LUC        |
|  | E 300 TE-24<br>E 320<br>E 320   | 162<br>162<br>162  | F 242721<br>F 242722   | 06.93<br>06.93<br>06.96  | 06.96<br>06.96<br>06.96  | 13.0441-4214.2   | 250091   |  | Dichtungssatz  | ATE<br>ATE                      |
|  | E 200<br>E 220<br>E 250 D<br>E 250 Turbo D<br>E 280<br>E 300 D<br>E 300 TE-24<br>E 300 Turbo D<br>E 320<br>E 36 AMG<br>E 300 4-matic<br>E 300 Turbo D 4-matic | 100<br>110<br>83<br>93<br>145<br>100<br>162<br>108<br>162<br>200<br>132<br>108   |  | 06.93<br>06.93<br>06.93<br>06.93<br>06.93<br>06.93<br>06.93<br>06.93<br>06.93<br>05.94<br>06.93<br>06.93 | 06.96<br>06.96<br>06.96<br>06.96<br>06.96<br>06.96<br>06.96<br>06.96<br>06.96<br>06.96<br>06.96<br>06.96 | 83.7754-0340.3   | 330794   | 2  | L=340  |                                 |
|  | E 300 4-matic<br>E 300 Turbo D 4-matic  | 132<br>108   |  | 06.93<br>06.93   | 06.96<br>06.96   | 83.6154-0526.3   | 330285   | 2  | L=525  |                                 |
|  | E 200<br>E 220<br>E 250 D<br>E 250 Turbo D<br>E 280<br>E 300 4-matic<br>E 300 D<br>E 300 Turbo D<br>E 300 Turbo D 4-matic<br>E 320<br>E 36 AMG                | 100<br>110<br>83<br>93<br>145<br>132<br>100<br>108<br>108<br>162<br>200          |  | 06.93<br>06.93<br>06.93<br>06.93<br>06.93<br>06.93<br>06.93<br>06.93<br>06.93<br>06.93<br>06.96<br>06.96 | 06.96<br>06.96<br>06.96<br>06.96<br>06.96<br>06.96<br>06.96<br>06.96<br>06.96<br>06.96<br>06.96<br>06.96 | 13.2381-8035.2<br>13.2381-8036.2<br>24.9238-8035.5<br>24.9238-8036.5<br>13.0441-3817.2 | 210037<br>210038<br>230025<br>230026<br>250071                                     | <br><br><br> | D=38<br>D=38<br>D=38<br>D=38<br>Dichtungssatz                        | ATE<br>ATE<br>ATE<br>ATE<br>ATE |
|  | E 320<br>E 36 AMG   | 162<br>200   | F 323056<br>F 323056   | 06.96<br>06.96   | 06.96<br>06.96   | 13.0441-3606.2   | 250147   |  | Dichtungssatz  | ATE                             |
|  | E 200<br>E 220<br>E 250 D<br>E 250 Turbo D<br>E 280<br>E 300 4-matic<br>E 300 D<br>E 300 TE-24<br>E 300 Turbo D<br>E 300 Turbo D 4-matic<br>E 320             | 100<br>110<br>83<br>93<br>145<br>132<br>100<br>162<br>108<br>108<br>162          |  | 06.93<br>06.93<br>06.93<br>06.93<br>06.93<br>06.93<br>06.93<br>06.93<br>06.93<br>06.93<br>06.93          | 06.96<br>06.96<br>06.96<br>06.96<br>06.96<br>06.96<br>06.96<br>06.96<br>06.96<br>06.96<br>06.96          | 83.7704-0281.3   | 330804   | 2  | L=280  |                                 |

1) + cast iron / + ghisa / + fonte grise / + fundición de gris

2) + aluminium / + alluminio / + aluminium / + aluminio



|     |  |  |  |  |  |  |  |  |                     |
|--|--|--|--|--|---|--|--|--|---------------------|
| <b>MERCEDES BENZ E-Klasse (S124) Kombi (93-96)</b>                                 |  |  |  |  |   |  |  |  |                     |
|    | E 36 AMG   | 200  |  | 05.94  | 06.96   | 83.7704-0281.3   | 330804   | 2  | L=280               |
|    | E 200  | 100  |  | 06.93  | 06.96   | 24.3727-0411.2   | 580411   | 1 ↑  | L=2496              |
|  | E 220  | 110  |  | 06.93  | 06.96   | 24.3727-0409.2   | 580409   | 2 ↓  | L=1060              |
|  | E 250 D  | 83   |  | 06.93  | 06.96   |  |  |  |                     |
|  | E 250 Turbo D  | 93   |  | 06.93  | 06.96   |  |  |  |                     |
|  | E 280  | 145  |  | 06.93  | 06.96   |  |  |  |                     |
|  | E 300 4-matic  | 132  |  | 06.93  | 06.96   |  |  |  |                     |
|  | E 300 D  | 100  |  | 06.93  | 06.96   |  |  |  |                     |
|  | E 300 TE-24  | 162  |  | 06.93  | 06.96   |  |  |  |                     |
|  | E 300 Turbo D  | 108  |  | 06.93  | 06.96   |  |  |  |                     |
|  | E 300 Turbo D 4-matic  | 108  |  | 06.93  | 06.96   |  |  |  |                     |
|  | E 320  | 162  |  | 06.93  | 06.96   |  |  |  |                     |
|  | E 36 AMG   | 200  |  | 05.94  | 06.96   |  |  |  |                     |
|    | E 200  | 100  |  | 06.93  | 06.96   | 24.2419-0915.3   | 030045   | + GG <sup>1)</sup>   | Gz 19,05            |
|  | E 220  | 110  |  | 06.93  | 06.96   | 24.2419-1703.3   | 030097   | + ALU <sup>2)</sup>  | Gz 19,05            |
|  | E 250 D  | 83   |  | 06.93  | 06.96   |  |  |  |                     |
|  | E 250 Turbo D  | 93   |  | 06.93  | 06.96   |  |  |  |                     |
|  | E 280  | 145  |  | 06.93  | 06.96   |  |  |  |                     |
|  | E 300 D  | 100  |  | 06.93  | 06.96   |  |  |  |                     |
|  | E 300 TE-24  | 162  |  | 06.93  | 06.96   |  |  |  |                     |
|  | E 320  | 162  |  | 06.93  | 06.96   |  |  |  |                     |
|  | E 36 AMG   | 200  |  | 05.94  | 06.96   |  |  |  |                     |
|    | E 200  | 100  |  | 06.93  | 06.96   | 03.2523-1310.3   | 040022   |  | Nz 23,81            |
|  | E 220  | 110  |  | 06.93  | 06.96   |  |  |  |                     |
|  | E 250 D  | 83   |  | 06.93  | 06.96   |  |  |  |                     |
|  | E 250 Turbo D  | 93   |  | 06.93  | 06.96   |  |  |  |                     |
|  | E 280  | 145  |  | 06.93  | 06.96   |  |  |  |                     |
|  | E 300 D  | 100  |  | 06.93  | 06.96   |  |  |  |                     |
|  | E 300 TE-24  | 162  |  | 06.93  | 06.96   |  |  |  |                     |
|  | E 320  | 162  |  | 06.93  | 06.96   |  |  |  |                     |
|  | E 36 AMG   | 200  |  | 05.94  | 06.96   |  |  |  |                     |
| <b>MERCEDES BENZ E-Klasse (C124) Coupe (93-97)</b>                                 |  |  |  |  |   |  |  |  |                     |
|    | E 200  | 100  |  | 06.93  | 06.97   | 03.7760-2702.4   | 300090   |  | 10" ATE             |
|  | E 220  | 110  |  | 06.93  | 06.97   |  |  |  |                     |
|  | E 320  | 162  |  | 06.93  | 06.97   |  |  |  |                     |
|  | E 36 AMG   | 195  |  | 06.93  | 04.95   |  |  |  |                     |
|  | E 36 AMG   | 200  |  | 05.94  | 06.97   |  |  |  |                     |
|  | E 200  | 100  | C 164263   | 06.93  |   | 03.2023-0825.3   | 010028   |  | Thz 23,81/19,05 ATE |
|  | E 220  | 110  | C 164263   | 06.93  |   |  |  |  |                     |
|  | E 320  | 162  | C 164263   | 06.93  |   |  |  |  |                     |
|  | E 36 AMG   | 195  | C 164263   | 06.93  |   |  |  |  |                     |
|  | E 36 AMG   | 200  | C 164263   | 05.94  |   |  |  |  |                     |
|  | E 200  | 100  |  | 06.93  | 06.97   | 24.3541-1603.5   | 240037   | ☐  | D=54, - Halter LUC  |
|  | E 220  | 110  |  | 06.93  | 06.97   | 24.3541-1604.5   | 240038   | ☐  | D=54, - Halter LUC  |
|  |  |  |  |  |   | 24.0101-3601.2   | 260044   |  | Einbausatz LUC      |
|  | E 320  | 162  | B 862121   | 06.93  |   | 13.0441-4214.2   | 250091   |  | Dichtungssatz ATE   |
|  | E 320  | 162  | B 862122   |  | 06.97   | 13.0441-4214.2   | 250091   |  | Dichtungssatz ATE   |
|  | E 200  | 100  |  | 06.93  | 06.97   | 83.7754-0340.3   | 330794   | 2  | L=340               |
|  | E 220  | 110  |  | 06.93  | 06.97   |  |  |  |                     |
|  | E 320  | 162  |  | 06.93  | 06.97   |  |  |  |                     |
|  | E 36 AMG   | 195  |  | 06.93  | 04.95   |  |  |  |                     |
|  | E 36 AMG   | 200  |  | 05.94  | 06.97   |  |  |  |                     |
|  | E 200  | 100  |  | 06.93  | 06.97   | 13.2351-8005.2   | 210014   | ☐  | D=35 ATE            |
|  | E 220  | 110  |  | 06.93  | 06.97   | 13.2351-8006.2   | 210015   | ☐  | D=35 ATE            |
|  |  |  |  |  |   | 24.9235-8005.5   | 230023   | ☐  | D=35 ATE            |
|  |  |  |  |  |   | 24.9235-8006.5   | 230024   | ☐  | D=35 ATE            |
|  |  |  |  |  |   | 13.0441-3505.2   | 250051   |  | Dichtungssatz ATE   |
|  | E 320  | 162  |  | 06.93  | 06.97   | 13.2381-8035.2   | 210037   | ☐  | D=38 ATE            |
|  | E 36 AMG   | 195  |  | 06.93  | 04.95   | 13.2381-8036.2   | 210038   | ☐  | D=38 ATE            |
|  | E 36 AMG   | 200  |  | 05.94  | 06.97   | 24.9238-8035.5   | 230025   | ☐  | D=38 ATE            |
|  |  |  |  |  |   | 24.9238-8036.5   | 230026   | ☐  | D=38 ATE            |
|  |  |  |  |  |   | 13.0441-3817.2   | 250071   |  | Dichtungssatz ATE   |
|  | E 200  | 100  |  | 06.93  | 06.97   | 83.7704-0281.3   | 330804   | 2  | L=280               |
|  | E 220  | 110  |  | 06.93  | 06.97   |  |  |  |                     |
|  | E 320  | 162  |  | 06.93  | 06.97   |  |  |  |                     |
|  | E 36 AMG   | 195  |  | 06.93  | 04.95   |  |  |  |                     |
|  | E 36 AMG   | 200  |  | 05.94  | 06.97   |  |  |  |                     |
|  | E 200  | 100  |  | 06.93  | 06.97   | 24.3727-0409.2   | 580409   | 2 ↓  | L=1060              |
|  | E 220  | 110  |  | 06.93  | 06.97   |  |  |  |                     |
|  | E 320  | 162  |  | 06.93  | 06.97   |  |  |  |                     |
|  | E 36 AMG   | 195  |  | 06.93  | 04.95   |  |  |  |                     |
|  | E 36 AMG   | 200  |  | 05.94  | 06.97   |  |  |  |                     |
|  | E 200  | 100  |  | 06.93  | 06.97   | 24.2419-0915.3   | 030045   | + GG <sup>1)</sup>   | Gz 19,05            |
|  | E 220  | 110  |  | 06.93  | 06.97   | 24.2419-1703.3   | 030097   | + ALU <sup>2)</sup>  | Gz 19,05            |
|  | E 320  | 162  |  | 06.93  | 06.97   |  |  |  |                     |
|  | E 36 AMG   | 195  |  | 06.93  | 04.95   |  |  |  |                     |
|  | E 36 AMG   | 200  |  | 05.94  | 06.97   |  |  |  |                     |
|  | E 200  | 100  |  | 06.93  | 06.97   | 03.2523-1210.3   | 040021   |  | Nz 23,81            |
|  |  |  |  |  |   | 03.2523-1310.3   | 040022   |  | Nz 23,81            |
|  | E 220  | 110  |  | 06.93  | 06.97   | 03.2523-1310.3   | 040022   |  | Nz 23,81            |
|  | E 320  | 162  |  | 06.93  | 06.97   |  |  |  |                     |
|  | E 36 AMG   | 195  |  | 06.93  | 04.95   |  |  |  |                     |

<sup>1)</sup> + cast iron / + ghisa / + fonte grise / + fundición de gris

<sup>2)</sup> + aluminium / + alluminio / + aluminium / + aluminio





**MERCEDES BENZ E-Klasse (C124) Coupe (93-97)**

|  |          |     |  |       |       |  |                |        |  |  |          |
|--|----------|-----|--|-------|-------|--|----------------|--------|--|--|----------|
|  | E 36 AMG | 200 |  | 05.94 | 06.97 |  | 03.2523-1310.3 | 040022 |  |  | Nz 23,81 |
|--|----------|-----|--|-------|-------|--|----------------|--------|--|--|----------|

**MERCEDES BENZ E-Klasse (A124) Cabrio (93-98)**

|  |          |     |          |       |       |  |                |        |   |          |                 |     |
|--|----------|-----|----------|-------|-------|--|----------------|--------|---|----------|-----------------|-----|
|  | E 200    | 100 |          | 06.93 | 03.98 |  | 03.7760-2702.4 | 300090 |   |          | 10"             | ATE |
|  | E 220    | 110 |          | 06.93 | 03.98 |  |                |        |   |          |                 |     |
|  | E 320    | 162 |          | 06.93 | 03.98 |  |                |        |   |          |                 |     |
|  | E 36 AMG | 200 |          | 05.94 | 03.98 |  |                |        |   |          |                 |     |
|  | E 200    | 100 | C 164263 | 06.93 |       |  | 03.2023-0825.3 | 010028 |   |          | THz 23,81/19,05 | ATE |
|  | E 220    | 110 | C 164263 | 06.93 |       |  |                |        |   |          |                 |     |
|  | E 320    | 162 | C 164263 | 06.93 |       |  |                |        |   |          |                 |     |
|  | E 36 AMG | 200 | C 164263 | 05.94 |       |  |                |        |   |          |                 |     |
|  | E 200    | 100 |          | 06.93 | 03.98 |  | 24.3541-1603.5 | 240037 |   |          | D=54, - Halter  | LUC |
|  | E 220    | 110 |          | 06.93 | 03.98 |  | 24.3541-1604.5 | 240038 |   |          | D=54, - Halter  | LUC |
|  | E 320    | 162 |          |       |       |  | 24.0101-3601.2 | 260044 |   |          | Einbausatz      | LUC |
|  | E 36 AMG | 200 |          |       |       |  |                |        |   |          |                 |     |
|  | E 320    | 162 | B 862121 | 06.93 |       |  | 13.0441-4214.2 | 250091 |   |          | Dichtungssatz   | ATE |
|  | E 320    | 162 | B 862122 |       | 03.98 |  | 13.0441-4214.2 | 250091 |   |          | Dichtungssatz   | ATE |
|  | E 36 AMG | 200 |          | 05.94 | 03.98 |  | 13.0441-4214.2 | 250091 |   |          | Dichtungssatz   | ATE |
|  | E 200    | 100 |          | 06.93 | 03.98 |  | 83.7754-0340.3 | 330794 | 2 |          | L=340           |     |
|  | E 220    | 110 |          | 06.93 | 03.98 |  |                |        |   |          |                 |     |
|  | E 320    | 162 |          | 06.93 | 03.98 |  |                |        |   |          |                 |     |
|  | E 36 AMG | 200 |          | 05.94 | 03.98 |  |                |        |   |          |                 |     |
|  | E 200    | 100 |          | 06.93 | 03.98 |  | 13.2381-8035.2 | 210037 |   |          | D=38            | ATE |
|  | E 220    | 110 |          | 06.93 | 03.98 |  | 13.2381-8036.2 | 210038 |   |          | D=38            | ATE |
|  | E 320    | 162 |          | 06.93 | 03.98 |  | 24.9238-8035.5 | 230025 |   |          | D=38            | ATE |
|  | E 36 AMG | 200 |          | 05.94 | 03.98 |  | 24.9238-8036.5 | 230026 |   |          | D=38            | ATE |
|  |          |     |          |       |       |  | 13.0441-3817.2 | 250071 |   |          | Dichtungssatz   | ATE |
|  | E 200    | 100 |          | 06.93 | 03.98 |  | 83.7704-0281.3 | 330804 | 2 |          | L=280           |     |
|  | E 220    | 110 |          | 06.93 | 03.98 |  |                |        |   |          |                 |     |
|  | E 320    | 162 |          | 06.93 | 03.98 |  |                |        |   |          |                 |     |
|  | E 36 AMG | 200 |          | 05.94 | 03.98 |  |                |        |   |          |                 |     |
|  | E 200    | 100 |          | 06.93 | 03.98 |  | 24.3727-0409.2 | 580409 | 2 |          | L=1060          |     |
|  | E 220    | 110 |          | 06.93 | 03.98 |  |                |        |   |          |                 |     |
|  | E 320    | 162 |          | 06.93 | 03.98 |  |                |        |   |          |                 |     |
|  | E 36 AMG | 200 |          | 05.94 | 03.98 |  |                |        |   |          |                 |     |
|  | E 200    | 100 |          | 06.93 | 03.98 |  | 24.2419-0915.3 | 030045 |   | + GG 1)  | Gz 19,05        |     |
|  | E 220    | 110 |          | 06.93 | 03.98 |  | 24.2419-1703.3 | 030097 |   | + ALU 2) | Gz 19,05        |     |
|  | E 320    | 162 |          | 06.93 | 03.98 |  |                |        |   |          |                 |     |
|  | E 36 AMG | 200 |          | 05.94 | 03.98 |  |                |        |   |          |                 |     |
|  | E 200    | 100 |          | 06.93 | 03.98 |  | 03.2523-1210.3 | 040021 |   |          | Nz 23,81        |     |
|  | E 220    | 110 |          | 06.93 | 03.98 |  | 03.2523-1310.3 | 040022 |   |          | Nz 23,81        |     |
|  | E 320    | 162 |          | 06.93 | 03.98 |  |                |        |   |          |                 |     |
|  | E 36 AMG | 200 |          | 05.94 | 03.98 |  |                |        |   |          |                 |     |

**MERCEDES BENZ E-Klasse (W210) Limousine (95-02)**

|         |           |         |         |       |       |       |                |        |  |  |                 |     |
|---------|-----------|---------|---------|-------|-------|-------|----------------|--------|--|--|-----------------|-----|
|         | E 200     |         | A394035 | 06.95 |       |       | 03.7760-4102.4 | 300091 |  |  | 10"             | ATE |
|         | E 200 D   |         | A394035 | 10.96 | + P   |       |                |        |  |  |                 |     |
|         | E 220 D   |         | A394035 | 06.95 |       |       |                |        |  |  |                 |     |
|         | E 230     |         | A394035 | 06.95 |       |       |                |        |  |  |                 |     |
|         | E 250 D   |         | A394035 | 06.95 |       |       |                |        |  |  |                 |     |
|         | E 250 D   |         | A394035 | 06.95 | + I   |       |                |        |  |  |                 |     |
|         | E 290 TD  |         | A394035 | 01.96 |       |       |                |        |  |  |                 |     |
|         | E 300 D   |         | A394035 | 06.95 |       |       |                |        |  |  |                 |     |
|         | E 200     |         | A394036 | 04.02 |       |       | 03.7863-0102.4 | 300142 |  |  | 10"             | ATE |
|         | E 200 CDI |         |         | 07.98 | 04.02 |       |                |        |  |  |                 |     |
|         | E 200 D   |         | A394036 | 04.02 | + P   |       |                |        |  |  |                 |     |
|         | E 220 CDI |         |         | 07.98 | 04.02 |       |                |        |  |  |                 |     |
|         | E 220 D   |         | A394036 | 06.98 |       |       |                |        |  |  |                 |     |
|         | E 240     |         |         | 09.97 | 04.02 | - ESP |                |        |  |  |                 |     |
|         | E 250 D   |         | A394036 | 04.02 | + I   |       |                |        |  |  |                 |     |
|         | E 250 TD  |         |         | 09.97 | 04.02 |       |                |        |  |  |                 |     |
|         | E 290 TD  |         | A394036 | 04.02 |       |       |                |        |  |  |                 |     |
|         | E 300 D   |         | A394036 | 04.02 |       |       |                |        |  |  |                 |     |
|         | E 200     |         | A394035 | 06.95 |       |       | 03.2023-1066.3 | 010032 |  |  | THz 23,81/19,05 | ATE |
|         | E 200 D   |         | A394035 | 10.96 | + P   |       |                |        |  |  |                 |     |
|         | E 220 D   |         | A394035 | 06.95 |       |       |                |        |  |  |                 |     |
|         | E 230     |         | A394035 | 06.95 |       |       |                |        |  |  |                 |     |
|         | E 250 D   |         | A394035 | 06.95 |       |       |                |        |  |  |                 |     |
|         | E 250 D   |         | A394035 | 06.95 | + I   |       |                |        |  |  |                 |     |
|         | E 290 TD  |         | A394035 | 01.96 |       |       |                |        |  |  |                 |     |
|         | E 300 D   |         | A394035 | 06.95 |       |       |                |        |  |  |                 |     |
|         | E 280     |         |         | 01.96 | 09.96 |       | 24.2025-1702.3 | 010515 |  |  | THz 25,40/19,05 | LUC |
|         | E 320     |         |         | 06.95 | 09.96 |       |                |        |  |  |                 |     |
|         | E 420     |         |         | 01.96 | 08.97 |       |                |        |  |  |                 |     |
|         | E 50 AMG  |         |         | 01.96 | 08.97 |       |                |        |  |  |                 |     |
|         | E 200     |         | A394036 | 04.02 |       |       | 03.2023-1812.3 | 010570 |  |  | THz 23,81/19,05 | ATE |
|         | E 200 CDI |         |         | 07.98 | 04.02 |       |                |        |  |  |                 |     |
|         | E 200 D   |         | A394036 | 04.02 | + P   |       |                |        |  |  |                 |     |
|         | E 220 CDI |         |         | 07.98 | 04.02 |       |                |        |  |  |                 |     |
|         | E 220 D   |         | A394036 | 06.98 |       |       |                |        |  |  |                 |     |
|         | E 240     |         |         | 09.97 | 04.02 | - ESP |                |        |  |  |                 |     |
|         | E 250 D   |         | A394036 | 04.02 |       |       |                |        |  |  |                 |     |
| E 250 D |           | A394036 | 04.02   | + I   |       |       |                |        |  |  |                 |     |

1) + cast iron / + ghisa / + fonte grise / + fundición de gris  
 2) + aluminium / + alluminio / + aluminium / + aluminio



| <b>MERCEDES BENZ E-Klasse (W210) Limousine (95-02)</b> |  |   |   |  |  |  |              |   |  |
|--|--|---|---|--|--|--|--------------|---|--|
|  | E 250 TD<br>E 290 TD<br>E 300 D  | A394036<br>A394036  | 09.97<br>04.02<br>04.02   | 04.02  | 03.2023-1812.3   | 010570   |              | THz 23,81/19,05<br><b>ATE</b>   |  |
|  | E 200 Kompressor<br>E 200 Kompressor<br>E 240<br>E 270 CDI<br>E 280<br>E 280 4-matic<br>E 300 TD<br>E 320<br>E 320 4-matic<br>E 320 CDI<br>E 430<br>E 430 4-matic<br>E 55 AMG  | 120<br>137  | 08.00<br>09.97<br>09.97<br>07.99<br>10.96<br>10.96<br>10.96<br>10.96<br>06.97<br>07.99<br>09.97<br>05.99<br>09.97   | 04.02<br>04.02<br>04.02 + ESP<br>04.02<br>04.02<br>04.02<br>04.02<br>04.02<br>04.02<br>04.02<br>04.02<br>04.02   | 24.2025-1703.3   | 010516   |              | THz 25,40/19,05<br><b>LUC</b>   |  |
|  | E 200<br>E 200 CDI<br>E 200 D<br>E 200 Kompressor<br>E 220 CDI<br>E 220 D<br>E 230<br>E 240<br>E 250 D<br>E 250 D<br>E 250 TD<br>E 290 TD<br>E 300 D   | 120   | 06.95<br>07.98<br>10.96<br>08.00<br>07.98<br>06.95<br>06.95<br>09.97<br>06.95<br>06.95<br>09.97<br>01.96<br>06.95   | 04.02<br>04.02<br>04.02 + P<br>04.02<br>04.02<br>06.98<br>08.97<br>04.02<br>04.02<br>04.02<br>04.02<br>04.02   | 11.3571-8511.2<br>11.3571-8512.2<br>24.3571-8511.5<br>24.3571-8512.5<br>11.0441-5703.2<br>11.0230-0096.2<br>11.0101-5407.2<br>11.8171-0008.1<br>11.8116-0253.1 | 220315<br>220316<br>240491<br>240492<br>250145<br>260033<br>260011<br>990049<br>390512 | <br><br><br> | D=57, - Halter<br>D=57, - Halter<br>D=57, - Halter<br>D=57, - Halter<br>Dichtungssatz<br>Haltersatz<br>Hülsensatz<br>Führungsbolzen<br>Haltefeder | <b>ATE</b><br><b>ATE</b><br><b>ATE</b><br><b>ATE</b><br><b>ATE</b><br><b>ATE</b><br><b>ATE</b><br><b>ATE</b><br><b>ATE</b> |
|  | E 200 Kompressor<br>E 270 CDI<br>E 280<br>E 280 4-matic<br>E 300 TD<br>E 320<br>E 320 4-matic<br>E 320 CDI   | 137   | 09.97<br>07.99<br>01.96<br>10.96<br>10.96<br>06.95<br>06.97<br>07.99  | 04.02<br>04.02<br>04.02<br>04.02<br>04.02<br>04.02<br>04.02<br>04.02   | 11.3571-8509.2<br>11.3571-8510.2<br>11.0441-5703.2<br>11.0101-5407.2<br>11.8171-0008.1<br>11.8116-0253.1   | 220313<br>220314<br>250145<br>260011<br>990049<br>390512                               | <br>         | D=57, - Halter<br>D=57, - Halter<br>Dichtungssatz<br>Hülsensatz<br>Führungsbolzen<br>Haltefeder   | <b>ATE</b><br><b>ATE</b><br><b>ATE</b><br><b>ATE</b><br><b>ATE</b><br><b>ATE</b>   |
|  | E 420<br>E 430   |   | 01.96<br>09.97  |  | 13.4421-8009.2<br>13.4421-8010.2<br>13.0441-4214.2   | 210228<br>210229<br>250091   | <br>         | D=42/38<br>D=42/38<br>Dichtungssatz   | <b>ATE</b><br><b>ATE</b><br><b>ATE</b>   |
|  | E 420<br>E 430<br>E 430 4-matic  | A 962231 / X 027613<br>A 962231 / X 027613<br>A 962232 / X 027614<br>A 962232 / X 027614        | 01.96<br>04.02<br>04.02<br>05.99  |  | 11.9441-9971.2<br>11.9441-9972.2<br>11.8116-0133.1   | 220839<br>220840<br>390511   | <br>         | D=44, - Halter<br>D=44, - Halter<br>Haltefeder  | <b>ATE</b><br><b>ATE</b><br><b>ATE</b>   |
|  | E 50 AMG<br>E 55 AMG   |   | 01.96<br>09.97  | 08.97<br>04.02   | 11.8116-0133.1   | 390511   | 2            | Haltefeder  | <b>ATE</b>   |
|  | E 200<br>E 200 CDI<br>E 200 D<br>E 200 Kompressor<br>E 200 Kompressor<br>E 220 CDI<br>E 220 D<br>E 230<br>E 240<br>E 250 D<br>E 250 D<br>E 250 TD<br>E 270 CDI<br>E 280<br>E 290 TD<br>E 300 D<br>E 300 TD<br>E 320<br>E 320 CDI<br>E 420<br>E 430<br>E 50 AMG<br>E 55 AMG | 120<br>137  | 06.95<br>07.98<br>10.96<br>08.00<br>09.97<br>07.98<br>06.95<br>06.95<br>09.97<br>06.95<br>06.95<br>09.97<br>07.99<br>01.96<br>01.96<br>06.95<br>10.96<br>06.95<br>07.99<br>01.96<br>09.97<br>09.97<br>01.96<br>09.97<br>09.97 | 04.02<br>04.02<br>04.02 + P<br>04.02<br>04.02<br>04.02<br>06.98<br>08.97<br>04.02<br>04.02<br>04.02<br>04.02<br>04.02<br>04.02<br>04.02<br>04.02<br>04.02<br>04.02<br>04.02<br>04.02<br>08.97<br>04.02<br>04.02<br>04.02 | 83.7705-0386.3   | 330828   | 2            | L=385   |  |
|  | E 280 4-matic<br>E 320 4-matic<br>E 430 4-matic  |   | 10.96<br>06.97<br>05.99   | 04.02<br>04.02<br>04.02  | 83.7715-0280.3   | 330806   | 2            | L=280   |  |
|  | E 200<br>E 200 D<br>E 220 D<br>E 230<br>E 240<br>E 250 D<br>E 250 D<br>E 290 TD<br>E 300 D   | A379346<br>A379346<br>A379346<br>A379346<br>A379346<br>A379346<br>A379346<br>A379346<br>A379346 | 06.95<br>10.96<br>06.95<br>06.95<br>09.97<br>06.95<br>06.95<br>01.96<br>06.95   |  | 13.2381-8035.2<br>13.2381-8036.2<br>24.9238-8035.5<br>24.9238-8036.5<br>13.0441-3817.2   | 210037<br>210038<br>230025<br>230026<br>250071   | <br><br><br> | D=38<br>D=38<br>D=38<br>D=38<br>Dichtungssatz   | <b>ATE</b><br><b>ATE</b><br><b>ATE</b><br><b>ATE</b><br><b>ATE</b>   |
|  | E 200<br>E 200 CDI<br>E 200 D<br>E 200 Kompressor<br>E 220 CDI<br>E 220 D  | A379347<br>A379347<br>A379347<br>120<br>A379347   | 07.98<br>04.02<br>04.02 + P<br>08.00<br>07.98<br>06.98  | 04.02  | 13.2361-8003.2<br>13.2361-8004.2<br>13.0441-3609.2   | 210220<br>210221<br>250057   | <br>         | D=36<br>D=36<br>Dichtungssatz   | <b>ATE</b><br><b>ATE</b><br><b>ATE</b>   |

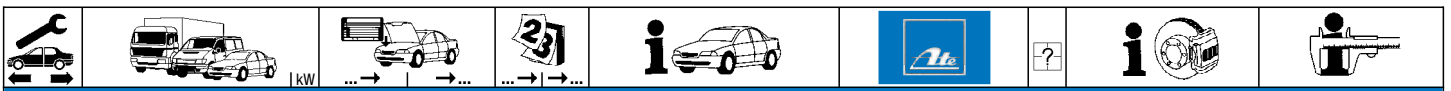

**MERCEDES BENZ E-Klasse (W210) Limousine (95-02)**

|                  |                  |         |         |       |     |                |                |                          |                          |               |               |     |
|------------------|------------------|---------|---------|-------|-----|----------------|----------------|--------------------------|--------------------------|---------------|---------------|-----|
|                  | E 230            | A379347 |         | 08.97 |     | 13.2361-8003.2 | 210220         | <input type="checkbox"/> |                          | D=36          | ATE           |     |
|                  | E 240            | A379347 |         | 04.02 |     | 13.2361-8004.2 | 210221         | <input type="checkbox"/> |                          | D=36          | ATE           |     |
|                  | E 250 D          | A379347 |         | 04.02 |     | 13.0441-3609.2 | 250057         | <input type="checkbox"/> |                          | Dichtungssatz | ATE           |     |
|                  | E 250 D          | A379347 |         | 04.02 | + ① |                |                |                          |                          |               |               |     |
|                  | E 250 TD         |         |         | 09.97 |     |                |                |                          |                          |               |               |     |
|                  | E 290 TD         | A379347 |         | 04.02 |     |                |                |                          |                          |               |               |     |
|                  | E 300 D          | A379347 |         | 04.02 |     |                |                |                          |                          |               |               |     |
|                  | E 280            |         | A379346 | 01.96 |     |                | 13.2361-8001.2 | 210214                   | <input type="checkbox"/> |               | D=36          | ATE |
|                  | E 280 4-matic    |         | A379346 | 10.96 |     |                | 13.2361-8002.2 | 210215                   | <input type="checkbox"/> |               | D=36          | ATE |
|                  | E 300 TD         |         | A379346 | 10.96 |     |                | 24.9236-8001.5 | 230007                   | <input type="checkbox"/> |               | D=36          | ATE |
|                  | E 320            |         | A379346 | 06.95 |     |                | 24.9236-8002.5 | 230008                   | <input type="checkbox"/> |               | D=36          | ATE |
|                  | E 320 4-matic    |         | A379346 | 06.97 |     |                | 13.0441-3606.2 | 250147                   | <input type="checkbox"/> |               | Dichtungssatz | ATE |
| E 420            |                  | A379346 | 01.96   |       |     |                |                |                          |                          |               |               |     |
| E 430            |                  | A379346 | 09.97   |       |     |                |                |                          |                          |               |               |     |
| E 200 Kompressor | 137              |         | 09.97   | 04.02 |     | 13.2361-8005.2 | 210237         | <input type="checkbox"/> |                          | D=36          | ATE           |     |
| E 270 CDI        |                  |         | 07.99   | 04.02 |     | 13.2361-8006.2 | 210238         | <input type="checkbox"/> |                          | D=36          | ATE           |     |
| E 280            | A379347          |         | 04.02   |       |     | 13.0441-3609.2 | 250057         | <input type="checkbox"/> |                          | Dichtungssatz | ATE           |     |
| E 280 4-matic    | A379347          |         | 04.02   |       |     |                |                |                          |                          |               |               |     |
| E 300 TD         | A379347          |         | 04.02   |       |     |                |                |                          |                          |               |               |     |
| E 320            | A379347          |         | 04.02   |       |     |                |                |                          |                          |               |               |     |
| E 320 4-matic    | A379347          |         | 04.02   |       |     |                |                |                          |                          |               |               |     |
| E 320 CDI        |                  |         | 07.99   | 04.02 |     |                |                |                          |                          |               |               |     |
| E 420            | A379347          |         | 08.97   |       |     |                |                |                          |                          |               |               |     |
| E 430            | A379347          |         | 04.02   |       |     |                |                |                          |                          |               |               |     |
| E 430 4-matic    |                  |         | 05.99   | 04.02 |     | 13.2421-8025.2 | 210061         | <input type="checkbox"/> |                          | D=42          | ATE           |     |
| E 50 AMG         |                  |         | 01.96   | 08.97 |     | 13.2421-8026.2 | 210062         | <input type="checkbox"/> |                          | D=42          | ATE           |     |
| E 55 AMG         |                  |         | 09.97   | 04.02 |     | 13.0441-4216.2 | 250093         | <input type="checkbox"/> |                          | Dichtungssatz | ATE           |     |
| E 270 CDI        |                  |         | 07.99   | 04.02 |     | 13.9421-7009.2 | 210269         | <input type="checkbox"/> |                          | D=42          | ATE           |     |
| E 280            |                  |         | 01.96   | 04.02 |     | 13.9421-7010.2 | 210270         | <input type="checkbox"/> |                          | D=42          | ATE           |     |
| E 320            |                  |         | 06.95   | 04.02 |     | 13.0441-4216.2 | 250093         | <input type="checkbox"/> |                          | Dichtungssatz | ATE           |     |
| E 420            |                  |         | 01.96   | 04.02 |     |                |                |                          |                          |               |               |     |
| E 430            |                  |         | 09.97   | 04.02 |     |                |                |                          |                          |               |               |     |
|                  | E 200            |         | 06.95   | 04.02 |     | 83.7715-0280.3 | 330806         | 2                        |                          | L=280         |               |     |
|                  | E 200 CDI        |         | 07.98   | 04.02 |     |                |                |                          |                          |               |               |     |
|                  | E 200 D          |         | 10.96   | 04.02 | + ② |                |                |                          |                          |               |               |     |
|                  | E 200 Kompressor | 120     | 08.00   | 04.02 |     |                |                |                          |                          |               |               |     |
|                  | E 200 Kompressor | 137     | 09.97   | 04.02 |     |                |                |                          |                          |               |               |     |
|                  | E 220 CDI        |         | 07.98   | 04.02 |     |                |                |                          |                          |               |               |     |
|                  | E 220 D          |         | 06.95   | 06.98 |     |                |                |                          |                          |               |               |     |
|                  | E 230            |         | 06.95   | 08.97 |     |                |                |                          |                          |               |               |     |
|                  | E 240            |         | 09.97   | 04.02 |     |                |                |                          |                          |               |               |     |
|                  | E 250 D          |         | 06.95   | 04.02 |     |                |                |                          |                          |               |               |     |
|                  | E 250 D          |         | 06.95   | 04.02 | + ① |                |                |                          |                          |               |               |     |
|                  | E 250 TD         |         | 09.97   | 04.02 |     |                |                |                          |                          |               |               |     |
|                  | E 270 CDI        |         | 07.99   | 04.02 |     |                |                |                          |                          |               |               |     |
|                  | E 280            |         | 01.96   | 04.02 |     |                |                |                          |                          |               |               |     |
|                  | E 290 TD         |         | 01.96   | 04.02 |     |                |                |                          |                          |               |               |     |
|                  | E 300 D          |         | 06.95   | 04.02 |     |                |                |                          |                          |               |               |     |
|                  | E 300 TD         |         | 10.96   | 04.02 |     |                |                |                          |                          |               |               |     |
|                  | E 320            |         | 06.95   | 04.02 |     |                |                |                          |                          |               |               |     |
|                  | E 320 CDI        |         | 07.99   | 04.02 |     |                |                |                          |                          |               |               |     |
|                  | E 420            |         | 01.96   | 08.97 |     |                |                |                          |                          |               |               |     |
|                  | E 430            |         | 09.97   | 04.02 |     |                |                |                          |                          |               |               |     |
|                  | E 50 AMG         |         | 01.96   | 08.97 |     |                |                |                          |                          |               |               |     |
|                  | E 55 AMG         |         | 09.97   | 04.02 |     |                |                |                          |                          |               |               |     |
|                  | E 280 4-matic    |         | 10.96   | 04.02 |     |                | 83.7715-0280.3 | 330806                   | 2                        |               | L=280         |     |
| E 320 4-matic    |                  | 06.97   | 04.02   |       |     |                |                |                          |                          |               |               |     |
| E 430 4-matic    |                  | 05.99   | 04.02   |       |     |                |                |                          |                          |               |               |     |
|                  | E 200            |         | 06.95   | 04.02 |     | 24.3727-0426.2 | 580426         | 1                        | <input type="checkbox"/> | L=2613        |               |     |
|                  | E 200 CDI        |         | 07.98   | 04.02 |     | 24.3727-0424.2 | 580424         | <input type="checkbox"/> |                          | L=1058        |               |     |
|                  | E 200 D          |         | 10.96   | 04.02 | + ② | 24.3727-0425.2 | 580425         | <input type="checkbox"/> |                          | L=1031        |               |     |
|                  | E 200 Kompressor | 120     | 08.00   | 04.02 |     |                |                |                          |                          |               |               |     |
|                  | E 200 Kompressor | 137     | 09.97   | 04.02 |     |                |                |                          |                          |               |               |     |
|                  | E 220 CDI        |         | 07.98   | 04.02 |     |                |                |                          |                          |               |               |     |
|                  | E 220 D          |         | 06.95   | 06.98 |     |                |                |                          |                          |               |               |     |
|                  | E 230            |         | 06.95   | 08.97 |     |                |                |                          |                          |               |               |     |
|                  | E 240            |         | 09.97   | 04.02 |     |                |                |                          |                          |               |               |     |
|                  | E 250 D          |         | 06.95   | 04.02 | + ① |                |                |                          |                          |               |               |     |
|                  | E 250 TD         |         | 09.97   | 04.02 |     |                |                |                          |                          |               |               |     |
|                  | E 270 CDI        |         | 07.99   | 04.02 |     |                |                |                          |                          |               |               |     |
|                  | E 280            |         | 01.96   | 04.02 |     |                |                |                          |                          |               |               |     |
|                  | E 280 4-matic    |         | 10.96   | 04.02 |     |                |                |                          |                          |               |               |     |
|                  | E 290 TD         |         | 01.96   | 04.02 |     |                |                |                          |                          |               |               |     |
|                  | E 300 D          |         | 06.95   | 04.02 |     |                |                |                          |                          |               |               |     |
|                  | E 300 TD         |         | 10.96   | 04.02 |     |                |                |                          |                          |               |               |     |
|                  | E 320            |         | 06.95   | 04.02 |     |                |                |                          |                          |               |               |     |
|                  | E 320 4-matic    |         | 06.97   | 04.02 |     |                |                |                          |                          |               |               |     |
|                  | E 320 CDI        |         | 07.99   | 04.02 |     |                |                |                          |                          |               |               |     |
|                  | E 420            |         | 01.96   | 08.97 |     |                |                |                          |                          |               |               |     |
|                  | E 430            |         | 09.97   | 04.02 |     |                |                |                          |                          |               |               |     |
|                  | E 430 4-matic    |         | 05.99   | 04.02 |     |                |                |                          |                          |               |               |     |
|                  | E 50 AMG         |         | 01.96   | 08.97 |     |                |                |                          |                          |               |               |     |
| E 55 AMG         |                  | 09.97   | 04.02   |       |     |                |                |                          |                          |               |               |     |
| E 200            |                  | 06.95   | 04.02   |       |     | 24.3727-0424.2 | 580424         | <input type="checkbox"/> |                          | L=1058        |               |     |
| E 220 D          |                  | 06.95   | 06.98   |       |     | 24.3727-0425.2 | 580425         | <input type="checkbox"/> |                          | L=1031        |               |     |
| E 230            |                  | 06.95   | 08.97   |       |     |                |                |                          |                          |               |               |     |

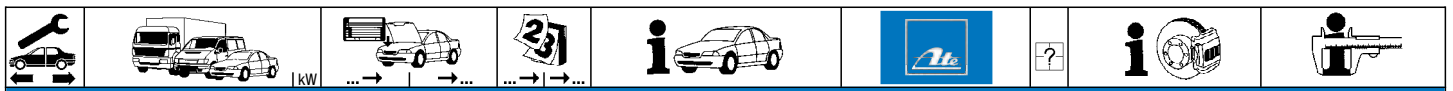

**MERCEDES BENZ E-Klasse (W210) Limousine (95-02)**

|               |                  |     |       |       |           |                |        |                          |                      |
|---------------|------------------|-----|-------|-------|-----------|----------------|--------|--------------------------|----------------------|
|               | E 250 D          |     |       | 06.95 | 04.02     | 24.3727-0424.2 | 580424 | <input type="checkbox"/> | L=1058<br>L=1031     |
|               | E 280            |     |       | 01.96 | 09.96     | 24.3727-0425.2 | 580425 | <input type="checkbox"/> |                      |
|               | E 290 TD         |     |       | 01.96 | 04.02     |                |        |                          |                      |
|               | E 300 D          |     |       | 06.95 | 04.02     |                |        |                          |                      |
|               | E 320            |     |       | 06.95 | 09.96     |                |        |                          |                      |
|               | E 420            |     |       | 01.96 | 08.97     |                |        |                          |                      |
|               | E 50 AMG         |     |       | 01.96 | 08.97     |                |        |                          |                      |
|               | E 200 CDI        |     |       | 07.98 | 04.02     | 24.3727-0424.2 | 580424 | <input type="checkbox"/> |                      |
|               | E 220 CDI        |     |       | 07.98 | 04.02     | 24.3727-0425.2 | 580425 | <input type="checkbox"/> |                      |
|               | E 240            |     |       | 09.97 | 04.02     |                |        |                          |                      |
| E 270 CDI     |                  |     | 07.99 | 04.02 |           |                |        |                          |                      |
| E 280         |                  |     | 10.96 | 04.02 |           |                |        |                          |                      |
| E 300 TD      |                  |     | 10.96 | 04.02 |           |                |        |                          |                      |
| E 320         |                  |     | 10.96 | 04.02 |           |                |        |                          |                      |
| E 320 CDI     |                  |     | 07.99 | 04.02 |           |                |        |                          |                      |
| E 430         |                  |     | 09.97 | 04.02 |           |                |        |                          |                      |
| E 430 4-matic |                  |     | 05.99 | 04.02 |           |                |        |                          |                      |
| E 55 AMG      |                  |     | 09.97 | 04.02 |           |                |        |                          |                      |
|               | E 200            |     |       | 06.95 | 04.02     | 24.2419-0915.3 | 030045 | + GG <sup>1)</sup>       | Gz 19,05<br>Gz 19,05 |
|               | E 200 CDI        |     |       | 07.98 | 04.02     | 24.2419-1703.3 | 030097 | + ALU <sup>2)</sup>      |                      |
|               | E 200 D          |     |       | 10.96 | 04.02 + ⊕ |                |        |                          |                      |
|               | E 200 Kompressor | 120 |       | 08.00 | 04.02     |                |        |                          |                      |
|               | E 200 Kompressor | 137 |       | 09.97 | 04.02     |                |        |                          |                      |
|               | E 220 CDI        |     |       | 07.98 | 04.02     |                |        |                          |                      |
|               | E 220 D          |     |       | 06.95 | 06.98     |                |        |                          |                      |
|               | E 230            |     |       | 06.95 | 08.97     |                |        |                          |                      |
|               | E 240            |     |       | 09.97 | 04.02     |                |        |                          |                      |
|               | E 250 D          |     |       | 06.95 | 04.02     |                |        |                          |                      |
|               | E 250 D          |     |       | 06.95 | 04.02 + ⊕ |                |        |                          |                      |
|               | E 250 TD         |     |       | 09.97 | 04.02     |                |        |                          |                      |
|               | E 270 CDI        |     |       | 07.99 | 04.02     |                |        |                          |                      |
|               | E 280            |     |       | 01.96 | 04.02     |                |        |                          |                      |
|               | E 290 TD         |     |       | 01.96 | 04.02     |                |        |                          |                      |
|               | E 300 D          |     |       | 06.95 | 04.02     |                |        |                          |                      |
|               | E 320 CDI        |     |       | 07.99 | 04.02     |                |        |                          |                      |

**MERCEDES BENZ E-Klasse (S210) Kombi (96-03)**

|               |                  |     |         |       |                                       |                                       |                |                          |  |   |                          |
|---------------|------------------|-----|---------|-------|---------------------------------------|---------------------------------------|----------------|--------------------------|--|---|--------------------------|
|               | E 200            |     | A394035 | 05.96 |                                       | 03.7760-4102.4                        | 300091         |                          | 10"  | ATE   |                          |
|               | E 230            |     | A394035 | 05.96 |                                       |                                       |                |                          |  |   |                          |
|               | E 250 D          |     | A394035 | 05.96 | + Radstand 2833mm <sup>3)</sup>       |                                       |                |                          |  |   |                          |
|               | E 250 D          |     | A394035 | 05.96 | + ⊕ / + Radstand 2833mm <sup>4)</sup> |                                       |                |                          |  |   |                          |
|               | E 290 TD         |     | A394035 | 05.96 | + Radstand 2833mm <sup>3)</sup>       |                                       |                |                          |  |   |                          |
|               | E 200            |     | A394036 | 07.98 | 04.03                                 | 03.7863-0102.4                        | 300142         |                          | 10"  | ATE   |                          |
|               | E 220 CDI        |     |         | 08.97 | 04.03                                 |                                       |                |                          |  |   |                          |
|               | E 230            |     | A394036 | 08.97 | + Radstand 2833mm <sup>3)</sup>       |                                       |                |                          |  |   |                          |
|               | E 240            |     |         | 09.97 | 04.03                                 | - ESP                                 |                |                          |  |   |                          |
|               | E 200            |     | A394035 | 05.96 |                                       | 03.2023-1066.3                        | 010032         |                          | Thz 23,81/19,05  | ATE   |                          |
|               | E 230            |     | A394035 | 05.96 |                                       |                                       |                |                          |  |   |                          |
|               | E 250 D          |     | A394035 | 05.96 | + Radstand 2833mm <sup>3)</sup>       |                                       |                |                          |  |   |                          |
|               | E 250 D          |     | A394035 | 05.96 | + ⊕ / + Radstand 2833mm <sup>4)</sup> |                                       |                |                          |  |   |                          |
|               | E 290 TD         |     | A394035 | 05.96 | + Radstand 2833mm <sup>3)</sup>       |                                       |                |                          |  |   |                          |
|               | E 250 D          |     | A394035 | 05.96 | + Radstand 3570mm <sup>5)</sup>       | 24.2025-1702.3                        | 010515         |                          | Thz 25,40/19,05  | LUC   |                          |
|               | E 290 TD         |     | A394035 | 05.96 | + Radstand 3570mm <sup>5)</sup>       |                                       |                |                          |  |   |                          |
|               | E 420            |     |         | 05.96 | 08.97                                 |                                       |                |                          |  |   |                          |
|               | E 200            |     | A394036 | 07.98 | 04.03                                 | 03.2023-1812.3                        | 010570         |                          | Thz 23,81/19,05  | ATE   |                          |
|               | E 220 CDI        |     |         | 08.97 | 04.03                                 | + Radstand 2833mm <sup>3)</sup>       |                |                          |  |   |                          |
|               | E 230            |     | A394036 | 08.97 | + Radstand 2833mm <sup>3)</sup>       |                                       |                |                          |  |   |                          |
|               | E 240            |     |         | 09.97 | 04.03                                 | - ESP                                 |                |                          |  |   |                          |
|               | E 200 Kompressor |     |         | 09.97 | 04.03                                 | 24.2025-1703.3                        | 010516         |                          | Thz 25,40/19,05  | LUC   |                          |
|               | E 220 CDI        |     |         | 07.98 | 04.03                                 | + Radstand 3570mm <sup>5)</sup>       |                |                          |  |   |                          |
|               | E 240            |     |         | 09.97 | 04.03                                 | + ESP                                 |                |                          |  |   |                          |
|               | E 250 D          |     | A394036 | 04.03 | + Radstand 3570mm <sup>5)</sup>       |                                       |                |                          |  |   |                          |
|               | E 250 D          |     | A394036 | 04.03 | + Radstand 2833mm <sup>3)</sup>       |                                       |                |                          |  |   |                          |
|               | E 250 D          |     | A394036 | 04.03 | + ⊕ / + Radstand 2833mm <sup>4)</sup> |                                       |                |                          |  |   |                          |
|               | E 250 TD         |     |         | 09.97 | 04.03                                 |                                       |                |                          |  |   |                          |
|               | E 270 CDI        |     |         | 07.99 | 04.03                                 |                                       |                |                          |  |   |                          |
|               | E 280            |     |         | 10.96 | 04.03                                 | + Radstand 3570mm <sup>5)</sup>       |                |                          |  |   |                          |
|               | E 280 4-matic    |     |         | 10.96 | 04.03                                 |                                       |                |                          |  |   |                          |
|               | E 290 TD         |     | A394036 | 04.03 |                                       |                                       |                |                          |  |   |                          |
|               | E 300 TD         |     |         | 10.96 | 04.03                                 |                                       |                |                          |  |   |                          |
|               | E 320            |     |         | 10.96 | 04.03                                 |                                       |                |                          |  |   |                          |
|               | E 320 4-matic    |     |         | 06.97 | 04.03                                 |                                       |                |                          |  |   |                          |
|               | E 320 CDI        |     |         | 07.99 | 04.03                                 |                                       |                |                          |  |   |                          |
| E 430         |                  |     | 09.97   | 04.03 |                                       |                                       |                |                          |  |   |                          |
| E 430 4-matic |                  |     | 05.99   | 04.03 |                                       |                                       |                |                          |  |   |                          |
| E 55 AMG      |                  |     | 09.97   | 04.03 |                                       |                                       |                |                          |  |   |                          |
|               | E 200            |     |         | 05.96 | 04.03                                 | 11.3571-8511.2                        | 220315         | <input type="checkbox"/> | D=57, - Halter<br>D=57, - Halter<br>D=57, - Halter<br>D=57, - Halter<br>Dichtungssatz<br>Haltersatz<br>Hülensatz<br>Führungsbolzen<br>Haltefeder | ATE<br>ATE<br>ATE<br>ATE<br>ATE<br>ATE<br>ATE<br>ATE<br>ATE |                          |
|               | E 200 Kompressor | 120 |         | 08.00 | 04.03                                 | 11.3571-8512.2                        | 220316         | <input type="checkbox"/> |  |   |                          |
|               | E 220 CDI        |     |         | 07.98 | 04.03                                 | + Radstand 2833mm <sup>3)</sup>       | 24.3571-8511.5 | 240491                   |  |   | <input type="checkbox"/> |
|               | E 230            |     |         | 05.96 | 08.97                                 |                                       | 24.3571-8512.5 | 240492                   |  |   | <input type="checkbox"/> |
|               | E 240            |     |         | 09.97 | 04.03                                 |                                       | 11.0441-5703.2 | 250145                   |  |   | <input type="checkbox"/> |
|               | E 250 D          |     |         | 05.96 | 04.03                                 | + Radstand 2833mm <sup>3)</sup>       | 11.0230-0096.2 | 260033                   |  |   | <input type="checkbox"/> |
|               | E 250 D          |     |         | 05.96 | 04.03                                 | + ⊕ / + Radstand 2833mm <sup>4)</sup> | 11.0101-5407.2 | 260011                   |  |   | <input type="checkbox"/> |
|               | E 250 TD         |     |         | 09.97 | 04.03                                 |                                       | 11.8171-0008.1 | 990049                   |  |   | <input type="checkbox"/> |
|               | E 290 TD         |     |         | 05.96 | 04.03                                 | + Radstand 2833mm <sup>3)</sup>       | 11.8116-0253.1 | 390512                   |  |   | <input type="checkbox"/> |

1) + cast iron / + ghisa / + fonte grise / + fundición de gris  
 2) + aluminium / + alluminio / + aluminium / + aluminio  
 3) + wheel base 2833 mm / + passo 2833 mm / + empattement 2833 mm / + distancia entre ejes 2833 mm  
 4) + ⊕ / + wheel base 2833mm / + ⊕ / + passo 2833mm / + ⊕ / + empattement 2833mm / + ⊕ / + dist.entre ejes 2833mm  
 5) + wheel base 3570 mm / + passo 3570 mm / + empattement 3570 mm / + distancia entre ejes 3570 mm



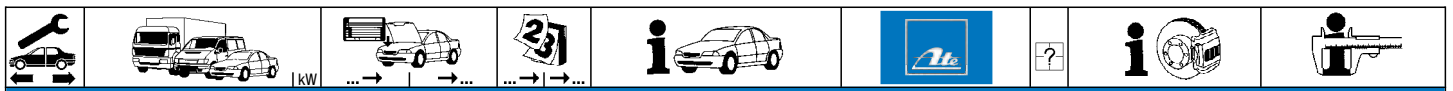

**MERCEDES BENZ E-Klasse (S210) Kombi (96-03)**

|           |                  |       |                     |       |                                       |                |        |   |     |   |  |
|-----------|------------------|-------|---------------------|-------|---------------------------------------|----------------|--------|---|-----|---|--|
|           | E 200 Kompressor | 137   | 09.97               | 04.03 |                                       | 11.3571-8509.2 | 220313 | 2 | ATE | D=57, - Halter<br>D=57, - Halter<br>Dichtungssatz<br>Hülzensatz<br>Führungsbolzen<br>Haltefeder | ATE<br>ATE<br>ATE<br>ATE<br>ATE<br>ATE |
|           | E 220 CDI        |       | 07.98               | 04.03 | + Radstand 3570mm <sup>1)</sup>       | 11.3571-8510.2 | 220314 |   |     |   |  |
|           | E 250 D          |       | 05.96               | 04.03 | + Radstand 3570mm <sup>1)</sup>       | 11.0441-5703.2 | 250145 |   |     |   |  |
|           | E 270 CDI        |       | 07.99               | 04.03 |                                       | 11.0101-5407.2 | 260011 |   |     |   |  |
|           | E 280            |       | 10.96               | 04.03 | + Radstand 3570mm <sup>1)</sup>       | 11.8171-0008.1 | 990049 |   |     |   |  |
|           | E 280 4-matic    |       | 10.96               | 04.03 |                                       | 11.8116-0253.1 | 390512 |   |     |   |  |
|           | E 290 TD         |       | 05.96               | 04.03 | + Radstand 3570mm <sup>1)</sup>       |                |        |   |     |   |  |
|           | E 300 TD         |       | 10.96               | 04.03 |                                       |                |        |   |     |   |  |
|           | E 320            |       | 10.96               | 04.03 |                                       |                |        |   |     |   |  |
|           | E 320 4-matic    |       | 06.97               | 04.03 |                                       |                |        |   |     |   |  |
| E 320 CDI |                  | 07.99 | 04.03               |       |                                       |                |        |   |     |   |  |
|           | E 420            |       | A 962231 / X 027613 | 05.96 |                                       | 13.4421-8009.2 | 210228 |   | ATE | D=42/38   | ATE                                    |
|           | E 430            |       | A 962231 / X 027613 | 09.97 |                                       | 13.4421-8010.2 | 210229 |   |     |   |  |
|           | E 420            |       | A 962232 / X 027614 | 04.03 |                                       | 11.9441-9971.2 | 220839 |   | ATE | D=44, - Halter  | ATE                                    |
|           | E 430            |       | A 962232 / X 027614 | 04.03 |                                       | 11.9441-9972.2 | 220840 |   |     |   |  |
|           | E 430 4-matic    |       |                     | 05.99 | 04.03                                 |                |        |   | ATE | D=44, - Halter  | ATE                                    |
|           | E 55 AMG         |       |                     | 09.97 | 04.03                                 | 11.8116-0133.1 | 390511 |   |     |   |  |
|           | E 200            |       | 05.96               | 04.03 |                                       | 83.7705-0386.3 | 330828 | 2 | ATE | L=385   |  |
|           | E 200 Kompressor |       | 09.97               | 04.03 |                                       |                |        |   |     |   |  |
|           | E 220 CDI        |       | 07.98               | 04.03 |                                       |                |        |   |     |   |  |
|           | E 230            |       | 05.96               | 08.97 |                                       |                |        |   |     |   |  |
|           | E 240            |       | 09.97               | 04.03 |                                       |                |        |   |     |   |  |
|           | E 250 D          |       | 05.96               | 04.03 | + Radstand 3570mm <sup>1)</sup>       |                |        |   |     |   |  |
|           | E 250 D          |       | 05.96               | 04.03 | + Radstand 2833mm <sup>2)</sup>       |                |        |   |     |   |  |
|           | E 250 D          |       | 05.96               | 04.03 | + ⊕ / + Radstand 2833mm <sup>3)</sup> |                |        |   |     |   |  |
|           | E 250 TD         |       | 09.97               | 04.03 |                                       |                |        |   |     |   |  |
|           | E 270 CDI        |       | 07.99               | 04.03 |                                       |                |        |   |     |   |  |
|           | E 280            |       | 10.96               | 04.03 | + Radstand 3570mm <sup>1)</sup>       |                |        |   |     |   |  |
|           | E 290 TD         |       | 05.96               | 04.03 |                                       |                |        |   |     |   |  |
|           | E 300 TD         |       | 10.96               | 04.03 |                                       |                |        |   |     |   |  |
|           | E 320            |       | 10.96               | 04.03 |                                       |                |        |   |     |   |  |
|           | E 320 CDI        |       | 07.99               | 04.03 |                                       |                |        |   |     |   |  |
|           | E 420            |       | 05.96               | 08.97 |                                       |                |        |   |     |   |  |
|           | E 430            |       | 09.97               | 04.03 |                                       |                |        |   |     |   |  |
| E 55 AMG  |                  | 09.97 | 04.03               |       |                                       |                |        |   |     |   |  |
|           | E 280 4-matic    |       | 10.96               | 04.03 |                                       | 83.7715-0280.3 | 330806 | 2 | ATE | L=280   |  |
|           | E 320 4-matic    |       | 06.97               | 04.03 |                                       |                |        |   |     |   |  |
|           | E 430 4-matic    |       | 05.99               | 04.03 |                                       |                |        |   |     |   |  |
|           | E 200            |       | 05.96               | 04.03 |                                       | 13.2401-8013.2 | 210051 | 2 | ATE | D=40<br>D=40<br>D=40<br>D=40<br>Dichtungssatz   | ATE<br>ATE<br>ATE<br>ATE<br>ATE        |
|           | E 200 Kompressor |       | 09.97               | 04.03 |                                       | 13.2401-8014.2 | 210052 |   |     |   |  |
|           | E 220 CDI        |       | 07.98               | 04.03 |                                       | 24.9240-8013.5 | 230019 |   |     |   |  |
|           | E 230            |       | 05.96               | 08.97 |                                       | 24.9240-8014.5 | 230020 |   |     |   |  |
|           | E 240            |       | 09.97               | 04.03 |                                       | 13.0441-4020.2 | 250084 |   |     |   |  |
|           | E 250 D          |       | 05.96               | 04.03 | + Radstand 3570mm <sup>1)</sup>       |                |        |   |     |   |  |
|           | E 250 D          |       | 05.96               | 04.03 | + Radstand 2833mm <sup>2)</sup>       |                |        |   |     |   |  |
|           | E 250 D          |       | 05.96               | 04.03 | + ⊕ / + Radstand 2833mm <sup>3)</sup> |                |        |   |     |   |  |
|           | E 250 TD         |       | 09.97               | 04.03 |                                       |                |        |   |     |   |  |
|           | E 270 CDI        |       | 07.99               | 04.03 |                                       |                |        |   |     |   |  |
|           | E 280            |       | 10.96               | 04.03 | + Radstand 3570mm <sup>1)</sup>       |                |        |   |     |   |  |
|           | E 280 4-matic    |       | 10.96               | 04.03 |                                       |                |        |   |     |   |  |
|           | E 290 TD         |       | 05.96               | 04.03 |                                       |                |        |   |     |   |  |
|           | E 300 TD         |       | 10.96               | 04.03 |                                       |                |        |   |     |   |  |
|           | E 320            |       | 10.96               | 04.03 |                                       |                |        |   |     |   |  |
|           | E 320 4-matic    |       | 06.97               | 04.03 |                                       |                |        |   |     |   |  |
|           | E 320 CDI        |       | 07.99               | 04.03 |                                       |                |        |   |     |   |  |
| E 420     |                  | 05.96 | 08.97               |       |                                       |                |        |   |     |   |  |
| E 430     |                  | 09.97 | 04.03               |       |                                       |                |        |   |     |   |  |
|           | E 430 4-matic    |       | 05.99               | 04.03 |                                       | 13.2461-8001.2 | 210226 | 2 | ATE | D=46<br>D=46<br>D=46<br>D=46<br>Dichtungssatz   | ATE<br>ATE<br>ATE<br>ATE               |
|           | E 55 AMG         |       | 09.97               | 04.03 |                                       | 13.2461-8002.2 | 210227 |   |     |   |  |
|           |                  |       |                     |       |                                       | 24.9246-8001.5 | 230021 |   |     |   |  |
|           |                  |       |                     |       |                                       | 24.9246-8002.5 | 230022 |   |     |   |  |
|           | E 270 CDI        |       | 07.99               | 04.03 |                                       | 13.9421-7009.2 | 210269 | 2 | ATE | D=42<br>D=42<br>Dichtungssatz   | ATE<br>ATE<br>ATE                      |
|           | E 280            |       | 10.96               | 04.03 |                                       | 13.9421-7010.2 | 210270 |   |     |   |  |
|           | E 430            |       | 05.99               | 04.03 |                                       | 13.0441-4216.2 | 250093 |   |     |   |  |
|           | E 430 4-matic    |       | 09.97               | 04.03 |                                       |                |        |   |     |   |  |
|           | E 200            |       | 05.96               | 04.03 |                                       | 83.7715-0280.3 | 330806 | 2 | ATE | L=280   |  |
|           | E 200 Kompressor |       | 09.97               | 04.03 |                                       |                |        |   |     |   |  |
|           | E 220 CDI        |       | 07.98               | 04.03 |                                       |                |        |   |     |   |  |
|           | E 230            |       | 05.96               | 08.97 |                                       |                |        |   |     |   |  |
|           | E 240            |       | 09.97               | 04.03 |                                       |                |        |   |     |   |  |
|           | E 250 D          |       | 05.96               | 04.03 | + Radstand 3570mm <sup>1)</sup>       |                |        |   |     |   |  |
|           | E 250 D          |       | 05.96               | 04.03 | + Radstand 2833mm <sup>2)</sup>       |                |        |   |     |   |  |
|           | E 250 D          |       | 05.96               | 04.03 | + ⊕ / + Radstand 2833mm <sup>3)</sup> |                |        |   |     |   |  |
|           | E 250 TD         |       | 09.97               | 04.03 |                                       |                |        |   |     |   |  |
|           | E 270 CDI        |       | 07.99               | 04.03 |                                       |                |        |   |     |   |  |
|           | E 280            |       | 10.96               | 04.03 | + Radstand 3570mm <sup>1)</sup>       |                |        |   |     |   |  |
|           | E 290 TD         |       | 05.96               | 04.03 |                                       |                |        |   |     |   |  |
|           | E 300 TD         |       | 10.96               | 04.03 |                                       |                |        |   |     |   |  |
|           | E 320            |       | 10.96               | 04.03 |                                       |                |        |   |     |   |  |
|           | E 320 CDI        |       | 07.99               | 04.03 |                                       |                |        |   |     |   |  |
|           | E 420            |       | 05.96               | 08.97 |                                       |                |        |   |     |   |  |
|           | E 430            |       | 09.97               | 04.03 |                                       |                |        |   |     |   |  |
| E 55 AMG  |                  | 09.97 | 04.03               |       |                                       |                |        |   |     |   |  |
|           | E 280 4-matic    |       | 10.96               | 04.03 |                                       | 83.7715-0280.3 | 330806 | 2 | ATE | L=280   |  |

1) + wheel base 3570 mm / + passo 3570 mm / + empattement 3570 mm / + distancia entre ejes 3570 mm  
 2) + wheel base 2833 mm / + passo 2833 mm / + empattement 2833 mm / + distancia entre ejes 2833 mm  
 3) + ⊕ / + wheel base 2833mm / + ⊕ / + passo 2833mm / + ⊕ / + empattement 2833mm / + ⊕ / + dist.entre ejes 2833mm



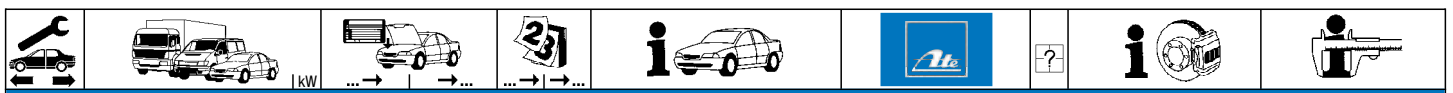

**MERCEDES BENZ E-Klasse (S210) Kombi (96-03)**

|  |   |  |  |  |   |  |                            |   |                            |
|--|---|--|--|--|---|--|----------------------------|---|----------------------------|
|  | E 320 4-matic<br>E 430 4-matic  |  | 06.97<br>05.99   | 04.03<br>04.03   | 83.7715-0280.3  | 330806   | 2                          |   | L=280                      |
|  | E 200<br>E 200 Kompressor<br>E 220 CDI<br>E 230<br>E 240<br>E 250 D<br>E 250 TD<br>E 270 CDI<br>E 280 4-matic<br>E 290 TD<br>E 300 TD<br>E 320<br>E 320 4-matic<br>E 320 CDI<br>E 420<br>E 430<br>E 430 4-matic<br>E 55 AMG |  | 05.96<br>09.97<br>07.98<br>05.96<br>09.97<br>05.96<br>09.97<br>07.99<br>10.96<br>05.96<br>10.96<br>10.96<br>06.97<br>07.99<br>05.96<br>09.97<br>05.99<br>09.97 | 04.03<br>04.03<br>04.03<br>08.97<br>04.03<br>04.03<br>04.03<br>04.03<br>04.03<br>04.03<br>04.03<br>04.03<br>04.03<br>04.03<br>08.97<br>04.03<br>04.03<br>04.03 |   | 24.3727-0426.2<br>24.3727-0424.2<br>24.3727-0425.2 | 580426<br>580424<br>580425 | 1<br>↑<br>□<br>□                          | L=2613<br>L=1058<br>L=1031 |
|  | E 250 D<br>E 280<br>E 290 TD  |  | 05.96<br>10.96<br>05.96  | 04.03<br>04.03<br>04.03  | + Radstand 3570mm <sup>3)</sup><br>+ Radstand 3570mm <sup>3)</sup><br>+ Radstand 3570mm <sup>3)</sup>   | 24.3727-0424.2<br>24.3727-0425.2                   | 580424<br>580425           | □<br>□<br>□                               | L=1058<br>L=1031           |
|  | E 200<br>E 230<br>E 250 D<br>E 290 TD<br>E 420  |  | 05.96<br>05.96<br>05.96<br>05.96<br>05.96  | 04.03<br>08.97<br>04.03<br>04.03<br>08.97  |   | 24.3727-0424.2<br>24.3727-0425.2                   | 580424<br>580425           | □<br>□<br>□                               | L=1058<br>L=1031           |
|  | E 240<br>E 270 CDI<br>E 300 TD<br>E 320<br>E 320 CDI<br>E 430<br>E 430 4-matic<br>E 55 AMG  |  | 09.97<br>07.99<br>10.96<br>10.96<br>07.99<br>09.97<br>05.99<br>09.97   | 04.03<br>04.03<br>04.03<br>04.03<br>04.03<br>04.03<br>04.03<br>04.03   |   | 24.3727-0424.2<br>24.3727-0425.2                   | 580424<br>580425           | □<br>□<br>□                               | L=1058<br>L=1031           |
|  | E 200<br>E 200 Kompressor<br>E 220 CDI<br>E 230<br>E 240<br>E 250 D<br>E 250 D<br>E 250 D<br>E 250 TD<br>E 270 CDI<br>E 280<br>E 290 TD<br>E 320 CDI  |  | 05.96<br>09.97<br>07.98<br>05.96<br>09.97<br>05.96<br>05.96<br>05.96<br>09.97<br>07.99<br>10.96<br>05.96<br>05.96<br>07.99                                     | 04.03<br>04.03<br>04.03<br>08.97<br>04.03<br>04.03<br>04.03<br>04.03<br>04.03<br>04.03<br>04.03<br>04.03<br>04.03<br>04.03                                     | + Radstand 2833mm <sup>2)</sup><br>+ Radstand 3570mm <sup>3)</sup><br>+ Radstand 2833mm <sup>2)</sup><br>+ Radstand 2833mm <sup>1)</sup><br>+ Radstand 3570mm <sup>3)</sup> | 24.2419-0915.3<br>24.2419-1703.3                   | 030045<br>030097           | + GG <sup>4)</sup><br>+ ALU <sup>5)</sup> | Gz 19,05<br>Gz 19,05       |

**MERCEDES BENZ E-Klasse (W211) Limousine (02-09)**

|  |   |   |  |   |  |  |  |        |  |                                 |
|--|---|---|--|---|--|--|--|--------|--|---------------------------------|
|  | E 240 4-matic<br>E 280 4-matic<br>E 280 CDI 4-matic<br>E 320 4-matic<br>E 320 CDI 4-matic<br>E 350 4-matic  | 130<br>170<br>140<br>165<br>165<br>200  | 03.03<br>05.05<br>03.05<br>03.03<br>03.05<br>12.04   | 02.09<br>02.09<br>02.09<br>02.09<br>02.09<br>02.09  | - Sportpaket / - Sportpaket AMG <sup>6)</sup><br>- Sportpaket / - Sportpaket AMG <sup>6)</sup><br>- Sportpaket / - Sportpaket AMG <sup>6)</sup><br>- Sportpaket / - Sportpaket AMG <sup>6)</sup> | 11.9601-9770.2<br>11.9601-9769.2<br>11.0101-5704.2<br>11.8171-0008.1<br>11.8116-0253.1 | 220878<br>220877<br>260095<br>990049<br>390512 | 2<br>2 | D=60, - Halter<br>D=60, - Halter<br>Hülsensatz<br>Führungsbolzen<br>Haltefeder | ATE<br>ATE<br>ATE<br>ATE<br>ATE |
|  | E 280 4-matic<br>E 280 CDI 4-matic<br>E 320 CDI 4-matic<br>E 350 4-matic<br>E 500 4-matic   | 170<br>140<br>165<br>200<br>225   | A 870950<br>A 870950<br>A 870950<br>A 870950<br>A 870950   | 05.05<br>03.05<br>03.05<br>12.04<br>10.03   | + Sportpaket / + Sportpaket AMG <sup>7)</sup><br>+ Sportpaket / + Sportpaket AMG <sup>7)</sup><br>+ Sportpaket / + Sportpaket AMG <sup>7)</sup><br>+ Sportpaket / + Sportpaket AMG <sup>7)</sup> | 11.9441-9972.2<br>11.9441-9971.2<br>11.0101-5704.2<br>11.8116-0133.1                   | 220840<br>220839<br>260095<br>390511           | 2<br>2 | D=44, - Halter<br>D=44, - Halter<br>Hülsensatz<br>Haltefeder                   | ATE<br>ATE<br>ATE<br>ATE        |
|  | E 280 4-matic<br>E 280 CDI 4-matic<br>E 320 CDI 4-matic<br>E 350 4-matic<br>E 500 4-matic<br>E 500 4-matic  | 170<br>140<br>165<br>200<br>225<br>285  | A 870951<br>A 870951<br>A 870951<br>A 870951<br>A 870951   | 02.09<br>02.09<br>02.09<br>02.09<br>02.09<br>04.06  | + Sportpaket / + Sportpaket AMG <sup>7)</sup><br>+ Sportpaket / + Sportpaket AMG <sup>7)</sup><br>+ Sportpaket / + Sportpaket AMG <sup>7)</sup><br>+ Sportpaket / + Sportpaket AMG <sup>7)</sup> | 11.9441-9955.2<br>11.9441-9956.2<br>11.8116-0133.1                                     | 220805<br>220806<br>390511                     | 2<br>2 | D=44, - Halter<br>D=44, - Halter<br>Haltefeder                                 | ATE<br>ATE<br>ATE               |
|  | E 200 CDI<br>E 200 CDI<br>E 200 CDI<br>E 200 Kompressor<br>E 200 Kompressor<br>E 200 NGT<br>E 220 CDI<br>E 220 CDI<br>E 220 CDI<br>E 220 CDI<br>E 230<br>E 240<br>E 250 CDI<br>E 270 CDI<br>E 270 CDI<br>E 280<br>E 280 CDI | 75<br>90<br>100<br>120<br>135<br>120<br>100<br>110<br>120<br>125<br>150<br>130<br>150<br>120<br>130<br>170<br>130 | 05.02<br>05.02<br>04.06<br>05.02<br>04.06<br>03.04<br>03.02<br>03.02<br>03.03<br>04.06<br>03.02<br>08.08<br>03.02<br>03.02<br>05.05<br>05.04 | 02.09<br>02.09<br>02.09<br>02.09<br>02.09<br>02.09<br>02.09<br>02.09<br>02.09<br>02.09<br>02.09<br>02.09<br>02.09<br>02.09<br>02.09<br>02.09<br>02.09 |  | 24.5123-0380.3   | 331256   | 2      | L=380  |                                 |

1) + ⊕ / + wheel base 2833mm / + ⊕ / + passo 2833mm / + ⊕ / + empattement 2833mm / + ⊕ / + dist.entre ejes 2833mm  
 2) + wheel base 2833 mm / + passo 2833 mm / + empattement 2833 mm / + distancia entre ejes 2833 mm  
 3) + wheel base 3570 mm / + passo 3570 mm / + empattement 3570 mm / + distancia entre ejes 3570 mm  
 4) + cast iron / + ghisa / + fonte grise / + fundición de gris  
 5) + aluminium / + alluminio / + aluminium / + aluminio  
 6) - sport package/- sport package AMG / - pacchetto sportivo/- pacchetto sport.AMG / - version sport/- version sport AMG / - kit deportivo/- kit deportivo AMG  
 7) + sports package/+ sports package AMG / + pacchetto sportivo/+ pacchetto sport.AMG / + version sport/+ version sport AMG / + kit deportivo/+ kit deportivo AMG





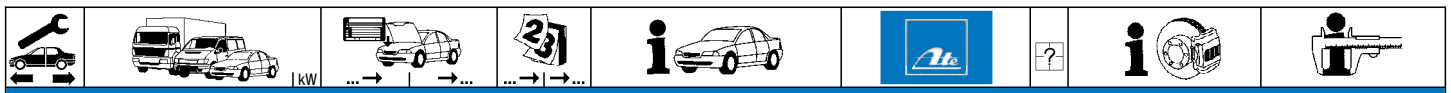

**MERCEDES BENZ E-Klasse (W211) Limousine (02-09)**

|  |                     |              |          |       |       |  |                |        |   |  |  |                |     |
|--|---------------------|--------------|----------|-------|-------|--|----------------|--------|---|--|--|----------------|-----|
|  | E 280 CDI           | 140          |          | 03.05 | 02.09 |  | 24.5123-0380.3 | 331256 | 2 |  |  | L=380          |     |
|  | E 300 Bluetec       | 155          |          | 09.07 | 02.09 |  |                |        |   |  |  |                |     |
|  | E 320               | 165          |          | 03.02 | 02.09 |  |                |        |   |  |  |                |     |
|  | E 320 CDI           | 150          |          | 11.02 | 02.09 |  |                |        |   |  |  |                |     |
|  | E 320 CDI           | 165          |          | 03.05 | 02.09 |  |                |        |   |  |  |                |     |
|  | E 350               | 200          |          | 12.04 | 02.09 |  |                |        |   |  |  |                |     |
|  | E 350 CGI           | 215          |          | 09.07 | 02.09 |  |                |        |   |  |  |                |     |
|  | E 400 CDI           | 191          |          | 03.03 | 02.09 |  |                |        |   |  |  |                |     |
|  | E 420 CDI           | 231          |          | 01.06 | 02.09 |  |                |        |   |  |  |                |     |
|  | E 500               | 225          |          | 03.02 | 02.09 |  |                |        |   |  |  |                |     |
|  | E 500               | 285          |          | 04.06 | 02.09 |  |                |        |   |  |  |                |     |
|  | E 55 Kompressor AMG | 350          |          | 10.02 | 02.09 |  |                |        |   |  |  |                |     |
|  | E 63 AMG            | 378          |          | 03.06 | 02.09 |  |                |        |   |  |  |                |     |
|  | E 200 CDI           | 75           |          | 05.02 | 02.09 | - Taxi / - Sportpaket / - Sportpaket AMG <sup>1)</sup> | 11.9426-9989.2 | 220639 | 2 |  |  | D=42, - Halter | ATE |
|  | E 200 CDI           | 90           |          | 05.02 | 02.09 | - Taxi / - Sportpaket / - Sportpaket AMG <sup>1)</sup> | 11.9426-9990.2 | 220640 | 2 |  |  | D=42, - Halter | ATE |
|  | E 200 CDI           | 100          |          | 04.06 | 02.09 | - Taxi / - Sportpaket / - Sportpaket AMG <sup>1)</sup> | 11.0441-4203.2 | 250013 | 2 |  |  | Dichtungssatz  | ATE |
|  | E 200 Kompressor    | 120          |          | 05.02 | 02.09 | - Taxi / - Sportpaket / - Sportpaket AMG <sup>1)</sup> | 11.0101-4202.2 | 260094 | 2 |  |  | Hülsensatz     | ATE |
|  | E 200 Kompressor    | 135          |          | 04.06 | 02.09 | - Taxi / - Sportpaket / - Sportpaket AMG <sup>1)</sup> | 11.8116-0323.1 | 390459 | 4 |  |  | Haltefeder     | ATE |
|  | E 200 NGT           | 120          |          | 03.04 | 02.09 | - Taxi / - Sportpaket / - Sportpaket AMG <sup>1)</sup> | 13.8190-0330.1 | 990134 | 4 |  |  | Halterschraube |     |
|  | E 220 CDI           | 100          |          | 03.02 | 02.09 | - Taxi / - Sportpaket / - Sportpaket AMG <sup>1)</sup> |                |        |   |  |  |                |     |
|  | E 220 CDI           | 110          |          | 03.02 | 02.09 | - Taxi / - Sportpaket / - Sportpaket AMG <sup>1)</sup> |                |        |   |  |  |                |     |
|  | E 220 CDI           | 120          |          | 03.03 | 02.09 | - Taxi / - Sportpaket / - Sportpaket AMG <sup>1)</sup> |                |        |   |  |  |                |     |
|  | E 220 CDI           | 125          |          | 04.06 | 02.09 | - Taxi / - Sportpaket / - Sportpaket AMG <sup>1)</sup> |                |        |   |  |  |                |     |
|  | E 230               | 150          |          | 04.06 | 02.09 | - Sportpaket / - Sportpaket AMG <sup>2)</sup>          |                |        |   |  |  |                |     |
|  | E 240               | 130          |          | 03.02 | 02.09 | - Taxi   |                |        |   |  |  |                |     |
|  | E 240 4-matic       | 130          |          | 03.03 | 02.09 |  |                |        |   |  |  |                |     |
|  | E 250 CDI           | 150          |          | 08.08 | 02.09 | - Taxi   |                |        |   |  |  |                |     |
|  | E 270 CDI           | 120          |          | 03.02 | 02.09 | - Taxi   |                |        |   |  |  |                |     |
|  | E 270 CDI           | 130          |          | 03.02 | 02.09 | - Taxi   |                |        |   |  |  |                |     |
|  | E 280 4-matic       | 170          |          | 05.05 | 02.09 | - Sportpaket / - Sportpaket AMG <sup>2)</sup>          |                |        |   |  |  |                |     |
|  | E 280 CDI           | 140          |          | 03.05 | 02.09 | - Sportpaket / - Sportpaket AMG <sup>2)</sup>          |                |        |   |  |  |                |     |
|  | E 280 CDI 4-matic   | 140          |          | 03.05 | 02.09 | - Sportpaket / - Sportpaket AMG <sup>2)</sup>          |                |        |   |  |  |                |     |
|  | E 320               | 165          | A 400547 | 03.02 | 02.09 | - Taxi   |                |        |   |  |  |                |     |
|  | E 320 4-matic       | 165 X 122526 |          | 03.02 | 02.09 |  |                |        |   |  |  |                |     |
|  | E 320 CDI           | 150          | A 400547 | 11.02 |       |  |                |        |   |  |  |                |     |
|  | E 200 CDI           | 75           |          | 05.02 | 02.09 | + Taxi   | 11.9426-9991.2 | 220641 | 2 |  |  | D=42, - Halter | ATE |
|  | E 200 CDI           | 75           |          | 05.02 | 02.09 | - Taxi / + Sportpaket / + Sportpaket AMG <sup>3)</sup> | 11.9426-9992.2 | 220642 | 2 |  |  | D=42, - Halter | ATE |
|  | E 200 CDI           | 90           |          | 05.02 | 02.09 | + Taxi   | 11.0441-4203.2 | 250013 | 2 |  |  | Dichtungssatz  | ATE |
|  | E 200 CDI           | 90           |          | 05.02 | 02.09 | - Taxi / + Sportpaket / + Sportpaket AMG <sup>3)</sup> | 11.0101-4202.2 | 260094 | 2 |  |  | Hülsensatz     | ATE |
|  | E 200 CDI           | 100          |          | 04.06 | 02.09 | + Taxi   | 11.8116-0323.1 | 390459 | 4 |  |  | Haltefeder     | ATE |
|  | E 200 CDI           | 100          |          | 04.06 | 02.09 | - Taxi / + Sportpaket / + Sportpaket AMG <sup>3)</sup> | 13.8190-0330.1 | 990134 | 4 |  |  | Halterschraube |     |
|  | E 200 Kompressor    | 120          |          | 05.02 | 02.09 | + Taxi   |                |        |   |  |  |                |     |
|  | E 200 Kompressor    | 120          |          | 05.02 | 02.09 | - Taxi / + Sportpaket / + Sportpaket AMG <sup>3)</sup> |                |        |   |  |  |                |     |
|  | E 200 Kompressor    | 135          |          | 04.06 | 02.09 | + Taxi   |                |        |   |  |  |                |     |
|  | E 200 Kompressor    | 135          |          | 04.06 | 02.09 | - Taxi / + Sportpaket / + Sportpaket AMG <sup>3)</sup> |                |        |   |  |  |                |     |
|  | E 200 NGT           | 120          |          | 03.04 | 02.09 | + Taxi   |                |        |   |  |  |                |     |
|  | E 200 NGT           | 120          |          | 03.04 | 02.09 | - Taxi / + Sportpaket / + Sportpaket AMG <sup>3)</sup> |                |        |   |  |  |                |     |
|  | E 220 CDI           | 100          |          | 03.02 | 02.09 | + Taxi   |                |        |   |  |  |                |     |
|  | E 220 CDI           | 100          |          | 03.02 | 02.09 | - Taxi / + Sportpaket / + Sportpaket AMG <sup>3)</sup> |                |        |   |  |  |                |     |
|  | E 220 CDI           | 110          |          | 03.02 | 02.09 | + Taxi   |                |        |   |  |  |                |     |
|  | E 220 CDI           | 110          |          | 03.02 | 02.09 | - Taxi / + Sportpaket / + Sportpaket AMG <sup>3)</sup> |                |        |   |  |  |                |     |
|  | E 220 CDI           | 120          |          | 03.03 | 02.09 | + Taxi   |                |        |   |  |  |                |     |
|  | E 220 CDI           | 120          |          | 03.03 | 02.09 | - Taxi / + Sportpaket / + Sportpaket AMG <sup>3)</sup> |                |        |   |  |  |                |     |
|  | E 220 CDI           | 125          |          | 04.06 | 02.09 | + Taxi   |                |        |   |  |  |                |     |
|  | E 220 CDI           | 125          |          | 04.06 | 02.09 | - Taxi / + Sportpaket / + Sportpaket AMG <sup>3)</sup> |                |        |   |  |  |                |     |
|  | E 230               | 150          |          | 04.06 | 02.09 | + Sportpaket / + Sportpaket AMG <sup>4)</sup>          |                |        |   |  |  |                |     |
|  | E 240               | 130          |          | 03.02 | 02.09 | + Taxi   |                |        |   |  |  |                |     |
|  | E 250 CDI           | 150          |          | 08.08 | 02.09 | + Taxi   |                |        |   |  |  |                |     |
|  | E 270 CDI           | 120          |          | 03.02 | 02.09 | + Taxi   |                |        |   |  |  |                |     |
|  | E 270 CDI           | 130          |          | 03.02 | 02.09 | + Taxi   |                |        |   |  |  |                |     |
|  | E 280               | 170          |          | 05.05 | 02.09 |  |                |        |   |  |  |                |     |
|  | E 280 4-matic       | 170          |          | 05.05 | 02.09 | + Sportpaket / + Sportpaket AMG <sup>4)</sup>          |                |        |   |  |  |                |     |
|  | E 280 CDI           | 130          |          | 05.04 | 02.09 |  |                |        |   |  |  |                |     |
|  | E 280 CDI           | 140          |          | 03.05 | 02.09 | + Sportpaket / + Sportpaket AMG <sup>4)</sup>          |                |        |   |  |  |                |     |
|  | E 280 CDI 4-matic   | 140          |          | 03.05 | 02.09 | + Sportpaket / + Sportpaket AMG <sup>4)</sup>          |                |        |   |  |  |                |     |
|  | E 300 Bluetec       | 155          |          | 09.07 | 02.09 |  |                |        |   |  |  |                |     |
|  | E 320               | 165          |          | 03.02 | 02.09 | + Taxi   |                |        |   |  |  |                |     |
|  | E 320               | 165 A 500548 |          | 02.09 |       | - Taxi   |                |        |   |  |  |                |     |
|  | E 320 4-matic       | 165          |          | 03.03 |       |  |                |        |   |  |  |                |     |
|  | E 320 CDI           | 150          | X 122525 | 11.02 | 02.09 | + Taxi   |                |        |   |  |  |                |     |
|  | E 320 CDI           | 150 A 400548 |          | 02.09 |       | - Taxi   |                |        |   |  |  |                |     |
|  | E 320 CDI           | 165          |          | 03.05 | 02.09 |  |                |        |   |  |  |                |     |
|  | E 320 CDI 4-matic   | 165          |          | 03.05 | 02.09 |  |                |        |   |  |  |                |     |
|  | E 350               | 200          |          | 12.04 | 02.09 |  |                |        |   |  |  |                |     |
|  | E 350 4-matic       | 200          |          | 12.04 | 02.09 |  |                |        |   |  |  |                |     |
|  | E 350 CGI           | 215          |          | 09.07 | 02.09 |  |                |        |   |  |  |                |     |
|  | E 400 CDI           | 191          |          | 03.03 | 02.09 |  |                |        |   |  |  |                |     |
|  | E 420 CDI           | 231          |          | 01.06 | 02.09 | + Sportpaket / + Sportpaket AMG <sup>4)</sup>          |                |        |   |  |  |                |     |
|  | E 500               | 225          |          | 03.02 | 02.09 |  |                |        |   |  |  |                |     |
|  | E 500 4-matic       | 225          |          | 10.03 | 02.09 |  |                |        |   |  |  |                |     |
|  | E 500 4-matic       | 285          |          | 04.06 | 02.09 |  |                |        |   |  |  |                |     |
|  | E 420 CDI           | 231          |          | 01.06 | 02.09 | - Sportpaket / - Sportpaket AMG <sup>2)</sup>          | 11.9426-9959.2 | 220801 | 2 |  |  | D=42, - Halter | ATE |
|  | E 500               | 285          |          | 04.06 | 02.09 |  | 11.9426-9960.2 | 220802 | 2 |  |  | D=42, - Halter | ATE |
|  |                     |              |          |       |       |  | 11.0441-4203.2 | 250013 | 2 |  |  | Dichtungssatz  | ATE |
|  |                     |              |          |       |       |  | 11.8171-0008.1 | 990049 | 2 |  |  | Führungsbolzen | ATE |
|  |                     |              |          |       |       |  | 11.0101-5407.2 | 260011 | 2 |  |  | Hülsensatz     | ATE |
|  |                     |              |          |       |       |  | 11.8116-0086.2 | 390606 | 2 |  |  | Haltefeder     | ATE |

<sup>1)</sup> - Taxi/-sports pack./-sports pack.AMG / - Taxi/-pacch.sport./-pacch.sport AMG / - Taxi/-vers.sport/-vers.sport AMG / - Taxi/-kit deport./-kit deport. AMG  
<sup>2)</sup> - sport package/- sport package AMG / - pacchetto sportivo/- pacchetto sport.AMG / - version sport/- version sport AMG / - kit deportivo/- kit deportivo AMG  
<sup>3)</sup> - Taxi/+sports pack./+sports pack.AMG / - Taxi/+pacch.sport./+pacch.sport AMG / - Taxi/+vers.sport./+vers.sport AMG / - Taxi/+kit deport./+kit deport. AMG  
<sup>4)</sup> + sports package/+ sports package AMG / + pacchetto sportivo/+ pacchetto sport.AMG / + version sport/+ version sport AMG / + kit deportivo/+ kit deportivo AMG

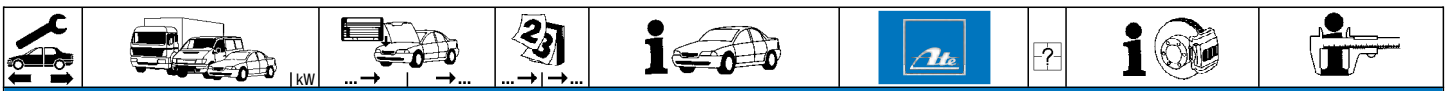

**MERCEDES BENZ E-Klasse (W211) Limousine (02-09)**

|  |                         |       |       |                |        |   |                          |        |                |        |  |                          |        |
|--|-------------------------|-------|-------|----------------|--------|---|--------------------------|--------|----------------|--------|--|--------------------------|--------|
|  | E 200 CDI 75            | 05.02 | 02.09 | 24.5238-0255.3 | 330674 | 2 |                          | L=255  |                |        |  |                          |        |
|  | E 200 CDI 90            | 05.02 | 02.09 |                |        |   |                          |        |                |        |  |                          |        |
|  | E 200 CDI 100           | 04.06 | 02.09 |                |        |   |                          |        |                |        |  |                          |        |
|  | E 200 Kompressor 120    | 05.02 | 02.09 |                |        |   |                          |        |                |        |  |                          |        |
|  | E 200 Kompressor 135    | 04.06 | 02.09 |                |        |   |                          |        |                |        |  |                          |        |
|  | E 200 NGT 120           | 03.04 | 02.09 |                |        |   |                          |        |                |        |  |                          |        |
|  | E 220 CDI 100           | 03.02 | 02.09 |                |        |   |                          |        |                |        |  |                          |        |
|  | E 220 CDI 110           | 03.02 | 02.09 |                |        |   |                          |        |                |        |  |                          |        |
|  | E 220 CDI 120           | 03.03 | 02.09 |                |        |   |                          |        |                |        |  |                          |        |
|  | E 220 CDI 125           | 04.06 | 02.09 |                |        |   |                          |        |                |        |  |                          |        |
|  | E 230 150               | 04.06 | 02.09 |                |        |   |                          |        |                |        |  |                          |        |
|  | E 240 130               | 03.02 | 02.09 |                |        |   |                          |        |                |        |  |                          |        |
|  | E 240 4-matic 130       | 03.03 | 02.09 |                |        |   |                          |        |                |        |  |                          |        |
|  | E 250 CDI 150           | 08.08 | 02.09 |                |        |   |                          |        |                |        |  |                          |        |
|  | E 270 CDI 120           | 03.02 | 02.09 |                |        |   |                          |        |                |        |  |                          |        |
|  | E 270 CDI 130           | 03.02 | 02.09 |                |        |   |                          |        |                |        |  |                          |        |
|  | E 280 170               | 05.05 | 02.09 |                |        |   |                          |        |                |        |  |                          |        |
|  | E 280 4-matic 170       | 05.05 | 02.09 |                |        |   |                          |        |                |        |  |                          |        |
|  | E 280 CDI 130           | 05.04 | 02.09 |                |        |   |                          |        |                |        |  |                          |        |
|  | E 280 CDI 140           | 03.05 | 02.09 |                |        |   |                          |        |                |        |  |                          |        |
|  | E 280 CDI 4-matic 140   | 03.05 | 02.09 |                |        |   |                          |        |                |        |  |                          |        |
|  | E 300 Bluetec 155       | 09.07 | 02.09 |                |        |   |                          |        |                |        |  |                          |        |
|  | E 320 165               | 03.02 | 02.09 |                |        |   |                          |        |                |        |  |                          |        |
|  | E 320 4-matic 165       | 03.03 | 02.09 |                |        |   |                          |        |                |        |  |                          |        |
|  | E 320 CDI 150           | 11.02 | 02.09 |                |        |   |                          |        |                |        |  |                          |        |
|  | E 320 CDI 165           | 03.05 | 02.09 |                |        |   |                          |        |                |        |  |                          |        |
|  | E 320 CDI 4-matic 165   | 03.05 | 02.09 |                |        |   |                          |        |                |        |  |                          |        |
|  | E 350 200               | 12.04 | 02.09 |                |        |   |                          |        |                |        |  |                          |        |
|  | E 350 4-matic 200       | 12.04 | 02.09 |                |        |   |                          |        |                |        |  |                          |        |
|  | E 350 CGI 215           | 09.07 | 02.09 |                |        |   |                          |        |                |        |  |                          |        |
|  | E 400 CDI 191           | 03.03 | 02.09 |                |        |   |                          |        |                |        |  |                          |        |
|  | E 420 CDI 231           | 01.06 | 02.09 |                |        |   |                          |        |                |        |  |                          |        |
|  | E 500 225               | 03.02 | 02.09 |                |        |   |                          |        |                |        |  |                          |        |
|  | E 500 285               | 04.06 | 02.09 |                |        |   |                          |        |                |        |  |                          |        |
|  | E 500 4-matic 225       | 10.03 | 02.09 |                |        |   |                          |        |                |        |  |                          |        |
|  | E 500 4-matic 285       | 04.06 | 02.09 |                |        |   |                          |        |                |        |  |                          |        |
|  | E 55 Kompressor AMG 350 | 10.02 | 02.09 |                |        |   |                          |        |                |        |  |                          |        |
|  | E 63 AMG 378            | 03.06 | 02.09 |                |        |   |                          |        |                |        |  |                          |        |
|  | E 200 CDI 75            | 05.02 | 02.09 | 24.3727-0447.2 | 580447 | 1 | <input type="checkbox"/> | L=1952 |                |        |  |                          |        |
|  | E 200 CDI 90            | 05.02 | 02.09 |                |        |   |                          |        |                |        |  |                          |        |
|  | E 200 CDI 100           | 04.06 | 02.09 |                |        |   |                          |        |                |        |  |                          |        |
|  | E 200 Kompressor 120    | 05.02 | 02.09 |                |        |   |                          |        |                |        |  |                          |        |
|  | E 200 Kompressor 135    | 04.06 | 02.09 |                |        |   |                          |        |                |        |  |                          |        |
|  | E 200 NGT 120           | 03.04 | 02.09 |                |        |   |                          |        |                |        |  |                          |        |
|  | E 220 CDI 100           | 03.02 | 02.09 |                |        |   |                          |        |                |        |  |                          |        |
|  | E 220 CDI 110           | 03.02 | 02.09 |                |        |   |                          |        |                |        |  |                          |        |
|  | E 220 CDI 120           | 03.03 | 02.09 |                |        |   |                          |        |                |        |  |                          |        |
|  | E 220 CDI 125           | 04.06 | 02.09 |                |        |   |                          |        |                |        |  |                          |        |
|  | E 230 150               | 04.06 | 02.09 |                |        |   |                          |        |                |        |  |                          |        |
|  | E 240 130               | 03.02 | 02.09 |                |        |   |                          |        |                |        |  |                          |        |
|  | E 240 4-matic 130       | 03.03 | 02.09 |                |        |   |                          |        |                |        |  |                          |        |
|  | E 250 CDI 150           | 08.08 | 02.09 |                |        |   |                          |        |                |        |  |                          |        |
|  | E 270 CDI 120           | 03.02 | 02.09 |                |        |   |                          |        |                |        |  |                          |        |
|  | E 270 CDI 130           | 03.02 | 02.09 |                |        |   |                          |        |                |        |  |                          |        |
|  | E 280 170               | 05.05 | 02.09 |                |        |   |                          |        |                |        |  |                          |        |
|  | E 280 4-matic 170       | 05.05 | 02.09 |                |        |   |                          |        |                |        |  |                          |        |
|  | E 280 CDI 130           | 05.04 | 02.09 |                |        |   |                          |        |                |        |  |                          |        |
|  | E 320 165               | 03.02 | 02.09 |                |        |   |                          |        |                |        |  |                          |        |
|  | E 320 4-matic 165       | 03.03 | 02.09 |                |        |   |                          |        |                |        |  |                          |        |
|  | E 320 CDI 150           | 11.02 | 02.09 |                |        |   |                          |        |                |        |  |                          |        |
|  | E 350 200               | 12.04 | 02.09 |                |        |   |                          |        |                |        |  |                          |        |
|  | E 350 4-matic 200       | 12.04 | 02.09 |                |        |   |                          |        |                |        |  |                          |        |
|  | E 350 CGI 215           | 09.07 | 02.09 |                |        |   |                          |        |                |        |  |                          |        |
|  | E 400 CDI 191           | 03.03 | 02.09 |                |        |   |                          |        |                |        |  |                          |        |
|  | E 420 CDI 231           | 01.06 | 02.09 |                |        |   |                          |        |                |        |  |                          |        |
|  | E 500 225               | 03.02 | 02.09 |                |        |   |                          |        |                |        |  |                          |        |
|  | E 500 285               | 04.06 | 02.09 |                |        |   |                          |        |                |        |  |                          |        |
|  | E 500 4-matic 225       | 10.03 | 02.09 |                |        |   |                          |        |                |        |  |                          |        |
|  | E 500 4-matic 285       | 04.06 | 02.09 |                |        |   |                          |        |                |        |  |                          |        |
|  | E 55 Kompressor AMG 350 | 10.02 | 02.09 |                |        |   |                          |        |                |        |  |                          |        |
|  | E 63 AMG 378            | 03.06 | 02.09 |                |        |   |                          |        |                |        |  |                          |        |
|  | E 200 CDI 75            | 05.02 | 02.09 | 24.3727-0449.2 | 580449 |   | <input type="checkbox"/> | L=1742 |                |        |  |                          |        |
|  | E 200 CDI 90            | 05.02 | 02.09 |                |        |   |                          |        |                |        |  |                          |        |
|  | E 200 CDI 100           | 04.06 | 02.09 |                |        |   |                          |        |                |        |  |                          |        |
|  | E 200 Kompressor 120    | 05.02 | 02.09 |                |        |   |                          |        |                |        |  |                          |        |
|  | E 200 Kompressor 135    | 04.06 | 02.09 |                |        |   |                          |        |                |        |  |                          |        |
|  | E 200 NGT 120           | 03.04 | 02.09 |                |        |   |                          |        |                |        |  |                          |        |
|  | E 220 CDI 100           | 03.02 | 02.09 |                |        |   |                          |        |                |        |  |                          |        |
|  | E 220 CDI 110           | 03.02 | 02.09 |                |        |   |                          |        |                |        |  |                          |        |
|  | E 220 CDI 120           | 03.03 | 02.09 |                |        |   |                          |        |                |        |  |                          |        |
|  | E 220 CDI 125           | 04.06 | 02.09 |                |        |   |                          |        |                |        |  |                          |        |
|  | E 230 150               | 04.06 | 02.09 |                |        |   |                          |        |                |        |  |                          |        |
|  | E 240 130               | 03.02 | 02.09 |                |        |   |                          |        |                |        |  |                          |        |
|  | E 240 4-matic 130       | 03.03 | 02.09 |                |        |   |                          |        |                |        |  |                          |        |
|  | E 250 CDI 150           | 08.08 | 02.09 |                |        |   |                          |        |                |        |  |                          |        |
|  | E 270 CDI 120           | 03.02 | 02.09 |                |        |   |                          |        |                |        |  |                          |        |
|  | E 270 CDI 130           | 03.02 | 02.09 |                |        |   |                          |        |                |        |  |                          |        |
|  | E 200 CDI 75            | 05.02 | 02.09 |                |        |   |                          |        | 24.3727-0448.2 | 580448 |  | <input type="checkbox"/> | L=1726 |
|  | E 200 CDI 90            | 05.02 | 02.09 |                |        |   |                          |        |                |        |  |                          |        |
|  | E 200 CDI 100           | 04.06 | 02.09 |                |        |   |                          |        |                |        |  |                          |        |
|  | E 200 Kompressor 120    | 05.02 | 02.09 |                |        |   |                          |        |                |        |  |                          |        |
|  | E 200 Kompressor 135    | 04.06 | 02.09 |                |        |   |                          |        |                |        |  |                          |        |
|  | E 200 NGT 120           | 03.04 | 02.09 |                |        |   |                          |        |                |        |  |                          |        |
|  | E 220 CDI 100           | 03.02 | 02.09 |                |        |   |                          |        |                |        |  |                          |        |
|  | E 220 CDI 110           | 03.02 | 02.09 |                |        |   |                          |        |                |        |  |                          |        |
|  | E 220 CDI 120           | 03.03 | 02.09 |                |        |   |                          |        |                |        |  |                          |        |
|  | E 220 CDI 125           | 04.06 | 02.09 |                |        |   |                          |        |                |        |  |                          |        |
|  | E 230 150               | 04.06 | 02.09 |                |        |   |                          |        |                |        |  |                          |        |
|  | E 240 130               | 03.02 | 02.09 |                |        |   |                          |        |                |        |  |                          |        |
|  | E 240 4-matic 130       | 03.03 | 02.09 |                |        |   |                          |        |                |        |  |                          |        |
|  | E 250 CDI 150           | 08.08 | 02.09 |                |        |   |                          |        |                |        |  |                          |        |
|  | E 270 CDI 120           | 03.02 | 02.09 |                |        |   |                          |        |                |        |  |                          |        |
|  | E 270 CDI 130           | 03.02 | 02.09 |                |        |   |                          |        |                |        |  |                          |        |



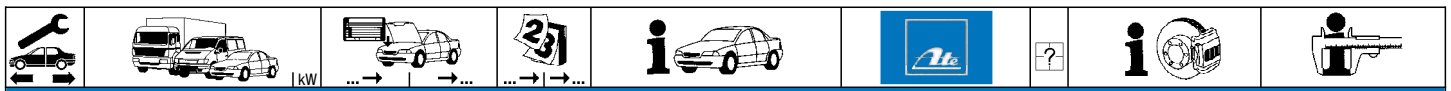

**MERCEDES BENZ E-Klasse (W211) Limousine (02-09)**















|  |                     |     |       |       |                |        |                          |  |        |
|--|---------------------|-----|-------|-------|----------------|--------|--------------------------|--|--------|
|  | E 280               | 170 | 05.05 | 02.09 | 24.3727-0449.2 | 580449 | <input type="checkbox"/> |  | L=1742 |
|  | E 280 4-matic       | 170 | 05.05 | 02.09 | 24.3727-0448.2 | 580448 | <input type="checkbox"/> |  | L=1726 |
|  | E 280 CDI           | 130 | 05.04 | 02.09 |                |        |                          |  |        |
|  | E 320               | 165 | 03.02 | 02.09 |                |        |                          |  |        |
|  | E 320 4-matic       | 165 | 03.03 | 02.09 |                |        |                          |  |        |
|  | E 320 CDI           | 150 | 11.02 | 02.09 |                |        |                          |  |        |
|  | E 350               | 200 | 12.04 | 02.09 |                |        |                          |  |        |
|  | E 350 4-matic       | 200 | 12.04 | 02.09 |                |        |                          |  |        |
|  | E 350 CGI           | 215 | 09.07 | 02.09 |                |        |                          |  |        |
|  | E 400 CDI           | 191 | 03.03 | 02.09 |                |        |                          |  |        |
|  | E 420 CDI           | 231 | 01.06 | 02.09 |                |        |                          |  |        |
|  | E 500               | 225 | 03.02 | 02.09 |                |        |                          |  |        |
|  | E 500               | 285 | 04.06 | 02.09 |                |        |                          |  |        |
|  | E 500 4-matic       | 225 | 10.03 | 02.09 |                |        |                          |  |        |
|  | E 500 4-matic       | 285 | 04.06 | 02.09 |                |        |                          |  |        |
|  | E 55 Kompressor AMG | 350 | 10.02 | 02.09 |                |        |                          |  |        |
|  | E 63 AMG            | 378 | 03.06 | 02.09 |                |        |                          |  |        |

**MERCEDES BENZ E-Klasse (S211) Kombi (03-09)**

|  |                     |     |          |       |                |        |                          |  |                |     |
|--|---------------------|-----|----------|-------|----------------|--------|--------------------------|--|----------------|-----|
|  | E 240 4-matic       | 130 | 07.03    | 10.09 | 11.9601-9770.2 | 220878 | <input type="checkbox"/> |  | D=60, - Halter | ATE |
|  | E 280 4-matic       | 170 | 05.05    | 10.09 | 11.9601-9769.2 | 220877 | <input type="checkbox"/> |  | D=60, - Halter | ATE |
|  | E 280 CDI 4-matic   | 140 | 05.05    | 10.09 | 11.0441-6007.2 | 250146 |                          |  | Dichtungssatz  | ATE |
|  | E 320 4-matic       | 165 | 07.03    | 10.09 | 11.0101-5704.2 | 260095 |                          |  | Hülsensatz     | ATE |
|  | E 320 CDI 4-matic   | 165 | 05.05    | 10.09 | 11.8171-0008.1 | 990049 |                          |  | Führungsbolzen | ATE |
|  | E 350 4-matic       | 200 | 12.04    | 10.09 | 11.8116-0253.1 | 390512 | 2                        |  | Haltefeder     | ATE |
|  | E 280 4-matic       | 170 | A 870950 | 05.05 | 11.9441-9972.2 | 220840 | <input type="checkbox"/> |  | D=44, - Halter | ATE |
|  | E 280 CDI 4-matic   | 140 | A 870950 | 05.05 | 11.9441-9971.2 | 220839 | <input type="checkbox"/> |  | D=44, - Halter | ATE |
|  | E 320 CDI 4-matic   | 165 | A 870950 | 05.05 | 11.0101-5704.2 | 260095 |                          |  | Hülsensatz     | ATE |
|  | E 350 4-matic       | 200 | A 870950 | 12.04 |                |        |                          |  |                |     |
|  | E 500 4-matic       | 225 | A 870950 | 10.03 |                |        |                          |  |                |     |
|  | E 280 4-matic       | 170 | A 870951 | 10.09 | 11.9441-9955.2 | 220805 | <input type="checkbox"/> |  | D=44, - Halter | ATE |
|  | E 280 CDI 4-matic   | 140 | A 870951 | 10.09 | 11.9441-9956.2 | 220806 | <input type="checkbox"/> |  | D=44, - Halter | ATE |
|  | E 320 CDI 4-matic   | 165 | A 870951 | 10.09 |                |        |                          |  |                |     |
|  | E 350 4-matic       | 200 | A 870951 | 10.09 |                |        |                          |  |                |     |
|  | E 500 4-matic       | 225 | A 870951 | 10.09 |                |        |                          |  |                |     |
|  | E 500 4-matic       | 285 | 04.06    | 10.09 |                |        |                          |  |                |     |
|  | E 200 CDI           | 100 | 04.06    | 10.09 | 24.5123-0380.3 | 331256 | 2                        |  | L=380          |     |
|  | E 200 Kompressor    | 120 | 03.03    | 10.09 |                |        |                          |  |                |     |
|  | E 200 Kompressor    | 135 | 04.06    | 10.09 |                |        |                          |  |                |     |
|  | E 220 CDI           | 125 | 03.03    | 10.09 |                |        |                          |  |                |     |
|  | E 220 CDI           | 125 | 04.06    | 10.09 |                |        |                          |  |                |     |
|  | E 230               | 150 | 05.07    | 10.09 |                |        |                          |  |                |     |
|  | E 240               | 130 | 03.03    | 10.09 |                |        |                          |  |                |     |
|  | E 270 CDI           | 120 | 03.03    | 10.09 |                |        |                          |  |                |     |
|  | E 270 CDI           | 130 | 03.03    | 10.09 |                |        |                          |  |                |     |
|  | E 280               | 170 | 05.05    | 10.09 |                |        |                          |  |                |     |
|  | E 280 CDI           | 130 | 05.04    | 10.09 |                |        |                          |  |                |     |
|  | E 280 CDI           | 140 | 03.05    | 10.09 |                |        |                          |  |                |     |
|  | E 320               | 165 | 03.03    | 10.09 |                |        |                          |  |                |     |
|  | E 320 CDI           | 150 | 03.03    | 10.09 |                |        |                          |  |                |     |
|  | E 320 CDI           | 165 | 03.05    | 10.09 |                |        |                          |  |                |     |
|  | E 350               | 200 | 12.04    | 10.09 |                |        |                          |  |                |     |
|  | E 350 CGI           | 215 | 05.06    | 10.09 |                |        |                          |  |                |     |
|  | E 500               | 225 | 10.03    | 10.09 |                |        |                          |  |                |     |
|  | E 500               | 285 | 04.06    | 10.09 |                |        |                          |  |                |     |
|  | E 55 Kompressor AMG | 350 | 07.03    | 10.09 |                |        |                          |  |                |     |
|  | E 63 AMG            | 378 | 03.06    | 10.09 |                |        |                          |  |                |     |
|  | E 200 CDI           | 100 | 04.06    | 10.09 | 11.9426-9989.2 | 220639 | <input type="checkbox"/> |  | D=42, - Halter | ATE |
|  | E 200 Kompressor    | 120 | 03.03    | 10.09 | 11.9426-9990.2 | 220640 | <input type="checkbox"/> |  | D=42, - Halter | ATE |
|  | E 200 Kompressor    | 135 | 04.06    | 10.09 | 11.0101-4202.2 | 260094 |                          |  | Hülsensatz     | ATE |
|  | E 220 CDI           | 125 | 03.03    | 10.09 | 11.0441-4203.2 | 250013 |                          |  | Dichtungssatz  | ATE |
|  | E 220 CDI           | 125 | 04.06    | 10.09 | 11.8116-0323.1 | 390459 | 2                        |  | Haltefeder     | ATE |
|  | E 240               | 130 | 03.03    | 10.09 |                |        |                          |  |                |     |
|  | E 240 4-matic       | 130 | 07.03    | 10.09 |                |        |                          |  |                |     |
|  | E 200 CDI           | 100 | 04.06    | 10.09 | 11.9426-9991.2 | 220641 | <input type="checkbox"/> |  | D=42, - Halter | ATE |
|  | E 200 CDI           | 100 | 04.06    | 10.09 | 11.9426-9992.2 | 220642 | <input type="checkbox"/> |  | D=42, - Halter | ATE |
|  | E 200 Kompressor    | 120 | 03.03    | 10.09 | 11.0101-4202.2 | 260094 |                          |  | Hülsensatz     | ATE |
|  | E 200 Kompressor    | 120 | 03.03    | 10.09 | 11.0441-4203.2 | 250013 |                          |  | Dichtungssatz  | ATE |
|  | E 200 Kompressor    | 135 | 04.06    | 10.09 | 11.8116-0323.1 | 390459 | 2                        |  | Haltefeder     | ATE |
|  | E 200 Kompressor    | 135 | 04.06    | 10.09 |                |        |                          |  |                |     |
|  | E 220 CDI           | 125 | 03.03    | 10.09 |                |        |                          |  |                |     |
|  | E 220 CDI           | 125 | 03.03    | 10.09 |                |        |                          |  |                |     |
|  | E 220 CDI           | 125 | 04.06    | 10.09 |                |        |                          |  |                |     |
|  | E 220 CDI           | 125 | 04.06    | 10.09 |                |        |                          |  |                |     |
|  | E 230               | 150 | 05.07    | 10.09 |                |        |                          |  |                |     |
|  | E 240               | 130 | 03.03    | 10.09 |                |        |                          |  |                |     |
|  | E 270 CDI           | 120 | 03.03    | 10.09 |                |        |                          |  |                |     |
|  | E 270 CDI           | 130 | 03.03    | 10.09 |                |        |                          |  |                |     |
|  | E 280               | 170 | 05.05    | 10.09 |                |        |                          |  |                |     |
|  | E 280 4-matic       | 170 | 05.05    | 10.09 |                |        |                          |  |                |     |
|  | E 280 CDI           | 130 | 05.04    | 10.09 |                |        |                          |  |                |     |
|  | E 280 CDI           | 140 | 03.05    | 10.09 |                |        |                          |  |                |     |
|  | E 280 CDI 4-matic   | 140 | 05.05    | 10.09 |                |        |                          |  |                |     |
|  | E 320               | 165 | 03.03    | 10.09 |                |        |                          |  |                |     |
|  | E 320 4-matic       | 165 | 07.03    | 10.09 |                |        |                          |  |                |     |
|  | E 320 CDI           | 150 | 03.03    | 10.09 |                |        |                          |  |                |     |
|  | E 320 CDI 4-matic   | 165 | 05.05    | 10.09 |                |        |                          |  |                |     |

1) - sport package/- sport package AMG / - pacchetto sportivo/- pacchetto sport.AMG / - version sport/- version sport AMG / - kit sportivo/- kit sportivo AMG  
 2) + sports package/+ sports package AMG / + pacchetto sportivo/+ pacchetto sport.AMG / + version sport/+ version sport AMG / + kit sportivo/+ kit sportivo AMG  
 3) -Taxi/-sports pack./-sports pack.AMG / -Taxi/-pachch.sport./-pachch.sport.AMG / -Taxi/-vers.sport./-vers.sport.AMG / -Taxi/-kit deport./-kit deport. AMG  
 4) -Taxi/+sports pack./+sports pack.AMG / -Taxi/+pachch.sport./+pachch.sport.AMG / -Taxi/+vers.sport./+vers.sport.AMG / -Taxi/+kit deport./+kit deport. AMG



|     |    |  |  |  |  |  |  |  |       |                |        |   |        |
|--|--|--|--|--|---|--|--|--|-------|----------------|--------|---|--------|
| <b>MERCEDES BENZ E-Klasse (S211) Kombi (03-09)</b>                                 |  |  |  |  |   |  |  |  |       |                |        |   |        |
|    | E 350  | 200  | 12.04  | 10.09  | 11.9426-9991.2  | 220641   | <input type="checkbox"/>   |  |       |                |        |   |        |
|  | E 350 4-matic  | 200  | 12.04  | 10.09  | 11.9426-9992.2  | 220642   | <input type="checkbox"/>   | D=42, - Halter   |       |                |        |   |        |
|  | E 350 CGI  | 215  | 05.06  | 10.09  | 11.0101-4202.2  | 260094   | <input type="checkbox"/>   | Hülsensatz   |       |                |        |   |        |
|  | E 500  | 225  | 10.03  | 10.09  | 11.0441-4203.2  | 250013   | <input type="checkbox"/>   | Dichtungssatz  |       |                |        |   |        |
|  | E 500 4-matic  | 225  | 10.03  | 10.09  | 11.8116-0323.1  | 390459   | 2  | Haltefeder   |       |                |        |   |        |
|  | E 500 4-matic  | 285  | 04.06  | 10.09  |   |  |  | ATE  |       |                |        |   |        |
|    | E 500  | 285  | 04.06  | 10.09  | 11.9426-9959.2  | 220801   | <input type="checkbox"/>   | D=42, - Halter   |       |                |        |   |        |
|  |  |  |  |  | 11.9426-9960.2  | 220802   | <input type="checkbox"/>   | D=42, - Halter   |       |                |        |   |        |
|  |  |  |  |  | 11.0441-4203.2  | 250013   |  | Dichtungssatz  |       |                |        |   |        |
|  |  |  |  |  | 11.8171-0008.1  | 990049   |  | Führungsbolzen   |       |                |        |   |        |
|  |  |  |  |  | 11.0101-5407.2  | 260011   |  | Hülsensatz   |       |                |        |   |        |
|  |  |  |  |  | 11.8116-0086.2  | 390606   | 2  | Haltefeder   |       |                |        |   |        |
|  | E 200 CDI  | 100  | 04.06  | 10.09  | 24.5238-0255.3  | 330674   | 2  | L=255  |       |                |        |   |        |
|  | E 200 Kompressor   | 120  | 03.03  | 10.09  |   |  |  |  |       |                |        |   |        |
|  | E 200 Kompressor   | 135  | 04.06  | 10.09  |   |  |  |  |       |                |        |   |        |
|  | E 220 CDI  |  | 03.03  | 10.09  |   |  |  |  |       |                |        |   |        |
|  | E 220 CDI  | 125  | 04.06  | 10.09  |   |  |  |  |       |                |        |   |        |
|  | E 230  | 150  | 05.07  | 10.09  |   |  |  |  |       |                |        |   |        |
|  | E 240  | 130  | 03.03  | 10.09  |   |  |  |  |       |                |        |   |        |
|  | E 240 4-matic  | 130  | 07.03  | 10.09  |   |  |  |  |       |                |        |   |        |
|  | E 270 CDI  | 120  | 03.03  | 10.09  |   |  |  |  |       |                |        |   |        |
|  | E 270 CDI  | 130  | 03.03  | 10.09  |   |  |  |  |       |                |        |   |        |
|  | E 280  | 170  | 05.05  | 10.09  |   |  |  |  |       |                |        |   |        |
|  | E 280 4-matic  | 170  | 05.05  | 10.09  |   |  |  |  |       |                |        |   |        |
|  | E 280 CDI  | 130  | 05.04  | 10.09  |   |  |  |  |       |                |        |   |        |
|  | E 280 CDI  | 140  | 03.05  | 10.09  |   |  |  |  |       |                |        |   |        |
|  | E 280 CDI 4-matic  | 140  | 05.05  | 10.09  |   |  |  |  |       |                |        |   |        |
|  | E 320  | 165  | 03.03  | 10.09  |   |  |  |  |       |                |        |   |        |
|  | E 320 4-matic  | 165  | 07.03  | 10.09  |   |  |  |  |       |                |        |   |        |
|  | E 320 CDI  | 150  | 03.03  | 10.09  |   |  |  |  |       |                |        |   |        |
|  | E 320 CDI  | 165  | 03.05  | 10.09  |   |  |  |  |       |                |        |   |        |
|  | E 320 CDI 4-matic  | 165  | 05.05  | 10.09  |   |  |  |  |       |                |        |   |        |
|  | E 350  | 200  | 12.04  | 10.09  |   |  |  |  |       |                |        |   |        |
|  | E 350 4-matic  | 200  | 12.04  | 10.09  |   |  |  |  |       |                |        |   |        |
|  | E 350 CGI  | 215  | 05.06  | 10.09  |   |  |  |  |       |                |        |   |        |
|  | E 500  | 225  | 10.03  | 10.09  |   |  |  |  |       |                |        |   |        |
|  | E 500  | 285  | 04.06  | 10.09  |   |  |  |  |       |                |        |   |        |
|  | E 500 4-matic  | 225  | 10.03  | 10.09  |   |  |  |  |       |                |        |   |        |
|  | E 500 4-matic  | 285  | 04.06  | 10.09  |   |  |  |  |       |                |        |   |        |
|  | E 55 Kompressor AMG  | 350  | 07.03  | 10.09  |   |  |  |  |       |                |        |   |        |
|  | E 63 AMG   | 378  | 03.06  | 10.09  |   |  |  |  |       |                |        |   |        |
|  |  | E 200 CDI  | 1100   | 04.06  |   |  |  |  | 10.09 | 24.3727-0447.2 | 580447 | 1 | L=1952 |
|  |  | E 200 Kompressor   | 1120   | 03.03  |   |  |  |  | 10.09 |                |        |   |        |
|  |  | E 200 Kompressor   | 1135   | 04.06  |   |  |  |  | 10.09 |                |        |   |        |
| E 220 CDI  |  | 11   | 03.03  | 10.09  |   |  |  |  |       |                |        |   |        |
| E 220 CDI  |  | 1125   | 04.06  | 10.09  |   |  |  |  |       |                |        |   |        |
| E 230  |  | 1150   | 05.07  | 10.09  |   |  |  |  |       |                |        |   |        |
| E 240  |  | 1130   | 03.03  | 10.09  |   |  |  |  |       |                |        |   |        |
| E 240 4-matic  |  | 1130   | 07.03  | 10.09  |   |  |  |  |       |                |        |   |        |
| E 270 CDI  |  | 1120   | 03.03  | 10.09  |   |  |  |  |       |                |        |   |        |
| E 270 CDI  |  | 1130   | 03.03  | 10.09  |   |  |  |  |       |                |        |   |        |
| E 280  |  | 1170   | 05.05  | 10.09  |   |  |  |  |       |                |        |   |        |
| E 280 4-matic  |  | 1170   | 05.05  | 10.09  |   |  |  |  |       |                |        |   |        |
| E 280 CDI  |  | 1130   | 05.04  | 10.09  |   |  |  |  |       |                |        |   |        |
| E 320  |  | 1165   | 03.03  | 10.09  |   |  |  |  |       |                |        |   |        |
| E 320 4-matic  |  | 1165   | 07.03  | 10.09  |   |  |  |  |       |                |        |   |        |
| E 320 CDI  |  | 1150   | 03.03  | 10.09  |   |  |  |  |       |                |        |   |        |
| E 320 CDI 4-matic  |  | 1165   | 05.05  | 10.09  |   |  |  |  |       |                |        |   |        |
| E 350  |  | 1200   | 12.04  | 10.09  |   |  |  |  |       |                |        |   |        |
| E 350 4-matic  |  | 1200   | 12.04  | 10.09  |   |  |  |  |       |                |        |   |        |
| E 350 CGI  |  | 1215   | 05.06  | 10.09  |   |  |  |  |       |                |        |   |        |
| E 500  | 1225   | 10.03  | 10.09  |  |   |  |  |  |       |                |        |   |        |
| E 500  | 1285   | 04.06  | 10.09  |  |   |  |  |  |       |                |        |   |        |
| E 500 4-matic  | 1225   | 10.03  | 10.09  |  |   |  |  |  |       |                |        |   |        |
| E 500 4-matic  | 1285   | 04.06  | 10.09  |  |   |  |  |  |       |                |        |   |        |
| E 55 Kompressor AMG  | 1350   | 07.03  | 10.09  |  |   |  |  |  |       |                |        |   |        |
| E 63 AMG   | 1378   | 03.06  | 10.09  |  |   |  |  |  |       |                |        |   |        |
|  | E 200 CDI  | 1100   | 04.06  | 10.09  | 24.3727-0449.2  | 580449   | <input type="checkbox"/>   | L=1742   |       |                |        |   |        |
|  | E 200 Kompressor   | 1120   | 03.03  | 10.09  |   |  |  |  |       |                |        |   |        |
|  | E 200 Kompressor   | 1135   | 04.06  | 10.09  |   |  |  |  |       |                |        |   |        |
|  | E 220 CDI  | 11   | 03.03  | 10.09  |   |  |  |  |       |                |        |   |        |
|  | E 220 CDI  | 1125   | 04.06  | 10.09  |   |  |  |  |       |                |        |   |        |
|  | E 230  | 1150   | 05.07  | 10.09  |   |  |  |  |       |                |        |   |        |
|  | E 240  | 1130   | 03.03  | 10.09  |   |  |  |  |       |                |        |   |        |
|  | E 240 4-matic  | 1130   | 07.03  | 10.09  |   |  |  |  |       |                |        |   |        |
|  | E 270 CDI  | 1120   | 03.03  | 10.09  |   |  |  |  |       |                |        |   |        |
|  | E 270 CDI  | 1130   | 03.03  | 10.09  |   |  |  |  |       |                |        |   |        |
|  | E 280  | 1170   | 05.05  | 10.09  |   |  |  |  |       |                |        |   |        |
|  | E 280 4-matic  | 1170   | 05.05  | 10.09  |   |  |  |  |       |                |        |   |        |
|  | E 280 CDI  | 1130   | 05.04  | 10.09  |   |  |  |  |       |                |        |   |        |
|  | E 320  | 1165   | 03.03  | 10.09  |   |  |  |  |       |                |        |   |        |
|  | E 320 4-matic  | 1165   | 07.03  | 10.09  |   |  |  |  |       |                |        |   |        |
|  | E 320 CDI  | 1150   | 03.03  | 10.09  |   |  |  |  |       |                |        |   |        |
|  | E 320 CDI 4-matic  | 1165   | 05.05  | 10.09  |   |  |  |  |       |                |        |   |        |
|  | E 350  | 1200   | 12.04  | 10.09  |   |  |  |  |       |                |        |   |        |
| E 350 4-matic  | 1200   | 12.04  | 10.09  |  |   |  |  |  |       |                |        |   |        |
| E 350 CGI  | 1215   | 05.06  | 10.09  |  |   |  |  |  |       |                |        |   |        |

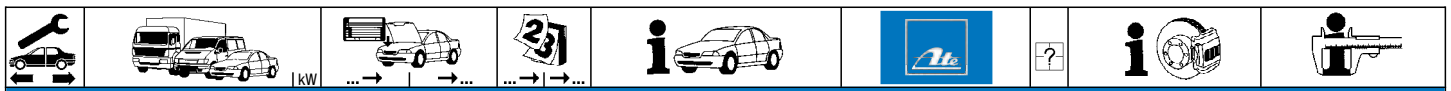

**MERCEDES BENZ E-Klasse (S211) Kombi (03-09)**

|  |                     |      |  |       |       |                |        |                          |  |        |
|--|---------------------|------|--|-------|-------|----------------|--------|--------------------------|--|--------|
|  | E 500               | ↳225 |  | 10.03 | 10.09 | 24.3727-0449.2 | 580449 | <input type="checkbox"/> |  | L=1742 |
|  | E 500               | ↳285 |  | 04.06 | 10.09 | 24.3727-0448.2 | 580448 | <input type="checkbox"/> |  | L=1726 |
|  | E 500 4-matic       | ↳225 |  | 10.03 | 10.09 |                |        |                          |  |        |
|  | E 500 4-matic       | ↳285 |  | 04.06 | 10.09 |                |        |                          |  |        |
|  | E 55 Kompressor AMG | ↳350 |  | 07.03 | 10.09 |                |        |                          |  |        |
|  | E 63 AMG            | ↳378 |  | 03.06 | 10.09 |                |        |                          |  |        |

**MERCEDES BENZ E-Klasse (W212) Limousine (09-)**

|  |                       |      |          |       |  |                |        |                          |  |                |     |
|--|-----------------------|------|----------|-------|--|----------------|--------|--------------------------|--|----------------|-----|
|  | E 200 CDI             | ↳100 |          | 03.09 |  | 03.2126-3146.3 | 010936 |                          |  | THz 26,99      | ATE |
|  | E 200 CGI             | ↳135 |          | 08.09 |  |                |        |                          |  |                |     |
|  | E 200 NGT             | ↳120 |          | 03.09 |  |                |        |                          |  |                |     |
|  | E 220 CDI             | ↳    |          | 03.09 |  |                |        |                          |  |                |     |
|  | E 250                 | ↳    |          | 03.09 |  |                |        |                          |  |                |     |
|  | E 250 CDI             | ↳150 |          | 03.09 |  |                |        |                          |  |                |     |
|  | E 250 CDI 4-matic     | ↳150 |          | 03.09 |  |                |        |                          |  |                |     |
|  | E 250 CGI             | ↳150 |          | 01.09 |  |                |        |                          |  |                |     |
|  | E 300                 | ↳170 |          | 03.09 |  |                |        |                          |  |                |     |
|  | E 300 BE 4-matic      | ↳185 |          | 07.11 |  |                |        |                          |  |                |     |
|  | E 300 BlueEfficiency  | ↳185 |          | 07.11 |  |                |        |                          |  |                |     |
|  | E 300 CDI             | ↳    |          | 04.11 |  |                |        |                          |  |                |     |
|  | E 350                 | ↳200 |          | 03.09 |  |                |        |                          |  |                |     |
|  | E 350                 | ↳225 |          | 09.11 |  |                |        |                          |  |                |     |
|  | E 350 4-matic         | ↳200 |          | 03.09 |  |                |        |                          |  |                |     |
|  | E 350 4-matic         | ↳225 |          | 09.11 |  |                |        |                          |  |                |     |
|  | E 350 Bluetec         | ↳155 |          | 03.09 |  |                |        |                          |  |                |     |
|  | E 350 BlueTec         | ↳185 |          | 01.13 |  |                |        |                          |  |                |     |
|  | E 350 BlueTec 4-matic | ↳185 |          | 01.13 |  |                |        |                          |  |                |     |
|  | E 350 CDI             | ↳170 |          | 03.09 |  |                |        |                          |  |                |     |
|  | E 350 CDI             | ↳195 |          | 03.11 |  |                |        |                          |  |                |     |
|  | E 350 CDI 4-matic     | ↳170 |          | 03.09 |  |                |        |                          |  |                |     |
|  | E 350 CDI 4-matic     | ↳195 |          | 03.11 |  |                |        |                          |  |                |     |
|  | E 350 CGI             | ↳215 |          | 03.09 |  |                |        |                          |  |                |     |
|  | E 400                 | ↳245 |          | 01.13 |  |                |        |                          |  |                |     |
|  | E 400 4-matic         | ↳245 |          | 01.13 |  |                |        |                          |  |                |     |
|  | E 500                 | ↳285 |          | 03.09 |  |                |        |                          |  |                |     |
|  | E 500                 | ↳300 |          | 09.11 |  |                |        |                          |  |                |     |
|  | E 500 4-matic         | ↳285 |          | 03.09 |  |                |        |                          |  |                |     |
|  | E 500 4-matic         | ↳300 |          | 09.11 |  |                |        |                          |  |                |     |
|  | E 63 AMG              | ↳386 |          | 02.11 |  |                |        |                          |  |                |     |
|  | E 63 AMG              | ↳386 |          | 03.09 |  |                |        |                          |  |                |     |
|  | E 63 AMG              | ↳410 |          | 02.11 |  |                |        |                          |  |                |     |
|  | E 63 AMG 4-matic      | ↳410 |          | 02.11 |  |                |        |                          |  |                |     |
|  | E 63 AMG S            | ↳430 |          | 04.13 |  |                |        |                          |  |                |     |
|  | E 63 AMG S 4-matic    | ↳430 |          | 04.13 |  |                |        |                          |  |                |     |
|  | E 200 CDI             | 100  |          | 03.09 |  | 11.9426-9990.2 | 220640 | <input type="checkbox"/> |  | D=42, - Halter | ATE |
|  | E 200 CGI             | 135  |          | 08.09 |  | 11.9426-9989.2 | 220639 | <input type="checkbox"/> |  | D=42, - Halter | ATE |
|  | E 200 NGT             | 120  |          | 03.09 |  | 11.0101-5407.2 | 260011 |                          |  | Hülsensatz     | ATE |
|  | E 220 CDI             |      | A 007599 |       |  | 11.8171-0008.1 | 990049 |                          |  | Führungsbolzen | ATE |
|  | E 220 CDI             |      |          | 03.09 |  | 11.8116-0087.2 | 390607 | 2                        |  | Haltefeder     | ATE |
|  | E 250                 |      |          | 03.09 |  |                |        |                          |  |                |     |
|  | E 250 CDI 4-matic     | 150  |          | 03.09 |  |                |        |                          |  |                |     |
|  | E 250 CGI             | 150  |          | 01.09 |  |                |        |                          |  |                |     |
|  | E 250 CDI             | 150  | A 007598 | 03.09 |  | 11.9426-9992.2 | 220642 | <input type="checkbox"/> |  | D=42, - Halter | ATE |
|  | E 300                 | 170  |          | 03.09 |  | 11.9426-9991.2 | 220641 | <input type="checkbox"/> |  | D=42, - Halter | ATE |
|  | E 300 BE 4-matic      | 185  |          | 07.11 |  | 11.0101-5407.2 | 260011 |                          |  | Hülsensatz     | ATE |
|  | E 300 BlueEfficiency  | 185  |          | 07.11 |  | 11.8171-0008.1 | 990049 |                          |  | Führungsbolzen | ATE |
|  | E 300 BlueTec Hybrid  | 150  |          | 06.12 |  | 11.8116-0087.2 | 390607 | 2                        |  | Haltefeder     | ATE |
|  | E 300 CDI             |      |          | 04.11 |  |                |        |                          |  |                |     |
|  | E 350                 | 200  |          | 03.09 |  |                |        |                          |  |                |     |
|  | E 350                 | 225  |          | 09.11 |  |                |        |                          |  |                |     |
|  | E 350 4-matic         | 200  |          | 03.09 |  |                |        |                          |  |                |     |
|  | E 350 4-matic         | 225  |          | 09.11 |  |                |        |                          |  |                |     |
|  | E 350 Bluetec         | 155  |          | 03.09 |  |                |        |                          |  |                |     |
|  | E 350 BlueTec         | 185  |          | 01.13 |  |                |        |                          |  |                |     |
|  | E 350 BlueTec 4-matic | 185  |          | 01.13 |  |                |        |                          |  |                |     |
|  | E 350 CDI             | 170  |          | 03.09 |  |                |        |                          |  |                |     |
|  | E 350 CDI             | 195  |          | 03.11 |  |                |        |                          |  |                |     |
|  | E 350 CDI 4-matic     | 170  |          | 03.09 |  |                |        |                          |  |                |     |
|  | E 350 CDI 4-matic     | 195  |          | 03.11 |  |                |        |                          |  |                |     |
|  | E 350 CGI             | 215  |          | 03.09 |  |                |        |                          |  |                |     |
|  | E 400                 | 245  |          | 01.13 |  |                |        |                          |  |                |     |
|  | E 400 4-matic         | 245  |          | 01.13 |  |                |        |                          |  |                |     |
|  | E 400 Hybrid          |      |          | 06.12 |  |                |        |                          |  |                |     |
|  | E 500                 | 285  |          | 03.09 |  | 11.9426-9959.2 | 220801 | <input type="checkbox"/> |  | D=42, - Halter | ATE |
|  | E 500                 | 300  |          | 09.11 |  | 11.9426-9960.2 | 220802 | <input type="checkbox"/> |  | D=42, - Halter | ATE |
|  | E 500 4-matic         | 285  |          | 03.09 |  | 11.8171-0008.1 | 990049 |                          |  | Führungsbolzen | ATE |
|  | E 500 4-matic         | 300  |          | 09.11 |  | 11.0101-5407.2 | 260011 |                          |  | Hülsensatz     | ATE |
|  |                       |      |          |       |  | 11.8116-0087.2 | 390607 | 2                        |  | Haltefeder     | ATE |

**MERCEDES BENZ E-Klasse (S212) Kombi (09-)**

|  |                   |      |  |       |  |                |        |  |  |           |     |
|--|-------------------|------|--|-------|--|----------------|--------|--|--|-----------|-----|
|  | E 200             | ↳135 |  | 03.13 |  | 03.2126-3146.3 | 010936 |  |  | THz 26,99 | ATE |
|  | E 200 CDI         | ↳100 |  | 11.09 |  |                |        |  |  |           |     |
|  | E 200 CGI         | ↳135 |  | 11.09 |  |                |        |  |  |           |     |
|  | E 220 CDI         | ↳125 |  | 11.09 |  |                |        |  |  |           |     |
|  | E 250             | ↳155 |  | 03.13 |  |                |        |  |  |           |     |
|  | E 250 CDI         | ↳150 |  | 11.09 |  |                |        |  |  |           |     |
|  | E 250 CDI 4-matic | ↳150 |  | 07.10 |  |                |        |  |  |           |     |



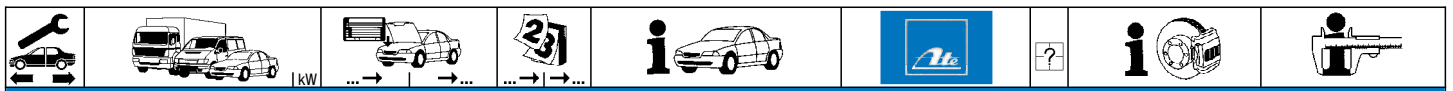

**MERCEDES BENZ E-Klasse (S212) Kombi (09-)**

|  |                       |     |       |                |        |   |  |                |     |
|--|-----------------------|-----|-------|----------------|--------|---|--|----------------|-----|
|  | E 250 CGI             | 150 | 11.09 | 03.2126-3146.3 | 010936 |   |  | THz 26,99      | ATE |
|  | E 300                 | 185 | 07.11 |                |        |   |  |                |     |
|  | E 300 4-matic         | 185 | 07.11 |                |        |   |  |                |     |
|  | E 300 CDI             | 150 | 03.11 |                |        |   |  |                |     |
|  | E 350                 | 200 | 11.09 |                |        |   |  |                |     |
|  | E 350                 | 225 | 09.11 |                |        |   |  |                |     |
|  | E 350 4-matic         | 200 | 11.09 |                |        |   |  |                |     |
|  | E 350 4-matic         | 225 | 09.11 |                |        |   |  |                |     |
|  | E 350 BlueTec         | 155 | 11.09 |                |        |   |  |                |     |
|  | E 350 BlueTec         | 185 | 01.13 |                |        |   |  |                |     |
|  | E 350 BlueTec 4-matic | 185 | 01.13 |                |        |   |  |                |     |
|  | E 350 CDI             | 170 | 11.09 |                |        |   |  |                |     |
|  | E 350 CDI             | 195 | 07.11 |                |        |   |  |                |     |
|  | E 350 CDI 4-matic     | 170 | 11.09 |                |        |   |  |                |     |
|  | E 350 CDI 4-matic     | 195 | 07.11 |                |        |   |  |                |     |
|  | E 350 CGI             | 215 | 11.09 |                |        |   |  |                |     |
|  | E 400                 | 245 | 01.13 |                |        |   |  |                |     |
|  | E 400 4-matic         | 245 | 01.13 |                |        |   |  |                |     |
|  | E 500                 | 285 | 11.09 |                |        |   |  |                |     |
|  | E 500                 | 300 | 09.11 |                |        |   |  |                |     |
|  | E 500 4-matic         | 300 | 09.11 |                |        |   |  |                |     |
|  | E 63 AMG              | 386 | 11.09 |                |        |   |  |                |     |
|  | E 63 AMG              | 386 | 02.11 |                |        |   |  |                |     |
|  | E 63 AMG              | 410 | 02.11 |                |        |   |  |                |     |
|  | E 63 AMG 4-matic      | 410 | 02.11 |                |        |   |  |                |     |
|  | E 63 AMG S            | 430 | 04.13 |                |        |   |  |                |     |
|  | E 63 AMG S 4-matic    | 430 | 04.13 |                |        |   |  |                |     |
|  | E 200                 | 135 | 03.13 | 11.9426-9990.2 | 220640 | ☐ |  | D=42, - Halter | ATE |
|  | E 200 CDI             | 100 | 11.09 | 11.9426-9989.2 | 220639 | ☐ |  | D=42, - Halter | ATE |
|  | E 200 CGI             | 135 | 11.09 | 11.0101-5407.2 | 260011 |   |  | Hülzensatz     | ATE |
|  | E 220 CDI             | 125 | 11.09 | 11.8116-0087.2 | 390607 | 2 |  | Haltefeder     | ATE |
|  | E 250                 | 155 | 03.13 |                |        |   |  |                |     |
|  | E 250 CDI             | 150 | 11.09 |                |        |   |  |                |     |
|  | E 250 CDI 4-matic     | 150 | 07.10 |                |        |   |  |                |     |
|  | E 250 CGI             | 150 | 11.09 |                |        |   |  |                |     |
|  | E 300                 | 185 | 07.11 | 11.9426-9992.2 | 220642 | ☐ |  | D=42, - Halter | ATE |
|  | E 300 4-matic         | 185 | 07.11 | 11.9426-9991.2 | 220641 | ☐ |  | D=42, - Halter | ATE |
|  | E 300 BlueTec Hybrid  | 150 | 06.12 | 11.8171-0008.1 | 990049 |   |  | Führungsbolzen | ATE |
|  | E 300 CDI             | 150 | 03.11 | 11.0101-5407.2 | 260011 |   |  | Hülzensatz     | ATE |
|  | E 350                 | 200 | 11.09 | 11.8116-0087.2 | 390607 | 2 |  | Haltefeder     | ATE |
|  | E 350                 | 225 | 09.11 |                |        |   |  |                |     |
|  | E 350 4-matic         | 200 | 11.09 |                |        |   |  |                |     |
|  | E 350 4-matic         | 225 | 09.11 |                |        |   |  |                |     |
|  | E 350 BlueTec         | 155 | 11.09 |                |        |   |  |                |     |
|  | E 350 BlueTec         | 185 | 01.13 |                |        |   |  |                |     |
|  | E 350 BlueTec 4-matic | 185 | 01.13 |                |        |   |  |                |     |
|  | E 350 CDI             | 170 | 11.09 |                |        |   |  |                |     |
|  | E 350 CDI             | 195 | 07.11 |                |        |   |  |                |     |
|  | E 350 CDI 4-matic     | 170 | 11.09 |                |        |   |  |                |     |
|  | E 350 CDI 4-matic     | 195 | 07.11 |                |        |   |  |                |     |
|  | E 350 CGI             | 215 | 11.09 |                |        |   |  |                |     |
|  | E 400                 | 245 | 01.13 |                |        |   |  |                |     |
|  | E 400 4-matic         | 245 | 01.13 |                |        |   |  |                |     |
|  | E 500                 | 285 | 11.09 | 11.9426-9959.2 | 220801 | ☐ |  | D=42, - Halter | ATE |
|  | E 500                 | 300 | 09.11 | 11.9426-9960.2 | 220802 | ☐ |  | D=42, - Halter | ATE |
|  | E 500 4-matic         | 300 | 09.11 | 11.8116-0087.2 | 390607 | 2 |  | Haltefeder     | ATE |
|  |                       |     |       | 11.8171-0008.1 | 990049 |   |  | Führungsbolzen | ATE |
|  |                       |     |       | 11.0101-5407.2 | 260011 |   |  | Hülzensatz     | ATE |













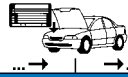

**MERCEDES BENZ E-Klasse (C207) Coupe (09-)**

|  |               |     |       |                |        |  |                                   |                 |     |
|--|---------------|-----|-------|----------------|--------|--|-----------------------------------|-----------------|-----|
|  | E 200         | 135 | 03.13 | 03.7745-6302.4 | 300261 |  | - Start/Stop-Anlage <sup>1)</sup> | 8"              | ATE |
|  | E 200 CGI     | 135 | 09.09 |                |        |  |                                   |                 |     |
|  | E 220 CDI     | 125 | 05.09 |                |        |  |                                   |                 |     |
|  | E 250         | 155 | 03.13 |                |        |  |                                   |                 |     |
|  | E 250 CDI     | 150 | 05.09 |                |        |  |                                   |                 |     |
|  | E 250 CGI     | 150 | 05.09 |                |        |  |                                   |                 |     |
|  | E 300 CGI     | 185 | 04.11 |                |        |  |                                   |                 |     |
|  | E 350         | 225 | 09.09 |                |        |  |                                   |                 |     |
|  | E 350 BlueTec | 185 | 01.13 |                |        |  |                                   |                 |     |
|  | E 350 CDI     | 170 | 05.09 |                |        |  |                                   |                 |     |
|  | E 350 CDI     | 195 | 04.11 |                |        |  |                                   |                 |     |
|  | E 350 CGI     | 215 | 05.09 |                |        |  |                                   |                 |     |
|  | E 400         | 245 | 03.13 |                |        |  |                                   |                 |     |
|  | E 500         | 285 | 05.09 |                |        |  |                                   |                 |     |
|  | E 500         | 300 | 06.13 |                |        |  |                                   |                 |     |
|  | E 550 CGI     | 300 | 09.11 |                |        |  |                                   |                 |     |
|  | E 200         | 135 | 03.13 | 03.2025-2301.3 | 010895 |  |                                   | THz 25,40/22,20 | ATE |
|  | E 200 CGI     | 135 | 09.09 |                |        |  |                                   |                 |     |
|  | E 220 CDI     | 125 | 05.09 |                |        |  |                                   |                 |     |
|  | E 250         | 155 | 03.13 |                |        |  |                                   |                 |     |
|  | E 250 CDI     | 150 | 05.09 |                |        |  |                                   |                 |     |
|  | E 250 CGI     | 150 | 05.09 |                |        |  |                                   |                 |     |
|  | E 300 CGI     | 185 | 04.11 |                |        |  |                                   |                 |     |
|  | E 350         | 225 | 09.09 |                |        |  |                                   |                 |     |
|  | E 350 BlueTec | 185 | 01.13 |                |        |  |                                   |                 |     |
|  | E 350 CDI     | 170 | 05.09 |                |        |  |                                   |                 |     |
|  | E 350 CDI     | 195 | 04.11 |                |        |  |                                   |                 |     |













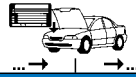

<sup>1)</sup> - idling stop system / - dispositivo start/stop / - unité marche/arrêt / - unidad arranque/paro

















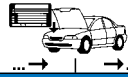





| MERCEDES BENZ E-Klasse (C207) Coupe (09-)  |  |  |  |  |   |  |  |  |                 |     |
|--|--|--|--|--|---|--|--|--|-----------------|-----|
|     |  |  |  |  |  |  |  |  |                 |     |
|    | E 350 CGI  | 215  | 05.09  |  | 03.2025-2301.3  | 010895   |  |  | ThZ 25,40/22,20 | ATE |
|  | E 400  | 245  | 03.13  |  |   |  |  |  |                 |     |
|  | E 500  | 285  | 05.09  |  |   |  |  |  |                 |     |
|  | E 500  | 300  | 06.13  |  |   |  |  |  |                 |     |
|  | E 550 CGI  | 300  | 09.11  |  |   |  |  |  |                 |     |
|    | E 200  | 135  | 03.13  |  | 83.7705-0386.3  | 330828   | 2  |  | L=385           |     |
|  | E 200 CGI  | 135  | 09.09  |  |   |  |  |  |                 |     |
|  | E 220 CDI  | 125  | 05.09  |  |   |  |  |  |                 |     |
|  | E 250  | 155  | 03.13  |  |   |  |  |  |                 |     |
|  | E 250 CDI  | 150  | 05.09  |  |   |  |  |  |                 |     |
|  | E 250 CGI  | 150  | 05.09  |  |   |  |  |  |                 |     |
|  | E 300 CGI  | 185  | 04.11  |  |   |  |  |  |                 |     |
|  | E 350  | 225  | 09.09  |  |   |  |  |  |                 |     |
|  | E 350 BlueTec  | 185  | 01.13  |  |   |  |  |  |                 |     |
|  | E 350 CDI  | 170  | 05.09  |  |   |  |  |  |                 |     |
|  | E 350 CDI  | 195  | 04.11  |  |   |  |  |  |                 |     |
|  | E 350 CGI  | 215  | 05.09  |  |   |  |  |  |                 |     |
|  | E 400  | 245  | 03.13  |  |   |  |  |  |                 |     |
|  | E 500  | 285  | 05.09  |  |   |  |  |  |                 |     |
|  | E 500  | 300  | 06.13  |  |   |  |  |  |                 |     |
|  | E 550 CGI  | 300  | 09.11  |  |   |  |  |  |                 |     |
|    | E 300 CGI  | 185  | 04.11  |  | 11.9406-9961.2  | 220951   | 2  | + ALU-Sättel <sup>1)</sup>   | D=40, - Halter  | ATE |
|  | E 350  | 225  | 09.09  |  | 11.9406-9962.2  | 220952   |  | + ALU-Sättel <sup>1)</sup>   | D=40, - Halter  | ATE |
|  | E 350 BlueTec  | 185  | 01.13  |  | 11.8116-0340.1  | 390595   |  |  | Haltefeder      | ATE |
|  | E 350 CDI  | 170  | 05.09  |  | 11.0101-5407.2  | 260011   |  |  | Hülzensatz      | ATE |
|  | E 350 CDI  | 195  | 04.11  |  | 11.8171-0008.1  | 990049   |  |  | Führungsbolzen  | ATE |
|  | E 350 CGI  | 215  | 05.09  |  |   |  |  |  |                 |     |
|  | E 500  | 285  | 05.09  |  |   |  |  |  |                 |     |
|  | E 500  | 300  | 06.13  |  |   |  |  |  |                 |     |
|  | E 550 CGI  | 300  | 09.11  |  |   |  |  |  |                 |     |
|  | E 200 CGI  | 135  | 09.09  |  | 11.9386-9991.2  | 220949   |  | + ALU-Sättel <sup>1)</sup>   | D=38, - Halter  | ATE |
|  | E 220 CDI  | 125  | 05.09  |  | 11.9386-9992.2  | 220950   |  | + ALU-Sättel <sup>1)</sup>   | D=38, - Halter  | ATE |
|  | E 250 CDI  | 150  | 05.09  |  | 11.8116-0340.1  | 390595   | 2  |  | Haltefeder      | ATE |
|  | E 250 CGI  | 150  | 05.09  |  |   |  |  |  |                 |     |
|  | E 200  | 135  | 03.13  |  | 11.9386-9991.2  | 220949   |  |  | D=38, - Halter  | ATE |
|  | E 250  | 155  | 03.13  |  | 11.9386-9992.2  | 220950   |  |  | D=38, - Halter  | ATE |
|  |  |  |  |  | 11.0101-5407.2  | 260011   |  |  | Hülzensatz      | ATE |
|  |  |  |  |  | 11.8116-0340.1  | 390595   | 2  |  | Haltefeder      | ATE |
|  | E 400  | 245  | 03.13  |  | 11.9406-9961.2  | 220951   |  |  | D=40, - Halter  | ATE |
|  |  |  |  |  | 11.9406-9962.2  | 220952   |  |  | D=40, - Halter  | ATE |
|  |  |  |  |  | 11.0101-5407.2  | 260011   |  |  | Hülzensatz      | ATE |
|  |  |  |  |  | 11.8116-0340.1  | 390595   | 2  |  | Haltefeder      | ATE |
|  | E 200  | 135  | 03.13  |  | 83.7715-0299.3  | 331117   | 2  |  | L=300           |     |
|  | E 200 CGI  | 135  | 09.09  |  |   |  |  |  |                 |     |
|  | E 220 CDI  | 125  | 05.09  |  |   |  |  |  |                 |     |
|  | E 250  | 155  | 03.13  |  |   |  |  |  |                 |     |
|  | E 250 CDI  | 150  | 05.09  |  |   |  |  |  |                 |     |
|  | E 250 CGI  | 150  | 05.09  |  |   |  |  |  |                 |     |
|  | E 300 CGI  | 185  | 04.11  |  |   |  |  |  |                 |     |
|  | E 350  | 225  | 09.09  |  |   |  |  |  |                 |     |
|  | E 350 BlueTec  | 185  | 01.13  |  |   |  |  |  |                 |     |
|  | E 350 CDI  | 170  | 05.09  |  |   |  |  |  |                 |     |
|  | E 350 CDI  | 195  | 04.11  |  |   |  |  |  |                 |     |
|  | E 350 CGI  | 215  | 05.09  |  |   |  |  |  |                 |     |
|  | E 400  | 245  | 03.13  |  |   |  |  |  |                 |     |
|  | E 500  | 285  | 05.09  |  |   |  |  |  |                 |     |
|  | E 500  | 300  | 06.13  |  |   |  |  |  |                 |     |
|  | E 550 CGI  | 300  | 09.11  |  |   |  |  |  |                 |     |
|  | E 200  | 135  | 03.13  |  | 24.3727-0465.2  | 580465   | 1  | ↑  | L=2057          |     |
|  | E 200 CGI  | 135  | 09.09  |  | 24.3727-0470.2  | 580470   | 1  | □  | L=1152          |     |
|  | E 220 CDI  | 125  | 05.09  |  | 24.3727-0467.2  | 580467   | 2  | ↓  | L=728           |     |
|  | E 250  | 155  | 03.13  |  |   |  |  |  |                 |     |
|  | E 250 CDI  | 150  | 05.09  |  |   |  |  |  |                 |     |
|  | E 250 CGI  | 150  | 05.09  |  |   |  |  |  |                 |     |
|  | E 300 CGI  | 185  | 04.11  |  |   |  |  |  |                 |     |
|  | E 350  | 225  | 09.09  |  |   |  |  |  |                 |     |
|  | E 350 BlueTec  | 185  | 01.13  |  |   |  |  |  |                 |     |
|  | E 350 CDI  | 170  | 05.09  |  |   |  |  |  |                 |     |
|  | E 350 CDI  | 195  | 04.11  |  |   |  |  |  |                 |     |
|  | E 350 CGI  | 215  | 05.09  |  |   |  |  |  |                 |     |
|  | E 400  | 245  | 03.13  |  |   |  |  |  |                 |     |
|  | E 500  | 285  | 05.09  |  |   |  |  |  |                 |     |
|  | E 500  | 300  | 06.13  |  |   |  |  |  |                 |     |
|  | E 550 CGI  | 300  | 09.11  |  |   |  |  |  |                 |     |
|  | E 200  | 135  | 03.13  |  | 24.3727-0470.2  | 580470   | 1  | □  | L=1152          |     |
|  | E 200 CGI  | 135  | 09.09  |  | 24.3727-0467.2  | 580467   | 2  | ↓  | L=728           |     |
|  | E 220 CDI  | 125  | 05.09  |  |   |  |  |  |                 |     |
|  | E 250  | 155  | 03.13  |  |   |  |  |  |                 |     |
|  | E 250 CDI  | 150  | 05.09  |  |   |  |  |  |                 |     |
|  | E 250 CGI  | 150  | 05.09  |  |   |  |  |  |                 |     |
|  | E 300 CGI  | 185  | 04.11  |  |   |  |  |  |                 |     |
|  | E 350  | 225  | 09.09  |  |   |  |  |  |                 |     |
|  | E 350 BlueTec  | 185  | 01.13  |  |   |  |  |  |                 |     |
|  | E 350 CDI  | 170  | 05.09  |  |   |  |  |  |                 |     |
|  | E 350 CDI  | 195  | 04.11  |  |   |  |  |  |                 |     |
|  | E 350 CGI  | 215  | 05.09  |  |   |  |  |  |                 |     |
|  | E 400  | 245  | 03.13  |  |   |  |  |  |                 |     |

<sup>1)</sup> + aluminium calipers / + pinze in alluminio / + étriers en aluminium / + pinzas de aluminio

| MERCEDES BENZ E-Klasse (C207) Coupe (09-)  |  |  |  |  |   |  |  |  |                     |
|--|--|--|--|--|---|--|--|--|---------------------|
|     |  |  |  |  |  |  |  |  |                     |
|  | E 500  | 285  | 05.09  |  | 24.3727-0470.2  | 580470   | 1  |  | L=1152              |
|  | E 500  | 300  | 06.13  |  | 24.3727-0467.2  | 580467   | 2  |  | L=728               |
|  | E 550 CGI  | 300  | 09.11  |  |   |  |  |  |                     |
| MERCEDES BENZ E-Klasse (A207) Cabrio (10-)   |  |  |  |  |   |  |  |  |                     |
|    | E 200  | 135  | 03.13  |  | 03.7745-6302.4  | 300261   |  | - Start/Stop-Anlage <sup>1)</sup>  | 8" ATE              |
|  | E 200 CGI  | 135  | 03.10  |  |   |  |  |  |                     |
|  | E 220 CDI  | 125  | 03.10  |  |   |  |  |  |                     |
|  | E 250  | 155  | 03.13  |  |   |  |  |  |                     |
|  | E 250 CDI  | 150  | 03.10  |  |   |  |  |  |                     |
|  | E 250 CGI  | 150  | 03.10  |  |   |  |  |  |                     |
|  | E 300 CGI  | 185  | 03.10  |  |   |  |  |  |                     |
|  | E 350  | 225  | 04.11  |  |   |  |  |  |                     |
|  | E 350 BlueTec  | 185  | 01.13  |  |   |  |  |  |                     |
|  | E 350 CDI  | 170  | 03.10  |  |   |  |  |  |                     |
|  | E 350 CDI  | 195  | 04.11  |  |   |  |  |  |                     |
|  | E 350 CGI  | 215  | 03.10  |  |   |  |  |  |                     |
|  | E 400  | 245  | 03.13  |  |   |  |  |  |                     |
|  | E 500  | 285  | 03.10  |  |   |  |  |  |                     |
|  | E 500  | 300  | 06.13  |  |   |  |  |  |                     |
|  | E 550 CGI  | 300  | 09.11  |  |   |  |  |  |                     |
|    | E 200  | 135  | 03.13  |  | 03.2025-2301.3  | 010895   |  |  | Thz 25,40/22,20 ATE |
|  | E 200 CGI  | 135  | 03.10  |  |   |  |  |  |                     |
|  | E 220 CDI  | 125  | 03.10  |  |   |  |  |  |                     |
|  | E 250  | 155  | 03.13  |  |   |  |  |  |                     |
|  | E 250 CDI  | 150  | 03.10  |  |   |  |  |  |                     |
|  | E 250 CGI  | 150  | 03.10  |  |   |  |  |  |                     |
|  | E 300 CGI  | 185  | 03.10  |  |   |  |  |  |                     |
|  | E 350  | 225  | 04.11  |  |   |  |  |  |                     |
|  | E 350 BlueTec  | 185  | 01.13  |  |   |  |  |  |                     |
|  | E 350 CDI  | 170  | 03.10  |  |   |  |  |  |                     |
|  | E 350 CDI  | 195  | 04.11  |  |   |  |  |  |                     |
|  | E 350 CGI  | 215  | 03.10  |  |   |  |  |  |                     |
|  | E 400  | 245  | 03.13  |  |   |  |  |  |                     |
|  | E 500  | 285  | 03.10  |  |   |  |  |  |                     |
|  | E 500  | 300  | 06.13  |  |   |  |  |  |                     |
|  | E 550 CGI  | 300  | 09.11  |  |   |  |  |  |                     |
|   | E 200  | 135  | 03.13  |  | 83.7705-0386.3  | 330828   | 2  |  | L=385               |
|  | E 200 CGI  | 135  | 03.10  |  |   |  |  |  |                     |
|  | E 220 CDI  | 125  | 03.10  |  |   |  |  |  |                     |
|  | E 250  | 155  | 03.13  |  |   |  |  |  |                     |
|  | E 250 CDI  | 150  | 03.10  |  |   |  |  |  |                     |
|  | E 250 CGI  | 150  | 03.10  |  |   |  |  |  |                     |
|  | E 300 CGI  | 185  | 03.10  |  |   |  |  |  |                     |
|  | E 350  | 225  | 04.11  |  |   |  |  |  |                     |
|  | E 350 BlueTec  | 185  | 01.13  |  |   |  |  |  |                     |
|  | E 350 CDI  | 170  | 03.10  |  |   |  |  |  |                     |
|  | E 350 CDI  | 195  | 04.11  |  |   |  |  |  |                     |
|  | E 350 CGI  | 215  | 03.10  |  |   |  |  |  |                     |
|  | E 400  | 245  | 03.13  |  |   |  |  |  |                     |
|  | E 500  | 285  | 03.10  |  |   |  |  |  |                     |
|  | E 500  | 300  | 06.13  |  |   |  |  |  |                     |
|  | E 550 CGI  | 300  | 09.11  |  |   |  |  |  |                     |
|  | E 200 CGI  | 135  | 03.10  |  | 11.9386-9991.2  | 220949   |  | + ALU-Sättel <sup>2)</sup>   | D=38, - Halter ATE  |
|  | E 220 CDI  | 125  | 03.10  |  | 11.9386-9992.2  | 220950   |  | + ALU-Sättel <sup>2)</sup>   | D=38, - Halter ATE  |
|  | E 250 CDI  | 150  | 03.10  |  |   |  |  |  |                     |
|  | E 250 CGI  | 150  | 03.10  |  |   |  |  |  |                     |
|  | E 200  | 135  | 03.13  |  | 11.9386-9991.2  | 220949   |  |  | D=38, - Halter ATE  |
|  | E 250  | 155  | 03.13  |  | 11.9386-9992.2  | 220950   |  |  | D=38, - Halter ATE  |
|  |  |  |  |  | 11.0101-5407.2  | 260011   |  |  | Hülzensatz ATE      |
|  |  |  |  |  | 11.8116-0340.1  | 390595   | 2  |  | Haltefeder ATE      |
|  | E 300 CGI  | 185  | 03.10  |  | 11.9406-9961.2  | 220951   |  | + ALU-Sättel <sup>2)</sup>   | D=40, - Halter ATE  |
|  | E 350  | 225  | 04.11  |  | 11.9406-9962.2  | 220952   |  | + ALU-Sättel <sup>2)</sup>   | D=40, - Halter ATE  |
|  | E 350 BlueTec  | 185  | 01.13  |  | 11.0101-5407.2  | 260011   |  |  | Hülzensatz ATE      |
|  | E 350 CDI  | 170  | 03.10  |  | 11.8171-0008.1  | 990049   |  |  | Führungsbolzen ATE  |
|  | E 350 CDI  | 195  | 04.11  |  | 11.8116-0340.1  | 390595   | 2  |  | Haltefeder ATE      |
|  | E 350 CGI  | 215  | 03.10  |  |   |  |  |  |                     |
|  | E 500  | 285  | 03.10  |  |   |  |  |  |                     |
|  | E 500  | 300  | 06.13  |  |   |  |  |  |                     |
|  | E 550 CGI  | 300  | 09.11  |  |   |  |  |  |                     |
|  | E 400  | 245  | 03.13  |  | 11.9406-9961.2  | 220951   |  |  | D=40, - Halter ATE  |
|  |  |  |  |  | 11.9406-9962.2  | 220952   |  |  | D=40, - Halter ATE  |
|  |  |  |  |  | 11.0101-5407.2  | 260011   |  |  | Hülzensatz ATE      |
|  |  |  |  |  | 11.8171-0008.1  | 990049   |  |  | Führungsbolzen ATE  |
|  |  |  |  |  | 11.8116-0340.1  | 390595   | 2  |  | Haltefeder ATE      |
|  | E 200  | 135  | 03.13  |  | 83.7715-0299.3  | 331117   | 2  |  | L=300               |
|  | E 200 CGI  | 135  | 03.10  |  |   |  |  |  |                     |
|  | E 220 CDI  | 125  | 03.10  |  |   |  |  |  |                     |
|  | E 250  | 155  | 03.13  |  |   |  |  |  |                     |
|  | E 250 CDI  | 150  | 03.10  |  |   |  |  |  |                     |
|  | E 250 CGI  | 150  | 03.10  |  |   |  |  |  |                     |
|  | E 300 CGI  | 185  | 03.10  |  |   |  |  |  |                     |
|  | E 350  | 225  | 04.11  |  |   |  |  |  |                     |
|  | E 350 BlueTec  | 185  | 01.13  |  |   |  |  |  |                     |
|  | E 350 CDI  | 170  | 03.10  |  |   |  |  |  |                     |
|  | E 350 CDI  | 195  | 04.11  |  |   |  |  |  |                     |
|  | E 350 CGI  | 215  | 03.10  |  |   |  |  |  |                     |

<sup>1)</sup> - idling stop system / - dispositivo start/stop / - unité marche/arrêt / - unidad arranque/paro

<sup>2)</sup> + aluminium calipers / + pinze in alluminio / + étriers en aluminium / + pinzas de aluminio

|     |  |  |  |  |  |  |     |  |
|--|--|--|--|--|---|--|---|--|
| <b>MERCEDES BENZ E-Klasse (A207) Cabrio (10-)</b>                                  |  |  |  |  |   |  |   |  |
|    | E 400  | 245  | 03.13  |  | 83.7715-0299.3  | 331117   | 2   | L=300  |
|  | E 500  | 285  | 03.10  |  |   |  |   |  |
|  | E 500  | 300  | 06.13  |  |   |  |   |  |
|  | E 550 CGI  | 300  | 09.11  |  |   |  |   |  |
|    | E 200  | 1135   | 03.13  |  | 24.3727-0465.2  | 580465   | 1  | L=2057   |
|  | E 200 CGI  | 1135   | 03.10  |  | 24.3727-0470.2  | 580470   | 1  | L=1152   |
|  | E 220 CDI  | 1125   | 03.10  |  | 24.3727-0467.2  | 580467   | 2  | L=728  |
|  | E 250  | 1155   | 03.13  |  |   |  |   |  |
|  | E 250 CDI  | 1150   | 03.10  |  |   |  |   |  |
|  | E 250 CGI  | 1150   | 03.10  |  |   |  |   |  |
|  | E 300 CGI  | 1185   | 03.10  |  |   |  |   |  |
|  | E 350  | 1225   | 04.11  |  |   |  |   |  |
|  | E 350 BlueTec  | 1185   | 01.13  |  |   |  |   |  |
|  | E 350 CDI  | 1170   | 03.10  |  |   |  |   |  |
|  | E 350 CDI  | 1195   | 04.11  |  |   |  |   |  |
|  | E 350 CGI  | 1215   | 03.10  |  |   |  |   |  |
|  | E 400  | 1245   | 03.13  |  |   |  |   |  |
|  | E 500  | 1285   | 03.10  |  |   |  |   |  |
|  | E 500  | 1300   | 06.13  |  |   |  |   |  |
|  | E 550 CGI  | 1300   | 09.11  |  |   |  |   |  |
|  | E 200  | 1135   | 03.13  |  | 24.3727-0470.2  | 580470   | 1  | L=1152   |
|  | E 200 CGI  | 1135   | 03.10  |  | 24.3727-0467.2  | 580467   | 2  | L=728  |
|  | E 220 CDI  | 1125   | 03.10  |  |   |  |   |  |
|  | E 250  | 1155   | 03.13  |  |   |  |   |  |
|  | E 250 CDI  | 1150   | 03.10  |  |   |  |   |  |
|  | E 250 CGI  | 1150   | 03.10  |  |   |  |   |  |
|  | E 300 CGI  | 1185   | 03.10  |  |   |  |   |  |
|  | E 350  | 1225   | 04.11  |  |   |  |   |  |
|  | E 350 BlueTec  | 1185   | 01.13  |  |   |  |   |  |
|  | E 350 CDI  | 1170   | 03.10  |  |   |  |   |  |
|  | E 350 CDI  | 1195   | 04.11  |  |   |  |   |  |
|  | E 350 CGI  | 1215   | 03.10  |  |   |  |   |  |
|  | E 400  | 1245   | 03.13  |  |   |  |   |  |
|  | E 500  | 1285   | 03.10  |  |   |  |   |  |
|  | E 500  | 1300   | 06.13  |  |   |  |   |  |
|  | E 550 CGI  | 1300   | 09.11  |  |   |  |   |  |
| <b>MERCEDES BENZ G-Klasse (W463) (90-)</b>   |  |  |  |  |   |  |   |  |
|   | 200 GE   | 85   | 01.90  |  | 03.6855-1402.4  | 300057   |   | 9" Tandem ATE  |
|  | 230 GE   |  | 06.90  |  |   |  |   |  |
|  | 250 GD   |  | 06.90  |  |   |  |   |  |
|  | 300 GD   |  | 09.89  |  |   |  |   |  |
|  | 300 GE   |  | 06.90  |  |   |  |   |  |
|  | 350 G Turbo  |  | 09.91  |  |   |  |   |  |
|  | G 270 CDI  |  | 10.01  |  |   |  |   |  |
|  | G 300 TD   |  | 08.96  |  |   |  |   |  |
|  | G 320  |  | 09.94  |  |   |  |   |  |
|  | G 36 AMG   |  | 01.95  |  |   |  |   |  |
|  | G 400 CDI  |  | 12.00  |  |   |  |   |  |
|  | G 500  |  | 04.98  |  |   |  |   |  |
|  | G 500 E  |  | 09.93  |  |   |  |   |  |
|  | G 55 AMG   |  | 04.99  |  |   |  |   |  |
|  | 200 GE   | 85   | 01.90  |  | 03.6855-1902.4  | 300059   |   | 9" Tandem ATE  |
|  | 230 GE   |  | 06.90  |  |   |  |   |  |
|  | 250 GD   |  | 06.90  |  |   |  |   |  |
|  | 300 GD   |  | 09.89  |  |   |  |   |  |
|  | 300 GE   |  | 06.90  |  |   |  |   |  |
|  | 350 G Turbo  |  | 09.91  |  |   |  |   |  |
|  | G 270 CDI  |  | 10.01  |  |   |  |   |  |
|  | G 300 TD   |  | 08.96  |  |   |  |   |  |
|  | G 320  |  | 09.94  |  |   |  |   |  |
|  | G 36 AMG   |  | 01.95  |  |   |  |   |  |
|  | G 400 CDI  |  | 12.00  |  |   |  |   |  |
|  | G 500  |  | 04.98  |  |   |  |   |  |
|  | G 500 E  |  | 09.93  |  |   |  |   |  |
|  | G 55 AMG   |  | 04.99  |  |   |  |   |  |
|  | 200 GE   | 85   | 01.90  |  | 03.2125-2102.3  | 010207   | - ABS   | Thz 25,40 ATE  |
|  | 230 GE   |  | 06.90  |  |   |  |   |  |
|  | 250 GD   |  | 06.90  |  |   |  |   |  |
|  | 300 GD   |  | 09.89  |  |   |  |   |  |
|  | 300 GE   |  | 06.90  |  |   |  |   |  |
|  | 350 G Turbo  |  | 09.91  |  |   |  |   |  |
|  | G 270 CDI  |  | 10.01  |  |   |  |   |  |
|  | G 300 TD   |  | 08.96  |  |   |  |   |  |
|  | G 320  |  | 09.94  |  |   |  |   |  |
|  | G 36 AMG   |  | 01.95  |  |   |  |   |  |
|  | G 400 CDI  |  | 12.00  |  |   |  |   |  |
|  | G 500  |  | 04.98  |  |   |  |   |  |
|  | G 500 E  |  | 09.93  |  |   |  |   |  |
|  | G 55 AMG   |  | 04.99  |  |   |  |   |  |
|  | 200 GE   | 85   | 01.90  |  | 13.0441-4408.2  | 250096   | - belüftete Scheiben <sup>1)</sup>  | Dichtungssatz ATE  |
|  | 230 GE   |  | 06.90  |  |   |  |   |  |
|  | 250 GD   |  | 06.90  |  |   |  |   |  |
|  | 300 GD   |  | 09.89  |  |   |  |   |  |
|  | 300 GE   |  | 06.90  |  |   |  |   |  |
|  | 350 G Turbo  |  | 09.91  |  |   |  |   |  |
|  | G 270 CDI  |  | 10.01  |  |   |  |   |  |

<sup>1)</sup> - ventilated discs / - dischi ventilati / - disques ventilés / - disco ventilado

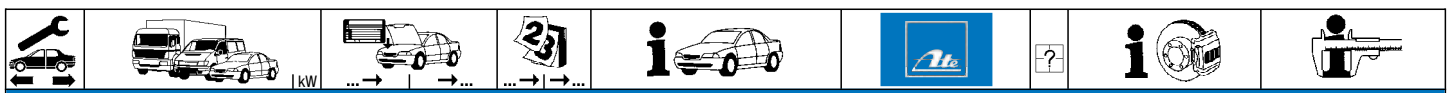

**MERCEDES BENZ G-Klasse (W463) (90-)**

|  |  |     |  |  |  |                            |   |                                    |                                  |     |
|--|--|-----|--|--|--|----------------------------|---|------------------------------------|----------------------------------|-----|
|  | G 300 TD<br>G 320<br>G 350 CDI BlueTec<br>G 36 AMG<br>G 400 CDI<br>G 500<br>G 500 E<br>G 55 AMG  |     | 08.96<br>09.94<br>06.10<br>01.95<br>12.00<br>04.98<br>09.93<br>04.99   |  | 13.0441-4408.2                                     | 250096                     |   | - belüftete Scheiben <sup>1)</sup> | Dichtungssatz                    | ATE |
|  | 200 GE<br>230 GE<br>250 GD<br>300 GD<br>300 GE<br>350 G Turbo<br>G 270 CDI<br>G 300 TD<br>G 320<br>G 36 AMG<br>G 400 CDI<br>G 500<br>G 500 E             | 85  | 01.90<br>06.90<br>06.90<br>09.89<br>06.90<br>09.91<br>10.01<br>08.96<br>09.94<br>01.95<br>12.00<br>04.98<br>09.93          |  | 24.5224-0460.3                                     | 331264                     | 2 |                                    | L=460                            |     |
|  | 230 GE<br>250 GD<br>300 GD<br>300 GE<br>350 G Turbo<br>G 270 CDI<br>G 300 TD<br>G 320<br>G 36 AMG<br>G 400 CDI<br>G 500<br>G 500 E                       |     | 06.90<br>06.90<br>09.89<br>06.90<br>09.91<br>10.01<br>08.96<br>09.94<br>01.95<br>12.00<br>04.98<br>09.93                   |  | 24.5165-0450.3                                     | 331259                     | 2 |                                    | L=450                            |     |
|  | G 320 CDI<br>G 350 CDI BlueTec<br>G 500  | 285 | 09.06<br>06.10<br>05.08  |  | 83.6104-0220.3                                     | 330474                     | 2 |                                    | L=220                            |     |
|  | 200 GE<br>230 GE<br>250 GD<br>300 GD<br>300 GE<br>350 G Turbo<br>G 270 CDI<br>G 300 TD<br>G 320<br>G 36 AMG<br>G 400 CDI<br>G 500<br>G 500 E<br>G 55 AMG | 85  | 01.90<br>06.90<br>06.90<br>09.89<br>06.90<br>09.91<br>10.01<br>08.96<br>09.94<br>01.95<br>12.00<br>04.98<br>09.93<br>04.99 |  | 24.3217-1109.3                                     | 020173                     |   |                                    | Rz 17,46                         |     |
|  | 200 GE<br>230 GE<br>250 GD<br>300 GD<br>300 GE<br>350 G Turbo<br>G 270 CDI<br>G 300 TD<br>G 320<br>G 36 AMG<br>G 400 CDI<br>G 500<br>G 500 E<br>G 55 AMG | 85  | 01.90<br>06.90<br>06.90<br>09.89<br>06.90<br>09.91<br>10.01<br>08.96<br>09.94<br>01.95<br>12.00<br>04.98<br>09.93<br>04.99 |  | 03.6513-0340.3                                     | 320084                     |   |                                    | BRL 1/3 (2)                      | ATE |
|  | 200 GE<br>230 GE<br>250 GD<br>300 GD<br>300 GE<br>350 G Turbo<br>G 270 CDI<br>G 300 TD<br>G 320<br>G 36 AMG<br>G 400 CDI<br>G 500<br>G 500 E<br>G 55 AMG | 85  | 01.90<br>06.90<br>06.90<br>09.89<br>06.90<br>09.91<br>10.01<br>08.96<br>09.94<br>01.95<br>12.00<br>04.98<br>09.93<br>04.99 |  | 24.2419-0942.3                                     | 030068                     |   |                                    | Gz 19,05                         |     |
|  | 200 GE<br>230 GE   | 85  | 01.90<br>06.90   |  | 03.2523-1310.3                                     | 040022                     |   |                                    | Nz 23,81                         |     |
|  | 250 GD<br>300 GD<br>300 GE<br>350 G Turbo  |     | 06.90<br>09.89<br>06.90<br>09.91   |  | 03.2523-0812.3<br>03.0450-2311.2<br>03.2523-1210.3 | 040020<br>082311<br>040021 |   |                                    | Nz 23,81<br>Nz 23,81<br>Nz 23,81 |     |

<sup>1)</sup> - ventilated discs / - dischi ventilati / - disques ventilés / - disco ventilado



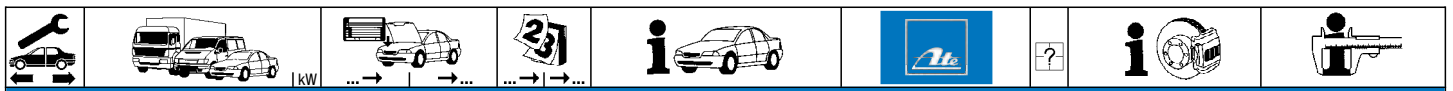



















**MERCEDES BENZ G-Klasse (W463) Cabrio (90-)**





















|  |  |  |  |                |        |                                    |               |     |
|--|--|--|--|----------------|--------|------------------------------------|---------------|-----|
|  | 200 GE<br>230 GE<br>300 GD<br>300 GE<br>320 GE<br>350 G Turbo<br>G 300 TD<br>G 320<br>G 400 CDI<br>G 500 | ↑<br>↑<br>↑<br>↑<br>↑<br>↑<br>↑<br>↑<br>↑<br>↑ | 01.90<br>06.90<br>12.90<br>09.89<br>09.94<br>09.91<br>09.96<br>11.97<br>12.00<br>04.98 | 03.6855-1402.4 | 300057 |                                    | 9" Tandem     | ATE |
|  | 200 GE<br>230 GE<br>300 GD<br>300 GE<br>320 GE<br>350 G Turbo<br>G 300 TD<br>G 320<br>G 400 CDI<br>G 500 | ↑<br>↑<br>↑<br>↑<br>↑<br>↑<br>↑<br>↑<br>↑<br>↑ | 01.90<br>06.90<br>12.90<br>09.89<br>09.94<br>09.91<br>09.96<br>11.97<br>12.00<br>04.98 | 03.6855-1902.4 | 300059 |                                    | 9" Tandem     | ATE |
|  | 200 GE<br>230 GE<br>300 GD<br>300 GE<br>320 GE<br>350 G Turbo<br>G 300 TD<br>G 320<br>G 400 CDI<br>G 500 | ↑<br>↑<br>↑<br>↑<br>↑<br>↑<br>↑<br>↑<br>↑<br>↑ | 01.90<br>06.90<br>12.90<br>09.89<br>09.94<br>09.91<br>09.96<br>11.97<br>12.00<br>04.98 | 03.2125-2102.3 | 010207 | - ABS                              | THz 25,40     | ATE |
|  | 200 GE<br>230 GE<br>300 GD<br>300 GE<br>320 GE<br>350 G Turbo<br>G 300 TD<br>G 320<br>G 400 CDI<br>G 500 | ↑<br>↑<br>↑<br>↑<br>↑<br>↑<br>↑<br>↑<br>↑<br>↑ | 01.90<br>06.90<br>12.90<br>09.89<br>09.94<br>09.91<br>09.96<br>11.97<br>12.00<br>04.98 | 13.0441-4408.2 | 250096 | - belüftete Scheiben <sup>1)</sup> | Dichtungssatz | ATE |
|  | 200 GE<br>230 GE<br>300 GD<br>300 GE<br>320 GE<br>350 G Turbo<br>G 300 TD<br>G 320<br>G 400 CDI<br>G 500 | ↑<br>↑<br>↑<br>↑<br>↑<br>↑<br>↑<br>↑<br>↑<br>↑ | 01.90<br>06.90<br>12.90<br>09.89<br>09.94<br>09.91<br>09.96<br>11.97<br>12.00<br>04.98 | 24.5224-0460.3 | 331264 | 2                                  | L=460         |     |
|  | 230 GE<br>300 GD<br>300 GE<br>320 GE<br>350 G Turbo<br>G 300 TD<br>G 320<br>G 400 CDI<br>G 500           | ↑<br>↑<br>↑<br>↑<br>↑<br>↑<br>↑<br>↑<br>↑      | 06.90<br>12.90<br>09.89<br>09.94<br>09.91<br>09.96<br>11.97<br>12.00<br>04.98          | 24.5165-0450.3 | 331259 | 2                                  | L=450         |     |
|  | G 320 CDI<br>G 350 CDI BlueTec   | ↑<br>↑   | 09.06<br>06.10   | 83.6104-0220.3 | 330474 | 2                                  | L=220         |     |
|  | 200 GE<br>230 GE<br>300 GD<br>300 GE<br>320 GE<br>350 G Turbo<br>G 300 TD<br>G 320<br>G 400 CDI<br>G 500 | ↑<br>↑<br>↑<br>↑<br>↑<br>↑<br>↑<br>↑<br>↑<br>↑ | 01.90<br>06.90<br>12.90<br>09.89<br>09.94<br>09.91<br>09.96<br>11.97<br>12.00<br>04.98 | 24.3217-1109.3 | 020173 |                                    | Rz 17,46      |     |
|  | 200 GE<br>230 GE<br>300 GD<br>300 GE<br>320 GE<br>350 G Turbo<br>G 300 TD<br>G 320<br>G 400 CDI<br>G 500 | ↑<br>↑<br>↑<br>↑<br>↑<br>↑<br>↑<br>↑<br>↑<br>↑ | 01.90<br>06.90<br>12.90<br>09.89<br>09.94<br>09.91<br>09.96<br>11.97<br>12.00<br>04.98 | 03.6513-0340.3 | 320084 |                                    | BRL 1/3 (2)   | ATE |
|  | 200 GE<br>230 GE<br>300 GD<br>300 GE<br>320 GE   | ↑<br>↑<br>↑<br>↑<br>↑                          | 01.90<br>06.90<br>12.90<br>09.89<br>09.94  | 24.2419-0942.3 | 030068 |                                    | Gz 19,05      |     |

<sup>1)</sup> - ventilated discs / - dischi ventilati / - disques ventilés / - disco ventilado

|     |    |                       |   |  |       |  |  |                  |
|--|--|---|---|--|--|--|--|--|
| <b>MERCEDES BENZ G-Klasse (W463) Cabrio (90-)</b>                                  |  |   |   |  |  |  |  |  |
|    | 350 G Turbo<br>G 300 TD<br>G 320<br>G 320 CDI<br>G 400 CDI<br>G 500  |   | 09.91<br>09.96<br>11.97<br>09.06<br>12.00<br>04.98  |  | 24.2419-0942.3   | 030068   |  | Gz 19,05   |
|    | 200 GE<br>230 GE<br>300 GD<br>300 GE<br>320 GE<br>350 G Turbo  |   | 01.90<br>06.90<br>12.90<br>09.89<br>09.94<br>09.91  |  | 03.2523-1310.3<br>03.2523-0812.3<br>03.0450-2311.2<br>03.2523-1210.3                   | 040022<br>040020<br>082311<br>040021   |  | Nz 23,81<br>Nz 23,81<br>Nz 23,81   |
| <b>MERCEDES BENZ GL-Klasse (X164) (06-12)</b>                                      |  |   |   |  |  |  |  |  |
|    | GL 350 BT 4-matic  |   | 05.09 06.12   |  | 03.4156-0014.3   | 010930   |  | Thz 26,99 - Behälter ATE   |
|    | GL 320 CDI 4-matic<br>GL 350 BT 4-matic<br>GL 350 CDI 4-matic<br>GL 420 CDI 4-matic<br>GL 450 4-matic<br>GL 450 CDI 4-matic<br>GL 500 4-matic  |   | 03.06 06.12<br>05.09 06.12<br>05.09 06.12<br>03.06 06.12<br>03.06 06.12<br>05.09 06.12<br>03.06 06.12                               |  | 11.8116-0133.1   | 390511   | 2  | Haltefeder ATE   |
|    | GL 320 CDI 4-matic<br>GL 350 BT 4-matic<br>GL 350 CDI 4-matic<br>GL 420 CDI 4-matic<br>GL 450 4-matic<br>GL 450 CDI 4-matic<br>GL 500 4-matic  |   | 03.06 06.12<br>05.09 06.12<br>05.09 06.12<br>03.06 06.12<br>03.06 06.12<br>05.09 06.12<br>03.06 06.12                               |  | 24.5123-0545.3   | 331240   | 2  | L=545  |
|    | GL 320 CDI 4-matic<br>GL 350 BT 4-matic<br>GL 350 CDI 4-matic<br>GL 420 CDI 4-matic<br>GL 450 4-matic<br>GL 450 CDI 4-matic<br>GL 500 4-matic  |   | 03.06 06.12<br>05.09 06.12<br>05.09 06.12<br>03.06 06.12<br>03.06 06.12<br>05.09 06.12<br>03.06 06.12                               |  | 11.9421-9965.2<br>11.9421-9966.2<br>11.8116-0323.1<br>11.8171-0008.1<br>11.0101-5407.2 | 220799<br>220800<br>390459<br>990049<br>260011                                     | 2<br>2   | D=42, - Halter ATE<br>D=42, - Halter ATE<br>Haltefeder ATE<br>Führungsbolzen ATE<br>Hülsensatz ATE |
|  | GL 320 CDI 4-matic<br>GL 350 BT 4-matic<br>GL 350 CDI 4-matic<br>GL 420 CDI 4-matic<br>GL 450 4-matic<br>GL 450 CDI 4-matic<br>GL 500 4-matic  |   | 03.06 06.12<br>05.09 06.12<br>05.09 06.12<br>03.06 06.12<br>03.06 06.12<br>05.09 06.12<br>03.06 06.12                               |  | 24.5123-0610.3   | 331241   | 2  | L=610  |
| <b>MERCEDES BENZ GLK-Klasse (X204) (08-)</b>                                       |  |   |   |  |  |  |  |  |
|  | GLK 200 CDI<br>GLK 220 BT 4-matic<br>GLK 220 CDI<br>GLK 220 CDI 4-matic<br>GLK 250 BT 4-matic<br>GLK 250 CDI 4-matic<br>GLK 280 4-matic<br>GLK 300 4-matic<br>GLK 320 CDI 4-matic<br>GLK 350<br>GLK 350 4-matic<br>GLK 350 4-matic<br>GLK 350 4-matic<br>GLK 350 CDI 4-matic<br>GLK 350 CDI 4-matic<br>GLK 350 CDI 4-matic | 105<br>105<br>105<br>105<br>105<br>150<br>170<br>170<br>165<br>200<br>200<br>225<br>165<br>170<br>195 | 07.10<br>03.12<br>04.09<br>04.09<br>03.12<br>09.08<br>09.08<br>04.09<br>09.08<br>09.08<br>09.08<br>09.08<br>04.09<br>02.10<br>07.12 |  | 03.7745-6302.4   | 300261   |  | - Start/Stop-Anlage <sup>1)</sup><br>8" ATE  |
|  | GLK 200 CDI<br>GLK 220 BT 4-matic<br>GLK 220 CDI<br>GLK 220 CDI 4-matic<br>GLK 250 BT 4-matic<br>GLK 250 CDI 4-matic<br>GLK 280 4-matic<br>GLK 300 4-matic<br>GLK 320 CDI 4-matic<br>GLK 350<br>GLK 350 4-matic<br>GLK 350 4-matic<br>GLK 350 4-matic<br>GLK 350 CDI 4-matic<br>GLK 350 CDI 4-matic<br>GLK 350 CDI 4-matic | 105<br>105<br>105<br>105<br>105<br>150<br>170<br>170<br>165<br>200<br>200<br>225<br>165<br>170<br>195 | 07.10<br>03.12<br>04.09<br>04.09<br>03.12<br>09.08<br>09.08<br>04.09<br>09.08<br>09.08<br>09.08<br>09.08<br>04.09<br>02.10<br>07.12 |  | 03.2025-2301.3   | 010895   |  | Thz 25,40/22,20 ATE  |
|  | GLK 200 CDI<br>GLK 220 BT 4-matic<br>GLK 220 CDI<br>GLK 220 CDI 4-matic<br>GLK 250 BT 4-matic<br>GLK 250 CDI 4-matic<br>GLK 280 4-matic<br>GLK 300 4-matic   | 105<br>105<br>105<br>105<br>105<br>150<br>170<br>170  | 07.10<br>03.12<br>04.09<br>04.09<br>03.12<br>09.08<br>09.08<br>04.09  |  | 83.7715-0299.3   | 331117   | 2  | L=300  |













<sup>1)</sup> - idling stop system / - dispositivo start/stop / - unité marche/arrêt / - unidad arranque/paro



| MERCEDES BENZ GLK-Klasse (X204) (08-)  |  |  |  |  |   |  |  |  |                          |                     |                          |
|--|--|--|--|--|---|--|--|--|--------------------------|---------------------|--------------------------|
|     |  |  |  |  |  |  |  |  |                          |                     |                          |
|    | GLK 320 CDI 4-matic  | 165  |  | 09.08  |   | 83.7715-0299.3   | 331117   | 2  |                          |                     | L=300                    |
|  | GLK 350  | 200  |  | 09.08  |   |  |  |  |                          |                     |                          |
|  | GLK 350 4-matic  | 200  |  | 09.08  |   |  |  |  |                          |                     |                          |
|  | GLK 350 4-matic  | 225  |  | 09.08  |   |  |  |  |                          |                     |                          |
|  | GLK 350 CDI 4-matic  | 165  |  | 04.09  |   |  |  |  |                          |                     |                          |
|  | GLK 350 CDI 4-matic  | 170  |  | 02.10  |   |  |  |  |                          |                     |                          |
|  | GLK 350 CDI 4-matic  | 195  |  | 07.12  |   |  |  |  |                          |                     |                          |
| MERCEDES BENZ M-Klasse (W163) (98-05)  |  |  |  |  |   |  |  |  |                          |                     |                          |
|    | ML 230   |  |  | 03.98  | 06.05   | 03.2125-7310.3   | 010743   |  |                          |                     | Thz 25,40 ATE            |
|  | ML 270 CDI   |  |  | 09.99  | 06.05   |  |  |  |                          |                     |                          |
|  | ML 320   |  |  | 03.98  | 08.02   |  |  |  |                          |                     |                          |
|  | ML 350   |  |  | 09.02  | 06.05   |  |  |  |                          |                     |                          |
|  | ML 400 CDI   |  |  | 07.01  | 06.05   |  |  |  |                          |                     |                          |
|  | ML 430   |  |  | 09.98  | 06.05   |  |  |  |                          |                     |                          |
|  | ML 500   |  |  | 07.01  | 06.05   |  |  |  |                          |                     |                          |
|  | ML 55 AMG  |  |  | 09.99  | 06.05   |  |  |  |                          |                     |                          |
|    | ML 230   |  |  | 03.98  | 08.00   | 83.6211-0532.3   | 330552   |  | <input type="checkbox"/> |                     | L=525                    |
|  | ML 270 CDI   |  |  | 09.99  | 08.00   | 83.6211-0531.3   | 330551   |  | <input type="checkbox"/> |                     | L=525                    |
|  | ML 320   |  |  | 03.98  | 08.00   |  |  |  |                          |                     |                          |
|  | ML 430   |  |  | 09.98  | 08.00   |  |  |  |                          |                     |                          |
|  | ML 55 AMG  |  |  | 09.99  | 08.00   |  |  |  |                          |                     |                          |
|    | ML 230   |  |  | 09.00  | 06.05   | 83.6211-0536.3   | 330628   |  | <input type="checkbox"/> |                     | L=525                    |
|  | ML 270 CDI   |  |  | 09.00  | 06.05   | 83.6211-0535.3   | 330627   |  | <input type="checkbox"/> |                     | L=525                    |
|  | ML 320   |  |  | 09.00  | 08.02   |  |  |  |                          |                     |                          |
|  | ML 350   |  |  | 09.02  | 06.05   |  |  |  |                          |                     |                          |
|  | ML 400 CDI   |  |  | 07.01  | 06.05   |  |  |  |                          |                     |                          |
|  | ML 430   |  |  | 09.00  | 06.05   |  |  |  |                          |                     |                          |
|  | ML 500   |  |  | 07.01  | 06.05   |  |  |  |                          |                     |                          |
|  | ML 55 AMG  |  |  | 09.00  | 06.05   |  |  |  |                          |                     |                          |
|    | ML 230   |  |  | 03.98  | 06.05   | 83.6105-0300.3   | 330537   | 2  |                          |                     | L=300                    |
|  | ML 270 CDI   |  |  | 09.99  | 06.05   |  |  |  |                          |                     |                          |
|  | ML 320   |  |  | 03.98  | 08.02   |  |  |  |                          |                     |                          |
|  | ML 350   |  |  | 09.02  | 06.05   |  |  |  |                          |                     |                          |
|  | ML 400 CDI   |  |  | 07.01  | 06.05   |  |  |  |                          |                     |                          |
|  | ML 430   |  |  | 09.98  | 06.05   |  |  |  |                          |                     |                          |
|  | ML 500   |  |  | 07.01  | 06.05   |  |  |  |                          |                     |                          |
|  | ML 55 AMG  |  |  | 09.99  | 06.05   |  |  |  |                          |                     |                          |
|   | ML 230   |  | +  | 03.98  | 06.05   | 24.3727-0432.2   | 580432   |  | <input type="checkbox"/> |                     | L=2025                   |
|  | ML 270 CDI   |  | +  | 09.99  | 06.05   | 24.3727-0437.2   | 580437   |  | <input type="checkbox"/> |                     | L=1932                   |
|  | ML 320   |  | +  | 03.98  | 08.02   |  |  |  |                          |                     |                          |
|  | ML 350   |  | +  | 09.02  | 06.05   |  |  |  |                          |                     |                          |
|  | ML 400 CDI   |  | +  | 07.01  | 06.05   |  |  |  |                          |                     |                          |
|  | ML 430   |  | +  | 09.98  | 06.05   |  |  |  |                          |                     |                          |
|  | ML 500   |  | +  | 07.01  | 06.05   |  |  |  |                          |                     |                          |
|  | ML 55 AMG  |  | +  | 09.99  | 06.05   |  |  |  |                          |                     |                          |
|  | ML 230   |  | +  | 03.98  | 06.05   | 24.3727-0432.2   | 580432   |  | <input type="checkbox"/> |                     | L=2025                   |
|  | ML 270 CDI   |  | +  | 09.99  | 06.05   | 24.3727-0437.2   | 580437   |  | <input type="checkbox"/> |                     | L=1932                   |
|  | ML 320   |  | +  | 03.98  | 08.02   |  |  |  |                          |                     |                          |
|  | ML 350   |  | +  | 09.02  | 06.05   |  |  |  |                          |                     |                          |
|  | ML 400 CDI   |  | +  | 07.01  | 06.05   |  |  |  |                          |                     |                          |
|  | ML 430   |  | +  | 09.98  | 06.05   |  |  |  |                          |                     |                          |
|  | ML 500   |  | +  | 07.01  | 06.05   |  |  |  |                          |                     |                          |
|  | ML 55 AMG  |  | +  | 09.99  | 06.05   |  |  |  |                          |                     |                          |
|  | ML 230   |  |  | 03.98  | 06.05   | 24.2419-0915.3   | 030045   |  | <input type="checkbox"/> | + GG <sup>1)</sup>  | Gz 19,05                 |
|  |  |  |  |  |   | 24.2419-1703.3   | 030097   |  | <input type="checkbox"/> | + ALU <sup>2)</sup> | Gz 19,05                 |
|  | ML 230   |  |  | 03.98  | 06.05   | 03.2523-1310.3   | 040022   |  |                          |                     | Nz 23,81                 |
| MERCEDES BENZ M-Klasse (W164) (05-11)  |  |  |  |  |   |  |  |  |                          |                     |                          |
|  | ML 300   |  |  | 05.09  | 05.11   | 03.4156-0014.3   | 010930   |  |                          |                     | Thz 26,99 - Behälter ATE |
|  | ML 300 CDI 4-matic   |  |  | 07.09  | 05.11   |  |  |  |                          |                     |                          |
|  | ML 350 BT 4-matic  |  |  | 05.09  | 05.11   |  |  |  |                          |                     |                          |
|  | ML 350 BT 4-matic  | A 209848   |  | 05.09  | 05.11   |  |  |  |                          |                     |                          |
|  | ML 350 CDI 4-matic   |  |  |  | 05.11   |  |  |  |                          |                     |                          |
|  | ML 450 CDI 4-matic   |  |  | 09.09  | 05.11   |  |  |  |                          |                     |                          |
|  | ML 450 Hybrid 4-matic  |  |  | 08.09  | 05.11   |  |  |  |                          |                     |                          |
|  | ML 280 CDI   |  |  | 07.05  | 05.11   | 11.8116-0133.1   | 390511   | 2  |                          |                     | Haltefeder ATE           |
|  | ML 300   |  |  | 05.09  | 05.11   |  |  |  |                          |                     |                          |
|  | ML 300 CDI 4-matic   |  |  | 07.09  | 05.11   |  |  |  |                          |                     |                          |
|  | ML 320 CDI   |  |  | 07.05  | 05.11   |  |  |  |                          |                     |                          |
|  | ML 350   |  |  | 07.05  | 05.11   |  |  |  |                          |                     |                          |
|  | ML 350 BT 4-matic  |  |  | 05.09  | 05.11   |  |  |  |                          |                     |                          |
|  | ML 350 CDI 4-matic   |  |  | 07.09  | 05.11   |  |  |  |                          |                     |                          |
|  | ML 420 CDI 4-matic   |  |  | 04.06  | 05.11   |  |  |  |                          |                     |                          |
|  | ML 450 CDI 4-matic   |  |  | 09.09  | 05.11   |  |  |  |                          |                     |                          |
|  | ML 450 Hybrid 4-matic  |  |  | 08.09  | 05.11   |  |  |  |                          |                     |                          |
|  | ML 500   |  |  | 07.05  | 05.11   |  |  |  |                          |                     |                          |
|  | ML 63 AMG  |  |  | 09.05  | 05.11   | 11.8171-0067.1   | 250153   |  |                          |                     | Führungsbolzen ATE       |
|  |  |  |  |  |   | 11.0101-5706.2   | 260097   |  |                          |                     | Hülzensatz ATE           |
|  |  |  |  |  |   | 11.8116-0353.2   | 390585   | 2  |                          |                     | Haltefeder ATE           |
|  | ML 280 CDI   |  |  | 07.05  | 05.11   | 24.5123-0545.3   | 331240   | 2  |                          |                     | L=545                    |
|  | ML 300   |  |  | 05.09  | 05.11   |  |  |  |                          |                     |                          |
|  | ML 300 CDI 4-matic   |  |  | 07.09  | 05.11   |  |  |  |                          |                     |                          |

1) + cast iron / + ghisa / + fonte grise / + fundición de gris

2) + aluminium / + alluminio / + aluminium / + aluminio

| MERCEDES BENZ M-Klasse (W164) (05-11)  |   |  |  |  |  |        |  |  |                                 |
|--|---|--|--|--|--|--------|--|--|---------------------------------|
|     | ML 320 CDI<br>ML 350<br>ML 350 BT 4-matic<br>ML 350 CDI 4-matic<br>ML 420 CDI 4-matic<br>ML 450 CDI 4-matic<br>ML 450 Hybrid 4-matic<br>ML 500<br>ML 63 AMG   | 07.05<br>07.05<br>05.09<br>07.09<br>04.06<br>09.09<br>08.09<br>07.05<br>09.05                            | 05.11<br>05.11<br>05.11<br>05.11<br>05.11<br>05.11<br>05.11<br>05.11<br>05.11                            | 24.5123-0545.3   | 331240   | 2      |  | L=545  |                                 |
|    | ML 280 CDI<br>ML 300<br>ML 300 CDI 4-matic<br>ML 320 CDI<br>ML 350<br>ML 350 BT 4-matic<br>ML 350 CDI 4-matic<br>ML 450 Hybrid 4-matic<br>ML 500  | 07.05<br>05.09<br>07.09<br>07.05<br>07.05<br>05.09<br>07.09<br>08.09<br>07.05                            | 05.11<br>05.11<br>05.11<br>05.11<br>05.11<br>05.11<br>05.11<br>05.11<br>05.11                            | 11.9421-9965.2<br>11.9421-9966.2<br>11.8116-0323.1<br>11.8171-0008.1<br>11.0101-5407.2                   | 220799<br>220800<br>390459<br>990049<br>260011 | 2      | + 18" Rad 1)<br>+ 18" Rad 1)           | D=42, - Halter<br>D=42, - Halter<br>Haltefeder<br>Führungsbolzen<br>Hülsensatz | ATE<br>ATE<br>ATE<br>ATE<br>ATE |
|    | ML 420 CDI 4-matic<br>ML 450 CDI 4-matic  | 04.06<br>09.09   | 05.11<br>05.11   | 11.9421-9965.2<br>11.9421-9966.2<br>11.8116-0323.1<br>11.8171-0008.1<br>11.0101-5407.2                   | 220799<br>220800<br>390459<br>990049<br>260011 | 2      |  | D=42, - Halter<br>D=42, - Halter<br>Haltefeder<br>Führungsbolzen<br>Hülsensatz | ATE<br>ATE<br>ATE<br>ATE<br>ATE |
|    | ML 280 CDI<br>ML 300<br>ML 300 CDI 4-matic<br>ML 320 CDI<br>ML 350<br>ML 350 BT 4-matic<br>ML 350 CDI 4-matic<br>ML 420 CDI 4-matic<br>ML 450 CDI 4-matic<br>ML 450 Hybrid 4-matic<br>ML 500<br>ML 63 AMG | 07.05<br>05.09<br>07.09<br>07.05<br>07.05<br>05.09<br>07.09<br>04.06<br>09.09<br>08.09<br>07.05<br>09.05 | 05.11<br>05.11<br>05.11<br>05.11<br>05.11<br>05.11<br>05.11<br>05.11<br>05.11<br>05.11<br>05.11<br>05.11 | 24.5123-0610.3   | 331241   | 2      |  | L=610  |                                 |
| MERCEDES BENZ R-Klasse (W251,V251) (06-12)   |   |  |  |  |  |        |  |  |                                 |
|   | R 280 CDI<br>R 350 4-matic<br>R 350 BT 4-matic  | 05.06<br>01.06<br>05.09  | 10.12<br>10.12<br>10.12  | 03.4156-0014.3   | 010930   |        |  | Thz 26,99 - Behälter   | ATE                             |
|  | R 63 AMG  | 11.05  | 10.12  | 11.8171-0067.1<br>11.0101-5706.2<br>11.8116-0353.2   | 250153<br>260097<br>390585                     | 2      |  | Führungsbolzen<br>Hülsensatz<br>Haltefeder                                     | ATE<br>ATE<br>ATE               |
|  | R 280<br>R 280 CDI 4-matic<br>R 300<br>R 300 CDI<br>R 300 CDI 4-matic<br>R 320 CDI 4-matic<br>R 350<br>R 350 BT 4-matic<br>R 350 CDI 4-matic<br>R 500 4-matic   | 01.07<br>11.05<br>07.09<br>07.09<br>07.09<br>11.05<br>11.05<br>05.09<br>05.09<br>11.05                   | 10.12<br>10.12<br>10.12<br>10.12<br>10.12<br>10.12<br>10.12<br>10.12<br>10.12<br>10.12                   | 11.9421-9965.2<br>11.9421-9966.2<br>11.8116-0323.1<br>11.8171-0008.1<br>11.0101-5407.2                   | 220799<br>220800<br>390459<br>990049<br>260011 | 2      | + 18" Rad 1)<br>+ 18" Rad 1)           | D=42, - Halter<br>D=42, - Halter<br>Haltefeder<br>Führungsbolzen<br>Hülsensatz | ATE<br>ATE<br>ATE<br>ATE<br>ATE |
|  | R 280 CDI<br>R 350 4-matic  | 05.06<br>01.06   | 10.12<br>10.12   | 11.9421-9965.2<br>11.9421-9966.2<br>11.8116-0323.1<br>11.8171-0008.1<br>11.0101-5407.2                   | 220799<br>220800<br>390459<br>990049<br>260011 | 2      | + 3. Sitzreihe 2)<br>+ 3. Sitzreihe 2) | D=42, - Halter<br>D=42, - Halter<br>Haltefeder<br>Führungsbolzen<br>Hülsensatz | ATE<br>ATE<br>ATE<br>ATE<br>ATE |
| MERCEDES BENZ S-Klasse (W140) (91-93)  |   |  |  |  |  |        |  |  |                                 |
|  | 300 SE 2.8 / S 280<br>300 SE 3.2<br>300 SEL 3.2<br>350 SD Turbo   | 08.92<br>04.91<br>04.91<br>03.93   | 06.93<br>06.93<br>06.93<br>06.93   | 03.2025-0211.3   | 010034   |        |  | Thz 25,40/19,05  | ATE                             |
|  | 400 SE<br>400 SEL<br>500 SE<br>500 SEC<br>500 SEL<br>600 SE V12<br>600 SEC V12<br>600 SEL V12   | A110607<br>A110607<br>A110607<br>A110607<br>A110607<br>A110607<br>A110607<br>A110607                     | 06.93<br>06.93<br>06.93<br>06.93<br>06.93<br>06.93<br>06.93<br>06.93                                     | 03.2026-0462.3   | 010728   |        |  | Thz 26,99/25,40  | ATE                             |
|  | 400 SE<br>400 SEL<br>500 SE<br>500 SEC<br>500 SEL<br>600 SE V12<br>600 SEC V12<br>600 SEL V12   | A110607<br>A110607<br>A110607<br>A110607<br>A110607<br>A110607<br>A110607<br>A110607                     | 06.93<br>06.93<br>06.93<br>06.93<br>06.93<br>06.93<br>06.93<br>06.93                                     | 03.2026-0512.3   | 010038   |        |  | Thz 26,99/25,40  | ATE                             |
|  | 300 SE 3.2<br>300 SE 3.2<br>300 SEL 3.2<br>300 SEL 3.2  | A050547<br>A023718<br>A050547<br>A023718   | 04.91<br>04.91<br>04.91<br>04.91   | + Leichtmetallfelgen 3)<br>- Leichtmetallfelgen 4)<br>+ Leichtmetallfelgen 3)<br>- Leichtmetallfelgen 4) | 24.9571-7005.5                                 | 230061 |  | D=57   | ATE                             |

1) + 18" wheel / + ruota 18" / + roue 18" / + rueda 18"

2) + 3rd seat row / + 3a fila di sedili / + 3ème rangée de sièges / + 3a fila de asientos

3) + light alloy rims / + cerchioni in lega / + jantes en alliage léger / + Llantas de aleación ligera

4) - light alloy rims / - cerchioni in lega / - jantes en alliage léger / - Llantas de aleación ligera

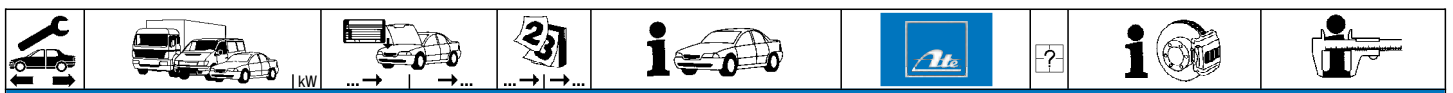

**MERCEDES BENZ S-Klasse (W140) (91-93)**

|  |                    |   |  |       |       |                |        |   |                     |               |     |
|--|--------------------|---|--|-------|-------|----------------|--------|---|---------------------|---------------|-----|
|  | 300 SE 2.8 / S 280 |   |  | 08.92 | 06.93 | 83.6154-0536.3 | 330286 | 2 |                     | L=535         |     |
|  | 300 SE 3.2         |   |  | 04.91 | 06.93 |                |        |   |                     |               |     |
|  | 300 SEL 3.2        |   |  | 04.91 | 06.93 |                |        |   |                     |               |     |
|  | 350 SD Turbo       |   |  | 03.93 | 06.93 |                |        |   |                     |               |     |
|  | 400 SE             |   |  | 04.91 | 06.93 |                |        |   |                     |               |     |
|  | 400 SEL            |   |  | 04.91 | 06.93 |                |        |   |                     |               |     |
|  | 500 SE             |   |  | 04.91 | 06.93 |                |        |   |                     |               |     |
|  | 500 SEC            |   |  | 06.92 | 06.93 |                |        |   |                     |               |     |
|  | 500 SEL            |   |  | 04.91 | 06.93 |                |        |   |                     |               |     |
|  | 600 SE V12         |   |  | 04.91 | 06.93 |                |        |   |                     |               |     |
|  | 600 SEC V12        |   |  | 06.92 | 06.93 |                |        |   |                     |               |     |
|  | 600 SEL V12        |   |  | 04.91 | 06.93 |                |        |   |                     |               |     |
|  | 300 SE 2.8 / S 280 |   |  | 08.92 | 06.93 | 13.2401-8013.2 | 210051 |   |                     | D=40          | ATE |
|  | 300 SE 3.2         |   |  | 04.91 | 06.93 | 13.2401-8014.2 | 210052 |   |                     | D=40          | ATE |
|  | 300 SEL 3.2        |   |  | 04.91 | 06.93 | 24.9240-8013.5 | 230019 |   |                     | D=40          | ATE |
|  | 350 SD Turbo       |   |  | 03.93 | 06.93 | 24.9240-8014.5 | 230020 |   |                     | D=40          | ATE |
|  |                    |   |  |       |       | 13.0441-4020.2 | 250084 |   |                     | Dichtungssatz | ATE |
|  | 400 SE             |   |  | 04.91 | 06.93 | 13.2461-8001.2 | 210226 |   |                     | D=46          | ATE |
|  | 400 SEL            |   |  | 04.91 | 06.93 | 13.2461-8002.2 | 210227 |   |                     | D=46          | ATE |
|  | 500 SE             |   |  | 04.91 | 06.93 | 24.9246-8001.5 | 230021 |   |                     | D=46          | ATE |
|  | 500 SEC            |   |  | 06.92 | 06.93 | 24.9246-8002.5 | 230022 |   |                     | D=46          | ATE |
|  | 500 SEL            |   |  | 04.91 | 06.93 | 13.0441-4601.2 | 250099 |   |                     | Dichtungssatz | ATE |
|  | 600 SE V12         |   |  | 04.91 | 06.93 |                |        |   |                     |               |     |
|  | 600 SEC V12        |   |  | 06.92 | 06.93 |                |        |   |                     |               |     |
|  | 600 SEL V12        |   |  | 04.91 | 06.93 |                |        |   |                     |               |     |
|  | 300 SE 2.8 / S 280 |   |  | 08.92 | 06.93 | 83.7704-0281.3 | 330804 | 2 |                     | L=280         |     |
|  | 300 SE 3.2         |   |  | 04.91 | 06.93 |                |        |   |                     |               |     |
|  | 300 SEL 3.2        |   |  | 04.91 | 06.93 |                |        |   |                     |               |     |
|  | 350 SD Turbo       |   |  | 03.93 | 06.93 |                |        |   |                     |               |     |
|  | 400 SE             |   |  | 04.91 | 06.93 |                |        |   |                     |               |     |
|  | 400 SEL            |   |  | 04.91 | 06.93 |                |        |   |                     |               |     |
|  | 500 SE             |   |  | 04.91 | 06.93 |                |        |   |                     |               |     |
|  | 500 SEC            |   |  | 06.92 | 06.93 |                |        |   |                     |               |     |
|  | 500 SEL            |   |  | 04.91 | 06.93 |                |        |   |                     |               |     |
|  | 600 SE V12         |   |  | 04.91 | 06.93 |                |        |   |                     |               |     |
|  | 600 SEC V12        |   |  | 06.92 | 06.93 |                |        |   |                     |               |     |
|  | 600 SEL V12        |   |  | 04.91 | 06.93 |                |        |   |                     |               |     |
|  | 300 SE 2.8 / S 280 | + |  | 08.92 | 06.93 | 24.3727-0462.2 | 580462 | 1 |                     | L=2622        |     |
|  | 300 SE 3.2         | + |  | 04.91 | 06.93 | 24.3727-0456.2 | 580456 |   |                     | L=1134        |     |
|  | 350 SD Turbo       | + |  | 03.93 | 06.93 | 24.3727-0455.2 | 580455 |   |                     | L=1109        |     |
|  | 400 SE             | + |  | 04.91 | 06.93 |                |        |   |                     |               |     |
|  | 500 SE             | + |  | 04.91 | 06.93 |                |        |   |                     |               |     |
|  | 500 SEC            | + |  | 06.92 | 06.93 |                |        |   |                     |               |     |
|  | 600 SE V12         | + |  | 04.91 | 06.93 |                |        |   |                     |               |     |
|  | 600 SEC V12        | + |  | 06.92 | 06.93 |                |        |   |                     |               |     |
|  | 300 SEL 3.2        | + |  | 04.91 | 06.93 | 24.3727-0456.2 | 580456 |   |                     | L=1134        |     |
|  | 400 SEL            | + |  | 04.91 | 06.93 | 24.3727-0455.2 | 580455 |   |                     | L=1109        |     |
|  | 500 SEL            | + |  | 04.91 | 06.93 |                |        |   |                     |               |     |
|  | 600 SEL V12        | + |  | 04.91 | 06.93 |                |        |   |                     |               |     |
|  | 300 SE 2.8 / S 280 | + |  | 08.92 | 06.93 | 24.3727-0456.2 | 580456 |   |                     | L=1134        |     |
|  | 300 SE 3.2         | + |  | 04.91 | 06.93 | 24.3727-0455.2 | 580455 |   |                     | L=1109        |     |
|  | 350 SD Turbo       | + |  | 03.93 | 06.93 |                |        |   |                     |               |     |
|  | 400 SE             | + |  | 04.91 | 06.93 |                |        |   |                     |               |     |
|  | 500 SE             | + |  | 04.91 | 06.93 |                |        |   |                     |               |     |
|  | 500 SEC            | + |  | 06.92 | 06.93 |                |        |   |                     |               |     |
|  | 600 SE V12         | + |  | 04.91 | 06.93 |                |        |   |                     |               |     |
|  | 600 SEC V12        | + |  | 06.92 | 06.93 |                |        |   |                     |               |     |
|  | 300 SEL 3.2        | + |  | 04.91 | 06.93 | 24.3727-0456.2 | 580456 |   |                     | L=1134        |     |
|  | 400 SEL            | + |  | 04.91 | 06.93 | 24.3727-0455.2 | 580455 |   |                     | L=1109        |     |
|  | 500 SEL            | + |  | 04.91 | 06.93 |                |        |   |                     |               |     |
|  | 600 SEL V12        | + |  | 04.91 | 06.93 |                |        |   |                     |               |     |
|  | 300 SE 2.8 / S 280 | + |  | 08.92 | 06.93 | 24.2419-0915.3 | 030045 |   | + GG <sup>1)</sup>  | Gz 19,05      |     |
|  | 300 SE 3.2         | + |  | 04.91 | 06.93 | 24.2419-1703.3 | 030097 |   | + ALU <sup>2)</sup> | Gz 19,05      |     |
|  | 300 SEL 3.2        | + |  | 04.91 | 06.93 |                |        |   |                     |               |     |
|  | 300 SE 2.8 / S 280 | + |  | 08.92 | 06.93 | 03.2523-1310.3 | 040022 |   |                     | Nz 23,81      |     |
|  | 300 SE 3.2         | + |  | 04.91 | 06.93 |                |        |   |                     |               |     |
|  | 300 SEL 3.2        | + |  | 04.91 | 06.93 |                |        |   |                     |               |     |

**MERCEDES BENZ S-Klasse (W140) (93-98)**

|  |                    |          |         |       |       |                |        |  |                             |                 |     |
|--|--------------------|----------|---------|-------|-------|----------------|--------|--|-----------------------------|-----------------|-----|
|  | S 280 / 300 SE 2.8 | A 358833 |         | 10.98 |       | 03.7858-0102.4 | 300262 |  | + Linkslenker <sup>3)</sup> | 9/8" Tandem     | ATE |
|  | S 300 TD           | A 358833 |         | 10.98 |       |                |        |  |                             |                 |     |
|  | S 320              | A 358833 |         | 10.98 |       |                |        |  |                             |                 |     |
|  | S 350 TD           | A 358833 |         | 06.96 |       |                |        |  |                             |                 |     |
|  | S 280 / 300 SE 2.8 |          | A212244 | 07.93 |       | 03.2025-0211.3 | 010034 |  |                             | Thz 25,40/19,05 | ATE |
|  | S 320              |          | A212244 | 07.93 |       |                |        |  |                             |                 |     |
|  | S 350 TD           |          | A212244 | 07.93 |       |                |        |  |                             |                 |     |
|  | S 280 / 300 SE 2.8 |          | A212245 | 10.98 |       | 24.2025-1702.3 | 010515 |  |                             | Thz 25,40/19,05 | LUC |
|  | S 300 TD           |          |         | 04.96 | 10.98 | 03.2025-1511.3 | 010704 |  |                             | Thz 25,40/20,64 | ATE |
|  | S 320              |          | A212245 | 10.98 |       |                |        |  |                             |                 |     |
|  | S 350 TD           |          | A212245 | 06.96 |       |                |        |  |                             |                 |     |
|  | S 420              | +        | A358832 | 07.93 |       | 03.2026-0462.3 | 010728 |  |                             | Thz 26,99/25,40 | ATE |
|  | S 420 C            | +        |         | 04.94 | 05.96 |                |        |  |                             |                 |     |
|  | S 500              | +        | A358832 | 07.93 |       |                |        |  |                             |                 |     |
|  | S 500 C            | +        | A358832 | 07.93 |       |                |        |  |                             |                 |     |
|  | S 600              | +        | A358832 | 07.93 |       |                |        |  |                             |                 |     |

1) + cast iron / + ghisa / + fonte grise / + fundición de gris

2) + aluminium / + alluminio / + aluminium / + aluminio

3) + left hand drive / + guida a sinistra / + conduite à gauche / + volante a la izquierda

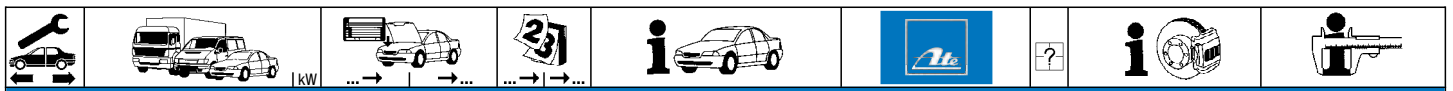































**MERCEDES BENZ S-Klasse (W140) (93-98)**

|          |                    |         |         |       |                                 |                                 |                |        |                          |                          |        |
|----------|--------------------|---------|---------|-------|---------------------------------|---------------------------------|----------------|--------|--------------------------|--------------------------|--------|
|          | S 600 C            |         | A358832 | 07.93 |                                 | 03.2026-0462.3                  | 010728         |        | THz 26,99/25,40          | ATE                      |        |
|          | S 420              | A358833 |         |       | 10.98                           | 03.2026-0712.3                  | 010730         |        | THz 26,99/25,40          | ATE                      |        |
|          | S 500              | A358833 |         |       | 10.98                           |                                 |                |        |                          |                          |        |
|          | S 500 C            | A358833 |         |       | 05.96                           |                                 |                |        |                          |                          |        |
|          | S 600              | A358833 |         |       | 10.98                           |                                 |                |        |                          |                          |        |
| S 600 C  | A358833            |         |         | 05.96 |                                 |                                 |                |        |                          |                          |        |
|          | S 420              |         | A212244 | 07.93 |                                 | 03.2026-0512.3                  | 010038         |        | THz 26,99/25,40          | ATE                      |        |
|          | S 500              |         | A212244 | 07.93 |                                 |                                 |                |        |                          |                          |        |
|          | S 500 C            |         | A212244 | 07.93 |                                 |                                 |                |        |                          |                          |        |
|          | S 600              |         | A212244 | 07.93 |                                 |                                 |                |        |                          |                          |        |
|          | S 600 C            |         | A212244 | 07.93 |                                 |                                 |                |        |                          |                          |        |
|          | S 420              | A212245 | A358832 |       | 04.94                           | 05.96                           | 03.2026-0562.3 | 010729 |                          | THz 26,99/25,40          | ATE    |
|          | S 420 C            |         |         |       |                                 |                                 |                |        |                          |                          |        |
|          | S 500              | A212245 | A358832 |       |                                 |                                 |                |        |                          |                          |        |
|          | S 500 C            | A212245 | A358832 |       |                                 |                                 |                |        |                          |                          |        |
|          | S 600              | A212245 | A358832 |       |                                 |                                 |                |        |                          |                          |        |
|          | S 600 C            | A212245 | A358832 |       |                                 |                                 |                |        |                          |                          |        |
|          | S 280 / 300 SE 2.8 |         | A290166 | 07.93 |                                 | 83.6154-0536.3                  | 330286         | 2      |                          | L=535                    |        |
|          | S 320              |         | A290166 | 07.93 |                                 |                                 |                |        |                          |                          |        |
|          | S 350 TD           |         | A290166 | 07.93 |                                 |                                 |                |        |                          |                          |        |
|          | S 420              |         | A290166 | 07.93 |                                 |                                 |                |        |                          |                          |        |
|          | S 420 C            |         |         | 04.94 | 08.95                           |                                 |                |        |                          |                          |        |
|          | S 500              |         | A290166 | 07.93 |                                 |                                 |                |        |                          |                          |        |
|          | S 500 C            |         |         | 07.93 | 08.95                           |                                 |                |        |                          |                          |        |
|          | S 600              |         | A290166 | 07.93 |                                 |                                 |                |        |                          |                          |        |
|          | S 600 C            |         |         | 07.93 | 08.95                           |                                 |                |        |                          |                          |        |
|          | S 280 / 300 SE 2.8 | A290167 |         |       | 04.96                           | 10.98                           | 83.6115-0480.3 | 330385 | 2                        | L=480                    |        |
|          | S 300 TD           |         |         |       |                                 | 10.98                           |                |        |                          |                          |        |
|          | S 320              | A290167 |         |       |                                 | 10.98                           |                |        |                          |                          |        |
|          | S 350 TD           | A290167 |         |       | 06.96                           |                                 |                |        |                          |                          |        |
|          | S 420              | A290167 |         |       |                                 | 10.98                           |                |        |                          |                          |        |
|          | S 420 C            |         |         | 09.95 | 05.96                           |                                 |                |        |                          |                          |        |
|          | S 500              | A290167 |         |       |                                 | 10.98                           |                |        |                          |                          |        |
|          | S 500 C            |         |         | 09.95 | 05.96                           |                                 |                |        |                          |                          |        |
|          | S 600              | A290167 |         |       |                                 | 10.98                           |                |        |                          |                          |        |
| S 600 C  |                    |         | 09.95   | 05.96 |                                 |                                 |                |        |                          |                          |        |
|          | S 280 / 300 SE 2.8 |         |         | 07.93 | 10.98                           | 13.2401-8013.2                  | 210051         |        | <input type="checkbox"/> | D=40                     | ATE    |
|          | S 300 TD           |         |         | 04.96 | 10.98                           | 13.2401-8014.2                  | 210052         |        | <input type="checkbox"/> | D=40                     | ATE    |
|          | S 320              |         |         | 07.93 | 10.98                           | 24.9240-8013.5                  | 230019         |        | <input type="checkbox"/> | D=40                     | ATE    |
|          | S 350 TD           |         |         | 07.93 | 06.96                           | 24.9240-8014.5                  | 230020         |        | <input type="checkbox"/> | D=40                     | ATE    |
|          |                    |         |         |       |                                 | 13.0441-4020.2                  | 250084         |        | <input type="checkbox"/> | Dichtungssatz            | ATE    |
|          | S 420              |         |         | 07.93 | 10.98                           | 13.2461-8001.2                  | 210226         |        | <input type="checkbox"/> | D=46                     | ATE    |
|          | S 420 C            |         |         | 04.94 | 05.96                           | 13.2461-8002.2                  | 210227         |        | <input type="checkbox"/> | D=46                     | ATE    |
|          | S 500              |         |         | 07.93 | 10.98                           | 24.9246-8001.5                  | 230021         |        | <input type="checkbox"/> | D=46                     | ATE    |
|          | S 500 C            |         |         | 07.93 | 05.96                           | 24.9246-8002.5                  | 230022         |        | <input type="checkbox"/> | D=46                     | ATE    |
|          | S 600              |         |         | 07.93 | 10.98                           | 13.0441-4601.2                  | 250099         |        | <input type="checkbox"/> | Dichtungssatz            | ATE    |
| S 600 C  |                    |         | 07.93   | 05.96 |                                 |                                 |                |        |                          |                          |        |
|          | S 280 / 300 SE 2.8 |         |         | 07.93 | 10.98                           | 83.7704-0281.3                  | 330804         | 2      |                          | L=280                    |        |
|          | S 300 TD           |         |         | 04.96 | 10.98                           |                                 |                |        |                          |                          |        |
|          | S 320              |         |         | 07.93 | 10.98                           |                                 |                |        |                          |                          |        |
|          | S 350 TD           |         |         | 07.93 | 06.96                           |                                 |                |        |                          |                          |        |
|          | S 420              |         |         | 07.93 | 10.98                           |                                 |                |        |                          |                          |        |
|          | S 420 C            |         |         | 04.94 | 05.96                           |                                 |                |        |                          |                          |        |
|          | S 500              |         |         | 07.93 | 10.98                           |                                 |                |        |                          |                          |        |
|          | S 500 C            |         |         | 07.93 | 05.96                           |                                 |                |        |                          |                          |        |
|          | S 600              |         |         | 07.93 | 10.98                           |                                 |                |        |                          |                          |        |
|          | S 600 C            |         |         | 07.93 | 05.96                           |                                 |                |        |                          |                          |        |
|          | S 280 / 300 SE 2.8 |         |         | 07.93 | 10.98                           | 24.3727-0462.2                  | 580462         | 1      | <input type="checkbox"/> | L=2622                   |        |
|          | S 300 TD           |         |         | 04.96 | 10.98                           | 24.3727-0456.2                  | 580456         |        | <input type="checkbox"/> | L=1134                   |        |
|          | S 320              |         |         | 07.93 | 10.98                           | 24.3727-0455.2                  | 580455         |        | <input type="checkbox"/> | L=1109                   |        |
|          | S 350 TD           |         |         | 07.93 | 06.96                           |                                 |                |        |                          |                          |        |
|          | S 420              |         |         | 07.93 | 10.98                           | + Radstand 3040mm <sup>1)</sup> |                |        |                          |                          |        |
|          | S 420 C            |         |         | 04.94 | 05.96                           |                                 |                |        |                          |                          |        |
|          | S 500              |         |         | 07.93 | 10.98                           | + Radstand 3040mm <sup>1)</sup> |                |        |                          |                          |        |
|          | S 500 C            |         |         | 07.93 | 05.96                           |                                 |                |        |                          |                          |        |
|          | S 600              |         |         | 07.93 | 10.98                           | + Radstand 3040mm <sup>1)</sup> |                |        |                          |                          |        |
|          | S 600 C            |         |         | 07.93 | 05.96                           |                                 |                |        |                          |                          |        |
|          | S 320              |         |         | 07.93 | 10.98                           | + Radstand 3140mm <sup>2)</sup> | 24.3727-0456.2 | 580456 |                          | <input type="checkbox"/> | L=1134 |
|          | S 420              |         |         | 07.93 | 10.98                           | + Radstand 3140mm <sup>2)</sup> | 24.3727-0455.2 | 580455 |                          | <input type="checkbox"/> | L=1109 |
|          | S 500              |         |         | 07.93 | 10.98                           | + Radstand 3140mm <sup>2)</sup> |                |        |                          |                          |        |
|          | S 600              |         |         | 07.93 | 10.98                           | + Radstand 3140mm <sup>2)</sup> |                |        |                          |                          |        |
|          | S 280 / 300 SE 2.8 |         |         | 07.93 | 10.98                           |                                 | 24.3727-0456.2 | 580456 |                          | <input type="checkbox"/> | L=1134 |
| S 300 TD |                    |         | 04.96   | 10.98 |                                 | 24.3727-0455.2                  | 580455         |        | <input type="checkbox"/> | L=1109                   |        |
| S 320    |                    |         | 07.93   | 10.98 | + Radstand 3040mm <sup>1)</sup> |                                 |                |        |                          |                          |        |
| S 350 TD |                    |         | 07.93   | 06.96 |                                 |                                 |                |        |                          |                          |        |
| S 420    |                    |         | 07.93   | 10.98 | + Radstand 3040mm <sup>1)</sup> |                                 |                |        |                          |                          |        |
| S 420 C  |                    |         | 04.94   | 05.96 |                                 |                                 |                |        |                          |                          |        |
| S 500    |                    |         | 07.93   | 10.98 | + Radstand 3040mm <sup>1)</sup> |                                 |                |        |                          |                          |        |
| S 500 C  |                    |         | 07.93   | 05.96 |                                 |                                 |                |        |                          |                          |        |
| S 600    |                    |         | 07.93   | 10.98 | + Radstand 3040mm <sup>1)</sup> |                                 |                |        |                          |                          |        |
| S 600 C  |                    |         | 07.93   | 05.96 |                                 |                                 |                |        |                          |                          |        |
| S 320    |                    |         | 07.93   | 10.98 | + Radstand 3140mm <sup>2)</sup> | 24.3727-0456.2                  | 580456         |        | <input type="checkbox"/> | L=1134                   |        |
| S 420    |                    |         | 07.93   | 10.98 | + Radstand 3140mm <sup>2)</sup> | 24.3727-0455.2                  | 580455         |        | <input type="checkbox"/> | L=1109                   |        |
| S 500    |                    |         | 07.93   | 10.98 | + Radstand 3140mm <sup>2)</sup> |                                 |                |        |                          |                          |        |
| S 600    |                    |         | 07.93   | 10.98 | + Radstand 3140mm <sup>2)</sup> |                                 |                |        |                          |                          |        |

1) + wheel base 3040 mm / + passo 3040 mm / + empattement 3040 mm / + distancia entre ejes 3040 mm

2) + wheel base 3140 mm / + passo 3140 mm / + empattement 3140 mm / + distancia entre ejes 3140 mm



|     |    |  |  |    |   |                        |  |    |  |                                 |
|--|--|--|--|--|--|--|--|--|--|---------------------------------|
| <b>MERCEDES BENZ S-Klasse (W140) (93-98)</b>                                       |  |  |  |  |  |  |  |  |  |                                 |
|    | S 280 / 300 SE 2.8<br>S 320  |  |  | 07.93<br>07.93   | 10.98<br>10.98   | 24.2419-0915.3<br>24.2419-1703.3   | 030045<br>030097   | + GG <sup>1)</sup><br>+ ALU <sup>2)</sup>  | Gz 19,05<br>Gz 19,05   |                                 |
|    | S 280 / 300 SE 2.8<br>S 320  |  |  | 07.93<br>07.93   | 10.98<br>10.98   | 03.2523-1310.3   | 040022   |  | Nz 23,81   |                                 |
| <b>MERCEDES BENZ S-Klasse (W220) (98-06)</b>                                       |  |  |  |  |  |  |  |  |  |                                 |
|    | S 280<br>S 320<br>S 320 CDI 145<br>S 320 CDI 150<br>S 350<br>S 350 4-matic<br>S 370<br>S 400 CDI<br>S 430<br>S 430 4-matic<br>S 500<br>S 500 4-matic<br>S 55 AMG<br>S 55 Kompressor AMG<br>S 600<br>S 65 AMG |  |  | 11.98<br>11.98<br>08.99<br>09.02<br>09.02<br>06.03<br>08.04<br>08.00<br>11.98<br>09.02<br>11.98<br>09.02<br>04.99<br>06.02<br>08.99<br>03.04 | 03.06<br>03.06<br>03.06<br>03.06<br>03.06<br>03.06<br>03.06<br>03.06<br>03.06<br>03.06<br>03.06<br>03.06<br>03.06<br>03.06<br>03.06<br>03.06 | 24.4025-1701.3   | 010719   |  | Thz 25,40  |                                 |
|    | S 350 4-matic  |  |  | 06.03  | 03.06  | 11.9601-9770.2<br>11.9601-9769.2<br>11.0441-6007.2<br>11.0101-5704.2<br>11.8171-0008.1<br>11.8116-0253.1 | 220878<br>220877<br>250146<br>260095<br>990049<br>390512                           | <br>   | D=60, - Halter<br>D=60, - Halter<br>Dichtungssatz<br>Hülssensatz<br>Führungsbolzen<br>Haltefeder | ATE<br>ATE<br>ATE<br>ATE<br>ATE |
|  | S 430 4-matic<br>S 500 4-matic   |  |  | 09.02<br>09.02   | 03.06<br>03.06   | 11.9441-9971.2<br>11.9441-9972.2<br>11.8116-0133.1   | 220839<br>220840<br>390511   | <br>   | D=44, - Halter<br>D=44, - Halter<br>Haltefeder   | ATE<br>ATE<br>ATE               |
|    | S 280<br>S 320<br>S 320 CDI 145<br>S 320 CDI 150<br>S 350<br>S 370<br>S 400 CDI<br>S 430<br>S 430 4-matic<br>S 500<br>S 500 4-matic<br>S 55 AMG<br>S 55 Kompressor AMG<br>S 600<br>S 65 AMG                  |  |  | 11.98<br>11.98<br>08.99<br>09.02<br>09.02<br>08.04<br>08.00<br>11.98<br>09.02<br>11.98<br>09.02<br>04.99<br>06.02<br>08.99<br>03.04          | 03.06<br>03.06<br>03.06<br>03.06<br>03.06<br>03.06<br>03.06<br>03.06<br>03.06<br>03.06<br>03.06<br>03.06<br>03.06<br>03.06<br>03.06          | 24.5123-0380.3   | 331256   |   | L=380  |                                 |
|  | S 280<br>S 320<br>S 320 CDI 145<br>S 320 CDI 150<br>S 370  |  |  | 11.98<br>11.98<br>08.99<br>09.02<br>08.04  | 03.06<br>03.06<br>03.06<br>03.06<br>03.06  | 13.9426-7001.2<br>13.9426-7002.2<br>11.0101-4202.2   | 210255<br>210256<br>260094   | <br>   | D=42, - Halter<br>D=42, - Halter<br>Hülssensatz  | ATE<br>ATE                      |
|  | S 350<br>S 350 4-matic   |  | A265053  | 09.02<br>06.03   | 03.06  | 11.9426-9979.2<br>11.9426-9980.2<br>11.0441-4203.2<br>11.0101-4202.2<br>11.8116-0323.1                   | 220921<br>220922<br>250013<br>260094<br>390459                                     | <br>   | D=42, - Halter<br>D=42, - Halter<br>Dichtungssatz<br>Hülssensatz<br>Haltefeder                   | ATE<br>ATE<br>ATE<br>ATE        |
|  | S 400 CDI<br>S 430<br>S 430 4-matic<br>S 500<br>S 500 4-matic  |  | A265053<br>A265053<br>A265053  | 08.00<br>11.98<br>09.02<br>11.98<br>09.02  | 03.06<br>03.06<br>03.06<br>03.06<br>03.06  | 11.0101-4202.2   | 260094   |  | Hülssensatz  |                                 |
|  | S 350 4-matic<br>S 430<br>S 430 4-matic<br>S 500 4-matic   | A265054<br>A265054<br>A265054<br>A265054   |  |  | 03.06<br>03.06<br>03.06<br>03.06   | 11.0101-4202.2   | 260094   |  | Hülssensatz  |                                 |
|  | S 500<br>S 600   |  |  | 11.98<br>08.99   | 03.06<br>03.06   | 13.2461-8001.2<br>13.2461-8002.2<br>24.9246-8001.5<br>24.9246-8002.5<br>13.0441-4601.2                   | 210226<br>210227<br>230021<br>230022<br>250099                                     | <br><br><br> | D=46<br>D=46<br>D=46<br>D=46<br>Dichtungssatz  | ATE<br>ATE<br>ATE<br>ATE        |
|  | S 280<br>S 320<br>S 320 CDI 145<br>S 320 CDI 150<br>S 350<br>S 370<br>S 400 CDI<br>S 430<br>S 500<br>S 55 AMG<br>S 55 Kompressor AMG<br>S 600  |  |  | 11.98<br>11.98<br>08.99<br>09.02<br>09.02<br>08.04<br>08.00<br>11.98<br>11.98<br>04.99<br>06.02<br>08.99                                     | 03.06<br>03.06<br>03.06<br>03.06<br>03.06<br>03.06<br>03.06<br>03.06<br>03.06<br>03.06<br>03.06<br>03.06                                     | 24.5123-0240.3   | 330759   |   | L=240  |                                 |
|  | S 350 4-matic<br>S 430 4-matic   |  |  | 06.03<br>09.02   | 03.06<br>03.06   | 24.5238-0255.3   | 330674   |   | L=255  |                                 |

1) + cast iron / + ghisa / + fonte grise / + fundición de gris

2) + aluminium / + alluminio / + aluminium / + aluminio

3) - armoured vehicles / - veicoli blindati / - véhicule blindé / - vehículo blindado

4) + armoured vehicles / + veicoli blindati / + véhicule blindé / + vehículo blindado

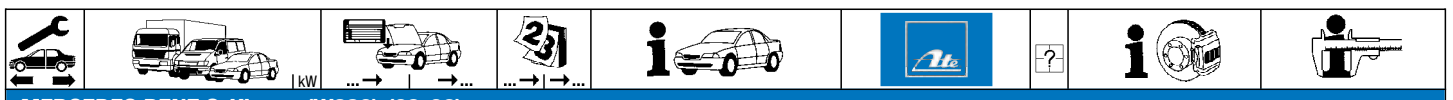

**MERCEDES BENZ S-Klasse (W220) (98-06)**

|  |                       |      |  |       |       |                |        |                          |  |        |
|--|-----------------------|------|--|-------|-------|----------------|--------|--------------------------|--|--------|
|  | S 500 4-matic         |      |  | 09.02 | 03.06 | 24.5238-0255.3 | 330674 | 2                        |  | L=255  |
|  | S 65 AMG              |      |  | 03.04 | 03.06 | 83.7715-0299.3 | 331117 | 2                        |  | L=300  |
|  | S 280                 | ↓    |  | 11.98 | 03.06 | 24.3727-0458.2 | 580458 | <input type="checkbox"/> |  | L=990  |
|  | S 320                 | ↓    |  | 11.98 | 03.06 | 24.3727-0457.2 | 580457 | <input type="checkbox"/> |  | L=980  |
|  | S 320 CDI             | ↓145 |  | 08.99 | 03.06 |                |        |                          |  |        |
|  | S 320 CDI             | ↓150 |  | 09.02 | 03.06 |                |        |                          |  |        |
|  | S 350 4-matic         | ↓    |  | 06.03 | 03.06 |                |        |                          |  |        |
|  | S 370                 | ↓    |  | 08.04 | 03.06 |                |        |                          |  |        |
|  | S 400 CDI             | ↓    |  | 08.00 | 03.06 |                |        |                          |  |        |
|  | S 430                 | ↓    |  | 11.98 | 03.06 |                |        |                          |  |        |
|  | S 430 4-matic         | ↓    |  | 09.02 | 03.06 |                |        |                          |  |        |
|  | S 500                 | ↓    |  | 11.98 | 03.06 |                |        |                          |  |        |
|  | S 500 4-matic         | ↓    |  | 09.02 | 03.06 |                |        |                          |  |        |
|  | S 55 AMG              | ↓    |  | 04.99 | 03.06 |                |        |                          |  |        |
|  | S 320 CDI L           | ↓    |  | 08.00 | 03.06 | 24.3727-0466.2 | 580466 | 1 ↑                      |  | L=2937 |
|  | S 320 L               | ↓    |  | 11.98 | 03.06 | 24.3727-0458.2 | 580458 | <input type="checkbox"/> |  | L=990  |
|  | S 350 L               | ↓    |  | 09.02 | 03.06 | 24.3727-0457.2 | 580457 | <input type="checkbox"/> |  | L=980  |
|  | S 350 L 4-matic       | ↓    |  | 06.03 | 03.06 |                |        |                          |  |        |
|  | S 400 CDI L           | ↓    |  | 08.00 | 03.06 |                |        |                          |  |        |
|  | S 430 L               | ↓    |  | 11.98 | 03.06 |                |        |                          |  |        |
|  | S 430 L 4-matic       | ↓    |  | 09.02 | 03.06 |                |        |                          |  |        |
|  | S 500 L               | ↓    |  | 11.98 | 03.06 |                |        |                          |  |        |
|  | S 500 L 4-matic       | ↓    |  | 09.02 | 03.06 |                |        |                          |  |        |
|  | S 55 AMG L            | ↓    |  | 04.99 | 03.06 |                |        |                          |  |        |
|  | S 600                 | ↓    |  | 08.99 | 03.06 |                |        |                          |  |        |
|  | S 55 L Kompressor AMG | ↓    |  | 06.02 | 03.06 | 24.3727-0466.2 | 580466 | 1 ↑                      |  | L=2937 |
|  | S 65 AMG              | ↓    |  | 03.04 | 03.06 | 24.3727-0466.2 | 580466 | 1 ↑                      |  | L=2937 |
|  | S 280                 | ↓    |  | 11.98 | 03.06 | 24.3727-0458.2 | 580458 | <input type="checkbox"/> |  | L=990  |
|  | S 320                 | ↓    |  | 11.98 | 03.06 | 24.3727-0457.2 | 580457 | <input type="checkbox"/> |  | L=980  |
|  | S 320 CDI             | ↓145 |  | 08.99 | 03.06 |                |        |                          |  |        |
|  | S 350 4-matic         | ↓    |  | 06.03 | 03.06 |                |        |                          |  |        |
|  | S 370                 | ↓    |  | 08.04 | 03.06 |                |        |                          |  |        |
|  | S 400 CDI             | ↓    |  | 08.00 | 03.06 |                |        |                          |  |        |
|  | S 430                 | ↓    |  | 11.98 | 03.06 |                |        |                          |  |        |
|  | S 430 4-matic         | ↓    |  | 09.02 | 03.06 |                |        |                          |  |        |
|  | S 500                 | ↓    |  | 11.98 | 03.06 |                |        |                          |  |        |
|  | S 500 4-matic         | ↓    |  | 09.02 | 03.06 |                |        |                          |  |        |
|  | S 55 AMG              | ↓    |  | 04.99 | 03.06 |                |        |                          |  |        |
|  | S 320 CDI L           | ↓    |  | 08.00 | 03.06 | 24.3727-0458.2 | 580458 | <input type="checkbox"/> |  | L=990  |
|  | S 320 L               | ↓    |  | 11.98 | 03.06 | 24.3727-0457.2 | 580457 | <input type="checkbox"/> |  | L=980  |
|  | S 350 L               | ↓    |  | 09.02 | 03.06 |                |        |                          |  |        |
|  | S 350 L 4-matic       | ↓    |  | 06.03 | 03.06 |                |        |                          |  |        |
|  | S 400 CDI L           | ↓    |  | 08.00 | 03.06 |                |        |                          |  |        |
|  | S 430 L               | ↓    |  | 11.98 | 03.06 |                |        |                          |  |        |
|  | S 430 L 4-matic       | ↓    |  | 09.02 | 03.06 |                |        |                          |  |        |
|  | S 500 L               | ↓    |  | 11.98 | 03.06 |                |        |                          |  |        |
|  | S 500 L 4-matic       | ↓    |  | 09.02 | 03.06 |                |        |                          |  |        |
|  | S 55 AMG L            | ↓    |  | 04.99 | 03.06 |                |        |                          |  |        |
|  | S 600                 | ↓    |  | 08.99 | 03.06 |                |        |                          |  |        |

**MERCEDES BENZ S-Klasse (W221) (06-13)**

|  |                       |     |          |       |  |                |        |  |                                      |             |     |
|--|-----------------------|-----|----------|-------|--|----------------|--------|--|--------------------------------------|-------------|-----|
|  | S 280 / S 300         | 170 | A 265574 | 04.06 |  | 03.7858-1932.4 | 300263 |  |                                      | 9/8" Tandem | ATE |
|  | S 320 CDI             | 155 | A 265574 | 12.05 |  |                |        |  |                                      |             |     |
|  | S 320 CDI / S 350 CDI | 173 | A 265574 | 12.05 |  |                |        |  |                                      |             |     |
|  | S 320 CDI 4-matic     | 155 | A 265574 | 12.05 |  |                |        |  |                                      |             |     |
|  | S 320 CDI 4-matic     | 173 | A 265574 | 05.06 |  |                |        |  |                                      |             |     |
|  | S 350                 | 200 | A 265574 | 12.05 |  |                |        |  |                                      |             |     |
|  | S 350 4-matic         | 200 | A 265574 | 02.07 |  |                |        |  |                                      |             |     |
|  | S 420 CDI / S 450 CDI | 235 | A 265574 | 04.06 |  |                |        |  |                                      |             |     |
|  | S 450                 | 250 | A 265574 | 04.06 |  |                |        |  |                                      |             |     |
|  | S 450 4-matic         | 250 | A 265574 | 04.06 |  |                |        |  |                                      |             |     |
|  | S 500                 | 285 | A 265574 | 12.05 |  |                |        |  |                                      |             |     |
|  | S 500 4-matic         | 285 | A 265574 | 04.06 |  |                |        |  |                                      |             |     |
|  | S 63 AMG              |     | A 265574 | 01.07 |  |                |        |  |                                      |             |     |
|  | S 280 / S 300         | 170 | A 293047 | 04.06 |  | 03.4055-0013.3 | 010793 |  | - gepanzerte Fahrzeuge <sup>3)</sup> | Thz 25,40   | ATE |
|  | S 320 CDI             | 155 | A 293047 | 12.05 |  |                |        |  |                                      |             |     |
|  | S 320 CDI / S 350 CDI | 173 | A 293047 | 12.05 |  |                |        |  |                                      |             |     |
|  | S 320 CDI 4-matic     | 155 | A 293047 | 12.05 |  |                |        |  |                                      |             |     |
|  | S 320 CDI 4-matic     | 173 | A 293047 | 05.06 |  |                |        |  |                                      |             |     |
|  | S 350                 | 200 | A 293047 | 12.05 |  |                |        |  |                                      |             |     |
|  | S 350 4-matic         | 200 | A 293047 | 02.07 |  |                |        |  |                                      |             |     |
|  | S 420 CDI / S 450 CDI | 235 | A 293047 | 04.06 |  |                |        |  |                                      |             |     |
|  | S 450                 | 250 | A 293047 | 04.06 |  |                |        |  |                                      |             |     |
|  | S 450 4-matic         | 250 | A 293047 | 04.06 |  |                |        |  |                                      |             |     |
|  | S 500                 | 285 | A 293047 | 12.05 |  |                |        |  |                                      |             |     |
|  | S 500 4-matic         | 285 | A 293047 | 04.06 |  |                |        |  |                                      |             |     |
|  | S 600                 | 380 | A 293047 | 12.05 |  |                |        |  |                                      |             |     |
|  | S 63 AMG              |     | A 293047 | 01.07 |  |                |        |  |                                      |             |     |
|  | S 65 AMG              |     | A 293047 | 04.06 |  |                |        |  |                                      |             |     |

1) + wheel base 2965 mm / + passo 2965 mm / + empattement 2965 mm / + distancia entre ejes 2965 mm  
 2) + wheel base 3085 mm / + passo 3085 mm / + empattement 3085 mm / + distancia entre ejes 3085 mm  
 3) - armoured vehicles / - veicoli blindati / - véhicule blindé / - vehículo blindado





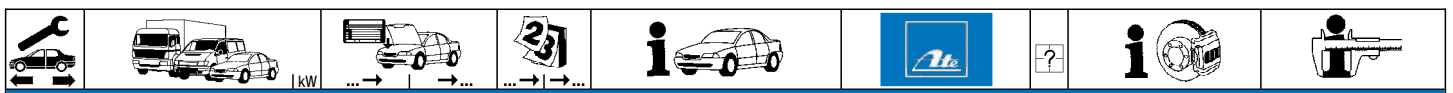

**MERCEDES BENZ S-Klasse (W221) (06-13)**

|                       |                       |     |          |       |       |  |                |        |                |  |                |  |                |     |
|-----------------------|-----------------------|-----|----------|-------|-------|--|----------------|--------|----------------|--|----------------|--|----------------|-----|
|                       | S 250 CDI             | 150 |          | 01.11 | 05.13 |  | 11.9426-9990.2 | 220640 | 2              | <input type="checkbox"/> - AMG Sportpaket 1)<br><input type="checkbox"/> - AMG Sportpaket 1)<br><input type="checkbox"/> + AMG Sportpaket 2)<br><input type="checkbox"/> + AMG Sportpaket 2) | D=42, - Halter | ATE  |                |     |
|                       |                       |     |          |       |       |  | 11.9426-9989.2 | 220639 |                |  | D=42, - Halter | ATE  |                |     |
|                       |                       |     |          |       |       |  | 11.9426-9959.2 | 220801 |                |  | D=42, - Halter | ATE  |                |     |
|                       |                       |     |          |       |       |  | 11.9426-9960.2 | 220802 |                |  | D=42, - Halter | ATE  |                |     |
|                       |                       |     |          |       |       |  | 11.8116-0086.2 | 390606 |                |  | Haltefeder     | ATE  |                |     |
|                       |                       |     |          |       |       |  | 11.8171-0008.1 | 990049 | Führungsbolzen | ATE  |                |  |                |     |
|                       |                       |     |          |       |       |  | 11.0101-5407.2 | 260011 | Hülsensatz     | ATE  |                |  |                |     |
|                       | S 280 / S 300         | 170 | A 265575 | 04.06 |       |  | 11.9426-9990.2 | 220640 | 2              | <input type="checkbox"/> - Sportpaket 3)<br><input type="checkbox"/> - Sportpaket 3)<br><input type="checkbox"/> + Sportpaket 4)<br><input type="checkbox"/> + Sportpaket 4)                 | D=42, - Halter | ATE  |                |     |
|                       | S 320 CDI             | 155 | A 265575 | 12.05 |       |  | 11.9426-9989.2 | 220639 |                |  | D=42, - Halter | ATE  |                |     |
|                       | S 320 CDI / S 350 CDI | 173 | A 265575 | 12.05 |       |  | 11.9426-9959.2 | 220801 |                |  | D=42, - Halter | ATE  |                |     |
|                       | S 320 CDI 4-matic     | 155 | A 265575 | 12.05 |       |  | 11.9426-9960.2 | 220802 |                |  | D=42, - Halter | ATE  |                |     |
|                       | S 320 CDI 4-matic     | 173 | A 265575 | 05.06 |       |  | 11.8116-0086.2 | 390606 |                |  | Haltefeder     | ATE  |                |     |
|                       | S 350                 | 200 | A 265575 | 12.05 |       |  | 11.8171-0008.1 | 990049 |                |  | Führungsbolzen | ATE  |                |     |
|                       | S 350 4-matic         | 200 | A 265575 | 02.07 |       |  | 11.0101-5407.2 | 260011 |                |  | Hülsensatz     | ATE  |                |     |
|                       | S 400 Hybrid          | 205 | A 265575 | 06.09 |       |  |                |        |                |  |                |  |                |     |
|                       | S 420 CDI / S 450 CDI | 235 |          | 04.06 | 05.13 |  |                |        |                |  |                |  |                |     |
|                       | S 450 4-matic         | 250 |          | 04.06 | 05.13 |  |                |        |                |  |                |  |                |     |
|                       | S 450                 | 250 |          | 04.06 | 05.13 |  | 11.9426-9959.2 | 220801 |                |  | 2              | <input type="checkbox"/><br><input type="checkbox"/> | D=42, - Halter | ATE |
|                       | S 450 4-matic         | 250 |          | 04.06 | 05.13 |  | 11.9426-9960.2 | 220802 |                |  |                |  | D=42, - Halter | ATE |
|                       | S 500                 | 285 |          | 12.05 | 05.13 |  | 11.8171-0008.1 | 990049 | Führungsbolzen | ATE  |                |  |                |     |
|                       | S 500 4-matic         | 285 |          | 04.06 | 05.13 |  | 11.0101-5407.2 | 260011 | Hülsensatz     | ATE  |                |  |                |     |
|                       | S 500 CGI             | 320 |          | 04.11 | 05.13 |  | 11.8116-0086.2 | 390606 | Haltefeder     | ATE  |                |  |                |     |
|                       | S 280 / S 300         | 170 | A 265576 |       | 05.13 |  | 11.9426-9992.2 | 220642 | 2              | <input type="checkbox"/> - Sportpaket 3)<br><input type="checkbox"/> - Sportpaket 3)<br><input type="checkbox"/> + Sportpaket 4)<br><input type="checkbox"/> + Sportpaket 4)                 | D=42, - Halter | ATE  |                |     |
|                       | S 320 CDI             | 155 | A 265576 |       | 05.13 |  | 11.9426-9991.2 | 220641 |                |  | D=42, - Halter | ATE  |                |     |
|                       | S 320 CDI / S 350 CDI | 173 | A 265576 |       | 05.13 |  | 11.9426-9959.2 | 220801 |                |  | D=42, - Halter | ATE  |                |     |
|                       | S 320 CDI 4-matic     | 155 | A 265576 |       | 05.13 |  | 11.9426-9960.2 | 220802 |                |  | D=42, - Halter | ATE  |                |     |
|                       | S 320 CDI 4-matic     | 173 | A 265576 |       | 05.13 |  | 11.8116-0086.2 | 390606 |                |  | Haltefeder     | ATE  |                |     |
|                       | S 350                 | 200 | A 265576 |       | 05.13 |  | 11.8171-0008.1 | 990049 |                |  | Führungsbolzen | ATE  |                |     |
|                       | S 350 4-matic         | 200 | A 265576 |       | 05.13 |  | 11.0101-5407.2 | 260011 |                |  | Hülsensatz     | ATE  |                |     |
|                       | S 350 BlueTec         | 190 |          | 04.11 | 05.13 |  |                |        |                |  |                |  |                |     |
|                       | S 350 BlueTec 4-matic | 190 |          | 04.11 | 05.13 |  |                |        |                |  |                |  |                |     |
|                       | S 350 CGI             | 225 |          | 04.11 | 05.13 |  |                |        |                |  |                |  |                |     |
|                       | S 350 CGI 4-matic     | 225 |          | 04.11 | 05.13 |  |                |        |                |  |                |  |                |     |
| S 400 Hybrid          | 205                   |     | 06.09    | 05.13 |       |  |                |        |                |  |                |  |                |     |
| S 420 CDI / S 450 CDI | 235                   |     | 04.06    | 05.13 |       |  |                |        |                |  |                |  |                |     |
| S 450                 | 250                   |     | 04.06    | 05.13 |       |  |                |        |                |  |                |  |                |     |
| S 450 4-matic         | 250                   |     | 04.06    | 05.13 |       |  |                |        |                |  |                |  |                |     |
| S 500                 | 285                   |     | 12.05    | 05.13 |       |  |                |        |                |  |                |  |                |     |
| S 500 4-matic         | 285                   |     | 04.06    | 05.13 |       |  |                |        |                |  |                |  |                |     |
| S 500 CGI             | 320                   |     | 04.11    | 05.13 |       |  |                |        |                |  |                |  |                |     |
| S 500 CGI 4-matic     | 320                   |     | 03.11    | 05.13 |       |  |                |        |                |  |                |  |                |     |
| S 600                 | 380                   |     | 12.05    | 05.13 |       |  |                |        |                |  |                |  |                |     |
| S 63 AMG              |                       |     | 01.07    | 05.13 |       |  |                |        |                |  |                |  |                |     |
| S 65 AMG              |                       |     | 04.06    | 05.13 |       |  |                |        |                |  |                |  |                |     |

















**MERCEDES BENZ S-Klasse (W222) (13-)**

|  |              |     |  |       |  |  |                |        |   |  |       |  |
|--|--------------|-----|--|-------|--|--|----------------|--------|---|--|-------|--|
|  | S 350 BT     | 190 |  | 03.13 |  |  | 24.5123-0350.3 | 330963 | 2 |  | L=350 |  |
|  | S 400 Hybrid | 225 |  | 03.13 |  |  |                |        |   |  |       |  |
|  | S 500        | 335 |  | 03.13 |  |  |                |        |   |  |       |  |

**MERCEDES BENZ SL-Klasse (R129) (93-01)**

|           |           |         |         |         |       |                       |                |                |               |  |                 |                 |     |
|-----------|-----------|---------|---------|---------|-------|-----------------------|----------------|----------------|---------------|--|-----------------|-----------------|-----|
|           | SL 280    | 142     | F102744 | 08.93   |       |                       | 03.2025-0211.3 | 010034         |               |  | Thz 25,40/19,05 | ATE             |     |
|           | SL 320    | 170     | F102744 | 08.93   |       |                       |                |                |               |  |                 |                 |     |
|           | SL 500    | 235     | F102744 | 08.93   |       |                       |                |                |               |  |                 |                 |     |
|           | SL 60 AMG | 280     | F102744 | 05.94   |       |                       |                |                |               |  |                 |                 |     |
|           | SL 280    | 142     | F102745 | F148143 |       |                       |                | 24.2025-1702.3 | 010515        |  |                 | Thz 25,40/19,05 | LUC |
|           | SL 320    | 170     | F102745 | F148143 |       |                       |                |                |               |  |                 |                 |     |
|           | SL 500    | 235     | F102745 | F148143 |       |                       |                |                |               |  |                 |                 |     |
|           | SL 60 AMG | 280     | F102745 | F148143 |       |                       |                |                |               |  |                 |                 |     |
|           | SL 280    | 142     | F148144 | F187941 | 08.93 |                       |                | 03.2025-1511.3 | 010704        |  |                 | Thz 25,40/20,64 | ATE |
|           | SL 280    | 150     | F148144 | F187941 | 05.98 |                       |                |                |               |  |                 |                 |     |
|           | SL 320    | 165     | F148144 |         | 09.01 |                       |                |                |               |  |                 |                 |     |
|           | SL 500    | 235     | F148144 |         | 09.01 |                       |                |                |               |  |                 |                 |     |
| SL 60 AMG | 280       | F148144 |         | 09.01   |       |                       |                |                |               |  |                 |                 |     |
|           | SL 280    | 142     | F155734 | 08.93   |       |                       | 13.0441-4214.2 | 250091         |               |  | Dichtungssatz   | ATE             |     |
|           | SL 500    | 235     |         | 08.93   | 09.01 | + AMG Technikpaket 5) |                |                |               |  |                 |                 |     |
|           | SL 500    | 235     | F103937 |         | 09.01 | - AMG Technikpaket 6) |                |                |               |  |                 |                 |     |
|           | SL 280    | 142     | F155735 |         | 09.01 |                       | 24.9442-8003.5 | 230053         | 2             | <input type="checkbox"/><br><input type="checkbox"/>   | D=42/38         | ATE             |     |
|           | SL 500    | 235     | F103936 | 08.93   |       | - AMG Technikpaket 6) | 24.9442-8004.5 | 230054         |               |  | D=42/38         | ATE             |     |
|           | SL 60 AMG | 280     | F103936 | 05.94   |       |                       | 13.0441-4214.2 | 250091         | Dichtungssatz | ATE  |                 |                 |     |
|           | SL 280    | 150     | F187941 | 08.93   |       |                       | 24.9442-8003.5 | 230053         | 2             | <input type="checkbox"/> - ESP<br><input type="checkbox"/> - ESP<br><input type="checkbox"/> - ESP | D=42/38         | ATE             |     |
|           | SL 320    | 165     | F187941 | 05.98   |       |                       | 24.9442-8004.5 | 230054         |               |  | D=42/38         | ATE             |     |
| SL 320    | 170       | F187941 | 08.93   |         |       | 13.0441-4214.2        | 250091         | Dichtungssatz  |               |  | ATE             |                 |     |
| SL 500    | 235       | F103937 |         | 09.01   |       |                       | 13.0441-4214.2 | 250091         |               |  | Dichtungssatz   | ATE             |     |











































1) - AMG sports package / - kit sportivo AMG / - version sport AMG / - paquete deportivo AMG  
 2) + AMG sports package / + pacchetto sportivo AMG / + version Sport AMG / + kit deportivo AMG  
 3) - sport package / - pacchetto sportivo / - version sport / - kit deportivo  
 4) + sports package / + pacchetto sportivo / + version sport / + kit deportivo  
 5) + AMG Performance package / + Performance package AMG / + Performance package AMG  
 6) - AMG Performance package / - Performance package AMG / - Performance package AMG / - Performance package AMG

|     |              |  |                          |  |  |    |  |   |
|--|--|--|--|--|---|--|--|---|
| <b>MERCEDES BENZ SL-Klasse (R129) (93-01)</b>                                      |  |  |  |  |   |  |  |   |
|    | SL 60 AMG<br>SL 600  | 280<br>F103937   |  | 08.93<br>09.01   |   | 13.0441-4214.2<br>250091   | - ESP  | Dichtungssatz<br>ATE  |
|    | SL 280<br>SL 320<br>SL 500<br>SL 60 AMG<br>SL 600  | 142<br>170<br>235<br>280   | F125157<br>F125157<br>F125157<br>F125157<br>F125157  | 08.93<br>08.93<br>08.93<br>05.94<br>08.93  |   | 83.7754-0340.3<br>330794   | 2  | L=340   |
|    | SL 280<br>SL 320<br>SL 500<br>SL 60 AMG  | 142<br>170<br>235<br>280   | F 125157<br>F 125157<br>F 103936<br>F 103936   | 08.93<br>08.93<br>08.93<br>05.94   |   | 13.2381-8035.2<br>13.2381-8036.2<br>24.9238-8035.5<br>24.9238-8036.5<br>13.0441-3817.2                                     | 210037<br>210038<br>230025<br>230026<br>250071                                     | D=38<br>D=38<br>D=38<br>D=38<br>Dichtungssatz<br>ATE<br>ATE<br>ATE<br>ATE   |
|  | SL 500<br>SL 60 AMG  | 235<br>280   | F 103937<br>F 103937   | F 125157<br>F 125157   |   | 13.2381-8033.2<br>13.2381-8034.2   | 210222<br>210223   | D=38<br>D=38<br>D=38<br>D=38<br>Dichtungssatz<br>ATE<br>ATE<br>ATE<br>ATE   |
|  | SL 280<br>SL 280<br>SL 320<br>SL 320<br>SL 500<br>SL 60 AMG                                  | 142<br>150<br>165<br>170<br>235<br>280   | F 125158<br>F 187941<br>F 125158<br>F 125158<br>F 125158<br>F 125158                                     | 09.01<br>09.01<br>05.98<br>09.01<br>09.01<br>09.01                               | - ESP<br>- ESP<br>- ESP<br>- ESP  | 13.2361-8001.2<br>13.2361-8002.2<br>24.9236-8001.5<br>24.9236-8002.5<br>13.0441-3606.2                                     | 210214<br>210215<br>230007<br>230008<br>250147                                     | D=36<br>D=36<br>D=36<br>D=36<br>Dichtungssatz<br>ATE<br>ATE<br>ATE<br>ATE   |
|  | SL 280<br>SL 320<br>SL 500<br>SL 60 AMG  | 150<br>165<br>235<br>280   | F 187941<br>F 187941   | 08.93<br>05.98   | + ESP<br>+ ESP  | 13.2421-8025.2<br>13.2421-8026.2<br>13.0441-4216.2   | 210061<br>210062<br>250093   | D=42<br>D=42<br>Dichtungssatz<br>ATE<br>ATE<br>ATE  |
|  | SL 280<br>SL 320<br>SL 500<br>SL 55 AMG  | 150<br>165<br>225<br>260   | F 187942<br>F 187942   | 09.01<br>09.01<br>05.98<br>03.00   |   | 13.2381-8035.2<br>13.2381-8036.2<br>24.9238-8035.5<br>24.9238-8036.5<br>13.2421-8025.2<br>13.2421-8026.2<br>13.0441-4216.2 | 210037<br>210038<br>230025<br>230026<br>210061<br>210062<br>250093                 | + SL Edition<br>+ SL Edition<br>+ SL Edition<br>+ SL Edition<br>- SL Edition<br>- SL Edition<br>Dichtungssatz<br>ATE<br>ATE<br>ATE<br>ATE<br>ATE<br>ATE |
|    | SL 280<br>SL 320<br>SL 500<br>SL 60 AMG<br>SL 600  | 142<br>170<br>235<br>280   | F 125157<br>F 125157<br>F 125157<br>F 125157<br>F 125157   | 08.93<br>08.93<br>08.93<br>05.94<br>08.93  |   | 83.7704-0281.3<br>330804   | 2  | L=280   |
|  | SL 280<br>SL 280<br>SL 320<br>SL 320<br>SL 500<br>SL 500<br>SL 55 AMG<br>SL 60 AMG<br>SL 600 | 142<br>150<br>165<br>170<br>225<br>235<br>260<br>280<br>F 125158                 | F 125158<br>F 125158<br>F 125158<br>F 125158<br>F 125158<br>F 125158<br>F 125158<br>F 125158<br>F 125158 | 09.01<br>08.93<br>09.01<br>09.01<br>05.98<br>09.01<br>09.01<br>09.01<br>09.01    |   | 83.7715-0280.3<br>330806   | 2  | L=280   |
|  | SL 280<br>SL 280<br>SL 320<br>SL 320<br>SL 500<br>SL 500<br>SL 55 AMG<br>SL 60 AMG<br>SL 600 | 142<br>150<br>165<br>170<br>225<br>235<br>260<br>280<br>1                        |  | 08.93<br>08.93<br>05.98<br>08.93<br>05.98<br>08.93<br>03.00<br>05.94<br>08.93    | 09.01<br>09.01<br>09.01<br>09.01<br>09.01<br>09.01<br>09.01<br>09.01<br>09.01     | 24.3727-0464.2<br>24.3727-0468.2   | 580464<br>580468   | 1<br>1<br>L=2297<br>L=1044  |
|  | SL 280<br>SL 280<br>SL 320<br>SL 320<br>SL 500<br>SL 500<br>SL 55 AMG<br>SL 60 AMG<br>SL 600 | 142<br>150<br>165<br>170<br>225<br>235<br>260<br>280<br>1                        |  | 08.93<br>08.93<br>05.98<br>08.93<br>05.98<br>08.93<br>03.00<br>05.94<br>08.93    | 09.01<br>09.01<br>09.01<br>09.01<br>09.01<br>09.01<br>09.01<br>09.01<br>09.01     | 24.3727-0468.2   | 580468   | 1<br>L=1044   |
|  | SL 280<br>SL 280   | 142<br>150   |  | 08.93<br>08.93   | 09.01<br>09.01  | 24.2419-0915.3<br>24.2419-1703.3   | 030045<br>030097   | + GG <sup>1)</sup><br>+ ALU <sup>2)</sup><br>Gz 19,05<br>Gz 19,05   |
|  | SL 280<br>SL 280   | 142<br>150   |  | 08.93<br>08.93   | 09.01<br>09.01  | 03.2523-1310.3   | 040022   | Nz 23,81  |
| <b>MERCEDES BENZ SL-Klasse (R230) (01-11)</b>                                      |  |  |  |  |   |  |  |   |
|  | SL 280<br>SL 300<br>SL 350<br>SL 350<br>SL 500   | 170<br>170<br>200<br>232<br>285  |  | 11.07<br>04.09<br>03.06<br>04.08<br>03.06  | 11.11<br>11.11<br>11.11<br>11.11<br>11.11   | + Sportpaket <sup>3)</sup><br>+ Sportpaket <sup>3)</sup><br>+ Sportpaket <sup>3)</sup><br>+ Sportpaket <sup>3)</sup>       | 220801<br>220802<br>390606<br>990049<br>260011                                     | D=42, - Halter<br>D=42, - Halter<br>Halterfeder<br>Führungsbolzen<br>Hülsensatz<br>ATE<br>ATE<br>ATE<br>ATE<br>ATE                                      |























<sup>1)</sup> + cast iron / + ghisa / + fonte grise / + fundición de gris

<sup>2)</sup> + aluminium / + alluminio / + aluminium / + aluminio













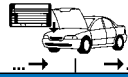



















<sup>3)</sup> + sports package / + pacchetto sportivo / + version sport / + kit deportivo

|     |    |  |  |  |  |  |  |  |   |   |                |
|--|--|--|--|--|---|--|--|--|---|---|----------------|
| <b>MERCEDES BENZ SL-Klasse (R230) (01-11)</b>                                      |  |  |  |  |   |  |  |  |   |   |                |
|    | SL 280   | 170  |  | 11.07  | 11.11   | - Sportpaket <sup>1)</sup>   | 11.9426-9990.2   | 220640   |    | D=42, - Halter  | ATE            |
|  | SL 300   | 170  |  | 04.09  | 11.11   | - Sportpaket <sup>1)</sup>   | 11.9426-9989.2   | 220639   |    | D=42, - Halter  | ATE            |
|  | SL 350   | 200  |  | 03.06  | 11.11   | - Sportpaket <sup>1)</sup>   | 11.8116-0086.2   | 390606   | 2   | Führungsbolzen  | ATE            |
|  |  |  |  |  |   |  | 11.8171-0008.1   | 990049   |   | Hülzensatz  | ATE            |
|  |  |  |  |  |   |  | 11.0101-5407.2   | 260011   |   | Hülzensatz  | ATE            |
|  | SL 350   | 180  |  | 02.03  | 11.11   |  | 11.9426-9989.2   | 220639   |    | D=42, - Halter  | ATE            |
|  |  |  |  |  |   |  | 11.9426-9990.2   | 220640   |    | D=42, - Halter  | ATE            |
|  |  |  |  |  |   |  | 11.0441-4203.2   | 250013   | 2   | Dichtungssatz   | ATE            |
|  |  |  |  |  |   |  | 11.8116-0323.1   | 390459   |   | Haltefeder  | ATE            |
|  |  |  |  |  |   |  | 11.0101-5407.2   | 260011   |   | Hülzensatz  | ATE            |
|  | SL 350   | 232  |  | 04.08  | 11.11   | - Sportpaket <sup>1)</sup>   | 11.9426-9991.2   | 220641   |    | D=42, - Halter  | ATE            |
|  | SL 500   | 225  |  | 09.01  | 11.11   |  | 11.9426-9992.2   | 220642   |    | D=42, - Halter  | ATE            |
|  |  |  |  |  |   | 11.0441-4203.2   | 250013   | 2  | Dichtungssatz   | ATE   |                |
|  |  |  |  |  |   | 11.0101-5407.2   | 260011   |  | Hülzensatz  | ATE   |                |
|  |  |  |  |  |   | 11.8171-0008.1   | 990049   |  | Führungsbolzen  | ATE   |                |
|  |  |  |  |  |   | 11.8116-0323.1   | 390459   | 2  | Haltefeder  | ATE   |                |
|    | SL 280   | 170  |  | 11.07  | 11.11   |  | 83.7715-0299.3   | 331117   | 2   | L=300   |                |
|  | SL 300   | 170  |  | 04.09  | 11.11   |  |  |  |   |   |                |
|  | SL 350   | 180  |  | 02.03  | 11.11   |  |  |  |   |   |                |
|  | SL 350   | 200  |  | 03.06  | 11.11   |  |  |  |   |   |                |
|  | SL 350   | 232  |  | 04.08  | 11.11   |  |  |  |   |   |                |
|  | SL 500   | 225  |  | 09.01  | 11.11   |  |  |  |   |   |                |
|  | SL 500   | 285  |  | 03.06  | 11.11   |  |  |  |   |   |                |
|  | SL 55 AMG  | 350  |  | 09.01  | 11.11   |  |  |  |   |   |                |
|  | SL 55 AMG  | 368  |  | 06.02  | 11.11   |  |  |  |   |   |                |
|  | SL 55 AMG  | 380  |  | 03.06  | 11.11   |  |  |  |   |   |                |
|  | SL 600   | 368  |  | 04.03  | 11.11   |  |  |  |   |   |                |
|  | SL 600   | 380  |  | 03.06  | 11.11   |  |  |  |   |   |                |
|  | SL 65 AMG  | 450  |  | 03.04  | 11.11   |  |  |  |   |   |                |
|  | SL 65 AMG BlackSeries  | 493  |  | 07.08  | 11.11   |  | 24.5238-0255.3   | 330674   | 2   | L=255   |                |
| <b>MERCEDES BENZ SLK-Klasse (R170) (96-04)</b>                                     |  |  |  |  |   |  |  |  |   |   |                |
|    | SLK 200  | 100  | F025730  | 09.96  |   |  | 24.2023-1701.3   | 010514   |   | Thz 23,81/19,05   | LUC            |
|  | SLK 200 Kompressor   | 141  | F025730  | 09.96  |   |  |  |  |   |   |                |
|  | SLK 230 Kompressor   | 142  | F025730  | 09.96  |   |  |  |  |   |   |                |
|    | SLK 200  | 100  | F025731  |  | 03.04   |  | 24.2023-1702.3   | 010534   |   | Thz 23,81/19,05   | LUC            |
|  | SLK 200 Kompressor   | 141  | F025731  |  | 03.04   |  |  |  |   |   |                |
|  | SLK 230 Kompressor   | 142  | F025731  |  | 03.04   |  |  |  |   |   |                |
|  | SLK 200 Kompressor   | 120  |  | 03.00  | 03.04   |  | 03.2025-1741.3   | 010705   |   | Thz 25,40/20,64   | ATE            |
|  | SLK 230 Kompressor   | 145  |  | 03.00  | 03.04   |  |  |  |   |   |                |
|  | SLK 32 AMG   | 260  |  | 03.01  | 03.04   |  |  |  |   |   |                |
|  | SLK 320  | 160  |  | 04.00  | 03.04   |  |  |  |   |   |                |
|  | SLK 200  | 100  |  | 09.96  | 03.04   |  | 11.3571-8511.2   | 220315   |  | D=57, - Halter  | ATE            |
|  | SLK 200 Kompressor   | 120  |  | 03.00  | 03.04   |  | 11.3571-8512.2   | 220316   |  | D=57, - Halter  | ATE            |
|  | SLK 200 Kompressor   | 141  |  | 09.96  | 03.04   |  | 24.3571-8511.5   | 240491   |  | D=57, - Halter  | ATE            |
|  | SLK 230 Kompressor   | 142  |  | 09.96  | 03.04   |  | 24.3571-8512.5   | 240492   |  | D=57, - Halter  | ATE            |
|  | SLK 230 Kompressor   | 145  |  | 03.00  | 03.04   |  | 11.0441-5703.2   | 250145   |   | Dichtungssatz   | ATE            |
|  |  |  |  |  |   |  | 11.0230-0096.2   | 260033   |   | Haltersatz  | ATE            |
|  |  |  |  |  |   |  | 11.0101-5407.2   | 260011   |   | Hülzensatz  | ATE            |
|  |  |  |  |  |   |  | 11.8171-0008.1   | 990049   |   | Führungsbolzen  | ATE            |
|  |  |  |  |  |   |  | 11.8116-0253.1   | 390512   | 2   | Haltefeder  | ATE            |
|  |  | SLK 320  | 160  |  | 04.00   | 03.04  |  | 11.3571-8509.2   | 220313  |  | D=57, - Halter |
|  |  |  |  |  |   |  | 11.3571-8510.2   | 220314   |  | D=57, - Halter  | ATE            |
|  |  |  |  |  |   |  | 11.0441-5703.2   | 250145   |   | Dichtungssatz   | ATE            |
|  |  |  |  |  |   |  | 11.0101-5407.2   | 260011   |   | Hülzensatz  | ATE            |
|  |  |  |  |  |   |  | 11.8171-0008.1   | 990049   |   | Führungsbolzen  | ATE            |
|  | SLK 32 AMG   | 260  |  | 03.01  | 03.04   |  | 11.9441-9971.2   | 220839   |  | D=44, - Halter  | ATE            |
|  |  |  |  |  |   |  | 11.9441-9972.2   | 220840   |  | D=44, - Halter  | ATE            |
|  |  |  |  |  |   |  | 11.0101-5704.2   | 260095   |   | Hülzensatz  | ATE            |
|  |  |  |  |  |   |  | 11.8116-0133.1   | 390511   | 2   | Haltefeder  | ATE            |
|  |  |  |  |  |   |  |  |  |   |   |                |
|  |  |  |  |  |   |  |  |  |   |   |                |
|  | SLK 200  | 100  |  | 09.96  | 03.04   |  | 83.7705-0386.3   | 330828   | 2   | L=385   |                |
|  | SLK 200 Kompressor   | 120  |  | 03.00  | 03.04   |  |  |  |   |   |                |
|  | SLK 200 Kompressor   | 141  |  | 09.96  | 03.04   |  |  |  |   |   |                |
|  | SLK 230 Kompressor   | 142  |  | 09.96  | 03.04   |  |  |  |   |   |                |
|  | SLK 230 Kompressor   | 145  |  | 03.00  | 03.04   |  |  |  |   |   |                |
|  | SLK 32 AMG   | 260  |  | 03.01  | 03.04   |  |  |  |   |   |                |
|  | SLK 320  | 160  |  | 04.00  | 03.04   |  |  |  |   |   |                |
|  |  |  |  |  |   |  |  |  |   |   |                |
|  | SLK 200  | 100  | F017687  | 09.96  |   |  | 13.2381-8035.2   | 210037   |  | D=38  | ATE            |
|  | SLK 200 Kompressor   | 141  | F017687  | 09.96  |   |  | 13.2381-8036.2   | 210038   |  | D=38  | ATE            |
|  | SLK 230 Kompressor   | 142  | F017687  | 09.96  |   |  | 24.9238-8035.5   | 230025   |  | D=38  | ATE            |
|  |  |  |  |  |   |  | 24.9238-8036.5   | 230026   |  | D=38  | ATE            |
|  |  |  |  |  |   |  | 13.0441-3817.2   | 250071   |   | Dichtungssatz   | ATE            |
|  | SLK 200  | 100  | F017688  |  | 03.04   |  | 13.2361-8003.2   | 210220   |  | D=36  | ATE            |
|  | SLK 200 Kompressor   | 120  |  | 03.00  | 03.04   |  | 13.2361-8004.2   | 210221   |  | D=36  | ATE            |
|  | SLK 200 Kompressor   | 141  | F017688  |  | 03.04   |  | 13.0441-3609.2   | 250057   |   | Dichtungssatz   | ATE            |
|  | SLK 230 Kompressor   | 142  | F017688  |  | 03.04   |  |  |  |   |   |                |
|  | SLK 230 Kompressor   | 145  |  | 03.00  | 03.04   |  |  |  |   |   |                |
|  | SLK 320  | 160  |  | 04.00  | 03.04   |  |  |  |   |   |                |
|  | SLK 32 AMG   | 260  |  | 03.01  | 03.04   |  | 13.2421-8025.2   | 210061   |  | D=42  | ATE            |
|  |  |  |  |  |   |  | 13.2421-8026.2   | 210062   |  | D=42  | ATE            |
|  |  |  |  |  |   |  | 13.0441-4216.2   | 250093   |   | Dichtungssatz   | ATE            |
|  |  |  |  |  |   |  |  |  |   |   |                |
|  | SLK 200  | 100  |  | 09.96  | 03.04   |  | 83.7715-0280.3   | 330806   | 2   | L=280   |                |
|  | SLK 200 Kompressor   | 120  |  | 03.00  | 03.04   |  |  |  |   |   |                |
|  | SLK 200 Kompressor   | 141  |  | 09.96  | 03.04   |  |  |  |   |   |                |
|  | SLK 230 Kompressor   | 142  |  | 09.96  | 03.04   |  |  |  |   |   |                |
|  | SLK 230 Kompressor   | 145  |  | 03.00  | 03.04   |  |  |  |   |   |                |





















<sup>1)</sup> - sport package / - pacchetto sportivo / - version sport / - kit deportivo

|     |    |  |  |  |  |  |  |  |  |  |                   |
|--|--|--|--|--|---|--|--|--|--|--|-------------------|
| <b>MERCEDES BENZ SLK-Klasse (R170) (96-04)</b>                                     |  |  |  |  |   |  |  |  |  |  |                   |
|    | SLK 32 AMG<br>SLK 320  | 260<br>160   |  | 03.01<br>04.00   | 03.04<br>03.04  |  | 83.7715-0280.3<br>330806   | 2  | L=280  |  |                   |
|    | SLK 200<br>SLK 200 Kompressor<br>SLK 200 Kompressor<br>SLK 230 Kompressor<br>SLK 230 Kompressor<br>SLK 32 AMG<br>SLK 320 | 100<br>120<br>141<br>142<br>145<br>260<br>160                                    |  | 09.96<br>03.00<br>09.96<br>09.96<br>03.00<br>03.01<br>04.00                      | 03.04<br>03.04<br>03.04<br>03.04<br>03.04<br>03.04<br>03.04                       |  | 24.3727-0433.2<br>24.3727-0434.2   | 580433<br>580434   | L=1005<br>L=994  |  |                   |
|    | SLK 200<br>SLK 200 Kompressor<br>SLK 200 Kompressor<br>SLK 230 Kompressor<br>SLK 230 Kompressor<br>SLK 32 AMG<br>SLK 320 | 100<br>120<br>141<br>142<br>145<br>260<br>160                                    |  | 09.96<br>03.00<br>09.96<br>09.96<br>03.00<br>03.01<br>04.00                      | 03.04<br>03.04<br>03.04<br>03.04<br>03.04<br>03.04<br>03.04                       |  | 24.2419-0915.3<br>24.2419-1703.3   | 030045<br>030097   | + GG 1)<br>+ ALU 2)  | Gz 19,05<br>Gz 19,05                           |                   |
| <b>MERCEDES BENZ SLK-Klasse (R171) (04-11)</b>                                     |  |  |  |  |   |  |  |  |  |  |                   |
|    | SLK 200 Kompressor<br>SLK 200 Kompressor<br>SLK 280<br>SLK 300<br>SLK 350<br>SLK 350<br>SLK 55 AMG                       | 120<br>135<br>170<br>170<br>200<br>224<br>1                                      | F 196638<br>F 196638<br>F 196638<br>F 196638<br>F 196638<br>F 196638<br>F 196638 | 03.04<br>01.08<br>04.05<br>03.09<br>03.04<br>01.08<br>03.04                      |   |  | 03.7848-9402.4   | 300227   |  | 7/8" Tandem                                    | ATE               |
|    | SLK 200 Kompressor<br>SLK 200 Kompressor<br>SLK 280<br>SLK 300<br>SLK 350<br>SLK 350<br>SLK 55 AMG                       | 120<br>135<br>170<br>170<br>200<br>224<br>1                                      |  | 03.04<br>01.08<br>04.05<br>03.09<br>03.04<br>01.08<br>03.04                      | 01.11<br>01.11<br>01.11<br>01.11<br>01.11<br>01.11<br>01.11                       |  | 03.2025-1741.3   | 010705   |  | Thz 25,40/20,64                                | ATE               |
|    | SLK 200 Kompressor<br>SLK 200 Kompressor<br>SLK 280<br>SLK 300   | 120<br>135<br>170<br>170   | F 197201<br>F 197201   | 03.04<br>01.08   |   | - Sportpaket 3)<br>- Sportpaket 3)   | 24.3571-1739.7<br>24.3571-1740.7<br>24.0101-3803.2                                 | 220667<br>220668<br>260101   | <input type="checkbox"/><br><input type="checkbox"/><br><input type="checkbox"/>                             | D=57, - Halter<br>D=57, - Halter<br>Einbausatz | LUC<br>LUC<br>LUC |
|   | SLK 200 Kompressor<br>SLK 200 Kompressor<br>SLK 280<br>SLK 300   | 120<br>135<br>170<br>170   |  | 03.04<br>01.08<br>04.05<br>03.09   | 01.11<br>01.11<br>01.11<br>01.11  | - Sportpaket 3)<br>- Sportpaket 3)   | 24.3571-1721.7<br>24.3571-1722.7   | 220555<br>220556   | <input type="checkbox"/><br><input type="checkbox"/><br><input type="checkbox"/>                             | D=57, - Halter<br>D=57, - Halter               | LUC<br>LUC        |
|  | SLK 200 Kompressor<br>SLK 200 Kompressor<br>SLK 280<br>SLK 300   | 120<br>135<br>170<br>170   |  | 03.04<br>01.08<br>04.05<br>03.09   | 01.11<br>01.11<br>01.11<br>01.11  | - Sportpaket 3)<br>- Sportpaket 3)<br>- Sportpaket 3)<br>- Sportpaket 3)           | 13.9361-0023.2<br>13.9361-0024.2<br>13.0441-3609.2                                 | 210241<br>210242<br>250057   | <input type="checkbox"/><br><input type="checkbox"/><br><input type="checkbox"/><br><input type="checkbox"/> | D=36<br>D=36<br>Dichtungssatz                  | ATE<br>ATE<br>ATE |
|  | SLK 200 Kompressor<br>SLK 200 Kompressor<br>SLK 280<br>SLK 300<br>SLK 350  | 135<br>135<br>170<br>170<br>200  |  | 01.08<br>01.08<br>04.05<br>03.09<br>03.04  | 01.11<br>01.11<br>01.11<br>01.11<br>01.11   | + Sportpaket 4)<br>+ Sportpaket 4)<br>+ Sportpaket 4)<br>+ Sportpaket 4)           | 13.9361-0035.2<br>13.9361-0036.2<br>13.0441-3609.2                                 | 210253<br>210254<br>250057   | <input type="checkbox"/><br><input type="checkbox"/><br><input type="checkbox"/><br><input type="checkbox"/> | D=36<br>D=36<br>Dichtungssatz                  | ATE<br>ATE<br>ATE |
|  | SLK 200 Kompressor<br>SLK 200 Kompressor<br>SLK 280<br>SLK 300<br>SLK 350<br>SLK 350<br>SLK 55 AMG                       | 120<br>135<br>170<br>170<br>200<br>224<br>1                                      |  | 03.04<br>01.08<br>04.05<br>03.09<br>03.04<br>01.08<br>03.04                      | 01.11<br>01.11<br>01.11<br>01.11<br>01.11<br>01.11<br>01.11                       |  | 83.7715-0280.3   | 330806   | 2  | L=280  |                   |
| <b>MERCEDES BENZ SLK-Klasse (R172) (11-)</b>                                       |  |  |  |  |   |  |  |  |  |  |                   |
|  | SLK 200<br>SLK 250<br>SLK 250 CDI<br>SLK 350<br>SLK 55 AMG   | 135<br>150<br>150<br>225<br>310  |  | 02.11<br>02.11<br>01.12<br>02.11<br>01.12  |   |  | 83.7705-0386.3   | 330828   | 2  | L=385  |                   |
| <b>MERCEDES BENZ Vaneo (BM414) (02-05)</b>   |  |  |  |  |   |  |  |  |  |  |                   |
|  | 1.4<br>1.6<br>1.6<br>1.7 CDI<br>1.7 CDI<br>1.9   | 60<br>60<br>75<br>55<br>67<br>92   |  | 06.02<br>02.02<br>02.02<br>02.02<br>02.02<br>02.02                               | 12.05<br>12.05<br>12.05<br>12.05<br>12.05<br>12.05                                |  | 24.4123-1703.3   | 010831   |  | Thz 23,81                                      | LUC               |
|  | 1.4<br>1.6<br>1.6<br>1.7 CDI<br>1.7 CDI<br>1.9   | 60<br>60<br>75<br>55<br>67<br>92   |  | 06.02<br>02.02<br>02.02<br>02.02<br>02.02<br>02.02                               | 12.05<br>12.05<br>12.05<br>12.05<br>12.05<br>12.05                                |  | 24.3571-1743.7<br>24.3571-1744.7<br>24.0101-3803.2                                 | 220687<br>220688<br>260101   | <input type="checkbox"/><br><input type="checkbox"/><br><input type="checkbox"/>                             | D=57, - Halter<br>D=57, - Halter<br>Einbausatz | LUC<br>LUC<br>LUC |

1) + cast iron / + ghisa / + fonte grise / + fundición de gris  
2) + aluminium / + alluminio / + aluminium / + aluminio  
3) - sport package / - pacchetto sportivo / - version sport / - kit deportivo  
4) + sports package / + pacchetto sportivo / + version sport / + kit deportivo

|     |                 |  |  |  |                         |  |    |               |  |
|--|---|--|--|--|--|--|--|---|--|
| <b>MERCEDES BENZ Vaneo (BM414) (02-05)</b>   |   |  |  |  |  |  |  |   |  |
|    | 1.4<br>1.6<br>1.6<br>1.7 CDI<br>1.7 CDI<br>1.9  | 60<br>60<br>75<br>55<br>67<br>92   | 06.02<br>02.02<br>02.02<br>02.02<br>02.02<br>02.02                               | 12.05<br>12.05<br>12.05<br>12.05<br>12.05<br>12.05                               | 24.5123-0295.3   | 330820   | 2  | L=295   |  |
|    | 1.4<br>1.6<br>1.6<br>1.7 CDI<br>1.7 CDI<br>1.9  | 60<br>60<br>75<br>55<br>67<br>92   | 06.02<br>02.02<br>02.02<br>02.02<br>02.02<br>02.02                               | 12.05<br>12.05<br>12.05<br>12.05<br>12.05<br>12.05                               | 24.3301-1701.7<br>24.3301-1702.7   | 220697<br>220698   | <br>   | D=30, - Halter<br>D=30, - Halter  | LUC<br>LUC                             |
|    | 1.4<br>1.6<br>1.6<br>1.7 CDI<br>1.7 CDI<br>1.9  | 60<br>60<br>75<br>55<br>67<br>92   | 06.02<br>02.02<br>02.02<br>02.02<br>02.02<br>02.02                               | 12.05<br>12.05<br>12.05<br>12.05<br>12.05<br>12.05                               | 24.5238-0230.3   | 330673   | 2  | L=230   |  |
|    | 1.4<br>1.6<br>1.6<br>1.7 CDI<br>1.7 CDI<br>1.9  | 60<br>60<br>75<br>55<br>67<br>92   | 06.02<br>02.02<br>02.02<br>02.02<br>02.02<br>02.02                               | 12.05<br>12.05<br>12.05<br>12.05<br>12.05<br>12.05                               | 24.3727-0450.2<br>24.3727-0428.2<br>24.3727-0427.2   | 580450<br>580428<br>580427   | 1 <br>   | L=1463<br>L=1038<br>L=685   |  |
| <b>MERCEDES BENZ V-Klasse (BM638) (96-03)</b>                                      |   |  |  |  |  |  |  |   |  |
|    | V 200<br>V 200 CDI<br>V 220 CDI<br>V 230<br>V 230 TD<br>V 280                                   |  | 09.96<br>03.99<br>03.99<br>09.96<br>09.96<br>09.97                               | 08.03<br>08.03<br>08.03<br>08.03<br>08.03<br>08.03                               | 24.2123-1712.3<br>24.2123-1729.3   | 010519<br>010567   | - ABS<br>+ ABS   | THz 23,81<br>THz 23,81  |  |
|    | V 200<br>V 200 CDI<br>V 220 CDI<br>V 230<br>V 230 TD<br>V 280                                   |  | 09.96<br>03.99<br>03.99<br>09.96<br>09.96<br>09.97                               | 08.03<br>08.03<br>08.03<br>08.03<br>08.03<br>08.03                               | 11.3601-8514.2<br>11.3601-8513.2<br>11.0441-6007.2<br>11.0101-5704.2<br>11.8171-0008.1<br>11.8116-0200.1 | 220394<br>220393<br>250146<br>260095<br>990049<br>390505                           | <br>   | D=60, - Halter<br>D=60, - Halter<br>Dichtungssatz<br>Hülsensatz<br>Führungsbolzen<br>Haltefeder | ATE<br>ATE<br>ATE<br>ATE<br>ATE<br>ATE |
|   | V 200<br>V 200 CDI<br>V 220 CDI<br>V 230<br>V 230 TD<br>V 280                                   |  | 09.96<br>03.99<br>03.99<br>09.96<br>09.96<br>09.97                               | 08.03<br>08.03<br>08.03<br>08.03<br>08.03<br>08.03                               | 24.5131-0495.3   | 330677   | 2  | L=495   |  |
|  | V 200<br>V 200 CDI<br>V 220 CDI<br>V 230<br>V 230 TD<br>V 280                                   |  | 09.96<br>03.99<br>03.99<br>09.96<br>09.96<br>09.97                               | 08.03<br>08.03<br>08.03<br>08.03<br>08.03<br>08.03                               | 11.3331-0039.2<br>11.3331-0040.2<br>24.3331-1701.5<br>24.3331-1702.5<br>11.0441-3305.2                   | 220387<br>220388<br>240543<br>240544<br>250006                                     | <br><br><br> | D=33, - Halter<br>D=33, - Halter<br>D=33, - Halter<br>D=33, - Halter<br>Dichtungssatz           | ATE<br>ATE<br>BOS<br>BOS<br>ATE        |
|  | V 200<br>V 200 CDI<br>V 220 CDI<br>V 230<br>V 230 TD<br>V 280                                   |  | 09.96<br>03.99<br>03.99<br>09.96<br>09.96<br>09.97                               | 08.03<br>08.03<br>08.03<br>08.03<br>08.03<br>08.03                               | 24.5113-0515.3   | 330668   | 2  | L=515   |  |
|  | V 200<br>V 200 CDI<br>V 220 CDI<br>V 230<br>V 230 TD<br>V 280                                   |  | 09.96<br>03.99<br>03.99<br>09.96<br>09.96<br>09.97                               | 08.03<br>08.03<br>08.03<br>08.03<br>08.03<br>08.03                               | 24.3727-0435.2   | 580435   | 2   | L=1167  |  |
|  | V 200<br>V 200 CDI<br>V 220 CDI<br>V 230<br>V 230 TD<br>V 280                                   |  | 09.96<br>03.99<br>03.99<br>09.96<br>09.96<br>09.97                               | 08.03<br>08.03<br>08.03<br>08.03<br>08.03<br>08.03                               | 24.2419-1712.3   | 030105   |  | Gz 19,05  |  |
|  | V 200<br>V 200 CDI<br>V 220 CDI<br>V 230<br>V 230 TD<br>V 280                                   |  | 09.96<br>03.99<br>03.99<br>09.96<br>09.96<br>09.97                               | 08.03<br>08.03<br>08.03<br>08.03<br>08.03<br>08.03                               | 24.2522-1704.3   | 040078   |  | Nz 22,20  |  |
| <b>MERCEDES BENZ VIANO (BM639) (03-)</b>   |   |  |  |  |  |  |  |   |  |
|  | 2.0 CDI<br>2.0 CDI 4-matic<br>2.2 CDI<br>2.2 CDI 4-matic<br>3.0<br>3.0 CDI<br>3.2<br>3.5<br>3.7 | 140<br>160<br>190<br>170   | 08.03<br>07.10<br>08.03<br>07.10<br>08.03<br>03.06<br>08.03<br>09.07<br>06.04    |  | 24.2123-1772.3   | 010858   |  | THz 23,81   | BOS                                    |



|     |    kW           |  |                       |  |                         |  |   |   |
|--|---|--|---|--|--|--|---|---|
| <b>MERCEDES BENZ VIANO (BM639) (03-)</b>   |   |  |   |  |  |  |   |   |
|    | 2.0 CDI<br>2.0 CDI 4-matic<br>2.2 CDI<br>2.2 CDI 4-matic<br>3.0<br>3.0 CDI<br>3.2<br>3.5<br>3.7 | 140<br>160<br>190<br>170   | 08.03<br>07.10<br>08.03<br>07.10<br>08.03<br>03.06<br>08.03<br>09.07<br>06.04                         |  | 24.3481-1803.7   | 220703   | <input type="checkbox"/>  | D=48/48, - Halter <b>BOS</b>  |
|    | 2.0 CDI<br>2.0 CDI 4-matic<br>2.2 CDI<br>2.2 CDI 4-matic<br>3.0<br>3.0 CDI<br>3.2<br>3.5<br>3.7 | 140<br>160<br>190<br>170   | 08.03<br>07.10<br>08.03<br>07.10<br>08.03<br>03.06<br>08.03<br>09.07<br>06.04                         |  | 24.5140-0498.3   | 330912   | 2   | L=498   |
|    | 2.0 CDI<br>2.0 CDI 4-matic<br>2.2 CDI<br>2.2 CDI 4-matic<br>3.0<br>3.0 CDI<br>3.2<br>3.5<br>3.7 | 140<br>160<br>190<br>170   | 08.03<br>07.10<br>08.03<br>07.10<br>08.03<br>03.06<br>08.03<br>09.07<br>06.04                         |  | 24.5123-0328.3   | 330910   | 2   | L=328   |
|    | 2.0 CDI<br>2.0 CDI 4-matic<br>2.2 CDI<br>2.2 CDI 4-matic<br>3.0<br>3.0 CDI<br>3.2<br>3.5<br>3.7 | 140<br>160<br>190<br>170   | 08.03<br>07.10<br>08.03<br>07.10<br>08.03<br>03.06<br>08.03<br>09.07<br>06.04                         |  | 24.3727-0453.2<br>24.3727-0454.2   | 580453<br>580454   | <input type="checkbox"/><br><input type="checkbox"/>  | L=1285<br>L=1152  |
| <b>MERCEDES BENZ VITO (BM638) (96-03)</b>  |   |  |   |  |  |  |   |   |
|   | 108 CDI<br>108 D<br>110 CDI<br>110 D<br>112 CDI<br>113<br>114                                   |  | 03.99 08.03<br>03.96 08.03<br>03.99 08.03<br>03.96 08.03<br>03.99 08.03<br>03.96 08.03<br>12.96 08.03 |  | 24.2123-1712.3<br>24.2123-1729.3   | 010519<br>010567   | - ABS<br>+ ABS  | THz 23,81<br>THz 23,81  |
|  | 108 CDI<br>108 D<br>110 CDI<br>110 D<br>112 CDI<br>113<br>114                                   |  | 03.99 08.03<br>03.96 08.03<br>03.99 08.03<br>03.96 08.03<br>03.99 08.03<br>03.96 08.03<br>12.96 08.03 |  | 11.3601-8514.2<br>11.3601-8513.2<br>11.0441-6007.2<br>11.0101-5704.2<br>11.8171-0008.1<br>11.8116-0200.1 | 220394<br>220393<br>250146<br>260095<br>990049<br>390505                           | <input type="checkbox"/><br><input type="checkbox"/><br><input type="checkbox"/><br><input type="checkbox"/><br><input type="checkbox"/><br>2 | D=60, - Halter <b>ATE</b><br>D=60, - Halter <b>ATE</b><br>Dichtungssatz <b>ATE</b><br>Hülzensatz <b>ATE</b><br>Führungsbolzen <b>ATE</b><br>Haltefeder <b>ATE</b> |
|  | 108 CDI<br>108 D<br>110 CDI<br>110 D<br>112 CDI<br>113<br>114                                   |  | 03.99 08.03<br>03.96 08.03<br>03.99 08.03<br>03.96 08.03<br>03.99 08.03<br>03.96 08.03<br>12.96 08.03 |  | 24.5131-0495.3   | 330677   | 2   | L=495   |
|  | 108 CDI<br>108 D<br>110 CDI<br>110 D<br>112 CDI<br>113<br>114                                   |  | 03.99 08.03<br>03.96 08.03<br>03.99 08.03<br>03.96 08.03<br>03.99 08.03<br>03.96 08.03<br>12.96 08.03 |  | 11.3331-0039.2<br>11.3331-0040.2<br>24.3331-1701.5<br>24.3331-1702.5<br>11.0441-3305.2                   | 220387<br>220388<br>240543<br>240544<br>250006                                     | <input type="checkbox"/><br><input type="checkbox"/><br><input type="checkbox"/><br><input type="checkbox"/><br><input type="checkbox"/>      | D=33, - Halter <b>ATE</b><br>D=33, - Halter <b>ATE</b><br>D=33, - Halter <b>BOS</b><br>D=33, - Halter <b>BOS</b><br>Dichtungssatz <b>ATE</b>                      |
|  | 108 CDI<br>108 D<br>110 CDI<br>110 D<br>112 CDI<br>113<br>114                                   |  | 03.99 08.03<br>03.96 08.03<br>03.99 08.03<br>03.96 08.03<br>03.99 08.03<br>03.96 08.03<br>12.96 08.03 |  | 24.5113-0515.3   | 330668   | 2   | L=515   |
|  | 108 CDI<br>108 D<br>110 CDI<br>110 D<br>112 CDI<br>113<br>114                                   |  | 03.99 08.03<br>03.96 08.03<br>03.99 08.03<br>03.96 08.03<br>03.99 08.03<br>03.96 08.03<br>12.96 08.03 |  | 24.3727-0435.2   | 580435   | 2 <input type="checkbox"/>  | L=1167  |
|  | 108 CDI<br>108 D<br>110 CDI<br>110 D<br>112 CDI<br>113  |  | 03.99 08.03<br>03.96 08.03<br>03.99 08.03<br>03.96 08.03<br>03.99 08.03<br>03.96 08.03                |  | 24.2419-1712.3   | 030105   |   | Gz 19,05  |



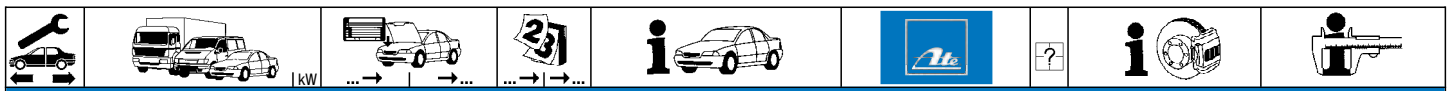

**MERCEDES BENZ VITO (BM638) (96-03)**

|  |         |  |  |       |       |  |                |        |  |          |
|--|---------|--|--|-------|-------|--|----------------|--------|--|----------|
|  | 114     |  |  | 12.96 | 08.03 |  | 24.2419-1712.3 | 030105 |  | Gz 19,05 |
|  | 108 CDI |  |  | 03.99 | 08.03 |  | 24.2522-1704.3 | 040078 |  | Nz 22,20 |
|  | 108 D   |  |  | 03.96 | 08.03 |  |                |        |  |          |
|  | 110 CDI |  |  | 03.99 | 08.03 |  |                |        |  |          |
|  | 110 D   |  |  | 03.96 | 08.03 |  |                |        |  |          |
|  | 112 CDI |  |  | 03.99 | 08.03 |  |                |        |  |          |
|  | 113     |  |  | 03.96 | 08.03 |  |                |        |  |          |
|  | 114     |  |  | 12.96 | 08.03 |  |                |        |  |          |

**MERCEDES BENZ VITO (BM639) (03-)**

|  |                 |     |         |       |  |  |                |        |   |                   |            |
|--|-----------------|-----|---------|-------|--|--|----------------|--------|---|-------------------|------------|
|  | 109 CDI         |     | 3558104 | 08.03 |  |  | 24.2123-1772.3 | 010858 |   | THz 23,81         | <b>BOS</b> |
|  | 109 CDI 4-matic | 70  | 3558104 | 09.07 |  |  |                |        |   |                   |            |
|  | 110 CDI         | 70  | 3558104 | 09.10 |  |  |                |        |   |                   |            |
|  | 111 CDI         |     | 3558104 | 08.03 |  |  |                |        |   |                   |            |
|  | 111 CDI 4-matic | 80  | 3558104 | 09.07 |  |  |                |        |   |                   |            |
|  | 113 CDI         | 100 | 3558104 | 09.10 |  |  |                |        |   |                   |            |
|  | 113 CDI 4-matic | 100 | 3558104 | 09.10 |  |  |                |        |   |                   |            |
|  | 115 CDI         | 110 | 3558104 | 08.03 |  |  |                |        |   |                   |            |
|  | 115 CDI 4-matic | 110 | 3558104 | 09.07 |  |  |                |        |   |                   |            |
|  | 116 CDI         | 120 | 3558104 | 09.10 |  |  |                |        |   |                   |            |
|  | 116 CDI 4-matic | 120 | 3558104 | 09.10 |  |  |                |        |   |                   |            |
|  | 119             | 140 | 3558104 | 08.03 |  |  |                |        |   |                   |            |
|  | 120 CDI         | 150 | 3558104 | 09.07 |  |  |                |        |   |                   |            |
|  | 122             | 160 | 3558104 | 08.03 |  |  |                |        |   |                   |            |
|  | 122 CDI         | 165 | 3558104 | 09.10 |  |  |                |        |   |                   |            |
|  | 123             | 170 | 3558104 | 06.04 |  |  |                |        |   |                   |            |
|  | 123             | 190 | 3558104 | 09.07 |  |  |                |        |   |                   |            |
|  | 126             | 190 | 3558104 | 09.07 |  |  |                |        |   |                   |            |
|  | 109 CDI         |     | 3558105 |       |  |  | 24.2123-1778.3 | 010947 |   | THz 23,81         | <b>LUC</b> |
|  | 109 CDI 4-matic | 70  | 3558105 |       |  |  |                |        |   |                   |            |
|  | 110 CDI         | 70  | 3558105 |       |  |  |                |        |   |                   |            |
|  | 111 CDI         |     | 3558105 |       |  |  |                |        |   |                   |            |
|  | 111 CDI 4-matic | 80  | 3558105 |       |  |  |                |        |   |                   |            |
|  | 113 CDI         | 100 | 3558105 |       |  |  |                |        |   |                   |            |
|  | 113 CDI 4-matic | 100 | 3558105 |       |  |  |                |        |   |                   |            |
|  | 115 CDI         | 110 | 3558105 |       |  |  |                |        |   |                   |            |
|  | 115 CDI 4-matic | 110 | 3558105 |       |  |  |                |        |   |                   |            |
|  | 116 CDI         | 120 | 3558105 |       |  |  |                |        |   |                   |            |
|  | 116 CDI 4-matic | 120 | 3558105 |       |  |  |                |        |   |                   |            |
|  | 119             | 140 | 3558105 |       |  |  |                |        |   |                   |            |
|  | 120 CDI         | 150 | 3558105 |       |  |  |                |        |   |                   |            |
|  | 122             | 160 | 3558105 |       |  |  |                |        |   |                   |            |
|  | 122 CDI         | 165 | 3558105 |       |  |  |                |        |   |                   |            |
|  | 123             | 170 | 3558105 |       |  |  |                |        |   |                   |            |
|  | 123             | 190 | 3558105 |       |  |  |                |        |   |                   |            |
|  | 126             | 190 | 3558105 |       |  |  |                |        |   |                   |            |
|  | 109 CDI         |     |         | 08.03 |  |  | 24.3481-1803.7 | 220703 |   | D=48/48, - Halter | <b>BOS</b> |
|  | 109 CDI 4-matic | 70  |         | 09.07 |  |  |                |        |   |                   |            |
|  | 110 CDI         | 70  |         | 09.10 |  |  |                |        |   |                   |            |
|  | 111 CDI         |     |         | 08.03 |  |  |                |        |   |                   |            |
|  | 111 CDI 4-matic | 80  |         | 09.07 |  |  |                |        |   |                   |            |
|  | 113 CDI         | 100 |         | 09.10 |  |  |                |        |   |                   |            |
|  | 113 CDI 4-matic | 100 |         | 09.10 |  |  |                |        |   |                   |            |
|  | 115 CDI         | 110 |         | 08.03 |  |  |                |        |   |                   |            |
|  | 115 CDI 4-matic | 110 |         | 09.07 |  |  |                |        |   |                   |            |
|  | 116 CDI         | 120 |         | 09.10 |  |  |                |        |   |                   |            |
|  | 116 CDI 4-matic | 120 |         | 09.10 |  |  |                |        |   |                   |            |
|  | 119             | 140 |         | 08.03 |  |  |                |        |   |                   |            |
|  | 120 CDI         | 150 |         | 09.07 |  |  |                |        |   |                   |            |
|  | 122             | 160 |         | 08.03 |  |  |                |        |   |                   |            |
|  | 122 CDI         | 165 |         | 09.10 |  |  |                |        |   |                   |            |
|  | 123             | 170 |         | 06.04 |  |  |                |        |   |                   |            |
|  | 123             | 190 |         | 09.07 |  |  |                |        |   |                   |            |
|  | 126             | 190 |         | 09.07 |  |  |                |        |   |                   |            |
|  | E-Cell          | 60  |         | 03.12 |  |  |                |        |   |                   |            |
|  | 109 CDI         |     | 342257  | 08.03 |  |  | 24.5140-0498.3 | 330912 | 2 | L=498             |            |
|  | 109 CDI 4-matic | 70  | 342257  | 09.07 |  |  |                |        |   |                   |            |
|  | 110 CDI         | 70  | 342257  | 09.10 |  |  |                |        |   |                   |            |
|  | 111 CDI         |     | 342257  | 08.03 |  |  |                |        |   |                   |            |
|  | 111 CDI 4-matic | 80  | 342257  | 09.07 |  |  |                |        |   |                   |            |
|  | 113 CDI         | 100 | 342257  | 09.10 |  |  |                |        |   |                   |            |
|  | 113 CDI 4-matic | 100 | 342257  | 09.10 |  |  |                |        |   |                   |            |
|  | 115 CDI         | 110 | 342257  | 08.03 |  |  |                |        |   |                   |            |
|  | 115 CDI 4-matic | 110 | 342257  | 09.07 |  |  |                |        |   |                   |            |
|  | 116 CDI         | 120 | 342257  | 09.10 |  |  |                |        |   |                   |            |
|  | 116 CDI 4-matic | 120 | 342257  | 09.10 |  |  |                |        |   |                   |            |
|  | 119             | 140 | 342257  | 08.03 |  |  |                |        |   |                   |            |
|  | 120 CDI         | 150 | 342257  | 09.07 |  |  |                |        |   |                   |            |
|  | 122             | 160 | 342257  | 08.03 |  |  |                |        |   |                   |            |
|  | 122 CDI         | 165 | 342257  | 09.10 |  |  |                |        |   |                   |            |
|  | 123             | 170 | 342257  | 06.04 |  |  |                |        |   |                   |            |
|  | 123             | 190 | 342257  | 09.07 |  |  |                |        |   |                   |            |
|  | 126             | 190 | 342257  | 09.07 |  |  |                |        |   |                   |            |



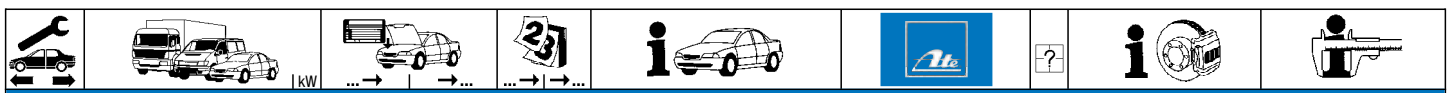

### MERCEDES BENZ VITO (BM639) (03-)

|  |                 |     |  |       |  |                |        |                          |  |        |
|--|-----------------|-----|--|-------|--|----------------|--------|--------------------------|--|--------|
|  | 109 CDI         |     |  | 08.03 |  | 24.5123-0328.3 | 330910 | 2                        |  | L=328  |
|  | 109 CDI 4-matic | 70  |  | 09.07 |  |                |        |                          |  |        |
|  | 110 CDI         | 70  |  | 09.10 |  |                |        |                          |  |        |
|  | 111 CDI         |     |  | 08.03 |  |                |        |                          |  |        |
|  | 111 CDI 4-matic | 80  |  | 09.07 |  |                |        |                          |  |        |
|  | 113 CDI         | 100 |  | 09.10 |  |                |        |                          |  |        |
|  | 113 CDI 4-matic | 100 |  | 09.10 |  |                |        |                          |  |        |
|  | 115 CDI         | 110 |  | 08.03 |  |                |        |                          |  |        |
|  | 115 CDI 4-matic | 110 |  | 09.07 |  |                |        |                          |  |        |
|  | 116 CDI         | 120 |  | 09.10 |  |                |        |                          |  |        |
|  | 116 CDI 4-matic | 120 |  | 09.10 |  |                |        |                          |  |        |
|  | 119             | 140 |  | 08.03 |  |                |        |                          |  |        |
|  | 120 CDI         | 150 |  | 09.07 |  |                |        |                          |  |        |
|  | 122             | 160 |  | 08.03 |  |                |        |                          |  |        |
|  | 122 CDI         | 165 |  | 09.10 |  |                |        |                          |  |        |
|  | 123             | 170 |  | 06.04 |  |                |        |                          |  |        |
|  | 123             | 190 |  | 09.07 |  |                |        |                          |  |        |
|  | 126             | 190 |  | 09.07 |  |                |        |                          |  |        |
|  | E-Cell          | 60  |  | 03.12 |  |                |        |                          |  |        |
|  | 109 CDI         |     |  | 08.03 |  | 24.3727-0453.2 | 580453 | <input type="checkbox"/> |  | L=1285 |
|  | 109 CDI 4-matic | 70  |  | 09.07 |  | 24.3727-0454.2 | 580454 | <input type="checkbox"/> |  | L=1152 |
|  | 110 CDI         | 70  |  | 09.10 |  |                |        |                          |  |        |
|  | 111 CDI         |     |  | 08.03 |  |                |        |                          |  |        |
|  | 111 CDI 4-matic | 80  |  | 09.07 |  |                |        |                          |  |        |
|  | 113 CDI         | 100 |  | 09.10 |  |                |        |                          |  |        |
|  | 113 CDI 4-matic | 100 |  | 09.10 |  |                |        |                          |  |        |
|  | 115 CDI         | 110 |  | 08.03 |  |                |        |                          |  |        |
|  | 115 CDI 4-matic | 110 |  | 09.07 |  |                |        |                          |  |        |
|  | 116 CDI         | 120 |  | 09.10 |  |                |        |                          |  |        |
|  | 116 CDI 4-matic | 120 |  | 09.10 |  |                |        |                          |  |        |
|  | 119             | 140 |  | 08.03 |  |                |        |                          |  |        |
|  | 120 CDI         | 150 |  | 09.07 |  |                |        |                          |  |        |
|  | 122             | 160 |  | 08.03 |  |                |        |                          |  |        |
|  | 122 CDI         | 165 |  | 09.10 |  |                |        |                          |  |        |
|  | 123             | 170 |  | 06.04 |  |                |        |                          |  |        |
|  | 123             | 190 |  | 09.07 |  |                |        |                          |  |        |
|  | 126             | 190 |  | 09.07 |  |                |        |                          |  |        |

### MERCEDES BENZ Transporter (BM 631) MB 100 D (87-96)

|  |           |        |        |       |       |  |                |        |                            |   |
|--|-----------|--------|--------|-------|-------|--|----------------|--------|----------------------------|---|
|  | MB 100 D  |        | 021971 | 09.87 |       | 24.2125-1718.3                               | 010665         |        |                            | THz 25,40                               |
|  | MB 100 D  |        | 021972 | 02.96 |       | 24.2125-1719.3                               | 010666         |        |                            | THz 25,40                               |
|  | MB 100 D  |        |        | 09.87 | 02.96 | - Triebkopf (BM 631.349) <sup>1)</sup>       | 24.3481-1759.5 | 240339 | 2 <input type="checkbox"/> | D=48/48, - Halter <b>BDX</b>            |
|  | MB 100 D  |        |        | 09.87 | 02.96 |  | 24.5232-0388.3 | 330580 | 4                          | L=360                                   |
|  | MB 100 D  |        |        | 09.87 | 02.96 |  | 24.3225-1102.3 | 020318 |                            | Rz 25,40                                |
|  | MB 100 D  |        |        | 09.87 | 02.96 | + Radstand 2450mm /- Triebkopf <sup>2)</sup> | 24.3727-0413.2 | 580413 | 1 <input type="checkbox"/> | L=1416                                  |
|  |           |        |        |       |       |  | 24.3727-0415.2 | 580415 | 2 <input type="checkbox"/> | L=1438                                  |
|  | MB 100 D  |        |        | 09.87 | 02.96 | + Radstand 2675mm <sup>3)</sup>              | 24.3727-0414.2 | 580414 | 1 <input type="checkbox"/> | L=1647                                  |
|  | Triebkopf |        |        | 09.87 | 02.96 | BM 631.349                                   | 24.3727-0415.2 | 580415 | 2 <input type="checkbox"/> | L=1438                                  |
|  | MB 100 D  | 099541 |        | 02.96 |       |  | 24.2419-1729.3 | 030118 |                            | Gz 19,05                                |
|  | MB 100 D  | 099541 |        | 02.96 |       |  | 03.2525-2602.3 | 040029 |                            | Druckstange mit Gabelkopf <sup>4)</sup> |

### MERCEDES BENZ Transporter (BM 901/902) SPRINTER (95-06)

|  |         |             |         |       |  |                |        |  |  |           |
|--|---------|-------------|---------|-------|--|----------------|--------|--|--|-----------|
|  | 208 CDI |             | A906425 | 04.00 |  | 24.2123-1711.3 | 010518 |  |  | THz 23,81 |
|  | 208 D   |             | A906425 | 02.95 |  |                |        |  |  |           |
|  | 210 D   |             | A906425 | 01.97 |  |                |        |  |  |           |
|  | 211 CDI |             | A906425 | 04.00 |  |                |        |  |  |           |
|  | 212 D   |             | A906425 | 02.95 |  |                |        |  |  |           |
|  | 213 CDI |             | A906425 | 04.00 |  |                |        |  |  |           |
|  | 214     | 92          | A906425 | 04.00 |  |                |        |  |  |           |
|  | 214     | 105         | A906425 | 02.95 |  |                |        |  |  |           |
|  | 216 CDI |             | A906425 | 04.00 |  |                |        |  |  |           |
|  | 208 CDI | A906426     |         | 05.06 |  | 24.2123-1754.3 | 010741 |  |  | THz 23,81 |
|  | 208 D   | A906426     |         | 05.06 |  |                |        |  |  |           |
|  | 210 D   | A906426     |         | 05.06 |  |                |        |  |  |           |
|  | 211 CDI | A906426     |         | 05.06 |  |                |        |  |  |           |
|  | 212 D   | A906426     |         | 05.06 |  |                |        |  |  |           |
|  | 213 CDI | A906426     |         | 05.06 |  |                |        |  |  |           |
|  | 214     | 92 A906426  |         | 05.06 |  |                |        |  |  |           |
|  | 214     | 105 A906426 |         | 05.06 |  |                |        |  |  |           |
|  | 216 CDI | A906426     |         | 05.06 |  |                |        |  |  |           |

















<sup>1)</sup> - drive head (BM 631.349) / - motrice sola cabina (BM 631.349) / - tête propulsion (BM 631.349) / - grupo motriz (BM 631.349)

<sup>2)</sup> + wheel base 2450 mm/- drivehead / + passo 2450 mm / - motr.sola cab. / + empatt.2450 mm / - tête propuls. / + dist.ejes 2450 mm / - grupo dif.

<sup>3)</sup> + wheel base 2675 mm / + passo 2675 mm / + empattement 2675 mm / + distancia entre ejes 2675mm

<sup>4)</sup> push rod with yoke / asta spinta +testa a forcilla / tige poussée avec fourchette / barra de presión con horquilla



|     |    |  |  |  |  |  |  |  |   |   |
|--|--|--|--|--|---|--|--|--|---|---|
| MERCEDES BENZ Transporter (BM 901/902) SPRINTER (95-06)                            |  |  |  |  |   |  |  |  |   |   |
|    | 208 CDI  |  |  | 04.00  | 05.06   | 11.3601-8513.2   | 220393   | 2  | D=60, - Halter<br>D=60, - Halter<br>Dichtungssatz<br>Hülsensatz<br>Führungsbolzen<br>Haltefeder                                     | ATE<br>ATE<br>ATE<br>ATE<br>ATE<br>ATE  |
|  | 208 D  |  |  | 02.95  | 05.06   | 11.3601-8514.2   | 220394   |  |   |   |
|  | 210 D  |  |  | 01.97  | 05.06   | 11.0441-6007.2   | 250146   |  |   |   |
|  | 211 CDI  |  |  | 04.00  | 05.06   | 11.0101-5704.2   | 260095   |  |   |   |
|  | 212 D  |  |  | 02.95  | 05.06   | 11.8171-0008.1   | 990049   |  |   |   |
|  | 213 CDI  |  |  | 04.00  | 05.06   | 11.8116-0200.1   | 390505   |  |   |   |
|  | 214  |  |  | 04.00  | 05.06   |  |  |  |   |   |
|  | 214  | 92   |  | 02.95  | 05.06   |  |  |  |   |   |
|  | 216 CDI  | 105  |  | 04.00  | 05.06   |  |  |  |   |   |
|  | 208 CDI  |  |  | 04.00  | 05.06   | 24.3441-1701.5   | 240331   |  |   |   |
| 208 D  |  |  | 02.95  | 05.06  | 24.3441-1702.5  | 240332   |  |  |   |   |
| 210 D  |  |  | 01.97  | 05.06  |   |  |  |  |   |   |
| 211 CDI  |  |  | 04.00  | 05.06  |   |  |  |  |   |   |
| 212 D  |  |  | 02.95  | 05.06  |   |  |  |  |   |   |
| 213 CDI  |  |  | 04.00  | 05.06  |   |  |  |  |   |   |
| 214  |  |  | 04.00  | 05.06  |   |  |  |  |   |   |
| 214  | 92   |  | 02.95  | 05.06  |   |  |  |  |   |   |
| 216 CDI  | 105  |  | 04.00  | 05.06  |   |  |  |  |   |   |
|    | 208 CDI  |  |  | 04.00  | 05.06   | 83.7716-0363.3   | 330829   | 2  | L=363   |   |
|  | 208 D  |  |  | 02.95  | 05.06   |  |  |  |   |   |
|  | 210 D  |  |  | 01.97  | 05.06   |  |  |  |   |   |
|  | 211 CDI  |  |  | 04.00  | 05.06   |  |  |  |   |   |
|  | 212 D  |  |  | 02.95  | 05.06   |  |  |  |   |   |
|  | 213 CDI  |  |  | 04.00  | 05.06   |  |  |  |   |   |
|  | 214  |  |  | 04.00  | 05.06   |  |  |  |   |   |
|  | 214  | 92   |  | 02.95  | 05.06   |  |  |  |   |   |
|  | 216 CDI  | 105  |  | 04.00  | 05.06   |  |  |  |   |   |
|  |    | 208 CDI (BM 901)   |  |  | 04.00   | 05.06  | 11.3451-8501.2   |  |   |   |
| 208 D (BM 901)   |  |  |  | 02.95  | 05.06   | 11.3451-8502.2   | 220390   |  |   |   |
| 210 D (BM 901)   |  |  |  | 01.97  | 05.06   | 11.0441-4502.2   | 250143   |  |   |   |
| 211 CDI (BM 901)   |  |  |  | 04.00  | 05.06   | 11.0101-5407.2   | 260011   |  |   |   |
| 212 D (BM 901)   |  |  |  | 02.95  | 05.06   | 11.8171-0008.1   | 990049   |  |   |   |
| 213 CDI (BM 901)   |  |  |  | 04.00  | 05.06   | 11.8116-0172.1   | 390500   |  |   |   |
| 214 (BM 901)   |  |  |  | 04.00  | 05.06   |  |  |  |   |   |
| 214 (BM 901)   |  | 92   |  | 02.95  | 05.06   |  |  |  |   |   |
| 216 CDI (BM 901)   |  | 105  |  | 04.00  | 05.06   |  |  |  |   |   |
| 208 CDI (BM 902)   |  |  |  | 04.00  | 05.06   | 11.3521-8501.2   | 220391   | 2  | D=52, - Halter<br>D=52, - Halter<br>D=52, - Halter<br>D=52, - Halter<br>Dichtungssatz<br>Hülsensatz<br>Führungsbolzen<br>Haltefeder | ATE<br>ATE<br>BOS<br>BOS<br>ATE<br>ATE<br>ATE<br>ATE  |
| 208 D (BM 902)   |  |  | 02.95  | 05.06  | 11.3521-8502.2  | 220392   |  |  |   |   |
| 210 D (BM 902)   |  |  | 01.97  | 05.06  | 24.3521-1707.5  | 240471   |  |  |   |   |
| 211 CDI (BM 902)   |  |  | 04.00  | 05.06  | 24.3521-1708.5  | 240472   |  |  |   |   |
| 212 D (BM 902)   |  |  | 02.95  | 05.06  | 11.0441-5203.2  | 250144   |  |  |   |   |
| 213 CDI (BM 902)   |  |  | 04.00  | 05.06  | 11.0101-5407.2  | 260011   |  |  |   |   |
| 214 (BM 902)   |  |  | 04.00  | 05.06  | 11.8171-0008.1  | 990049   |  |  |   |   |
| 214 (BM 902)   | 92   |  | 02.95  | 05.06  | 11.8116-0191.1  | 390522   |  |  |   |   |
| 216 CDI (BM 902)   | 105  |  | 04.00  | 05.06  |   |  |  |  |   |   |
|  | 208 CDI  |  |  | 04.00  | 05.06   | 83.7716-0363.3   | 330829   |  |   |   |
|  | 208 D  |  |  | 02.95  | 05.06   |  |  |  |   |   |
|  | 210 D  |  |  | 01.97  | 05.06   |  |  |  |   |   |
|  | 211 CDI  |  |  | 04.00  | 05.06   |  |  |  |   |   |
|  | 212 D  |  |  | 02.95  | 05.06   |  |  |  |   |   |
|  | 213 CDI  |  |  | 04.00  | 05.06   |  |  |  |   |   |
|  | 214  |  |  | 04.00  | 05.06   |  |  |  |   |   |
|  | 214  | 92   |  | 02.95  | 05.06   |  |  |  |   |   |
|  | 216 CDI  | 105  |  | 04.00  | 05.06   |  |  |  |   |   |
|  |  | 208 CDI  |  |  | 04.00   | 05.06  | 24.3727-0442.2   | 580442   | 2   | + Radstand 3000mm / - Fzg. mit Drehsitz <sup>1)</sup><br>+ Radstand 3000mm / + Fzg. mit Drehsitz <sup>2)</sup><br>+ Radstand 3550mm / - Fzg. mit Drehsitz <sup>3)</sup><br>+ Radstand 3550mm / + Fzg. mit Drehsitz <sup>4)</sup><br>+ Radstand 4025mm <sup>5)</sup><br>Komponentennummer: 504013/01 <sup>6)</sup><br>Komponentennummer: 504013/04 <sup>7)</sup> |
| 208 D  |  |  |  | 02.95  | 05.06   | 24.3727-0445.2   | 580445   |  |   |   |
| 210 D  |  |  |  | 01.97  | 05.06   | 24.3727-0443.2   | 580443   |  |   |   |
| 211 CDI  |  |  |  | 04.00  | 05.06   | 24.3727-0444.2   | 580444   |  |   |   |
| 212 D  |  |  |  | 02.95  | 05.06   | 24.3727-0441.2   | 580441   |  |   |   |
| 213 CDI  |  |  |  | 04.00  | 05.06   | 24.3727-0438.2   | 580438   |  |   |   |
| 214  |  |  |  | 04.00  | 05.06   | 24.3727-0463.2   | 580463   |  |   |   |
| 214  |  | 92   |  | 02.95  | 05.06   |  |  |  |   |   |
| 216 CDI  |  | 105  |  | 04.00  | 05.06   |  |  |  |   |   |
|  |  | 208 CDI  |  |  | 04.00   | 05.06  | 24.2419-1712.3   | 030105   |   |   |
|  | 208 D  |  |  | 02.95  | 05.06   |  |  |  |   |   |
|  | 210 D  |  |  | 01.97  | 05.06   |  |  |  |   |   |
|  | 211 CDI  |  |  | 04.00  | 05.06   |  |  |  |   |   |
|  | 212 D  |  |  | 02.95  | 05.06   |  |  |  |   |   |
|  | 213 CDI  |  |  | 04.00  | 05.06   |  |  |  |   |   |
|  | 214  |  |  | 04.00  | 05.06   |  |  |  |   |   |
|  | 214  | 92   |  | 02.95  | 05.06   |  |  |  |   |   |
| 216 CDI  | 105  |  | 04.00  | 05.06  |   |  |  |  |   |   |
|  | 208 CDI  |  |  | 04.00  | 05.06   | 24.2522-1703.3   | 040077   |  | Nz 22,20  |   |
|  | 208 D  |  |  | 02.95  | 05.06   |  |  |  |   |   |
|  | 210 D  |  |  | 01.97  | 05.06   |  |  |  |   |   |
|  | 211 CDI  |  |  | 04.00  | 05.06   |  |  |  |   |   |
|  | 212 D  |  |  | 02.95  | 05.06   |  |  |  |   |   |
|  | 213 CDI  |  |  | 04.00  | 05.06   |  |  |  |   |   |
|  | 214  |  |  | 04.00  | 05.06   |  |  |  |   |   |
|  | 214  | 92   |  | 02.95  | 05.06   |  |  |  |   |   |
| 216 CDI  | 105  |  | 04.00  | 05.06  |   |  |  |  |   |   |

1) +wheel bas.3000mm/-swivel seat / +passo 3000mm/-sedile girevole / +empatt.3000mm/-siège pivotant / +dist. rueda 3000mm/-asiento giratorio  
2) +wheel bas.3000mm/+swivel seat / +passo 3000mm/+sedile girevole / +empatt.3000mm/+siège pivotant / +dist.rueda 3000mm/+asiento giratorio  
3) +wheel bas.3550mm/-swivel seat / +passo 3550mm/-sedile girevole / +empatt.3550mm/-siège pivotant / +dist. rueda 3550mm/-asiento giratorio  
4) +wheel bas.3550mm/+swivel seat / +passo 3550mm/+sedile girevole / +empatt.3550mm/+siège pivotant / +dist.rueda 3550mm/+asiento giratorio



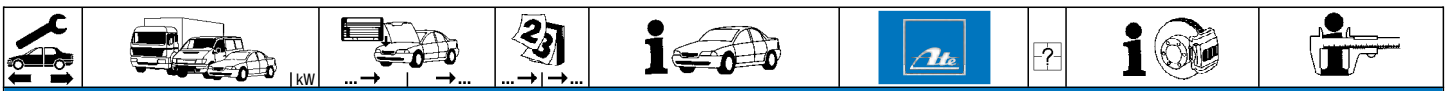













5) + wheel base 4025 mm / + passo 4025 mm / + empattement 4025 mm / + distancia entre rueda 4025mm  
6) component no.: 504013/01 / no. componente: 504013/01 / no.de composant: 504013/01 / no. componente: 504013/01  
7) component no.: 504013/04 / no. componente: 504013/04 / no.de composant: 504013/04 / no. componente: 504013/04



**MERCEDES BENZ Transporter (BM 903/904) SPRINTER (95-06)**

|         |         |         |         |       |       |                |        |   |  |                |     |
|---------|---------|---------|---------|-------|-------|----------------|--------|---|--|----------------|-----|
|         | 308 CDI |         | A906425 | 04.00 |       | 24.2123-1711.3 | 010518 |   |  | THz 23,81      |     |
|         | 308 D   |         | A906425 | 02.95 |       |                |        |   |  |                |     |
|         | 310 D   |         | A906425 | 02.95 |       |                |        |   |  |                |     |
|         | 311 CDI |         | A906425 | 04.00 |       |                |        |   |  |                |     |
|         | 312 D   |         | A906425 | 02.95 |       |                |        |   |  |                |     |
|         | 313 CDI |         | A906425 | 04.00 |       |                |        |   |  |                |     |
|         | 314     | 92      | A906425 | 04.00 |       |                |        |   |  |                |     |
| 314     | 105     | A906425 | 02.95   |       |       |                |        |   |  |                |     |
| 316 CDI |         | A906425 | 04.00   |       |       |                |        |   |  |                |     |
|         | 308 CDI |         | A906426 | 05.06 |       | 24.2123-1754.3 | 010741 |   |  | THz 23,81      |     |
|         | 308 D   |         | A906426 | 05.06 |       |                |        |   |  |                |     |
|         | 310 D   |         | A906426 | 05.06 |       |                |        |   |  |                |     |
|         | 311 CDI |         | A906426 | 05.06 |       |                |        |   |  |                |     |
|         | 312 D   |         | A906426 | 05.06 |       |                |        |   |  |                |     |
|         | 313 CDI |         | A906426 | 05.06 |       |                |        |   |  |                |     |
|         | 314     | 92      | A906426 | 05.06 |       |                |        |   |  |                |     |
| 314     | 105     | A906426 | 05.06   |       |       |                |        |   |  |                |     |
| 316 CDI |         | A906426 | 05.06   |       |       |                |        |   |  |                |     |
|         | 408 CDI |         | A906425 | 04.00 |       | 24.2125-1727.3 | 010723 |   |  | THz 25,40      |     |
|         | 408 D   |         | A906425 | 06.95 |       |                |        |   |  |                |     |
|         | 410 D   |         | A906425 | 09.96 |       |                |        |   |  |                |     |
|         | 411 CDI |         | A906425 | 04.00 |       |                |        |   |  |                |     |
|         | 412 D   |         | A906425 | 06.95 |       |                |        |   |  |                |     |
|         | 413 CDI |         | A906425 | 04.00 |       |                |        |   |  |                |     |
|         | 414     | 92      | A906425 | 04.00 |       |                |        |   |  |                |     |
| 414     | 105     | A906425 | 06.95   |       |       |                |        |   |  |                |     |
| 416 CDI |         | A906425 | 04.00   |       |       |                |        |   |  |                |     |
|         | 408 CDI |         | A906426 | 05.06 |       | 24.2125-1728.3 | 010751 |   |  | THz 25,40      |     |
|         | 408 D   |         | A906426 | 05.06 |       |                |        |   |  |                |     |
|         | 410 D   |         | A906426 | 05.06 |       |                |        |   |  |                |     |
|         | 411 CDI |         | A906426 | 05.06 |       |                |        |   |  |                |     |
|         | 412 D   |         | A906426 | 05.06 |       |                |        |   |  |                |     |
|         | 413 CDI |         | A906426 | 05.06 |       |                |        |   |  |                |     |
|         | 414     | 92      | A906426 | 05.06 |       |                |        |   |  |                |     |
| 414     | 105     | A906426 | 05.06   |       |       |                |        |   |  |                |     |
| 416 CDI |         | A906426 | 05.06   |       |       |                |        |   |  |                |     |
|         | 308 CDI |         |         | 04.00 | 05.06 | 11.3601-8513.2 | 220393 | ☐ |  | D=60, - Halter | ATE |
|         | 308 D   |         |         | 02.95 | 05.06 | 11.3601-8514.2 | 220394 | ☐ |  | D=60, - Halter | ATE |
|         | 310 D   |         |         | 02.95 | 05.06 | 11.0441-6007.2 | 250146 |   |  | Dichtungssatz  | ATE |
|         | 311 CDI |         |         | 04.00 | 05.06 | 11.0101-5704.2 | 260095 |   |  | Hülzensatz     | ATE |
|         | 312 D   |         |         | 02.95 | 05.06 | 11.8171-0008.1 | 990049 |   |  | Führungsbolzen | ATE |
|         | 313 CDI |         |         | 04.00 | 05.06 | 11.8116-0200.1 | 390505 | 2 |  | Haltefeder     | ATE |
|         | 314     | 92      |         | 04.00 | 05.06 |                |        |   |  |                |     |
|         | 314     | 105     |         | 02.95 | 05.06 |                |        |   |  |                |     |
|         | 316 CDI |         |         | 04.00 | 05.06 |                |        |   |  |                |     |
|         | 408 CDI |         |         | 04.00 | 05.06 |                |        |   |  |                |     |
|         | 408 D   |         |         | 06.95 | 05.06 |                |        |   |  |                |     |
|         | 410 D   |         |         | 09.96 | 05.06 |                |        |   |  |                |     |
|         | 411 CDI |         |         | 04.00 | 05.06 |                |        |   |  |                |     |
|         | 412 D   |         |         | 06.95 | 05.06 |                |        |   |  |                |     |
|         | 413 CDI |         |         | 04.00 | 05.06 |                |        |   |  |                |     |
|         | 414     | 92      |         | 04.00 | 05.06 |                |        |   |  |                |     |
| 414     | 105     |         | 06.95   | 05.06 |       |                |        |   |  |                |     |
| 416 CDI |         |         | 04.00   | 05.06 |       |                |        |   |  |                |     |
|         | 308 CDI |         |         | 04.00 | 05.06 | 24.3441-1701.5 | 240331 | ☐ |  | D=44, - Halter | PER |
|         | 308 D   |         |         | 02.95 | 05.06 | 24.3441-1702.5 | 240332 | ☐ |  | D=44, - Halter | PER |
|         | 310 D   |         |         | 02.95 | 05.06 |                |        |   |  |                |     |
|         | 311 CDI |         |         | 04.00 | 05.06 |                |        |   |  |                |     |
|         | 312 D   |         |         | 02.95 | 05.06 |                |        |   |  |                |     |
|         | 313 CDI |         |         | 04.00 | 05.06 |                |        |   |  |                |     |
|         | 314     | 92      |         | 04.00 | 05.06 |                |        |   |  |                |     |
|         | 314     | 105     |         | 02.95 | 05.06 |                |        |   |  |                |     |
|         | 316 CDI |         |         | 04.00 | 05.06 |                |        |   |  |                |     |
|         | 408 CDI |         |         | 04.00 | 05.06 |                |        |   |  |                |     |
|         | 408 D   |         |         | 06.95 | 05.06 |                |        |   |  |                |     |
|         | 410 D   |         |         | 09.96 | 05.06 |                |        |   |  |                |     |
|         | 411 CDI |         |         | 04.00 | 05.06 |                |        |   |  |                |     |
|         | 412 D   |         |         | 06.95 | 05.06 |                |        |   |  |                |     |
|         | 413 CDI |         |         | 04.00 | 05.06 |                |        |   |  |                |     |
|         | 414     | 92      |         | 04.00 | 05.06 |                |        |   |  |                |     |
| 414     | 105     |         | 06.95   | 05.06 |       |                |        |   |  |                |     |
| 416 CDI |         |         | 04.00   | 05.06 |       |                |        |   |  |                |     |
|         | 308 CDI |         |         | 04.00 | 05.06 | 83.7716-0363.3 | 330829 | 2 |  | L=363          |     |
|         | 308 D   |         |         | 02.95 | 05.06 | 24.5237-0490.3 | 330672 | 2 |  | L=490          |     |
|         | 310 D   |         |         | 02.95 | 05.06 |                |        |   |  |                |     |
|         | 311 CDI |         |         | 04.00 | 05.06 |                |        |   |  |                |     |
|         | 312 D   |         |         | 02.95 | 05.06 |                |        |   |  |                |     |
|         | 313 CDI |         |         | 04.00 | 05.06 |                |        |   |  |                |     |
|         | 314     | 92      |         | 04.00 | 05.06 |                |        |   |  |                |     |
|         | 314     | 105     |         | 02.95 | 05.06 |                |        |   |  |                |     |
|         | 316 CDI |         |         | 04.00 | 05.06 |                |        |   |  |                |     |
|         | 408 CDI |         |         | 04.00 | 05.06 |                |        |   |  |                |     |
| 408 D   |         |         | 06.95   | 05.06 |       |                |        |   |  |                |     |
| 410 D   |         |         | 09.96   | 05.06 |       |                |        |   |  |                |     |
| 411 CDI |         |         | 04.00   | 05.06 |       |                |        |   |  |                |     |
| 412 D   |         |         | 06.95   | 05.06 |       |                |        |   |  |                |     |
| 413 CDI |         |         | 04.00   | 05.06 |       |                |        |   |  |                |     |



|     |    |  |  |    |   |    |  |  |  |  |
|--|--|--|--|--|--|--|--|--|--|--|
| <b>MERCEDES BENZ Transporter (BM 903/904) SPRINTER (95-06)</b>                     |  |  |  |  |  |  |  |  |  |  |
|    | 414<br>414<br>416 CDI  | 92<br>105  |  | 04.00<br>06.95<br>04.00  | 05.06<br>05.06<br>05.06  | 83.7716-0363.3<br>24.5237-0490.3   | 330829<br>330672   | 2<br>2   | L=363<br>L=490   |  |
|    | 308 CDI<br>308 D<br>310 D<br>311 CDI<br>312 D<br>313 CDI<br>314<br>314<br>316 CDI  | 92<br>105  |  | 04.00<br>02.95<br>02.95<br>04.00<br>02.95<br>04.00<br>04.00<br>02.95<br>04.00  | 05.06<br>05.06<br>05.06<br>05.06<br>05.06<br>05.06<br>05.06<br>05.06<br>05.06  | 11.3521-8501.2<br>11.3521-8502.2<br>24.3521-1707.5<br>24.3521-1708.5<br>11.0441-5203.2<br>11.0101-5407.2<br>11.8171-0008.1<br>11.8116-0191.1 | 220391<br>220392<br>240471<br>240472<br>250144<br>260011<br>990049<br>390522       | 2<br>2<br>2  | D=52, - Halter<br>D=52, - Halter<br>D=52, - Halter<br>Dichtungssatz<br>Hülzensatz<br>Führungsbolzen<br>Haltefeder  | ATE<br>ATE<br>BOS<br>ATE<br>ATE<br>ATE<br>ATE                      |
|    | 408 CDI<br>408 D<br>410 D<br>411 CDI<br>412 D<br>413 CDI<br>414<br>414<br>416 CDI  | 92<br>105  |  | 04.00<br>06.95<br>09.96<br>04.00<br>06.95<br>04.00<br>04.00<br>06.95<br>04.00  | 05.06<br>05.06<br>05.06<br>05.06<br>05.06<br>05.06<br>05.06<br>05.06<br>05.06  | 24.3441-1701.5<br>24.3441-1702.5   | 240331<br>240332   | 2<br>2   | D=44, - Halter<br>D=44, - Halter   | PER<br>PER   |
|    | 308 CDI<br>308 D<br>310 D<br>311 CDI<br>312 D<br>313 CDI<br>314<br>314<br>316 CDI<br>408 CDI<br>408 D<br>410 D<br>411 CDI<br>412 D<br>413 CDI<br>414<br>414<br>416 CDI | 92<br>105  |  | 04.00<br>02.95<br>02.95<br>04.00<br>02.95<br>04.00<br>04.00<br>02.95<br>04.00<br>04.00<br>06.95<br>09.96<br>04.00<br>06.95<br>04.00<br>04.00<br>06.95<br>04.00 | 05.06<br>05.06<br>05.06<br>05.06<br>05.06<br>05.06<br>05.06<br>05.06<br>05.06<br>05.06<br>05.06<br>05.06<br>05.06<br>05.06<br>05.06<br>05.06<br>05.06<br>05.06 | 83.7716-0363.3<br>83.6105-0510.3<br>24.5237-0235.3   | 330829<br>330622<br>330781   | 2<br>2<br>2  | am Bremssattel 1)  | L=363<br>L=510<br>L=235  |
|   | 308 CDI<br>308 D<br>310 D<br>311 CDI<br>312 D<br>313 CDI<br>314<br>314<br>316 CDI  | 92<br>105  |  | 04.00<br>02.95<br>02.95<br>04.00<br>02.95<br>04.00<br>04.00<br>02.95<br>04.00  | 05.06<br>05.06<br>05.06<br>05.06<br>05.06<br>05.06<br>05.06<br>05.06<br>05.06  | 24.3727-0442.2<br>24.3727-0445.2<br>24.3727-0443.2<br>24.3727-0444.2<br>24.3727-0441.2<br>24.3727-0438.2<br>24.3727-0463.2                   | 580442<br>580445<br>580443<br>580444<br>580441<br>580438<br>580463                 | 1<br>1<br>1<br>1<br>1<br>2<br>2  | + Radstand 3000mm / - Fzg. mit Drehsitz 2)<br>+ Radstand 3000mm / + Fzg. mit Drehsitz 3)<br>+ Radstand 3550mm / - Fzg. mit Drehsitz 4)<br>+ Radstand 3550mm / + Fzg. mit Drehsitz 5)<br>+ Radstand 4025mm 6)<br>Komponentennummer: 504013/01 7)<br>Komponentennummer: 504013/04 8) | L=1435<br>L=1415<br>L=1990<br>L=1970<br>L=2460<br>L=1513<br>L=1545 |
|  | 408 CDI<br>408 D<br>410 D<br>411 CDI<br>412 D<br>413 CDI<br>414<br>414<br>416 CDI  | 92<br>105  |  | 04.00<br>06.95<br>09.96<br>04.00<br>06.95<br>04.00<br>04.00<br>06.95<br>04.00  | 05.06<br>05.06<br>05.06<br>05.06<br>05.06<br>05.06<br>05.06<br>05.06<br>05.06  | 24.3727-0181.2<br>24.3727-0179.2<br>24.3727-0180.2   | 580181<br>580179<br>580180   | 1<br>1<br>1  | L=2440<br>L=1525<br>L=1526   |  |
|  | 308 CDI<br>308 D<br>310 D<br>311 CDI<br>312 D<br>313 CDI<br>314<br>314<br>316 CDI<br>408 CDI<br>408 D<br>410 D<br>411 CDI<br>412 D<br>413 CDI<br>414<br>414<br>416 CDI | 92<br>105  |  | 04.00<br>02.95<br>02.95<br>04.00<br>02.95<br>04.00<br>04.00<br>02.95<br>04.00<br>04.00<br>06.95<br>09.96<br>04.00<br>06.95<br>04.00<br>04.00<br>06.95<br>04.00 | 05.06<br>05.06<br>05.06<br>05.06<br>05.06<br>05.06<br>05.06<br>05.06<br>05.06<br>05.06<br>05.06<br>05.06<br>05.06<br>05.06<br>05.06<br>05.06<br>05.06<br>05.06 | 24.2419-1712.3   | 030105   |  | Gz 19,05   |  |
|  | 308 CDI<br>308 D<br>310 D<br>311 CDI<br>312 D<br>313 CDI<br>314<br>314<br>316 CDI<br>408 CDI<br>408 D  | 92<br>105  |  | 04.00<br>02.95<br>02.95<br>04.00<br>02.95<br>04.00<br>04.00<br>02.95<br>04.00<br>04.00<br>06.95  | 05.06<br>05.06<br>05.06<br>05.06<br>05.06<br>05.06<br>05.06<br>05.06<br>05.06<br>05.06<br>05.06  | 24.2522-1703.3   | 040077   |  | Nz 22,20   |  |

1) on the brake caliper / sulla pinza freno / sur l'étrier de frein / a la pinza de freno

2) +wheel bas.3000mm/-swivel seat / +passo 3000mm/-sedile girevole / +empatt.3000mm/-siège pivotant / +dist. rueda 3000mm/-asiento giratorio

3) +wheel bas.3000mm/+swivel seat / +passo 3000mm/+sedile girevole / +empatt.3000mm/+siège pivotant / +dist.rueda 3000mm/+asiento giratorio

4) +wheel bas.3550mm/-swivel seat / +passo 3550mm/-sedile girevole / +empatt.3550mm/-siège pivotant / +dist. rueda 3550mm/-asiento giratorio

5) +wheel bas.3550mm/+swivel seat / +passo 3550mm/+sedile girevole / +empatt.3550mm/+siège pivotant / +dist.rueda 3550mm/+asiento giratorio

6) + wheel base 4025 mm / + passo 4025 mm / + empattement 4025 mm / + distancia entre rueda 4025mm

7) component no.: 504013/01 / no. componente: 504013/01 / no.de composant: 504013/01 / no. componente: 504013/01

8) component no.: 504013/04 / no. componente: 504013/04 / no.de composant: 504013/04 / no. componente: 504013/04

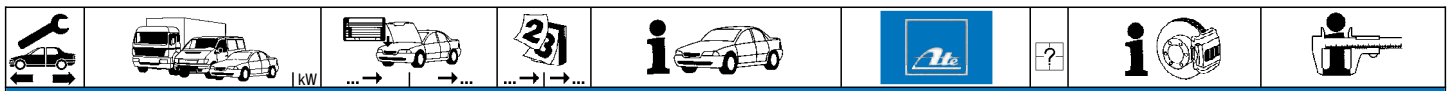

**MERCEDES BENZ Transporter (BM 903/904) SPRINTER (95-06)**

|  |   |  |  |           |   |   |                |        |  |  |          |
|--|---|--|--|-----------|---|---|----------------|--------|--|--|----------|
|  | 410 D<br>411 CDI<br>412 D<br>413 CDI<br>414<br>414<br>416 CDI |  |  | 92<br>105 | 09.96<br>04.00<br>06.95<br>04.00<br>04.00<br>06.95<br>04.00 | 05.06<br>05.06<br>05.06<br>05.06<br>05.06<br>05.06<br>05.06 | 24.2522-1703.3 | 040077 |  |  | Nz 22,20 |
|--|---|--|--|-----------|---|---|----------------|--------|--|--|----------|

**MERCEDES BENZ Transporter (BM 905) SPRINTER (01-06)**

|  |         |  |  |  |       |       |                                  |                  |  |                              |                                  |            |
|--|---------|--|--|--|-------|-------|----------------------------------|------------------|--|------------------------------|----------------------------------|------------|
|  | 616 CDI |  |  |  | 04.01 | 05.06 | 24.3441-1701.5<br>24.3441-1702.5 | 240331<br>240332 | <input type="checkbox"/><br><input type="checkbox"/> |                              | D=44, - Halter<br>D=44, - Halter | PER<br>PER |
|  | 616 CDI |  |  |  | 04.01 | 05.06 | 24.5137-0365.3                   | 331130           | 2  |                              | L=355                            |            |
|  | 616 CDI |  |  |  | 04.01 | 05.06 | 24.5237-0235.3                   | 330781           | 2  | am Bremssattel <sup>1)</sup> | L=235                            |            |
|  | 616 CDI |  |  |  | 04.01 | 05.06 | 24.2419-1712.3                   | 030105           |  |                              | Gz 19,05                         |            |

**MERCEDES BENZ Transporter (BM 906) SPRINTER (06-)**

|  |   |  |  |                  |  |  |                                  |                  |        |  |  |                |  |
|--|---|--|--|------------------|--|--|----------------------------------|------------------|--------|--|--|----------------|--|
|  | 209 CDI<br>210 CDI<br>211 CDI<br>213 CDI<br>215 CDI<br>216<br>216 CDI<br>218 CDI<br>224<br>309 CDI<br>310 CDI<br>311 CDI<br>311 CDI 4x4<br>313 CDI<br>313 CDI 4x4<br>315 CDI<br>315 CDI 4x4<br>316<br>316 CDI<br>316 CDI 4x4<br>316 LGT<br>316 NGT<br>318 CDI<br>318 CDI 4x4<br>319 CDI<br>319 CDI 4x4<br>324<br>411 CDI<br>413 CDI<br>415 CDI<br>416 CDI<br>418 CDI<br>419 CDI<br>424<br>509 CDI<br>510 CDI<br>511 CDI<br>511 CDI 4x4<br>513 CDI<br>513 CDI 4x4<br>515 CDI<br>515 CDI 4x4<br>516<br>516 CDI<br>516 CDI 4x4<br>516 NGT<br>518 CDI<br>518 CDI 4x4<br>519 CDI<br>519 CDI 4x4<br>524 |  |  | 80<br>120<br>140 | 04.06<br>03.09<br>04.06<br>04.06<br>04.06<br>09.08<br>03.09<br>04.06<br>04.06<br>04.06<br>03.09<br>02.08<br>04.06<br>06.06<br>04.06<br>02.08<br>03.09<br>03.09<br>04.06<br>09.08<br>03.09<br>04.06<br>02.08<br>03.09<br>03.09<br>04.06<br>06.09<br>04.06<br>04.06<br>04.06<br>03.09<br>04.06<br>03.09<br>03.09<br>04.06<br>04.06<br>04.06<br>03.09<br>04.06<br>04.06<br>03.09<br>04.06<br>04.06<br>04.06<br>03.09<br>04.06<br>04.06<br>04.06<br>03.09<br>03.09<br>04.06<br>02.08 |  | 24.5137-0385.3<br>24.5137-0455.3 | 331089<br>331131 | 2<br>2 | - Allrad <sup>2)</sup><br>+ Allrad <sup>3)</sup> |  | L=385<br>L=455 |  |
|  | 209 CDI<br>210 CDI<br>211 CDI<br>213 CDI<br>215 CDI<br>216<br>216 CDI<br>218 CDI<br>224<br>309 CDI<br>310 CDI<br>311 CDI<br>311 CDI 4x4   |  |  | 80               | 04.06<br>03.09<br>04.06<br>04.06<br>04.06<br>09.08<br>03.09<br>04.06<br>04.06<br>03.09<br>02.08<br>03.09<br>03.09<br>04.06<br>06.09<br>04.06<br>04.06<br>04.06<br>03.09<br>04.06<br>04.06<br>04.06<br>03.09<br>04.06<br>04.06<br>03.09<br>03.09<br>04.06<br>04.06<br>04.06<br>03.09<br>04.06<br>04.06<br>04.06<br>03.09<br>03.09<br>04.06<br>02.08   |  | 24.5137-0490.3<br>24.5137-0495.3 | 330964<br>331132 | 2<br>2 | - Allrad <sup>2)</sup><br>+ Allrad <sup>3)</sup> |  | L=490<br>L=495 |  |

<sup>1)</sup> on the brake caliper / sulla pinza freno / sur l'étrier de frein / a la pinza de freno  
<sup>2)</sup> - 4 wheel drive / - 4 ruote motrici / - 4 roues motrices / - tracción a las 4 ruedas  
<sup>3)</sup> + 4 wheel drive / + 4 ruote motrici / + 4 roues motrices / + tracción a las 4 ruedas





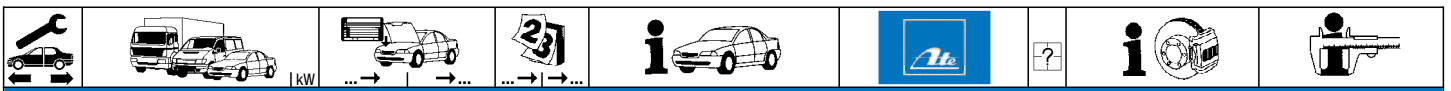





























**MERCEDES BENZ Transporter (BM 906) SPRINTER (06-)**

|             |             |          |          |          |                |                |        |                            |        |
|-------------|-------------|----------|----------|----------|----------------|----------------|--------|----------------------------|--------|
|             | 313 CDI     |          |          | 04.06    | 24.5137-0490.3 | 330964         | 2      | - Allrad 1)<br>+ Allrad 2) | L=490  |
|             | 313 CDI 4x4 |          |          | 06.06    | 24.5137-0495.3 | 331132         | 2      |                            | L=495  |
|             | 315 CDI     |          |          | 04.06    |                |                |        |                            |        |
|             | 315 CDI 4x4 |          |          | 02.08    |                |                |        |                            |        |
|             | 316         |          |          | 09.08    |                |                |        |                            |        |
|             | 316 CDI     |          |          | 03.09    |                |                |        |                            |        |
|             | 316 CDI 4x4 |          |          | 03.09    |                |                |        |                            |        |
|             | 316 LGT     | 115      |          | 09.08    |                |                |        |                            |        |
|             | 316 NGT     |          |          | 09.08    |                |                |        |                            |        |
|             | 318 CDI     |          |          | 04.06    |                |                |        |                            |        |
|             | 318 CDI 4x4 |          |          | 02.08    |                |                |        |                            |        |
|             | 319 CDI     |          |          | 03.09    |                |                |        |                            |        |
|             | 319 CDI 4x4 |          |          | 03.09    |                |                |        |                            |        |
|             | 324         |          |          | 04.06    |                |                |        |                            |        |
|             |             | 411 CDI  | 80       |          | 06.09          | 24.5131-0415.3 | 331238 |                            | 2      |
| 413 CDI     |             |          |          | 04.06    | 24.5137-0470.3 | 331090         | 2      | L=470                      |        |
| 415 CDI     |             |          |          | 04.06    |                |                |        |                            |        |
| 416 CDI     |             | 120      |          | 03.09    |                |                |        |                            |        |
| 418 CDI     |             |          |          | 04.06    |                |                |        |                            |        |
| 419 CDI     |             | 140      |          | 03.09    |                |                |        |                            |        |
| 424         |             |          |          | 04.06    |                |                |        |                            |        |
| 509 CDI     |             |          |          | 04.06    |                |                |        |                            |        |
| 510 CDI     |             | 70       |          | 03.09    |                |                |        |                            |        |
| 511 CDI     |             |          |          | 04.06    |                |                |        |                            |        |
| 511 CDI 4x4 |             | 80       |          | 06.06    |                |                |        |                            |        |
| 513 CDI     |             |          |          | 03.09    |                |                |        |                            |        |
| 513 CDI 4x4 |             | 95       |          | 06.06    |                |                |        |                            |        |
| 515 CDI     |             |          |          | 04.06    |                |                |        |                            |        |
| 515 CDI 4x4 |             | 110      |          | 06.06    |                |                |        |                            |        |
| 516         |             | 115      |          | 09.08    |                |                |        |                            |        |
| 516 CDI     |             |          |          | 03.09    |                |                |        |                            |        |
| 516 CDI 4x4 |             | 120      |          | 06.06    |                |                |        |                            |        |
| 516 NGT     |             | 115      |          | 09.08    |                |                |        |                            |        |
| 518 CDI     |             |          |          | 04.06    |                |                |        |                            |        |
| 518 CDI 4x4 |             | 135      |          | 06.06    |                |                |        |                            |        |
| 519 CDI     |             |          |          | 03.09    |                |                |        |                            |        |
| 519 CDI 4x4 |             | 140      |          | 03.09    |                |                |        |                            |        |
| 524         |             |          |          | 04.06    |                |                |        |                            |        |
|             |             | 509 CDI  |          | S 544979 | 04.06          | 24.3727-0474.2 | 580474 | 1 ↑                        |        |
|             | 510 CDI     | 70       | S 544979 | 03.09    |                |                |        |                            |        |
|             | 511 CDI     |          | S 544979 | 04.06    |                |                |        |                            |        |
|             | 511 CDI 4x4 | 80       | S 544979 | 06.06    |                |                |        |                            |        |
|             | 513 CDI     |          | S 544979 | 03.09    |                |                |        |                            |        |
|             | 513 CDI 4x4 | 95       | S 544979 | 06.06    |                |                |        |                            |        |
|             | 515 CDI     |          | S 544979 | 04.06    |                |                |        |                            |        |
|             | 515 CDI 4x4 | 110      | S 544979 | 06.06    |                |                |        |                            |        |
|             | 516         | 115      | S 544979 | 09.08    |                |                |        |                            |        |
|             | 516 CDI     |          | S 544979 | 03.09    |                |                |        |                            |        |
|             | 516 CDI 4x4 | 120      | S 544979 | 06.06    |                |                |        |                            |        |
|             | 516 NGT     | 115      | S 544979 | 09.08    |                |                |        |                            |        |
|             | 518 CDI     |          | S 544979 | 04.06    |                |                |        |                            |        |
|             | 518 CDI 4x4 | 135      | S 544979 | 06.06    |                |                |        |                            |        |
|             | 519 CDI     |          | S 544979 | 03.09    |                |                |        |                            |        |
| 519 CDI 4x4 | 140         | S 544979 | 03.09    |          |                |                |        |                            |        |
| 524         |             | S 544979 | 04.06    |          |                |                |        |                            |        |
|             | 509 CDI     |          | S 544980 |          | 24.3727-0474.2 | 580474         | 1 ↑    |                            | L=1867 |
|             | 510 CDI     | 70       | S 544980 |          |                |                |        |                            |        |
|             | 511 CDI     |          | S 544980 |          |                |                |        |                            |        |
|             | 511 CDI 4x4 | 80       | S 544980 |          |                |                |        |                            |        |
|             | 513 CDI     |          | S 544980 |          |                |                |        |                            |        |
|             | 513 CDI 4x4 | 95       | S 544980 |          |                |                |        |                            |        |
|             | 515 CDI     |          | S 544980 |          |                |                |        |                            |        |
|             | 515 CDI 4x4 | 110      | S 544980 |          |                |                |        |                            |        |
|             | 516         | 115      | S 544980 |          |                |                |        |                            |        |
|             | 516 CDI     |          | S 544980 |          |                |                |        |                            |        |
|             | 516 CDI 4x4 | 120      | S 544980 |          |                |                |        |                            |        |
|             | 516 NGT     | 115      | S 544980 |          |                |                |        |                            |        |
|             | 518 CDI     |          | S 544980 |          |                |                |        |                            |        |
|             | 518 CDI 4x4 | 135      | S 544980 |          |                |                |        |                            |        |
|             | 519 CDI     |          | S 544980 |          |                |                |        |                            |        |
| 519 CDI 4x4 | 140         | S 544980 |          |          |                |                |        |                            |        |
| 524         |             | S 544980 |          |          |                |                |        |                            |        |
|             | 509 CDI     |          |          | 04.06    | 24.3727-0474.2 | 580474         | 1 ↑    |                            | L=1867 |
|             | 510 CDI     | 70       |          | 03.09    | 24.3727-0471.2 | 580471         | 2 ↓    |                            |        |
|             | 511 CDI     |          |          | 04.06    |                |                |        |                            |        |
|             | 511 CDI 4x4 | 80       |          | 06.06    |                |                |        |                            |        |
|             | 513 CDI     |          |          | 03.09    |                |                |        |                            |        |
|             | 513 CDI 4x4 | 95       |          | 06.06    |                |                |        |                            |        |
|             | 515 CDI     |          |          | 04.06    |                |                |        |                            |        |
|             | 515 CDI 4x4 | 110      |          | 06.06    |                |                |        |                            |        |
|             | 516         | 115      |          | 09.08    |                |                |        |                            |        |
|             | 516 CDI     |          |          | 03.09    |                |                |        |                            |        |
| 516 CDI 4x4 | 120         |          | 06.06    |          |                |                |        |                            |        |
| 516 NGT     | 115         |          | 09.08    |          |                |                |        |                            |        |
| 518 CDI     |             |          | 04.06    |          |                |                |        |                            |        |
| 518 CDI 4x4 | 135         |          | 06.06    |          |                |                |        |                            |        |
| 519 CDI     |             |          | 03.09    |          |                |                |        |                            |        |

1) - 4 wheel drive / - 4 ruote motrici / - 4 roues motrices / - tracción a las 4 ruedas  
 2) + 4 wheel drive / + 4 ruote motrici / + 4 roues motrices / + tracción a las 4 ruedas  
 3) - tyre 285/65 / - cerchio 285/65 / - pneu 285/65 / - cerco 285/65  
 4) + tyre 285/65 / + cerchio 285/65 / + pneu 285/65 / + cerco 285/65  
 5) for 285/65 R 16 C / per 285/65 R 16 C / pour 285/65 R 16 C / para 285/65 R 16 C

| MERCEDES BENZ Transporter (BM 906) SPRINTER (06-)                                  |  |   |  |   |   |  |  |   |  |                                 |
|--|--|---|--|---|---|--|--|---|--|---------------------------------|
|     | 519 CDI 4x4<br>524   | 140   |  | 03.09<br>04.06  |   | 24.3727-0474.2<br>24.3727-0471.2   | 580474<br>580471                               | 1 <br>2       | für 285/65 R 16 C <sup>1)</sup>  | L=1867<br>L=1430                |
| MERCEDES BENZ Transporter VARIO (96-)  |  |   |  |   |   |  |  |   |  |                                 |
|    | VARIO 512 D<br>VARIO 612 D<br>VARIO 613 D / 614 D<br>VARIO 615 D / 616 D<br>VARIO 618 D<br>VARIO 810 D<br>VARIO 812 D<br>VARIO 813 D / 814 D<br>VARIO 813 DA / 814 DA<br>VARIO 815 D / 816 D<br>VARIO 815 DA / 816 DA<br>VARIO 818 D<br>VARIO 818 DA |   |  | 09.96<br>09.96<br>09.96<br>09.98<br>09.96<br>09.96<br>09.96<br>09.96<br>09.96<br>09.96<br>09.96<br>09.96<br>09.06 |   | 03.2128-1203.2   | 010922   |   |  | THz 28,57<br>ATE                |
| MG ZT Limousine (01-05)  |  |   |  |   |   |  |  |   |  |                                 |
|    | 1.8 16V (160)<br>1.8 T 16V (160)<br>2.0 CDTi<br>2.0 CDTi<br>2.5 V6 (180)<br>2.5 V6 (190)<br>4.6 V8 (260X)  | 118<br>118<br>85<br>96<br>130<br>140<br>191 |  | 06.01 12.05<br>01.03 12.05<br>06.02 09.03<br>11.02 12.05<br>01.03 12.05<br>06.01 12.05<br>10.03 12.05             | + Bremsscheibe 284 X 22 <sup>2)</sup><br>+ Bremsscheibe 284 X 22 <sup>2)</sup><br>+ Bremsscheibe 284 X 22 <sup>2)</sup><br>+ Bremsscheibe 284 X 22 <sup>2)</sup><br>+ Bremsscheibe 284 X 22 <sup>2)</sup><br>+ Bremsscheibe 325 X 25 <sup>3)</sup><br>+ Bremsscheibe 325 X 25 <sup>3)</sup> | 11.9571-9871.2<br>11.9571-9872.2   | 220425<br>220426                               | <br>          | D=57, - Halter<br>D=57, - Halter   | ATE<br>ATE                      |
|    | 1.8 16V (160)<br>1.8 T 16V (160)<br>2.0 CDTi<br>2.0 CDTi<br>2.5 V6 (180)<br>2.5 V6 (190)   | 118<br>118<br>85<br>96<br>130<br>140        |  | 06.01 12.05<br>01.03 12.05<br>06.02 09.03<br>11.02 12.05<br>01.03 12.05<br>06.01 12.05                            | + Bremsscheibe 280 X 10 <sup>4)</sup><br>+ Bremsscheibe 280 X 10 <sup>4)</sup><br>+ Bremsscheibe 280 X 10 <sup>4)</sup><br>+ Bremsscheibe 280 X 10 <sup>4)</sup><br>+ Bremsscheibe 280 X 10 <sup>4)</sup><br>+ Bremsscheibe 280 X 10 <sup>4)</sup>  | 11.9361-9961.2<br>11.9361-9962.2   | 220855<br>220856                               | <br>          | D=36, - Halter<br>D=36, - Halter   | ATE<br>ATE                      |
|    | 1.8 16V (160)<br>1.8 T 16V (160)<br>2.0 CDTi<br>2.0 CDTi<br>2.5 V6 (180)<br>2.5 V6 (190)   | 118<br>118<br>85<br>96<br>130<br>140        |  | 06.01 12.05<br>01.03 12.05<br>06.02 09.03<br>11.02 12.05<br>01.03 12.05<br>06.01 12.05                            | + Bremsscheibe 276 X 19 <sup>5)</sup><br>+ Bremsscheibe 276 X 19 <sup>5)</sup><br>+ Bremsscheibe 276 X 19 <sup>5)</sup><br>+ Bremsscheibe 276 X 19 <sup>5)</sup><br>+ Bremsscheibe 276 X 19 <sup>5)</sup><br>+ Bremsscheibe 276 X 19 <sup>5)</sup>  | 24.3401-1703.5<br>24.3401-1704.5   | 240351<br>240352                               | <br>          | D=40, - Halter<br>D=40, - Halter   | ATE<br>ATE                      |
| MG ZT-T Kombi (01-05)  |  |   |  |   |   |  |  |   |  |                                 |
|  | 1.8 16V (160)<br>1.8 T 16V (160)<br>2.0 CDTi<br>2.0 CDTi<br>2.5 V6 (180)<br>2.5 V6 (190)<br>4.6 V8 (260X)  | 118<br>118<br>85<br>96<br>130<br>140<br>191 |  | 10.01 12.05<br>01.03 12.05<br>06.02 09.03<br>11.02 12.05<br>01.03 12.05<br>10.01 12.05<br>10.03 12.05             | + Bremsscheibe 284 X 22 <sup>2)</sup><br>+ Bremsscheibe 284 X 22 <sup>2)</sup><br>+ Bremsscheibe 284 X 22 <sup>2)</sup><br>+ Bremsscheibe 284 X 22 <sup>2)</sup><br>+ Bremsscheibe 284 X 22 <sup>2)</sup><br>+ Bremsscheibe 325 X 25 <sup>3)</sup><br>+ Bremsscheibe 325 X 25 <sup>3)</sup> | 11.9571-9871.2<br>11.9571-9872.2   | 220425<br>220426                               | <br>      | D=57, - Halter<br>D=57, - Halter   | ATE<br>ATE                      |
|  | 1.8 16V (160)<br>1.8 T 16V (160)<br>2.0 CDTi<br>2.0 CDTi<br>2.5 V6 (180)<br>2.5 V6 (190)   | 118<br>118<br>85<br>96<br>130<br>140        |  | 10.01 12.05<br>01.03 12.05<br>06.02 09.03<br>11.02 12.05<br>01.03 12.05<br>10.01 12.05                            | + Bremsscheibe 280 X 10 <sup>4)</sup><br>+ Bremsscheibe 280 X 10 <sup>4)</sup><br>+ Bremsscheibe 280 X 10 <sup>4)</sup><br>+ Bremsscheibe 280 X 10 <sup>4)</sup><br>+ Bremsscheibe 280 X 10 <sup>4)</sup><br>+ Bremsscheibe 280 X 10 <sup>4)</sup>  | 11.9361-9961.2<br>11.9361-9962.2   | 220855<br>220856                               | <br>      | D=36, - Halter<br>D=36, - Halter   | ATE<br>ATE                      |
|  | 1.8 16V (160)<br>1.8 T 16V (160)<br>2.0 CDTi<br>2.0 CDTi<br>2.5 V6 (180)<br>2.5 V6 (190)   | 118<br>118<br>85<br>96<br>130<br>140        |  | 10.01 12.05<br>01.03 12.05<br>06.02 09.03<br>11.02 12.05<br>01.03 12.05<br>10.01 12.05                            | + Bremsscheibe 276 X 19 <sup>5)</sup><br>+ Bremsscheibe 276 X 19 <sup>5)</sup><br>+ Bremsscheibe 276 X 19 <sup>5)</sup><br>+ Bremsscheibe 276 X 19 <sup>5)</sup><br>+ Bremsscheibe 276 X 19 <sup>5)</sup><br>+ Bremsscheibe 276 X 19 <sup>5)</sup>  | 24.3401-1703.5<br>24.3401-1704.5   | 240351<br>240352                               | <br>      | D=40, - Halter<br>D=40, - Halter   | ATE<br>ATE                      |
| MINI R50/R53 (00-06)   |  |   |  |   |   |  |  |   |  |                                 |
|  | Cooper<br>Cooper S<br>Cooper S JCW<br>One<br>One 1.4<br>One D  | 85<br>155<br>66                             |  | 06.00 11.06<br>07.02 11.06<br>11.03 11.06<br>06.00 11.06<br>06.00 11.06<br>03.03 11.06                            |   | 03.7860-1402.4   | 300228   |   | 10"  | ATE                             |
|  | Cooper<br>Cooper S<br>Cooper S JCW<br>One<br>One 1.4<br>One D  | 85<br>155<br>66                             |  | 06.00 11.06<br>07.02 11.06<br>11.03 11.06<br>06.00 11.06<br>06.00 11.06<br>03.03 11.06                            |   | 03.2122-1853.3<br>03.2122-1824.3   | 010893<br>010892                               | - DSC<br>+ DSC  | THz 22,20<br>THz 22,20   | ATE<br>ATE                      |
|  | Cooper<br>Cooper S<br>One<br>One 1.4<br>One D  | 85<br>66                                    |  | 06.00 11.06<br>07.02 11.06<br>06.00 11.06<br>06.00 11.06<br>03.03 11.06   |   | 11.9481-9811.2<br>11.9481-9812.2<br>11.0101-5402.2<br>11.8171-0008.1<br>11.8116-0274.1 | 220445<br>220446<br>260009<br>990049<br>390516 | <br><br>2 | D=48, - Halter<br>D=48, - Halter<br>Hülzensatz<br>Führungsbolzen<br>Haltefeder | ATE<br>ATE<br>ATE<br>ATE<br>ATE |
|  | Cooper<br>Cooper S<br>Cooper S JCW<br>One<br>One 1.4<br>One D  | 85<br>155<br>66                             |  | 06.00 11.06<br>07.02 11.06<br>11.03 11.06<br>06.00 11.06<br>06.00 11.06<br>03.03 11.06                            |   | 83.6248-0565.3   | 330644   | 2   | L=565  |                                 |













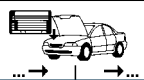











<sup>1)</sup> for 285/65 R 16 C / per 285/65 R 16 C / pour 285/65 R 16 C / para 285/65 R 16 C





































<sup>2)</sup> + brake disc 284 X 22 / + dischi freno 284 X 22 / + disque de frein 284 X 22 / + disco de freno 284 X 22

<sup>3)</sup> + brake disc 325 X 25 / + dischi freno 325 X 25 / + disque de frein 325 X 25 / + disco de freno 325 X 25

<sup>4)</sup> + brake disc 280 X 10 / + dischi freno 280 X 10 / + disque de frein 280 X 10 / + disco de freno 280 X 10

<sup>5)</sup> + brake disc 276 X 19 / + dischi freno 276 X 19 / + disque de frein 276 X 19 / + disco de freno 276 X 19

|     |    kW |  |  |  |  |  |  |  |  |
|--|---|--|--|--|---|--|--|--|--|
| <b>MINI R50/R53 (00-06)</b>  |   |  |  |  |   |  |  |  |  |
|    | Cooper  | 85   | 06.00  | 03.03  | 11.9347-7001.2  | 220473   | ☐<br>☐   |  | D=34, - Halter<br>ATE<br>D=34, - Halter<br>ATE<br>Haltersatz<br>ATE<br>Hülzensatz<br>ATE<br>Führungsbolzen<br>ATE                      |
|  | Cooper S  |  | 07.02  | 03.03  | 11.9347-7002.2  | 220474   |  |  |  |
|  | One   | 66   | 06.00  | 03.03  | 11.0230-0162.2  | 260090   |  |  |  |
|  | One 1.4   |  | 06.00  | 03.03  | 11.0101-5407.2  | 260011   |  |  |  |
|  | One D   |  | 03.03  | 03.03  | 11.8171-0008.1  | 990049   |  |  |  |
|    | Cooper  | 85   | 04.03  | 11.06  | 11.9347-7003.2  | 220565   | ☐<br>☐   |  | D=34, - Halter<br>ATE<br>D=34, - Halter<br>ATE<br>Haltersatz<br>ATE<br>Hülzensatz<br>ATE<br>Führungsbolzen<br>ATE<br>Haltefeder<br>ATE |
|  | Cooper S  |  | 04.03  | 11.06  | 11.9347-7004.2  | 220566   |  |  |  |
|  | Cooper S JCW  | 155  | 11.03  | 11.06  | 11.0230-0162.2  | 260090   |  |  |  |
|  | One   | 66   | 04.03  | 11.06  | 11.0101-5407.2  | 260011   |  |  |  |
|  | One 1.4   |  | 04.03  | 11.06  | 11.8171-0008.1  | 990049   |  |  |  |
| One D  |   | 04.03  | 11.06  | 11.8116-0340.1   | 390595  | 2  |  |  |  |
|    | Cooper  | 85   | 06.00  | 03.03  | 83.6248-0432.3  | 330713   |  |  | L=430  |
|  | Cooper S  |  | 07.02  | 03.03  |   |  |  |  |  |
|  | One   | 66   | 06.00  | 03.03  |   |  |  |  |  |
|  | One 1.4   |  | 06.00  | 03.03  |   |  |  |  |  |
|  | One D   |  | 03.03  | 03.03  |   |  |  |  |  |
|    | Cooper  | 85   | 04.03  | 11.06  | 24.5125-0415.3  | 330821   |  |  | L=415  |
|  | Cooper S  |  | 04.03  | 11.06  |   |  |  |  |  |
|  | Cooper S JCW  | 155  | 11.03  | 11.06  |   |  |  |  |  |
|  | One   | 66   | 04.03  | 11.06  |   |  |  |  |  |
|  | One 1.4   |  | 04.03  | 11.06  |   |  |  |  |  |
| One D  |   | 04.03  | 11.06  |  |   |  |  |  |  |
|    | Cooper  | 85   | 06.00  | 11.06  | 24.3727-0245.2  | 580245   | ☐<br>☐   |  | L=1433<br>L=1435   |
|  | Cooper S  |  | 07.02  | 11.06  | 24.3727-0244.2  | 580244   |  |  |  |
|  | Cooper S JCW  | 155  | 11.03  | 11.06  |   |  |  |  |  |
|  | One   | 66   | 06.00  | 11.06  |   |  |  |  |  |
|  | One 1.4   |  | 06.00  | 11.06  |   |  |  |  |  |
| One D  |   | 03.03  | 11.06  |  |   |  |  |  |  |
| <b>MINI R52 Cabrio (04-08)</b>   |   |  |  |  |   |  |  |  |  |
|    | Cooper  | 85   | 04.04  | 08.08  | 03.7860-1402.4  | 300228   |  |  | 10" ATE  |
|  | Cooper S  | 125  | 04.04  | 08.08  |   |  |  |  |  |
|  | Cooper S JCW  | 155  | 11.03  | 08.08  |   |  |  |  |  |
|  | One   | 66   | 04.04  | 08.08  |   |  |  |  |  |
|    | Cooper  | 85   | 04.04  | 08.08  | 03.2122-1853.3  | 010893   | - DSC<br>+ DSC   |  | THz 22,20<br>THz 22,20 ATE   |
|  | Cooper S  | 125  | 04.04  | 08.08  | 03.2122-1824.3  | 010892   |  |  |  |
|  | Cooper S JCW  | 155  | 11.03  | 08.08  |   |  |  |  |  |
|  | One   | 66   | 04.04  | 08.08  |   |  |  |  |  |
|  | Cooper  | 85   | 04.04  | 08.08  | 11.9481-9811.2  | 220445   | ☐<br>☐   |  | D=48, - Halter<br>ATE<br>D=48, - Halter<br>ATE<br>Hülzensatz<br>ATE<br>Führungsbolzen<br>ATE<br>Haltefeder<br>ATE                      |
|  | Cooper S  | 125  | 04.04  | 08.08  | 11.9481-9812.2  | 220446   |  |  |  |
|  | One   | 66   | 04.04  | 08.08  | 11.0101-5407.2  | 260011   |  |  |  |
|  |   |  |  |  | 11.8171-0008.1  | 990049   |  |  |  |
|  | Cooper  | 85   | 04.04  | 08.08  | 83.6248-0565.3  | 330644   |  |  | L=565  |
|  | Cooper S  | 125  | 04.04  | 08.08  |   |  |  |  |  |
|  | Cooper S JCW  | 155  | 11.03  | 08.08  |   |  |  |  |  |
|  | One   | 66   | 04.04  | 08.08  |   |  |  |  |  |
|  |   |  |  |  |   |  |  |  |  |
|  | Cooper  | 85   | 04.04  | 08.08  | 11.9347-7003.2  | 220565   | ☐<br>☐   |  | D=34, - Halter<br>ATE<br>D=34, - Halter<br>ATE<br>Haltersatz<br>ATE<br>Hülzensatz<br>ATE<br>Führungsbolzen<br>ATE<br>Haltefeder<br>ATE |
|  | Cooper S  | 125  | 04.04  | 08.08  | 11.9347-7004.2  | 220566   |  |  |  |
|  | Cooper S JCW  | 155  | 11.03  | 08.08  | 11.0230-0162.2  | 260090   |  |  |  |
|  | One   | 66   | 04.04  | 08.08  | 11.0101-5407.2  | 260011   |  |  |  |
|  |   |  |  |  | 11.8171-0008.1  | 990049   |  |  |  |
|  | Cooper  | 85   | 04.04  | 08.08  | 24.5125-0415.3  | 330821   |  |  | L=415  |
|  | Cooper S  | 125  | 04.04  | 08.08  |   |  |  |  |  |
|  | Cooper S JCW  | 155  | 11.03  | 08.08  |   |  |  |  |  |
|  | One   | 66   | 04.04  | 08.08  |   |  |  |  |  |
|  |   |  |  |  |   |  |  |  |  |
|  | Cooper  | 85   | 04.04  | 08.08  | 24.3727-0245.2  | 580245   | ☐<br>☐   |  | L=1433<br>L=1435   |
|  | Cooper S  | 125  | 04.04  | 08.08  | 24.3727-0244.2  | 580244   |  |  |  |
|  | Cooper S JCW  | 155  | 11.03  | 08.08  |   |  |  |  |  |
|  | One   | 66   | 04.04  | 08.08  |   |  |  |  |  |
|  |   |  |  |  |   |  |  |  |  |
| <b>MINI R55 Clubman (07-)</b>  |   |  |  |  |   |  |  |  |  |
|  | Cooper  |  | 09.07  |  | 24.4123-1712.3  | 010897   |  |  | THz 23,81 LUC  |
|  | Cooper D  |  | 09.07  |  |   |  |  |  |  |
|  | Cooper S  |  | 09.07  |  |   |  |  |  |  |
|  | Cooper SD   | 105  | 02.11  |  |   |  |  |  |  |
|  | John Cooper Works   | 155  | 03.08  |  |   |  |  |  |  |
|  | One   |  | 03.10  |  |   |  |  |  |  |
|  | Cooper  |  | 09.07  |  | 24.3541-1843.5  | 240585   | ☐<br>☐   |  | D=54, - Halter<br>LUC<br>D=54, - Halter<br>LUC   |
|  | Cooper D  |  | 09.07  |  | 24.3541-1844.5  | 240586   |  |  |  |
|  | One   |  | 03.10  |  |   |  |  |  |  |
|  | One D   | 66   | 03.10  |  |   |  |  |  |  |
|  | Cooper S  |  | 09.07  |  | 24.3541-1843.5  | 240585   | ☐<br>☐   |  | D=54, - Halter<br>LUC<br>D=54, - Halter<br>LUC   |
|  | Cooper SD   | 105  | 02.11  |  | 24.3541-1844.5  | 240586   |  |  |  |
|  |   |  |  |  |   |  |  |  |  |
|  |   |  |  |  |   |  |  |  |  |
|  | Cooper  |  | 09.07  |  | 83.7750-0523.3  | 331101   | 2<br>2   |  | L=523<br>L=523   |
|  | Cooper D  |  | 09.07  |  | 83.7750-0524.3  | 331230   |  |  |  |
|  | Cooper S  |  | 09.07  |  |   |  |  |  |  |
|  | Cooper SD   | 105  | 02.11  |  |   |  |  |  |  |
|  | John Cooper Works   | 155  | 03.08  |  |   |  |  |  |  |
|  | One   |  | 03.10  |  |   |  |  |  |  |
| One D  | 66  | 03.10  |  |  |   |  |  |  |  |

|     |  |  |  |  |  |  |     |  |        |
|--|--|--|--|--|---|--|---|--|--------|
| <b>MINI R55 Clubman (07-)</b>  |  |  |  |  |   |  |   |  |        |
|    | Cooper   |  | 09.07  |  | 24.3367-1711.7  | 220753   |    | D=36, - Halter   | LUC    |
|  | Cooper D   |  | 09.07  |  | 24.3367-1712.7  | 220754   |    | D=36, - Halter   | LUC    |
|  | Cooper S   |  | 09.07  |  | 24.0101-3803.2  | 260101   |   | Einbausatz   | LUC    |
|  | Cooper SD  | 105  | 02.11  |  |   |  |   |  |        |
|  | One  |  | 03.10  |  |   |  |   |  |        |
|  | One D  | 66   | 03.10  |  |   |  |   |  |        |
|    | Cooper   |  | 09.07  |  | 83.7751-0417.3  | 331102   | 2   |  | L=418  |
|  | Cooper D   |  | 09.07  |  |   |  |   |  |        |
|  | Cooper S   |  | 09.07  |  |   |  |   |  |        |
|  | Cooper SD  | 105  | 02.11  |  |   |  |   |  |        |
|  | John Cooper Works  | 155  | 03.08  |  |   |  |   |  |        |
|  | One  |  | 03.10  |  |   |  |   |  |        |
|  | One D  | 66   | 03.10  |  |   |  |   |  |        |
|    | Cooper   |  | 09.07  |  | 24.3727-0240.2  | 580240   |    |  | L=1474 |
|  | Cooper D   |  | 09.07  |  | 24.3727-0243.2  | 580243   |    |  | L=1483 |
|  | Cooper S   |  | 09.07  |  |   |  |   |  |        |
|  | Cooper SD  | 105  | 02.11  |  |   |  |   |  |        |
|  | John Cooper Works  | 155  | 03.08  |  |   |  |   |  |        |
|  | One  |  | 03.10  |  |   |  |   |  |        |
|  | One D  | 66   | 03.10  |  |   |  |   |  |        |
| <b>MINI R55 Clubvan (12-)</b>  |  |  |  |  |   |  |   |  |        |
|    | Cooper   | 90   | 12.12  |  | 24.4123-1712.3  | 010897   |   | THz 23,81  | LUC    |
|  | Cooper D   | 82   | 12.12  |  |   |  |   |  |        |
|  | One  | 72   | 12.12  |  |   |  |   |  |        |
|    | Cooper   | 90   | 12.12  |  | 24.3541-1843.5  | 240585   |    | D=54, - Halter   | LUC    |
|  | Cooper D   | 82   | 12.12  |  | 24.3541-1844.5  | 240586   |    | D=54, - Halter   | LUC    |
|  | One  | 72   | 12.12  |  |   |  |   |  |        |
|    | Cooper   | 90   | 12.12  |  | 83.7750-0523.3  | 331101   | 2   | L=523  |        |
|  | Cooper D   | 82   | 12.12  |  | 83.7750-0524.3  | 331230   | 2   | L=523  |        |
|  | One  | 72   | 12.12  |  |   |  |   |  |        |
|    | Cooper   | 90   | 12.12  |  | 24.3367-1711.7  | 220753   |    | D=36, - Halter   | LUC    |
|  | Cooper D   | 82   | 12.12  |  | 24.3367-1712.7  | 220754   |    | D=36, - Halter   | LUC    |
|  | One  | 72   | 12.12  |  |   |  |   |  |        |
|    | Cooper   | 90   | 12.12  |  | 83.7751-0417.3  | 331102   | 2   | L=418  |        |
|  | Cooper D   | 82   | 12.12  |  |   |  |   |  |        |
|  | One  | 72   | 12.12  |  |   |  |   |  |        |
|   | Cooper   | 90   | 12.12  |  | 24.3727-0240.2  | 580240   |   | L=1474   |        |
|  | Cooper D   | 82   | 12.12  |  | 24.3727-0243.2  | 580243   |  | L=1483   |        |
|  | One  | 72   | 12.12  |  |   |  |   |  |        |
| <b>MINI R56 (06-)</b>  |  |  |  |  |   |  |   |  |        |
|  | Cooper   | 85   | 03.10  |  | 24.4123-1712.3  | 010897   |   | THz 23,81  | LUC    |
|  | Cooper   | 88   | 11.06  |  |   |  |   |  |        |
|  | Cooper   | 90   | 03.10  |  |   |  |   |  |        |
|  | Cooper D   |  | 04.07  |  |   |  |   |  |        |
|  | Cooper S   |  | 03.10  |  |   |  |   |  |        |
|  | Cooper S   | 128  | 11.06  |  |   |  |   |  |        |
|  | Cooper S   | 147  | 01.12  |  |   |  |   |  |        |
|  | Cooper SD  |  | 02.11  |  |   |  |   |  |        |
|  | John Cooper Works  | 155  | 03.08  |  |   |  |   |  |        |
|  | John Cooper Works  | 160  | 07.07  |  |   |  |   |  |        |
|  | One  | 55   | 03.09  |  |   |  |   |  |        |
|  | One  | 70   | 04.07  |  |   |  |   |  |        |
|  | One  | 72   | 03.10  |  |   |  |   |  |        |
|  | One D  | 66   | 03.10  |  |   |  |   |  |        |
|  | Cooper   | 85   | 03.10  |  | 24.3541-1843.5  | 240585   |  | D=54, - Halter   | LUC    |
|  | Cooper   | 88   | 11.06  |  | 24.3541-1844.5  | 240586   |  | D=54, - Halter   | LUC    |
|  | Cooper   | 90   | 03.10  |  |   |  |   |  |        |
|  | Cooper D   |  | 04.07  |  |   |  |   |  |        |
|  | Cooper SD  |  | 02.11  |  |   |  |   |  |        |
|  | One  | 55   | 03.09  |  |   |  |   |  |        |
|  | One  | 70   | 04.07  |  |   |  |   |  |        |
|  | One  | 72   | 03.10  |  |   |  |   |  |        |
|  | One D  | 66   | 03.10  |  |   |  |   |  |        |
|  | Cooper S   | 128  | 03.10  |  | 24.3541-1843.5  | 240585   |  | D=54, - Halter   | LUC    |
|  | Cooper S   | 147  | 11.06  |  | 24.3541-1844.5  | 240586   |  | D=54, - Halter   | LUC    |
|  | Cooper S   | 147  | 01.12  |  |   |  |   |  |        |
|  | Cooper   | 85   | 03.10  |  | 83.7750-0523.3  | 331101   | 2   | L=523  |        |
|  | Cooper   | 88   | 11.06  |  | 83.7750-0524.3  | 331230   | 2   | L=523  |        |
|  | Cooper   | 90   | 03.10  |  |   |  |   |  |        |
|  | Cooper D   |  | 04.07  |  |   |  |   |  |        |
|  | Cooper S   |  | 03.10  |  |   |  |   |  |        |
|  | Cooper S   | 128  | 11.06  |  |   |  |   |  |        |
|  | Cooper S   | 147  | 01.12  |  |   |  |   |  |        |
|  | Cooper SD  |  | 02.11  |  |   |  |   |  |        |
|  | John Cooper Works  | 155  | 03.08  |  |   |  |   |  |        |
|  | John Cooper Works  | 160  | 07.07  |  |   |  |   |  |        |
|  | John Cooper Works GP   | 160  | 09.12  |  |   |  |   |  |        |
|  | One  | 55   | 03.09  |  |   |  |   |  |        |
|  | One  | 70   | 04.07  |  |   |  |   |  |        |
|  | One  | 72   | 03.10  |  |   |  |   |  |        |
|  | One D  | 66   | 03.10  |  |   |  |   |  |        |

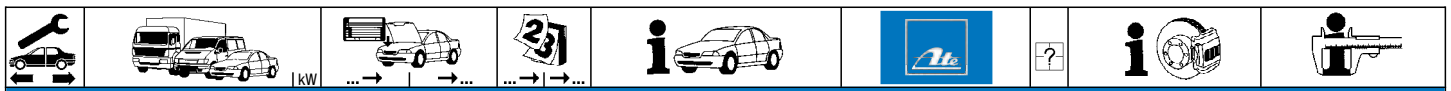



















**MINI R56 (06-)**

|                      |                   |       |       |                |                          |                          |                          |                          |                          |        |                          |                          |            |                          |            |                          |                          |  |  |                          |  |  |                          |  |  |                          |                          |        |                          |                |        |                          |        |  |
|----------------------|-------------------|-------|-------|----------------|--------------------------|--------------------------|--------------------------|--------------------------|--------------------------|--------|--------------------------|--------------------------|------------|--------------------------|------------|--------------------------|--------------------------|--|--|--------------------------|--|--|--------------------------|--|--|--------------------------|--------------------------|--------|--------------------------|----------------|--------|--------------------------|--------|--|
|                      | Cooper            | 85    | 03.10 | 24.3367-1711.7 | 220753                   | <input type="checkbox"/> | D=36, - Halter           | <b>LUC</b>               |                          |        |                          |                          |            |                          |            |                          |                          |  |  |                          |  |  |                          |  |  |                          |                          |        |                          |                |        |                          |        |  |
|                      | Cooper            | 88    | 11.06 |                |                          |                          |                          |                          | 24.3367-1712.7           | 220754 | <input type="checkbox"/> | D=36, - Halter           | <b>LUC</b> |                          |            |                          |                          |  |  |                          |  |  |                          |  |  |                          |                          |        |                          |                |        |                          |        |  |
|                      | Cooper            | 90    | 03.10 |                |                          |                          |                          |                          | 24.0101-3803.2           | 260101 |                          |                          |            | <input type="checkbox"/> | Einbausatz | <b>LUC</b>               |                          |  |  |                          |  |  |                          |  |  |                          |                          |        |                          |                |        |                          |        |  |
|                      | Cooper D          |       | 04.07 |                |                          |                          |                          |                          |                          |        |                          |                          |            |                          |            |                          | <input type="checkbox"/> |  |  |                          |  |  |                          |  |  |                          |                          |        |                          |                |        |                          |        |  |
|                      | Cooper S          |       | 03.10 |                |                          |                          |                          |                          |                          |        |                          |                          |            |                          |            |                          |                          |  |  | <input type="checkbox"/> |  |  |                          |  |  |                          |                          |        |                          |                |        |                          |        |  |
|                      | Cooper S          | 128   | 11.06 |                |                          |                          |                          |                          |                          |        |                          |                          |            |                          |            |                          |                          |  |  |                          |  |  | <input type="checkbox"/> |  |  |                          |                          |        |                          |                |        |                          |        |  |
|                      | Cooper S          | 147   | 01.12 |                |                          |                          |                          |                          |                          |        |                          |                          |            |                          |            |                          |                          |  |  |                          |  |  |                          |  |  | <input type="checkbox"/> |                          |        |                          |                |        |                          |        |  |
|                      | Cooper SD         |       | 02.11 |                |                          |                          |                          |                          |                          |        |                          |                          |            |                          |            |                          |                          |  |  |                          |  |  |                          |  |  |                          |                          |        | <input type="checkbox"/> |                |        |                          |        |  |
|                      | One               | 55    | 03.09 |                |                          |                          |                          |                          |                          |        |                          |                          |            |                          |            |                          |                          |  |  |                          |  |  |                          |  |  |                          |                          |        |                          |                |        | <input type="checkbox"/> |        |  |
|                      | One               | 70    | 04.07 |                |                          |                          |                          |                          |                          |        |                          |                          |            |                          |            |                          |                          |  |  |                          |  |  |                          |  |  |                          |                          |        |                          |                |        |                          |        |  |
| One                  | 72                | 03.10 |       |                | <input type="checkbox"/> |                          |                          |                          |                          |        |                          |                          |            |                          |            |                          |                          |  |  |                          |  |  |                          |  |  |                          |                          |        |                          |                |        |                          |        |  |
| One D                | 66                | 03.10 |       |                |                          |                          |                          | <input type="checkbox"/> |                          |        |                          |                          |            |                          |            |                          |                          |  |  |                          |  |  |                          |  |  |                          |                          |        |                          |                |        |                          |        |  |
|                      | Cooper            | 85    | 03.10 | 83.7751-0417.3 |                          |                          |                          |                          |                          |        | 331102                   | 2                        | L=418      |                          |            |                          |                          |  |  |                          |  |  |                          |  |  |                          |                          |        |                          |                |        |                          |        |  |
|                      | Cooper            | 88    | 11.06 |                |                          |                          |                          |                          |                          |        |                          |                          |            |                          |            |                          | <input type="checkbox"/> |  |  |                          |  |  |                          |  |  |                          |                          |        |                          |                |        |                          |        |  |
|                      | Cooper            | 90    | 03.10 |                |                          |                          |                          |                          |                          |        |                          |                          |            |                          |            |                          |                          |  |  | <input type="checkbox"/> |  |  |                          |  |  |                          |                          |        |                          |                |        |                          |        |  |
|                      | Cooper D          |       | 04.07 |                |                          |                          |                          |                          |                          |        |                          |                          |            |                          |            |                          |                          |  |  |                          |  |  | <input type="checkbox"/> |  |  |                          |                          |        |                          |                |        |                          |        |  |
|                      | Cooper S          |       | 03.10 |                |                          |                          |                          |                          |                          |        |                          |                          |            |                          |            |                          |                          |  |  |                          |  |  |                          |  |  | <input type="checkbox"/> |                          |        |                          |                |        |                          |        |  |
|                      | Cooper S          | 128   | 11.06 |                |                          |                          |                          |                          |                          |        |                          |                          |            |                          |            |                          |                          |  |  |                          |  |  |                          |  |  |                          |                          |        | <input type="checkbox"/> |                |        |                          |        |  |
|                      | Cooper S          | 147   | 01.12 |                |                          |                          |                          |                          |                          |        |                          |                          |            |                          |            |                          |                          |  |  |                          |  |  |                          |  |  |                          |                          |        |                          |                |        | <input type="checkbox"/> |        |  |
|                      | Cooper SD         |       | 02.11 |                |                          |                          |                          |                          |                          |        |                          |                          |            |                          |            |                          |                          |  |  |                          |  |  |                          |  |  |                          |                          |        |                          |                |        |                          |        |  |
|                      | John Cooper Works | 155   | 03.08 |                |                          |                          | <input type="checkbox"/> |                          |                          |        |                          |                          |            |                          |            |                          |                          |  |  |                          |  |  |                          |  |  |                          |                          |        |                          |                |        |                          |        |  |
|                      | John Cooper Works | 160   | 07.07 |                |                          |                          |                          | <input type="checkbox"/> |                          |        |                          |                          |            |                          |            |                          |                          |  |  |                          |  |  |                          |  |  |                          |                          |        |                          |                |        |                          |        |  |
| John Cooper Works GP | 160               | 09.12 |       |                | <input type="checkbox"/> |                          |                          |                          |                          |        |                          |                          |            |                          |            |                          |                          |  |  |                          |  |  |                          |  |  |                          |                          |        |                          |                |        |                          |        |  |
| One                  | 55                | 03.09 |       |                |                          |                          |                          |                          |                          |        |                          | <input type="checkbox"/> |            |                          |            |                          |                          |  |  |                          |  |  |                          |  |  |                          |                          |        |                          |                |        |                          |        |  |
| One                  | 70                | 04.07 |       |                |                          |                          |                          |                          |                          |        |                          |                          |            |                          |            |                          | <input type="checkbox"/> |  |  |                          |  |  |                          |  |  |                          |                          |        |                          |                |        |                          |        |  |
| One                  | 72                | 03.10 |       |                |                          |                          |                          |                          |                          |        |                          |                          |            |                          |            |                          |                          |  |  | <input type="checkbox"/> |  |  |                          |  |  |                          |                          |        |                          |                |        |                          |        |  |
| One D                | 66                | 03.10 |       |                |                          |                          |                          |                          |                          |        |                          |                          |            |                          |            |                          |                          |  |  |                          |  |  | <input type="checkbox"/> |  |  |                          |                          |        |                          |                |        |                          |        |  |
|                      | Cooper            | 85    | 03.10 | 24.3727-0241.2 |                          |                          |                          |                          |                          |        |                          |                          |            |                          |            |                          |                          |  |  |                          |  |  |                          |  |  | 580241                   | <input type="checkbox"/> | L=1393 |                          |                |        |                          |        |  |
|                      | Cooper            | 88    | 11.06 |                |                          |                          |                          |                          |                          |        |                          |                          |            |                          |            |                          |                          |  |  |                          |  |  |                          |  |  |                          |                          |        |                          | 24.3727-0242.2 | 580242 | <input type="checkbox"/> | L=1402 |  |
|                      | Cooper            | 90    | 03.10 |                |                          |                          |                          |                          |                          |        |                          |                          |            |                          |            |                          |                          |  |  |                          |  |  |                          |  |  |                          |                          |        |                          |                |        |                          |        |  |
|                      | Cooper D          |       | 04.07 |                |                          |                          |                          |                          |                          |        |                          |                          |            |                          |            | <input type="checkbox"/> |                          |  |  |                          |  |  |                          |  |  |                          |                          |        |                          |                |        |                          |        |  |
|                      | Cooper S          |       | 03.10 |                |                          |                          |                          |                          | <input type="checkbox"/> |        |                          |                          |            |                          |            |                          |                          |  |  |                          |  |  |                          |  |  |                          |                          |        |                          |                |        |                          |        |  |
|                      | Cooper S          | 128   | 11.06 |                |                          |                          | <input type="checkbox"/> |                          |                          |        |                          |                          |            |                          |            |                          |                          |  |  |                          |  |  |                          |  |  |                          |                          |        |                          |                |        |                          |        |  |
|                      | Cooper S          | 147   | 01.12 |                |                          |                          |                          |                          |                          |        |                          | <input type="checkbox"/> |            |                          |            |                          |                          |  |  |                          |  |  |                          |  |  |                          |                          |        |                          |                |        |                          |        |  |
|                      | Cooper SD         |       | 02.11 |                |                          |                          |                          |                          |                          |        |                          |                          |            |                          |            |                          | <input type="checkbox"/> |  |  |                          |  |  |                          |  |  |                          |                          |        |                          |                |        |                          |        |  |
|                      | John Cooper Works | 155   | 03.08 |                |                          |                          |                          |                          |                          |        |                          |                          |            |                          |            |                          |                          |  |  | <input type="checkbox"/> |  |  |                          |  |  |                          |                          |        |                          |                |        |                          |        |  |
|                      | John Cooper Works | 160   | 07.07 |                |                          |                          |                          |                          |                          |        |                          |                          |            |                          |            |                          |                          |  |  |                          |  |  | <input type="checkbox"/> |  |  |                          |                          |        |                          |                |        |                          |        |  |
| John Cooper Works GP | 160               | 09.12 |       |                | <input type="checkbox"/> |                          |                          |                          |                          |        |                          |                          |            |                          |            |                          |                          |  |  |                          |  |  |                          |  |  |                          |                          |        |                          |                |        |                          |        |  |
| One                  | 55                | 03.09 |       |                |                          |                          |                          |                          |                          |        |                          |                          |            |                          |            |                          |                          |  |  |                          |  |  |                          |  |  |                          | <input type="checkbox"/> |        |                          |                |        |                          |        |  |
| One                  | 70                | 04.07 |       |                |                          |                          |                          |                          |                          |        |                          |                          |            |                          |            |                          |                          |  |  |                          |  |  |                          |  |  |                          |                          |        |                          |                |        | <input type="checkbox"/> |        |  |
| One                  | 72                | 03.10 |       |                |                          |                          |                          |                          |                          |        |                          |                          |            |                          |            | <input type="checkbox"/> |                          |  |  |                          |  |  |                          |  |  |                          |                          |        |                          |                |        |                          |        |  |
| One D                | 66                | 03.10 |       |                |                          |                          |                          |                          | <input type="checkbox"/> |        |                          |                          |            |                          |            |                          |                          |  |  |                          |  |  |                          |  |  |                          |                          |        |                          |                |        |                          |        |  |

**MINI R57 Cabrio (09-)**

|     |                   |       |       |                |                          |                          |                          |            |                          |                |                          |                |                          |                          |                |            |                          |                |            |                          |                |            |                          |  |  |
|-----|-------------------|-------|-------|----------------|--------------------------|--------------------------|--------------------------|------------|--------------------------|----------------|--------------------------|----------------|--------------------------|--------------------------|----------------|------------|--------------------------|----------------|------------|--------------------------|----------------|------------|--------------------------|--|--|
|     | Cooper            | 90    | 01.09 | 24.4123-1712.3 | 010897                   | <input type="checkbox"/> | THz 23,81                | <b>LUC</b> |                          |                |                          |                |                          |                          |                |            |                          |                |            |                          |                |            |                          |  |  |
|     | Cooper            | 82    | 03.10 |                |                          |                          |                          |            |                          |                | <input type="checkbox"/> |                |                          |                          |                |            |                          |                |            |                          |                |            |                          |  |  |
|     | Cooper D          |       | 06.10 |                |                          |                          |                          |            |                          |                |                          |                |                          | <input type="checkbox"/> |                |            |                          |                |            |                          |                |            |                          |  |  |
|     | Cooper S          |       | 03.10 |                |                          |                          |                          |            |                          |                |                          |                |                          |                          |                |            | <input type="checkbox"/> |                |            |                          |                |            |                          |  |  |
|     | Cooper S          | 128   | 01.09 |                |                          |                          |                          |            |                          |                |                          |                |                          |                          |                |            |                          |                |            | <input type="checkbox"/> |                |            |                          |  |  |
|     | Cooper SD         | 105   | 02.11 |                |                          |                          |                          |            |                          |                |                          |                |                          |                          |                |            |                          |                |            |                          |                |            | <input type="checkbox"/> |  |  |
|     | John Cooper Works | 155   | 03.09 |                |                          |                          |                          |            |                          |                |                          |                |                          |                          |                |            |                          |                |            |                          |                |            |                          |  |  |
| One | 72                | 03.10 |       |                | <input type="checkbox"/> |                          |                          |            |                          |                |                          |                |                          |                          |                |            |                          |                |            |                          |                |            |                          |  |  |
|     | Cooper            | 90    | 01.09 | 24.3541-1843.5 |                          |                          |                          | 240585     | <input type="checkbox"/> | D=54, - Halter | <b>LUC</b>               |                |                          |                          |                |            |                          |                |            |                          |                |            |                          |  |  |
|     | Cooper            | 82    | 03.10 |                |                          |                          |                          |            |                          |                |                          | 24.3541-1844.5 | 240586                   | <input type="checkbox"/> | D=54, - Halter | <b>LUC</b> |                          |                |            |                          |                |            |                          |  |  |
|     | Cooper D          |       | 06.10 |                |                          |                          |                          |            |                          |                |                          | 24.3541-1843.5 | 240585                   |                          |                |            | <input type="checkbox"/> | D=54, - Halter | <b>LUC</b> |                          |                |            |                          |  |  |
|     | Cooper S          |       | 03.10 |                |                          |                          |                          |            |                          |                |                          | 24.3541-1844.5 | 240586                   |                          |                |            |                          |                |            | <input type="checkbox"/> | D=54, - Halter | <b>LUC</b> |                          |  |  |
|     | Cooper S          | 128   | 01.09 |                |                          |                          |                          |            |                          |                |                          |                |                          |                          |                |            |                          |                |            |                          |                |            | <input type="checkbox"/> |  |  |
|     | Cooper SD         | 105   | 02.11 |                |                          |                          |                          |            |                          |                |                          |                |                          |                          |                |            |                          |                |            |                          |                |            |                          |  |  |
|     | One               | 72    | 03.10 |                |                          |                          | <input type="checkbox"/> |            |                          |                |                          |                |                          |                          |                |            |                          |                |            |                          |                |            |                          |  |  |
|     | Cooper            | 90    | 01.09 | 83.7750-0523.3 | 331101                   | 2                        |                          | L=523      |                          |                |                          |                |                          |                          |                |            |                          |                |            |                          |                |            |                          |  |  |
|     | Cooper            | 82    | 03.10 |                |                          |                          |                          |            |                          | 83.7750-0524.3 | 331230                   |                |                          | <input type="checkbox"/> | L=523          |            |                          |                |            |                          |                |            |                          |  |  |
|     | Cooper D          |       | 06.10 |                |                          |                          |                          |            |                          |                |                          |                |                          |                          |                |            | <input type="checkbox"/> |                |            |                          |                |            |                          |  |  |
|     | Cooper S          |       | 03.10 |                |                          |                          |                          |            |                          |                |                          |                |                          |                          |                |            |                          |                |            | <input type="checkbox"/> |                |            |                          |  |  |
|     | Cooper S          | 128   | 01.09 |                |                          |                          |                          |            |                          |                |                          |                |                          |                          |                |            |                          |                |            |                          |                |            | <input type="checkbox"/> |  |  |
|     | Cooper SD         | 105   | 02.11 |                |                          |                          |                          |            |                          |                |                          |                |                          |                          |                |            |                          |                |            |                          |                |            |                          |  |  |
|     | John Cooper Works | 155   | 03.09 |                |                          |                          |                          |            |                          |                | <input type="checkbox"/> |                |                          |                          |                |            |                          |                |            |                          |                |            |                          |  |  |
| One | 72                | 03.10 |       |                | <input type="checkbox"/> |                          |                          |            |                          |                |                          |                |                          |                          |                |            |                          |                |            |                          |                |            |                          |  |  |
|     | Cooper            | 90    | 01.09 | 24.3367-1711.7 |                          |                          |                          | 220753     | <input type="checkbox"/> | D=36, - Halter |                          |                |                          | <b>LUC</b>               |                |            |                          |                |            |                          |                |            |                          |  |  |
|     | Cooper            | 82    | 03.10 |                |                          |                          |                          |            |                          |                |                          |                |                          |                          | 24.3367-1712.7 | 220754     | <input type="checkbox"/> | D=36, - Halter | <b>LUC</b> |                          |                |            |                          |  |  |
|     | Cooper D          |       | 06.10 |                |                          |                          |                          |            |                          |                |                          |                |                          |                          | 24.0101-3803.2 | 260101     |                          |                |            | <input type="checkbox"/> | Einbausatz     | <b>LUC</b> |                          |  |  |
|     | Cooper S          |       | 03.10 |                |                          |                          |                          |            |                          |                |                          |                |                          |                          |                |            |                          |                |            |                          |                |            | <input type="checkbox"/> |  |  |
|     | Cooper S          | 128   | 01.09 |                |                          |                          |                          |            |                          |                |                          |                |                          |                          |                |            |                          |                |            |                          |                |            |                          |  |  |
|     | Cooper SD         | 105   | 02.11 |                |                          |                          |                          |            |                          |                |                          |                | <input type="checkbox"/> |                          |                |            |                          |                |            |                          |                |            |                          |  |  |
|     | One               | 72    | 03.10 |                |                          |                          | <input type="checkbox"/> |            |                          |                |                          |                |                          |                          |                |            |                          |                |            |                          |                |            |                          |  |  |
|     | Cooper            | 90    | 01.09 | 83.7751-0417.3 | 331102                   | 2                        |                          | L=418      |                          |                |                          |                |                          |                          |                |            |                          |                |            |                          |                |            |                          |  |  |
|     | Cooper            | 82    | 03.10 |                |                          |                          |                          |            |                          |                |                          |                |                          |                          |                |            | <input type="checkbox"/> |                |            |                          |                |            |                          |  |  |
|     | Cooper D          |       | 06.10 |                |                          |                          |                          |            |                          |                |                          |                |                          |                          |                |            |                          |                |            | <input type="checkbox"/> |                |            |                          |  |  |
|     | Cooper S          |       | 03.10 |                |                          |                          |                          |            |                          |                |                          |                |                          |                          |                |            |                          |                |            |                          |                |            | <input type="checkbox"/> |  |  |
|     | Cooper S          | 128   | 01.09 |                |                          |                          |                          |            |                          |                |                          |                |                          |                          |                |            |                          |                |            |                          |                |            |                          |  |  |
|     | Cooper SD         | 105   | 02.11 |                |                          |                          |                          |            |                          |                |                          |                |                          | <input type="checkbox"/> |                |            |                          |                |            |                          |                |            |                          |  |  |
|     | John Cooper Works | 155   | 03.09 |                |                          |                          |                          |            |                          |                | <input type="checkbox"/> |                |                          |                          |                |            |                          |                |            |                          |                |            |                          |  |  |
| One | 72                | 03.10 |       |                | <input type="checkbox"/> |                          |                          |            |                          |                |                          |                |                          |                          |                |            |                          |                |            |                          |                |            |                          |  |  |
|     | Cooper            | 90    | 01.09 | 24.3727-0241.2 |                          |                          |                          | 580241     | <input type="checkbox"/> | L=1393         |                          |                |                          |                          |                |            |                          |                |            |                          |                |            |                          |  |  |
|     | Cooper            | 82    | 03.10 |                |                          |                          |                          |            |                          |                |                          |                |                          |                          |                |            |                          | 24.3727-0242.2 | 580242     | <input type="checkbox"/> | L=1402         |            |                          |  |  |
|     | Cooper D          |       | 06.10 |                |                          |                          |                          |            |                          |                |                          |                |                          |                          |                |            |                          |                |            |                          |                |            | <input type="checkbox"/> |  |  |
|     | Cooper S          |       | 03.10 |                |                          |                          |                          |            |                          |                |                          |                |                          |                          |                |            |                          |                |            |                          |                |            |                          |  |  |



| MINI R57 Cabrio (09-)  |                   |     |  |       |       |                |                |                          |                          |  |  |                |     |
|--|-------------------|-----|--|-------|-------|----------------|----------------|--------------------------|--------------------------|--|--|----------------|-----|
|     | Cooper S          | 128 |  | 01.09 |       | 24.3727-0241.2 | 580241         | <input type="checkbox"/> |                          |  |  | L=1393         |     |
|  | Cooper SD         | 105 |  | 02.11 |       | 24.3727-0242.2 | 580242         | <input type="checkbox"/> |                          |  |  | L=1402         |     |
|  | John Cooper Works | 155 |  | 03.09 |       |                |                |                          |                          |  |  |                |     |
|  | One               | 72  |  | 03.10 |       |                |                |                          |                          |  |  |                |     |
| MINI R58 Coupe (11-)   |                   |     |  |       |       |                |                |                          |                          |  |  |                |     |
|    | Cooper            |     |  | 10.11 |       | 24.4123-1712.3 | 010897         |                          |                          |  |  | THz 23,81      | LUC |
|  | Cooper S          |     |  | 10.11 |       |                |                |                          |                          |  |  |                |     |
|  | Cooper S JCW      | 155 |  | 10.11 |       |                |                |                          |                          |  |  |                |     |
|  | Cooper SD         |     |  | 10.11 |       |                |                |                          |                          |  |  |                |     |
|    | Cooper            |     |  | 10.11 |       | 24.3541-1843.5 | 240585         | <input type="checkbox"/> |                          |  |  | D=54, - Halter | LUC |
|  | Cooper SD         |     |  | 10.11 |       | 24.3541-1844.5 | 240586         | <input type="checkbox"/> |                          |  |  | D=54, - Halter | LUC |
|  | Cooper S          |     |  | 10.11 |       | 24.3541-1843.5 | 240585         | <input type="checkbox"/> |                          |  |  | D=54, - Halter | LUC |
|  |                   |     |  | 10.11 |       | 24.3541-1844.5 | 240586         | <input type="checkbox"/> |                          |  |  | D=54, - Halter | LUC |
|    | Cooper            |     |  | 10.11 |       | 83.7750-0523.3 | 331101         | 2                        |                          |  |  | L=523          |     |
|  | Cooper S          |     |  | 10.11 |       | 83.7750-0524.3 | 331230         | 2                        |                          |  |  | L=523          |     |
|  | Cooper S JCW      | 155 |  | 10.11 |       |                |                |                          |                          |  |  |                |     |
|  | Cooper SD         |     |  | 10.11 |       |                |                |                          |                          |  |  |                |     |
|    | Cooper            |     |  | 10.11 |       | 24.3367-1711.7 | 220753         | <input type="checkbox"/> |                          |  |  | D=36, - Halter | LUC |
|  | Cooper S          |     |  | 10.11 |       | 24.3367-1712.7 | 220754         | <input type="checkbox"/> |                          |  |  | D=36, - Halter | LUC |
|  | Cooper SD         |     |  | 10.11 |       |                |                |                          |                          |  |  |                |     |
|    | Cooper            |     |  | 10.11 |       | 83.7751-0417.3 | 331102         | 2                        |                          |  |  | L=418          |     |
|  | Cooper S          |     |  | 10.11 |       |                |                |                          |                          |  |  |                |     |
|  | Cooper S JCW      | 155 |  | 10.11 |       |                |                |                          |                          |  |  |                |     |
|  | Cooper SD         |     |  | 10.11 |       |                |                |                          |                          |  |  |                |     |
|    | Cooper            |     |  | 10.11 |       | 24.3727-0241.2 | 580241         | <input type="checkbox"/> |                          |  |  | L=1393         |     |
|  | Cooper S          |     |  | 10.11 |       | 24.3727-0242.2 | 580242         | <input type="checkbox"/> |                          |  |  | L=1402         |     |
|  | Cooper S JCW      | 155 |  | 10.11 |       |                |                |                          |                          |  |  |                |     |
|  | Cooper SD         |     |  | 10.11 |       |                |                |                          |                          |  |  |                |     |
| MINI R59 Roadster (12-)  |                   |     |  |       |       |                |                |                          |                          |  |  |                |     |
|    | Cooper            |     |  | 02.12 |       | 24.4123-1712.3 | 010897         |                          |                          |  |  | THz 23,81      | LUC |
|  | Cooper S          |     |  | 02.12 |       |                |                |                          |                          |  |  |                |     |
|  | Cooper S JCW      | 155 |  | 02.12 |       |                |                |                          |                          |  |  |                |     |
|  | Cooper SD         |     |  | 02.12 |       |                |                |                          |                          |  |  |                |     |
|    | Cooper            |     |  | 02.12 |       | 24.3541-1843.5 | 240585         | <input type="checkbox"/> |                          |  |  | D=54, - Halter | LUC |
|  | Cooper S          |     |  | 02.12 |       | 24.3541-1844.5 | 240586         | <input type="checkbox"/> |                          |  |  | D=54, - Halter | LUC |
|  | Cooper SD         |     |  | 02.12 |       |                |                |                          |                          |  |  |                |     |
|  | Cooper            |     |  | 02.12 |       | 83.7750-0523.3 | 331101         | 2                        |                          |  |  | L=523          |     |
|  | Cooper S          |     |  | 02.12 |       | 83.7750-0524.3 | 331230         | 2                        |                          |  |  | L=523          |     |
|  | Cooper S JCW      | 155 |  | 02.12 |       |                |                |                          |                          |  |  |                |     |
|  | Cooper SD         |     |  | 02.12 |       |                |                |                          |                          |  |  |                |     |
|  | Cooper            |     |  | 02.12 |       | 24.3367-1711.7 | 220753         | <input type="checkbox"/> |                          |  |  | D=36, - Halter | LUC |
|  | Cooper S          |     |  | 02.12 |       | 24.3367-1712.7 | 220754         | <input type="checkbox"/> |                          |  |  | D=36, - Halter | LUC |
|  | Cooper SD         |     |  | 02.12 |       |                |                |                          |                          |  |  |                |     |
|  | Cooper            |     |  | 02.12 |       | 83.7751-0417.3 | 331102         | 2                        |                          |  |  | L=418          |     |
|  | Cooper S          |     |  | 02.12 |       |                |                |                          |                          |  |  |                |     |
|  | Cooper S JCW      | 155 |  | 02.12 |       |                |                |                          |                          |  |  |                |     |
|  | Cooper SD         |     |  | 02.12 |       |                |                |                          |                          |  |  |                |     |
|  | Cooper            |     |  | 02.12 |       | 24.3727-0241.2 | 580241         | <input type="checkbox"/> |                          |  |  | L=1393         |     |
|  | Cooper S          |     |  | 02.12 |       | 24.3727-0242.2 | 580242         | <input type="checkbox"/> |                          |  |  | L=1402         |     |
|  | Cooper S JCW      | 155 |  | 02.12 |       |                |                |                          |                          |  |  |                |     |
|  | Cooper SD         |     |  | 02.12 |       |                |                |                          |                          |  |  |                |     |
| MINI R60 Countryman (10-)  |                   |     |  |       |       |                |                |                          |                          |  |  |                |     |
|  | Cooper            | 90  |  | 09.10 |       | 24.4123-1712.3 | 010897         |                          |                          |  |  | THz 23,81      | LUC |
|  | Cooper D          | 82  |  | 09.10 |       |                |                |                          |                          |  |  |                |     |
|  | Cooper S          | 135 |  | 09.10 |       |                |                |                          |                          |  |  |                |     |
|  | Cooper S          | 147 |  | 02.12 |       |                |                |                          |                          |  |  |                |     |
|  | Cooper S All4     |     |  | 09.10 |       |                |                |                          |                          |  |  |                |     |
|  | Cooper S JCW      | 160 |  | 09.12 |       |                |                |                          |                          |  |  |                |     |
|  | Cooper SD         | 105 |  | 02.11 |       |                |                |                          |                          |  |  |                |     |
|  | Cooper SD All4    |     |  | 02.11 |       |                |                |                          |                          |  |  |                |     |
|  | Cooper D All4     | 82  |  | 09.10 |       |                |                |                          |                          |  |  |                |     |
|  | One               | 72  |  | 09.10 |       |                |                |                          |                          |  |  |                |     |
|  | One D             | 66  |  | 09.10 |       |                |                |                          |                          |  |  |                |     |
| MINI R61 Paceman (12-)   |                   |     |  |       |       |                |                |                          |                          |  |  |                |     |
|  | Cooper            | 90  |  | 11.12 |       | 24.4123-1712.3 | 010897         |                          |                          |  |  | THz 23,81      | LUC |
|  | Cooper D          | 82  |  | 11.12 |       |                |                |                          |                          |  |  |                |     |
|  | Cooper D All4     | 82  |  | 11.12 |       |                |                |                          |                          |  |  |                |     |
|  | Cooper S          | 135 |  | 11.12 |       |                |                |                          |                          |  |  |                |     |
|  | Cooper S All4     | 135 |  | 11.12 |       |                |                |                          |                          |  |  |                |     |
|  | Cooper S JCW      | 160 |  | 11.12 |       |                |                |                          |                          |  |  |                |     |
|  | Cooper SD         | 105 |  | 11.12 |       |                |                |                          |                          |  |  |                |     |
|  | Cooper SD All4    | 105 |  | 11.12 |       |                |                |                          |                          |  |  |                |     |
| MITSUBISHI CARISMA (95-06)   |                   |     |  |       |       |                |                |                          |                          |  |  |                |     |
|  | 1.6 i (DA1A)      | 66  |  | 07.95 | 06.06 | - ABS          | 24.2122-1718.3 | 010517                   |                          |  |  | THz 22,20      |     |
|  | 1.8 i (DA2A)      | 85  |  | 07.95 | 06.06 | - ABS          |                |                          |                          |  |  |                |     |
|  | 1.8 i 16V (DA2A)  | 103 |  | 07.95 | 06.06 | - ABS          |                |                          |                          |  |  |                |     |
|  | 1.6 i (DA1A)      | 66  |  | 03.99 | 06.00 |                | 24.3541-1783.5 | 240269                   | <input type="checkbox"/> |  |  | D=54, - Halter | LUC |
|  | 1.6 i 16V (DA1A)  | 70  |  | 03.99 | 06.06 |                | 24.3541-1784.5 | 240270                   | <input type="checkbox"/> |  |  | D=54, - Halter | LUC |
|  | 1.6 i 16V (DA1A)  | 73  |  | 03.99 | 06.06 |                |                |                          |                          |  |  |                |     |
|  | 1.8 i (DA2A)      | 85  |  | 07.95 | 02.99 |                |                |                          |                          |  |  |                |     |
|  | 1.8 i 16V (DA2A)  | 103 |  | 07.95 | 02.99 |                |                |                          |                          |  |  |                |     |



















































**MITSUBISHI CARISMA (95-06)**

|                      |                      |                  |       |             |                |                |                          |                                  |                          |                          |                  |  |
|----------------------|----------------------|------------------|-------|-------------|----------------|----------------|--------------------------|----------------------------------|--------------------------|--------------------------|------------------|--|
|                      | 1.8 i 16V GDI (DA2A) | 92               | 09.97 | 08.00       | 24.3541-1783.5 | 240269         | <input type="checkbox"/> | D=54, - Halter<br>D=54, - Halter | <b>LUC</b><br><b>LUC</b> |                          |                  |  |
|                      | 1.9 TD (DA4A)        | 66               | 03.99 | 09.00       | 24.3541-1784.5 | 240270         | <input type="checkbox"/> |                                  |                          |                          |                  |  |
|                      | 1.3 i (DA6A)         | 55               | 09.00 | 10.04       | 24.3541-1785.5 | 240271         | <input type="checkbox"/> |                                  |                          |                          |                  |  |
|                      | 1.6 i (DA1A)         | 66               | 07.00 | 06.06       | 24.3541-1786.5 | 240272         | <input type="checkbox"/> |                                  |                          |                          |                  |  |
|                      | 1.6 i 16V (DA1A)     | 76               | 06.99 | 06.06       |                |                |                          |                                  |                          |                          |                  |  |
|                      | 1.8 i (DA2A)         | 85               | 03.99 | 06.06       |                |                |                          |                                  |                          |                          |                  |  |
|                      | 1.8 i 16V (DA2A)     | 103              | 03.99 | 06.06       |                |                |                          |                                  |                          |                          |                  |  |
|                      | 1.8 i 16V GDI (DA2A) | 92               | 09.00 | 06.06       |                |                |                          |                                  |                          |                          |                  |  |
|                      | 1.9 DI-D (DA5A)      | 75               | 09.00 | 06.06       |                |                |                          |                                  |                          |                          |                  |  |
| 1.9 DI-D (DA5A)      | 85                   | 09.00            | 06.06 |             |                |                |                          |                                  |                          |                          |                  |  |
|                      | 1.3 i (DA6A)         | 55               | 09.00 | 10.04       | 24.5248-0461.3 | 330707         | 2                        | L=461                            |                          |                          |                  |  |
|                      | 1.6 i (DA1A)         | 66               | 07.95 | 06.06       |                |                |                          |                                  |                          |                          |                  |  |
|                      | 1.6 i 16V (DA1A)     | 70               | 12.98 | 06.06       |                |                |                          |                                  |                          |                          |                  |  |
|                      | 1.6 i 16V (DA1A)     | 73               | 05.97 | 06.06       |                |                |                          |                                  |                          |                          |                  |  |
|                      | 1.6 i 16V (DA1A)     | 76               | 06.99 | 06.06       |                |                |                          |                                  |                          |                          |                  |  |
|                      | 1.8 i (DA2A)         | 85               | 07.95 | 06.06       |                |                |                          |                                  |                          |                          |                  |  |
|                      | 1.8 i 16V (DA2A)     | 103              | 07.95 | 06.06       |                |                |                          |                                  |                          |                          |                  |  |
|                      | 1.8 i 16V GDI (DA2A) | 90               | 10.00 | 06.06       |                |                |                          |                                  |                          |                          |                  |  |
|                      | 1.8 i 16V GDI (DA2A) | 92               | 09.97 | 06.06       |                |                |                          |                                  |                          |                          |                  |  |
|                      | 1.9 DI-D (DA5A)      | 75               | 09.00 | 06.06       |                |                |                          |                                  |                          |                          |                  |  |
|                      | 1.9 DI-D (DA5A)      | 85               | 09.00 | 06.06       |                |                |                          |                                  |                          |                          |                  |  |
| 1.9 TD (DA4A)        | 66                   | 10.96            | 09.00 |             |                |                |                          |                                  |                          |                          |                  |  |
|                      | 1.3 i (DA6A)         | 55               | 09.00 | 10.04       | 24.3384-1743.5 | 240319         | <input type="checkbox"/> | D=38, - Halter<br>D=38, - Halter | <b>LUC</b><br><b>LUC</b> |                          |                  |  |
|                      | 1.6 i (DA1A)         | 66               | 06.99 | 06.06 + ABS | 24.3384-1744.5 | 240320         | <input type="checkbox"/> |                                  |                          |                          |                  |  |
|                      | 1.6 i 16V (DA1A)     | 76               | 06.99 | 06.06 + ABS |                |                |                          |                                  |                          |                          |                  |  |
|                      | 1.8 i (DA2A)         | 85               | 11.97 | 06.06 + ABS |                |                |                          |                                  |                          |                          |                  |  |
|                      | 1.8 i 16V (DA2A)     | 103              | 11.97 | 06.06 + ABS |                |                |                          |                                  |                          |                          |                  |  |
|                      | 1.8 i 16V GDI (DA2A) | 90               | 10.00 | 06.06 + ABS |                |                |                          |                                  |                          |                          |                  |  |
|                      | 1.8 i 16V GDI (DA2A) | 92               | 06.99 | 06.06 + ABS |                |                |                          |                                  |                          |                          |                  |  |
|                      | 1.9 DI-D (DA5A)      | 75               | 09.00 | 06.06       |                |                |                          |                                  |                          |                          |                  |  |
|                      | 1.9 DI-D (DA5A)      | 85               | 09.00 | 06.06       |                |                |                          |                                  |                          |                          |                  |  |
|                      | 1.3 i (DA6A)         | 55               | 09.00 | 10.04       | 24.5249-0416.3 | 330708         | 2                        | L=416                            |                          |                          |                  |  |
|                      | 1.6 i (DA1A)         | 66               | 07.95 | 06.06       |                |                |                          |                                  |                          |                          |                  |  |
|                      | 1.6 i 16V (DA1A)     | 70               | 12.98 | 06.06       |                |                |                          |                                  |                          |                          |                  |  |
|                      | 1.6 i 16V (DA1A)     | 73               | 05.97 | 06.06       |                |                |                          |                                  |                          |                          |                  |  |
|                      | 1.6 i 16V (DA1A)     | 76               | 06.99 | 06.06       |                |                |                          |                                  |                          |                          |                  |  |
|                      | 1.8 i (DA2A)         | 85               | 07.95 | 06.06       |                |                |                          |                                  |                          |                          |                  |  |
|                      | 1.8 i 16V (DA2A)     | 103              | 07.95 | 06.06       |                |                |                          |                                  |                          |                          |                  |  |
|                      | 1.8 i 16V GDI (DA2A) | 90               | 10.00 | 06.06       |                |                |                          |                                  |                          |                          |                  |  |
|                      | 1.8 i 16V GDI (DA2A) | 92               | 09.97 | 06.06       |                |                |                          |                                  |                          |                          |                  |  |
|                      | 1.9 DI-D (DA5A)      | 75               | 09.00 | 06.06       |                |                |                          |                                  |                          |                          |                  |  |
|                      | 1.9 DI-D (DA5A)      | 85               | 09.00 | 06.06       |                |                |                          |                                  |                          |                          |                  |  |
| 1.9 TD (DA4A)        | 66                   | 10.96            | 09.00 |             |                |                |                          |                                  |                          |                          |                  |  |
|                      | 1.6 i (DA1A)         | 66               | 07.95 | 09.98 - ABS | 24.3219-1753.3 | 020506         |                          | Rz 19,05                         |                          |                          |                  |  |
|                      | 1.6 i 16V (DA1A)     | 73               | 05.97 | 09.98 - ABS |                |                |                          |                                  |                          |                          |                  |  |
|                      | 1.8 i (DA2A)         | 85               | 07.95 | 06.06 - ABS |                |                |                          |                                  |                          |                          |                  |  |
|                      | 1.8 i 16V (DA2A)     | 103              | 07.95 | 06.06 - ABS |                |                |                          |                                  |                          |                          |                  |  |
|                      | 1.8 i 16V GDI (DA2A) | 92               | 09.97 | 09.98 - ABS |                |                |                          |                                  |                          |                          |                  |  |
|                      | 1.9 TD (DA4A)        | 66               | 10.96 | 09.98 - ABS |                |                |                          |                                  |                          |                          |                  |  |
|                      | 1.6 i (DA1A)         | 66               | 10.98 | 06.06 - ABS | 24.3219-1745.3 | 020496         |                          | Rz 19,05                         |                          |                          |                  |  |
|                      | 1.6 i 16V (DA1A)     | 70               | 12.98 | 06.06 - ABS |                |                |                          |                                  |                          |                          |                  |  |
|                      | 1.6 i 16V (DA1A)     | 73               | 10.98 | 06.06 - ABS |                |                |                          |                                  |                          |                          |                  |  |
|                      | 1.6 i 16V (DA1A)     | 76               | 06.99 | 06.06 - ABS |                |                |                          |                                  |                          |                          |                  |  |
|                      | 1.8 i 16V GDI (DA2A) | 90               | 10.00 | 06.06 - ABS |                |                |                          |                                  |                          |                          |                  |  |
|                      | 1.8 i 16V GDI (DA2A) | 92               | 10.98 | 06.06 - ABS |                |                |                          |                                  |                          |                          |                  |  |
|                      | 1.9 TD (DA4A)        | 66               | 10.98 | 09.00 - ABS |                |                |                          |                                  |                          |                          |                  |  |
|                      |                      | 1.3 i (DA6A)     | 55    | 09.00       | 10.04          | 24.3727-2109.2 | 582109                   |                                  |                          | <input type="checkbox"/> | L=1588<br>L=1588 |  |
|                      |                      | 1.6 i 16V (DA1A) | 76    | 09.00       | 06.06          | 24.3727-2108.2 | 582108                   |                                  |                          | <input type="checkbox"/> |                  |  |
| 1.8 i (DA2A)         |                      | 85               | 07.00 | 06.06       |                |                |                          |                                  |                          |                          |                  |  |
| 1.8 i 16V (DA2A)     |                      | 103              | 07.00 | 06.06       |                |                |                          |                                  |                          |                          |                  |  |
| 1.8 i 16V GDI (DA2A) |                      | 90               | 10.00 | 06.06       |                |                |                          |                                  |                          |                          |                  |  |
| 1.8 i 16V GDI (DA2A) |                      | 92               | 07.00 | 06.06       |                |                |                          |                                  |                          |                          |                  |  |
| 1.9 DI-D (DA5A)      |                      | 75               | 09.00 | 06.06       |                |                |                          |                                  |                          |                          |                  |  |
| 1.9 DI-D (DA5A)      |                      | 85               | 09.00 | 06.06       |                |                |                          |                                  |                          |                          |                  |  |





























**MITSUBISHI COLT/LANCER Limousine (88-92)**





































|  |                |  |       |             |                |        |  |          |  |
|--|----------------|--|-------|-------------|----------------|--------|--|----------|--|
|  | 1.2 (C65A)     |  | 04.88 | 05.90       | 24.3219-1716.3 | 020071 |  | Rz 19,05 |  |
|  | 1.3 (C51A/V)   |  | 04.88 | 05.90       |                |        |  |          |  |
|  | 1.3 (C61A)     |  | 04.88 | 05.90       |                |        |  |          |  |
|  | 1.5 (C52A) KAT |  | 04.88 | 05.90       |                |        |  |          |  |
|  | 1.5 (C62A)     |  | 04.88 | 05.90       |                |        |  |          |  |
|  | 1.8 D (C54A)   |  | 04.88 | 05.90       |                |        |  |          |  |
|  | 1.8 D (C64A)   |  | 04.88 | 05.90       |                |        |  |          |  |
|  | 1.2 (C65A)     |  | 06.90 | 05.92       | 24.3219-1752.3 | 020505 |  | Rz 19,05 |  |
|  | 1.3 (C51A/V)   |  | 06.90 | 05.92       |                |        |  |          |  |
|  | 1.3 (C61A)     |  | 06.90 | 10.92       |                |        |  |          |  |
|  | 1.5 (C52A) KAT |  | 06.90 | 05.92       |                |        |  |          |  |
|  | 1.5 (C62A)     |  | 06.90 | 10.92       |                |        |  |          |  |
|  | 1.6 16V (C66A) |  | 06.92 | 10.92 - ABS |                |        |  |          |  |
|  | 1.6 4x4 (C76A) |  | 06.92 | 10.92       |                |        |  |          |  |
|  | 1.8 4x4 (C77A) |  | 05.89 | 05.92       |                |        |  |          |  |
|  | 1.8 D (C54A)   |  | 06.90 | 05.92       |                |        |  |          |  |
|  | 1.8 D (C64A)   |  | 06.90 | 05.92       |                |        |  |          |  |
|  | 2.0 D (C67A)   |  | 06.92 | 10.92       |                |        |  |          |  |

























|     |    |  |  |  |  |  |  |  |
|--|--|--|--|--|---|--|--|--|
| <b>MITSUBISHI COLT/LANCER Limousine (92-96)</b>                                    |  |  |  |  |   |  |  |  |
|    | 1.3 (CA1A)<br>1.3 (CB1A)   |  | 12.91<br>05.92   | 04.96<br>04.96   | 24.3219-1752.3  | 020505   |  | Rz 19,05   |
| <b>MITSUBISHI COLT/LANCER Limousine (96-03)</b>                                    |  |  |  |  |   |  |  |  |
|    | 1.3 i 12V (CJ1A)<br>1.3 i 12V (CK1A)<br>1.3 i 16V (CJ1A)<br>1.6 i 16V (CJ4A)<br>1.6 i 16V (CJ4A)<br>1.6 i 16V (CK4A)                                     | 55<br>55<br>60<br>66<br>76<br>66   | 05.96<br>05.96<br>09.00<br>05.96<br>09.00<br>05.96                               | 08.00<br>07.01<br>06.03<br>08.00<br>06.03<br>07.01                               | 24.5205-0205.3  | 330780   | 2  | L=205  |
|    | 1.3 i 12V (CJ1A)<br>1.3 i 12V (CK1A)<br>1.3 i 16V (CJ1A)<br>1.6 i 16V (CJ4A)<br>1.6 i 16V (CJ4A)<br>1.6 i 16V (CK4A)                                     | 55<br>55<br>60<br>66<br>76<br>66   | 05.96<br>05.96<br>09.00<br>05.96<br>09.00<br>05.96                               | 08.00<br>07.01<br>06.03<br>08.00<br>06.03<br>07.01                               | 24.3219-1752.3  | 020505   | - ABS  | Rz 19,05   |
| <b>MITSUBISHI COLT (04-)</b>   |  |  |  |  |   |  |  |  |
|    | 1.1 i 12V (Z32A)<br>1.3 i 16V (Z34A)<br>1.5 CZT (Z37A)<br>1.5 DI-D (Z38A)<br>1.5 DI-D (Z39A)<br>1.5 i 16V (Z27A)<br>1.5 i 16V (Z36A)<br>1.5 i 16V (Z37A) | 55<br>70<br>110<br>50<br>70<br>72<br>80<br>132                                   | 10.04<br>06.04<br>03.05<br>08.04<br>08.04<br>09.04<br>06.04<br>05.07             | 09.08<br>09.08<br>09.08<br>08.04<br>08.04<br>02.06<br>09.08<br>09.08             | 24.2122-1770.3  | 010898   |  | Thz 22,20 LUC  |
|    | 1.1 i 12V (Z32A)<br>1.3 i 16V (Z34A)<br>1.5 DI-D (Z38A)<br>1.5 DI-D (Z39A)<br>1.5 i 16V (Z27A)<br>1.5 i 16V (Z36A)                                       | 55<br>70<br>50<br>70<br>72<br>80   | 10.04<br>06.04<br>08.04<br>08.04<br>09.04<br>06.04                               | 09.08<br>09.08<br>08.04<br>08.04<br>02.06<br>09.08                               | 24.3541-1819.7<br>24.3541-1820.7  | 220767<br>220768   | <input type="checkbox"/><br><input type="checkbox"/>                               | D=54, - Halter<br>D=54, - Halter LUC   |
|    | 1.1 i 12V (Z32A)<br>1.3 i 16V (Z34A)<br>1.5 CZT (Z37A)<br>1.5 DI-D (Z38A)<br>1.5 DI-D (Z39A)<br>1.5 i 16V (Z27A)<br>1.5 i 16V (Z36A)<br>1.5 i 16V (Z37A) | 55<br>70<br>110<br>50<br>70<br>72<br>80<br>132                                   | 05.07<br>05.07<br>05.07<br>05.07<br>05.07<br>05.07<br>05.07                      |  | 24.5298-0475.3  | 331255   | 2  | L=474  |
|  | 1.1 i 12V (Z32A)<br>1.3 i 16V (Z34A)<br>1.5 CZT (Z37A)<br>1.5 DI-D (Z38A)<br>1.5 DI-D (Z39A)<br>1.5 i 16V (Z27A)<br>1.5 i 16V (Z36A)<br>1.5 i 16V (Z37A) | 55<br>70<br>110<br>50<br>70<br>72<br>80<br>132                                   | 10.04<br>06.04<br>03.05<br>08.04<br>08.04<br>09.04<br>06.04<br>05.07             | + ABS<br>+ ABS<br><br>+ ABS<br>+ ABS   | 24.3344-1725.7<br>24.3344-1726.7  | 220771<br>220772   | <input type="checkbox"/><br><input type="checkbox"/>                               | D=34, - Halter<br>D=34, - Halter LUC   |
|  | 1.1 i 12V (Z32A)<br>1.3 i 16V (Z34A)<br>1.5 CZT (Z37A)<br>1.5 DI-D (Z38A)<br>1.5 DI-D (Z39A)<br>1.5 i 16V (Z27A)<br>1.5 i 16V (Z36A)<br>1.5 i 16V (Z37A) | 55<br>70<br>110<br>50<br>70<br>72<br>80<br>132                                   | 10.04<br>06.04<br>03.05<br>08.04<br>08.04<br>09.04<br>06.04<br>05.07             | + ABS<br>+ ABS<br><br>+ ABS<br>+ ABS   | 24.5150-0459.3  | 331018   | 2  | L=459  |
|  | 1.1 i 12V (Z32A)<br>1.3 i 16V (Z34A)<br>1.5 DI-D (Z38A)<br>1.5 DI-D (Z39A)   | 55<br>70<br>50<br>70   | 10.04<br>06.04<br>08.04<br>08.04   | - ABS<br>- ABS<br>- ABS<br>- ABS   | 24.3219-1757.3  | 020517   |  | Rz 19,05 LUC   |
|  | 1.1 i 12V (Z32A)<br>1.3 i 16V (Z34A)<br>1.5 DI-D (Z38A)<br>1.5 DI-D (Z39A)   | 55<br>70<br>50<br>70   | 10.04<br>06.04<br>08.04<br>08.04   | - ABS<br>- ABS<br>- ABS<br>- ABS   | 24.3727-2112.2<br>24.3727-2113.2  | 582112<br>582113   | <input type="checkbox"/><br><input type="checkbox"/>                               | L=1525<br>L=1560   |
|  | 1.1 i 12V (Z32A)<br>1.3 i 16V (Z34A)<br>1.5 CZT (Z37A)<br>1.5 DI-D (Z38A)<br>1.5 DI-D (Z39A)<br>1.5 i 16V (Z27A)<br>1.5 i 16V (Z36A)<br>1.5 i 16V (Z37A) | 55<br>70<br>110<br>50<br>70<br>72<br>80<br>132                                   | 10.04<br>06.04<br>03.05<br>08.04<br>08.04<br>09.04<br>06.04<br>07.05             | + ABS<br>+ ABS<br><br>+ ABS<br>+ ABS   | 24.3727-2110.2<br>24.3727-2111.2  | 582110<br>582111   | <input type="checkbox"/><br><input type="checkbox"/>                               | L=1540<br>L=1570   |
| <b>MITSUBISHI COLT CZC Cabriolet (06-08)</b>                                       |  |  |  |  |   |  |  |  |
|  | 1.5 i 16V (Z36A)<br>1.5 Turbo (Z37A)   | 80<br>110  | 05.06<br>05.06   | 07.08<br>07.08   | 24.2122-1770.3  | 010898   |  | Thz 22,20 LUC  |
|  | 1.5 i 16V (Z36A)   | 80   | 05.06  | 07.08  | 24.3541-1819.7<br>24.3541-1820.7  | 220767<br>220768   | <input type="checkbox"/><br><input type="checkbox"/>                               | D=54, - Halter<br>D=54, - Halter LUC   |
|  | 1.5 i 16V (Z36A)<br>1.5 Turbo (Z37A)   | 80<br>110  | 05.07<br>05.07   | 07.08<br>07.08   | 24.5298-0475.3  | 331255   | 2  | L=474  |

|     |   |  |  |  |  |  |  |  |  |   |                  |
|--|---|--|--|--|---|--|--|--|--|---|------------------|
| <b>MITSUBISHI COLT CZC Cabriolet (06-08)</b>                                       |   |  |  |  |   |  |  |  |  |   |                  |
|    | 1.5 i 16V (Z36A)<br>1.5 Turbo (Z37A)  | 80<br>110  |  | 05.06<br>05.06   | 07.08<br>07.08  |  | 24.3344-1725.7<br>24.3344-1726.7   | 220771<br>220772   | <input type="checkbox"/><br><input type="checkbox"/>   | D=34, - Halter<br>D=34, - Halter  | LUC<br>LUC       |
|    | 1.5 i 16V (Z36A)<br>1.5 Turbo (Z37A)  | 80<br>110  |  | 05.06<br>05.06   | 07.08<br>07.08  |  | 24.5150-0459.3   | 331018   | 2  |   | L=459            |
|    | 1.5 i 16V (Z36A)<br>1.5 Turbo (Z37A)  | 80<br>110  |  | 05.06<br>05.06   | 07.08<br>07.08  |  | 24.3727-2110.2<br>24.3727-2111.2   | 582110<br>582111   | <input type="checkbox"/><br><input type="checkbox"/>   |   | L=1540<br>L=1570 |
| <b>MITSUBISHI GALANT (4-türig) (87-92)</b>   |   |  |  |  |   |  |  |  |  |   |                  |
|    | 1.8 (E32A)<br>1.8 TD (E34A)   |  |  | 06.90<br>06.90   | 10.92<br>10.92  | - ABS  | 24.3541-1815.5<br>24.3541-1816.5   | 240383<br>240384   | <input type="checkbox"/><br><input type="checkbox"/>   | D=54, - Halter<br>D=54, - Halter  | SUM<br>SUM       |
| <b>MITSUBISHI GALANT (5-türig) (88-92)</b>   |   |  |  |  |   |  |  |  |  |   |                  |
|    | 1.8 (E32A)<br>1.8 TD (E34A)   |  |  | 06.90<br>06.90   | 10.92<br>10.92  | - ABS  | 24.3541-1815.5<br>24.3541-1816.5   | 240383<br>240384   | <input type="checkbox"/><br><input type="checkbox"/>   | D=54, - Halter<br>D=54, - Halter  | SUM<br>SUM       |
| <b>MITSUBISHI GALANT (92-96)</b>   |   |  |  |  |   |  |  |  |  |   |                  |
|    | 2.5 i V6 4x4 (E88A)   |  |  | 11.92  | 09.96   |  | 24.3431-1701.5<br>24.3431-1702.5   | 240437<br>240438   | <input type="checkbox"/><br><input type="checkbox"/>   | D=43/43, - Halter<br>D=43/43, - Halter                                  |                  |
| <b>MITSUBISHI GALANT (96-03)</b>   |   |  |  |  |   |  |  |  |  |   |                  |
|    | 2.4 GDi (EA3)<br>2.5 i V6 (EA5)   | 110<br>120   |  | 03.99<br>12.97   | 03.00<br>03.00  |  | 24.3431-1701.5<br>24.3431-1702.5   | 240437<br>240438   | <input type="checkbox"/><br><input type="checkbox"/>   | D=43/43, - Halter<br>D=43/43, - Halter                                  |                  |
|    | 2.0 i 16V (EA2)<br>2.0 i 16V (EA2)<br>2.0 i 16V (EA2W)<br>2.0 i 16V (EA2W)<br>2.0 TDi (EA6)<br>2.4 GDi (EA3)<br>2.4 GDi (EA3)<br>2.5 i V6 (EA5)<br>2.5 i V6 (EA5) | 98<br>100<br>98<br>100<br>66<br>106<br>110<br>118<br>120                         |  | 04.00<br>10.96<br>04.00<br>10.96<br>10.96<br>04.00<br>03.99<br>04.00<br>10.96    | 10.03<br>10.03<br>10.03<br>10.03<br>07.01<br>10.03<br>10.03<br>10.03<br>10.03     |  | 24.5290-0545.3   | 331063   | 2  |   | L=545            |
|   | 2.0 TDi (EA6)<br>2.0 i 16V (EA2)<br>2.0 i 16V (EA2)<br>2.0 i 16V (EA2W)<br>2.0 i 16V (EA2W)<br>2.4 GDi (EA3)<br>2.4 GDi (EA3)<br>2.5 i V6 (EA5)<br>2.5 i V6 (EA5) | 66<br>98<br>100<br>98<br>100<br>106<br>110<br>118<br>120                         |  | 10.96<br>04.00<br>10.96<br>04.00<br>10.96<br>04.00<br>03.99<br>04.00<br>10.96    | 07.01<br>10.03<br>10.03<br>10.03<br>10.03<br>10.03<br>10.03<br>10.03<br>10.03     |  | 24.5230-0243.3<br>24.5156-0230.3   | 331155<br>331068   | 2<br>2   |   | L=243<br>L=230   |
| <b>MITSUBISHI i-MiEV (11-)</b>   |   |  |  |  |   |  |  |  |  |   |                  |
|  | i-MiEV  | 49   |  | 02.11  |   |  | 24.3219-1753.3   | 020506   |  |   | Rz 19,05         |
| <b>MITSUBISHI L 200 (86-96)</b>  |   |  |  |  |   |  |  |  |  |   |                  |
|  | 1.6 (K11T)<br>2.0 (K12T)<br>2.5 D (K14T)<br>2.5 TD 4WD (K34T)   | 60<br>75<br>51<br>64   |  | 04.87<br>11.86<br>11.86<br>05.93   | 05.92<br>08.96<br>08.96<br>08.96  |  | 24.3571-1737.5<br>24.3571-1738.5<br>24.3571-1738.5<br>24.3431-1705.5               | 240387<br>240388<br>240388<br>240365   | <input type="checkbox"/><br><input type="checkbox"/><br><input type="checkbox"/><br><input type="checkbox"/>   | D=57, - Halter<br>D=57, - Halter<br>D=57, - Halter<br>D=43/43, - Halter |                  |
| <b>MITSUBISHI L 200 (96-06)</b>  |   |  |  |  |   |  |  |  |  |   |                  |
|  | 2.5 TD 4WD (K74T)<br>2.5 TD 4WD (K74T)<br>2.5 TDi 4WD (K74T)  | 73<br>85<br>98   |  | 06.96<br>08.01<br>08.01  | 07.01<br>04.06<br>04.06   |  | 24.3431-1705.5<br>24.3431-1706.5   | 240365<br>240366   | <input type="checkbox"/><br><input type="checkbox"/><br><input type="checkbox"/>   | D=43/43, - Halter<br>D=43/43, - Halter<br>D=43/43, - Halter             |                  |
|  | 2.5 TD 4WD (K74T)<br>2.5 TD 4WD (K74T)<br>2.5 TDi 4WD (K74T)  | 73<br>85<br>98   |  | 06.96<br>08.01<br>08.01  | 07.01<br>04.06<br>04.06   |  | 24.5260-0155.3   | 331156   | 2  |   | L=155            |
| <b>MITSUBISHI L 300 (86-94)</b>  |   |  |  |  |   |  |  |  |  |   |                  |
|  | 1.6 (P02V)<br>1.6 (P12V)<br>2.0 (P03V)<br>2.0 (P03W)<br>2.0 (P13V)<br>2.4 (P04V/W/P14V)<br>2.5 D (P05V/W)<br>2.5 D (P15V)   |  |  | 11.88<br>11.88<br>11.86<br>11.86<br>11.86<br>11.90<br>11.86<br>11.86             | 05.94<br>05.94<br>05.94<br>05.94<br>05.94<br>05.94<br>05.94<br>05.94              |  | 24.3571-1737.5<br>24.3571-1738.5   | 240387<br>240388   | <input type="checkbox"/><br><input type="checkbox"/><br><input type="checkbox"/><br><input type="checkbox"/><br><input type="checkbox"/><br><input type="checkbox"/><br><input type="checkbox"/><br><input type="checkbox"/> | D=57, - Halter<br>D=57, - Halter  |                  |
| <b>MITSUBISHI L 400 (96-02)</b>  |   |  |  |  |   |  |  |  |  |   |                  |
|  | 2.4   | 97   |  | 06.96  | 10.02   |  | 24.3431-1705.5<br>24.3431-1706.5   | 240365<br>240366   | <input type="checkbox"/><br><input type="checkbox"/>   | D=43/43, - Halter<br>D=43/43, - Halter                                  |                  |

























































































1) + power steering / + servosterzo / + direction assistée / + dirección asistida





|     |  |  |  |  |  |  |  |  |  |  |
|--|--|--|--|--|---|--|--|--|--|--|
| <b>MITSUBISHI LANCER Evolution (04-07)</b>   |  |  |  |  |   |  |  |  |  |  |
|    | 2.0 i 16V 4WD (CT9A)   | 195  |  | 03.04  | 12.05   |  | 24.3431-1701.5<br>24.3431-1702.5   | 240437<br>240438   | <br>     | D=43/43, - Halter<br>D=43/43, - Halter |
|    | 2.0 i 16V (CT9A)   | 206  |  | 01.06  | 08.07   |  | 24.5286-0545.3   | 331250   | 2  | L=545                                  |
| <b>MITSUBISHI LANCER Limousine (03-07)</b>   |  |  |  |  |   |  |  |  |  |  |
|    | 1.3 i 16V (CS1A)   | 60   |  | 09.03  | 03.07   |  | 24.5286-0545.3   | 331250   | 2  | L=545                                  |
|  | 1.6 i 16V (CS3A)   | 72   |  | 09.03  | 03.07   |  |  |  |  |  |
|  | 2.0 i 16V (CS9A)   | 99   |  | 12.03  | 03.07   |  |  |  |  |  |
| <b>MITSUBISHI LANCER Kombi (92-96)</b>   |  |  |  |  |   |  |  |  |  |  |
|    | 1.6 16V (CB4W)   | 83   |  | 06.92  | 09.96   | - ABS  | 24.3219-1752.3   | 020505   |  | Rz 19,05                               |
|  | 2.0 D (CB8W)   | 50   |  | 06.92  | 09.96   | - ABS  |  |  |  |  |
|  | 1.6 16V 4WD (CD4W)   | 83   |  | 06.92  | 02.95   |  | 24.3219-1716.3   | 020071   |  | Rz 19,05                               |
| <b>MITSUBISHI LANCER Kombi (03-07)</b>   |  |  |  |  |   |  |  |  |  |  |
|    | 1.6 i 16V (CS3W)   | 72   |  | 09.03  | 03.07   |  | 24.5286-0545.3   | 331250   | 2  | L=545                                  |
|  | 2.0 i 16V (CS9W)   | 99   |  | 09.03  | 03.07   |  |  |  |  |  |
|  | 2.4 i 16V (CS9W)   | 98   |  | 09.03  | 03.07   |  |  |  |  |  |
| <b>MITSUBISHI OUTLANDER I (03-06)</b>  |  |  |  |  |   |  |  |  |  |  |
|    | 2.0 i 16V  | 100  |  | 05.03  | 10.06   |  | 24.5286-0555.3   | 331075   | 2  | L=555                                  |
|  | 2.0 i 16V 4WD  | 100  |  | 05.03  | 10.06   |  |  |  |  |  |
|  | 2.0 i 16V Turbo 4WD  | 148  |  | 04.04  | 10.06   |  |  |  |  |  |
|  | 2.4 i 16V 4WD  | 102  |  | 05.03  | 10.06   |  |  |  |  |  |
|  | 2.4 i 16V 4WD  | 118  |  | 11.03  | 10.06   |  |  |  |  |  |
|  | 2.4 Mivec  | 118  |  | 11.03  | 10.06   |  |  |  |  |  |
| <b>MITSUBISHI OUTLANDER II (06-)</b>   |  |  |  |  |   |  |  |  |  |  |
|    | 2.0 i 16V  | 100  |  | 01.07  |   |  | 24.5286-0555.3   | 331075   | 2  | L=555                                  |
|  | 2.4 i 16V  | 125  |  | 11.06  |   |  |  |  |  |  |
|  | 2.4 i 16V 4x4  | 118  |  | 01.07  |   |  |  |  |  |  |
|  | 2.4 Mivec 4x4  | 125  |  | 09.07  |   |  |  |  |  |  |
| <b>MITSUBISHI PAJERO (90-00)</b>   |  |  |  |  |   |  |  |  |  |  |
|   | 2.4 (V21C/V21W)  |  |  | 12.90  | 03.00   |  | 24.3431-1705.5   | 240365   | <br>    | D=43/43, - Halter<br>D=43/43, - Halter |
|  | 2.4 (V41W)   |  |  | 12.90  | 03.00   |  | 24.3431-1706.5   | 240366   |  |  |
|  | 2.5 TD (V24C/V24W)   |  |  | 12.90  | 03.00   |  |  |  |  |  |
|  | 2.5 TD (V44W)  |  |  | 12.90  | 03.00   |  |  |  |  |  |
|  | 2.8 TD (V26W)  |  |  | 11.93  | 03.00   |  |  |  |  |  |
|  | 2.8 TD (V46W)  |  |  | 11.93  | 03.00   |  |  |  |  |  |
|  | 3.0 V6 (V23C/V23W)   |  |  | 12.90  | 03.00   |  |  |  |  |  |
|  | 3.0 V6 (V43W)  |  |  | 12.90  | 03.00   |  |  |  |  |  |
|  | 2.4 (V21C/V21W)  |  |  | 12.90  | 03.00   |  | 24.3431-1703.5   | 240363   | <br> | D=43, - Halter<br>D=43, - Halter       |
|  | 2.4 (V41W)   |  |  | 12.90  | 03.00   |  | 24.3431-1704.5   | 240364   |  |  |
|  | 2.5 TD (V24C/V24W)   |  |  | 12.90  | 03.00   |  |  |  |  |  |
|  | 2.5 TD (V44W)  |  |  | 12.90  | 03.00   |  |  |  |  |  |
|  | 2.8 TD (V26W)  |  |  | 11.93  | 03.00   |  |  |  |  |  |
|  | 2.8 TD (V46W)  |  |  | 11.93  | 03.00   |  |  |  |  |  |
|  | 3.0 V6 (V23C/V23W)   |  |  | 12.90  | 03.00   |  |  |  |  |  |
|  | 3.0 V6 (V43W)  |  |  | 12.90  | 03.00   |  |  |  |  |  |
|  | 3.5 V6 (V25W)  |  |  | 11.93  | 03.00   |  |  |  |  |  |
|  | 3.5 V6 (V45W)  |  |  | 11.93  | 03.00   |  |  |  |  |  |
| <b>MITSUBISHI PAJERO (00-07)</b>   |  |  |  |  |   |  |  |  |  |  |
|  | 2.5 TDiC (V64W)  | 73   |  | 04.00  | 01.07   |  | 24.5286-0660.3   | 331252   | 2  | L=660                                  |
|  | 2.5 TDiC (V64W)  | 85   |  | 04.00  | 01.07   |  |  |  |  |  |
|  | 3.2 DiD (V68W)   | 118  |  | 10.01  | 08.06   |  |  |  |  |  |
|  | 3.2 DiD (V68W)   | 121  |  | 04.00  | 09.01   |  |  |  |  |  |
|  | 3.5 i V6 GDI (V65W)  | 149  |  | 04.00  | 08.06   |  |  |  |  |  |
|  | 2.5 TDiC (V64W)  | 73   |  | 04.00  | 01.07   |  | 24.5286-0540.3   | 331249   | 2  | L=540                                  |
|  | 2.5 TDiC (V64W)  | 85   |  | 04.00  | 01.07   |  |  |  |  |  |
|  | 3.2 DiD (V68W)   | 118  |  | 10.01  | 08.06   |  |  |  |  |  |
|  | 3.2 DiD (V68W)   | 121  |  | 04.00  | 09.01   |  |  |  |  |  |
|  | 3.5 i V6 GDI (V65W)  | 149  |  | 04.00  | 08.06   |  |  |  |  |  |
| <b>MITSUBISHI PAJERO (07-)</b>   |  |  |  |  |   |  |  |  |  |  |
|  | 3.0 i V6 (V93W)  | 131  |  | 02.07  |   |  | 24.5286-0660.3   | 331252   | 2  | L=660                                  |
|  | 3.2 4x4 (V88W)   | 140  |  | 02.07  |   |  |  |  |  |  |
|  | 3.2 DI-D (V88W)  | 118  |  | 02.07  |   |  |  |  |  |  |
|  | 3.2 DI-D (V88W)  | 125  |  | 02.07  |   |  |  |  |  |  |
|  | 3.2 DI-D (V98W)  | 118  |  | 02.07  |   |  |  |  |  |  |
|  | 3.2 DI-D (V98W)  | 125  |  | 02.07  |   |  |  |  |  |  |
|  | 3.2 TD 4x4 (V88W)  | 147  |  | 01.09  |   |  |  |  |  |  |
|  | 3.2 TD 4x4 (V98W)  | 147  |  | 01.09  |   |  |  |  |  |  |
|  | 3.8 i V6 (V87W)  | 182  |  | 02.10  |   |  |  |  |  |  |
|  | 3.8 i V6 (V87W)  | 184  |  | 02.07  |   |  |  |  |  |  |
|  | 3.8 i V6 (V97W)  | 182  |  | 02.10  |   |  |  |  |  |  |
|  | 3.8 i V6 (V97W)  | 184  |  | 02.07  |   |  |  |  |  |  |
|  | 3.2 4x4 (V88W)   | 140  |  | 02.07  |   |  | 24.5286-0540.3   | 331249   | 2  | L=540                                  |
|  | 3.2 DI-D (V88W)  | 118  |  | 02.07  |   |  |  |  |  |  |
|  | 3.2 DI-D (V88W)  | 125  |  | 02.07  |   |  |  |  |  |  |
|  | 3.2 TD 4x4 (V88W)  | 147  |  | 01.09  |   |  |  |  |  |  |
|  | 3.8 i V6 (V87W)  | 182  |  | 02.10  |   |  |  |  |  |  |





|     |  |  |  |  |  |  |  |  |   |   |                   |
|--|--|--|--|--|---|--|--|--|---|---|-------------------|
| <b>MITSUBISHI PAJERO (07-)</b>   |  |  |  |  |   |  |  |  |   |   |                   |
|    | 3.8 i V6 (V87W)  | 184  |  | 02.07  |   |  | 24.5286-0540.3   | 331249   | 2 |   | L=540             |
|  | 3.0 i V6 (V93W)  | 131  |  | 02.07  |   |  | 24.5286-0556.3   | 331251   | 2 |   | L=555             |
|  | 3.2 DI-D (V98W)  | 118  |  | 02.07  |   |  |  |  |   |   |                   |
|  | 3.2 DI-D (V98W)  | 125  |  | 02.07  |   |  |  |  |   |   |                   |
|  | 3.2 TD 4x4 (V98W)  | 147  |  | 01.09  |   |  |  |  |   |   |                   |
|  | 3.8 i V6 (V97W)  | 182  |  | 02.10  |   |  |  |  |   |   |                   |
|  | 3.8 i V6 (V97W)  | 184  |  | 02.07  |   |  |  |  |   |   |                   |
| <b>MITSUBISHI PAJERO PININ / SHOGUN PININ (GB) (99-05)</b>                         |  |  |  |  |   |  |  |  |   |   |                   |
|    | 1.8 i 16V (H67W)   | 84   |  | 11.01  | 02.05   |  | 24.5286-0485.3   | 331172   | 2 |   | L=495             |
|  | 1.8 i 16V GDi (H66W)   | 88   |  | 10.99  | 10.01   |  |  |  |   |   |                   |
|  | 2.0 16V GDi (H77W)   | 95   |  | 09.00  | 02.05   |  |  |  |   |   |                   |
|    | 1.8 i 16V (H67W)   | 84   |  | 11.01  | 02.05   |  | 24.5279-0225.3   | 331163   | 2 |   | L=225             |
|  | 1.8 i 16V GDi (H66W)   | 88   |  | 10.99  | 10.01   |  | 24.5160-0215.3   | 331154   | 2 |   | L=215             |
|  | 2.0 16V GDi (H77W)   | 95   |  | 09.00  | 02.05   |  |  |  |   |   |                   |
| <b>MITSUBISHI PAJERO SPORT / MONTERO (USA) (98-09)</b>                             |  |  |  |  |   |  |  |  |   |   |                   |
|    | 2.5 TDCi (K94W)  | 73   |  | 11.98  | 02.09   |  | 24.3431-1705.5   | 240365   |   |    | D=43/43, - Halter |
|  | 2.5 TDCi (K94W)  | 85   |  | 07.02  | 02.09   |  | 24.3431-1706.5   | 240366   |   |    | D=43/43, - Halter |
|  | 2.5 TDCi (K94W)  | 98   |  | 08.03  | 02.09   |  |  |  |   |   |                   |
|    | 2.5 TDCi (K94W)  | 73   |  | 11.98  | 02.09   |  | 24.5158-0164.3   | 331152   | 2 |   | L=165             |
|  | 2.5 TDCi (K94W)  | 85   |  | 07.02  | 02.09   |  | 24.5284-0400.3   | 331060   | 2 |   | L=400             |
|  | 2.5 TDCi (K94W)  | 98   |  | 08.03  | 02.09   |  |  |  |   |   |                   |
|  | 3.0 i V6 (K96W)  | 125  |  | 06.00  | 02.09   |  |  |  |   |   |                   |
|  | 3.0 i V6 (K96W)  | 130  |  | 11.98  | 09.01   |  |  |  |   |   |                   |
|    | 2.5 TDCi (K94W)  | 73   |  | 11.98  | 02.09   |  | 24.5159-0195.3   | 331153   | 2 |   | L=195             |
|  | 2.5 TDCi (K94W)  | 85   |  | 07.02  | 02.09   |  |  |  |   |   |                   |
|  | 2.5 TDCi (K94W)  | 98   |  | 08.03  | 02.09   |  |  |  |   |   |                   |
|  | 3.0 i V6 (K96W)  | 125  |  | 06.00  | 02.09   |  |  |  |   |   |                   |
|  | 3.0 i V6 (K96W)  | 130  |  | 11.98  | 09.01   |  |  |  |   |   |                   |
| <b>MITSUBISHI SIGMA (90-96)</b>  |  |  |  |  |   |  |  |  |   |   |                   |
|    | 3.0 V6 (F07W)  | 125  |  | 01.93  | 07.96   |  | 24.5156-0230.3   | 331068   | 2 |   | L=230             |
|  | 3.0 V6 (F16A)  | 130  |  | 12.90  | 07.96   |  |  |  |   |   |                   |
|  | 3.0 V6 (F16A)  | 151  |  | 12.90  | 07.96   |  |  |  |   |   |                   |
| <b>MITSUBISHI SPACE GEAR (95-00)</b>   |  |  |  |  |   |  |  |  |   |   |                   |
|   | 2.4 i 4x4  | 97   |  | 05.95  | 05.00   |  | 24.3431-1705.5   | 240365   |   |    | D=43/43, - Halter |
|  | 2.5 TDiC 4x4   | 73   |  | 05.95  | 05.00   |  | 24.3431-1706.5   | 240366   |   |   | D=43/43, - Halter |
| <b>MITSUBISHI SPACE RUNNER (91-99)</b>   |  |  |  |  |   |  |  |  |   |   |                   |
|  | 1.8 (N11W)   |  |  | 06.91  | 08.99   |  | 24.3541-1815.5   | 240383   |   |  | D=54, - Halter    |
|  | 1.8 4x4 (N21W)   |  |  | 06.91  | 08.99   |  | 24.3541-1816.5   | 240384   |   |  | D=54, - Halter    |
|  | 2.0 TD (N18W)  |  |  | 06.92  | 08.99   |  |  |  |   |   |                   |
|  | 1.8 (N11W)   |  |  | 06.91  | 08.99   |  | 24.3219-1752.3   | 020505   |   |   | Rz 19,05          |
|  | 2.0 TD (N18W)  |  |  | 06.92  | 08.99   |  |  |  |   |   |                   |
|  | 1.8 4x4 (N21W)   |  |  | 06.91  | 08.99   |  | 24.3219-1716.3   | 020071   |   |   | Rz 19,05          |
| <b>MITSUBISHI SPACE RUNNER (99-03)</b>   |  |  |  |  |   |  |  |  |   |   |                   |
|  | 2.0 i 16V (N63W)   | 100  |  | 09.99  | 04.00   |  | 24.3431-1701.5   | 240437   |   |  | D=43/43, - Halter |
|  | 2.4 16V GDi (N64W)   | 110  |  | 09.99  | 04.00   |  | 24.3431-1702.5   | 240438   |   |  | D=43/43, - Halter |
| <b>MITSUBISHI SPACE STAR (98-06)</b>   |  |  |  |  |   |  |  |  |   |   |                   |
|  | 1.3 i (DG1A)   | 60   |  | 08.00  | 03.06   |  | 24.3541-1783.5   | 240269   |   |  | D=54, - Halter    |
|  | 1.3 i (DG1A)   | 61   |  | 12.98  | 03.06   |  | 24.3541-1784.5   | 240270   |   |  | D=54, - Halter    |
|  | 1.3 i (DG1A)   | 63   |  | 06.98  | 07.00   |  |  |  |   |   |                   |
|  | 1.6 i 16V (DG3A)   | 72   |  | 09.01  | 03.06   |  |  |  |   |   |                   |
|  | 1.8 GDI (DG5A)   | 82   |  | 10.02  | 03.06   |  |  |  |   |   |                   |
|  | 1.8 GDI (DG5A)   | 90   |  | 06.98  | 03.06   |  |  |  |   |   |                   |
|  | 1.9 DI-D (DG4A)  | 75   |  | 02.01  | 03.06   |  |  |  |   |   |                   |
|  | 1.9 DI-D (DG4A)  | 85   |  | 10.02  | 03.06   |  |  |  |   |   |                   |
|  | 1.3 i (DG1A)   | 60   |  | 08.00  | 03.06   |  | 24.5248-0461.3   | 330707   | 2 |   | L=461             |
|  | 1.3 i (DG1A)   | 61   |  | 12.98  | 03.06   |  |  |  |   |   |                   |
|  | 1.3 i (DG1A)   | 63   |  | 06.98  | 07.00   |  |  |  |   |   |                   |
|  | 1.6 i 16V (DG3A)   | 72   |  | 09.01  | 03.06   |  |  |  |   |   |                   |
|  | 1.8 GDI (DG5A)   | 82   |  | 10.02  | 03.06   |  |  |  |   |   |                   |
|  | 1.8 GDI (DG5A)   | 90   |  | 06.98  | 03.06   |  |  |  |   |   |                   |
|  | 1.9 DI-D (DG4A)  | 75   |  | 02.01  | 03.06   |  |  |  |   |   |                   |
|  | 1.9 DI-D (DG4A)  | 85   |  | 10.02  | 03.06   |  |  |  |   |   |                   |
|  | 1.3 i (DG1A)   | 60   |  | 08.00  | 03.06   |  | 24.3384-1743.5   | 240319   |   |  | D=38, - Halter    |
|  | 1.6 i 16V (DG3A)   | 72   |  | 09.01  | 03.06   |  | 24.3384-1744.5   | 240320   |   |  | D=38, - Halter    |
|  | 1.8 GDI (DG5A)   | 82   |  | 10.02  | 03.06   |  |  |  |   |   |                   |
|  | 1.8 GDI (DG5A)   | 90   |  | 08.00  | 03.06   |  |  |  |   |   |                   |
|  | 1.9 DI-D (DG4A)  | 75   |  | 02.01  | 03.06   |  |  |  |   |   |                   |
|  | 1.9 DI-D (DG4A)  | 85   |  | 10.02  | 03.06   |  |  |  |   |   |                   |
|  | 1.3 i (DG1A)   | 60   |  | 08.00  | 03.06   |  | 24.5249-0416.3   | 330708   | 2 |   | L=416             |
|  | 1.3 i (DG1A)   | 61   |  | 12.98  | 03.06   |  |  |  |   |   |                   |
|  | 1.3 i (DG1A)   | 63   |  | 06.98  | 07.00   |  |  |  |   |   |                   |
|  | 1.6 i 16V (DG3A)   | 72   |  | 09.01  | 03.06   |  |  |  |   |   |                   |
|  | 1.8 GDI (DG5A)   | 82   |  | 10.02  | 03.06   |  |  |  |   |   |                   |
|  | 1.8 GDI (DG5A)   | 90   |  | 06.98  | 03.06   |  |  |  |   |   |                   |
|  | 1.9 DI-D (DG4A)  | 75   |  | 02.01  | 03.06   |  |  |  |   |   |                   |
|  | 1.9 DI-D (DG4A)  | 85   |  | 10.02  | 03.06   |  |  |  |   |   |                   |





|     |  |  |  |  |  |  |  |  |
|--|--|--|--|--|---|--|--|--|
| <b>MITSUBISHI SPACE STAR (98-06)</b>   |  |  |  |  |   |  |  |  |
|    | 1.3 i (DG1A)   | 63   | 06.98  | 09.98  | - ABS   | 24.3219-1753.3   | 020506   | Rz 19,05   |
|  | 1.3 i (DG1A)   | 60   | 08.00  | 03.06  | - ABS   | 24.3219-1745.3   | 020496   | Rz 19,05   |
|  | 1.3 i (DG1A)   | 61   | 12.98  | 03.06  | - ABS   |  |  |  |
|  | 1.3 i (DG1A)   | 63   | 10.98  | 07.00  | - ABS   |  |  |  |
|  | 1.8 GDI (DG5A)   | 82   | 10.02  | 03.06  | - ABS   |  |  |  |
|  | 1.8 GDI (DG5A)   | 90   | 06.98  | 03.06  | - ABS   |  |  |  |
| <b>MITSUBISHI SPACE STAR (A05A) (12-)</b>  |  |  |  |  |   |  |  |  |
|    | 1.0 12V  | 52   | 05.12  |  |   | 24.3219-1753.3   | 020506   | Rz 19,05   |
|  | 1.2 12V  | 57   | 05.12  |  |   |  |  |  |
|  | 1.2 12V  | 59   | 10.12  |  |   |  |  |  |
| <b>MITSUBISHI SPACE WAGON (91-98)</b>  |  |  |  |  |   |  |  |  |
|    | 1.8 (N31W)   |  | 05.91  | 05.92  | - (N)   | 24.3541-1815.5   | 240383   | D=54, - Halter   |
|  | 1.8 4x4 (N41W)   |  | 05.91  | 05.92  | - (N)   | 24.3541-1816.5   | 240384   | D=54, - Halter   |
|  | 1.8 TD (N35W)  |  | 05.91  | 05.92  |   |  |  |  |
|  | 2.0 (N33W)   |  | 06.92  | 10.98  | - (N)   |  |  |  |
|  | 2.0 4x4 (N43W)   |  | 06.92  | 10.98  |   |  |  |  |
|  | 2.0 TD (N38W)  |  | 06.92  | 10.98  |   |  |  |  |
|  | 2.4 (N34W)   |  | 06.92  | 05.96  |   |  |  |  |
|    | 1.8 (N31W)   |  | 05.91  | 05.92  |   | 24.3219-1716.3   | 020071   | Rz 19,05   |
|  | 1.8 4x4 (N41W)   |  | 05.91  | 05.92  |   |  |  |  |
|  | 1.8 TD (N35W)  |  | 05.91  | 05.92  |   |  |  |  |
|  | 2.0 (N33W)   |  | 06.92  | 10.98  |   |  |  |  |
|  | 2.0 4x4 (N43W)   |  | 06.92  | 10.98  |   |  |  |  |
|  | 2.0 TD (N38W)  |  | 06.92  | 10.98  |   |  |  |  |
|  | 2.4 (N34W)   |  | 06.92  | 05.96  |   |  |  |  |
| <b>MITSUBISHI SPACE WAGON (98-05)</b>  |  |  |  |  |   |  |  |  |
|    | 2.0 GDi (N83W)   | 98   | 05.02  | 08.05  |   | 24.3431-1701.5   | 240437   | D=43/43, - Halter  |
|  | 2.0 GLX (N83W)   | 80   | 10.98  | 04.02  |   | 24.3431-1702.5   | 240438   | D=43/43, - Halter  |
|  | 2.4 GDi (N84W)   | 108  | 09.00  | 08.03  |   |  |  |  |
|  | 2.4 GDi (N84W)   | 110  | 10.98  | 08.03  |   |  |  |  |
|  | 2.4 GDi 4x4 (N94W)   | 108  | 09.00  | 08.03  |   |  |  |  |
|  | 2.4 GDi 4x4 (N94W)   | 110  | 10.98  | 08.03  |   |  |  |  |
| <b>NISSAN 100 NX (B13) (90-94)</b>   |  |  |  |  |   |  |  |  |
|    | 1.6  |  | 10.90  | 10.94  |   | 24.3481-1725.5   | 240187   | D=48, - Halter   |
|  |  |  |  |  |   | 24.3481-1726.5   | 240188   | D=48, - Halter   |
|  | 1.6  |  | 10.90  | 10.94  | - ABS   | 24.3215-1107.3   | 020352   | Rz 15,87   |
|  | 1.6  |  | 10.90  | 10.94  | + ABS   | 24.3727-1710.2   | 581710   | L=1313   |
|  | 2.0 GTI  | 105  | 10.90  | 10.94  |   | 24.3727-1711.2   | 581711   | L=1312   |
|  | 1.6  |  | 10.90  | 10.94  |   | 24.3728-1703.2   | 591703   | L=728  |
| <b>NISSAN ALMERA (N15) (95-00)</b>   |  |  |  |  |   |  |  |  |
|  | 1.4 i  |  | 01.98  | 04.00  | + ABS   | 24.2123-1761.3   | 010780   | Thz 23,81 + Behälter   |
|  | 1.6 i  |  | 01.98  | 04.00  | + ABS   |  |  | LUC  |
|  | 2.0 D  |  | 01.98  | 04.00  | + ABS   |  |  |  |
|  | 2.0 i  |  | 01.98  | 04.00  |   |  |  |  |
|  | 1.4 i  |  | 07.95  | 04.00  |   | 24.5283-0471.3   | 330960   | L=470  |
|  | 1.6 i  |  | 07.95  | 04.00  |   | 24.5283-0470.3   | 330959   | L=470  |
|  | 2.0 D  |  | 07.95  | 04.00  |   |  |  |  |
|  | 2.0 i  |  | 04.96  | 04.00  |   |  |  |  |
|  | 1.4 i  |  | 01.98  | 04.00  | + ABS   | 24.3344-1719.5   | 240343   | D=34, - Halter   |
|  | 1.6 i  |  | 01.98  | 04.00  | + ABS   | 24.3344-1720.5   | 240344   | D=34, - Halter   |
|  | 2.0 D  |  | 01.98  | 04.00  | + ABS   |  |  |  |
|  | 2.0 i  |  | 01.98  | 04.00  | + ABS   |  |  |  |
|  | 1.4 i  |  | 07.95  | 04.00  |   | 24.5281-0556.3   | 330955   | L=555  |
|  | 1.6 i  |  | 07.95  | 04.00  |   |  |  |  |
|  | 2.0 D  |  | 07.95  | 04.00  |   |  |  |  |
|  | 2.0 i  |  | 04.96  | 04.00  |   |  |  |  |
|  | 1.4 i  |  | 07.95  | 04.00  | - ABS   | 24.3215-1107.3   | 020352   | Rz 15,87   |
|  | 1.6 i  |  | 07.95  | 04.00  | - ABS   |  |  |  |
|  | 2.0 D  |  | 07.95  | 04.00  | - ABS   |  |  |  |
|  | 1.4 i  |  | 07.95  | 03.96  | - ABS   | 24.3727-1701.2   | 581701   | L=250  |
|  | 1.6 i  |  | 07.95  | 03.96  | - ABS   |  |  |  |
|  | 2.0 D  |  | 07.95  | 03.96  | - ABS   |  |  |  |
|  | 1.4 i  |  | 04.96  | 04.00  | - ABS   | 24.3727-1701.2   | 581701   | L=250  |
|  | 1.6 i  |  | 04.96  | 04.00  | - ABS   |  |  |  |
|  | 2.0 D  |  | 04.96  | 04.00  | - ABS   |  |  |  |
|  | 1.4 i  |  | 07.95  | 03.96  | + ABS   | 24.3727-1701.2   | 581701   | L=250  |
|  | 1.6 i  |  | 07.95  | 03.96  | + ABS   |  |  |  |
|  | 2.0 D  |  | 07.95  | 03.96  | + ABS   |  |  |  |
|  | 1.4 i  |  | 04.96  | 12.97  | + ABS   | 24.3727-1701.2   | 581701   | L=250  |
|  | 1.6 i  |  | 04.96  | 12.97  | + ABS   |  |  |  |
|  | 2.0 D  |  | 04.96  | 12.97  | + ABS   |  |  |  |
|  | 1.4 i  |  | 01.98  | 04.00  | + ABS   | 24.3727-1701.2   | 581701   | L=250  |
|  | 1.6 i  |  | 01.98  | 04.00  | + ABS   |  |  |  |
|  | 2.0 D  |  | 01.98  | 04.00  | + ABS   |  |  |  |





| NISSAN ALMERA (N15) (95-00)  |   |   |  |   |   |  |                                  |                  |  |                                  |                                 |
|--|---|---|--|---|---|--|----------------------------------|------------------|--|----------------------------------|---------------------------------|
|     | 2.0 i   |   |  | 04.96   | 04.00   |  | 24.3727-1701.2                   | 581701           |   |                                  | L=250                           |
|    | 1.4 i<br>1.6 i  |   |  | 07.95<br>07.95  | 04.00<br>04.00  |  | 24.3728-1707.2                   | 591707           |  |                                  | L=725                           |
| NISSAN ALMERA (N16) (00-06)  |   |   |  |   |   |  |                                  |                  |  |                                  |                                 |
|    | 1.5 i<br>1.8 i<br>2.2 Di  | 66<br>84<br>81  |  | 03.00<br>03.00<br>03.00   | 03.01<br>03.01<br>03.01   | + ABS/ Herst.Land  <sup>1)</sup><br>Herst.Land  <sup>2)</sup><br>Herst.Land  <sup>2)</sup>  | 24.2123-1761.3                   | 010780           |  |                                  | Thz 23,81 + Behälter <b>LUC</b> |
|    | 1.5 dCi<br>1.5 i<br>1.5 i<br>1.5 i<br>1.8 i<br>1.8 i<br>1.8 i<br>2.2 dCi<br>2.2 dCi<br>2.2 Di<br>2.2 Di | 60<br>66<br>66<br>72<br>84<br>84<br>85<br>82<br>100<br>81<br>81 |  | 01.03<br>03.00<br>02.00<br>10.02<br>03.00<br>02.00<br>10.02<br>09.03<br>09.03<br>03.00<br>02.00 | 11.06<br>03.01<br>11.06<br>11.06<br>03.01<br>11.06<br>11.06<br>11.06<br>11.06<br>03.01<br>11.06 | + ABS<br>+ ABS/ Herst.Land  <sup>1)</sup><br>+ ABS<br>+ ABS<br>Herst.Land  <sup>2)</sup><br><br><br><br><br>Herst.Land  <sup>2)</sup> | 24.3571-1731.5<br>24.3571-1732.5 | 240321<br>240322 | <br><br><br><br><br><br><br><br><br><br><br> | D=57, - Halter<br>D=57, - Halter | <b>LUC</b><br><b>LUC</b>        |
|    | 1.5 dCi<br>1.5 i<br>1.5 i<br>1.8 i<br>1.8 i<br>1.8 i<br>2.2 dCi<br>2.2 dCi<br>2.2 Di                    | 60<br>66<br>72<br>84<br>85<br>82<br>100<br>81                   |  | 01.03<br>02.00<br>10.02<br>02.00<br>10.02<br>09.03<br>09.03<br>02.00                            | 11.06<br>11.06<br>11.06<br>11.06<br>11.06<br>11.06<br>11.06                                     |  | 24.5266-0453.3<br>24.5266-0452.3 | 330931<br>330930 | <br><br><br><br><br><br><br><br>  | L=452<br>L=452                   |                                 |
|    | 1.5 i<br>1.8 i<br>2.2 Di  | 66<br>84<br>81  |  | 03.00<br>03.00<br>03.00   | 03.01<br>03.01<br>03.01   | Herst.Land  <sup>2)</sup><br>Herst.Land  <sup>2)</sup><br>Herst.Land  <sup>2)</sup>   | 24.5266-0475.3<br>24.5266-0476.3 | 331139<br>331140 | <br><br>  | L=475<br>L=475                   |                                 |
|    | 1.5 i<br>1.8 i<br>2.2 Di  | 66<br>84<br>81  |  | 02.00<br>02.00<br>02.00   | 03.01<br>03.01<br>03.01   | - ABS<br>- ABS<br>- ABS  | 24.3344-1717.5<br>24.3344-1718.5 | 240341<br>240342 | <br><br>  | D=34, - Halter<br>D=34, - Halter | <b>LUC</b><br><b>LUC</b>        |
|   | 1.5 i<br>1.8 i<br>2.2 Di  | 66<br>84<br>81  |  | 03.00<br>03.00<br>03.00   | 03.01<br>03.01<br>03.01   | + ABS/ Herst.Land  <sup>1)</sup><br>Herst.Land  <sup>2)</sup><br>Herst.Land  <sup>2)</sup>   | 24.3344-1719.5<br>24.3344-1720.5 | 240343<br>240344 | <br><br>   | D=34, - Halter<br>D=34, - Halter |                                 |
|  | 1.5 dCi<br>1.5 i<br>1.5 i   | 60<br>66<br>72  |  | 01.03<br>02.00<br>10.02   | 11.06<br>11.06<br>11.06   | - ABS<br>- ABS<br>- ABS  | 24.5247-0311.3<br>24.5247-0310.3 | 330952<br>330951 | <br><br>  | L=310<br>L=310                   |                                 |
|  | 1.5 dCi<br>1.5 i<br>1.5 i<br>1.8 i<br>1.8 i<br>2.2 dCi<br>2.2 dCi<br>2.2 Di                             | 60<br>66<br>72<br>84<br>85<br>82<br>100<br>81                   |  | 01.03<br>02.00<br>10.02<br>02.00<br>10.02<br>09.03<br>09.03<br>02.00                            | 11.06<br>11.06<br>11.06<br>11.06<br>11.06<br>11.06<br>11.06                                     | + ABS<br>+ ABS<br>+ ABS  | 24.5281-0554.3<br>24.5281-0553.3 | 331005<br>331004 | <br><br><br><br><br><br><br>   | L=555<br>L=555                   |                                 |
|  | 1.5 i   | 66  |  | 03.00   | 03.01   | - ABS/ Herst.Land  <sup>3)</sup>  | 24.5282-0316.3<br>24.5282-0315.3 | 330958<br>330957 | <br>   | L=315<br>L=315                   |                                 |
|  | 1.5 i<br>1.8 i<br>2.2 Di  | 66<br>84<br>81  |  | 03.00<br>03.00<br>03.00   | 03.01<br>03.01<br>03.01   | + ABS/ Herst.Land  <sup>1)</sup><br>Herst.Land  <sup>2)</sup><br>Herst.Land  <sup>2)</sup>                                      | 24.5281-0555.3<br>24.5281-0557.3 | 330954<br>330956 | <br><br>  | L=555<br>L=555                   |                                 |
|  | 1.5 dCi<br>1.5 i<br>1.5 i<br>1.5 i  | 60<br>66<br>66<br>72  |  | 01.03<br>03.00<br>02.00<br>10.02  | 11.06<br>03.01<br>11.06<br>11.06  | - ABS<br>- ABS/ Herst.Land  <sup>3)</sup><br>- ABS<br>- ABS   | 24.3217-1720.3                   | 020495           |  |                                  | Rz 17,46                        |
|  | 1.5 dCi<br>1.5 i<br>1.5 i<br>1.8 i<br>1.8 i<br>2.2 dCi<br>2.2 dCi<br>2.2 Di                             | 60<br>66<br>66<br>72<br>84<br>85<br>82<br>100<br>81             |  | 01.03<br>02.00<br>10.02<br>02.00<br>10.02<br>09.03<br>09.03<br>02.00                            | 11.06<br>11.06<br>11.06<br>11.06<br>11.06<br>11.06<br>11.06                                     | + ABS<br>+ ABS<br>+ ABS  | 24.3727-1724.2<br>24.3727-1725.2 | 581724<br>581725 | <br><br>  | L=1650<br>L=1661                 |                                 |
|  | 1.5 dCi<br>1.5 i<br>1.5 i<br>1.5 i<br>1.8 i<br>1.8 i<br>1.8 i   | 60<br>66<br>66<br>72<br>84<br>84<br>85                          |  | 01.03<br>03.00<br>02.00<br>10.02<br>03.00<br>02.00<br>10.02                                     | 11.06<br>11.06<br>11.06<br>11.06<br>03.01<br>03.01<br>11.06                                     | Herst.Land  <sup>2)</sup><br><br><br><br>Herst.Land  <sup>2)</sup>   | 24.2519-1703.3                   | 040091           |  |                                  | Nz 19,05                        |
|  | 2.2 dCi<br>2.2 dCi<br>2.2 Di  | 82<br>100<br>81   |  | 09.03<br>09.03<br>09.01   | 11.06<br>11.06<br>11.06   |  | 24.2519-1704.3                   | 040092           |  |                                  | Nz 19,05                        |
| NISSAN ALMERA (B10RS) (06-)  |   |   |  |   |   |  |                                  |                  |  |                                  |                                 |
|  | 1.6 i   | 79  |  | 01.06   |   | -   | 24.5282-0316.3<br>24.5282-0315.3 | 330958<br>330957 | <br>   |                                  | L=315<br>L=315                  |

<sup>1)</sup> + ABS/ country of manufacture  / + ABS/ paese del costruttore  / + ABS/ pays du constructeur  / + ABS/ país del fabricante 



















<sup>2)</sup> country of manufacture  / paese del costruttore  / pays du constructeur  / país del fabricante 

<sup>3)</sup> - ABS/ country of manufacture  / - ABS/ paese del costruttore  / - ABS/ pays du constructeur  / - ABS/ país del fabricante 

| NISSAN ALMERA TINO (V10M) (00-05)  |   |           |       |       |                |        |                |                           |   |           |           |    |       |       |       |                |        |   |        |           |    |       |       |       |                |        |   |        |           |     |       |       |       |                |        |  |          |         |     |       |       |       |  |  |  |  |         |     |       |       |       |  |  |  |  |         |     |       |       |       |  |  |  |  |         |     |       |       |       |  |  |  |  |         |    |       |       |       |                |        |  |           |         |    |       |       |       |  |  |  |  |         |    |       |       |       |  |  |  |  |         |    |       |       |       |                |        |  |                      |         |    |       |       |       |  |  |  |  |         |    |       |       |       |  |  |  |  |         |    |       |       |       |  |  |  |  |         |    |       |       |       |  |  |  |  |         |    |       |       |       |  |  |  |  |         |     |       |       |       |  |  |  |  |         |     |       |       |       |  |  |  |  |         |    |       |       |       |                |        |     |       |         |    |       |       |       |                |        |     |       |         |    |       |       |       |  |  |  |  |         |    |       |       |       |  |  |  |  |         |    |       |       |       |  |  |  |  |         |    |       |       |       |  |  |  |  |         |     |       |       |       |  |  |  |  |         |     |       |       |       |  |  |  |  |         |    |       |       |       |                |        |     |       |         |    |       |       |       |                |        |     |       |         |    |       |       |       |  |  |  |  |         |    |       |       |       |                |        |   |       |         |    |       |       |       |  |  |  |  |         |    |       |       |       |  |  |  |  |         |    |       |       |       |  |  |  |  |         |    |       |       |       |  |  |  |  |         |    |       |       |       |  |  |  |  |         |     |       |       |       |  |  |  |  |         |     |       |       |       |  |  |  |  |         |    |       |       |  |                |        |   |                           |         |    |       |       |  |                |        |   |                           |         |    |       |       |  |  |  |  |  |         |    |       |       |  |  |  |  |  |         |    |       |       |  |  |  |  |  |         |    |       |       |  |  |  |  |  |         |     |       |       |  |  |  |  |  |         |     |       |       |  |  |  |  |  |         |    |       |       |  |                |        |     |       |         |    |       |       |  |                |        |     |       |         |    |       |       |  |  |  |  |  |         |    |       |       |  |                |        |   |       |         |    |       |       |  |                |        |   |       |         |    |       |       |  |  |  |  |  |         |    |       |       |  |  |  |  |  |         |    |       |       |  |  |  |  |  |         |    |       |       |  |  |  |  |  |         |     |       |       |  |  |  |  |  |         |     |       |       |  |  |  |  |  |         |    |       |       |  |                |        |     |        |         |    |       |       |  |                |        |     |        |         |    |       |       |  |  |  |  |  |         |    |       |       |  |  |  |  |  |         |    |       |       |  |  |  |  |  |         |    |       |       |  |  |  |  |  |         |     |       |       |  |  |  |  |  |         |     |       |       |  |  |  |  |  |         |    |       |       |  |                |        |  |          |         |    |       |       |  |  |  |  |  |         |    |       |       |  |  |  |  |  |
|--|---|-----------|-------|-------|----------------|--------|----------------|---------------------------|---|-----------|-----------|----|-------|-------|-------|----------------|--------|---|--------|-----------|----|-------|-------|-------|----------------|--------|---|--------|-----------|-----|-------|-------|-------|----------------|--------|--|----------|---------|-----|-------|-------|-------|--|--|--|--|---------|-----|-------|-------|-------|--|--|--|--|---------|-----|-------|-------|-------|--|--|--|--|---------|-----|-------|-------|-------|--|--|--|--|---------|----|-------|-------|-------|----------------|--------|--|-----------|---------|----|-------|-------|-------|--|--|--|--|---------|----|-------|-------|-------|--|--|--|--|---------|----|-------|-------|-------|----------------|--------|--|----------------------|---------|----|-------|-------|-------|--|--|--|--|---------|----|-------|-------|-------|--|--|--|--|---------|----|-------|-------|-------|--|--|--|--|---------|----|-------|-------|-------|--|--|--|--|---------|----|-------|-------|-------|--|--|--|--|---------|-----|-------|-------|-------|--|--|--|--|---------|-----|-------|-------|-------|--|--|--|--|---------|----|-------|-------|-------|----------------|--------|-----|-------|---------|----|-------|-------|-------|----------------|--------|-----|-------|---------|----|-------|-------|-------|--|--|--|--|---------|----|-------|-------|-------|--|--|--|--|---------|----|-------|-------|-------|--|--|--|--|---------|----|-------|-------|-------|--|--|--|--|---------|-----|-------|-------|-------|--|--|--|--|---------|-----|-------|-------|-------|--|--|--|--|---------|----|-------|-------|-------|----------------|--------|-----|-------|---------|----|-------|-------|-------|----------------|--------|-----|-------|---------|----|-------|-------|-------|--|--|--|--|---------|----|-------|-------|-------|----------------|--------|---|-------|---------|----|-------|-------|-------|--|--|--|--|---------|----|-------|-------|-------|--|--|--|--|---------|----|-------|-------|-------|--|--|--|--|---------|----|-------|-------|-------|--|--|--|--|---------|----|-------|-------|-------|--|--|--|--|---------|-----|-------|-------|-------|--|--|--|--|---------|-----|-------|-------|-------|--|--|--|--|---------|----|-------|-------|--|----------------|--------|---|---------------------------|---------|----|-------|-------|--|----------------|--------|---|---------------------------|---------|----|-------|-------|--|--|--|--|--|---------|----|-------|-------|--|--|--|--|--|---------|----|-------|-------|--|--|--|--|--|---------|----|-------|-------|--|--|--|--|--|---------|-----|-------|-------|--|--|--|--|--|---------|-----|-------|-------|--|--|--|--|--|---------|----|-------|-------|--|----------------|--------|-----|-------|---------|----|-------|-------|--|----------------|--------|-----|-------|---------|----|-------|-------|--|--|--|--|--|---------|----|-------|-------|--|----------------|--------|---|-------|---------|----|-------|-------|--|----------------|--------|---|-------|---------|----|-------|-------|--|--|--|--|--|---------|----|-------|-------|--|--|--|--|--|---------|----|-------|-------|--|--|--|--|--|---------|----|-------|-------|--|--|--|--|--|---------|-----|-------|-------|--|--|--|--|--|---------|-----|-------|-------|--|--|--|--|--|---------|----|-------|-------|--|----------------|--------|-----|--------|---------|----|-------|-------|--|----------------|--------|-----|--------|---------|----|-------|-------|--|--|--|--|--|---------|----|-------|-------|--|--|--|--|--|---------|----|-------|-------|--|--|--|--|--|---------|----|-------|-------|--|--|--|--|--|---------|-----|-------|-------|--|--|--|--|--|---------|-----|-------|-------|--|--|--|--|--|---------|----|-------|-------|--|----------------|--------|--|----------|---------|----|-------|-------|--|--|--|--|--|---------|----|-------|-------|--|--|--|--|--|
|   | <table border="1"> <tr><td>1.6 i 16V</td><td>71</td><td>08.00</td><td>11.05</td><td>- ⊕</td><td>24.3727-1733.2</td><td>581733</td><td>↑</td><td>L=221</td></tr> <tr><td>1.8 i 16V</td><td>84</td><td>08.00</td><td>11.05</td><td></td><td>24.3727-1734.2</td><td>581734</td><td>□</td><td>L=1660</td></tr> <tr><td>1.8 i 16V</td><td>85</td><td>12.02</td><td>11.05</td><td></td><td>24.3727-1735.2</td><td>581735</td><td>□</td><td>L=1670</td></tr> <tr><td>2.0 i 16V</td><td>100</td><td>08.00</td><td>08.03</td><td></td><td></td><td></td><td></td><td></td></tr> <tr><td>2.2 dCi</td><td>82</td><td>09.03</td><td>11.05</td><td></td><td></td><td></td><td></td><td></td></tr> <tr><td>2.2 dCi</td><td>100</td><td>09.03</td><td>11.05</td><td></td><td></td><td></td><td></td><td></td></tr> <tr><td>2.2 Di</td><td>84</td><td>08.00</td><td>08.03</td><td></td><td></td><td></td><td></td><td></td></tr> </table>   | 1.6 i 16V | 71    | 08.00 | 11.05          | - ⊕    | 24.3727-1733.2 | 581733                    | ↑ | L=221     | 1.8 i 16V | 84 | 08.00 | 11.05 |       | 24.3727-1734.2 | 581734 | □ | L=1660 | 1.8 i 16V | 85 | 12.02 | 11.05 |       | 24.3727-1735.2 | 581735 | □ | L=1670 | 2.0 i 16V | 100 | 08.00 | 08.03 |       |                |        |  |          | 2.2 dCi | 82  | 09.03 | 11.05 |       |  |  |  |  | 2.2 dCi | 100 | 09.03 | 11.05 |       |  |  |  |  | 2.2 Di  | 84  | 08.00 | 08.03 |       |  |  |  |  |         |     |       |       |       |  |  |  |  |         |    |       |       |       |                |        |  |           |         |    |       |       |       |  |  |  |  |         |    |       |       |       |  |  |  |  |         |    |       |       |       |                |        |  |                      |         |    |       |       |       |  |  |  |  |         |    |       |       |       |  |  |  |  |         |    |       |       |       |  |  |  |  |         |    |       |       |       |  |  |  |  |         |    |       |       |       |  |  |  |  |         |     |       |       |       |  |  |  |  |         |     |       |       |       |  |  |  |  |         |    |       |       |       |                |        |     |       |         |    |       |       |       |                |        |     |       |         |    |       |       |       |  |  |  |  |         |    |       |       |       |  |  |  |  |         |    |       |       |       |  |  |  |  |         |    |       |       |       |  |  |  |  |         |     |       |       |       |  |  |  |  |         |     |       |       |       |  |  |  |  |         |    |       |       |       |                |        |     |       |         |    |       |       |       |                |        |     |       |         |    |       |       |       |  |  |  |  |         |    |       |       |       |                |        |   |       |         |    |       |       |       |  |  |  |  |         |    |       |       |       |  |  |  |  |         |    |       |       |       |  |  |  |  |         |    |       |       |       |  |  |  |  |         |    |       |       |       |  |  |  |  |         |     |       |       |       |  |  |  |  |         |     |       |       |       |  |  |  |  |         |    |       |       |  |                |        |   |                           |         |    |       |       |  |                |        |   |                           |         |    |       |       |  |  |  |  |  |         |    |       |       |  |  |  |  |  |         |    |       |       |  |  |  |  |  |         |    |       |       |  |  |  |  |  |         |     |       |       |  |  |  |  |  |         |     |       |       |  |  |  |  |  |         |    |       |       |  |                |        |     |       |         |    |       |       |  |                |        |     |       |         |    |       |       |  |  |  |  |  |         |    |       |       |  |                |        |   |       |         |    |       |       |  |                |        |   |       |         |    |       |       |  |  |  |  |  |         |    |       |       |  |  |  |  |  |         |    |       |       |  |  |  |  |  |         |    |       |       |  |  |  |  |  |         |     |       |       |  |  |  |  |  |         |     |       |       |  |  |  |  |  |         |    |       |       |  |                |        |     |        |         |    |       |       |  |                |        |     |        |         |    |       |       |  |  |  |  |  |         |    |       |       |  |  |  |  |  |         |    |       |       |  |  |  |  |  |         |    |       |       |  |  |  |  |  |         |     |       |       |  |  |  |  |  |         |     |       |       |  |  |  |  |  |         |    |       |       |  |                |        |  |          |         |    |       |       |  |  |  |  |  |         |    |       |       |  |  |  |  |  |
| 1.6 i 16V  | 71  | 08.00     | 11.05 | - ⊕   | 24.3727-1733.2 | 581733 | ↑              | L=221                     |   |           |           |    |       |       |       |                |        |   |        |           |    |       |       |       |                |        |   |        |           |     |       |       |       |                |        |  |          |         |     |       |       |       |  |  |  |  |         |     |       |       |       |  |  |  |  |         |     |       |       |       |  |  |  |  |         |     |       |       |       |  |  |  |  |         |    |       |       |       |                |        |  |           |         |    |       |       |       |  |  |  |  |         |    |       |       |       |  |  |  |  |         |    |       |       |       |                |        |  |                      |         |    |       |       |       |  |  |  |  |         |    |       |       |       |  |  |  |  |         |    |       |       |       |  |  |  |  |         |    |       |       |       |  |  |  |  |         |    |       |       |       |  |  |  |  |         |     |       |       |       |  |  |  |  |         |     |       |       |       |  |  |  |  |         |    |       |       |       |                |        |     |       |         |    |       |       |       |                |        |     |       |         |    |       |       |       |  |  |  |  |         |    |       |       |       |  |  |  |  |         |    |       |       |       |  |  |  |  |         |    |       |       |       |  |  |  |  |         |     |       |       |       |  |  |  |  |         |     |       |       |       |  |  |  |  |         |    |       |       |       |                |        |     |       |         |    |       |       |       |                |        |     |       |         |    |       |       |       |  |  |  |  |         |    |       |       |       |                |        |   |       |         |    |       |       |       |  |  |  |  |         |    |       |       |       |  |  |  |  |         |    |       |       |       |  |  |  |  |         |    |       |       |       |  |  |  |  |         |    |       |       |       |  |  |  |  |         |     |       |       |       |  |  |  |  |         |     |       |       |       |  |  |  |  |         |    |       |       |  |                |        |   |                           |         |    |       |       |  |                |        |   |                           |         |    |       |       |  |  |  |  |  |         |    |       |       |  |  |  |  |  |         |    |       |       |  |  |  |  |  |         |    |       |       |  |  |  |  |  |         |     |       |       |  |  |  |  |  |         |     |       |       |  |  |  |  |  |         |    |       |       |  |                |        |     |       |         |    |       |       |  |                |        |     |       |         |    |       |       |  |  |  |  |  |         |    |       |       |  |                |        |   |       |         |    |       |       |  |                |        |   |       |         |    |       |       |  |  |  |  |  |         |    |       |       |  |  |  |  |  |         |    |       |       |  |  |  |  |  |         |    |       |       |  |  |  |  |  |         |     |       |       |  |  |  |  |  |         |     |       |       |  |  |  |  |  |         |    |       |       |  |                |        |     |        |         |    |       |       |  |                |        |     |        |         |    |       |       |  |  |  |  |  |         |    |       |       |  |  |  |  |  |         |    |       |       |  |  |  |  |  |         |    |       |       |  |  |  |  |  |         |     |       |       |  |  |  |  |  |         |     |       |       |  |  |  |  |  |         |    |       |       |  |                |        |  |          |         |    |       |       |  |  |  |  |  |         |    |       |       |  |  |  |  |  |
| 1.8 i 16V  | 84  | 08.00     | 11.05 |       | 24.3727-1734.2 | 581734 | □              | L=1660                    |   |           |           |    |       |       |       |                |        |   |        |           |    |       |       |       |                |        |   |        |           |     |       |       |       |                |        |  |          |         |     |       |       |       |  |  |  |  |         |     |       |       |       |  |  |  |  |         |     |       |       |       |  |  |  |  |         |     |       |       |       |  |  |  |  |         |    |       |       |       |                |        |  |           |         |    |       |       |       |  |  |  |  |         |    |       |       |       |  |  |  |  |         |    |       |       |       |                |        |  |                      |         |    |       |       |       |  |  |  |  |         |    |       |       |       |  |  |  |  |         |    |       |       |       |  |  |  |  |         |    |       |       |       |  |  |  |  |         |    |       |       |       |  |  |  |  |         |     |       |       |       |  |  |  |  |         |     |       |       |       |  |  |  |  |         |    |       |       |       |                |        |     |       |         |    |       |       |       |                |        |     |       |         |    |       |       |       |  |  |  |  |         |    |       |       |       |  |  |  |  |         |    |       |       |       |  |  |  |  |         |    |       |       |       |  |  |  |  |         |     |       |       |       |  |  |  |  |         |     |       |       |       |  |  |  |  |         |    |       |       |       |                |        |     |       |         |    |       |       |       |                |        |     |       |         |    |       |       |       |  |  |  |  |         |    |       |       |       |                |        |   |       |         |    |       |       |       |  |  |  |  |         |    |       |       |       |  |  |  |  |         |    |       |       |       |  |  |  |  |         |    |       |       |       |  |  |  |  |         |    |       |       |       |  |  |  |  |         |     |       |       |       |  |  |  |  |         |     |       |       |       |  |  |  |  |         |    |       |       |  |                |        |   |                           |         |    |       |       |  |                |        |   |                           |         |    |       |       |  |  |  |  |  |         |    |       |       |  |  |  |  |  |         |    |       |       |  |  |  |  |  |         |    |       |       |  |  |  |  |  |         |     |       |       |  |  |  |  |  |         |     |       |       |  |  |  |  |  |         |    |       |       |  |                |        |     |       |         |    |       |       |  |                |        |     |       |         |    |       |       |  |  |  |  |  |         |    |       |       |  |                |        |   |       |         |    |       |       |  |                |        |   |       |         |    |       |       |  |  |  |  |  |         |    |       |       |  |  |  |  |  |         |    |       |       |  |  |  |  |  |         |    |       |       |  |  |  |  |  |         |     |       |       |  |  |  |  |  |         |     |       |       |  |  |  |  |  |         |    |       |       |  |                |        |     |        |         |    |       |       |  |                |        |     |        |         |    |       |       |  |  |  |  |  |         |    |       |       |  |  |  |  |  |         |    |       |       |  |  |  |  |  |         |    |       |       |  |  |  |  |  |         |     |       |       |  |  |  |  |  |         |     |       |       |  |  |  |  |  |         |    |       |       |  |                |        |  |          |         |    |       |       |  |  |  |  |  |         |    |       |       |  |  |  |  |  |
| 1.8 i 16V  | 85  | 12.02     | 11.05 |       | 24.3727-1735.2 | 581735 | □              | L=1670                    |   |           |           |    |       |       |       |                |        |   |        |           |    |       |       |       |                |        |   |        |           |     |       |       |       |                |        |  |          |         |     |       |       |       |  |  |  |  |         |     |       |       |       |  |  |  |  |         |     |       |       |       |  |  |  |  |         |     |       |       |       |  |  |  |  |         |    |       |       |       |                |        |  |           |         |    |       |       |       |  |  |  |  |         |    |       |       |       |  |  |  |  |         |    |       |       |       |                |        |  |                      |         |    |       |       |       |  |  |  |  |         |    |       |       |       |  |  |  |  |         |    |       |       |       |  |  |  |  |         |    |       |       |       |  |  |  |  |         |    |       |       |       |  |  |  |  |         |     |       |       |       |  |  |  |  |         |     |       |       |       |  |  |  |  |         |    |       |       |       |                |        |     |       |         |    |       |       |       |                |        |     |       |         |    |       |       |       |  |  |  |  |         |    |       |       |       |  |  |  |  |         |    |       |       |       |  |  |  |  |         |    |       |       |       |  |  |  |  |         |     |       |       |       |  |  |  |  |         |     |       |       |       |  |  |  |  |         |    |       |       |       |                |        |     |       |         |    |       |       |       |                |        |     |       |         |    |       |       |       |  |  |  |  |         |    |       |       |       |                |        |   |       |         |    |       |       |       |  |  |  |  |         |    |       |       |       |  |  |  |  |         |    |       |       |       |  |  |  |  |         |    |       |       |       |  |  |  |  |         |    |       |       |       |  |  |  |  |         |     |       |       |       |  |  |  |  |         |     |       |       |       |  |  |  |  |         |    |       |       |  |                |        |   |                           |         |    |       |       |  |                |        |   |                           |         |    |       |       |  |  |  |  |  |         |    |       |       |  |  |  |  |  |         |    |       |       |  |  |  |  |  |         |    |       |       |  |  |  |  |  |         |     |       |       |  |  |  |  |  |         |     |       |       |  |  |  |  |  |         |    |       |       |  |                |        |     |       |         |    |       |       |  |                |        |     |       |         |    |       |       |  |  |  |  |  |         |    |       |       |  |                |        |   |       |         |    |       |       |  |                |        |   |       |         |    |       |       |  |  |  |  |  |         |    |       |       |  |  |  |  |  |         |    |       |       |  |  |  |  |  |         |    |       |       |  |  |  |  |  |         |     |       |       |  |  |  |  |  |         |     |       |       |  |  |  |  |  |         |    |       |       |  |                |        |     |        |         |    |       |       |  |                |        |     |        |         |    |       |       |  |  |  |  |  |         |    |       |       |  |  |  |  |  |         |    |       |       |  |  |  |  |  |         |    |       |       |  |  |  |  |  |         |     |       |       |  |  |  |  |  |         |     |       |       |  |  |  |  |  |         |    |       |       |  |                |        |  |          |         |    |       |       |  |  |  |  |  |         |    |       |       |  |  |  |  |  |
| 2.0 i 16V  | 100   | 08.00     | 08.03 |       |                |        |                |                           |   |           |           |    |       |       |       |                |        |   |        |           |    |       |       |       |                |        |   |        |           |     |       |       |       |                |        |  |          |         |     |       |       |       |  |  |  |  |         |     |       |       |       |  |  |  |  |         |     |       |       |       |  |  |  |  |         |     |       |       |       |  |  |  |  |         |    |       |       |       |                |        |  |           |         |    |       |       |       |  |  |  |  |         |    |       |       |       |  |  |  |  |         |    |       |       |       |                |        |  |                      |         |    |       |       |       |  |  |  |  |         |    |       |       |       |  |  |  |  |         |    |       |       |       |  |  |  |  |         |    |       |       |       |  |  |  |  |         |    |       |       |       |  |  |  |  |         |     |       |       |       |  |  |  |  |         |     |       |       |       |  |  |  |  |         |    |       |       |       |                |        |     |       |         |    |       |       |       |                |        |     |       |         |    |       |       |       |  |  |  |  |         |    |       |       |       |  |  |  |  |         |    |       |       |       |  |  |  |  |         |    |       |       |       |  |  |  |  |         |     |       |       |       |  |  |  |  |         |     |       |       |       |  |  |  |  |         |    |       |       |       |                |        |     |       |         |    |       |       |       |                |        |     |       |         |    |       |       |       |  |  |  |  |         |    |       |       |       |                |        |   |       |         |    |       |       |       |  |  |  |  |         |    |       |       |       |  |  |  |  |         |    |       |       |       |  |  |  |  |         |    |       |       |       |  |  |  |  |         |    |       |       |       |  |  |  |  |         |     |       |       |       |  |  |  |  |         |     |       |       |       |  |  |  |  |         |    |       |       |  |                |        |   |                           |         |    |       |       |  |                |        |   |                           |         |    |       |       |  |  |  |  |  |         |    |       |       |  |  |  |  |  |         |    |       |       |  |  |  |  |  |         |    |       |       |  |  |  |  |  |         |     |       |       |  |  |  |  |  |         |     |       |       |  |  |  |  |  |         |    |       |       |  |                |        |     |       |         |    |       |       |  |                |        |     |       |         |    |       |       |  |  |  |  |  |         |    |       |       |  |                |        |   |       |         |    |       |       |  |                |        |   |       |         |    |       |       |  |  |  |  |  |         |    |       |       |  |  |  |  |  |         |    |       |       |  |  |  |  |  |         |    |       |       |  |  |  |  |  |         |     |       |       |  |  |  |  |  |         |     |       |       |  |  |  |  |  |         |    |       |       |  |                |        |     |        |         |    |       |       |  |                |        |     |        |         |    |       |       |  |  |  |  |  |         |    |       |       |  |  |  |  |  |         |    |       |       |  |  |  |  |  |         |    |       |       |  |  |  |  |  |         |     |       |       |  |  |  |  |  |         |     |       |       |  |  |  |  |  |         |    |       |       |  |                |        |  |          |         |    |       |       |  |  |  |  |  |         |    |       |       |  |  |  |  |  |
| 2.2 dCi  | 82  | 09.03     | 11.05 |       |                |        |                |                           |   |           |           |    |       |       |       |                |        |   |        |           |    |       |       |       |                |        |   |        |           |     |       |       |       |                |        |  |          |         |     |       |       |       |  |  |  |  |         |     |       |       |       |  |  |  |  |         |     |       |       |       |  |  |  |  |         |     |       |       |       |  |  |  |  |         |    |       |       |       |                |        |  |           |         |    |       |       |       |  |  |  |  |         |    |       |       |       |  |  |  |  |         |    |       |       |       |                |        |  |                      |         |    |       |       |       |  |  |  |  |         |    |       |       |       |  |  |  |  |         |    |       |       |       |  |  |  |  |         |    |       |       |       |  |  |  |  |         |    |       |       |       |  |  |  |  |         |     |       |       |       |  |  |  |  |         |     |       |       |       |  |  |  |  |         |    |       |       |       |                |        |     |       |         |    |       |       |       |                |        |     |       |         |    |       |       |       |  |  |  |  |         |    |       |       |       |  |  |  |  |         |    |       |       |       |  |  |  |  |         |    |       |       |       |  |  |  |  |         |     |       |       |       |  |  |  |  |         |     |       |       |       |  |  |  |  |         |    |       |       |       |                |        |     |       |         |    |       |       |       |                |        |     |       |         |    |       |       |       |  |  |  |  |         |    |       |       |       |                |        |   |       |         |    |       |       |       |  |  |  |  |         |    |       |       |       |  |  |  |  |         |    |       |       |       |  |  |  |  |         |    |       |       |       |  |  |  |  |         |    |       |       |       |  |  |  |  |         |     |       |       |       |  |  |  |  |         |     |       |       |       |  |  |  |  |         |    |       |       |  |                |        |   |                           |         |    |       |       |  |                |        |   |                           |         |    |       |       |  |  |  |  |  |         |    |       |       |  |  |  |  |  |         |    |       |       |  |  |  |  |  |         |    |       |       |  |  |  |  |  |         |     |       |       |  |  |  |  |  |         |     |       |       |  |  |  |  |  |         |    |       |       |  |                |        |     |       |         |    |       |       |  |                |        |     |       |         |    |       |       |  |  |  |  |  |         |    |       |       |  |                |        |   |       |         |    |       |       |  |                |        |   |       |         |    |       |       |  |  |  |  |  |         |    |       |       |  |  |  |  |  |         |    |       |       |  |  |  |  |  |         |    |       |       |  |  |  |  |  |         |     |       |       |  |  |  |  |  |         |     |       |       |  |  |  |  |  |         |    |       |       |  |                |        |     |        |         |    |       |       |  |                |        |     |        |         |    |       |       |  |  |  |  |  |         |    |       |       |  |  |  |  |  |         |    |       |       |  |  |  |  |  |         |    |       |       |  |  |  |  |  |         |     |       |       |  |  |  |  |  |         |     |       |       |  |  |  |  |  |         |    |       |       |  |                |        |  |          |         |    |       |       |  |  |  |  |  |         |    |       |       |  |  |  |  |  |
| 2.2 dCi  | 100   | 09.03     | 11.05 |       |                |        |                |                           |   |           |           |    |       |       |       |                |        |   |        |           |    |       |       |       |                |        |   |        |           |     |       |       |       |                |        |  |          |         |     |       |       |       |  |  |  |  |         |     |       |       |       |  |  |  |  |         |     |       |       |       |  |  |  |  |         |     |       |       |       |  |  |  |  |         |    |       |       |       |                |        |  |           |         |    |       |       |       |  |  |  |  |         |    |       |       |       |  |  |  |  |         |    |       |       |       |                |        |  |                      |         |    |       |       |       |  |  |  |  |         |    |       |       |       |  |  |  |  |         |    |       |       |       |  |  |  |  |         |    |       |       |       |  |  |  |  |         |    |       |       |       |  |  |  |  |         |     |       |       |       |  |  |  |  |         |     |       |       |       |  |  |  |  |         |    |       |       |       |                |        |     |       |         |    |       |       |       |                |        |     |       |         |    |       |       |       |  |  |  |  |         |    |       |       |       |  |  |  |  |         |    |       |       |       |  |  |  |  |         |    |       |       |       |  |  |  |  |         |     |       |       |       |  |  |  |  |         |     |       |       |       |  |  |  |  |         |    |       |       |       |                |        |     |       |         |    |       |       |       |                |        |     |       |         |    |       |       |       |  |  |  |  |         |    |       |       |       |                |        |   |       |         |    |       |       |       |  |  |  |  |         |    |       |       |       |  |  |  |  |         |    |       |       |       |  |  |  |  |         |    |       |       |       |  |  |  |  |         |    |       |       |       |  |  |  |  |         |     |       |       |       |  |  |  |  |         |     |       |       |       |  |  |  |  |         |    |       |       |  |                |        |   |                           |         |    |       |       |  |                |        |   |                           |         |    |       |       |  |  |  |  |  |         |    |       |       |  |  |  |  |  |         |    |       |       |  |  |  |  |  |         |    |       |       |  |  |  |  |  |         |     |       |       |  |  |  |  |  |         |     |       |       |  |  |  |  |  |         |    |       |       |  |                |        |     |       |         |    |       |       |  |                |        |     |       |         |    |       |       |  |  |  |  |  |         |    |       |       |  |                |        |   |       |         |    |       |       |  |                |        |   |       |         |    |       |       |  |  |  |  |  |         |    |       |       |  |  |  |  |  |         |    |       |       |  |  |  |  |  |         |    |       |       |  |  |  |  |  |         |     |       |       |  |  |  |  |  |         |     |       |       |  |  |  |  |  |         |    |       |       |  |                |        |     |        |         |    |       |       |  |                |        |     |        |         |    |       |       |  |  |  |  |  |         |    |       |       |  |  |  |  |  |         |    |       |       |  |  |  |  |  |         |    |       |       |  |  |  |  |  |         |     |       |       |  |  |  |  |  |         |     |       |       |  |  |  |  |  |         |    |       |       |  |                |        |  |          |         |    |       |       |  |  |  |  |  |         |    |       |       |  |  |  |  |  |
| 2.2 Di   | 84  | 08.00     | 08.03 |       |                |        |                |                           |   |           |           |    |       |       |       |                |        |   |        |           |    |       |       |       |                |        |   |        |           |     |       |       |       |                |        |  |          |         |     |       |       |       |  |  |  |  |         |     |       |       |       |  |  |  |  |         |     |       |       |       |  |  |  |  |         |     |       |       |       |  |  |  |  |         |    |       |       |       |                |        |  |           |         |    |       |       |       |  |  |  |  |         |    |       |       |       |  |  |  |  |         |    |       |       |       |                |        |  |                      |         |    |       |       |       |  |  |  |  |         |    |       |       |       |  |  |  |  |         |    |       |       |       |  |  |  |  |         |    |       |       |       |  |  |  |  |         |    |       |       |       |  |  |  |  |         |     |       |       |       |  |  |  |  |         |     |       |       |       |  |  |  |  |         |    |       |       |       |                |        |     |       |         |    |       |       |       |                |        |     |       |         |    |       |       |       |  |  |  |  |         |    |       |       |       |  |  |  |  |         |    |       |       |       |  |  |  |  |         |    |       |       |       |  |  |  |  |         |     |       |       |       |  |  |  |  |         |     |       |       |       |  |  |  |  |         |    |       |       |       |                |        |     |       |         |    |       |       |       |                |        |     |       |         |    |       |       |       |  |  |  |  |         |    |       |       |       |                |        |   |       |         |    |       |       |       |  |  |  |  |         |    |       |       |       |  |  |  |  |         |    |       |       |       |  |  |  |  |         |    |       |       |       |  |  |  |  |         |    |       |       |       |  |  |  |  |         |     |       |       |       |  |  |  |  |         |     |       |       |       |  |  |  |  |         |    |       |       |  |                |        |   |                           |         |    |       |       |  |                |        |   |                           |         |    |       |       |  |  |  |  |  |         |    |       |       |  |  |  |  |  |         |    |       |       |  |  |  |  |  |         |    |       |       |  |  |  |  |  |         |     |       |       |  |  |  |  |  |         |     |       |       |  |  |  |  |  |         |    |       |       |  |                |        |     |       |         |    |       |       |  |                |        |     |       |         |    |       |       |  |  |  |  |  |         |    |       |       |  |                |        |   |       |         |    |       |       |  |                |        |   |       |         |    |       |       |  |  |  |  |  |         |    |       |       |  |  |  |  |  |         |    |       |       |  |  |  |  |  |         |    |       |       |  |  |  |  |  |         |     |       |       |  |  |  |  |  |         |     |       |       |  |  |  |  |  |         |    |       |       |  |                |        |     |        |         |    |       |       |  |                |        |     |        |         |    |       |       |  |  |  |  |  |         |    |       |       |  |  |  |  |  |         |    |       |       |  |  |  |  |  |         |    |       |       |  |  |  |  |  |         |     |       |       |  |  |  |  |  |         |     |       |       |  |  |  |  |  |         |    |       |       |  |                |        |  |          |         |    |       |       |  |  |  |  |  |         |    |       |       |  |  |  |  |  |
|  | <table border="1"> <tr><td>1.6 i 16V</td><td>71</td><td>08.00</td><td>11.05</td><td>- ⊕</td><td>24.2519-1703.3</td><td>040091</td><td></td><td>Nz 19,05</td></tr> <tr><td>1.8 i 16V</td><td>84</td><td>08.00</td><td>11.05</td><td></td><td></td><td></td><td></td><td></td></tr> <tr><td>1.8 i 16V</td><td>85</td><td>12.02</td><td>11.05</td><td></td><td></td><td></td><td></td><td></td></tr> <tr><td>2.2 dCi</td><td>82</td><td>09.03</td><td>11.05</td><td></td><td>24.2519-1704.3</td><td>040092</td><td></td><td>Nz 19,05</td></tr> <tr><td>2.2 dCi</td><td>100</td><td>09.03</td><td>11.05</td><td></td><td></td><td></td><td></td><td></td></tr> <tr><td>2.2 Di</td><td>84</td><td>07.01</td><td>08.03</td><td></td><td></td><td></td><td></td><td></td></tr> </table>  | 1.6 i 16V | 71    | 08.00 | 11.05          | - ⊕    | 24.2519-1703.3 | 040091                    |   | Nz 19,05  | 1.8 i 16V | 84 | 08.00 | 11.05 |       |                |        |   |        | 1.8 i 16V | 85 | 12.02 | 11.05 |       |                |        |   |        | 2.2 dCi   | 82  | 09.03 | 11.05 |       | 24.2519-1704.3 | 040092 |  | Nz 19,05 | 2.2 dCi | 100 | 09.03 | 11.05 |       |  |  |  |  | 2.2 Di  | 84  | 07.01 | 08.03 |       |  |  |  |  |         |     |       |       |       |  |  |  |  |         |     |       |       |       |  |  |  |  |         |    |       |       |       |                |        |  |           |         |    |       |       |       |  |  |  |  |         |    |       |       |       |  |  |  |  |         |    |       |       |       |                |        |  |                      |         |    |       |       |       |  |  |  |  |         |    |       |       |       |  |  |  |  |         |    |       |       |       |  |  |  |  |         |    |       |       |       |  |  |  |  |         |    |       |       |       |  |  |  |  |         |     |       |       |       |  |  |  |  |         |     |       |       |       |  |  |  |  |         |    |       |       |       |                |        |     |       |         |    |       |       |       |                |        |     |       |         |    |       |       |       |  |  |  |  |         |    |       |       |       |  |  |  |  |         |    |       |       |       |  |  |  |  |         |    |       |       |       |  |  |  |  |         |     |       |       |       |  |  |  |  |         |     |       |       |       |  |  |  |  |         |    |       |       |       |                |        |     |       |         |    |       |       |       |                |        |     |       |         |    |       |       |       |  |  |  |  |         |    |       |       |       |                |        |   |       |         |    |       |       |       |  |  |  |  |         |    |       |       |       |  |  |  |  |         |    |       |       |       |  |  |  |  |         |    |       |       |       |  |  |  |  |         |    |       |       |       |  |  |  |  |         |     |       |       |       |  |  |  |  |         |     |       |       |       |  |  |  |  |         |    |       |       |  |                |        |   |                           |         |    |       |       |  |                |        |   |                           |         |    |       |       |  |  |  |  |  |         |    |       |       |  |  |  |  |  |         |    |       |       |  |  |  |  |  |         |    |       |       |  |  |  |  |  |         |     |       |       |  |  |  |  |  |         |     |       |       |  |  |  |  |  |         |    |       |       |  |                |        |     |       |         |    |       |       |  |                |        |     |       |         |    |       |       |  |  |  |  |  |         |    |       |       |  |                |        |   |       |         |    |       |       |  |                |        |   |       |         |    |       |       |  |  |  |  |  |         |    |       |       |  |  |  |  |  |         |    |       |       |  |  |  |  |  |         |    |       |       |  |  |  |  |  |         |     |       |       |  |  |  |  |  |         |     |       |       |  |  |  |  |  |         |    |       |       |  |                |        |     |        |         |    |       |       |  |                |        |     |        |         |    |       |       |  |  |  |  |  |         |    |       |       |  |  |  |  |  |         |    |       |       |  |  |  |  |  |         |    |       |       |  |  |  |  |  |         |     |       |       |  |  |  |  |  |         |     |       |       |  |  |  |  |  |         |    |       |       |  |                |        |  |          |         |    |       |       |  |  |  |  |  |         |    |       |       |  |  |  |  |  |
| 1.6 i 16V  | 71  | 08.00     | 11.05 | - ⊕   | 24.2519-1703.3 | 040091 |                | Nz 19,05                  |   |           |           |    |       |       |       |                |        |   |        |           |    |       |       |       |                |        |   |        |           |     |       |       |       |                |        |  |          |         |     |       |       |       |  |  |  |  |         |     |       |       |       |  |  |  |  |         |     |       |       |       |  |  |  |  |         |     |       |       |       |  |  |  |  |         |    |       |       |       |                |        |  |           |         |    |       |       |       |  |  |  |  |         |    |       |       |       |  |  |  |  |         |    |       |       |       |                |        |  |                      |         |    |       |       |       |  |  |  |  |         |    |       |       |       |  |  |  |  |         |    |       |       |       |  |  |  |  |         |    |       |       |       |  |  |  |  |         |    |       |       |       |  |  |  |  |         |     |       |       |       |  |  |  |  |         |     |       |       |       |  |  |  |  |         |    |       |       |       |                |        |     |       |         |    |       |       |       |                |        |     |       |         |    |       |       |       |  |  |  |  |         |    |       |       |       |  |  |  |  |         |    |       |       |       |  |  |  |  |         |    |       |       |       |  |  |  |  |         |     |       |       |       |  |  |  |  |         |     |       |       |       |  |  |  |  |         |    |       |       |       |                |        |     |       |         |    |       |       |       |                |        |     |       |         |    |       |       |       |  |  |  |  |         |    |       |       |       |                |        |   |       |         |    |       |       |       |  |  |  |  |         |    |       |       |       |  |  |  |  |         |    |       |       |       |  |  |  |  |         |    |       |       |       |  |  |  |  |         |    |       |       |       |  |  |  |  |         |     |       |       |       |  |  |  |  |         |     |       |       |       |  |  |  |  |         |    |       |       |  |                |        |   |                           |         |    |       |       |  |                |        |   |                           |         |    |       |       |  |  |  |  |  |         |    |       |       |  |  |  |  |  |         |    |       |       |  |  |  |  |  |         |    |       |       |  |  |  |  |  |         |     |       |       |  |  |  |  |  |         |     |       |       |  |  |  |  |  |         |    |       |       |  |                |        |     |       |         |    |       |       |  |                |        |     |       |         |    |       |       |  |  |  |  |  |         |    |       |       |  |                |        |   |       |         |    |       |       |  |                |        |   |       |         |    |       |       |  |  |  |  |  |         |    |       |       |  |  |  |  |  |         |    |       |       |  |  |  |  |  |         |    |       |       |  |  |  |  |  |         |     |       |       |  |  |  |  |  |         |     |       |       |  |  |  |  |  |         |    |       |       |  |                |        |     |        |         |    |       |       |  |                |        |     |        |         |    |       |       |  |  |  |  |  |         |    |       |       |  |  |  |  |  |         |    |       |       |  |  |  |  |  |         |    |       |       |  |  |  |  |  |         |     |       |       |  |  |  |  |  |         |     |       |       |  |  |  |  |  |         |    |       |       |  |                |        |  |          |         |    |       |       |  |  |  |  |  |         |    |       |       |  |  |  |  |  |
| 1.8 i 16V  | 84  | 08.00     | 11.05 |       |                |        |                |                           |   |           |           |    |       |       |       |                |        |   |        |           |    |       |       |       |                |        |   |        |           |     |       |       |       |                |        |  |          |         |     |       |       |       |  |  |  |  |         |     |       |       |       |  |  |  |  |         |     |       |       |       |  |  |  |  |         |     |       |       |       |  |  |  |  |         |    |       |       |       |                |        |  |           |         |    |       |       |       |  |  |  |  |         |    |       |       |       |  |  |  |  |         |    |       |       |       |                |        |  |                      |         |    |       |       |       |  |  |  |  |         |    |       |       |       |  |  |  |  |         |    |       |       |       |  |  |  |  |         |    |       |       |       |  |  |  |  |         |    |       |       |       |  |  |  |  |         |     |       |       |       |  |  |  |  |         |     |       |       |       |  |  |  |  |         |    |       |       |       |                |        |     |       |         |    |       |       |       |                |        |     |       |         |    |       |       |       |  |  |  |  |         |    |       |       |       |  |  |  |  |         |    |       |       |       |  |  |  |  |         |    |       |       |       |  |  |  |  |         |     |       |       |       |  |  |  |  |         |     |       |       |       |  |  |  |  |         |    |       |       |       |                |        |     |       |         |    |       |       |       |                |        |     |       |         |    |       |       |       |  |  |  |  |         |    |       |       |       |                |        |   |       |         |    |       |       |       |  |  |  |  |         |    |       |       |       |  |  |  |  |         |    |       |       |       |  |  |  |  |         |    |       |       |       |  |  |  |  |         |    |       |       |       |  |  |  |  |         |     |       |       |       |  |  |  |  |         |     |       |       |       |  |  |  |  |         |    |       |       |  |                |        |   |                           |         |    |       |       |  |                |        |   |                           |         |    |       |       |  |  |  |  |  |         |    |       |       |  |  |  |  |  |         |    |       |       |  |  |  |  |  |         |    |       |       |  |  |  |  |  |         |     |       |       |  |  |  |  |  |         |     |       |       |  |  |  |  |  |         |    |       |       |  |                |        |     |       |         |    |       |       |  |                |        |     |       |         |    |       |       |  |  |  |  |  |         |    |       |       |  |                |        |   |       |         |    |       |       |  |                |        |   |       |         |    |       |       |  |  |  |  |  |         |    |       |       |  |  |  |  |  |         |    |       |       |  |  |  |  |  |         |    |       |       |  |  |  |  |  |         |     |       |       |  |  |  |  |  |         |     |       |       |  |  |  |  |  |         |    |       |       |  |                |        |     |        |         |    |       |       |  |                |        |     |        |         |    |       |       |  |  |  |  |  |         |    |       |       |  |  |  |  |  |         |    |       |       |  |  |  |  |  |         |    |       |       |  |  |  |  |  |         |     |       |       |  |  |  |  |  |         |     |       |       |  |  |  |  |  |         |    |       |       |  |                |        |  |          |         |    |       |       |  |  |  |  |  |         |    |       |       |  |  |  |  |  |
| 1.8 i 16V  | 85  | 12.02     | 11.05 |       |                |        |                |                           |   |           |           |    |       |       |       |                |        |   |        |           |    |       |       |       |                |        |   |        |           |     |       |       |       |                |        |  |          |         |     |       |       |       |  |  |  |  |         |     |       |       |       |  |  |  |  |         |     |       |       |       |  |  |  |  |         |     |       |       |       |  |  |  |  |         |    |       |       |       |                |        |  |           |         |    |       |       |       |  |  |  |  |         |    |       |       |       |  |  |  |  |         |    |       |       |       |                |        |  |                      |         |    |       |       |       |  |  |  |  |         |    |       |       |       |  |  |  |  |         |    |       |       |       |  |  |  |  |         |    |       |       |       |  |  |  |  |         |    |       |       |       |  |  |  |  |         |     |       |       |       |  |  |  |  |         |     |       |       |       |  |  |  |  |         |    |       |       |       |                |        |     |       |         |    |       |       |       |                |        |     |       |         |    |       |       |       |  |  |  |  |         |    |       |       |       |  |  |  |  |         |    |       |       |       |  |  |  |  |         |    |       |       |       |  |  |  |  |         |     |       |       |       |  |  |  |  |         |     |       |       |       |  |  |  |  |         |    |       |       |       |                |        |     |       |         |    |       |       |       |                |        |     |       |         |    |       |       |       |  |  |  |  |         |    |       |       |       |                |        |   |       |         |    |       |       |       |  |  |  |  |         |    |       |       |       |  |  |  |  |         |    |       |       |       |  |  |  |  |         |    |       |       |       |  |  |  |  |         |    |       |       |       |  |  |  |  |         |     |       |       |       |  |  |  |  |         |     |       |       |       |  |  |  |  |         |    |       |       |  |                |        |   |                           |         |    |       |       |  |                |        |   |                           |         |    |       |       |  |  |  |  |  |         |    |       |       |  |  |  |  |  |         |    |       |       |  |  |  |  |  |         |    |       |       |  |  |  |  |  |         |     |       |       |  |  |  |  |  |         |     |       |       |  |  |  |  |  |         |    |       |       |  |                |        |     |       |         |    |       |       |  |                |        |     |       |         |    |       |       |  |  |  |  |  |         |    |       |       |  |                |        |   |       |         |    |       |       |  |                |        |   |       |         |    |       |       |  |  |  |  |  |         |    |       |       |  |  |  |  |  |         |    |       |       |  |  |  |  |  |         |    |       |       |  |  |  |  |  |         |     |       |       |  |  |  |  |  |         |     |       |       |  |  |  |  |  |         |    |       |       |  |                |        |     |        |         |    |       |       |  |                |        |     |        |         |    |       |       |  |  |  |  |  |         |    |       |       |  |  |  |  |  |         |    |       |       |  |  |  |  |  |         |    |       |       |  |  |  |  |  |         |     |       |       |  |  |  |  |  |         |     |       |       |  |  |  |  |  |         |    |       |       |  |                |        |  |          |         |    |       |       |  |  |  |  |  |         |    |       |       |  |  |  |  |  |
| 2.2 dCi  | 82  | 09.03     | 11.05 |       | 24.2519-1704.3 | 040092 |                | Nz 19,05                  |   |           |           |    |       |       |       |                |        |   |        |           |    |       |       |       |                |        |   |        |           |     |       |       |       |                |        |  |          |         |     |       |       |       |  |  |  |  |         |     |       |       |       |  |  |  |  |         |     |       |       |       |  |  |  |  |         |     |       |       |       |  |  |  |  |         |    |       |       |       |                |        |  |           |         |    |       |       |       |  |  |  |  |         |    |       |       |       |  |  |  |  |         |    |       |       |       |                |        |  |                      |         |    |       |       |       |  |  |  |  |         |    |       |       |       |  |  |  |  |         |    |       |       |       |  |  |  |  |         |    |       |       |       |  |  |  |  |         |    |       |       |       |  |  |  |  |         |     |       |       |       |  |  |  |  |         |     |       |       |       |  |  |  |  |         |    |       |       |       |                |        |     |       |         |    |       |       |       |                |        |     |       |         |    |       |       |       |  |  |  |  |         |    |       |       |       |  |  |  |  |         |    |       |       |       |  |  |  |  |         |    |       |       |       |  |  |  |  |         |     |       |       |       |  |  |  |  |         |     |       |       |       |  |  |  |  |         |    |       |       |       |                |        |     |       |         |    |       |       |       |                |        |     |       |         |    |       |       |       |  |  |  |  |         |    |       |       |       |                |        |   |       |         |    |       |       |       |  |  |  |  |         |    |       |       |       |  |  |  |  |         |    |       |       |       |  |  |  |  |         |    |       |       |       |  |  |  |  |         |    |       |       |       |  |  |  |  |         |     |       |       |       |  |  |  |  |         |     |       |       |       |  |  |  |  |         |    |       |       |  |                |        |   |                           |         |    |       |       |  |                |        |   |                           |         |    |       |       |  |  |  |  |  |         |    |       |       |  |  |  |  |  |         |    |       |       |  |  |  |  |  |         |    |       |       |  |  |  |  |  |         |     |       |       |  |  |  |  |  |         |     |       |       |  |  |  |  |  |         |    |       |       |  |                |        |     |       |         |    |       |       |  |                |        |     |       |         |    |       |       |  |  |  |  |  |         |    |       |       |  |                |        |   |       |         |    |       |       |  |                |        |   |       |         |    |       |       |  |  |  |  |  |         |    |       |       |  |  |  |  |  |         |    |       |       |  |  |  |  |  |         |    |       |       |  |  |  |  |  |         |     |       |       |  |  |  |  |  |         |     |       |       |  |  |  |  |  |         |    |       |       |  |                |        |     |        |         |    |       |       |  |                |        |     |        |         |    |       |       |  |  |  |  |  |         |    |       |       |  |  |  |  |  |         |    |       |       |  |  |  |  |  |         |    |       |       |  |  |  |  |  |         |     |       |       |  |  |  |  |  |         |     |       |       |  |  |  |  |  |         |    |       |       |  |                |        |  |          |         |    |       |       |  |  |  |  |  |         |    |       |       |  |  |  |  |  |
| 2.2 dCi  | 100   | 09.03     | 11.05 |       |                |        |                |                           |   |           |           |    |       |       |       |                |        |   |        |           |    |       |       |       |                |        |   |        |           |     |       |       |       |                |        |  |          |         |     |       |       |       |  |  |  |  |         |     |       |       |       |  |  |  |  |         |     |       |       |       |  |  |  |  |         |     |       |       |       |  |  |  |  |         |    |       |       |       |                |        |  |           |         |    |       |       |       |  |  |  |  |         |    |       |       |       |  |  |  |  |         |    |       |       |       |                |        |  |                      |         |    |       |       |       |  |  |  |  |         |    |       |       |       |  |  |  |  |         |    |       |       |       |  |  |  |  |         |    |       |       |       |  |  |  |  |         |    |       |       |       |  |  |  |  |         |     |       |       |       |  |  |  |  |         |     |       |       |       |  |  |  |  |         |    |       |       |       |                |        |     |       |         |    |       |       |       |                |        |     |       |         |    |       |       |       |  |  |  |  |         |    |       |       |       |  |  |  |  |         |    |       |       |       |  |  |  |  |         |    |       |       |       |  |  |  |  |         |     |       |       |       |  |  |  |  |         |     |       |       |       |  |  |  |  |         |    |       |       |       |                |        |     |       |         |    |       |       |       |                |        |     |       |         |    |       |       |       |  |  |  |  |         |    |       |       |       |                |        |   |       |         |    |       |       |       |  |  |  |  |         |    |       |       |       |  |  |  |  |         |    |       |       |       |  |  |  |  |         |    |       |       |       |  |  |  |  |         |    |       |       |       |  |  |  |  |         |     |       |       |       |  |  |  |  |         |     |       |       |       |  |  |  |  |         |    |       |       |  |                |        |   |                           |         |    |       |       |  |                |        |   |                           |         |    |       |       |  |  |  |  |  |         |    |       |       |  |  |  |  |  |         |    |       |       |  |  |  |  |  |         |    |       |       |  |  |  |  |  |         |     |       |       |  |  |  |  |  |         |     |       |       |  |  |  |  |  |         |    |       |       |  |                |        |     |       |         |    |       |       |  |                |        |     |       |         |    |       |       |  |  |  |  |  |         |    |       |       |  |                |        |   |       |         |    |       |       |  |                |        |   |       |         |    |       |       |  |  |  |  |  |         |    |       |       |  |  |  |  |  |         |    |       |       |  |  |  |  |  |         |    |       |       |  |  |  |  |  |         |     |       |       |  |  |  |  |  |         |     |       |       |  |  |  |  |  |         |    |       |       |  |                |        |     |        |         |    |       |       |  |                |        |     |        |         |    |       |       |  |  |  |  |  |         |    |       |       |  |  |  |  |  |         |    |       |       |  |  |  |  |  |         |    |       |       |  |  |  |  |  |         |     |       |       |  |  |  |  |  |         |     |       |       |  |  |  |  |  |         |    |       |       |  |                |        |  |          |         |    |       |       |  |  |  |  |  |         |    |       |       |  |  |  |  |  |
| 2.2 Di   | 84  | 07.01     | 08.03 |       |                |        |                |                           |   |           |           |    |       |       |       |                |        |   |        |           |    |       |       |       |                |        |   |        |           |     |       |       |       |                |        |  |          |         |     |       |       |       |  |  |  |  |         |     |       |       |       |  |  |  |  |         |     |       |       |       |  |  |  |  |         |     |       |       |       |  |  |  |  |         |    |       |       |       |                |        |  |           |         |    |       |       |       |  |  |  |  |         |    |       |       |       |  |  |  |  |         |    |       |       |       |                |        |  |                      |         |    |       |       |       |  |  |  |  |         |    |       |       |       |  |  |  |  |         |    |       |       |       |  |  |  |  |         |    |       |       |       |  |  |  |  |         |    |       |       |       |  |  |  |  |         |     |       |       |       |  |  |  |  |         |     |       |       |       |  |  |  |  |         |    |       |       |       |                |        |     |       |         |    |       |       |       |                |        |     |       |         |    |       |       |       |  |  |  |  |         |    |       |       |       |  |  |  |  |         |    |       |       |       |  |  |  |  |         |    |       |       |       |  |  |  |  |         |     |       |       |       |  |  |  |  |         |     |       |       |       |  |  |  |  |         |    |       |       |       |                |        |     |       |         |    |       |       |       |                |        |     |       |         |    |       |       |       |  |  |  |  |         |    |       |       |       |                |        |   |       |         |    |       |       |       |  |  |  |  |         |    |       |       |       |  |  |  |  |         |    |       |       |       |  |  |  |  |         |    |       |       |       |  |  |  |  |         |    |       |       |       |  |  |  |  |         |     |       |       |       |  |  |  |  |         |     |       |       |       |  |  |  |  |         |    |       |       |  |                |        |   |                           |         |    |       |       |  |                |        |   |                           |         |    |       |       |  |  |  |  |  |         |    |       |       |  |  |  |  |  |         |    |       |       |  |  |  |  |  |         |    |       |       |  |  |  |  |  |         |     |       |       |  |  |  |  |  |         |     |       |       |  |  |  |  |  |         |    |       |       |  |                |        |     |       |         |    |       |       |  |                |        |     |       |         |    |       |       |  |  |  |  |  |         |    |       |       |  |                |        |   |       |         |    |       |       |  |                |        |   |       |         |    |       |       |  |  |  |  |  |         |    |       |       |  |  |  |  |  |         |    |       |       |  |  |  |  |  |         |    |       |       |  |  |  |  |  |         |     |       |       |  |  |  |  |  |         |     |       |       |  |  |  |  |  |         |    |       |       |  |                |        |     |        |         |    |       |       |  |                |        |     |        |         |    |       |       |  |  |  |  |  |         |    |       |       |  |  |  |  |  |         |    |       |       |  |  |  |  |  |         |    |       |       |  |  |  |  |  |         |     |       |       |  |  |  |  |  |         |     |       |       |  |  |  |  |  |         |    |       |       |  |                |        |  |          |         |    |       |       |  |  |  |  |  |         |    |       |       |  |  |  |  |  |
| NISSAN INTERSTAR (X70) (02-10)   |   |           |       |       |                |        |                |                           |   |           |           |    |       |       |       |                |        |   |        |           |    |       |       |       |                |        |   |        |           |     |       |       |       |                |        |  |          |         |     |       |       |       |  |  |  |  |         |     |       |       |       |  |  |  |  |         |     |       |       |       |  |  |  |  |         |     |       |       |       |  |  |  |  |         |    |       |       |       |                |        |  |           |         |    |       |       |       |  |  |  |  |         |    |       |       |       |  |  |  |  |         |    |       |       |       |                |        |  |                      |         |    |       |       |       |  |  |  |  |         |    |       |       |       |  |  |  |  |         |    |       |       |       |  |  |  |  |         |    |       |       |       |  |  |  |  |         |    |       |       |       |  |  |  |  |         |     |       |       |       |  |  |  |  |         |     |       |       |       |  |  |  |  |         |    |       |       |       |                |        |     |       |         |    |       |       |       |                |        |     |       |         |    |       |       |       |  |  |  |  |         |    |       |       |       |  |  |  |  |         |    |       |       |       |  |  |  |  |         |    |       |       |       |  |  |  |  |         |     |       |       |       |  |  |  |  |         |     |       |       |       |  |  |  |  |         |    |       |       |       |                |        |     |       |         |    |       |       |       |                |        |     |       |         |    |       |       |       |  |  |  |  |         |    |       |       |       |                |        |   |       |         |    |       |       |       |  |  |  |  |         |    |       |       |       |  |  |  |  |         |    |       |       |       |  |  |  |  |         |    |       |       |       |  |  |  |  |         |    |       |       |       |  |  |  |  |         |     |       |       |       |  |  |  |  |         |     |       |       |       |  |  |  |  |         |    |       |       |  |                |        |   |                           |         |    |       |       |  |                |        |   |                           |         |    |       |       |  |  |  |  |  |         |    |       |       |  |  |  |  |  |         |    |       |       |  |  |  |  |  |         |    |       |       |  |  |  |  |  |         |     |       |       |  |  |  |  |  |         |     |       |       |  |  |  |  |  |         |    |       |       |  |                |        |     |       |         |    |       |       |  |                |        |     |       |         |    |       |       |  |  |  |  |  |         |    |       |       |  |                |        |   |       |         |    |       |       |  |                |        |   |       |         |    |       |       |  |  |  |  |  |         |    |       |       |  |  |  |  |  |         |    |       |       |  |  |  |  |  |         |    |       |       |  |  |  |  |  |         |     |       |       |  |  |  |  |  |         |     |       |       |  |  |  |  |  |         |    |       |       |  |                |        |     |        |         |    |       |       |  |                |        |     |        |         |    |       |       |  |  |  |  |  |         |    |       |       |  |  |  |  |  |         |    |       |       |  |  |  |  |  |         |    |       |       |  |  |  |  |  |         |     |       |       |  |  |  |  |  |         |     |       |       |  |  |  |  |  |         |    |       |       |  |                |        |  |          |         |    |       |       |  |  |  |  |  |         |    |       |       |  |  |  |  |  |
|  | <table border="1"> <tr><td>1.9 dCi</td><td>60</td><td>07.02</td><td>08.06</td><td>- ABS</td><td>24.2025-1708.3</td><td>010692</td><td></td><td>THz 25,40</td></tr> <tr><td>2.2 dCi</td><td>66</td><td>07.02</td><td>08.06</td><td>- ABS</td><td></td><td></td><td></td><td></td></tr> <tr><td>2.5 dCi</td><td>73</td><td>11.03</td><td>06.10</td><td>- ABS</td><td></td><td></td><td></td><td></td></tr> <tr><td>2.5 dCi</td><td>74</td><td>04.06</td><td>06.10</td><td>- ABS</td><td></td><td></td><td></td><td></td></tr> <tr><td>2.5 dCi</td><td>84</td><td>07.02</td><td>08.06</td><td>- ABS</td><td></td><td></td><td></td><td></td></tr> <tr><td>2.5 dCi</td><td>88</td><td>09.06</td><td>06.10</td><td>- ABS</td><td></td><td></td><td></td><td></td></tr> <tr><td>2.5 dCi</td><td>107</td><td>09.06</td><td>06.10</td><td>- ABS</td><td></td><td></td><td></td><td></td></tr> <tr><td>3.0 dCi</td><td>100</td><td>11.03</td><td>08.06</td><td>- ABS</td><td></td><td></td><td></td><td></td></tr> <tr><td>1.9 dCi</td><td>60</td><td>07.02</td><td>12.02</td><td>+ ABS</td><td>24.2025-1706.3</td><td>010676</td><td></td><td>THz 25,40</td></tr> <tr><td>2.2 dCi</td><td>66</td><td>07.02</td><td>12.02</td><td>+ ABS</td><td></td><td></td><td></td><td></td></tr> <tr><td>2.5 dCi</td><td>84</td><td>07.02</td><td>12.02</td><td>+ ABS</td><td></td><td></td><td></td><td></td></tr> <tr><td>1.9 dCi</td><td>60</td><td>01.03</td><td>08.06</td><td>+ ABS</td><td>24.2123-1759.3</td><td>010768</td><td></td><td>THz 23,81 <b>BOS</b></td></tr> <tr><td>2.2 dCi</td><td>66</td><td>01.03</td><td>08.06</td><td>+ ABS</td><td></td><td></td><td></td><td></td></tr> <tr><td>2.5 dCi</td><td>73</td><td>11.03</td><td>06.10</td><td>+ ABS</td><td></td><td></td><td></td><td></td></tr> <tr><td>2.5 dCi</td><td>74</td><td>04.06</td><td>06.10</td><td>+ ABS</td><td></td><td></td><td></td><td></td></tr> <tr><td>2.5 dCi</td><td>84</td><td>01.03</td><td>08.06</td><td>+ ABS</td><td></td><td></td><td></td><td></td></tr> <tr><td>2.5 dCi</td><td>88</td><td>09.06</td><td>06.10</td><td>+ ABS</td><td></td><td></td><td></td><td></td></tr> <tr><td>2.5 dCi</td><td>107</td><td>09.06</td><td>06.10</td><td>+ ABS</td><td></td><td></td><td></td><td></td></tr> <tr><td>3.0 dCi</td><td>100</td><td>11.03</td><td>08.06</td><td>+ ABS</td><td></td><td></td><td></td><td></td></tr> <tr><td>1.9 dCi</td><td>60</td><td>07.02</td><td>08.06</td><td>- ABS</td><td>24.5134-0457.3</td><td>330752</td><td>2 ↑</td><td>L=457</td></tr> <tr><td>2.2 dCi</td><td>66</td><td>07.02</td><td>08.06</td><td>- ABS</td><td>24.5134-0468.3</td><td>330704</td><td>2 ↓</td><td>L=468</td></tr> <tr><td>2.5 dCi</td><td>73</td><td>11.03</td><td>06.10</td><td>- ABS</td><td></td><td></td><td></td><td></td></tr> <tr><td>2.5 dCi</td><td>74</td><td>04.06</td><td>06.10</td><td>- ABS</td><td></td><td></td><td></td><td></td></tr> <tr><td>2.5 dCi</td><td>84</td><td>07.02</td><td>08.06</td><td>- ABS</td><td></td><td></td><td></td><td></td></tr> <tr><td>2.5 dCi</td><td>88</td><td>09.06</td><td>06.10</td><td>- ABS</td><td></td><td></td><td></td><td></td></tr> <tr><td>2.5 dCi</td><td>107</td><td>09.06</td><td>06.10</td><td>- ABS</td><td></td><td></td><td></td><td></td></tr> <tr><td>3.0 dCi</td><td>100</td><td>11.03</td><td>08.06</td><td>- ABS</td><td></td><td></td><td></td><td></td></tr> <tr><td>1.9 dCi</td><td>60</td><td>07.02</td><td>10.03</td><td>+ ABS</td><td>24.5134-0457.3</td><td>330752</td><td>2 ↑</td><td>L=457</td></tr> <tr><td>2.2 dCi</td><td>66</td><td>07.02</td><td>10.03</td><td>+ ABS</td><td>24.5134-0468.3</td><td>330704</td><td>2 ↓</td><td>L=468</td></tr> <tr><td>2.5 dCi</td><td>84</td><td>07.02</td><td>10.03</td><td>+ ABS</td><td></td><td></td><td></td><td></td></tr> <tr><td>1.9 dCi</td><td>60</td><td>11.03</td><td>08.06</td><td>+ ABS</td><td>24.5111-0510.3</td><td>330819</td><td>2</td><td>L=510</td></tr> <tr><td>2.2 dCi</td><td>66</td><td>11.03</td><td>08.06</td><td>+ ABS</td><td></td><td></td><td></td><td></td></tr> <tr><td>2.5 dCi</td><td>73</td><td>11.03</td><td>06.10</td><td>+ ABS</td><td></td><td></td><td></td><td></td></tr> <tr><td>2.5 dCi</td><td>74</td><td>04.06</td><td>06.10</td><td>+ ABS</td><td></td><td></td><td></td><td></td></tr> <tr><td>2.5 dCi</td><td>84</td><td>11.03</td><td>08.06</td><td>+ ABS</td><td></td><td></td><td></td><td></td></tr> <tr><td>2.5 dCi</td><td>88</td><td>09.06</td><td>06.10</td><td>+ ABS</td><td></td><td></td><td></td><td></td></tr> <tr><td>2.5 dCi</td><td>107</td><td>09.06</td><td>06.10</td><td>+ ABS</td><td></td><td></td><td></td><td></td></tr> <tr><td>3.0 dCi</td><td>100</td><td>11.03</td><td>08.06</td><td>+ ABS</td><td></td><td></td><td></td><td></td></tr> <tr><td>1.9 dCi</td><td>60</td><td>07.02</td><td>08.06</td><td></td><td>24.3424-1701.5</td><td>240561</td><td>□</td><td>D=42, - Halter <b>BOS</b></td></tr> <tr><td>2.2 dCi</td><td>66</td><td>07.02</td><td>08.06</td><td></td><td>24.3424-1702.5</td><td>240562</td><td>□</td><td>D=42, - Halter <b>BOS</b></td></tr> <tr><td>2.5 dCi</td><td>73</td><td>11.03</td><td>06.10</td><td></td><td></td><td></td><td></td><td></td></tr> <tr><td>2.5 dCi</td><td>74</td><td>04.06</td><td>06.10</td><td></td><td></td><td></td><td></td><td></td></tr> <tr><td>2.5 dCi</td><td>84</td><td>07.02</td><td>08.06</td><td></td><td></td><td></td><td></td><td></td></tr> <tr><td>2.5 dCi</td><td>88</td><td>09.06</td><td>06.10</td><td></td><td></td><td></td><td></td><td></td></tr> <tr><td>2.5 dCi</td><td>107</td><td>09.06</td><td>06.10</td><td></td><td></td><td></td><td></td><td></td></tr> <tr><td>3.0 dCi</td><td>100</td><td>11.03</td><td>08.06</td><td></td><td></td><td></td><td></td><td></td></tr> <tr><td>1.9 dCi</td><td>60</td><td>07.02</td><td>10.03</td><td></td><td>24.5111-0410.3</td><td>330681</td><td>1 □</td><td>L=410</td></tr> <tr><td>2.2 dCi</td><td>66</td><td>07.02</td><td>10.03</td><td></td><td>24.5111-0326.3</td><td>330766</td><td>2 ↓</td><td>L=326</td></tr> <tr><td>2.5 dCi</td><td>84</td><td>07.02</td><td>10.03</td><td></td><td></td><td></td><td></td><td></td></tr> <tr><td>1.9 dCi</td><td>60</td><td>11.03</td><td>08.06</td><td></td><td>24.5258-0450.3</td><td>330824</td><td>□</td><td>L=450</td></tr> <tr><td>2.2 dCi</td><td>66</td><td>11.03</td><td>08.06</td><td></td><td>24.5251-0465.3</td><td>330822</td><td>□</td><td>L=465</td></tr> <tr><td>2.5 dCi</td><td>73</td><td>11.03</td><td>06.10</td><td></td><td></td><td></td><td></td><td></td></tr> <tr><td>2.5 dCi</td><td>74</td><td>04.06</td><td>06.10</td><td></td><td></td><td></td><td></td><td></td></tr> <tr><td>2.5 dCi</td><td>84</td><td>11.03</td><td>08.06</td><td></td><td></td><td></td><td></td><td></td></tr> <tr><td>2.5 dCi</td><td>88</td><td>09.06</td><td>06.10</td><td></td><td></td><td></td><td></td><td></td></tr> <tr><td>2.5 dCi</td><td>107</td><td>09.06</td><td>06.10</td><td></td><td></td><td></td><td></td><td></td></tr> <tr><td>3.0 dCi</td><td>100</td><td>11.03</td><td>08.06</td><td></td><td></td><td></td><td></td><td></td></tr> <tr><td>1.9 dCi</td><td>60</td><td>07.02</td><td>08.06</td><td></td><td>24.3727-0762.2</td><td>580762</td><td>1 ↑</td><td>L=1175</td></tr> <tr><td>2.2 dCi</td><td>66</td><td>07.02</td><td>08.06</td><td></td><td>24.3727-1072.2</td><td>581072</td><td>2 ↓</td><td>L=1420</td></tr> <tr><td>2.5 dCi</td><td>73</td><td>11.03</td><td>06.10</td><td></td><td></td><td></td><td></td><td></td></tr> <tr><td>2.5 dCi</td><td>74</td><td>04.06</td><td>06.10</td><td></td><td></td><td></td><td></td><td></td></tr> <tr><td>2.5 dCi</td><td>84</td><td>07.02</td><td>08.06</td><td></td><td></td><td></td><td></td><td></td></tr> <tr><td>2.5 dCi</td><td>88</td><td>09.06</td><td>06.10</td><td></td><td></td><td></td><td></td><td></td></tr> <tr><td>2.5 dCi</td><td>107</td><td>09.06</td><td>06.10</td><td></td><td></td><td></td><td></td><td></td></tr> <tr><td>3.0 dCi</td><td>100</td><td>11.03</td><td>08.06</td><td></td><td></td><td></td><td></td><td></td></tr> <tr><td>1.9 dCi</td><td>60</td><td>07.02</td><td>12.02</td><td></td><td>24.2415-1710.3</td><td>030124</td><td></td><td>Gz 15,87</td></tr> <tr><td>2.2 dCi</td><td>66</td><td>07.02</td><td>12.02</td><td></td><td></td><td></td><td></td><td></td></tr> <tr><td>2.5 dCi</td><td>84</td><td>07.02</td><td>12.02</td><td></td><td></td><td></td><td></td><td></td></tr> </table> | 1.9 dCi   | 60    | 07.02 | 08.06          | - ABS  | 24.2025-1708.3 | 010692                    |   | THz 25,40 | 2.2 dCi   | 66 | 07.02 | 08.06 | - ABS |                |        |   |        | 2.5 dCi   | 73 | 11.03 | 06.10 | - ABS |                |        |   |        | 2.5 dCi   | 74  | 04.06 | 06.10 | - ABS |                |        |  |          | 2.5 dCi | 84  | 07.02 | 08.06 | - ABS |  |  |  |  | 2.5 dCi | 88  | 09.06 | 06.10 | - ABS |  |  |  |  | 2.5 dCi | 107 | 09.06 | 06.10 | - ABS |  |  |  |  | 3.0 dCi | 100 | 11.03 | 08.06 | - ABS |  |  |  |  | 1.9 dCi | 60 | 07.02 | 12.02 | + ABS | 24.2025-1706.3 | 010676 |  | THz 25,40 | 2.2 dCi | 66 | 07.02 | 12.02 | + ABS |  |  |  |  | 2.5 dCi | 84 | 07.02 | 12.02 | + ABS |  |  |  |  | 1.9 dCi | 60 | 01.03 | 08.06 | + ABS | 24.2123-1759.3 | 010768 |  | THz 23,81 <b>BOS</b> | 2.2 dCi | 66 | 01.03 | 08.06 | + ABS |  |  |  |  | 2.5 dCi | 73 | 11.03 | 06.10 | + ABS |  |  |  |  | 2.5 dCi | 74 | 04.06 | 06.10 | + ABS |  |  |  |  | 2.5 dCi | 84 | 01.03 | 08.06 | + ABS |  |  |  |  | 2.5 dCi | 88 | 09.06 | 06.10 | + ABS |  |  |  |  | 2.5 dCi | 107 | 09.06 | 06.10 | + ABS |  |  |  |  | 3.0 dCi | 100 | 11.03 | 08.06 | + ABS |  |  |  |  | 1.9 dCi | 60 | 07.02 | 08.06 | - ABS | 24.5134-0457.3 | 330752 | 2 ↑ | L=457 | 2.2 dCi | 66 | 07.02 | 08.06 | - ABS | 24.5134-0468.3 | 330704 | 2 ↓ | L=468 | 2.5 dCi | 73 | 11.03 | 06.10 | - ABS |  |  |  |  | 2.5 dCi | 74 | 04.06 | 06.10 | - ABS |  |  |  |  | 2.5 dCi | 84 | 07.02 | 08.06 | - ABS |  |  |  |  | 2.5 dCi | 88 | 09.06 | 06.10 | - ABS |  |  |  |  | 2.5 dCi | 107 | 09.06 | 06.10 | - ABS |  |  |  |  | 3.0 dCi | 100 | 11.03 | 08.06 | - ABS |  |  |  |  | 1.9 dCi | 60 | 07.02 | 10.03 | + ABS | 24.5134-0457.3 | 330752 | 2 ↑ | L=457 | 2.2 dCi | 66 | 07.02 | 10.03 | + ABS | 24.5134-0468.3 | 330704 | 2 ↓ | L=468 | 2.5 dCi | 84 | 07.02 | 10.03 | + ABS |  |  |  |  | 1.9 dCi | 60 | 11.03 | 08.06 | + ABS | 24.5111-0510.3 | 330819 | 2 | L=510 | 2.2 dCi | 66 | 11.03 | 08.06 | + ABS |  |  |  |  | 2.5 dCi | 73 | 11.03 | 06.10 | + ABS |  |  |  |  | 2.5 dCi | 74 | 04.06 | 06.10 | + ABS |  |  |  |  | 2.5 dCi | 84 | 11.03 | 08.06 | + ABS |  |  |  |  | 2.5 dCi | 88 | 09.06 | 06.10 | + ABS |  |  |  |  | 2.5 dCi | 107 | 09.06 | 06.10 | + ABS |  |  |  |  | 3.0 dCi | 100 | 11.03 | 08.06 | + ABS |  |  |  |  | 1.9 dCi | 60 | 07.02 | 08.06 |  | 24.3424-1701.5 | 240561 | □ | D=42, - Halter <b>BOS</b> | 2.2 dCi | 66 | 07.02 | 08.06 |  | 24.3424-1702.5 | 240562 | □ | D=42, - Halter <b>BOS</b> | 2.5 dCi | 73 | 11.03 | 06.10 |  |  |  |  |  | 2.5 dCi | 74 | 04.06 | 06.10 |  |  |  |  |  | 2.5 dCi | 84 | 07.02 | 08.06 |  |  |  |  |  | 2.5 dCi | 88 | 09.06 | 06.10 |  |  |  |  |  | 2.5 dCi | 107 | 09.06 | 06.10 |  |  |  |  |  | 3.0 dCi | 100 | 11.03 | 08.06 |  |  |  |  |  | 1.9 dCi | 60 | 07.02 | 10.03 |  | 24.5111-0410.3 | 330681 | 1 □ | L=410 | 2.2 dCi | 66 | 07.02 | 10.03 |  | 24.5111-0326.3 | 330766 | 2 ↓ | L=326 | 2.5 dCi | 84 | 07.02 | 10.03 |  |  |  |  |  | 1.9 dCi | 60 | 11.03 | 08.06 |  | 24.5258-0450.3 | 330824 | □ | L=450 | 2.2 dCi | 66 | 11.03 | 08.06 |  | 24.5251-0465.3 | 330822 | □ | L=465 | 2.5 dCi | 73 | 11.03 | 06.10 |  |  |  |  |  | 2.5 dCi | 74 | 04.06 | 06.10 |  |  |  |  |  | 2.5 dCi | 84 | 11.03 | 08.06 |  |  |  |  |  | 2.5 dCi | 88 | 09.06 | 06.10 |  |  |  |  |  | 2.5 dCi | 107 | 09.06 | 06.10 |  |  |  |  |  | 3.0 dCi | 100 | 11.03 | 08.06 |  |  |  |  |  | 1.9 dCi | 60 | 07.02 | 08.06 |  | 24.3727-0762.2 | 580762 | 1 ↑ | L=1175 | 2.2 dCi | 66 | 07.02 | 08.06 |  | 24.3727-1072.2 | 581072 | 2 ↓ | L=1420 | 2.5 dCi | 73 | 11.03 | 06.10 |  |  |  |  |  | 2.5 dCi | 74 | 04.06 | 06.10 |  |  |  |  |  | 2.5 dCi | 84 | 07.02 | 08.06 |  |  |  |  |  | 2.5 dCi | 88 | 09.06 | 06.10 |  |  |  |  |  | 2.5 dCi | 107 | 09.06 | 06.10 |  |  |  |  |  | 3.0 dCi | 100 | 11.03 | 08.06 |  |  |  |  |  | 1.9 dCi | 60 | 07.02 | 12.02 |  | 24.2415-1710.3 | 030124 |  | Gz 15,87 | 2.2 dCi | 66 | 07.02 | 12.02 |  |  |  |  |  | 2.5 dCi | 84 | 07.02 | 12.02 |  |  |  |  |  |
| 1.9 dCi  | 60  | 07.02     | 08.06 | - ABS | 24.2025-1708.3 | 010692 |                | THz 25,40                 |   |           |           |    |       |       |       |                |        |   |        |           |    |       |       |       |                |        |   |        |           |     |       |       |       |                |        |  |          |         |     |       |       |       |  |  |  |  |         |     |       |       |       |  |  |  |  |         |     |       |       |       |  |  |  |  |         |     |       |       |       |  |  |  |  |         |    |       |       |       |                |        |  |           |         |    |       |       |       |  |  |  |  |         |    |       |       |       |  |  |  |  |         |    |       |       |       |                |        |  |                      |         |    |       |       |       |  |  |  |  |         |    |       |       |       |  |  |  |  |         |    |       |       |       |  |  |  |  |         |    |       |       |       |  |  |  |  |         |    |       |       |       |  |  |  |  |         |     |       |       |       |  |  |  |  |         |     |       |       |       |  |  |  |  |         |    |       |       |       |                |        |     |       |         |    |       |       |       |                |        |     |       |         |    |       |       |       |  |  |  |  |         |    |       |       |       |  |  |  |  |         |    |       |       |       |  |  |  |  |         |    |       |       |       |  |  |  |  |         |     |       |       |       |  |  |  |  |         |     |       |       |       |  |  |  |  |         |    |       |       |       |                |        |     |       |         |    |       |       |       |                |        |     |       |         |    |       |       |       |  |  |  |  |         |    |       |       |       |                |        |   |       |         |    |       |       |       |  |  |  |  |         |    |       |       |       |  |  |  |  |         |    |       |       |       |  |  |  |  |         |    |       |       |       |  |  |  |  |         |    |       |       |       |  |  |  |  |         |     |       |       |       |  |  |  |  |         |     |       |       |       |  |  |  |  |         |    |       |       |  |                |        |   |                           |         |    |       |       |  |                |        |   |                           |         |    |       |       |  |  |  |  |  |         |    |       |       |  |  |  |  |  |         |    |       |       |  |  |  |  |  |         |    |       |       |  |  |  |  |  |         |     |       |       |  |  |  |  |  |         |     |       |       |  |  |  |  |  |         |    |       |       |  |                |        |     |       |         |    |       |       |  |                |        |     |       |         |    |       |       |  |  |  |  |  |         |    |       |       |  |                |        |   |       |         |    |       |       |  |                |        |   |       |         |    |       |       |  |  |  |  |  |         |    |       |       |  |  |  |  |  |         |    |       |       |  |  |  |  |  |         |    |       |       |  |  |  |  |  |         |     |       |       |  |  |  |  |  |         |     |       |       |  |  |  |  |  |         |    |       |       |  |                |        |     |        |         |    |       |       |  |                |        |     |        |         |    |       |       |  |  |  |  |  |         |    |       |       |  |  |  |  |  |         |    |       |       |  |  |  |  |  |         |    |       |       |  |  |  |  |  |         |     |       |       |  |  |  |  |  |         |     |       |       |  |  |  |  |  |         |    |       |       |  |                |        |  |          |         |    |       |       |  |  |  |  |  |         |    |       |       |  |  |  |  |  |
| 2.2 dCi  | 66  | 07.02     | 08.06 | - ABS |                |        |                |                           |   |           |           |    |       |       |       |                |        |   |        |           |    |       |       |       |                |        |   |        |           |     |       |       |       |                |        |  |          |         |     |       |       |       |  |  |  |  |         |     |       |       |       |  |  |  |  |         |     |       |       |       |  |  |  |  |         |     |       |       |       |  |  |  |  |         |    |       |       |       |                |        |  |           |         |    |       |       |       |  |  |  |  |         |    |       |       |       |  |  |  |  |         |    |       |       |       |                |        |  |                      |         |    |       |       |       |  |  |  |  |         |    |       |       |       |  |  |  |  |         |    |       |       |       |  |  |  |  |         |    |       |       |       |  |  |  |  |         |    |       |       |       |  |  |  |  |         |     |       |       |       |  |  |  |  |         |     |       |       |       |  |  |  |  |         |    |       |       |       |                |        |     |       |         |    |       |       |       |                |        |     |       |         |    |       |       |       |  |  |  |  |         |    |       |       |       |  |  |  |  |         |    |       |       |       |  |  |  |  |         |    |       |       |       |  |  |  |  |         |     |       |       |       |  |  |  |  |         |     |       |       |       |  |  |  |  |         |    |       |       |       |                |        |     |       |         |    |       |       |       |                |        |     |       |         |    |       |       |       |  |  |  |  |         |    |       |       |       |                |        |   |       |         |    |       |       |       |  |  |  |  |         |    |       |       |       |  |  |  |  |         |    |       |       |       |  |  |  |  |         |    |       |       |       |  |  |  |  |         |    |       |       |       |  |  |  |  |         |     |       |       |       |  |  |  |  |         |     |       |       |       |  |  |  |  |         |    |       |       |  |                |        |   |                           |         |    |       |       |  |                |        |   |                           |         |    |       |       |  |  |  |  |  |         |    |       |       |  |  |  |  |  |         |    |       |       |  |  |  |  |  |         |    |       |       |  |  |  |  |  |         |     |       |       |  |  |  |  |  |         |     |       |       |  |  |  |  |  |         |    |       |       |  |                |        |     |       |         |    |       |       |  |                |        |     |       |         |    |       |       |  |  |  |  |  |         |    |       |       |  |                |        |   |       |         |    |       |       |  |                |        |   |       |         |    |       |       |  |  |  |  |  |         |    |       |       |  |  |  |  |  |         |    |       |       |  |  |  |  |  |         |    |       |       |  |  |  |  |  |         |     |       |       |  |  |  |  |  |         |     |       |       |  |  |  |  |  |         |    |       |       |  |                |        |     |        |         |    |       |       |  |                |        |     |        |         |    |       |       |  |  |  |  |  |         |    |       |       |  |  |  |  |  |         |    |       |       |  |  |  |  |  |         |    |       |       |  |  |  |  |  |         |     |       |       |  |  |  |  |  |         |     |       |       |  |  |  |  |  |         |    |       |       |  |                |        |  |          |         |    |       |       |  |  |  |  |  |         |    |       |       |  |  |  |  |  |
| 2.5 dCi  | 73  | 11.03     | 06.10 | - ABS |                |        |                |                           |   |           |           |    |       |       |       |                |        |   |        |           |    |       |       |       |                |        |   |        |           |     |       |       |       |                |        |  |          |         |     |       |       |       |  |  |  |  |         |     |       |       |       |  |  |  |  |         |     |       |       |       |  |  |  |  |         |     |       |       |       |  |  |  |  |         |    |       |       |       |                |        |  |           |         |    |       |       |       |  |  |  |  |         |    |       |       |       |  |  |  |  |         |    |       |       |       |                |        |  |                      |         |    |       |       |       |  |  |  |  |         |    |       |       |       |  |  |  |  |         |    |       |       |       |  |  |  |  |         |    |       |       |       |  |  |  |  |         |    |       |       |       |  |  |  |  |         |     |       |       |       |  |  |  |  |         |     |       |       |       |  |  |  |  |         |    |       |       |       |                |        |     |       |         |    |       |       |       |                |        |     |       |         |    |       |       |       |  |  |  |  |         |    |       |       |       |  |  |  |  |         |    |       |       |       |  |  |  |  |         |    |       |       |       |  |  |  |  |         |     |       |       |       |  |  |  |  |         |     |       |       |       |  |  |  |  |         |    |       |       |       |                |        |     |       |         |    |       |       |       |                |        |     |       |         |    |       |       |       |  |  |  |  |         |    |       |       |       |                |        |   |       |         |    |       |       |       |  |  |  |  |         |    |       |       |       |  |  |  |  |         |    |       |       |       |  |  |  |  |         |    |       |       |       |  |  |  |  |         |    |       |       |       |  |  |  |  |         |     |       |       |       |  |  |  |  |         |     |       |       |       |  |  |  |  |         |    |       |       |  |                |        |   |                           |         |    |       |       |  |                |        |   |                           |         |    |       |       |  |  |  |  |  |         |    |       |       |  |  |  |  |  |         |    |       |       |  |  |  |  |  |         |    |       |       |  |  |  |  |  |         |     |       |       |  |  |  |  |  |         |     |       |       |  |  |  |  |  |         |    |       |       |  |                |        |     |       |         |    |       |       |  |                |        |     |       |         |    |       |       |  |  |  |  |  |         |    |       |       |  |                |        |   |       |         |    |       |       |  |                |        |   |       |         |    |       |       |  |  |  |  |  |         |    |       |       |  |  |  |  |  |         |    |       |       |  |  |  |  |  |         |    |       |       |  |  |  |  |  |         |     |       |       |  |  |  |  |  |         |     |       |       |  |  |  |  |  |         |    |       |       |  |                |        |     |        |         |    |       |       |  |                |        |     |        |         |    |       |       |  |  |  |  |  |         |    |       |       |  |  |  |  |  |         |    |       |       |  |  |  |  |  |         |    |       |       |  |  |  |  |  |         |     |       |       |  |  |  |  |  |         |     |       |       |  |  |  |  |  |         |    |       |       |  |                |        |  |          |         |    |       |       |  |  |  |  |  |         |    |       |       |  |  |  |  |  |
| 2.5 dCi  | 74  | 04.06     | 06.10 | - ABS |                |        |                |                           |   |           |           |    |       |       |       |                |        |   |        |           |    |       |       |       |                |        |   |        |           |     |       |       |       |                |        |  |          |         |     |       |       |       |  |  |  |  |         |     |       |       |       |  |  |  |  |         |     |       |       |       |  |  |  |  |         |     |       |       |       |  |  |  |  |         |    |       |       |       |                |        |  |           |         |    |       |       |       |  |  |  |  |         |    |       |       |       |  |  |  |  |         |    |       |       |       |                |        |  |                      |         |    |       |       |       |  |  |  |  |         |    |       |       |       |  |  |  |  |         |    |       |       |       |  |  |  |  |         |    |       |       |       |  |  |  |  |         |    |       |       |       |  |  |  |  |         |     |       |       |       |  |  |  |  |         |     |       |       |       |  |  |  |  |         |    |       |       |       |                |        |     |       |         |    |       |       |       |                |        |     |       |         |    |       |       |       |  |  |  |  |         |    |       |       |       |  |  |  |  |         |    |       |       |       |  |  |  |  |         |    |       |       |       |  |  |  |  |         |     |       |       |       |  |  |  |  |         |     |       |       |       |  |  |  |  |         |    |       |       |       |                |        |     |       |         |    |       |       |       |                |        |     |       |         |    |       |       |       |  |  |  |  |         |    |       |       |       |                |        |   |       |         |    |       |       |       |  |  |  |  |         |    |       |       |       |  |  |  |  |         |    |       |       |       |  |  |  |  |         |    |       |       |       |  |  |  |  |         |    |       |       |       |  |  |  |  |         |     |       |       |       |  |  |  |  |         |     |       |       |       |  |  |  |  |         |    |       |       |  |                |        |   |                           |         |    |       |       |  |                |        |   |                           |         |    |       |       |  |  |  |  |  |         |    |       |       |  |  |  |  |  |         |    |       |       |  |  |  |  |  |         |    |       |       |  |  |  |  |  |         |     |       |       |  |  |  |  |  |         |     |       |       |  |  |  |  |  |         |    |       |       |  |                |        |     |       |         |    |       |       |  |                |        |     |       |         |    |       |       |  |  |  |  |  |         |    |       |       |  |                |        |   |       |         |    |       |       |  |                |        |   |       |         |    |       |       |  |  |  |  |  |         |    |       |       |  |  |  |  |  |         |    |       |       |  |  |  |  |  |         |    |       |       |  |  |  |  |  |         |     |       |       |  |  |  |  |  |         |     |       |       |  |  |  |  |  |         |    |       |       |  |                |        |     |        |         |    |       |       |  |                |        |     |        |         |    |       |       |  |  |  |  |  |         |    |       |       |  |  |  |  |  |         |    |       |       |  |  |  |  |  |         |    |       |       |  |  |  |  |  |         |     |       |       |  |  |  |  |  |         |     |       |       |  |  |  |  |  |         |    |       |       |  |                |        |  |          |         |    |       |       |  |  |  |  |  |         |    |       |       |  |  |  |  |  |
| 2.5 dCi  | 84  | 07.02     | 08.06 | - ABS |                |        |                |                           |   |           |           |    |       |       |       |                |        |   |        |           |    |       |       |       |                |        |   |        |           |     |       |       |       |                |        |  |          |         |     |       |       |       |  |  |  |  |         |     |       |       |       |  |  |  |  |         |     |       |       |       |  |  |  |  |         |     |       |       |       |  |  |  |  |         |    |       |       |       |                |        |  |           |         |    |       |       |       |  |  |  |  |         |    |       |       |       |  |  |  |  |         |    |       |       |       |                |        |  |                      |         |    |       |       |       |  |  |  |  |         |    |       |       |       |  |  |  |  |         |    |       |       |       |  |  |  |  |         |    |       |       |       |  |  |  |  |         |    |       |       |       |  |  |  |  |         |     |       |       |       |  |  |  |  |         |     |       |       |       |  |  |  |  |         |    |       |       |       |                |        |     |       |         |    |       |       |       |                |        |     |       |         |    |       |       |       |  |  |  |  |         |    |       |       |       |  |  |  |  |         |    |       |       |       |  |  |  |  |         |    |       |       |       |  |  |  |  |         |     |       |       |       |  |  |  |  |         |     |       |       |       |  |  |  |  |         |    |       |       |       |                |        |     |       |         |    |       |       |       |                |        |     |       |         |    |       |       |       |  |  |  |  |         |    |       |       |       |                |        |   |       |         |    |       |       |       |  |  |  |  |         |    |       |       |       |  |  |  |  |         |    |       |       |       |  |  |  |  |         |    |       |       |       |  |  |  |  |         |    |       |       |       |  |  |  |  |         |     |       |       |       |  |  |  |  |         |     |       |       |       |  |  |  |  |         |    |       |       |  |                |        |   |                           |         |    |       |       |  |                |        |   |                           |         |    |       |       |  |  |  |  |  |         |    |       |       |  |  |  |  |  |         |    |       |       |  |  |  |  |  |         |    |       |       |  |  |  |  |  |         |     |       |       |  |  |  |  |  |         |     |       |       |  |  |  |  |  |         |    |       |       |  |                |        |     |       |         |    |       |       |  |                |        |     |       |         |    |       |       |  |  |  |  |  |         |    |       |       |  |                |        |   |       |         |    |       |       |  |                |        |   |       |         |    |       |       |  |  |  |  |  |         |    |       |       |  |  |  |  |  |         |    |       |       |  |  |  |  |  |         |    |       |       |  |  |  |  |  |         |     |       |       |  |  |  |  |  |         |     |       |       |  |  |  |  |  |         |    |       |       |  |                |        |     |        |         |    |       |       |  |                |        |     |        |         |    |       |       |  |  |  |  |  |         |    |       |       |  |  |  |  |  |         |    |       |       |  |  |  |  |  |         |    |       |       |  |  |  |  |  |         |     |       |       |  |  |  |  |  |         |     |       |       |  |  |  |  |  |         |    |       |       |  |                |        |  |          |         |    |       |       |  |  |  |  |  |         |    |       |       |  |  |  |  |  |
| 2.5 dCi  | 88  | 09.06     | 06.10 | - ABS |                |        |                |                           |   |           |           |    |       |       |       |                |        |   |        |           |    |       |       |       |                |        |   |        |           |     |       |       |       |                |        |  |          |         |     |       |       |       |  |  |  |  |         |     |       |       |       |  |  |  |  |         |     |       |       |       |  |  |  |  |         |     |       |       |       |  |  |  |  |         |    |       |       |       |                |        |  |           |         |    |       |       |       |  |  |  |  |         |    |       |       |       |  |  |  |  |         |    |       |       |       |                |        |  |                      |         |    |       |       |       |  |  |  |  |         |    |       |       |       |  |  |  |  |         |    |       |       |       |  |  |  |  |         |    |       |       |       |  |  |  |  |         |    |       |       |       |  |  |  |  |         |     |       |       |       |  |  |  |  |         |     |       |       |       |  |  |  |  |         |    |       |       |       |                |        |     |       |         |    |       |       |       |                |        |     |       |         |    |       |       |       |  |  |  |  |         |    |       |       |       |  |  |  |  |         |    |       |       |       |  |  |  |  |         |    |       |       |       |  |  |  |  |         |     |       |       |       |  |  |  |  |         |     |       |       |       |  |  |  |  |         |    |       |       |       |                |        |     |       |         |    |       |       |       |                |        |     |       |         |    |       |       |       |  |  |  |  |         |    |       |       |       |                |        |   |       |         |    |       |       |       |  |  |  |  |         |    |       |       |       |  |  |  |  |         |    |       |       |       |  |  |  |  |         |    |       |       |       |  |  |  |  |         |    |       |       |       |  |  |  |  |         |     |       |       |       |  |  |  |  |         |     |       |       |       |  |  |  |  |         |    |       |       |  |                |        |   |                           |         |    |       |       |  |                |        |   |                           |         |    |       |       |  |  |  |  |  |         |    |       |       |  |  |  |  |  |         |    |       |       |  |  |  |  |  |         |    |       |       |  |  |  |  |  |         |     |       |       |  |  |  |  |  |         |     |       |       |  |  |  |  |  |         |    |       |       |  |                |        |     |       |         |    |       |       |  |                |        |     |       |         |    |       |       |  |  |  |  |  |         |    |       |       |  |                |        |   |       |         |    |       |       |  |                |        |   |       |         |    |       |       |  |  |  |  |  |         |    |       |       |  |  |  |  |  |         |    |       |       |  |  |  |  |  |         |    |       |       |  |  |  |  |  |         |     |       |       |  |  |  |  |  |         |     |       |       |  |  |  |  |  |         |    |       |       |  |                |        |     |        |         |    |       |       |  |                |        |     |        |         |    |       |       |  |  |  |  |  |         |    |       |       |  |  |  |  |  |         |    |       |       |  |  |  |  |  |         |    |       |       |  |  |  |  |  |         |     |       |       |  |  |  |  |  |         |     |       |       |  |  |  |  |  |         |    |       |       |  |                |        |  |          |         |    |       |       |  |  |  |  |  |         |    |       |       |  |  |  |  |  |
| 2.5 dCi  | 107   | 09.06     | 06.10 | - ABS |                |        |                |                           |   |           |           |    |       |       |       |                |        |   |        |           |    |       |       |       |                |        |   |        |           |     |       |       |       |                |        |  |          |         |     |       |       |       |  |  |  |  |         |     |       |       |       |  |  |  |  |         |     |       |       |       |  |  |  |  |         |     |       |       |       |  |  |  |  |         |    |       |       |       |                |        |  |           |         |    |       |       |       |  |  |  |  |         |    |       |       |       |  |  |  |  |         |    |       |       |       |                |        |  |                      |         |    |       |       |       |  |  |  |  |         |    |       |       |       |  |  |  |  |         |    |       |       |       |  |  |  |  |         |    |       |       |       |  |  |  |  |         |    |       |       |       |  |  |  |  |         |     |       |       |       |  |  |  |  |         |     |       |       |       |  |  |  |  |         |    |       |       |       |                |        |     |       |         |    |       |       |       |                |        |     |       |         |    |       |       |       |  |  |  |  |         |    |       |       |       |  |  |  |  |         |    |       |       |       |  |  |  |  |         |    |       |       |       |  |  |  |  |         |     |       |       |       |  |  |  |  |         |     |       |       |       |  |  |  |  |         |    |       |       |       |                |        |     |       |         |    |       |       |       |                |        |     |       |         |    |       |       |       |  |  |  |  |         |    |       |       |       |                |        |   |       |         |    |       |       |       |  |  |  |  |         |    |       |       |       |  |  |  |  |         |    |       |       |       |  |  |  |  |         |    |       |       |       |  |  |  |  |         |    |       |       |       |  |  |  |  |         |     |       |       |       |  |  |  |  |         |     |       |       |       |  |  |  |  |         |    |       |       |  |                |        |   |                           |         |    |       |       |  |                |        |   |                           |         |    |       |       |  |  |  |  |  |         |    |       |       |  |  |  |  |  |         |    |       |       |  |  |  |  |  |         |    |       |       |  |  |  |  |  |         |     |       |       |  |  |  |  |  |         |     |       |       |  |  |  |  |  |         |    |       |       |  |                |        |     |       |         |    |       |       |  |                |        |     |       |         |    |       |       |  |  |  |  |  |         |    |       |       |  |                |        |   |       |         |    |       |       |  |                |        |   |       |         |    |       |       |  |  |  |  |  |         |    |       |       |  |  |  |  |  |         |    |       |       |  |  |  |  |  |         |    |       |       |  |  |  |  |  |         |     |       |       |  |  |  |  |  |         |     |       |       |  |  |  |  |  |         |    |       |       |  |                |        |     |        |         |    |       |       |  |                |        |     |        |         |    |       |       |  |  |  |  |  |         |    |       |       |  |  |  |  |  |         |    |       |       |  |  |  |  |  |         |    |       |       |  |  |  |  |  |         |     |       |       |  |  |  |  |  |         |     |       |       |  |  |  |  |  |         |    |       |       |  |                |        |  |          |         |    |       |       |  |  |  |  |  |         |    |       |       |  |  |  |  |  |
| 3.0 dCi  | 100   | 11.03     | 08.06 | - ABS |                |        |                |                           |   |           |           |    |       |       |       |                |        |   |        |           |    |       |       |       |                |        |   |        |           |     |       |       |       |                |        |  |          |         |     |       |       |       |  |  |  |  |         |     |       |       |       |  |  |  |  |         |     |       |       |       |  |  |  |  |         |     |       |       |       |  |  |  |  |         |    |       |       |       |                |        |  |           |         |    |       |       |       |  |  |  |  |         |    |       |       |       |  |  |  |  |         |    |       |       |       |                |        |  |                      |         |    |       |       |       |  |  |  |  |         |    |       |       |       |  |  |  |  |         |    |       |       |       |  |  |  |  |         |    |       |       |       |  |  |  |  |         |    |       |       |       |  |  |  |  |         |     |       |       |       |  |  |  |  |         |     |       |       |       |  |  |  |  |         |    |       |       |       |                |        |     |       |         |    |       |       |       |                |        |     |       |         |    |       |       |       |  |  |  |  |         |    |       |       |       |  |  |  |  |         |    |       |       |       |  |  |  |  |         |    |       |       |       |  |  |  |  |         |     |       |       |       |  |  |  |  |         |     |       |       |       |  |  |  |  |         |    |       |       |       |                |        |     |       |         |    |       |       |       |                |        |     |       |         |    |       |       |       |  |  |  |  |         |    |       |       |       |                |        |   |       |         |    |       |       |       |  |  |  |  |         |    |       |       |       |  |  |  |  |         |    |       |       |       |  |  |  |  |         |    |       |       |       |  |  |  |  |         |    |       |       |       |  |  |  |  |         |     |       |       |       |  |  |  |  |         |     |       |       |       |  |  |  |  |         |    |       |       |  |                |        |   |                           |         |    |       |       |  |                |        |   |                           |         |    |       |       |  |  |  |  |  |         |    |       |       |  |  |  |  |  |         |    |       |       |  |  |  |  |  |         |    |       |       |  |  |  |  |  |         |     |       |       |  |  |  |  |  |         |     |       |       |  |  |  |  |  |         |    |       |       |  |                |        |     |       |         |    |       |       |  |                |        |     |       |         |    |       |       |  |  |  |  |  |         |    |       |       |  |                |        |   |       |         |    |       |       |  |                |        |   |       |         |    |       |       |  |  |  |  |  |         |    |       |       |  |  |  |  |  |         |    |       |       |  |  |  |  |  |         |    |       |       |  |  |  |  |  |         |     |       |       |  |  |  |  |  |         |     |       |       |  |  |  |  |  |         |    |       |       |  |                |        |     |        |         |    |       |       |  |                |        |     |        |         |    |       |       |  |  |  |  |  |         |    |       |       |  |  |  |  |  |         |    |       |       |  |  |  |  |  |         |    |       |       |  |  |  |  |  |         |     |       |       |  |  |  |  |  |         |     |       |       |  |  |  |  |  |         |    |       |       |  |                |        |  |          |         |    |       |       |  |  |  |  |  |         |    |       |       |  |  |  |  |  |
| 1.9 dCi  | 60  | 07.02     | 12.02 | + ABS | 24.2025-1706.3 | 010676 |                | THz 25,40                 |   |           |           |    |       |       |       |                |        |   |        |           |    |       |       |       |                |        |   |        |           |     |       |       |       |                |        |  |          |         |     |       |       |       |  |  |  |  |         |     |       |       |       |  |  |  |  |         |     |       |       |       |  |  |  |  |         |     |       |       |       |  |  |  |  |         |    |       |       |       |                |        |  |           |         |    |       |       |       |  |  |  |  |         |    |       |       |       |  |  |  |  |         |    |       |       |       |                |        |  |                      |         |    |       |       |       |  |  |  |  |         |    |       |       |       |  |  |  |  |         |    |       |       |       |  |  |  |  |         |    |       |       |       |  |  |  |  |         |    |       |       |       |  |  |  |  |         |     |       |       |       |  |  |  |  |         |     |       |       |       |  |  |  |  |         |    |       |       |       |                |        |     |       |         |    |       |       |       |                |        |     |       |         |    |       |       |       |  |  |  |  |         |    |       |       |       |  |  |  |  |         |    |       |       |       |  |  |  |  |         |    |       |       |       |  |  |  |  |         |     |       |       |       |  |  |  |  |         |     |       |       |       |  |  |  |  |         |    |       |       |       |                |        |     |       |         |    |       |       |       |                |        |     |       |         |    |       |       |       |  |  |  |  |         |    |       |       |       |                |        |   |       |         |    |       |       |       |  |  |  |  |         |    |       |       |       |  |  |  |  |         |    |       |       |       |  |  |  |  |         |    |       |       |       |  |  |  |  |         |    |       |       |       |  |  |  |  |         |     |       |       |       |  |  |  |  |         |     |       |       |       |  |  |  |  |         |    |       |       |  |                |        |   |                           |         |    |       |       |  |                |        |   |                           |         |    |       |       |  |  |  |  |  |         |    |       |       |  |  |  |  |  |         |    |       |       |  |  |  |  |  |         |    |       |       |  |  |  |  |  |         |     |       |       |  |  |  |  |  |         |     |       |       |  |  |  |  |  |         |    |       |       |  |                |        |     |       |         |    |       |       |  |                |        |     |       |         |    |       |       |  |  |  |  |  |         |    |       |       |  |                |        |   |       |         |    |       |       |  |                |        |   |       |         |    |       |       |  |  |  |  |  |         |    |       |       |  |  |  |  |  |         |    |       |       |  |  |  |  |  |         |    |       |       |  |  |  |  |  |         |     |       |       |  |  |  |  |  |         |     |       |       |  |  |  |  |  |         |    |       |       |  |                |        |     |        |         |    |       |       |  |                |        |     |        |         |    |       |       |  |  |  |  |  |         |    |       |       |  |  |  |  |  |         |    |       |       |  |  |  |  |  |         |    |       |       |  |  |  |  |  |         |     |       |       |  |  |  |  |  |         |     |       |       |  |  |  |  |  |         |    |       |       |  |                |        |  |          |         |    |       |       |  |  |  |  |  |         |    |       |       |  |  |  |  |  |
| 2.2 dCi  | 66  | 07.02     | 12.02 | + ABS |                |        |                |                           |   |           |           |    |       |       |       |                |        |   |        |           |    |       |       |       |                |        |   |        |           |     |       |       |       |                |        |  |          |         |     |       |       |       |  |  |  |  |         |     |       |       |       |  |  |  |  |         |     |       |       |       |  |  |  |  |         |     |       |       |       |  |  |  |  |         |    |       |       |       |                |        |  |           |         |    |       |       |       |  |  |  |  |         |    |       |       |       |  |  |  |  |         |    |       |       |       |                |        |  |                      |         |    |       |       |       |  |  |  |  |         |    |       |       |       |  |  |  |  |         |    |       |       |       |  |  |  |  |         |    |       |       |       |  |  |  |  |         |    |       |       |       |  |  |  |  |         |     |       |       |       |  |  |  |  |         |     |       |       |       |  |  |  |  |         |    |       |       |       |                |        |     |       |         |    |       |       |       |                |        |     |       |         |    |       |       |       |  |  |  |  |         |    |       |       |       |  |  |  |  |         |    |       |       |       |  |  |  |  |         |    |       |       |       |  |  |  |  |         |     |       |       |       |  |  |  |  |         |     |       |       |       |  |  |  |  |         |    |       |       |       |                |        |     |       |         |    |       |       |       |                |        |     |       |         |    |       |       |       |  |  |  |  |         |    |       |       |       |                |        |   |       |         |    |       |       |       |  |  |  |  |         |    |       |       |       |  |  |  |  |         |    |       |       |       |  |  |  |  |         |    |       |       |       |  |  |  |  |         |    |       |       |       |  |  |  |  |         |     |       |       |       |  |  |  |  |         |     |       |       |       |  |  |  |  |         |    |       |       |  |                |        |   |                           |         |    |       |       |  |                |        |   |                           |         |    |       |       |  |  |  |  |  |         |    |       |       |  |  |  |  |  |         |    |       |       |  |  |  |  |  |         |    |       |       |  |  |  |  |  |         |     |       |       |  |  |  |  |  |         |     |       |       |  |  |  |  |  |         |    |       |       |  |                |        |     |       |         |    |       |       |  |                |        |     |       |         |    |       |       |  |  |  |  |  |         |    |       |       |  |                |        |   |       |         |    |       |       |  |                |        |   |       |         |    |       |       |  |  |  |  |  |         |    |       |       |  |  |  |  |  |         |    |       |       |  |  |  |  |  |         |    |       |       |  |  |  |  |  |         |     |       |       |  |  |  |  |  |         |     |       |       |  |  |  |  |  |         |    |       |       |  |                |        |     |        |         |    |       |       |  |                |        |     |        |         |    |       |       |  |  |  |  |  |         |    |       |       |  |  |  |  |  |         |    |       |       |  |  |  |  |  |         |    |       |       |  |  |  |  |  |         |     |       |       |  |  |  |  |  |         |     |       |       |  |  |  |  |  |         |    |       |       |  |                |        |  |          |         |    |       |       |  |  |  |  |  |         |    |       |       |  |  |  |  |  |
| 2.5 dCi  | 84  | 07.02     | 12.02 | + ABS |                |        |                |                           |   |           |           |    |       |       |       |                |        |   |        |           |    |       |       |       |                |        |   |        |           |     |       |       |       |                |        |  |          |         |     |       |       |       |  |  |  |  |         |     |       |       |       |  |  |  |  |         |     |       |       |       |  |  |  |  |         |     |       |       |       |  |  |  |  |         |    |       |       |       |                |        |  |           |         |    |       |       |       |  |  |  |  |         |    |       |       |       |  |  |  |  |         |    |       |       |       |                |        |  |                      |         |    |       |       |       |  |  |  |  |         |    |       |       |       |  |  |  |  |         |    |       |       |       |  |  |  |  |         |    |       |       |       |  |  |  |  |         |    |       |       |       |  |  |  |  |         |     |       |       |       |  |  |  |  |         |     |       |       |       |  |  |  |  |         |    |       |       |       |                |        |     |       |         |    |       |       |       |                |        |     |       |         |    |       |       |       |  |  |  |  |         |    |       |       |       |  |  |  |  |         |    |       |       |       |  |  |  |  |         |    |       |       |       |  |  |  |  |         |     |       |       |       |  |  |  |  |         |     |       |       |       |  |  |  |  |         |    |       |       |       |                |        |     |       |         |    |       |       |       |                |        |     |       |         |    |       |       |       |  |  |  |  |         |    |       |       |       |                |        |   |       |         |    |       |       |       |  |  |  |  |         |    |       |       |       |  |  |  |  |         |    |       |       |       |  |  |  |  |         |    |       |       |       |  |  |  |  |         |    |       |       |       |  |  |  |  |         |     |       |       |       |  |  |  |  |         |     |       |       |       |  |  |  |  |         |    |       |       |  |                |        |   |                           |         |    |       |       |  |                |        |   |                           |         |    |       |       |  |  |  |  |  |         |    |       |       |  |  |  |  |  |         |    |       |       |  |  |  |  |  |         |    |       |       |  |  |  |  |  |         |     |       |       |  |  |  |  |  |         |     |       |       |  |  |  |  |  |         |    |       |       |  |                |        |     |       |         |    |       |       |  |                |        |     |       |         |    |       |       |  |  |  |  |  |         |    |       |       |  |                |        |   |       |         |    |       |       |  |                |        |   |       |         |    |       |       |  |  |  |  |  |         |    |       |       |  |  |  |  |  |         |    |       |       |  |  |  |  |  |         |    |       |       |  |  |  |  |  |         |     |       |       |  |  |  |  |  |         |     |       |       |  |  |  |  |  |         |    |       |       |  |                |        |     |        |         |    |       |       |  |                |        |     |        |         |    |       |       |  |  |  |  |  |         |    |       |       |  |  |  |  |  |         |    |       |       |  |  |  |  |  |         |    |       |       |  |  |  |  |  |         |     |       |       |  |  |  |  |  |         |     |       |       |  |  |  |  |  |         |    |       |       |  |                |        |  |          |         |    |       |       |  |  |  |  |  |         |    |       |       |  |  |  |  |  |
| 1.9 dCi  | 60  | 01.03     | 08.06 | + ABS | 24.2123-1759.3 | 010768 |                | THz 23,81 <b>BOS</b>      |   |           |           |    |       |       |       |                |        |   |        |           |    |       |       |       |                |        |   |        |           |     |       |       |       |                |        |  |          |         |     |       |       |       |  |  |  |  |         |     |       |       |       |  |  |  |  |         |     |       |       |       |  |  |  |  |         |     |       |       |       |  |  |  |  |         |    |       |       |       |                |        |  |           |         |    |       |       |       |  |  |  |  |         |    |       |       |       |  |  |  |  |         |    |       |       |       |                |        |  |                      |         |    |       |       |       |  |  |  |  |         |    |       |       |       |  |  |  |  |         |    |       |       |       |  |  |  |  |         |    |       |       |       |  |  |  |  |         |    |       |       |       |  |  |  |  |         |     |       |       |       |  |  |  |  |         |     |       |       |       |  |  |  |  |         |    |       |       |       |                |        |     |       |         |    |       |       |       |                |        |     |       |         |    |       |       |       |  |  |  |  |         |    |       |       |       |  |  |  |  |         |    |       |       |       |  |  |  |  |         |    |       |       |       |  |  |  |  |         |     |       |       |       |  |  |  |  |         |     |       |       |       |  |  |  |  |         |    |       |       |       |                |        |     |       |         |    |       |       |       |                |        |     |       |         |    |       |       |       |  |  |  |  |         |    |       |       |       |                |        |   |       |         |    |       |       |       |  |  |  |  |         |    |       |       |       |  |  |  |  |         |    |       |       |       |  |  |  |  |         |    |       |       |       |  |  |  |  |         |    |       |       |       |  |  |  |  |         |     |       |       |       |  |  |  |  |         |     |       |       |       |  |  |  |  |         |    |       |       |  |                |        |   |                           |         |    |       |       |  |                |        |   |                           |         |    |       |       |  |  |  |  |  |         |    |       |       |  |  |  |  |  |         |    |       |       |  |  |  |  |  |         |    |       |       |  |  |  |  |  |         |     |       |       |  |  |  |  |  |         |     |       |       |  |  |  |  |  |         |    |       |       |  |                |        |     |       |         |    |       |       |  |                |        |     |       |         |    |       |       |  |  |  |  |  |         |    |       |       |  |                |        |   |       |         |    |       |       |  |                |        |   |       |         |    |       |       |  |  |  |  |  |         |    |       |       |  |  |  |  |  |         |    |       |       |  |  |  |  |  |         |    |       |       |  |  |  |  |  |         |     |       |       |  |  |  |  |  |         |     |       |       |  |  |  |  |  |         |    |       |       |  |                |        |     |        |         |    |       |       |  |                |        |     |        |         |    |       |       |  |  |  |  |  |         |    |       |       |  |  |  |  |  |         |    |       |       |  |  |  |  |  |         |    |       |       |  |  |  |  |  |         |     |       |       |  |  |  |  |  |         |     |       |       |  |  |  |  |  |         |    |       |       |  |                |        |  |          |         |    |       |       |  |  |  |  |  |         |    |       |       |  |  |  |  |  |
| 2.2 dCi  | 66  | 01.03     | 08.06 | + ABS |                |        |                |                           |   |           |           |    |       |       |       |                |        |   |        |           |    |       |       |       |                |        |   |        |           |     |       |       |       |                |        |  |          |         |     |       |       |       |  |  |  |  |         |     |       |       |       |  |  |  |  |         |     |       |       |       |  |  |  |  |         |     |       |       |       |  |  |  |  |         |    |       |       |       |                |        |  |           |         |    |       |       |       |  |  |  |  |         |    |       |       |       |  |  |  |  |         |    |       |       |       |                |        |  |                      |         |    |       |       |       |  |  |  |  |         |    |       |       |       |  |  |  |  |         |    |       |       |       |  |  |  |  |         |    |       |       |       |  |  |  |  |         |    |       |       |       |  |  |  |  |         |     |       |       |       |  |  |  |  |         |     |       |       |       |  |  |  |  |         |    |       |       |       |                |        |     |       |         |    |       |       |       |                |        |     |       |         |    |       |       |       |  |  |  |  |         |    |       |       |       |  |  |  |  |         |    |       |       |       |  |  |  |  |         |    |       |       |       |  |  |  |  |         |     |       |       |       |  |  |  |  |         |     |       |       |       |  |  |  |  |         |    |       |       |       |                |        |     |       |         |    |       |       |       |                |        |     |       |         |    |       |       |       |  |  |  |  |         |    |       |       |       |                |        |   |       |         |    |       |       |       |  |  |  |  |         |    |       |       |       |  |  |  |  |         |    |       |       |       |  |  |  |  |         |    |       |       |       |  |  |  |  |         |    |       |       |       |  |  |  |  |         |     |       |       |       |  |  |  |  |         |     |       |       |       |  |  |  |  |         |    |       |       |  |                |        |   |                           |         |    |       |       |  |                |        |   |                           |         |    |       |       |  |  |  |  |  |         |    |       |       |  |  |  |  |  |         |    |       |       |  |  |  |  |  |         |    |       |       |  |  |  |  |  |         |     |       |       |  |  |  |  |  |         |     |       |       |  |  |  |  |  |         |    |       |       |  |                |        |     |       |         |    |       |       |  |                |        |     |       |         |    |       |       |  |  |  |  |  |         |    |       |       |  |                |        |   |       |         |    |       |       |  |                |        |   |       |         |    |       |       |  |  |  |  |  |         |    |       |       |  |  |  |  |  |         |    |       |       |  |  |  |  |  |         |    |       |       |  |  |  |  |  |         |     |       |       |  |  |  |  |  |         |     |       |       |  |  |  |  |  |         |    |       |       |  |                |        |     |        |         |    |       |       |  |                |        |     |        |         |    |       |       |  |  |  |  |  |         |    |       |       |  |  |  |  |  |         |    |       |       |  |  |  |  |  |         |    |       |       |  |  |  |  |  |         |     |       |       |  |  |  |  |  |         |     |       |       |  |  |  |  |  |         |    |       |       |  |                |        |  |          |         |    |       |       |  |  |  |  |  |         |    |       |       |  |  |  |  |  |
| 2.5 dCi  | 73  | 11.03     | 06.10 | + ABS |                |        |                |                           |   |           |           |    |       |       |       |                |        |   |        |           |    |       |       |       |                |        |   |        |           |     |       |       |       |                |        |  |          |         |     |       |       |       |  |  |  |  |         |     |       |       |       |  |  |  |  |         |     |       |       |       |  |  |  |  |         |     |       |       |       |  |  |  |  |         |    |       |       |       |                |        |  |           |         |    |       |       |       |  |  |  |  |         |    |       |       |       |  |  |  |  |         |    |       |       |       |                |        |  |                      |         |    |       |       |       |  |  |  |  |         |    |       |       |       |  |  |  |  |         |    |       |       |       |  |  |  |  |         |    |       |       |       |  |  |  |  |         |    |       |       |       |  |  |  |  |         |     |       |       |       |  |  |  |  |         |     |       |       |       |  |  |  |  |         |    |       |       |       |                |        |     |       |         |    |       |       |       |                |        |     |       |         |    |       |       |       |  |  |  |  |         |    |       |       |       |  |  |  |  |         |    |       |       |       |  |  |  |  |         |    |       |       |       |  |  |  |  |         |     |       |       |       |  |  |  |  |         |     |       |       |       |  |  |  |  |         |    |       |       |       |                |        |     |       |         |    |       |       |       |                |        |     |       |         |    |       |       |       |  |  |  |  |         |    |       |       |       |                |        |   |       |         |    |       |       |       |  |  |  |  |         |    |       |       |       |  |  |  |  |         |    |       |       |       |  |  |  |  |         |    |       |       |       |  |  |  |  |         |    |       |       |       |  |  |  |  |         |     |       |       |       |  |  |  |  |         |     |       |       |       |  |  |  |  |         |    |       |       |  |                |        |   |                           |         |    |       |       |  |                |        |   |                           |         |    |       |       |  |  |  |  |  |         |    |       |       |  |  |  |  |  |         |    |       |       |  |  |  |  |  |         |    |       |       |  |  |  |  |  |         |     |       |       |  |  |  |  |  |         |     |       |       |  |  |  |  |  |         |    |       |       |  |                |        |     |       |         |    |       |       |  |                |        |     |       |         |    |       |       |  |  |  |  |  |         |    |       |       |  |                |        |   |       |         |    |       |       |  |                |        |   |       |         |    |       |       |  |  |  |  |  |         |    |       |       |  |  |  |  |  |         |    |       |       |  |  |  |  |  |         |    |       |       |  |  |  |  |  |         |     |       |       |  |  |  |  |  |         |     |       |       |  |  |  |  |  |         |    |       |       |  |                |        |     |        |         |    |       |       |  |                |        |     |        |         |    |       |       |  |  |  |  |  |         |    |       |       |  |  |  |  |  |         |    |       |       |  |  |  |  |  |         |    |       |       |  |  |  |  |  |         |     |       |       |  |  |  |  |  |         |     |       |       |  |  |  |  |  |         |    |       |       |  |                |        |  |          |         |    |       |       |  |  |  |  |  |         |    |       |       |  |  |  |  |  |
| 2.5 dCi  | 74  | 04.06     | 06.10 | + ABS |                |        |                |                           |   |           |           |    |       |       |       |                |        |   |        |           |    |       |       |       |                |        |   |        |           |     |       |       |       |                |        |  |          |         |     |       |       |       |  |  |  |  |         |     |       |       |       |  |  |  |  |         |     |       |       |       |  |  |  |  |         |     |       |       |       |  |  |  |  |         |    |       |       |       |                |        |  |           |         |    |       |       |       |  |  |  |  |         |    |       |       |       |  |  |  |  |         |    |       |       |       |                |        |  |                      |         |    |       |       |       |  |  |  |  |         |    |       |       |       |  |  |  |  |         |    |       |       |       |  |  |  |  |         |    |       |       |       |  |  |  |  |         |    |       |       |       |  |  |  |  |         |     |       |       |       |  |  |  |  |         |     |       |       |       |  |  |  |  |         |    |       |       |       |                |        |     |       |         |    |       |       |       |                |        |     |       |         |    |       |       |       |  |  |  |  |         |    |       |       |       |  |  |  |  |         |    |       |       |       |  |  |  |  |         |    |       |       |       |  |  |  |  |         |     |       |       |       |  |  |  |  |         |     |       |       |       |  |  |  |  |         |    |       |       |       |                |        |     |       |         |    |       |       |       |                |        |     |       |         |    |       |       |       |  |  |  |  |         |    |       |       |       |                |        |   |       |         |    |       |       |       |  |  |  |  |         |    |       |       |       |  |  |  |  |         |    |       |       |       |  |  |  |  |         |    |       |       |       |  |  |  |  |         |    |       |       |       |  |  |  |  |         |     |       |       |       |  |  |  |  |         |     |       |       |       |  |  |  |  |         |    |       |       |  |                |        |   |                           |         |    |       |       |  |                |        |   |                           |         |    |       |       |  |  |  |  |  |         |    |       |       |  |  |  |  |  |         |    |       |       |  |  |  |  |  |         |    |       |       |  |  |  |  |  |         |     |       |       |  |  |  |  |  |         |     |       |       |  |  |  |  |  |         |    |       |       |  |                |        |     |       |         |    |       |       |  |                |        |     |       |         |    |       |       |  |  |  |  |  |         |    |       |       |  |                |        |   |       |         |    |       |       |  |                |        |   |       |         |    |       |       |  |  |  |  |  |         |    |       |       |  |  |  |  |  |         |    |       |       |  |  |  |  |  |         |    |       |       |  |  |  |  |  |         |     |       |       |  |  |  |  |  |         |     |       |       |  |  |  |  |  |         |    |       |       |  |                |        |     |        |         |    |       |       |  |                |        |     |        |         |    |       |       |  |  |  |  |  |         |    |       |       |  |  |  |  |  |         |    |       |       |  |  |  |  |  |         |    |       |       |  |  |  |  |  |         |     |       |       |  |  |  |  |  |         |     |       |       |  |  |  |  |  |         |    |       |       |  |                |        |  |          |         |    |       |       |  |  |  |  |  |         |    |       |       |  |  |  |  |  |
| 2.5 dCi  | 84  | 01.03     | 08.06 | + ABS |                |        |                |                           |   |           |           |    |       |       |       |                |        |   |        |           |    |       |       |       |                |        |   |        |           |     |       |       |       |                |        |  |          |         |     |       |       |       |  |  |  |  |         |     |       |       |       |  |  |  |  |         |     |       |       |       |  |  |  |  |         |     |       |       |       |  |  |  |  |         |    |       |       |       |                |        |  |           |         |    |       |       |       |  |  |  |  |         |    |       |       |       |  |  |  |  |         |    |       |       |       |                |        |  |                      |         |    |       |       |       |  |  |  |  |         |    |       |       |       |  |  |  |  |         |    |       |       |       |  |  |  |  |         |    |       |       |       |  |  |  |  |         |    |       |       |       |  |  |  |  |         |     |       |       |       |  |  |  |  |         |     |       |       |       |  |  |  |  |         |    |       |       |       |                |        |     |       |         |    |       |       |       |                |        |     |       |         |    |       |       |       |  |  |  |  |         |    |       |       |       |  |  |  |  |         |    |       |       |       |  |  |  |  |         |    |       |       |       |  |  |  |  |         |     |       |       |       |  |  |  |  |         |     |       |       |       |  |  |  |  |         |    |       |       |       |                |        |     |       |         |    |       |       |       |                |        |     |       |         |    |       |       |       |  |  |  |  |         |    |       |       |       |                |        |   |       |         |    |       |       |       |  |  |  |  |         |    |       |       |       |  |  |  |  |         |    |       |       |       |  |  |  |  |         |    |       |       |       |  |  |  |  |         |    |       |       |       |  |  |  |  |         |     |       |       |       |  |  |  |  |         |     |       |       |       |  |  |  |  |         |    |       |       |  |                |        |   |                           |         |    |       |       |  |                |        |   |                           |         |    |       |       |  |  |  |  |  |         |    |       |       |  |  |  |  |  |         |    |       |       |  |  |  |  |  |         |    |       |       |  |  |  |  |  |         |     |       |       |  |  |  |  |  |         |     |       |       |  |  |  |  |  |         |    |       |       |  |                |        |     |       |         |    |       |       |  |                |        |     |       |         |    |       |       |  |  |  |  |  |         |    |       |       |  |                |        |   |       |         |    |       |       |  |                |        |   |       |         |    |       |       |  |  |  |  |  |         |    |       |       |  |  |  |  |  |         |    |       |       |  |  |  |  |  |         |    |       |       |  |  |  |  |  |         |     |       |       |  |  |  |  |  |         |     |       |       |  |  |  |  |  |         |    |       |       |  |                |        |     |        |         |    |       |       |  |                |        |     |        |         |    |       |       |  |  |  |  |  |         |    |       |       |  |  |  |  |  |         |    |       |       |  |  |  |  |  |         |    |       |       |  |  |  |  |  |         |     |       |       |  |  |  |  |  |         |     |       |       |  |  |  |  |  |         |    |       |       |  |                |        |  |          |         |    |       |       |  |  |  |  |  |         |    |       |       |  |  |  |  |  |
| 2.5 dCi  | 88  | 09.06     | 06.10 | + ABS |                |        |                |                           |   |           |           |    |       |       |       |                |        |   |        |           |    |       |       |       |                |        |   |        |           |     |       |       |       |                |        |  |          |         |     |       |       |       |  |  |  |  |         |     |       |       |       |  |  |  |  |         |     |       |       |       |  |  |  |  |         |     |       |       |       |  |  |  |  |         |    |       |       |       |                |        |  |           |         |    |       |       |       |  |  |  |  |         |    |       |       |       |  |  |  |  |         |    |       |       |       |                |        |  |                      |         |    |       |       |       |  |  |  |  |         |    |       |       |       |  |  |  |  |         |    |       |       |       |  |  |  |  |         |    |       |       |       |  |  |  |  |         |    |       |       |       |  |  |  |  |         |     |       |       |       |  |  |  |  |         |     |       |       |       |  |  |  |  |         |    |       |       |       |                |        |     |       |         |    |       |       |       |                |        |     |       |         |    |       |       |       |  |  |  |  |         |    |       |       |       |  |  |  |  |         |    |       |       |       |  |  |  |  |         |    |       |       |       |  |  |  |  |         |     |       |       |       |  |  |  |  |         |     |       |       |       |  |  |  |  |         |    |       |       |       |                |        |     |       |         |    |       |       |       |                |        |     |       |         |    |       |       |       |  |  |  |  |         |    |       |       |       |                |        |   |       |         |    |       |       |       |  |  |  |  |         |    |       |       |       |  |  |  |  |         |    |       |       |       |  |  |  |  |         |    |       |       |       |  |  |  |  |         |    |       |       |       |  |  |  |  |         |     |       |       |       |  |  |  |  |         |     |       |       |       |  |  |  |  |         |    |       |       |  |                |        |   |                           |         |    |       |       |  |                |        |   |                           |         |    |       |       |  |  |  |  |  |         |    |       |       |  |  |  |  |  |         |    |       |       |  |  |  |  |  |         |    |       |       |  |  |  |  |  |         |     |       |       |  |  |  |  |  |         |     |       |       |  |  |  |  |  |         |    |       |       |  |                |        |     |       |         |    |       |       |  |                |        |     |       |         |    |       |       |  |  |  |  |  |         |    |       |       |  |                |        |   |       |         |    |       |       |  |                |        |   |       |         |    |       |       |  |  |  |  |  |         |    |       |       |  |  |  |  |  |         |    |       |       |  |  |  |  |  |         |    |       |       |  |  |  |  |  |         |     |       |       |  |  |  |  |  |         |     |       |       |  |  |  |  |  |         |    |       |       |  |                |        |     |        |         |    |       |       |  |                |        |     |        |         |    |       |       |  |  |  |  |  |         |    |       |       |  |  |  |  |  |         |    |       |       |  |  |  |  |  |         |    |       |       |  |  |  |  |  |         |     |       |       |  |  |  |  |  |         |     |       |       |  |  |  |  |  |         |    |       |       |  |                |        |  |          |         |    |       |       |  |  |  |  |  |         |    |       |       |  |  |  |  |  |
| 2.5 dCi  | 107   | 09.06     | 06.10 | + ABS |                |        |                |                           |   |           |           |    |       |       |       |                |        |   |        |           |    |       |       |       |                |        |   |        |           |     |       |       |       |                |        |  |          |         |     |       |       |       |  |  |  |  |         |     |       |       |       |  |  |  |  |         |     |       |       |       |  |  |  |  |         |     |       |       |       |  |  |  |  |         |    |       |       |       |                |        |  |           |         |    |       |       |       |  |  |  |  |         |    |       |       |       |  |  |  |  |         |    |       |       |       |                |        |  |                      |         |    |       |       |       |  |  |  |  |         |    |       |       |       |  |  |  |  |         |    |       |       |       |  |  |  |  |         |    |       |       |       |  |  |  |  |         |    |       |       |       |  |  |  |  |         |     |       |       |       |  |  |  |  |         |     |       |       |       |  |  |  |  |         |    |       |       |       |                |        |     |       |         |    |       |       |       |                |        |     |       |         |    |       |       |       |  |  |  |  |         |    |       |       |       |  |  |  |  |         |    |       |       |       |  |  |  |  |         |    |       |       |       |  |  |  |  |         |     |       |       |       |  |  |  |  |         |     |       |       |       |  |  |  |  |         |    |       |       |       |                |        |     |       |         |    |       |       |       |                |        |     |       |         |    |       |       |       |  |  |  |  |         |    |       |       |       |                |        |   |       |         |    |       |       |       |  |  |  |  |         |    |       |       |       |  |  |  |  |         |    |       |       |       |  |  |  |  |         |    |       |       |       |  |  |  |  |         |    |       |       |       |  |  |  |  |         |     |       |       |       |  |  |  |  |         |     |       |       |       |  |  |  |  |         |    |       |       |  |                |        |   |                           |         |    |       |       |  |                |        |   |                           |         |    |       |       |  |  |  |  |  |         |    |       |       |  |  |  |  |  |         |    |       |       |  |  |  |  |  |         |    |       |       |  |  |  |  |  |         |     |       |       |  |  |  |  |  |         |     |       |       |  |  |  |  |  |         |    |       |       |  |                |        |     |       |         |    |       |       |  |                |        |     |       |         |    |       |       |  |  |  |  |  |         |    |       |       |  |                |        |   |       |         |    |       |       |  |                |        |   |       |         |    |       |       |  |  |  |  |  |         |    |       |       |  |  |  |  |  |         |    |       |       |  |  |  |  |  |         |    |       |       |  |  |  |  |  |         |     |       |       |  |  |  |  |  |         |     |       |       |  |  |  |  |  |         |    |       |       |  |                |        |     |        |         |    |       |       |  |                |        |     |        |         |    |       |       |  |  |  |  |  |         |    |       |       |  |  |  |  |  |         |    |       |       |  |  |  |  |  |         |    |       |       |  |  |  |  |  |         |     |       |       |  |  |  |  |  |         |     |       |       |  |  |  |  |  |         |    |       |       |  |                |        |  |          |         |    |       |       |  |  |  |  |  |         |    |       |       |  |  |  |  |  |
| 3.0 dCi  | 100   | 11.03     | 08.06 | + ABS |                |        |                |                           |   |           |           |    |       |       |       |                |        |   |        |           |    |       |       |       |                |        |   |        |           |     |       |       |       |                |        |  |          |         |     |       |       |       |  |  |  |  |         |     |       |       |       |  |  |  |  |         |     |       |       |       |  |  |  |  |         |     |       |       |       |  |  |  |  |         |    |       |       |       |                |        |  |           |         |    |       |       |       |  |  |  |  |         |    |       |       |       |  |  |  |  |         |    |       |       |       |                |        |  |                      |         |    |       |       |       |  |  |  |  |         |    |       |       |       |  |  |  |  |         |    |       |       |       |  |  |  |  |         |    |       |       |       |  |  |  |  |         |    |       |       |       |  |  |  |  |         |     |       |       |       |  |  |  |  |         |     |       |       |       |  |  |  |  |         |    |       |       |       |                |        |     |       |         |    |       |       |       |                |        |     |       |         |    |       |       |       |  |  |  |  |         |    |       |       |       |  |  |  |  |         |    |       |       |       |  |  |  |  |         |    |       |       |       |  |  |  |  |         |     |       |       |       |  |  |  |  |         |     |       |       |       |  |  |  |  |         |    |       |       |       |                |        |     |       |         |    |       |       |       |                |        |     |       |         |    |       |       |       |  |  |  |  |         |    |       |       |       |                |        |   |       |         |    |       |       |       |  |  |  |  |         |    |       |       |       |  |  |  |  |         |    |       |       |       |  |  |  |  |         |    |       |       |       |  |  |  |  |         |    |       |       |       |  |  |  |  |         |     |       |       |       |  |  |  |  |         |     |       |       |       |  |  |  |  |         |    |       |       |  |                |        |   |                           |         |    |       |       |  |                |        |   |                           |         |    |       |       |  |  |  |  |  |         |    |       |       |  |  |  |  |  |         |    |       |       |  |  |  |  |  |         |    |       |       |  |  |  |  |  |         |     |       |       |  |  |  |  |  |         |     |       |       |  |  |  |  |  |         |    |       |       |  |                |        |     |       |         |    |       |       |  |                |        |     |       |         |    |       |       |  |  |  |  |  |         |    |       |       |  |                |        |   |       |         |    |       |       |  |                |        |   |       |         |    |       |       |  |  |  |  |  |         |    |       |       |  |  |  |  |  |         |    |       |       |  |  |  |  |  |         |    |       |       |  |  |  |  |  |         |     |       |       |  |  |  |  |  |         |     |       |       |  |  |  |  |  |         |    |       |       |  |                |        |     |        |         |    |       |       |  |                |        |     |        |         |    |       |       |  |  |  |  |  |         |    |       |       |  |  |  |  |  |         |    |       |       |  |  |  |  |  |         |    |       |       |  |  |  |  |  |         |     |       |       |  |  |  |  |  |         |     |       |       |  |  |  |  |  |         |    |       |       |  |                |        |  |          |         |    |       |       |  |  |  |  |  |         |    |       |       |  |  |  |  |  |
| 1.9 dCi  | 60  | 07.02     | 08.06 | - ABS | 24.5134-0457.3 | 330752 | 2 ↑            | L=457                     |   |           |           |    |       |       |       |                |        |   |        |           |    |       |       |       |                |        |   |        |           |     |       |       |       |                |        |  |          |         |     |       |       |       |  |  |  |  |         |     |       |       |       |  |  |  |  |         |     |       |       |       |  |  |  |  |         |     |       |       |       |  |  |  |  |         |    |       |       |       |                |        |  |           |         |    |       |       |       |  |  |  |  |         |    |       |       |       |  |  |  |  |         |    |       |       |       |                |        |  |                      |         |    |       |       |       |  |  |  |  |         |    |       |       |       |  |  |  |  |         |    |       |       |       |  |  |  |  |         |    |       |       |       |  |  |  |  |         |    |       |       |       |  |  |  |  |         |     |       |       |       |  |  |  |  |         |     |       |       |       |  |  |  |  |         |    |       |       |       |                |        |     |       |         |    |       |       |       |                |        |     |       |         |    |       |       |       |  |  |  |  |         |    |       |       |       |  |  |  |  |         |    |       |       |       |  |  |  |  |         |    |       |       |       |  |  |  |  |         |     |       |       |       |  |  |  |  |         |     |       |       |       |  |  |  |  |         |    |       |       |       |                |        |     |       |         |    |       |       |       |                |        |     |       |         |    |       |       |       |  |  |  |  |         |    |       |       |       |                |        |   |       |         |    |       |       |       |  |  |  |  |         |    |       |       |       |  |  |  |  |         |    |       |       |       |  |  |  |  |         |    |       |       |       |  |  |  |  |         |    |       |       |       |  |  |  |  |         |     |       |       |       |  |  |  |  |         |     |       |       |       |  |  |  |  |         |    |       |       |  |                |        |   |                           |         |    |       |       |  |                |        |   |                           |         |    |       |       |  |  |  |  |  |         |    |       |       |  |  |  |  |  |         |    |       |       |  |  |  |  |  |         |    |       |       |  |  |  |  |  |         |     |       |       |  |  |  |  |  |         |     |       |       |  |  |  |  |  |         |    |       |       |  |                |        |     |       |         |    |       |       |  |                |        |     |       |         |    |       |       |  |  |  |  |  |         |    |       |       |  |                |        |   |       |         |    |       |       |  |                |        |   |       |         |    |       |       |  |  |  |  |  |         |    |       |       |  |  |  |  |  |         |    |       |       |  |  |  |  |  |         |    |       |       |  |  |  |  |  |         |     |       |       |  |  |  |  |  |         |     |       |       |  |  |  |  |  |         |    |       |       |  |                |        |     |        |         |    |       |       |  |                |        |     |        |         |    |       |       |  |  |  |  |  |         |    |       |       |  |  |  |  |  |         |    |       |       |  |  |  |  |  |         |    |       |       |  |  |  |  |  |         |     |       |       |  |  |  |  |  |         |     |       |       |  |  |  |  |  |         |    |       |       |  |                |        |  |          |         |    |       |       |  |  |  |  |  |         |    |       |       |  |  |  |  |  |
| 2.2 dCi  | 66  | 07.02     | 08.06 | - ABS | 24.5134-0468.3 | 330704 | 2 ↓            | L=468                     |   |           |           |    |       |       |       |                |        |   |        |           |    |       |       |       |                |        |   |        |           |     |       |       |       |                |        |  |          |         |     |       |       |       |  |  |  |  |         |     |       |       |       |  |  |  |  |         |     |       |       |       |  |  |  |  |         |     |       |       |       |  |  |  |  |         |    |       |       |       |                |        |  |           |         |    |       |       |       |  |  |  |  |         |    |       |       |       |  |  |  |  |         |    |       |       |       |                |        |  |                      |         |    |       |       |       |  |  |  |  |         |    |       |       |       |  |  |  |  |         |    |       |       |       |  |  |  |  |         |    |       |       |       |  |  |  |  |         |    |       |       |       |  |  |  |  |         |     |       |       |       |  |  |  |  |         |     |       |       |       |  |  |  |  |         |    |       |       |       |                |        |     |       |         |    |       |       |       |                |        |     |       |         |    |       |       |       |  |  |  |  |         |    |       |       |       |  |  |  |  |         |    |       |       |       |  |  |  |  |         |    |       |       |       |  |  |  |  |         |     |       |       |       |  |  |  |  |         |     |       |       |       |  |  |  |  |         |    |       |       |       |                |        |     |       |         |    |       |       |       |                |        |     |       |         |    |       |       |       |  |  |  |  |         |    |       |       |       |                |        |   |       |         |    |       |       |       |  |  |  |  |         |    |       |       |       |  |  |  |  |         |    |       |       |       |  |  |  |  |         |    |       |       |       |  |  |  |  |         |    |       |       |       |  |  |  |  |         |     |       |       |       |  |  |  |  |         |     |       |       |       |  |  |  |  |         |    |       |       |  |                |        |   |                           |         |    |       |       |  |                |        |   |                           |         |    |       |       |  |  |  |  |  |         |    |       |       |  |  |  |  |  |         |    |       |       |  |  |  |  |  |         |    |       |       |  |  |  |  |  |         |     |       |       |  |  |  |  |  |         |     |       |       |  |  |  |  |  |         |    |       |       |  |                |        |     |       |         |    |       |       |  |                |        |     |       |         |    |       |       |  |  |  |  |  |         |    |       |       |  |                |        |   |       |         |    |       |       |  |                |        |   |       |         |    |       |       |  |  |  |  |  |         |    |       |       |  |  |  |  |  |         |    |       |       |  |  |  |  |  |         |    |       |       |  |  |  |  |  |         |     |       |       |  |  |  |  |  |         |     |       |       |  |  |  |  |  |         |    |       |       |  |                |        |     |        |         |    |       |       |  |                |        |     |        |         |    |       |       |  |  |  |  |  |         |    |       |       |  |  |  |  |  |         |    |       |       |  |  |  |  |  |         |    |       |       |  |  |  |  |  |         |     |       |       |  |  |  |  |  |         |     |       |       |  |  |  |  |  |         |    |       |       |  |                |        |  |          |         |    |       |       |  |  |  |  |  |         |    |       |       |  |  |  |  |  |
| 2.5 dCi  | 73  | 11.03     | 06.10 | - ABS |                |        |                |                           |   |           |           |    |       |       |       |                |        |   |        |           |    |       |       |       |                |        |   |        |           |     |       |       |       |                |        |  |          |         |     |       |       |       |  |  |  |  |         |     |       |       |       |  |  |  |  |         |     |       |       |       |  |  |  |  |         |     |       |       |       |  |  |  |  |         |    |       |       |       |                |        |  |           |         |    |       |       |       |  |  |  |  |         |    |       |       |       |  |  |  |  |         |    |       |       |       |                |        |  |                      |         |    |       |       |       |  |  |  |  |         |    |       |       |       |  |  |  |  |         |    |       |       |       |  |  |  |  |         |    |       |       |       |  |  |  |  |         |    |       |       |       |  |  |  |  |         |     |       |       |       |  |  |  |  |         |     |       |       |       |  |  |  |  |         |    |       |       |       |                |        |     |       |         |    |       |       |       |                |        |     |       |         |    |       |       |       |  |  |  |  |         |    |       |       |       |  |  |  |  |         |    |       |       |       |  |  |  |  |         |    |       |       |       |  |  |  |  |         |     |       |       |       |  |  |  |  |         |     |       |       |       |  |  |  |  |         |    |       |       |       |                |        |     |       |         |    |       |       |       |                |        |     |       |         |    |       |       |       |  |  |  |  |         |    |       |       |       |                |        |   |       |         |    |       |       |       |  |  |  |  |         |    |       |       |       |  |  |  |  |         |    |       |       |       |  |  |  |  |         |    |       |       |       |  |  |  |  |         |    |       |       |       |  |  |  |  |         |     |       |       |       |  |  |  |  |         |     |       |       |       |  |  |  |  |         |    |       |       |  |                |        |   |                           |         |    |       |       |  |                |        |   |                           |         |    |       |       |  |  |  |  |  |         |    |       |       |  |  |  |  |  |         |    |       |       |  |  |  |  |  |         |    |       |       |  |  |  |  |  |         |     |       |       |  |  |  |  |  |         |     |       |       |  |  |  |  |  |         |    |       |       |  |                |        |     |       |         |    |       |       |  |                |        |     |       |         |    |       |       |  |  |  |  |  |         |    |       |       |  |                |        |   |       |         |    |       |       |  |                |        |   |       |         |    |       |       |  |  |  |  |  |         |    |       |       |  |  |  |  |  |         |    |       |       |  |  |  |  |  |         |    |       |       |  |  |  |  |  |         |     |       |       |  |  |  |  |  |         |     |       |       |  |  |  |  |  |         |    |       |       |  |                |        |     |        |         |    |       |       |  |                |        |     |        |         |    |       |       |  |  |  |  |  |         |    |       |       |  |  |  |  |  |         |    |       |       |  |  |  |  |  |         |    |       |       |  |  |  |  |  |         |     |       |       |  |  |  |  |  |         |     |       |       |  |  |  |  |  |         |    |       |       |  |                |        |  |          |         |    |       |       |  |  |  |  |  |         |    |       |       |  |  |  |  |  |
| 2.5 dCi  | 74  | 04.06     | 06.10 | - ABS |                |        |                |                           |   |           |           |    |       |       |       |                |        |   |        |           |    |       |       |       |                |        |   |        |           |     |       |       |       |                |        |  |          |         |     |       |       |       |  |  |  |  |         |     |       |       |       |  |  |  |  |         |     |       |       |       |  |  |  |  |         |     |       |       |       |  |  |  |  |         |    |       |       |       |                |        |  |           |         |    |       |       |       |  |  |  |  |         |    |       |       |       |  |  |  |  |         |    |       |       |       |                |        |  |                      |         |    |       |       |       |  |  |  |  |         |    |       |       |       |  |  |  |  |         |    |       |       |       |  |  |  |  |         |    |       |       |       |  |  |  |  |         |    |       |       |       |  |  |  |  |         |     |       |       |       |  |  |  |  |         |     |       |       |       |  |  |  |  |         |    |       |       |       |                |        |     |       |         |    |       |       |       |                |        |     |       |         |    |       |       |       |  |  |  |  |         |    |       |       |       |  |  |  |  |         |    |       |       |       |  |  |  |  |         |    |       |       |       |  |  |  |  |         |     |       |       |       |  |  |  |  |         |     |       |       |       |  |  |  |  |         |    |       |       |       |                |        |     |       |         |    |       |       |       |                |        |     |       |         |    |       |       |       |  |  |  |  |         |    |       |       |       |                |        |   |       |         |    |       |       |       |  |  |  |  |         |    |       |       |       |  |  |  |  |         |    |       |       |       |  |  |  |  |         |    |       |       |       |  |  |  |  |         |    |       |       |       |  |  |  |  |         |     |       |       |       |  |  |  |  |         |     |       |       |       |  |  |  |  |         |    |       |       |  |                |        |   |                           |         |    |       |       |  |                |        |   |                           |         |    |       |       |  |  |  |  |  |         |    |       |       |  |  |  |  |  |         |    |       |       |  |  |  |  |  |         |    |       |       |  |  |  |  |  |         |     |       |       |  |  |  |  |  |         |     |       |       |  |  |  |  |  |         |    |       |       |  |                |        |     |       |         |    |       |       |  |                |        |     |       |         |    |       |       |  |  |  |  |  |         |    |       |       |  |                |        |   |       |         |    |       |       |  |                |        |   |       |         |    |       |       |  |  |  |  |  |         |    |       |       |  |  |  |  |  |         |    |       |       |  |  |  |  |  |         |    |       |       |  |  |  |  |  |         |     |       |       |  |  |  |  |  |         |     |       |       |  |  |  |  |  |         |    |       |       |  |                |        |     |        |         |    |       |       |  |                |        |     |        |         |    |       |       |  |  |  |  |  |         |    |       |       |  |  |  |  |  |         |    |       |       |  |  |  |  |  |         |    |       |       |  |  |  |  |  |         |     |       |       |  |  |  |  |  |         |     |       |       |  |  |  |  |  |         |    |       |       |  |                |        |  |          |         |    |       |       |  |  |  |  |  |         |    |       |       |  |  |  |  |  |
| 2.5 dCi  | 84  | 07.02     | 08.06 | - ABS |                |        |                |                           |   |           |           |    |       |       |       |                |        |   |        |           |    |       |       |       |                |        |   |        |           |     |       |       |       |                |        |  |          |         |     |       |       |       |  |  |  |  |         |     |       |       |       |  |  |  |  |         |     |       |       |       |  |  |  |  |         |     |       |       |       |  |  |  |  |         |    |       |       |       |                |        |  |           |         |    |       |       |       |  |  |  |  |         |    |       |       |       |  |  |  |  |         |    |       |       |       |                |        |  |                      |         |    |       |       |       |  |  |  |  |         |    |       |       |       |  |  |  |  |         |    |       |       |       |  |  |  |  |         |    |       |       |       |  |  |  |  |         |    |       |       |       |  |  |  |  |         |     |       |       |       |  |  |  |  |         |     |       |       |       |  |  |  |  |         |    |       |       |       |                |        |     |       |         |    |       |       |       |                |        |     |       |         |    |       |       |       |  |  |  |  |         |    |       |       |       |  |  |  |  |         |    |       |       |       |  |  |  |  |         |    |       |       |       |  |  |  |  |         |     |       |       |       |  |  |  |  |         |     |       |       |       |  |  |  |  |         |    |       |       |       |                |        |     |       |         |    |       |       |       |                |        |     |       |         |    |       |       |       |  |  |  |  |         |    |       |       |       |                |        |   |       |         |    |       |       |       |  |  |  |  |         |    |       |       |       |  |  |  |  |         |    |       |       |       |  |  |  |  |         |    |       |       |       |  |  |  |  |         |    |       |       |       |  |  |  |  |         |     |       |       |       |  |  |  |  |         |     |       |       |       |  |  |  |  |         |    |       |       |  |                |        |   |                           |         |    |       |       |  |                |        |   |                           |         |    |       |       |  |  |  |  |  |         |    |       |       |  |  |  |  |  |         |    |       |       |  |  |  |  |  |         |    |       |       |  |  |  |  |  |         |     |       |       |  |  |  |  |  |         |     |       |       |  |  |  |  |  |         |    |       |       |  |                |        |     |       |         |    |       |       |  |                |        |     |       |         |    |       |       |  |  |  |  |  |         |    |       |       |  |                |        |   |       |         |    |       |       |  |                |        |   |       |         |    |       |       |  |  |  |  |  |         |    |       |       |  |  |  |  |  |         |    |       |       |  |  |  |  |  |         |    |       |       |  |  |  |  |  |         |     |       |       |  |  |  |  |  |         |     |       |       |  |  |  |  |  |         |    |       |       |  |                |        |     |        |         |    |       |       |  |                |        |     |        |         |    |       |       |  |  |  |  |  |         |    |       |       |  |  |  |  |  |         |    |       |       |  |  |  |  |  |         |    |       |       |  |  |  |  |  |         |     |       |       |  |  |  |  |  |         |     |       |       |  |  |  |  |  |         |    |       |       |  |                |        |  |          |         |    |       |       |  |  |  |  |  |         |    |       |       |  |  |  |  |  |
| 2.5 dCi  | 88  | 09.06     | 06.10 | - ABS |                |        |                |                           |   |           |           |    |       |       |       |                |        |   |        |           |    |       |       |       |                |        |   |        |           |     |       |       |       |                |        |  |          |         |     |       |       |       |  |  |  |  |         |     |       |       |       |  |  |  |  |         |     |       |       |       |  |  |  |  |         |     |       |       |       |  |  |  |  |         |    |       |       |       |                |        |  |           |         |    |       |       |       |  |  |  |  |         |    |       |       |       |  |  |  |  |         |    |       |       |       |                |        |  |                      |         |    |       |       |       |  |  |  |  |         |    |       |       |       |  |  |  |  |         |    |       |       |       |  |  |  |  |         |    |       |       |       |  |  |  |  |         |    |       |       |       |  |  |  |  |         |     |       |       |       |  |  |  |  |         |     |       |       |       |  |  |  |  |         |    |       |       |       |                |        |     |       |         |    |       |       |       |                |        |     |       |         |    |       |       |       |  |  |  |  |         |    |       |       |       |  |  |  |  |         |    |       |       |       |  |  |  |  |         |    |       |       |       |  |  |  |  |         |     |       |       |       |  |  |  |  |         |     |       |       |       |  |  |  |  |         |    |       |       |       |                |        |     |       |         |    |       |       |       |                |        |     |       |         |    |       |       |       |  |  |  |  |         |    |       |       |       |                |        |   |       |         |    |       |       |       |  |  |  |  |         |    |       |       |       |  |  |  |  |         |    |       |       |       |  |  |  |  |         |    |       |       |       |  |  |  |  |         |    |       |       |       |  |  |  |  |         |     |       |       |       |  |  |  |  |         |     |       |       |       |  |  |  |  |         |    |       |       |  |                |        |   |                           |         |    |       |       |  |                |        |   |                           |         |    |       |       |  |  |  |  |  |         |    |       |       |  |  |  |  |  |         |    |       |       |  |  |  |  |  |         |    |       |       |  |  |  |  |  |         |     |       |       |  |  |  |  |  |         |     |       |       |  |  |  |  |  |         |    |       |       |  |                |        |     |       |         |    |       |       |  |                |        |     |       |         |    |       |       |  |  |  |  |  |         |    |       |       |  |                |        |   |       |         |    |       |       |  |                |        |   |       |         |    |       |       |  |  |  |  |  |         |    |       |       |  |  |  |  |  |         |    |       |       |  |  |  |  |  |         |    |       |       |  |  |  |  |  |         |     |       |       |  |  |  |  |  |         |     |       |       |  |  |  |  |  |         |    |       |       |  |                |        |     |        |         |    |       |       |  |                |        |     |        |         |    |       |       |  |  |  |  |  |         |    |       |       |  |  |  |  |  |         |    |       |       |  |  |  |  |  |         |    |       |       |  |  |  |  |  |         |     |       |       |  |  |  |  |  |         |     |       |       |  |  |  |  |  |         |    |       |       |  |                |        |  |          |         |    |       |       |  |  |  |  |  |         |    |       |       |  |  |  |  |  |
| 2.5 dCi  | 107   | 09.06     | 06.10 | - ABS |                |        |                |                           |   |           |           |    |       |       |       |                |        |   |        |           |    |       |       |       |                |        |   |        |           |     |       |       |       |                |        |  |          |         |     |       |       |       |  |  |  |  |         |     |       |       |       |  |  |  |  |         |     |       |       |       |  |  |  |  |         |     |       |       |       |  |  |  |  |         |    |       |       |       |                |        |  |           |         |    |       |       |       |  |  |  |  |         |    |       |       |       |  |  |  |  |         |    |       |       |       |                |        |  |                      |         |    |       |       |       |  |  |  |  |         |    |       |       |       |  |  |  |  |         |    |       |       |       |  |  |  |  |         |    |       |       |       |  |  |  |  |         |    |       |       |       |  |  |  |  |         |     |       |       |       |  |  |  |  |         |     |       |       |       |  |  |  |  |         |    |       |       |       |                |        |     |       |         |    |       |       |       |                |        |     |       |         |    |       |       |       |  |  |  |  |         |    |       |       |       |  |  |  |  |         |    |       |       |       |  |  |  |  |         |    |       |       |       |  |  |  |  |         |     |       |       |       |  |  |  |  |         |     |       |       |       |  |  |  |  |         |    |       |       |       |                |        |     |       |         |    |       |       |       |                |        |     |       |         |    |       |       |       |  |  |  |  |         |    |       |       |       |                |        |   |       |         |    |       |       |       |  |  |  |  |         |    |       |       |       |  |  |  |  |         |    |       |       |       |  |  |  |  |         |    |       |       |       |  |  |  |  |         |    |       |       |       |  |  |  |  |         |     |       |       |       |  |  |  |  |         |     |       |       |       |  |  |  |  |         |    |       |       |  |                |        |   |                           |         |    |       |       |  |                |        |   |                           |         |    |       |       |  |  |  |  |  |         |    |       |       |  |  |  |  |  |         |    |       |       |  |  |  |  |  |         |    |       |       |  |  |  |  |  |         |     |       |       |  |  |  |  |  |         |     |       |       |  |  |  |  |  |         |    |       |       |  |                |        |     |       |         |    |       |       |  |                |        |     |       |         |    |       |       |  |  |  |  |  |         |    |       |       |  |                |        |   |       |         |    |       |       |  |                |        |   |       |         |    |       |       |  |  |  |  |  |         |    |       |       |  |  |  |  |  |         |    |       |       |  |  |  |  |  |         |    |       |       |  |  |  |  |  |         |     |       |       |  |  |  |  |  |         |     |       |       |  |  |  |  |  |         |    |       |       |  |                |        |     |        |         |    |       |       |  |                |        |     |        |         |    |       |       |  |  |  |  |  |         |    |       |       |  |  |  |  |  |         |    |       |       |  |  |  |  |  |         |    |       |       |  |  |  |  |  |         |     |       |       |  |  |  |  |  |         |     |       |       |  |  |  |  |  |         |    |       |       |  |                |        |  |          |         |    |       |       |  |  |  |  |  |         |    |       |       |  |  |  |  |  |
| 3.0 dCi  | 100   | 11.03     | 08.06 | - ABS |                |        |                |                           |   |           |           |    |       |       |       |                |        |   |        |           |    |       |       |       |                |        |   |        |           |     |       |       |       |                |        |  |          |         |     |       |       |       |  |  |  |  |         |     |       |       |       |  |  |  |  |         |     |       |       |       |  |  |  |  |         |     |       |       |       |  |  |  |  |         |    |       |       |       |                |        |  |           |         |    |       |       |       |  |  |  |  |         |    |       |       |       |  |  |  |  |         |    |       |       |       |                |        |  |                      |         |    |       |       |       |  |  |  |  |         |    |       |       |       |  |  |  |  |         |    |       |       |       |  |  |  |  |         |    |       |       |       |  |  |  |  |         |    |       |       |       |  |  |  |  |         |     |       |       |       |  |  |  |  |         |     |       |       |       |  |  |  |  |         |    |       |       |       |                |        |     |       |         |    |       |       |       |                |        |     |       |         |    |       |       |       |  |  |  |  |         |    |       |       |       |  |  |  |  |         |    |       |       |       |  |  |  |  |         |    |       |       |       |  |  |  |  |         |     |       |       |       |  |  |  |  |         |     |       |       |       |  |  |  |  |         |    |       |       |       |                |        |     |       |         |    |       |       |       |                |        |     |       |         |    |       |       |       |  |  |  |  |         |    |       |       |       |                |        |   |       |         |    |       |       |       |  |  |  |  |         |    |       |       |       |  |  |  |  |         |    |       |       |       |  |  |  |  |         |    |       |       |       |  |  |  |  |         |    |       |       |       |  |  |  |  |         |     |       |       |       |  |  |  |  |         |     |       |       |       |  |  |  |  |         |    |       |       |  |                |        |   |                           |         |    |       |       |  |                |        |   |                           |         |    |       |       |  |  |  |  |  |         |    |       |       |  |  |  |  |  |         |    |       |       |  |  |  |  |  |         |    |       |       |  |  |  |  |  |         |     |       |       |  |  |  |  |  |         |     |       |       |  |  |  |  |  |         |    |       |       |  |                |        |     |       |         |    |       |       |  |                |        |     |       |         |    |       |       |  |  |  |  |  |         |    |       |       |  |                |        |   |       |         |    |       |       |  |                |        |   |       |         |    |       |       |  |  |  |  |  |         |    |       |       |  |  |  |  |  |         |    |       |       |  |  |  |  |  |         |    |       |       |  |  |  |  |  |         |     |       |       |  |  |  |  |  |         |     |       |       |  |  |  |  |  |         |    |       |       |  |                |        |     |        |         |    |       |       |  |                |        |     |        |         |    |       |       |  |  |  |  |  |         |    |       |       |  |  |  |  |  |         |    |       |       |  |  |  |  |  |         |    |       |       |  |  |  |  |  |         |     |       |       |  |  |  |  |  |         |     |       |       |  |  |  |  |  |         |    |       |       |  |                |        |  |          |         |    |       |       |  |  |  |  |  |         |    |       |       |  |  |  |  |  |
| 1.9 dCi  | 60  | 07.02     | 10.03 | + ABS | 24.5134-0457.3 | 330752 | 2 ↑            | L=457                     |   |           |           |    |       |       |       |                |        |   |        |           |    |       |       |       |                |        |   |        |           |     |       |       |       |                |        |  |          |         |     |       |       |       |  |  |  |  |         |     |       |       |       |  |  |  |  |         |     |       |       |       |  |  |  |  |         |     |       |       |       |  |  |  |  |         |    |       |       |       |                |        |  |           |         |    |       |       |       |  |  |  |  |         |    |       |       |       |  |  |  |  |         |    |       |       |       |                |        |  |                      |         |    |       |       |       |  |  |  |  |         |    |       |       |       |  |  |  |  |         |    |       |       |       |  |  |  |  |         |    |       |       |       |  |  |  |  |         |    |       |       |       |  |  |  |  |         |     |       |       |       |  |  |  |  |         |     |       |       |       |  |  |  |  |         |    |       |       |       |                |        |     |       |         |    |       |       |       |                |        |     |       |         |    |       |       |       |  |  |  |  |         |    |       |       |       |  |  |  |  |         |    |       |       |       |  |  |  |  |         |    |       |       |       |  |  |  |  |         |     |       |       |       |  |  |  |  |         |     |       |       |       |  |  |  |  |         |    |       |       |       |                |        |     |       |         |    |       |       |       |                |        |     |       |         |    |       |       |       |  |  |  |  |         |    |       |       |       |                |        |   |       |         |    |       |       |       |  |  |  |  |         |    |       |       |       |  |  |  |  |         |    |       |       |       |  |  |  |  |         |    |       |       |       |  |  |  |  |         |    |       |       |       |  |  |  |  |         |     |       |       |       |  |  |  |  |         |     |       |       |       |  |  |  |  |         |    |       |       |  |                |        |   |                           |         |    |       |       |  |                |        |   |                           |         |    |       |       |  |  |  |  |  |         |    |       |       |  |  |  |  |  |         |    |       |       |  |  |  |  |  |         |    |       |       |  |  |  |  |  |         |     |       |       |  |  |  |  |  |         |     |       |       |  |  |  |  |  |         |    |       |       |  |                |        |     |       |         |    |       |       |  |                |        |     |       |         |    |       |       |  |  |  |  |  |         |    |       |       |  |                |        |   |       |         |    |       |       |  |                |        |   |       |         |    |       |       |  |  |  |  |  |         |    |       |       |  |  |  |  |  |         |    |       |       |  |  |  |  |  |         |    |       |       |  |  |  |  |  |         |     |       |       |  |  |  |  |  |         |     |       |       |  |  |  |  |  |         |    |       |       |  |                |        |     |        |         |    |       |       |  |                |        |     |        |         |    |       |       |  |  |  |  |  |         |    |       |       |  |  |  |  |  |         |    |       |       |  |  |  |  |  |         |    |       |       |  |  |  |  |  |         |     |       |       |  |  |  |  |  |         |     |       |       |  |  |  |  |  |         |    |       |       |  |                |        |  |          |         |    |       |       |  |  |  |  |  |         |    |       |       |  |  |  |  |  |
| 2.2 dCi  | 66  | 07.02     | 10.03 | + ABS | 24.5134-0468.3 | 330704 | 2 ↓            | L=468                     |   |           |           |    |       |       |       |                |        |   |        |           |    |       |       |       |                |        |   |        |           |     |       |       |       |                |        |  |          |         |     |       |       |       |  |  |  |  |         |     |       |       |       |  |  |  |  |         |     |       |       |       |  |  |  |  |         |     |       |       |       |  |  |  |  |         |    |       |       |       |                |        |  |           |         |    |       |       |       |  |  |  |  |         |    |       |       |       |  |  |  |  |         |    |       |       |       |                |        |  |                      |         |    |       |       |       |  |  |  |  |         |    |       |       |       |  |  |  |  |         |    |       |       |       |  |  |  |  |         |    |       |       |       |  |  |  |  |         |    |       |       |       |  |  |  |  |         |     |       |       |       |  |  |  |  |         |     |       |       |       |  |  |  |  |         |    |       |       |       |                |        |     |       |         |    |       |       |       |                |        |     |       |         |    |       |       |       |  |  |  |  |         |    |       |       |       |  |  |  |  |         |    |       |       |       |  |  |  |  |         |    |       |       |       |  |  |  |  |         |     |       |       |       |  |  |  |  |         |     |       |       |       |  |  |  |  |         |    |       |       |       |                |        |     |       |         |    |       |       |       |                |        |     |       |         |    |       |       |       |  |  |  |  |         |    |       |       |       |                |        |   |       |         |    |       |       |       |  |  |  |  |         |    |       |       |       |  |  |  |  |         |    |       |       |       |  |  |  |  |         |    |       |       |       |  |  |  |  |         |    |       |       |       |  |  |  |  |         |     |       |       |       |  |  |  |  |         |     |       |       |       |  |  |  |  |         |    |       |       |  |                |        |   |                           |         |    |       |       |  |                |        |   |                           |         |    |       |       |  |  |  |  |  |         |    |       |       |  |  |  |  |  |         |    |       |       |  |  |  |  |  |         |    |       |       |  |  |  |  |  |         |     |       |       |  |  |  |  |  |         |     |       |       |  |  |  |  |  |         |    |       |       |  |                |        |     |       |         |    |       |       |  |                |        |     |       |         |    |       |       |  |  |  |  |  |         |    |       |       |  |                |        |   |       |         |    |       |       |  |                |        |   |       |         |    |       |       |  |  |  |  |  |         |    |       |       |  |  |  |  |  |         |    |       |       |  |  |  |  |  |         |    |       |       |  |  |  |  |  |         |     |       |       |  |  |  |  |  |         |     |       |       |  |  |  |  |  |         |    |       |       |  |                |        |     |        |         |    |       |       |  |                |        |     |        |         |    |       |       |  |  |  |  |  |         |    |       |       |  |  |  |  |  |         |    |       |       |  |  |  |  |  |         |    |       |       |  |  |  |  |  |         |     |       |       |  |  |  |  |  |         |     |       |       |  |  |  |  |  |         |    |       |       |  |                |        |  |          |         |    |       |       |  |  |  |  |  |         |    |       |       |  |  |  |  |  |
| 2.5 dCi  | 84  | 07.02     | 10.03 | + ABS |                |        |                |                           |   |           |           |    |       |       |       |                |        |   |        |           |    |       |       |       |                |        |   |        |           |     |       |       |       |                |        |  |          |         |     |       |       |       |  |  |  |  |         |     |       |       |       |  |  |  |  |         |     |       |       |       |  |  |  |  |         |     |       |       |       |  |  |  |  |         |    |       |       |       |                |        |  |           |         |    |       |       |       |  |  |  |  |         |    |       |       |       |  |  |  |  |         |    |       |       |       |                |        |  |                      |         |    |       |       |       |  |  |  |  |         |    |       |       |       |  |  |  |  |         |    |       |       |       |  |  |  |  |         |    |       |       |       |  |  |  |  |         |    |       |       |       |  |  |  |  |         |     |       |       |       |  |  |  |  |         |     |       |       |       |  |  |  |  |         |    |       |       |       |                |        |     |       |         |    |       |       |       |                |        |     |       |         |    |       |       |       |  |  |  |  |         |    |       |       |       |  |  |  |  |         |    |       |       |       |  |  |  |  |         |    |       |       |       |  |  |  |  |         |     |       |       |       |  |  |  |  |         |     |       |       |       |  |  |  |  |         |    |       |       |       |                |        |     |       |         |    |       |       |       |                |        |     |       |         |    |       |       |       |  |  |  |  |         |    |       |       |       |                |        |   |       |         |    |       |       |       |  |  |  |  |         |    |       |       |       |  |  |  |  |         |    |       |       |       |  |  |  |  |         |    |       |       |       |  |  |  |  |         |    |       |       |       |  |  |  |  |         |     |       |       |       |  |  |  |  |         |     |       |       |       |  |  |  |  |         |    |       |       |  |                |        |   |                           |         |    |       |       |  |                |        |   |                           |         |    |       |       |  |  |  |  |  |         |    |       |       |  |  |  |  |  |         |    |       |       |  |  |  |  |  |         |    |       |       |  |  |  |  |  |         |     |       |       |  |  |  |  |  |         |     |       |       |  |  |  |  |  |         |    |       |       |  |                |        |     |       |         |    |       |       |  |                |        |     |       |         |    |       |       |  |  |  |  |  |         |    |       |       |  |                |        |   |       |         |    |       |       |  |                |        |   |       |         |    |       |       |  |  |  |  |  |         |    |       |       |  |  |  |  |  |         |    |       |       |  |  |  |  |  |         |    |       |       |  |  |  |  |  |         |     |       |       |  |  |  |  |  |         |     |       |       |  |  |  |  |  |         |    |       |       |  |                |        |     |        |         |    |       |       |  |                |        |     |        |         |    |       |       |  |  |  |  |  |         |    |       |       |  |  |  |  |  |         |    |       |       |  |  |  |  |  |         |    |       |       |  |  |  |  |  |         |     |       |       |  |  |  |  |  |         |     |       |       |  |  |  |  |  |         |    |       |       |  |                |        |  |          |         |    |       |       |  |  |  |  |  |         |    |       |       |  |  |  |  |  |
| 1.9 dCi  | 60  | 11.03     | 08.06 | + ABS | 24.5111-0510.3 | 330819 | 2              | L=510                     |   |           |           |    |       |       |       |                |        |   |        |           |    |       |       |       |                |        |   |        |           |     |       |       |       |                |        |  |          |         |     |       |       |       |  |  |  |  |         |     |       |       |       |  |  |  |  |         |     |       |       |       |  |  |  |  |         |     |       |       |       |  |  |  |  |         |    |       |       |       |                |        |  |           |         |    |       |       |       |  |  |  |  |         |    |       |       |       |  |  |  |  |         |    |       |       |       |                |        |  |                      |         |    |       |       |       |  |  |  |  |         |    |       |       |       |  |  |  |  |         |    |       |       |       |  |  |  |  |         |    |       |       |       |  |  |  |  |         |    |       |       |       |  |  |  |  |         |     |       |       |       |  |  |  |  |         |     |       |       |       |  |  |  |  |         |    |       |       |       |                |        |     |       |         |    |       |       |       |                |        |     |       |         |    |       |       |       |  |  |  |  |         |    |       |       |       |  |  |  |  |         |    |       |       |       |  |  |  |  |         |    |       |       |       |  |  |  |  |         |     |       |       |       |  |  |  |  |         |     |       |       |       |  |  |  |  |         |    |       |       |       |                |        |     |       |         |    |       |       |       |                |        |     |       |         |    |       |       |       |  |  |  |  |         |    |       |       |       |                |        |   |       |         |    |       |       |       |  |  |  |  |         |    |       |       |       |  |  |  |  |         |    |       |       |       |  |  |  |  |         |    |       |       |       |  |  |  |  |         |    |       |       |       |  |  |  |  |         |     |       |       |       |  |  |  |  |         |     |       |       |       |  |  |  |  |         |    |       |       |  |                |        |   |                           |         |    |       |       |  |                |        |   |                           |         |    |       |       |  |  |  |  |  |         |    |       |       |  |  |  |  |  |         |    |       |       |  |  |  |  |  |         |    |       |       |  |  |  |  |  |         |     |       |       |  |  |  |  |  |         |     |       |       |  |  |  |  |  |         |    |       |       |  |                |        |     |       |         |    |       |       |  |                |        |     |       |         |    |       |       |  |  |  |  |  |         |    |       |       |  |                |        |   |       |         |    |       |       |  |                |        |   |       |         |    |       |       |  |  |  |  |  |         |    |       |       |  |  |  |  |  |         |    |       |       |  |  |  |  |  |         |    |       |       |  |  |  |  |  |         |     |       |       |  |  |  |  |  |         |     |       |       |  |  |  |  |  |         |    |       |       |  |                |        |     |        |         |    |       |       |  |                |        |     |        |         |    |       |       |  |  |  |  |  |         |    |       |       |  |  |  |  |  |         |    |       |       |  |  |  |  |  |         |    |       |       |  |  |  |  |  |         |     |       |       |  |  |  |  |  |         |     |       |       |  |  |  |  |  |         |    |       |       |  |                |        |  |          |         |    |       |       |  |  |  |  |  |         |    |       |       |  |  |  |  |  |
| 2.2 dCi  | 66  | 11.03     | 08.06 | + ABS |                |        |                |                           |   |           |           |    |       |       |       |                |        |   |        |           |    |       |       |       |                |        |   |        |           |     |       |       |       |                |        |  |          |         |     |       |       |       |  |  |  |  |         |     |       |       |       |  |  |  |  |         |     |       |       |       |  |  |  |  |         |     |       |       |       |  |  |  |  |         |    |       |       |       |                |        |  |           |         |    |       |       |       |  |  |  |  |         |    |       |       |       |  |  |  |  |         |    |       |       |       |                |        |  |                      |         |    |       |       |       |  |  |  |  |         |    |       |       |       |  |  |  |  |         |    |       |       |       |  |  |  |  |         |    |       |       |       |  |  |  |  |         |    |       |       |       |  |  |  |  |         |     |       |       |       |  |  |  |  |         |     |       |       |       |  |  |  |  |         |    |       |       |       |                |        |     |       |         |    |       |       |       |                |        |     |       |         |    |       |       |       |  |  |  |  |         |    |       |       |       |  |  |  |  |         |    |       |       |       |  |  |  |  |         |    |       |       |       |  |  |  |  |         |     |       |       |       |  |  |  |  |         |     |       |       |       |  |  |  |  |         |    |       |       |       |                |        |     |       |         |    |       |       |       |                |        |     |       |         |    |       |       |       |  |  |  |  |         |    |       |       |       |                |        |   |       |         |    |       |       |       |  |  |  |  |         |    |       |       |       |  |  |  |  |         |    |       |       |       |  |  |  |  |         |    |       |       |       |  |  |  |  |         |    |       |       |       |  |  |  |  |         |     |       |       |       |  |  |  |  |         |     |       |       |       |  |  |  |  |         |    |       |       |  |                |        |   |                           |         |    |       |       |  |                |        |   |                           |         |    |       |       |  |  |  |  |  |         |    |       |       |  |  |  |  |  |         |    |       |       |  |  |  |  |  |         |    |       |       |  |  |  |  |  |         |     |       |       |  |  |  |  |  |         |     |       |       |  |  |  |  |  |         |    |       |       |  |                |        |     |       |         |    |       |       |  |                |        |     |       |         |    |       |       |  |  |  |  |  |         |    |       |       |  |                |        |   |       |         |    |       |       |  |                |        |   |       |         |    |       |       |  |  |  |  |  |         |    |       |       |  |  |  |  |  |         |    |       |       |  |  |  |  |  |         |    |       |       |  |  |  |  |  |         |     |       |       |  |  |  |  |  |         |     |       |       |  |  |  |  |  |         |    |       |       |  |                |        |     |        |         |    |       |       |  |                |        |     |        |         |    |       |       |  |  |  |  |  |         |    |       |       |  |  |  |  |  |         |    |       |       |  |  |  |  |  |         |    |       |       |  |  |  |  |  |         |     |       |       |  |  |  |  |  |         |     |       |       |  |  |  |  |  |         |    |       |       |  |                |        |  |          |         |    |       |       |  |  |  |  |  |         |    |       |       |  |  |  |  |  |
| 2.5 dCi  | 73  | 11.03     | 06.10 | + ABS |                |        |                |                           |   |           |           |    |       |       |       |                |        |   |        |           |    |       |       |       |                |        |   |        |           |     |       |       |       |                |        |  |          |         |     |       |       |       |  |  |  |  |         |     |       |       |       |  |  |  |  |         |     |       |       |       |  |  |  |  |         |     |       |       |       |  |  |  |  |         |    |       |       |       |                |        |  |           |         |    |       |       |       |  |  |  |  |         |    |       |       |       |  |  |  |  |         |    |       |       |       |                |        |  |                      |         |    |       |       |       |  |  |  |  |         |    |       |       |       |  |  |  |  |         |    |       |       |       |  |  |  |  |         |    |       |       |       |  |  |  |  |         |    |       |       |       |  |  |  |  |         |     |       |       |       |  |  |  |  |         |     |       |       |       |  |  |  |  |         |    |       |       |       |                |        |     |       |         |    |       |       |       |                |        |     |       |         |    |       |       |       |  |  |  |  |         |    |       |       |       |  |  |  |  |         |    |       |       |       |  |  |  |  |         |    |       |       |       |  |  |  |  |         |     |       |       |       |  |  |  |  |         |     |       |       |       |  |  |  |  |         |    |       |       |       |                |        |     |       |         |    |       |       |       |                |        |     |       |         |    |       |       |       |  |  |  |  |         |    |       |       |       |                |        |   |       |         |    |       |       |       |  |  |  |  |         |    |       |       |       |  |  |  |  |         |    |       |       |       |  |  |  |  |         |    |       |       |       |  |  |  |  |         |    |       |       |       |  |  |  |  |         |     |       |       |       |  |  |  |  |         |     |       |       |       |  |  |  |  |         |    |       |       |  |                |        |   |                           |         |    |       |       |  |                |        |   |                           |         |    |       |       |  |  |  |  |  |         |    |       |       |  |  |  |  |  |         |    |       |       |  |  |  |  |  |         |    |       |       |  |  |  |  |  |         |     |       |       |  |  |  |  |  |         |     |       |       |  |  |  |  |  |         |    |       |       |  |                |        |     |       |         |    |       |       |  |                |        |     |       |         |    |       |       |  |  |  |  |  |         |    |       |       |  |                |        |   |       |         |    |       |       |  |                |        |   |       |         |    |       |       |  |  |  |  |  |         |    |       |       |  |  |  |  |  |         |    |       |       |  |  |  |  |  |         |    |       |       |  |  |  |  |  |         |     |       |       |  |  |  |  |  |         |     |       |       |  |  |  |  |  |         |    |       |       |  |                |        |     |        |         |    |       |       |  |                |        |     |        |         |    |       |       |  |  |  |  |  |         |    |       |       |  |  |  |  |  |         |    |       |       |  |  |  |  |  |         |    |       |       |  |  |  |  |  |         |     |       |       |  |  |  |  |  |         |     |       |       |  |  |  |  |  |         |    |       |       |  |                |        |  |          |         |    |       |       |  |  |  |  |  |         |    |       |       |  |  |  |  |  |
| 2.5 dCi  | 74  | 04.06     | 06.10 | + ABS |                |        |                |                           |   |           |           |    |       |       |       |                |        |   |        |           |    |       |       |       |                |        |   |        |           |     |       |       |       |                |        |  |          |         |     |       |       |       |  |  |  |  |         |     |       |       |       |  |  |  |  |         |     |       |       |       |  |  |  |  |         |     |       |       |       |  |  |  |  |         |    |       |       |       |                |        |  |           |         |    |       |       |       |  |  |  |  |         |    |       |       |       |  |  |  |  |         |    |       |       |       |                |        |  |                      |         |    |       |       |       |  |  |  |  |         |    |       |       |       |  |  |  |  |         |    |       |       |       |  |  |  |  |         |    |       |       |       |  |  |  |  |         |    |       |       |       |  |  |  |  |         |     |       |       |       |  |  |  |  |         |     |       |       |       |  |  |  |  |         |    |       |       |       |                |        |     |       |         |    |       |       |       |                |        |     |       |         |    |       |       |       |  |  |  |  |         |    |       |       |       |  |  |  |  |         |    |       |       |       |  |  |  |  |         |    |       |       |       |  |  |  |  |         |     |       |       |       |  |  |  |  |         |     |       |       |       |  |  |  |  |         |    |       |       |       |                |        |     |       |         |    |       |       |       |                |        |     |       |         |    |       |       |       |  |  |  |  |         |    |       |       |       |                |        |   |       |         |    |       |       |       |  |  |  |  |         |    |       |       |       |  |  |  |  |         |    |       |       |       |  |  |  |  |         |    |       |       |       |  |  |  |  |         |    |       |       |       |  |  |  |  |         |     |       |       |       |  |  |  |  |         |     |       |       |       |  |  |  |  |         |    |       |       |  |                |        |   |                           |         |    |       |       |  |                |        |   |                           |         |    |       |       |  |  |  |  |  |         |    |       |       |  |  |  |  |  |         |    |       |       |  |  |  |  |  |         |    |       |       |  |  |  |  |  |         |     |       |       |  |  |  |  |  |         |     |       |       |  |  |  |  |  |         |    |       |       |  |                |        |     |       |         |    |       |       |  |                |        |     |       |         |    |       |       |  |  |  |  |  |         |    |       |       |  |                |        |   |       |         |    |       |       |  |                |        |   |       |         |    |       |       |  |  |  |  |  |         |    |       |       |  |  |  |  |  |         |    |       |       |  |  |  |  |  |         |    |       |       |  |  |  |  |  |         |     |       |       |  |  |  |  |  |         |     |       |       |  |  |  |  |  |         |    |       |       |  |                |        |     |        |         |    |       |       |  |                |        |     |        |         |    |       |       |  |  |  |  |  |         |    |       |       |  |  |  |  |  |         |    |       |       |  |  |  |  |  |         |    |       |       |  |  |  |  |  |         |     |       |       |  |  |  |  |  |         |     |       |       |  |  |  |  |  |         |    |       |       |  |                |        |  |          |         |    |       |       |  |  |  |  |  |         |    |       |       |  |  |  |  |  |
| 2.5 dCi  | 84  | 11.03     | 08.06 | + ABS |                |        |                |                           |   |           |           |    |       |       |       |                |        |   |        |           |    |       |       |       |                |        |   |        |           |     |       |       |       |                |        |  |          |         |     |       |       |       |  |  |  |  |         |     |       |       |       |  |  |  |  |         |     |       |       |       |  |  |  |  |         |     |       |       |       |  |  |  |  |         |    |       |       |       |                |        |  |           |         |    |       |       |       |  |  |  |  |         |    |       |       |       |  |  |  |  |         |    |       |       |       |                |        |  |                      |         |    |       |       |       |  |  |  |  |         |    |       |       |       |  |  |  |  |         |    |       |       |       |  |  |  |  |         |    |       |       |       |  |  |  |  |         |    |       |       |       |  |  |  |  |         |     |       |       |       |  |  |  |  |         |     |       |       |       |  |  |  |  |         |    |       |       |       |                |        |     |       |         |    |       |       |       |                |        |     |       |         |    |       |       |       |  |  |  |  |         |    |       |       |       |  |  |  |  |         |    |       |       |       |  |  |  |  |         |    |       |       |       |  |  |  |  |         |     |       |       |       |  |  |  |  |         |     |       |       |       |  |  |  |  |         |    |       |       |       |                |        |     |       |         |    |       |       |       |                |        |     |       |         |    |       |       |       |  |  |  |  |         |    |       |       |       |                |        |   |       |         |    |       |       |       |  |  |  |  |         |    |       |       |       |  |  |  |  |         |    |       |       |       |  |  |  |  |         |    |       |       |       |  |  |  |  |         |    |       |       |       |  |  |  |  |         |     |       |       |       |  |  |  |  |         |     |       |       |       |  |  |  |  |         |    |       |       |  |                |        |   |                           |         |    |       |       |  |                |        |   |                           |         |    |       |       |  |  |  |  |  |         |    |       |       |  |  |  |  |  |         |    |       |       |  |  |  |  |  |         |    |       |       |  |  |  |  |  |         |     |       |       |  |  |  |  |  |         |     |       |       |  |  |  |  |  |         |    |       |       |  |                |        |     |       |         |    |       |       |  |                |        |     |       |         |    |       |       |  |  |  |  |  |         |    |       |       |  |                |        |   |       |         |    |       |       |  |                |        |   |       |         |    |       |       |  |  |  |  |  |         |    |       |       |  |  |  |  |  |         |    |       |       |  |  |  |  |  |         |    |       |       |  |  |  |  |  |         |     |       |       |  |  |  |  |  |         |     |       |       |  |  |  |  |  |         |    |       |       |  |                |        |     |        |         |    |       |       |  |                |        |     |        |         |    |       |       |  |  |  |  |  |         |    |       |       |  |  |  |  |  |         |    |       |       |  |  |  |  |  |         |    |       |       |  |  |  |  |  |         |     |       |       |  |  |  |  |  |         |     |       |       |  |  |  |  |  |         |    |       |       |  |                |        |  |          |         |    |       |       |  |  |  |  |  |         |    |       |       |  |  |  |  |  |
| 2.5 dCi  | 88  | 09.06     | 06.10 | + ABS |                |        |                |                           |   |           |           |    |       |       |       |                |        |   |        |           |    |       |       |       |                |        |   |        |           |     |       |       |       |                |        |  |          |         |     |       |       |       |  |  |  |  |         |     |       |       |       |  |  |  |  |         |     |       |       |       |  |  |  |  |         |     |       |       |       |  |  |  |  |         |    |       |       |       |                |        |  |           |         |    |       |       |       |  |  |  |  |         |    |       |       |       |  |  |  |  |         |    |       |       |       |                |        |  |                      |         |    |       |       |       |  |  |  |  |         |    |       |       |       |  |  |  |  |         |    |       |       |       |  |  |  |  |         |    |       |       |       |  |  |  |  |         |    |       |       |       |  |  |  |  |         |     |       |       |       |  |  |  |  |         |     |       |       |       |  |  |  |  |         |    |       |       |       |                |        |     |       |         |    |       |       |       |                |        |     |       |         |    |       |       |       |  |  |  |  |         |    |       |       |       |  |  |  |  |         |    |       |       |       |  |  |  |  |         |    |       |       |       |  |  |  |  |         |     |       |       |       |  |  |  |  |         |     |       |       |       |  |  |  |  |         |    |       |       |       |                |        |     |       |         |    |       |       |       |                |        |     |       |         |    |       |       |       |  |  |  |  |         |    |       |       |       |                |        |   |       |         |    |       |       |       |  |  |  |  |         |    |       |       |       |  |  |  |  |         |    |       |       |       |  |  |  |  |         |    |       |       |       |  |  |  |  |         |    |       |       |       |  |  |  |  |         |     |       |       |       |  |  |  |  |         |     |       |       |       |  |  |  |  |         |    |       |       |  |                |        |   |                           |         |    |       |       |  |                |        |   |                           |         |    |       |       |  |  |  |  |  |         |    |       |       |  |  |  |  |  |         |    |       |       |  |  |  |  |  |         |    |       |       |  |  |  |  |  |         |     |       |       |  |  |  |  |  |         |     |       |       |  |  |  |  |  |         |    |       |       |  |                |        |     |       |         |    |       |       |  |                |        |     |       |         |    |       |       |  |  |  |  |  |         |    |       |       |  |                |        |   |       |         |    |       |       |  |                |        |   |       |         |    |       |       |  |  |  |  |  |         |    |       |       |  |  |  |  |  |         |    |       |       |  |  |  |  |  |         |    |       |       |  |  |  |  |  |         |     |       |       |  |  |  |  |  |         |     |       |       |  |  |  |  |  |         |    |       |       |  |                |        |     |        |         |    |       |       |  |                |        |     |        |         |    |       |       |  |  |  |  |  |         |    |       |       |  |  |  |  |  |         |    |       |       |  |  |  |  |  |         |    |       |       |  |  |  |  |  |         |     |       |       |  |  |  |  |  |         |     |       |       |  |  |  |  |  |         |    |       |       |  |                |        |  |          |         |    |       |       |  |  |  |  |  |         |    |       |       |  |  |  |  |  |
| 2.5 dCi  | 107   | 09.06     | 06.10 | + ABS |                |        |                |                           |   |           |           |    |       |       |       |                |        |   |        |           |    |       |       |       |                |        |   |        |           |     |       |       |       |                |        |  |          |         |     |       |       |       |  |  |  |  |         |     |       |       |       |  |  |  |  |         |     |       |       |       |  |  |  |  |         |     |       |       |       |  |  |  |  |         |    |       |       |       |                |        |  |           |         |    |       |       |       |  |  |  |  |         |    |       |       |       |  |  |  |  |         |    |       |       |       |                |        |  |                      |         |    |       |       |       |  |  |  |  |         |    |       |       |       |  |  |  |  |         |    |       |       |       |  |  |  |  |         |    |       |       |       |  |  |  |  |         |    |       |       |       |  |  |  |  |         |     |       |       |       |  |  |  |  |         |     |       |       |       |  |  |  |  |         |    |       |       |       |                |        |     |       |         |    |       |       |       |                |        |     |       |         |    |       |       |       |  |  |  |  |         |    |       |       |       |  |  |  |  |         |    |       |       |       |  |  |  |  |         |    |       |       |       |  |  |  |  |         |     |       |       |       |  |  |  |  |         |     |       |       |       |  |  |  |  |         |    |       |       |       |                |        |     |       |         |    |       |       |       |                |        |     |       |         |    |       |       |       |  |  |  |  |         |    |       |       |       |                |        |   |       |         |    |       |       |       |  |  |  |  |         |    |       |       |       |  |  |  |  |         |    |       |       |       |  |  |  |  |         |    |       |       |       |  |  |  |  |         |    |       |       |       |  |  |  |  |         |     |       |       |       |  |  |  |  |         |     |       |       |       |  |  |  |  |         |    |       |       |  |                |        |   |                           |         |    |       |       |  |                |        |   |                           |         |    |       |       |  |  |  |  |  |         |    |       |       |  |  |  |  |  |         |    |       |       |  |  |  |  |  |         |    |       |       |  |  |  |  |  |         |     |       |       |  |  |  |  |  |         |     |       |       |  |  |  |  |  |         |    |       |       |  |                |        |     |       |         |    |       |       |  |                |        |     |       |         |    |       |       |  |  |  |  |  |         |    |       |       |  |                |        |   |       |         |    |       |       |  |                |        |   |       |         |    |       |       |  |  |  |  |  |         |    |       |       |  |  |  |  |  |         |    |       |       |  |  |  |  |  |         |    |       |       |  |  |  |  |  |         |     |       |       |  |  |  |  |  |         |     |       |       |  |  |  |  |  |         |    |       |       |  |                |        |     |        |         |    |       |       |  |                |        |     |        |         |    |       |       |  |  |  |  |  |         |    |       |       |  |  |  |  |  |         |    |       |       |  |  |  |  |  |         |    |       |       |  |  |  |  |  |         |     |       |       |  |  |  |  |  |         |     |       |       |  |  |  |  |  |         |    |       |       |  |                |        |  |          |         |    |       |       |  |  |  |  |  |         |    |       |       |  |  |  |  |  |
| 3.0 dCi  | 100   | 11.03     | 08.06 | + ABS |                |        |                |                           |   |           |           |    |       |       |       |                |        |   |        |           |    |       |       |       |                |        |   |        |           |     |       |       |       |                |        |  |          |         |     |       |       |       |  |  |  |  |         |     |       |       |       |  |  |  |  |         |     |       |       |       |  |  |  |  |         |     |       |       |       |  |  |  |  |         |    |       |       |       |                |        |  |           |         |    |       |       |       |  |  |  |  |         |    |       |       |       |  |  |  |  |         |    |       |       |       |                |        |  |                      |         |    |       |       |       |  |  |  |  |         |    |       |       |       |  |  |  |  |         |    |       |       |       |  |  |  |  |         |    |       |       |       |  |  |  |  |         |    |       |       |       |  |  |  |  |         |     |       |       |       |  |  |  |  |         |     |       |       |       |  |  |  |  |         |    |       |       |       |                |        |     |       |         |    |       |       |       |                |        |     |       |         |    |       |       |       |  |  |  |  |         |    |       |       |       |  |  |  |  |         |    |       |       |       |  |  |  |  |         |    |       |       |       |  |  |  |  |         |     |       |       |       |  |  |  |  |         |     |       |       |       |  |  |  |  |         |    |       |       |       |                |        |     |       |         |    |       |       |       |                |        |     |       |         |    |       |       |       |  |  |  |  |         |    |       |       |       |                |        |   |       |         |    |       |       |       |  |  |  |  |         |    |       |       |       |  |  |  |  |         |    |       |       |       |  |  |  |  |         |    |       |       |       |  |  |  |  |         |    |       |       |       |  |  |  |  |         |     |       |       |       |  |  |  |  |         |     |       |       |       |  |  |  |  |         |    |       |       |  |                |        |   |                           |         |    |       |       |  |                |        |   |                           |         |    |       |       |  |  |  |  |  |         |    |       |       |  |  |  |  |  |         |    |       |       |  |  |  |  |  |         |    |       |       |  |  |  |  |  |         |     |       |       |  |  |  |  |  |         |     |       |       |  |  |  |  |  |         |    |       |       |  |                |        |     |       |         |    |       |       |  |                |        |     |       |         |    |       |       |  |  |  |  |  |         |    |       |       |  |                |        |   |       |         |    |       |       |  |                |        |   |       |         |    |       |       |  |  |  |  |  |         |    |       |       |  |  |  |  |  |         |    |       |       |  |  |  |  |  |         |    |       |       |  |  |  |  |  |         |     |       |       |  |  |  |  |  |         |     |       |       |  |  |  |  |  |         |    |       |       |  |                |        |     |        |         |    |       |       |  |                |        |     |        |         |    |       |       |  |  |  |  |  |         |    |       |       |  |  |  |  |  |         |    |       |       |  |  |  |  |  |         |    |       |       |  |  |  |  |  |         |     |       |       |  |  |  |  |  |         |     |       |       |  |  |  |  |  |         |    |       |       |  |                |        |  |          |         |    |       |       |  |  |  |  |  |         |    |       |       |  |  |  |  |  |
| 1.9 dCi  | 60  | 07.02     | 08.06 |       | 24.3424-1701.5 | 240561 | □              | D=42, - Halter <b>BOS</b> |   |           |           |    |       |       |       |                |        |   |        |           |    |       |       |       |                |        |   |        |           |     |       |       |       |                |        |  |          |         |     |       |       |       |  |  |  |  |         |     |       |       |       |  |  |  |  |         |     |       |       |       |  |  |  |  |         |     |       |       |       |  |  |  |  |         |    |       |       |       |                |        |  |           |         |    |       |       |       |  |  |  |  |         |    |       |       |       |  |  |  |  |         |    |       |       |       |                |        |  |                      |         |    |       |       |       |  |  |  |  |         |    |       |       |       |  |  |  |  |         |    |       |       |       |  |  |  |  |         |    |       |       |       |  |  |  |  |         |    |       |       |       |  |  |  |  |         |     |       |       |       |  |  |  |  |         |     |       |       |       |  |  |  |  |         |    |       |       |       |                |        |     |       |         |    |       |       |       |                |        |     |       |         |    |       |       |       |  |  |  |  |         |    |       |       |       |  |  |  |  |         |    |       |       |       |  |  |  |  |         |    |       |       |       |  |  |  |  |         |     |       |       |       |  |  |  |  |         |     |       |       |       |  |  |  |  |         |    |       |       |       |                |        |     |       |         |    |       |       |       |                |        |     |       |         |    |       |       |       |  |  |  |  |         |    |       |       |       |                |        |   |       |         |    |       |       |       |  |  |  |  |         |    |       |       |       |  |  |  |  |         |    |       |       |       |  |  |  |  |         |    |       |       |       |  |  |  |  |         |    |       |       |       |  |  |  |  |         |     |       |       |       |  |  |  |  |         |     |       |       |       |  |  |  |  |         |    |       |       |  |                |        |   |                           |         |    |       |       |  |                |        |   |                           |         |    |       |       |  |  |  |  |  |         |    |       |       |  |  |  |  |  |         |    |       |       |  |  |  |  |  |         |    |       |       |  |  |  |  |  |         |     |       |       |  |  |  |  |  |         |     |       |       |  |  |  |  |  |         |    |       |       |  |                |        |     |       |         |    |       |       |  |                |        |     |       |         |    |       |       |  |  |  |  |  |         |    |       |       |  |                |        |   |       |         |    |       |       |  |                |        |   |       |         |    |       |       |  |  |  |  |  |         |    |       |       |  |  |  |  |  |         |    |       |       |  |  |  |  |  |         |    |       |       |  |  |  |  |  |         |     |       |       |  |  |  |  |  |         |     |       |       |  |  |  |  |  |         |    |       |       |  |                |        |     |        |         |    |       |       |  |                |        |     |        |         |    |       |       |  |  |  |  |  |         |    |       |       |  |  |  |  |  |         |    |       |       |  |  |  |  |  |         |    |       |       |  |  |  |  |  |         |     |       |       |  |  |  |  |  |         |     |       |       |  |  |  |  |  |         |    |       |       |  |                |        |  |          |         |    |       |       |  |  |  |  |  |         |    |       |       |  |  |  |  |  |
| 2.2 dCi  | 66  | 07.02     | 08.06 |       | 24.3424-1702.5 | 240562 | □              | D=42, - Halter <b>BOS</b> |   |           |           |    |       |       |       |                |        |   |        |           |    |       |       |       |                |        |   |        |           |     |       |       |       |                |        |  |          |         |     |       |       |       |  |  |  |  |         |     |       |       |       |  |  |  |  |         |     |       |       |       |  |  |  |  |         |     |       |       |       |  |  |  |  |         |    |       |       |       |                |        |  |           |         |    |       |       |       |  |  |  |  |         |    |       |       |       |  |  |  |  |         |    |       |       |       |                |        |  |                      |         |    |       |       |       |  |  |  |  |         |    |       |       |       |  |  |  |  |         |    |       |       |       |  |  |  |  |         |    |       |       |       |  |  |  |  |         |    |       |       |       |  |  |  |  |         |     |       |       |       |  |  |  |  |         |     |       |       |       |  |  |  |  |         |    |       |       |       |                |        |     |       |         |    |       |       |       |                |        |     |       |         |    |       |       |       |  |  |  |  |         |    |       |       |       |  |  |  |  |         |    |       |       |       |  |  |  |  |         |    |       |       |       |  |  |  |  |         |     |       |       |       |  |  |  |  |         |     |       |       |       |  |  |  |  |         |    |       |       |       |                |        |     |       |         |    |       |       |       |                |        |     |       |         |    |       |       |       |  |  |  |  |         |    |       |       |       |                |        |   |       |         |    |       |       |       |  |  |  |  |         |    |       |       |       |  |  |  |  |         |    |       |       |       |  |  |  |  |         |    |       |       |       |  |  |  |  |         |    |       |       |       |  |  |  |  |         |     |       |       |       |  |  |  |  |         |     |       |       |       |  |  |  |  |         |    |       |       |  |                |        |   |                           |         |    |       |       |  |                |        |   |                           |         |    |       |       |  |  |  |  |  |         |    |       |       |  |  |  |  |  |         |    |       |       |  |  |  |  |  |         |    |       |       |  |  |  |  |  |         |     |       |       |  |  |  |  |  |         |     |       |       |  |  |  |  |  |         |    |       |       |  |                |        |     |       |         |    |       |       |  |                |        |     |       |         |    |       |       |  |  |  |  |  |         |    |       |       |  |                |        |   |       |         |    |       |       |  |                |        |   |       |         |    |       |       |  |  |  |  |  |         |    |       |       |  |  |  |  |  |         |    |       |       |  |  |  |  |  |         |    |       |       |  |  |  |  |  |         |     |       |       |  |  |  |  |  |         |     |       |       |  |  |  |  |  |         |    |       |       |  |                |        |     |        |         |    |       |       |  |                |        |     |        |         |    |       |       |  |  |  |  |  |         |    |       |       |  |  |  |  |  |         |    |       |       |  |  |  |  |  |         |    |       |       |  |  |  |  |  |         |     |       |       |  |  |  |  |  |         |     |       |       |  |  |  |  |  |         |    |       |       |  |                |        |  |          |         |    |       |       |  |  |  |  |  |         |    |       |       |  |  |  |  |  |
| 2.5 dCi  | 73  | 11.03     | 06.10 |       |                |        |                |                           |   |           |           |    |       |       |       |                |        |   |        |           |    |       |       |       |                |        |   |        |           |     |       |       |       |                |        |  |          |         |     |       |       |       |  |  |  |  |         |     |       |       |       |  |  |  |  |         |     |       |       |       |  |  |  |  |         |     |       |       |       |  |  |  |  |         |    |       |       |       |                |        |  |           |         |    |       |       |       |  |  |  |  |         |    |       |       |       |  |  |  |  |         |    |       |       |       |                |        |  |                      |         |    |       |       |       |  |  |  |  |         |    |       |       |       |  |  |  |  |         |    |       |       |       |  |  |  |  |         |    |       |       |       |  |  |  |  |         |    |       |       |       |  |  |  |  |         |     |       |       |       |  |  |  |  |         |     |       |       |       |  |  |  |  |         |    |       |       |       |                |        |     |       |         |    |       |       |       |                |        |     |       |         |    |       |       |       |  |  |  |  |         |    |       |       |       |  |  |  |  |         |    |       |       |       |  |  |  |  |         |    |       |       |       |  |  |  |  |         |     |       |       |       |  |  |  |  |         |     |       |       |       |  |  |  |  |         |    |       |       |       |                |        |     |       |         |    |       |       |       |                |        |     |       |         |    |       |       |       |  |  |  |  |         |    |       |       |       |                |        |   |       |         |    |       |       |       |  |  |  |  |         |    |       |       |       |  |  |  |  |         |    |       |       |       |  |  |  |  |         |    |       |       |       |  |  |  |  |         |    |       |       |       |  |  |  |  |         |     |       |       |       |  |  |  |  |         |     |       |       |       |  |  |  |  |         |    |       |       |  |                |        |   |                           |         |    |       |       |  |                |        |   |                           |         |    |       |       |  |  |  |  |  |         |    |       |       |  |  |  |  |  |         |    |       |       |  |  |  |  |  |         |    |       |       |  |  |  |  |  |         |     |       |       |  |  |  |  |  |         |     |       |       |  |  |  |  |  |         |    |       |       |  |                |        |     |       |         |    |       |       |  |                |        |     |       |         |    |       |       |  |  |  |  |  |         |    |       |       |  |                |        |   |       |         |    |       |       |  |                |        |   |       |         |    |       |       |  |  |  |  |  |         |    |       |       |  |  |  |  |  |         |    |       |       |  |  |  |  |  |         |    |       |       |  |  |  |  |  |         |     |       |       |  |  |  |  |  |         |     |       |       |  |  |  |  |  |         |    |       |       |  |                |        |     |        |         |    |       |       |  |                |        |     |        |         |    |       |       |  |  |  |  |  |         |    |       |       |  |  |  |  |  |         |    |       |       |  |  |  |  |  |         |    |       |       |  |  |  |  |  |         |     |       |       |  |  |  |  |  |         |     |       |       |  |  |  |  |  |         |    |       |       |  |                |        |  |          |         |    |       |       |  |  |  |  |  |         |    |       |       |  |  |  |  |  |
| 2.5 dCi  | 74  | 04.06     | 06.10 |       |                |        |                |                           |   |           |           |    |       |       |       |                |        |   |        |           |    |       |       |       |                |        |   |        |           |     |       |       |       |                |        |  |          |         |     |       |       |       |  |  |  |  |         |     |       |       |       |  |  |  |  |         |     |       |       |       |  |  |  |  |         |     |       |       |       |  |  |  |  |         |    |       |       |       |                |        |  |           |         |    |       |       |       |  |  |  |  |         |    |       |       |       |  |  |  |  |         |    |       |       |       |                |        |  |                      |         |    |       |       |       |  |  |  |  |         |    |       |       |       |  |  |  |  |         |    |       |       |       |  |  |  |  |         |    |       |       |       |  |  |  |  |         |    |       |       |       |  |  |  |  |         |     |       |       |       |  |  |  |  |         |     |       |       |       |  |  |  |  |         |    |       |       |       |                |        |     |       |         |    |       |       |       |                |        |     |       |         |    |       |       |       |  |  |  |  |         |    |       |       |       |  |  |  |  |         |    |       |       |       |  |  |  |  |         |    |       |       |       |  |  |  |  |         |     |       |       |       |  |  |  |  |         |     |       |       |       |  |  |  |  |         |    |       |       |       |                |        |     |       |         |    |       |       |       |                |        |     |       |         |    |       |       |       |  |  |  |  |         |    |       |       |       |                |        |   |       |         |    |       |       |       |  |  |  |  |         |    |       |       |       |  |  |  |  |         |    |       |       |       |  |  |  |  |         |    |       |       |       |  |  |  |  |         |    |       |       |       |  |  |  |  |         |     |       |       |       |  |  |  |  |         |     |       |       |       |  |  |  |  |         |    |       |       |  |                |        |   |                           |         |    |       |       |  |                |        |   |                           |         |    |       |       |  |  |  |  |  |         |    |       |       |  |  |  |  |  |         |    |       |       |  |  |  |  |  |         |    |       |       |  |  |  |  |  |         |     |       |       |  |  |  |  |  |         |     |       |       |  |  |  |  |  |         |    |       |       |  |                |        |     |       |         |    |       |       |  |                |        |     |       |         |    |       |       |  |  |  |  |  |         |    |       |       |  |                |        |   |       |         |    |       |       |  |                |        |   |       |         |    |       |       |  |  |  |  |  |         |    |       |       |  |  |  |  |  |         |    |       |       |  |  |  |  |  |         |    |       |       |  |  |  |  |  |         |     |       |       |  |  |  |  |  |         |     |       |       |  |  |  |  |  |         |    |       |       |  |                |        |     |        |         |    |       |       |  |                |        |     |        |         |    |       |       |  |  |  |  |  |         |    |       |       |  |  |  |  |  |         |    |       |       |  |  |  |  |  |         |    |       |       |  |  |  |  |  |         |     |       |       |  |  |  |  |  |         |     |       |       |  |  |  |  |  |         |    |       |       |  |                |        |  |          |         |    |       |       |  |  |  |  |  |         |    |       |       |  |  |  |  |  |
| 2.5 dCi  | 84  | 07.02     | 08.06 |       |                |        |                |                           |   |           |           |    |       |       |       |                |        |   |        |           |    |       |       |       |                |        |   |        |           |     |       |       |       |                |        |  |          |         |     |       |       |       |  |  |  |  |         |     |       |       |       |  |  |  |  |         |     |       |       |       |  |  |  |  |         |     |       |       |       |  |  |  |  |         |    |       |       |       |                |        |  |           |         |    |       |       |       |  |  |  |  |         |    |       |       |       |  |  |  |  |         |    |       |       |       |                |        |  |                      |         |    |       |       |       |  |  |  |  |         |    |       |       |       |  |  |  |  |         |    |       |       |       |  |  |  |  |         |    |       |       |       |  |  |  |  |         |    |       |       |       |  |  |  |  |         |     |       |       |       |  |  |  |  |         |     |       |       |       |  |  |  |  |         |    |       |       |       |                |        |     |       |         |    |       |       |       |                |        |     |       |         |    |       |       |       |  |  |  |  |         |    |       |       |       |  |  |  |  |         |    |       |       |       |  |  |  |  |         |    |       |       |       |  |  |  |  |         |     |       |       |       |  |  |  |  |         |     |       |       |       |  |  |  |  |         |    |       |       |       |                |        |     |       |         |    |       |       |       |                |        |     |       |         |    |       |       |       |  |  |  |  |         |    |       |       |       |                |        |   |       |         |    |       |       |       |  |  |  |  |         |    |       |       |       |  |  |  |  |         |    |       |       |       |  |  |  |  |         |    |       |       |       |  |  |  |  |         |    |       |       |       |  |  |  |  |         |     |       |       |       |  |  |  |  |         |     |       |       |       |  |  |  |  |         |    |       |       |  |                |        |   |                           |         |    |       |       |  |                |        |   |                           |         |    |       |       |  |  |  |  |  |         |    |       |       |  |  |  |  |  |         |    |       |       |  |  |  |  |  |         |    |       |       |  |  |  |  |  |         |     |       |       |  |  |  |  |  |         |     |       |       |  |  |  |  |  |         |    |       |       |  |                |        |     |       |         |    |       |       |  |                |        |     |       |         |    |       |       |  |  |  |  |  |         |    |       |       |  |                |        |   |       |         |    |       |       |  |                |        |   |       |         |    |       |       |  |  |  |  |  |         |    |       |       |  |  |  |  |  |         |    |       |       |  |  |  |  |  |         |    |       |       |  |  |  |  |  |         |     |       |       |  |  |  |  |  |         |     |       |       |  |  |  |  |  |         |    |       |       |  |                |        |     |        |         |    |       |       |  |                |        |     |        |         |    |       |       |  |  |  |  |  |         |    |       |       |  |  |  |  |  |         |    |       |       |  |  |  |  |  |         |    |       |       |  |  |  |  |  |         |     |       |       |  |  |  |  |  |         |     |       |       |  |  |  |  |  |         |    |       |       |  |                |        |  |          |         |    |       |       |  |  |  |  |  |         |    |       |       |  |  |  |  |  |
| 2.5 dCi  | 88  | 09.06     | 06.10 |       |                |        |                |                           |   |           |           |    |       |       |       |                |        |   |        |           |    |       |       |       |                |        |   |        |           |     |       |       |       |                |        |  |          |         |     |       |       |       |  |  |  |  |         |     |       |       |       |  |  |  |  |         |     |       |       |       |  |  |  |  |         |     |       |       |       |  |  |  |  |         |    |       |       |       |                |        |  |           |         |    |       |       |       |  |  |  |  |         |    |       |       |       |  |  |  |  |         |    |       |       |       |                |        |  |                      |         |    |       |       |       |  |  |  |  |         |    |       |       |       |  |  |  |  |         |    |       |       |       |  |  |  |  |         |    |       |       |       |  |  |  |  |         |    |       |       |       |  |  |  |  |         |     |       |       |       |  |  |  |  |         |     |       |       |       |  |  |  |  |         |    |       |       |       |                |        |     |       |         |    |       |       |       |                |        |     |       |         |    |       |       |       |  |  |  |  |         |    |       |       |       |  |  |  |  |         |    |       |       |       |  |  |  |  |         |    |       |       |       |  |  |  |  |         |     |       |       |       |  |  |  |  |         |     |       |       |       |  |  |  |  |         |    |       |       |       |                |        |     |       |         |    |       |       |       |                |        |     |       |         |    |       |       |       |  |  |  |  |         |    |       |       |       |                |        |   |       |         |    |       |       |       |  |  |  |  |         |    |       |       |       |  |  |  |  |         |    |       |       |       |  |  |  |  |         |    |       |       |       |  |  |  |  |         |    |       |       |       |  |  |  |  |         |     |       |       |       |  |  |  |  |         |     |       |       |       |  |  |  |  |         |    |       |       |  |                |        |   |                           |         |    |       |       |  |                |        |   |                           |         |    |       |       |  |  |  |  |  |         |    |       |       |  |  |  |  |  |         |    |       |       |  |  |  |  |  |         |    |       |       |  |  |  |  |  |         |     |       |       |  |  |  |  |  |         |     |       |       |  |  |  |  |  |         |    |       |       |  |                |        |     |       |         |    |       |       |  |                |        |     |       |         |    |       |       |  |  |  |  |  |         |    |       |       |  |                |        |   |       |         |    |       |       |  |                |        |   |       |         |    |       |       |  |  |  |  |  |         |    |       |       |  |  |  |  |  |         |    |       |       |  |  |  |  |  |         |    |       |       |  |  |  |  |  |         |     |       |       |  |  |  |  |  |         |     |       |       |  |  |  |  |  |         |    |       |       |  |                |        |     |        |         |    |       |       |  |                |        |     |        |         |    |       |       |  |  |  |  |  |         |    |       |       |  |  |  |  |  |         |    |       |       |  |  |  |  |  |         |    |       |       |  |  |  |  |  |         |     |       |       |  |  |  |  |  |         |     |       |       |  |  |  |  |  |         |    |       |       |  |                |        |  |          |         |    |       |       |  |  |  |  |  |         |    |       |       |  |  |  |  |  |
| 2.5 dCi  | 107   | 09.06     | 06.10 |       |                |        |                |                           |   |           |           |    |       |       |       |                |        |   |        |           |    |       |       |       |                |        |   |        |           |     |       |       |       |                |        |  |          |         |     |       |       |       |  |  |  |  |         |     |       |       |       |  |  |  |  |         |     |       |       |       |  |  |  |  |         |     |       |       |       |  |  |  |  |         |    |       |       |       |                |        |  |           |         |    |       |       |       |  |  |  |  |         |    |       |       |       |  |  |  |  |         |    |       |       |       |                |        |  |                      |         |    |       |       |       |  |  |  |  |         |    |       |       |       |  |  |  |  |         |    |       |       |       |  |  |  |  |         |    |       |       |       |  |  |  |  |         |    |       |       |       |  |  |  |  |         |     |       |       |       |  |  |  |  |         |     |       |       |       |  |  |  |  |         |    |       |       |       |                |        |     |       |         |    |       |       |       |                |        |     |       |         |    |       |       |       |  |  |  |  |         |    |       |       |       |  |  |  |  |         |    |       |       |       |  |  |  |  |         |    |       |       |       |  |  |  |  |         |     |       |       |       |  |  |  |  |         |     |       |       |       |  |  |  |  |         |    |       |       |       |                |        |     |       |         |    |       |       |       |                |        |     |       |         |    |       |       |       |  |  |  |  |         |    |       |       |       |                |        |   |       |         |    |       |       |       |  |  |  |  |         |    |       |       |       |  |  |  |  |         |    |       |       |       |  |  |  |  |         |    |       |       |       |  |  |  |  |         |    |       |       |       |  |  |  |  |         |     |       |       |       |  |  |  |  |         |     |       |       |       |  |  |  |  |         |    |       |       |  |                |        |   |                           |         |    |       |       |  |                |        |   |                           |         |    |       |       |  |  |  |  |  |         |    |       |       |  |  |  |  |  |         |    |       |       |  |  |  |  |  |         |    |       |       |  |  |  |  |  |         |     |       |       |  |  |  |  |  |         |     |       |       |  |  |  |  |  |         |    |       |       |  |                |        |     |       |         |    |       |       |  |                |        |     |       |         |    |       |       |  |  |  |  |  |         |    |       |       |  |                |        |   |       |         |    |       |       |  |                |        |   |       |         |    |       |       |  |  |  |  |  |         |    |       |       |  |  |  |  |  |         |    |       |       |  |  |  |  |  |         |    |       |       |  |  |  |  |  |         |     |       |       |  |  |  |  |  |         |     |       |       |  |  |  |  |  |         |    |       |       |  |                |        |     |        |         |    |       |       |  |                |        |     |        |         |    |       |       |  |  |  |  |  |         |    |       |       |  |  |  |  |  |         |    |       |       |  |  |  |  |  |         |    |       |       |  |  |  |  |  |         |     |       |       |  |  |  |  |  |         |     |       |       |  |  |  |  |  |         |    |       |       |  |                |        |  |          |         |    |       |       |  |  |  |  |  |         |    |       |       |  |  |  |  |  |
| 3.0 dCi  | 100   | 11.03     | 08.06 |       |                |        |                |                           |   |           |           |    |       |       |       |                |        |   |        |           |    |       |       |       |                |        |   |        |           |     |       |       |       |                |        |  |          |         |     |       |       |       |  |  |  |  |         |     |       |       |       |  |  |  |  |         |     |       |       |       |  |  |  |  |         |     |       |       |       |  |  |  |  |         |    |       |       |       |                |        |  |           |         |    |       |       |       |  |  |  |  |         |    |       |       |       |  |  |  |  |         |    |       |       |       |                |        |  |                      |         |    |       |       |       |  |  |  |  |         |    |       |       |       |  |  |  |  |         |    |       |       |       |  |  |  |  |         |    |       |       |       |  |  |  |  |         |    |       |       |       |  |  |  |  |         |     |       |       |       |  |  |  |  |         |     |       |       |       |  |  |  |  |         |    |       |       |       |                |        |     |       |         |    |       |       |       |                |        |     |       |         |    |       |       |       |  |  |  |  |         |    |       |       |       |  |  |  |  |         |    |       |       |       |  |  |  |  |         |    |       |       |       |  |  |  |  |         |     |       |       |       |  |  |  |  |         |     |       |       |       |  |  |  |  |         |    |       |       |       |                |        |     |       |         |    |       |       |       |                |        |     |       |         |    |       |       |       |  |  |  |  |         |    |       |       |       |                |        |   |       |         |    |       |       |       |  |  |  |  |         |    |       |       |       |  |  |  |  |         |    |       |       |       |  |  |  |  |         |    |       |       |       |  |  |  |  |         |    |       |       |       |  |  |  |  |         |     |       |       |       |  |  |  |  |         |     |       |       |       |  |  |  |  |         |    |       |       |  |                |        |   |                           |         |    |       |       |  |                |        |   |                           |         |    |       |       |  |  |  |  |  |         |    |       |       |  |  |  |  |  |         |    |       |       |  |  |  |  |  |         |    |       |       |  |  |  |  |  |         |     |       |       |  |  |  |  |  |         |     |       |       |  |  |  |  |  |         |    |       |       |  |                |        |     |       |         |    |       |       |  |                |        |     |       |         |    |       |       |  |  |  |  |  |         |    |       |       |  |                |        |   |       |         |    |       |       |  |                |        |   |       |         |    |       |       |  |  |  |  |  |         |    |       |       |  |  |  |  |  |         |    |       |       |  |  |  |  |  |         |    |       |       |  |  |  |  |  |         |     |       |       |  |  |  |  |  |         |     |       |       |  |  |  |  |  |         |    |       |       |  |                |        |     |        |         |    |       |       |  |                |        |     |        |         |    |       |       |  |  |  |  |  |         |    |       |       |  |  |  |  |  |         |    |       |       |  |  |  |  |  |         |    |       |       |  |  |  |  |  |         |     |       |       |  |  |  |  |  |         |     |       |       |  |  |  |  |  |         |    |       |       |  |                |        |  |          |         |    |       |       |  |  |  |  |  |         |    |       |       |  |  |  |  |  |
| 1.9 dCi  | 60  | 07.02     | 10.03 |       | 24.5111-0410.3 | 330681 | 1 □            | L=410                     |   |           |           |    |       |       |       |                |        |   |        |           |    |       |       |       |                |        |   |        |           |     |       |       |       |                |        |  |          |         |     |       |       |       |  |  |  |  |         |     |       |       |       |  |  |  |  |         |     |       |       |       |  |  |  |  |         |     |       |       |       |  |  |  |  |         |    |       |       |       |                |        |  |           |         |    |       |       |       |  |  |  |  |         |    |       |       |       |  |  |  |  |         |    |       |       |       |                |        |  |                      |         |    |       |       |       |  |  |  |  |         |    |       |       |       |  |  |  |  |         |    |       |       |       |  |  |  |  |         |    |       |       |       |  |  |  |  |         |    |       |       |       |  |  |  |  |         |     |       |       |       |  |  |  |  |         |     |       |       |       |  |  |  |  |         |    |       |       |       |                |        |     |       |         |    |       |       |       |                |        |     |       |         |    |       |       |       |  |  |  |  |         |    |       |       |       |  |  |  |  |         |    |       |       |       |  |  |  |  |         |    |       |       |       |  |  |  |  |         |     |       |       |       |  |  |  |  |         |     |       |       |       |  |  |  |  |         |    |       |       |       |                |        |     |       |         |    |       |       |       |                |        |     |       |         |    |       |       |       |  |  |  |  |         |    |       |       |       |                |        |   |       |         |    |       |       |       |  |  |  |  |         |    |       |       |       |  |  |  |  |         |    |       |       |       |  |  |  |  |         |    |       |       |       |  |  |  |  |         |    |       |       |       |  |  |  |  |         |     |       |       |       |  |  |  |  |         |     |       |       |       |  |  |  |  |         |    |       |       |  |                |        |   |                           |         |    |       |       |  |                |        |   |                           |         |    |       |       |  |  |  |  |  |         |    |       |       |  |  |  |  |  |         |    |       |       |  |  |  |  |  |         |    |       |       |  |  |  |  |  |         |     |       |       |  |  |  |  |  |         |     |       |       |  |  |  |  |  |         |    |       |       |  |                |        |     |       |         |    |       |       |  |                |        |     |       |         |    |       |       |  |  |  |  |  |         |    |       |       |  |                |        |   |       |         |    |       |       |  |                |        |   |       |         |    |       |       |  |  |  |  |  |         |    |       |       |  |  |  |  |  |         |    |       |       |  |  |  |  |  |         |    |       |       |  |  |  |  |  |         |     |       |       |  |  |  |  |  |         |     |       |       |  |  |  |  |  |         |    |       |       |  |                |        |     |        |         |    |       |       |  |                |        |     |        |         |    |       |       |  |  |  |  |  |         |    |       |       |  |  |  |  |  |         |    |       |       |  |  |  |  |  |         |    |       |       |  |  |  |  |  |         |     |       |       |  |  |  |  |  |         |     |       |       |  |  |  |  |  |         |    |       |       |  |                |        |  |          |         |    |       |       |  |  |  |  |  |         |    |       |       |  |  |  |  |  |
| 2.2 dCi  | 66  | 07.02     | 10.03 |       | 24.5111-0326.3 | 330766 | 2 ↓            | L=326                     |   |           |           |    |       |       |       |                |        |   |        |           |    |       |       |       |                |        |   |        |           |     |       |       |       |                |        |  |          |         |     |       |       |       |  |  |  |  |         |     |       |       |       |  |  |  |  |         |     |       |       |       |  |  |  |  |         |     |       |       |       |  |  |  |  |         |    |       |       |       |                |        |  |           |         |    |       |       |       |  |  |  |  |         |    |       |       |       |  |  |  |  |         |    |       |       |       |                |        |  |                      |         |    |       |       |       |  |  |  |  |         |    |       |       |       |  |  |  |  |         |    |       |       |       |  |  |  |  |         |    |       |       |       |  |  |  |  |         |    |       |       |       |  |  |  |  |         |     |       |       |       |  |  |  |  |         |     |       |       |       |  |  |  |  |         |    |       |       |       |                |        |     |       |         |    |       |       |       |                |        |     |       |         |    |       |       |       |  |  |  |  |         |    |       |       |       |  |  |  |  |         |    |       |       |       |  |  |  |  |         |    |       |       |       |  |  |  |  |         |     |       |       |       |  |  |  |  |         |     |       |       |       |  |  |  |  |         |    |       |       |       |                |        |     |       |         |    |       |       |       |                |        |     |       |         |    |       |       |       |  |  |  |  |         |    |       |       |       |                |        |   |       |         |    |       |       |       |  |  |  |  |         |    |       |       |       |  |  |  |  |         |    |       |       |       |  |  |  |  |         |    |       |       |       |  |  |  |  |         |    |       |       |       |  |  |  |  |         |     |       |       |       |  |  |  |  |         |     |       |       |       |  |  |  |  |         |    |       |       |  |                |        |   |                           |         |    |       |       |  |                |        |   |                           |         |    |       |       |  |  |  |  |  |         |    |       |       |  |  |  |  |  |         |    |       |       |  |  |  |  |  |         |    |       |       |  |  |  |  |  |         |     |       |       |  |  |  |  |  |         |     |       |       |  |  |  |  |  |         |    |       |       |  |                |        |     |       |         |    |       |       |  |                |        |     |       |         |    |       |       |  |  |  |  |  |         |    |       |       |  |                |        |   |       |         |    |       |       |  |                |        |   |       |         |    |       |       |  |  |  |  |  |         |    |       |       |  |  |  |  |  |         |    |       |       |  |  |  |  |  |         |    |       |       |  |  |  |  |  |         |     |       |       |  |  |  |  |  |         |     |       |       |  |  |  |  |  |         |    |       |       |  |                |        |     |        |         |    |       |       |  |                |        |     |        |         |    |       |       |  |  |  |  |  |         |    |       |       |  |  |  |  |  |         |    |       |       |  |  |  |  |  |         |    |       |       |  |  |  |  |  |         |     |       |       |  |  |  |  |  |         |     |       |       |  |  |  |  |  |         |    |       |       |  |                |        |  |          |         |    |       |       |  |  |  |  |  |         |    |       |       |  |  |  |  |  |
| 2.5 dCi  | 84  | 07.02     | 10.03 |       |                |        |                |                           |   |           |           |    |       |       |       |                |        |   |        |           |    |       |       |       |                |        |   |        |           |     |       |       |       |                |        |  |          |         |     |       |       |       |  |  |  |  |         |     |       |       |       |  |  |  |  |         |     |       |       |       |  |  |  |  |         |     |       |       |       |  |  |  |  |         |    |       |       |       |                |        |  |           |         |    |       |       |       |  |  |  |  |         |    |       |       |       |  |  |  |  |         |    |       |       |       |                |        |  |                      |         |    |       |       |       |  |  |  |  |         |    |       |       |       |  |  |  |  |         |    |       |       |       |  |  |  |  |         |    |       |       |       |  |  |  |  |         |    |       |       |       |  |  |  |  |         |     |       |       |       |  |  |  |  |         |     |       |       |       |  |  |  |  |         |    |       |       |       |                |        |     |       |         |    |       |       |       |                |        |     |       |         |    |       |       |       |  |  |  |  |         |    |       |       |       |  |  |  |  |         |    |       |       |       |  |  |  |  |         |    |       |       |       |  |  |  |  |         |     |       |       |       |  |  |  |  |         |     |       |       |       |  |  |  |  |         |    |       |       |       |                |        |     |       |         |    |       |       |       |                |        |     |       |         |    |       |       |       |  |  |  |  |         |    |       |       |       |                |        |   |       |         |    |       |       |       |  |  |  |  |         |    |       |       |       |  |  |  |  |         |    |       |       |       |  |  |  |  |         |    |       |       |       |  |  |  |  |         |    |       |       |       |  |  |  |  |         |     |       |       |       |  |  |  |  |         |     |       |       |       |  |  |  |  |         |    |       |       |  |                |        |   |                           |         |    |       |       |  |                |        |   |                           |         |    |       |       |  |  |  |  |  |         |    |       |       |  |  |  |  |  |         |    |       |       |  |  |  |  |  |         |    |       |       |  |  |  |  |  |         |     |       |       |  |  |  |  |  |         |     |       |       |  |  |  |  |  |         |    |       |       |  |                |        |     |       |         |    |       |       |  |                |        |     |       |         |    |       |       |  |  |  |  |  |         |    |       |       |  |                |        |   |       |         |    |       |       |  |                |        |   |       |         |    |       |       |  |  |  |  |  |         |    |       |       |  |  |  |  |  |         |    |       |       |  |  |  |  |  |         |    |       |       |  |  |  |  |  |         |     |       |       |  |  |  |  |  |         |     |       |       |  |  |  |  |  |         |    |       |       |  |                |        |     |        |         |    |       |       |  |                |        |     |        |         |    |       |       |  |  |  |  |  |         |    |       |       |  |  |  |  |  |         |    |       |       |  |  |  |  |  |         |    |       |       |  |  |  |  |  |         |     |       |       |  |  |  |  |  |         |     |       |       |  |  |  |  |  |         |    |       |       |  |                |        |  |          |         |    |       |       |  |  |  |  |  |         |    |       |       |  |  |  |  |  |
| 1.9 dCi  | 60  | 11.03     | 08.06 |       | 24.5258-0450.3 | 330824 | □              | L=450                     |   |           |           |    |       |       |       |                |        |   |        |           |    |       |       |       |                |        |   |        |           |     |       |       |       |                |        |  |          |         |     |       |       |       |  |  |  |  |         |     |       |       |       |  |  |  |  |         |     |       |       |       |  |  |  |  |         |     |       |       |       |  |  |  |  |         |    |       |       |       |                |        |  |           |         |    |       |       |       |  |  |  |  |         |    |       |       |       |  |  |  |  |         |    |       |       |       |                |        |  |                      |         |    |       |       |       |  |  |  |  |         |    |       |       |       |  |  |  |  |         |    |       |       |       |  |  |  |  |         |    |       |       |       |  |  |  |  |         |    |       |       |       |  |  |  |  |         |     |       |       |       |  |  |  |  |         |     |       |       |       |  |  |  |  |         |    |       |       |       |                |        |     |       |         |    |       |       |       |                |        |     |       |         |    |       |       |       |  |  |  |  |         |    |       |       |       |  |  |  |  |         |    |       |       |       |  |  |  |  |         |    |       |       |       |  |  |  |  |         |     |       |       |       |  |  |  |  |         |     |       |       |       |  |  |  |  |         |    |       |       |       |                |        |     |       |         |    |       |       |       |                |        |     |       |         |    |       |       |       |  |  |  |  |         |    |       |       |       |                |        |   |       |         |    |       |       |       |  |  |  |  |         |    |       |       |       |  |  |  |  |         |    |       |       |       |  |  |  |  |         |    |       |       |       |  |  |  |  |         |    |       |       |       |  |  |  |  |         |     |       |       |       |  |  |  |  |         |     |       |       |       |  |  |  |  |         |    |       |       |  |                |        |   |                           |         |    |       |       |  |                |        |   |                           |         |    |       |       |  |  |  |  |  |         |    |       |       |  |  |  |  |  |         |    |       |       |  |  |  |  |  |         |    |       |       |  |  |  |  |  |         |     |       |       |  |  |  |  |  |         |     |       |       |  |  |  |  |  |         |    |       |       |  |                |        |     |       |         |    |       |       |  |                |        |     |       |         |    |       |       |  |  |  |  |  |         |    |       |       |  |                |        |   |       |         |    |       |       |  |                |        |   |       |         |    |       |       |  |  |  |  |  |         |    |       |       |  |  |  |  |  |         |    |       |       |  |  |  |  |  |         |    |       |       |  |  |  |  |  |         |     |       |       |  |  |  |  |  |         |     |       |       |  |  |  |  |  |         |    |       |       |  |                |        |     |        |         |    |       |       |  |                |        |     |        |         |    |       |       |  |  |  |  |  |         |    |       |       |  |  |  |  |  |         |    |       |       |  |  |  |  |  |         |    |       |       |  |  |  |  |  |         |     |       |       |  |  |  |  |  |         |     |       |       |  |  |  |  |  |         |    |       |       |  |                |        |  |          |         |    |       |       |  |  |  |  |  |         |    |       |       |  |  |  |  |  |
| 2.2 dCi  | 66  | 11.03     | 08.06 |       | 24.5251-0465.3 | 330822 | □              | L=465                     |   |           |           |    |       |       |       |                |        |   |        |           |    |       |       |       |                |        |   |        |           |     |       |       |       |                |        |  |          |         |     |       |       |       |  |  |  |  |         |     |       |       |       |  |  |  |  |         |     |       |       |       |  |  |  |  |         |     |       |       |       |  |  |  |  |         |    |       |       |       |                |        |  |           |         |    |       |       |       |  |  |  |  |         |    |       |       |       |  |  |  |  |         |    |       |       |       |                |        |  |                      |         |    |       |       |       |  |  |  |  |         |    |       |       |       |  |  |  |  |         |    |       |       |       |  |  |  |  |         |    |       |       |       |  |  |  |  |         |    |       |       |       |  |  |  |  |         |     |       |       |       |  |  |  |  |         |     |       |       |       |  |  |  |  |         |    |       |       |       |                |        |     |       |         |    |       |       |       |                |        |     |       |         |    |       |       |       |  |  |  |  |         |    |       |       |       |  |  |  |  |         |    |       |       |       |  |  |  |  |         |    |       |       |       |  |  |  |  |         |     |       |       |       |  |  |  |  |         |     |       |       |       |  |  |  |  |         |    |       |       |       |                |        |     |       |         |    |       |       |       |                |        |     |       |         |    |       |       |       |  |  |  |  |         |    |       |       |       |                |        |   |       |         |    |       |       |       |  |  |  |  |         |    |       |       |       |  |  |  |  |         |    |       |       |       |  |  |  |  |         |    |       |       |       |  |  |  |  |         |    |       |       |       |  |  |  |  |         |     |       |       |       |  |  |  |  |         |     |       |       |       |  |  |  |  |         |    |       |       |  |                |        |   |                           |         |    |       |       |  |                |        |   |                           |         |    |       |       |  |  |  |  |  |         |    |       |       |  |  |  |  |  |         |    |       |       |  |  |  |  |  |         |    |       |       |  |  |  |  |  |         |     |       |       |  |  |  |  |  |         |     |       |       |  |  |  |  |  |         |    |       |       |  |                |        |     |       |         |    |       |       |  |                |        |     |       |         |    |       |       |  |  |  |  |  |         |    |       |       |  |                |        |   |       |         |    |       |       |  |                |        |   |       |         |    |       |       |  |  |  |  |  |         |    |       |       |  |  |  |  |  |         |    |       |       |  |  |  |  |  |         |    |       |       |  |  |  |  |  |         |     |       |       |  |  |  |  |  |         |     |       |       |  |  |  |  |  |         |    |       |       |  |                |        |     |        |         |    |       |       |  |                |        |     |        |         |    |       |       |  |  |  |  |  |         |    |       |       |  |  |  |  |  |         |    |       |       |  |  |  |  |  |         |    |       |       |  |  |  |  |  |         |     |       |       |  |  |  |  |  |         |     |       |       |  |  |  |  |  |         |    |       |       |  |                |        |  |          |         |    |       |       |  |  |  |  |  |         |    |       |       |  |  |  |  |  |
| 2.5 dCi  | 73  | 11.03     | 06.10 |       |                |        |                |                           |   |           |           |    |       |       |       |                |        |   |        |           |    |       |       |       |                |        |   |        |           |     |       |       |       |                |        |  |          |         |     |       |       |       |  |  |  |  |         |     |       |       |       |  |  |  |  |         |     |       |       |       |  |  |  |  |         |     |       |       |       |  |  |  |  |         |    |       |       |       |                |        |  |           |         |    |       |       |       |  |  |  |  |         |    |       |       |       |  |  |  |  |         |    |       |       |       |                |        |  |                      |         |    |       |       |       |  |  |  |  |         |    |       |       |       |  |  |  |  |         |    |       |       |       |  |  |  |  |         |    |       |       |       |  |  |  |  |         |    |       |       |       |  |  |  |  |         |     |       |       |       |  |  |  |  |         |     |       |       |       |  |  |  |  |         |    |       |       |       |                |        |     |       |         |    |       |       |       |                |        |     |       |         |    |       |       |       |  |  |  |  |         |    |       |       |       |  |  |  |  |         |    |       |       |       |  |  |  |  |         |    |       |       |       |  |  |  |  |         |     |       |       |       |  |  |  |  |         |     |       |       |       |  |  |  |  |         |    |       |       |       |                |        |     |       |         |    |       |       |       |                |        |     |       |         |    |       |       |       |  |  |  |  |         |    |       |       |       |                |        |   |       |         |    |       |       |       |  |  |  |  |         |    |       |       |       |  |  |  |  |         |    |       |       |       |  |  |  |  |         |    |       |       |       |  |  |  |  |         |    |       |       |       |  |  |  |  |         |     |       |       |       |  |  |  |  |         |     |       |       |       |  |  |  |  |         |    |       |       |  |                |        |   |                           |         |    |       |       |  |                |        |   |                           |         |    |       |       |  |  |  |  |  |         |    |       |       |  |  |  |  |  |         |    |       |       |  |  |  |  |  |         |    |       |       |  |  |  |  |  |         |     |       |       |  |  |  |  |  |         |     |       |       |  |  |  |  |  |         |    |       |       |  |                |        |     |       |         |    |       |       |  |                |        |     |       |         |    |       |       |  |  |  |  |  |         |    |       |       |  |                |        |   |       |         |    |       |       |  |                |        |   |       |         |    |       |       |  |  |  |  |  |         |    |       |       |  |  |  |  |  |         |    |       |       |  |  |  |  |  |         |    |       |       |  |  |  |  |  |         |     |       |       |  |  |  |  |  |         |     |       |       |  |  |  |  |  |         |    |       |       |  |                |        |     |        |         |    |       |       |  |                |        |     |        |         |    |       |       |  |  |  |  |  |         |    |       |       |  |  |  |  |  |         |    |       |       |  |  |  |  |  |         |    |       |       |  |  |  |  |  |         |     |       |       |  |  |  |  |  |         |     |       |       |  |  |  |  |  |         |    |       |       |  |                |        |  |          |         |    |       |       |  |  |  |  |  |         |    |       |       |  |  |  |  |  |
| 2.5 dCi  | 74  | 04.06     | 06.10 |       |                |        |                |                           |   |           |           |    |       |       |       |                |        |   |        |           |    |       |       |       |                |        |   |        |           |     |       |       |       |                |        |  |          |         |     |       |       |       |  |  |  |  |         |     |       |       |       |  |  |  |  |         |     |       |       |       |  |  |  |  |         |     |       |       |       |  |  |  |  |         |    |       |       |       |                |        |  |           |         |    |       |       |       |  |  |  |  |         |    |       |       |       |  |  |  |  |         |    |       |       |       |                |        |  |                      |         |    |       |       |       |  |  |  |  |         |    |       |       |       |  |  |  |  |         |    |       |       |       |  |  |  |  |         |    |       |       |       |  |  |  |  |         |    |       |       |       |  |  |  |  |         |     |       |       |       |  |  |  |  |         |     |       |       |       |  |  |  |  |         |    |       |       |       |                |        |     |       |         |    |       |       |       |                |        |     |       |         |    |       |       |       |  |  |  |  |         |    |       |       |       |  |  |  |  |         |    |       |       |       |  |  |  |  |         |    |       |       |       |  |  |  |  |         |     |       |       |       |  |  |  |  |         |     |       |       |       |  |  |  |  |         |    |       |       |       |                |        |     |       |         |    |       |       |       |                |        |     |       |         |    |       |       |       |  |  |  |  |         |    |       |       |       |                |        |   |       |         |    |       |       |       |  |  |  |  |         |    |       |       |       |  |  |  |  |         |    |       |       |       |  |  |  |  |         |    |       |       |       |  |  |  |  |         |    |       |       |       |  |  |  |  |         |     |       |       |       |  |  |  |  |         |     |       |       |       |  |  |  |  |         |    |       |       |  |                |        |   |                           |         |    |       |       |  |                |        |   |                           |         |    |       |       |  |  |  |  |  |         |    |       |       |  |  |  |  |  |         |    |       |       |  |  |  |  |  |         |    |       |       |  |  |  |  |  |         |     |       |       |  |  |  |  |  |         |     |       |       |  |  |  |  |  |         |    |       |       |  |                |        |     |       |         |    |       |       |  |                |        |     |       |         |    |       |       |  |  |  |  |  |         |    |       |       |  |                |        |   |       |         |    |       |       |  |                |        |   |       |         |    |       |       |  |  |  |  |  |         |    |       |       |  |  |  |  |  |         |    |       |       |  |  |  |  |  |         |    |       |       |  |  |  |  |  |         |     |       |       |  |  |  |  |  |         |     |       |       |  |  |  |  |  |         |    |       |       |  |                |        |     |        |         |    |       |       |  |                |        |     |        |         |    |       |       |  |  |  |  |  |         |    |       |       |  |  |  |  |  |         |    |       |       |  |  |  |  |  |         |    |       |       |  |  |  |  |  |         |     |       |       |  |  |  |  |  |         |     |       |       |  |  |  |  |  |         |    |       |       |  |                |        |  |          |         |    |       |       |  |  |  |  |  |         |    |       |       |  |  |  |  |  |
| 2.5 dCi  | 84  | 11.03     | 08.06 |       |                |        |                |                           |   |           |           |    |       |       |       |                |        |   |        |           |    |       |       |       |                |        |   |        |           |     |       |       |       |                |        |  |          |         |     |       |       |       |  |  |  |  |         |     |       |       |       |  |  |  |  |         |     |       |       |       |  |  |  |  |         |     |       |       |       |  |  |  |  |         |    |       |       |       |                |        |  |           |         |    |       |       |       |  |  |  |  |         |    |       |       |       |  |  |  |  |         |    |       |       |       |                |        |  |                      |         |    |       |       |       |  |  |  |  |         |    |       |       |       |  |  |  |  |         |    |       |       |       |  |  |  |  |         |    |       |       |       |  |  |  |  |         |    |       |       |       |  |  |  |  |         |     |       |       |       |  |  |  |  |         |     |       |       |       |  |  |  |  |         |    |       |       |       |                |        |     |       |         |    |       |       |       |                |        |     |       |         |    |       |       |       |  |  |  |  |         |    |       |       |       |  |  |  |  |         |    |       |       |       |  |  |  |  |         |    |       |       |       |  |  |  |  |         |     |       |       |       |  |  |  |  |         |     |       |       |       |  |  |  |  |         |    |       |       |       |                |        |     |       |         |    |       |       |       |                |        |     |       |         |    |       |       |       |  |  |  |  |         |    |       |       |       |                |        |   |       |         |    |       |       |       |  |  |  |  |         |    |       |       |       |  |  |  |  |         |    |       |       |       |  |  |  |  |         |    |       |       |       |  |  |  |  |         |    |       |       |       |  |  |  |  |         |     |       |       |       |  |  |  |  |         |     |       |       |       |  |  |  |  |         |    |       |       |  |                |        |   |                           |         |    |       |       |  |                |        |   |                           |         |    |       |       |  |  |  |  |  |         |    |       |       |  |  |  |  |  |         |    |       |       |  |  |  |  |  |         |    |       |       |  |  |  |  |  |         |     |       |       |  |  |  |  |  |         |     |       |       |  |  |  |  |  |         |    |       |       |  |                |        |     |       |         |    |       |       |  |                |        |     |       |         |    |       |       |  |  |  |  |  |         |    |       |       |  |                |        |   |       |         |    |       |       |  |                |        |   |       |         |    |       |       |  |  |  |  |  |         |    |       |       |  |  |  |  |  |         |    |       |       |  |  |  |  |  |         |    |       |       |  |  |  |  |  |         |     |       |       |  |  |  |  |  |         |     |       |       |  |  |  |  |  |         |    |       |       |  |                |        |     |        |         |    |       |       |  |                |        |     |        |         |    |       |       |  |  |  |  |  |         |    |       |       |  |  |  |  |  |         |    |       |       |  |  |  |  |  |         |    |       |       |  |  |  |  |  |         |     |       |       |  |  |  |  |  |         |     |       |       |  |  |  |  |  |         |    |       |       |  |                |        |  |          |         |    |       |       |  |  |  |  |  |         |    |       |       |  |  |  |  |  |
| 2.5 dCi  | 88  | 09.06     | 06.10 |       |                |        |                |                           |   |           |           |    |       |       |       |                |        |   |        |           |    |       |       |       |                |        |   |        |           |     |       |       |       |                |        |  |          |         |     |       |       |       |  |  |  |  |         |     |       |       |       |  |  |  |  |         |     |       |       |       |  |  |  |  |         |     |       |       |       |  |  |  |  |         |    |       |       |       |                |        |  |           |         |    |       |       |       |  |  |  |  |         |    |       |       |       |  |  |  |  |         |    |       |       |       |                |        |  |                      |         |    |       |       |       |  |  |  |  |         |    |       |       |       |  |  |  |  |         |    |       |       |       |  |  |  |  |         |    |       |       |       |  |  |  |  |         |    |       |       |       |  |  |  |  |         |     |       |       |       |  |  |  |  |         |     |       |       |       |  |  |  |  |         |    |       |       |       |                |        |     |       |         |    |       |       |       |                |        |     |       |         |    |       |       |       |  |  |  |  |         |    |       |       |       |  |  |  |  |         |    |       |       |       |  |  |  |  |         |    |       |       |       |  |  |  |  |         |     |       |       |       |  |  |  |  |         |     |       |       |       |  |  |  |  |         |    |       |       |       |                |        |     |       |         |    |       |       |       |                |        |     |       |         |    |       |       |       |  |  |  |  |         |    |       |       |       |                |        |   |       |         |    |       |       |       |  |  |  |  |         |    |       |       |       |  |  |  |  |         |    |       |       |       |  |  |  |  |         |    |       |       |       |  |  |  |  |         |    |       |       |       |  |  |  |  |         |     |       |       |       |  |  |  |  |         |     |       |       |       |  |  |  |  |         |    |       |       |  |                |        |   |                           |         |    |       |       |  |                |        |   |                           |         |    |       |       |  |  |  |  |  |         |    |       |       |  |  |  |  |  |         |    |       |       |  |  |  |  |  |         |    |       |       |  |  |  |  |  |         |     |       |       |  |  |  |  |  |         |     |       |       |  |  |  |  |  |         |    |       |       |  |                |        |     |       |         |    |       |       |  |                |        |     |       |         |    |       |       |  |  |  |  |  |         |    |       |       |  |                |        |   |       |         |    |       |       |  |                |        |   |       |         |    |       |       |  |  |  |  |  |         |    |       |       |  |  |  |  |  |         |    |       |       |  |  |  |  |  |         |    |       |       |  |  |  |  |  |         |     |       |       |  |  |  |  |  |         |     |       |       |  |  |  |  |  |         |    |       |       |  |                |        |     |        |         |    |       |       |  |                |        |     |        |         |    |       |       |  |  |  |  |  |         |    |       |       |  |  |  |  |  |         |    |       |       |  |  |  |  |  |         |    |       |       |  |  |  |  |  |         |     |       |       |  |  |  |  |  |         |     |       |       |  |  |  |  |  |         |    |       |       |  |                |        |  |          |         |    |       |       |  |  |  |  |  |         |    |       |       |  |  |  |  |  |
| 2.5 dCi  | 107   | 09.06     | 06.10 |       |                |        |                |                           |   |           |           |    |       |       |       |                |        |   |        |           |    |       |       |       |                |        |   |        |           |     |       |       |       |                |        |  |          |         |     |       |       |       |  |  |  |  |         |     |       |       |       |  |  |  |  |         |     |       |       |       |  |  |  |  |         |     |       |       |       |  |  |  |  |         |    |       |       |       |                |        |  |           |         |    |       |       |       |  |  |  |  |         |    |       |       |       |  |  |  |  |         |    |       |       |       |                |        |  |                      |         |    |       |       |       |  |  |  |  |         |    |       |       |       |  |  |  |  |         |    |       |       |       |  |  |  |  |         |    |       |       |       |  |  |  |  |         |    |       |       |       |  |  |  |  |         |     |       |       |       |  |  |  |  |         |     |       |       |       |  |  |  |  |         |    |       |       |       |                |        |     |       |         |    |       |       |       |                |        |     |       |         |    |       |       |       |  |  |  |  |         |    |       |       |       |  |  |  |  |         |    |       |       |       |  |  |  |  |         |    |       |       |       |  |  |  |  |         |     |       |       |       |  |  |  |  |         |     |       |       |       |  |  |  |  |         |    |       |       |       |                |        |     |       |         |    |       |       |       |                |        |     |       |         |    |       |       |       |  |  |  |  |         |    |       |       |       |                |        |   |       |         |    |       |       |       |  |  |  |  |         |    |       |       |       |  |  |  |  |         |    |       |       |       |  |  |  |  |         |    |       |       |       |  |  |  |  |         |    |       |       |       |  |  |  |  |         |     |       |       |       |  |  |  |  |         |     |       |       |       |  |  |  |  |         |    |       |       |  |                |        |   |                           |         |    |       |       |  |                |        |   |                           |         |    |       |       |  |  |  |  |  |         |    |       |       |  |  |  |  |  |         |    |       |       |  |  |  |  |  |         |    |       |       |  |  |  |  |  |         |     |       |       |  |  |  |  |  |         |     |       |       |  |  |  |  |  |         |    |       |       |  |                |        |     |       |         |    |       |       |  |                |        |     |       |         |    |       |       |  |  |  |  |  |         |    |       |       |  |                |        |   |       |         |    |       |       |  |                |        |   |       |         |    |       |       |  |  |  |  |  |         |    |       |       |  |  |  |  |  |         |    |       |       |  |  |  |  |  |         |    |       |       |  |  |  |  |  |         |     |       |       |  |  |  |  |  |         |     |       |       |  |  |  |  |  |         |    |       |       |  |                |        |     |        |         |    |       |       |  |                |        |     |        |         |    |       |       |  |  |  |  |  |         |    |       |       |  |  |  |  |  |         |    |       |       |  |  |  |  |  |         |    |       |       |  |  |  |  |  |         |     |       |       |  |  |  |  |  |         |     |       |       |  |  |  |  |  |         |    |       |       |  |                |        |  |          |         |    |       |       |  |  |  |  |  |         |    |       |       |  |  |  |  |  |
| 3.0 dCi  | 100   | 11.03     | 08.06 |       |                |        |                |                           |   |           |           |    |       |       |       |                |        |   |        |           |    |       |       |       |                |        |   |        |           |     |       |       |       |                |        |  |          |         |     |       |       |       |  |  |  |  |         |     |       |       |       |  |  |  |  |         |     |       |       |       |  |  |  |  |         |     |       |       |       |  |  |  |  |         |    |       |       |       |                |        |  |           |         |    |       |       |       |  |  |  |  |         |    |       |       |       |  |  |  |  |         |    |       |       |       |                |        |  |                      |         |    |       |       |       |  |  |  |  |         |    |       |       |       |  |  |  |  |         |    |       |       |       |  |  |  |  |         |    |       |       |       |  |  |  |  |         |    |       |       |       |  |  |  |  |         |     |       |       |       |  |  |  |  |         |     |       |       |       |  |  |  |  |         |    |       |       |       |                |        |     |       |         |    |       |       |       |                |        |     |       |         |    |       |       |       |  |  |  |  |         |    |       |       |       |  |  |  |  |         |    |       |       |       |  |  |  |  |         |    |       |       |       |  |  |  |  |         |     |       |       |       |  |  |  |  |         |     |       |       |       |  |  |  |  |         |    |       |       |       |                |        |     |       |         |    |       |       |       |                |        |     |       |         |    |       |       |       |  |  |  |  |         |    |       |       |       |                |        |   |       |         |    |       |       |       |  |  |  |  |         |    |       |       |       |  |  |  |  |         |    |       |       |       |  |  |  |  |         |    |       |       |       |  |  |  |  |         |    |       |       |       |  |  |  |  |         |     |       |       |       |  |  |  |  |         |     |       |       |       |  |  |  |  |         |    |       |       |  |                |        |   |                           |         |    |       |       |  |                |        |   |                           |         |    |       |       |  |  |  |  |  |         |    |       |       |  |  |  |  |  |         |    |       |       |  |  |  |  |  |         |    |       |       |  |  |  |  |  |         |     |       |       |  |  |  |  |  |         |     |       |       |  |  |  |  |  |         |    |       |       |  |                |        |     |       |         |    |       |       |  |                |        |     |       |         |    |       |       |  |  |  |  |  |         |    |       |       |  |                |        |   |       |         |    |       |       |  |                |        |   |       |         |    |       |       |  |  |  |  |  |         |    |       |       |  |  |  |  |  |         |    |       |       |  |  |  |  |  |         |    |       |       |  |  |  |  |  |         |     |       |       |  |  |  |  |  |         |     |       |       |  |  |  |  |  |         |    |       |       |  |                |        |     |        |         |    |       |       |  |                |        |     |        |         |    |       |       |  |  |  |  |  |         |    |       |       |  |  |  |  |  |         |    |       |       |  |  |  |  |  |         |    |       |       |  |  |  |  |  |         |     |       |       |  |  |  |  |  |         |     |       |       |  |  |  |  |  |         |    |       |       |  |                |        |  |          |         |    |       |       |  |  |  |  |  |         |    |       |       |  |  |  |  |  |
| 1.9 dCi  | 60  | 07.02     | 08.06 |       | 24.3727-0762.2 | 580762 | 1 ↑            | L=1175                    |   |           |           |    |       |       |       |                |        |   |        |           |    |       |       |       |                |        |   |        |           |     |       |       |       |                |        |  |          |         |     |       |       |       |  |  |  |  |         |     |       |       |       |  |  |  |  |         |     |       |       |       |  |  |  |  |         |     |       |       |       |  |  |  |  |         |    |       |       |       |                |        |  |           |         |    |       |       |       |  |  |  |  |         |    |       |       |       |  |  |  |  |         |    |       |       |       |                |        |  |                      |         |    |       |       |       |  |  |  |  |         |    |       |       |       |  |  |  |  |         |    |       |       |       |  |  |  |  |         |    |       |       |       |  |  |  |  |         |    |       |       |       |  |  |  |  |         |     |       |       |       |  |  |  |  |         |     |       |       |       |  |  |  |  |         |    |       |       |       |                |        |     |       |         |    |       |       |       |                |        |     |       |         |    |       |       |       |  |  |  |  |         |    |       |       |       |  |  |  |  |         |    |       |       |       |  |  |  |  |         |    |       |       |       |  |  |  |  |         |     |       |       |       |  |  |  |  |         |     |       |       |       |  |  |  |  |         |    |       |       |       |                |        |     |       |         |    |       |       |       |                |        |     |       |         |    |       |       |       |  |  |  |  |         |    |       |       |       |                |        |   |       |         |    |       |       |       |  |  |  |  |         |    |       |       |       |  |  |  |  |         |    |       |       |       |  |  |  |  |         |    |       |       |       |  |  |  |  |         |    |       |       |       |  |  |  |  |         |     |       |       |       |  |  |  |  |         |     |       |       |       |  |  |  |  |         |    |       |       |  |                |        |   |                           |         |    |       |       |  |                |        |   |                           |         |    |       |       |  |  |  |  |  |         |    |       |       |  |  |  |  |  |         |    |       |       |  |  |  |  |  |         |    |       |       |  |  |  |  |  |         |     |       |       |  |  |  |  |  |         |     |       |       |  |  |  |  |  |         |    |       |       |  |                |        |     |       |         |    |       |       |  |                |        |     |       |         |    |       |       |  |  |  |  |  |         |    |       |       |  |                |        |   |       |         |    |       |       |  |                |        |   |       |         |    |       |       |  |  |  |  |  |         |    |       |       |  |  |  |  |  |         |    |       |       |  |  |  |  |  |         |    |       |       |  |  |  |  |  |         |     |       |       |  |  |  |  |  |         |     |       |       |  |  |  |  |  |         |    |       |       |  |                |        |     |        |         |    |       |       |  |                |        |     |        |         |    |       |       |  |  |  |  |  |         |    |       |       |  |  |  |  |  |         |    |       |       |  |  |  |  |  |         |    |       |       |  |  |  |  |  |         |     |       |       |  |  |  |  |  |         |     |       |       |  |  |  |  |  |         |    |       |       |  |                |        |  |          |         |    |       |       |  |  |  |  |  |         |    |       |       |  |  |  |  |  |
| 2.2 dCi  | 66  | 07.02     | 08.06 |       | 24.3727-1072.2 | 581072 | 2 ↓            | L=1420                    |   |           |           |    |       |       |       |                |        |   |        |           |    |       |       |       |                |        |   |        |           |     |       |       |       |                |        |  |          |         |     |       |       |       |  |  |  |  |         |     |       |       |       |  |  |  |  |         |     |       |       |       |  |  |  |  |         |     |       |       |       |  |  |  |  |         |    |       |       |       |                |        |  |           |         |    |       |       |       |  |  |  |  |         |    |       |       |       |  |  |  |  |         |    |       |       |       |                |        |  |                      |         |    |       |       |       |  |  |  |  |         |    |       |       |       |  |  |  |  |         |    |       |       |       |  |  |  |  |         |    |       |       |       |  |  |  |  |         |    |       |       |       |  |  |  |  |         |     |       |       |       |  |  |  |  |         |     |       |       |       |  |  |  |  |         |    |       |       |       |                |        |     |       |         |    |       |       |       |                |        |     |       |         |    |       |       |       |  |  |  |  |         |    |       |       |       |  |  |  |  |         |    |       |       |       |  |  |  |  |         |    |       |       |       |  |  |  |  |         |     |       |       |       |  |  |  |  |         |     |       |       |       |  |  |  |  |         |    |       |       |       |                |        |     |       |         |    |       |       |       |                |        |     |       |         |    |       |       |       |  |  |  |  |         |    |       |       |       |                |        |   |       |         |    |       |       |       |  |  |  |  |         |    |       |       |       |  |  |  |  |         |    |       |       |       |  |  |  |  |         |    |       |       |       |  |  |  |  |         |    |       |       |       |  |  |  |  |         |     |       |       |       |  |  |  |  |         |     |       |       |       |  |  |  |  |         |    |       |       |  |                |        |   |                           |         |    |       |       |  |                |        |   |                           |         |    |       |       |  |  |  |  |  |         |    |       |       |  |  |  |  |  |         |    |       |       |  |  |  |  |  |         |    |       |       |  |  |  |  |  |         |     |       |       |  |  |  |  |  |         |     |       |       |  |  |  |  |  |         |    |       |       |  |                |        |     |       |         |    |       |       |  |                |        |     |       |         |    |       |       |  |  |  |  |  |         |    |       |       |  |                |        |   |       |         |    |       |       |  |                |        |   |       |         |    |       |       |  |  |  |  |  |         |    |       |       |  |  |  |  |  |         |    |       |       |  |  |  |  |  |         |    |       |       |  |  |  |  |  |         |     |       |       |  |  |  |  |  |         |     |       |       |  |  |  |  |  |         |    |       |       |  |                |        |     |        |         |    |       |       |  |                |        |     |        |         |    |       |       |  |  |  |  |  |         |    |       |       |  |  |  |  |  |         |    |       |       |  |  |  |  |  |         |    |       |       |  |  |  |  |  |         |     |       |       |  |  |  |  |  |         |     |       |       |  |  |  |  |  |         |    |       |       |  |                |        |  |          |         |    |       |       |  |  |  |  |  |         |    |       |       |  |  |  |  |  |
| 2.5 dCi  | 73  | 11.03     | 06.10 |       |                |        |                |                           |   |           |           |    |       |       |       |                |        |   |        |           |    |       |       |       |                |        |   |        |           |     |       |       |       |                |        |  |          |         |     |       |       |       |  |  |  |  |         |     |       |       |       |  |  |  |  |         |     |       |       |       |  |  |  |  |         |     |       |       |       |  |  |  |  |         |    |       |       |       |                |        |  |           |         |    |       |       |       |  |  |  |  |         |    |       |       |       |  |  |  |  |         |    |       |       |       |                |        |  |                      |         |    |       |       |       |  |  |  |  |         |    |       |       |       |  |  |  |  |         |    |       |       |       |  |  |  |  |         |    |       |       |       |  |  |  |  |         |    |       |       |       |  |  |  |  |         |     |       |       |       |  |  |  |  |         |     |       |       |       |  |  |  |  |         |    |       |       |       |                |        |     |       |         |    |       |       |       |                |        |     |       |         |    |       |       |       |  |  |  |  |         |    |       |       |       |  |  |  |  |         |    |       |       |       |  |  |  |  |         |    |       |       |       |  |  |  |  |         |     |       |       |       |  |  |  |  |         |     |       |       |       |  |  |  |  |         |    |       |       |       |                |        |     |       |         |    |       |       |       |                |        |     |       |         |    |       |       |       |  |  |  |  |         |    |       |       |       |                |        |   |       |         |    |       |       |       |  |  |  |  |         |    |       |       |       |  |  |  |  |         |    |       |       |       |  |  |  |  |         |    |       |       |       |  |  |  |  |         |    |       |       |       |  |  |  |  |         |     |       |       |       |  |  |  |  |         |     |       |       |       |  |  |  |  |         |    |       |       |  |                |        |   |                           |         |    |       |       |  |                |        |   |                           |         |    |       |       |  |  |  |  |  |         |    |       |       |  |  |  |  |  |         |    |       |       |  |  |  |  |  |         |    |       |       |  |  |  |  |  |         |     |       |       |  |  |  |  |  |         |     |       |       |  |  |  |  |  |         |    |       |       |  |                |        |     |       |         |    |       |       |  |                |        |     |       |         |    |       |       |  |  |  |  |  |         |    |       |       |  |                |        |   |       |         |    |       |       |  |                |        |   |       |         |    |       |       |  |  |  |  |  |         |    |       |       |  |  |  |  |  |         |    |       |       |  |  |  |  |  |         |    |       |       |  |  |  |  |  |         |     |       |       |  |  |  |  |  |         |     |       |       |  |  |  |  |  |         |    |       |       |  |                |        |     |        |         |    |       |       |  |                |        |     |        |         |    |       |       |  |  |  |  |  |         |    |       |       |  |  |  |  |  |         |    |       |       |  |  |  |  |  |         |    |       |       |  |  |  |  |  |         |     |       |       |  |  |  |  |  |         |     |       |       |  |  |  |  |  |         |    |       |       |  |                |        |  |          |         |    |       |       |  |  |  |  |  |         |    |       |       |  |  |  |  |  |
| 2.5 dCi  | 74  | 04.06     | 06.10 |       |                |        |                |                           |   |           |           |    |       |       |       |                |        |   |        |           |    |       |       |       |                |        |   |        |           |     |       |       |       |                |        |  |          |         |     |       |       |       |  |  |  |  |         |     |       |       |       |  |  |  |  |         |     |       |       |       |  |  |  |  |         |     |       |       |       |  |  |  |  |         |    |       |       |       |                |        |  |           |         |    |       |       |       |  |  |  |  |         |    |       |       |       |  |  |  |  |         |    |       |       |       |                |        |  |                      |         |    |       |       |       |  |  |  |  |         |    |       |       |       |  |  |  |  |         |    |       |       |       |  |  |  |  |         |    |       |       |       |  |  |  |  |         |    |       |       |       |  |  |  |  |         |     |       |       |       |  |  |  |  |         |     |       |       |       |  |  |  |  |         |    |       |       |       |                |        |     |       |         |    |       |       |       |                |        |     |       |         |    |       |       |       |  |  |  |  |         |    |       |       |       |  |  |  |  |         |    |       |       |       |  |  |  |  |         |    |       |       |       |  |  |  |  |         |     |       |       |       |  |  |  |  |         |     |       |       |       |  |  |  |  |         |    |       |       |       |                |        |     |       |         |    |       |       |       |                |        |     |       |         |    |       |       |       |  |  |  |  |         |    |       |       |       |                |        |   |       |         |    |       |       |       |  |  |  |  |         |    |       |       |       |  |  |  |  |         |    |       |       |       |  |  |  |  |         |    |       |       |       |  |  |  |  |         |    |       |       |       |  |  |  |  |         |     |       |       |       |  |  |  |  |         |     |       |       |       |  |  |  |  |         |    |       |       |  |                |        |   |                           |         |    |       |       |  |                |        |   |                           |         |    |       |       |  |  |  |  |  |         |    |       |       |  |  |  |  |  |         |    |       |       |  |  |  |  |  |         |    |       |       |  |  |  |  |  |         |     |       |       |  |  |  |  |  |         |     |       |       |  |  |  |  |  |         |    |       |       |  |                |        |     |       |         |    |       |       |  |                |        |     |       |         |    |       |       |  |  |  |  |  |         |    |       |       |  |                |        |   |       |         |    |       |       |  |                |        |   |       |         |    |       |       |  |  |  |  |  |         |    |       |       |  |  |  |  |  |         |    |       |       |  |  |  |  |  |         |    |       |       |  |  |  |  |  |         |     |       |       |  |  |  |  |  |         |     |       |       |  |  |  |  |  |         |    |       |       |  |                |        |     |        |         |    |       |       |  |                |        |     |        |         |    |       |       |  |  |  |  |  |         |    |       |       |  |  |  |  |  |         |    |       |       |  |  |  |  |  |         |    |       |       |  |  |  |  |  |         |     |       |       |  |  |  |  |  |         |     |       |       |  |  |  |  |  |         |    |       |       |  |                |        |  |          |         |    |       |       |  |  |  |  |  |         |    |       |       |  |  |  |  |  |
| 2.5 dCi  | 84  | 07.02     | 08.06 |       |                |        |                |                           |   |           |           |    |       |       |       |                |        |   |        |           |    |       |       |       |                |        |   |        |           |     |       |       |       |                |        |  |          |         |     |       |       |       |  |  |  |  |         |     |       |       |       |  |  |  |  |         |     |       |       |       |  |  |  |  |         |     |       |       |       |  |  |  |  |         |    |       |       |       |                |        |  |           |         |    |       |       |       |  |  |  |  |         |    |       |       |       |  |  |  |  |         |    |       |       |       |                |        |  |                      |         |    |       |       |       |  |  |  |  |         |    |       |       |       |  |  |  |  |         |    |       |       |       |  |  |  |  |         |    |       |       |       |  |  |  |  |         |    |       |       |       |  |  |  |  |         |     |       |       |       |  |  |  |  |         |     |       |       |       |  |  |  |  |         |    |       |       |       |                |        |     |       |         |    |       |       |       |                |        |     |       |         |    |       |       |       |  |  |  |  |         |    |       |       |       |  |  |  |  |         |    |       |       |       |  |  |  |  |         |    |       |       |       |  |  |  |  |         |     |       |       |       |  |  |  |  |         |     |       |       |       |  |  |  |  |         |    |       |       |       |                |        |     |       |         |    |       |       |       |                |        |     |       |         |    |       |       |       |  |  |  |  |         |    |       |       |       |                |        |   |       |         |    |       |       |       |  |  |  |  |         |    |       |       |       |  |  |  |  |         |    |       |       |       |  |  |  |  |         |    |       |       |       |  |  |  |  |         |    |       |       |       |  |  |  |  |         |     |       |       |       |  |  |  |  |         |     |       |       |       |  |  |  |  |         |    |       |       |  |                |        |   |                           |         |    |       |       |  |                |        |   |                           |         |    |       |       |  |  |  |  |  |         |    |       |       |  |  |  |  |  |         |    |       |       |  |  |  |  |  |         |    |       |       |  |  |  |  |  |         |     |       |       |  |  |  |  |  |         |     |       |       |  |  |  |  |  |         |    |       |       |  |                |        |     |       |         |    |       |       |  |                |        |     |       |         |    |       |       |  |  |  |  |  |         |    |       |       |  |                |        |   |       |         |    |       |       |  |                |        |   |       |         |    |       |       |  |  |  |  |  |         |    |       |       |  |  |  |  |  |         |    |       |       |  |  |  |  |  |         |    |       |       |  |  |  |  |  |         |     |       |       |  |  |  |  |  |         |     |       |       |  |  |  |  |  |         |    |       |       |  |                |        |     |        |         |    |       |       |  |                |        |     |        |         |    |       |       |  |  |  |  |  |         |    |       |       |  |  |  |  |  |         |    |       |       |  |  |  |  |  |         |    |       |       |  |  |  |  |  |         |     |       |       |  |  |  |  |  |         |     |       |       |  |  |  |  |  |         |    |       |       |  |                |        |  |          |         |    |       |       |  |  |  |  |  |         |    |       |       |  |  |  |  |  |
| 2.5 dCi  | 88  | 09.06     | 06.10 |       |                |        |                |                           |   |           |           |    |       |       |       |                |        |   |        |           |    |       |       |       |                |        |   |        |           |     |       |       |       |                |        |  |          |         |     |       |       |       |  |  |  |  |         |     |       |       |       |  |  |  |  |         |     |       |       |       |  |  |  |  |         |     |       |       |       |  |  |  |  |         |    |       |       |       |                |        |  |           |         |    |       |       |       |  |  |  |  |         |    |       |       |       |  |  |  |  |         |    |       |       |       |                |        |  |                      |         |    |       |       |       |  |  |  |  |         |    |       |       |       |  |  |  |  |         |    |       |       |       |  |  |  |  |         |    |       |       |       |  |  |  |  |         |    |       |       |       |  |  |  |  |         |     |       |       |       |  |  |  |  |         |     |       |       |       |  |  |  |  |         |    |       |       |       |                |        |     |       |         |    |       |       |       |                |        |     |       |         |    |       |       |       |  |  |  |  |         |    |       |       |       |  |  |  |  |         |    |       |       |       |  |  |  |  |         |    |       |       |       |  |  |  |  |         |     |       |       |       |  |  |  |  |         |     |       |       |       |  |  |  |  |         |    |       |       |       |                |        |     |       |         |    |       |       |       |                |        |     |       |         |    |       |       |       |  |  |  |  |         |    |       |       |       |                |        |   |       |         |    |       |       |       |  |  |  |  |         |    |       |       |       |  |  |  |  |         |    |       |       |       |  |  |  |  |         |    |       |       |       |  |  |  |  |         |    |       |       |       |  |  |  |  |         |     |       |       |       |  |  |  |  |         |     |       |       |       |  |  |  |  |         |    |       |       |  |                |        |   |                           |         |    |       |       |  |                |        |   |                           |         |    |       |       |  |  |  |  |  |         |    |       |       |  |  |  |  |  |         |    |       |       |  |  |  |  |  |         |    |       |       |  |  |  |  |  |         |     |       |       |  |  |  |  |  |         |     |       |       |  |  |  |  |  |         |    |       |       |  |                |        |     |       |         |    |       |       |  |                |        |     |       |         |    |       |       |  |  |  |  |  |         |    |       |       |  |                |        |   |       |         |    |       |       |  |                |        |   |       |         |    |       |       |  |  |  |  |  |         |    |       |       |  |  |  |  |  |         |    |       |       |  |  |  |  |  |         |    |       |       |  |  |  |  |  |         |     |       |       |  |  |  |  |  |         |     |       |       |  |  |  |  |  |         |    |       |       |  |                |        |     |        |         |    |       |       |  |                |        |     |        |         |    |       |       |  |  |  |  |  |         |    |       |       |  |  |  |  |  |         |    |       |       |  |  |  |  |  |         |    |       |       |  |  |  |  |  |         |     |       |       |  |  |  |  |  |         |     |       |       |  |  |  |  |  |         |    |       |       |  |                |        |  |          |         |    |       |       |  |  |  |  |  |         |    |       |       |  |  |  |  |  |
| 2.5 dCi  | 107   | 09.06     | 06.10 |       |                |        |                |                           |   |           |           |    |       |       |       |                |        |   |        |           |    |       |       |       |                |        |   |        |           |     |       |       |       |                |        |  |          |         |     |       |       |       |  |  |  |  |         |     |       |       |       |  |  |  |  |         |     |       |       |       |  |  |  |  |         |     |       |       |       |  |  |  |  |         |    |       |       |       |                |        |  |           |         |    |       |       |       |  |  |  |  |         |    |       |       |       |  |  |  |  |         |    |       |       |       |                |        |  |                      |         |    |       |       |       |  |  |  |  |         |    |       |       |       |  |  |  |  |         |    |       |       |       |  |  |  |  |         |    |       |       |       |  |  |  |  |         |    |       |       |       |  |  |  |  |         |     |       |       |       |  |  |  |  |         |     |       |       |       |  |  |  |  |         |    |       |       |       |                |        |     |       |         |    |       |       |       |                |        |     |       |         |    |       |       |       |  |  |  |  |         |    |       |       |       |  |  |  |  |         |    |       |       |       |  |  |  |  |         |    |       |       |       |  |  |  |  |         |     |       |       |       |  |  |  |  |         |     |       |       |       |  |  |  |  |         |    |       |       |       |                |        |     |       |         |    |       |       |       |                |        |     |       |         |    |       |       |       |  |  |  |  |         |    |       |       |       |                |        |   |       |         |    |       |       |       |  |  |  |  |         |    |       |       |       |  |  |  |  |         |    |       |       |       |  |  |  |  |         |    |       |       |       |  |  |  |  |         |    |       |       |       |  |  |  |  |         |     |       |       |       |  |  |  |  |         |     |       |       |       |  |  |  |  |         |    |       |       |  |                |        |   |                           |         |    |       |       |  |                |        |   |                           |         |    |       |       |  |  |  |  |  |         |    |       |       |  |  |  |  |  |         |    |       |       |  |  |  |  |  |         |    |       |       |  |  |  |  |  |         |     |       |       |  |  |  |  |  |         |     |       |       |  |  |  |  |  |         |    |       |       |  |                |        |     |       |         |    |       |       |  |                |        |     |       |         |    |       |       |  |  |  |  |  |         |    |       |       |  |                |        |   |       |         |    |       |       |  |                |        |   |       |         |    |       |       |  |  |  |  |  |         |    |       |       |  |  |  |  |  |         |    |       |       |  |  |  |  |  |         |    |       |       |  |  |  |  |  |         |     |       |       |  |  |  |  |  |         |     |       |       |  |  |  |  |  |         |    |       |       |  |                |        |     |        |         |    |       |       |  |                |        |     |        |         |    |       |       |  |  |  |  |  |         |    |       |       |  |  |  |  |  |         |    |       |       |  |  |  |  |  |         |    |       |       |  |  |  |  |  |         |     |       |       |  |  |  |  |  |         |     |       |       |  |  |  |  |  |         |    |       |       |  |                |        |  |          |         |    |       |       |  |  |  |  |  |         |    |       |       |  |  |  |  |  |
| 3.0 dCi  | 100   | 11.03     | 08.06 |       |                |        |                |                           |   |           |           |    |       |       |       |                |        |   |        |           |    |       |       |       |                |        |   |        |           |     |       |       |       |                |        |  |          |         |     |       |       |       |  |  |  |  |         |     |       |       |       |  |  |  |  |         |     |       |       |       |  |  |  |  |         |     |       |       |       |  |  |  |  |         |    |       |       |       |                |        |  |           |         |    |       |       |       |  |  |  |  |         |    |       |       |       |  |  |  |  |         |    |       |       |       |                |        |  |                      |         |    |       |       |       |  |  |  |  |         |    |       |       |       |  |  |  |  |         |    |       |       |       |  |  |  |  |         |    |       |       |       |  |  |  |  |         |    |       |       |       |  |  |  |  |         |     |       |       |       |  |  |  |  |         |     |       |       |       |  |  |  |  |         |    |       |       |       |                |        |     |       |         |    |       |       |       |                |        |     |       |         |    |       |       |       |  |  |  |  |         |    |       |       |       |  |  |  |  |         |    |       |       |       |  |  |  |  |         |    |       |       |       |  |  |  |  |         |     |       |       |       |  |  |  |  |         |     |       |       |       |  |  |  |  |         |    |       |       |       |                |        |     |       |         |    |       |       |       |                |        |     |       |         |    |       |       |       |  |  |  |  |         |    |       |       |       |                |        |   |       |         |    |       |       |       |  |  |  |  |         |    |       |       |       |  |  |  |  |         |    |       |       |       |  |  |  |  |         |    |       |       |       |  |  |  |  |         |    |       |       |       |  |  |  |  |         |     |       |       |       |  |  |  |  |         |     |       |       |       |  |  |  |  |         |    |       |       |  |                |        |   |                           |         |    |       |       |  |                |        |   |                           |         |    |       |       |  |  |  |  |  |         |    |       |       |  |  |  |  |  |         |    |       |       |  |  |  |  |  |         |    |       |       |  |  |  |  |  |         |     |       |       |  |  |  |  |  |         |     |       |       |  |  |  |  |  |         |    |       |       |  |                |        |     |       |         |    |       |       |  |                |        |     |       |         |    |       |       |  |  |  |  |  |         |    |       |       |  |                |        |   |       |         |    |       |       |  |                |        |   |       |         |    |       |       |  |  |  |  |  |         |    |       |       |  |  |  |  |  |         |    |       |       |  |  |  |  |  |         |    |       |       |  |  |  |  |  |         |     |       |       |  |  |  |  |  |         |     |       |       |  |  |  |  |  |         |    |       |       |  |                |        |     |        |         |    |       |       |  |                |        |     |        |         |    |       |       |  |  |  |  |  |         |    |       |       |  |  |  |  |  |         |    |       |       |  |  |  |  |  |         |    |       |       |  |  |  |  |  |         |     |       |       |  |  |  |  |  |         |     |       |       |  |  |  |  |  |         |    |       |       |  |                |        |  |          |         |    |       |       |  |  |  |  |  |         |    |       |       |  |  |  |  |  |
| 1.9 dCi  | 60  | 07.02     | 12.02 |       | 24.2415-1710.3 | 030124 |                | Gz 15,87                  |   |           |           |    |       |       |       |                |        |   |        |           |    |       |       |       |                |        |   |        |           |     |       |       |       |                |        |  |          |         |     |       |       |       |  |  |  |  |         |     |       |       |       |  |  |  |  |         |     |       |       |       |  |  |  |  |         |     |       |       |       |  |  |  |  |         |    |       |       |       |                |        |  |           |         |    |       |       |       |  |  |  |  |         |    |       |       |       |  |  |  |  |         |    |       |       |       |                |        |  |                      |         |    |       |       |       |  |  |  |  |         |    |       |       |       |  |  |  |  |         |    |       |       |       |  |  |  |  |         |    |       |       |       |  |  |  |  |         |    |       |       |       |  |  |  |  |         |     |       |       |       |  |  |  |  |         |     |       |       |       |  |  |  |  |         |    |       |       |       |                |        |     |       |         |    |       |       |       |                |        |     |       |         |    |       |       |       |  |  |  |  |         |    |       |       |       |  |  |  |  |         |    |       |       |       |  |  |  |  |         |    |       |       |       |  |  |  |  |         |     |       |       |       |  |  |  |  |         |     |       |       |       |  |  |  |  |         |    |       |       |       |                |        |     |       |         |    |       |       |       |                |        |     |       |         |    |       |       |       |  |  |  |  |         |    |       |       |       |                |        |   |       |         |    |       |       |       |  |  |  |  |         |    |       |       |       |  |  |  |  |         |    |       |       |       |  |  |  |  |         |    |       |       |       |  |  |  |  |         |    |       |       |       |  |  |  |  |         |     |       |       |       |  |  |  |  |         |     |       |       |       |  |  |  |  |         |    |       |       |  |                |        |   |                           |         |    |       |       |  |                |        |   |                           |         |    |       |       |  |  |  |  |  |         |    |       |       |  |  |  |  |  |         |    |       |       |  |  |  |  |  |         |    |       |       |  |  |  |  |  |         |     |       |       |  |  |  |  |  |         |     |       |       |  |  |  |  |  |         |    |       |       |  |                |        |     |       |         |    |       |       |  |                |        |     |       |         |    |       |       |  |  |  |  |  |         |    |       |       |  |                |        |   |       |         |    |       |       |  |                |        |   |       |         |    |       |       |  |  |  |  |  |         |    |       |       |  |  |  |  |  |         |    |       |       |  |  |  |  |  |         |    |       |       |  |  |  |  |  |         |     |       |       |  |  |  |  |  |         |     |       |       |  |  |  |  |  |         |    |       |       |  |                |        |     |        |         |    |       |       |  |                |        |     |        |         |    |       |       |  |  |  |  |  |         |    |       |       |  |  |  |  |  |         |    |       |       |  |  |  |  |  |         |    |       |       |  |  |  |  |  |         |     |       |       |  |  |  |  |  |         |     |       |       |  |  |  |  |  |         |    |       |       |  |                |        |  |          |         |    |       |       |  |  |  |  |  |         |    |       |       |  |  |  |  |  |
| 2.2 dCi  | 66  | 07.02     | 12.02 |       |                |        |                |                           |   |           |           |    |       |       |       |                |        |   |        |           |    |       |       |       |                |        |   |        |           |     |       |       |       |                |        |  |          |         |     |       |       |       |  |  |  |  |         |     |       |       |       |  |  |  |  |         |     |       |       |       |  |  |  |  |         |     |       |       |       |  |  |  |  |         |    |       |       |       |                |        |  |           |         |    |       |       |       |  |  |  |  |         |    |       |       |       |  |  |  |  |         |    |       |       |       |                |        |  |                      |         |    |       |       |       |  |  |  |  |         |    |       |       |       |  |  |  |  |         |    |       |       |       |  |  |  |  |         |    |       |       |       |  |  |  |  |         |    |       |       |       |  |  |  |  |         |     |       |       |       |  |  |  |  |         |     |       |       |       |  |  |  |  |         |    |       |       |       |                |        |     |       |         |    |       |       |       |                |        |     |       |         |    |       |       |       |  |  |  |  |         |    |       |       |       |  |  |  |  |         |    |       |       |       |  |  |  |  |         |    |       |       |       |  |  |  |  |         |     |       |       |       |  |  |  |  |         |     |       |       |       |  |  |  |  |         |    |       |       |       |                |        |     |       |         |    |       |       |       |                |        |     |       |         |    |       |       |       |  |  |  |  |         |    |       |       |       |                |        |   |       |         |    |       |       |       |  |  |  |  |         |    |       |       |       |  |  |  |  |         |    |       |       |       |  |  |  |  |         |    |       |       |       |  |  |  |  |         |    |       |       |       |  |  |  |  |         |     |       |       |       |  |  |  |  |         |     |       |       |       |  |  |  |  |         |    |       |       |  |                |        |   |                           |         |    |       |       |  |                |        |   |                           |         |    |       |       |  |  |  |  |  |         |    |       |       |  |  |  |  |  |         |    |       |       |  |  |  |  |  |         |    |       |       |  |  |  |  |  |         |     |       |       |  |  |  |  |  |         |     |       |       |  |  |  |  |  |         |    |       |       |  |                |        |     |       |         |    |       |       |  |                |        |     |       |         |    |       |       |  |  |  |  |  |         |    |       |       |  |                |        |   |       |         |    |       |       |  |                |        |   |       |         |    |       |       |  |  |  |  |  |         |    |       |       |  |  |  |  |  |         |    |       |       |  |  |  |  |  |         |    |       |       |  |  |  |  |  |         |     |       |       |  |  |  |  |  |         |     |       |       |  |  |  |  |  |         |    |       |       |  |                |        |     |        |         |    |       |       |  |                |        |     |        |         |    |       |       |  |  |  |  |  |         |    |       |       |  |  |  |  |  |         |    |       |       |  |  |  |  |  |         |    |       |       |  |  |  |  |  |         |     |       |       |  |  |  |  |  |         |     |       |       |  |  |  |  |  |         |    |       |       |  |                |        |  |          |         |    |       |       |  |  |  |  |  |         |    |       |       |  |  |  |  |  |
| 2.5 dCi  | 84  | 07.02     | 12.02 |       |                |        |                |                           |   |           |           |    |       |       |       |                |        |   |        |           |    |       |       |       |                |        |   |        |           |     |       |       |       |                |        |  |          |         |     |       |       |       |  |  |  |  |         |     |       |       |       |  |  |  |  |         |     |       |       |       |  |  |  |  |         |     |       |       |       |  |  |  |  |         |    |       |       |       |                |        |  |           |         |    |       |       |       |  |  |  |  |         |    |       |       |       |  |  |  |  |         |    |       |       |       |                |        |  |                      |         |    |       |       |       |  |  |  |  |         |    |       |       |       |  |  |  |  |         |    |       |       |       |  |  |  |  |         |    |       |       |       |  |  |  |  |         |    |       |       |       |  |  |  |  |         |     |       |       |       |  |  |  |  |         |     |       |       |       |  |  |  |  |         |    |       |       |       |                |        |     |       |         |    |       |       |       |                |        |     |       |         |    |       |       |       |  |  |  |  |         |    |       |       |       |  |  |  |  |         |    |       |       |       |  |  |  |  |         |    |       |       |       |  |  |  |  |         |     |       |       |       |  |  |  |  |         |     |       |       |       |  |  |  |  |         |    |       |       |       |                |        |     |       |         |    |       |       |       |                |        |     |       |         |    |       |       |       |  |  |  |  |         |    |       |       |       |                |        |   |       |         |    |       |       |       |  |  |  |  |         |    |       |       |       |  |  |  |  |         |    |       |       |       |  |  |  |  |         |    |       |       |       |  |  |  |  |         |    |       |       |       |  |  |  |  |         |     |       |       |       |  |  |  |  |         |     |       |       |       |  |  |  |  |         |    |       |       |  |                |        |   |                           |         |    |       |       |  |                |        |   |                           |         |    |       |       |  |  |  |  |  |         |    |       |       |  |  |  |  |  |         |    |       |       |  |  |  |  |  |         |    |       |       |  |  |  |  |  |         |     |       |       |  |  |  |  |  |         |     |       |       |  |  |  |  |  |         |    |       |       |  |                |        |     |       |         |    |       |       |  |                |        |     |       |         |    |       |       |  |  |  |  |  |         |    |       |       |  |                |        |   |       |         |    |       |       |  |                |        |   |       |         |    |       |       |  |  |  |  |  |         |    |       |       |  |  |  |  |  |         |    |       |       |  |  |  |  |  |         |    |       |       |  |  |  |  |  |         |     |       |       |  |  |  |  |  |         |     |       |       |  |  |  |  |  |         |    |       |       |  |                |        |     |        |         |    |       |       |  |                |        |     |        |         |    |       |       |  |  |  |  |  |         |    |       |       |  |  |  |  |  |         |    |       |       |  |  |  |  |  |         |    |       |       |  |  |  |  |  |         |     |       |       |  |  |  |  |  |         |     |       |       |  |  |  |  |  |         |    |       |       |  |                |        |  |          |         |    |       |       |  |  |  |  |  |         |    |       |       |  |  |  |  |  |













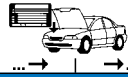











1) on the brake caliper / sulla pinza freno / sur l'étrier de frein / a la pinza de freno













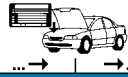











2) - long wheel base / - passo lungo / - empattement long / - distancia larga entre ejes

|     |    |  |  |  |  |  |  |  |                          |                                |            |            |
|--|--|--|--|--|---|--|--|--|--------------------------|--------------------------------|------------|------------|
| <b>NISSAN KUBISTAR (X76) Kombi (03-09)</b>   |  |  |  |  |   |  |  |  |                          |                                |            |            |
|    | 1.2  | 44   |  | 08.03  | 08.05   | - ABS  | 24.2122-1727.3   | 010586   |                          | THz 22,20                      | <b>BDX</b> |            |
|  | 1.2  | 55   |  | 08.03  | 10.09   | - ABS  |  |  |                          |                                |            |            |
|  | 1.5 dCi  | 42   |  | 08.03  | 08.05   | - ABS  |  |  |                          |                                |            |            |
|  | 1.5 dCi  | 44   |  | 09.05  | 10.09   | - ABS  |  |  |                          |                                |            |            |
|  | 1.5 dCi  | 48   |  | 08.03  | 08.05   | - ABS  |  |  |                          |                                |            |            |
|  | 1.5 dCi  | 51   |  | 09.05  | 10.09   | - ABS  |  |  |                          |                                |            |            |
|  | 1.5 dCi  | 60   |  | 08.03  | 08.05   | - ABS  |  |  |                          |                                |            |            |
|  | 1.5 dCi  | 66   |  | 09.05  | 10.09   | - ABS  |  |  |                          |                                |            |            |
|  | 1.6 i 16V  | 70   |  | 08.03  | 10.09   | - ABS  |  |  |                          |                                |            |            |
|  | 1.2  | 44   |  | 08.03  | 08.05   | + ABS  | 24.2122-1745.3   | 010715   |                          | THz 22,20                      |            |            |
|  | 1.2  | 55   |  | 08.03  | 10.09   | + ABS  |  |  |                          |                                |            |            |
|  | 1.5 dCi  | 42   |  | 08.03  | 08.05   | + ABS  |  |  |                          |                                |            |            |
|  | 1.5 dCi  | 44   |  | 09.05  | 10.09   | + ABS  |  |  |                          |                                |            |            |
|  | 1.5 dCi  | 48   |  | 08.03  | 08.05   | + ABS  |  |  |                          |                                |            |            |
| 1.5 dCi  | 51   |  | 09.05  | 10.09  | + ABS   |  |  |  |                          |                                |            |            |
| 1.5 dCi  | 60   |  | 08.03  | 08.05  | + ABS   |  |  |  |                          |                                |            |            |
| 1.5 dCi  | 66   |  | 09.05  | 10.09  | + ABS   |  |  |  |                          |                                |            |            |
| 1.6 i 16V  | 70   |  | 08.03  | 10.09  | + ABS   |  |  |  |                          |                                |            |            |
|    | 1.2  | 44   |  | 08.03  | 08.05   |  | 24.3541-1765.5   | 240235   | <input type="checkbox"/> | D=54, - Halter                 | <b>BOS</b> |            |
|  | 1.2  | 55   |  | 08.03  | 10.09   |  | 24.3541-1766.5   | 240236   | <input type="checkbox"/> | D=54, - Halter                 | <b>BOS</b> |            |
|  | 1.5 dCi  | 42   |  | 08.03  | 08.05   |  |  |  |                          |                                |            |            |
|  | 1.5 dCi  | 44   |  | 09.05  | 10.09   |  |  |  |                          |                                |            |            |
|  | 1.5 dCi  | 48   |  | 08.03  | 08.05   |  |  |  |                          |                                |            |            |
|  | 1.5 dCi  | 51   |  | 09.05  | 10.09   |  |  |  |                          |                                |            |            |
|  | 1.5 dCi  | 60   |  | 08.03  | 08.05   |  |  |  |                          |                                |            |            |
|  | 1.5 dCi  | 66   |  | 09.05  | 10.09   |  |  |  |                          |                                |            |            |
|  | 1.6 i 16V  | 70   |  | 08.03  | 10.09   |  |  |  |                          |                                |            |            |
|  |    | 1.2  | 44   |  | 08.03   | 08.05  |  | 24.5111-0336.3   | 330570                   | 2                              | L=335      |            |
|  |  | 1.2  | 55   |  | 08.03   | 10.09  |  |  |                          |                                |            |            |
|  |  | 1.5 dCi  | 42   |  | 08.03   | 08.05  |  |  |                          |                                |            |            |
|  |  | 1.5 dCi  | 44   |  | 09.05   | 10.09  |  |  |                          |                                |            |            |
|  |  | 1.5 dCi  | 48   |  | 08.03   | 08.05  |  |  |                          |                                |            |            |
| 1.5 dCi  |  | 51   |  | 09.05  | 10.09   |  |  |  |                          |                                |            |            |
| 1.5 dCi  |  | 60   |  | 08.03  | 08.05   |  |  |  |                          |                                |            |            |
| 1.5 dCi  |  | 66   |  | 09.05  | 10.09   |  |  |  |                          |                                |            |            |
| 1.6 i 16V  |  | 70   |  | 08.03  | 10.09   |  |  |  |                          |                                |            |            |
|    |  | 1.2  | 44   |  | 08.03   | 08.05  |  | 24.5111-0336.3   | 330570                   | <input type="checkbox"/> - ABS | L=335      |            |
|  |  | 1.2  | 55   |  | 08.03   | 10.09  |  | 24.5229-0193.3   | 330571                   | <input type="checkbox"/> - ABS | L=193      |            |
|  |  | 1.5 dCi  | 42   |  | 08.03   | 08.05  |  |  |                          |                                |            |            |
|  |  | 1.5 dCi  | 44   |  | 09.05   | 10.09  |  |  |                          |                                |            |            |
|  |  | 1.5 dCi  | 48   |  | 08.03   | 08.05  |  |  |                          |                                |            |            |
|  | 1.5 dCi  | 51   |  | 09.05  | 10.09   |  |  |  |                          |                                |            |            |
|  | 1.5 dCi  | 60   |  | 08.03  | 08.05   |  |  |  |                          |                                |            |            |
|  | 1.5 dCi  | 66   |  | 09.05  | 10.09   |  |  |  |                          |                                |            |            |
|  | 1.6 i 16V  | 70   |  | 08.03  | 10.09   |  |  |  |                          |                                |            |            |
|  |  | 1.2  | 44   |  | 08.03   | 08.05  |  | 24.5229-0193.3   | 330571                   | <input type="checkbox"/> + ABS | L=193      |            |
|  |  | 1.2  | 55   |  | 08.03   | 10.09  |  |  |                          |                                |            |            |
|  |  | 1.5 dCi  | 42   |  | 08.03   | 08.05  |  |  |                          |                                |            |            |
|  |  | 1.5 dCi  | 44   |  | 09.05   | 10.09  |  |  |                          |                                |            |            |
|  |  | 1.5 dCi  | 48   |  | 08.03   | 08.05  |  |  |                          |                                |            |            |
| 1.5 dCi  |  | 51   |  | 09.05  | 10.09   |  |  |  |                          |                                |            |            |
| 1.5 dCi  |  | 60   |  | 08.03  | 08.05   |  |  |  |                          |                                |            |            |
| 1.5 dCi  |  | 66   |  | 09.05  | 10.09   |  |  |  |                          |                                |            |            |
| 1.6 i 16V  |  | 70   |  | 08.03  | 10.09   |  |  |  |                          |                                |            |            |
|  |  | 1.2  | 44   |  | 08.03   | 08.05  |  | 24.3222-1716.3   | 020434                   | + 8" Bremse <sup>1)</sup>      | Rz 22,00   | <b>BDX</b> |
|  |  | 1.2  | 55   |  | 08.03   | 10.09  |  |  |                          |                                |            |            |
|  |  | 1.5 dCi  | 42   |  | 08.03   | 08.05  |  |  |                          |                                |            |            |
|  |  | 1.5 dCi  | 44   |  | 09.05   | 10.09  |  |  |                          |                                |            |            |
|  |  | 1.5 dCi  | 48   |  | 08.03   | 08.05  |  |  |                          |                                |            |            |
|  | 1.5 dCi  | 51   |  | 09.05  | 10.09   |  |  |  |                          |                                |            |            |
|  | 1.5 dCi  | 60   |  | 08.03  | 08.05   |  |  |  |                          |                                |            |            |
|  | 1.5 dCi  | 66   |  | 09.05  | 10.09   |  |  |  |                          |                                |            |            |
|  | 1.6 i 16V  | 70   |  | 08.03  | 10.09   |  |  |  |                          |                                |            |            |
|  |  | 1.2  | 44   |  | 08.03   | 08.05  |  | 24.3222-1715.3   | 020433                   | + 9" Bremse <sup>2)</sup>      | Rz 22,00   | <b>BDX</b> |
|  |  | 1.2  | 55   |  | 08.03   | 10.09  |  |  |                          |                                |            |            |
|  |  | 1.5 dCi  | 42   |  | 08.03   | 08.05  |  |  |                          |                                |            |            |
|  |  | 1.5 dCi  | 44   |  | 09.05   | 10.09  |  |  |                          |                                |            |            |
|  |  | 1.5 dCi  | 48   |  | 08.03   | 08.05  |  |  |                          |                                |            |            |
| 1.5 dCi  |  | 51   |  | 09.05  | 10.09   |  |  |  |                          |                                |            |            |
| 1.5 dCi  |  | 60   |  | 08.03  | 08.05   |  |  |  |                          |                                |            |            |
| 1.5 dCi  |  | 66   |  | 09.05  | 10.09   |  |  |  |                          |                                |            |            |
| 1.6 i 16V  |  | 70   |  | 08.03  | 10.09   |  |  |  |                          |                                |            |            |
|  |  | 1.2  | 44   |  | 08.03   | 08.05  |  | 24.3727-1041.2   | 581041                   | <input type="checkbox"/>       | L=1423     |            |
|  |  | 1.2  | 55   |  | 08.03   | 10.09  |  | 24.3727-1042.2   | 581042                   | <input type="checkbox"/>       | L=1421     |            |
|  |  | 1.5 dCi  | 42   |  | 08.03   | 08.05  |  |  |                          |                                |            |            |
|  |  | 1.5 dCi  | 44   |  | 09.05   | 10.09  |  |  |                          |                                |            |            |
|  |  | 1.5 dCi  | 48   |  | 08.03   | 08.05  |  |  |                          |                                |            |            |
|  | 1.5 dCi  | 51   |  | 09.05  | 10.09   |  |  |  |                          |                                |            |            |
|  | 1.5 dCi  | 60   |  | 08.03  | 08.05   |  |  |  |                          |                                |            |            |
|  | 1.5 dCi  | 66   |  | 09.05  | 10.09   |  |  |  |                          |                                |            |            |
|  | 1.6 i 16V  | 70   |  | 08.03  | 10.09   |  |  |  |                          |                                |            |            |
|  |  | 1.2  | 44   |  | 08.03   | 08.05  |  | 24.3728-1016.2   | 591016                   |                                | L=969      |            |
|  |  | 1.2  | 55   |  | 08.03   | 10.09  |  |  |                          |                                |            |            |
|  |  | 1.6 i 16V  | 70   |  | 08.03   | 10.09  |  |  |                          |                                |            |            |
|  |  | 1.5 dCi  | 42   |  | 08.03   | 08.05  |  | 24.3728-1023.2   | 591023                   |                                | L=960      |            |
|  |  | 1.5 dCi  | 44   |  | 09.05   | 10.09  |  |  |                          |                                |            |            |

1) + 8" brake / + servofreno da 8" / + frein de 8" / + freno de 8"

2) + 9" brake / + servofreno da 9" / + frein de 9" / + freno de 9"

|     |    |  |  |  |  |  |  |  |                          |                          |                |            |
|--|--|--|--|--|---|--|--|--|--------------------------|--------------------------|----------------|------------|
| <b>NISSAN KUBISTAR (X76) Kombi (03-09)</b>   |  |  |  |  |   |  |  |  |                          |                          |                |            |
|    | 1.5 dCi  | 48   |  | 08.03  | 08.05   | 24.3728-1023.2   | 591023   |  | L=960                    |                          |                |            |
|  | 1.5 dCi  | 51   |  | 09.05  | 10.09   |  |  |  |                          |                          |                |            |
|  | 1.5 dCi  | 51   |  | 09.05  | 10.09   |  |  |  |                          |                          |                |            |
|  | 1.5 dCi  | 60   |  | 08.03  | 08.05   |  |  |  |                          |                          |                |            |
| <b>NISSAN MICRA (K11E) (92-02)</b>   |  |  |  |  |   |  |  |  |                          |                          |                |            |
|    | 1.0 i 16V  | 40   |  | 08.92  | 07.00   | - ABS  | 24.3481-1763.5   | 240367   | <input type="checkbox"/> | D=48, - Halter           | <b>AKE</b>     |            |
|  | 1.0 i 16V  | 44   |  | 08.00  | 12.02   | - ABS  | 24.3481-1764.5   | 240368   | <input type="checkbox"/> | D=48, - Halter           | <b>AKE</b>     |            |
|  | 1.3 i 16V  | 55   |  | 08.92  | 07.00   | - ABS  |  |  |                          |                          |                |            |
|  | 1.4 i 16V  | 60   |  | 08.00  | 12.02   | - ABS  |  |  |                          |                          |                |            |
|  | 1.5 D  | 42   |  | 02.98  | 12.02   | - ABS  |  |  |                          |                          |                |            |
|    | 1.0 i 16V  | 40   |  | 08.92  | 08.00   | - ABS  | 24.5269-0462.3   | 331027   | 2                        |                          | L=462          |            |
|  | 1.0 i 16V  | 44   |  | 09.00  | 12.02   | - ABS  |  |  |                          |                          |                |            |
|  | 1.3 i 16V  | 55   |  | 08.92  | 08.00   | - ABS  |  |  |                          |                          |                |            |
|  | 1.4 i 16V  | 60   |  | 09.00  | 12.02   | - ABS  |  |  |                          |                          |                |            |
|  | 1.5 D  | 42   |  | 02.98  | 12.02   | - ABS  |  |  |                          |                          |                |            |
|    | 1.0 i 16V  | 40   |  | 08.92  | 08.00   | + ABS  | 24.5269-0460.3   | 331026   | 2                        |                          | L=460          |            |
|  | 1.0 i 16V  | 44   |  | 09.00  | 12.02   | + ABS  |  |  |                          |                          |                |            |
|  | 1.3 i 16V  | 55   |  | 08.92  | 08.00   | + ABS  |  |  |                          |                          |                |            |
|  | 1.4 i 16V  | 60   |  | 09.00  | 12.02   | + ABS  |  |  |                          |                          |                |            |
|  | 1.5 D  | 42   |  | 02.98  | 12.02   | + ABS  |  |  |                          |                          |                |            |
|    | 1.0 i 16V  | 40   |  | 08.92  | 08.00   | + ABS  | 24.3304-1709.5   | 240359   | <input type="checkbox"/> | D=30, - Halter           | <b>AKE</b>     |            |
|  | 1.0 i 16V  | 44   |  | 09.00  | 12.02   | + ABS  | 24.3304-1710.5   | 240360   | <input type="checkbox"/> | D=30, - Halter           | <b>AKE</b>     |            |
|  | 1.3 i 16V  | 55   |  | 08.92  | 08.00   | + ABS  |  |  |                          |                          |                |            |
|  | 1.4 i 16V  | 60   |  | 09.00  | 12.02   | + ABS  |  |  |                          |                          |                |            |
|    | 1.0 i 16V  | 40   |  | 08.92  | 01.98   | - ABS  | 24.5247-0210.3   | 331023   | 2                        |                          | L=210          |            |
|  | 1.3 i 16V  | 55   |  | 08.92  | 01.98   | - ABS  |  |  |                          |                          |                |            |
|  | 1.0 i 16V  | 40   |  | 08.92  | 01.98   | + ABS  | 24.5269-0195.3   | 330935   | 2                        |                          | L=195          |            |
|    | 1.3 i 16V  | 55   |  | 08.92  | 01.98   | + ABS  |  |  |                          |                          |                |            |
|  | 1.0 i 16V  | 40   |  | 02.98  | 08.00   |  | 24.5247-0195.3   | 330919   | 2                        |                          | L=195          |            |
|  | 1.0 i 16V  | 44   |  | 09.00  | 12.02   |  |  |  |                          |                          |                |            |
|  | 1.3 i 16V  | 55   |  | 02.98  | 08.00   |  |  |  |                          |                          |                |            |
|  | 1.4 i 16V  | 60   |  | 09.00  | 12.02   |  |  |  |                          |                          |                |            |
|    | 1.5 D  | 42   |  | 02.98  | 12.02   |  |  |  |                          |                          |                |            |
|  | 1.0 i 16V  | 40   |  | 08.92  | 08.00   | - ABS  | 24.3217-1708.3   | 020414   |                          |                          | Rz 17,78       |            |
|  | 1.0 i 16V  | 44   |  | 09.00  | 12.02   | - ABS  |  |  |                          |                          |                |            |
|  | 1.3 i 16V  | 55   |  | 08.92  | 08.00   | - ABS  |  |  |                          |                          |                |            |
|  | 1.4 i 16V  | 60   |  | 09.00  | 12.02   | - ABS  |  |  |                          |                          |                |            |
|   | 1.5 D  | 42   |  | 02.98  | 12.02   |  |  |  |                          |                          |                |            |
|  | 1.0 i 16V  | 40   |  | 08.92  | 08.00   | - ABS  | 24.3727-1701.2   | 581701   | <input type="checkbox"/> |                          | L=250          |            |
|  | 1.3 i 16V  | 55   |  | 08.92  | 08.00   | - ABS  | 24.3727-1705.2   | 581705   | <input type="checkbox"/> |                          | L=1410         |            |
|  | 1.5 D  | 42   |  | 02.98  | 08.00   |  | 24.3727-1704.2   | 581704   | <input type="checkbox"/> |                          | L=1433         |            |
|  | 1.0 i 16V  | 44   |  | 09.00  | 12.02   | - ABS  | 24.3727-1701.2   | 581701   | <input type="checkbox"/> |                          | L=250          |            |
|  | 1.4 i 16V  | 60   |  | 09.00  | 12.02   | - ABS  |  |  |                          |                          |                |            |
|  | 1.5 D  | 42   |  | 09.00  | 12.02   |  |  |  |                          |                          |                |            |
|  | 1.0 i 16V  | 40   |  | 08.92  | 08.00   | + ABS  | 24.3727-1701.2   | 581701   | <input type="checkbox"/> |                          | L=250          |            |
|  | 1.0 i 16V  | 44   |  | 09.00  | 12.02   | + ABS  | 24.3727-1715.2   | 581715   | <input type="checkbox"/> |                          | L=1287         |            |
|  | 1.3 i 16V  | 55   |  | 08.92  | 08.00   | + ABS  | 24.3727-1714.2   | 581714   | <input type="checkbox"/> |                          | L=1310         |            |
|  | 1.4 i 16V  | 60   |  | 09.00  | 12.02   | + ABS  |  |  |                          |                          |                |            |
|  | 1.0 i 16V  | 40   |  | 08.92  | 01.98   |  | 24.3728-1708.2   | 591708   |                          |                          | L=623          |            |
|  | 1.3 i 16V  | 55   |  | 08.92  | 01.98   |  |  |  |                          |                          |                |            |
|  | 1.0 i 16V  | 40   |  | 02.98  | 08.00   |  | 24.3728-1709.2   | 591709   |                          |                          | L=655          |            |
|  | 1.0 i 16V  | 44   |  | 09.00  | 12.02   |  |  |  |                          |                          |                |            |
|  | 1.3 i 16V  | 55   |  | 02.98  | 08.00   |  |  |  |                          |                          |                |            |
|  | 1.4 i 16V  | 60   |  | 09.00  | 12.02   |  |  |  |                          |                          |                |            |
|  | 1.5 D  | 42   |  | 09.00  | 12.02   |  |  |  |                          |                          |                |            |
| <b>NISSAN MICRA (K12E) (03-10)</b>   |  |  |  |  |   |  |  |  |                          |                          |                |            |
|  | 1.0 i 16V  | 48   |  | 01.03  | 06.10   |  | 03.7863-3002.4   | 300223   |                          |                          | 10"            | <b>ATE</b> |
|  | 1.2 i 16V  | 48   |  | 01.03  | 06.10   |  |  |  |                          |                          |                |            |
|  | 1.2 i 16V  | 59   |  | 01.03  | 06.10   |  |  |  |                          |                          |                |            |
|  | 1.4 i 16V  | 65   |  | 01.03  | 06.10   |  |  |  |                          |                          |                |            |
|  | 1.5 dCi  | 48   |  | 01.03  | 06.10   |  |  |  |                          |                          |                |            |
|  | 1.5 dCi  | 50   |  | 06.05  | 06.10   |  |  |  |                          |                          |                |            |
|  | 1.5 dCi  | 60   |  | 09.03  | 06.10   |  |  |  |                          |                          |                |            |
|  | 1.5 dCi  | 63   |  | 01.03  | 06.10   |  |  |  |                          |                          |                |            |
|  | 1.6 i 16V  | 81   |  | 05.05  | 06.10   |  |  |  |                          |                          |                |            |
|  |  | 1.0 i 16V  | 48   |  | 01.03   | 06.10  |  | 03.2123-2863.3   | 010790                   |                          | - ESP          | THz 23,81  |
| 1.2 i 16V  |  | 48   |  | 01.03  | 06.10   |  | 03.2123-2923.3   | 010791   |                          | + ESP                    | THz 23,81      | <b>ATE</b> |
| 1.2 i 16V  |  | 59   |  | 01.03  | 06.10   |  |  |  |                          |                          |                |            |
| 1.4 i 16V  |  | 65   |  | 01.03  | 06.10   |  |  |  |                          |                          |                |            |
| 1.5 dCi  |  | 48   |  | 01.03  | 06.10   |  |  |  |                          |                          |                |            |
| 1.5 dCi  |  | 50   |  | 06.05  | 06.10   |  |  |  |                          |                          |                |            |
| 1.5 dCi  |  | 60   |  | 09.03  | 06.10   |  |  |  |                          |                          |                |            |
| 1.5 dCi  |  | 63   |  | 01.03  | 06.10   |  |  |  |                          |                          |                |            |
| 1.6 i 16V  |  | 81   |  | 05.05  | 06.10   |  |  |  |                          |                          |                |            |
|  |  | 1.0 i 16V  | 48   |  | 01.03   | 06.10  |  | 24.3541-1823.5   | 240417                   | <input type="checkbox"/> | D=54, - Halter |            |
|  | 1.2 i 16V  | 48   |  | 01.03  | 06.10   |  | 24.3541-1824.5   | 240418   | <input type="checkbox"/> | D=54, - Halter           |                |            |
|  | 1.2 i 16V  | 59   |  | 01.03  | 06.10   |  |  |  |                          |                          |                |            |
|  | 1.4 i 16V  | 65   |  | 01.03  | 06.10   |  |  |  |                          |                          |                |            |
|  | 1.5 dCi  | 48   |  | 01.03  | 06.10   |  |  |  |                          |                          |                |            |
|  | 1.5 dCi  | 50   |  | 06.05  | 06.10   |  |  |  |                          |                          |                |            |
|  | 1.5 dCi  | 60   |  | 09.03  | 06.10   |  |  |  |                          |                          |                |            |
| 1.5 dCi  | 63   |  | 01.03  | 06.10  |   |  |  |  |                          |                          |                |            |
| 1.6 i 16V  | 81   |  | 05.05  | 06.10  |   |  |  |  |                          |                          |                |            |

|     |  |  |  |  |  |  |  |  |                |
|--|--|--|--|--|---|--|--|--|----------------|
| <b>NISSAN MICRA (K12E) (03-10)</b>   |  |  |  |  |   |  |  |  |                |
|    | 1.0 i 16V  | 48   |  | 01.03  | 06.10   | 24.5292-0605.3   | 331030   | <input type="checkbox"/>   | L=605          |
|  | 1.2 i 16V  | 48   |  | 01.03  | 06.10   | 24.5293-0605.3   | 331031   | <input type="checkbox"/>   | L=605          |
|  | 1.2 i 16V  | 59   |  | 01.03  | 06.10   |  |  |  |                |
|  | 1.4 i 16V  | 65   |  | 01.03  | 06.10   |  |  |  |                |
|  | 1.5 dCi  | 48   |  | 01.03  | 06.10   |  |  |  |                |
|  | 1.5 dCi  | 50   |  | 06.05  | 06.10   |  |  |  |                |
|  | 1.5 dCi  | 60   |  | 09.03  | 06.10   |  |  |  |                |
|  | 1.5 dCi  | 63   |  | 01.03  | 06.10   |  |  |  |                |
|  | 1.6 i 16V  | 81   |  | 05.05  | 06.10   |  |  |  |                |
|    | 1.0 i 16V  | 48   |  | 01.03  | 06.10   | 24.5247-0281.3   | 330967   | 2  | L=280          |
|  | 1.2 i 16V  | 48   |  | 01.03  | 06.10   |  |  |  |                |
|  | 1.2 i 16V  | 59   |  | 01.03  | 06.10   |  |  |  |                |
|  | 1.4 i 16V  | 65   |  | 01.03  | 06.10   |  |  |  |                |
|  | 1.5 dCi  | 48   |  | 01.03  | 06.10   |  |  |  |                |
|  | 1.5 dCi  | 50   |  | 06.05  | 06.10   |  |  |  |                |
|  | 1.5 dCi  | 60   |  | 09.03  | 06.10   |  |  |  |                |
|  | 1.5 dCi  | 63   |  | 01.03  | 06.10   |  |  |  |                |
|  | 1.6 i 16V  | 81   |  | 05.05  | 06.10   |  |  |  |                |
|    | 1.0 i 16V  | 48   |  | 01.03  | 06.10   | 24.3219-1755.3   | 020508   |  | Rz 19,05       |
|  | 1.2 i 16V  | 48   |  | 01.03  | 06.10   |  |  |  |                |
|  | 1.2 i 16V  | 59   |  | 01.03  | 06.10   |  |  |  |                |
|  | 1.4 i 16V  | 65   |  | 01.03  | 06.10   |  |  |  |                |
|  | 1.5 dCi  | 48   |  | 01.03  | 06.10   |  |  |  |                |
|  | 1.5 dCi  | 50   |  | 06.05  | 06.10   |  |  |  |                |
|  | 1.5 dCi  | 60   |  | 09.03  | 06.10   |  |  |  |                |
|  | 1.5 dCi  | 63   |  | 01.03  | 06.10   |  |  |  |                |
|  | 1.6 i 16V  | 81   |  | 05.05  | 06.10   |  |  |  |                |
|    | 1.0 i 16V  | 48   |  | 01.03  | 06.10   | 24.3727-1722.2   | 581722   | <input type="checkbox"/>   | L=200          |
|  | 1.2 i 16V  | 48   |  | 01.03  | 06.10   | 24.3727-1718.2   | 581718   | <input type="checkbox"/>   | L=1540         |
|  | 1.2 i 16V  | 59   |  | 01.03  | 06.10   | 24.3727-1719.2   | 581719   | <input type="checkbox"/>   | L=1604         |
|  | 1.4 i 16V  | 65   |  | 01.03  | 06.10   |  |  |  |                |
|  | 1.5 dCi  | 48   |  | 01.03  | 06.10   |  |  |  |                |
|  | 1.5 dCi  | 50   |  | 06.05  | 06.10   |  |  |  |                |
|  | 1.5 dCi  | 60   |  | 09.03  | 06.10   |  |  |  |                |
|  | 1.5 dCi  | 63   |  | 01.03  | 06.10   |  |  |  |                |
|  | 1.6 i 16V  | 81   |  | 05.05  | 06.10   |  |  |  |                |
| <b>NISSAN MICRA C+C (CK12E) (05-10)</b>  |  |  |  |  |   |  |  |  |                |
|   | 1.4 i 16V  | 65   |  | 08.05  | 12.10   | 03.7863-3002.4   | 300223   |  | 10" ATE        |
|  | 1.6 i 16V  | 81   |  | 08.05  | 12.10   |  |  |  |                |
|  | 1.4 i 16V  | 65   |  | 08.05  | 12.10   | 03.2123-2863.3   | 010790   | - ESP  | Thz 23,81 ATE  |
|  | 1.6 i 16V  | 81   |  | 08.05  | 12.10   | 03.2123-2923.3   | 010791   | + ESP  | Thz 23,81 ATE  |
|  | 1.4 i 16V  | 65   |  | 08.05  | 12.10   | 24.3541-1823.5   | 240417   | <input type="checkbox"/>   | D=54, - Halter |
|  | 1.6 i 16V  | 81   |  | 08.05  | 12.10   | 24.3541-1824.5   | 240418   | <input type="checkbox"/>   | D=54, - Halter |
|  | 1.4 i 16V  | 65   |  | 08.05  | 12.10   | 24.5292-0605.3   | 331030   | <input type="checkbox"/>   | L=605          |
|  | 1.6 i 16V  | 81   |  | 08.05  | 12.10   | 24.5293-0605.3   | 331031   | <input type="checkbox"/>   | L=605          |
|  | 1.4 i 16V  | 65   |  | 08.05  | 12.10   | 24.5247-0281.3   | 330967   | 2  | L=280          |
|  | 1.6 i 16V  | 81   |  | 08.05  | 12.10   |  |  |  |                |
|  | 1.4 i 16V  | 65   |  | 08.05  | 12.10   | 24.3219-1755.3   | 020508   |  | Rz 19,05       |
|  | 1.6 i 16V  | 81   |  | 08.05  | 12.10   |  |  |  |                |
|  | 1.4 i 16V  | 65   |  | 08.05  | 12.10   | 24.3727-1722.2   | 581722   | <input type="checkbox"/>   | L=200          |
|  | 1.6 i 16V  | 81   |  | 08.05  | 12.10   | 24.3727-1718.2   | 581718   | <input type="checkbox"/>   | L=1540         |
|  |  |  |  |  |   | 24.3727-1719.2   | 581719   | <input type="checkbox"/>   | L=1604         |
| <b>NISSAN NAVARA (D40M) (05-)</b>  |  |  |  |  |   |  |  |  |                |
|  | 2.5 dCi  | 106  |  | 07.05  | 09.06   | 03.2125-0161.3   | 010920   |  | Thz 25,40 ATE  |
|  | 2.5 dCi  | 128  |  | 12.05  | 09.06   |  |  |  |                |
|  | 2.5 dCi 4WD  | 128  |  | 07.05  | 09.06   |  |  |  |                |
|  | 2.5 dCi  | 106  |  | 07.05  |   | 24.3222-1702.3   | 020525   |  | Rz 22,20       |
|  | 2.5 dCi  | 120  |  | 10.06  |   |  |  |  |                |
|  | 2.5 dCi  | 128  |  | 12.05  |   |  |  |  |                |
|  | 2.5 dCi 4WD  | 126  |  | 10.06  |   |  |  |  |                |
|  | 2.5 dCi 4WD  | 128  |  | 07.05  |   |  |  |  |                |
|  | 2.5 dCi 4WD  | 140  |  | 12.09  |   |  |  |  |                |
|  | 3.0 dCi 4WD  | 170  |  | 02.10  |   |  |  |  |                |
| <b>NISSAN NOTE (E11E) (06-)</b>  |  |  |  |  |   |  |  |  |                |
|  | 1.4  | 65   |  | 03.06  |   | 03.7863-3002.4   | 300223   |  | 10" ATE        |
|  | 1.5 dCi  | 50   |  | 03.06  |   |  |  |  |                |
|  | 1.5 dCi  | 63   |  | 03.06  |   |  |  |  |                |
|  | 1.5 dCi  | 66   |  | 09.10  |   |  |  |  |                |
|  | 1.5 dCi  | 76   |  | 07.08  |   |  |  |  |                |
|  | 1.6  | 81   |  | 03.06  |   |  |  |  |                |
|  | 1.4  | 65   |  | 03.06  |   | 03.2123-2863.3   | 010790   | - ESP  | Thz 23,81 ATE  |
|  | 1.5 dCi  | 50   |  | 03.06  |   | 03.2123-2923.3   | 010791   | + ESP  | Thz 23,81 ATE  |
|  | 1.5 dCi  | 63   |  | 03.06  |   |  |  |  |                |
|  | 1.5 dCi  | 66   |  | 09.10  |   |  |  |  |                |
|  | 1.5 dCi  | 76   |  | 07.08  |   |  |  |  |                |
|  | 1.6  | 81   |  | 03.06  |   |  |  |  |                |
|  |  |  |  |  |   |  |  |  |                |

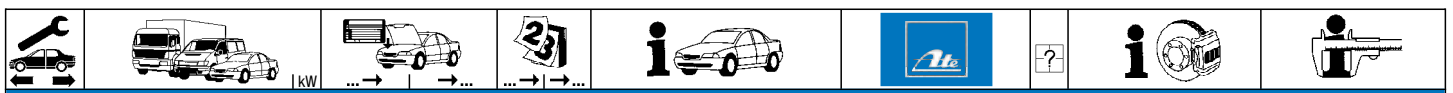

| NISSAN NOTE (E11E) (06-)              |               |     |  |       |                                   |                |        |   |  |                 |
|---------------------------------------|---------------|-----|--|-------|-----------------------------------|----------------|--------|---|--|-----------------|
|                                       | 1.4           | 65  |  | 03.06 |                                   | 24.3541-1823.5 | 240417 |   |  | D=54, - Halter  |
|                                       | 1.5 dCi       | 50  |  | 03.06 |                                   | 24.3541-1824.5 | 240418 |   |  | D=54, - Halter  |
|                                       | 1.5 dCi       | 63  |  | 03.06 |                                   |                |        |   |  |                 |
|                                       | 1.5 dCi       | 66  |  | 09.10 |                                   |                |        |   |  |                 |
|                                       | 1.5 dCi       | 76  |  | 07.08 |                                   |                |        |   |  |                 |
|                                       | 1.6           | 81  |  | 03.06 |                                   |                |        |   |  |                 |
|                                       | 1.4           | 65  |  | 03.06 |                                   | 24.5292-0605.3 | 331030 |   |  | L=605           |
|                                       | 1.5 dCi       | 50  |  | 03.06 |                                   | 24.5293-0605.3 | 331031 |   |  | L=605           |
|                                       | 1.5 dCi       | 63  |  | 03.06 |                                   |                |        |   |  |                 |
|                                       | 1.5 dCi       | 66  |  | 09.10 |                                   |                |        |   |  |                 |
|                                       | 1.5 dCi       | 76  |  | 07.08 |                                   |                |        |   |  |                 |
|                                       | 1.6           | 81  |  | 03.06 |                                   |                |        |   |  |                 |
|                                       | 1.4           | 65  |  | 03.06 |                                   | 24.5247-0281.3 | 330967 | 2 |  | L=280           |
|                                       | 1.5 dCi       | 50  |  | 03.06 |                                   |                |        |   |  |                 |
|                                       | 1.5 dCi       | 63  |  | 03.06 |                                   |                |        |   |  |                 |
|                                       | 1.5 dCi       | 66  |  | 09.10 |                                   |                |        |   |  |                 |
|                                       | 1.5 dCi       | 76  |  | 07.08 |                                   |                |        |   |  |                 |
|                                       | 1.6           | 81  |  | 03.06 |                                   |                |        |   |  |                 |
|                                       | 1.4           | 65  |  | 03.06 |                                   | 24.3219-1755.3 | 020508 |   |  | Rz 19,05        |
|                                       | 1.5 dCi       | 50  |  | 03.06 |                                   |                |        |   |  |                 |
|                                       | 1.5 dCi       | 63  |  | 03.06 |                                   |                |        |   |  |                 |
|                                       | 1.5 dCi       | 66  |  | 09.10 |                                   |                |        |   |  |                 |
|                                       | 1.5 dCi       | 76  |  | 07.08 |                                   |                |        |   |  |                 |
|                                       | 1.6           | 81  |  | 03.06 |                                   |                |        |   |  |                 |
|                                       | 1.4           | 65  |  | 03.06 |                                   | 24.3727-1722.2 | 581722 |   |  | L=200           |
|                                       | 1.5 dCi       | 50  |  | 03.06 |                                   |                |        |   |  |                 |
|                                       | 1.5 dCi       | 63  |  | 03.06 |                                   |                |        |   |  |                 |
|                                       | 1.5 dCi       | 66  |  | 09.10 |                                   |                |        |   |  |                 |
|                                       | 1.5 dCi       | 76  |  | 07.08 |                                   |                |        |   |  |                 |
|                                       | 1.6           | 81  |  | 03.06 |                                   |                |        |   |  |                 |
| NISSAN NP 300 (D40M) (08-)            |               |     |  |       |                                   |                |        |   |  |                 |
|                                       | 2.5 dCi       | 98  |  | 04.08 |                                   | 03.2125-0161.3 | 010920 |   |  | THz 25,40 ATE   |
|                                       | 2.5 dCi 4x4   | 98  |  | 04.08 |                                   |                |        |   |  |                 |
|                                       | 2.5 dCi       | 98  |  | 04.08 |                                   | 24.3222-1702.3 | 020525 |   |  | Rz 22,20        |
|                                       | 2.5 dCi 4x4   | 98  |  | 04.08 |                                   |                |        |   |  |                 |
| NISSAN PATHFINDER (R51M) (05-)        |               |     |  |       |                                   |                |        |   |  |                 |
|                                       | 2.5 dCi       | 128 |  | 10.06 | + Automatikgetriebe <sup>1)</sup> | 03.7858-7602.4 | 300277 |   |  | 9/8" Tandem ATE |
|                                       | 2.5 dCi 4WD   | 126 |  | 10.06 | + Automatikgetriebe <sup>1)</sup> |                |        |   |  |                 |
|                                       | 2.5 dCi 4WD   | 128 |  | 10.06 | + Automatikgetriebe <sup>1)</sup> |                |        |   |  |                 |
|                                       | 4.0           | 198 |  | 10.06 |                                   |                |        |   |  |                 |
|                                       | 4.0 4WD       | 198 |  | 10.06 |                                   |                |        |   |  |                 |
|                                       | 2.5 dCi       | 128 |  | 01.05 | - Spezialausrüstung <sup>2)</sup> | 03.2125-0161.3 | 010920 |   |  | THz 25,40 ATE   |
|                                       | 2.5 dCi 4WD   | 126 |  | 10.06 | - Spezialausrüstung <sup>2)</sup> |                |        |   |  |                 |
|                                       | 2.5 dCi 4WD   | 128 |  | 03.05 | - Spezialausrüstung <sup>2)</sup> |                |        |   |  |                 |
|                                       | 2.5 dCi 4WD   | 140 |  | 08.10 |                                   |                |        |   |  |                 |
|                                       | 2.5 dCi       | 128 |  | 01.05 | + Spezialausrüstung <sup>3)</sup> | 03.2125-0531.3 | 010945 |   |  | THz 25,40 ATE   |
|                                       | 2.5 dCi 4WD   | 126 |  | 10.06 | + Spezialausrüstung <sup>3)</sup> |                |        |   |  |                 |
|                                       | 2.5 dCi 4WD   | 128 |  | 03.05 | + Spezialausrüstung <sup>3)</sup> |                |        |   |  |                 |
|                                       | 4.0           | 198 |  | 01.05 |                                   |                |        |   |  |                 |
|                                       | 4.0 4WD       | 198 |  | 09.05 |                                   |                |        |   |  |                 |
| NISSAN PRAIRIE (M11) (EUROPA) (88-94) |               |     |  |       |                                   |                |        |   |  |                 |
|                                       | 2.0           | 72  |  | 10.88 | 03.92                             | 24.3220-1703.3 | 020391 |   |  | Rz 20,64        |
| NISSAN PRIMASTAR (X83) Bus (01-)      |               |     |  |       |                                   |                |        |   |  |                 |
|                                       | 1.9 dCi (100) | 74  |  | 03.01 | 01.03 - ABS                       | 24.2120-1738.3 | 010759 |   |  | THz 20,64 LUC   |
|                                       | 1.9 dCi (80)  | 60  |  | 03.01 | 01.03 - ABS                       |                |        |   |  |                 |
|                                       | 2.0 i 16V     | 88  |  | 03.01 | 01.03 - ABS                       |                |        |   |  |                 |
|                                       | 1.9 dCi (100) | 74  |  | 02.03 | 08.06 - ABS                       | 24.2120-1740.3 | 010764 |   |  | THz 20,64 LUC   |
|                                       | 1.9 dCi (80)  | 60  |  | 02.03 | 08.06 - ABS                       |                |        |   |  |                 |
|                                       | 2.0 dCi (115) | 84  |  | 09.08 | - ABS                             |                |        |   |  |                 |
|                                       | 2.0 dCi (120) | 84  |  | 09.06 | - ABS                             |                |        |   |  |                 |
|                                       | 2.0 dCi (90)  | 66  |  | 09.06 | - ABS                             |                |        |   |  |                 |
|                                       | 2.0 i 16V     | 88  |  | 02.03 | - ABS                             |                |        |   |  |                 |
|                                       | 2.5 dCi (140) | 99  |  | 07.03 | 08.06 - ABS                       |                |        |   |  |                 |
|                                       | 2.5 dCi (150) | 107 |  | 09.06 | - ABS                             |                |        |   |  |                 |
|                                       | 1.9 dCi (100) | 74  |  | 03.01 | 01.03 + ABS                       | 24.2125-1730.3 | 010760 |   |  | THz 25,40 LUC   |
|                                       | 1.9 dCi (80)  | 60  |  | 03.01 | 01.03 + ABS                       |                |        |   |  |                 |
|                                       | 2.0 i 16V     | 88  |  | 03.01 | 01.03 + ABS                       |                |        |   |  |                 |
|                                       | 1.9 dCi (100) | 74  |  | 02.03 | 08.06 + ABS                       | 24.2125-1731.3 | 010826 |   |  | THz 25,40 LUC   |
|                                       | 1.9 dCi (80)  | 60  |  | 02.03 | 08.06 + ABS                       |                |        |   |  |                 |
|                                       | 2.0 dCi (115) | 84  |  | 09.08 | + ABS                             |                |        |   |  |                 |
|                                       | 2.0 dCi (120) | 84  |  | 09.06 | + ABS                             |                |        |   |  |                 |
|                                       | 2.0 dCi (90)  | 66  |  | 09.06 | + ABS                             |                |        |   |  |                 |
|                                       | 2.0 i 16V     | 88  |  | 02.03 | + ABS                             |                |        |   |  |                 |
|                                       | 2.5 dCi (140) | 99  |  | 07.03 | 08.06 + ABS                       |                |        |   |  |                 |
|                                       | 2.5 dCi (150) | 107 |  | 09.06 | + ABS                             |                |        |   |  |                 |
|                                       | 1.9 dCi (100) | 74  |  | 04.06 | + ESP                             | 24.2125-1734.3 | 010878 |   |  | THz 25,40 LUC   |
|                                       | 1.9 dCi (80)  | 60  |  | 04.06 | + ESP                             |                |        |   |  |                 |

<sup>1)</sup> + autom.transmission / + scatola cambio automatico / + transmission automatique / + cambio automático

<sup>2)</sup> - special equipment / - dotazione speciale / - équipement spécial / - equipamiento especial

<sup>3)</sup> + special equipment / + dotazione speciale / + équipement spécial / + equipamiento especial







### NISSAN PRIMASTAR (X83) Bus (01-)

|  |  |   |  |  |  |  |  |   |  |   |            |
|--|--|---|--|--|--|--|--|---|--|---|------------|
|  | 2.0 dCi (115)<br>2.0 dCi (120)<br>2.0 dCi (90)<br>2.0 i 16V<br>2.5 dCi (140)<br>2.5 dCi (150)                                  | 84<br>84<br>66<br>88<br>99<br>107             |  | 09.08<br>09.06<br>09.06<br>02.03<br>07.03<br>09.06                   | + ESP<br>+ ESP<br>+ ESP<br>+ ESP<br>+ ESP<br>+ ESP | 24.2125-1734.3   | 010878   |   |  | THz 25,40   | LUC        |
|  | 1.9 dCi (100)<br>1.9 dCi (80)<br>2.0 dCi (115)<br>2.0 dCi (120)<br>2.0 dCi (90)<br>2.0 i 16V<br>2.5 dCi (140)<br>2.5 dCi (150) | 74<br>60<br>84<br>84<br>66<br>88<br>99<br>107 |  | 03.01<br>03.01<br>09.08<br>09.06<br>09.06<br>03.01<br>07.03<br>09.06 | 08.06<br>08.06                                     | 24.3451-1713.7<br>24.3451-1714.7   | 220737<br>220738                               | <input type="checkbox"/><br><input type="checkbox"/>  |  | D=40/45, - Halter<br>D=40/45, - Halter                | LUC<br>LUC |
|  | 1.9 dCi (100)<br>1.9 dCi (80)<br>2.0 dCi (115)<br>2.0 dCi (120)<br>2.0 dCi (90)<br>2.0 i 16V<br>2.5 dCi (140)<br>2.5 dCi (150) | 74<br>60<br>84<br>84<br>66<br>88<br>99<br>107 |  | 03.01<br>03.01<br>09.08<br>09.06<br>09.06<br>03.01<br>07.03<br>09.06 | 08.06<br>08.06                                     | 24.5111-0386.3   | 330503   | 2   |  | L=385   |            |
|  | 1.9 dCi (100)<br>1.9 dCi (80)<br>2.0 dCi (115)<br>2.0 dCi (120)<br>2.0 dCi (90)<br>2.0 i 16V<br>2.5 dCi (140)<br>2.5 dCi (150) | 74<br>60<br>84<br>84<br>66<br>88<br>99<br>107 |  | 03.01<br>03.01<br>09.08<br>09.06<br>09.06<br>03.01<br>09.03<br>09.06 | 08.06<br>08.06                                     | 24.3414-1707.5<br>24.3414-1708.5   | 240337<br>240338                               | <input type="checkbox"/><br><input type="checkbox"/>  |  | D=41, - Halter<br>D=41, - Halter                      | LUC<br>LUC |
|  | 1.9 dCi (100)<br>1.9 dCi (80)<br>2.0 dCi (115)<br>2.0 dCi (120)<br>2.0 dCi (90)<br>2.0 i 16V<br>2.5 dCi (140)<br>2.5 dCi (150) | 74<br>60<br>84<br>84<br>66<br>88<br>99<br>107 |  | 03.01<br>03.01<br>09.08<br>09.06<br>09.06<br>03.01<br>07.03<br>09.06 | 08.06<br>08.06                                     | 24.5229-0200.3<br>24.5111-0221.3   | 330572<br>330818                               | 2<br>2  | am Bremssattel <sup>1)</sup>                                       | L=200<br>L=220  |            |
|  | 1.9 dCi (100)<br>1.9 dCi (80)<br>2.0 dCi (115)<br>2.0 dCi (120)<br>2.0 dCi (90)<br>2.0 i 16V<br>2.5 dCi (140)<br>2.5 dCi (150) | 74<br>60<br>84<br>84<br>66<br>88<br>99<br>107 |  | 03.01<br>03.01<br>09.08<br>09.06<br>09.06<br>03.01<br>07.03<br>09.06 | 08.06<br>08.06                                     | 24.3727-0765.2<br>24.3727-0796.2<br>24.3727-0797.2<br>24.3727-1068.2<br>24.3727-1071.2 | 580765<br>580796<br>580797<br>581068<br>581071 | 1<br><input type="checkbox"/><br><input type="checkbox"/><br><input type="checkbox"/><br><input type="checkbox"/> | + kurzer Radstand <sup>2)</sup><br>+ langer Radstand <sup>3)</sup> | L=508<br>L=1245/498<br>L=1643/498<br>L=1503<br>L=1603 |            |























### NISSAN PRIMASTAR (X83) Kasten/Pritsche (02-)

|  |  |   |  |  |  |                                  |                  |  |  |  |            |
|--|--|---|--|--|--|----------------------------------|------------------|--|--|--|------------|
|  | 1.9 dCi (100)<br>1.9 dCi (80)<br>2.0 i 16V   | 74<br>60<br>88                                |  | 07.02<br>07.02<br>07.02  | 01.03 - ABS<br>01.03 - ABS<br>01.03 - ABS  | 24.2120-1738.3                   | 010759           |  |  | THz 20,64                              | LUC        |
|  | 1.9 dCi (100)<br>1.9 dCi (80)<br>2.0 dCi (115)<br>2.0 dCi (120)<br>2.0 dCi (90)<br>2.0 i 16V<br>2.5 dCi (140)<br>2.5 dCi (150) | 74<br>60<br>84<br>84<br>66<br>88<br>99<br>107 |  | 02.03<br>02.03<br>09.08<br>09.06<br>09.06<br>02.03<br>07.03<br>09.06 | 08.06 - ABS<br>08.06 - ABS<br>- ABS<br>- ABS<br>- ABS<br>- ABS<br>08.06 - ABS<br>- ABS | 24.2120-1740.3                   | 010764           |  |  | THz 20,64                              | LUC        |
|  | 1.9 dCi (100)<br>1.9 dCi (80)<br>2.0 i 16V   | 74<br>60<br>88                                |  | 07.02<br>07.02<br>07.02  | 01.03 + ABS<br>01.03 + ABS<br>01.03 + ABS  | 24.2125-1730.3                   | 010760           |  |  | THz 25,40                              | LUC        |
|  | 1.9 dCi (100)<br>1.9 dCi (80)<br>2.0 dCi (115)<br>2.0 dCi (120)<br>2.0 dCi (90)<br>2.0 i 16V<br>2.5 dCi (140)<br>2.5 dCi (150) | 74<br>60<br>84<br>84<br>66<br>88<br>99<br>107 |  | 02.03<br>02.03<br>09.08<br>09.06<br>09.06<br>02.03<br>07.03<br>09.06 | 08.06 + ABS<br>08.06 + ABS<br>+ ABS<br>+ ABS<br>+ ABS<br>+ ABS<br>08.06 + ABS<br>+ ABS | 24.2125-1731.3                   | 010826           |  |  | THz 25,40                              | LUC        |
|  | 1.9 dCi (100)<br>1.9 dCi (80)<br>2.0 dCi (120)<br>2.0 dCi (90)<br>2.0 i 16V<br>2.5 dCi (140)<br>2.5 dCi (150)                  | 74<br>60<br>84<br>66<br>88<br>99<br>107       |  | 04.06<br>04.06<br>09.06<br>09.06<br>02.03<br>07.03<br>09.06          | + ESP<br>+ ESP<br>+ ESP<br>+ ESP<br>+ ESP<br>+ ESP<br>+ ESP                            | 24.2125-1734.3                   | 010878           |  |  | THz 25,40                              | LUC        |
|  | 1.9 dCi (100)<br>1.9 dCi (80)<br>2.0 dCi (115)<br>2.0 dCi (120)<br>2.0 dCi (90)<br>2.0 i 16V<br>2.5 dCi (140)<br>2.5 dCi (150) | 74<br>60<br>84<br>84<br>66<br>88<br>99<br>107 |  | 07.02<br>07.02<br>09.08<br>09.06<br>09.06<br>07.02<br>07.03<br>09.06 | 08.06<br>08.06   | 24.3451-1713.7<br>24.3451-1714.7 | 220737<br>220738 | <input type="checkbox"/><br><input type="checkbox"/> |  | D=40/45, - Halter<br>D=40/45, - Halter | LUC<br>LUC |























<sup>1)</sup> on the brake caliper / sulla pinza freno / sur l'étrier de frein / a la pinza de freno



















<sup>2)</sup> + short wheel base / + passo lungo / + empattement court / + distancia corta entre ejes





















<sup>3)</sup> + long wheel base / + passo lungo / + empattement long / + distancia larga entre ejes

|     |    |  |  |  |  |                        |  |  |   |   |
|--|--|--|--|--|---|--|--|--|---|---|
| <b>NISSAN PRIMASTAR (X83) Kasten/Pritsche (02-)</b>                                |  |  |  |  |   |  |  |  |   |   |
|    | 1.9 dCi (100)<br>1.9 dCi (80)<br>2.0 dCi (115)<br>2.0 dCi (120)<br>2.0 dCi (90)<br>2.0 i 16V<br>2.5 dCi (140)<br>2.5 dCi (150) | 74<br>60<br>84<br>84<br>66<br>88<br>99<br>107                                    |  | 07.02<br>07.02<br>09.08<br>09.06<br>09.06<br>07.02<br>07.03<br>09.06             | 08.06<br>08.06  | 24.5111-0386.3   | 330503   | 2  | L=385   |   |
|    | 1.9 dCi (100)<br>1.9 dCi (80)<br>2.0 dCi (115)<br>2.0 dCi (120)<br>2.0 dCi (90)<br>2.0 i 16V<br>2.5 dCi (140)<br>2.5 dCi (150) | 74<br>60<br>84<br>84<br>66<br>88<br>99<br>107                                    |  | 07.02<br>07.02<br>09.08<br>09.06<br>09.06<br>07.02<br>07.03<br>09.06             | 08.06<br>08.06  | 24.3414-1707.5<br>24.3414-1708.5   | 240337<br>240338   | <input type="checkbox"/><br><input type="checkbox"/>                               | D=41, - Halter<br>D=41, - Halter  | LUC<br>LUC  |
|    | 1.9 dCi (100)<br>1.9 dCi (80)<br>2.0 dCi (115)<br>2.0 dCi (120)<br>2.0 dCi (90)<br>2.0 i 16V<br>2.5 dCi (140)<br>2.5 dCi (150) | 74<br>60<br>84<br>84<br>66<br>88<br>99<br>107                                    |  | 07.02<br>07.02<br>09.08<br>09.06<br>09.06<br>07.02<br>07.03<br>09.06             | 08.06<br>08.06  | 24.5229-0200.3<br>24.5111-0221.3   | 330572<br>330818   | 2<br>2   | am Bremssattel <sup>1)</sup>  | L=200<br>L=220  |
|    | 1.9 dCi (100)<br>1.9 dCi (80)<br>2.0 dCi (115)<br>2.0 dCi (120)<br>2.0 dCi (90)<br>2.0 i 16V<br>2.5 dCi (140)<br>2.5 dCi (150) | 74<br>60<br>84<br>84<br>66<br>88<br>99<br>107                                    |  | 07.02<br>07.02<br>09.08<br>09.06<br>09.06<br>07.02<br>07.03<br>09.06             | 08.06<br>08.06  | 24.3727-0765.2<br>24.3727-0763.2<br>24.3727-0796.2<br>24.3727-0797.2<br>24.3727-1068.2<br>24.3727-1071.2 | 580765<br>580763<br>580796<br>580797<br>581068<br>581071                           | 1<br>1   | + kurzer Radstand <sup>3)</sup><br>+ kurzer Radstand <sup>3)</sup><br>+ langer Radstand <sup>4)</sup> | L=508<br>L=1190<br>L=1245/498<br>L=1643/498<br>L=1503<br>L=1603 |
|  | 1.9 dCi (100)  | 74   |  | 07.02<br>09.06   | 08.06<br>08.06  | 24.3727-0765.2<br>24.3727-1068.2<br>24.3727-1071.2   | 580765<br>581068<br>581071   | 1  | + Pritsche/Fahrgestell <sup>5)</sup>  | L=508<br>L=1503<br>L=1603                                       |
| <b>NISSAN PRIMERA (P10E) Limousine (90-96)</b>                                     |  |  |  |  |   |  |  |  |   |   |
|   | 1.6<br>1.6 i<br>2.0 D<br>2.0 i 16V<br>2.0 i 16V 4x4  |  |  | 05.93<br>05.93<br>05.93<br>06.90<br>09.94  | 01.96<br>01.96<br>01.96<br>01.96<br>06.96   | 24.3344-1701.5<br>24.3344-1702.5<br>24.0101-3401.2   | 240087<br>240088<br>260043   | <input type="checkbox"/><br><input type="checkbox"/>                               | D=34, - Halter<br>D=34, - Halter<br>Einbausatz  | LUC<br>LUC<br>LUC   |
|  | 1.6<br>1.6 i   |  |  | 06.90<br>05.93   | 08.94<br>08.94  | 24.3220-1625.3   | 020377   | <input type="checkbox"/>   | RzR 20,64   |   |
|  | 1.6<br>1.6 i<br>2.0 D<br>2.0 i 16V   |  |  | 05.93<br>05.93<br>05.93<br>06.90   | 01.96<br>01.96<br>01.96<br>01.96  | 24.3727-1709.2<br>24.3727-1708.2   | 581709<br>581708   | <input type="checkbox"/><br><input type="checkbox"/>                               | L=1516<br>L=1491  |   |
|  | 2.0 i 16V<br>2.0 D   |  |  | 06.90<br>06.90   | 01.96<br>01.96  | 24.3728-1706.2<br>24.3728-1704.2   | 591706<br>591704   |  | L=717<br>L=695  |   |
| <b>NISSAN PRIMERA (P11E) Limousine (96-02)</b>                                     |  |  |  |  |   |  |  |  |   |   |
|  | 1.6 i 16V<br>1.8 i 16V<br>2.0 i 16V<br>2.0 i 16V<br>2.0 i 16V<br>2.0 i 16V<br>2.0 i 16V<br>2.0 TD                              | 84<br>85<br>96<br>103<br>110<br>66   |  | 06.96<br>06.99<br>06.96<br>04.98<br>06.99<br>06.96                               | 02.02<br>02.02<br>02.02<br>02.02<br>02.02<br>02.02<br>02.02                       | 24.3571-1731.5<br>24.3571-1732.5   | 240321<br>240322   | <input type="checkbox"/><br><input type="checkbox"/>                               | D=57, - Halter<br>D=57, - Halter  | LUC<br>LUC  |
|  | 1.6 i 16V<br>1.8 i 16V<br>2.0 i 16V<br>2.0 i 16V<br>2.0 i 16V<br>2.0 i 16V<br>2.0 TD   | 84<br>85<br>96<br>103<br>110<br>66   |  | 06.96<br>06.99<br>06.96<br>06.99<br>06.96<br>06.96                               | 02.02<br>02.02<br>02.02<br>02.02<br>02.02<br>02.02                                | 24.5267-0391.3<br>24.5267-0390.3   | 330974<br>330932   | <input type="checkbox"/><br><input type="checkbox"/>                               | L=390<br>L=390  |   |
|  | 1.8 i 16V<br>2.0 i 16V<br>2.0 i 16V<br>2.0 i 16V<br>2.0 i 16V  | 84<br>85<br>96<br>103<br>110   |  | 06.99<br>06.96<br>06.96<br>06.99<br>06.96  | 03.01<br>03.01<br>03.01<br>03.01<br>03.01   | 24.3344-1717.5<br>24.3344-1718.5   | 240341<br>240342   | <input type="checkbox"/><br><input type="checkbox"/>                               | D=34, - Halter<br>D=34, - Halter  | LUC<br>LUC  |
|  | 1.6 i 16V<br>1.8 i 16V<br>2.0 i 16V<br>2.0 i 16V<br>2.0 i 16V<br>2.0 TD  | 84<br>85<br>96<br>103<br>110<br>66   |  | 06.96<br>06.99<br>06.96<br>06.99<br>06.96<br>06.96                               | 02.02<br>02.02<br>02.02<br>02.02<br>02.02<br>02.02                                | 24.5281-0585.3<br>24.5281-0580.3   | 331007<br>331006   | <input type="checkbox"/><br><input type="checkbox"/>                               | L=585<br>L=580  |   |
|  | 1.6 i 16V<br>2.0 TD  | 66   |  | 06.96<br>06.96   | 02.02<br>02.02  | 24.3220-1718.3   | 020438   |  | Rz 20,64  | BDX   |

1) on the brake caliper / sulla pinza freno / sur l'étrier de frein / a la pinza de freno  
2) - Pickup/Chassis / - Autocarro a cassone/Telaio / - Camion plateau/Châssis / - Camión plataforma/Chasis  
3) + short wheel base / + passo lungo / + empattement court / + distancia corta entre ejes  
4) + long wheel base / + passo lungo / + empattement long / + distancia larga entre ejes  
5) + Pickup/Chassis / + Autocarro a cassone/Telaio / + Camion plateau/Châssis / + Camión plataforma/Chasis

|     |  |  |  |  |  |  |  |  |                |
|--|--|--|--|--|---|--|--|--|----------------|
| <b>NISSAN PRIMERA (P11E) Limousine (96-02)</b>                                     |  |  |  |  |   |  |  |  |                |
|    | 1.6 i 16V  |  | 06.96  | 02.02  | 24.3727-1713.2  | 581713   | <input type="checkbox"/>   | L=1620   |                |
|  | 2.0 TD   | 66   | 06.96  | 02.02  | 24.3727-1712.2  | 581712   |  | <input type="checkbox"/>   | L=1640         |
|  | 1.8 i 16V  | 84   | 06.99  | 02.02  | 24.3727-1731.2  | 581731   |  | <input type="checkbox"/>   | L=1632         |
|  | 2.0 i 16V  | 85   | 06.96  | 02.02  | 24.3727-1730.2  | 581730   |  | <input type="checkbox"/>   | L=1657         |
|  | 2.0 i 16V  | 96   | 06.96  | 02.02  |   |  |  |  |                |
|    | 2.0 i 16V  | 103  | 06.99  | 02.02  |   |  |  |  |                |
|  | 2.0 i 16V  | 110  | 06.96  | 02.02  |   |  |  |  |                |
|  |  |  |  |  |   |  |  |  |                |
|    | 1.6 i 16V  |  | 02.00  | 02.02  | 24.2519-1703.3  | 040091   |  | Nz 19,05   |                |
|  | 1.8 i 16V  | 84   | 02.00  | 02.02  |   |  |  |  |                |
|  | 2.0 i 16V  | 103  | 02.00  | 02.02  |   |  |  |  |                |
| <b>NISSAN PRIMERA (P12E) Limousine (02-08)</b>                                     |  |  |  |  |   |  |  |  |                |
|    | 1.6  | 78   | 03.02  | 10.08  | 24.5278-0661.3  | 331190   | <input type="checkbox"/>   | L=661  |                |
|  | 1.6  | 80   | 03.02  | 04.06  | 24.5278-0652.3  | 331189   |  | <input type="checkbox"/>   | L=652          |
|  | 1.8  | 85   | 03.02  | 10.08  |   |  |  |  |                |
|  | 1.9 dCi  | 88   | 04.03  | 10.07  |   |  |  |  |                |
|  | 2.0  | 103  | 03.02  | 10.08  |   |  |  |  |                |
|  | 2.2 dCi  | 102  | 04.03  | 10.07  |   |  |  |  |                |
|  | 2.2 Di   | 93   | 03.02  | 04.03  |   |  |  |  |                |
|  | 2.5  | 125  | 03.02  | 04.06  |   |  |  |  |                |
|    | 1.6  | 78   | 03.02  | 10.08  | 11.9387-7021.2  | 220629   | <input type="checkbox"/>   | D=38, - Halter   |                |
|  | 1.6  | 80   | 03.02  | 04.06  | 11.9387-7022.2  | 220630   |  | <input type="checkbox"/>   | ATE            |
|  | 1.8  | 85   | 03.02  | 10.08  | 11.0101-5407.2  | 260011   |  |  | ATE            |
|  | 1.9 dCi  | 88   | 04.03  | 10.07  | 11.8171-0008.1  | 990049   |  |  | Führungsbolzen |
|  | 2.0  | 103  | 03.02  | 10.08  | 11.8116-0340.1  | 390595   |  | 2  | Haltefeder     |
|  | 2.2 dCi  | 102  | 04.03  | 10.07  |   |  |  |  | ATE            |
|  | 2.2 Di   | 93   | 03.02  | 04.03  |   |  |  |  |                |
|  | 2.5  | 125  | 03.02  | 04.06  |   |  |  |  |                |
|    | 1.6  | 78   | 03.02  | 10.08  | 24.5281-0641.3  | 330969   | <input type="checkbox"/>   | L=640  |                |
|  | 1.6  | 80   | 03.02  | 04.06  | 24.5281-0640.3  | 330968   |  | <input type="checkbox"/>   | L=640          |
|  | 1.8  | 85   | 03.02  | 10.08  |   |  |  |  |                |
|  | 1.9 dCi  | 88   | 04.03  | 10.07  |   |  |  |  |                |
|  | 2.0  | 103  | 03.02  | 10.08  |   |  |  |  |                |
|  | 2.2 dCi  | 102  | 04.03  | 10.07  |   |  |  |  |                |
|  | 2.2 Di   | 93   | 03.02  | 04.03  |   |  |  |  |                |
|  | 2.5  | 125  | 03.02  | 04.06  |   |  |  |  |                |
|    | 1.6  | 78   | 03.02  | 10.08  | 24.3727-1723.2  | 581723   | <input type="checkbox"/>   | L=236  |                |
|  | 1.6  | 80   | 03.02  | 04.06  | 24.3727-1729.2  | 581729   |  | <input type="checkbox"/>   | L=1778         |
|  | 1.8  | 85   | 03.02  | 10.08  | 24.3727-1728.2  | 581728   |  | <input type="checkbox"/>   | L=1778         |
|  | 1.9 dCi  | 88   | 04.03  | 10.07  |   |  |  |  |                |
|  | 2.0  | 103  | 03.02  | 10.08  |   |  |  |  |                |
|  | 2.2 dCi  | 102  | 04.03  | 10.07  |   |  |  |  |                |
|  | 2.2 Di   | 93   | 03.02  | 04.03  |   |  |  |  |                |
|  | 2.5  | 125  | 03.02  | 04.06  |   |  |  |  |                |
|  | 1.6  | 78   | 03.02  | 10.08  | 24.2519-1703.3  | 040091   |  | Nz 19,05   |                |
|  | 1.6  | 80   | 03.02  | 04.06  |   |  |  |  |                |
|  | 1.8  | 85   | 03.02  | 10.08  |   |  |  |  |                |
|  | 1.9 dCi  | 88   | 04.03  | 10.07  |   |  |  |  |                |
|  | 2.2 dCi  | 102  | 04.03  | 10.07  | 24.2519-1704.3  | 040092   |  | Nz 19,05   |                |
| 2.2 Di   | 93   | 03.02  | 04.03  |  |   |  |  |  |                |
| <b>NISSAN PRIMERA (W10) Kombi (90-98)</b>  |  |  |  |  |   |  |  |  |                |
|  | 1.6  |  | 07.90  | 03.98  | 24.3220-1703.3  | 020391   | <input type="checkbox"/>   | Rz 20,64   |                |
|  | 2.0 D  |  | 07.90  | 12.95  |   |  |  | <input type="checkbox"/>   |                |
|  | 1.6  |  | 07.90  | 03.98  | 24.3727-1701.2  | 581701   | <input type="checkbox"/>   | L=250  |                |
|  | 2.0 D  |  | 07.90  | 12.95  |   |  |  | <input type="checkbox"/>   |                |
|  | 1.6  |  | 07.90  | 03.98  | 24.3727-1701.2  | 581701   |  | <input type="checkbox"/>   | L=250          |
|  | 2.0 D  |  | 07.90  | 12.95  |   |  |  | <input type="checkbox"/>   |                |
|  | 2.0 i  |  | 07.90  | 12.95  |   |  |  |  |                |
| <b>NISSAN PRIMERA (W11) Kombi (98-02)</b>  |  |  |  |  |   |  |  |  |                |
|  | 1.6 i 16V  | 66   | 04.98  | 02.02  | 24.3571-1731.5  | 240321   | <input type="checkbox"/>   | D=57, - Halter   |                |
|  | 1.6 i 16V  | 73   | 04.98  | 02.02  | 24.3571-1732.5  | 240322   |  | <input type="checkbox"/>   | LUC            |
|  | 1.8 i 16V  | 84   | 08.99  | 02.02  |   |  |  |  |                |
|  | 2.0 i 16V  | 85   | 04.98  | 06.99  |   |  |  |  |                |
|  | 2.0 i 16V  | 96   | 04.98  | 06.99  |   |  |  |  |                |
|  | 2.0 TD   | 66   | 04.98  | 02.02  |   |  |  |  |                |
|  | 2.0 i 16V  | 85   | 07.99  | 02.02  | 11.0101-5407.2  | 260011   | <input type="checkbox"/>   | Hülsensatz   |                |
|  | 2.0 i 16V  | 96   | 07.99  | 02.02  | 11.8171-0008.1  | 990049   |  | <input type="checkbox"/>   | ATE            |
|  | 2.0 i 16V  | 103  | 08.99  | 02.02  | 11.8116-0274.1  | 390516   |  | 2  | ATE            |
|  | 1.6 i 16V  | 66   | 04.98  | 02.02  | 24.5267-0391.3  | 330974   | <input type="checkbox"/>   | L=390  |                |
|  | 1.6 i 16V  | 73   | 04.98  | 02.02  | 24.5267-0390.3  | 330932   |  | <input type="checkbox"/>   | L=390          |
|  | 1.8 i 16V  | 84   | 08.99  | 02.02  |   |  |  |  |                |
|  | 2.0 i 16V  | 85   | 04.98  | 02.02  |   |  |  |  |                |
|  | 2.0 i 16V  | 96   | 04.98  | 02.02  |   |  |  |  |                |
|  | 2.0 i 16V  | 103  | 08.99  | 02.02  |   |  |  |  |                |
|  | 2.0 TD   | 66   | 04.98  | 02.02  |   |  |  |  |                |
|  | 1.6 i 16V  | 66   | 04.98  | 02.02  | 24.5281-0585.3  | 331007   | <input type="checkbox"/>   | L=585  |                |
|  | 1.6 i 16V  | 73   | 04.98  | 02.02  | 24.5281-0580.3  | 331006   |  | <input type="checkbox"/>   | L=580          |
|  | 1.8 i 16V  | 84   | 08.99  | 02.02  |   |  |  |  |                |
|  | 2.0 i 16V  | 85   | 04.98  | 02.02  |   |  |  |  |                |
|  | 2.0 i 16V  | 96   | 04.98  | 02.02  |   |  |  |  |                |
|  | 2.0 i 16V  | 103  | 08.99  | 02.02  |   |  |  |  |                |
|  | 2.0 TD   | 66   | 04.98  | 02.02  |   |  |  |  |                |

|     |  |  |  |  |  |  |  |  |
|--|--|--|--|--|---|--|--|--|
| <b>NISSAN PRIMERA (W11) Kombi (98-02)</b>  |  |  |  |  |   |  |  |  |
|    | 1.6 i 16V  | 66   | 04.98  | 03.01  | 24.3727-1716.2  | 581716   | <input type="checkbox"/>   | L=1642<br>L=1668   |
|  | 1.6 i 16V  | 73   | 04.98  | 03.01  | 24.3727-1717.2  | 581717   |  |  |
|  | 1.8 i 16V  | 84   | 08.99  | 03.01  |   |  |  |  |
|  | 2.0 i 16V  | 85   | 04.98  | 03.01  |   |  |  |  |
|  | 2.0 i 16V  | 96   | 04.98  | 03.01  |   |  |  |  |
|  | 2.0 i 16V  | 103  | 08.99  | 03.01  |   |  |  |  |
|  | 2.0 TD   | 66   | 04.98  | 03.01  |   |  |  |  |
|  | 1.6 i 16V  | 66   | 04.01  | 02.02  | 24.3727-1720.2  | 581720   |  |  |
|  | 1.6 i 16V  | 73   | 04.01  | 02.02  | 24.3727-1721.2  | 581721   |  |  |
|  | 1.8 i 16V  | 84   | 04.01  | 02.02  |   |  |  |  |
| 2.0 i 16V  | 85   | 04.01  | 02.02  |  |   |  |  |  |
| 2.0 i 16V  | 96   | 04.01  | 02.02  |  |   |  |  |  |
| 2.0 i 16V  | 103  | 04.01  | 02.02  |  |   |  |  |  |
| 2.0 TD   | 66   | 04.01  | 02.02  |  |   |  |  |  |
|    | 1.8 i 16V  | 84   | 08.99  | 02.02  | 24.2519-1703.3  | 040091   |  | Nz 19,05   |
|  | 2.0 i 16V  | 103  | 08.99  | 02.02  |   |  |  |  |
| <b>NISSAN PRIMERA (W12) Kombi (02-08)</b>  |  |  |  |  |   |  |  |  |
|    | 1.6  | 78   | 03.02  | 10.08  | 24.5278-0661.3  | 331190   | <input type="checkbox"/>   | L=661<br>L=652   |
|  | 1.6  | 80   | 03.02  | 04.06  | 24.5278-0652.3  | 331189   |  |  |
|  | 1.8  | 85   | 03.02  | 10.08  |   |  |  |  |
|  | 1.9 dCi  | 88   | 04.03  | 10.07  |   |  |  |  |
|  | 2.0  | 103  | 03.02  | 10.08  |   |  |  |  |
|  | 2.2 dCi  | 102  | 04.03  | 10.07  |   |  |  |  |
|  | 2.2 Di   | 93   | 03.02  | 04.03  |   |  |  |  |
|    | 1.6  | 78   | 03.02  | 10.08  | 11.9387-7021.2  | 220629   | <input type="checkbox"/>   | D=38, - Halter<br>D=38, - Halter<br>Hülensatz<br>Führungsbolzen<br>Haltefeder      |
|  | 1.6  | 80   | 03.02  | 04.06  | 11.9387-7022.2  | 220630   |  |  |
|  | 1.8  | 85   | 03.02  | 10.08  | 11.0101-5407.2  | 260011   |  |  |
|  | 1.9 dCi  | 88   | 04.03  | 10.07  | 11.8171-0008.1  | 990049   |  |  |
|  | 2.0  | 103  | 03.02  | 10.08  | 11.8116-0340.1  | 390595   |  |  |
|  | 2.2 dCi  | 102  | 04.03  | 10.07  |   |  |  |  |
|  | 2.2 Di   | 93   | 03.02  | 04.03  |   |  |  |  |
|    | 1.6  | 78   | 03.02  | 10.08  | 24.5281-0641.3  | 330969   | <input type="checkbox"/>   | L=640<br>L=640   |
|  | 1.6  | 80   | 03.02  | 04.06  | 24.5281-0640.3  | 330968   |  |  |
|  | 1.8  | 85   | 03.02  | 10.08  |   |  |  |  |
|  | 1.9 dCi  | 88   | 04.03  | 10.07  |   |  |  |  |
|  | 2.0  | 103  | 03.02  | 10.08  |   |  |  |  |
|  | 2.2 dCi  | 102  | 04.03  | 10.07  |   |  |  |  |
|  | 2.2 Di   | 93   | 03.02  | 04.03  |   |  |  |  |
|  | 1.6  | 78   | 03.02  | 10.08  | 24.3727-1723.2  | 581723   | <input type="checkbox"/>   | L=236<br>L=1778<br>L=1778  |
|  | 1.6  | 80   | 03.02  | 04.06  | 24.3727-1729.2  | 581729   |  |  |
|  | 1.8  | 85   | 03.02  | 10.08  | 24.3727-1728.2  | 581728   |  |  |
|  | 1.9 dCi  | 88   | 04.03  | 10.07  |   |  |  |  |
|  | 2.0  | 103  | 03.02  | 10.08  |   |  |  |  |
|  | 2.2 dCi  | 102  | 04.03  | 10.07  |   |  |  |  |
|  | 2.2 Di   | 93   | 03.02  | 04.03  |   |  |  |  |
|  | 1.6  | 78   | 03.02  | 10.08  | 24.2519-1703.3  | 040091   |  | Nz 19,05   |
|  | 1.6  | 80   | 03.02  | 04.06  |   |  |  |  |
|  | 1.8  | 85   | 03.02  | 10.08  |   |  |  |  |
|  | 1.9 dCi  | 88   | 04.03  | 10.07  |   |  |  |  |
|  | 2.2 dCi  | 102  | 04.03  | 10.07  | 24.2519-1704.3  | 040092   |  | Nz 19,05   |
| 2.2 Di   | 93   | 03.02  | 04.03  |  |   |  |  |  |
| <b>NISSAN QASHQAI / QASHQAI +2 (J10,JJ10) (07-)</b>                                |  |  |  |  |   |  |  |  |
|  | 1.5 dCi  | 76   | 07.08  |  | 24.5266-0600.3  | 331161   | <input type="checkbox"/>   | L=600<br>L=600   |
|  | 1.5 dCi  | 78   | 02.07  |  | 24.5266-0601.3  | 331162   |  |  |
|  | 1.5 dCi  | 81   | 11.10  |  |   |  |  |  |
|  | 1.6 dCi  | 96   | 10.11  |  |   |  |  |  |
|  | 1.6 dCi Allrad   | 96   | 10.11  |  |   |  |  |  |
|  | 1.6 i 16V  | 84   | 02.07  |  |   |  |  |  |
|  | 1.6 i 16V  | 86   | 11.10  |  |   |  |  |  |
|  | 2.0 dCi  | 110  | 02.07  |  |   |  |  |  |
|  | 2.0 dCi Allrad   | 110  | 02.07  |  |   |  |  |  |
|  | 2.0 i 16V  | 103  | 02.07  |  |   |  |  |  |
|  | 2.0 i 16V  | 104  | 11.10  |  |   |  |  |  |
|  | 1.5 dCi  | 76   | 07.08  |  | 24.5292-0240.3  | 331225   | <input type="checkbox"/>   | L=240<br>L=240   |
|  | 1.5 dCi  | 78   | 02.07  |  | 24.5292-0241.3  | 331226   |  |  |
|  | 1.5 dCi  | 81   | 11.10  |  |   |  |  |  |
|  | 1.6 dCi  | 96   | 10.11  |  |   |  |  |  |
|  | 1.6 dCi Allrad   | 96   | 10.11  |  |   |  |  |  |
|  | 1.6 i 16V  | 84   | 02.07  |  |   |  |  |  |
|  | 1.6 i 16V  | 86   | 11.10  |  |   |  |  |  |
|  | 2.0 dCi  | 110  | 02.07  |  |   |  |  |  |
|  | 2.0 dCi Allrad   | 110  | 02.07  |  |   |  |  |  |
|  | 2.0 i 16V  | 103  | 02.07  |  |   |  |  |  |
|  | 2.0 i 16V  | 104  | 11.10  |  |   |  |  |  |
| 2.0 i 16V Allrad   | 103  | 02.07  |  |  |   |  |  |  |
| 2.0 i 16V Allrad   | 104  | 11.10  |  |  |   |  |  |  |

| NISSAN QASHQAI / QASHQAI +2 (J10, JJ10) (07-)                                      |  |  |  |  |   |  |  |  |   |  |                      |
|--|--|--|--|--|---|--|--|--|---|--|----------------------|
|     |  |  |  |  |  |  |  |  |   |  |                      |
|  |  |  |  |  |   |  |  |  |   |  |                      |
|    | 1.5 dCi  | 76   |  | 07.08  |   |  | 24.3727-1732.2   | 581732   | ↑ |  | L=262                |
|  | 1.5 dCi  | 78   |  | 02.07  |   |  |  |  |   |  |                      |
|  | 1.5 dCi  | 81   |  | 11.10  |   |  |  |  |   |  |                      |
|  | 1.6 dCi  | 96   |  | 10.11  |   |  |  |  |   |  |                      |
|  | 1.6 dCi Allrad   | 96   |  | 10.11  |   |  |  |  |   |  |                      |
|  | 1.6 i 16V  | 84   |  | 02.07  |   |  |  |  |   |  |                      |
|  | 1.6 i 16V  | 86   |  | 11.10  |   |  |  |  |   |  |                      |
|  | 2.0 dCi  | 110  |  | 02.07  |   |  |  |  |   |  |                      |
|  | 2.0 dCi Allrad   | 110  |  | 02.07  |   |  |  |  |   |  |                      |
|  | 2.0 i 16V  | 103  |  | 02.07  |   |  |  |  |   |  |                      |
|  | 2.0 i 16V  | 104  |  | 11.10  |   |  |  |  |   |  |                      |
|  | 2.0 i 16V Allrad   | 103  |  | 02.07  |   |  |  |  |   |  |                      |
|  | 2.0 i 16V Allrad   | 104  |  | 11.10  |   |  |  |  |   |  |                      |
|  | 1.5 dCi  | 76   |  | 08.08  | 01.10   |  | 24.3727-1732.2   | 581732   | ↑ |  | L=262                |
|  | 1.5 dCi  | 78   |  | 08.08  | 01.10   |  |  |  |   |  |                      |
|  | 1.5 dCi  | 81   |  | 02.10  |   |  |  |  |   |  |                      |
|  | 1.6 dCi  | 96   |  | 07.11  |   |  |  |  |   |  |                      |
|  | 1.6 dCi Allrad   | 96   |  | 07.11  |   |  |  |  |   |  |                      |
|  | 1.6 i 16V  | 84   |  | 08.08  |   |  |  |  |   |  |                      |
|  | 1.6 i 16V  | 86   |  | 02.10  |   |  |  |  |   |  |                      |
|  | 2.0 dCi  | 110  |  | 08.08  |   |  |  |  |   |  |                      |
|  | 2.0 dCi Allrad   | 110  |  | 08.08  |   |  |  |  |   |  |                      |
|  | 2.0 i 16V  | 104  |  | 08.08  |   |  |  |  |   |  |                      |
|  | 2.0 i 16V Allrad   | 104  |  | 08.08  |   |  |  |  |   |  |                      |
| NISSAN SERENA/VANETTE CARGO (C23M/963) (92-01)                                     |  |  |  |  |   |  |  |  |   |  |                      |
|    | 1.6 i 16V  | 71   |  | 07.92  | 11.01   |  | 24.3223-1709.3   | 020444   |   |  | Rz 23,81             |
|  | 2.0 D  | 49   |  | 07.92  | 08.94   |  |  |  |   |  |                      |
|  | 2.0 i 16V  | 93   |  | 07.92  | 11.01   |  |  |  |   |  |                      |
|  | 2.3 D  | 55   |  | 09.94  | 11.01   |  |  |  |   |  |                      |
|    | 1.6 i 16V  | 71   |  | 06.94  | 11.01   |  | 24.3727-1727.2   | 581727   | ☐ |  | L=1234               |
|  | 2.0 D  | 49   |  | 06.94  | 08.94   |  | 24.3727-1726.2   | 581726   | ☐ |  | L=1608               |
|  | 2.3 D  | 55   |  | 09.94  | 11.01   |  |  |  |   |  |                      |
| NISSAN SUNNY (N14) Limousine (90-95)   |  |  |  |  |   |  |  |  |   |  |                      |
|    | 1.4  |  |  | 10.90  | 05.95   |  | 24.3481-1725.5   | 240187   | ☐ |  | D=48, - Halter       |
|  | 1.6 16V  |  |  | 10.90  | 05.95   |  | 24.3481-1726.5   | 240188   | ☐ |  | SUM                  |
|  | 1.6 16V 4x4  |  |  | 10.90  | 05.95   |  |  |  |   |  |                      |
|  | 2.0 D  |  |  | 10.90  | 05.95   |  |  |  |   |  |                      |
|   | 1.4  |  |  | 10.90  | 05.95   | - ABS  | 24.3215-1107.3   | 020352   |   |  | Rz 15,87             |
|  | 1.6 16V  |  |  | 10.90  | 05.95   | - ABS  |  |  |   |  |                      |
|  | 2.0 D  |  |  | 10.90  | 05.95   | - ABS  |  |  |   |  |                      |
|  | 1.4  |  |  | 10.90  | 05.95   | - ABS  | 24.3727-1701.2   | 581701   | ↑ |  | L=250                |
|  | 1.6 16V  |  |  | 10.90  | 05.95   | - ABS  |  |  |   |  |                      |
|  | 2.0 D  |  |  | 10.90  | 05.95   | - ABS  |  |  |   |  |                      |
|  | 1.4  |  |  | 10.90  | 05.95   | + ABS  | 24.3727-1701.2   | 581701   | ↑ |  | L=250                |
|  | 1.6 16V  |  |  | 10.90  | 05.95   | + ABS  | 24.3727-1710.2   | 581710   | ☐ |  | L=1313               |
|  | 2.0 16V GTI  |  |  | 10.90  | 05.95   |  | 24.3727-1711.2   | 581711   | ☐ |  | L=1312               |
|  | 2.0 D  |  |  | 10.90  | 05.95   | + ABS  |  |  |   |  |                      |
|  | 1.6 16V 4x4  |  |  | 10.90  | 05.95   | - ABS  | 24.3727-1701.2   | 581701   | ↑ |  | L=250                |
|  | 1.6 16V 4x4  |  |  | 10.90  | 05.95   | + ABS  | 24.3727-1701.2   | 581701   | ↑ |  | L=250                |
|  | 2.0 GTI R 4x4  |  |  | 10.90  | 05.95   |  | 24.3727-1701.2   | 581701   | ↑ |  | L=250                |
|  | 1.4  |  |  | 10.90  | 04.92   |  | 24.3728-1703.2   | 591703   |   |  | L=728                |
|  | 1.6 16V  |  |  | 10.90  | 05.95   |  |  |  |   |  |                      |
|  | 1.6 16V 4x4  |  |  | 10.90  | 05.95   |  |  |  |   |  |                      |
| NISSAN SUNNY (Y10) Kombi (90-00)   |  |  |  |  |   |  |  |  |   |  |                      |
|  | 1.6 16V  |  |  | 11.90  | 03.00   |  | 24.3727-1701.2   | 581701   | ↑ |  | L=250                |
|  | 2.0 D  |  |  | 11.90  | 03.00   |  |  |  |   |  |                      |
|  | 1.6 16V 4x4  |  |  | 11.90  | 03.00   |  | 24.3727-1701.2   | 581701   | ↑ |  | L=250                |
|  | 1.7 D  |  |  | 11.90  | 03.00   |  | 24.3727-1701.2   | 581701   | ↑ |  | L=250                |
|  | 1.6 16V  |  |  | 11.90  | 03.00   |  | 24.3728-1703.2   | 591703   |   |  | L=728                |
|  | 1.6 16V 4x4  |  |  | 11.90  | 03.00   |  |  |  |   |  |                      |
| NISSAN TERRANO II (R20) (93-06)  |  |  |  |  |   |  |  |  |   |  |                      |
|  | 2.4 i 4WD  | 91   |  | 02.93  | 04.96   | - ABS  | 24.2123-1726.3   | 010557   |   |  | THz 23,81 - Behälter |
|  | 2.7 TD 4WD   | 74   |  | 02.93  | 04.96   | - ABS  |  |  |   |  |                      |
|  | 2.4 i 4WD  | 87   |  | 05.96  | 11.05   | - ABS  | 24.2125-1738.3   | 010931   |   |  | THz 25,40            |
|  | 2.7 TD 4WD   | 74   |  | 05.96  | 01.02   | - ABS  |  |  |   |  | LUC                  |
|  | 2.7 TDi 4WD  | 92   |  | 05.96  | 11.05   | - ABS  |  |  |   |  |                      |
|  | 3.0 Di 4WD   | 113  |  | 05.02  | 04.06   | - ABS  |  |  |   |  |                      |
|  | 2.4 i 4WD  | 87   |  | 09.00  | 11.05   | + ABS  | 24.5290-0414.3   | 331175   | ☐ |  | L=414                |
|  | 2.7 TD 4WD   | 74   |  | 09.00  | 01.02   | + ABS  | 24.5290-0410.3   | 331081   | ☐ |  | L=410                |
|  | 2.7 TDi 4WD  | 92   |  | 09.00  | 11.05   | + ABS  |  |  |   |  |                      |
|  | 3.0 Di 4WD   | 113  |  | 05.02  | 04.06   | + ABS  |  |  |   |  |                      |
|  | 2.4 i 4WD  | 87   |  | 05.96  | 11.05   |  | 24.5278-0467.3   | 331073   | 2 |  | L=467                |
|  | 2.4 i 4WD  | 91   |  | 02.93  | 04.96   |  |  |  |   |  |                      |
|  | 2.7 TD 4WD   | 74   |  | 02.93  | 01.02   |  |  |  |   |  |                      |
|  | 2.7 TDi 4WD  | 92   |  | 05.96  | 11.05   |  |  |  |   |  |                      |
|  | 3.0 Di 4WD   | 113  |  | 05.02  | 04.06   |  |  |  |   |  |                      |

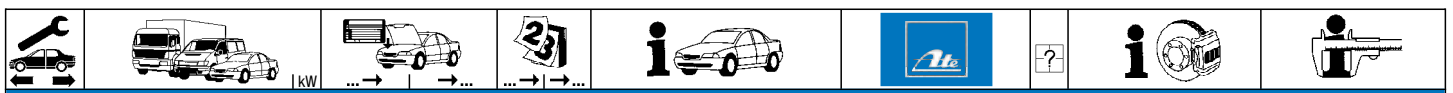

| NISSAN TERRANO II (R20) (93-06) |             |     |  |       |       |  |  |                |        |          |
|---------------------------------|-------------|-----|--|-------|-------|--|--|----------------|--------|----------|
|                                 | 2.4 i 4WD   | 91  |  | 02.93 | 04.96 | + 2 türg <sup>1)</sup>                           |  | 24.3222-1717.3 | 020443 | Rz 22,20 |
|                                 | 2.7 TD 4WD  | 74  |  | 02.93 | 04.96 | + 2 türg <sup>1)</sup>                           |  |                |        |          |
|                                 | 2.4 i 4WD   | 87  |  | 05.96 | 09.99 | + 2 türg <sup>1)</sup>                           |  | 24.3223-1709.3 | 020444 | Rz 23,81 |
|                                 | 2.4 i 4WD   | 91  |  | 02.93 | 04.96 | + 4 türg <sup>2)</sup>                           |  |                |        |          |
|                                 | 2.7 TD 4WD  | 74  |  | 02.93 | 04.96 | + 4 türg <sup>2)</sup>                           |  |                |        |          |
|                                 | 2.7 TD 4WD  | 74  |  | 05.96 | 09.99 | + 2 türg <sup>1)</sup>                           |  |                |        |          |
|                                 | 2.7 TDi 4WD | 92  |  | 05.96 | 09.99 | + 2 türg <sup>1)</sup>                           |  |                |        |          |
|                                 | 2.7 TDi 4WD | 92  |  | 05.96 | 09.99 | + 2 türg <sup>1)</sup>                           |  |                |        |          |
|                                 | 2.4 i 4WD   | 87  |  | 05.96 | 09.99 | + 4 türg <sup>2)</sup>                           |  | 24.3225-1703.3 | 020481 | Rz 25,40 |
|                                 | 2.7 TD 4WD  | 74  |  | 05.96 | 09.99 | + 4 türg <sup>2)</sup>                           |  |                |        |          |
|                                 | 2.7 TDi 4WD | 92  |  | 05.96 | 09.99 | + 4 türg <sup>2)</sup>                           |  |                |        |          |
|                                 | 2.4 i 4WD   | 87  |  | 10.99 | 01.02 | + ABS/ + 4 türg <sup>3)</sup>                    |  | 24.3222-1124.3 | 020344 | Rz 22,20 |
|                                 | 2.4 i 4WD   | 87  |  | 10.99 | 01.02 | - ABS/ + 2 türg <sup>4)</sup>                    |  |                |        |          |
|                                 | 2.7 TD 4WD  | 74  |  | 10.99 | 01.02 | + ABS/ + 4 türg <sup>3)</sup>                    |  |                |        |          |
|                                 | 2.7 TD 4WD  | 74  |  | 10.99 | 01.02 | - ABS/ + 2 türg <sup>4)</sup>                    |  |                |        |          |
|                                 | 2.7 TDi 4WD | 92  |  | 02.02 | 11.05 | + 2 türg <sup>1)</sup>                           |  |                |        |          |
|                                 | 2.7 TDi 4WD | 92  |  | 10.99 | 01.02 | - ABS/+ Automatikgetriebe/+ 4 türg <sup>5)</sup> |  |                |        |          |
|                                 | 2.7 TDi 4WD | 92  |  | 10.99 | 01.02 | + ABS/ + Schaltgetriebe/ + 4 türg <sup>6)</sup>  |  |                |        |          |
|                                 | 2.7 TDi 4WD | 92  |  | 10.99 | 01.02 | - ABS/ + Schaltgetriebe/ + 2 türg <sup>7)</sup>  |  |                |        |          |
|                                 | 3.0 Di 4WD  | 113 |  | 05.02 | 04.06 | + 2 türg <sup>1)</sup>                           |  |                |        |          |
|                                 | 3.0 Di 4WD  | 113 |  | 05.02 | 04.06 | + 2 türg <sup>1)</sup>                           |  |                |        |          |
|                                 | 2.4 i 4WD   | 87  |  | 10.99 | 01.02 | + ABS/ + 2 türg <sup>8)</sup>                    |  | 24.3220-1121.3 | 020343 | Rz 20,64 |
|                                 | 2.7 TD 4WD  | 74  |  | 10.99 | 01.02 | + ABS/ + 2 türg <sup>8)</sup>                    |  |                |        |          |
|                                 | 2.7 TDi 4WD | 92  |  | 10.99 | 01.02 | + Automatikgetriebe/ + 2 türg <sup>9)</sup>      |  |                |        |          |
|                                 | 2.7 TDi 4WD | 92  |  | 10.99 | 01.02 | + ABS/ + Schaltgetriebe/ + 2 türg <sup>10)</sup> |  |                |        |          |
|                                 | 2.4 i 4WD   | 87  |  | 02.02 | 11.05 | + 4 türg <sup>2)</sup>                           |  | 24.3223-1706.3 | 020479 | Rz 23,81 |
|                                 | 2.4 i 4WD   | 87  |  | 10.99 | 01.02 | - ABS/ + 4 türg <sup>11)</sup>                   |  |                |        |          |
|                                 | 2.7 TD 4WD  | 74  |  | 10.99 | 01.02 | - ABS/ + 4 türg <sup>11)</sup>                   |  |                |        |          |
|                                 | 2.7 TDi 4WD | 92  |  | 02.02 | 11.05 | + 4 türg <sup>2)</sup>                           |  |                |        |          |
|                                 | 2.7 TDi 4WD | 92  |  | 10.99 | 01.02 | - ABS/ + Schaltgetriebe/ + 4 türg                |  |                |        |          |
|                                 | 3.0 Di 4WD  | 113 |  | 05.02 | 04.06 | + 4 türg <sup>2)</sup>                           |  |                |        |          |

| NISSAN VANETTE (C220) (87-95) |       |  |  |       |       |  |  |                |        |          |
|-------------------------------|-------|--|--|-------|-------|--|--|----------------|--------|----------|
|                               | 1.5   |  |  | 04.87 | 01.95 |  |  | 24.3220-1703.3 | 020391 | Rz 20,64 |
|                               | 2.0 D |  |  | 04.87 | 01.95 |  |  |                |        |          |

| NISSAN X-TRAIL (T30) (01-07) |               |     |  |       |       |  |  |                |        |          |
|------------------------------|---------------|-----|--|-------|-------|--|--|----------------|--------|----------|
|                              | 2.0 i 16V     | 103 |  | 07.01 | 02.07 |  |  | 24.5290-0505.3 | 331083 | L=505    |
|                              | 2.0 i 16V     | 110 |  | 09.01 | 02.07 |  |  | 24.5290-0502.3 | 331164 | L=502    |
|                              | 2.0 i 16V 4x4 | 103 |  | 07.01 | 02.07 |  |  |                |        |          |
|                              | 2.0 i 16V 4x4 | 110 |  | 09.01 | 02.07 |  |  |                |        |          |
|                              | 2.2 DCi       | 84  |  | 10.04 | 02.07 |  |  |                |        |          |
|                              | 2.2 dCi       | 100 |  | 12.03 | 02.07 |  |  |                |        |          |
|                              | 2.2 dCi 4x4   | 100 |  | 12.03 | 02.07 |  |  |                |        |          |
|                              | 2.2 DCi FWD   | 84  |  | 07.01 | 09.03 |  |  |                |        |          |
|                              | 2.2 Di 4x4    | 84  |  | 07.01 | 09.03 |  |  |                |        |          |
|                              | 2.5 i 16V 4x4 | 121 |  | 01.03 | 02.07 |  |  |                |        |          |
|                              | 2.5 i 16V 4x4 | 132 |  | 11.02 | 02.07 |  |  |                |        |          |
|                              | 2.5 i 16V 4x4 | 134 |  | 09.01 | 02.07 |  |  |                |        |          |
|                              | 2.5 i 16V FWD | 131 |  | 11.02 | 02.07 |  |  |                |        |          |
|                              | 2.0 i 16V     | 103 |  | 07.01 | 02.07 |  |  | 24.5290-0486.3 | 331178 | L=485    |
|                              | 2.0 i 16V     | 110 |  | 09.01 | 02.07 |  |  | 24.5290-0485.3 | 331082 | L=485    |
|                              | 2.0 i 16V 4x4 | 103 |  | 07.01 | 02.07 |  |  |                |        |          |
|                              | 2.0 i 16V 4x4 | 110 |  | 09.01 | 02.07 |  |  |                |        |          |
|                              | 2.2 DCi       | 84  |  | 10.04 | 02.07 |  |  |                |        |          |
|                              | 2.2 dCi       | 100 |  | 12.03 | 02.07 |  |  |                |        |          |
|                              | 2.2 dCi 4x4   | 100 |  | 12.03 | 02.07 |  |  |                |        |          |
|                              | 2.2 DCi FWD   | 84  |  | 07.01 | 09.03 |  |  |                |        |          |
|                              | 2.2 Di 4x4    | 84  |  | 07.01 | 09.03 |  |  |                |        |          |
|                              | 2.5 i 16V 4x4 | 121 |  | 01.03 | 02.07 |  |  |                |        |          |
|                              | 2.5 i 16V 4x4 | 132 |  | 11.02 | 02.07 |  |  |                |        |          |
|                              | 2.5 i 16V 4x4 | 134 |  | 09.01 | 02.07 |  |  |                |        |          |
|                              | 2.5 i 16V FWD | 131 |  | 11.02 | 02.07 |  |  |                |        |          |
|                              | 2.2 dCi       | 100 |  | 12.03 | 02.07 |  |  | 24.2519-1704.3 | 040092 | Nz 19,05 |
|                              | 2.2 dCi 4x4   | 100 |  | 12.03 | 02.07 |  |  |                |        |          |
|                              | 2.2 DCi FWD   | 84  |  | 07.01 | 09.03 |  |  |                |        |          |
|                              | 2.2 Di 4x4    | 84  |  | 07.01 | 09.03 |  |  |                |        |          |

| OPEL ADAM / Vauxhall Adam (13-) |             |    |  |       |  |  |  |                |        |                    |
|---------------------------------|-------------|----|--|-------|--|--|--|----------------|--------|--------------------|
|                                 | 1.0         | 50 |  | 07.13 |  |  |  | 24.3541-1769.7 | 220707 | D=54, - Halter BOS |
|                                 | 1.2         | 69 |  | 07.13 |  |  |  | 24.3541-1770.7 | 220708 | D=54, - Halter BOS |
|                                 | 1.2 ecoFLEX | 51 |  | 01.13 |  |  |  |                |        |                    |
|                                 | 1.4 ecoFLEX | 64 |  | 01.13 |  |  |  |                |        |                    |
|                                 | 1.4 ecoFLEX | 74 |  | 01.13 |  |  |  |                |        |                    |
|                                 | 1.4 LPG     | 64 |  | 07.13 |  |  |  |                |        |                    |
|                                 | 1.0         | 50 |  | 07.13 |  |  |  | 24.3219-1755.3 | 020508 | Rz 19,05           |
|                                 | 1.2         | 69 |  | 07.13 |  |  |  |                |        |                    |
|                                 | 1.2 ecoFLEX | 51 |  | 01.13 |  |  |  |                |        |                    |
|                                 | 1.4 ecoFLEX | 64 |  | 01.13 |  |  |  |                |        |                    |
|                                 | 1.4 ecoFLEX | 74 |  | 01.13 |  |  |  |                |        |                    |
|                                 | 1.4 LPG     | 64 |  | 07.13 |  |  |  |                |        |                    |













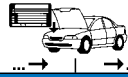













<sup>1)</sup> + 2 door / + 2 porte / + 2 portes / + 2 puertas  
<sup>2)</sup> + 4 door / + 4 porte / + 4 portes / + 4 puertas  
<sup>3)</sup> + ABS/ + 4 door / + ABS/ + 4 porte / + ABS/ + 4 portes / + ABS/ + 4 puertas  
<sup>4)</sup> - ABS/ + 2 door / - ABS/ + 2 porte / - ABS/ + 2 portes / - ABS/ + 2 puertas  
<sup>5)</sup> - ABS/+ autom.transm./+ 4 door / - ABS/+ scatola cambio autom./+ 4 porte / - ABS/+ transmission autom./+ 4 portes / - ABS/+ cambio autom./+ 4 puertas  
<sup>6)</sup> + ABS/ + manual transm./+ 4 door / + ABS/+ scatola camb.velocità/+ 4 porte / + ABS/ + transmiss.mécanique/ + 4 portes / + ABS/ + cambio velocidad/+ 4 puertas  
<sup>7)</sup> - ABS/ + manual transm./+ 2 door / - ABS/+ sc.camb.velocità/+ 2 porte / - ABS/ + transmiss.mécanique/ + 2 portes / - ABS/ + cambio velocidad/+ 2 puertas  
<sup>8)</sup> + ABS/ + 2 door / + ABS/ + 2 porte / + ABS/ + 2 portes / + ABS/ + 2 portes / + ABS/ + 2 portes  
<sup>9)</sup> + autom.transm./ + 2 door / + scatola camb.autom./ + 2 porte / + transmission automatique/ + 2 portes / + cambio automático/ + 2 puertas  
<sup>10)</sup> + ABS/ + manual transm./+ 2 door / + ABS/+ scatola camb.velocità/+ 2 porte / + ABS/ + transmiss.mécanique/ + 2 portes / + ABS/ + cambio velocidad/+ 2 puertas  
<sup>11)</sup> - ABS/ + 4 door / - ABS/ + 4 porte / - ABS/ + 4 portes / - ABS/ + 4 puertas





| OPEL AGILA / Vauxhall Agila Mk I (00-07)    |   |        |          |       |       |  |                |                |                          |   |
|---|---|--------|----------|-------|-------|--|----------------|----------------|--------------------------|---|
|   | 1.0                                     | 44     |          | 08.03 | 07.07 | - ABS                                    | 24.2120-1731.3 | 010667         |                          | Thz 20,64   |
|   | 1.0 12V                                 | 43     |          | 09.00 | 07.07 | - ABS                                    |                |                |                          |   |
|   | 1.2 16V                                 | 55     |          | 09.00 | 07.07 | - ABS                                    |                |                |                          |   |
|   | 1.3 CDTI                                | 51     |          | 08.03 | 07.07 | - ABS                                    |                |                |                          |   |
|   | 1.0                                     | 44     |          | 08.03 | 07.07 | + ABS                                    | 24.2120-1730.3 | 010678         |                          | Thz 20,64   |
|   | 1.0 12V                                 | 43     |          | 09.00 | 07.07 | + ABS                                    |                |                |                          |   |
|   | 1.2 16V                                 | 55     |          | 09.00 | 07.07 | + ABS                                    |                |                |                          |   |
|   | 1.3 CDTI                                | 51     |          | 08.03 | 07.07 | + ABS                                    |                |                |                          |   |
|   | 1.0                                     | 44     | 3G002367 | 08.03 |       |  | 24.3481-1757.5 | 240325         | <input type="checkbox"/> | D=48, - Halter <b>BOS</b>   |
|   | 1.0 12V                                 | 43     | 3G002367 | 09.00 |       |  | 24.3481-1758.5 | 240326         | <input type="checkbox"/> | D=48, - Halter <b>BOS</b>   |
|   | 1.2 16V                                 | 55     | 3G002367 | 09.00 |       |  |                |                |                          |   |
|   | 1.2 16V Twinport                        | 59     | 3G002367 | 07.04 |       |  |                |                |                          |   |
|   | 1.3 CDTI                                | 51     | 3G002367 | 08.03 |       |  |                |                |                          |   |
|   | 1.0                                     | 44     |          | 08.03 | 07.07 |  | 24.5247-0280.3 | 330700         | 2                        | L=280   |
|   | 1.0 12V                                 | 43     |          | 09.00 | 07.07 |  |                |                |                          |   |
|   | 1.2 16V                                 | 55     |          | 09.00 | 07.07 |  |                |                |                          |   |
|   | 1.2 16V Twinport                        | 59     |          | 07.04 | 07.07 |  |                |                |                          |   |
|   | 1.3 CDTI                                | 51     |          | 08.03 | 07.07 |  |                |                |                          |   |
|   | 1.0                                     | 44     |          | 08.03 | 07.07 |  | 24.3215-1701.3 | 020493         |                          | Rz 15,87  |
|   | 1.0 12V                                 | 43     |          | 09.00 | 07.07 |  |                |                |                          |   |
|   | 1.2 16V                                 | 55     |          | 09.00 | 07.07 |  |                |                |                          |   |
|   | 1.2 16V Twinport                        | 59     |          | 07.04 | 07.07 |  |                |                |                          |   |
|   | 1.3 CDTI                                | 51     |          | 08.03 | 07.07 |  |                |                |                          |   |
|   | 1.0 12V                                 | 43     | 1G075421 | 09.00 |       |  | 24.3727-0771.2 | 580771         | <input type="checkbox"/> | L=1516, + Zub   |
|   | 1.2 16V                                 | 55     | 1G075421 | 09.00 |       |  | 24.3727-0774.2 | 580774         | <input type="checkbox"/> | L=1507, + Zub   |
|   | 1.0 12V                                 | 43     | 1G075422 |       |       |  | 24.3727-0771.2 | 580771         | <input type="checkbox"/> | L=1516, + Zub   |
|   | 1.2 16V                                 | 55     | 1G075422 |       |       |  | 24.3727-0772.2 | 580772         | <input type="checkbox"/> | L=1498  |
|   | 1.0                                     | 44     |          | 08.03 | 07.07 |  | 24.3727-0777.2 | 580777         | <input type="checkbox"/> | L=1536, + Zub   |
|   | 1.0 12V                                 | 43     | 3G000001 |       | 07.07 |  | 24.3727-0778.2 | 580778         | <input type="checkbox"/> | L=1530, + Zub   |
|   | 1.2 16V                                 | 55     | 3G000001 |       | 07.07 |  |                |                |                          |   |
|   | 1.2 16V Twinport                        | 59     |          | 07.04 | 07.07 |  |                |                |                          |   |
|   | 1.3 CDTI                                | 51     |          | 08.03 | 07.07 |  |                |                |                          |   |
|   | 1.0 12V                                 | 43     | YG057598 | 09.00 |       |  | 24.3728-0727.2 | 590727         |                          | L=690   |
|   | 1.0                                     | 44     |          | 08.03 | 07.07 |  | 24.3728-0727.2 | 590727         |                          | L=690   |
|   | 1.0 12V                                 | 43     | YG057599 |       | 07.07 |  |                |                |                          |   |
|   | 1.2 16V                                 | 55     | YG057523 |       | 07.07 |  | 24.3728-0725.2 | 590725         |                          | L=675   |
|   | 1.3 CDTI                                | 51     |          | 08.03 | 07.07 |  |                |                |                          |   |
|   | OPEL AGILA / Vauxhall Agila Mk II (08-) |        |          |       |       |  |                |                |                          |   |
|   | 1.0                                     | 48     |          | 01.08 |       |  | 24.3219-1756.3 | 020511         |                          | Rz 19,05 <b>BOS</b>   |
|   | 1.0                                     | 50     |          | 07.11 |       |  |                |                |                          |   |
|   | 1.2                                     | 63     |          | 01.08 |       |  |                |                |                          |   |
|   | 1.2                                     | 69     |          | 11.10 |       |  |                |                |                          |   |
|   | 1.3 CDTI                                | 55     |          | 01.08 |       |  |                |                |                          |   |
|   | 1.0                                     | 48     |          | 01.08 |       |  | 24.3727-0793.2 | 580793         | <input type="checkbox"/> | L=1600  |
|   | 1.0                                     | 50     |          | 07.11 |       |  | 24.3727-0792.2 | 580792         | <input type="checkbox"/> | L=1600  |
|   | 1.2                                     | 63     |          | 01.08 |       |  |                |                |                          |   |
|   | 1.2                                     | 69     |          | 11.10 |       |  |                |                |                          |   |
|   | 1.3 CDTI                                | 55     |          | 01.08 |       |  |                |                |                          |   |
|   | 1.0                                     | 48     | AM999999 | 01.08 |       |  | 24.3728-0728.2 | 590728         |                          | L=716   |
|   | 1.0                                     | 50     | AM999999 | 07.11 |       |  |                |                |                          |   |
|   | 1.2                                     | 63     | AM999999 | 01.08 |       |  |                |                |                          |   |
|   | 1.2                                     | 69     | AM999999 | 11.10 |       |  |                |                |                          |   |
|   | OPEL AMPERA / Vauxhall Ampera (11-)     |        |          |       |       |  |                |                |                          |   |
|   |   | EV 150 | 111      |       | 11.11 |  |                | 11.9601-2601.2 | 220913                   | <input type="checkbox"/>  |
|   |   |        |          |       |       |  | 11.9601-2602.2 | 220914         | <input type="checkbox"/> | D=60, - Halter <b>ATE</b>   |
|   | EV 150                                  | 111    |          | 11.11 |       |  | 11.9382-7001.2 | 220889         | <input type="checkbox"/> | elektrische Feststellbremse <sup>1)</sup> D=38, - Halter <b>ATE</b> |
|   |   |        |          |       |       |  | 11.9382-7002.2 | 220890         | <input type="checkbox"/> | elektrische Feststellbremse <sup>1)</sup> D=38, - Halter <b>ATE</b> |
| OPEL ARENA / Vauxhall Arena (97-01)         |   |        |          |       |       |  |                |                |                          |   |
|   | 1.9 D                                   |        |          | 03.98 | 09.01 | - ABS                                    | 24.3223-1106.3 | 020317         |                          | Rz 23,81 <b>BDX</b>   |
|   | 1.9 D                                   |        |          | 03.98 | 09.01 | + ABS                                    | 24.3225-1601.3 | 020359         |                          | Rz 25,40 <b>LUC</b>   |
|   | 2.5 D                                   |        |          | 03.98 | 09.01 |  |                |                |                          |   |
| OPEL ASTRA F / Vauxhall Astra MKIII (91-01) |   |        |          |       |       |  |                |                |                          |   |
|   | 1.4 N                                   |        |          | 10.91 | 09.98 | - ABS                                    | 24.2120-0702.3 | 010361         |                          | Kennzeichen: EB/nicht für Delco BKV <sup>2)</sup> Thz 20,64         |
|   | 1.4 S                                   |        |          | 10.91 | 09.98 | - ABS/ - verstärkte Bremse <sup>3)</sup> |                |                |                          |   |
|   | 1.6                                     | 52     |          | 10.91 | 09.98 | - ABS                                    |                |                |                          |   |
|   | 1.7 D                                   |        |          | 10.91 | 09.98 | - ABS/ - verstärkte Bremse <sup>3)</sup> |                |                |                          |   |
|   | 1.7 TD                                  |        |          | 10.91 | 09.98 | - ABS                                    |                |                |                          |   |
|   | 1.8                                     | 66     |          | 10.91 | 09.98 | - ABS                                    |                |                |                          |   |
|   | 1.4 S                                   |        |          | 10.91 | 09.98 | - ABS/ + verstärkte Bremse <sup>4)</sup> | 03.2122-0264.3 | 010129         |                          | Thz 22,20 <b>ATE</b>  |
|   | 1.6 16V                                 |        |          | 02.93 | 09.98 | - ABS                                    | 24.2122-1739.3 | 010710         | <input type="checkbox"/> | Thz 22,20 <b>DEL</b>  |
|   | 1.6 S                                   |        |          | 10.91 | 09.98 | - ABS                                    |                |                |                          |   |
|   | 1.7 D                                   |        |          | 10.91 | 09.98 | - ABS/ + verstärkte Bremse <sup>4)</sup> |                |                |                          |   |
|   | 1.8 16V                                 |        |          | 10.91 | 09.98 | - ABS                                    |                |                |                          |   |
|   | 2.0                                     | 85     |          | 10.91 | 09.98 | - ABS                                    |                |                |                          |   |
|   | 1.4                                     |        |          | 10.91 | 09.98 | + ABS                                    | 03.2122-0282.3 | 010130         |                          | Thz 22,20 <b>ATE</b>  |
|   | 1.6                                     |        |          | 10.91 | 09.98 | + ABS                                    |                |                |                          |   |
|   | 1.6 16V                                 |        |          | 02.93 | 09.98 | + ABS                                    |                |                |                          |   |
|   | 1.6 S                                   |        |          | 10.91 | 09.98 | + ABS                                    |                |                |                          |   |

<sup>1)</sup> electric parking brake / fr.di stazionamento elettrico / frein à main électrique / freno de mano eléctrico  
<sup>2)</sup> registration no.: EB/not for Delco BKV / targa: EB/non per Delco BKV / indice: EB/sans pour Delco BKV / distiativo: EB/no para Delco BKV  
<sup>3)</sup> - ABS/ - heavy duty brake / - ABS/ - freno rinforzato / - ABS/ - frein renforcé / - ABS/ - freno reforzado  
<sup>4)</sup> - ABS/ + heavy duty brake / - ABS/ + freno rinforzato / - ABS/ + frein renforcé / - ABS/ + freno reforzado  
<sup>5)</sup> registration number: EK / targa: EK / indice: EK / distiativo: EK

|     |    |  |    |    |                         |  |    |   |
|--|--|--|--|--|--|--|--|---|
| <b>OPEL ASTRA F / Vauxhall Astra MKIII (91-01)</b>                                 |  |  |  |  |  |  |  |   |
|    | 1.7 D<br>1.7 TD<br>1.8<br>1.8 16V<br>2.0<br>2.0 GSi<br>2.0 GSi 16V   |  |  | 10.91 09.98 + ABS<br>10.91 09.98 + ABS<br>10.91 09.98 + ABS<br>10.91 09.98 + ABS<br>10.91 09.98 + ABS<br>10.91 09.98 + ABS   | 03.2122-0282.3   | 010130   |  | Thz 22,20<br>ATE  |
|    | 1.4 N<br>1.4 S<br>1.6 N Limousine  |  |  | 10.91 09.98<br>10.91 09.98 - verstärkte Br./+ Schaltgetr. 1)<br>10.91 09.98 + Schaltgetriebe 2)  | 24.3481-1733.5<br>24.3481-1734.5<br>11.0441-4811.2<br>11.0101-5407.2<br>11.8171-0008.1<br>11.8116-0129.1 | 240213<br>240214<br>250024<br>260011<br>990049<br>390591                           | <br>   | D=48, - Halter<br>D=48, - Halter<br>Dichtungssatz<br>Hülensatz<br>Führungsbolzen<br>Haltefeder<br>ATE<br>ATE<br>ATE<br>ATE<br>ATE |
|  | 1.4 Cabrio<br>1.4 S<br>1.6 Cabrio<br>1.6 N Caravan<br>1.6 N Limousine<br>1.6 S<br>1.6 Si<br>1.7 D<br>1.7 TD  |  |  | 10.91 03.01<br>10.91 09.98 - verstärkte Br./+ Automatikg. 3)<br>10.91 03.01<br>10.91 09.98<br>10.91 09.98 + Automatikgetriebe 4)<br>10.91 09.98<br>03.92 12.94<br>10.91 09.98 - verstärkte Bremse 5)<br>10.91 09.98 - verstärkte Bremse 5) | 11.9481-9871.2<br>11.9481-9872.2<br>11.0441-4811.2<br>11.0101-5407.2<br>11.8171-0008.1<br>11.8116-0129.1 | 220681<br>220682<br>250024<br>260011<br>990049<br>390591                           | <br>   | D=48, - Halter<br>D=48, - Halter<br>Dichtungssatz<br>Hülensatz<br>Führungsbolzen<br>Haltefeder<br>ATE<br>ATE<br>ATE<br>ATE<br>ATE |
|  | 1.8  | 66   |  | 10.91 09.98  | 11.9481-9871.2<br>11.9481-9872.2<br>11.0441-4811.2<br>11.0101-5407.2<br>11.8171-0008.1<br>11.8116-0129.1 | 220681<br>220682<br>250024<br>260011<br>990049<br>390591                           | <br>   | D=48, - Halter<br>D=48, - Halter<br>Dichtungssatz<br>Hülensatz<br>Führungsbolzen<br>Haltefeder<br>ATE<br>ATE<br>ATE<br>ATE        |
|  | 1.4 S<br>1.6<br>1.6 16V<br>1.7 D<br>1.7 TD<br>1.8 16V<br>1.8 Cabrio<br>2.0<br>2.0 Cabrio<br>2.0 GSi<br>2.0 GSi 16V   |  |  | 10.91 09.98 + verstärkte Bremse 6)<br>10.91 09.98<br>02.93 09.98<br>10.91 09.98 + verstärkte Bremse 6)<br>10.91 09.98 + verstärkte Bremse 6)<br>10.91 09.98<br>10.91 03.01<br>10.91 09.98<br>10.91 10.94<br>10.91 09.98<br>10.91 09.98     | 24.3521-1701.5<br>24.3521-1702.5<br>11.0441-5202.2<br>11.0101-5407.2<br>11.8171-0008.1<br>11.8116-0097.1 | 240001<br>240002<br>250026<br>260011<br>990049<br>390590                           | <br>   | D=52, - Halter<br>D=52, - Halter<br>Dichtungssatz<br>Hülensatz<br>Führungsbolzen<br>Haltefeder<br>ATE<br>ATE<br>ATE<br>ATE<br>ATE |
|   | 1.4<br>1.6<br>1.6 16V<br>1.6 S<br>1.7 D<br>1.7 TD<br>1.8<br>1.8 16V<br>2.0<br>2.0 GSi<br>2.0 GSi 16V   |  |  | 10.91 09.98<br>10.91 09.98<br>02.93 09.98<br>10.91 09.98<br>10.91 09.98<br>10.91 09.98<br>10.91 09.98<br>10.91 09.98<br>10.91 09.98<br>10.91 09.98<br>10.91 09.98  | 83.7288-0318.3<br>24.5298-0322.3   | 330375<br>331314   | 2<br>2   | L=315<br>L=322  |
|  | 1.8 16V<br>2.0 GSi<br>2.0 GSi 16V  |  |  | 10.91 09.98<br>10.91 09.98<br>10.91 09.98  | 13.2351-0013.2<br>13.2351-0014.2<br>24.9235-0013.5<br>24.9235-0014.5<br>13.0441-3506.2                   | 210010<br>210011<br>230001<br>230002<br>250052                                     | <br><br><br> | D=35<br>D=35<br>D=35<br>D=35<br>Dichtungssatz<br>ATE<br>ATE<br>ATE<br>ATE   |
|  | 1.4 Limousine<br>1.6 16V Limousine<br>1.6 Limousine<br>1.6 S Limousine<br>1.7 D Limousine<br>1.7 TD Limousine<br>1.8 16V<br>1.8 Limousine<br>2.0 GSi<br>2.0 GSi 16V<br>2.0 Limousine                             |  |  | 10.91 09.98<br>02.93 09.98<br>10.91 09.98<br>10.91 09.98<br>10.91 09.98<br>10.91 09.98<br>10.91 09.98<br>10.91 09.98<br>10.91 09.98<br>10.91 09.98<br>10.91 09.98  | 24.5117-0195.3   | 330565   | 2  | L=198   |
|  | 1.4 Caravan<br>1.6 Caravan<br>1.6 S Caravan<br>1.7 D Caravan<br>1.7 TD Caravan<br>1.8 Caravan<br>2.0 Caravan   |  |  | 10.91 09.98<br>10.91 09.98<br>03.92 09.98<br>10.91 09.98<br>10.91 09.98<br>10.91 09.98<br>10.91 09.98  | 24.5233-0200.3   | 330425   | 2  | L=198   |
|  | 1.4 Cabrio<br>1.4 N Limousine<br>1.4 S Limousine<br>1.6<br>1.6 16V Limousine<br>1.6 Cabrio<br>1.6 Limousine<br>1.7 D Limousine<br>1.7 TD Limousine<br>1.8 Cabrio<br>1.8 Limousine<br>2.0 Cabrio<br>2.0 Limousine | 52   | R2500000<br>R2500000<br>R2500000<br>R2500000<br>R2500000<br>R2500000<br>R2500000<br>R2500000<br>R2500000<br>R2500000<br>R2500000<br>R2500000 | 10.91<br>10.91<br>10.91<br>05.93<br>02.93<br>10.91<br>10.91<br>10.91<br>10.91<br>10.91<br>10.91<br>10.91<br>10.91  | 03.3217-3512.3   | 020032   |  | Rz 17,46<br>LUC   |
|  |  | 66   |  | - verstärkte Bremse 5)   |  |  |  |   |
|  |  | 85   |  |  |  |  |  |   |

1) - heavy duty br./+ manual trans. / - fr.rinforzato/+ scatola camb.velocità / - frein renforcé/ + transm.mécanique / - freno reforzado/ + camb.velocidad  
2) + manual transmission / + scatola cambio velocità / + transmission mécanique / + cambio de velocidad  
3) - heavy duty br./+ autom.trans. / - fr.rinforzato/+ scatola cambio autom. / - frein renforcé/ + transm.automatique / - freno reforzado/ + camb.automático  
4) + autom.transmission / + scatola cambio automatico / + transmission automatique / + cambio automático  
5) - heavy duty brake / - freno rinforzato / - frein renforcé / - freno reforzado  
6) + heavy duty brake / + freno rinforzato / + frein renforcé / + freno reforzado



**OPEL ASTRA F / Vauxhall Astra MKIII (91-01)**

|                  |                   |             |          |       |                                   |                                  |                  |  |                                 |            |             |
|------------------|-------------------|-------------|----------|-------|-----------------------------------|----------------------------------|------------------|--|---------------------------------|------------|-------------|
|                  | 1.4 Cabrio        | R2500001    |          | 10.91 | 03.01<br>09.98                    | 03.3219-6311.3<br>24.3219-1715.3 | 020057<br>020122 | + GG <sup>1)</sup><br>+ ALU <sup>2)</sup>                              | Rz 19,05 (GG)<br>Rz 19,05 (ALU) | <b>LUC</b> |             |
|                  | 1.4 Caravan       |             |          |       | 09.98                             |                                  |                  |  |                                 |            |             |
|                  | 1.4 N Limousine   | R2500001    |          | 10.91 | 09.98                             |                                  |                  |  |                                 |            |             |
|                  | 1.4 S Limousine   |             |          |       | 09.98                             |                                  |                  |  |                                 |            |             |
|                  | 1.4 S Limousine   | R2500001    |          |       | 09.98                             |                                  |                  | + verstärkte Bremse <sup>3)</sup><br>- verstärkte Bremse <sup>4)</sup> |                                 |            |             |
|                  | 1.6               | 52 R2500001 |          |       | 07.96                             |                                  |                  |  |                                 |            |             |
|                  | 1.6 16V Limousine | R2500001    |          |       | 09.98                             |                                  |                  |  |                                 |            |             |
|                  | 1.6 Cabrio        | R2500001    |          | 10.91 | 09.98                             |                                  |                  |  |                                 |            |             |
|                  | 1.6 Caravan       |             |          |       | 09.98                             |                                  |                  |  |                                 |            |             |
|                  | 1.6 Limousine     | R2500001    |          |       | 09.98                             |                                  |                  |  |                                 |            |             |
|                  | 1.7 D Caravan     |             |          | 10.91 | 09.98                             |                                  |                  |  |                                 |            |             |
|                  | 1.7 D Limousine   | R2500001    |          |       | 09.98                             |                                  |                  |  |                                 |            |             |
|                  | 1.7 TD Caravan    |             |          | 10.91 | 09.98                             |                                  |                  |  |                                 |            |             |
|                  | 1.7 TD Limousine  | R2500001    |          |       | 09.98                             |                                  |                  |  |                                 |            |             |
|                  | 1.8 16V Cabrio    | 85          |          |       | 11.94                             | 03.01                            |                  |  |                                 |            |             |
|                  | 1.8 16V Caravan   | 85          |          |       | 07.94                             | 01.98                            |                  |  |                                 |            |             |
|                  | 1.8 16V Limousine | 85          |          |       | 11.94                             | 09.98                            |                  |  |                                 |            |             |
|                  | 1.8 Cabrio        | R2500001    |          |       | 03.01                             |                                  |                  |  |                                 |            |             |
|                  | 1.8 Caravan       |             |          | 10.91 | 09.98                             |                                  |                  |  |                                 |            |             |
|                  | 1.8 Limousine     | 66 R2500001 |          |       | 09.98                             |                                  |                  |  |                                 |            |             |
| 2.0 Cabrio       | R2500001          |             |          | 10.94 |                                   |                                  |                  |  |                                 |            |             |
| 2.0 Caravan      |                   |             | 10.91    | 09.98 |                                   |                                  |                  |  |                                 |            |             |
| 2.0 Limousine    | 85 R2500001       |             |          | 09.98 |                                   |                                  |                  |  |                                 |            |             |
|                  | 1.4 Limousine     |             |          | 10.91 | 09.98                             | 24.3727-0735.2                   | 580735           | 1  | L=1274/1689, + Zub              |            |             |
|                  | 1.6 16V Limousine |             |          | 02.93 | 09.98                             |                                  |                  |  |                                 |            |             |
|                  | 1.6 Limousine     |             |          | 10.91 | 09.98                             |                                  |                  |  |                                 |            |             |
|                  | 1.6 S Limousine   |             |          | 10.91 | 09.98                             |                                  |                  |  |                                 |            |             |
|                  | 1.7 D Limousine   |             |          | 10.91 | 09.98                             |                                  |                  |  |                                 |            |             |
|                  | 1.7 TD Limousine  |             |          | 10.91 | 09.98                             |                                  |                  |  |                                 |            |             |
|                  | 1.8 Limousine     |             |          | 10.91 | 09.98                             |                                  |                  |  |                                 |            |             |
|                  | 2.0 Limousine     |             |          | 10.91 | 09.98                             |                                  |                  |  |                                 |            |             |
|                  | 1.4 Caravan       |             |          | 10.91 | 09.98                             | 24.3727-0732.2                   | 580732           | 1  | L=1288/1398, + Zub              |            |             |
|                  | 1.6 Caravan       |             |          | 10.91 | 09.98                             |                                  |                  |  |                                 |            |             |
|                  | 1.6 S Caravan     |             |          | 03.92 | 09.98                             |                                  |                  |  |                                 |            |             |
|                  | 1.7 D Caravan     |             |          | 10.91 | 09.98                             |                                  |                  |  |                                 |            |             |
| 1.7 TD Caravan   |                   |             | 10.91    | 09.98 |                                   |                                  |                  |  |                                 |            |             |
| 1.8 Caravan      |                   |             | 10.91    | 09.98 |                                   |                                  |                  |  |                                 |            |             |
| 2.0 Caravan      | R8999999          |             | 10.91    | 09.98 |                                   |                                  |                  |  |                                 |            |             |
| 1.8 16V          |                   |             | 10.91    | 09.98 | 24.3727-0742.2                    | 580742                           | 1                | L=1175/1575, + Zub   |                                 |            |             |
| 2.0 GSi          |                   |             | 10.91    | 09.98 |                                   |                                  |                  |  |                                 |            |             |
| 2.0 GSi 16V      |                   |             | 10.91    | 09.98 |                                   |                                  |                  |  |                                 |            |             |
|                  | 1.4 N Limousine   |             | R2500000 | 10.91 | 09.98                             | 03.0101-0027.2                   | 320022           |  | BRES 3/45                       | <b>ATE</b> |             |
|                  | 1.4 S Limousine   |             | R2500000 | 10.91 | 09.98                             |                                  |                  |  |                                 |            |             |
|                  | 1.6 Cabrio        |             | R2500000 | 10.91 | 09.98                             |                                  |                  |  | + Schaltgetriebe <sup>5)</sup>  |            |             |
|                  | 1.6 N Limousine   |             | R2500000 | 10.91 | 09.98                             |                                  |                  |  |                                 |            |             |
|                  | 1.8 Limousine     | 66          |          | 10.91 | 07.93                             |                                  |                  |  |                                 |            |             |
|                  | 2.0 Limousine     | 85          |          | 10.91 | 07.93                             |                                  |                  |  |                                 |            |             |
|                  | 1.6 S Limousine   |             |          | 10.91 | 07.93                             | 03.0101-0026.2                   | 320230           |  | BRES 3/40                       |            |             |
|                  | 1.7 D Limousine   |             |          | 10.91 | 07.93                             |                                  |                  |  |                                 |            |             |
|                  | 1.6 Cabrio        | T2526384    |          |       | 03.01                             | 09.98                            | 03.0101-0031.2   | 320211   |                                 |            | BRES 3/30   |
|                  | 1.6 N Limousine   | T2526384    |          |       | 09.98                             |                                  |                  |  |                                 |            |             |
|                  | 1.7 D Limousine   |             |          | 08.93 | 09.98                             |                                  |                  |  |                                 |            |             |
|                  | 1.6 16V Limousine |             |          | 02.93 | 09.98                             | - (cc)                           | 03.6583-0054.3   | 320146   |                                 |            | BRL 8/3 (4) |
|                  | 1.6 S Limousine   |             |          | 08.93 | 09.98                             |                                  |                  |  |                                 |            |             |
|                  | 1.8 Limousine     |             |          | 08.93 | 09.98                             |                                  |                  |  |                                 |            |             |
|                  | 2.0 GSi 16V       |             |          | 08.92 | 09.98                             |                                  |                  |  |                                 |            |             |
|                  | 2.0 Limousine     | 85          |          | 08.93 | 09.98                             |                                  |                  |  |                                 |            |             |
|                  | 1.6 16V Limousine |             |          | 02.93 | 09.98                             | + (cc)                           | 03.6585-0018.3   | 320114   |                                 |            | BRL 8/5 (4) |
|                  | 1.6 Cabrio        | R2500001    | T2526383 |       |                                   |                                  | 03.0101-0025.2   | 320014   |                                 |            | BRES 3/35   |
|                  | 1.6 N Limousine   | R2500001    | T2526383 |       |                                   |                                  |                  |  |                                 |            |             |
|                  | 1.7 TD Limousine  |             |          | 10.91 | 07.93                             |                                  |                  |  |                                 |            |             |
| 1.7 TD Limousine |                   |             | 08.93    | 09.98 | - verstärkte Bremse <sup>4)</sup> | 03.0101-0032.2                   | 320231           |  | BRES 3/25                       |            |             |
| 1.7 TD Limousine |                   |             | 08.93    | 09.98 | + verstärkte Bremse <sup>3)</sup> | 03.0101-0025.2                   | 320014           |  | BRES 3/35                       |            |             |
| 1.4 Caravan      |                   |             | 10.91    | 09.98 |                                   | 03.6565-0130.3                   | 320098           |  | BRL 6/5 (4)                     |            |             |
| 1.6 Caravan      |                   |             | 10.91    | 09.98 |                                   |                                  |                  |  |                                 |            |             |
| 1.7 D Caravan    |                   |             | 10.91    | 09.98 |                                   |                                  |                  |  |                                 |            |             |
| 1.7 TD Caravan   |                   |             | 10.91    | 09.98 |                                   |                                  |                  |  |                                 |            |             |
| 1.8 Caravan      |                   |             | 10.91    | 09.98 |                                   |                                  |                  |  |                                 |            |             |
| 2.0 Caravan      |                   |             | 10.91    | 09.98 |                                   |                                  |                  |  |                                 |            |             |
|                  | 1.4               | ↓           | S8999999 | 10.91 |                                   | 24.3728-0711.2                   | 590711           |  | L=815                           |            |             |
|                  | 1.6               | ↓           | S8999999 | 10.91 |                                   |                                  |                  |  |                                 |            |             |
|                  | 1.6 16V           | ↓           | S8999999 | 02.93 |                                   |                                  |                  |  |                                 |            |             |
|                  | 1.6 S             | ↓           | S8999999 | 10.91 |                                   |                                  |                  |  |                                 |            |             |
|                  | 1.7 D             | ↓           | S8999999 | 10.91 |                                   |                                  |                  |  |                                 |            |             |
|                  | 1.7 TD            | ↓           | S8999999 | 10.91 |                                   |                                  |                  |  |                                 |            |             |
|                  | 1.8               | ↓           | S8999999 | 10.91 |                                   |                                  |                  |  |                                 |            |             |
|                  | 1.8 16V           | ↓           | S8999999 | 10.91 |                                   |                                  |                  |  |                                 |            |             |
|                  | 2.0               | ↓           | S8999999 | 10.91 |                                   |                                  |                  |  |                                 |            |             |
|                  | 2.0 16V           | ↓           | S8999999 | 10.91 |                                   |                                  |                  |  |                                 |            |             |
|                  | 1.4               | ↓           | T2500001 |       | 09.98                             | - Klimaanlage <sup>6)</sup>      | 24.3728-0723.2   | 590723   |                                 | L=882      |             |
|                  | 1.6               | ↓           | T2500001 |       | 09.98                             | - Klimaanlage <sup>6)</sup>      |                  |  |                                 |            |             |
| 1.6 16V          | ↓                 | T2500001    |          | 09.98 | - Klimaanlage <sup>6)</sup>       |                                  |                  |  |                                 |            |             |
| 1.6 S            | ↓                 | T2500001    |          | 09.98 | - Klimaanlage <sup>6)</sup>       |                                  |                  |  |                                 |            |             |
| 1.7 D            | ↓                 | T2500001    |          | 09.98 |                                   |                                  |                  |  |                                 |            |             |
| 1.7 TD           | ↓                 | T2500001    |          | 09.98 |                                   |                                  |                  |  |                                 |            |             |

<sup>1)</sup> + cast iron / + ghisa / + fonte grise / + fundición de gris  
<sup>2)</sup> + aluminium / + alluminio / + aluminium / + aluminio  
<sup>3)</sup> + heavy duty brake / + freno rinforzato / + frein renforcé / + freno reforzado  
<sup>4)</sup> - heavy duty brake / - freno rinforzato / - frein renforcé / - freno reforzado  
<sup>5)</sup> + manual transmission / + scatola cambio velocità / + transmission mécanique / + cambio de velocidad  
<sup>6)</sup> - air conditioning / - aria condizionata / - air conditionné / - aire acondicionado

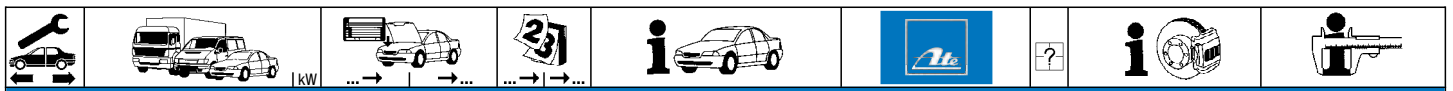

**OPEL ASTRA F / Vauxhall Astra MKIII (91-01)**



























|  |         |          |  |       |                  |                |        |  |  |       |
|--|---------|----------|--|-------|------------------|----------------|--------|--|--|-------|
|  | 1.8     | T2500001 |  | 09.98 |                  | 24.3728-0723.2 | 590723 |  |  | L=882 |
|  | 1.4     | T2500001 |  | 09.98 | + Klimaanlage 1) | 24.3728-0722.2 | 590722 |  |  | L=923 |
|  | 1.6     | T2500001 |  | 09.98 | + Klimaanlage 1) |                |        |  |  |       |
|  | 1.6 16V | T2500001 |  | 09.98 | + Klimaanlage 1) |                |        |  |  |       |
|  | 1.6 S   | T2500001 |  | 09.98 | + Klimaanlage 1) |                |        |  |  |       |
|  | 1.8 16V | T2500001 |  | 09.98 |                  |                |        |  |  |       |
|  | 2.0     | T2500001 |  | 09.98 |                  |                |        |  |  |       |
|  | 2.0 16V | T2500001 |  | 09.98 |                  |                |        |  |  |       |
|  | 2.0 GSi | T2500001 |  | 09.98 |                  |                |        |  |  |       |

**OPEL ASTRA G / Vauxhall Astra MKIV (98-04)**

|  |                    |          |          |       |                                     |                |        |   |  |                |     |
|--|--------------------|----------|----------|-------|-------------------------------------|----------------|--------|---|--|----------------|-----|
|  | 1.2 16V            |          |          | 04.98 | 12.04 - ESP/ + HA-Scheibenbremse 2) | 24.2123-1734.3 | 010640 |   |  | Thz 23,81      | LUC |
|  | 1.2 16V            | 22000001 |          |       | 12.04 - ESP/ + HA-Trommelbremse 3)  |                |        |   |  |                |     |
|  | 1.4 16V            |          |          | 04.98 | 12.04 - ESP/ + HA-Scheibenbremse 2) |                |        |   |  |                |     |
|  | 1.4 16V            | 22000001 |          |       | 12.04 - ESP/ + HA-Trommelbremse 3)  |                |        |   |  |                |     |
|  | 1.6                |          |          | 04.98 | 12.04 - ESP/ + HA-Scheibenbremse 2) |                |        |   |  |                |     |
|  | 1.6                | 22000001 |          |       | 12.04 - ESP/ + HA-Trommelbremse 3)  |                |        |   |  |                |     |
|  | 1.6 16V            |          |          | 04.98 | 12.04 - ESP/ + HA-Scheibenbremse 2) |                |        |   |  |                |     |
|  | 1.6 16V            | 22000001 |          |       | 12.04 - ESP/ + HA-Trommelbremse 3)  |                |        |   |  |                |     |
|  | 1.6 16V Cabrio     |          |          | 03.01 | 12.04 - ESP                         |                |        |   |  |                |     |
|  | 1.6 CNG            |          |          | 03.03 | 07.04 - ESP                         |                |        |   |  |                |     |
|  | 1.7 CDTI           |          |          | 04.03 | 12.04 - ESP                         |                |        |   |  |                |     |
|  | 1.7 DTI            |          |          | 02.00 | 12.04 - ESP/ + HA-Scheibenbremse 2) |                |        |   |  |                |     |
|  | 1.7 DTI            | 22000001 |          |       | 12.04 - ESP/ + HA-Trommelbremse 3)  |                |        |   |  |                |     |
|  | 1.7 TD             |          |          | 04.98 | 08.00 - ESP/ + HA-Scheibenbremse 2) |                |        |   |  |                |     |
|  | 1.8 16V            |          |          | 04.98 | 12.04 - ESP                         |                |        |   |  |                |     |
|  | 1.8 16V Cabrio     |          |          | 03.01 | 12.04 - ESP                         |                |        |   |  |                |     |
|  | 1.8 16V Caravan    |          |          | 04.98 | 12.04 - ESP                         |                |        |   |  |                |     |
|  | 1.8 16V Coupe      |          |          | 03.00 | 12.04 - ESP                         |                |        |   |  |                |     |
|  | 2.0 16V            |          |          | 04.98 | 12.04 - ESP                         |                |        |   |  |                |     |
|  | 2.0 16V OPC        |          |          | 10.99 | 12.04 - ESP                         |                |        |   |  |                |     |
|  | 2.0 16V OPC Cabrio |          |          | 03.02 | 12.04 - ESP                         |                |        |   |  |                |     |
|  | 2.0 DI             |          |          | 04.98 | 12.04 - ESP                         |                |        |   |  |                |     |
|  | 2.0 DTI 16V        |          |          | 08.99 | 12.04 - ESP                         |                |        |   |  |                |     |
|  | 2.0 Turbo          |          |          | 03.00 | 12.04 - ESP                         |                |        |   |  |                |     |
|  | 2.2 16V            |          |          | 09.00 | 12.04 - ESP                         |                |        |   |  |                |     |
|  | 2.2 16V Cabrio     |          |          | 03.01 | 12.04 - ESP                         |                |        |   |  |                |     |
|  | 2.2 16V Coupe      |          |          | 09.00 | 12.04 - ESP                         |                |        |   |  |                |     |
|  | 2.2 DTI 16V        |          |          | 09.02 | 12.04 - ESP                         |                |        |   |  |                |     |
|  | 2.2 DTI 16V Cabrio |          |          | 09.02 | 12.04 - ESP                         |                |        |   |  |                |     |
|  | 2.2 DTI 16V Coupe  |          |          | 09.02 | 12.04 - ESP                         |                |        |   |  |                |     |
|  | 1.2 16V            |          |          | 04.98 | 12.04 + ESP                         | 24.2123-1739.3 | 010661 |   |  | Thz 23,81      |     |
|  | 1.4 16V            |          |          | 04.98 | 12.04 + ESP                         |                |        |   |  |                |     |
|  | 1.6                |          |          | 04.98 | 12.04 + ESP                         |                |        |   |  |                |     |
|  | 1.6 16V            |          |          | 04.98 | 12.04 + ESP                         |                |        |   |  |                |     |
|  | 1.6 16V Cabrio     |          |          | 03.01 | 12.04 + ESP                         |                |        |   |  |                |     |
|  | 1.6 CNG            |          |          | 03.03 | 07.04 + ESP                         |                |        |   |  |                |     |
|  | 1.7 DTI            |          |          | 02.00 | 12.04 + ESP                         |                |        |   |  |                |     |
|  | 1.7 TD             |          |          | 04.98 | 08.00 + ESP                         |                |        |   |  |                |     |
|  | 1.8 16V            |          |          | 04.98 | 12.04 + ESP                         |                |        |   |  |                |     |
|  | 1.8 16V Cabrio     |          |          | 03.01 | 12.04 + ESP                         |                |        |   |  |                |     |
|  | 1.8 16V Caravan    |          |          | 04.98 | 12.04 + ESP                         |                |        |   |  |                |     |
|  | 1.8 16V Coupe      |          |          | 03.00 | 12.04 + ESP                         |                |        |   |  |                |     |
|  | 2.0 16V            |          |          | 04.98 | 12.04 + ESP                         |                |        |   |  |                |     |
|  | 2.0 16V OPC        |          |          | 10.99 | 12.04 + ESP                         |                |        |   |  |                |     |
|  | 2.0 16V OPC Cabrio |          |          | 03.02 | 12.04 + ESP                         |                |        |   |  |                |     |
|  | 2.0 DI             |          |          | 04.98 | 12.04 + ESP                         |                |        |   |  |                |     |
|  | 2.0 DTI 16V        |          |          | 08.99 | 12.04 + ESP                         |                |        |   |  |                |     |
|  | 2.0 Turbo          |          |          | 03.00 | 12.04 + ESP                         |                |        |   |  |                |     |
|  | 2.2 16V            |          |          | 09.00 | 12.04 + ESP                         |                |        |   |  |                |     |
|  | 2.2 16V Cabrio     |          |          | 03.01 | 12.04 + ESP                         |                |        |   |  |                |     |
|  | 2.2 16V Coupe      |          |          | 09.00 | 12.04 + ESP                         |                |        |   |  |                |     |
|  | 2.2 DTI 16V        |          |          | 09.02 | 12.04 + ESP                         |                |        |   |  |                |     |
|  | 2.2 DTI 16V        |          |          | 09.02 | 12.04 + ESP                         |                |        |   |  |                |     |
|  | 2.2 DTI 16V Coupe  |          |          | 09.02 | 12.04 + ESP                         |                |        |   |  |                |     |
|  | 1.2 16V            |          | 18999999 | 04.98 | + HA-Trommelbremse 4)               | 11.0101-5407.2 | 260011 |   |  | Hülsensatz     | ATE |
|  |                    |          |          |       |                                     | 11.8171-0008.1 | 990049 |   |  | Führungsbolzen | ATE |
|  | 1.2 16V            | 22000001 |          |       | 12.04                               | 11.9521-7001.2 | 220499 |   |  | D=52, - Halter | ATE |
|  | 1.4 16V            |          |          | 04.98 | 12.04                               | 11.9521-7002.2 | 220500 |   |  | D=52, - Halter | ATE |
|  | 1.6                |          |          | 04.98 | 12.04                               | 24.3521-7001.5 | 240481 |   |  | D=52, - Halter | ATE |
|  | 1.6 16V            |          |          | 04.98 | 12.04                               | 24.3521-7002.5 | 240482 |   |  | D=52, - Halter | ATE |
|  | 1.6 16V Cabrio     |          |          | 03.01 | 12.04                               | 11.0101-5407.2 | 260011 |   |  | Hülsensatz     | ATE |
|  | 1.7 CDTI           |          |          | 04.03 | 12.04                               | 11.8171-0008.1 | 990049 |   |  | Führungsbolzen | ATE |
|  | 1.7 DTI            |          |          | 02.00 | 12.04                               | 11.8116-0292.1 | 390521 | 2 |  | Haltefeder     | ATE |
|  | 1.7 TD             |          |          | 04.98 | 08.00                               |                |        |   |  |                |     |
|  | 1.8 16V            |          |          | 04.98 | 12.04 - ABS                         |                |        |   |  |                |     |
|  | 1.8 16V Cabrio     |          |          | 03.01 | 12.04 - ABS                         |                |        |   |  |                |     |
|  | 1.8 16V Caravan    |          |          | 04.98 | 12.04 - ABS                         |                |        |   |  |                |     |
|  | 2.0 DI             |          |          | 04.98 | 12.04 - ABS                         |                |        |   |  |                |     |

1) + air conditioning / + aria condizionata / + air conditionné / + aire acondicionado  
 2) - ESP/ + RA disc brake / - ESP/ + P disco freno / - ESP/ + fr.à disque essieu AR / - ESP/ + ET disco de freno  
 3) - ESP/ + RA drum brake / - ESP/ + P freno a tamburo / - ESP/ + fr.à tambour essieu AR / - ESP/ + ET tambores de freno  
 4) + RA drum brake / + P freno a tamburo / + frein à tambour essieu AR / + ET-tambores de freno



|     |    |  |  |  |  |     |     |   |
|--|--|--|--|--|---|---|---|---|
| <b>OPEL ASTRA G / Vauxhall Astra MKIV (98-04)</b>                                  |  |  |  |  |   |   |   |   |
|    | 1.6 CNG  |  | 03.03  | 12.04  | 11.9571-9823.2  | 220471  |    | D=57, - Halter<br>ATE<br>D=57, - Halter<br>ATE<br>D=57, - Halter<br>ATE<br>Dichtungssatz<br>ATE<br>Hülensatz<br>ATE<br>Führungsbolzen<br>ATE<br>Haltefeder<br>ATE |
|  | 1.8 16V  |  | 04.98  | 12.04 + ABS  | 11.9571-9824.2  | 220472  |    |   |
|  | 1.8 16V Cabrio   |  | 03.01  | 12.04 + ABS  | 24.3571-9823.5  | 240499  |    |   |
|  | 1.8 16V Caravan  |  | 04.98  | 12.04  | 24.3571-9824.5  | 240500  |    |   |
|  | 1.8 16V Coupe  |  | 03.00  | 12.04  | 11.0441-5704.2  | 250034  |   |   |
|  | 2.0 16V  |  | 04.98  | 12.04  | 11.0101-5407.2  | 260011  |   |   |
|  | 2.0 DI   |  | 04.98  | 12.04 + ABS  | 11.8171-0008.1  | 990049  |   |   |
|  | 2.0 DTI 16V  |  | 08.99  | 12.04  | 11.8116-0292.1  | 390521  | 2   |   |
|  | 2.0 Turbo  |  | 03.00  | 12.04  |   |   |   |   |
|  | 2.2 16V  |  | 09.00  | 12.04  |   |   |   |   |
|  | 2.2 16V Cabrio   |  | 03.01  | 12.04  |   |   |   |   |
|  | 2.2 16V Coupe  |  | 09.00  | 12.04  |   |   |   |   |
|  | 2.2 DTI 16V  |  | 09.02  | 12.04  |   |   |   |   |
|  | 2.2 DTI 16V Cabrio   |  | 09.02  | 12.04  |   |   |   |   |
|  | 2.2 DTI 16V Coupe  |  | 09.02  | 12.04  |   |   |   |   |
|  | 2.0 16V OPC  |  | 10.99  | 12.04  | 11.9571-9823.2  | 220471  |    |   |
|  | 2.0 16V OPC Cabrio   |  | 03.02  | 12.04  | 11.9571-9824.2  | 220472  |    |   |
|  |  |  |  |  | 24.3571-9823.5  | 240499  |    |   |
|  |  |  |  |  | 24.3571-9824.5  | 240500  |    |   |
|  |  |  |  |  | 11.0441-5704.2  | 250034  |   |   |
|  |  |  |  | 11.0101-5407.2   | 260011  |   |   |   |
|  |  |  |  | 11.8171-0008.1   | 990049  |   |   |   |
|  |  |  |  | 11.8116-0292.1   | 390521  | 2   |   |   |
|    | 1.2 16V  |  | 04.98  | 12.04  | 83.7207-0396.3  | 330560  | 2   | L=396   |
|  | 1.4 16V  |  | 04.98  | 12.04  |   |   |   |   |
|  | 1.6  |  | 04.98  | 12.04  |   |   |   |   |
|  | 1.6 16V  |  | 04.98  | 12.04  |   |   |   |   |
|  | 1.6 16V Cabrio   |  | 03.01  | 12.04  |   |   |   |   |
|  | 1.6 CNG  |  | 03.03  | 07.04  |   |   |   |   |
|  | 1.7 CDTI   |  | 04.03  | 12.04  |   |   |   |   |
|  | 1.7 DTI  |  | 02.00  | 12.04  |   |   |   |   |
|  | 1.7 TD   |  | 04.98  | 08.00  |   |   |   |   |
|  | 1.8 16V  |  | 04.98  | 12.04  |   |   |   |   |
|  | 1.8 16V Cabrio   |  | 03.01  | 12.04  |   |   |   |   |
|  | 1.8 16V Caravan  |  | 04.98  | 12.04  |   |   |   |   |
|  | 1.8 16V Coupe  |  | 03.00  | 12.04  |   |   |   |   |
|  | 2.0 16V  |  | 04.98  | 12.04  |   |   |   |   |
|  | 2.0 16V OPC  |  | 10.99  | 12.04  |   |   |   |   |
|  | 2.0 16V OPC Cabrio   |  | 03.02  | 12.04  |   |   |   |   |
|  | 2.0 DI   |  | 04.98  | 12.04  |   |   |   |   |
|  | 2.0 DTI 16V  |  | 08.99  | 12.04  |   |   |   |   |
|  | 2.0 Turbo  |  | 03.00  | 12.04  |   |   |   |   |
|  | 2.2 16V  |  | 09.00  | 12.04  |   |   |   |   |
|  | 2.2 16V Cabrio   |  | 03.01  | 12.04  |   |   |   |   |
|  | 2.2 16V Coupe  |  | 09.00  | 12.04  |   |   |   |   |
|  | 2.2 DTI 16V  |  | 09.02  | 12.04  |   |   |   |   |
|  | 2.2 DTI 16V Cabrio   |  | 09.02  | 12.04  |   |   |   |   |
|  | 2.2 DTI 16V Coupe  |  | 09.02  | 12.04  |   |   |   |   |
|  |  | 1.2 16V  |  | 07.01  | 07.03   | 24.3344-1713.7  | 220559  |   |
| 1.4 16V  |  |  | 07.01  | 07.03  | 24.3344-1714.7  | 220560  |  |   |
| 1.6  |  |  | 07.01  | 07.03  |   |   |   |   |
| 1.6 16V  |  |  | 07.01  | 07.03  |   |   |   |   |
| 1.6 CNG  |  |  | 03.03  | 07.03  |   |   |   |   |
| 1.7 CDTI   |  |  | 04.03  | 07.03  |   |   |   |   |
| 1.7 DTI  |  |  | 07.01  | 07.03  |   |   |   |   |
| 1.8 16V  |  |  | 07.01  | 07.03  |   |   |   |   |
| 2.0 DI   |  |  | 07.01  | 07.03  |   |   |   |   |
| 1.6 16V Cabrio   |  |  | 07.01  | 12.04  | 24.3367-1713.7  | 220779  |  |   |
| 2.0 DTI 16V  |  |  | 07.01  | 12.04  | 24.3367-1714.7  | 220780  |  |   |
| 2.2 16V  |  |  | 07.01  | 12.04  |   |   |   |   |
| 2.2 DTI 16V  |  |  | 09.02  | 12.04  |   |   |   |   |
| 1.6 CNG  |  |  | 03.03  | 07.04  | 24.3384-1753.7  | 220633  |  |   |
| 1.8 16V Cabrio   |  | 07.01  | 12.04  | 24.3384-1754.7   | 220634  |  |   |   |
| 1.8 16V Coupe  |  | 07.01  | 12.04  |  |   |   |   |   |
| 2.0 16V OPC  |  | 07.01  | 12.04  |  |   |   |   |   |
| 2.0 16V OPC Cabrio   |  | 03.02  | 12.04  |  |   |   |   |   |
| 2.0 Turbo  |  | 07.01  | 12.04  |  |   |   |   |   |
| 2.2 16V Cabrio   |  | 07.01  | 12.04  |  |   |   |   |   |
| 2.2 16V Coupe  |  | 07.01  | 12.04  |  |   |   |   |   |
| 2.2 DTI 16V Cabrio   |  | 09.02  | 12.04  |  |   |   |   |   |
| 2.2 DTI 16V Coupe  |  | 09.02  | 12.04  |  |   |   |   |   |
|  | 1.2 16V  |  | 04.98  | 12.04  | 24.5240-0220.3  | 330619  | 2   | + HA-Trommelbremse <sup>1)</sup><br>L=220   |
|  | 1.4 16V  |  | 04.98  | 12.04  |   |   |   |   |
|  | 1.6  |  | 04.98  | 12.04  |   |   |   |   |
|  | 1.6 16V  |  | 04.98  | 12.04  |   |   |   |   |
|  | 1.6 CNG  |  | 03.03  | 07.04  |   |   |   |   |
|  | 1.7 DTI  |  | 02.00  | 12.04  |   |   |   |   |
|  | 1.7 TD   |  | 04.98  | 08.00  |   |   |   |   |
|  | 1.2 16V  | 22999999   | 04.98  | + HA-Scheibenbremse <sup>2)</sup>  | 24.5241-0200.3  | 330620  | 2   |   |
|  | 1.4 16V  | 22999999   | 04.98  | + HA-Scheibenbremse <sup>2)</sup>  |   |   |   |   |
|  | 1.6  | 22999999   | 04.98  | + HA-Scheibenbremse <sup>2)</sup>  |   |   |   |   |
| 1.6 16V  | 22999999   | 04.98  | + HA-Scheibenbremse <sup>2)</sup>  |  |   |   |   |   |
| 1.6 16V Cabrio   | 22999999   | 03.01  |  |  |   |   |   |   |
| 1.6 CNG  | 22999999   | 03.03  | + HA-Scheibenbremse <sup>2)</sup>  |  |   |   |   |   |
| 1.7 CDTI   | 22999999   | 04.03  |  |  |   |   |   |   |
| 1.7 DTI  | 22999999   | 02.00  | + HA-Scheibenbremse <sup>2)</sup>  |  |   |   |   |   |
| 1.7 TD   |  | 04.98  | 08.00 + HA-Scheibenbremse <sup>2)</sup>  |  |   |   |   |   |

<sup>1)</sup> + RA drum brake / + P freno a tamburo / + frein à tambour essieu AR / + ET-tambores de freno

<sup>2)</sup> + RA disc brake / + P disco freno / + frein à disque essieu AR / + ET-disco de freno

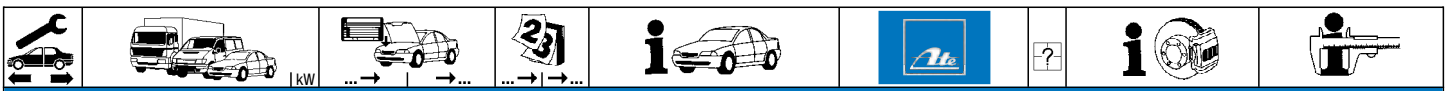

**OPEL ASTRA G / Vauxhall Astra MKIV (98-04)**

|                   |                    |          |          |       |                                   |                                   |                |   |                                  |                          |
|-------------------|--------------------|----------|----------|-------|-----------------------------------|-----------------------------------|----------------|---|----------------------------------|--------------------------|
|                   | 1.8 16V            |          | 22999999 | 04.98 |                                   | 24.5241-0200.3                    | 330620         | 2   |                                  | L=200                    |
|                   | 1.8 16V Cabrio     |          | 22999999 | 03.01 |                                   |                                   |                |   |                                  |                          |
|                   | 1.8 16V Caravan    |          | 22999999 | 04.98 |                                   |                                   |                |   |                                  |                          |
|                   | 1.8 16V Coupe      |          | 22999999 | 03.00 |                                   |                                   |                |   |                                  |                          |
|                   | 2.0 16V            |          | 22999999 | 04.98 |                                   |                                   |                |   |                                  |                          |
|                   | 2.0 16V OPC        |          | 22999999 | 10.99 |                                   |                                   |                |   |                                  |                          |
|                   | 2.0 16V OPC Cabrio |          | 22999999 | 03.02 |                                   |                                   |                |   |                                  |                          |
|                   | 2.0 DI             |          | 22999999 | 04.98 |                                   |                                   |                |   |                                  |                          |
|                   | 2.0 DTI 16V        |          | 22999999 | 08.99 |                                   |                                   |                |   |                                  |                          |
|                   | 2.0 Turbo          |          | 22999999 | 03.00 |                                   |                                   |                |   |                                  |                          |
|                   | 2.2 16V            |          | 22999999 | 09.00 |                                   |                                   |                |   |                                  |                          |
|                   | 2.2 16V Cabrio     |          | 22999999 | 03.01 |                                   |                                   |                |   |                                  |                          |
|                   | 2.2 16V Coupe      |          | 22999999 | 09.00 |                                   |                                   |                |   |                                  |                          |
|                   | 2.2 DTI 16V        |          | 22999999 | 09.02 |                                   |                                   |                |   |                                  |                          |
|                   | 2.2 DTI 16V Cabrio |          | 22999999 | 09.02 |                                   |                                   |                |   |                                  |                          |
| 2.2 DTI 16V Coupe |                    | 22999999 | 09.02    |       |                                   |                                   |                |   |                                  |                          |
|                   | 1.2 16V            | 32000001 |          | 12.04 | + HA-Scheibenbremse <sup>1)</sup> | 24.5157-0218.3                    | 331095         |   |                                  | L=219/185, + Rohrleitung |
|                   | 1.4 16V            | 32000001 |          | 12.04 | + HA-Scheibenbremse <sup>1)</sup> | 24.5157-0219.3                    | 331096         |   |                                  | L=219/185, + Rohrleitung |
|                   | 1.6                | 32000001 |          | 12.04 | + HA-Scheibenbremse <sup>1)</sup> |                                   |                |   |                                  |                          |
|                   | 1.6 16V            | 32000001 |          | 12.04 | + HA-Scheibenbremse <sup>1)</sup> |                                   |                |   |                                  |                          |
|                   | 1.6 16V Cabrio     | 32000001 |          | 12.04 |                                   |                                   |                |   |                                  |                          |
|                   | 1.6 CNG            | 32000001 |          | 07.04 | + HA-Scheibenbremse <sup>1)</sup> |                                   |                |   |                                  |                          |
|                   | 1.7 CDTI           | 32000001 |          | 12.04 |                                   |                                   |                |   |                                  |                          |
|                   | 1.7 DTI            | 32000001 |          | 12.04 | + HA-Scheibenbremse <sup>1)</sup> |                                   |                |   |                                  |                          |
|                   | 1.8 16V            | 32000001 |          | 12.04 |                                   |                                   |                |   |                                  |                          |
|                   | 1.8 16V Cabrio     | 32000001 |          | 12.04 |                                   |                                   |                |   |                                  |                          |
|                   | 1.8 16V Caravan    | 32000001 |          | 12.04 |                                   |                                   |                |   |                                  |                          |
|                   | 1.8 16V Coupe      | 32000001 |          | 12.04 |                                   |                                   |                |   |                                  |                          |
|                   | 2.0 16V            | 32000001 |          | 12.04 |                                   |                                   |                |   |                                  |                          |
|                   | 2.0 16V OPC        | 32000001 |          | 12.04 |                                   |                                   |                |   |                                  |                          |
|                   | 2.0 16V OPC Cabrio | 32000001 |          | 12.04 |                                   |                                   |                |   |                                  |                          |
|                   | 2.0 DI             | 32000001 |          | 12.04 |                                   |                                   |                |   |                                  |                          |
|                   | 2.0 DTI 16V        | 32000001 |          | 12.04 |                                   |                                   |                |   |                                  |                          |
|                   | 2.0 Turbo          | 32000001 |          | 12.04 |                                   |                                   |                |   |                                  |                          |
|                   | 2.2 16V            | 32000001 |          | 12.04 |                                   |                                   |                |   |                                  |                          |
|                   | 2.2 16V Cabrio     | 32000001 |          | 12.04 |                                   |                                   |                |   |                                  |                          |
|                   | 2.2 16V Coupe      | 32000001 |          | 12.04 |                                   |                                   |                |   |                                  |                          |
|                   | 2.2 DTI 16V        | 32000001 |          | 12.04 |                                   |                                   |                |   |                                  |                          |
|                   | 2.2 DTI 16V Cabrio | 32000001 |          | 12.04 |                                   |                                   |                |   |                                  |                          |
|                   | 2.2 DTI 16V Coupe  | 32000001 |          | 12.04 |                                   |                                   |                |   |                                  |                          |
|                   |                    | 1.2 16V  |          |       | 04.98                             | 12.04                             | 24.3219-1715.3 | 020122                                    |                                  |                          |
| 1.4 16V           |                    |          |          | 04.98 | 12.04                             |                                   |                |   |                                  |                          |
| 1.6               |                    |          |          | 04.98 | 12.04                             |                                   |                |   |                                  |                          |
| 1.6 16V           |                    |          |          | 04.98 | 12.04                             |                                   |                |   |                                  |                          |
| 1.6 CNG           |                    |          |          | 03.03 | 07.04                             |                                   |                |   |                                  |                          |
| 1.7 DTI           |                    |          |          | 02.00 | 12.04                             |                                   |                |   |                                  |                          |
| 1.7 TD            |                    |          |          | 04.98 | 08.00                             |                                   |                |   |                                  |                          |
| 1.2 16V           |                    |          |          | 04.98 | 12.04                             | 24.3727-0748.2                    | 580748         | 1   | + HA-Trommelbremse <sup>2)</sup> | L=279, + Zub             |
| 1.4 16V           |                    |          | 04.98    | 12.04 | 24.3727-0747.2                    | 580747                            | 1              | Basis/ + HA-Trommelbremse <sup>3)</sup>   | L=1252/1252, + Zub               |                          |
| 1.6               |                    |          | 04.98    | 12.04 | 24.3727-0746.2                    | 580746                            | 2              | Verlängerung/+HA-Trommelbr. <sup>4)</sup> | L=182, + Zub                     |                          |
| 1.6 16V           |                    |          | 04.98    | 12.04 |                                   |                                   |                |   |                                  |                          |
| 1.6 CNG           |                    |          | 03.03    | 07.04 |                                   |                                   |                |   |                                  |                          |
| 1.7 DTI           |                    |          | 02.00    | 12.04 |                                   |                                   |                |   |                                  |                          |
| 1.7 TD            |                    |          | 04.98    | 08.00 |                                   |                                   |                |   |                                  |                          |
|                   | 1.2 16V            | 22006460 |          | 04.98 | + HA-Scheibenbremse <sup>1)</sup> | 24.3727-0748.2                    | 580748         | 1   |                                  | L=279, + Zub             |
|                   | 1.4 16V            | 22006460 |          | 04.98 | + HA-Scheibenbremse <sup>1)</sup> | 24.3727-0752.2                    | 580752         | 1   |                                  | L=1593/1593, + Zub       |
|                   | 1.6                | 22006460 |          | 04.98 | + HA-Scheibenbremse <sup>1)</sup> |                                   |                |   |                                  |                          |
|                   | 1.6 16V            | 22006460 |          | 04.98 | + HA-Scheibenbremse <sup>1)</sup> |                                   |                |   |                                  |                          |
|                   | 1.6 CNG            | 22006460 |          | 03.03 | + HA-Scheibenbremse <sup>1)</sup> |                                   |                |   |                                  |                          |
|                   | 1.7 DTI            | 22006460 |          | 02.00 | + HA-Scheibenbremse <sup>1)</sup> |                                   |                |   |                                  |                          |
|                   | 1.7 TD             |          |          | 04.98 | 08.00                             | + HA-Scheibenbremse <sup>1)</sup> |                |   |                                  |                          |
|                   | 1.8 16V            | 22006460 |          | 04.98 |                                   |                                   |                |   |                                  |                          |
|                   | 1.8 16V Caravan    | 22006460 |          | 04.98 |                                   |                                   |                |   |                                  |                          |
|                   | 1.8 16V Coupe      | 22006460 |          | 03.00 |                                   |                                   |                |   |                                  |                          |
|                   | 2.0 16V            | 22006460 |          | 04.98 |                                   |                                   |                |   |                                  |                          |
|                   | 2.0 16V OPC        | 22006460 |          | 10.99 |                                   |                                   |                |   |                                  |                          |
|                   | 2.0 16V OPC Cabrio | 22006460 |          | 03.02 |                                   |                                   |                |   |                                  |                          |
|                   | 2.0 DI             | 22006460 |          | 04.98 |                                   |                                   |                |   |                                  |                          |
|                   | 2.0 DTI 16V        | 22006460 |          | 08.99 |                                   |                                   |                |   |                                  |                          |
|                   | 2.0 Turbo          | 22006460 |          | 03.00 |                                   |                                   |                |   |                                  |                          |
|                   | 2.2 16V            | 22006460 |          | 09.00 |                                   |                                   |                |   |                                  |                          |
|                   | 2.2 16V Coupe      | 22006460 |          | 09.00 |                                   |                                   |                |   |                                  |                          |
|                   | 2.2 DTI 16V        | 22006460 |          | 09.02 |                                   |                                   |                |   |                                  |                          |
|                   | 2.2 DTI 16V Cabrio | 22006460 |          | 09.02 |                                   |                                   |                |   |                                  |                          |
| 2.2 DTI 16V Coupe | 22006460           |          | 09.02    |       |                                   |                                   |                |   |                                  |                          |
|                   | 1.2 16V            | 22006461 | 38999999 |       | + HA-Scheibenbremse <sup>1)</sup> | 24.3727-0748.2                    | 580748         | 1   |                                  | L=279, + Zub             |
|                   | 1.4 16V            | 22006461 | 38999999 |       | + HA-Scheibenbremse <sup>1)</sup> | 24.3727-0753.2                    | 580753         | 1   |                                  | L=1592/1592, + Zub       |
|                   | 1.6                | 22006461 | 38999999 |       | + HA-Scheibenbremse <sup>1)</sup> |                                   |                |   |                                  |                          |
|                   | 1.6 16V            | 22006461 | 38999999 |       | + HA-Scheibenbremse <sup>1)</sup> |                                   |                |   |                                  |                          |
|                   | 1.6 CNG            | 22006461 | 38999999 |       | + HA-Scheibenbremse <sup>1)</sup> |                                   |                |   |                                  |                          |
|                   | 1.7 CDTI           |          |          | 04.03 |                                   |                                   |                |   |                                  |                          |
|                   | 1.7 DTI            | 22006461 | 38999999 |       | + HA-Scheibenbremse <sup>1)</sup> |                                   |                |   |                                  |                          |
|                   | 1.8 16V            | 22006461 | 38999999 |       |                                   |                                   |                |   |                                  |                          |
|                   | 1.8 16V Caravan    | 22006461 | 38999999 |       |                                   |                                   |                |   |                                  |                          |
|                   | 1.8 16V Coupe      | 22006461 | 38999999 |       |                                   |                                   |                |   |                                  |                          |
|                   | 2.0 16V            | 22006461 | 38999999 |       |                                   |                                   |                |   |                                  |                          |
|                   | 2.0 16V OPC        | 22006461 | 38999999 |       |                                   |                                   |                |   |                                  |                          |

<sup>1)</sup> + RA disc brake / + P disco freno / + frein à disque essieu AR / + ET-disco de freno  
<sup>2)</sup> + RA drum brake / + P freno a tamburo / + frein à tambour essieu AR / + ET-tambores de freno  
<sup>3)</sup> basic/ + RA drum brake / base/ + P freno a tamburo / base/ + fr.tambour essieu AR / base/ + ET tambores de freno  
<sup>4)</sup> extension only/ + RA drum br. / solo prolonga/+ P fr.a tamburo / rallonge seulem.+ tamb.ess.AR / solam. prolongad./+ tambores ET





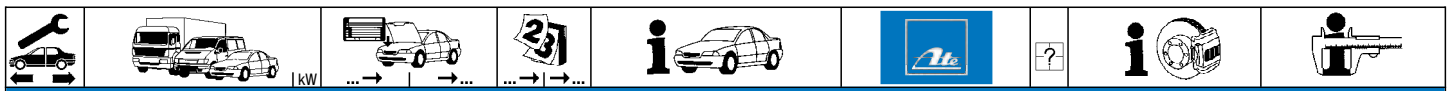





















**OPEL ASTRA G / Vauxhall Astra MKIV (98-04)**

|                    |                    |          |          |       |       |                                   |                |        |   |                                    |             |     |
|--------------------|--------------------|----------|----------|-------|-------|-----------------------------------|----------------|--------|---|------------------------------------|-------------|-----|
|                    | 2.0 16V OPC Cabrio | 22006461 | 38999999 |       |       | 24.3727-0748.2                    | 580748         | 1      | ↑ | L=279, + Zub<br>L=1592/1592, + Zub |             |     |
|                    | 2.0 DI             | 22006461 | 38999999 |       |       | 24.3727-0753.2                    | 580753         | 1      | ↓ |                                    |             |     |
|                    | 2.0 DTI 16V        | 22006461 | 38999999 |       |       |                                   |                |        |   |                                    |             |     |
|                    | 2.0 Turbo          | 22006461 | 38999999 |       |       |                                   |                |        |   |                                    |             |     |
|                    | 2.2 16V            | 22006461 | 38999999 |       |       |                                   |                |        |   |                                    |             |     |
|                    | 2.2 16V Coupe      | 22006461 | 38999999 |       |       |                                   |                |        |   |                                    |             |     |
|                    | 2.2 DTI 16V        | 22006461 | 38999999 |       |       |                                   |                |        |   |                                    |             |     |
|                    | 2.2 DTI 16V Cabrio | 22006461 | 38999999 |       |       |                                   |                |        |   |                                    |             |     |
|                    | 2.2 DTI 16V Coupe  | 22006461 | 38999999 |       |       |                                   |                |        |   |                                    |             |     |
|                    | 1.2 16V            | 42000001 |          |       | 12.04 | + HA-Scheibenbremse <sup>1)</sup> | 24.3727-0748.2 | 580748 | 1 |                                    | ↑           |     |
|                    | 1.4 16V            | 42000001 |          |       | 12.04 | + HA-Scheibenbremse <sup>1)</sup> | 24.3727-0783.2 | 580783 | 1 |                                    | ↓           |     |
|                    | 1.6                | 42000001 |          |       | 12.04 | + HA-Scheibenbremse <sup>1)</sup> |                |        |   |                                    |             |     |
|                    | 1.6 16V            | 42000001 |          |       | 12.04 | + HA-Scheibenbremse <sup>1)</sup> |                |        |   |                                    |             |     |
|                    | 1.6 CNG            | 42000001 |          |       | 07.04 | + HA-Scheibenbremse <sup>1)</sup> |                |        |   |                                    |             |     |
|                    | 1.7 CDTI           | 42000001 |          |       | 12.04 |                                   |                |        |   |                                    |             |     |
|                    | 1.7 DTI            | 42000001 |          |       | 12.04 | + HA-Scheibenbremse <sup>1)</sup> |                |        |   |                                    |             |     |
|                    | 1.8 16V            | 42000001 |          |       | 12.04 |                                   |                |        |   |                                    |             |     |
|                    | 1.8 16V Caravan    | 42000001 |          |       | 12.04 |                                   |                |        |   |                                    |             |     |
|                    | 1.8 16V Coupe      | 42000001 |          |       | 12.04 |                                   |                |        |   |                                    |             |     |
|                    | 2.0 16V            | 42000001 |          |       | 12.04 |                                   |                |        |   |                                    |             |     |
| 2.0 16V OPC        | 42000001           |          |          | 12.04 |       |                                   |                |        |   |                                    |             |     |
| 2.0 16V OPC Cabrio | 42000001           |          |          | 12.04 |       |                                   |                |        |   |                                    |             |     |
| 2.0 DI             | 42000001           |          |          | 12.04 |       |                                   |                |        |   |                                    |             |     |
| 2.0 DTI 16V        | 42000001           |          |          | 12.04 |       |                                   |                |        |   |                                    |             |     |
| 2.0 Turbo          | 42000001           |          |          | 12.04 |       |                                   |                |        |   |                                    |             |     |
| 2.2 16V            | 42000001           |          |          | 12.04 |       |                                   |                |        |   |                                    |             |     |
| 2.2 16V Coupe      | 42000001           |          |          | 12.04 |       |                                   |                |        |   |                                    |             |     |
| 2.2 DTI 16V        | 42000001           |          |          | 12.04 |       |                                   |                |        |   |                                    |             |     |
| 2.2 DTI 16V Cabrio | 42000001           |          |          | 12.04 |       |                                   |                |        |   |                                    |             |     |
| 2.2 DTI 16V Coupe  | 42000001           |          |          | 12.04 |       |                                   |                |        |   |                                    |             |     |
|                    | 1.2 16V            |          |          | 04.98 | 12.04 | - ABS                             | 03.6583-0073.3 | 320234 |   | BRL 8/3 (4)                        | ATE         |     |
|                    | 1.4 16V Caravan    |          |          | 04.98 | 12.04 | - ABS                             |                |        |   |                                    |             |     |
|                    | 1.6 16V Caravan    |          |          | 04.98 | 12.04 | - ABS                             |                |        |   |                                    |             |     |
|                    | 1.6 Caravan        |          |          | 04.98 | 12.04 | - ABS                             |                |        |   |                                    |             |     |
|                    | 1.6 CNG            |          |          | 03.03 | 07.04 | - ABS                             |                |        |   |                                    |             |     |
|                    | 1.7 CDTI Caravan   |          |          | 04.03 | 12.04 | - ABS                             |                |        |   |                                    |             |     |
|                    | 1.7 DTI Caravan    |          |          | 02.00 | 12.04 | - ABS                             |                |        |   |                                    |             |     |
|                    | 1.7 TD Caravan     |          |          | 04.98 | 08.00 | - ABS                             |                |        |   |                                    |             |     |
|                    | 1.8 16V Caravan    |          |          | 04.98 | 12.04 | - ABS                             |                |        |   |                                    |             |     |
|                    | 2.0 16V Caravan    |          |          | 04.98 | 12.04 | - ABS                             |                |        |   |                                    |             |     |
|                    | 1.4 16V Limousine  |          |          | 04.98 | 12.04 | - ABS                             | 03.6583-0074.3 | 320235 |   |                                    | BRL 8/3 (4) | ATE |
|                    | 1.6 16V Limousine  |          |          | 04.98 | 12.04 | - ABS                             |                |        |   |                                    |             |     |
|                    | 1.6 Limousine      |          |          | 04.98 | 12.04 | - ABS                             |                |        |   |                                    |             |     |
|                    | 1.7 CDTI Limousine |          |          | 04.03 | 12.04 | - ABS                             |                |        |   |                                    |             |     |
| 1.7 DTI Limousine  |                    |          | 02.00    | 12.04 | - ABS |                                   |                |        |   |                                    |             |     |
| 1.7 TD Limousine   |                    |          | 04.98    | 08.00 | - ABS |                                   |                |        |   |                                    |             |     |
| 1.8 16V Limousine  |                    |          | 04.98    | 12.04 | - ABS |                                   |                |        |   |                                    |             |     |
| 2.0 16V Limousine  |                    |          | 04.98    | 12.04 | - ABS |                                   |                |        |   |                                    |             |     |
| 2.0 DI             |                    |          | 04.98    | 12.04 | - ABS |                                   |                |        |   |                                    |             |     |
| 2.0 DTI 16V        |                    |          | 08.99    | 12.04 | - ABS |                                   |                |        |   |                                    |             |     |
|                    | 1.2 16V            | ↓        |          | 04.98 | 12.04 |                                   | 24.2415-1704.3 | 030087 |   |                                    | Gz 15,87    |     |
|                    | 1.4 16V            | ↓        |          | 04.98 | 12.04 |                                   |                |        |   |                                    |             |     |
|                    | 1.6                | ↓        |          | 04.98 | 12.04 |                                   |                |        |   |                                    |             |     |
|                    | 1.6 16V            | ↓        |          | 04.98 | 12.04 |                                   |                |        |   |                                    |             |     |
|                    | 1.6 16V Cabrio     | ↓        |          | 03.01 | 12.04 |                                   |                |        |   |                                    |             |     |
|                    | 1.6 CNG            | ↓        |          | 03.03 | 07.04 |                                   |                |        |   |                                    |             |     |
|                    | 1.7 CDTI           | ↓        |          | 04.03 | 12.04 |                                   |                |        |   |                                    |             |     |
|                    | 1.7 DTI            | ↓        |          | 02.00 | 12.04 |                                   |                |        |   |                                    |             |     |
|                    | 1.7 TD             | ↓        |          | 04.98 | 08.00 |                                   |                |        |   |                                    |             |     |
|                    | 1.8 16V            | ↓        |          | 04.98 | 12.04 |                                   |                |        |   |                                    |             |     |
|                    | 1.8 16V Cabrio     | ↓        |          | 03.01 | 12.04 |                                   |                |        |   |                                    |             |     |
|                    | 1.8 16V Caravan    | ↓        |          | 04.98 | 12.04 |                                   |                |        |   |                                    |             |     |
|                    | 1.8 16V Coupe      | ↓        |          | 03.00 | 12.04 |                                   |                |        |   |                                    |             |     |
|                    | 2.0 16V            | ↓        |          | 04.98 | 12.04 |                                   |                |        |   |                                    |             |     |
|                    | 2.0 16V OPC        | ↓        |          | 10.99 | 12.04 |                                   |                |        |   |                                    |             |     |
|                    | 2.0 16V OPC Cabrio | ↓        |          | 03.02 | 12.04 |                                   |                |        |   |                                    |             |     |
|                    | 2.0 DI             | ↓        |          | 04.98 | 12.04 |                                   |                |        |   |                                    |             |     |
|                    | 2.0 DTI 16V        | ↓        |          | 08.99 | 12.04 |                                   |                |        |   |                                    |             |     |
|                    | 2.0 Turbo          | ↓        |          | 03.00 | 12.04 |                                   |                |        |   |                                    |             |     |
|                    | 2.2 16V            | ↓        |          | 09.00 | 12.04 |                                   |                |        |   |                                    |             |     |
| 2.2 16V Cabrio     | ↓                  |          | 03.01    | 12.04 |       |                                   |                |        |   |                                    |             |     |
| 2.2 16V Coupe      | ↓                  |          | 09.00    | 12.04 |       |                                   |                |        |   |                                    |             |     |
| 2.2 DTI 16V        | ↓                  |          | 09.02    | 12.04 |       |                                   |                |        |   |                                    |             |     |
| 2.2 DTI 16V Cabrio | ↓                  |          | 09.02    | 12.04 |       |                                   |                |        |   |                                    |             |     |
| 2.2 DTI 16V Coupe  | ↓                  |          | 09.02    | 12.04 |       |                                   |                |        |   |                                    |             |     |

**OPEL ASTRA H / GTC / Vauxhall Astra Mk V (04-10)**

|  |           |       |          |       |       |  |                |        |  |       |           |     |
|--|-----------|-------|----------|-------|-------|--|----------------|--------|--|-------|-----------|-----|
|  | 1.9 CDTI  | ↓ 74  |          | 09.05 | 11.10 |  | 03.7863-7803.4 | 300237 |  |       | 10"       | ATE |
|  | 1.9 CDTI  | ↓ 88  |          | 09.04 | 11.10 |  |                |        |  |       |           |     |
|  | 1.9 CDTI  | ↓ 110 |          | 09.04 | 11.10 |  |                |        |  |       |           |     |
|  | 1.2       | ↓     | 68999999 | 08.05 |       |  | 24.2125-1737.3 | 010906 |  | - ESP | THz 25,40 | LUC |
|  | 1.3 CDTI  | ↓ 66  | 68999999 | 08.05 |       |  | 24.2125-1736.3 | 010904 |  | + ESP | THz 25,40 | LUC |
|  | 1.4       | ↓     | 68999999 | 01.04 |       |  |                |        |  |       |           |     |
|  | 1.6       | ↓ 77  | 68999999 | 01.04 |       |  |                |        |  |       |           |     |
|  | 1.6       | ↓ 85  | 68999999 | 01.07 |       |  |                |        |  |       |           |     |
|  | 1.6 Turbo | ↓ 132 | 68999999 | 01.07 |       |  |                |        |  |       |           |     |
|  | 1.7 CDTI  | ↓ 59  | 68999999 | 01.04 |       |  |                |        |  |       |           |     |

<sup>1)</sup> + RA disc brake / + P disco freno / + frein à disque essieu AR / + ET-disco de freno

|     |  |  |  |  |  |  |  |     |                |     |
|--|--|--|--|--|---|--|--|---|----------------|-----|
| <b>OPEL ASTRA H / GTC / Vauxhall Astra Mk V (04-10)</b>                            |  |  |  |  |   |  |  |   |                |     |
|    | 1.7 CDTI   | 74   | 68999999   | 01.04  |   | 24.2125-1737.3   | 010906   | - ESP   | THz 25,40      | LUC |
|  | 1.7 CDTI   | 81   | 68999999   | 04.07  |   | 24.2125-1736.3   | 010904   | + ESP   | THz 25,40      | LUC |
|  | 1.7 CDTI   | 92   | 68999999   | 04.07  |   |  |  |   |                |     |
|  | 1.8  | 92   | 68999999   | 01.04  |   |  |  |   |                |     |
|  | 1.8  | 103  | 68999999   | 01.06  |   |  |  |   |                |     |
|  | 2.0 Turbo  | 125  | 68999999   | 01.04  |   |  |  |   |                |     |
|  | 2.0 Turbo  | 147  | 68999999   | 09.04  |   |  |  |   |                |     |
|  | 2.0 Turbo OPC  | 177  | 68999999   | 03.05  |   |  |  |   |                |     |
|  | 1.2  | 72000001   |  |  | 11.10   | 24.2125-1704.3   | 010446   | - ESP   | THz 25,40      | LUC |
|  | 1.3 CDTI   | 66   | 72000001   |  | 11.10   | 24.2125-1703.3   | 010483   | + ESP   | THz 25,40      |     |
|  | 1.4  | 72000001   |  |  | 11.10   |  |  |   |                |     |
|  | 1.6  | 77   | 72000001   |  | 11.10   |  |  |   |                |     |
|  | 1.6  | 85   | 72000001   |  | 11.10   |  |  |   |                |     |
|  | 1.6 Turbo  | 132  | 72000001   |  | 11.10   |  |  |   |                |     |
|  | 1.7 CDTI   | 59   | 72000001   |  | 11.10   |  |  |   |                |     |
|  | 1.7 CDTI   | 74   | 72000001   |  | 11.10   |  |  |   |                |     |
|  | 1.7 CDTI   | 81   | 72000001   |  | 11.10   |  |  |   |                |     |
|  | 1.7 CDTI   | 92   | 72000001   |  | 11.10   |  |  |   |                |     |
|  | 1.8  | 92   | 72000001   |  | 11.10   |  |  |   |                |     |
|  | 1.8  | 103  | 72000001   |  | 11.10   |  |  |   |                |     |
|  | 2.0 Turbo  | 125  | 72000001   |  | 11.10   |  |  |   |                |     |
|  | 2.0 Turbo  | 147  | 72000001   |  | 11.10   |  |  |   |                |     |
|  | 2.0 Turbo OPC  | 177  | 72000001   |  | 11.10   |  |  |   |                |     |
|  | 1.2  |  | 68999999   | 08.05  |   | 24.2125-1736.3   | 010904   |   | THz 25,40      | LUC |
|  | 1.3 CDTI   | 66   | 68999999   | 08.05  |   |  |  |   |                |     |
|  | 1.4  |  | 68999999   | 01.04  |   |  |  |   |                |     |
|  | 1.6  | 77   | 68999999   | 01.04  |   |  |  |   |                |     |
|  | 1.6  | 85   | 68999999   | 01.07  |   |  |  |   |                |     |
|  | 1.6 Turbo  | 132  | 68999999   | 01.07  |   |  |  |   |                |     |
|  | 1.7 CDTI   | 59   | 68999999   | 01.04  |   |  |  |   |                |     |
|  | 1.7 CDTI   | 74   | 68999999   | 01.04  |   |  |  |   |                |     |
|  | 1.7 CDTI   | 81   | 68999999   | 04.07  |   |  |  |   |                |     |
|  | 1.7 CDTI   | 92   | 68999999   | 04.07  |   |  |  |   |                |     |
|  | 1.8  | 92   | 68999999   | 01.04  |   |  |  |   |                |     |
|  | 1.8  | 103  | 68999999   | 01.06  |   |  |  |   |                |     |
|  | 2.0 Turbo  | 125  | 68999999   | 01.04  |   |  |  |   |                |     |
|  | 2.0 Turbo  | 147  | 68999999   | 09.04  |   |  |  |   |                |     |
|  | 2.0 Turbo OPC  | 177  | 68999999   | 03.05  |   |  |  |   |                |     |
|  | 1.2  | 72000001   |  |  | 11.10   | 24.4125-1703.3   | 010907   |   | THz 25,40      | LUC |
|  | 1.3 CDTI   | 66   | 72000001   |  | 11.10   |  |  |   |                |     |
|  | 1.4  | 72000001   |  |  | 11.10   |  |  |   |                |     |
|  | 1.6  | 77   | 72000001   |  | 11.10   |  |  |   |                |     |
|  | 1.6  | 85   | 72000001   |  | 11.10   |  |  |   |                |     |
|  | 1.6 Turbo  | 132  | 72000001   |  | 11.10   |  |  |   |                |     |
|  | 1.7 CDTI   | 59   | 72000001   |  | 11.10   |  |  |   |                |     |
|  | 1.7 CDTI   | 74   | 72000001   |  | 11.10   |  |  |   |                |     |
|  | 1.7 CDTI   | 81   | 72000001   |  | 11.10   |  |  |   |                |     |
|  | 1.7 CDTI   | 92   | 72000001   |  | 11.10   |  |  |   |                |     |
|  | 1.8  | 92   | 72000001   |  | 11.10   |  |  |   |                |     |
|  | 1.8  | 103  | 72000001   |  | 11.10   |  |  |   |                |     |
|  | 2.0 Turbo  | 125  | 72000001   |  | 11.10   |  |  |   |                |     |
|  | 2.0 Turbo  | 147  | 72000001   |  | 11.10   |  |  |   |                |     |
|  | 2.0 Turbo OPC  | 177  | 72000001   |  | 11.10   |  |  |   |                |     |
|  | 1.9 CDTI   | 74   |  | 09.05  | 11.10   | 03.4155-0156.3   | 010862   |   | THz 25,40      | ATE |
|  | 1.9 CDTI   | 88   |  | 09.04  | 11.10   |  |  |   |                |     |
|  | 1.9 CDTI   | 110  |  | 09.04  | 11.10   |  |  |   |                |     |
|  | 1.2  |  |  | 08.05  | 11.10   | 11.9571-9823.2   | 220471   |  | D=57, - Halter | ATE |
|  | 1.3 CDTI   | 66   |  | 08.05  | 11.10   | 11.9571-9824.2   | 220472   |  | D=57, - Halter | ATE |
|  | 1.4  |  |  | 01.04  | 11.10   | 24.3571-9823.5   | 240499   |  | D=57, - Halter | ATE |
|  | 1.6  | 77   |  | 01.04  | 11.10   | 24.3571-9824.5   | 240500   |  | D=57, - Halter | ATE |
|  | 1.6  | 85   |  | 01.07  | 11.10   | 11.0441-5704.2   | 250034   |  | Dichtungssatz  | ATE |
|  | 1.7 CDTI   | 59   |  | 01.04  | 11.10   | 11.0101-5407.2   | 260011   |   | Hülsensatz     | ATE |
|  | 1.7 CDTI   | 74   |  | 01.04  | 11.10   | 11.8171-0008.1   | 990049   |   | Führungsbolzen | ATE |
|  | 1.7 CDTI   | 81   |  | 04.07  | 11.10   | 11.8116-0292.1   | 390521   | 2   | Haltefeder     | ATE |
|  | 1.8  | 92   |  | 01.04  | 11.10   |  |  |   |                |     |
|  | 1.8  | 103  |  | 01.06  | 11.10   |  |  |   |                |     |
|  | 1.6 Turbo  | 132  |  | 01.07  | 11.10   | 11.9571-9823.2   | 220471   |  | D=57, - Halter | ATE |
|  | 1.7 CDTI   | 92   |  | 04.07  | 11.10   | 11.9571-9824.2   | 220472   |  | D=57, - Halter | ATE |
|  | 1.9 CDTI   | 74   |  | 09.05  | 11.10   | 24.3571-9823.5   | 240499   |  | D=57, - Halter | ATE |
|  | 1.9 CDTI   | 88   |  | 09.04  | 11.10   | 24.3571-9824.5   | 240500   |  | D=57, - Halter | ATE |
|  | 1.9 CDTI   | 110  |  | 09.04  | 11.10   | 11.0441-5704.2   | 250034   |   | Dichtungssatz  | ATE |
|  | 2.0 Turbo  | 125  |  | 01.04  | 11.10   | 11.0101-5407.2   | 260011   |   | Hülsensatz     | ATE |
|  | 2.0 Turbo  | 147  |  | 09.04  | 11.10   | 11.8171-0008.1   | 990049   |   | Führungsbolzen | ATE |
|  | 2.0 Turbo OPC  | 177  |  | 03.05  | 11.10   | 11.8116-0292.1   | 390521   | 2   | Haltefeder     | ATE |
|  | 2.0 Turbo OPC  | 177  |  | 03.05  | 11.10   | 11.0101-5407.2   | 260011   |   | Hülsensatz     | ATE |
|  |  |  |  |  |   | 11.8171-0008.1   | 990049   |   | Führungsbolzen | ATE |
|  |  |  |  |  |   | 11.8116-0356.1   | 390586   | 2   | Haltefeder     | ATE |
|  | 1.2  |  |  | 08.05  | 11.10   | 24.5241-0430.3   | 330918   | 2   | L=430          |     |
|  | 1.3 CDTI   | 66   |  | 08.05  | 11.10   |  |  |   |                |     |
|  | 1.4  |  |  | 01.04  | 11.10   |  |  |   |                |     |
|  | 1.6  | 77   |  | 01.04  | 11.10   |  |  |   |                |     |
|  | 1.6  | 85   |  | 01.07  | 11.10   |  |  |   |                |     |
|  | 1.6 Turbo  | 132  |  | 01.07  | 11.10   |  |  |   |                |     |
|  | 1.7 CDTI   | 59   |  | 01.04  | 11.10   |  |  |   |                |     |
|  | 1.7 CDTI   | 74   |  | 01.04  | 11.10   |  |  |   |                |     |
|  | 1.7 CDTI   | 81   |  | 04.07  | 11.10   |  |  |   |                |     |
|  | 1.7 CDTI   | 92   |  | 04.07  | 11.10   |  |  |   |                |     |



**OPEL ASTRA H / GTC / Vauxhall Astra Mk V (04-10)**

|  |               |     |       |       |                |        |   |  |                          |
|--|---------------|-----|-------|-------|----------------|--------|---|--|--------------------------|
|  | 1.8           | 92  | 01.04 | 11.10 | 24.5241-0430.3 | 330918 | 2 |  | L=430                    |
|  | 1.8           | 103 | 01.06 | 11.10 |                |        |   |  |                          |
|  | 1.9 CDTI      | 74  | 09.05 | 11.10 |                |        |   |  |                          |
|  | 1.9 CDTI      | 88  | 09.04 | 11.10 |                |        |   |  |                          |
|  | 1.9 CDTI      | 110 | 09.04 | 11.10 |                |        |   |  |                          |
|  | 2.0 Turbo     | 125 | 01.04 | 11.10 |                |        |   |  |                          |
|  | 2.0 Turbo     | 147 | 09.04 | 11.10 |                |        |   |  |                          |
|  | 1.2           |     | 08.05 | 11.10 | 24.3367-1707.7 | 220669 |   | <input type="checkbox"/> für 4-Loch-Felge <sup>1)</sup>    | D=36, - Halter           |
|  | 1.3 CDTI      | 66  | 08.05 | 11.10 | 24.3367-1708.7 | 220670 |   | <input type="checkbox"/> für 4-Loch-Felge <sup>1)</sup>    | D=36, - Halter           |
|  | 1.4           |     | 01.04 | 11.10 | 24.3387-1701.7 | 220673 |   | <input type="checkbox"/> für 5-Loch-Felge <sup>2)</sup>    | D=38, - Halter           |
|  | 1.6           | 77  | 01.04 | 11.10 | 24.3387-1702.7 | 220674 |   | <input type="checkbox"/> für 5-Loch-Felge <sup>2)</sup>    | D=38, - Halter           |
|  | 1.6           | 85  | 01.07 | 11.10 |                |        |   |  |                          |
|  | 1.6 Turbo     | 132 | 01.07 | 11.10 |                |        |   |  |                          |
|  | 1.7 CDTI      | 59  | 01.04 | 11.10 |                |        |   |  |                          |
|  | 1.7 CDTI      | 74  | 01.04 | 11.10 |                |        |   |  |                          |
|  | 1.7 CDTI      | 81  | 04.07 | 11.10 |                |        |   |  |                          |
|  | 1.7 CDTI      | 92  | 04.07 | 11.10 |                |        |   |  |                          |
|  | 1.8           | 92  | 01.04 | 11.10 |                |        |   |  |                          |
|  | 1.8           | 103 | 01.06 | 11.10 |                |        |   |  |                          |
|  | 1.9 CDTI      | 74  | 09.05 | 11.10 |                |        |   |  |                          |
|  | 1.9 CDTI      | 88  | 09.04 | 11.10 |                |        |   |  |                          |
|  | 1.9 CDTI      | 110 | 09.04 | 11.10 |                |        |   |  |                          |
|  | 2.0 Turbo     | 125 | 01.04 | 11.10 |                |        |   |  |                          |
|  | 2.0 Turbo     | 147 | 09.04 | 11.10 |                |        |   |  |                          |
|  | 1.2           |     | 08.05 | 11.10 | 24.5157-0218.3 | 331095 |   | <input type="checkbox"/> + HA-Scheibenbremse <sup>3)</sup> | L=219/185, + Rohrleitung |
|  | 1.3 CDTI      | 66  | 08.05 | 11.10 | 24.5157-0219.3 | 331096 |   | <input type="checkbox"/> + HA-Scheibenbremse <sup>3)</sup> | L=219/185, + Rohrleitung |
|  | 1.4           |     | 01.04 | 11.10 |                |        |   |  |                          |
|  | 1.6           | 77  | 01.04 | 11.10 |                |        |   |  |                          |
|  | 1.6           | 85  | 01.07 | 11.10 |                |        |   |  |                          |
|  | 1.6 Turbo     | 132 | 01.07 | 11.10 |                |        |   |  |                          |
|  | 1.7 CDTI      | 59  | 01.04 | 11.10 |                |        |   |  |                          |
|  | 1.7 CDTI      | 74  | 01.04 | 11.10 |                |        |   |  |                          |
|  | 1.7 CDTI      | 81  | 04.07 | 11.10 |                |        |   |  |                          |
|  | 1.7 CDTI      | 92  | 04.07 | 11.10 |                |        |   |  |                          |
|  | 1.8           | 92  | 01.04 | 11.10 |                |        |   |  |                          |
|  | 1.8           | 103 | 01.06 | 11.10 |                |        |   |  |                          |
|  | 1.9 CDTI      | 74  | 09.05 | 11.10 |                |        |   |  |                          |
|  | 1.9 CDTI      | 88  | 09.04 | 11.10 |                |        |   |  |                          |
|  | 1.9 CDTI      | 110 | 09.04 | 11.10 |                |        |   |  |                          |
|  | 2.0 Turbo     | 125 | 01.04 | 11.10 |                |        |   |  |                          |
|  | 2.0 Turbo     | 147 | 09.04 | 11.10 |                |        |   |  |                          |
|  | 2.0 Turbo OPC | 177 | 03.05 | 11.10 |                |        |   |  |                          |
|  | 1.2           |     | 08.05 | 11.10 | 24.5152-0218.3 | 331042 |   | <input type="checkbox"/> + HA-Trommelbremse <sup>4)</sup>  | L=230, + Rohrleitung     |
|  | 1.3 CDTI      | 66  | 08.05 | 11.10 | 24.5152-0219.3 | 331043 |   | <input type="checkbox"/> + HA-Trommelbremse <sup>4)</sup>  | L=230, + Rohrleitung     |
|  | 1.4           |     | 01.04 | 11.10 |                |        |   |  |                          |
|  | 1.6           | 77  | 01.04 | 11.10 |                |        |   |  |                          |
|  | 1.6           | 85  | 01.07 | 11.10 |                |        |   |  |                          |
|  | 1.7 CDTI      | 59  | 01.04 | 11.10 |                |        |   |  |                          |
|  | 1.7 CDTI      | 74  | 01.04 | 11.10 |                |        |   |  |                          |
|  | 1.8           | 92  | 01.04 | 11.10 |                |        |   |  |                          |
|  | 1.8           | 103 | 01.06 | 11.10 |                |        |   |  |                          |
|  | 1.9 CDTI      | 74  | 09.05 | 11.10 |                |        |   |  |                          |
|  | 1.9 CDTI      | 88  | 09.04 | 11.10 |                |        |   |  |                          |
|  | 1.9 CDTI      | 110 | 09.04 | 11.10 |                |        |   |  |                          |
|  | 2.0 Turbo     | 125 | 01.04 | 11.10 |                |        |   |  |                          |
|  | 2.0 Turbo     | 147 | 09.04 | 11.10 |                |        |   |  |                          |
|  | 2.0 Turbo OPC | 177 | 03.05 | 11.10 |                |        |   |  |                          |
|  | 1.2           |     | 08.05 | 07.06 | 24.3220-1719.3 | 020448 |   |  | Rz 20,64                 |
|  | 1.4           |     | 01.04 | 07.06 |                |        |   |  |                          |
|  | 1.6           | 77  | 01.04 | 07.06 |                |        |   |  |                          |
|  | 1.7 CDTI      | 59  | 01.04 | 07.06 |                |        |   |  |                          |
|  | 1.7 CDTI      | 74  | 01.04 | 07.06 |                |        |   |  |                          |
|  | 1.2           |     | 08.06 | 11.10 | 24.3219-1755.3 | 020508 |   |  | Rz 19,05                 |
|  | 1.4           |     | 08.06 | 11.10 |                |        |   |  |                          |
|  | 1.6           | 77  | 08.06 | 11.10 |                |        |   |  |                          |
|  | 1.7 CDTI      | 59  | 08.06 | 11.10 |                |        |   |  |                          |
|  | 1.7 CDTI      | 74  | 08.06 | 11.10 |                |        |   |  |                          |
|  | 1.2           |     | 08.05 | 11.10 | 24.3727-0775.2 | 580775 | 1 | <input type="checkbox"/> + HA-Scheibenbremse <sup>3)</sup> | L=1647/1665              |
|  | 1.3 CDTI      | 66  | 08.05 | 11.10 |                |        |   |  |                          |
|  | 1.4           |     | 01.04 | 11.10 |                |        |   |  |                          |
|  | 1.6           | 77  | 01.04 | 11.10 |                |        |   |  |                          |
|  | 1.6           | 85  | 01.07 | 11.10 |                |        |   |  |                          |
|  | 1.6 Turbo     | 132 | 01.07 | 11.10 |                |        |   |  |                          |
|  | 1.7 CDTI      | 59  | 01.04 | 11.10 |                |        |   |  |                          |
|  | 1.7 CDTI      | 74  | 01.04 | 11.10 |                |        |   |  |                          |
|  | 1.7 CDTI      | 81  | 04.07 | 11.10 |                |        |   |  |                          |
|  | 1.7 CDTI      | 92  | 04.07 | 11.10 |                |        |   |  |                          |
|  | 1.8           | 92  | 01.04 | 11.10 |                |        |   |  |                          |
|  | 1.8           | 103 | 01.06 | 11.10 |                |        |   |  |                          |
|  | 1.9 CDTI      | 74  | 09.05 | 11.10 |                |        |   |  |                          |
|  | 1.9 CDTI      | 88  | 09.04 | 11.10 |                |        |   |  |                          |
|  | 1.9 CDTI      | 110 | 09.04 | 11.10 |                |        |   |  |                          |
|  | 2.0 Turbo     | 125 | 01.04 | 11.10 |                |        |   |  |                          |
|  | 2.0 Turbo     | 147 | 09.04 | 11.10 |                |        |   |  |                          |
|  | 2.0 Turbo OPC | 177 | 03.05 | 11.10 |                |        |   |  |                          |

1) for 4 bore wheel rim / per cerchione a 4 fori / pour jante à 4 trous / para Llantas de 4 taladros  
 2) for 5 bore wheel rim / per cerchione a 5 fori / pour jante à 5 trous / para Llantas de 5 taladros  
 3) + RA disc brake / + P disco freno / + frein à disque essieu AR / + ET-disco de freno  
 4) + RA drum brake / + P freno a tamburo / + frein à tambour essieu AR / + ET-tambores de freno



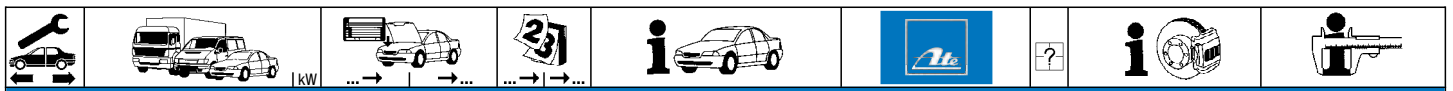

**OPEL ASTRA H / GTC / Vauxhall Astra Mk V (04-10)**















|               |           |      |       |       |       |                |        |   |   |                    |
|---------------|-----------|------|-------|-------|-------|----------------|--------|---|---|--------------------|
|               | 1.2       |      |       | 08.05 | 07.06 | 24.3727-0770.2 | 580770 | 1 | + HA-Trommelbremse <sup>1)</sup>          | L=1295/1328, + Zub |
|               | 1.4       |      |       | 01.04 | 07.06 | 24.3727-0746.2 | 580746 | 2 | Verlängerung/+HA-Trommelbr. <sup>2)</sup> | L=182, + Zub       |
|               | 1.6       | 77   |       | 01.04 | 07.06 |                |        |   |   |                    |
|               | 1.7 CDTI  | 59   |       | 01.04 | 07.06 |                |        |   |   |                    |
|               | 1.7 CDTI  | 74   |       | 01.04 | 07.06 |                |        |   |   |                    |
|               | 1.2       |      |       | 08.06 | 11.10 | 24.3727-0770.2 | 580770 | 1 | + HA-Trommelbremse <sup>1)</sup>          | L=1295/1328, + Zub |
|               | 1.4       |      |       | 08.06 | 11.10 |                |        |   |   |                    |
|               | 1.6       | 77   |       | 08.06 | 11.10 |                |        |   |   |                    |
|               | 1.7 CDTI  | 59   |       | 08.06 | 11.10 |                |        |   |   |                    |
|               | 1.7 CDTI  | 74   |       | 08.06 | 11.10 |                |        |   |   |                    |
|               | 1.2       | ‡    |       | 08.05 | 11.10 | 24.2415-1704.3 | 030087 |   |   | Gz 15,87           |
|               | 1.3 CDTI  | ‡ 66 |       | 08.05 | 11.10 |                |        |   |   |                    |
|               | 1.4       | ‡    |       | 01.04 | 11.10 |                |        |   |   |                    |
|               | 1.6       | ‡ 77 |       | 01.04 | 11.10 |                |        |   |   |                    |
|               | 1.6       | ‡ 85 |       | 01.07 | 11.10 |                |        |   |   |                    |
|               | 1.6 Turbo | ‡132 |       | 01.07 | 11.10 |                |        |   |   |                    |
|               | 1.7 CDTI  | ‡ 59 |       | 01.04 | 11.10 |                |        |   |   |                    |
|               | 1.7 CDTI  | ‡ 74 |       | 01.04 | 11.10 |                |        |   |   |                    |
|               | 1.7 CDTI  | ‡ 81 |       | 04.07 | 11.10 |                |        |   |   |                    |
|               | 1.7 CDTI  | ‡ 92 |       | 04.07 | 11.10 |                |        |   |   |                    |
|               | 1.8       | ‡ 92 |       | 01.04 | 11.10 |                |        |   |   |                    |
|               | 1.8       | ‡103 |       | 01.06 | 11.10 |                |        |   |   |                    |
|               | 1.9 CDTI  | ‡ 74 |       | 09.05 | 11.10 |                |        |   |   |                    |
|               | 1.9 CDTI  | ‡ 88 |       | 09.04 | 11.10 |                |        |   |   |                    |
|               | 1.9 CDTI  | ‡110 |       | 09.04 | 11.10 |                |        |   |   |                    |
|               | 2.0 Turbo | ‡125 |       | 01.04 | 11.10 |                |        |   |   |                    |
|               | 2.0 Turbo | ‡147 |       | 09.04 | 11.10 |                |        |   |   |                    |
| 2.0 Turbo OPC | ‡177      |      | 03.05 | 11.10 |       |                |        |   |   |                    |

**OPEL ASTRA H Caravan/Vau. Astra MKV Estate (04-10)**

|           |           |      |          |          |       |                |                |        |       |           |           |
|-----------|-----------|------|----------|----------|-------|----------------|----------------|--------|-------|-----------|-----------|
|           | 1.9 CDTI  | ‡ 74 |          | 09.05    | 11.10 | 03.7863-7803.4 | 300237         |        |       | 10"       | ATE       |
|           | 1.9 CDTI  | ‡ 88 |          | 08.04    | 11.10 |                |                |        |       |           |           |
|           | 1.9 CDTI  | ‡110 |          | 09.04    | 11.10 |                |                |        |       |           |           |
|           | 1.2       | ‡ 59 | 68999999 | 08.05    |       | 24.2125-1737.3 | 010906         |        | - ESP | THz 25,40 | LUC       |
|           | 1.3 CDTI  | ‡ 66 | 68999999 | 08.05    |       | 24.2125-1736.3 | 010904         |        | + ESP | THz 25,40 | LUC       |
|           | 1.4       | ‡    | 68999999 | 08.04    |       |                |                |        |       |           |           |
|           | 1.6       | ‡ 77 | 68999999 | 08.04    |       |                |                |        |       |           |           |
|           | 1.6       | ‡ 85 | 68999999 | 01.07    |       |                |                |        |       |           |           |
|           | 1.6 LPG   | ‡ 85 | 68999999 | 08.09    |       |                |                |        |       |           |           |
|           | 1.6 Turbo | ‡132 | 68999999 | 01.07    |       |                |                |        |       |           |           |
|           | 1.7 CDTI  | ‡ 59 | 68999999 | 08.04    |       |                |                |        |       |           |           |
|           | 1.7 CDTI  | ‡ 74 | 68999999 | 08.04    |       |                |                |        |       |           |           |
|           | 1.7 CDTI  | ‡ 81 | 68999999 | 04.07    |       |                |                |        |       |           |           |
|           | 1.7 CDTI  | ‡ 92 | 68999999 | 04.07    |       |                |                |        |       |           |           |
|           | 1.7 TD    | ‡ 79 | 68999999 | 08.04    |       |                |                |        |       |           |           |
|           | 1.8       | ‡ 92 | 68999999 | 08.04    |       |                |                |        |       |           |           |
|           | 1.8       | ‡103 | 68999999 | 08.05    |       |                |                |        |       |           |           |
|           | 2.0 Turbo | ‡125 | 68999999 | 08.04    |       |                |                |        |       |           |           |
|           | 2.0 Turbo | ‡147 | 68999999 | 09.04    |       |                |                |        |       |           |           |
|           |           | 1.2  | ‡ 59     | 72000001 |       | 11.10          | 24.2125-1704.3 | 010446 |       | - ESP     | THz 25,40 |
| 1.3 CDTI  |           | ‡ 66 | 72000001 |          | 11.10 | 24.2125-1703.3 | 010483         |        | + ESP | THz 25,40 | LUC       |
| 1.4       |           | ‡    | 72000001 |          | 11.10 |                |                |        |       |           |           |
| 1.6       |           | ‡ 77 | 72000001 |          | 11.10 |                |                |        |       |           |           |
| 1.6       |           | ‡ 85 | 72000001 |          | 11.10 |                |                |        |       |           |           |
| 1.6 LPG   |           | ‡ 85 | 72000001 |          | 11.10 |                |                |        |       |           |           |
| 1.6 Turbo |           | ‡132 | 72000001 |          | 11.10 |                |                |        |       |           |           |
| 1.7 CDTI  |           | ‡ 59 | 72000001 |          | 11.10 |                |                |        |       |           |           |
| 1.7 CDTI  |           | ‡ 74 | 72000001 |          | 11.10 |                |                |        |       |           |           |
| 1.7 CDTI  |           | ‡ 81 | 72000001 |          | 11.10 |                |                |        |       |           |           |
| 1.7 CDTI  |           | ‡ 92 | 72000001 |          | 11.10 |                |                |        |       |           |           |
| 1.7 TD    |           | ‡ 79 | 72000001 |          | 11.10 |                |                |        |       |           |           |
| 1.8       |           | ‡ 92 | 72000001 |          | 11.10 |                |                |        |       |           |           |
| 1.8       |           | ‡103 | 72000001 |          | 11.10 |                |                |        |       |           |           |
| 2.0 Turbo |           | ‡125 | 72000001 |          | 11.10 |                |                |        |       |           |           |
| 2.0 Turbo |           | ‡147 | 72000001 |          | 11.10 |                |                |        |       |           |           |
|           |           | 1.2  | ‡ 59     | 62999999 | 08.05 |                | 24.2125-1736.3 | 010904 |       |           | THz 25,40 |
|           | 1.3 CDTI  | ‡ 66 | 62999999 | 08.05    |       |                |                |        |       |           |           |
|           | 1.4       | ‡    | 62999999 | 08.04    |       |                |                |        |       |           |           |
|           | 1.6       | ‡ 77 | 62999999 | 08.04    |       |                |                |        |       |           |           |
|           | 1.6       | ‡ 85 | 62999999 | 01.07    |       |                |                |        |       |           |           |
|           | 1.6 LPG   | ‡ 85 | 62999999 | 08.09    |       |                |                |        |       |           |           |
|           | 1.6 Turbo | ‡132 | 62999999 | 01.07    |       |                |                |        |       |           |           |
|           | 1.7 CDTI  | ‡ 59 | 62999999 | 08.04    |       |                |                |        |       |           |           |
|           | 1.7 CDTI  | ‡ 74 | 62999999 | 08.04    |       |                |                |        |       |           |           |
|           | 1.7 CDTI  | ‡ 81 | 62999999 | 04.07    |       |                |                |        |       |           |           |
|           | 1.7 CDTI  | ‡ 92 | 62999999 | 04.07    |       |                |                |        |       |           |           |
|           | 1.7 TD    | ‡ 79 | 62999999 | 08.04    |       |                |                |        |       |           |           |
|           | 1.8       | ‡ 92 | 62999999 | 08.04    |       |                |                |        |       |           |           |
|           | 1.8       | ‡103 | 62999999 | 08.05    |       |                |                |        |       |           |           |
|           | 2.0 Turbo | ‡125 | 62999999 | 08.04    |       |                |                |        |       |           |           |
|           | 2.0 Turbo | ‡147 | 62999999 | 09.04    |       |                |                |        |       |           |           |
|           |           | 1.2  | ‡ 59     | 72000001 |       | 11.10          | 24.4125-1703.3 | 010907 |       |           | THz 25,40 |
| 1.3 CDTI  |           | ‡ 66 | 72000001 |          | 11.10 |                |                |        |       |           |           |
| 1.4       |           | ‡    | 72000001 |          | 11.10 |                |                |        |       |           |           |
| 1.6       |           | ‡ 77 | 72000001 |          | 11.10 |                |                |        |       |           |           |
| 1.6 LPG   |           | ‡ 85 | 72000001 |          | 11.10 |                |                |        |       |           |           |

<sup>1)</sup> + RA drum brake / + P freno a tamburo / + frein à tambour essieu AR / + ET-tambores de freno  
<sup>2)</sup> extension only / + RA drum br. / solo prolunga/+ P fra tamburo / rallonge seulem.+ tamb.ess.AR / solam. prolongad./+ tambores ET



|     |    |    |  |    |   |    |    |   |   |
|--|--|--|--|--|--|--|--|---|---|
| <b>OPEL ASTRA H Caravan/Vau. Astra MKV Estate (04-10)</b>                          |  |  |  |  |  |  |  |   |   |
|    | 1.6 Turbo<br>1.7 CDTI<br>1.7 CDTI<br>1.7 CDTI<br>1.7 CDTI<br>1.7 TD<br>1.8<br>1.8<br>2.0 Turbo<br>2.0 Turbo  | 132 72000001<br>59 72000001<br>74 72000001<br>81 72000001<br>92 72000001<br>79 72000001<br>92 72000001<br>103 72000001<br>125 72000001<br>147 72000001 |  |  | 11.10<br>11.10<br>11.10<br>11.10<br>11.10<br>11.10<br>11.10<br>11.10<br>11.10<br>11.10   | 24.4125-1703.3<br>010907   |  | THz 25,40   | LUC   |
|  | 1.9 CDTI<br>1.9 CDTI<br>1.9 CDTI   | 74<br>88<br>110  |  | 09.05<br>08.04<br>09.04  | 11.10<br>11.10<br>11.10  | 03.4155-0156.3<br>010862   |  | THz 25,40   | ATE   |
|    | 1.2<br>1.3 CDTI<br>1.4<br>1.6<br>1.6<br>1.6 LPG<br>1.7 CDTI<br>1.7 CDTI<br>1.7 CDTI<br>1.7 TD<br>1.8<br>1.8<br>1.6 Turbo<br>1.7 CDTI<br>1.9 CDTI<br>1.9 CDTI<br>2.0 Turbo<br>2.0 Turbo | 59<br>66<br><br>77<br>85<br>85<br>59<br>74<br>81<br>79<br>92<br>103<br>132<br>92<br>74<br>88<br>110<br>125<br>147                                      |  | 08.05<br>08.05<br>08.04<br>08.04<br>01.07<br>08.09<br>08.04<br>08.04<br>04.07<br>08.04<br>09.04<br>08.05<br>01.07<br>04.07<br>09.05<br>08.04<br>09.04          | 11.10<br>11.10<br>11.10<br>11.10<br>11.10<br>11.10<br>11.10<br>11.10<br>11.10<br>11.10<br>11.10<br>11.10<br>11.10<br>11.10<br>11.10<br>11.10<br>11.10<br>11.10 | 11.9571-9823.2<br>11.9571-9824.2<br>24.3571-9823.5<br>24.3571-9824.5<br>11.0441-5704.2<br>11.0101-5407.2<br>11.8171-0008.1<br>11.8116-0292.1<br>220471<br>220472<br>240499<br>240500<br>250034<br>260011<br>990049<br>390521 | 2<br>2   | D=57, - Halter<br>D=57, - Halter<br>D=57, - Halter<br>D=57, - Halter<br>Dichtungssatz<br>Hülsensatz<br>Führungsbolzen<br>Haltefeder | ATE<br>ATE<br>ATE<br>ATE<br>ATE<br>ATE<br>ATE<br>ATE<br>ATE<br>ATE<br>ATE<br>ATE<br>ATE<br>ATE<br>ATE<br>ATE<br>ATE<br>ATE<br>ATE |
|    | 1.2<br>1.3 CDTI<br>1.4<br>1.6<br>1.6<br>1.6 LPG<br>1.6 Turbo<br>1.7 CDTI<br>1.7 CDTI<br>1.7 CDTI<br>1.7 TD<br>1.8<br>1.8<br>1.9 CDTI<br>1.9 CDTI<br>1.9 CDTI<br>2.0 Turbo<br>2.0 Turbo | 59<br>66<br><br>77<br>85<br>85<br>132<br>59<br>74<br>81<br>79<br>92<br>103<br>74<br>88<br>110<br>125<br>147  |  | 08.05<br>08.05<br>08.04<br>08.04<br>01.07<br>08.09<br>01.07<br>08.04<br>08.04<br>04.07<br>08.04<br>09.04<br>08.05<br>09.05<br>08.04<br>09.04<br>08.04<br>09.04 | 11.10<br>11.10<br>11.10<br>11.10<br>11.10<br>11.10<br>11.10<br>11.10<br>11.10<br>11.10<br>11.10<br>11.10<br>11.10<br>11.10<br>11.10<br>11.10<br>11.10<br>11.10 | 24.5241-0430.3<br>330918   | 2  | L=430   |   |
|  | 1.2<br>1.3 CDTI<br>1.4<br>1.6<br>1.6<br>1.6 LPG<br>1.6 Turbo<br>1.7 CDTI<br>1.7 CDTI<br>1.7 CDTI<br>1.7 TD<br>1.8<br>1.8<br>1.9 CDTI<br>1.9 CDTI<br>1.9 CDTI<br>2.0 Turbo<br>2.0 Turbo | 59<br>66<br><br>77<br>85<br>85<br>132<br>59<br>74<br>81<br>79<br>92<br>103<br>74<br>88<br>110<br>125<br>147  |  | 08.05<br>08.05<br>08.04<br>08.04<br>01.07<br>08.09<br>01.07<br>08.04<br>08.04<br>04.07<br>08.04<br>09.04<br>08.05<br>09.05<br>08.04<br>09.04<br>08.04<br>09.04 | 11.10<br>11.10<br>11.10<br>11.10<br>11.10<br>11.10<br>11.10<br>11.10<br>11.10<br>11.10<br>11.10<br>11.10<br>11.10<br>11.10<br>11.10<br>11.10<br>11.10<br>11.10 | 24.3367-1707.7<br>24.3367-1708.7<br>24.3387-1701.7<br>24.3387-1702.7<br>220669<br>220670<br>220673<br>220674   | <input type="checkbox"/> für 4-Loch-Felge <sup>1)</sup><br><input type="checkbox"/> für 4-Loch-Felge <sup>1)</sup><br><input type="checkbox"/> für 5-Loch-Felge <sup>2)</sup><br><input type="checkbox"/> für 5-Loch-Felge <sup>2)</sup> | D=36, - Halter<br>D=36, - Halter<br>D=38, - Halter<br>D=38, - Halter  | LUC<br>LUC<br>LUC<br>LUC<br>LUC<br>LUC<br>LUC<br>LUC<br>LUC<br>LUC<br>LUC<br>LUC<br>LUC<br>LUC<br>LUC<br>LUC<br>LUC<br>LUC<br>LUC |
|  | 1.2<br>1.3 CDTI<br>1.4<br>1.6<br>1.6<br>1.6 LPG<br>1.6 Turbo<br>1.7 CDTI<br>1.7 CDTI<br>1.7 CDTI<br>1.7 TD<br>1.8<br>1.8<br>1.9 CDTI<br>1.9 CDTI                                       | 59<br>66<br><br>77<br>85<br>85<br>132<br>59<br>74<br>81<br>79<br>92<br>103<br>74<br>88   |  | 08.08<br>08.05<br>08.04<br>08.04<br>01.07<br>08.09<br>01.07<br>08.04<br>08.04<br>04.07<br>08.04<br>09.04<br>08.05<br>09.05                                     | 11.10<br>11.10<br>11.10<br>11.10<br>11.10<br>11.10<br>11.10<br>11.10<br>11.10<br>11.10<br>11.10<br>11.10<br>11.10<br>11.10                                     | 24.5157-0218.3<br>24.5157-0219.3<br>331095<br>331096   | <input type="checkbox"/><br><input type="checkbox"/>   | L=219/185, + Rohrleitung<br>L=219/185, + Rohrleitung  |   |

<sup>1)</sup> for 4 bore wheel rim / per cerchione a 4 fori / pour jante à 4 trous / para Llantas de 4 taladros  
<sup>2)</sup> for 5 bore wheel rim / per cerchione a 5 fori / pour jante à 5 trous / para Llantas de 5 taladros





**OPEL ASTRA H Caravan/Vau. Astra MKV Estate (04-10)**

|  |           |     |  |       |       |                |        |   |   |   |  |                          |
|--|-----------|-----|--|-------|-------|----------------|--------|---|---|---|--|--------------------------|
|  | 1.9 CDTI  | 110 |  | 09.04 | 11.10 | 24.5157-0218.3 | 331095 |   |   |   |  |                          |
|  | 2.0 Turbo | 125 |  | 08.04 | 11.10 | 24.5157-0219.3 | 331096 |   |   |   |  | L=219/185, + Rohrleitung |
|  | 2.0 Turbo | 147 |  | 09.04 | 11.10 |                |        |   |   |   |  | L=219/185, + Rohrleitung |
|  | 1.4       |     |  | 08.04 | 07.06 | 24.3220-1719.3 | 020448 |   |   |   |  | Rz 20,64                 |
|  | 1.6       | 77  |  | 08.04 | 07.06 |                |        |   |   |   |  |                          |
|  | 1.7 CDTI  | 59  |  | 08.04 | 07.06 |                |        |   |   |   |  |                          |
|  | 1.7 CDTI  | 74  |  | 08.04 | 07.06 |                |        |   |   |   |  |                          |
|  | 1.4       |     |  | 08.06 | 11.10 | 24.3219-1755.3 | 020508 |   |   |   |  | Rz 19,05                 |
|  | 1.6       | 77  |  | 08.06 | 11.10 |                |        |   |   |   |  |                          |
|  | 1.7 CDTI  | 59  |  | 08.06 | 11.10 |                |        |   |   |   |  |                          |
|  | 1.7 CDTI  | 74  |  | 08.06 | 11.10 |                |        |   |   |   |  |                          |
|  | 1.2       | 59  |  | 08.05 | 11.10 | 24.3727-0785.2 | 580785 | 1 | + | HA-Scheibenbremse <sup>1)</sup>           |  | L=1735/1760, + Zub       |
|  | 1.3 CDTI  | 66  |  | 08.05 | 11.10 |                |        |   |   |   |  |                          |
|  | 1.4       |     |  | 08.04 | 11.10 |                |        |   |   |   |  |                          |
|  | 1.6       | 77  |  | 08.04 | 11.10 |                |        |   |   |   |  |                          |
|  | 1.6       | 85  |  | 01.07 | 11.10 |                |        |   |   |   |  |                          |
|  | 1.6 LPG   | 85  |  | 08.09 | 11.10 |                |        |   |   |   |  |                          |
|  | 1.6 Turbo | 132 |  | 01.07 | 11.10 |                |        |   |   |   |  |                          |
|  | 1.7 CDTI  | 59  |  | 08.04 | 11.10 |                |        |   |   |   |  |                          |
|  | 1.7 CDTI  | 74  |  | 08.04 | 11.10 |                |        |   |   |   |  |                          |
|  | 1.7 CDTI  | 81  |  | 04.07 | 11.10 |                |        |   |   |   |  |                          |
|  | 1.7 CDTI  | 92  |  | 04.07 | 11.10 |                |        |   |   |   |  |                          |
|  | 1.7 TD    | 79  |  | 08.05 | 11.10 |                |        |   |   |   |  |                          |
|  | 1.8       | 92  |  | 09.04 | 11.10 |                |        |   |   |   |  |                          |
|  | 1.8       | 103 |  | 08.05 | 11.10 |                |        |   |   |   |  |                          |
|  | 1.9 CDTI  | 74  |  | 09.05 | 11.10 |                |        |   |   |   |  |                          |
|  | 1.9 CDTI  | 88  |  | 08.04 | 11.10 |                |        |   |   |   |  |                          |
|  | 1.9 CDTI  | 110 |  | 09.04 | 11.10 |                |        |   |   |   |  |                          |
|  | 2.0 Turbo | 125 |  | 08.04 | 11.10 |                |        |   |   |   |  |                          |
|  | 2.0 Turbo | 147 |  | 09.04 | 11.10 |                |        |   |   |   |  |                          |
|  | 1.2       | 59  |  | 08.05 | 11.10 | 24.3727-0770.2 | 580770 | 1 | + | HA-Trommelbremse <sup>2)</sup>            |  | L=1295/1328, + Zub       |
|  | 1.4       |     |  | 08.04 | 11.10 | 24.3727-0746.2 | 580746 | 2 | + | Verlängerung/+HA-Trommelbr. <sup>3)</sup> |  | L=182, + Zub             |
|  | 1.6       | 77  |  | 08.04 | 11.10 |                |        |   |   |   |  |                          |
|  | 1.7 CDTI  | 59  |  | 08.04 | 11.10 |                |        |   |   |   |  |                          |
|  | 1.7 CDTI  | 74  |  | 08.04 | 11.10 |                |        |   |   |   |  |                          |
|  | 1.7 TD    | 79  |  | 08.04 | 11.10 |                |        |   |   |   |  |                          |
|  | 1.2       | 59  |  | 08.05 | 11.10 | 24.2415-1704.3 | 030087 |   |   |   |  | Gz 15,87                 |
|  | 1.3 CDTI  | 66  |  | 08.05 | 11.10 |                |        |   |   |   |  |                          |
|  | 1.4       |     |  | 08.04 | 11.10 |                |        |   |   |   |  |                          |
|  | 1.6       | 77  |  | 08.04 | 11.10 |                |        |   |   |   |  |                          |
|  | 1.6       | 85  |  | 01.07 | 11.10 |                |        |   |   |   |  |                          |
|  | 1.6 LPG   | 85  |  | 08.09 | 11.10 |                |        |   |   |   |  |                          |
|  | 1.6 Turbo | 132 |  | 01.07 | 11.10 |                |        |   |   |   |  |                          |
|  | 1.7 CDTI  | 59  |  | 08.04 | 11.10 |                |        |   |   |   |  |                          |
|  | 1.7 CDTI  | 74  |  | 08.04 | 11.10 |                |        |   |   |   |  |                          |
|  | 1.7 CDTI  | 81  |  | 04.07 | 11.10 |                |        |   |   |   |  |                          |
|  | 1.7 CDTI  | 92  |  | 04.07 | 11.10 |                |        |   |   |   |  |                          |
|  | 1.7 TD    | 79  |  | 08.04 | 11.10 |                |        |   |   |   |  |                          |
|  | 1.8       | 92  |  | 09.04 | 11.10 |                |        |   |   |   |  |                          |
|  | 1.8       | 103 |  | 08.05 | 11.10 |                |        |   |   |   |  |                          |
|  | 1.9 CDTI  | 74  |  | 09.05 | 11.10 |                |        |   |   |   |  |                          |
|  | 1.9 CDTI  | 88  |  | 08.04 | 11.10 |                |        |   |   |   |  |                          |
|  | 1.9 CDTI  | 110 |  | 09.04 | 11.10 |                |        |   |   |   |  |                          |
|  | 2.0 Turbo | 125 |  | 08.04 | 11.10 |                |        |   |   |   |  |                          |
|  | 2.0 Turbo | 147 |  | 09.04 | 11.10 |                |        |   |   |   |  |                          |

**OPEL ASTRA H TwinTop (06-10)**

|  |           |     |          |       |       |                |        |  |       |  |           |     |
|--|-----------|-----|----------|-------|-------|----------------|--------|--|-------|--|-----------|-----|
|  | 1.9 CDTI  | 110 |          | 03.06 | 11.10 | 03.7863-7803.4 | 300237 |  |       |  | 10"       | ATE |
|  | 1.6       | 77  | 68999999 | 03.06 |       | 24.2125-1737.3 | 010906 |  | - ESP |  | THz 25,40 | LUC |
|  | 1.6       | 85  | 68999999 | 12.06 |       | 24.2125-1736.3 | 010904 |  | + ESP |  | THz 25,40 | LUC |
|  | 1.6 Turbo | 132 | 68999999 | 02.07 |       |                |        |  |       |  |           |     |
|  | 1.8       |     | 68999999 | 03.06 |       |                |        |  |       |  |           |     |
|  | 2.0 Turbo | 125 | 68999999 | 03.06 |       |                |        |  |       |  |           |     |
|  | 2.0 Turbo | 147 | 68999999 | 03.06 |       |                |        |  |       |  |           |     |
|  | 1.6       | 77  | 72000001 |       | 11.10 | 24.4125-1704.3 | 010908 |  | - ESP |  | THz 25,40 | LUC |
|  | 1.6       | 85  | 72000001 |       | 11.10 | 24.4125-1703.3 | 010907 |  | + ESP |  | THz 25,40 | LUC |
|  | 1.6 Turbo | 132 | 72000001 |       | 11.10 |                |        |  |       |  |           |     |
|  | 1.8       |     | 72000001 |       | 11.10 |                |        |  |       |  |           |     |
|  | 2.0 Turbo | 125 | 72000001 |       | 11.10 |                |        |  |       |  |           |     |
|  | 2.0 Turbo | 147 | 72000001 |       | 11.10 |                |        |  |       |  |           |     |
|  | 1.9 CDTI  | 110 |          | 03.06 | 11.10 | 03.4155-0156.3 | 010862 |  | + ESP |  | THz 25,40 | ATE |
|  | 1.6       | 77  | 68999999 | 03.06 |       | 24.2125-1736.3 | 010904 |  |       |  | THz 25,40 | LUC |
|  | 1.6       | 85  | 68999999 | 12.06 |       |                |        |  |       |  |           |     |
|  | 1.6 Turbo | 132 | 68999999 | 02.07 |       |                |        |  |       |  |           |     |
|  | 1.8       |     | 68999999 | 03.06 |       |                |        |  |       |  |           |     |
|  | 2.0 Turbo | 125 | 68999999 | 03.06 |       |                |        |  |       |  |           |     |
|  | 2.0 Turbo | 147 | 68999999 | 03.06 |       |                |        |  |       |  |           |     |
|  | 1.6       | 77  |          | 03.06 | 11.10 | 24.4125-1703.3 | 010907 |  |       |  | THz 25,40 | LUC |
|  | 1.6       | 85  |          | 12.06 | 11.10 |                |        |  |       |  |           |     |
|  | 1.6 Turbo | 132 |          | 02.07 | 11.10 |                |        |  |       |  |           |     |
|  | 1.8       |     |          | 03.06 | 11.10 |                |        |  |       |  |           |     |
|  | 2.0 Turbo | 125 |          | 03.06 | 11.10 |                |        |  |       |  |           |     |
|  | 2.0 Turbo | 147 |          | 03.06 | 11.10 |                |        |  |       |  |           |     |

1) + RA disc brake / + P disco freno / + frein à disque essieu AR / + ET-disco de freno  
 2) + RA drum brake / + P freno a tamburo / + frein à tambour essieu AR / + ET-tambores de freno  
 3) extension only / + RA drum br. / solo prolonga/+ P fra tamburo / rallonge seules.+ tamb.ess.AR / solam. prolongad./+ tambores ET





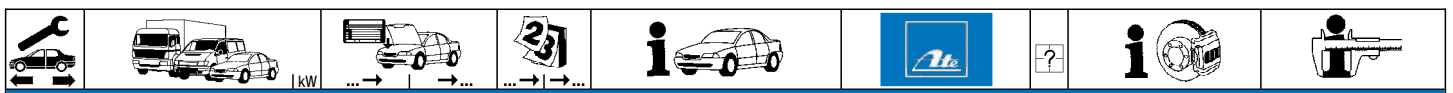

**OPEL ASTRA H TwinTop (06-10)**

|  |           |     |  |       |       |  |                |        |   |                                   |                                   |             |
|--|-----------|-----|--|-------|-------|--|----------------|--------|---|-----------------------------------|-----------------------------------|-------------|
|  | 1.9 CDTI  | 110 |  | 03.06 | 11.10 |  | 03.4155-0156.3 | 010862 |   |                                   | THz 25,40                         | ATE         |
|  | 1.6       | 77  |  | 03.06 | 11.10 |  | 11.9571-9823.2 | 220471 |   |                                   | D=57, - Halter                    | ATE         |
|  | 1.6       | 85  |  | 12.06 | 11.10 |  | 11.9571-9824.2 | 220472 |   |                                   | D=57, - Halter                    | ATE         |
|  | 1.8       |     |  | 03.06 | 11.10 |  | 24.3571-9823.5 | 240499 |   |                                   | D=57, - Halter                    | ATE         |
|  |           |     |  |       |       |  | 24.3571-9824.5 | 240500 |   |                                   | D=57, - Halter                    | ATE         |
|  |           |     |  |       |       |  | 11.0441-5704.2 | 250034 |   |                                   | Dichtungssatz                     | ATE         |
|  |           |     |  |       |       |  | 11.0101-5407.2 | 260011 |   |                                   | Hülsensatz                        | ATE         |
|  |           |     |  |       |       |  | 11.8171-0008.1 | 990049 |   |                                   | Führungsbolzen                    | ATE         |
|  |           |     |  |       |       |  | 11.8116-0292.1 | 390521 | 2 |                                   | Haltefeder                        | ATE         |
|  | 1.6 Turbo | 132 |  | 02.07 | 11.10 |  | 11.9571-9823.2 | 220471 |   |                                   | D=57, - Halter                    | ATE         |
|  | 1.9 CDTI  | 110 |  | 03.06 | 11.10 |  | 11.9571-9824.2 | 220472 |   |                                   | D=57, - Halter                    | ATE         |
|  | 2.0 Turbo | 125 |  | 03.06 | 11.10 |  | 24.3571-9823.5 | 240499 |   |                                   | D=57, - Halter                    | ATE         |
|  | 2.0 Turbo | 147 |  | 03.06 | 11.10 |  | 24.3571-9824.5 | 240500 |   |                                   | D=57, - Halter                    | ATE         |
|  |           |     |  |       |       |  | 11.0441-5704.2 | 250034 |   |                                   | Dichtungssatz                     | ATE         |
|  |           |     |  |       |       |  | 11.0101-5407.2 | 260011 |   |                                   | Hülsensatz                        | ATE         |
|  |           |     |  |       |       |  | 11.8171-0008.1 | 990049 |   |                                   | Führungsbolzen                    | ATE         |
|  |           |     |  |       |       |  | 11.8116-0292.1 | 390521 | 2 |                                   | Haltefeder                        | ATE         |
|  | 1.6       | 77  |  | 03.06 | 11.10 |  | 24.5241-0430.3 | 330918 | 2 |                                   | L=430                             |             |
|  | 1.6       | 85  |  | 12.06 | 11.10 |  |                |        |   |                                   |                                   |             |
|  | 1.6 Turbo | 132 |  | 02.07 | 11.10 |  |                |        |   |                                   |                                   |             |
|  | 1.8       |     |  | 03.06 | 11.10 |  |                |        |   |                                   |                                   |             |
|  | 1.9 CDTI  | 110 |  | 03.06 | 11.10 |  |                |        |   |                                   |                                   |             |
|  | 2.0 Turbo | 125 |  | 03.06 | 11.10 |  |                |        |   |                                   |                                   |             |
|  | 2.0 Turbo | 147 |  | 03.06 | 11.10 |  |                |        |   |                                   |                                   |             |
|  | 1.6       | 77  |  | 03.06 | 11.10 |  | 24.3367-1707.7 | 220669 |   | für 4-Loch-Felge <sup>1)</sup>    | D=36, - Halter                    | LUC         |
|  | 1.6       | 85  |  | 12.06 | 11.10 |  | 24.3367-1708.7 | 220670 |   | für 4-Loch-Felge <sup>1)</sup>    | D=36, - Halter                    | LUC         |
|  | 1.6 Turbo | 132 |  | 02.07 | 11.10 |  | 24.3387-1701.7 | 220673 |   | für 5-Loch-Felge <sup>2)</sup>    | D=38, - Halter                    | LUC         |
|  | 1.8       |     |  | 03.06 | 11.10 |  | 24.3387-1702.7 | 220674 |   | für 5-Loch-Felge <sup>2)</sup>    | D=38, - Halter                    | LUC         |
|  | 1.9 CDTI  | 110 |  | 03.06 | 11.10 |  |                |        |   |                                   |                                   |             |
|  | 2.0 Turbo | 125 |  | 03.06 | 11.10 |  |                |        |   |                                   |                                   |             |
|  | 2.0 Turbo | 147 |  | 03.06 | 11.10 |  |                |        |   |                                   |                                   |             |
|  | 1.6       | 77  |  | 03.06 | 11.10 |  | 24.5157-0218.3 | 331095 |   | + HA-Scheibenbremse <sup>3)</sup> | L=219/185, + Rohrleitung          |             |
|  | 1.6       | 85  |  | 12.06 | 11.10 |  | 24.5157-0219.3 | 331096 |   | + HA-Scheibenbremse <sup>3)</sup> | L=219/185, + Rohrleitung          |             |
|  | 1.6 Turbo | 132 |  | 02.07 | 11.10 |  |                |        |   |                                   |                                   |             |
|  | 1.8       |     |  | 03.06 | 11.10 |  |                |        |   |                                   |                                   |             |
|  | 1.9 CDTI  | 110 |  | 03.06 | 11.10 |  |                |        |   |                                   |                                   |             |
|  | 2.0 Turbo | 125 |  | 03.06 | 11.10 |  |                |        |   |                                   |                                   |             |
|  | 2.0 Turbo | 147 |  | 03.06 | 11.10 |  |                |        |   |                                   |                                   |             |
|  | 1.6       | 77  |  | 03.06 | 11.10 |  | 24.3727-0775.2 | 580775 | 1 |                                   | + HA-Scheibenbremse <sup>3)</sup> | L=1647/1665 |
|  | 1.6       | 85  |  | 12.06 | 11.10 |  |                |        |   |                                   |                                   |             |
|  | 1.6 Turbo | 132 |  | 02.07 | 11.10 |  |                |        |   |                                   |                                   |             |
|  | 1.8       |     |  | 03.06 | 11.10 |  |                |        |   |                                   |                                   |             |
|  | 1.9 CDTI  | 110 |  | 03.06 | 11.10 |  |                |        |   |                                   |                                   |             |
|  | 2.0 Turbo | 125 |  | 03.06 | 11.10 |  |                |        |   |                                   |                                   |             |
|  | 2.0 Turbo | 147 |  | 03.06 | 11.10 |  |                |        |   |                                   |                                   |             |
|  | 1.6       | 77  |  | 03.06 | 11.10 |  | 24.2415-1704.3 | 030087 |   |                                   | Gz 15,87                          |             |
|  | 1.6       | 85  |  | 12.06 | 11.10 |  |                |        |   |                                   |                                   |             |
|  | 1.6 Turbo | 132 |  | 02.07 | 11.10 |  |                |        |   |                                   |                                   |             |
|  | 1.8       |     |  | 03.06 | 11.10 |  |                |        |   |                                   |                                   |             |
|  | 1.9 CDTI  | 110 |  | 03.06 | 11.10 |  |                |        |   |                                   |                                   |             |
|  | 2.0 Turbo | 125 |  | 03.06 | 11.10 |  |                |        |   |                                   |                                   |             |
|  | 2.0 Turbo | 147 |  | 03.06 | 11.10 |  |                |        |   |                                   |                                   |             |

**OPEL ASTRA J / GTC / Vauxhall Astra MK VI (09-)**

|  |                       |     |  |       |  |  |                |        |  |  |             |     |
|--|-----------------------|-----|--|-------|--|--|----------------|--------|--|--|-------------|-----|
|  | 1.3 CDTI ECOTEC       | 70  |  | 12.09 |  |  | 03.7858-0732.4 | 300272 |  |  | 9/8" Tandem | ATE |
|  | 1.4 ecoFLEX           | 64  |  | 12.09 |  |  |                |        |  |  |             |     |
|  | 1.4 ecoFLEX           | 74  |  | 12.09 |  |  |                |        |  |  |             |     |
|  | 1.4 LPG Turbo ecoFLEX | 103 |  | 01.12 |  |  |                |        |  |  |             |     |
|  | 1.4 Turbo ECOTEC      | 88  |  | 11.10 |  |  |                |        |  |  |             |     |
|  | 1.4 Turbo ECOTEC      | 103 |  | 12.09 |  |  |                |        |  |  |             |     |
|  | 1.6 SIDI              | 125 |  | 12.12 |  |  |                |        |  |  |             |     |
|  | 1.6 Turbo ECOTEC      | 85  |  | 12.09 |  |  |                |        |  |  |             |     |
|  | 1.6 Turbo ECOTEC      | 132 |  | 12.09 |  |  |                |        |  |  |             |     |
|  | 1.7 CDTI ECOTEC       | 81  |  | 12.09 |  |  |                |        |  |  |             |     |
|  | 1.7 CDTI ECOTEC       | 96  |  | 12.09 |  |  |                |        |  |  |             |     |
|  | 1.8                   | 103 |  | 10.11 |  |  |                |        |  |  |             |     |
|  | 2.0 CDTi BiTurbo      | 143 |  | 12.12 |  |  |                |        |  |  |             |     |
|  | 2.0 CDTI ECOTEC       |     |  | 12.09 |  |  |                |        |  |  |             |     |
|  | 1.3 CDTI ECOTEC       | 70  |  | 12.09 |  |  | 03.2125-0421.3 | 010934 |  |  | THz 25,40   | ATE |
|  | 1.4 ecoFLEX           | 64  |  | 12.09 |  |  |                |        |  |  |             |     |
|  | 1.4 ecoFLEX           | 74  |  | 12.09 |  |  |                |        |  |  |             |     |
|  | 1.4 LPG Turbo ecoFLEX | 103 |  | 01.12 |  |  |                |        |  |  |             |     |
|  | 1.4 Turbo ECOTEC      | 88  |  | 11.10 |  |  |                |        |  |  |             |     |
|  | 1.4 Turbo ECOTEC      | 103 |  | 12.09 |  |  |                |        |  |  |             |     |
|  | 1.6 SIDI              | 125 |  | 12.12 |  |  |                |        |  |  |             |     |
|  | 1.6 Turbo ECOTEC      | 85  |  | 12.09 |  |  |                |        |  |  |             |     |
|  | 1.6 Turbo ECOTEC      | 132 |  | 12.09 |  |  |                |        |  |  |             |     |
|  | 1.7 CDTI ECOTEC       | 81  |  | 12.09 |  |  |                |        |  |  |             |     |
|  | 1.7 CDTI ECOTEC       | 96  |  | 12.09 |  |  |                |        |  |  |             |     |
|  | 1.8                   | 103 |  | 10.11 |  |  |                |        |  |  |             |     |
|  | 2.0 CDTi BiTurbo      | 143 |  | 12.12 |  |  |                |        |  |  |             |     |
|  | 2.0 CDTI ECOTEC       |     |  | 12.09 |  |  |                |        |  |  |             |     |

<sup>1)</sup> for 4 bore wheel rim / per cerchione a 4 fori / pour jante à 4 trous / para Llantas de 4 taladros

<sup>2)</sup> for 5 bore wheel rim / per cerchione a 5 fori / pour jante à 5 trous / para Llantas de 5 taladros

<sup>3)</sup> + RA disc brake / + P disco freno / + frein à disque essieu AR / + ET-disco de freno

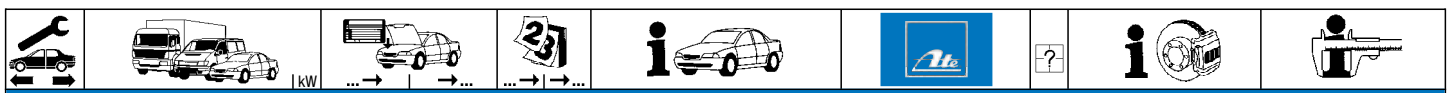

**OPEL ASTRA J / GTC / Vauxhall Astra MK VI (09-)**

|                  |                       |       |       |                |        |   |                |     |
|------------------|-----------------------|-------|-------|----------------|--------|---|----------------|-----|
|                  | 1.3 CDTi ECOTEC       | 70    | 12.09 | 11.9601-2603.2 | 220915 | + 15" Rad <sup>1)</sup>                     | D=60, - Halter | ATE |
|                  | 1.4 ecoFLEX           | 64    | 12.09 |                |        |   |                |     |
|                  | 1.4 ecoFLEX           | 74    | 12.09 |                |        |   |                |     |
|                  | 1.4 LPG Turbo ecoFLEX | 103   | 01.12 |                |        |   |                |     |
|                  | 1.4 Turbo ECOTEC      | 88    | 11.10 |                |        |   |                |     |
|                  | 1.4 Turbo ECOTEC      | 103   | 12.09 |                |        |   |                |     |
|                  | 1.6 SIDI              | 125   | 12.12 |                |        |   |                |     |
|                  | 1.6 Turbo ECOTEC      | 85    | 12.09 |                |        |   |                |     |
|                  | 1.6 Turbo ECOTEC      | 132   | 12.09 |                |        |   |                |     |
|                  | 1.7 CDTi ECOTEC       | 81    | 12.09 |                |        |   |                |     |
|                  | 1.7 CDTi ECOTEC       | 96    | 12.09 |                |        |   |                |     |
|                  | 2.0 CDTi BiTurbo      | 143   | 12.12 |                |        |   |                |     |
| 2.0 CDTi ECOTEC  |                       | 12.09 |       |                |        |   |                |     |
|                  | 1.3 CDTi ECOTEC       | 70    | 12.09 | 11.9601-2601.2 | 220913 | + 16" Rad <sup>2)</sup>                     | D=60, - Halter | ATE |
|                  | 1.4 ecoFLEX           | 64    | 12.09 |                |        |   |                |     |
|                  | 1.4 ecoFLEX           | 74    | 12.09 |                |        |   |                |     |
|                  | 1.4 LPG Turbo ecoFLEX | 103   | 01.12 |                |        |   |                |     |
|                  | 1.4 Turbo ECOTEC      | 88    | 11.10 |                |        |   |                |     |
|                  | 1.4 Turbo ECOTEC      | 103   | 12.09 |                |        |   |                |     |
|                  | 1.6 SIDI              | 125   | 12.12 |                |        |   |                |     |
|                  | 1.6 Turbo ECOTEC      | 85    | 12.09 |                |        |   |                |     |
|                  | 1.6 Turbo ECOTEC      | 132   | 12.09 |                |        |   |                |     |
|                  | 1.7 CDTi ECOTEC       | 81    | 12.09 |                |        |   |                |     |
|                  | 1.7 CDTi ECOTEC       | 96    | 12.09 |                |        |   |                |     |
|                  | 2.0 CDTi BiTurbo      | 143   | 12.12 |                |        |   |                |     |
| 2.0 CDTi ECOTEC  |                       | 12.09 |       |                |        |   |                |     |
|                  | 1.3 CDTi ECOTEC       | 70    | 12.09 | 11.9382-7001.2 | 220889 | - elektrische Feststellbremse <sup>3)</sup> | D=38, - Halter | ATE |
|                  | 1.4 ecoFLEX           | 64    | 12.09 |                |        |   |                |     |
|                  | 1.4 ecoFLEX           | 74    | 12.09 |                |        |   |                |     |
|                  | 1.4 LPG Turbo ecoFLEX | 103   | 01.12 |                |        |   |                |     |
|                  | 1.4 Turbo ECOTEC      | 88    | 11.10 |                |        |   |                |     |
|                  | 1.4 Turbo ECOTEC      | 103   | 12.09 |                |        |   |                |     |
|                  | 1.6 SIDI              | 125   | 12.12 |                |        |   |                |     |
|                  | 1.6 Turbo ECOTEC      | 85    | 12.09 |                |        |   |                |     |
|                  | 1.6 Turbo ECOTEC      | 132   | 12.09 |                |        |   |                |     |
|                  | 1.7 CDTi ECOTEC       | 81    | 12.09 |                |        |   |                |     |
|                  | 1.7 CDTi ECOTEC       | 96    | 12.09 |                |        |   |                |     |
|                  | 1.8                   | 103   | 10.11 |                |        |   |                |     |
| 2.0 CDTi BiTurbo | 143                   | 12.12 |       |                |        |   |                |     |
| 2.0 CDTi ECOTEC  |                       | 12.09 |       |                |        |   |                |     |
|                  | 1.3 CDTi ECOTEC       | 70    | 12.09 | 11.9382-7002.2 | 220890 | - elektrische Feststellbremse <sup>3)</sup> | D=38, - Halter | ATE |
|                  | 1.4 ecoFLEX           | 64    | 12.09 |                |        |   |                |     |
|                  | 1.4 ecoFLEX           | 74    | 12.09 |                |        |   |                |     |
|                  | 1.4 LPG Turbo ecoFLEX | 103   | 01.12 |                |        |   |                |     |
|                  | 1.4 Turbo ECOTEC      | 88    | 11.10 |                |        |   |                |     |
|                  | 1.4 Turbo ECOTEC      | 103   | 12.09 |                |        |   |                |     |
|                  | 1.6 SIDI              | 125   | 12.12 |                |        |   |                |     |
|                  | 1.6 Turbo ECOTEC      | 85    | 12.09 |                |        |   |                |     |
|                  | 1.6 Turbo ECOTEC      | 132   | 12.09 |                |        |   |                |     |
|                  | 1.7 CDTi ECOTEC       | 81    | 12.09 |                |        |   |                |     |
|                  | 1.7 CDTi ECOTEC       | 96    | 12.09 |                |        |   |                |     |
|                  | 1.8                   | 103   | 10.11 |                |        |   |                |     |
| 2.0 CDTi BiTurbo | 143                   | 12.12 |       |                |        |   |                |     |
| 2.0 CDTi ECOTEC  |                       | 12.09 |       |                |        |   |                |     |
|                  | 1.3 CDTi ECOTEC       | 70    | 12.09 | 11.9382-7003.2 | 220891 | + elektrische Feststellbremse <sup>4)</sup> | D=38, - Halter | ATE |
|                  | 1.4 ecoFLEX           | 64    | 12.09 |                |        |   |                |     |
|                  | 1.4 ecoFLEX           | 74    | 12.09 |                |        |   |                |     |
|                  | 1.4 LPG Turbo ecoFLEX | 103   | 01.12 |                |        |   |                |     |
|                  | 1.4 Turbo ECOTEC      | 88    | 11.10 |                |        |   |                |     |
|                  | 1.4 Turbo ECOTEC      | 103   | 12.09 |                |        |   |                |     |
|                  | 1.6 SIDI              | 125   | 12.12 |                |        |   |                |     |
|                  | 1.6 Turbo ECOTEC      | 85    | 12.09 |                |        |   |                |     |
|                  | 1.6 Turbo ECOTEC      | 132   | 12.09 |                |        |   |                |     |
|                  | 1.7 CDTi ECOTEC       | 81    | 12.09 |                |        |   |                |     |
|                  | 1.7 CDTi ECOTEC       | 96    | 12.09 |                |        |   |                |     |
|                  | 1.8                   | 103   | 10.11 |                |        |   |                |     |
| 2.0 CDTi BiTurbo | 143                   | 12.12 |       |                |        |   |                |     |
| 2.0 CDTi ECOTEC  |                       | 12.09 |       |                |        |   |                |     |
|                  | 1.3 CDTi ECOTEC       | 70    | 12.09 | 11.9382-7004.2 | 220892 | + elektrische Feststellbremse <sup>4)</sup> | D=38, - Halter | ATE |
|                  | 1.4 ecoFLEX           | 64    | 12.09 |                |        |   |                |     |
|                  | 1.4 ecoFLEX           | 74    | 12.09 |                |        |   |                |     |
|                  | 1.4 LPG Turbo ecoFLEX | 103   | 01.12 |                |        |   |                |     |
|                  | 1.4 Turbo ECOTEC      | 88    | 11.10 |                |        |   |                |     |
|                  | 1.4 Turbo ECOTEC      | 103   | 12.09 |                |        |   |                |     |
|                  | 1.6 SIDI              | 125   | 12.12 |                |        |   |                |     |
|                  | 1.6 Turbo ECOTEC      | 85    | 12.09 |                |        |   |                |     |
|                  | 1.6 Turbo ECOTEC      | 132   | 12.09 |                |        |   |                |     |
|                  | 1.7 CDTi ECOTEC       | 81    | 12.09 |                |        |   |                |     |
|                  | 1.7 CDTi ECOTEC       | 96    | 12.09 |                |        |   |                |     |
|                  | 1.8                   | 103   | 10.11 |                |        |   |                |     |
| 2.0 CDTi BiTurbo | 143                   | 12.12 |       |                |        |   |                |     |
| 2.0 CDTi ECOTEC  |                       | 12.09 |       |                |        |   |                |     |

**OPEL ASTRA J Sports Tourer/Vau.Astra Sports Tourer (10-)**



















|                  |                       |       |       |                |        |                         |                |     |
|------------------|-----------------------|-------|-------|----------------|--------|-------------------------|----------------|-----|
|                  | 1.3 CDTi ECOTEC       | 70    | 11.10 | 03.7858-0732.4 | 300272 |                         | 9/8" Tandem    | ATE |
|                  | 1.4 ecoFLEX           | 64    | 11.10 |                |        |                         |                |     |
|                  | 1.4 ecoFLEX           | 74    | 11.10 |                |        |                         |                |     |
|                  | 1.4 LPG Turbo ecoFLEX | 103   | 01.12 |                |        |                         |                |     |
|                  | 1.4 Turbo ECOTEC      | 88    | 11.10 |                |        |                         |                |     |
|                  | 1.4 Turbo ECOTEC      | 103   | 11.10 |                |        |                         |                |     |
|                  | 1.6 ECOTEC            | 85    | 11.10 |                |        |                         |                |     |
|                  | 1.6 LPG               | 84    | 10.12 |                |        |                         |                |     |
|                  | 1.6 SIDI              | 125   | 12.12 |                |        |                         |                |     |
|                  | 1.6 Turbo ECOTEC      | 132   | 11.10 |                |        |                         |                |     |
|                  | 1.7 CDTi ECOTEC       | 92    | 11.10 |                |        |                         |                |     |
|                  | 1.7 CDTi ECOTEC       | 92    | 11.10 |                |        |                         |                |     |
| 2.0 CDTi BiTurbo | 143                   | 12.12 |       |                |        |                         |                |     |
| 2.0 CDTi ECOTEC  |                       | 11.10 |       |                |        |                         |                |     |
|                  | 1.3 CDTi ECOTEC       | 70    | 11.10 | 03.2125-0421.3 | 010934 |                         | Thz 25,40      | ATE |
|                  | 1.4 ecoFLEX           | 64    | 11.10 |                |        |                         |                |     |
|                  | 1.4 ecoFLEX           | 74    | 11.10 |                |        |                         |                |     |
|                  | 1.4 LPG Turbo ecoFLEX | 103   | 01.12 |                |        |                         |                |     |
|                  | 1.4 Turbo ECOTEC      | 88    | 11.10 |                |        |                         |                |     |
|                  | 1.4 Turbo ECOTEC      | 103   | 11.10 |                |        |                         |                |     |
|                  | 1.6 ECOTEC            | 85    | 11.10 |                |        |                         |                |     |
|                  | 1.6 LPG               | 84    | 10.12 |                |        |                         |                |     |
|                  | 1.6 SIDI              | 125   | 12.12 |                |        |                         |                |     |
|                  | 1.6 Turbo ECOTEC      | 132   | 11.10 |                |        |                         |                |     |
|                  | 1.7 CDTi ECOTEC       | 92    | 11.10 |                |        |                         |                |     |
|                  | 1.7 CDTi ECOTEC       | 92    | 11.10 |                |        |                         |                |     |
| 2.0 CDTi BiTurbo | 143                   | 12.12 |       |                |        |                         |                |     |
| 2.0 CDTi ECOTEC  |                       | 11.10 |       |                |        |                         |                |     |
|                  | 1.3 CDTi ECOTEC       | 70    | 11.10 | 11.9601-2603.2 | 220915 | + 15" Rad <sup>1)</sup> | D=60, - Halter | ATE |
|                  | 1.4 ecoFLEX           | 64    | 11.10 |                |        |                         |                |     |
|                  | 1.4 ecoFLEX           | 74    | 11.10 |                |        |                         |                |     |
|                  | 1.4 LPG Turbo ecoFLEX | 103   | 01.12 |                |        |                         |                |     |
|                  | 1.4 Turbo ECOTEC      | 88    | 11.10 |                |        |                         |                |     |
|                  | 1.4 Turbo ECOTEC      | 103   | 11.10 |                |        |                         |                |     |
|                  | 1.6 ECOTEC            | 85    | 11.10 |                |        |                         |                |     |
|                  | 1.6 LPG               | 84    | 10.12 |                |        |                         |                |     |
|                  | 1.6 SIDI              | 125   | 12.12 |                |        |                         |                |     |
|                  | 1.6 Turbo ECOTEC      | 132   | 11.10 |                |        |                         |                |     |
|                  | 1.7 CDTi ECOTEC       | 92    | 11.10 |                |        |                         |                |     |
|                  | 1.7 CDTi ECOTEC       | 92    | 11.10 |                |        |                         |                |     |
| 2.0 CDTi BiTurbo | 143                   | 12.12 |       |                |        |                         |                |     |
| 2.0 CDTi ECOTEC  |                       | 11.10 |       |                |        |                         |                |     |
|                  | 1.3 CDTi ECOTEC       | 70    | 11.10 | 11.9601-2601.2 | 220913 | + 16" Rad <sup>2)</sup> | D=60, - Halter | ATE |
|                  | 1.4 ecoFLEX           | 64    | 11.10 |                |        |                         |                |     |
|                  | 1.4 ecoFLEX           | 74    | 11.10 |                |        |                         |                |     |
|                  | 1.3 CDTi ECOTEC       | 70    | 11.10 | 11.9601-2602.2 | 220914 | + 16" Rad <sup>2)</sup> | D=60, - Halter | ATE |
|                  | 1.4 ecoFLEX           | 64    | 11.10 |                |        |                         |                |     |
|                  | 1.4 ecoFLEX           | 74    | 11.10 |                |        |                         |                |     |

<sup>1)</sup> + 15" wheel / + ruota 15" / + roue 15" / + rueda 15"

<sup>2)</sup> + 16" wheel / + ruota 16" / + roue 16" / + rueda 16"

<sup>3)</sup> - electric parking brake / - freno a mano elettrico / - frein à main électrique / - freno de mano eléctrico

<sup>4)</sup> + electric parking brake / + freno a mano elettrico / + frein à main électrique / + freno de mano eléctrico

|     |  |  |  |  |  |  |  |          |  |  |  |  |  |
|--|--|--|--|--|---|--|--|--|--|--|--|--|--|
| <b>OPEL ASTRA J Sports Tourer/Vau.Astra Sports Tourer (10-)</b>                    |  |  |  |  |   |  |  |  |  |  |  |  |  |
|    | 1.4 LPG Turbo ecoFLEX  | 103  |  | 01.12  |   | 11.9601-2601.2   | 220913   | + 16" Rad <sup>1)</sup><br>+ 16" Rad <sup>1)</sup>   | D=60, - Halter<br>D=60, - Halter   | ATE<br>ATE   |  |  |  |
|  | 1.4 Turbo ECOTEC   | 88   |  | 11.10  |   | 11.9601-2602.2   | 220914   |  |  |  |  |  |  |
|  | 1.4 Turbo ECOTEC   | 103  |  | 11.10  |   |  |  |  |  |  |  |  |  |
|  | 1.6 ECOTEC   | 85   |  | 11.10  |   |  |  |  |  |  |  |  |  |
|  | 1.6 LPG  | 84   |  | 10.12  |   |  |  |  |  |  |  |  |  |
|  | 1.6 SIDI   | 125  |  | 12.12  |   |  |  |  |  |  |  |  |  |
|  | 1.6 Turbo ECOTEC   | 132  |  | 11.10  |   |  |  |  |  |  |  |  |  |
|  | 1.7 CDTi ECOTEC  |  |  | 11.10  |   |  |  |  |  |  |  |  |  |
|  | 1.7 CDTi ECOTEC  | 92   |  | 11.10  |   |  |  |  |  |  |  |  |  |
|  | 2.0 CDTi BiTurbo   | 143  |  | 12.12  |   |  |  |  |  |  |  |  |  |
| 2.0 CDTi ECOTEC  |  |  | 11.10  |  |   |  |  |  |  |  |  |  |  |
|    | 1.3 CDTi ECOTEC  | 70   |  | 11.10  |   | 11.9382-7003.2   | 220891   | - elektrische Feststellbremse <sup>2)</sup><br>- elektrische Feststellbremse <sup>2)</sup> | D=38, - Halter<br>D=38, - Halter   | ATE<br>ATE   |  |  |  |
|  | 1.4 ecoFLEX  | 64   |  | 11.10  |   | 11.9382-7004.2   | 220892   |  |  |  |  |  |  |
|  | 1.4 ecoFLEX  | 74   |  | 11.10  |   |  |  |  |  |  |  |  |  |
|  | 1.4 LPG Turbo ecoFLEX  | 103  |  | 01.12  |   |  |  |  |  |  |  |  |  |
|  | 1.4 Turbo ECOTEC   | 88   |  | 11.10  |   |  |  |  |  |  |  |  |  |
|  | 1.4 Turbo ECOTEC   | 103  |  | 11.10  |   |  |  |  |  |  |  |  |  |
|  | 1.6 ECOTEC   | 85   |  | 11.10  |   |  |  |  |  |  |  |  |  |
|  | 1.6 LPG  | 84   |  | 10.12  |   |  |  |  |  |  |  |  |  |
|  | 1.6 SIDI   | 125  |  | 12.12  |   |  |  |  |  |  |  |  |  |
|  | 1.6 Turbo ECOTEC   | 132  |  | 11.10  |   |  |  |  |  |  |  |  |  |
|  | 1.7 CDTi ECOTEC  |  |  | 11.10  |   |  |  |  |  |  |  |  |  |
|  | 1.7 CDTi ECOTEC  | 92   |  | 11.10  |   |  |  |  |  |  |  |  |  |
|  | 2.0 CDTi BiTurbo   | 143  |  | 12.12  |   |  |  |  |  |  |  |  |  |
|  | 2.0 CDTi ECOTEC  |  |  | 11.10  |   |  |  |  |  |  |  |  |  |
|  | <b>OPEL CALIBRA / Vauxhall Calibra (89-97)</b>                                   |  |  |  |   |  |  |  |  |  |  |  |  |
|    | 2.0  |  |  | 09.89  | 07.97   | 03.2122-0282.3   | 010130   |  | THz 22,20  | ATE  |  |  |  |
|  | 2.0 16V  |  |  | 09.89  | 07.97   |  |  |  |  |  |  |  |  |
|  | 2.0 16V 4x4  |  |  | 09.89  | 07.97   |  |  |  |  |  |  |  |  |
|    | 2.0 4x4  |  |  | 09.89  | 07.97   |  |  |  |  |  |  |  |  |
|  | 2.0 Turbo  |  |  | 03.92  | 07.97   | 03.2123-1121.3   | 010176   |  | THz 23,81  | ATE  |  |  |  |
|  | 2.5  |  |  | 02.93  | 07.97   |  |  |  |  |  |  |  |  |
|    | 2.0  |  |  | 09.89  | 07.97   | 24.3521-1701.5   | 240001   | -<br>-<br>-<br>-<br>-<br>-<br>-<br>-<br>-<br>-   | D=52, - Halter<br>D=52, - Halter<br>Dichtungssatz<br>Hülzensatz<br>Führungsbolzen                | ATE<br>ATE<br>ATE<br>ATE<br>ATE<br>ATE<br>ATE<br>ATE<br>ATE<br>ATE |  |  |  |
|  | 2.0 16V  |  |  | 09.89  | 07.97   | 24.3521-1702.5   | 240002   |  |  |  |  |  |  |
|  |  |  |  |  |   | 11.0441-5202.2   | 250026   |  |  |  |  |  |  |
|  |  |  |  |  |   | 11.0101-5407.2   | 260011   |  |  |  |  |  |  |
|  |  |  |  |  |   | 11.8171-0008.1   | 990049   |  |  |  |  |  |  |
|  | 2.0 16V 4x4  |  |  | 09.89  | 07.97   | 11.0441-5402.2   | 250028   |  |  |  |  |  |  |
|  | 2.0 4x4  |  |  | 09.89  | 07.97   | 11.0101-5407.2   | 260011   |  |  |  |  |  |  |
|  |  |  |  |  |   | 11.8171-0008.1   | 990049   |  |  |  |  |  |  |
|  |  |  |  |  |   | 11.8116-0097.1   | 390590   |  |  |  |  |  |  |
|  |  |  |  |  |   |  | 2  |  |  |  |  |  |  |
| 2.0 Turbo  |  |  | S9999999   | 03.92  |   | 11.3541-8085.2   | 220287   | -<br>-<br>-<br>-<br>-<br>-<br>-<br>-<br>-<br>-   | D=54, + Halter<br>D=54, - Halter<br>D=54, - Halter<br>Hülzensatz<br>Führungsbolzen<br>Haltefeder | ATE<br>ATE<br>ATE<br>ATE<br>ATE<br>ATE<br>ATE<br>ATE<br>ATE<br>ATE |  |  |  |
| 2.5  |  |  | S9999999   | 02.93  |   | 24.3541-8086.5   | 240526   |  |  |  |  |  |  |
|  |  |  |  |  | 24.3541-8085.5  | 240525   |  |  |  |  |  |  |  |
|  |  |  |  |  | 11.0101-5407.2  | 260011   |  |  |  |  |  |  |  |
|  |  |  |  |  | 11.8171-0008.1  | 990049   |  |  |  |  |  |  |  |
|  |  |  |  |  | 11.8116-0292.1  | 390521   |  |  |  |  |  |  |  |
|  |  |  |  |  |   | 2  |  |  |  |  |  |  |  |
| 2.0 Turbo  |  |  | T1000001   | 07.97  |   | 11.3571-8525.2   | 220363   |  |  |  | -<br>-<br>-<br>-<br>-<br>-<br>-<br>-<br>-<br>- | D=57, - Halter<br>D=57, - Halter<br>Hülzensatz<br>Führungsbolzen<br>Haltefeder | ATE<br>ATE<br>ATE<br>ATE<br>ATE<br>ATE<br>ATE<br>ATE<br>ATE<br>ATE |
| 2.5  |  |  | T1000001   | 07.97  |   | 11.3571-8526.2   | 220364   |  |  |  |  |  |  |
|  |  |  |  |  | 11.0101-5407.2  | 260011   |  |  |  |  |  |  |  |
|  |  |  |  |  | 11.8171-0008.1  | 990049   |  |  |  |  |  |  |  |
|  |  |  |  |  | 11.8116-0292.1  | 390521   |  |  |  |  |  |  |  |
|  |  |  |  |  |   | 2  |  |  |  |  |  |  |  |
|  |  |  |  |  |   |  |  |  |  |  |  |  |  |
|  |  |  |  |  |   |  |  |  |  |  |  |  |  |
|  |  |  |  |  |   |  |  |  |  |  |  |  |  |
|  |  |  |  |  |   |  |  |  |  |  |  |  |  |
|  | 2.0  |  |  | 09.89  | 07.97   | 83.7288-0318.3   | 330375   | 2<br>2   | L=315<br>L=322   |  |  |  |  |
|  | 2.0 16V  |  |  | 09.89  | 07.97   | 24.5298-0322.3   | 331314   |  |  |  |  |  |  |
|  | 2.0 16V 4x4  |  |  | 09.89  | 07.97   |  |  |  |  |  |  |  |  |
|  | 2.0 4x4  |  |  | 09.89  | 07.97   |  |  |  |  |  |  |  |  |
|  | 2.0 Turbo  |  |  | 03.92  | 07.97   |  |  |  |  |  |  |  |  |
|  | 2.5  |  |  | 02.93  | 07.97   |  |  |  |  |  |  |  |  |
|  | 2.0  |  |  | 09.89  | 07.97   | 13.2351-0013.2   | 210010   | -<br>-<br>-<br>-<br>-<br>-<br>-<br>-   | D=35<br>D=35<br>D=35<br>D=35<br>Dichtungssatz  | ATE<br>ATE<br>ATE<br>ATE<br>ATE<br>ATE<br>ATE<br>ATE               |  |  |  |
|  | 2.0 16V  |  |  | 09.89  | 07.97   | 13.2351-0014.2   | 210011   |  |  |  |  |  |  |
|  | 2.5  |  |  | S9999999   | 02.93   | 24.9235-0013.5   | 230001   |  |  |  |  |  |  |
|  |  |  |  |  |   | 24.9235-0014.5   | 230002   |  |  |  |  |  |  |
|  |  |  |  |  |   | 13.0441-3506.2   | 250052   |  |  |  |  |  |  |
|  | 2.5  |  |  | T1000001   | 07.97   | 13.0441-3506.2   | 250052   |  |  |  |  |  |  |
|  | 2.0 16V 4x4  |  |  | T1000001   | 07.97   | 13.2351-0013.2   | 210010   |  |  |  |  |  |  |
|  | 2.0 4x4  |  |  | T1000001   | 07.97   | 13.2351-0014.2   | 210011   |  |  |  |  |  |  |
| 2.0 Turbo  |  |  | T1000001   | 07.97  | 24.9235-0013.5  | 230001   |  |  |  |  |  |  |  |
|  |  |  |  |  | 24.9235-0014.5  | 230002   |  |  |  |  |  |  |  |
|  |  |  |  |  | 13.0441-3506.2  | 250052   |  |  |  |  |  |  |  |
|  | 2.0  |  |  | N1999999   | 09.89   | 24.5233-0200.3   | 330425   | 2  | L=198  |  |  |  |  |
|  | 2.0 16V  |  |  | N1999999   | 09.89   |  |  |  |  |  |  |  |  |
|  | 2.0 16V 4x4  |  |  | N1999999   | 09.89   |  |  |  |  |  |  |  |  |
|  | 2.0 4x4  |  |  | N1999999   | 09.89   |  |  |  |  |  |  |  |  |
|  | 2.0 Turbo  |  |  | N1999999   | 03.92   |  |  |  |  |  |  |  |  |
|  |  |  |  |  |   |  |  |  |  |  |  |  |  |
|  | 2.0  |  |  | P1000001   | 07.97   | 24.5117-0195.3   | 330565   | 2  | L=198  |  |  |  |  |
|  | 2.0 16V  |  |  | P1000001   | 07.97   |  |  |  |  |  |  |  |  |
|  | 2.0 16V 4x4  |  |  | P1000001   | 07.97   |  |  |  |  |  |  |  |  |
|  | 2.0 4x4  |  |  | P1000001   | 07.97   |  |  |  |  |  |  |  |  |
|  | 2.0 Turbo  |  |  | P1000001   | 07.97   |  |  |  |  |  |  |  |  |
|  | 2.5  |  |  |  | 02.93   | 07.97  |  |  |  |  |  |  |  |
|  | 2.0  |  |  | 09.89  | 07.97   | 24.3727-0736.2   | 580736   | 1<br>↓   | L=1365/1498, + Zub   |  |  |  |  |
|  | 2.0 16V  |  |  | 09.89  | 07.97   |  |  |  |  |  |  |  |  |
|  | 2.0 16V 4x4  |  |  | 09.89  | 07.97   |  |  |  |  |  |  |  |  |
|  | 2.0 4x4  |  |  | 09.89  | 07.97   |  |  |  |  |  |  |  |  |
|  | 2.0 Turbo  |  |  | 03.92  | 07.97   |  |  |  |  |  |  |  |  |
|  | 2.5  |  |  | 02.93  | 07.97   |  |  |  |  |  |  |  |  |

<sup>1)</sup> + 16" wheel / + ruota 16" / + roue 16" / + rueda 16"

<sup>2)</sup> - electric parking brake / - freno a mano elettrico / - frein à main électrique / - freno de mano eléctrico

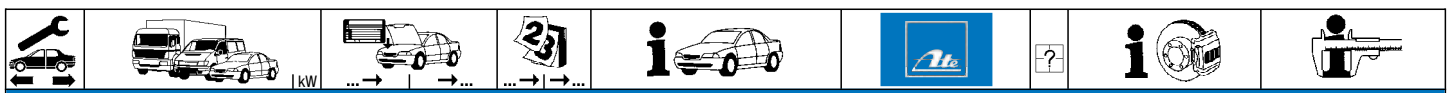

| OPEL CALIBRA / Vauxhall Calibra (89-97) |                  |          |          |          |       |       |                |                |                          |   |                   |     |
|---|------------------|----------|----------|----------|-------|-------|----------------|----------------|--------------------------|---|-------------------|-----|
|   | 2.0              |          |          | N1999999 | 09.89 |       |                | 03.0101-0023.2 | 320242                   | BRES 5/25   | ATE               |     |
|   | 2.0 16V          |          |          | N1999999 | 09.89 |       |                |                |                          |   |                   |     |
|   | 2.0 16V 4x4      |          |          | N1999999 | 09.89 |       |                |                |                          |   |                   |     |
|   | 2.0 4x4          |          |          | N1999999 | 09.89 |       |                |                |                          |   |                   |     |
|   | 2.0              |          | P1000001 |          |       | 07.97 |                | 03.0101-0038.2 | 320245                   | BRES 4/5  | ATE               |     |
| 2.0 16V                                 |                  | P1000001 |          |          | 07.97 |       |                |                |                          |   |                   |     |
| 2.0 16V 4x4                             |                  | P1000001 |          |          | 07.97 |       |                |                |                          |   |                   |     |
| 2.0 4x4                                 |                  | P1000001 |          |          | 07.97 |       |                |                |                          |   |                   |     |
| 2.5                                     |                  | T1000001 |          |          | 07.97 |       | 03.0101-0038.2 | 320245         |                          | BRES 4/5  | ATE               |     |
|   | 2.0              |          |          | S9999999 | 09.89 |       |                | 24.3728-0715.2 | 590715                   | L=835   |                   |     |
|   | 2.0 16V          |          |          | S9999999 | 09.89 |       |                |                |                          |   |                   |     |
|   | 2.0 16V 4x4      |          |          | S9999999 | 09.89 |       |                |                |                          |   |                   |     |
|   | 2.0 4x4          |          |          | S9999999 | 09.89 |       |                |                |                          |   |                   |     |
|   | 2.5              |          |          | S9999999 | 02.93 |       |                |                |                          |   |                   |     |
| DIV                                     | 2.0 16V 4x4      |          |          |          | 09.89 | 07.97 |                | 10.0515-0515.3 | 340024                   | + Verteilergetriebe 1)                                    | Hydraulikspeicher | ATE |
|   | 2.0 4x4          |          |          |          | 09.89 | 07.97 |                |                |                          |   |                   |     |
|   | 2.0 Turbo        |          |          |          | 03.92 | 07.97 |                |                |                          |   |                   |     |
| OPEL CAMPO (91-96)                      |                  |          |          |          |       |       |                |                |                          |   |                   |     |
|   | 2.2 D            |          |          |          | 01.92 | 08.96 |                | 24.3225-1702.3 | 020425                   |   | Rz 25,40          |     |
|   | 2.3              |          |          |          | 01.92 | 08.96 |                |                |                          |   |                   |     |
|   | 2.5 D            |          |          |          | 01.92 | 08.96 |                |                |                          |   |                   |     |
|   | 2.5 TD           |          |          |          | 07.94 | 08.96 |                |                |                          |   |                   |     |
|   | 3.1 TD           |          |          |          | 01.92 | 08.96 |                |                |                          |   |                   |     |
| OPEL CAMPO (97-01)                      |                  |          |          |          |       |       |                |                |                          |   |                   |     |
|   | 2.5 DTI          |          |          |          | 09.96 | 05.01 |                | 24.3225-1702.3 | 020425                   |   | Rz 25,40          |     |
|   | 2.5 DTI 4x4      |          |          |          | 09.96 | 05.01 |                |                |                          |   |                   |     |
|   | 3.1 TD           |          |          |          | 09.96 | 05.01 |                |                |                          |   |                   |     |
|   | 3.1 TD 4x4       |          |          |          | 09.96 | 05.01 |                |                |                          |   |                   |     |
| OPEL CASCADE / Vauxhall Cascada (13-)   |                  |          |          |          |       |       |                |                |                          |   |                   |     |
|   | 1.4 Turbo ECOTEC | 88       |          |          | 01.13 |       |                | 03.7858-0732.4 | 300272                   |   | 9/8" Tandem       | ATE |
|   | 1.4 Turbo ECOTEC | 103      |          |          | 01.13 |       |                |                |                          |   |                   |     |
|   | 1.6 SIDI Turbo   | 125      |          |          | 01.13 |       |                |                |                          |   |                   |     |
|   | 2.0 CDTi BiTurbo | 143      |          |          | 01.13 |       |                |                |                          |   |                   |     |
|   | 2.0 CDTi ECOTEC  | 121      |          |          | 01.13 |       |                |                |                          |   |                   |     |
|   | 1.4 Turbo ECOTEC | 88       |          |          | 01.13 |       |                | 03.2125-0421.3 | 010934                   |   | Thz 25,40         | ATE |
|   | 1.4 Turbo ECOTEC | 103      |          |          | 01.13 |       |                |                |                          |   |                   |     |
|   | 1.6 SIDI Turbo   | 125      |          |          | 01.13 |       |                |                |                          |   |                   |     |
|   | 2.0 CDTi BiTurbo | 143      |          |          | 01.13 |       |                |                |                          |   |                   |     |
|   | 2.0 CDTi ECOTEC  | 121      |          |          | 01.13 |       |                |                |                          |   |                   |     |
|   | 1.4 Turbo ECOTEC | 88       |          |          | 01.13 |       |                | 11.9382-7001.2 | 220889                   | <input type="checkbox"/> - elektrische Feststellbremse 2) | D=38, - Halter    | ATE |
|   | 1.4 Turbo ECOTEC | 103      |          |          | 01.13 |       |                | 11.9382-7002.2 | 220890                   | <input type="checkbox"/> - elektrische Feststellbremse 2) | D=38, - Halter    | ATE |
|   | 1.6 SIDI Turbo   | 125      |          |          | 01.13 |       |                | 11.9382-7003.2 | 220891                   | <input type="checkbox"/> + elektrische Feststellbremse 3) | D=38, - Halter    | ATE |
|   | 2.0 CDTi BiTurbo | 143      |          |          | 01.13 |       |                | 11.9382-7004.2 | 220892                   | <input type="checkbox"/> + elektrische Feststellbremse 3) | D=38, - Halter    | ATE |
|   | 2.0 CDTi ECOTEC  | 121      |          |          | 01.13 |       |                |                |                          |   |                   |     |
| OPEL COMBO / Vauxhall Combo (01-11)     |                  |          |          |          |       |       |                |                |                          |   |                   |     |
|   | 1.3 CDTi         |          |          | 33999999 | 06.03 |       |                | 24.2122-1740.3 | 010711                   |   | Thz 22,20         | DEL |
|   | 1.4 16V          |          |          | 33999999 | 10.01 |       |                |                |                          |   |                   |     |
|   | 1.6              |          |          | 33999999 | 10.01 |       |                |                |                          |   |                   |     |
|   | 1.7 DI 16V       |          |          | 33999999 | 10.01 |       |                |                |                          |   |                   |     |
|   | 1.7 DTI 16V      |          |          | 33999999 | 10.01 |       |                |                |                          |   |                   |     |
|   | 1.3 CDTi         | 43000001 |          |          |       | 10.11 | - ABS          | 24.2122-1756.3 | 010766                   | + HA-Trommelbremse 4)                                     | Thz 22,20         | BOS |
|   | 1.4 16V          | 43000001 |          |          |       | 10.11 | - ABS          |                |                          |   |                   |     |
|   | 1.6              | 43000001 |          |          |       | 10.11 | - ABS          |                |                          |   |                   |     |
|   | 1.6 CNG          |          |          | 04.05    |       | 10.11 | - ABS          |                |                          |   |                   |     |
|   | 1.7 DI 16V       | 43000001 |          |          |       | 10.11 | - ABS          |                |                          |   |                   |     |
| 1.7 DTI 16V                             | 43000001         |          |          |          | 10.11 | - ABS |                |                |                          |   |                   |     |
|   | 1.3 CDTi         | 43000001 |          |          |       | 10.11 | - ESP          | 24.2123-1767.3 | 010844                   | + HA-Scheibenbremse 5)                                    | Thz 23,81         | BOS |
|   | 1.4 16V          | 43000001 |          |          |       | 10.11 | - ESP          |                |                          |   |                   |     |
|   | 1.6              | 43000001 |          |          |       | 10.11 | - ESP          |                |                          |   |                   |     |
|   | 1.6 CNG          |          |          | 04.05    |       | 10.11 | - ESP          |                |                          |   |                   |     |
|   | 1.7 CDTi 16V     |          |          | 06.04    |       | 10.11 | - ESP          |                |                          |   |                   |     |
|   | 1.7 DI 16V       | 43000001 |          |          |       | 10.11 | - ESP          |                |                          |   |                   |     |
|   | 1.7 DTI 16V      | 43000001 |          |          |       | 10.11 | - ESP          |                |                          |   |                   |     |
|   | 1.3 CDTi         | 43000001 |          |          |       | 10.11 | + ESP          | 24.2122-1757.3 | 010769                   | + HA-Trommelbremse 4)                                     | Thz 22,20         | BOS |
|   | 1.4 16V          | 43000001 |          |          |       | 10.11 | + ESP          |                |                          |   |                   |     |
|   | 1.6              | 43000001 |          |          |       | 10.11 | + ESP          |                |                          |   |                   |     |
|   | 1.6 CNG          |          |          | 04.05    |       | 10.11 | + ESP          |                |                          |   |                   |     |
|   | 1.7 CDTi 16V     |          |          | 06.04    |       | 10.11 | + ESP          |                |                          |   |                   |     |
|   | 1.7 DI 16V       | 43000001 |          |          |       | 10.11 | + ESP          |                |                          |   |                   |     |
|   | 1.7 DTI 16V      | 43000001 |          |          |       | 10.11 | + ESP          |                |                          |   |                   |     |
|   | 1.3 CDTi         | 43000001 |          |          |       | 10.11 | + ESP          | 24.2123-1768.3 | 010845                   | + HA-Scheibenbremse 5)                                    | Thz 23,81         | BOS |
|   | 1.4 16V          | 43000001 |          |          |       | 10.11 | + ESP          |                |                          |   |                   |     |
|   | 1.6              | 43000001 |          |          |       | 10.11 | + ESP          |                |                          |   |                   |     |
|   | 1.6 CNG          |          |          | 04.05    |       | 10.11 | + ESP          |                |                          |   |                   |     |
|   | 1.7 CDTi 16V     |          |          | 06.04    |       | 10.11 | + ESP          |                |                          |   |                   |     |
|   | 1.7 DI 16V       | 43000001 |          |          |       | 10.11 | + ESP          |                |                          |   |                   |     |
|   | 1.7 DTI 16V      | 43000001 |          |          |       | 10.11 | + ESP          |                |                          |   |                   |     |
|   | 1.3 CDTi         |          |          | 06.03    |       | 10.11 |                | 24.3541-1795.7 | 220551                   | <input type="checkbox"/>                                  | D=54, - Halter    | LUC |
| 1.4 16V                                 |                  |          | 10.01    |          | 10.11 |       | 24.3541-1796.7 | 220552         | <input type="checkbox"/> | D=54, - Halter  | LUC               |     |
| 1.6                                     |                  |          | 10.01    |          | 10.11 |       |                |                |                          |   |                   |     |
| 1.7 DI 16V                              |                  |          | 10.01    |          | 10.11 |       |                |                |                          |   |                   |     |
| 1.7 DTI 16V                             |                  |          | 10.01    |          | 10.11 |       |                |                |                          |   |                   |     |

1) + distribution transmission / + differenziale centrale / + transmission 4x4 / + engranaje de distribución  
2) - electric parking brake / - freno a mano elettrico / - frein à main électrique / - freno de mano eléctrico  
3) + electric parking brake / + freno a mano elettrico / + frein à main électrique / + freno de mano eléctrico  
4) + RA drum brake / + P freno a tamburo / + frein à tambour essieu AR / + ET-tambores de freno  
5) + RA disc brake / + P disco freno / + frein à disque essieu AR / + ET-disco de freno



| OPEL COMBO / Vauxhall Combo (01-11)   |              |          |       |       |                            |                |                |   |   |   |        |  |   |  |
|---------------------------------------|--------------|----------|-------|-------|----------------------------|----------------|----------------|---|---|---|--------|--|---|--|
|                                       | 1.3 CDTi     | 53000001 |       | 10.11 |                            | 11.9571-9823.2 | 220471         |   | D=57, - Halter<br>D=57, - Halter<br>D=57, - Halter<br>D=57, - Halter<br>Dichtungssatz<br>Hülsensatz<br>Führungsbolzen<br>Haltefeder | ATE<br>ATE<br>ATE<br>ATE<br>ATE<br>ATE<br>ATE |        |  |   |  |
|                                       | 1.4 16V      | 53000001 |       | 10.11 |                            | 11.9571-9824.2 | 220472         |   |   |   |        |  |   |  |
|                                       | 1.6          | 53000001 |       | 10.11 |                            | 24.3571-9823.5 | 240499         |   |   |   |        |  |   |  |
|                                       | 1.6 CNG      |          |       | 04.05 | 10.11                      | 24.3571-9824.5 | 240500         |   |   |   |        |  |   |  |
|                                       | 1.7 CDTi 16V |          |       | 06.04 | 10.11                      | 11.0441-5704.2 | 250034         |   |   |   |        |  |   |  |
|                                       | 1.7 DI 16V   | 53000001 |       |       | 10.11                      | 11.0101-5407.2 | 260011         |   |   |   |        |  |   |  |
|                                       | 1.7 DTI 16V  | 53000001 |       |       | 10.11                      | 11.8171-0008.1 | 990049         |   |   |   |        |  |   |  |
|                                       |              |          |       |       |                            | 11.8116-0292.1 | 390521         | 2 |   |   |        |  |   |  |
|                                       | 1.3 CDTi     |          |       | 06.03 | 10.11                      | 24.5256-0298.3 | 330756         |   | L=298   |   |        |  |   |  |
|                                       | 1.4 16V      |          |       | 10.01 | 10.11                      |                |                |   |   |   |        |  |   |  |
|                                       | 1.6          |          |       | 10.01 | 10.11                      |                |                |   |   |   |        |  |   |  |
|                                       | 1.6 CNG      |          |       | 04.05 | 10.11                      |                |                |   |   |   |        |  |   |  |
|                                       | 1.7 CDTi 16V |          |       | 06.04 | 10.11                      |                |                |   |   |   |        |  |   |  |
|                                       | 1.7 DI 16V   |          |       | 10.01 | 10.11                      |                |                |   |   |   |        |  |   |  |
|                                       | 1.7 DTI 16V  |          |       | 10.01 | 10.11                      |                |                |   |   |   |        |  |   |  |
|                                       | 1.3 CDTi     |          |       | 06.03 | 10.11                      | 24.3387-1701.7 | 220673         |   | D=38, - Halter<br>D=38, - Halter  | LUC<br>LUC                                    |        |  |   |  |
|                                       | 1.4 16V      |          |       | 10.01 | 10.11                      | 24.3387-1702.7 | 220674         |   |   |   |        |  |   |  |
|                                       | 1.6          |          |       | 10.01 | 10.11                      |                |                |   |   |   |        |  |   |  |
|                                       | 1.6 CNG      |          |       | 04.05 | 10.11                      |                |                |   |   |   |        |  |   |  |
|                                       | 1.7 CDTi 16V |          |       | 06.04 | 10.11                      |                |                |   |   |   |        |  |   |  |
|                                       | 1.7 DI 16V   |          |       | 10.01 | 10.11                      |                |                |   |   |   |        |  |   |  |
|                                       | 1.7 DTI 16V  |          |       | 10.01 | 10.11                      |                |                |   |   |   |        |  |   |  |
|                                       | 1.3 CDTi     |          |       | 06.03 | 10.11                      | 24.5240-0220.3 | 330619         |   | L=220   |   |        |  |   |  |
|                                       | 1.4 16V      |          |       | 10.01 | 10.11                      |                |                |   |   |   |        |  |   |  |
|                                       | 1.6          |          |       | 10.01 | 10.11                      |                |                |   |   |   |        |  |   |  |
|                                       | 1.6 CNG      |          |       | 04.05 | 10.11                      |                |                |   |   |   |        |  |   |  |
|                                       | 1.7 CDTi 16V |          |       | 06.04 | 10.11                      |                |                |   |   |   |        |  |   |  |
|                                       | 1.7 DI 16V   |          |       | 10.01 | 10.11                      |                |                |   |   |   |        |  |   |  |
|                                       | 1.7 DTI 16V  |          |       | 10.01 | 10.11                      |                |                |   |   |   |        |  |   |  |
|                                       | 1.3 CDTi     |          |       | 06.03 | 10.11                      | 24.3219-1715.3 | 020122         |   | Rz 19,05 (ALU)  |   |        |  |   |  |
|                                       | 1.4 16V      |          |       | 10.01 | 10.11                      |                |                |   |   |   |        |  |   |  |
|                                       | 1.6          |          |       | 10.01 | 10.11                      |                |                |   |   |   |        |  |   |  |
|                                       | 1.6 CNG      |          |       | 04.05 | 10.11                      |                |                |   |   |   |        |  |   |  |
|                                       | 1.7 CDTi 16V |          |       | 06.04 | 10.11                      |                |                |   |   |   |        |  |   |  |
|                                       | 1.7 DI 16V   |          |       | 10.01 | 10.11                      |                |                |   |   |   |        |  |   |  |
|                                       | 1.7 DTI 16V  |          |       | 10.01 | 10.11                      |                |                |   |   |   |        |  |   |  |
|                                       | 1.3 CDTi     |          |       | 06.03 | 10.11                      | 24.3727-0767.2 | 580767         |   | L=445<br>L=1235/1235<br>L=182, + Zub  |   |        |  |   |  |
|                                       | 1.4 16V      |          |       | 10.01 | 10.11                      | 24.3727-0761.2 | 580761         |   |   |   |        |  |   |  |
|                                       | 1.6          |          |       | 10.01 | 10.11                      | 24.3727-0746.2 | 580746         |   |   |   |        |  |   |  |
|                                       | 1.6 CNG      |          |       | 04.05 | 10.11                      |                |                |   |   |   |        |  |   |  |
|                                       | 1.7 CDTi 16V |          |       | 06.04 | 10.11                      |                |                |   |   |   |        |  |   |  |
|                                       | 1.7 DI 16V   |          |       | 10.01 | 10.11                      |                |                |   |   |   |        |  |   |  |
|                                       | 1.7 DTI 16V  |          |       | 10.01 | 10.11                      |                |                |   |   |   |        |  |   |  |
|                                       | 1.3 CDTi     |          |       | 06.03 | 10.11                      | 24.3727-0767.2 | 580767         |   |   |   |        |  |   |  |
|                                       | 1.4 16V      |          |       | 10.01 | 10.11                      | 24.3727-0746.2 | 580746         |   |   |   |        |  |   |  |
|                                       | 1.6          |          |       | 10.01 | 10.11                      |                |                |   |   |   |        |  |   |  |
|                                       | 1.6 CNG      |          |       | 04.05 | 10.11                      |                |                |   |   |   |        |  |   |  |
|                                       | 1.7 CDTi 16V |          |       | 06.04 | 10.11                      |                |                |   |   |   |        |  |   |  |
|                                       | 1.7 DI 16V   |          |       | 10.01 | 10.11                      |                |                |   |   |   |        |  |   |  |
|                                       | 1.7 DTI 16V  |          |       | 10.01 | 10.11                      |                |                |   |   |   |        |  |   |  |
|                                       | 1.3 CDTi     |          |       | 06.03 | 10.11                      | 03.6583-0196.3 | 320246         |   | BRL 8/3 (4)   | ATE   |        |  |   |  |
|                                       | 1.4 16V      |          |       | 10.01 | 10.11                      |                |                |   |   |   |        |  |   |  |
|                                       | 1.6          |          |       | 10.01 | 10.11                      |                |                |   |   |   |        |  |   |  |
|                                       | 1.6 CNG      |          |       | 04.05 | 10.11                      |                |                |   |   |   |        |  |   |  |
|                                       | 1.7 CDTi 16V |          |       | 06.04 | 10.11                      |                |                |   |   |   |        |  |   |  |
|                                       | 1.7 DI 16V   |          |       | 10.01 | 10.11                      |                |                |   |   |   |        |  |   |  |
|                                       | 1.7 DTI 16V  |          |       | 10.01 | 10.11                      |                |                |   |   |   |        |  |   |  |
| OPEL COMBO D / Vauxhall Combo D (11-) |              |          |       |       |                            |                |                |   |   |   |        |  |   |  |
|                                       | 1.3 CDTi     | 66       |       | 11.11 | + 10" Bremse <sup>2)</sup> | 24.3225-1704.3 | 020541         |   | Rz 25,40  |   |        |  |   |  |
|                                       | 1.4          | 70       |       | 11.11 | + 10" Bremse <sup>2)</sup> |                |                |   |   |   |        |  |   |  |
|                                       | 1.4 CNG      | 88       |       | 11.11 | + 10" Bremse <sup>2)</sup> |                |                |   |   |   |        |  |   |  |
|                                       | 1.6 CDTi     | 66       |       | 11.11 | + 10" Bremse <sup>2)</sup> |                |                |   |   |   |        |  |   |  |
|                                       | 1.6 CDTi     | 74       |       | 11.11 | + 10" Bremse <sup>2)</sup> |                |                |   |   |   |        |  |   |  |
|                                       | 1.6 CDTi     | 77       |       | 11.11 | + 10" Bremse <sup>2)</sup> |                |                |   |   |   |        |  |   |  |
|                                       | 2.0 CDTi     | 99       |       | 11.11 | + 10" Bremse <sup>2)</sup> |                |                |   |   |   |        |  |   |  |
| OPEL CORSA B / Vauxhall Corsa (93-00) |              |          |       |       |                            |                |                |   |   |   |        |  |   |  |
|                                       | 1.0 12V      | ↓        |       | 11.96 | 09.00                      | 24.2120-0702.3 | 010361         |   | - ABS/Kennzeichen:EB/nicht für Delco BKV <sup>3)</sup> THZ 20,64  |   |        |  |   |  |
|                                       | 1.2          | ↓        |       | 03.93 | 09.00                      |                |                |   |   |   |        |  |   |  |
|                                       | 1.2 16V      | ↓        |       | 04.98 | 09.00                      |                |                |   |   |   |        |  |   |  |
|                                       | 1.4          | ↓        |       | 03.93 | 09.00                      |                |                |   |   |   |        |  |   |  |
|                                       | 1.4 i 16V    | ↓        |       | 03.93 | 09.00                      |                |                |   |   |   |        |  |   |  |
|                                       | 1.4 Si       | ↓ 60     |       | 03.93 | 09.00                      |                |                |   |   |   |        |  |   |  |
|                                       | 1.5 D        | ↓        |       | 03.93 | 09.00                      |                |                |   |   |   |        |  |   |  |
|                                       | 1.5 TD       | ↓        |       | 03.93 | 09.00                      |                |                |   |   |   |        |  |   |  |
|                                       | 1.6 GSI 16V  | ↓ 109    |       | 09.93 | 09.00                      |                |                |   |   |   |        |  |   |  |
|                                       | 1.6 i 16V    | ↓        |       | 09.93 | 09.00                      |                |                |   |   |   |        |  |   |  |
|                                       | 1.7 D        | ↓        |       | 09.93 | 09.00                      |                |                |   |   |   |        |  |   |  |
|                                       |              | 1.0 12V  | ↓     |       | 11.96                      | 09.00          | 24.3481-1733.5 |   |   |   | 240213 |  | D=48, - Halter<br>D=48, - Halter<br>Dichtungssatz<br>Hülsensatz<br>Führungsbolzen<br>Haltefeder | ATE<br>ATE<br>ATE<br>ATE<br>ATE<br>ATE |
|                                       |              | 1.2      | ↓     |       | 03.93                      | 09.00          | 24.3481-1734.5 |   |   |   | 240214 |  |   |  |
| 1.2                                   |              | ↓        |       | 03.93 | 09.00                      | 11.0441-4811.2 | 250024         |   |   |   |        |  |   |  |
| 1.2 16V                               |              | ↓        |       | 04.98 | 09.00                      | 11.0101-5407.2 | 260011         |   |   |   |        |  |   |  |
| 1.2 16V                               |              | ↓        |       | 04.98 | 09.00                      | 11.8171-0008.1 | 990049         |   |   |   |        |  |   |  |
| 1.4                                   |              | ↓        |       | 03.93 | 09.00                      | 11.8116-0129.1 | 390591         |   |   |   |        |  |   |  |
| 1.4                                   |              | ↓        |       | 03.93 | 09.00                      |                |                |   |   |   |        |  |   |  |
| 1.5 D                                 | ↓            |          | 03.93 | 09.00 |                            |                |                |   |   |   |        |  |   |  |

<sup>1)</sup> extension only / solo prolonga / rallonge seulement / solamente prolongador

<sup>2)</sup> + 10" brake / + freno 10" / + frein de 10" / + freno de 10"

<sup>3)</sup> - ABS/markings:EB/not for Delco BKV / - ABS/marcatura:EB/non per Delco BKV / - ABS/marçaje:EB/no para Delco BKV

<sup>4)</sup> - Sport/+ auto.transm./- air condit. / - Sport/+ scatola.auto./- aria condiz. / - Sport/+ transm.auto./- air condit. / - Sport/+ cambio auto./- aire acond.

<sup>5)</sup> - Sport/+ manual transm. / - Sport/+ cambio velocità / - Sport/+ transm. mécanique / - Sport/+ cambio velocidad

| <b>OPEL CORSA B / Vauxhall Corsa (93-00)</b> |             |     |          |       |       |   |                |        |  |  |
|--|-------------|-----|----------|-------|-------|---|----------------|--------|--|--|
|  | 1.5 TD      |     |          | 03.93 | 09.00 | 24.3481-1733.5                              | 240213         | 2      | D=48, - Halter<br>ATE<br>D=48, - Halter<br>ATE<br>Dichtungssatz<br>ATE<br>Hülensatz<br>ATE<br>Führungsbolzen<br>ATE<br>Haltefeder<br>ATE |  |
|  | 1.7 D       |     |          | 09.93 | 09.00 | 24.3481-1734.5                              | 240214         |        |  |  |
|  |             |     |          |       |       | 11.0441-4811.2                              | 250024         |        |  |  |
|  |             |     |          |       |       | 11.0101-5407.2                              | 260011         |        |  |  |
|  |             |     |          |       |       | 11.8171-0008.1                              | 990049         |        |  |  |
|  |             |     |          |       |       | 11.8116-0129.1                              | 390591         |        |  |  |
|  |             |     |          |       |       |   |                |        |  |  |
|  | 1.2         |     |          | 03.93 | 09.00 | - Sport/ + Automatikgetr./ + Klimaanlage 1) | 11.9481-9871.2 | 220681 | 2  | D=48, - Halter<br>ATE<br>D=48, - Halter<br>ATE<br>Dichtungssatz<br>ATE<br>Hülensatz<br>ATE<br>Führungsbolzen<br>ATE<br>Haltefeder<br>ATE |
|  | 1.2 16V     |     |          | 04.98 | 09.00 | + Sport 2)                                  | 11.9481-9872.2 | 220682 |  |  |
|  | 1.2 16V     |     |          | 04.98 | 09.00 | - Sport/ + Automatikgetr./ + Klimaanlage 1) | 11.0441-4811.2 | 250024 |  |  |
|  | 1.4         |     |          | 03.93 | 09.00 | + Sport 2)                                  | 11.0101-5407.2 | 260011 |  |  |
|  | 1.4 i 16V   |     |          | 03.93 | 09.00 | - Sport/ + Automatikgetr./ + Klimaanlage 1) | 11.8171-0008.1 | 990049 |  |  |
|  | 1.4 Si      | 60  |          | 03.93 | 09.00 |   | 11.8116-0129.1 | 390591 |  |  |
|  | Combo       |     |          | 09.93 | 09.00 |   |                |        |  |  |
|  | 1.6 GSI 16V | 109 |          | 09.93 | 09.00 |   | 11.9481-9871.2 | 220681 | 2  | D=48, - Halter<br>ATE<br>D=48, - Halter<br>ATE<br>Dichtungssatz<br>ATE<br>Hülensatz<br>ATE<br>Führungsbolzen<br>ATE<br>Haltefeder<br>ATE |
|  | 1.6 i 16V   |     |          | 09.93 | 09.00 |   | 11.9481-9872.2 | 220682 |  |  |
|  |             |     |          |       |       | 11.0441-4811.2                              | 250024         |        |  |  |
|  |             |     |          |       |       | 11.0101-5407.2                              | 260011         |        |  |  |
|  |             |     |          |       |       | 11.8171-0008.1                              | 990049         |        |  |  |
|  |             |     |          |       |       | 11.8116-0129.1                              | 390591         |        |  |  |
|  |             |     |          |       |       |   |                |        |  |  |
|  | 1.0 12V     |     |          | 11.96 | 09.00 |   | 24.5231-0320.3 | 330496 | 2  | L=320  |
|  | 1.2         |     |          | 03.93 | 09.00 |   |                |        |  |  |
|  | 1.2 16V     |     |          | 04.98 | 09.00 |   |                |        |  |  |
|  | 1.4         |     |          | 03.93 | 09.00 |   |                |        |  |  |
|  | 1.4 i 16V   |     |          | 03.93 | 09.00 |   |                |        |  |  |
|  | 1.4 Si      | 60  |          | 03.93 | 09.00 |   |                |        |  |  |
|  | 1.5 D       |     |          | 03.93 | 09.00 |   |                |        |  |  |
|  | 1.5 TD      |     |          | 03.93 | 09.00 |   |                |        |  |  |
|  | 1.6 GSI 16V | 109 |          | 09.93 | 09.00 |   |                |        |  |  |
|  | 1.6 i 16V   |     |          | 09.93 | 09.00 |   |                |        |  |  |
| 1.7 D  |             |     | 09.93    | 09.00 |       |   |                |        |  |  |
|  | 1.0 12V     |     |          | 11.96 | 09.00 |   | 24.5233-0200.3 | 330425 | 2  | L=198  |
|  | 1.2         |     |          | 03.93 | 09.00 |   |                |        |  |  |
|  | 1.2 16V     |     |          | 04.98 | 09.00 |   |                |        |  |  |
|  | 1.4         |     |          | 03.93 | 09.00 |   |                |        |  |  |
|  | 1.4 i 16V   |     |          | 03.93 | 09.00 |   |                |        |  |  |
|  | 1.4 Si      | 60  |          | 03.93 | 09.00 |   |                |        |  |  |
|  | 1.5 D       |     |          | 03.93 | 09.00 |   |                |        |  |  |
|  | 1.5 TD      |     |          | 03.93 | 09.00 |   |                |        |  |  |
|  | 1.6 GSI 16V | 109 |          | 09.93 | 09.00 |   |                |        |  |  |
|  | 1.6 i 16V   |     |          | 09.93 | 09.00 |   |                |        |  |  |
| 1.7 D  |             |     | 09.93    | 09.00 |       |   |                |        |  |  |
|  | 1.0 12V     |     |          | 11.96 | 09.00 |   | 03.3219-6311.3 | 020057 | + GG 3)<br>+ ALU 4)  | Rz 19,05 (GG)<br>Rz 19,05 (ALU)  |
|  | 1.2         |     |          | 03.93 | 09.00 |   | 24.3219-1715.3 | 020122 |  |  |
|  | 1.2 16V     |     |          | 04.98 | 09.00 |   |                |        |  |  |
|  | 1.4         |     |          | 03.93 | 09.00 |   |                |        |  |  |
|  | 1.4 i 16V   |     |          | 03.93 | 09.00 |   |                |        |  |  |
|  | 1.4 Si      | 60  |          | 03.93 | 09.00 |   |                |        |  |  |
|  | 1.5 D       |     |          | 03.93 | 09.00 |   |                |        |  |  |
|  | 1.5 TD      |     |          | 03.93 | 09.00 |   |                |        |  |  |
|  | 1.6 GSI 16V | 109 |          | 09.93 | 09.00 |   |                |        |  |  |
|  | 1.6 i 16V   |     |          | 09.93 | 09.00 |   |                |        |  |  |
| 1.7 D  |             |     | 09.93    | 09.00 |       |   |                |        |  |  |
| Combo  |             |     | 09.93    | 09.00 |       | 24.3219-1111.3                              | 020194         |        | Rz 19,05   |  |
|  | 1.0 12V     |     |          | 11.96 | 09.00 |   | 24.3727-0743.2 | 580743 | 1  | L=1373, + Zub<br>L=1078, + Zub   |
|  | 1.2         |     |          | 03.93 | 09.00 |   | 24.3727-0744.2 | 580744 |  |  |
|  | 1.2 16V     |     |          | 04.98 | 09.00 |   |                |        |  |  |
|  | 1.4         |     |          | 03.93 | 09.00 |   |                |        |  |  |
|  | 1.4 i 16V   |     |          | 03.93 | 09.00 |   |                |        |  |  |
|  | 1.4 Si      | 60  |          | 03.93 | 09.00 |   |                |        |  |  |
|  | 1.5 D       |     |          | 03.93 | 09.00 |   |                |        |  |  |
|  | 1.5 TD      |     |          | 03.93 | 09.00 |   |                |        |  |  |
|  | 1.6 GSI 16V | 109 |          | 09.93 | 09.00 |   |                |        |  |  |
|  | 1.6 i 16V   |     |          | 09.93 | 09.00 |   |                |        |  |  |
| 1.7 D  |             |     | 09.93    | 09.00 |       |   |                |        |  |  |
| Combo  |             |     | 09.93    | 09.00 |       | 24.3727-0759.2                              | 580759         |        | L=1659/1521  |  |
|  | 1.0 12V     |     |          | 11.96 | 09.00 |   | 03.0101-0031.2 | 320211 | 1  | BRES 3/30  |
|  | 1.2         |     |          | 03.93 | 09.00 |   |                |        |  |  |
|  | 1.2 16V     |     |          | 04.98 | 09.00 |   | 03.6585-0018.3 | 320114 |  |  |
|  | 1.4         |     |          | 03.93 | 09.00 |   |                |        |  |  |
|  | 1.4 i 16V   |     |          | 03.93 | 09.00 |   |                |        |  |  |
|  | 1.4 Si      | 60  |          | 03.93 | 09.00 |   |                |        |  |  |
|  | 1.5 D       |     |          | 03.93 | 09.00 |   |                |        |  |  |
|  | 1.5 TD      |     |          | 03.93 | 09.00 |   |                |        |  |  |
|  | 1.6 GSI 16V | 109 |          | 09.93 | 09.00 |   |                |        |  |  |
|  | 1.6 i 16V   |     |          | 09.93 | 09.00 |   |                |        |  |  |
| 1.7 D  |             |     | 09.93    | 09.00 |       |   |                |        |  |  |
| Combo  |             |     | 09.93    | 10.01 |       | 03.6585-0019.3                              | 320239         |        | BRL 8/5 (4)  |  |
|  | 1.0 12V     |     |          | 11.96 | 09.00 |   | 24.3728-0724.2 | 590724 | 1  | L=841  |
|  | 1.2         |     |          | 03.93 | 09.00 |   | 24.3728-0720.2 | 590720 |  |  |
|  | 1.4         |     |          | 03.93 | 09.00 |   |                |        |  |  |
|  | 1.4 i 16V   |     |          | 03.93 | 09.00 |   |                |        |  |  |
|  | 1.4 Si      | 60  |          | 03.93 | 09.00 |   |                |        |  |  |
|  | 1.5 D       |     |          | 03.93 | 09.00 |   |                |        |  |  |
| 1.5 TD                                       |             |     | 03.93    | 09.00 |       |   |                |        |  |  |
|  | 1.2         |     | S3/S4/S6 | 03.93 | 09.00 |   |                |        | 1  | L=727  |
|  | 1.4         |     | S3/S4/S6 | 03.93 | 09.00 |   |                |        |  |  |
|  | 1.4 i 16V   |     | S3/S4/S6 | 03.93 | 09.00 |   |                |        |  |  |
|  | 1.4 Si      | 60  |          | 03.93 | 09.00 |   |                |        |  |  |
|  | 1.5 D       |     | S3/S4/S6 | 03.93 | 09.00 |   |                |        |  |  |
|  | 1.5 TD      |     | S3/S4/S6 | 03.93 | 09.00 |   |                |        |  |  |

1) - Sport/+ auto.transm./+ air condit. / - Sport/+ scatola.auto./+ aria condiz. / - Sport/+ transm.auto./+ air condit. / - Sport/+ cambio auto./+ aire acond.

2) + Sport / + Sportivo / + Sport / + Deportivo

3) + cast iron / + ghisa / + fonte grise / + fundición de gris

4) + aluminium / + alluminio / + aluminium / + aluminio



| OPEL CORSA B / Vauxhall Corsa (93-00)       |             |          |          |       |       |                |                |                |                          |          |                    |               |
|---|-------------|----------|----------|-------|-------|----------------|----------------|----------------|--------------------------|----------|--------------------|---------------|
|   | 1.6 GSI 16V | 1109     | S3/S4/S6 | 09.93 |       | 24.3728-0720.2 | 590720         |                |                          |          | L=727              |               |
|   | 1.6 i 16V   |          | S3/S4/S6 | 09.93 |       |                |                |                |                          |          |                    |               |
|   | 1.7 D       |          | S3/S4/S6 | 09.93 |       |                |                |                |                          |          |                    |               |
|   | 1.2         |          | T3/T4/T6 |       | 04.98 | 09.00          |                | 24.3728-0721.2 | 590721                   |          | L=794              |               |
|   | 1.2 16V     |          |          |       |       | 09.00          |                |                |                          |          |                    |               |
|   | 1.4         |          | T3/T4/T6 |       |       | 09.00          |                |                |                          |          |                    |               |
|   | 1.4 i 16V   |          | T3/T4/T6 |       |       | 09.00          |                |                |                          |          |                    |               |
|   | 1.5 D       |          | T3/T4/T6 |       |       | 09.00          |                |                |                          |          |                    |               |
|   | 1.5 TD      |          | T3/T4/T6 |       |       | 09.00          |                |                |                          |          |                    |               |
| 1.6 GSI 16V                                 | 1109        | T3/T4/T6 |          |       | 09.00 |                |                |                |                          |          |                    |               |
| 1.6 i 16V                                   |             | T3/T4/T6 |          |       | 09.00 |                |                |                |                          |          |                    |               |
| 1.7 D                                       |             | T3/T4/T6 |          |       | 09.00 |                |                |                |                          |          |                    |               |
| OPEL CORSA C / Vauxhall Corsa MK II (00-06) |             |          |          |       |       |                |                |                |                          |          |                    |               |
|   | 1.0 12V     |          | 36999999 | 09.00 |       | 24.2122-1740.3 | 010711         |                |                          |          | THz 22,20 DEL      |               |
|   | 1.2 16V     |          | 36999999 | 09.00 |       |                |                |                |                          |          |                    |               |
|   | 1.3 CDTI    |          | 36999999 | 06.03 |       |                |                |                |                          |          |                    |               |
|   | 1.6         |          | 36999999 | 09.01 |       |                |                |                |                          |          |                    |               |
|   | 1.7 CDTI    |          | 36999999 | 06.03 |       |                |                |                |                          |          |                    |               |
|   | 1.7 DI 16V  |          | 36999999 | 09.00 |       |                |                |                |                          |          |                    |               |
|   | 1.7 DTI 16V |          | 36999999 | 09.00 |       |                |                |                |                          |          |                    |               |
|   | 1.0 12V     | 43000001 |          |       |       | 09.06          | - ABS          | 24.2122-1756.3 | 010766                   |          |                    | THz 22,20 BOS |
|   | 1.2 16V     | 43000001 |          |       |       | 09.06          | - ABS          |                |                          |          |                    |               |
|   | 1.3 CDTI    | 43000001 |          |       |       | 09.06          | - ABS          |                |                          |          |                    |               |
| 1.6   | 43000001    |          |          |       | 09.06 | - ABS          |                |                |                          |          |                    |               |
| 1.7 CDTI                                    | 43000001    |          |          |       | 09.06 | - ABS          |                |                |                          |          |                    |               |
| 1.7 DI 16V                                  | 43000001    |          |          |       | 09.06 | - ABS          |                |                |                          |          |                    |               |
| 1.7 DTI 16V                                 | 43000001    |          |          |       | 09.06 | - ABS          |                |                |                          |          |                    |               |
| 1.0 12V                                     | 43000001    |          |          |       | 09.06 | + ESP          | 24.2122-1757.3 | 010769         |                          |          | THz 22,20 BOS      |               |
| 1.2 16V                                     | 43000001    |          |          |       | 09.06 | + ESP          |                |                |                          |          |                    |               |
| 1.3 CDTI                                    | 43000001    |          |          |       | 09.06 | + ESP          |                |                |                          |          |                    |               |
| 1.6   | 43000001    |          |          |       | 09.06 | + ESP          |                |                |                          |          |                    |               |
| 1.7 CDTI                                    | 43000001    |          |          |       | 09.06 | + ESP          |                |                |                          |          |                    |               |
| 1.7 DI 16V                                  | 43000001    |          |          |       | 09.06 | + ESP          |                |                |                          |          |                    |               |
| 1.7 DTI 16V                                 | 43000001    |          |          |       | 09.06 | + ESP          |                |                |                          |          |                    |               |
| 1.4 16V                                     | 43000001    |          |          |       | 09.06 | - ABS          | 24.2122-1756.3 | 010766         |                          |          | THz 22,20 BOS      |               |
| 1.8 16V                                     | 43000001    |          |          |       | 09.06 | - ABS          |                |                |                          |          |                    |               |
| 1.4 16V                                     | 43000001    |          |          |       | 09.06 | - ESP          | 24.2123-1767.3 | 010844         |                          |          | THz 23,81 BOS      |               |
| 1.8 16V                                     | 43000001    |          |          |       | 09.06 | - ESP          |                |                |                          |          |                    |               |
| 1.4 16V                                     | 43000001    |          |          |       | 09.06 | + ESP          | 24.2123-1768.3 | 010845         |                          |          | THz 23,81 BOS      |               |
| 1.8 16V                                     | 43000001    |          |          |       | 09.06 | + ESP          |                |                |                          |          |                    |               |
|   | 1.0 12V     |          |          | 09.00 | 09.06 | - ABS          | 24.3481-1767.5 | 240371         | <input type="checkbox"/> |          | D=48, - Halter LUC |               |
|   | 1.2 16V     |          |          | 09.00 | 09.06 | - ABS          | 24.3481-1768.5 | 240372         | <input type="checkbox"/> |          | D=48, - Halter LUC |               |
|   | 1.0 12V     |          |          | 09.00 | 09.06 | + ABS          | 24.3481-1765.5 | 240369         | <input type="checkbox"/> |          | D=48, - Halter LUC |               |
|   | 1.2 16V     |          |          | 09.00 | 09.06 | + ABS          | 24.3481-1766.5 | 240370         | <input type="checkbox"/> |          | D=48, - Halter LUC |               |
|   | 1.7 DI 16V  |          |          | 09.00 | 09.06 |                |                |                |                          |          |                    |               |
|   | 1.3 CDTI    |          |          | 06.03 | 09.06 |                | 24.3541-1795.7 | 220551         | <input type="checkbox"/> |          | D=54, - Halter LUC |               |
|   | 1.4 16V     |          |          | 09.00 | 09.06 |                | 24.3541-1796.7 | 220552         | <input type="checkbox"/> |          | D=54, - Halter LUC |               |
|   | 1.6         |          |          | 09.01 | 09.06 |                |                |                |                          |          |                    |               |
|   | 1.7 DTI 16V |          |          | 09.00 | 09.06 |                |                |                |                          |          |                    |               |
|   | 1.8 16V     |          |          | 09.00 | 09.06 |                |                |                |                          |          |                    |               |
| 1.7 CDTI                                    |             |          | 06.03    | 09.06 |       |                |                |                |                          |          |                    |               |
|   | 1.0 12V     |          |          | 09.00 | 09.06 |                | 11.9571-9823.2 | 220471         | <input type="checkbox"/> |          | D=57, - Halter ATE |               |
|   | 1.2 16V     |          |          | 09.00 | 09.06 |                | 11.9571-9824.2 | 220472         | <input type="checkbox"/> |          | D=57, - Halter ATE |               |
|   | 1.3 CDTI    |          |          | 06.03 | 09.06 |                | 24.3571-9823.5 | 240499         | <input type="checkbox"/> |          | D=57, - Halter ATE |               |
|   | 1.4 16V     |          |          | 09.00 | 09.06 |                | 24.3571-9824.5 | 240500         | <input type="checkbox"/> |          | D=57, - Halter ATE |               |
|   | 1.6         |          |          | 09.01 | 09.06 |                | 11.0441-5704.2 | 250034         |                          |          | Dichtungssatz ATE  |               |
|   | 1.7 CDTI    |          |          | 06.03 | 09.06 |                | 11.0101-5407.2 | 260011         |                          |          | Hülsensatz ATE     |               |
|   | 1.7 DI 16V  |          |          | 09.00 | 09.06 |                | 11.8171-0008.1 | 990049         |                          |          | Führungsbolzen ATE |               |
|   | 1.7 DTI 16V |          |          | 09.00 | 09.06 |                | 11.8116-0292.1 | 390521         | 2                        |          | Haltefeder ATE     |               |
|   | 1.8 16V     |          |          | 09.00 | 09.06 |                |                |                |                          |          |                    |               |
|   |             |          |          |       |       |                | 24.5256-0298.3 | 330756         | 2                        |          | L=298              |               |
|   | 1.0 12V     |          |          | 09.00 | 09.06 |                |                |                |                          |          |                    |               |
|   | 1.2 16V     |          |          | 09.00 | 09.06 |                |                |                |                          |          |                    |               |
|   | 1.3 CDTI    |          |          | 06.03 | 09.06 |                |                |                |                          |          |                    |               |
|   | 1.4 16V     |          |          | 09.00 | 09.06 |                |                |                |                          |          |                    |               |
|   | 1.6         |          |          | 09.01 | 09.06 |                |                |                |                          |          |                    |               |
|   | 1.7 CDTI    |          |          | 06.03 | 09.06 |                |                |                |                          |          |                    |               |
|   | 1.7 DI 16V  |          |          | 09.00 | 09.06 |                |                |                |                          |          |                    |               |
|   | 1.7 DTI 16V |          |          | 09.00 | 09.06 |                |                |                |                          |          |                    |               |
|   | 1.8 16V     |          |          | 09.00 | 09.06 |                |                |                |                          |          |                    |               |
|   |             |          |          |       |       |                | 24.5240-0195.3 | 330753         | 2                        |          | L=195              |               |
|   | 1.0 12V     |          |          | 09.00 | 09.06 |                |                |                |                          |          |                    |               |
|   | 1.2 16V     |          |          | 09.00 | 09.06 |                |                |                |                          |          |                    |               |
|   | 1.3 CDTI    |          |          | 06.03 | 09.06 |                |                |                |                          |          |                    |               |
|   | 1.6         |          |          | 09.01 | 09.06 |                |                |                |                          |          |                    |               |
|   | 1.7 CDTI    |          |          | 06.03 | 09.06 |                |                |                |                          |          |                    |               |
|   | 1.7 DI 16V  |          |          | 09.00 | 09.06 |                |                |                |                          |          |                    |               |
|   | 1.7 DTI 16V |          |          | 09.00 | 09.06 |                |                |                |                          |          |                    |               |
|   | 1.4 16V     |          |          | 09.00 | 09.06 |                |                |                |                          |          |                    |               |
|   | 1.8 16V     |          |          | 09.00 | 09.06 |                | 24.5111-0210.3 | 330765         | 2                        |          | L=210              |               |
|   |             |          |          |       |       |                | 24.3219-1715.3 | 020122         |                          |          | Rz 19,05 (ALU)     |               |
|   | 1.0 12V     |          |          | 09.00 | 09.06 |                |                |                |                          |          |                    |               |
|   | 1.2 16V     |          |          | 09.00 | 09.06 |                |                |                |                          |          |                    |               |
|   | 1.3 CDTI    |          |          | 06.03 | 09.06 |                |                |                |                          |          |                    |               |
|   | 1.4 16V     |          |          | 09.00 | 09.06 |                |                |                |                          |          |                    |               |
|   | 1.6         |          |          | 09.01 | 09.06 |                |                |                |                          |          |                    |               |
|   | 1.7 DI 16V  |          |          | 09.00 | 09.06 |                |                |                |                          |          |                    |               |
| 1.7 DTI 16V                                 |             |          | 09.00    | 09.06 |       |                |                |                |                          |          |                    |               |
| 1.7 CDTI                                    |             |          | 06.03    | 09.06 |       | 24.3220-1719.3 | 020448         |                |                          | Rz 20,64 |                    |               |

1) - red caliper / - pinza rossa / - étrier rouge / - pinza roja

| <b>OPEL CORSA C / Vauxhall Corsa MK II (00-06)</b> |                   |     |          |          |       |                |                |                                    |                                    |
|--|-------------------|-----|----------|----------|-------|----------------|----------------|------------------------------------|------------------------------------|
|  | 1.0 12V           |     |          | 09.00    | 09.06 | 24.3727-0755.2 | 580755         | 1 ↑                                | L=330, + Zub                       |
|  | 1.2 16V           |     |          | 09.00    | 09.06 | 24.3727-0750.2 | 580750         | 1 ↓                                | L=1095, + Zub                      |
|  | 1.6               |     |          | 09.01    | 09.06 | 24.3727-0749.2 | 580749         | 1 ↓                                | L=832, + Zub                       |
|  | 1.7 DI 16V        |     |          | 09.00    | 09.06 | 24.3727-0787.2 | 580787         | 2 ↓                                | L=217                              |
|  |                   |     |          |          |       | 24.3727-0786.2 | 580786         | 2 ↓                                | L=217                              |
|  | 1.3 CDTI          |     |          | 06.03    | 09.06 | 24.3727-0755.2 | 580755         | 1 ↑                                | L=330, + Zub                       |
|  | 1.7 CDTI          |     |          | 06.03    | 09.06 | 24.3727-0769.2 | 580769         | 1 ↓                                | L=1106                             |
|  | 1.7 DTI 16V       |     |          | 09.00    | 09.06 | 24.3727-0749.2 | 580749         | 2 ↓                                | L=832, + Zub                       |
|  |                   |     |          |          |       | 24.3727-0787.2 | 580787         | 2 ↓                                | L=217                              |
|  |                   |     |          |          |       | 24.3727-0786.2 | 580786         | 2 ↓                                | L=217                              |
|  | 1.4 16V           |     |          | 09.00    | 09.06 | 24.3727-0755.2 | 580755         | 1 ↑                                | L=330, + Zub                       |
|  | 1.8 16V           |     |          | 09.00    | 09.06 | 24.3727-0769.2 | 580769         | 1 ↓                                | L=1106                             |
|  |                   |     |          |          |       | 24.3727-0749.2 | 580749         | 2 ↓                                | L=832, + Zub                       |
|  |                   |     |          |          |       | 24.3727-0787.2 | 580787         | 2 ↓                                | L=217                              |
|  |                   |     |          |          |       | 24.3727-0786.2 | 580786         | 2 ↓                                | L=217                              |
|  |                   |     |          |          |       | 24.3727-0768.2 | 580768         | 2 ↓                                | L=1426                             |
|  |                   |     |          |          |       | 24.3727-0766.2 | 580766         | 2 ↓                                | L=1143                             |
|  | 1.0 12V           |     |          | 09.00    | 09.06 | 03.6043-0964.3 | 320268         | + M10                              | BRE 3/30                           |
|  | 1.2 16V           |     |          | 09.00    | 09.06 | 03.6043-0974.3 | 320244         | + M12                              | BRE 3/30                           |
| <b>OPEL CORSA D / Vauxhall Corsa MK III (06-)</b>  |                   |     |          |          |       |                |                |                                    |                                    |
|  | 1.0 i             |     |          | 10.06    |       | 24.4122-1705.3 | 010852         | + ESP                              | Thz 22,20 + Behälter               |
|  | 1.2               | 51  |          | 06.10    |       |                |                |                                    | <b>BOS</b>                         |
|  | 1.2               | 63  |          | 06.10    |       |                |                |                                    | <b>BOS</b>                         |
|  | 1.2 i 16V         | 59  |          | 10.06    |       |                |                |                                    |                                    |
|  | 1.2 LPG           |     |          | 09.09    |       |                |                |                                    |                                    |
|  | 1.3 CDTI          | 55  |          | 10.06    |       |                |                |                                    |                                    |
|  | 1.3 CDTI          | 66  |          | 10.06    |       |                |                |                                    |                                    |
|  | 1.3 CDTi          | 70  |          | 06.10    |       |                |                |                                    |                                    |
|  | 1.4               | 64  |          | 09.09    |       |                |                |                                    |                                    |
|  | 1.4               | 74  |          | 06.10    |       |                |                |                                    |                                    |
|  | 1.4 i 16V         | 66  |          | 10.06    |       |                |                |                                    |                                    |
|  | 1.0 i             |     |          | 10.06    |       | 24.3541-1769.7 | 220707         | + belüftete Scheiben <sup>5)</sup> | D=54, - Halter                     |
|  | 1.2               | 51  |          | 06.10    |       | 24.3541-1770.7 | 220708         | + belüftete Scheiben <sup>5)</sup> | D=54, - Halter                     |
|  | 1.2               | 63  |          | 06.10    |       |                |                |                                    | <b>BOS</b>                         |
|  | 1.2 i 16V         | 59  |          | 10.06    |       |                |                |                                    |                                    |
|  | 1.2 LPG           |     |          | 09.09    |       |                |                |                                    |                                    |
|  | 1.3 CDTI          | 55  |          | 10.06    |       |                |                |                                    |                                    |
|  | 1.3 CDTI          | 70  |          | 06.10    |       |                |                |                                    |                                    |
|  | 1.4               | 64  |          | 09.09    |       |                |                |                                    |                                    |
|  | 1.4               | 74  |          | 06.10    |       |                |                |                                    |                                    |
|  | 1.4 i 16V         | 66  |          | 10.06    |       |                |                |                                    |                                    |
|  |                   |     | 74098701 | 76999999 |       |                | 24.3541-1837.7 | 220745                             | - belüftete Scheiben <sup>7)</sup> |
|  |                   |     |          |          |       | 24.3541-1838.7 | 220746         | - belüftete Scheiben <sup>7)</sup> | D=54, - Halter                     |
|  | 1.6 Turbo GSI     | 110 |          | 06.07    |       | 11.9571-9823.2 | 220471         |                                    | D=57, - Halter                     |
|  |                   |     |          |          |       | 11.9571-9824.2 | 220472         |                                    | D=57, - Halter                     |
|  |                   |     |          |          |       | 24.3571-9823.5 | 240499         |                                    | D=57, - Halter                     |
|  |                   |     |          |          |       | 24.3571-9824.5 | 240500         |                                    | D=57, - Halter                     |
|  |                   |     |          |          |       | 11.0441-5704.2 | 250034         |                                    | Dichtungssatz                      |
|  |                   |     |          |          |       | 11.8171-0008.1 | 990049         |                                    | Führungsbolzen                     |
|  |                   |     |          |          |       | 11.8116-0292.1 | 390521         | 2                                  | Haltefeder                         |
|  | 1.6 Turbo OPC     |     |          | 03.07    |       | 11.0441-5704.2 | 250034         |                                    | Dichtungssatz                      |
|  |                   |     |          |          |       | 11.8171-0008.1 | 990049         |                                    | Führungsbolzen                     |
|  |                   |     |          |          |       | 11.8116-0292.1 | 390521         | 2                                  | Haltefeder                         |
|  | 1.0 i             |     |          | 10.06    |       | 24.5112-0402.3 | 331297         | 2                                  | L=402                              |
|  | 1.2               | 51  |          | 06.10    |       |                |                |                                    |                                    |
|  | 1.2               | 63  |          | 06.10    |       |                |                |                                    |                                    |
|  | 1.2 i 16V         | 59  |          | 10.06    |       |                |                |                                    |                                    |
|  | 1.2 LPG           |     |          | 09.09    |       |                |                |                                    |                                    |
|  | 1.3 CDTI          | 55  |          | 10.06    |       |                |                |                                    |                                    |
|  | 1.3 CDTI          | 66  |          | 10.06    |       |                |                |                                    |                                    |
|  | 1.3 CDTi          | 70  |          | 06.10    |       |                |                |                                    |                                    |
|  | 1.4               | 64  |          | 09.09    |       |                |                |                                    |                                    |
|  | 1.4               | 74  |          | 06.10    |       |                |                |                                    |                                    |
|  | 1.4 i 16V         | 66  |          | 10.06    |       |                |                |                                    |                                    |
|  | 1.7 CDTI          | 92  |          | 10.06    |       |                |                |                                    |                                    |
|  | 1.7 CDTi          | 96  |          | 06.10    |       |                |                |                                    |                                    |
|  | 1.0 i             |     |          | 10.06    |       | 24.5112-0142.3 | 331016         | 2                                  | + Scheibenbremse <sup>8)</sup>     |
|  | 1.2               | 51  |          | 06.10    |       |                |                |                                    | L=142                              |
|  | 1.2               | 63  |          | 06.10    |       |                |                |                                    |                                    |
|  | 1.2 i 16V         | 59  |          | 10.06    |       |                |                |                                    |                                    |
|  | 1.2 LPG           |     |          | 09.09    |       |                |                |                                    |                                    |
|  | 1.3 CDTI          | 55  |          | 10.06    |       |                |                |                                    |                                    |
|  | 1.3 CDTI          | 66  |          | 10.06    |       |                |                |                                    |                                    |
|  | 1.3 CDTi          | 70  |          | 06.10    |       |                |                |                                    |                                    |
|  | 1.4               | 64  |          | 09.09    |       |                |                |                                    |                                    |
|  | 1.4               | 74  |          | 06.10    |       |                |                |                                    |                                    |
|  | 1.4 i 16V         | 66  |          | 10.06    |       |                |                |                                    |                                    |
|  | 1.4 Turbo ecoFLEX | 88  |          | 06.12    |       |                |                |                                    |                                    |
|  | 1.6 Turbo GSI     | 110 |          | 06.07    |       |                |                |                                    |                                    |
|  | 1.6 Turbo OPC     |     |          | 03.07    |       |                |                |                                    |                                    |
|  | 1.7 CDTI          | 92  |          | 10.06    |       |                |                |                                    |                                    |
|  | 1.7 CDTi          | 96  |          | 06.10    |       |                |                |                                    |                                    |

<sup>1)</sup> extens.only/+ RA-drum br./-ABS / solo prol./+P fr.a tambu./-ABS / rallong.seul./-tamb.es.AR/+ABS / solam.

<sup>2)</sup> extens.only/+ RA-drum br./+ABS / solo prol./+P fr.a tambu./+ABS / rallong.seul./+tamb.es.AR/+ABS / solam.

<sup>3)</sup> + RA drum brake / + P freno a tamburo / + frein à tambour essieu AR / + ET-tambores de freno

<sup>4)</sup> + RA disc brake / + P disco freno / + frein à disque essieu AR / + ET-disco de freno

<sup>5)</sup> + ventilated discs / + dischi ventilati / + disques ventilés / + disco ventilado

<sup>6)</sup> + brake disc 257mm / + dischi freno 257mm / + disque de frein 257mm / + disco de freno 257mm

<sup>7)</sup> - ventilated discs / - dischi ventilati / - disques ventilés / - disco ventilado

<sup>8)</sup> + disc brake / + disco freno / + disques de frein / + disco de freno

| <b>OPEL CORSA D / Vauxhall Corsa MK III (06-)</b> |                       |          |          |       |       |                |        |   |   |                              |  |  |  |                |                    |
|---|-----------------------|----------|----------|-------|-------|----------------|--------|---|---|------------------------------|--|--|--|----------------|--------------------|
|   | 1.0 i                 |          |          | 10.06 |       | 24.3219-1755.3 | 020508 |   |   |                              |  |  |  |                | Rz 19,05           |
|   | 1.2                   | 51       |          | 06.10 |       |                |        |   |   |                              |  |  |  |                |                    |
|   | 1.2                   | 63       |          | 06.10 |       |                |        |   |   |                              |  |  |  |                |                    |
|   | 1.2 i 16V             | 59       |          | 10.06 |       |                |        |   |   |                              |  |  |  |                |                    |
|   | 1.2 LPG               |          |          | 09.09 |       |                |        |   |   |                              |  |  |  |                |                    |
|   | 1.2 LPG               |          |          | 09.09 |       |                |        |   |   |                              |  |  |  |                |                    |
|   | 1.3 CDTi              | 55       |          | 10.06 |       |                |        |   |   |                              |  |  |  |                |                    |
|   | 1.3 CDTi              | 66       |          | 10.06 |       |                |        |   |   |                              |  |  |  |                |                    |
|   | 1.3 CDTi              | 70       |          | 06.10 |       |                |        |   |   |                              |  |  |  |                |                    |
|   | 1.4                   | 74       |          | 06.10 |       |                |        |   |   |                              |  |  |  |                |                    |
|   | 1.4 i 16V             | 66       |          | 10.06 |       |                |        |   |   |                              |  |  |  |                |                    |
|   | 1.0 i                 |          | 76064268 | 10.06 |       | 24.3727-0781.2 | 580781 | 1 | ☑ | + 3 türig <sup>1)</sup>      |  |  |  |                | L=1477/1462, + Zub |
|   | 1.2                   | 51       | 76064268 | 06.10 |       |                |        |   |   |                              |  |  |  |                |                    |
|   | 1.2                   | 63       | 76064268 | 06.10 |       |                |        |   |   |                              |  |  |  |                |                    |
|   | 1.2 i 16V             | 59       | 76064268 | 10.06 |       |                |        |   |   |                              |  |  |  |                |                    |
|   | 1.2 LPG               |          | 76064268 | 09.09 |       |                |        |   |   |                              |  |  |  |                |                    |
|   | 1.0 i                 |          |          | 10.06 |       | 24.3727-0782.2 | 580782 | 1 | ☑ | + 5 türig <sup>2)</sup>      |  |  |  |                | L=1477/1492, + Zub |
|   | 1.2                   | 51       |          | 06.10 |       |                |        |   |   |                              |  |  |  |                |                    |
|   | 1.2                   | 63       |          | 06.10 |       |                |        |   |   |                              |  |  |  |                |                    |
|   | 1.2 i 16V             | 59       |          | 10.06 |       |                |        |   |   |                              |  |  |  |                |                    |
|   | 1.2 LPG               |          |          | 09.09 |       |                |        |   |   |                              |  |  |  |                |                    |
|   | 1.3 CDTi              | 55       |          | 10.06 |       | 24.3727-0782.2 | 580782 | 1 | ☑ |                              |  |  |  |                | L=1477/1492, + Zub |
|   | 1.3 CDTi              | 66       |          | 10.06 |       |                |        |   |   |                              |  |  |  |                |                    |
|   | 1.3 CDTi              | 70       |          | 06.10 |       |                |        |   |   |                              |  |  |  |                |                    |
|   | 1.4                   | 64       |          | 09.09 |       |                |        |   |   |                              |  |  |  |                |                    |
|   | 1.4                   | 74       |          | 06.10 |       |                |        |   |   |                              |  |  |  |                |                    |
|   | 1.4 i 16V             | 66       |          | 10.06 |       |                |        |   |   |                              |  |  |  |                |                    |
| <b>OPEL FRONTERA A (92-98)</b>                    |                       |          |          |       |       |                |        |   |   |                              |  |  |  |                |                    |
|   | 2.0                   | SV720103 |          | 10.98 |       | 24.3601-1717.5 | 240391 |   | ☑ |                              |  |  |  | D=60, - Halter | <b>AKE</b>         |
|   | 2.2 16V               | SV720103 |          | 10.98 |       | 24.3601-1718.5 | 240392 |   | ☑ |                              |  |  |  | D=60, - Halter | <b>AKE</b>         |
|   | 2.3 TD                | SV720103 |          | 10.98 |       |                |        |   |   |                              |  |  |  |                |                    |
|   | 2.4                   | SV720103 |          | 10.98 |       |                |        |   |   |                              |  |  |  |                |                    |
|   | 2.5 TDS               | SV720103 |          | 10.98 |       |                |        |   |   |                              |  |  |  |                |                    |
|   | 2.8 TD                | SV720103 |          | 10.98 |       |                |        |   |   |                              |  |  |  |                |                    |
|   | 2.0                   | SV720103 |          | 10.98 |       | 24.3411-1701.5 | 240361 |   | ☑ |                              |  |  |  | D=41, - Halter | <b>AKE</b>         |
|   | 2.2 16V               | SV720103 |          | 10.98 |       | 24.3411-1702.5 | 240362 |   | ☑ |                              |  |  |  | D=41, - Halter | <b>AKE</b>         |
|   | 2.3 TD                | SV720103 |          | 10.98 |       |                |        |   |   |                              |  |  |  |                |                    |
|   | 2.4                   | SV720103 |          | 10.98 |       |                |        |   |   |                              |  |  |  |                |                    |
|   | 2.5 TDS               | SV720103 |          | 10.98 |       |                |        |   |   |                              |  |  |  |                |                    |
|   | 2.8 TD                | SV720103 |          | 10.98 |       |                |        |   |   |                              |  |  |  |                |                    |
|   | 2.0                   | SV720102 |          | 03.92 |       | 24.3225-1702.3 | 020425 |   |   |                              |  |  |  |                | Rz 25,40           |
|   | 2.2 16V               | SV720102 |          | 03.95 |       |                |        |   |   |                              |  |  |  |                |                    |
|   | 2.3 TD                | SV720102 |          | 03.92 |       |                |        |   |   |                              |  |  |  |                |                    |
|   | 2.4                   | SV720102 |          | 03.92 |       |                |        |   |   |                              |  |  |  |                |                    |
|   | 2.5 TDS               | SV720102 |          | 09.96 |       |                |        |   |   |                              |  |  |  |                |                    |
|   | 2.8 TD                | SV720102 |          | 03.95 |       |                |        |   |   |                              |  |  |  |                |                    |
| <b>OPEL FRONTERA B (98-04)</b>                    |                       |          |          |       |       |                |        |   |   |                              |  |  |  |                |                    |
|   | 2.2 DTI               |          |          | 10.98 | 02.04 | 24.3601-1717.5 | 240391 |   | ☑ |                              |  |  |  | D=60, - Halter | <b>AKE</b>         |
|   | 2.2 i                 |          |          | 10.98 | 02.04 | 24.3601-1718.5 | 240392 |   | ☑ |                              |  |  |  | D=60, - Halter | <b>AKE</b>         |
|   | 3.2 i                 |          |          | 10.98 | 02.04 |                |        |   |   |                              |  |  |  |                |                    |
|   | 2.2 DTI               |          |          | 10.98 | 02.04 | 24.5277-0420.3 | 330944 | 2 |   |                              |  |  |  | L=420          |                    |
|   | 2.2 i                 |          |          | 10.98 | 02.04 |                |        |   |   |                              |  |  |  |                |                    |
|   | 3.2 i                 |          |          | 10.98 | 02.04 |                |        |   |   |                              |  |  |  |                |                    |
|   | 2.2 DTI               |          |          | 10.98 | 02.04 | 24.3411-1701.5 | 240361 |   | ☑ |                              |  |  |  | D=41, - Halter | <b>AKE</b>         |
|   | 2.2 i                 |          |          | 10.98 | 02.04 | 24.3411-1702.5 | 240362 |   | ☑ |                              |  |  |  | D=41, - Halter | <b>AKE</b>         |
|   | 3.2 i                 |          |          | 10.98 | 02.04 |                |        |   |   |                              |  |  |  |                |                    |
|   | 2.2 DTI               |          |          | 10.98 | 02.04 | 24.5278-0335.3 | 330945 | 2 |   |                              |  |  |  | L=335          |                    |
|   | 2.2 i                 |          |          | 10.98 | 02.04 | 24.5290-0180.3 | 331028 | 2 |   | am Bremssattel <sup>3)</sup> |  |  |  | L=180          |                    |
|   | 3.2 i                 |          |          | 10.98 | 02.04 |                |        |   |   |                              |  |  |  |                |                    |
| <b>OPEL INSIGNIA / Vauxhall Insignia (08-)</b>    |                       |          |          |       |       |                |        |   |   |                              |  |  |  |                |                    |
|   | 1.4 Turbo ecoFLEX     | †103     |          | 06.11 |       | 03.7858-0732.4 | 300272 |   |   |                              |  |  |  | 9/8" Tandem    | <b>ATE</b>         |
|   | 1.4 Turbo LPG ecoFLEX | †103     |          | 07.12 |       |                |        |   |   |                              |  |  |  |                |                    |
|   | 1.6                   | †85      |          | 07.08 |       |                |        |   |   |                              |  |  |  |                |                    |
|   | 1.6 SIDI              | †125     |          | 03.13 |       |                |        |   |   |                              |  |  |  |                |                    |
|   | 1.6 Turbo             | †132     |          | 10.08 |       |                |        |   |   |                              |  |  |  |                |                    |
|   | 1.8                   | †103     |          | 07.08 |       |                |        |   |   |                              |  |  |  |                |                    |
|   | 2.0 BiTurbo CDTi      | †        |          | 07.08 |       |                |        |   |   |                              |  |  |  |                |                    |
|   | 2.0 BiTurbo CDTi 4x4  | †        |          | 07.08 |       |                |        |   |   |                              |  |  |  |                |                    |
|   | 2.0 CDTi              | †81      |          | 07.08 |       |                |        |   |   |                              |  |  |  |                |                    |
|   | 2.0 CDTi              | †88      |          | 03.13 |       |                |        |   |   |                              |  |  |  |                |                    |
|   | 2.0 CDTi              | †96      |          | 07.08 |       |                |        |   |   |                              |  |  |  |                |                    |
|   | 2.0 CDTi              | †103     |          | 07.13 |       |                |        |   |   |                              |  |  |  |                |                    |
|   | 2.0 CDTi              | †118     |          | 07.08 |       |                |        |   |   |                              |  |  |  |                |                    |
|   | 2.0 CDTi              | †120     |          | 07.13 |       |                |        |   |   |                              |  |  |  |                |                    |
|   | 2.0 CDTi 4x4          | †118     |          | 06.10 |       |                |        |   |   |                              |  |  |  |                |                    |
|   | 2.0 CDTi 4x4          | †120     |          | 07.13 |       |                |        |   |   |                              |  |  |  |                |                    |
|   | 2.0 Turbo             | †162     |          | 07.08 |       |                |        |   |   |                              |  |  |  |                |                    |
|   | 2.0 Turbo             | †184     |          | 06.11 |       |                |        |   |   |                              |  |  |  |                |                    |
|   | 2.0 Turbo 4x4         | †162     |          | 07.08 |       |                |        |   |   |                              |  |  |  |                |                    |
|   | 2.0 Turbo 4x4         | †184     |          | 09.11 |       |                |        |   |   |                              |  |  |  |                |                    |

<sup>1)</sup> + 3 door / + 3 porte / + 3 portes / + 3 puertas

<sup>2)</sup> + 5 door / + 5 porte / + 5 portes / + 5 puertas

<sup>3)</sup> on the brake caliper / sulla pinza freno / sur l'étrier de frein / a la pinza de freno

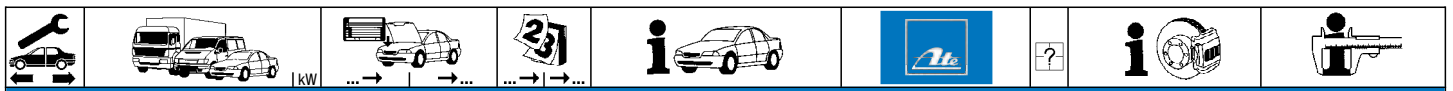































**OPEL INSIGNIA / Vauxhall Insignia (08-)**

|  |   |  |   |                |        |     |               |     |
|--|---|--|---|----------------|--------|-----|---------------|-----|
|  | 1.4 Turbo ecoFLEX #103<br>1.4 Turbo LPG ecoFLEX #103<br>1.6 # 85<br>1.6 SIDI #125<br>1.6 Turbo #132<br>1.8 #103<br>2.0 BiTurbo CDTI #<br>2.0 BiTurbo CDTI 4x4 #<br>2.0 CDTI # 81<br>2.0 CDTI # 88<br>2.0 CDTI # 96<br>2.0 CDTi #103<br>2.0 CDTI #118<br>2.0 CDTI #120<br>2.0 CDTI 4x4 #118<br>2.0 CDTi 4x4 #120<br>2.0 Turbo #162<br>2.0 Turbo #184<br>2.0 Turbo 4x4 #162<br>2.0 Turbo 4x4 #184<br>2.8 V6 T 4x4 OPC #239<br>2.8 V6 Turbo 4x4 #191 |  | 06.11<br>07.12<br>07.08<br>03.13<br>10.08<br>07.08<br>07.08<br>07.08<br>03.13<br>07.08<br>07.13<br>07.08<br>07.13<br>06.10<br>07.13<br>07.08<br>06.11<br>07.08<br>09.11<br>07.09<br>07.08 | 03.2125-0421.3 | 010934 |     | THz 25,40     | ATE |
|  | 1.4 Turbo ecoFLEX 103<br>1.6 85<br>1.6 Turbo 132<br>1.8 103<br>2.0 BiTurbo CDTI<br>2.0 CDTI 81<br>2.0 CDTI 96<br>2.0 CDTI 118<br>2.0 Turbo 162<br>2.0 Turbo 184   | B1182367<br>B1182367<br>B1182367<br>B1182367<br>B1182367<br>B1182367<br>B1182367<br>B1182367<br>B1182367<br>B1182367 | 06.11<br>07.08<br>10.08<br>07.08<br>07.08<br>07.08<br>07.08<br>07.08<br>06.11   | 24.3727-0791.2 | 580791 | 2 ↓ | L=1937, + Zub |     |
|  | 2.0 BiTurbo CDTI 4x4<br>2.0 CDTI 4x4<br>2.0 Turbo 4x4<br>2.0 Turbo 4x4<br>2.8 V6 T 4x4 OPC<br>2.8 V6 Turbo 4x4  | A1006683<br>A1006683<br>A1006683<br>A1006683<br>A1006683<br>A1006683   | 07.08<br>06.10<br>07.08<br>09.11<br>07.09<br>07.08  | 24.3727-0789.2 | 580789 | 2 ↓ | L=2005, + Zub |     |

**OPEL INSIGNIA Sports Tourer / Vauxh. Insignia SportsTourer (08-)**













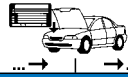



















|  |   |  |   |                |        |     |               |     |
|--|---|--|---|----------------|--------|-----|---------------|-----|
|  | 1.4 Turbo ecoFLEX #103<br>1.4 Turbo LPG ecoFLEX #103<br>1.6 # 85<br>1.6 SIDI #125<br>1.6 Turbo #132<br>1.8 #103<br>2.0 BiTurbo CDTI #<br>2.0 BiTurbo CDTI 4x4 #<br>2.0 CDTI # 81<br>2.0 CDTI # 88<br>2.0 CDTI # 96<br>2.0 CDTi #103<br>2.0 CDTI #118<br>2.0 CDTi #120<br>2.0 CDTI 4x4 #118<br>2.0 CDTi 4x4 #120<br>2.0 Turbo #162<br>2.0 Turbo #184<br>2.0 Turbo 4x4 #162<br>2.0 Turbo 4x4 #184   |  | 06.11<br>07.12<br>07.08<br>03.13<br>10.08<br>07.08<br>07.08<br>07.08<br>03.13<br>07.08<br>07.13<br>07.08<br>07.13<br>06.10<br>07.13<br>07.08<br>06.11<br>07.08<br>09.11                   | 03.7858-0732.4 | 300272 |     | 9/8" Tandem   | ATE |
|  | 1.4 Turbo ecoFLEX #103<br>1.4 Turbo LPG ecoFLEX #103<br>1.6 # 85<br>1.6 SIDI #125<br>1.6 Turbo #132<br>1.8 #103<br>2.0 BiTurbo CDTI #<br>2.0 BiTurbo CDTI 4x4 #<br>2.0 CDTI # 81<br>2.0 CDTI # 88<br>2.0 CDTI # 96<br>2.0 CDTi #103<br>2.0 CDTI #118<br>2.0 CDTi #120<br>2.0 CDTI 4x4 #118<br>2.0 CDTi 4x4 #120<br>2.0 Turbo #162<br>2.0 Turbo #184<br>2.0 Turbo 4x4 #162<br>2.0 Turbo 4x4 #184<br>2.8 V6 T 4x4 OPC #239<br>2.8 V6 Turbo 4x4 #191 |  | 06.11<br>07.12<br>07.08<br>03.13<br>10.08<br>07.08<br>07.08<br>07.08<br>03.13<br>07.08<br>07.13<br>07.08<br>07.13<br>06.10<br>07.13<br>07.08<br>06.11<br>07.08<br>09.11<br>07.09<br>07.08 | 03.2125-0421.3 | 010934 |     | THz 25,40     | ATE |
|  | 1.4 Turbo ecoFLEX 103<br>1.6 85<br>1.6 Turbo 132<br>1.8 103<br>2.0 BiTurbo CDTI   | B1182367<br>B1182367<br>B1182367<br>B1182367<br>B1182367 | 06.11<br>07.08<br>10.08<br>07.08<br>07.08   | 24.3727-0791.2 | 580791 | 2 ↓ | L=1937, + Zub |     |















































|     |  |  |  |  |  |  |  |     |                          |
|--|--|--|--|--|---|--|--|---|--------------------------|
| <b>OPEL INSIGNIA Sports Tourer / Vauxh. Insignia SportsTourer (08-)</b>            |  |  |  |  |   |  |  |   |                          |
|    | 2.0 CDTI   | 81   | B1182367   | 07.08  |   | 24.3727-0791.2   | 580791   | 2 ↓   | L=1937, + Zub            |
|  | 2.0 CDTI   | 96   | B1182367   | 07.08  |   |  |  |   |                          |
|  | 2.0 CDTI   | 118  | B1182367   | 07.08  |   |  |  |   |                          |
|  | 2.0 Turbo  | 162  | B1182367   | 07.08  |   |  |  |   |                          |
|  | 2.0 Turbo  | 184  | B1182367   | 06.11  |   |  |  |   |                          |
|  | 2.0 BiTurbo CDTI 4x4   |  | A1006683   | 07.08  |   | 24.3727-0789.2   | 580789   | 2 ↓   | L=2005, + Zub            |
|  | 2.0 CDTI 4x4   | 118  | A1006683   | 06.10  |   |  |  |   |                          |
|  | 2.0 Turbo 4x4  | 162  | A1006683   | 07.08  |   |  |  |   |                          |
|  | 2.0 Turbo 4x4  | 184  | A1006683   | 09.11  |   |  |  |   |                          |
|  | 2.8 V6 T 4x4 OPC   | 239  | A1006683   | 07.09  |   |  |  |   |                          |
|  | 2.8 V6 Turbo 4x4   | 191  | A1006683   | 07.08  |   |  |  |   |                          |
| <b>OPEL MERIVA A / Vauxhall Meriva Mk I (03-10)</b>                                |  |  |  |  |   |  |  |   |                          |
|    | 1.3 CDTI   | 51   | 44999999   | 04.05  |   | 24.2123-1764.3   | 010824   | - ESP   | THz 23,81                |
|  | 1.3 CDTI   | 55   | 44999999   | 09.03  |   | 24.2123-1765.3   | 010829   | + ESP   | THz 23,81                |
|  | 1.4 16V  | 66   | 44999999   | 07.04  |   |  |  |   |                          |
|  | 1.4 LPG  | 66   | 44999999   | 07.04  |   |  |  |   |                          |
|  | 1.6  | 64   | 44999999   | 05.03  |   |  |  |   |                          |
|  | 1.6  | 77   | 44999999   | 01.06  |   |  |  |   |                          |
|  | 1.6 16V  | 74   | 44999999   | 05.03  |   |  |  |   |                          |
|  | 1.6 Turbo OPC  | 132  | 44999999   | 09.05  |   |  |  |   |                          |
|  | 1.7 CDTI   | 74   | 44999999   | 09.03  |   |  |  |   |                          |
|  | 1.7 CDTI   | 92   | 44999999   | 09.06  |   |  |  |   |                          |
|  | 1.7 DTI  | 48   | 44999999   | 05.03  |   |  |  |   |                          |
|  | 1.7 DTI 16V  | 55   | 44999999   | 09.02  |   |  |  |   |                          |
|  | 1.8 16V  | 92   | 44999999   | 09.02  |   |  |  |   |                          |
|    | 1.4 16V  | 66   |  | 07.04  | 05.10   | 24.3541-1795.7   | 220551   |    | D=54, - Halter           |
|  | 1.4 LPG  | 66   |  | 07.04  | 05.10   | 24.3541-1796.7   | 220552   |    | D=54, - Halter           |
|  | 1.6  | 64   |  | 05.03  | 05.10   |  |  |   |                          |
|  | 1.3 CDTI   | 51   |  | 04.05  | 05.10   | 11.9571-9823.2   | 220471   |    | D=57, - Halter           |
|  | 1.3 CDTI   | 55   |  | 09.03  | 05.10   | 11.9571-9824.2   | 220472   |    | D=57, - Halter           |
|  | 1.4 16V  | 66   |  | 07.04  | 05.10   | 24.3571-9823.5   | 240499   |    | D=57, - Halter           |
|  | 1.4 LPG  | 66   |  | 07.04  | 05.10   | 24.3571-9824.5   | 240500   |    | D=57, - Halter           |
|  | 1.6  | 77   |  | 01.06  | 05.10   | 11.0441-5704.2   | 250034   |   | Dichtungssatz            |
|  | 1.6 16V  | 74   |  | 05.03  | 05.10   | 11.0101-5407.2   | 260011   |   | Hülzensatz               |
|  | 1.7 CDTI   | 74   |  | 09.03  | 05.10   | 11.8171-0008.1   | 990049   |   | Führungsbolzen           |
|  | 1.7 CDTI   | 92   |  | 09.06  | 05.10   | 11.8116-0292.1   | 390521   | 2   | Haltefeder               |
|  | 1.7 DTI  | 48   |  | 05.03  | 05.10   |  |  |   |                          |
|  | 1.7 DTI 16V  | 55   |  | 05.03  | 05.10   |  |  |   |                          |
|  | 1.8 16V  | 92   |  | 05.03  | 05.10   |  |  |   |                          |
|  | 1.3 CDTI   | 51   |  | 04.05  | 05.10   | 24.5250-0313.3   | 331024   | 2   | L=313                    |
|  | 1.3 CDTI   | 55   |  | 09.03  | 05.10   |  |  |   |                          |
|  | 1.4 16V  | 66   |  | 07.04  | 05.10   |  |  |   |                          |
|  | 1.4 LPG  | 66   |  | 07.04  | 05.10   |  |  |   |                          |
|  | 1.6  | 64   |  | 05.03  | 05.10   |  |  |   |                          |
|  | 1.6 16V  | 74   |  | 05.03  | 05.10   |  |  |   |                          |
|  | 1.7 CDTI   | 74   |  | 09.03  | 05.10   |  |  |   |                          |
|  | 1.7 CDTI   | 92   |  | 09.06  | 05.10   |  |  |   |                          |
|  | 1.7 DTI  | 48   |  | 05.03  | 05.10   |  |  |   |                          |
|  | 1.7 DTI 16V  | 55   |  | 05.03  | 05.10   |  |  |   |                          |
|  | 1.8 16V  | 92   |  | 05.03  | 05.10   |  |  |   |                          |
|  | 1.6  | 64   | 34999999   | 05.03  |   | 24.3367-1713.7   | 220779   |  | D=36, - Halter           |
|  | 1.4 16V  | 66   |  | 07.04  | 05.10   | 24.3367-1714.7   | 220780   |  | D=36, - Halter           |
|  | 1.4 LPG  | 66   |  | 07.04  | 05.10   | 24.3367-1707.7   | 220669   |  | D=36, - Halter           |
|  | 1.6  | 64   | 44000001   | 05.10  |   | 24.3367-1708.7   | 220670   |  | D=36, - Halter           |
|  | 1.6 16V  | 74   | 34999999   | 05.03  |   | 24.3384-1753.7   | 220633   |  | D=38, - Halter           |
|  | 1.7 CDTI   | 74   | 34999999   | 09.03  |   | 24.3384-1754.7   | 220634   |  | D=38, - Halter           |
|  | 1.7 DTI  | 48   | 34999999   | 05.03  |   |  |  |   |                          |
|  | 1.7 DTI 16V  | 55   | 34999999   | 05.03  |   |  |  |   |                          |
|  | 1.8 16V  | 92   | 34999999   | 05.03  |   |  |  |   |                          |
|  | 1.3 CDTI   | 51   |  | 04.05  | 05.10   | 24.3387-1701.7   | 220673   |  | D=38, - Halter           |
|  | 1.3 CDTI   | 55   |  | 09.03  | 05.10   | 24.3387-1702.7   | 220674   |  | D=38, - Halter           |
|  | 1.4 16V  | 66   |  | 07.04  | 05.10   |  |  |   |                          |
|  | 1.4 LPG  | 66   |  | 07.04  | 05.10   |  |  |   |                          |
|  | 1.6  | 77   |  | 01.06  | 05.10   |  |  |   |                          |
|  | 1.6 16V  | 74   | 44000001   |  | 05.10   |  |  |   |                          |
|  | 1.7 CDTI   | 74   | 44000001   |  | 05.10   |  |  |   |                          |
|  | 1.7 CDTI   | 92   |  | 09.06  | 05.10   |  |  |   |                          |
|  | 1.7 DTI  | 48   | 44000001   |  | 05.10   |  |  |   |                          |
|  | 1.7 DTI 16V  | 55   | 44000001   |  | 05.10   |  |  |   |                          |
|  | 1.8 16V  | 92   | 44000001   |  | 05.10   |  |  |   |                          |
|  | 1.3 CDTI   | 51   |  | 04.05  | 05.10   | 24.5157-0218.3   | 331095   |  | L=219/185, + Rohrleitung |
|  | 1.3 CDTI   | 55   |  | 09.03  | 05.10   | 24.5157-0219.3   | 331096   |  | L=219/185, + Rohrleitung |
|  | 1.4 16V  | 66   |  | 07.04  | 05.10   |  |  |   |                          |
|  | 1.4 LPG  | 66   |  | 07.04  | 05.10   |  |  |   |                          |
|  | 1.6  | 64   |  | 05.03  | 05.10   |  |  |   |                          |
|  | 1.6  | 77   |  | 01.06  | 05.10   |  |  |   |                          |
|  | 1.6 16V  | 74   |  | 05.03  | 05.10   |  |  |   |                          |
|  | 1.6 Turbo OPC  | 132  |  | 09.05  | 05.10   |  |  |   |                          |
|  | 1.7 CDTI   | 74   |  | 09.03  | 05.10   |  |  |   |                          |
|  | 1.7 CDTI   | 92   |  | 09.06  | 05.10   |  |  |   |                          |
|  | 1.7 DTI  | 48   |  | 05.03  | 05.10   |  |  |   |                          |
|  | 1.7 DTI 16V  | 55   |  | 05.03  | 05.10   |  |  |   |                          |
|  | 1.8 16V  | 92   |  | 05.03  | 05.10   |  |  |   |                          |

1) + 4 bore wheel rim / + cerchione a 4 fori / + jante à 4 trous / + Llantas de 4 taladros

2) + 5 bore wheel rim / + cerchione a 5 fori / + jante à 5 trous / + Llantas de 5 taladros

|     |  |  |  |  |  |  |     |     |                    |                          |     |
|--|--|--|--|--|---|--|---|---|--------------------|--------------------------|-----|
| <b>OPEL MERIVA A / Vauxhall Meriva Mk I (03-10)</b>                                |  |  |  |  |   |  |   |   |                    |                          |     |
|    | 1.3 CDTI   | 51   | 34999999   | 04.05  |   | 24.3727-0780.2   | 580780  | 1   | L=1610/1610, + Zub |                          |     |
|  | 1.3 CDTI   | 55   | 34999999   | 09.03  |   |  |   |   |                    |                          |     |
|  | 1.4 16V  | 66   | 34999999   | 07.04  |   |  |   |   |                    |                          |     |
|  | 1.4 LPG  | 66   | 34999999   | 07.04  |   |  |   |   |                    |                          |     |
|  | 1.6  | 64   | 34999999   | 05.03  |   |  |   |   |                    |                          |     |
|  | 1.6  | 77   | 34999999   | 01.06  |   |  |   |   |                    |                          |     |
|  | 1.6 16V  | 74   | 34999999   | 05.03  |   |  |   |   |                    |                          |     |
|  | 1.6 Turbo OPC  | 132  | 34999999   | 09.05  |   |  |   |   |                    |                          |     |
|  | 1.7 CDTI   | 74   | 34999999   | 09.03  |   |  |   |   |                    |                          |     |
|  | 1.7 CDTI   | 92   | 34999999   | 09.06  |   |  |   |   |                    |                          |     |
|  | 1.7 DTI  | 48   | 34999999   | 05.03  |   |  |   |   |                    |                          |     |
|  | 1.7 DTI 16V  | 55   | 34999999   | 05.03  |   |  |   |   |                    |                          |     |
|  | 1.8 16V  | 92   | 34999999   | 05.03  |   |  |   |   |                    |                          |     |
|  | 1.3 CDTI   | 51   | 44000001   |  | 05.03   |  | 24.3727-0779.2  | 580779  | 1                  | L=1615/1615, + Zub       |     |
|  | 1.3 CDTI   | 55   | 44000001   |  | 05.10   |  |   |   |                    |                          |     |
|  | 1.4 16V  | 66   | 44000001   |  | 05.10   |  |   |   |                    |                          |     |
|  | 1.4 LPG  | 66   | 44000001   |  | 05.10   |  |   |   |                    |                          |     |
| 1.6  | 64   | 44000001   |  | 05.10  |   |  |   |   |                    |                          |     |
| 1.6  | 77   | 44000001   |  | 05.10  |   |  |   |   |                    |                          |     |
| 1.6 16V  | 74   | 44000001   |  | 05.10  |   |  |   |   |                    |                          |     |
| 1.6 Turbo OPC  | 132  | 44000001   |  | 05.10  |   |  |   |   |                    |                          |     |
| 1.7 CDTI   | 74   | 44000001   |  | 05.10  |   |  |   |   |                    |                          |     |
| 1.7 CDTI   | 92   | 44000001   |  | 05.10  |   |  |   |   |                    |                          |     |
| 1.7 DTI  | 48   | 44000001   |  | 05.10  |   |  |   |   |                    |                          |     |
| 1.7 DTI 16V  | 55   | 44000001   |  | 05.10  |   |  |   |   |                    |                          |     |
| 1.8 16V  | 92   | 44000001   |  | 05.10  |   |  |   |   |                    |                          |     |
|    | 1.3 CDTI   | 51   |  | 04.05  | 05.10   | 03.6583-0102.3   | 320280  |   | - ABS              | BRL 8/3 (4)              | ATE |
|  | 1.3 CDTI   | 55   |  | 09.03  | 05.10   |  |   |   |                    |                          |     |
|  | 1.4 16V  | 66   |  | 07.04  | 05.10   |  |   |   |                    |                          |     |
|  | 1.4 LPG  | 66   |  | 07.04  | 05.10   |  |   |   |                    |                          |     |
|  | 1.6  | 64   |  | 05.03  | 05.10   |  |   |   |                    |                          |     |
|  | 1.6  | 77   |  | 01.06  | 05.10   |  |   |   |                    |                          |     |
|  | 1.6 16V  | 74   |  | 05.03  | 05.10   |  |   |   |                    |                          |     |
|  | 1.7 CDTI   | 74   |  | 09.03  | 05.10   |  |   |   |                    |                          |     |
|  | 1.7 CDTI   | 92   |  | 09.06  | 05.10   |  |   |   |                    |                          |     |
|  | 1.7 DTI  | 48   |  | 05.03  | 05.03   |  |   |   |                    |                          |     |
|  | 1.7 DTI 16V  | 55   |  | 05.03  | 05.10   |  |   |   |                    |                          |     |
|  | 1.8 16V  | 92   |  | 05.03  | 05.10   |  |   |   |                    |                          |     |
|  | <b>OPEL MERIVA B / Vauxhall Meriva Mk II (10-)</b>                               |  |  |  |   |  |   |   |                    |                          |     |
|  | 1.3 CDTI   | 55   |  | 06.10  |   | 11.9571-9823.2   | 220471  |  |                    | D=57, - Halter           | ATE |
|  | 1.3 CDTI   | 70   |  | 06.10  |   | 11.9571-9824.2   | 220472  |  |                    | D=57, - Halter           | ATE |
|  | 1.4  | 74   |  | 06.10  |   | 24.3571-9823.5   | 240499  |  |                    | D=57, - Halter           | ATE |
|  | 1.4 ecoFLEX  | 88   |  | 06.10  |   | 24.3571-9824.5   | 240500  |  |                    | D=57, - Halter           | ATE |
|  | 1.7 CDTi   | 74   |  | 06.10  |   | 11.0441-5704.2   | 250034  |   |                    | Dichtungssatz            | ATE |
|  | 1.7 CDTi   | 81   |  | 06.10  |   | 11.0101-5407.2   | 260011  |   |                    | Hülzensatz               | ATE |
|  | 1.7 CDTi   | 96   |  | 06.10  |   | 11.8171-0008.1   | 990049  |   |                    | Führungsbolzen           | ATE |
|  |  |  |  |  |   | 11.8116-0292.1   | 390521  | 2   |                    | Haltefeder               | ATE |
|  | 1.4  | 103  |  | 06.10  |   | 11.9571-9823.2   | 220471  |  |                    | D=57, - Halter           | ATE |
|  | 1.7 CDTi   | 74   |  | 06.10  |   | 11.9571-9824.2   | 220472  |  |                    | D=57, - Halter           | ATE |
| 1.7 CDTi   | 81   |  | 06.10  |  | 24.3571-9823.5  | 240499   |  |   | D=57, - Halter     | ATE                      |     |
| 1.7 CDTi   | 96   |  | 06.10  |  | 24.3571-9824.5  | 240500   |  |   | D=57, - Halter     | ATE                      |     |
|  |  |  |  |  | 11.0441-5704.2  | 250034   |   |   | Dichtungssatz      | ATE                      |     |
|  |  |  |  |  | 11.0101-5407.2  | 260011   |   |   | Hülzensatz         | ATE                      |     |
|  |  |  |  |  | 11.8171-0008.1  | 990049   |   |   | Führungsbolzen     | ATE                      |     |
|  |  |  |  |  | 11.8116-0292.1  | 390521   | 2   |   | Haltefeder         | ATE                      |     |
|  | 1.3 CDTI   | 55   |  | 06.10  |   | 24.5157-0219.3   | 331096  |  |                    | L=219/185, + Rohrleitung |     |
|  | 1.3 CDTI   | 70   |  | 06.10  |   | 24.5157-0218.3   | 331095  |  |                    | L=219/185, + Rohrleitung |     |
|  | 1.4  | 74   |  | 06.10  |   |  |   |   |                    |                          |     |
|  | 1.4  | 103  |  | 06.10  |   |  |   |   |                    |                          |     |
|  | 1.4 ecoFLEX  | 88   |  | 06.10  |   |  |   |   |                    |                          |     |
|  | 1.7 CDTi   | 74   |  | 06.10  |   |  |   |   |                    |                          |     |
|  | 1.7 CDTi   | 81   |  | 06.10  |   |  |   |   |                    |                          |     |
| 1.7 CDTi   | 96   |  | 06.10  |  |   |  |   |   |                    |                          |     |
| <b>OPEL MOKKA / Vauxhall Mokka (12-)</b>   |  |  |  |  |   |  |   |   |                    |                          |     |
|  | 1.4  | 103  |  | 04.13  |   | 11.9601-2601.2   | 220913  |  |                    | D=60, - Halter           | ATE |
|  | 1.4 4x4  | 103  |  | 06.12  |   | 11.9601-2602.2   | 220914  |  |                    | D=60, - Halter           | ATE |
|  | 1.6  | 85   |  | 06.12  |   |  |   |   |                    |                          |     |
|  | 1.7 CDTi   | 96   |  | 06.12  |   |  |   |   |                    |                          |     |
|  | 1.7 CDTi 4x4   | 96   |  | 06.12  |   |  |   |   |                    |                          |     |
|  | 1.8  | 103  |  | 01.13  |   |  |   |   |                    |                          |     |
| 1.8 4x4  | 103  |  | 01.13  |  |   |  |   |   |                    |                          |     |
|  | 1.4  | 103  |  | 04.13  |   | 11.9382-7003.2   | 220891  |  |                    | D=38, - Halter           | ATE |
|  | 1.4 4x4  | 103  |  | 06.12  |   | 11.9382-7004.2   | 220892  |  |                    | D=38, - Halter           | ATE |
|  | 1.6  | 85   |  | 06.12  |   |  |   |   |                    |                          |     |
|  | 1.7 CDTi   | 96   |  | 06.12  |   |  |   |   |                    |                          |     |
|  | 1.7 CDTi 4x4   | 96   |  | 06.12  |   |  |   |   |                    |                          |     |
|  | 1.8  | 103  |  | 01.13  |   |  |   |   |                    |                          |     |
| 1.8 4x4  | 103  |  | 01.13  |  |   |  |   |   |                    |                          |     |
| <b>OPEL MONTEREY (92-98)</b>   |  |  |  |  |   |  |   |   |                    |                          |     |
|  | 3.1 TD   |  |  | 09.91  | 07.98   | 24.3601-1717.5   | 240391  |  |                    | D=60, - Halter           | AKE |
|  | 3.2  |  |  | 05.92  | 07.98   | 24.3601-1718.5   | 240392  |  |                    | D=60, - Halter           | AKE |



|     |  |  |  |  |  |                            |  |  |  |  |                            |   |                              |  |                                  |  |  |  |
|--|--|--|--|--|--|--|--|--|--|---|----------------------------|---|------------------------------|--|----------------------------------|--|--|--|
| <b>OPEL MONTEREY (92-98)</b>   |  |  |  |  |  |  |  |  |  |   |                            |   |                              |  |                                  |  |  |  |
|    | 3.1 TD<br>3.2  |  |  |  | 09.91<br>05.92   | 07.98<br>07.98   |  |  |  | 24.3411-1701.5<br>24.3411-1702.5  | 240361<br>240362           | <br>  |                              |  | D=41, - Halter<br>D=41, - Halter | <b>AKE</b><br><b>AKE</b>   |  |  |
| <b>OPEL MONTEREY (98-99)</b>   |  |  |  |  |  |  |  |  |  |   |                            |   |                              |  |                                  |  |  |  |
|    | 3.0 DTI<br>3.5 V6  |  |  |  | 07.98<br>07.98   | 08.99<br>08.99   |  |  |  | 24.3601-1717.5<br>24.3601-1718.5  | 240391<br>240392           | <br>  |                              | D=60, - Halter<br>D=60, - Halter   | <b>AKE</b><br><b>AKE</b>         |  |  |  |
|    | 3.0 DTI<br>3.5 V6  |  |  |  | 07.98<br>07.98   | 08.99<br>08.99   |  |  |  | 24.3411-1701.5<br>24.3411-1702.5  | 240361<br>240362           | <br>  |                              | D=41, - Halter<br>D=41, - Halter   | <b>AKE</b><br><b>AKE</b>         |  |  |  |
| <b>OPEL MOVANO A (98-10)</b>   |  |  |  |  |  |  |  |  |  |   |                            |   |                              |  |                                  |  |  |  |
|    | 1.9 DTI<br>2.2 DTI 16V<br>2.5 D<br>2.5 DTI<br>2.8 DTI<br>3.0 DTI                         |  |  |  | 09.00<br>09.00<br>07.98<br>10.01<br>07.98<br>10.03                   | 01.10<br>01.10<br>- ABS<br>01.10<br>- ABS<br>01.10<br>- ABS  |  |  |  | 24.2025-1708.3  | 010692                     |   |                              | THz 25,40  |                                  |  |  |  |
|    | 1.9 DTI<br>2.2 DTI 16V<br>2.5 D<br>2.5 DTI<br>2.8 DTI                                    | 66<br>59   |  |  | 09.00<br>09.00<br>07.98<br>10.01<br>07.98                            | 08.03<br>08.03<br>+ ABS<br>08.03<br>+ ABS<br>08.03<br>+ ABS  |  |  |  | 24.2025-1706.3  | 010676                     |   |                              | THz 25,40  |                                  |  |  |  |
|    | 1.9 DTI<br>2.2 DTI 16V<br>2.5 DTI<br>3.0 DTI   | 66<br>66<br>100  |  |  | 09.03<br>09.03<br>09.03<br>10.03                                     | 08.06<br>08.06<br>+ ABS<br>08.06<br>+ ABS  |  |  |  | 24.2123-1759.3  | 010768                     |   |                              | THz 23,81  | <b>BOS</b>                       |  |  |  |
|    | 1.9 DTI<br>2.2 DTI 16V<br>2.5 D<br>2.5 DTI<br>2.8 DTI                                    | 66<br>59   |  |  | 09.00<br>09.00<br>07.98<br>10.01<br>07.98                            | 08.03<br>08.03<br>+ HA-Trommelbremse <sup>1)</sup><br>08.03<br>+ HA-Trommelbremse <sup>1)</sup><br>08.03   |  |  |  | 24.5134-0518.3<br>24.5134-0562.3  | 330705<br>330706           | 2 <br>2   |                              | L=518<br>L=568   |                                  |  |  |  |
|    | 1.9 DTI<br>2.2 DTI 16V<br>2.5 D<br>2.5 DTI<br>2.8 DTI                                    | 66<br>59   |  |  | 09.00<br>09.00<br>07.98<br>10.01<br>07.98                            | 08.03<br>08.03<br>+ HA-Scheibenbremse <sup>2)</sup><br>08.03<br>+ HA-Scheibenbremse <sup>2)</sup><br>08.03 |  |  |  | 24.5134-0457.3<br>24.5134-0468.3  | 330752<br>330704           | 2 <br>2   |                              | L=457<br>L=468   |                                  |  |  |  |
|    | 1.9 DTI<br>2.2 DTI 16V<br>2.5 DTI<br>3.0 DTI   | 66<br>66<br>100  |  |  | 09.03<br>09.03<br>09.03<br>10.03                                     | 08.06<br>08.06<br>+ ABS<br>08.06<br>+ ABS  |  |  |  | 24.5111-0510.3  | 330819                     | 2   |                              | L=510  |                                  |  |  |  |
|    | 1.9 DTI<br>2.2 DTI 16V<br>2.5 CDTI<br>2.5 CDTI<br>2.5 D<br>2.5 DTI<br>2.8 DTI<br>3.0 DTI | 66<br>74<br>88<br>107<br>59  |  |  | 09.00<br>09.00<br>09.06<br>09.06<br>07.98<br>10.01<br>07.98<br>10.03 | 01.10<br>01.10<br>01.10<br>01.10<br>09.00<br>01.10<br>01.10<br>01.10                                       |  |  |  | 24.3424-1701.5<br>24.3424-1702.5  | 240561<br>240562           | <br>  |                              | D=42, - Halter<br>D=42, - Halter   | <b>BOS</b><br><b>BOS</b>         |  |  |  |
|    | 2.5 D<br>2.8 DTI   | 59   |  |  | 07.98<br>07.98   | 09.00<br>10.01   |  |  |  | 24.5111-0326.3  | 330766                     | 2   | am Bremssattel <sup>3)</sup> | L=326  |                                  |  |  |  |
|   | 1.9 DTI<br>2.2 DTI 16V<br>2.5 DTI  | 66   |  |  | 09.00<br>09.00<br>10.01  | 08.03<br>08.03<br>08.03  |  |  |  | 24.5111-0410.3<br>24.5111-0326.3  | 330681<br>330766           | 2<br>2  | am Bremssattel <sup>3)</sup> | L=410<br>L=326   |                                  |  |  |  |
|  | 1.9 DTI<br>2.2 DTI 16V<br>2.5 CDTI<br>2.5 CDTI<br>2.5 DTI<br>3.0 DTI                     | 66<br>74<br>88<br>107<br>100   |  |  | 09.03<br>09.03<br>09.06<br>09.06<br>09.03<br>10.03                   | 01.10<br>01.10<br>01.10<br>01.10<br>01.10<br>01.10   |  |  |  | 24.5258-0450.3<br>24.5251-0465.3  | 330824<br>330822           | <br>  |                              | L=450<br>L=465   |                                  |  |  |  |
|  | 1.9 DTI<br>2.2 DTI 16V<br>2.5 D<br>2.5 DTI<br>2.8 DTI                                    | 66<br>59   |  |  | 09.00<br>09.00<br>07.98<br>10.01<br>07.98                            | 01.10<br>01.10<br>01.10<br>01.10<br>01.10  |  |  |  | 24.3223-1707.3<br>24.3223-1708.3  | 020435<br>020436           | <br>  |                              | Rz 23,81<br>Rz 23,81   | <b>BDX</b><br><b>BDX</b>         |  |  |  |
|  | 1.9 DTI<br>2.2 DTI 16V<br>2.5 CDTI<br>2.5 CDTI<br>2.5 D<br>2.5 DTI<br>2.8 DTI<br>3.0 DTI | 66<br>74<br>88<br>107<br>59  |  |  | 09.00<br>09.00<br>09.06<br>09.06<br>07.98<br>10.01<br>07.98<br>10.03 | 01.10<br>01.10<br>01.10<br>01.10<br>09.00<br>01.10<br>01.10<br>01.10                                       |  |  |  | 24.3727-0762.2<br>24.3727-1072.2<br>24.3727-1000.2                                | 580762<br>581072<br>581000 | 1 <br>2 <br>2  |                              | L=1175<br>L=1420<br>L=1737   |                                  |  |  |  |
|  | 1.9 DTI<br>2.2 DTI 16V<br>2.5 D<br>2.5 DTI<br>2.8 DTI<br>3.0 DTI                         | 66<br>59<br>100  |  |  | 09.00<br>09.00<br>07.98<br>10.01<br>07.98<br>10.03                   | 01.10<br>01.10<br>01.10<br>01.10<br>01.10<br>01.10   |  |  |  | 24.2415-1710.3  | 030124                     |   |                              | Gz 15,87   |                                  |  |  |  |

<sup>1)</sup> + RA drum brake / + P freno a tamburo / + frein à tambour essieu AR / + ET-tambores de freno

<sup>2)</sup> + RA disc brake / + P disco freno / + frein à disque essieu AR / + ET-disco de freno

<sup>3)</sup> on the brake caliper / sulla pinza freno / sur l'étrier de frein / a la pinza de freno

| OPEL OMEGA B / Vauxhall Omega (94-03) |             |          |          |       |  |                |        |       |                                    |               |     |
|---------------------------------------|-------------|----------|----------|-------|--|----------------|--------|-------|------------------------------------|---------------|-----|
|                                       | 2.0         |          | V1999999 | 03.94 | - Polizei <sup>1)</sup>                    | 24.2123-1740.3 | 010662 |       | THz 23,81                          |               |     |
|                                       | 2.0 16V     |          | V1999999 | 03.94 | - Polizei <sup>1)</sup>                    |                |        |       |                                    |               |     |
|                                       | 2.0         |          | V1999999 | 03.94 | + Polizei <sup>2)</sup>                    | 24.2125-1717.3 | 010664 |       | THz 25,40                          |               |     |
|                                       | 2.0 16V     |          | V1999999 | 03.94 | + Polizei <sup>2)</sup>                    |                |        |       |                                    |               |     |
|                                       | 2.5 TD      |          | V1999999 | 04.94 |  |                |        |       |                                    |               |     |
|                                       | 2.5 V6      |          | V1999999 | 03.94 | - Sonderfahrzeuge <sup>3)</sup>            |                |        |       |                                    |               |     |
|                                       | 3.0 V6      |          | V1999999 | 04.94 | - Sonderfahrzeuge <sup>3)</sup>            |                |        |       |                                    |               |     |
|                                       | 2.0         | W1000001 |          | 09.99 |  | 24.2125-1724.3 | 010690 | - ESP | THz 25,40                          |               |     |
|                                       | 2.0 16V     | W1000001 |          | 09.99 |  |                |        |       |                                    |               |     |
|                                       | 2.0 DTI 16V |          |          | 09.97 | 08.00                                      |                |        |       |                                    |               |     |
| 2.2 16V                               |             |          | 10.99    | 08.03 |  |                |        |       |                                    |               |     |
| 2.2 DTI 16V                           |             |          | 09.00    | 08.03 |  |                |        |       |                                    |               |     |
| 2.5 DTI                               |             |          | 09.01    | 08.03 |  |                |        |       |                                    |               |     |
| 2.5 TD                                | W1000001    |          | 08.03    | 08.03 |  |                |        |       |                                    |               |     |
| 2.5 V6                                | W1000001    |          | 09.00    | 08.03 | - Sonderfahrzeuge <sup>3)</sup>            |                |        |       |                                    |               |     |
| 2.6 V6                                |             |          | 09.00    | 08.03 | - Sonderfahrzeuge <sup>3)</sup>            |                |        |       |                                    |               |     |
| 3.0 V6                                | W1000001    |          | 01.01    | 08.03 | - Sonderfahrzeuge <sup>3)</sup>            |                |        |       |                                    |               |     |
| 3.2 V6                                |             |          | 02.01    | 08.03 | - Sonderfahrzeuge <sup>3)</sup>            |                |        |       |                                    |               |     |
|                                       | 2.0         |          | V1999999 | 03.94 | - Sonderfahrzeuge/ - Polizei <sup>4)</sup> | 11.3541-8083.2 | 220241 |       | D=54, + Halter                     | ATE           |     |
|                                       | 2.0 16V     |          | V1999999 | 03.94 | - Sonderfahrzeuge/ - Polizei <sup>4)</sup> | 11.3541-8084.2 | 220242 |       | D=54, - Halter                     | ATE           |     |
|                                       |             |          |          |       |  | 24.3541-8083.5 | 240483 |       | D=54, - Halter                     | ATE           |     |
|                                       |             |          |          |       |  | 24.3541-8084.5 | 240484 |       | Hülzensatz                         | ATE           |     |
|                                       |             |          |          |       |  | 11.0101-5407.2 | 260011 |       | Führungsbolzen                     | ATE           |     |
|                                       |             |          |          |       |  | 11.8171-0008.1 | 990049 |       | Haltefeder                         | ATE           |     |
|                                       |             |          |          |       |  | 11.8116-0292.1 | 390521 | 2     |                                    | ATE           |     |
|                                       | 2.0         | W1000001 |          | 09.99 |  | 24.3571-1705.5 | 240069 |       | D=57, - Halter                     | LUC           |     |
|                                       | 2.0 16V     | W1000001 |          | 09.99 |  | 24.3571-1706.5 | 240070 |       | D=57, - Halter                     | LUC           |     |
|                                       | 2.0 DTI 16V |          |          | 09.97 | 08.00                                      | 24.0101-3401.2 | 260043 |       | Einbausatz                         | LUC           |     |
| 2.2 16V                               |             |          | 10.99    | 08.03 |  |                |        |       |                                    |               |     |
| 2.2 DTI 16V                           |             |          | 09.00    | 08.03 |  |                |        |       |                                    |               |     |
| 2.5 DTI                               |             |          | 09.01    | 08.03 |  |                |        |       |                                    |               |     |
| 2.5 TD                                |             |          | 04.94    | 08.03 |  |                |        |       |                                    |               |     |
| 2.5 V6                                |             |          | 03.94    | 09.00 |  |                |        |       |                                    |               |     |
| 2.6 V6                                |             |          | 09.00    | 08.03 |  |                |        |       |                                    |               |     |
| 3.0 V6                                |             |          | 04.94    | 01.01 |  |                |        |       |                                    |               |     |
| 3.2 V6                                |             |          | 02.01    | 08.03 |  |                |        |       |                                    |               |     |
|                                       | 2.0         |          |          | 03.94 | 09.99                                      | 83.7216-0404.3 | 330374 | 2     | L=400                              |               |     |
|                                       | 2.0 16V     |          |          | 03.94 | 09.99                                      |                |        |       |                                    |               |     |
|                                       | 2.0 DTI 16V |          |          | 09.97 | 08.00                                      |                |        |       |                                    |               |     |
|                                       | 2.2 16V     |          |          | 10.99 | 08.03                                      |                |        |       |                                    |               |     |
|                                       | 2.2 DTI 16V |          |          | 09.00 | 08.03                                      |                |        |       |                                    |               |     |
|                                       | 2.5 DTI     |          |          | 09.01 | 08.03                                      |                |        |       |                                    |               |     |
|                                       | 2.5 TD      |          |          | 04.94 | 08.03                                      |                |        |       |                                    |               |     |
|                                       | 2.5 V6      |          |          | 03.94 | 09.00                                      |                |        |       |                                    |               |     |
|                                       | 2.6 V6      |          |          | 09.00 | 08.03                                      |                |        |       |                                    |               |     |
|                                       | 3.0 V6      |          |          | 04.94 | 01.01                                      |                |        |       |                                    |               |     |
| 3.2 V6                                |             |          | 02.01    | 08.03 |  |                |        |       |                                    |               |     |
|                                       | 2.0         |          |          | 03.94 | 09.99                                      | 13.2401-0039.2 | 210153 |       | - belüftete Scheiben <sup>5)</sup> | D=40          | ATE |
|                                       | 2.0 16V     |          |          | 03.94 | 09.99                                      | 13.2401-0040.2 | 210154 |       | - belüftete Scheiben <sup>5)</sup> | D=40          | ATE |
|                                       | 2.0 DTI 16V |          |          | 09.97 | 08.00                                      | 24.9240-0039.5 | 230055 |       | - belüftete Scheiben <sup>5)</sup> | D=40          | ATE |
|                                       | 2.2 16V     |          |          | 10.99 | 08.03                                      | 24.9240-0040.5 | 230056 |       | - belüftete Scheiben <sup>5)</sup> | D=40          | ATE |
|                                       | 2.2 DTI 16V |          |          | 09.00 | 08.03                                      | 13.0441-4022.2 | 250149 |       | - belüftete Scheiben <sup>5)</sup> | Dichtungssatz | ATE |
|                                       | 2.5 DTI     |          |          | 09.01 | 08.03                                      | 13.2421-0043.2 | 210193 |       | + belüftete Scheiben <sup>6)</sup> | D=42          | ATE |
|                                       | 2.5 TD      |          |          | 04.94 | 08.03                                      | 13.2421-0044.2 | 210194 |       | + belüftete Scheiben <sup>6)</sup> | D=42          | ATE |
|                                       | 2.5 V6      |          |          | 03.94 | 09.00                                      | 13.0441-4216.2 | 250093 |       | + belüftete Scheiben <sup>6)</sup> | Dichtungssatz | ATE |
|                                       | 2.6 V6      |          |          | 09.00 | 08.03                                      |                |        |       |                                    |               |     |
|                                       | 3.0 V6      |          |          | 04.94 | 01.01                                      |                |        |       |                                    |               |     |
| 3.2 V6                                |             |          | 02.01    | 08.03 |  |                |        |       |                                    |               |     |
|                                       | 2.0         |          |          | 03.94 | 09.99                                      | 24.5233-0200.3 | 330425 | 2     | L=198                              |               |     |
|                                       | 2.0 16V     |          |          | 03.94 | 09.99                                      |                |        |       |                                    |               |     |
|                                       | 2.0 DTI 16V |          |          | 09.97 | 08.00                                      |                |        |       |                                    |               |     |
|                                       | 2.2 16V     |          |          | 10.99 | 08.03                                      |                |        |       |                                    |               |     |
|                                       | 2.2 DTI 16V |          |          | 09.00 | 08.03                                      |                |        |       |                                    |               |     |
|                                       | 2.5 DTI     |          |          | 09.01 | 08.03                                      |                |        |       |                                    |               |     |
|                                       | 2.5 TD      |          |          | 04.94 | 08.03                                      |                |        |       |                                    |               |     |
|                                       | 2.5 V6      |          |          | 03.94 | 09.00                                      |                |        |       |                                    |               |     |
|                                       | 2.6 V6      |          |          | 09.00 | 08.03                                      |                |        |       |                                    |               |     |
|                                       | 3.0 V6      |          |          | 04.94 | 01.01                                      |                |        |       |                                    |               |     |
| 3.2 V6                                |             |          | 02.01    | 08.03 |  |                |        |       |                                    |               |     |
|                                       | 2.0         |          |          | 03.94 | 09.99                                      | 24.3727-0725.2 | 580725 | 1     | L=1550/1550, + Zub                 |               |     |
|                                       | 2.0 16V     |          |          | 03.94 | 09.99                                      |                |        |       |                                    |               |     |
|                                       | 2.0 DTI 16V |          |          | 09.97 | 08.00                                      |                |        |       |                                    |               |     |
|                                       | 2.2 16V     |          |          | 10.99 | 08.03                                      |                |        |       |                                    |               |     |
|                                       | 2.2 DTI 16V |          |          | 09.00 | 08.03                                      |                |        |       |                                    |               |     |
|                                       | 2.5 DTI     |          |          | 09.01 | 08.03                                      |                |        |       |                                    |               |     |
|                                       | 2.5 TD      |          |          | 04.94 | 08.03                                      |                |        |       |                                    |               |     |
|                                       | 2.5 V6      |          |          | 03.94 | 09.00                                      |                |        |       |                                    |               |     |
|                                       | 2.6 V6      |          |          | 09.00 | 08.03                                      |                |        |       |                                    |               |     |
|                                       | 3.0 V6      |          |          | 04.94 | 01.01                                      |                |        |       |                                    |               |     |
| 3.2 V6                                |             |          | 02.01    | 08.03 |  |                |        |       |                                    |               |     |
|                                       | 2.0         |          |          | 03.94 | 09.99                                      | 24.2419-1709.3 | 030103 |       | Gz 19,05                           |               |     |
|                                       | 2.0 16V     |          |          | 03.94 | 09.99                                      |                |        |       |                                    |               |     |
|                                       | 2.0 DTI 16V |          |          | 09.97 | 08.00                                      |                |        |       |                                    |               |     |
|                                       | 2.2 16V     |          |          | 10.99 | 08.03                                      |                |        |       |                                    |               |     |
|                                       | 2.5 DTI     |          |          | 09.01 | 08.03                                      |                |        |       |                                    |               |     |

<sup>1)</sup> - Police / - Polizia / - voiture de police / - Police













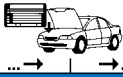

<sup>2)</sup> + Police / + Polizia / + voiture de police / + Police

<sup>3)</sup> - special vehicles / - veicoli speciali / - véhicule spécial / - vehículo especial













<sup>4)</sup> - special vehicles/ - Police / - veicoli speciali/ - Polizia / - véhicule spécial/ - Police / - vehículo especial/ - Police

<sup>5)</sup> - ventilated discs / - dischi ventilati / - disques ventilés / - disco ventilado

<sup>6)</sup> + ventilated discs / + dischi ventilati / + disques ventilés / + disco ventilado

|     |  |  |  |  |  |  |  |  |
|--|--|--|--|--|---|--|--|--|
| <b>OPEL OMEGA B / Vauxhall Omega (94-03)</b>                                       |  |  |  |  |   |  |  |  |
|    | 2.5 TD   |  |  | 04.94  | 08.03   | 24.2419-1709.3   | 030103   | Gz 19,05   |
|  | 2.5 V6   |  |  | 03.94  | 09.00   |  |  |  |
|  | 2.6 V6   |  |  | 09.00  | 08.03   |  |  |  |
|  | 3.0 V6   |  |  | 04.94  | 01.01   |  |  |  |
|  | 3.2 V6   |  |  | 02.01  | 08.03   |  |  |  |
| <b>OPEL SIGNUM / Vauxhall Signum (03-08)</b>                                       |  |  |  |  |   |  |  |  |
|    | 1.8  | 90   |  | 05.03  | 05.08   | 24.2125-1732.3   | 010827   | + ESP<br>Thz 25,40<br>LUC  |
|  | 1.8  | 103  |  | 09.05  | 05.08   |  |  |  |
|  | 1.9 CDTI   | 74   |  | 08.05  | 05.08   |  |  |  |
|  | 1.9 CDTI   | 88   |  | 04.04  | 05.08   |  |  |  |
|  | 1.9 CDTI   | 110  |  | 04.04  | 05.08   |  |  |  |
|  | 2.0 DTI  |  |  | 05.03  | 05.08   |  |  |  |
|  | 2.0 Turbo  |  |  | 05.03  | 05.08   |  |  |  |
|  | 2.2  |  |  | 03.03  | 05.08   |  |  |  |
|  | 2.2 DTI  |  |  | 05.03  | 05.08   |  |  |  |
|  | 3.0 V6 CDTI  | 130  |  | 05.03  | 05.08   |  |  |  |
|  | 3.0 V6 CDTI  | 135  |  | 09.05  | 05.08   |  |  |  |
|  | 3.2 V6   |  |  | 05.03  | 05.08   |  |  |  |
|    | 1.8  | 90   |  | 05.03  | 05.08   | 11.9571-9781.2   | 220659   | GG / nur paarweise austauschen <sup>2)</sup><br>D=57, - Halter<br>ATE              |
|  | 1.8  | 103  |  | 09.05  | 05.08   | 11.9571-9782.2   | 220660   | GG / nur paarweise austauschen <sup>2)</sup><br>D=57, - Halter<br>ATE              |
|  | 1.9 CDTI   | 74   |  | 08.05  | 05.08   | 11.0101-5407.2   | 260011   | Führungsbolzen<br>ATE  |
|  | 1.9 CDTI   | 88   |  | 04.04  | 05.08   | 11.8171-0008.1   | 990049   | Haltefeder<br>ATE  |
|  | 1.9 CDTI   | 110  |  | 04.04  | 05.08   | 11.8116-0295.2   | 390524   | Haltefeder<br>ATE  |
|  | 2.0 DTI  |  |  | 05.03  | 05.08   | 11.8116-0356.1   | 390586   | 2 + ALU-Sättel <sup>3)</sup><br>2 + GG-Sättel <sup>4)</sup>                        |
|  | 2.2  |  |  | 03.03  | 05.08   |  |  |  |
|  | 2.2 DTI  |  |  | 05.03  | 05.08   |  |  |  |
|  | 2.2 DTI  |  |  | 05.03  | 05.08   |  |  |  |
|  | 1.8  | 90   | 51066206   | 05.03  |   | 11.0101-5407.2   | 260011   | Hülzensatz<br>ATE  |
|  | 1.9 CDTI   | 88   | 51066206   | 04.04  |   | 11.8171-0008.1   | 990049   | Führungsbolzen<br>ATE  |
|  | 1.9 CDTI   | 110  | 51066206   | 04.04  |   | 11.8116-0325.2   | 390461   | 2 Haltefeder<br>ATE  |
|  | 2.0 Turbo  |  | 51066206   | 05.03  |   |  |  |  |
|  | 2.2  |  | 51066206   | 03.03  |   |  |  |  |
|  | 2.2 DTI  |  | 51066206   | 05.03  |   |  |  |  |
|  | 3.0 V6 CDTI  | 130  | 31068238   | 05.03  |   |  |  |  |
|  | 3.2 V6   |  | 31068238   | 05.03  |   |  |  |  |
|  | 1.8  | 90   | 51066207   | 05.08  |   | 11.9571-9779.2   | 220657   | GG / nur paarweise austauschen <sup>2)</sup><br>D=57, - Halter<br>ATE              |
|  | 1.8  | 103  |  | 09.05  |   | 11.9571-9780.2   | 220658   | GG / nur paarweise austauschen <sup>2)</sup><br>D=57, - Halter<br>ATE              |
|  | 1.9 CDTI   | 74   |  | 08.05  |   | 11.0101-5407.2   | 260011   | Hülzensatz<br>ATE  |
|  | 1.9 CDTI   | 88   | 51066207   | 05.08  |   | 11.8171-0008.1   | 990049   | Führungsbolzen<br>ATE  |
|  | 1.9 CDTI   | 110  | 51066207   | 05.08  |   | 11.8116-0356.1   | 390586   | 2 Haltefeder<br>ATE  |
|  | 2.0 Turbo  |  | 51066207   | 05.08  |   |  |  |  |
|  | 2.2  |  | 51066207   | 05.08  |   |  |  |  |
|  | 2.2 DTI  |  | 51066207   | 05.08  |   |  |  |  |
|  | 2.2 DTI  |  | 51066207   | 05.08  |   |  |  |  |
|  | 3.0 V6 CDTI  | 130  | 51999999   | 09.05  |   | 11.9606-9971.2   | 220589   | GG / nur paarweise austauschen <sup>2)</sup><br>D=60, - Halter<br>ATE              |
|  | 3.0 V6 CDTI  | 135  |  | 09.05  |   | 11.9606-9972.2   | 220590   | GG / nur paarweise austauschen <sup>2)</sup><br>D=60, - Halter<br>ATE              |
|  | 3.2 V6   |  | 31068239   | 09.05  |   | 11.0441-6008.2   | 250038   | Dichtungssatz<br>ATE   |
|  |  |  | 51999999   | 09.05  |   | 11.0101-5407.2   | 260011   | Hülzensatz<br>ATE  |
|  |  |  |  | 09.05  |   | 11.8171-0008.1   | 990049   | Führungsbolzen<br>ATE  |
|  |  |  |  | 09.05  |   | 11.8116-0345.2   | 390596   | 2 Haltefeder<br>ATE  |
|  | 2.8 V6 Turbo   |  |  | 03.06  |   | 11.9606-9971.2   | 220589   | GG / nur paarweise austauschen <sup>2)</sup><br>D=60, - Halter<br>ATE              |
|  | 2.8 V6 Turbo   | 169  |  | 09.05  |   | 11.9606-9972.2   | 220590   | GG / nur paarweise austauschen <sup>2)</sup><br>D=60, - Halter<br>ATE              |
|  |  |  |  | 09.05  |   | 11.0441-6008.2   | 250038   | Dichtungssatz<br>ATE   |
|  |  |  |  | 09.05  |   | 11.0101-5407.2   | 260011   | Hülzensatz<br>ATE  |
|  |  |  |  | 09.05  |   | 11.8171-0008.1   | 990049   | Führungsbolzen<br>ATE  |
|  |  |  |  | 09.05  |   | 11.8116-0345.2   | 390596   | 2 Haltefeder<br>ATE  |
|  | 2.8 V6 Turbo   |  |  | 03.06  |   | 11.9606-9971.2   | 220589   | GG / nur paarweise austauschen <sup>2)</sup><br>D=60, - Halter<br>ATE              |
|  | 2.8 V6 Turbo   | 169  |  | 09.05  |   | 11.9606-9972.2   | 220590   | GG / nur paarweise austauschen <sup>2)</sup><br>D=60, - Halter<br>ATE              |
|  |  |  |  | 09.05  |   | 11.0101-5407.2   | 260011   | Hülzensatz<br>ATE  |
|  |  |  |  | 09.05  |   | 11.8171-0008.1   | 990049   | Führungsbolzen<br>ATE  |
|  |  |  |  | 09.05  |   | 11.8116-0345.2   | 390596   | 2 Haltefeder<br>ATE  |
|  | 1.8  | 90   |  | 05.03  | 05.08   | 83.7807-0412.3   | 331098   | 2 L=412  |
|  | 1.8  | 103  |  | 09.05  | 05.08   |  |  |  |
|  | 1.9 CDTI   | 74   |  | 08.05  | 05.08   |  |  |  |
|  | 1.9 CDTI   | 88   |  | 04.04  | 05.08   |  |  |  |
|  | 1.9 CDTI   | 110  |  | 04.04  | 05.08   |  |  |  |
|  | 2.0 DTI  |  |  | 05.03  | 05.08   |  |  |  |
|  | 2.0 Turbo  |  |  | 05.03  | 05.08   |  |  |  |
|  | 2.2  |  |  | 03.03  | 05.08   |  |  |  |
|  | 2.2 DTI  |  |  | 05.03  | 05.08   |  |  |  |
|  | 2.8 V6 Turbo   |  |  | 03.06  | 05.08   |  |  |  |
|  | 2.8 V6 Turbo   | 169  |  | 09.05  | 05.08   |  |  |  |
|  | 3.0 V6 CDTI  | 130  |  | 05.03  | 05.08   |  |  |  |
|  | 3.0 V6 CDTI  | 135  |  | 09.05  | 05.08   |  |  |  |
|  | 3.2 V6   |  |  | 05.03  | 05.08   |  |  |  |
|  | 1.8  | 90   | 41085480   | 05.03  |   | 11.9407-7001.2   | 220573   | GG / nur paarweise austauschen <sup>2)</sup><br>D=40, - Halter<br>ATE              |
|  | 1.9 CDTI   | 88   | 41085480   | 04.04  |   | 11.9407-7002.2   | 220574   | GG / nur paarweise austauschen <sup>2)</sup><br>D=40, - Halter<br>ATE              |
|  | 1.9 CDTI   | 110  | 41085480   | 04.04  |   | 11.0101-5407.2   | 260011   | Hülzensatz<br>ATE  |
|  | 2.0 DTI  |  | 41085480   | 05.03  |   | 11.8171-0008.1   | 990049   | Führungsbolzen<br>ATE  |
|  | 2.2  |  | 41085480   | 03.03  |   | 11.8116-0340.1   | 390595   | 2 Haltefeder<br>ATE  |
|  | 2.2 DTI  |  | 41085480   | 05.03  |   |  |  |  |
|  | 1.8  | 90   | 41085481   | 09.05  |   | 11.9407-7005.2   | 220637   | GG / nur paarweise austauschen <sup>2)</sup><br>D=40, - Halter<br>ATE              |
|  | 1.8  | 103  |  | 09.05  |   | 11.9407-7006.2   | 220638   | GG / nur paarweise austauschen <sup>2)</sup><br>D=40, - Halter<br>ATE              |
|  | 1.9 CDTI   | 74   |  | 08.05  |   | 11.0101-5407.2   | 260011   | Hülzensatz<br>ATE  |
|  | 1.9 CDTI   | 88   | 41085481   | 05.08  |   | 11.8171-0008.1   | 990049   | Führungsbolzen<br>ATE  |
|  | 1.9 CDTI   | 110  | 41085481   | 05.08  |   | 11.8116-0340.1   | 390595   | 2 Haltefeder<br>ATE  |
|  | 2.0 DTI  |  | 41085481   | 05.08  |   |  |  |  |
|  | 2.2  |  | 41085481   | 05.08  |   |  |  |  |
|  | 2.2 DTI  |  | 41085481   | 05.08  |   |  |  |  |

1) - sports suspension / - sospensione sportiva / - châssis de sport / - suspensión deportiva  
2) GG/ replace only in pairs / GG/ sostituire solo a coppie / GG/ ne remplacer que par paires / GG/ reemplazar sólo por pares  
3) + aluminium calipers / + pinze in alluminio / + étriers en aluminium / + pinzas de aluminio  
4) + cast iron caliper / + pinza in ghisa / + étriers en fonte grise / + fundición gris-pinza  
5) - Police / - Polizia / - voiture de police / - Police  
6) + sports suspension / + sospensione sportiva / + châssis de sport / + suspensión deportiva  
7) + Police / + Polizia / + voiture de police / + Police  
8) - ventilated discs / - dischi ventilati / - disques ventilés / - disco ventilado

| OPEL SIGNUM / Vauxhall Signum (03-08)  |              |          |          |       |       |                |        |  |  |                                 |
|--|--------------|----------|----------|-------|-------|----------------|--------|--|--|---------------------------------|
|    | 2.2 DTI      | 41085481 |          | 05.08 |       | 11.9407-7005.2 | 220637 | <input type="checkbox"/> - belüftete Scheiben <sup>1)</sup><br><input type="checkbox"/> - belüftete Scheiben <sup>1)</sup> | D=40, - Halter<br>D=40, - Halter<br>Hülzensatz<br>Führungsbolzen<br>Haltefeder | ATE<br>ATE<br>ATE<br>ATE<br>ATE |
|  | 1.8          | 90       | 41085480 | 05.03 |       | 11.9407-7003.2 | 220835 | <input type="checkbox"/> + belüftete Scheiben <sup>2)</sup><br><input type="checkbox"/> + belüftete Scheiben <sup>2)</sup> | D=40, - Halter<br>D=40, - Halter<br>Hülzensatz<br>Führungsbolzen<br>Haltefeder | ATE<br>ATE<br>ATE<br>ATE<br>ATE |
|  | 1.9 CDTI     | 88       | 41085480 | 04.04 |       | 11.9407-7004.2 | 220836 |  |  |                                 |
|  | 1.9 CDTI     | 110      | 41085480 | 04.04 |       | 11.0101-5407.2 | 260011 |  |  |                                 |
|  | 2.0 DTI      |          | 41085480 | 05.03 |       | 11.8171-0008.1 | 990049 |  |  |                                 |
|  | 2.0 Turbo    |          | 41085480 | 05.03 |       | 11.8116-0340.1 | 390595 |  |  |                                 |
|  | 2.2          |          | 41085480 | 03.03 |       |                |        |  |  |                                 |
|  | 2.2 DTI      |          | 41085480 | 05.03 |       |                |        |  |  |                                 |
|  | 3.0 V6 CDTI  | 130      | 41085480 | 05.03 |       |                |        |  |  |                                 |
|  | 3.2 V6       |          | 41085480 | 05.03 |       |                |        |  |  |                                 |
|  | 1.8          | 90       | 41085481 | 05.08 |       | 11.9407-7007.2 | 220867 | <input type="checkbox"/> + belüftete Scheiben <sup>2)</sup><br><input type="checkbox"/> + belüftete Scheiben <sup>2)</sup> | D=40, - Halter<br>D=40, - Halter<br>Hülzensatz<br>Führungsbolzen<br>Haltefeder | ATE<br>ATE<br>ATE<br>ATE<br>ATE |
|  | 1.9 CDTI     | 88       | 41085481 | 05.08 |       | 11.9407-7008.2 | 220868 |  |  |                                 |
|  | 1.9 CDTI     | 110      | 41085481 | 05.08 |       | 11.0101-5407.2 | 260011 |  |  |                                 |
|  | 2.0 DTI      |          | 41085481 | 05.08 |       | 11.8171-0008.1 | 990049 |  |  |                                 |
|  | 2.0 Turbo    |          | 41085481 | 05.08 |       | 11.8116-0340.1 | 390595 |  |  |                                 |
|  | 2.2          |          | 41085481 | 05.08 |       |                |        |  |  |                                 |
|  | 2.2 DTI      |          | 41085481 | 05.08 |       |                |        |  |  |                                 |
|  | 2.8 V6 Turbo |          |          | 03.06 | 05.08 |                |        |  |  |                                 |
|  | 2.8 V6 Turbo | 169      |          | 09.05 | 05.08 |                |        |  |  |                                 |
|  | 3.0 V6 CDTI  | 130      | 41085481 |       | 05.08 |                |        |  |  |                                 |
|  | 3.0 V6 CDTI  | 135      |          | 09.05 | 05.08 |                |        |  |  |                                 |
|  | 3.2 V6       | 41085481 |          |       | 05.08 |                |        |  |  |                                 |
|    | 1.8          | 90       |          | 05.03 | 05.08 | 24.5259-0315.3 | 330882 |  | L=315  |                                 |
|  | 1.8          | 103      |          | 09.05 | 05.08 |                |        |  |  |                                 |
|  | 1.9 CDTI     | 74       |          | 08.05 | 05.08 |                |        |  |  |                                 |
|  | 1.9 CDTI     | 88       |          | 04.04 | 05.08 |                |        |  |  |                                 |
|  | 1.9 CDTI     | 110      |          | 04.04 | 05.08 |                |        |  |  |                                 |
|  | 2.0 DTI      |          |          | 05.03 | 05.08 |                |        |  |  |                                 |
|  | 2.0 Turbo    |          |          | 05.03 | 05.08 |                |        |  |  |                                 |
|  | 2.2          |          |          | 03.03 | 05.08 |                |        |  |  |                                 |
|  | 2.2 DTI      |          |          | 05.03 | 05.08 |                |        |  |  |                                 |
|  | 2.8 V6 Turbo |          |          | 03.06 | 05.08 |                |        |  |  |                                 |
|  | 2.8 V6 Turbo | 169      |          | 09.05 | 05.08 |                |        |  |  |                                 |
|  | 3.0 V6 CDTI  | 130      |          | 05.03 | 05.08 |                |        |  |  |                                 |
|  | 3.0 V6 CDTI  | 135      |          | 09.05 | 05.08 |                |        |  |  |                                 |
|  | 3.2 V6       |          |          | 05.03 | 05.08 |                |        |  |  |                                 |
|   | 1.9 CDTI     | 88       |          | 04.04 | 05.08 | 24.3727-0788.2 | 580788 | <input type="checkbox"/>   | L=1800/1800  |                                 |
|  | 1.9 CDTI     | 110      |          | 04.04 | 05.08 |                |        |  |  |                                 |
|  | 2.0 DTI      |          |          | 05.03 | 05.08 |                |        |  |  |                                 |
|  | 2.2 DTI      |          |          | 05.03 | 05.08 |                |        |  |  |                                 |
|  | 3.0 V6 CDTI  | 130      |          | 05.03 | 05.08 |                |        |  |  |                                 |
| OPEL TIGRA / Vauxhall Tigra (94-00)  |              |          |          |       |       |                |        |  |  |                                 |
|  | 1.4 16V      |          |          | 07.94 | 12.00 | 24.2120-0702.3 | 010361 | - ABS/Kennzeichen:EB/nicht für Delco BKV <sup>4)</sup>   | THz 20,64  |                                 |
|  | 1.6 16V      |          |          | 07.94 | 08.98 |                |        |  |  |                                 |
|  | 1.4 16V      |          |          | 07.94 | 12.00 | 11.9481-9871.2 | 220681 | <input type="checkbox"/>   | D=48, - Halter   | ATE                             |
|  | 1.6 16V      |          |          | 07.94 | 08.98 | 11.9481-9872.2 | 220682 | <input type="checkbox"/>   | D=48, - Halter   | ATE                             |
|  |              |          |          |       |       | 11.0441-4811.2 | 250024 |  | Dichtungssatz  | ATE                             |
|  |              |          |          |       |       | 11.0101-5407.2 | 260011 |  | Hülzensatz   | ATE                             |
|  |              |          |          |       |       | 11.8171-0008.1 | 990049 |  | Führungsbolzen   | ATE                             |
|  |              |          |          |       |       | 11.8116-0129.1 | 390591 |  | Haltefeder   | ATE                             |
|  | 1.4 16V      |          |          | 07.94 | 12.00 | 24.5231-0320.3 | 330496 |  | L=320  |                                 |
|  | 1.6 16V      |          |          | 07.94 | 08.98 |                |        |  |  |                                 |
|  | 1.4 16V      |          |          | 07.94 | 12.00 | 24.5233-0200.3 | 330425 |  | L=198  |                                 |
|  | 1.6 16V      |          |          | 07.94 | 08.98 |                |        |  |  |                                 |
|  | 1.4 16V      |          |          | 07.94 | 12.00 | 03.3219-6311.3 | 020057 | + GG <sup>5)</sup>   | Rz 19,05 (GG)  | LUC                             |
|  | 1.6 16V      |          |          | 07.94 | 08.98 | 24.3219-1715.3 | 020122 | + ALU <sup>6)</sup>  | Rz 19,05 (ALU)   |                                 |
|  | 1.4 16V      |          |          | 07.94 | 12.00 | 24.3727-0743.2 | 580743 | <input type="checkbox"/>   | L=1373, + Zub  |                                 |
|  | 1.6 16V      |          |          | 07.94 | 08.98 | 24.3727-0744.2 | 580744 | <input type="checkbox"/>   | L=1078, + Zub  |                                 |
|  | 1.4 16V      |          |          | 07.94 | 12.00 | 03.6585-0018.3 | 320114 |  | BRL 8/5 (4)  | ATE                             |
|  | 1.6 16V      |          |          | 07.94 | 08.98 |                |        |  |  |                                 |
|  | 1.4 16V      |          | S3/S4/S6 | 07.94 |       | 24.3728-0720.2 | 590720 |  | L=727  |                                 |
|  | 1.6 16V      |          | S3/S4/S6 | 07.94 |       |                |        |  |  |                                 |
|  | 1.4 16V      |          | T3/T4/T6 |       | 12.00 | 24.3728-0721.2 | 590721 |  | L=794  |                                 |
|  | 1.6 16V      |          | T3/T4/T6 |       | 08.98 |                |        |  |  |                                 |
| OPEL TIGRA TWIN TOP / Vau. Tigra Twin Top (04-09)                                  |              |          |          |       |       |                |        |  |  |                                 |
|  | 1.3 CDTI     | 51       |          | 06.04 | 08.09 | 24.2123-1767.3 | 010844 |  | THz 23,81  | BOS                             |
|  | 1.4          | 66       |          | 06.04 | 08.09 |                |        |  |  |                                 |
|  | 1.8          | 92       |          | 06.04 | 08.09 |                |        |  |  |                                 |
|  | 1.3 CDTI     | 51       |          | 06.04 | 08.09 | 24.2123-1768.3 | 010845 |  | THz 23,81  | BOS                             |
|  | 1.4          | 66       |          | 06.04 | 08.09 |                |        |  |  |                                 |
|  | 1.8          | 92       |          | 06.04 | 08.09 |                |        |  |  |                                 |

<sup>1)</sup> - ventilated discs / - dischi ventilati / - disques ventilés / - disco ventilado

<sup>2)</sup> + ventilated discs / + dischi ventilati / + disques ventilés / + disco ventilado

<sup>3)</sup> - rough road construction / - versione per percorsi accidentati / - version pour mauvaise route / - versión 4x4

<sup>4)</sup> - ABS/markings:EB/not for Delco BKV / - ABS/marcatura:EB/non per Delco BKV / - ABS/marquage:EB/pas pour Delco BKV / - ABS/marcaje:EB/no para Delco BKV

<sup>5)</sup> + cast iron / + ghisa / + fonte grise / + fundición de gris

<sup>6)</sup> + aluminium / + alluminio / + aluminium / + aluminio





















|  |                        |                |  |                         |                         |  |  |                       |   |  |
|--|------------------------|----------------|--|-------------------------|-------------------------|--|--|-----------------------|---|--|
|  |                        |                |  |                         |                         |  |  |                       |   |  |
| <b>OPEL TIGRA TWIN TOP / Vau. Tigra Twin Top (04-09)</b> |                        |                |  |                         |                         |  |  |                       |   |  |
|  | 1.3 CDTI<br>1.4<br>1.8 | 51<br>66<br>92 |  | 06.04<br>06.04<br>06.04 | 08.09<br>08.09<br>08.09 | 24.3541-1795.7<br>24.3541-1796.7   | 220551<br>220552                               |                       | D=54, - Halter<br>D=54, - Halter  | LUC<br>LUC   |
|  | 1.3 CDTI<br>1.4<br>1.8 | 51<br>66<br>92 |  | 06.04<br>06.04<br>06.04 | 08.09<br>08.09<br>08.09 | 24.5256-0298.3   | 330756   | 2                     | L=298   |  |
|  | 1.3 CDTI<br>1.4<br>1.8 | 51<br>66<br>92 |  | 06.04<br>06.04<br>06.04 | 08.09<br>08.09<br>08.09 | 24.5240-0195.3<br>24.5111-0210.3   | 330753<br>330765                               | 2<br>2                | L=195<br>L=210  |  |
|  | 1.3 CDTI<br>1.4<br>1.8 | 51<br>66<br>92 |  | 06.04<br>06.04<br>06.04 | 08.09<br>08.09<br>08.09 | 24.3219-1715.3   | 020122   |                       | Rz 19,05 (ALU)  |  |
|  | 1.3 CDTI<br>1.4<br>1.8 | 51<br>66<br>92 |  | 06.04<br>06.04<br>06.04 | 08.09<br>08.09<br>08.09 | 24.3727-0750.2<br>24.3727-0749.2<br>24.3727-0786.2<br>24.3727-0768.2<br>24.3727-0766.2 | 580750<br>580749<br>580786<br>580768<br>580766 | 2<br>2<br>2<br>2<br>2 | + HA-Trommelbremse <sup>1)</sup><br>+ HA-Trommelbremse <sup>1)</sup><br>Verlängerung/+HA-Trommelbr. <sup>2)</sup><br>+ HA-Scheibenbremse <sup>3)</sup><br>+ HA-Scheibenbremse <sup>3)</sup> | L=1095, + Zub<br>L=832, + Zub<br>L=217<br>L=1426<br>L=1143 |

|  |  |  |  |  |  |  |  |      |   |   |  |
|--|--|--|--|--|--|--|--|------|---|---|--|
| <b>OPEL VECTRA A / Vauxhall Cavalier (89-95)</b> |  |  |  |  |  |  |  |      |   |   |  |
|  | 1.4<br>1.6<br>1.7 D<br>1.7 TD<br>1.8<br>1.8 4x4                              |  | N5299999<br>N5299999<br>N5299999<br>N5299999<br>N5299999   | 09.88<br>09.88<br>09.88<br>09.88<br>09.88  | - ABS<br>- ABS<br>- ABS<br>- ABS<br>- ABS  | 24.2120-0913.3   | 010392   |      | Kennzeichen: EA <sup>4)</sup>                     | THz 20,64   | DEL                                    |
|  | 1.4<br>1.6<br>1.7 D<br>1.7 TD<br>1.8   | P1000001<br>P1000001<br>P1000001<br>P1000001<br>P1000001             |  | 08.95<br>08.95<br>08.95<br>08.95<br>08.95  | - ABS<br>- ABS<br>- ABS<br>- ABS<br>- ABS  | 24.2120-0702.3   | 010361   |      | Kennzeichen: EB/nicht für Delco BKV <sup>5)</sup> | THz 20,64   |  |
|  | 2.0<br>2.0<br>2.0<br>2.0 16V<br>2.0 16V<br>2.0 16V                           |  | NV129999<br>N5299999<br>N1299999<br>NV129999<br>N5299999<br>N1299999   | 09.88<br>09.88<br>09.88<br>09.88<br>09.88<br>09.88                                     | - ABS<br>- ABS<br>- ABS<br>- ABS<br>- ABS<br>- ABS   | 03.2122-0264.3   | 010129   |      |   | THz 22,20   | ATE                                    |
|  | 2.0<br>2.0<br>2.0<br>2.0 16V<br>2.0 16V<br>2.0 16V                           | P7000001<br>P5000001<br>P1000001<br>P7000001<br>P5000001<br>P1000001 |  | 08.95<br>08.95<br>08.95<br>08.95<br>08.95<br>08.95                                     | - ABS<br>- ABS<br>- ABS<br>- ABS<br>- ABS<br>- ABS   | 03.2122-0264.3<br>24.2122-1746.3   | 010129<br>010716   |      | Kennzeichen: EF <sup>6)</sup>                     | THz 22,20<br>THz 22,20  | ATE<br>DEL                             |
|  | 2.0<br>2.0 16V   |  |  | 09.88<br>09.88   | 08.95 - ABS<br>08.95 - ABS   | 24.2122-1739.3   | 010710   |      | Kennzeichen: EK <sup>7)</sup>                     | THz 22,20   | DEL                                    |
|  | 1.4<br>1.6<br>1.7 D<br>1.7 TD<br>1.8<br>1.8 4x4<br>2.0<br>2.0 16V            |  |  | 09.88<br>09.88<br>09.88<br>09.88<br>09.88<br>09.88<br>09.88<br>09.88                   | 08.95 + ABS<br>08.95 + ABS<br>08.95 + ABS<br>08.95 + ABS<br>08.95 + ABS<br>08.89 + ABS<br>08.95 + ABS<br>08.95 + ABS | 03.2122-0282.3   | 010130   |      |   | THz 22,20   | ATE                                    |
|  | 2.0 Turbo<br>2.5 i   |  |  | 03.92<br>02.93   | 08.95<br>08.95   | 03.2123-1121.3   | 010176   |      |   | THz 23,81   | ATE                                    |
|  | 1.4<br>1.4<br>1.6<br>1.6<br>1.7 D<br>1.7 D<br>1.7 TD<br>1.7 TD<br>1.8<br>1.8 |  | N1038529<br>M5999999<br>N1038529<br>M5999999<br>N1038529<br>M5999999<br>N1038529<br>M5999999<br>N1038529<br>M5999999 | 09.88<br>09.88<br>09.88<br>09.88<br>09.88<br>09.88<br>09.88<br>09.88<br>09.88<br>09.88 |  | 11.0441-4803.2<br>11.0101-4802.2   | 250018<br>260007   |      |   | Dichtungssatz<br>Hülsensatz   | ATE<br>ATE                             |
|  | 1.4<br>1.4<br>1.6<br>1.6   | N5000001<br>N1038530<br>N5000001<br>N1038530                         |  | 08.95<br>08.95<br>08.95<br>08.95   |  | 11.9481-9871.2<br>11.9481-9872.2<br>11.0441-4811.2<br>11.0101-5407.2<br>11.8171-0008.1<br>11.8116-0129.1 | 220681<br>220682<br>250024<br>260011<br>990049<br>390591 | <br> |   | D=48, - Halter<br>D=48, - Halter<br>Dichtungssatz<br>Hülsensatz<br>Führungsbolzen<br>Haltefeder | ATE<br>ATE<br>ATE<br>ATE<br>ATE<br>ATE |
|  | 1.7 D<br>1.7 D<br>1.7 TD<br>1.7 TD<br>1.8<br>1.8                             | N5000001<br>N1038530<br>N5000001<br>N1038530<br>N5000001<br>N1038530 | R5999999<br>R1999999<br>R5999999<br>R1999999<br>R5999999<br>R1999999   |  |  | 11.9481-9871.2<br>11.9481-9872.2<br>11.0441-4811.2<br>11.0101-5407.2<br>11.8171-0008.1<br>11.8116-0129.1 | 220681<br>220682<br>250024<br>260011<br>990049<br>390591 | <br> |   | D=48, - Halter<br>D=48, - Halter<br>Dichtungssatz<br>Hülsensatz<br>Führungsbolzen<br>Haltefeder | ATE<br>ATE<br>ATE<br>ATE<br>ATE<br>ATE |
|  | 1.7 D<br>1.7 D<br>1.7 D<br>1.7 TD<br>1.8<br>1.8<br>2.0<br>2.0 16V            | S5000001<br>S5000001<br>S1000001<br>S1000001<br>S5000001<br>S1000001 |  | 08.95<br>08.95<br>08.95<br>08.95<br>08.95<br>08.95<br>09.88<br>08.95                   |  | 24.3521-1701.5<br>24.3521-1702.5<br>11.0441-5202.2<br>11.0101-5407.2<br>11.8171-0008.1<br>11.8116-0097.1 | 240001<br>240002<br>250026<br>260011<br>990049<br>390590 | <br> |   | D=52, - Halter<br>D=52, - Halter<br>Dichtungssatz<br>Hülsensatz<br>Führungsbolzen<br>Haltefeder | ATE<br>ATE<br>ATE<br>ATE<br>ATE<br>ATE |

1) + RA drum brake / + P freno a tamburo / + frein à tambour essieu AR / + ET-tambores de freno  
2) extension only/ + RA drum br. / solo prolunga/+ P fra tamburo / rallonge seul.em.+ tamb.ess.AR / solam. prolongad./+ tambores ET  
3) + RA disc brake / + P disco freno / + frein à disque essieu AR / + ET-disco de freno  
4) registration number: EA / targa: EA / indice: EA / distiutiv: EA  
5) registration no.: EB/not for Delco BKV / targa: EB/non per Delco BKV / indice: EB/sans pour Delco BKV / distiutiv: EB/non para Delco BKV  
6) registration number: EF / targa: EF / indice: EF / distiutiv: EF  
7) registration number: EK / targa: EK / indice: EK / distiutiv: EK





|     |  |  |  |  |  |  |  |  |                    |     |
|--|--|--|--|--|---|--|--|--|--------------------|-----|
| <b>OPEL VECTRA A / Vauxhall Cavalier (89-95)</b>                                   |  |  |  |  |   |  |  |  |                    |     |
|    | 1.8 4x4  |  |  | 09.88  | 08.89   | 11.0441-5402.2   | 250028   |  | Dichtungssatz      | ATE |
|  | 2.0 16V 4x4  |  |  | 09.88  | 08.95   | 11.0101-5407.2   | 260011   |  | Hülensatz          | ATE |
|  | 2.0 4x4  |  |  | 09.88  | 08.95   | 11.8171-0008.1   | 990049   |  | Führungsbolzen     | ATE |
|  |  |  |  |  |   | 11.8116-0097.1   | 390590   | 2  | Haltefeder         | ATE |
|  | 2.0 Turbo  |  |  | 03.92  | 08.95   | 11.3541-8085.2   | 220287   | <input type="checkbox"/>   | D=54, + Halter     | ATE |
|  | 2.5 i  |  |  | 02.93  | 08.95   | 24.3541-8086.5   | 240526   | <input type="checkbox"/>   | D=54, - Halter     | ATE |
|  |  |  |  |  |   | 24.3541-8085.5   | 240525   | <input type="checkbox"/>   | D=54, - Halter     | ATE |
|  |  |  |  |  |   | 11.0101-5407.2   | 260011   |  | Hülensatz          | ATE |
|  |  |  |  |  |   | 11.8171-0008.1   | 990049   |  | Führungsbolzen     | ATE |
|  |  |  |  |  |   | 11.8116-0129.1   | 390591   | 2  | Haltefeder         | ATE |
|    | 1.4  |  |  | 09.88  | 08.95   | 83.7288-0318.3   | 330375   | 2  | L=315              |     |
|  | 1.6  |  |  | 09.88  | 08.95   | 24.5298-0322.3   | 331314   | 2  | L=322              |     |
|  | 1.7 D  |  |  | 09.88  | 08.95   |  |  |  |                    |     |
|  | 1.7 TD   |  |  | 09.88  | 08.95   |  |  |  |                    |     |
|  | 1.8  |  |  | 09.88  | 08.95   |  |  |  |                    |     |
|  | 1.8 4x4  |  |  | 09.88  | 08.89   |  |  |  |                    |     |
|  | 2.0  |  |  | 09.88  | 08.95   |  |  |  |                    |     |
|  | 2.0 16V  |  |  | 09.88  | 08.95   |  |  |  |                    |     |
| 2.0 Turbo  |  |  | 03.92  | 08.95  |   |  |  |  |                    |     |
|    | 2.0  |  |  | 09.88  | 08.95   | 13.2351-0013.2   | 210010   | <input type="checkbox"/>   | D=35               | ATE |
|  | 2.0 16V  |  |  | 09.88  | 08.95   | 13.2351-0014.2   | 210011   | <input type="checkbox"/>   | D=35               | ATE |
|  | 2.5 i  |  |  | 02.93  | 08.95   | 24.9235-0013.5   | 230001   | <input type="checkbox"/>   | D=35               | ATE |
|  |  |  |  |  |   | 24.9235-0014.5   | 230002   | <input type="checkbox"/>   | D=35               | ATE |
|  |  |  |  |  | 13.0441-3506.2  | 250052   |  | Dichtungssatz  | ATE                |     |
|  |  |  |  |  | 24.5233-0200.3  | 330425   | 2  |  |                    |     |
|    | 1.4  |  | N5999999   | 09.88  |   |  |  |  | L=198              |     |
|  | 1.6  |  | N5999999   | 09.88  |   |  |  |  |                    |     |
|  | 1.7 D  |  | N5999999   | 09.88  |   |  |  |  |                    |     |
|  | 1.7 TD   |  | N5999999   | 09.88  |   |  |  |  |                    |     |
|  | 1.8  |  | N5999999   | 09.88  |   |  |  |  |                    |     |
|  | 1.8 4x4  |  |  | 09.88  | 08.89   |  |  |  |                    |     |
|  | 2.0  |  | N5999999   | 09.88  |   |  |  |  |                    |     |
|  | 2.0 16V  |  | N5999999   | 09.88  |   |  |  |  |                    |     |
| 2.0 Turbo  |  | N5999999   | 03.92  |  |   |  |  |  |                    |     |
|    | 1.4  | P1000001   |  |  | 08.95   | 24.5117-0195.3   | 330565   | 2  | L=198              |     |
|  | 1.6  | P1000001   |  |  | 08.95   |  |  |  |                    |     |
|  | 1.7 D  | P1000001   |  |  | 08.95   |  |  |  |                    |     |
|  | 1.7 TD   | P1000001   |  |  | 08.95   |  |  |  |                    |     |
|  | 1.8  | P1000001   |  |  | 08.95   |  |  |  |                    |     |
|  | 2.0  | P1000001   |  |  | 08.95   |  |  |  |                    |     |
|  | 2.0 16V  | P1000001   |  |  | 08.95   |  |  |  |                    |     |
|  | 2.0 Turbo  | P1000001   |  |  | 08.95   |  |  |  |                    |     |
|  | 1.4  |  |  | 09.88  | 08.95   | 03.3219-6311.3   | 020057   | + GG <sup>1)</sup>   | Rz 19,05 (GG)      | LUC |
|  | 1.6  |  |  | 09.88  | 08.95   | 24.3219-1715.3   | 020122   | + ALU <sup>2)</sup>  | Rz 19,05 (ALU)     |     |
|  | 1.7 D  |  |  | 09.88  | 08.95   |  |  |  |                    |     |
|  | 1.7 TD   |  |  | 09.88  | 08.95   |  |  |  |                    |     |
|  | 1.8  |  |  | 09.88  | 08.95   |  |  |  |                    |     |
|  | 1.4  |  |  | 09.88  | 08.95   | 24.3727-0734.2   | 580734   | <input type="checkbox"/>   | L=750, + Zub       |     |
|  | 1.6  |  |  | 09.88  | 08.95   | 24.3727-0733.2   | 580733   | <input type="checkbox"/>   | L=2120, + Zub      |     |
|  | 1.7 D  |  |  | 09.88  | 08.95   |  |  |  |                    |     |
|  | 1.7 TD   |  |  | 09.88  | 08.95   |  |  |  |                    |     |
|  | 1.8  |  |  | 09.88  | 08.95   |  |  |  |                    |     |
|  | 1.8 4x4  |  |  | 09.88  | 08.89   | 24.3727-0736.2   | 580736   | 1 <input type="checkbox"/>   | L=1365/1498, + Zub |     |
| 2.0 16V  |  |  | 09.88  | 08.95  |   |  |  |  |                    |     |
| 2.0 4x4  |  | NV299999   | 09.88  | 08.95  |   |  |  |  |                    |     |
| 2.0 Turbo  |  |  | 03.92  | 08.95  |   |  |  |  |                    |     |
| 2.0  |  |  | 09.88  | 08.95  | 24.3727-0739.2  | 580739   | <input type="checkbox"/>   | L=665, + Zub   |                    |     |
| 2.0 16V  |  | P1000001   |  | 08.95  | 24.3727-0740.2  | 580740   | <input type="checkbox"/>   | L=2022, + Zub  |                    |     |
| 2.5 i  |  |  | 02.93  | 08.95  |   |  |  |  |                    |     |
|  | 1.4  |  |  |  | 08.95   | 03.0101-0027.2   | 320022   |  | BRES 3/45          | ATE |
|  | 1.6  |  | P1000001   |  | 08.95   |  |  |  |                    |     |
|  | 1.7 D  |  | P1000001   |  | 08.95   |  |  |  |                    |     |
|  | 1.7 TD   |  | P1000001   |  | 08.95   |  |  |  |                    |     |
|  | 1.8  |  | P1000001   |  | 08.95   |  |  |  |                    |     |
| 2.0  |  |  | 09.88  | 08.95  | + ABS   | 03.0101-0023.2   | 320242   |  | BRES 5/25          | ATE |
| 2.5 i  |  |  | 02.93  | 08.95  |   | 03.0101-0025.2   | 320014   |  | BRES 3/35          | ATE |
|  | 1.4  |  |  | 09.88  | 08.95   | 24.3728-0712.2   | 590712   |  | L=835              |     |
|  | 1.6  |  |  | 09.88  | 08.95   |  |  |  |                    |     |
|  | 1.7 D  |  |  | 09.88  | 08.95   |  |  |  |                    |     |
|  | 1.7 TD   |  |  | 09.88  | 08.95   |  |  |  |                    |     |
|  | 1.8  |  |  | 09.88  | 08.95   | 24.3728-0715.2   | 590715   |  | L=835              |     |
|  | 2.0  |  |  | 09.88  | 08.95   |  |  |  |                    |     |
| 2.0 16V  |  |  | 09.88  | 08.95  |   |  |  |  |                    |     |
| 2.5 i  |  |  | 02.93  | 08.95  |   |  |  |  |                    |     |
| <b>DIV</b>   | 1.8 4x4  |  |  | 09.88  | 08.89   | 10.0515-0515.3   | 340024   | + Verteilergetriebe <sup>3)</sup>  | Hydraulikspeicher  | ATE |
|  | 2.0 4x4  |  |  | 09.88  | 08.95   |  |  |  |                    |     |
|  | 2.0 Turbo 4x4  |  |  | 03.92  | 08.95   |  |  |  |                    |     |
| <b>OPEL VECTRA B / Vauxhall Vectra (96-02)</b>                                     |  |  |  |  |   |  |  |  |                    |     |
|  | 2.0 16V  |  | W1285446   | 09.95  |   | 03.7745-3003.4   | 300157   |  | 8" Tandem          | ATE |
|  | 2.5 V6   |  |  | 09.95  | 09.00   |  |  |  |                    |     |
|  | 2.6 V6   |  |  | 09.00  | 04.02   |  |  |  |                    |     |
|  | 1.6  |  | V7999999   | 09.95  |   | 24.2122-1724.3   | 010561   |  | THz 22,20          |     |
|  | 1.6  |  | V5999999   | 09.95  |   |  |  |  |                    |     |
|  | 1.6  |  | V1999999   | 09.95  |   |  |  |  |                    |     |
|  | 1.6 16V  |  | V7999999   | 09.95  |   |  |  |  |                    |     |
|  |  |  |  |  |   |  |  |  |                    |     |

<sup>1)</sup> + cast iron / + ghisa / + fonte grise / + fundición de gris

<sup>2)</sup> + aluminium / + aluminio / + aluminium / + aluminio





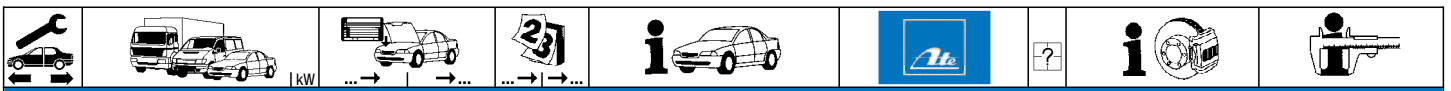











<sup>3)</sup> + distribution transmission / + differenziale centrale <sup>3)</sup> / + transmission 4x4 / + engranaje de distribución





**OPEL VECTRA B / Vauxhall Vectra (96-02)**

|  |             |   |          |          |       |  |                |        |  |           |
|--|-------------|---|----------|----------|-------|--|----------------|--------|--|-----------|
|  | 1.6 16V     | ↕ |          | V5999999 | 09.95 |  | 24.2122-1724.3 | 010561 |  | THz 22,20 |
|  | 1.6 16V     | ↕ |          | V1999999 | 09.95 |  |                |        |  |           |
|  | 1.7 TD      | ↕ |          |          | 11.96 |  |                |        |  |           |
|  | 1.8 i 16V   | ↕ |          | V7999999 | 09.95 |  |                |        |  |           |
|  | 1.8 i 16V   | ↕ |          | V5999999 | 09.95 |  |                |        |  |           |
|  | 1.8 i 16V   | ↕ |          | V1999999 | 09.95 |  |                |        |  |           |
|  | 2.0 DI 16V  | ↕ |          | V7999999 | 11.96 |  |                |        |  |           |
|  | 2.0 DI 16V  | ↕ |          | V5999999 | 11.96 |  |                |        |  |           |
|  | 2.0 DI 16V  | ↕ |          | V1999999 | 11.96 |  |                |        |  |           |
|  | 2.0 DTI 16V | ↕ |          | V7999999 | 06.97 |  |                |        |  |           |
|  | 2.0 DTI 16V | ↕ |          | V5999999 | 06.97 |  |                |        |  |           |
|  | 2.0 DTI 16V | ↕ |          | V1999999 | 06.97 |  |                |        |  |           |
|  | 1.6         | ↕ |          | W7999999 | 09.95 |  | 24.2122-1724.3 | 010561 |  | THz 22,20 |
|  | 1.6         | ↕ |          | W5999999 | 09.95 |  |                |        |  |           |
|  | 1.6         | ↕ |          | W1999999 | 09.95 |  |                |        |  |           |
|  | 1.6 16V     | ↕ |          | W7999999 | 09.95 |  |                |        |  |           |
|  | 1.6 16V     | ↕ |          | W5999999 | 09.95 |  |                |        |  |           |
|  | 1.6 16V     | ↕ |          | W1999999 | 09.95 |  |                |        |  |           |
|  | 1.8 i 16V   | ↕ |          | W7999999 | 09.95 |  |                |        |  |           |
|  | 1.8 i 16V   | ↕ |          | W5999999 | 09.95 |  |                |        |  |           |
|  | 1.8 i 16V   | ↕ |          | W1999999 | 09.95 |  |                |        |  |           |
|  | 2.0 DI 16V  | ↕ |          | W7999999 | 11.96 |  |                |        |  |           |
|  | 2.0 DI 16V  | ↕ |          | W5999999 | 11.96 |  |                |        |  |           |
|  | 2.0 DI 16V  | ↕ |          | W1999999 | 11.96 |  |                |        |  |           |
|  | 2.0 DTI 16V | ↕ |          | W7999999 | 06.97 |  |                |        |  |           |
|  | 2.0 DTI 16V | ↕ |          | W5999999 | 06.97 |  |                |        |  |           |
|  | 2.0 DTI 16V | ↕ |          | W1999999 | 06.97 |  |                |        |  |           |
|  | 1.6         | ↕ | W7000001 | W7999999 |       |  | 24.2123-1777.3 | 010943 |  | THz 23,81 |
|  | 1.6         | ↕ | W5000001 | W5999999 |       |  |                |        |  |           |
|  | 1.6         | ↕ | W1000001 | W1999999 |       |  |                |        |  |           |
|  | 1.6 16V     | ↕ | W7000001 | W7999999 |       |  |                |        |  |           |
|  | 1.6 16V     | ↕ | W5000001 | W5999999 |       |  |                |        |  |           |
|  | 1.6 16V     | ↕ | W1000001 | W1999999 |       |  |                |        |  |           |
|  | 1.8 i 16V   | ↕ | W7000001 | W7999999 |       |  |                |        |  |           |
|  | 1.8 i 16V   | ↕ | W5000001 | W5999999 |       |  |                |        |  |           |
|  | 1.8 i 16V   | ↕ | W1000001 | W1999999 |       |  |                |        |  |           |
|  | 2.0 DI 16V  | ↕ | W7000001 | W7999999 |       |  |                |        |  |           |
|  | 2.0 DI 16V  | ↕ | W5000001 | W5999999 |       |  |                |        |  |           |
|  | 2.0 DI 16V  | ↕ | W1000001 | W1999999 |       |  |                |        |  |           |
|  | 2.0 DTI 16V | ↕ | W7000001 | W7999999 |       |  |                |        |  |           |
|  | 2.0 DTI 16V | ↕ | W5000001 | W5999999 |       |  |                |        |  |           |
|  | 2.0 DTI 16V | ↕ | W1000001 | W1999999 |       |  |                |        |  |           |
|  | 1.6         | ↕ | X7000001 |          | 04.02 |  | 24.2125-1714.3 | 010641 |  | THz 25,40 |
|  | 1.6         | ↕ | X5000001 |          | 04.02 |  |                |        |  | LUC       |
|  | 1.6         | ↕ | X1000001 |          | 04.02 |  |                |        |  |           |
|  | 1.6 16V     | ↕ | X7000001 |          | 04.02 |  |                |        |  |           |
|  | 1.6 16V     | ↕ | X5000001 |          | 04.02 |  |                |        |  |           |
|  | 1.6 16V     | ↕ | X1000001 |          | 04.02 |  |                |        |  |           |
|  | 1.8 i 16V   | ↕ | X7000001 |          | 04.02 |  |                |        |  |           |
|  | 1.8 i 16V   | ↕ | X5000001 |          | 04.02 |  |                |        |  |           |
|  | 1.8 i 16V   | ↕ | X1000001 |          | 04.02 |  |                |        |  |           |
|  | 2.0 DI 16V  | ↕ | X7000001 |          | 04.02 |  |                |        |  |           |
|  | 2.0 DI 16V  | ↕ | X5000001 |          | 04.02 |  |                |        |  |           |
|  | 2.0 DI 16V  | ↕ | X1000001 |          | 04.02 |  |                |        |  |           |
|  | 2.0 DTI 16V | ↕ | X7000001 |          | 04.02 |  |                |        |  |           |
|  | 2.0 DTI 16V | ↕ | X5000001 |          | 04.02 |  |                |        |  |           |
|  | 2.0 DTI 16V | ↕ | X1000001 |          | 04.02 |  |                |        |  |           |
|  | 2.0 16V     | ↕ | W7154258 | W7154258 | 09.95 |  | 03.2123-1622.3 | 010470 |  | THz 23,81 |
|  | 2.0 16V     | ↕ | W5276825 | W5276825 | 09.95 |  |                |        |  | ATE       |
|  | 2.0 16V     | ↕ | W1285446 | W1285446 | 09.95 |  |                |        |  |           |
|  | 2.5 V6      | ↕ | W7154258 | W7154258 | 09.95 |  |                |        |  |           |
|  | 2.5 V6      | ↕ | W5276825 | W5276825 | 09.95 |  |                |        |  |           |
|  | 2.5 V6      | ↕ | W1285446 | W1285446 | 09.95 |  |                |        |  |           |
|  | 2.0 16V     | ↕ | W7154259 |          | 04.02 |  | 24.2125-1714.3 | 010641 |  | THz 25,40 |
|  | 2.0 16V     | ↕ | W5276826 |          | 04.02 |  |                |        |  | LUC       |
|  | 2.0 16V     | ↕ | W1285447 |          | 04.02 |  |                |        |  |           |
|  | 2.2 16V     | ↕ |          |          | 09.00 |  |                |        |  |           |
|  | 2.2 DTI 16V | ↕ |          |          | 09.00 |  |                |        |  |           |
|  | 2.5 V6      | ↕ | W7154259 |          | 09.00 |  | 03.2125-7402.3 | 010541 |  | THz 25,40 |
|  | 2.5 V6      | ↕ | W5276826 |          | 09.00 |  |                |        |  | ATE       |
|  | 2.5 V6      | ↕ | W1285447 |          | 09.00 |  |                |        |  |           |
|  | 2.6 V6      | ↕ |          |          | 09.00 |  |                |        |  |           |
|  | 2.0 16V     | ↕ | W7154258 | W7154258 | 09.95 |  | 03.2123-1722.3 | 010471 |  | THz 23,81 |
|  | 2.0 16V     | ↕ | W5276825 | W5276825 | 09.95 |  |                |        |  | ATE       |
|  | 2.0 16V     | ↕ | W1285446 | W1285446 | 09.95 |  |                |        |  |           |
|  | 2.5 V6      | ↕ | W7154258 | W7154258 | 09.95 |  |                |        |  |           |
|  | 2.5 V6      | ↕ | W5276825 | W5276825 | 09.95 |  |                |        |  |           |
|  | 2.5 V6      | ↕ | W1285446 | W1285446 | 09.95 |  |                |        |  |           |
|  | 2.0 16V     | ↕ | W7154259 |          | 04.02 |  | 03.2125-7502.3 | 010616 |  | THz 25,40 |
|  | 2.0 16V     | ↕ | W5276826 |          | 04.02 |  |                |        |  | ATE       |
|  | 2.0 16V     | ↕ | W1285447 |          | 04.02 |  |                |        |  |           |
|  | 2.2 16V     | ↕ |          |          | 09.00 |  |                |        |  |           |
|  | 2.5 V6      | ↕ | W7154259 |          | 09.00 |  |                |        |  |           |
|  | 2.5 V6      | ↕ | W5276826 |          | 09.00 |  |                |        |  |           |
|  | 2.5 V6      | ↕ | W1285447 |          | 09.00 |  |                |        |  |           |
|  | 2.6 V6      | ↕ |          |          | 09.00 |  |                |        |  |           |

|     |  |  |  |  |  |  |  |  |   |  |
|--|--|--|--|--|---|--|--|--|---|--|
| <b>OPEL VECTRA B / Vauxhall Vectra (96-02)</b>                                     |  |  |  |  |   |  |  |  |   |  |
|    | 1.6  |  | W7999999   | 09.95  |   | 24.3521-1701.5   | 240001   | 2  | D=52, - Halter<br>D=52, - Halter<br>Dichtungssatz<br>Hülsensatz<br>Führungsbolzen<br>Haltefeder | ATE<br>ATE<br>ATE<br>ATE<br>ATE<br>ATE |
|  | 1.6 16V  |  | W7999999   | 09.95  |   | 24.3521-1702.5   | 240002   |  |   |  |
|  | 1.7 TD   |  |  | 09.95  | 11.96   | 11.0441-5202.2   | 250026   |  |   |  |
|  | 1.8 i 16V  |  | W7999999   | 09.95  |   | 11.0101-5407.2   | 260011   |  |   |  |
|  | 2.0 DI 16V   |  | W7999999   | 11.96  |   | 11.8171-0008.1   | 990049   |  |   |  |
|  | 2.0 DTI 16V  |  | W7999999   | 06.97  |   | 11.8116-0097.1   | 390590   |  |   |  |
|  | 1.6  |  |  |  | 04.02   | 11.3571-8525.2   | 220363   |  |   |  |
|  | 1.6 16V  | X1000001   |  |  | 04.02   | 11.3571-8526.2   | 220364   |  |   |  |
|  | 1.8 i 16V  | X1000001   |  |  | 04.02   | 11.0441-5704.2   | 250034   |  |   |  |
|  | 2.0 16V  |  |  | 09.95  | 04.02   | 11.0101-5407.2   | 260011   |  |   |  |
| 2.0 DI 16V   | X1000001   |  |  | 04.02  | 11.8171-0008.1  | 990049   |  |  |   |  |
| 2.0 DTI 16V  | X1000001   |  |  | 04.02  | 11.8116-0292.1  | 390521   |  |  |   |  |
| 2.2 16V  |  |  | 09.00  | 04.02  |   |  |  |  |   |  |
| 2.2 DTI 16V  |  |  | 09.00  | 04.02  |   |  |  |  |   |  |
| 2.5 V6   |  |  | 09.95  | 09.00  |   |  |  |  |   |  |
| 2.6 V6   |  |  | 09.00  | 04.02  |   |  |  |  |   |  |
| i 500 2.5  | 143  |  | 05.98  | 09.00  |   |  |  |  |   |  |
|    | 1.6  |  |  | 09.95  | 04.02   | 83.7257-0388.3   | 330486   | 2  | L=388   |  |
|  | 1.6 16V  |  |  | 09.95  | 04.02   |  |  |  |   |  |
|  | 1.7 TD   |  |  | 09.95  | 11.96   |  |  |  |   |  |
|  | 1.8 i 16V  |  |  | 09.95  | 04.02   |  |  |  |   |  |
|  | 2.0 16V  |  |  | 09.95  | 04.02   |  |  |  |   |  |
|  | 2.0 DI 16V   |  |  | 11.96  | 04.02   |  |  |  |   |  |
|  | 2.0 DTI 16V  |  |  | 06.97  | 04.02   |  |  |  |   |  |
|  | 2.2 16V  |  |  | 09.00  | 04.02   |  |  |  |   |  |
|  | 2.2 DTI 16V  |  |  | 09.00  | 04.02   |  |  |  |   |  |
|  | 2.5 V6   |  |  | 09.95  | 09.00   |  |  |  |   |  |
| 2.6 V6   |  |  | 09.00  | 04.02  |   |  |  |  |   |  |
|    | 1.6 16V  |  | V7999999   | 09.95  |   | 13.2351-0025.2   | 210210   | 2  | D=35<br>D=35<br>Dichtungssatz   | ATE<br>ATE<br>ATE                      |
|  | 1.7 TD   |  | V7999999   | 09.95  |   | 13.2351-0026.2   | 210211   |  |   |  |
|  | 1.8 i 16V  |  | V7999999   | 09.95  |   | 13.0441-3506.2   | 250052   |  |   |  |
|  | 2.0 16V  |  | V7999999   | 09.95  |   |  |  |  |   |  |
|  | 2.0 DI 16V Caravan   |  | V7999999   | 11.96  |   |  |  |  |   |  |
|  | 2.0 DTI 16V  |  | V7999999   | 06.97  |   |  |  |  |   |  |
|  | 2.5 V6   |  | V7999999   | 09.95  |   |  |  |  |   |  |
|  | 1.6 16V  | W1000001   |  |  | 04.02   | 13.2351-0051.2   | 210180   |  |   |  |
|  | 1.7 TD   | W1000001   |  |  | 11.96   | 13.2351-0052.2   | 210181   |  |   |  |
|  | 1.8 i 16V  | W1000001   |  |  | 04.02   | 24.9235-0051.5   | 230003   |  |   |  |
| 2.0 16V  | W1000001   |  |  | 04.02  | 24.9235-0052.5  | 230004   |  |  |   |  |
| 2.0 DI 16V Caravan   | W1000001   |  |  | 04.02  | 13.0441-3507.2  | 250053   |  |  |   |  |
| 2.0 DTI 16V  | W1000001   |  |  | 04.02  |   |  |  |  |   |  |
| 2.2 16V  |  |  | 09.00  | 04.02  |   |  |  |  |   |  |
| 2.2 DTI 16V  |  |  | 09.00  | 04.02  |   |  |  |  |   |  |
| 2.5 V6   | W1000001   |  |  | 09.00  |   |  |  |  |   |  |
| 2.6 V6   |  |  | 09.00  | 04.02  |   |  |  |  |   |  |
|  | 1.6  |  |  | 09.95  | 04.02   | 24.5233-0200.3   | 330425   | 2  | L=198   |  |
|  | 1.6 16V  |  |  | 09.95  | 04.02   |  |  |  |   |  |
|  | 1.7 TD   |  |  | 09.95  | 11.96   |  |  |  |   |  |
|  | 1.8 i 16V  |  |  | 09.95  | 04.02   |  |  |  |   |  |
|  | 2.0 16V  |  |  | 09.95  | 04.02   |  |  |  |   |  |
|  | 2.0 DI 16V   |  |  | 11.96  | 04.02   |  |  |  |   |  |
|  | 2.0 DTI 16V  |  |  | 06.97  | 04.02   |  |  |  |   |  |
|  | 2.2 16V  |  |  | 09.00  | 04.02   |  |  |  |   |  |
|  | 2.2 DTI 16V  |  |  | 09.00  | 04.02   |  |  |  |   |  |
|  | 2.5 V6   |  |  | 09.95  | 09.00   |  |  |  |   |  |
| 2.6 V6   |  |  | 09.00  | 04.02  |   |  |  |  |   |  |
|  | 1.6  |  | W7152258   | 09.95  |   | 03.3219-6311.3   | 020057   | + GG <sup>1)</sup><br>+ ALU <sup>2)</sup>  | Rz 19,05 (GG)<br>Rz 19,05 (ALU)   | LUC                                    |
|  | 1.6  |  | W5276825   | 09.95  |   | 24.3219-1715.3   | 020122   |  |   |  |
|  | 1.6  |  | W1238518   | 09.95  |   |  |  |  |   |  |
|  | 2.0 DI 16V Limousine   |  | W7152258   | 11.96  |   |  |  |  |   |  |
|  | 2.0 DI 16V Limousine   |  | W5276825   | 11.96  |   |  |  |  |   |  |
|  | 2.0 DI 16V Limousine   |  | W1238518   | 11.96  |   |  |  |  |   |  |
|  | 1.6  | W7154259   | W7999999   |  |   | 24.3219-1715.3   | 020122   |  |   |  |
|  | 1.6  | W5276826   | W5999999   |  |   |  |  |  |   |  |
|  | 1.6  | W1238519   | W1999999   |  |   |  |  |  |   |  |
|  | 2.0 DI 16V Limousine   | W7154259   | W7999999   |  |   |  |  |  |   |  |
| 2.0 DI 16V Limousine   | W5276826   | W5999999   |  |  |   |  |  |  |   |  |
| 2.0 DI 16V Limousine   | W1238519   | W1999999   |  |  |   |  |  |  |   |  |
| 1.6  | X7000001   |  |  | 04.02  | 24.3220-1719.3  | 020448   |  |  |   |  |
| 1.6  | X5000001   |  |  | 04.02  |   |  |  |  |   |  |
| 1.6  | X1000001   |  |  | 04.02  |   |  |  |  |   |  |
| 2.0 DI 16V Limousine   | X7000001   |  |  | 04.02  |   |  |  |  |   |  |
| 2.0 DI 16V Limousine   | X5000001   |  |  | 04.02  |   |  |  |  |   |  |
| 2.0 DI 16V Limousine   | X1000001   |  |  | 04.02  |   |  |  |  |   |  |
|  | 1.6  |  |  | 09.95  | 04.02   | 24.3727-0748.2   | 580748   | 1 ↑<br>1 □<br>2 ↓ Verlängerung <sup>3)</sup>                                       | L=279, + Zub<br>L=1455/1455, + Zub<br>L=210, + Zub  |  |
|  | 1.6 16V  |  |  | 09.95  | 04.02   | 24.3727-0748.2   | 580748   |  |   |  |
|  | 1.7 TD   |  |  | 09.95  | 11.96   | 24.3727-0751.2   | 580751   |  |   |  |
|  | 1.8 i 16V  |  |  | 09.95  | 04.02   | 24.3727-0745.2   | 580745   |  |   |  |
|  | 2.0 16V  |  |  | 09.95  | 04.02   |  |  |  |   |  |
|  | 2.0 DI 16V Caravan   |  |  | 11.96  | 04.02   |  |  |  |   |  |
|  | 2.0 DTI 16V  |  |  | 06.97  | 04.02   |  |  |  |   |  |
|  | 2.2 16V  |  |  | 09.00  | 04.02   |  |  |  |   |  |
|  | 2.2 DTI 16V  |  |  | 09.00  | 04.02   |  |  |  |   |  |
|  | 2.5 V6   |  |  | 09.95  | 09.00   |  |  |  |   |  |
|  | 1.6  |  |  | 09.95  | 04.02   | 24.3727-0748.2   | 580748   | 1 ↑<br>1 □<br>2 ↓ Verlängerung <sup>3)</sup>                                       | L=279, + Zub<br>L=1455/1455, + Zub<br>L=128, + Zub  |  |
|  | 1.6 16V  |  |  | 09.95  | 04.02   | 24.3727-0748.2   | 580748   |  |   |  |
|  | 1.7 TD   |  |  | 09.95  | 11.96   | 24.3727-0751.2   | 580751   |  |   |  |
|  | 1.8 i 16V  |  |  | 09.95  | 04.02   | 24.3727-0754.2   | 580754   |  |   |  |
|  | 2.0 16V  |  |  | 09.95  | 04.02   |  |  |  |   |  |
|  | 2.0 DI 16V Caravan   |  |  | 11.96  | 04.02   |  |  |  |   |  |
|  | 2.0 DTI 16V  |  |  | 06.97  | 04.02   |  |  |  |   |  |
|  | 2.2 16V  |  |  | 09.00  | 04.02   |  |  |  |   |  |
|  | 2.2 DTI 16V  |  |  | 09.00  | 04.02   |  |  |  |   |  |
|  | 2.5 V6   |  |  | 09.95  | 09.00   |  |  |  |   |  |

<sup>1)</sup> + cast iron / + ghisa / + fonte grise / + fundición de gris

<sup>2)</sup> + aluminium / + alluminio / + aluminium / + aluminio

<sup>3)</sup> extension only / solo prolunga / rallonge seulement / solamente prolongador

| <b>OPEL VECTRA B / Vauxhall Vectra (96-02)</b> |  |          |          |          |                               |  |                |                |                |                                    |  |                |     |
|--|--|----------|----------|----------|-------------------------------|--|----------------|----------------|----------------|------------------------------------|--|----------------|-----|
|  | 2.6 V6   |          |          | 09.00    | 04.02                         |  |                | 24.3727-0748.2 | 580748         | 1                                  | L=279, + Zub                                 |                |     |
|  | 2.0 DI 16V Limousine                                     |          |          | 11.96    | 04.02                         |  |                | 24.3727-0751.2 | 580751         | 1<br>2  Verlängerung <sup>1)</sup> | L=1455/1455, + Zub<br>L=128, + Zub           |                |     |
|  | 1.6  |          | W1238518 | 09.95    |                               |  |                | 24.2415-1703.3 | 030102         | 1<br>2  Verlängerung <sup>1)</sup> | L=279, + Zub<br>L=1455/1455, + Zub<br>L=220  |                |     |
|  | 1.6 16V  |          | W1238518 | 09.95    |                               |  |                |                |                |                                    | Gz 15,87                                     |                |     |
|  | 1.7 TD   |          |          | 09.95    | 11.96                         |  |                |                |                |                                    |  |                |     |
|  | 1.8 i 16V  |          | W1238518 | 09.95    |                               |  |                |                |                |                                    |  |                |     |
|  | 2.0 16V  |          | W1238518 | 09.95    |                               |  |                |                |                |                                    |  |                |     |
|  | 2.0 DI 16V   |          | W1238518 | 11.96    |                               |  |                |                |                |                                    |  |                |     |
|  | 2.0 DTI 16V  |          | W1238518 | 06.97    |                               |  |                |                |                |                                    |  |                |     |
|  | 1.6  |          | W1238519 |          | 04.02                         |  |                | 24.2415-1708.3 | 030119         |                                    | Gz 15,87                                     |                |     |
|  | 1.6 16V  |          | W1238519 |          | 04.02                         |  |                |                |                |                                    |  |                |     |
|  | 1.8 i 16V  |          | W1238519 |          | 04.02                         |  |                |                |                |                                    |  |                |     |
|  | 2.0 16V  |          | W1238519 |          | 04.02                         |  |                |                |                |                                    |  |                |     |
|  | 2.0 DI 16V   |          | W1238519 |          | 04.02                         |  |                |                |                |                                    |  |                |     |
|  | 2.0 DTI 16V  |          | W1238519 |          | 04.02                         |  |                |                |                |                                    |  |                |     |
|  | 2.2 16V  |          |          | 09.00    | 04.02                         |  |                |                |                |                                    |  |                |     |
|  | 2.2 DTI 16V  |          |          | 09.00    | 04.02                         |  |                |                |                |                                    |  |                |     |
|  | 2.5 V6   |          | W1238519 |          | 09.00                         |  |                |                |                |                                    |  |                |     |
|  | 2.6 V6   |          |          | 09.00    | 04.02                         |  |                |                |                |                                    |  |                |     |
|  | <b>OPEL VECTRA C (F68,F69)/Vau. Vectra MK II (02-08)</b> |          |          |          |                               |  |                |                |                |                                    |  |                |     |
|  |  | 1.6      | 74       |          | 08.05                         | 10.08                                    | + ESP          |                | 24.2125-1732.3 | 010827                             |  | Thz 25,40      | LUC |
|  |  | 1.6      | 77       |          | 01.06                         | 10.08                                    | + ESP          |                |                |                                    |  |                |     |
|  |  | 1.6 16V  |          |          | 04.02                         | 10.08                                    | + ESP          |                |                |                                    |  |                |     |
|  |  | 1.8      | 81       |          | 04.02                         | 10.08                                    | + ESP          |                |                |                                    |  |                |     |
|  |  | 1.8      | 103      |          | 01.06                         | 10.08                                    | + ESP          |                |                |                                    |  |                |     |
|  |  | 1.8 16V  | 90       |          | 04.02                         | 10.08                                    | + ESP          |                |                |                                    |  |                |     |
|  |  | 1.9 CDTI | 74       |          | 10.05                         | 10.08                                    | + ESP          |                |                |                                    |  |                |     |
| 1.9 CDTI                                       |  | 88       |          | 04.04    | 10.08                         | + ESP                                    |                |                |                |                                    |  |                |     |
| 1.9 CDTI                                       |  | 110      |          | 04.04    | 10.08                         | + ESP                                    |                |                |                |                                    |  |                |     |
| 2.0 DTI 16V                                    |  |          |          | 04.02    | 10.08                         | + ESP                                    |                |                |                |                                    |  |                |     |
| 2.0 Turbo                                      |  |          |          | 03.03    | 10.08                         | + ESP                                    |                |                |                |                                    |  |                |     |
| 2.2 16V  |  | 108      |          | 04.02    | 10.08                         | + ESP                                    |                |                |                |                                    |  |                |     |
| 2.2 direct                                     |  | 114      |          | 10.03    | 10.08                         | + ESP                                    |                |                |                |                                    |  |                |     |
|  | 2.2 DTI 16V  |          |          | 04.02    | 10.08                         | + ESP                                    |                |                |                |                                    |  |                |     |
|  | 3.0 CDTI   |          |          | 05.03    | 10.08                         | + ESP                                    |                |                |                |                                    |  |                |     |
|  | 3.0 V6 CDTI  | 135      |          | 08.05    | 10.08                         | + ESP                                    |                |                |                |                                    |  |                |     |
|  | 3.2 V6   |          |          | 04.02    | 10.08                         | + ESP                                    |                |                |                |                                    |  |                |     |
|  | 1.6  | 74       |          | 08.05    | 10.08                         |  |                | 11.9571-9781.2 | 220659         | 2                                  | GG / nur paarweise austauschen <sup>2)</sup> | D=57, - Halter | ATE |
|  | 1.6  | 77       |          | 01.06    | 10.08                         |  |                | 11.9571-9782.2 | 220660         | 2                                  | GG / nur paarweise austauschen <sup>2)</sup> | D=57, - Halter | ATE |
|  | 1.6 16V  |          |          | 04.02    | 10.08                         |  |                | 11.0101-5407.2 | 260011         |                                    |  | Hülsensatz     | ATE |
|  | 1.8  | 81       |          | 04.02    | 10.08                         | - Sportfahrwerk <sup>5)</sup>            |                | 11.8171-0008.1 | 990049         |                                    |  | Führungsbolzen | ATE |
|  | 1.8  | 103      |          | 01.06    | 10.08                         | + Sportfahrwerk/ - Polizei <sup>6)</sup> |                | 11.8116-0295.2 | 390524         | 2                                  | + ALU-Sättel <sup>3)</sup>                   | Haltefeder     | ATE |
|  | 1.8 16V  | 90       |          | 04.02    | 10.08                         | - Sportfahrwerk <sup>5)</sup>            |                | 11.8116-0356.1 | 390586         | 2                                  | + GG-Sättel <sup>4)</sup>                    | Haltefeder     | ATE |
|  | 1.9 CDTI   | 74       | 61000001 |          | 10.08                         | - Polizei <sup>7)</sup>                  |                |                |                |                                    |  |                |     |
|  | 1.9 CDTI   | 88       |          | 04.04    | 10.08                         |  |                |                |                |                                    |  |                |     |
|  | 1.9 CDTI   | 110      |          | 04.04    | 10.08                         |  |                |                |                |                                    |  |                |     |
|  | 2.0 DTI 16V  |          |          | 04.02    | 10.08                         |  |                |                |                |                                    |  |                |     |
|  | 2.2 16V  | 108      |          | 04.02    | 10.08                         | - Sportfahrwerk <sup>5)</sup>            |                |                |                |                                    |  |                |     |
|  | 2.2 direct   | 114      |          | 10.03    | 10.08                         | - Sportfahrwerk <sup>5)</sup>            |                |                |                |                                    |  |                |     |
| 2.2 DTI 16V                                    |  |          | 04.02    | 10.08    | - Sportfahrwerk <sup>5)</sup> |  |                |                |                |                                    |  |                |     |
|  | 1.8  | 81       |          | 04.02    | 10.08                         | + Sportfahrwerk <sup>8)</sup>            |                | 11.0101-5407.2 | 260011         |                                    |  | Hülsensatz     | ATE |
|  | 1.8 16V  | 90       |          | 04.02    | 10.08                         | + Sportfahrwerk <sup>8)</sup>            |                | 11.8171-0008.1 | 990049         |                                    |  | Führungsbolzen | ATE |
|  | 2.0 Turbo  |          |          | 03.03    | 10.08                         |  |                | 11.8116-0325.2 | 390461         | 2                                  |  | Haltefeder     | ATE |
|  | 2.2 16V  | 108      |          | 04.02    | 10.08                         | + Sportfahrwerk <sup>8)</sup>            |                |                |                |                                    |  |                |     |
|  | 2.2 direct   | 114      |          | 10.03    | 10.08                         | + Sportfahrwerk <sup>8)</sup>            |                |                |                |                                    |  |                |     |
|  | 2.2 DTI 16V  |          |          | 04.02    | 10.08                         | + Sportfahrwerk <sup>8)</sup>            |                |                |                |                                    |  |                |     |
|  | 3.0 CDTI   |          |          | 31070293 | 05.03                         |  |                |                |                |                                    |  |                |     |
|  | 3.2 V6   |          |          | 31070293 | 04.02                         |  |                |                |                |                                    |  |                |     |
|  | 1.8  | 103      |          | 01.06    | 10.08                         | + Sportfahrwerk/ + Polizei <sup>9)</sup> |                | 11.9571-9779.2 | 220657         |                                    |  | D=57, - Halter | ATE |
|  | 1.9 CDTI   | 74       | 61000001 |          | 10.08                         | + Polizei <sup>10)</sup>                 |                | 11.9571-9780.2 | 220658         |                                    |  | D=57, - Halter | ATE |
|  |  |          |          |          |                               |  |                | 11.0101-5407.2 | 260011         |                                    |  | Hülsensatz     | ATE |
|  |  |          |          |          |                               |  |                | 11.8171-0008.1 | 990049         |                                    |  | Führungsbolzen | ATE |
|  |  |          |          |          |                               |  | 11.8116-0356.1 | 390586         | 2              |                                    | Haltefeder                                   | ATE            |     |
|  | 2.8 V6 Turbo   | 169      | 61000001 |          | 10.08                         | - OPC / -VXR                             |                | 11.9606-9971.2 | 220589         |                                    |  | D=60, - Halter | ATE |
|  | 2.8 V6 Turbo   | 184      | 61000001 |          | 10.08                         | - OPC / -VXR                             |                | 11.9606-9972.2 | 220590         |                                    |  | D=60, - Halter | ATE |
|  | 3.0 CDTI   |          | 31070294 |          | 10.08                         |  |                | 11.0441-6008.2 | 250038         |                                    |  | Dichtungssatz  | ATE |
|  | 3.0 V6 CDTI  | 135      | 61000001 |          | 10.08                         |  |                | 11.0101-5407.2 | 260011         |                                    |  | Hülsensatz     | ATE |
|  | 3.2 V6   |          | 31070294 |          | 10.08                         |  |                | 11.8171-0008.1 | 990049         |                                    |  | Führungsbolzen | ATE |
|  |  |          |          |          |                               |  |                | 11.8116-0345.2 | 390596         | 2                                  |  | Haltefeder     | ATE |
|  | 2.8 V6 Turbo   | 169      | 61000001 |          | 10.08                         | + OPC / +VXR                             |                | 11.9606-9971.2 | 220589         |                                    |  | D=60, - Halter | ATE |
|  | 2.8 V6 Turbo   | 184      | 61000001 |          | 10.08                         | + OPC / +VXR                             |                | 11.9606-9972.2 | 220590         |                                    |  | D=60, - Halter | ATE |
|  |  |          |          |          |                               |  |                | 11.0101-5407.2 | 260011         |                                    |  | Hülsensatz     | ATE |
|  |  |          |          |          |                               |  |                | 11.8171-0008.1 | 990049         |                                    |  | Führungsbolzen | ATE |
|  |  |          |          |          |                               |  |                | 11.8116-0410.2 | 390589         | 2                                  |  | Haltefeder     | ATE |
|  | 1.6  | 74       |          | 08.05    | 10.08                         |  |                | 83.7807-0412.3 | 331098         | 2                                  |  | L=412          |     |
|  | 1.6  | 77       |          | 01.06    | 10.08                         |  |                |                |                |                                    |  |                |     |
|  | 1.6 16V  |          |          | 04.02    | 10.08                         |  |                |                |                |                                    |  |                |     |
|  | 1.8  | 81       |          | 04.02    | 10.08                         |  |                |                |                |                                    |  |                |     |

<sup>1)</sup> extension only / solo prolonga / rallonge seulement / solamente prolongador

<sup>2)</sup> GG/ replace only in pairs / GG/ sostituire solo a coppie / GG/ ne remplacer que par paires / GG/ reemplazar sólo por pares

<sup>3)</sup> + aluminium calipers / + pinze in alluminio / + étriers en aluminium / + pinzas de aluminio

<sup>4)</sup> + cast iron caliper / + pinza in ghisa / + étriers en fonte grise / + fundición gris-pinza

<sup>5)</sup> - sports suspension / - sospensione sportiva / - châssis de sport / - suspensión deportiva



















<sup>6)</sup> + sports suspension/ - Police / + sospensione sportiva/ - Polizia / + châssis de sport/ - Police / + suspensión deportiva/ - Police

<sup>7)</sup> - Police / - Polizia / - voiture de police / - Police

<sup>8)</sup> + sports suspension / + sospensione sportiva / + châssis de sport / + suspensión deportiva

<sup>9)</sup> + sports suspension/ + Police / + sospensione sportiva/ + Polizia / + châssis de sport/ + Police / + suspensión deportiva/ + Police









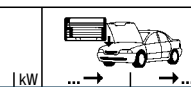
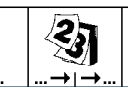

<sup>10)</sup> + Police / + Polizia / + voiture de police / + Police

| OPEL VECTRA C (F68,F69)/Vau. Vectra MK II (02-08)                                  |  |  |  |  |   |  |  |   |                |     |
|--|--|--|--|--|---|--|--|---|----------------|-----|
|     |  |  |  |  |  |  |  |       |                |     |
|    | 1.8  | 103  |  | 01.06  | 10.08   | 83.7807-0412.3   | 331098   | 2   | L=412          |     |
|  | 1.8 16V  | 90   |  | 04.02  | 10.08   |  |  |   |                |     |
|  | 1.9 CDTI   | 74   |  | 10.05  | 10.08   |  |  |   |                |     |
|  | 1.9 CDTI   | 88   |  | 04.04  | 10.08   |  |  |   |                |     |
|  | 1.9 CDTI   | 110  |  | 04.04  | 10.08   |  |  |   |                |     |
|  | 2.0 DTI 16V  |  |  | 04.02  | 10.08   |  |  |   |                |     |
|  | 2.0 Turbo  |  |  | 03.03  | 10.08   |  |  |   |                |     |
|  | 2.2 16V  | 108  |  | 04.02  | 10.08   |  |  |   |                |     |
|  | 2.2 direct   | 114  |  | 10.03  | 10.08   |  |  |   |                |     |
|  | 2.2 DTI 16V  |  |  | 04.02  | 10.08   |  |  |   |                |     |
|  | 2.8 V6 Turbo   | 169  |  | 08.05  | 10.08   |  |  |   |                |     |
|  | 2.8 V6 Turbo   | 184  |  | 08.06  | 10.08   |  |  |   |                |     |
|  | 2.8 V6 Turbo OPC   | 188  |  | 08.05  | 10.08   |  |  |   |                |     |
|  | 3.0 CDTI   |  |  | 05.03  | 10.08   |  |  |   |                |     |
|  | 3.0 V6 CDTI  | 135  |  | 08.05  | 10.08   |  |  |   |                |     |
|  | 3.2 V6   |  |  | 04.02  | 10.08   |  |  |   |                |     |
|    | 1.6  | 74   |  | 08.05  | 10.08   | 11.9387-7003.2   | 220567   |      | D=38, - Halter | ATE |
|  | 1.6  | 77   |  | 01.06  | 10.08   | 11.9387-7004.2   | 220568   |      | D=38, - Halter | ATE |
|  | 1.6 16V  |  |  | 04.02  | 10.08   | 11.0101-5407.2   | 260011   |   | Hülensatz      | ATE |
|  | 1.8  | 81   |  | 04.02  | 10.08   | 11.8171-0008.1   | 990049   |   | Führungsbolzen | ATE |
|  | 1.8  | 103  |  | 01.06  | 10.08   | 11.8116-0340.1   | 390595   | 2   | Haltefeder     | ATE |
|  | 1.8 16V  | 90   |  | 04.02  | 10.08   |  |  |   |                |     |
|  | 1.9 CDTI   | 74   |  | 10.05  | 10.08   |  |  |   |                |     |
|  | 1.9 CDTI   | 88   |  | 04.04  | 10.08   |  |  |   |                |     |
|  | 1.9 CDTI   | 110  |  | 04.04  | 10.08   |  |  |   |                |     |
|  | 2.0 DTI 16V  |  |  | 04.02  | 10.08   |  |  |   |                |     |
|  | 2.0 Turbo  |  |  | 03.03  | 10.08   |  |  |   |                |     |
|  | 2.2 16V  | 108  |  | 04.02  | 10.08   |  |  |   |                |     |
|  | 2.2 direct   | 114  |  | 10.03  | 10.08   |  |  |   |                |     |
|  | 2.2 DTI 16V  |  |  | 04.02  | 10.08   |  |  |   |                |     |
|  | 2.8 V6 Turbo   | 169  |  | 08.05  | 10.08   |  |  |   |                |     |
|  | 2.8 V6 Turbo   | 184  |  | 08.06  | 10.08   |  |  |   |                |     |
|  | 3.0 CDTI   |  |  | 05.03  | 10.08   |  |  |   |                |     |
|  | 3.0 V6 CDTI  | 135  |  | 08.05  | 10.08   |  |  |   |                |     |
|  | 3.2 V6   |  |  | 04.02  | 10.08   |  |  |   |                |     |
|  | 1.6  | 74   |  | 08.05  | 10.08   | 11.9387-7005.2   | 220569   |      | D=38, - Halter | ATE |
|  | 1.6  | 77   |  | 01.06  | 10.08   | 11.9387-7006.2   | 220570   |      | D=38, - Halter | ATE |
|  | 1.6 16V  |  |  | 04.02  | 10.08   | 11.0101-5407.2   | 260011   |   | Hülensatz      | ATE |
|  | 1.8  | 81   |  | 04.02  | 10.08   | 11.8171-0008.1   | 990049   |   | Führungsbolzen | ATE |
|  | 1.8  | 103  |  | 01.06  | 10.08   | 11.8116-0340.1   | 390595   | 2   | Haltefeder     | ATE |
|  | 1.8 16V  | 90   |  | 04.02  | 10.08   |  |  |   |                |     |
|  | 1.9 CDTI   | 74   |  | 10.05  | 10.08   |  |  |   |                |     |
|  | 1.9 CDTI   | 88   |  | 04.04  | 10.08   |  |  |   |                |     |
|  | 1.9 CDTI   | 110  |  | 04.04  | 10.08   |  |  |   |                |     |
|  | 2.0 DTI 16V  |  |  | 04.02  | 10.08   |  |  |   |                |     |
|  | 2.0 Turbo  |  |  | 03.03  | 10.08   |  |  |   |                |     |
|  | 2.2 16V  | 108  |  | 04.02  | 10.08   |  |  |   |                |     |
|  | 2.2 direct   | 114  |  | 10.03  | 10.08   |  |  |   |                |     |
|  | 2.2 DTI 16V  |  |  | 04.02  | 10.08   |  |  |   |                |     |
|  | 2.8 V6 Turbo   | 169  |  | 08.05  | 10.08   |  |  |   |                |     |
|  | 2.8 V6 Turbo   | 184  |  | 08.06  | 10.08   |  |  |   |                |     |
|  | 3.0 CDTI   |  |  | 05.03  | 10.08   |  |  |   |                |     |
|  | 3.0 V6 CDTI  | 135  |  | 08.05  | 10.08   |  |  |   |                |     |
|  | 3.2 V6   |  |  | 04.02  | 10.08   |  |  |   |                |     |
|  | 2.8 V6 Turbo OPC   | 188  |  | 08.05  | 10.08   | 11.0101-5407.2   | 260011   |   | Hülensatz      | ATE |
|  |  |  |  |  |   | 11.8171-0008.1   | 990049   |   | Führungsbolzen | ATE |
|  |  |  |  |  |   | 11.8116-0340.1   | 390595   | 2   | Haltefeder     | ATE |
|  | 1.6  | 74   |  | 08.05  | 10.08   | 24.5259-0315.3   | 330882   | 2   | L=315          |     |
|  | 1.6  | 77   |  | 01.06  | 10.08   |  |  |   |                |     |
|  | 1.6 16V  |  |  | 04.02  | 10.08   |  |  |   |                |     |
|  | 1.8  | 81   |  | 04.02  | 10.08   |  |  |   |                |     |
|  | 1.8  | 103  |  | 01.06  | 10.08   |  |  |   |                |     |
|  | 1.8 16V  | 90   |  | 04.02  | 10.08   |  |  |   |                |     |
|  | 1.9 CDTI   | 74   |  | 10.05  | 10.08   |  |  |   |                |     |
|  | 1.9 CDTI   | 88   |  | 04.04  | 10.08   |  |  |   |                |     |
|  | 1.9 CDTI   | 110  |  | 04.04  | 10.08   |  |  |   |                |     |
|  | 2.0 DTI 16V  |  |  | 04.02  | 10.08   |  |  |   |                |     |
|  | 2.0 Turbo  |  |  | 03.03  | 10.08   |  |  |   |                |     |
|  | 2.2 16V  | 108  |  | 04.02  | 10.08   |  |  |   |                |     |
|  | 2.2 direct   | 114  |  | 10.03  | 10.08   |  |  |   |                |     |
|  | 2.2 DTI 16V  |  |  | 04.02  | 10.08   |  |  |   |                |     |
|  | 2.8 V6 Turbo   | 169  |  | 08.05  | 10.08   |  |  |   |                |     |
|  | 2.8 V6 Turbo   | 184  |  | 08.06  | 10.08   |  |  |   |                |     |
|  | 2.8 V6 Turbo OPC   | 188  |  | 08.05  | 10.08   |  |  |   |                |     |
|  | 3.0 CDTI   |  |  | 05.03  | 10.08   |  |  |   |                |     |
|  | 3.0 V6 CDTI  | 135  |  | 08.05  | 10.08   |  |  |   |                |     |
|  | 3.2 V6   |  |  | 04.02  | 10.08   |  |  |   |                |     |
|  | 1.6  | 74   |  | 08.05  | 10.08   | 24.3727-0758.2   | 580758   | 1  | L=1630/1573    |     |
|  | 1.6  | 77   |  | 01.06  | 10.08   |  |  |   |                |     |
|  | 1.6 16V  |  |  | 04.02  | 10.08   |  |  |   |                |     |
|  | 1.8  | 81   |  | 04.02  | 10.08   |  |  |   |                |     |
|  | 1.8  | 103  |  | 01.06  | 10.08   |  |  |   |                |     |
|  | 1.8 16V  | 90   |  | 04.02  | 10.08   |  |  |   |                |     |
|  | 2.0 Turbo  |  |  | 03.03  | 10.08   |  |  |   |                |     |
|  | 2.2 16V  | 108  |  | 04.02  | 10.08   |  |  |   |                |     |
|  | 2.2 direct   | 114  |  | 10.03  | 10.08   |  |  |   |                |     |
|  | 2.8 V6 Turbo   | 169  |  | 08.05  | 10.08   |  |  |   |                |     |
|  |  |  |  | 08.05  | 10.08   |  |  |   |                |     |

1) - ventilated discs / - dischi ventilati / - disques ventilés / - disco ventilado

2) + ventilated discs / + dischi ventilati / + disques ventilés / + disco ventilado

3) - rough road construction / - versione per percorsi accidentati / - version pour mauvaise route / - versión 4x4

|     |   |    |   |    |                         |  |  |   |
|--|---|--|---|--|--|--|--|---|
| <b>OPEL VECTRA C (F68,F69)/Vau. Vectra MK II (02-08)</b>                           |   |  |   |  |  |  |  |   |
|    | 2.8 V6 Turbo<br>2.8 V6 Turbo OPC<br>3.2 V6  | 184<br>188   | 08.06<br>08.05<br>04.02   | 10.08 - Schlechtwegeausführung 1)<br>10.08 - Schlechtwegeausführung 1)<br>10.08 - Schlechtwegeausführung 1)  | 24.3727-0758.2   | 580758   | 1 ↓  | L=1630/1573   |
| <b>OPEL VECTRA C Caravan (F35) / Vau. MK II (03-08)</b>                            |   |  |   |  |  |  |  |   |
|    | 1.6<br>1.6 16V<br>1.8<br>1.8<br>1.8 16V<br>1.9 CDTI<br>1.9 CDTI<br>1.9 CDTI<br>2.0 DTI 16V<br>2.0 Turbo<br>2.2 16V<br>2.2 direct<br>2.2 DTI 16V<br>3.0 V6 CDTI<br>3.0 V6 CDTI<br>3.2 V6   | 77<br>74<br>81<br>103<br>90<br>74<br>88<br>110<br>74<br>129<br>108<br>114<br>92<br>130<br>135<br>155                             | 06.06<br>10.03<br>04.02<br>01.06<br>10.03<br>10.05<br>04.04<br>04.04<br>10.03<br>10.03<br>10.03<br>10.03<br>10.03<br>10.03<br>08.05<br>10.03                            | 10.08 + ESP<br>10.08 + ESP<br>10.08 + ESP<br>10.08 + ESP<br>10.08 + ESP<br>10.08 + ESP<br>10.08 + ESP<br>10.08 + ESP<br>10.08 + ESP<br>10.08 + ESP<br>10.08 + ESP<br>10.08 + ESP<br>10.08 + ESP<br>10.08 + ESP<br>10.08 + ESP<br>10.08 + ESP   | 24.2125-1732.3   | 010827   |  | Thz 25,40 <b>LUC</b>  |
|    | 1.6<br>1.6 16V<br>1.8<br>1.8<br>1.8 16V<br>1.9 CDTI<br>1.9 CDTI<br>1.9 CDTI<br>2.0 DTI 16V<br>2.2 16V<br>2.2 direct<br>2.2 DTI 16V  | 77<br>74<br>81<br>103<br>90<br>74 6100001<br>88<br>110<br>74<br>108<br>114<br>92   | 06.06<br>10.03<br>04.04<br>01.06<br>10.03<br>10.08<br>04.04<br>04.04<br>10.03<br>10.03<br>10.03<br>10.03  | 10.08<br>10.08<br>10.08 - Sportfahrwerk 5)<br>10.08 - Sportfahrwerk/ - Polizei 6)<br>10.08 - Sportfahrwerk 5)<br>10.08 - Sportfahrwerk/ - Polizei 7)<br>10.08 - Sportfahrwerk/ - Polizei 7)  | 11.9571-9781.2<br>11.9571-9782.2<br>11.0101-5407.2<br>11.8171-0008.1<br>11.8116-0295.2<br>11.8116-0356.1 | 220659<br>220660<br>260011<br>990049<br>390524<br>390586                           | 2  | GG / nur paarweise austauschen 2)<br>GG / nur paarweise austauschen 2)<br>D=57, - Halter<br>D=57, - Halter<br>Hülsensatz<br>Führungsbolzen<br>Haltefeder<br>Haltefeder<br>+ ALU-Sättel 3)<br>+ GG-Sättel 4) |
|  | 1.8<br>1.8 16V<br>2.0 Turbo<br>2.2 16V<br>2.2 direct<br>2.2 DTI 16V   | 81<br>90<br>129<br>108<br>114<br>92  | 51066206<br>10.03<br>10.03<br>10.03<br>10.03<br>10.03   | 10.08 + Sportfahrwerk 8)<br>10.08 + Sportfahrwerk 8)<br>10.08 + Sportfahrwerk 8)<br>10.08 + Sportfahrwerk 8)<br>10.08 + Sportfahrwerk 8)   | 11.0101-5407.2<br>11.8171-0008.1<br>11.8116-0325.2   | 260011<br>990049<br>390461   | 2  | Hülsensatz<br>Führungsbolzen<br>Haltefeder<br><b>ATE</b><br><b>ATE</b><br><b>ATE</b>  |
|  | 1.8<br>1.8<br>1.9 CDTI<br>1.9 CDTI  | 81<br>103<br>74<br>88  | 51066207<br>01.06<br>10.05<br>04.04   | 10.08 + Sportfahrwerk 8)<br>10.08 + Sportfahrwerk/ + Polizei 9)<br>10.08 + Sportfahrwerk/ + Polizei 9)<br>10.08 + Sportfahrwerk/ + Polizei 9)  | 11.9571-9779.2<br>11.9571-9780.2<br>11.0101-5407.2<br>11.8171-0008.1                                     | 220657<br>220658<br>260011<br>990049   | 2  | D=57, - Halter<br>D=57, - Halter<br>Hülsensatz<br>Führungsbolzen<br>Haltefeder<br><b>ATE</b><br><b>ATE</b><br><b>ATE</b><br><b>ATE</b>  |
|  | 2.8 V6 Turbo<br>2.8 V6 Turbo<br>3.0 V6 CDTI<br>3.0 V6 CDTI<br>3.2 V6  | 169 6100001<br>184<br>130 31070294<br>135<br>155 31070294  | 11.06<br>10.08<br>08.05<br>10.08  | 10.08<br>10.08<br>10.08<br>10.08   | 11.9606-9971.2<br>11.9606-9972.2<br>11.0441-6008.2<br>11.0101-5407.2<br>11.8171-0008.1<br>11.8116-0345.2 | 220589<br>220590<br>250038<br>260011<br>990049<br>390596                           | 2  | D=60, - Halter<br>D=60, - Halter<br>Dichtungssatz<br>Hülsensatz<br>Führungsbolzen<br>Haltefeder<br><b>ATE</b><br><b>ATE</b><br><b>ATE</b><br><b>ATE</b>   |
|  | 2.8 V6 Turbo OPC<br>2.8 V6 Turbo OPC  | 188 6100001<br>206   | 06.06<br>10.08  | 10.08<br>10.08   | 11.0101-5407.2<br>11.8171-0008.1<br>11.8116-0410.2   | 260011<br>990049<br>390589   | 2  | Hülsensatz<br>Führungsbolzen<br>Haltefeder<br><b>ATE</b><br><b>ATE</b>  |
|  | 1.6<br>1.6 16V<br>1.8<br>1.8<br>1.8 16V<br>1.9 CDTI<br>1.9 CDTI<br>1.9 CDTI<br>2.0 DTI 16V<br>2.0 Turbo<br>2.2 16V<br>2.2 direct<br>2.2 DTI 16V<br>2.8 V6 Turbo<br>2.8 V6 Turbo<br>2.8 V6 Turbo OPC<br>2.8 V6 Turbo OPC<br>3.0 V6 CDTI<br>3.0 V6 CDTI<br>3.2 V6 | 77<br>74<br>81<br>103<br>90<br>74<br>88<br>110<br>74<br>129<br>108<br>114<br>92<br>169<br>184<br>188<br>206<br>130<br>135<br>155 | 06.06<br>10.03<br>04.02<br>01.06<br>10.03<br>10.05<br>04.04<br>04.04<br>10.03<br>10.03<br>10.03<br>10.03<br>08.05<br>11.06<br>08.05<br>06.06<br>10.03<br>08.05<br>10.03 | 10.08<br>10.08<br>10.08<br>10.08<br>10.08<br>10.08<br>10.08<br>10.08<br>10.08<br>10.08<br>10.08<br>10.08<br>10.08<br>10.08<br>10.08<br>10.08<br>10.08<br>10.08<br>10.08<br>10.08   | 83.7807-0412.3   | 331098   | 2  | L=412   |
|  | 1.6<br>1.6 16V<br>1.8<br>1.8<br>1.8 16V<br>1.9 CDTI<br>1.9 CDTI<br>1.9 CDTI<br>2.0 DTI 16V<br>2.0 Turbo<br>2.2 16V<br>2.2 direct  | 77<br>74<br>81<br>103<br>90<br>74<br>88<br>110<br>74<br>129<br>108<br>114  | 06.06<br>10.03<br>04.02<br>01.06<br>10.03<br>10.05<br>04.04<br>04.04<br>10.03<br>10.03<br>10.03<br>10.03  | 10.08 - belüftete Scheiben 10)<br>10.08 - belüftete Scheiben 10)<br>10.08 - belüftete Scheiben 10)<br>10.08 - belüftete Scheiben 10)<br>10.08 - belüftete Scheiben 10)<br>10.08 - belüftete Scheiben 10)<br>10.08 - belüftete Scheiben 10)<br>10.08 - belüftete Scheiben 10)<br>10.08 - belüftete Scheiben 10)<br>10.08 - belüftete Scheiben 10)<br>10.08 - belüftete Scheiben 10)<br>10.08 - belüftete Scheiben 10) | 11.9407-7001.2<br>11.9407-7002.2<br>11.0101-5407.2<br>11.8171-0008.1<br>11.8116-0340.1                   | 220573<br>220574<br>260011<br>990049<br>390595                                     | 2  | D=40, - Halter<br>D=40, - Halter<br>Hülsensatz<br>Führungsbolzen<br>Haltefeder<br><b>ATE</b><br><b>ATE</b><br><b>ATE</b><br><b>ATE</b>  |

1) - rough road construction / - versione per percorsi accidentati / - version pour mauvaise route / - versión 4x4  
2) GG/ replace only in pairs / GG/ sostituire solo a coppie / GG/ ne remplacer que par paires / GG/ reemplazar sólo por pares  
3) + aluminium calipers / + pinze in alluminio / + étriers en aluminium / + pinzas de aluminio  
4) + cast iron caliper / + pinza in ghisa / + étriers en fonte grise / + fundición gris-pinza  
5) - sports suspension / - sospensione sportiva / - châssis de sport / - suspensión deportiva  
6) + sports suspension/ - Police / + sospensione sportiva/ - Polizia / + châssis de sport/ - Police / + suspensión deportiva/ - Police  
7) - sports suspens./ - Police / - sospensione sportiva/ - Polizia / - châssis de sport/ - Police / - suspens.deportiva/ - Police  
8) + sports suspension / + sospensione sportiva / + châssis de sport / + suspensión deportiva  
9) + sports suspension/ + Police / + sospensione sportiva/ + Polizia / + châssis de sport/ + Police / + suspensión deportiva/ + Police  
10) - ventilated discs / - dischi ventilati / - disques ventilés / - disco ventilado



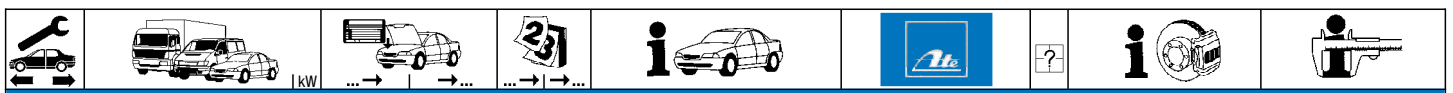

**OPEL VECTRA C Caravan (F35) / Vau. MK II (03-08)**

|                  |              |          |       |       |                                    |  |                |        |  |  |                                 |
|------------------|--------------|----------|-------|-------|------------------------------------|--|----------------|--------|--|--|---------------------------------|
|                  | 2.2 DTI 16V  | 92       |       | 10.03 | 10.08                              | - belüftete Scheiben <sup>1)</sup>     | 11.9407-7001.2 | 220573 | 2  | D=40, - Halter<br>D=40, - Halter<br>Hülzensatz<br>Führungsbolzen<br>Haltefeder | ATE<br>ATE<br>ATE<br>ATE<br>ATE |
|                  | 3.0 V6 CDTI  | 130      |       | 10.03 | 10.08                              | - belüftete Scheiben <sup>1)</sup>     | 11.9407-7002.2 | 220574 |  |  |                                 |
|                  | 3.0 V6 CDTI  | 135      |       | 08.05 | 10.08                              | - belüftete Scheiben <sup>1)</sup>     | 11.0101-5407.2 | 260011 |  |  |                                 |
|                  | 3.2 V6       | 155      |       | 10.03 | 10.08                              | - belüftete Scheiben <sup>1)</sup>     | 11.8171-0008.1 | 990049 |  |  |                                 |
|                  |              |          |       |       |                                    |  | 11.8116-0340.1 | 390595 |  |  |                                 |
|                  | 1.6          | 77       |       | 06.06 | 10.08                              | + belüftete Scheiben <sup>2)</sup>     | 11.9407-7003.2 | 220835 |  |  |                                 |
|                  | 1.6 16V      | 74       |       | 10.03 | 10.08                              | + belüftete Scheiben <sup>2)</sup>     | 11.9407-7004.2 | 220836 |  |  |                                 |
|                  | 1.8          | 81       |       | 04.02 | 10.08                              | + belüftete Scheiben <sup>2)</sup>     | 11.0101-5407.2 | 260011 |  |  |                                 |
|                  | 1.8          | 103      |       | 01.06 | 10.08                              | + belüftete Scheiben <sup>2)</sup>     | 11.8171-0008.1 | 990049 |  |  |                                 |
|                  | 1.8 16V      | 90       |       | 10.03 | 10.08                              | + belüftete Scheiben <sup>2)</sup>     | 11.8116-0340.1 | 390595 |  |  |                                 |
|                  | 1.9 CDTI     | 74       |       | 10.03 | 10.08                              | + belüftete Scheiben <sup>2)</sup>     |                |        |  |  |                                 |
|                  | 1.9 CDTI     | 88       |       | 04.04 | 10.08                              | + belüftete Scheiben <sup>2)</sup>     |                |        |  |  |                                 |
| 1.9 CDTI         | 110          |          | 04.04 | 10.08 | + belüftete Scheiben <sup>2)</sup> |  |                |        |  |  |                                 |
| 2.0 DTI 16V      | 74           |          | 10.03 | 10.08 | + belüftete Scheiben <sup>2)</sup> |  |                |        |  |  |                                 |
| 2.0 Turbo        | 129          |          | 10.03 | 10.08 | + belüftete Scheiben <sup>2)</sup> |  |                |        |  |  |                                 |
| 2.2 16V          | 108          |          | 10.03 | 10.08 | + belüftete Scheiben <sup>2)</sup> |  |                |        |  |  |                                 |
| 2.2 direct       | 114          |          | 10.03 | 10.08 | + belüftete Scheiben <sup>2)</sup> |  |                |        |  |  |                                 |
| 2.2 DTI 16V      | 92           |          | 10.03 | 10.08 | + belüftete Scheiben <sup>2)</sup> |  |                |        |  |  |                                 |
| 3.0 V6 CDTI      | 130          |          | 10.03 | 10.08 | + belüftete Scheiben <sup>2)</sup> |  |                |        |  |  |                                 |
| 3.0 V6 CDTI      | 135          |          | 08.05 | 10.08 | + belüftete Scheiben <sup>2)</sup> |  |                |        |  |  |                                 |
| 3.2 V6           | 155          |          | 10.03 | 10.08 | + belüftete Scheiben <sup>2)</sup> |  |                |        |  |  |                                 |
| 2.8 V6 Turbo     | 169          | 41085480 |       | 10.08 |                                    | 11.9407-7007.2                         | 220867         | 2      | D=40, - Halter<br>D=40, - Halter<br>Hülzensatz<br>Führungsbolzen<br>Haltefeder | ATE<br>ATE<br>ATE<br>ATE   |                                 |
| 2.8 V6 Turbo     | 184          |          | 11.06 | 10.08 |                                    | 11.9407-7008.2                         | 220868         |        |  |  |                                 |
|                  |              |          |       |       |                                    | 11.0101-5407.2                         | 260011         |        |  |  |                                 |
|                  |              |          |       |       |                                    | 11.8171-0008.1                         | 990049         |        |  |  |                                 |
|                  |              |          |       |       |                                    | 11.8116-0340.1                         | 390595         |        |  |  |                                 |
| 2.8 V6 Turbo OPC | 188          | 41085480 |       | 10.08 |                                    | 11.0101-5407.2                         | 260011         |        | Hülzensatz<br>Führungsbolzen   | ATE<br>ATE   |                                 |
| 2.8 V6 Turbo OPC | 206          |          | 06.06 | 10.08 |                                    | 11.8171-0008.1                         | 990049         |        |  |  |                                 |
|                  | 1.6          | 77       |       | 06.06 | 10.08                              |  | 24.5259-0315.3 | 330882 | 2  | L=315  |                                 |
|                  | 1.6 16V      | 74       |       | 10.03 | 10.08                              |  |                |        |  |  |                                 |
|                  | 1.8          | 81       |       | 04.02 | 10.08                              |  |                |        |  |  |                                 |
|                  | 1.8          | 103      |       | 01.06 | 10.08                              |  |                |        |  |  |                                 |
|                  | 1.8 16V      | 90       |       | 10.03 | 10.08                              |  |                |        |  |  |                                 |
|                  | 1.9 CDTI     | 74       |       | 10.05 | 10.08                              |  |                |        |  |  |                                 |
|                  | 1.9 CDTI     | 88       |       | 04.04 | 10.08                              |  |                |        |  |  |                                 |
|                  | 1.9 CDTI     | 110      |       | 04.04 | 10.08                              |  |                |        |  |  |                                 |
|                  | 2.0 DTI 16V  | 74       |       | 10.03 | 10.08                              |  |                |        |  |  |                                 |
|                  | 2.0 Turbo    | 129      |       | 10.03 | 10.08                              |  |                |        |  |  |                                 |
|                  | 2.2 16V      | 108      |       | 10.03 | 10.08                              |  |                |        |  |  |                                 |
|                  | 2.2 direct   | 114      |       | 10.03 | 10.08                              |  |                |        |  |  |                                 |
|                  | 2.2 DTI 16V  | 92       |       | 10.03 | 10.08                              |  |                |        |  |  |                                 |
|                  | 2.8 V6 Turbo | 169      |       | 08.05 | 10.08                              |  |                |        |  |  |                                 |
|                  | 2.8 V6 Turbo | 184      |       | 11.06 | 10.08                              |  |                |        |  |  |                                 |
| 2.8 V6 Turbo OPC | 188          |          | 08.05 | 10.08 |                                    |  |                |        |  |  |                                 |
| 2.8 V6 Turbo OPC | 206          |          | 06.06 | 10.08 |                                    |  |                |        |  |  |                                 |
| 3.0 V6 CDTI      | 130          |          | 10.03 | 10.08 |                                    |  |                |        |  |  |                                 |
| 3.0 V6 CDTI      | 135          |          | 08.05 | 10.08 |                                    |  |                |        |  |  |                                 |
| 3.2 V6           | 155          |          | 10.03 | 10.08 |                                    |  |                |        |  |  |                                 |
|                  | 1.9 CDTI     | 88       |       | 04.04 | 10.08                              | - Schlechtwegeausführung <sup>3)</sup> | 24.3727-0788.2 | 580788 | 1  | L=1800/1800  |                                 |
|                  | 1.9 CDTI     | 110      |       | 04.04 | 10.08                              | - Schlechtwegeausführung <sup>3)</sup> |                |        |  |  |                                 |
|                  | 2.0 DTI 16V  | 74       |       | 10.03 | 10.08                              | - Schlechtwegeausführung <sup>3)</sup> |                |        |  |  |                                 |
|                  | 2.2 DTI 16V  | 92       |       | 10.03 | 10.08                              | - Schlechtwegeausführung <sup>3)</sup> |                |        |  |  |                                 |
|                  | 3.0 V6 CDTI  | 130      |       | 10.03 | 10.08                              | - Schlechtwegeausführung <sup>3)</sup> |                |        |  |  |                                 |

**OPEL VIVARO (01-)**

|          |          |          |          |       |  |                |                |        |     |           |           |     |   |     |           |     |
|----------|----------|----------|----------|-------|--|----------------|----------------|--------|-----|-----------|-----------|-----|---|-----|-----------|-----|
|          | 1.9 CDTI | 60       | 6V699999 | 08.01 |  |                | 24.2125-1734.3 | 010878 | +   | ASR       | Thz 25,40 | LUC |   |     |           |     |
|          | 1.9 CDTI | 74       | 6V699999 | 08.01 |  |                |                |        |     |           |           |     |   |     |           |     |
|          | 1.9 Di   | 60       | 6V699999 | 08.06 |  |                |                |        |     |           |           |     |   |     |           |     |
|          | 2.0      | 86       | 6V699999 | 08.06 |  |                |                |        |     |           |           |     |   |     |           |     |
|          | 2.0 16V  | 88       | 6V699999 | 08.01 |  |                |                |        |     |           |           |     |   |     |           |     |
|          | 2.0 CDTI | 66       | 6V699999 | 08.06 |  |                |                |        |     |           |           |     |   |     |           |     |
|          | 2.0 CDTI | 84       | 6V699999 | 08.06 |  |                |                |        |     |           |           |     |   |     |           |     |
|          | 2.5 CDTI | 84       | 6V699999 | 08.06 |  |                |                |        |     |           |           |     |   |     |           |     |
|          | 2.5 CDTI | 99       | 6V699999 | 05.03 |  |                |                |        |     |           |           |     |   |     |           |     |
|          | 2.5 CDTI | 107      | 6V699999 | 08.06 |  |                |                |        |     |           |           |     |   |     |           |     |
|          | 2.5 DTi  | 99       | 6V699999 | 08.06 |  |                |                |        |     |           |           |     |   |     |           |     |
|          | 1.9 CDTI | 60       | 4V602167 | 08.01 |  |                | 24.2125-1730.3 | 010760 |     |           |           |     | - | ASR | Thz 25,40 | LUC |
|          | 1.9 CDTI | 74       | 4V602167 | 08.01 |  |                |                |        |     |           |           |     |   |     |           |     |
|          | 1.9 Di   | 60       | 4V602167 | 08.06 |  |                |                |        |     |           |           |     |   |     |           |     |
|          | 2.0      | 86       | 4V602167 | 08.06 |  |                |                |        |     |           |           |     |   |     |           |     |
|          | 2.0 16V  | 88       | 4V602167 | 08.01 |  |                |                |        |     |           |           |     |   |     |           |     |
|          | 2.0 CDTI | 66       | 4V602167 | 08.06 |  |                |                |        |     |           |           |     |   |     |           |     |
|          | 2.0 CDTI | 84       | 4V602167 | 08.06 |  |                |                |        |     |           |           |     |   |     |           |     |
|          | 2.5 CDTI | 84       | 4V602167 | 08.06 |  |                |                |        |     |           |           |     |   |     |           |     |
| 2.5 CDTI | 99       | 4V602167 | 05.03    |       |  |                |                |        |     |           |           |     |   |     |           |     |
| 2.5 CDTI | 107      | 4V602167 | 08.06    |       |  |                |                |        |     |           |           |     |   |     |           |     |
| 2.5 DTi  | 99       | 4V602167 | 08.06    |       |  |                |                |        |     |           |           |     |   |     |           |     |
| 1.9 CDTI | 60       | 4V602168 | 6V699999 |       |  | 24.2125-1731.3 | 010826         | -      | ASR | Thz 25,40 | LUC       |     |   |     |           |     |
| 1.9 CDTI | 74       | 4V602168 | 6V699999 |       |  |                |                |        |     |           |           |     |   |     |           |     |
| 1.9 Di   | 60       | 4V602168 | 6V699999 |       |  |                |                |        |     |           |           |     |   |     |           |     |
| 2.0      | 86       | 4V602168 | 6V699999 |       |  |                |                |        |     |           |           |     |   |     |           |     |
| 2.0 16V  | 88       | 4V602168 | 6V699999 |       |  |                |                |        |     |           |           |     |   |     |           |     |
| 2.0 CDTI | 66       | 4V602168 | 6V699999 |       |  |                |                |        |     |           |           |     |   |     |           |     |
| 2.0 CDTI | 84       | 4V602168 | 6V699999 |       |  |                |                |        |     |           |           |     |   |     |           |     |
| 2.5 CDTI | 84       | 4V602168 | 6V699999 |       |  |                |                |        |     |           |           |     |   |     |           |     |
| 2.5 CDTI | 99       | 4V602168 | 6V699999 |       |  |                |                |        |     |           |           |     |   |     |           |     |
| 2.5 CDTI | 107      | 4V602168 | 6V699999 |       |  |                |                |        |     |           |           |     |   |     |           |     |































<sup>1)</sup> - ventilated discs / - dischi ventilati / - disques ventilés / - disco ventilado

<sup>2)</sup> + ventilated discs / + dischi ventilati / + disques ventilés / + disco ventilado

<sup>3)</sup> - rough road construction / - versione per percorsi accidentati / - version pour mauvaise route / - versión 4x4





|  |          |  |  |  |  |  |  |  |       |  |     |
|--|----------|---|--|--|--|--|---|--|---|--|-----|
| OPEL VIVARO (01-)  |          |   |  |  |  |  |   |  |   |  |     |
|    | 2.5 DTI  | 99  | 4V602168   | 6V699999   |  |  | 24.2125-1731.3  | 010826   | - ASR   | THz 25,40  | LUC |
|  | 1.9 CDTI | 60  | 7V600001 / 7Y000001  |  |  |  | 24.2120-1748.3  | 010894   | + ABS   | THz 20,64  | LUC |
|  | 1.9 CDTI | 74  | 7V600001 / 7Y000001  |  |  |  | 24.2120-1753.3  | 010946   | + ASR   | THz 20,64  | LUC |
|  | 1.9 Di   | 60  | 7V600001 / 7Y000001  |  |  |  |   |  |   |  |     |
|  | 2.0      | 86  | 7V600001 / 7Y000001  |  |  |  |   |  |   |  |     |
|  | 2.0 16V  | 88  | 7V600001 / 7Y000001  |  |  |  |   |  |   |  |     |
|  | 2.0 CDTI | 66  | 7V600001 / 7Y000001  |  |  |  |   |  |   |  |     |
|  | 2.0 CDTI | 84  | 7V600001 / 7Y000001  |  |  |  |   |  |   |  |     |
|  | 2.5 CDTI | 84  | 7V600001 / 7Y000001  |  |  |  |   |  |   |  |     |
|  | 2.5 CDTI | 99  | 7V600001 / 7Y000001  |  |  |  |   |  |   |  |     |
|  | 2.5 CDTI | 107   | 7V600001 / 7Y000001  |  |  |  |   |  |   |  |     |
|  | 2.5 DTi  | 99  | 7V600001 / 7Y000001  |  |  |  |   |  |   |  |     |
|    | 1.9 CDTI | 60  |  |  | 08.01  |  | 24.3451-1713.7  | 220737   |      | D=40/45, - Halter  | LUC |
|  | 1.9 CDTI | 74  |  |  | 08.01  |  | 24.3451-1714.7  | 220738   |      | D=40/45, - Halter  | LUC |
|  | 1.9 Di   | 60  |  |  | 08.06  |  |   |  |   |  |     |
|  | 2.0      | 86  |  |  | 08.06  |  |   |  |   |  |     |
|  | 2.0 16V  | 88  |  |  | 08.01  |  |   |  |   |  |     |
|  | 2.0 CDTI | 66  |  |  | 08.06  |  |   |  |   |  |     |
|  | 2.0 CDTI | 84  |  |  | 08.06  |  |   |  |   |  |     |
|  | 2.5 CDTI | 84  |  |  | 08.06  |  |   |  |   |  |     |
|  | 2.5 CDTI | 99  |  |  | 05.03  |  |   |  |   |  |     |
|  | 2.5 CDTI | 107   |  |  | 08.06  |  |   |  |   |  |     |
|  | 2.5 DTi  | 99  |  |  | 08.06  |  |   |  |   |  |     |
|    | 1.9 CDTI | 60  |  |  | 08.01  |  | 24.5111-0386.3  | 330503   | 2   | L=385  |     |
|  | 1.9 CDTI | 74  |  |  | 08.01  |  |   |  |   |  |     |
|  | 1.9 Di   | 60  |  |  | 08.06  |  |   |  |   |  |     |
|  | 2.0      | 86  |  |  | 08.06  |  |   |  |   |  |     |
|  | 2.0 16V  | 88  |  |  | 08.01  |  |   |  |   |  |     |
|  | 2.0 CDTI | 66  |  |  | 08.06  |  |   |  |   |  |     |
|  | 2.0 CDTI | 84  |  |  | 08.06  |  |   |  |   |  |     |
|  | 2.5 CDTI | 84  |  |  | 08.06  |  |   |  |   |  |     |
|  | 2.5 CDTI | 99  |  |  | 05.03  |  |   |  |   |  |     |
|  | 2.5 CDTI | 107   |  |  | 08.06  |  |   |  |   |  |     |
|  | 2.5 DTi  | 99  |  |  | 08.06  |  |   |  |   |  |     |
|    | 1.9 CDTI | 60  | 2V607599   | 6V699999 / 6Y999999  |  |  | 24.3414-1707.5  | 240337   |      | D=41, - Halter   | LUC |
|  | 1.9 CDTI | 74  | 2V607599   | 6V699999 / 6Y999999  |  |  | 24.3414-1708.5  | 240338   |      | D=41, - Halter   | LUC |
|  | 1.9 Di   | 60  | 2V607599   | 6V699999 / 6Y999999  |  |  |   |  |   |  |     |
|  | 2.0      | 86  | 2V607599   | 6V699999 / 6Y999999  |  |  |   |  |   |  |     |
|  | 2.0 16V  | 88  | 2V607599   | 6V699999 / 6Y999999  |  |  |   |  |   |  |     |
|  | 2.0 CDTI | 66  | 2V607599   | 6V699999 / 6Y999999  |  |  |   |  |   |  |     |
|  | 2.0 CDTI | 84  | 2V607599   | 6V699999 / 6Y999999  |  |  |   |  |   |  |     |
|  | 2.5 CDTI | 84  | 2V607599   | 6V699999 / 6Y999999  |  |  |   |  |   |  |     |
|  | 2.5 CDTI | 99  | 2V607599   | 6V699999 / 6Y999999  |  |  |   |  |   |  |     |
|  | 2.5 CDTI | 107   | 2V607599   | 6V699999 / 6Y999999  |  |  |   |  |   |  |     |
|  | 2.5 DTi  | 99  | 2V607599   | 6V699999 / 6Y999999  |  |  |   |  |   |  |     |
|  | 1.9 CDTI | 60  | 7V600001 / 7Y000001  |  |  |  | 24.3414-1707.5  | 240337   |    | D=41, - Halter   | LUC |
|  | 1.9 CDTI | 74  | 7V600001 / 7Y000001  |  |  |  | 24.3414-1708.5  | 240338   |    | D=41, - Halter   | LUC |
|  | 1.9 Di   | 60  | 7V600001 / 7Y000001  |  |  |  |   |  |   |  |     |
|  | 2.0      | 86  | 7V600001 / 7Y000001  |  |  |  |   |  |   |  |     |
|  | 2.0 16V  | 88  | 7V600001 / 7Y000001  |  |  |  |   |  |   |  |     |
|  | 2.0 CDTI | 66  | 7V600001 / 7Y000001  |  |  |  |   |  |   |  |     |
|  | 2.0 CDTI | 84  | 7V600001 / 7Y000001  |  |  |  |   |  |   |  |     |
|  | 2.5 CDTI | 84  | 7V600001 / 7Y000001  |  |  |  |   |  |   |  |     |
|  | 2.5 CDTI | 99  | 7V600001 / 7Y000001  |  |  |  |   |  |   |  |     |
|  | 2.5 CDTI | 107   | 7V600001 / 7Y000001  |  |  |  |   |  |   |  |     |
|  | 2.5 DTi  | 99  | 7V600001 / 7Y000001  |  |  |  |   |  |   |  |     |
|  | 1.9 CDTI | 60  |  |  | 08.01  |  | 24.5229-0200.3  | 330572   | 2   | L=200  |     |
|  | 1.9 CDTI | 74  |  |  | 08.01  |  | 24.5111-0221.3  | 330818   | 2   | L=220  |     |
|  | 1.9 Di   | 60  |  |  | 08.06  |  |   |  |   |  |     |
|  | 2.0      | 86  |  |  | 08.06  |  |   |  |   |  |     |
|  | 2.0 16V  | 88  |  |  | 08.01  |  |   |  |   |  |     |
|  | 2.0 CDTI | 66  |  |  | 08.06  |  |   |  |   |  |     |
|  | 2.0 CDTI | 84  |  |  | 08.06  |  |   |  |   |  |     |
|  | 2.5 CDTI | 84  |  |  | 08.06  |  |   |  |   |  |     |
|  | 2.5 CDTI | 99  |  |  | 05.03  |  |   |  |   |  |     |
|  | 2.5 CDTI | 107   |  |  | 08.06  |  |   |  |   |  |     |
|  | 2.5 DTi  | 99  |  |  | 08.06  |  |   |  |   |  |     |
|  | 1.9 CDTI | 60  | 606709   | 08.01  | - Pritsche/Fahrgestell <sup>2)</sup>   |  | 24.3727-0765.2  | 580765   | 1  | L=508  |     |
|  | 1.9 CDTI | 74  | 606709   | 08.01  | - Pritsche/Fahrgestell <sup>2)</sup>   |  | 24.3727-0796.2  | 580796   | 1  | L=1245/498   |     |
|  | 1.9 Di   | 60  | 606709   | 08.06  | - Pritsche/Fahrgestell <sup>2)</sup>   |  | 24.3727-0797.2  | 580797   | 1  | L=1643/498   |     |
|  | 2.0      | 86  | 606709   | 08.06  | - Pritsche/Fahrgestell <sup>2)</sup>   |  | 24.3727-0763.2  | 580763   | 1  | L=1190   |     |
|  | 2.0 16V  | 88  | 606709   | 08.01  | - Pritsche/Fahrgestell <sup>2)</sup>   |  | 24.3727-0764.2  | 580764   | 1  | L=1585   |     |
|  | 2.0 CDTI | 66  | 606709   | 08.06  | - Pritsche/Fahrgestell <sup>2)</sup>   |  | 24.3727-1068.2  | 581068   | 1  | L=1503   |     |
|  | 2.0 CDTI | 84  | 606709   | 08.06  | - Pritsche/Fahrgestell <sup>2)</sup>   |  | 24.3727-1071.2  | 581071   | 1  | L=1603   |     |
|  | 2.5 CDTI | 84  | 606709   | 08.06  | - Pritsche/Fahrgestell <sup>2)</sup>   |  |   |  |   |  |     |
|  | 2.5 CDTI | 99  | 606709   | 05.03  | - Pritsche/Fahrgestell <sup>2)</sup>   |  |   |  |   |  |     |
|  | 2.5 CDTI | 107   | 606709   | 08.06  | - Pritsche/Fahrgestell <sup>2)</sup>   |  |   |  |   |  |     |
|  | 2.5 DTi  | 99  | 606709   | 08.06  | - Pritsche/Fahrgestell <sup>2)</sup>   |  |   |  |   |  |     |
|  | 1.9 CDTI | 60  | 606709   | 08.01  | + Pritsche/Fahrgestell <sup>5)</sup>   |  | 24.3727-0765.2  | 580765   | 1  | L=508  |     |
|  | 1.9 CDTI | 74  | 606709   | 08.01  | + Pritsche/Fahrgestell <sup>5)</sup>   |  | 24.3727-1068.2  | 581068   | 1  | L=1503   |     |
|  | 1.9 Di   | 60  | 606709   | 08.06  | + Pritsche/Fahrgestell <sup>5)</sup>   |  | 24.3727-1071.2  | 581071   | 1  | L=1603   |     |
|  | 2.0      | 86  | 606709   | 08.06  | + Pritsche/Fahrgestell <sup>5)</sup>   |  |   |  |   |  |     |
|  | 2.0 16V  | 88  | 606709   | 08.01  | + Pritsche/Fahrgestell <sup>5)</sup>   |  |   |  |   |  |     |
|  | 2.0 CDTI | 66  | 606709   | 08.06  | + Pritsche/Fahrgestell <sup>5)</sup>   |  |   |  |   |  |     |
|  | 2.0 CDTI | 84  | 606709   | 08.06  | + Pritsche/Fahrgestell <sup>5)</sup>   |  |   |  |   |  |     |
|  | 2.5 CDTI | 84  | 606709   | 08.06  | + Pritsche/Fahrgestell <sup>5)</sup>   |  |   |  |   |  |     |
|  | 2.5 CDTI | 99  | 606709   | 08.06  | + Pritsche/Fahrgestell <sup>5)</sup>   |  |   |  |   |  |     |

1) on the brake caliper / sulla pinza freno / sur l'étrier de frein / a la pinza de freno  
2) - Pickup/Chassis / - Autocarro a cassone/Telaio / - Camion plateau/Châssis / - Camión plataforma/Chasis  
3) + short wheel base / + passo lungo / + empattement court / + distancia corta entre ejes  
4) + long wheel base / + passo lungo / + empattement long / + distancia larga entre ejes  
5) + Pickup/Chassis / + Autocarro a cassone/Telaio / + Camion plateau/Châssis / + Camión plataforma/Chasis

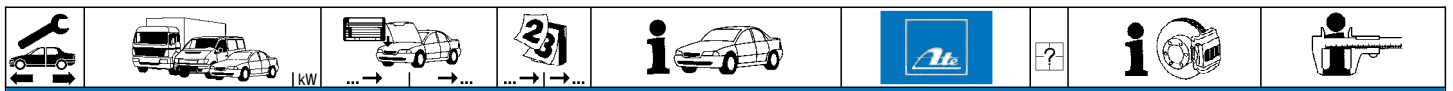

**OPEL VIVARO (01-)**

|          |          |        |        |                           |                           |                |        |  |  |  |
|----------|----------|--------|--------|---------------------------|---------------------------|----------------|--------|--|--|--|
|          | 2.5 CDTI | 99     | 606709 | 05.03                     | + Pritsche/Fahrgestell 1) | 24.3727-0765.2 | 580765 | 1  | <input type="checkbox"/> L=508<br><input type="checkbox"/> L=1503<br><input type="checkbox"/> L=1603 |  |
|          | 2.5 CDTI | 107    | 606709 | 08.06                     | + Pritsche/Fahrgestell 1) | 24.3727-1068.2 | 581068 |  |  |  |
|          | 2.5 DTi  | 99     | 606709 | 08.06                     | + Pritsche/Fahrgestell 1) | 24.3727-1071.2 | 581071 |  |  |  |
|          | 1.9 CDTI | 60     | 606710 |                           | - Pritsche/Fahrgestell 2) | 24.3727-1068.2 | 581068 |  |  | <input type="checkbox"/> L=1503<br><input type="checkbox"/> L=1603   |
|          | 1.9 CDTI | 74     | 606710 |                           | - Pritsche/Fahrgestell 2) | 24.3727-1071.2 | 581071 |  |  |  |
|          | 1.9 Di   | 60     | 606710 |                           | - Pritsche/Fahrgestell 2) |                |        |  |  |  |
|          | 2.0      | 86     | 606710 |                           | - Pritsche/Fahrgestell 2) |                |        |  |  |  |
|          | 2.0 16V  | 88     | 606710 |                           | - Pritsche/Fahrgestell 2) |                |        |  |  |  |
|          | 2.0 CDTI | 66     | 606710 |                           | - Pritsche/Fahrgestell 2) |                |        |  |  |  |
|          | 2.0 CDTI | 84     | 606710 |                           | - Pritsche/Fahrgestell 2) |                |        |  |  |  |
|          | 2.5 CDTI | 84     | 606710 |                           | - Pritsche/Fahrgestell 2) |                |        |  |  |  |
|          | 2.5 CDTI | 99     | 606710 |                           | - Pritsche/Fahrgestell 2) |                |        |  |  |  |
| 2.5 CDTI | 107      | 606710 |        | - Pritsche/Fahrgestell 2) |                           |                |        |  |  |  |
| 2.5 DTi  | 99       | 606710 |        | - Pritsche/Fahrgestell 2) |                           |                |        |  |  |  |
| 1.9 CDTI | 60       | 606710 |        | + Pritsche/Fahrgestell 1) | 24.3727-1068.2            | 581068         |        | <input type="checkbox"/> L=1503<br><input type="checkbox"/> L=1603 |  |  |
| 1.9 CDTI | 74       | 606710 |        | + Pritsche/Fahrgestell 1) | 24.3727-1071.2            | 581071         |        |  |  |  |
| 1.9 Di   | 60       | 606710 |        | + Pritsche/Fahrgestell 1) |                           |                |        |  |  |  |
| 2.0      | 86       | 606710 |        | + Pritsche/Fahrgestell 1) |                           |                |        |  |  |  |
| 2.0 16V  | 88       | 606710 |        | + Pritsche/Fahrgestell 1) |                           |                |        |  |  |  |
| 2.0 CDTI | 66       | 606710 |        | + Pritsche/Fahrgestell 1) |                           |                |        |  |  |  |
| 2.0 CDTI | 84       | 606710 |        | + Pritsche/Fahrgestell 1) |                           |                |        |  |  |  |
| 2.5 CDTI | 84       | 606710 |        | + Pritsche/Fahrgestell 1) |                           |                |        |  |  |  |
| 2.5 CDTI | 99       | 606710 |        | + Pritsche/Fahrgestell 1) |                           |                |        |  |  |  |
| 2.5 CDTI | 107      | 606710 |        | + Pritsche/Fahrgestell 1) |                           |                |        |  |  |  |
| 2.5 DTi  | 99       | 606710 |        | + Pritsche/Fahrgestell 1) |                           |                |        |  |  |  |
| 1.9 CDTI | 60       | 606709 | 08.01  | - Pritsche/Fahrgestell 2) | 24.3727-0763.2            | 580763         | 1      |  | <input type="checkbox"/> + kurzer Radstand 3)<br><input type="checkbox"/> + langer Radstand 4)       | <input type="checkbox"/> L=1190<br><input type="checkbox"/> L=1585<br><input type="checkbox"/> L=1503<br><input type="checkbox"/> L=1603 |
| 1.9 CDTI | 74       | 606709 | 08.01  | - Pritsche/Fahrgestell 2) | 24.3727-0764.2            | 580764         | 1      |  |  |  |
| 1.9 Di   | 60       | 606709 | 08.06  | - Pritsche/Fahrgestell 2) | 24.3727-1068.2            | 581068         |        |  |  |  |
| 2.0      | 86       | 606709 | 08.06  | - Pritsche/Fahrgestell 2) | 24.3727-1071.2            | 581071         |        |  |  |  |
| 2.0 16V  | 88       | 606709 | 08.01  | - Pritsche/Fahrgestell 2) |                           |                |        |  |  |  |
| 2.0 CDTI | 66       | 606709 | 08.06  | - Pritsche/Fahrgestell 2) |                           |                |        |  |  |  |
| 2.0 CDTI | 84       | 606709 | 08.06  | - Pritsche/Fahrgestell 2) |                           |                |        |  |  |  |
| 2.5 CDTI | 84       | 606709 | 08.06  | - Pritsche/Fahrgestell 2) |                           |                |        |  |  |  |
| 2.5 CDTI | 99       | 606709 | 05.03  | - Pritsche/Fahrgestell 2) |                           |                |        |  |  |  |
| 2.5 CDTI | 107      | 606709 | 08.06  | - Pritsche/Fahrgestell 2) |                           |                |        |  |  |  |
| 2.5 DTi  | 99       | 606709 | 08.06  | - Pritsche/Fahrgestell 2) |                           |                |        |  |  |  |
| 1.9 CDTI | 60       | 606709 | 08.01  | + Pritsche/Fahrgestell 1) | 24.3727-1068.2            | 581068         |        | <input type="checkbox"/> L=1503<br><input type="checkbox"/> L=1603 |  |  |
| 1.9 CDTI | 74       | 606709 | 08.01  | + Pritsche/Fahrgestell 1) | 24.3727-1071.2            | 581071         |        |  |  |  |
| 1.9 Di   | 60       | 606709 | 08.06  | + Pritsche/Fahrgestell 1) |                           |                |        |  |  |  |
| 2.0      | 86       | 606709 | 08.06  | + Pritsche/Fahrgestell 1) |                           |                |        |  |  |  |
| 2.0 16V  | 88       | 606709 | 08.01  | + Pritsche/Fahrgestell 1) |                           |                |        |  |  |  |
| 2.0 CDTI | 66       | 606709 | 08.06  | + Pritsche/Fahrgestell 1) |                           |                |        |  |  |  |
| 2.0 CDTI | 84       | 606709 | 08.06  | + Pritsche/Fahrgestell 1) |                           |                |        |  |  |  |
| 2.5 CDTI | 84       | 606709 | 08.06  | + Pritsche/Fahrgestell 1) |                           |                |        |  |  |  |
| 2.5 CDTI | 99       | 606709 | 05.03  | + Pritsche/Fahrgestell 1) |                           |                |        |  |  |  |
| 2.5 CDTI | 107      | 606709 | 08.06  | + Pritsche/Fahrgestell 1) |                           |                |        |  |  |  |
| 2.5 DTi  | 99       | 606709 | 08.06  | + Pritsche/Fahrgestell 1) |                           |                |        |  |  |  |
| 1.9 CDTI | 60       | 606710 |        | - Pritsche/Fahrgestell 2) | 24.3727-1068.2            | 581068         |        |  | <input type="checkbox"/> L=1503<br><input type="checkbox"/> L=1603                                   |  |
| 1.9 CDTI | 74       | 606710 |        | - Pritsche/Fahrgestell 2) | 24.3727-1071.2            | 581071         |        |  |  |  |
| 1.9 Di   | 60       | 606710 |        | - Pritsche/Fahrgestell 2) |                           |                |        |  |  |  |
| 2.0      | 86       | 606710 |        | - Pritsche/Fahrgestell 2) |                           |                |        |  |  |  |
| 2.0 16V  | 88       | 606710 |        | - Pritsche/Fahrgestell 2) |                           |                |        |  |  |  |
| 2.0 CDTI | 66       | 606710 |        | - Pritsche/Fahrgestell 2) |                           |                |        |  |  |  |
| 2.0 CDTI | 84       | 606710 |        | - Pritsche/Fahrgestell 2) |                           |                |        |  |  |  |
| 2.5 CDTI | 84       | 606710 |        | - Pritsche/Fahrgestell 2) |                           |                |        |  |  |  |
| 2.5 CDTI | 99       | 606710 |        | - Pritsche/Fahrgestell 2) |                           |                |        |  |  |  |
| 2.5 CDTI | 107      | 606710 |        | - Pritsche/Fahrgestell 2) |                           |                |        |  |  |  |
| 2.5 DTi  | 99       | 606710 |        | - Pritsche/Fahrgestell 2) |                           |                |        |  |  |  |
| 1.9 CDTI | 60       | 606710 |        | + Pritsche/Fahrgestell 1) | 24.3727-1068.2            | 581068         |        | <input type="checkbox"/> L=1503<br><input type="checkbox"/> L=1603 |  |  |
| 1.9 CDTI | 74       | 606710 |        | + Pritsche/Fahrgestell 1) | 24.3727-1071.2            | 581071         |        |  |  |  |
| 1.9 Di   | 60       | 606710 |        | + Pritsche/Fahrgestell 1) |                           |                |        |  |  |  |
| 2.0      | 86       | 606710 |        | + Pritsche/Fahrgestell 1) |                           |                |        |  |  |  |
| 2.0 16V  | 88       | 606710 |        | + Pritsche/Fahrgestell 1) |                           |                |        |  |  |  |
| 2.0 CDTI | 66       | 606710 |        | + Pritsche/Fahrgestell 1) |                           |                |        |  |  |  |
| 2.0 CDTI | 84       | 606710 |        | + Pritsche/Fahrgestell 1) |                           |                |        |  |  |  |
| 2.5 CDTI | 84       | 606710 |        | + Pritsche/Fahrgestell 1) |                           |                |        |  |  |  |
| 2.5 CDTI | 99       | 606710 |        | + Pritsche/Fahrgestell 1) |                           |                |        |  |  |  |
| 2.5 CDTI | 107      | 606710 |        | + Pritsche/Fahrgestell 1) |                           |                |        |  |  |  |
| 2.5 DTi  | 99       | 606710 |        | + Pritsche/Fahrgestell 1) |                           |                |        |  |  |  |

**OPEL ZAFIRA I / Vauxhall Zafira I (99-05)**

|             |             |  |       |       |       |       |                |                |        |                             |  |           |
|-------------|-------------|--|-------|-------|-------|-------|----------------|----------------|--------|-----------------------------|--|-----------|
|             | 1.6 16V     |  |       | 04.99 | 06.05 | - ESP | 24.2123-1734.3 | 010640         |        | Thz 23,81<br><br><b>LUC</b> |  |           |
|             | 1.8 16V     |  |       | 04.99 | 06.05 | - ESP |                |                |        |                             |  |           |
|             | 2.0 16V OPC |  |       | 09.01 | 06.05 | - ESP |                |                |        |                             |  |           |
|             | 2.0 DI 16V  |  |       | 10.99 | 06.05 | - ESP |                |                |        |                             |  |           |
|             | 2.0 DTI 16V |  |       | 06.00 | 06.05 | - ESP |                |                |        |                             |  |           |
|             | 2.2 16V     |  |       | 09.00 | 06.05 | - ESP |                |                |        |                             |  |           |
|             | 2.2 DTI 16V |  |       | 01.02 | 06.05 | - ESP |                |                |        |                             |  |           |
|             | 1.6 16V     |  |       |       | 04.99 | 06.05 | + ESP          | 24.2123-1739.3 | 010661 |                             |  | Thz 23,81 |
|             | 1.8 16V     |  |       | 04.99 | 06.05 | + ESP |                |                |        |                             |  |           |
|             | 2.0 16V OPC |  |       | 09.01 | 06.05 | + ESP |                |                |        |                             |  |           |
|             | 2.0 DI 16V  |  |       | 10.99 | 06.05 | + ESP |                |                |        |                             |  |           |
|             | 2.0 DTI 16V |  |       | 06.00 | 06.05 | + ESP |                |                |        |                             |  |           |
| 2.2 16V     |             |  | 09.00 | 06.05 | + ESP |       |                |                |        |                             |  |           |
| 2.2 DTI 16V |             |  | 01.02 | 06.05 | + ESP |       |                |                |        |                             |  |           |

1) + Pickup/Chassis / + Autocarro a cassone/Telaio / + Camion plateau/Châssis / + Camión plataforma/Chasis  
 2) - Pickup/Chassis / - Autocarro a cassone/Telaio / - Camion plateau/Châssis / - Camión plataforma/Chasis  
 3) + short wheel base / + passo lungo / + empattement court / + distancia corta entre ejes  
 4) + long wheel base / + passo lungo / + empattement long / + distancia larga entre ejes



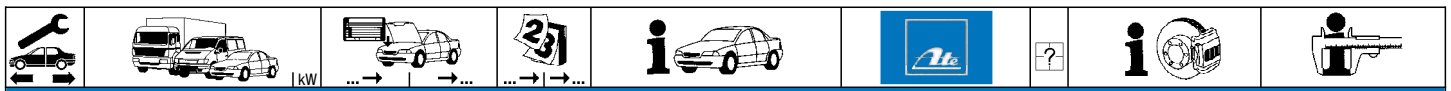



























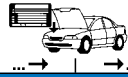







**OPEL ZAFIRA I / Vauxhall Zafira I (99-05)**

|  |  |  |  |   |   |  |  |  |  |        |  |   |   |
|--|--|--|--|---|---|--|--|--|--|--------|--|---|---|
|  | 1.6 16V<br>1.8 16V<br>2.0 16V OPC<br>2.0 DI 16V<br>2.0 DTI 16V<br>2.2 16V<br>2.2 DTI 16V |  |  | 04.99<br>04.99<br>09.01<br>10.99<br>06.00<br>09.00<br>01.02 | 06.05<br>06.05<br>06.05<br>06.05<br>06.05<br>06.05<br>06.05 |  |  | 11.9571-9823.2<br>11.9571-9824.2<br>24.3571-9823.5<br>24.3571-9824.5<br>11.0441-5704.2<br>11.0101-5407.2<br>11.8171-0008.1<br>11.8116-0292.1 | 220471<br>220472<br>240499<br>240500<br>250034<br>260011<br>990049<br>390521 | 2      |  | D=57, - Halter<br>D=57, - Halter<br>D=57, - Halter<br>Dichtungssatz<br>Hülzensatz<br>Führungsbolzen<br>Haltefeder | ATE<br>ATE<br>ATE<br>ATE<br>ATE<br>ATE<br>ATE |
|  | 1.6 16V<br>1.8 16V<br>2.0 16V OPC<br>2.0 DI 16V<br>2.0 DTI 16V<br>2.2 16V<br>2.2 DTI 16V |  |  | 04.99<br>04.99<br>09.01<br>10.99<br>06.00<br>09.00<br>01.02 | 06.05<br>06.05<br>06.05<br>06.05<br>06.05<br>06.05<br>06.05 |  |  | 83.7207-0396.3   | 330560   | 2      |  | L=396   |   |
|  | 1.6 16V<br>1.8 16V<br>2.0 16V OPC<br>2.0 DI 16V<br>2.0 DTI 16V<br>2.2 16V<br>2.2 DTI 16V |  |  | 04.99<br>04.99<br>09.01<br>10.99<br>06.00<br>09.00<br>01.02 | 06.05<br>06.05<br>06.05<br>06.05<br>06.05<br>06.05<br>06.05 | + D A CH   |  | 24.3384-1753.2<br>24.3384-1754.7   | 220633<br>220634   |        |  | D=38, - Halter<br>D=38, - Halter  | LUC<br>LUC                                    |
|  | 1.6 16V<br>1.8 16V<br>2.0 16V OPC<br>2.0 DI 16V<br>2.0 DTI 16V<br>2.2 16V<br>2.2 DTI 16V |  |  | 04.99<br>04.99<br>09.01<br>10.99<br>06.00<br>09.00<br>01.02 | 06.05<br>06.05<br>06.05<br>06.05<br>06.05<br>06.05<br>06.05 | - D A CH   |  | 24.5240-0220.3   | 330619   | 2      |  | L=220   |   |
|  | 1.6 16V<br>1.8 16V<br>2.0 16V OPC<br>2.0 DI 16V<br>2.0 DTI 16V<br>2.2 16V<br>2.2 DTI 16V |  | 22999999<br>22999999<br>22999999<br>22999999<br>22999999<br>22999999<br>22999999 | 04.99<br>04.99<br>09.01<br>10.99<br>06.00<br>09.00<br>01.02 | 06.05<br>06.05<br>06.05<br>06.05<br>06.05<br>06.05<br>06.05 | + D A CH   |  | 24.5241-0200.3   | 330620   | 2      |  | L=200   |   |
|  | 1.6 16V<br>1.8 16V<br>2.0 16V OPC<br>2.0 DI 16V<br>2.0 DTI 16V<br>2.2 16V<br>2.2 DTI 16V | 32000001<br>32000001<br>32000001<br>32000001<br>32000001<br>32000001<br>32000001 |  | 06.05<br>06.05<br>06.05<br>06.05<br>06.05<br>06.05<br>06.05 | 06.05<br>06.05<br>06.05<br>06.05<br>06.05<br>06.05<br>06.05 | + D A CH   |  | 24.5157-0218.3<br>24.5157-0219.3   | 331095<br>331096   |        |  | L=219/185, + Rohrleitung<br>L=219/185, + Rohrleitung  |   |
|  | 1.6 16V  |  |  | 04.99   | 06.05   | - D A CH   |  | 24.3220-1719.3   | 020448   |        |  | Rz 20,64  |   |
|  | 1.6 16V  |  |  | 04.99   | 06.05   | - verstärktes Fahrwerk/ - D A CH                   |  | 24.3727-0748.2<br>24.3727-0746.2   | 580748<br>580746   | 1<br>2 |  | L=279, + Zub<br>L=182, + Zub  |   |
|  | 1.6 16V  |  |  | 04.99   | 06.05   | + verstärktes Fahrwerk/ - D A CH                   |  | 24.3727-0748.2<br>24.3727-0746.2   | 580748<br>580746   | 1<br>2 |  | L=279, + Zub<br>L=182, + Zub  |   |
|  | 1.6 16V<br>1.8 16V<br>2.0 16V OPC<br>2.0 DI 16V<br>2.0 DTI 16V<br>2.2 16V<br>2.2 DTI 16V | 22006460<br>22006460<br>22006460<br>22006460<br>22006460<br>22006460<br>22006460 |  | 04.99<br>04.99<br>09.01<br>10.99<br>06.00<br>09.00<br>01.02 | 06.05<br>06.05<br>06.05<br>06.05<br>06.05<br>06.05<br>06.05 | + D A CH   |  | 24.3727-0748.2<br>24.3727-0757.2   | 580748<br>580757   | 1<br>1 |  | L=279, + Zub<br>L=1680/1495, + Zub  |   |
|  | 1.6 16V<br>1.8 16V<br>2.0 16V OPC<br>2.0 DI 16V<br>2.0 DTI 16V<br>2.2 16V<br>2.2 DTI 16V | 22006461<br>22006461<br>22006461<br>22006461<br>22006461<br>22006461<br>22006461 | 32999999<br>32999999<br>32999999<br>32999999<br>32999999<br>32999999<br>32999999 |   |   | + D A CH   |  | 24.3727-0748.2<br>24.3727-0756.2   | 580748<br>580756   | 1<br>1 |  | L=279, + Zub<br>L=1680/1495, + Zub  |   |
|  | 1.6 16V<br>1.8 16V<br>2.0 16V OPC<br>2.0 DI 16V<br>2.0 DTI 16V<br>2.2 16V<br>2.2 DTI 16V |  | 1H999999<br>1H999999<br>1H999999<br>1H999999<br>1H999999<br>1H999999<br>1H999999 | 04.99<br>04.99<br>09.01<br>10.99<br>06.00<br>09.00<br>01.02 | 06.05<br>06.05<br>06.05<br>06.05<br>06.05<br>06.05<br>06.05 | + D A CH   |  | 24.3727-0748.2<br>24.3727-0757.2   | 580748<br>580757   | 1<br>1 |  | L=279, + Zub<br>L=1680/1495, + Zub  |   |
|  | 1.6 16V<br>1.8 16V<br>2.0 16V OPC<br>2.0 DI 16V<br>2.0 DTI 16V<br>2.2 16V<br>2.2 DTI 16V | 2H000001<br>2H000001<br>2H000001<br>2H000001<br>2H000001<br>2H000001<br>2H000001 | 32999999<br>32999999<br>32999999<br>32999999<br>32999999<br>32999999<br>32999999 |   |   | + D A CH   |  | 24.3727-0748.2<br>24.3727-0756.2   | 580748<br>580756   | 1<br>1 |  | L=279, + Zub<br>L=1680/1495, + Zub  |   |
|  | 1.6 16V<br>1.8 16V<br>2.0 16V OPC<br>2.0 DI 16V<br>2.0 DTI 16V<br>2.2 16V<br>2.2 DTI 16V | 42000001<br>42000001<br>42000001<br>42000001<br>42000001<br>42000001<br>42000001 |  | 06.05<br>06.05<br>06.05<br>06.05<br>06.05<br>06.05<br>06.05 | 06.05<br>06.05<br>06.05<br>06.05<br>06.05<br>06.05<br>06.05 | + D A CH   |  | 24.3727-0748.2<br>24.3727-0784.2   | 580748<br>580784   | 1<br>1 |  | L=279, + Zub<br>L=1677/1677, + Zub  |   |
|  | 1.6 16V<br>1.8 16V<br>2.0 16V OPC<br>2.0 DI 16V<br>2.0 DTI 16V<br>2.2 16V                |  |  | 04.99<br>04.99<br>09.01<br>10.99<br>06.00<br>09.00          | 06.05<br>06.05<br>06.05<br>06.05<br>06.05<br>06.05          | - ABS<br>- ABS<br>- ABS<br>- ABS<br>- ABS<br>- ABS |  | 03.6583-0085.3   | 320238   |        |  | BRL 8/3 (4)   | ATE   |

1) - reinforced susp./-D A CH / - sospensione rinforzata/ - D A CH / - châssis renforcé/ - D A CH / - suspensión reforzada/ - D A CH  
 2) extension only / solo prolunga / rallonge seulement / solamente prolongador  
 3) + reinforced susp./+D A CH / + sospensione rinforzata/ + D A CH / + châssis renforcé/ + D A CH / + suspensión reforzada/ + D A CH  
 4) - rough road construction / - versione per percorsi accidentati / - version pour mauvaise route / - versión 4x4



|     |  |  |  |  |  |  |  |  |
|--|--|--|--|--|---|--|--|--|
| <b>OPEL ZAFIRA I / Vauxhall Zafira I (99-05)</b>                                   |  |  |  |  |   |  |  |  |
|    | 2.2 DTI 16V  |  | 01.02  | 06.05  | - ABS   | 03.6583-0085.3   | 320238   | BRL 8/3 (4) ATE  |
| <b>OPEL ZAFIRA II / Vauxhall Zafira II (05-11)</b>                                 |  |  |  |  |   |  |  |  |
|    | 1.6  | 77   | 07.05  | 10.11  |   | 03.7863-7803.4   | 300237   | + ESP 10" ATE  |
|  | 1.6  | 85   | 12.07  | 10.11  |   |  |  |  |
|  | 1.6 CNG  | 69   | 01.06  | 10.11  |   |  |  |  |
|  | 1.6 CNG Turbo  | 110  | 02.09  | 10.11  |   |  |  |  |
|  | 1.7 CDTI   | 81   | 12.07  | 10.11  |   |  |  |  |
|  | 1.7 CDTI   | 92   | 12.07  | 10.11  |   |  |  |  |
|  | 1.8  | 103  | 07.05  | 10.11  |   |  |  |  |
|  | 1.9 CDTI   | 74   | 07.05  | 10.11  |   |  |  |  |
|  | 1.9 CDTI   | 88   | 07.05  | 10.11  |   |  |  |  |
|  | 1.9 CDTI   | 110  | 07.05  | 10.11  |   |  |  |  |
|  | 2.0  | 125  | 07.05  | 10.11  |   |  |  |  |
|  | 2.0 OPC  | 177  | 09.05  | 10.11  |   |  |  |  |
|  | 2.0 Turbo  | 147  | 07.05  | 10.11  |   |  |  |  |
|  | 2.2  | 110  | 07.05  | 10.11  |   |  |  |  |
|    | 1.6  | 77   | 07.05  | 10.11  |   | 03.4155-0153.3   | 010927   | - ESP THz 25,40 ATE  |
|  | 1.6  | 85   | 12.07  | 10.11  |   | 03.4155-0156.3   | 010862   | + ESP THz 25,40 ATE  |
|  | 1.6 CNG  | 69   | 01.06  | 10.11  |   |  |  |  |
|  | 1.6 CNG Turbo  | 110  | 02.09  | 10.11  |   |  |  |  |
|  | 1.7 CDTI   | 81   | 12.07  | 10.11  |   |  |  |  |
|  | 1.7 CDTI   | 92   | 12.07  | 10.11  |   |  |  |  |
|  | 1.8  | 103  | 07.05  | 10.11  |   |  |  |  |
|  | 1.9 CDTI   | 74   | 07.05  | 10.11  |   |  |  |  |
|  | 1.9 CDTI   | 88   | 07.05  | 10.11  |   |  |  |  |
|  | 1.9 CDTI   | 110  | 07.05  | 10.11  |   |  |  |  |
|  | 2.0  | 125  | 07.05  | 10.11  |   |  |  |  |
|  | 2.0 OPC  | 177  | 09.05  | 10.11  |   |  |  |  |
|  | 2.0 Turbo  | 147  | 07.05  | 10.11  |   |  |  |  |
|  | 2.2  | 110  | 07.05  | 10.11  |   |  |  |  |
|  | 1.6  | 77   | 07.05  | 10.11  |   | 24.2125-1736.3   | 010904   | THz 25,40 LUC  |
|  | 1.6 CNG Turbo  | 110  | 02.09  | 10.11  |   |  |  |  |
|  | 1.8  | 103  | 07.05  | 10.11  |   |  |  |  |
|  | 2.0  | 125  | 07.05  | 10.11  |   |  |  |  |
|  | 2.0 OPC  | 177  | 09.05  | 10.11  |   |  |  |  |
|  | 2.0 Turbo  | 147  | 07.05  | 10.11  |   |  |  |  |
|  | 1.7 CDTI   | 81   | 12.07  | 10.11  |   | 03.4155-0156.3   | 010862   | THz 25,40 ATE  |
|  | 1.7 CDTI   | 92   | 12.07  | 10.11  |   |  |  |  |
|  | 1.9 CDTI   | 74   | 07.05  | 10.11  |   |  |  |  |
|  | 1.9 CDTI   | 88   | 07.05  | 10.11  |   |  |  |  |
|  | 1.9 CDTI   | 110  | 07.05  | 10.11  |   |  |  |  |
|  | 2.2  | 110  | 07.05  | 10.11  |   |  |  |  |
|  | 1.6  | 77   | 07.05  | 10.11  |   | 11.9571-9823.2   | 220471   | D=57, - Halter ATE   |
|  | 1.6  | 85   | 12.07  | 10.11  |   | 11.9571-9824.2   | 220472   | D=57, - Halter ATE   |
|  | 1.8  | 103  | 07.05  | 10.11  |   | 24.3571-9823.5   | 240499   | D=57, - Halter ATE   |
|  |  |  |  |  |   | 24.3571-9824.5   | 240500   | D=57, - Halter ATE   |
|  |  |  |  |  |   | 11.0441-5704.2   | 250034   | Dichtungssatz ATE  |
|  |  |  |  |  |   | 11.0101-5407.2   | 260011   | Hülssensatz ATE  |
|  |  |  |  |  |   | 11.8171-0008.1   | 990049   | Führungsbolzen ATE   |
|  |  |  |  |  |   | 11.8116-0292.1   | 390521   | Haltefeder ATE   |
|  | 1.6 CNG  | 69   | 01.06  | 10.11  |   | 11.9571-9823.2   | 220471   | D=57, - Halter ATE   |
|  | 1.6 CNG Turbo  | 110  | 02.09  | 10.11  |   | 11.9571-9824.2   | 220472   | D=57, - Halter ATE   |
|  | 1.7 CDTI   | 81   | 12.07  | 10.11  |   | 24.3571-9823.5   | 240499   | D=57, - Halter ATE   |
|  | 1.7 CDTI   | 92   | 12.07  | 10.11  |   | 24.3571-9824.5   | 240500   | D=57, - Halter ATE   |
|  | 1.9 CDTI   | 74   | 07.05  | 10.11  |   | 11.0441-5704.2   | 250034   | Dichtungssatz ATE  |
|  | 1.9 CDTI   | 88   | 07.05  | 10.11  |   | 11.0101-5407.2   | 260011   | Hülssensatz ATE  |
|  | 1.9 CDTI   | 110  | 07.05  | 10.11  |   | 11.8171-0008.1   | 990049   | Führungsbolzen ATE   |
|  | 2.0  | 125  | 07.05  | 10.11  |   | 11.8116-0292.1   | 390521   | Haltefeder ATE   |
|  | 2.0 Turbo  | 147  | 07.05  | 10.11  |   |  |  |  |
|  | 2.2  | 110  | 07.05  | 10.11  |   |  |  |  |
|  | 2.0 OPC  | 177  | 09.05  | 10.11  |   | 11.0101-5407.2   | 260011   | Hülssensatz ATE  |
|  |  |  |  |  |   | 11.8171-0008.1   | 990049   | Führungsbolzen ATE   |
|  |  |  |  |  |   | 11.8116-0356.1   | 390586   | Haltefeder ATE   |
|  | 1.6  | 77   | 07.05  | 10.11  |   | 24.5241-0430.3   | 330918   | L=430  |
|  | 1.6  | 85   | 12.07  | 10.11  |   |  |  |  |
|  | 1.6 CNG  | 69   | 01.06  | 10.11  |   |  |  |  |
|  | 1.6 CNG Turbo  | 110  | 02.09  | 10.11  |   |  |  |  |
|  | 1.7 CDTI   | 81   | 12.07  | 10.11  |   |  |  |  |
|  | 1.7 CDTI   | 92   | 12.07  | 10.11  |   |  |  |  |
|  | 1.8  | 103  | 07.05  | 10.11  |   |  |  |  |
|  | 1.9 CDTI   | 74   | 07.05  | 10.11  |   |  |  |  |
|  | 1.9 CDTI   | 88   | 07.05  | 10.11  |   |  |  |  |
|  | 1.9 CDTI   | 110  | 07.05  | 10.11  |   |  |  |  |
|  | 2.0  | 125  | 07.05  | 10.11  |   |  |  |  |
|  | 2.0 Turbo  | 147  | 07.05  | 10.11  |   |  |  |  |
|  | 2.2  | 110  | 07.05  | 10.11  |   |  |  |  |
|  | 1.6  | 77   | 07.05  | 10.11  |   | 24.3417-1703.7   | 220759   | D=41, - Halter LUC   |
|  | 1.6  | 85   | 12.07  | 10.11  |   | 24.3417-1704.7   | 220760   | D=41, - Halter LUC   |
|  | 1.6 CNG  | 69   | 01.06  | 10.11  |   | 24.0101-3803.2   | 260101   | Einbausatz LUC   |
|  | 1.6 CNG Turbo  | 110  | 02.09  | 10.11  |   |  |  |  |
|  | 1.7 CDTI   | 81   | 12.07  | 10.11  |   |  |  |  |
|  | 1.7 CDTI   | 92   | 12.07  | 10.11  |   |  |  |  |
|  | 1.8  | 103  | 07.05  | 10.11  |   |  |  |  |
|  | 1.9 CDTI   | 74   | 07.05  | 10.11  |   |  |  |  |

|     |    |  |   |  |  |     |  |  |
|--|--|--|---|--|---|---|--|--|
| <b>OPEL ZAFIRA II / Vauxhall Zafira II (05-11)</b>                                 |  |  |   |  |   |   |  |  |
|    | 1.9 CDTi 88<br>1.9 CDTi 110<br>2.0 125<br>2.0 Turbo 147<br>2.2 110   |  | 07.05 10.11<br>07.05 10.11<br>07.05 10.11<br>07.05 10.11<br>07.05 10.11   |  | 24.3417-1703.7 220759<br>24.3417-1704.7 220760<br>24.0101-3803.2 260101           |    |  | D=41, - Halter LUC<br>D=41, - Halter LUC<br>Einbausatz LUC                         |
|    | 1.6 77<br>1.6 85<br>1.6 CNG 69<br>1.6 CNG Turbo 110<br>1.7 CDTi 81<br>1.7 CDTi 92<br>1.8 103<br>1.9 CDTi 74<br>1.9 CDTi 88<br>1.9 CDTi 110<br>2.0 125<br>2.0 OPC 177<br>2.0 Turbo 147<br>2.2 110 |  | 07.05 10.11<br>12.07 10.11<br>01.06 10.11<br>02.09 10.11<br>12.07 10.11<br>12.07 10.11<br>07.05 10.11<br>07.05 10.11<br>07.05 10.11<br>07.05 10.11<br>09.05 10.11<br>07.05 10.11<br>07.05 10.11 |  | 24.5157-0218.3 331095<br>24.5157-0219.3 331096                                    |    |  | L=219/185, + Rohrleitung<br>L=219/185, + Rohrleitung                               |
|    | 1.6 77<br>1.6 85<br>1.6 CNG 69<br>1.6 CNG Turbo 110<br>1.7 CDTi 81<br>1.7 CDTi 92<br>1.8 103<br>1.9 CDTi 74<br>1.9 CDTi 88<br>1.9 CDTi 110<br>2.0 125<br>2.0 OPC 177<br>2.0 Turbo 147<br>2.2 110 |  | 07.05 10.11<br>12.07 10.11<br>01.06 10.11<br>02.09 10.11<br>12.07 10.11<br>12.07 10.11<br>07.05 10.11<br>07.05 10.11<br>07.05 10.11<br>07.05 10.11<br>09.05 10.11<br>07.05 10.11<br>07.05 10.11 |  | 24.3727-0790.2 580790   |    |  | L=1749/1774, + Zub   |
| <b>OPEL ZAFIRA III Tourer / Vauxhall Zafira III Tourer (11-)</b>                   |  |  |   |  |   |   |  |  |
|    | 1.4 T 88<br>1.4 T 103<br>1.4 T LPG 103<br>1.6 CDTi ecoFLEX 100<br>1.6 SIDI 125<br>1.6 T CNG 110<br>1.8 81<br>1.8 103<br>1.8 LPG 101<br>2.0 CDTi 81<br>2.0 CDTi 96<br>2.0 CDTi BiTurbo 143        |  | 11.11<br>11.11<br>11.11<br>03.13<br>12.12<br>11.11<br>11.11<br>11.11<br>11.11<br>11.11<br>11.11<br>12.12  |  | 03.7858-0732.4 300272   |   |  | 9/8" Tandem ATE  |
|  | 1.4 T 88<br>1.4 T 103<br>1.4 T LPG 103<br>1.6 CDTi ecoFLEX 100<br>1.6 SIDI 125<br>1.6 T CNG 110<br>1.8 81<br>1.8 103<br>1.8 LPG 101<br>2.0 CDTi 81<br>2.0 CDTi 96<br>2.0 CDTi BiTurbo 143        |  | 11.11<br>11.11<br>11.11<br>03.13<br>12.12<br>11.11<br>11.11<br>11.11<br>11.11<br>11.11<br>11.11<br>12.12  |  | 03.2125-0421.3 010934   |   |  | Thz 25,40 ATE  |
|  | 1.4 T 88<br>1.4 T 103<br>1.4 T LPG 103<br>1.6 CDTi ecoFLEX 100<br>1.6 SIDI 125<br>1.6 T CNG 110<br>1.8 81<br>1.8 103<br>1.8 LPG 101<br>2.0 CDTi 81<br>2.0 CDTi 96<br>2.0 CDTi BiTurbo 143        |  | 11.11<br>11.11<br>11.11<br>03.13<br>12.12<br>11.11<br>11.11<br>11.11<br>11.11<br>11.11<br>11.11<br>12.12  |  | 11.9601-2601.2 220913<br>11.9601-2602.2 220914                                    |  | + 16" Rad <sup>1)</sup><br>+ 16" Rad <sup>1)</sup>                                 | D=60, - Halter ATE<br>D=60, - Halter ATE   |
| <b>PEUGEOT 106 (91-96)</b>   |  |  |   |  |   |   |  |  |
|  | 1.0 44<br>1.1 55<br>1.4 37<br>1.4 D 65<br>1.5 D 65<br>1.6 76   |  | 08.91 04.96 - ABS/ + 3 türig <sup>2)</sup><br>08.91 04.96 - ABS/ + 3 türig <sup>2)</sup><br>08.91 04.96 - ABS<br>08.92 04.96 - ABS<br>06.94 04.96 - ABS<br>06.93 04.96 - ABS                    |  | 03.2119-3389.3 010057   |   |  | Thz 19,05 ATE  |
|  | 1.0 44<br>1.1 72<br>1.3 Rallye 69<br>1.4 76<br>1.6 76  |  | 08.91 04.96 - ABS/ + 5 türig <sup>3)</sup><br>08.91 04.96 - ABS/ + 5 türig <sup>3)</sup><br>10.93 04.96 - ABS<br>08.91 04.96 - ABS<br>01.94 04.96 - ABS   |  | 03.2120-2031.3 010106   |   |  | Thz 20,64 ATE  |

<sup>1)</sup> + 16" wheel / + ruota 16" / + roue 16" / + rueda 16"

<sup>2)</sup> - ABS/ + 3 door / - ABS/ + 3 porte / - ABS/ + 3 portes / - ABS/ + 3 puertas

<sup>3)</sup> - ABS/ + 5 door / - ABS/ + 5 porte / - ABS/ + 5 portes / - ABS/ + 5 puertas

| PEUGEOT 106 (91-96) |            |    |            |       |       |                                      |                |        |   |                              |           |
|---------------------|------------|----|------------|-------|-------|--------------------------------------|----------------|--------|---|------------------------------|-----------|
|                     | 1.0        |    |            | 08.91 | 04.96 | - ABS                                | 11.0441-4501.2 | 250015 |   | Dichtungssatz                | ATE       |
|                     | 1.1        | 44 |            | 08.91 | 04.96 | - ABS                                | 11.0101-4504.2 | 260004 |   | Tragbolzensatz               | ATE       |
|                     | 1.3 Rallye | 72 | S 51132347 |       | 04.96 |                                      | 11.3481-9833.2 | 220561 |   | D=48, - Halter               | ATE       |
|                     | 1.4        | 55 | S 51132347 |       | 04.96 | + ABS                                | 11.3481-9834.2 | 220562 |   | D=48, - Halter               | ATE       |
|                     | 1.4 D      | 37 | S 51132347 |       | 04.96 | + ABS                                | 24.3481-9833.5 | 240479 |   | D=48, - Halter               | ATE       |
|                     | 1.5 D      |    | S 51132347 |       | 04.96 | + ABS                                | 24.3481-9834.5 | 240480 |   | D=48, - Halter               | ATE       |
|                     | 1.6        | 65 | S 51132347 |       | 04.96 | + ABS                                | 11.0441-4811.2 | 250024 |   | Dichtungssatz                | ATE       |
|                     | 1.6        | 76 | S 51132347 |       | 04.96 |                                      | 11.0101-5407.2 | 260011 |   | Hülzensatz                   | ATE       |
|                     |            |    |            |       |       |                                      | 11.8171-0008.1 | 990049 |   | Führungsbolzen               | ATE       |
|                     |            |    |            |       |       |                                      | 11.8116-0129.1 | 390591 | 2 | Haltefeder                   | ATE       |
|                     | 1.0        |    |            | 08.91 | 04.96 | - ABS/ + 3 türig <sup>1)</sup>       | 24.5111-0290.3 | 330108 | 2 |                              | L=290     |
|                     | 1.1        | 44 |            | 08.91 | 04.96 | - ABS/ + 3 türig <sup>1)</sup>       |                |        |   |                              |           |
|                     | 1.0        |    |            | 08.91 | 04.96 | - ABS/ + 5 türig <sup>2)</sup>       | 24.5111-0330.3 | 330160 | 2 |                              | L=330     |
|                     | 1.1        | 44 |            | 08.91 | 04.96 | - ABS/ + 5 türig <sup>2)</sup>       |                |        |   |                              |           |
|                     | 1.0        |    |            | 08.91 | 03.95 | + ABS                                | 24.5111-0290.3 | 330108 | 2 |                              | L=290     |
|                     | 1.1        | 44 |            | 08.91 | 03.95 | + ABS                                |                |        |   |                              |           |
|                     | 1.0        |    |            | 04.95 | 04.96 | + ABS                                | 24.5111-0301.3 | 330499 | 2 |                              | L=300     |
|                     | 1.1        | 44 |            | 04.95 | 04.96 | + ABS                                |                |        |   |                              |           |
|                     | 1.3 Rallye | 72 |            | 10.93 | 03.95 |                                      | 24.5111-0290.3 | 330108 | 2 |                              | L=290     |
|                     | 1.4        | 55 |            | 08.91 | 04.96 | - ABS                                |                |        |   |                              |           |
|                     | 1.4        | 69 |            | 08.91 | 04.96 | - ABS                                |                |        |   |                              |           |
|                     | 1.4 D      | 37 |            | 08.92 | 04.96 | - ABS                                |                |        |   |                              |           |
|                     | 1.5 D      |    |            | 06.94 | 04.96 | - ABS                                |                |        |   |                              |           |
|                     | 1.6        | 65 |            | 06.93 | 04.96 | - ABS                                |                |        |   |                              |           |
|                     | 1.6        | 76 |            | 01.94 | 03.95 |                                      |                |        |   |                              |           |
|                     | 1.4        | 55 |            | 08.91 | 03.95 | + ABS                                | 24.5111-0290.3 | 330108 | 2 |                              | L=290     |
|                     | 1.4        | 69 |            | 08.91 | 03.95 | + ABS                                |                |        |   |                              |           |
|                     | 1.4 D      | 37 |            | 08.92 | 03.95 | + ABS                                |                |        |   |                              |           |
|                     | 1.5 D      |    |            | 06.94 | 03.95 | + ABS                                |                |        |   |                              |           |
|                     | 1.6        | 65 |            | 01.94 | 03.95 | + ABS                                |                |        |   |                              |           |
|                     | 1.3 Rallye | 72 |            | 04.95 | 04.96 |                                      | 24.5111-0301.3 | 330499 | 2 |                              | L=300     |
|                     | 1.4        | 55 |            | 04.95 | 04.96 | + ABS                                |                |        |   |                              |           |
|                     | 1.4        | 69 |            | 04.95 | 04.96 | + ABS                                |                |        |   |                              |           |
|                     | 1.4 D      | 37 |            | 04.95 | 04.96 | + ABS                                |                |        |   |                              |           |
| 1.5 D               |            |    | 04.95      | 04.96 | + ABS |                                      |                |        |   |                              |           |
| 1.6                 | 65         |    | 04.95      | 04.96 | + ABS |                                      |                |        |   |                              |           |
| 1.6                 | 76         |    | 04.95      | 04.96 |       |                                      |                |        |   |                              |           |
|                     | 1.0        |    |            | 08.91 | 04.96 | - verstärktes Fahrwerk <sup>3)</sup> | 24.5229-0199.3 | 330534 | 2 |                              | L=200     |
|                     | 1.1        | 44 |            | 08.91 | 04.96 | - verstärktes Fahrwerk <sup>3)</sup> |                |        |   |                              |           |
|                     | 1.3 Rallye | 72 |            | 10.93 | 04.96 | - verstärktes Fahrwerk <sup>3)</sup> |                |        |   |                              |           |
|                     | 1.4        | 55 |            | 08.91 | 04.96 | - verstärktes Fahrwerk <sup>3)</sup> |                |        |   |                              |           |
|                     | 1.4        | 69 |            | 08.91 | 04.96 | - verstärktes Fahrwerk <sup>3)</sup> |                |        |   |                              |           |
|                     | 1.4 D      | 37 |            | 08.92 | 04.96 | - verstärktes Fahrwerk <sup>3)</sup> |                |        |   |                              |           |
|                     | 1.5 D      |    |            | 06.94 | 04.96 | - verstärktes Fahrwerk <sup>3)</sup> |                |        |   |                              |           |
|                     | 1.6        | 65 |            | 06.93 | 04.96 | - verstärktes Fahrwerk <sup>3)</sup> |                |        |   |                              |           |
|                     | 1.6        | 76 |            | 01.94 | 04.96 | - verstärktes Fahrwerk <sup>3)</sup> |                |        |   |                              |           |
|                     | 1.0        |    |            | 08.91 | 04.96 | + verstärktes Fahrwerk <sup>4)</sup> | 24.5229-0199.3 | 330534 |   |                              | L=200     |
|                     | 1.1        | 44 |            | 08.91 | 04.96 | + verstärktes Fahrwerk <sup>4)</sup> | 24.5229-0211.3 | 330573 |   |                              | L=210     |
|                     | 1.3 Rallye | 72 |            | 10.93 | 04.96 | + verstärktes Fahrwerk <sup>4)</sup> |                |        |   |                              |           |
|                     | 1.4        | 55 |            | 08.91 | 04.96 | + verstärktes Fahrwerk <sup>4)</sup> |                |        |   |                              |           |
|                     | 1.4        | 69 |            | 08.91 | 04.96 | + verstärktes Fahrwerk <sup>4)</sup> |                |        |   |                              |           |
|                     | 1.4 D      | 37 |            | 08.92 | 04.96 | + verstärktes Fahrwerk <sup>4)</sup> |                |        |   |                              |           |
|                     | 1.5 D      |    |            | 06.94 | 04.96 | + verstärktes Fahrwerk <sup>4)</sup> |                |        |   |                              |           |
|                     | 1.6        | 65 |            | 06.93 | 04.96 | + verstärktes Fahrwerk <sup>4)</sup> |                |        |   |                              |           |
|                     | 1.6        | 76 |            | 01.94 | 04.96 | + verstärktes Fahrwerk <sup>4)</sup> |                |        |   |                              |           |
|                     | 1.0        |    |            | 08.91 | 04.96 | - ABS/ + 3 türig <sup>1)</sup>       | 24.3219-1609.3 | 020319 |   | + 4-Loch-Felge <sup>5)</sup> | RzR 19,05 |
|                     | 1.1        | 44 |            | 08.91 | 04.96 | - ABS/ + 3 türig <sup>1)</sup>       | 24.3219-1610.3 | 020320 |   | + 4-Loch-Felge <sup>5)</sup> | RzR 19,05 |
|                     | 1.0        |    |            | 08.91 | 04.96 | - ABS/ + 5 türig <sup>2)</sup>       | 24.3219-1603.3 | 020200 |   | + 3-Loch-Felge <sup>6)</sup> | RzR 19,05 |
|                     | 1.1        | 44 |            | 08.91 | 04.96 | - ABS/ + 5 türig <sup>2)</sup>       | 24.3219-1604.3 | 020201 |   | + 3-Loch-Felge <sup>6)</sup> | RzR 19,05 |
|                     | 1.0        |    |            | 08.91 | 04.96 | + ABS                                | 24.3219-1112.3 | 020311 |   |                              | Rz 19,05  |
|                     | 1.1        | 44 |            | 08.91 | 04.96 | + ABS                                |                |        |   |                              | BDX       |
|                     | 1.3 Rallye | 72 |            | 10.93 | 04.96 | - ABS                                | 24.3219-1609.3 | 020319 |   |                              | RzR 19,05 |
|                     | 1.4        | 55 |            | 08.91 | 04.96 | - ABS                                | 24.3219-1610.3 | 020320 |   |                              | RzR 19,05 |
|                     | 1.4        | 69 |            | 08.91 | 04.96 | - ABS                                |                |        |   |                              |           |
|                     | 1.4 D      | 37 |            | 08.92 | 04.96 | - ABS                                |                |        |   |                              |           |
|                     | 1.5 D      |    |            | 06.94 | 04.96 | - ABS                                |                |        |   |                              |           |
|                     | 1.6        | 65 |            | 06.93 | 04.96 | - ABS                                |                |        |   |                              |           |
|                     | 1.6        | 76 |            | 01.94 | 04.96 | - ABS                                |                |        |   |                              |           |
|                     | 1.3 Rallye | 72 |            | 10.93 | 04.96 | + ABS                                | 24.3219-1112.3 | 020311 |   |                              | Rz 19,05  |
|                     | 1.4        | 55 |            | 08.91 | 04.96 | + ABS                                |                |        |   |                              |           |
|                     | 1.4        | 69 |            | 08.91 | 04.96 | + ABS                                |                |        |   |                              |           |
|                     | 1.4 D      | 37 |            | 08.92 | 04.96 | + ABS                                |                |        |   |                              |           |
|                     | 1.5 D      |    |            | 06.94 | 04.96 | + ABS                                |                |        |   |                              |           |
| 1.6                 | 65         |    | 06.93      | 04.96 | + ABS |                                      |                |        |   |                              |           |
| 1.6                 | 76         |    | 01.94      | 04.96 | + ABS |                                      |                |        |   |                              |           |
|                     | 1.0        |    | S 51224674 | 08.91 |       |                                      | 24.3727-0807.2 | 580807 | 2 |                              | L=1292    |
|                     | 1.1        | 44 | S 51224674 | 08.91 |       |                                      |                |        |   |                              |           |
|                     | 1.3 Rallye | 72 | S 51224674 | 10.93 |       |                                      |                |        |   |                              |           |
|                     | 1.4        | 55 | S 51224674 | 08.91 |       |                                      |                |        |   |                              |           |
|                     | 1.4        | 69 | S 51224674 | 08.91 |       |                                      |                |        |   |                              |           |
|                     | 1.4 D      | 37 | S 51224674 | 08.92 |       |                                      |                |        |   |                              |           |
|                     | 1.5 D      |    | S 51224674 | 06.94 |       |                                      |                |        |   |                              |           |
|                     | 1.6        | 65 | S 51224674 | 06.93 |       |                                      |                |        |   |                              |           |
|                     | 1.6        | 76 | S 51224674 | 01.94 |       |                                      |                |        |   |                              |           |
|                     | 1.0        |    | S 51224675 |       | 04.96 |                                      | 24.3727-0816.2 | 580816 | 2 |                              | L=1442    |

<sup>1)</sup> - ABS/ + 3 door / - ABS/ + 3 porte / - ABS/ + 3 puertas  
<sup>2)</sup> - ABS/ + 5 door / - ABS/ + 5 porte / - ABS/ + 5 puertas  
<sup>3)</sup> - reinforced suspension / - sospensione rinforzata / - châssis renforcé / - suspensión reforzada  
<sup>4)</sup> + reinforced suspension / + sospensione rinforzata / + châssis renforcé / + suspensión reforzada  
<sup>5)</sup> + 4 bore wheel rim / + cerchione a 4 fori / + jante à 4 trous / + Liantas de 4 taladros  
<sup>6)</sup> + 3 bore wheel rim / + cerchione a 3 fori / + jante à 3 trous / + Liantas de 3 taladros



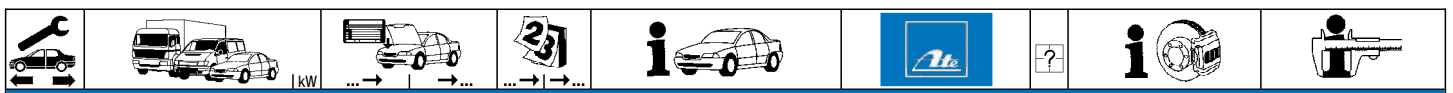

**PEUGEOT 106 (91-96)**

|       |               |               |       |       |   |   |                |                |        |        |        |
|-------|---------------|---------------|-------|-------|---|---|----------------|----------------|--------|--------|--------|
|       | 1.1           | 44 S 51224675 |       | 04.96 |   | 24.3727-0816.2                              | 580816         | 2 ↓            |        | L=1442 |        |
|       | 1.3 Rallye    | 72 S 51224675 |       | 04.96 |   |   |                |                |        |        |        |
|       | 1.4           | 55 S 51224675 |       | 04.96 |   |   |                |                |        |        |        |
|       | 1.4           | 69 S 51224675 |       | 04.96 |   |   |                |                |        |        |        |
|       | 1.4 D         | 37 S 51224675 |       | 04.96 |   |   |                |                |        |        |        |
|       | 1.5 D         | S 51224675    |       | 04.96 |   |   |                |                |        |        |        |
|       | 1.6           | 65 S 51224675 |       | 04.96 |   |   |                |                |        |        |        |
| 1.6   | 76 S 51224675 |               | 04.96 |       |   |   |                |                |        |        |        |
|       | 1.0           | ↓             |       | 08.91 | 04.96                                       | - Servolenkung <sup>1)</sup>                |                | 24.3728-0812.2 | 590812 |        | L=658  |
|       | 1.1           | ↓ 44          |       | 08.91 | 04.96                                       | - Servolenkung <sup>1)</sup>                |                |                |        |        |        |
|       | 1.3 Rallye    | ↓ 72          |       | 10.93 | 04.96                                       | - Servolenkung <sup>1)</sup>                |                |                |        |        |        |
|       | 1.0           | ↓             |       | 08.91 | 04.96                                       | + Servolenkung <sup>2)</sup>                |                | 24.3728-0814.2 | 590814 |        | L=678  |
|       | 1.1           | ↓ 44          |       | 08.91 | 04.96                                       | + Servolenkung <sup>2)</sup>                |                |                |        |        |        |
|       | 1.3 Rallye    | ↓ 72          |       | 10.93 | 04.96                                       | + Servolenkung <sup>2)</sup>                |                |                |        |        |        |
|       | 1.4           | ↓ 55          |       | 08.91 | 04.96                                       | - Servolenkung <sup>1)</sup>                |                | 24.3728-0819.2 | 590819 |        | L=1276 |
|       | 1.4           | ↓ 69          |       | 08.91 | 04.96                                       | - Servolenkung <sup>1)</sup>                |                |                |        |        |        |
|       | 1.4 D         | ↓ 37          |       | 08.92 | 04.96                                       | - Servolenkung <sup>1)</sup>                |                |                |        |        |        |
|       | 1.5 D         | ↓             |       | 06.94 | 04.96                                       | - Servolenkung <sup>1)</sup>                |                |                |        |        |        |
|       | 1.6           | ↓ 65          |       | 06.93 | 04.96                                       | - Servolenkung/ - Klimaanlage <sup>3)</sup> |                |                |        |        |        |
|       | 1.6           | ↓ 76          |       | 01.94 | 04.96                                       | - Servolenkung/ - Klimaanlage <sup>3)</sup> |                |                |        |        |        |
|       | 1.3 Rallye    | ↓ 72          |       | 10.93 | 04.96                                       | + Servolenkung <sup>2)</sup>                |                | 24.3728-0814.2 | 590814 |        | L=678  |
|       | 1.4           | ↓ 55          |       | 08.91 | 04.96                                       | + Servolenkung <sup>2)</sup>                |                |                |        |        |        |
| 1.4   | ↓ 69          |               | 08.91 | 04.96 | + Servolenkung <sup>2)</sup>                |   |                |                |        |        |        |
| 1.4 D | ↓ 37          |               | 08.92 | 04.96 | + Servolenkung <sup>2)</sup>                |   |                |                |        |        |        |
| 1.6   | ↓ 65          |               | 06.93 | 04.96 | + Servolenkung/ + Klimaanlage <sup>4)</sup> |   |                |                |        |        |        |
| 1.6   | ↓ 76          |               | 01.94 | 04.96 | + Servolenkung/ + Klimaanlage <sup>4)</sup> |   |                |                |        |        |        |
| 1.5 D | ↓             |               | 06.94 | 04.96 | + Servolenkung <sup>2)</sup>                |   | 24.3728-0315.2 | 590315         |        | L=673  |        |

**PEUGEOT 106 (96-04)**

|         |                  |      |            |       |       |       |                |                |        |                |                                |       |
|---------|------------------|------|------------|-------|-------|-------|----------------|----------------|--------|----------------|--------------------------------|-------|
|         | 1.0 i            | ↓ 33 | ORGA 08787 | 05.96 |       | - ABS |                | 03.7740-3302.4 | 300107 |                | 8"                             | ATE   |
|         | 1.0 i            | ↓ 37 | ORGA 08787 | 01.97 |       | - ABS |                |                |        |                |                                |       |
|         | 1.1              | ↓ 42 | ORGA 08787 | 09.00 |       | - ABS |                |                |        |                |                                |       |
|         | 1.1 i            | ↓ 40 | ORGA 08787 | 01.97 |       | - ABS |                |                |        |                |                                |       |
|         | 1.1 i            | ↓ 44 | ORGA 08787 | 05.96 |       | - ABS |                |                |        |                |                                |       |
|         | 1.6              | ↓ 65 |            | 05.96 | 03.04 | - ABS |                |                |        |                |                                |       |
|         | 1.6              | ↓ 74 |            | 05.96 | 03.04 | - ABS |                |                |        |                |                                |       |
|         | 1.6 16V Electric | ↓ 87 |            | 05.96 | 03.04 | - ABS |                |                |        |                |                                |       |
| 1.6 16V | ↓ 87             |      | 04.96      | 07.04 | - ABS |       |                |                |        |                |                                |       |
|         | 1.6 16V          | ↓ 87 |            | 05.96 | 03.04 | + ABS |                | 03.7750-8202.4 | 300115 |                | 9"                             | ATE   |
|         | 1.0 i            | 33   | ORGA 08787 | 05.96 |       | - ABS |                | 03.2120-4166.3 | 010452 |                | Thz 20,64                      | ATE   |
|         | 1.0 i            | 37   | ORGA 08787 | 01.97 |       | - ABS |                | 24.2120-1722.3 | 010544 |                | Thz 20,64                      | BDX   |
|         | 1.1 i            | 40   | ORGA 08787 | 01.97 |       | - ABS |                |                |        |                |                                |       |
|         | 1.1 i            | 44   | ORGA 08787 | 05.96 |       | - ABS |                |                |        |                |                                |       |
|         | 1.6              | 65   |            | 05.96 | 03.04 | - ABS |                |                |        |                |                                |       |
|         | 1.6              | 74   |            | 05.96 | 03.04 | - ABS |                |                |        |                |                                |       |
|         | 1.6 16V Electric | 87   |            | 05.96 | 03.04 | - ABS |                |                |        |                |                                |       |
|         | 1.6 16V          | 20   |            | 04.96 | 07.04 | - ABS |                |                |        |                |                                |       |
|         | 1.0 i            | 33   | ORGA 08788 |       | 03.04 | - ABS |                | 24.2119-1708.3 | 010543 |                | Thz 19,05                      | BDX   |
|         | 1.0 i            | 37   | ORGA 08788 |       | 03.04 | - ABS |                |                |        |                |                                |       |
|         | 1.1 i            | 40   | ORGA 08788 |       | 03.04 | - ABS |                |                |        |                |                                |       |
|         | 1.1 i            | 44   | ORGA 08788 |       | 03.04 | - ABS |                |                |        |                |                                |       |
|         | 1.4 i            | 55   |            | 05.96 | 03.04 | - ABS |                |                |        |                |                                |       |
|         | 1.5 D            | 40   |            | 05.96 | 03.04 | - ABS |                |                |        |                |                                |       |
| 1.5 D   | 42               |      | 10.00      | 03.04 | - ABS |       |                |                |        |                |                                |       |
| 1.0 i   | 33               |      | 05.96      | 03.04 | + ABS |       | 24.2120-1728.3 | 010626         |        | Thz 20,64      |                                |       |
| 1.0 i   | 37               |      | 01.97      | 03.01 | + ABS |       |                |                |        |                |                                |       |
| 1.1     | 42               |      | 09.00      | 10.02 | + ABS |       |                |                |        |                |                                |       |
| 1.1 i   | 40               |      | 01.97      | 03.04 | + ABS |       |                |                |        |                |                                |       |
| 1.1 i   | 44               |      | 05.96      | 03.04 | + ABS |       |                |                |        |                |                                |       |
| 1.4 i   | 55               |      | 05.96      | 03.04 | + ABS |       |                |                |        |                |                                |       |
| 1.5 D   | 40               |      | 05.96      | 03.04 | + ABS |       |                |                |        |                |                                |       |
| 1.5 D   | 42               |      | 10.00      | 03.04 | + ABS |       |                |                |        |                |                                |       |
| 1.6     | 65               |      | 05.96      | 03.04 | + ABS |       |                |                |        |                |                                |       |
| 1.6     | 74               |      | 05.96      | 03.04 | + ABS |       |                |                |        |                |                                |       |
| 1.6 16V | 87               |      | 05.96      | 03.04 | + ABS |       | 03.2122-1281.3 | 010606         |        | Thz 22,20      | ATE                            |       |
|         | 1.0 i            | 33   |            | 05.96 | 03.04 |       |                | 11.0441-4501.2 | 250015 |                | Dichtungssatz                  | ATE   |
|         | 1.0 i            | 37   |            | 01.97 | 03.04 |       |                | 11.0101-4504.2 | 260004 |                | Tragbolzensatz                 | ATE   |
|         | 1.1              | 42   |            | 09.00 | 10.02 |       |                |                |        |                |                                |       |
|         | 1.1 i            | 40   |            | 01.97 | 03.04 |       |                |                |        |                |                                |       |
|         | 1.1 i            | 44   |            | 05.96 | 03.04 |       |                |                |        |                |                                |       |
|         | 1.6              | 74   |            | 05.96 | 03.04 |       |                | 11.3481-9833.2 | 220561 |                | D=48, - Halter                 | ATE   |
|         | 1.6 16V          | 87   |            | 05.96 | 03.04 |       |                | 11.3481-9834.2 | 220562 |                | D=48, - Halter                 | ATE   |
|         |                  |      |            |       |       |       |                | 24.3481-9833.5 | 240479 |                | D=48, - Halter                 | ATE   |
|         |                  |      |            |       |       |       | 24.3481-9834.5 | 240480         |        | D=48, - Halter | ATE                            |       |
|         |                  |      |            |       |       |       | 11.0441-4811.2 | 250024         |        | Dichtungssatz  | ATE                            |       |
|         |                  |      |            |       |       |       | 11.0101-5407.2 | 260011         |        | Hülssensatz    | ATE                            |       |
|         |                  |      |            |       |       |       | 11.8171-0008.1 | 990049         |        | Führungsbolzen | ATE                            |       |
|         |                  |      |            |       |       |       | 11.8116-0129.1 | 390591         |        | Haltefeder     | ATE                            |       |
|         | 1.0 i            | 33   | ORGA 07874 | 05.96 |       | + ABS |                | 24.5111-0330.3 | 330160 | 2              | für 3-Loch-Felge <sup>5)</sup> | L=330 |
|         | 1.0 i            | 33   | ORGA 07664 | 05.96 |       | - ABS |                | 24.5111-0301.3 | 330499 | 2              | für 4-Loch-Felge <sup>6)</sup> | L=300 |
|         | 1.0 i            | 37   | ORGA 07874 | 01.97 |       | + ABS |                |                |        |                |                                |       |
|         | 1.0 i            | 37   | ORGA 07664 | 01.97 |       | - ABS |                |                |        |                |                                |       |
|         | 1.1              | 42   | ORGA 07664 | 09.00 |       | - ABS |                |                |        |                |                                |       |
|         | 1.1 i            | 44   | ORGA 07664 | 05.96 |       | - ABS |                |                |        |                |                                |       |
|         | 1.0 i            | 33   | ORGA 07875 |       | 03.04 | + ABS |                | 24.5111-0290.3 | 330108 | 2              |                                | L=290 |
|         | 1.0 i            | 33   | ORGA 07665 |       | 03.04 | - ABS |                |                |        |                |                                |       |

1) - power steering / - servosterzo / - direction assistée / - dirección asistida  
2) + power steering / + servosterzo / + direction assistée / + dirección asistida  
3) - power steering/ - air condition / - servosterzo/ + aria condizionata / - direc.assis/ - air conditionné / - direc. asist./ - aire acondic.  
4) + power steering/ + air condition. / + servosterzo/ + aria condizionata / + direc.assis/ + air conditionné / + direc. asist./ + aire acondic.  
5) for 3 bore wheel rim / per cerchione a 3 fori / pour jante à 3 trous / para Llantas de 3 taladros  
6) for 4 bore wheel rim / per cerchione a 4 fori / pour jante à 4 trous / para Llantas de 4 taladros



| PEUGEOT 106 (96-04) |       |            |            |       |                                      |                                      |                |                          |                              |           |
|---------------------|-------|------------|------------|-------|--------------------------------------|--------------------------------------|----------------|--------------------------|------------------------------|-----------|
|                     | 1.0 i | 37         | ORGA 07875 |       | 03.12                                | + ABS                                | 24.5111-0290.3 | 330108                   | 2                            | L=290     |
|                     | 1.0 i | 37         | ORGA 07665 |       | 03.04                                | - ABS                                |                |                          |                              |           |
|                     | 1.1   | 42         | ORGA 07665 |       | 10.02                                | - ABS                                |                |                          |                              |           |
|                     | 1.1 i | 40         | ORGA 07665 |       | 03.04                                | - ABS                                |                |                          |                              |           |
|                     | 1.1 i | 44         | ORGA 07665 |       | 03.04                                | - ABS                                |                |                          |                              |           |
|                     | 1.4 i | 55         | ORGA 07874 | 05.96 | 03.04                                | + ABS                                | 24.5111-0301.3 | 330499                   | 2                            | L=300     |
|                     | 1.4 i | 55         | ORGA 07664 | 05.96 |                                      | - ABS                                |                |                          |                              |           |
|                     | 1.5 D | 40         | ORGA 07874 | 05.96 |                                      | + ABS                                |                |                          |                              |           |
|                     | 1.5 D | 40         | ORGA 07664 | 05.96 |                                      | - ABS                                |                |                          |                              |           |
|                     | 1.6   | 65         | ORGA 07874 | 05.96 |                                      | + ABS                                |                |                          |                              |           |
| 1.6                 | 65    | ORGA 07664 | 05.96      |       | - ABS                                |                                      |                |                          |                              |           |
| 1.6                 | 74    | ORGA 07874 | 05.96      |       | + ABS                                |                                      |                |                          |                              |           |
| 1.6                 | 74    | ORGA 07664 | 05.96      |       | - ABS                                |                                      |                |                          |                              |           |
| 1.6 16V             | 87    | ORGA 07874 | 05.96      |       | + ABS                                |                                      |                |                          |                              |           |
| 1.6 16V Electric    | 87    | ORGA 07664 | 05.96      |       | - ABS                                |                                      |                |                          |                              |           |
|                     | 20    |            | 04.96      | 07.04 |                                      |                                      |                |                          |                              |           |
|                     | 1.4 i | 55         | ORGA 07875 |       | 03.04                                | + ABS                                | 24.5111-0290.3 | 330108                   | 2                            | L=290     |
|                     | 1.4 i | 55         | ORGA 07665 |       | 03.04                                | - ABS                                |                |                          |                              |           |
|                     | 1.5 D | 40         | ORGA 07875 |       | 03.04                                | + ABS                                |                |                          |                              |           |
|                     | 1.5 D | 40         | ORGA 07665 |       | 03.04                                | - ABS                                |                |                          |                              |           |
|                     | 1.5 D | 42         |            | 10.00 | 03.04                                | + ABS                                |                |                          |                              |           |
|                     | 1.5 D | 42         |            | 10.00 | 03.04                                | - ABS                                |                |                          |                              |           |
|                     | 1.6   | 65         | ORGA 07875 |       | 03.04                                | + ABS                                |                |                          |                              |           |
|                     | 1.6   | 65         | ORGA 07665 |       | 03.04                                | - ABS                                |                |                          |                              |           |
|                     | 1.6   | 74         | ORGA 07875 |       | 03.04                                | + ABS                                |                |                          |                              |           |
|                     | 1.6   | 74         | ORGA 07665 |       | 03.04                                | - ABS                                |                |                          |                              |           |
| 1.6 16V             | 87    | ORGA 07875 |            | 03.04 | + ABS                                |                                      |                |                          |                              |           |
| 1.6 16V Electric    | 87    | ORGA 07665 |            | 03.04 | - ABS                                |                                      |                |                          |                              |           |
|                     | 1.0 i | 33         |            | 05.96 | 03.04                                | - verstärktes Fahrwerk <sup>1)</sup> | 24.5229-0199.3 | 330534                   | 2                            | L=200     |
|                     | 1.0 i | 37         |            | 01.97 | 03.04                                | - verstärktes Fahrwerk <sup>1)</sup> |                |                          |                              |           |
|                     | 1.1   | 42         |            | 09.02 | 10.02                                | - verstärktes Fahrwerk <sup>1)</sup> |                |                          |                              |           |
|                     | 1.1 i | 40         |            | 01.97 | 03.04                                | - verstärktes Fahrwerk <sup>1)</sup> |                |                          |                              |           |
|                     | 1.1 i | 44         |            | 05.96 | 03.04                                | - verstärktes Fahrwerk <sup>1)</sup> |                |                          |                              |           |
|                     | 1.4 i | 55         |            | 05.96 | 03.04                                | - verstärktes Fahrwerk <sup>1)</sup> |                |                          |                              |           |
|                     | 1.5 D | 40         |            | 05.96 | 03.04                                | - verstärktes Fahrwerk <sup>1)</sup> |                |                          |                              |           |
|                     | 1.5 D | 42         |            | 10.00 | 03.04                                | - verstärktes Fahrwerk <sup>1)</sup> |                |                          |                              |           |
|                     | 1.6   | 65         |            | 05.96 | 03.04                                | - verstärktes Fahrwerk <sup>1)</sup> |                |                          |                              |           |
|                     | 1.6   | 74         |            | 05.96 | 03.04                                | - verstärktes Fahrwerk <sup>1)</sup> |                |                          |                              |           |
| 1.6 16V Electric    | 87    |            | 04.96      | 07.04 |                                      |                                      |                |                          |                              |           |
|                     | 1.0 i | 33         |            | 05.96 | 03.04                                | + verstärktes Fahrwerk <sup>2)</sup> | 24.5229-0199.3 | 330534                   | <input type="checkbox"/>     | L=200     |
|                     | 1.0 i | 37         |            | 01.97 | 03.04                                | + verstärktes Fahrwerk <sup>2)</sup> | 24.5229-0211.3 | 330573                   | <input type="checkbox"/>     | L=210     |
|                     | 1.1   | 42         |            | 09.00 | 10.02                                | + verstärktes Fahrwerk <sup>2)</sup> |                |                          |                              |           |
|                     | 1.1 i | 40         |            | 01.97 | 03.04                                | + verstärktes Fahrwerk <sup>2)</sup> |                |                          |                              |           |
|                     | 1.1 i | 44         |            | 05.96 | 03.04                                | + verstärktes Fahrwerk <sup>2)</sup> |                |                          |                              |           |
|                     | 1.4 i | 55         |            | 05.96 | 03.04                                | + verstärktes Fahrwerk <sup>2)</sup> |                |                          |                              |           |
|                     | 1.5 D | 40         |            | 05.96 | 03.04                                | + verstärktes Fahrwerk <sup>2)</sup> |                |                          |                              |           |
|                     | 1.5 D | 42         |            | 10.00 | 03.04                                | + verstärktes Fahrwerk <sup>2)</sup> |                |                          |                              |           |
|                     | 1.6   | 65         |            | 05.96 | 03.04                                | + verstärktes Fahrwerk <sup>2)</sup> |                |                          |                              |           |
|                     | 1.6   | 74         |            | 05.96 | 03.04                                | + verstärktes Fahrwerk <sup>2)</sup> |                |                          |                              |           |
| 1.6 16V             | 87    |            | 05.96      | 03.04 | + verstärktes Fahrwerk <sup>2)</sup> |                                      |                |                          |                              |           |
|                     | 1.0 i | 33         |            | 05.96 | 03.04                                | - ABS                                | 24.3219-1603.3 | 020200                   | <input type="checkbox"/>     | RzR 19,05 |
|                     | 1.0 i | 37         |            | 01.97 | 03.04                                | - ABS                                | 24.3219-1604.3 | 020201                   | <input type="checkbox"/>     | RzR 19,05 |
|                     | 1.1   | 42         |            | 09.00 | 10.02                                | - ABS                                | 24.3219-1609.3 | 020319                   | <input type="checkbox"/>     | RzR 19,05 |
|                     | 1.1 i | 40         |            | 01.97 | 03.04                                | - ABS                                | 24.3219-1610.3 | 020320                   | <input type="checkbox"/>     | RzR 19,05 |
|                     | 1.1 i | 44         |            | 05.96 | 03.04                                | - ABS                                |                |                          |                              |           |
|                     | 1.0 i | 33         | ORGA 08056 | 05.96 |                                      | + ABS                                | 24.3220-1711.3 | 020409                   |                              | Rz 20,64  |
|                     | 1.0 i | 37         | ORGA 08056 | 01.97 |                                      | + ABS                                |                |                          |                              |           |
|                     | 1.1 i | 40         | ORGA 08056 | 01.97 |                                      | + ABS                                |                |                          |                              |           |
|                     | 1.1 i | 44         | ORGA 08056 | 05.96 |                                      | + ABS                                |                |                          |                              |           |
|                     | 1.0 i | 33         | ORGA 08057 |       | 03.04                                | + ABS                                | 24.3220-1717.3 | 020430                   |                              | Rz 20,64  |
| 1.0 i               | 37    | ORGA 08057 |            | 03.04 | + ABS                                |                                      |                |                          |                              |           |
| 1.1                 | 42    |            | 09.00      | 10.02 | + ABS                                |                                      |                |                          |                              |           |
| 1.1 i               | 40    | ORGA 08057 |            | 03.04 | + ABS                                |                                      |                |                          |                              |           |
| 1.1 i               | 44    | ORGA 08057 |            | 03.04 | + ABS                                |                                      |                |                          |                              |           |
| 1.4 i               | 55    |            | 05.96      | 03.04 | - ABS                                | 24.3219-1609.3                       | 020319         | <input type="checkbox"/> | RzR 19,05                    |           |
| 1.5 D               | 40    |            | 05.96      | 03.04 | - ABS                                | 24.3219-1610.3                       | 020320         | <input type="checkbox"/> | RzR 19,05                    |           |
| 1.5 D               | 42    |            | 10.00      | 03.04 | - ABS                                |                                      |                |                          |                              |           |
| 1.6                 | 65    |            | 05.96      | 03.04 | - ABS                                |                                      |                |                          |                              |           |
| 1.4 i               | 55    | ORGA 08056 | 05.96      |       | + ABS                                | 24.3220-1711.3                       | 020409         |                          | Rz 20,64                     |           |
| 1.5 D               | 40    | ORGA 08056 | 05.96      |       | + ABS                                |                                      |                |                          |                              |           |
| 1.6                 | 65    | ORGA 08056 | 05.96      |       | + ABS                                |                                      |                |                          |                              |           |
| 1.4 i               | 55    | ORGA 08057 |            | 03.04 | + ABS                                | 24.3220-1717.3                       | 020430         |                          | Rz 20,64                     |           |
| 1.5 D               | 40    | ORGA 08057 |            | 03.04 | + ABS                                |                                      |                |                          |                              |           |
| 1.5 D               | 42    |            | 10.00      | 03.04 | + ABS                                |                                      |                |                          |                              |           |
| 1.6                 | 65    | ORGA 08057 |            | 03.04 | + ABS                                |                                      |                |                          |                              |           |
| Electric            | 20    |            | 04.96      | 07.04 | - ABS                                | 24.3219-1112.3                       | 020311         |                          | + 4-Loch-Felge <sup>5)</sup> | Rz 19,05  |
|                     | 1.0 i | 33         |            | 05.96 | 03.04                                |                                      | 24.3727-0816.2 | 580816                   | 2                            | L=1442    |
|                     | 1.0 i | 37         |            | 01.97 | 03.04                                |                                      |                |                          |                              |           |
|                     | 1.1   | 42         |            | 09.00 | 10.02                                |                                      |                |                          |                              |           |
|                     | 1.1 i | 40         |            | 01.97 | 03.04                                |                                      |                |                          |                              |           |
|                     | 1.1 i | 44         |            | 05.96 | 03.04                                |                                      |                |                          |                              |           |
|                     | 1.4 i | 55         |            | 05.96 | 03.04                                |                                      |                |                          |                              |           |
|                     | 1.5 D | 40         |            | 05.96 | 03.04                                |                                      |                |                          |                              |           |
|                     | 1.5 D | 42         |            | 10.00 | 03.04                                |                                      |                |                          |                              |           |
|                     |       |            |            |       |                                      |                                      |                |                          |                              |           |
|                     |       |            |            |       |                                      |                                      |                |                          |                              |           |

1) - reinforced suspension / - sospensione rinforzata / - châssis renforcé / - suspensión reforzada  
2) + reinforced suspension / + sospensione rinforzata / + châssis renforcé / + suspensión reforzada  
3) for 3 bore wheel rim / per cerchione a 3 fori / pour jante à 3 trous / para Llantas de 3 taladros  
4) for 4 bore wheel rim / per cerchione a 4 fori / pour jante à 4 trous / para Llantas de 4 taladros  
5) + 4 bore wheel rim / + cerchione a 4 fori / + jante à 4 trous / + Llantas de 4 taladros

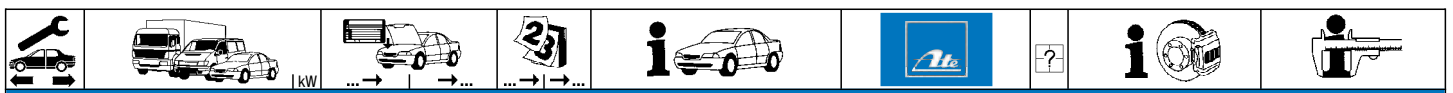

**PEUGEOT 106 (96-04)**

|  |         |    |            |       |       |   |                |        |     |  |               |
|--|---------|----|------------|-------|-------|---|----------------|--------|-----|--|---------------|
|  | 1.6     | 65 |            | 05.96 | 03.04 |   | 24.3727-0816.2 | 580816 | 2 ↓ |  | L=1442        |
|  | 1.6     | 74 |            | 05.96 | 03.04 |   | 24.3727-0817.2 | 580817 | 2 ↓ |  | L=1505        |
|  | 1.6 16V | 87 |            | 05.96 | 03.04 |   |                |        |     |  |               |
|  | 1.0 i   | 33 |            | 05.96 | 03.04 | - Servolenkung <sup>1)</sup>                | 24.3728-0842.2 | 590842 |     |  | L=1337, + AUT |
|  | 1.0 i   | 37 |            | 01.97 | 03.04 | - Servolenkung <sup>1)</sup>                |                |        |     |  |               |
|  | 1.1     | 42 |            | 09.00 | 10.02 | - Servolenkung <sup>1)</sup>                |                |        |     |  |               |
|  | 1.1 i   | 40 |            | 01.97 | 03.04 | - Servolenkung <sup>1)</sup>                |                |        |     |  |               |
|  | 1.1 i   | 44 |            | 05.96 | 03.04 | - Servolenkung <sup>1)</sup>                |                |        |     |  |               |
|  | 1.4 i   | 55 |            | 05.96 | 03.04 | - Servolenkung <sup>1)</sup>                |                |        |     |  |               |
|  | 1.5 D   | 40 |            | 05.96 | 03.04 | - Servolenkung <sup>1)</sup>                |                |        |     |  |               |
|  | 1.5 D   | 42 |            | 10.00 | 03.04 | - Servolenkung <sup>1)</sup>                |                |        |     |  |               |
|  | 1.6     | 65 |            | 05.96 | 03.04 | - Servolenkung <sup>1)</sup>                |                |        |     |  |               |
|  | 1.6     | 74 |            | 05.96 | 03.04 | - Servolenkung <sup>1)</sup>                |                |        |     |  |               |
|  | 1.6 16V | 87 |            | 05.96 | 03.04 | - Servolenkung <sup>1)</sup>                |                |        |     |  |               |
|  | 1.1     | 42 | ORGA 08940 | 09.00 |       | - Fahrschule / + Servolenkung <sup>2)</sup> | 24.3728-0844.2 | 590844 |     |  | L=1463, + AUT |
|  | 1.1 i   | 40 | ORGA 08940 | 01.97 |       | - Fahrschule / + Servolenkung <sup>2)</sup> |                |        |     |  |               |
|  | 1.1 i   | 44 | ORGA 08940 | 05.96 |       | - Fahrschule / + Servolenkung <sup>2)</sup> |                |        |     |  |               |
|  | 1.4 i   | 55 | ORGA 08940 | 05.96 |       | + Servolenkung <sup>3)</sup>                |                |        |     |  |               |
|  | 1.5 D   | 40 | ORGA 08940 | 05.96 |       | + Servolenkung <sup>3)</sup>                |                |        |     |  |               |
|  | 1.5 D   | 42 | ORGA 08940 | 10.00 |       | + Servolenkung <sup>3)</sup>                |                |        |     |  |               |
|  | 1.6     | 65 | ORGA 08940 | 05.96 |       | + Servolenkung <sup>3)</sup>                |                |        |     |  |               |
|  | 1.6     | 74 | ORGA 08940 | 05.96 |       | + Servolenkung <sup>3)</sup>                |                |        |     |  |               |
|  | 1.6 16V | 87 | ORGA 08940 | 05.96 |       | + Servolenkung <sup>3)</sup>                |                |        |     |  |               |
|  | 1.0 i   | 33 |            | 05.96 | 03.04 | + Servolenkung <sup>3)</sup>                | 24.3728-0315.2 | 590315 |     |  | L=673         |
|  | 1.0 i   | 37 |            | 01.97 | 03.04 | + Servolenkung <sup>3)</sup>                |                |        |     |  |               |
|  | 1.1     | 42 | ORGA 08941 |       | 10.02 | - Fahrschule/ + Servolenkung <sup>4)</sup>  |                |        |     |  |               |
|  | 1.1 i   | 40 | ORGA 08941 |       | 03.04 | - Fahrschule/ + Servolenkung <sup>4)</sup>  |                |        |     |  |               |
|  | 1.1 i   | 44 | ORGA 08941 |       | 03.04 | - Fahrschule/ + Servolenkung <sup>4)</sup>  |                |        |     |  |               |
|  | 1.4 i   | 55 | ORGA 08941 |       | 03.04 | + Servolenkung <sup>3)</sup>                |                |        |     |  |               |
|  | 1.5 D   | 40 | ORGA 08941 |       | 03.04 | + Servolenkung <sup>3)</sup>                |                |        |     |  |               |
|  | 1.5 D   | 42 | ORGA 08941 |       | 03.04 | + Servolenkung <sup>3)</sup>                |                |        |     |  |               |
|  | 1.6     | 65 | ORGA 08941 |       | 03.04 | + Servolenkung <sup>3)</sup>                |                |        |     |  |               |
|  | 1.6     | 74 | ORGA 08941 |       | 03.04 | + Servolenkung <sup>3)</sup>                |                |        |     |  |               |
|  | 1.6 16V | 87 | ORGA 08941 |       | 03.04 | + Servolenkung <sup>3)</sup>                |                |        |     |  |               |
|  | 1.1     | 42 |            | 09.00 | 10.02 | + Fahrschule/ + Servolenkung <sup>5)</sup>  | 24.3728-0814.2 | 590814 |     |  | L=678         |
|  | 1.1 i   | 44 |            | 05.96 | 03.04 | + Fahrschule/ + Servolenkung <sup>5)</sup>  |                |        |     |  |               |

**PEUGEOT 107 (05-)**

















|  |         |    |  |       |  |  |                |        |   |       |           |            |
|--|---------|----|--|-------|--|--|----------------|--------|---|-------|-----------|------------|
|  | 1.0     | 50 |  | 06.05 |  |  | 24.4120-1701.3 | 010846 |   | - DSC | THz 20,64 | <b>BOS</b> |
|  | 1.4 HDi | 40 |  | 06.05 |  |  |                |        |   |       |           |            |
|  | 1.0     | 50 |  | 06.05 |  |  | 24.5295-0496.3 | 331033 |   |       | L=496     |            |
|  | 1.4 HDi | 40 |  | 06.05 |  |  | 24.5262-0501.3 | 331025 |   |       | L=501     |            |
|  | 1.0     | 50 |  | 06.05 |  |  | 24.5261-0225.3 | 330909 | 2 |       | L=225     |            |
|  | 1.4 HDi | 40 |  | 06.05 |  |  |                |        |   |       |           |            |
|  | 1.0     | 50 |  | 06.05 |  |  | 24.3217-1719.3 | 020482 |   |       | Rz 17,46  | <b>BOS</b> |
|  | 1.4 HDi | 40 |  | 06.05 |  |  |                |        |   |       |           |            |
|  | 1.0     | 50 |  | 06.05 |  |  | 24.3728-0851.2 | 590851 |   |       | L=1596    |            |
|  | 1.4 HDi | 40 |  | 06.05 |  |  | 24.3728-0852.2 | 590852 |   |       | L=1479    |            |

**PEUGEOT 205 (91-98)**

|  |             |    |  |       |       |       |                |        |   |                              |                   |            |
|--|-------------|----|--|-------|-------|-------|----------------|--------|---|------------------------------|-------------------|------------|
|  | 1.0         | 33 |  | 09.90 | 09.98 |       | 03.2119-3389.3 | 010057 |   | + 4 Anschlüsse <sup>6)</sup> | THz 19,05         | <b>ATE</b> |
|  | 1.1         | 44 |  | 09.90 | 09.98 |       | 03.2120-2482.3 | 010114 |   | + 3 Anschlüsse <sup>7)</sup> | THz 20,64         | <b>ATE</b> |
|  | 1.1 i       | 44 |  | 09.90 | 09.98 |       | 03.2120-2031.3 | 010106 |   | + 4 Anschlüsse <sup>6)</sup> | THz 20,64         | <b>ATE</b> |
|  | 1.4         | 55 |  | 09.90 | 09.98 |       | 03.3517-5100.1 | 390326 |   |                              | Verschlußschraube | <b>ATE</b> |
|  | 1.4 i       | 55 |  | 09.90 | 09.98 |       |                |        |   |                              |                   |            |
|  | 1.6         | 66 |  | 09.90 | 09.98 |       |                |        |   |                              |                   |            |
|  | 1.6 i       | 66 |  | 09.90 | 09.98 | - ABS |                |        |   |                              |                   |            |
|  | 1.7 D       | 44 |  | 03.94 | 09.98 |       |                |        |   |                              |                   |            |
|  | 1.7 TD      | 57 |  | 09.90 | 09.98 |       |                |        |   |                              |                   |            |
|  | 1.9 D       | 47 |  | 09.90 | 09.98 |       |                |        |   |                              |                   |            |
|  | 1.9 GTI     | 88 |  | 09.90 | 10.94 | - ABS |                |        |   |                              |                   |            |
|  | 1.9 GTI     | 94 |  | 09.90 | 09.98 | - ABS |                |        |   |                              |                   |            |
|  | 1.9 GTI/CTI | 75 |  | 09.90 | 07.94 | - ABS |                |        |   |                              |                   |            |
|  | 1.0         | 33 |  | 09.90 | 09.98 |       | 24.3481-1609.7 | 220197 |   |                              | D=48, + Halter    | <b>LUC</b> |
|  | 1.1         | 44 |  | 09.90 | 09.98 |       | 24.3481-1610.7 | 220198 |   |                              | D=48, + Halter    | <b>LUC</b> |
|  | 1.4         | 55 |  | 09.90 | 09.98 |       |                |        |   |                              |                   |            |
|  | 1.6         | 66 |  | 09.90 | 09.98 |       |                |        |   |                              |                   |            |
|  | 1.1 i       | 44 |  | 09.90 | 09.98 |       | 24.3481-1609.7 | 220197 |   |                              | D=48, + Halter    | <b>LUC</b> |
|  | 1.4 i       | 55 |  | 09.90 | 09.98 |       | 24.3481-1610.7 | 220198 |   |                              | D=48, + Halter    | <b>LUC</b> |
|  | 1.6 i       | 66 |  | 09.90 | 09.98 |       |                |        |   |                              |                   |            |
|  | 1.9 GTI/CTI | 75 |  | 09.90 | 07.94 |       |                |        |   |                              |                   |            |
|  | 1.7 TD      | 57 |  | 06.93 | 09.98 |       | 11.3481-9833.2 | 220561 |   |                              | D=48, - Halter    | <b>ATE</b> |
|  |             |    |  |       |       |       | 11.3481-9834.2 | 220562 |   |                              | D=48, - Halter    | <b>ATE</b> |
|  |             |    |  |       |       |       | 24.3481-9833.5 | 240479 |   |                              | D=48, - Halter    | <b>ATE</b> |
|  |             |    |  |       |       |       | 24.3481-9834.5 | 240480 |   |                              | D=48, - Halter    | <b>ATE</b> |
|  |             |    |  |       |       |       | 11.0441-4811.2 | 250024 |   |                              | Dichtungssatz     | <b>ATE</b> |
|  |             |    |  |       |       |       | 11.0101-5407.2 | 260011 |   |                              | Hülssensatz       | <b>ATE</b> |
|  |             |    |  |       |       |       | 11.8171-0008.1 | 990049 |   |                              | Führungsbolzen    | <b>ATE</b> |
|  |             |    |  |       |       |       | 11.8116-0129.1 | 390591 | 2 |                              | Haltefeder        | <b>ATE</b> |
|  | 1.9 D       | 47 |  | 09.90 | 09.98 |       | 24.3481-1609.7 | 220197 |   |                              | D=48, + Halter    | <b>LUC</b> |
|  |             |    |  |       |       |       | 24.3481-1610.7 | 220198 |   |                              | D=48, + Halter    | <b>LUC</b> |

1) - power steering / - servosterzo / - direction assistée / - dirección asistida  
2) - driving school/+power steering / - scuola guida/ + servosterzo / - auto école/ + direct.assistée / - autoescuela/ + direcc.asistida  
3) + power steering / + servosterzo / + direction assistée / + dirección asistida  
4) - driving school/+power steering / - scuola guida/ + servosterzo / - auto école/ + direct.assistée / - autoescuela/ + direcc.asistida  
5) + driving school/+power steering / + scuola guida/ + servosterzo / + auto école/ + direction assistée / + autoescuela/ + direcc.asistida  
6) + 4 connections / + 4 attacchi / + 4 raccordements / + 4 conexiones  
7) + 3 connections / + 3 attacchi / + 3 raccordements / + 3 conexiones



|     |  |  |  |  |  |  |  |  |                              |           |
|--|--|--|--|--|---|--|--|--|------------------------------|-----------|
| PEUGEOT 205 (91-98)  |  |  |  |  |   |  |  |  |                              |           |
|    | 1.9 GTI  | 88   |  | 09.90  | 10.94   | 11.3481-9833.2   | 220561   | <input type="checkbox"/>   | D=48, - Halter               | ATE       |
|  | 1.9 GTI  | 94   |  | 09.90  | 09.98   | 11.3481-9834.2   | 220562   | <input type="checkbox"/>   | D=48, - Halter               | ATE       |
|  |  |  |  |  |   | 24.3481-1615.5   | 240031   | <input type="checkbox"/>   | D=48, - Halter               | LUC       |
|  |  |  |  |  |   | 24.3481-1616.5   | 240032   | <input type="checkbox"/>   | D=48, - Halter               | LUC       |
|  |  |  |  |  |   | 11.0441-4811.2   | 250024   | <input type="checkbox"/>   | Dichtungssatz                | ATE       |
|  |  |  |  |  |   | 11.0101-5407.2   | 260011   |  | Hülssensatz                  | ATE       |
|  |  |  |  |  |   | 24.0101-4806.2   | 260052   |  | Einbausatz                   | LUC       |
|  |  |  |  |  |   | 11.8116-0129.1   | 390591   |  | Haltefeder                   | ATE       |
|  |  |  |  |  |   | 11.8171-0008.1   | 990049   |  | Führungsbolzen               | ATE       |
|    | 1.0  | 33   |  | 09.90  | 09.98   | 24.5112-0325.3   | 330415   | 2  | Länge beachten <sup>1)</sup> | L=355     |
|  | 1.1  |  |  | 09.90  | 09.98   | 24.5112-0405.3   | 330428   | 2  | Länge beachten <sup>1)</sup> | L=405     |
|  | 1.1 i  | 44   |  | 09.90  | 09.98   |  |  |  |                              |           |
|  | 1.4  |  |  | 09.90  | 09.98   |  |  |  |                              |           |
|  | 1.4 i  | 55   |  | 09.90  | 09.98   |  |  |  |                              |           |
|  | 1.6  |  |  | 09.90  | 09.98   |  |  |  |                              |           |
|  | 1.6 i  |  |  | 09.90  | 09.98   |  |  |  |                              |           |
|  | 1.7 D  | 44   |  | 03.94  | 09.98   |  |  |  |                              |           |
|  | 1.9 D  | 47   |  | 09.90  | 09.98   |  |  |  |                              |           |
|  | 1.9 GTI/CTI  | 75   |  | 09.90  | 07.94   |  |  |  |                              |           |
|  | 1.7 TD   | 57   |  | 09.90  | 09.98   | 24.5112-0430.3   | 330615   | 2  |                              | L=430     |
|  | 1.6 i  | 66   |  | 09.90  | 09.98   | 24.5112-0405.3   | 330428   | 2  |                              | L=405     |
|  | 1.9 GTI  | 88   |  | 09.90  | 10.94   |  |  |  |                              |           |
|  | 1.9 GTI  | 94   |  | 09.90  | 09.98   |  |  |  |                              |           |
|  | 1.9 GTI/CTI  | 75   |  | 09.90  | 07.94   |  |  |  |                              |           |
|    | 1.0  | 33   |  | 09.90  | 09.98   | 24.5228-0255.3   | 330409   | 2  |                              | L=255     |
|  | 1.1  |  |  | 09.90  | 09.98   |  |  |  |                              |           |
|  | 1.1 i  | 44   |  | 09.90  | 09.98   |  |  |  |                              |           |
|  | 1.4  |  |  | 09.90  | 09.98   |  |  |  |                              |           |
|  | 1.4 i  | 55   |  | 09.90  | 09.98   |  |  |  |                              |           |
|  | 1.6  |  |  | 09.90  | 09.98   |  |  |  |                              |           |
|  | 1.6 i  |  |  | 09.90  | 09.98   |  |  |  |                              |           |
|  | 1.7 TD   | 57   |  | 09.90  | 09.98   |  |  |  |                              |           |
|  | 1.9 D Lim.   | 47   |  | 09.90  | 09.98   |  |  |  |                              |           |
|  | 1.9 GTI/CTI  | 75   |  | 09.90  | 07.94   |  |  |  |                              |           |
|  | 1.7 D  | 44   |  | 03.94  | 09.98   | 24.5112-0325.3   | 330415   | 2  |                              | L=355     |
|  | 1.9 D Kombi  | 47   |  | 09.90  | 09.98   |  |  |  |                              |           |
|  | 1.9 GTI  | 88   |  | 09.90  | 10.94   | 24.5112-0155.3   | 330507   | 2  | Länge beachten <sup>1)</sup> | L=155     |
|  | 1.9 GTI  | 94   |  | 09.90  | 09.98   | 24.5228-0255.3   | 330409   | 2  | Länge beachten <sup>1)</sup> | L=255     |
|  | 1.6 i  | 66   |  | 09.90  | 09.98   | 24.5112-0300.3   | 330696   | 2  | Länge beachten <sup>1)</sup> | L=300     |
|  | 1.9 GTI  | 88   |  | 09.90  | 10.94   | 24.5112-0155.3   | 330507   | 2  | Länge beachten <sup>1)</sup> | L=155     |
|  | 1.9 GTI  | 94   |  | 09.90  | 09.98   |  |  |  |                              |           |
|  | 1.9 GTI/CTI  | 75   |  | 09.90  | 07.94   |  |  |  |                              |           |
|  | 1.0  | 33   |  | 09.90  | 09.98   | 24.3219-1605.3   | 020202   | <input type="checkbox"/>   |                              | RzR 19,05 |
|  | 1.1  |  |  | 09.90  | 09.98   | 24.3219-1606.3   | 020203   | <input type="checkbox"/>   |                              | RzR 19,05 |
|  | 1.1 i  | 44   |  | 09.90  | 09.98   | 24.3219-1601.3   | 020198   | <input type="checkbox"/>   |                              | RzR 19,05 |
|  | 1.4  |  |  | 09.90  | 09.98   | 24.3219-1602.3   | 020199   | <input type="checkbox"/>   |                              | RzR 19,05 |
|  | 1.4 i  | 55   |  | 09.90  | 09.98   |  |  |  |                              |           |
|  | 1.6  |  |  | 09.90  | 09.98   |  |  |  |                              |           |
|  | 1.6 i  | 66   |  | 09.90  | 09.98   |  |  |  |                              |           |
|  | 1.7 TD   | 57   |  | 09.90  | 09.98   |  |  |  |                              |           |
|  | 1.9 D Lim.   | 47   |  | 09.90  | 09.98   |  |  |  |                              |           |
|  | 1.7 TD   | 57   |  | 09.90  | 09.98   | 24.3219-1118.3   | 020332   |  |                              | Rz 19,05  |
|  | 1.9 GTI/CTI  | 75   |  | 09.90  | 07.94   |  |  |  |                              |           |
|  | 1.7 D  | 44   |  | 03.94  | 09.98   | 24.3220-1619.3   | 020246   |  |                              | Rz 20,64  |
|  | 1.9 D Kombi  | 47   |  | 09.90  | 09.98   |  |  |  |                              |           |
|  | 1.0  | 33   |  | 09.90  | 09.98   | 24.3727-0802.2   | 580802   | <input type="checkbox"/>   |                              | L=1372    |
|  | 1.1  |  |  | 09.90  | 09.98   | 24.3727-0801.2   | 580801   | <input type="checkbox"/>   |                              | L=1386    |
|  | 1.1 i  | 44   |  | 09.90  | 09.98   |  |  |  |                              |           |
|  | 1.4  |  |  | 09.90  | 09.98   |  |  |  |                              |           |
|  | 1.4 i  | 55   |  | 09.90  | 09.98   |  |  |  |                              |           |
|  | 1.6  |  |  | 09.90  | 09.98   |  |  |  |                              |           |
|  | 1.6 i  | 66   |  | 09.90  | 09.98   |  |  |  |                              |           |
|  | 1.7 D  | 44   |  | 03.94  | 09.98   |  |  |  |                              |           |
|  | 1.7 TD   | 57   |  | 09.90  | 09.98   |  |  |  |                              |           |
|  | 1.9 D  | 47   |  | 09.90  | 09.98   |  |  |  |                              |           |
|  | 1.9 GTI/CTI  | 75   |  | 09.90  | 07.94   |  |  |  |                              |           |
|  | 1.9 GTI  | 88   |  | 09.90  | 10.94   | 24.3727-0810.2   | 580810   | <input type="checkbox"/>   |                              | L=1417    |
|  | 1.9 GTI  | 94   |  | 09.90  | 09.98   | 24.3727-0811.2   | 580811   | <input type="checkbox"/>   |                              | L=1432    |
|  | 1.9 GTI  | 88   |  | 09.90  | 10.94   | 24.6042-1701.3   | 320149   |  |                              | BRE 2/20  |
|  | 1.9 GTI  | 94   |  | 09.90  | 09.98   |  |  |  |                              |           |
|  | 1.0  | 33   |  | 09.90  | 09.98   | 24.3728-0810.2   | 590810   |  |                              | L=625     |
|  | 1.1  |  |  | 09.90  | 09.98   |  |  |  |                              |           |
|  | 1.1 i  | 44   |  | 09.90  | 09.98   |  |  |  |                              |           |
|  | 1.4  |  |  | 09.90  | 09.98   | 24.3728-0811.2   | 590811   |  |                              | L=1271    |
|  | 1.4 i  | 55   |  | 09.90  | 09.98   |  |  |  |                              |           |
|  | 1.6  |  |  | 09.90  | 09.98   | 24.3728-0813.2   | 590813   |  |                              | L=660     |
|  | 1.6 i  | 66   |  | 09.90  | 09.98   |  |  |  |                              |           |
|  | 1.7 D  | 44   |  | 03.94  | 09.98   |  |  |  |                              |           |
|  | 1.7 TD   | 57   |  | 09.90  | 09.98   |  |  |  |                              |           |
|  | 1.9 D  | 47   |  | 09.90  | 09.98   |  |  |  |                              |           |
|  | 1.9 GTI  | 88   |  | 09.90  | 10.94   |  |  |  |                              |           |
|  | 1.9 GTI  | 94   |  | 09.90  | 09.98   |  |  |  |                              |           |
|  | 1.9 GTI/CTI  | 75   |  | 09.90  | 07.94   |  |  |  |                              |           |

<sup>1)</sup> notice length / attenzione lunghezza / faire attention longueur / atención largo

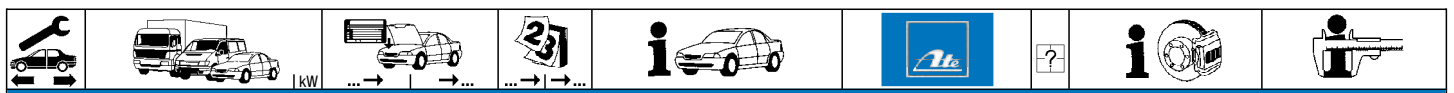

**PEUGEOT 206 Limousine (98-09)**

|  |                |     |            |              |  |                       |        |  |           |     |
|--|----------------|-----|------------|--------------|--|-----------------------|--------|--|-----------|-----|
|  | 1.4            | 55  | ORGA 09820 | <b>09.98</b> | - ABS/ + Schaltgetriebe <sup>1)</sup>    | <b>03.7750-0532.4</b> | 300110 |  | 9"        | ATE |
|  | 1.4 HDi        | 50  | ORGA 09820 | <b>09.01</b> | - ABS                                    |                       |        |  |           |     |
|  | 1.4 HDi        | 51  | ORGA 09820 | <b>09.02</b> | - ABS                                    |                       |        |  |           |     |
|  | 1.6            | 65  |            | <b>09.98</b> | - ABS/ + Schaltgetriebe <sup>1)</sup>    |                       |        |  |           |     |
|  | 1.1            |     | ORGA 09456 | <b>09.98</b> | + ABS                                    | <b>03.7750-1832.4</b> | 300111 |  | 9"        | ATE |
|  | 1.4            | 55  | ORGA 09456 | <b>09.98</b> | + ABS/ + Schaltgetriebe <sup>2)</sup>    |                       |        |  |           |     |
|  | 1.4 HDi        | 50  | ORGA 09456 | <b>09.01</b> | + ABS                                    |                       |        |  |           |     |
|  | 1.4 HDi        | 51  | ORGA 09456 | <b>09.02</b> | + ABS                                    |                       |        |  |           |     |
|  | 1.6            | 65  |            | <b>09.98</b> | + ABS/ + Schaltgetriebe <sup>2)</sup>    |                       |        |  |           |     |
|  | 1.6 16V        | 80  |            | <b>12.00</b> | + ABS/ + Schaltgetriebe <sup>2)</sup>    |                       |        |  |           |     |
|  | 1.6 16V        | 80  |            | <b>12.00</b> | - ABS/ + Schaltgetriebe <sup>1)</sup>    |                       |        |  |           |     |
|  | 1.6 16V        | 80  | ORGA 09821 |              | - ABS/ + Schaltgetriebe <sup>1)</sup>    | <b>03.7750-6232.4</b> | 300215 |  | 9"        | ATE |
|  | 1.1            |     | ORGA 09457 |              | + ABS                                    | <b>03.7853-1602.4</b> | 300167 |  | 9"        | ATE |
|  | 1.4            | 55  | ORGA 09457 |              | + ABS/ + Schaltgetriebe <sup>2)</sup>    |                       |        |  |           |     |
|  | 1.4 HDi        | 50  | ORGA 09457 |              | + ABS                                    |                       |        |  |           |     |
|  | 1.4 HDi        | 51  | ORGA 09457 |              | + ABS                                    |                       |        |  |           |     |
|  | 1.6 16V        | 80  | ORGA 09457 |              | + ABS/ + Schaltgetriebe <sup>2)</sup>    |                       |        |  |           |     |
|  | 1.1            |     | ORGA 09741 |              | + ABS                                    | <b>03.7853-2602.4</b> | 300196 |  | 9"        | ATE |
|  | 1.4            | 55  | ORGA 09741 |              | + ABS/ + Schaltgetriebe <sup>2)</sup>    |                       |        |  |           |     |
|  | 1.4 16V        | 65  |            | <b>10.03</b> | + ABS                                    |                       |        |  |           |     |
|  | 1.4 HDi        | 50  | ORGA 09821 |              | + ABS                                    |                       |        |  |           |     |
|  | 1.4 HDi        | 51  | ORGA 09821 |              | + ABS                                    |                       |        |  |           |     |
|  | 1.4 HDi eco 70 | 50  |            | <b>09.08</b> | + ABS                                    |                       |        |  |           |     |
|  | 1.6 16V        | 80  | ORGA 09741 |              | + ABS/ + Schaltgetriebe <sup>2)</sup>    |                       |        |  |           |     |
|  | 1.6 HDi 110    | 80  |            | <b>05.04</b> | + ABS/ + (N) (S) (FIN)                   |                       |        |  |           |     |
|  | 1.4            | 55  | ORGA 09820 | <b>09.98</b> | - ABS/ + Automatikgetriebe <sup>3)</sup> | <b>03.7750-2232.4</b> | 300112 |  | 9"        | ATE |
|  | 1.4            | 55  | ORGA 09456 | <b>09.98</b> | + ABS/ + Automatikgetriebe <sup>4)</sup> |                       |        |  |           |     |
|  | 1.6            | 65  |            | <b>09.98</b> | + Automatikgetriebe <sup>3)</sup>        |                       |        |  |           |     |
|  | 1.6 16V        | 80  | ORGA 09820 | <b>12.00</b> | - ABS/ + Automatikgetriebe <sup>3)</sup> |                       |        |  |           |     |
|  | 1.6 16V        | 80  | ORGA 09456 | <b>12.00</b> | + ABS/ + Automatikgetriebe <sup>4)</sup> |                       |        |  |           |     |
|  | 1.4            | 55  | ORGA 09821 |              | - ABS/ + Automatikgetriebe <sup>3)</sup> | <b>03.7750-6332.4</b> | 300226 |  | 9"        | ATE |
|  | 1.4 16V        | 65  |            | <b>10.03</b> | - ABS/ + Automatikgetriebe <sup>3)</sup> |                       |        |  |           |     |
|  | 1.6 16V        | 80  | ORGA 09821 |              | - ABS/ + Automatikgetriebe <sup>3)</sup> |                       |        |  |           |     |
|  | 1.4            | 55  | ORGA 09741 |              | + ABS/ + Automatikgetriebe <sup>4)</sup> | <b>03.7853-2702.4</b> | 300269 |  | 9"        | ATE |
|  | 1.6 16V        | 80  | ORGA 09741 |              | + ABS/ + Automatikgetriebe <sup>4)</sup> |                       |        |  |           |     |
|  | 1.6 HDi 110    | 80  |            | <b>05.04</b> | + ABS/ + (N) (S) (FIN)                   |                       |        |  |           |     |
|  | 1.9 D          | 51  |            | <b>09.98</b> | <b>02.09</b>                             | <b>03.7750-0532.4</b> | 300110 |  | 9"        | ATE |
|  |                |     |            |              |  | <b>03.7750-2232.4</b> | 300112 |  | 9"        | ATE |
|  |                |     |            |              |  |                       |        |  |           |     |
|  | 1.9 D          | 51  | ORGA 09456 | <b>09.98</b> | + ABS                                    | <b>03.7750-1832.4</b> | 300111 |  | 9"        | ATE |
|  |                |     |            |              |  | <b>03.7750-2232.4</b> | 300112 |  | 9"        | ATE |
|  |                |     |            |              |  |                       |        |  |           |     |
|  | 1.9 D          | 51  | ORGA 09457 |              | + ABS                                    | <b>03.7853-1602.4</b> | 300167 |  | 9"        | ATE |
|  |                |     |            |              |  |                       |        |  |           |     |
|  | 2.0 HDi        | 66  | ORGA 09820 | <b>12.99</b> |  | <b>03.7750-1832.4</b> | 300111 |  | 9"        | ATE |
|  |                |     |            |              |  | <b>03.7750-2232.4</b> | 300112 |  | 9"        | ATE |
|  |                |     |            |              |  |                       |        |  |           |     |
|  | 2.0 HDi        | 66  | ORGA 09821 |              | <b>02.09</b>                             | <b>03.7750-6232.4</b> | 300215 |  | 9"        | ATE |
|  |                |     |            |              |  | <b>03.7750-6332.4</b> | 300226 |  | 9"        | ATE |
|  |                |     |            |              |  |                       |        |  |           |     |
|  | 2.0 HDi        | 66  | ORGA 09456 | <b>12.99</b> | + ABS                                    | <b>03.7750-1832.4</b> | 300111 |  | 9"        | ATE |
|  |                |     |            |              |  | <b>03.7750-2232.4</b> | 300112 |  | 9"        | ATE |
|  |                |     |            |              |  |                       |        |  |           |     |
|  | 2.0 HDi        | 66  | ORGA 09457 |              | + ABS                                    | <b>03.7853-1602.4</b> | 300167 |  | 9"        | ATE |
|  |                |     | ORGA 09820 |              |  |                       |        |  |           |     |
|  |                |     |            |              |  |                       |        |  |           |     |
|  | 2.0 HDi        | 66  | ORGA 09821 |              | + ABS                                    | <b>03.7853-2602.4</b> | 300196 |  | 9"        | ATE |
|  |                |     |            |              |  | <b>03.7853-2702.4</b> | 300269 |  | 9"        | ATE |
|  |                |     |            |              |  |                       |        |  |           |     |
|  | 2.0 S16        | 99  |            | <b>04.99</b> | <b>10.00</b>                             | <b>03.7760-5302.4</b> | 300179 |  | 10"       | ATE |
|  | 2.0 S16        | 100 | ORGA 09456 | <b>10.00</b> |  |                       |        |  |           |     |
|  |                |     |            |              |  |                       |        |  |           |     |
|  | 2.0 RC         | 130 | ORGA 09555 |              | <b>02.09</b>                             | <b>03.7863-6502.4</b> | 300232 |  | 10"       | ATE |
|  | 2.0 S16        | 100 | ORGA 09457 |              | <b>02.09</b>                             |                       |        |  |           |     |
|  | 1.1            |     |            | <b>09.98</b> | <b>02.09</b>                             | <b>03.2120-4321.3</b> | 010525 |  | THz 20,64 | ATE |
|  | 1.4            | 55  |            | <b>09.98</b> | <b>02.09</b>                             | <b>24.2120-1737.3</b> | 010757 |  | THz 20,64 | ATE |
|  | 1.4 HDi eco 70 | 50  |            | <b>09.08</b> | <b>02.09</b>                             | <b>03.2122-1351.3</b> | 010528 |  | THz 22,20 | ATE |
|  | 1.6            | 65  |            | <b>09.98</b> | + Schaltgetriebe <sup>6)</sup>           |                       |        |  |           |     |
|  | 1.9 D          | 51  |            | <b>09.98</b> | - (N) (S) (FIN)                          |                       |        |  |           |     |
|  | 1.4 HDi        | 50  |            | <b>09.01</b> | <b>02.09</b>                             | <b>03.2120-4321.3</b> | 010525 |  | THz 20,64 | ATE |
|  | 1.4 HDi        | 51  |            | <b>09.02</b> | <b>02.07</b>                             | <b>24.2120-1737.3</b> | 010757 |  | THz 20,64 | ATE |
|  |                |     |            |              |  |                       |        |  |           |     |
|  | 1.4            | 55  |            | <b>09.98</b> | + Automatikgetriebe <sup>5)</sup>        | <b>03.4122-0031.3</b> | 010611 |  | THz 22,20 | ATE |
|  | 1.6            | 65  |            | <b>09.98</b> | + Automatikgetriebe <sup>5)</sup>        | <b>03.4122-0041.3</b> | 010612 |  | THz 22,20 | ATE |
|  | 1.9 D          | 51  |            | <b>09.98</b> | + (N) (S) (FIN)                          |                       |        |  |           |     |
|  | 2.0 HDi        | 66  |            | <b>12.99</b> | + (N) (S) (FIN)                          |                       |        |  |           |     |
|  | 1.4 16V        | 65  |            | <b>10.03</b> | <b>02.09</b>                             | <b>03.2122-1356.3</b> | 010529 |  | THz 22,20 | ATE |
|  | 1.6 16V        | 80  |            | <b>12.00</b> | <b>02.09</b>                             |                       |        |  |           |     |
|  | 2.0 HDi        | 66  |            | <b>12.99</b> | + Schaltgetriebe <sup>6)</sup>           |                       |        |  |           |     |
|  |                |     |            |              |  |                       |        |  |           |     |
|  | 1.6 16V        | 80  |            | <b>12.00</b> | + Automatikgetriebe <sup>5)</sup>        | <b>03.4122-0031.3</b> | 010611 |  | THz 22,20 | ATE |
|  | 2.0 HDi        | 66  |            | <b>12.99</b> | + (N) (S) (FIN)                          |                       |        |  |           |     |
|  |                |     |            |              |  |                       |        |  |           |     |
|  | 1.4 16V        | 65  |            | <b>10.03</b> | <b>02.09</b>                             | <b>03.2122-1351.3</b> | 010528 |  | THz 22,20 | ATE |
|  | 1.4 HDi        | 50  |            | <b>09.01</b> | <b>02.09</b>                             | <b>03.2122-1942.3</b> | 010700 |  | THz 22,20 | ATE |
|  | 1.4 HDi        | 51  |            | <b>09.02</b> | <b>02.07</b>                             |                       |        |  |           |     |
|  | 1.4 HDi eco 70 | 50  |            | <b>09.08</b> | <b>02.09</b>                             |                       |        |  |           |     |
|  | 1.6 16V        | 80  |            | <b>12.00</b> | + Schaltgetriebe <sup>6)</sup>           |                       |        |  |           |     |
|  | 1.6 HDi 110    | 80  |            | <b>05.04</b> | - (N) (S) (FIN)                          |                       |        |  |           |     |
|  | 2.0 HDi        | 66  |            | <b>09.98</b> | - (N) (S) (FIN)                          |                       |        |  |           |     |
|  | 2.0 S16        | 99  |            | <b>04.99</b> | <b>10.00</b>                             |                       |        |  |           |     |
|  | 2.0 S16        | 100 |            | <b>10.00</b> | <b>02.07</b>                             |                       |        |  |           |     |
|  |                |     |            |              |  |                       |        |  |           |     |
|  | 1.6 16V        | 80  |            | <b>10.00</b> | + Automatikgetriebe <sup>5)</sup>        | <b>03.4122-0041.3</b> | 010612 |  | THz 22,20 | ATE |
|  | 1.6 HDi 110    | 80  |            | <b>05.04</b> | + (N) (S) (FIN)                          | <b>03.4122-0054.3</b> | 010813 |  | THz 22,20 | ATE |
|  | 2.0 HDi        | 66  |            | <b>12.99</b> | + (N) (S) (FIN)                          |                       |        |  |           |     |

<sup>1)</sup> - ABS/ + manual transmission / - ABS/ + scatola camb.velocità / - ABS/ + transmission mécanique / - ABS/ + cambio de velocidad  
<sup>2)</sup> + ABS/ + manual transm. / + ABS/+ scatola camb.velocità / + ABS/ + transmission mécanique / + ABS/ + cambio de velocidad  
<sup>3)</sup> - ABS/ + autom.transmission / - ABS/ + scatola cambio autom. / - ABS/ + transmission automatique / - ABS/ + cambio automático  
<sup>4)</sup> + ABS/ + autom.transmission / + ABS/ + scatola cambio autom. / + ABS/ + transmission automatique / + ABS/ + cambio automático

<sup>5)</sup> + autom.transmission / + scatola cambio automatico / + transmission automatique / + cambio automático  
<sup>6)</sup> + manual transmission / + scatola cambio velocità / + transmission mécanique / + cambio de velocidad



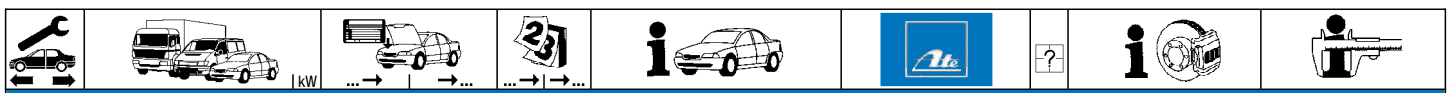

**PEUGEOT 206 Limousine (98-09)**

|  |                   |     |            |            |       |   |                                  |                  |                |                                    |                |     |
|--|-------------------|-----|------------|------------|-------|---|----------------------------------|------------------|----------------|------------------------------------|----------------|-----|
|  | 1.6 16V           | 80  |            | 12.00      | 02.09 | + Schaltgetriebe <sup>1)</sup>          | 03.2122-1356.3<br>03.2122-1351.3 | 010529<br>010528 | - ABS<br>+ ABS | THz 22,20<br>THz 22,20             | ATE<br>ATE     |     |
|  | 2.0 RC            | 130 |            | 07.03      | 02.09 |   | 03.2122-1942.3                   | 010700           |                | THz 22,20                          | ATE            |     |
|  | 1.1               |     | ORGA 08882 | 09.98      |       | + ABS                                   | 24.3481-1741.5                   | 240245           |                | D=48, - Halter                     | BOS            |     |
|  | 1.1               |     | ORGA 08238 | 09.98      |       | - ABS                                   | 24.3481-1742.5                   | 240246           |                | D=48, - Halter                     | BOS            |     |
|  | 1.4               | 55  | ORGA 08882 | 09.98      |       | - ROL GAR/+Schaltgetriebe <sup>2)</sup> |                                  |                  |                |                                    |                |     |
|  | 1.1               |     | ORGA 08610 | ORGA 08882 |       | - ABS                                   | 24.3481-1741.5<br>24.3481-1742.5 | 240245<br>240246 | +              | D=48, - Halter<br>D=48, - Halter   | BOS<br>BOS     |     |
|  | 1.1               |     | ORGA 08883 | ORGA 09974 |       | + ABS                                   | 24.3481-1771.5                   | 240375           |                | D=48, - Halter                     | BOS            |     |
|  | 1.1               |     | ORGA 08883 | ORGA 09974 |       | +  /-ABS                                | 24.3481-1772.5                   | 240376           |                | D=48, - Halter                     | BOS            |     |
|  | 1.4               | 55  | ORGA 08883 | ORGA 09974 |       | - ROL GAR/+Schaltgetriebe <sup>2)</sup> |                                  |                  |                |                                    |                |     |
|  | 1.1               |     | ORGA 09975 |            | 02.09 |   | 24.3481-1771.5                   | 240375           |                | - belüftete Scheiben <sup>3)</sup> | D=48, - Halter | BOS |
|  | 1.4               | 55  | ORGA 09975 |            | 02.09 | - ROL GAR/+Schaltgetriebe <sup>2)</sup> | 24.3481-1772.5                   | 240376           |                | - belüftete Scheiben <sup>3)</sup> | D=48, - Halter | BOS |
|  | 1.4 HDi           | 50  |            | 09.01      | 02.09 |   | 24.3481-1769.5                   | 240373           |                | + belüftete Scheiben <sup>4)</sup> | D=48, - Halter | BOS |
|  | 1.4 HDi           | 51  |            | 09.02      | 02.07 |   | 24.3481-1770.5                   | 240374           |                | + belüftete Scheiben <sup>4)</sup> | D=48, - Halter | BOS |
|  | 1.4 HDi eco 70    | 50  |            | 09.08      | 02.09 |   |                                  |                  |                |                                    |                |     |
|  | 1.4               | 55  | ORGA 08749 | 09.98      |       | + Automatikgetriebe <sup>5)</sup>       | 24.3481-1739.5                   | 240243           |                | D=48, - Halter                     | BOS            |     |
|  | 1.4 Roland Garros | 55  | ORGA 08749 | 09.98      |       |   | 24.3481-1740.5                   | 240244           |                | D=48, - Halter                     | BOS            |     |
|  | 1.6               | 65  | ORGA 08749 | 09.98      |       |   |                                  |                  |                |                                    |                |     |
|  | 1.9 D             | 51  | ORGA 08749 | 09.98      |       |   |                                  |                  |                |                                    |                |     |
|  | 1.4               | 55  | ORGA 08750 |            | 02.09 | + Automatikgetriebe <sup>5)</sup>       | 24.3481-1769.5                   | 240373           |                | D=48, - Halter                     | BOS            |     |
|  | 1.4 Roland Garros | 55  | ORGA 08750 |            | 02.09 |   | 24.3481-1770.5                   | 240374           |                | D=48, - Halter                     | BOS            |     |
|  | 1.6               | 65  | ORGA 08750 |            | 02.09 |   |                                  |                  |                |                                    |                |     |
|  | 1.9 D             | 51  | ORGA 08750 |            | 02.09 |   |                                  |                  |                |                                    |                |     |
|  | 1.6 16V           | 80  | ORGA 08777 | 12.00      |       |   | 24.3541-1767.5                   | 240237           |                | D=54, - Halter                     | BOS            |     |
|  | 2.0 HDi           | 66  | ORGA 08777 | 12.99      |       |   | 24.3541-1768.5                   | 240238           |                | D=54, - Halter                     | BOS            |     |
|  | 2.0 S16           | 99  |            | 04.99      | 10.00 |   |                                  |                  |                |                                    |                |     |
|  | 2.0 S16           | 100 | ORGA 08777 | 10.00      |       |   |                                  |                  |                |                                    |                |     |
|  | 1.4 16V           | 65  |            | 10.03      | 02.09 |   | 24.3541-1771.5                   | 240239           |                | D=54, - Halter                     | BOS            |     |
|  | 1.6 16V           | 80  | ORGA 09079 |            | 02.09 |   | 24.3541-1772.5                   | 240240           |                | D=54, - Halter                     | BOS            |     |
|  | 1.6 HDi 110       | 80  |            | 05.04      | 02.09 |   |                                  |                  |                |                                    |                |     |
|  | 2.0 HDi           | 66  | ORGA 09079 |            | 02.09 |   |                                  |                  |                |                                    |                |     |
|  | 2.0 S16           | 100 | ORGA 09079 |            | 02.09 |   |                                  |                  |                |                                    |                |     |
|  | 1.1               |     |            | 09.98      | 02.09 |   | 24.5111-0306.3                   | 330596           | 2              |                                    | L=305          |     |
|  | 1.4               | 55  |            | 09.98      | 02.09 |   |                                  |                  |                |                                    |                |     |
|  | 1.4 16V           | 65  |            | 10.03      | 02.09 |   |                                  |                  |                |                                    |                |     |
|  | 1.4 HDi           | 50  |            | 09.01      | 02.09 |   |                                  |                  |                |                                    |                |     |
|  | 1.4 HDi           | 51  |            | 09.02      | 02.07 |   |                                  |                  |                |                                    |                |     |
|  | 1.4 HDi eco 70    | 50  |            | 09.08      | 02.09 |   |                                  |                  |                |                                    |                |     |
|  | 1.6               | 65  |            | 09.98      | 12.00 |   |                                  |                  |                |                                    |                |     |
|  | 1.6 16V           | 80  |            | 12.00      | 02.09 |   |                                  |                  |                |                                    |                |     |
|  | 1.6 HDi 110       | 80  |            | 05.04      | 02.09 |   |                                  |                  |                |                                    |                |     |
|  | 1.9 D             | 51  |            | 09.98      | 02.09 |   |                                  |                  |                |                                    |                |     |
|  | 2.0 HDi           | 66  |            | 12.99      | 02.09 |   |                                  |                  |                |                                    |                |     |
|  | 2.0 RC            | 130 |            | 07.03      | 02.09 |   |                                  |                  |                |                                    |                |     |
|  | 2.0 S16           | 99  |            | 04.99      | 10.00 |   |                                  |                  |                |                                    |                |     |
|  | 2.0 S16           | 100 |            | 10.00      | 02.09 |   |                                  |                  |                |                                    |                |     |
|  | 1.1               |     | ORGA 09155 | 09.98      |       | - ABS                                   | 24.5229-0240.3                   | 330400           |                | L=242                              |                |     |
|  | 1.4               | 55  | ORGA 09155 | 09.98      |       | - ABS                                   | 24.5229-0200.3                   | 330572           |                | L=200                              |                |     |
|  | 1.4 HDi           | 50  | ORGA 09155 | 09.01      |       | - ABS                                   |                                  |                  |                |                                    |                |     |
|  | 1.4 HDi           | 51  | ORGA 09155 | 09.02      |       | - ABS                                   |                                  |                  |                |                                    |                |     |
|  | 1.4 HDi eco 70    | 50  |            | 09.08      | 02.09 |   |                                  |                  |                |                                    |                |     |
|  | 1.6               | 65  |            | 09.98      | 12.00 |   |                                  |                  |                |                                    |                |     |
|  | 1.6 16V           | 80  | ORGA 09155 | 12.00      |       | - ABS                                   |                                  |                  |                |                                    |                |     |
|  | 1.9 D             | 51  | ORGA 09155 | 09.98      |       | - ABS                                   |                                  |                  |                |                                    |                |     |
|  | 2.0 HDi           | 66  | ORGA 09155 | 12.99      |       | - ABS                                   |                                  |                  |                |                                    |                |     |
|  | 2.0 S16           | 99  |            | 04.99      | 10.00 |   |                                  |                  |                |                                    |                |     |
|  | 2.0 S16           | 100 | ORGA 09155 | 10.00      |       | - ABS                                   |                                  |                  |                |                                    |                |     |
|  | 1.1               |     | ORGA 09156 | 09.98      | 02.09 | + ABS                                   | 24.5229-0200.3                   | 330572           | 2              |                                    | L=200          |     |
|  | 1.1               |     |            | 09.98      | 02.09 | - ABS                                   |                                  |                  |                |                                    |                |     |
|  | 1.4               | 55  | ORGA 09156 | 09.98      | 02.09 | + ABS                                   |                                  |                  |                |                                    |                |     |
|  | 1.4               | 55  | ORGA 09156 | 09.98      | 02.09 | - ABS                                   |                                  |                  |                |                                    |                |     |
|  | 1.4 16V           | 65  |            | 10.03      | 02.09 |   |                                  |                  |                |                                    |                |     |
|  | 1.4 HDi           | 50  |            | 09.01      | 02.09 | + ABS                                   |                                  |                  |                |                                    |                |     |
|  | 1.4 HDi           | 50  | ORGA 09156 | 09.02      | 02.09 | - ABS                                   |                                  |                  |                |                                    |                |     |
|  | 1.4 HDi           | 51  |            | 09.02      | 02.07 | + ABS                                   |                                  |                  |                |                                    |                |     |
|  | 1.4 HDi           | 51  | ORGA 09156 | 09.02      | 02.09 | - ABS                                   |                                  |                  |                |                                    |                |     |
|  | 1.6 16V           | 80  |            | 12.00      | 02.09 | + ABS                                   |                                  |                  |                |                                    |                |     |
|  | 1.6 16V           | 80  | ORGA 09156 | 12.00      | 02.09 | - ABS                                   |                                  |                  |                |                                    |                |     |
|  | 1.6 HDi 110       | 80  |            | 05.04      | 02.09 |   |                                  |                  |                |                                    |                |     |
|  | 1.9 D             | 51  |            | 09.98      | 02.09 | + ABS                                   |                                  |                  |                |                                    |                |     |
|  | 1.9 D             | 51  | ORGA 09156 | 09.98      | 02.09 | - ABS                                   |                                  |                  |                |                                    |                |     |
|  | 2.0 HDi           | 66  |            | 12.99      | 02.09 | + ABS                                   |                                  |                  |                |                                    |                |     |
|  | 2.0 HDi           | 66  | ORGA 09156 | 12.99      | 02.09 | - ABS                                   |                                  |                  |                |                                    |                |     |
|  | 2.0 RC            | 130 |            | 07.03      | 02.09 |   |                                  |                  |                |                                    |                |     |
|  | 2.0 S16           | 100 |            | 10.00      | 02.09 | + ABS                                   |                                  |                  |                |                                    |                |     |
|  | 2.0 S16           | 100 | ORGA 09156 | 10.00      | 02.09 | - ABS                                   |                                  |                  |                |                                    |                |     |
|  | 1.1               |     |            | 09.98      | 02.09 | - ABS                                   | 24.3219-1112.3                   | 020311           |                | Rz 19,05                           | BDX            |     |
|  | 1.4               | 55  |            | 09.98      | 02.09 | - ABS                                   |                                  |                  |                |                                    |                |     |
|  | 1.4 HDi           | 50  |            | 09.01      | 02.09 | - ABS                                   |                                  |                  |                |                                    |                |     |
|  | 1.4 HDi           | 51  |            | 09.02      | 02.07 | - ABS                                   |                                  |                  |                |                                    |                |     |
|  | 1.4 HDi eco 70    | 50  |            | 09.08      | 02.09 | - ABS                                   |                                  |                  |                |                                    |                |     |
|  | 1.6               | 65  |            | 09.98      | 12.00 | - ABS/+ Schaltgetriebe <sup>6)</sup>    |                                  |                  |                |                                    |                |     |
|  | 1.9 D             | 51  |            | 09.98      | 02.09 | - ABS                                   |                                  |                  |                |                                    |                |     |

1) + manual transmission / + scatola cambio velocità / + transmission mécanique / + cambio de velocidad  
2) - ROL GAR/ + manuel transmission / - ROL GAR/ + cambio velocità / - ROL GAR/ + transm. mécanique / - ROL GAR/ + cambio velocità  
3) - ventilated discs / - dischi ventilati / - disques ventilés / - disco ventilado  
4) + ventilated discs / + dischi ventilati / + disques ventilés / + disco ventilado  
5) + autom.transmission / + scatola cambio automatico / + transmission automatique / + cambio automático  
6) - ABS/ + manual transmission / - ABS/+ scatola camb.velocità / - ABS/ + transmission mécanique / - ABS/ + cambio de velocidad







**PEUGEOT 206 Limousine (98-09)**

|         |                |            |            |            |       |  |                |        |  |              |            |
|---------|----------------|------------|------------|------------|-------|--|----------------|--------|--|--------------|------------|
|         | 1.1            |            |            | 09.98      | 02.09 | - ABS                                    | 24.3220-1617.3 | 020244 |  | RzR 20,64    | <b>BDX</b> |
|         | 1.4            | 55         |            | 09.98      | 02.09 | - ABS                                    | 24.3220-1618.3 | 020245 |  |              |            |
|         | 1.4 HDi        | 50         |            | 09.01      | 02.09 | - ABS                                    |                |        |  |              |            |
|         | 1.4 HDi        | 51         |            | 09.02      | 02.07 | - ABS                                    |                |        |  |              |            |
|         | 1.4 HDi eco 70 | 50         |            | 09.08      | 02.09 | - ABS                                    |                |        |  |              |            |
|         | 1.6            | 65         |            | 09.98      | 12.00 | - ABS/ + Schaltgetriebe <sup>1)</sup>    |                |        |  |              |            |
|         | 1.6            | 65         |            | 09.98      | 12.00 | - ABS/ + Automatikgetriebe <sup>2)</sup> | 24.3219-1733.3 | 020460 |  |              |            |
|         | 1.9 D          | 51         |            | 09.98      | 02.09 | - ABS                                    | 24.3219-1734.3 | 020461 |  |              |            |
|         | 1.6            | 65         |            | 09.98      | 12.00 | - ABS/ + Automatikgetriebe <sup>2)</sup> | 24.3220-1717.3 | 020430 |  |              |            |
|         | 1.6            | 65         |            | 09.98      | 12.00 | - ABS/ + Automatikgetriebe <sup>2)</sup> | 24.3220-1717.3 | 020430 |  |              |            |
|         | 1.1            |            | ORGA 11108 | 09.98      |       | + ABS                                    | 24.3220-1717.3 | 020430 |  | Rz 20,64     | <b>LUC</b> |
|         | 1.4            | 55         |            | 09.98      | 02.09 | + ABS                                    |                |        |  |              |            |
|         | 1.4 16V        | 65         |            | 10.03      | 02.09 |  |                |        |  |              |            |
|         | 1.4 HDi        | 50         |            | 09.01      | 02.09 | + ABS                                    |                |        |  |              |            |
|         | 1.4 HDi        | 51         |            | 09.02      | 02.07 | + ABS                                    |                |        |  |              |            |
|         | 1.4 HDi eco 70 | 50         |            | 09.08      | 02.09 | + ABS                                    |                |        |  |              |            |
|         | 1.6            | 65         |            | 09.98      | 12.00 | + ABS                                    |                |        |  |              |            |
|         | 1.6 16V        | 80         |            | 12.00      | 02.09 |  |                |        |  |              |            |
|         | 1.9 D          | 51         |            | 09.98      | 02.09 | + ABS                                    |                |        |  |              |            |
|         | 2.0 HDi        | 66         |            | 12.99      | 02.09 | + ABS                                    |                |        |  |              |            |
|         | 1.1            |            | ORGA 11108 | 09.98      |       |  | 24.3727-0830.2 | 580830 |  | L=1638       |            |
|         | 1.4            | 55         |            | 09.98      |       |  |                |        |  |              |            |
|         | 1.4 HDi        | 50         |            | 09.01      |       |  |                |        |  |              |            |
|         | 1.4 HDi        | 51         |            | 09.02      |       |  |                |        |  |              |            |
|         | 1.6            | 65         |            | 09.98      | 12.00 |  |                |        |  |              |            |
|         | 1.9 D          | 51         |            | 09.98      |       |  |                |        |  |              |            |
|         | 2.0 HDi        | 66         |            | 12.99      |       |  |                |        |  |              |            |
|         | 1.4 16V        | 65         |            | 10.03      |       |  | 24.3727-0833.2 | 580833 |  |              |            |
|         | 1.6 16V        | 80         |            | 12.00      |       |  |                |        |  |              |            |
|         | 1.6 HDi 110    | 80         |            | 05.04      |       |  |                |        |  |              |            |
| 2.0 RC  | 130            |            | 07.03      |            |       |  |                |        |  |              |            |
| 2.0 S16 | 99             |            | 04.99      | 10.00      |       |  |                |        |  |              |            |
| 2.0 S16 | 100            |            | 10.00      |            |       |  |                |        |  |              |            |
|         | 1.1            |            | ORGA 09456 | 09.98      |       |  | 24.3728-0845.2 | 590845 |  | L=660, + AUT |            |
|         | 1.4            | 55         |            | 09.98      |       |  |                |        |  |              |            |
|         | 1.6            | 65         |            | 09.98      | 12.00 |  |                |        |  |              |            |
|         | 1.6 16V        | 80         |            | 12.00      |       |  |                |        |  |              |            |
|         | 1.1            |            | ORGA 09457 | ORGA 09921 |       |  | 24.3728-0832.2 | 590832 |  |              |            |
|         | 1.4            | 55         | ORGA 09457 | ORGA 09921 |       |  |                |        |  |              |            |
|         | 1.4 16V        | 65         |            | ORGA 09921 | 10.03 |  |                |        |  |              |            |
|         | 1.6 16V        | 80         | ORGA 09457 | ORGA 09921 |       |  |                |        |  |              |            |
|         | 1.1            |            | ORGA 09922 |            | 02.09 |  | 24.3728-0848.2 | 590848 |  |              |            |
|         | 1.4            | 55         | ORGA 09922 |            | 02.09 |  |                |        |  |              |            |
| 1.4 16V | 65             | ORGA 09922 |            | 02.09      |       |  |                |        |  |              |            |
| 1.6 16V | 80             | ORGA 09922 |            | 02.09      |       |  |                |        |  |              |            |
| 1.4 HDi | 50             |            | ORGA 09456 | 09.01      |       | 24.3728-0827.2                           | 590827         |        |  |              |            |
| 1.4 HDi | 51             |            | ORGA 09456 | 09.02      |       |  |                |        |  |              |            |
| 2.0 HDi | 66             |            | ORGA 09457 | 12.99      |       |  |                |        |  |              |            |
| 2.0 S16 | 99             |            |            | 04.99      | 10.00 |  |                |        |  |              |            |
| 2.0 S16 | 100            |            | ORGA 09426 | 10.00      |       |  |                |        |  |              |            |
| 1.4 HDi | 50             | ORGA 09457 | ORGA 09921 |            |       | 24.3728-0833.2                           | 590833         |        |  |              |            |
| 1.4 HDi | 51             | ORGA 09457 | ORGA 09921 |            |       |  |                |        |  |              |            |
| 2.0 HDi | 66             | ORGA 09457 | ORGA 09921 |            |       |  |                |        |  |              |            |
| 2.0 RC  | 130            |            | ORGA 09921 | 07.03      |       |  |                |        |  |              |            |
| 2.0 S16 | 100            | ORGA 09583 | ORGA 09921 |            |       |  |                |        |  |              |            |
| 1.9 D   | 51             |            | ORGA 09456 | 09.98      |       | 24.3728-0841.2                           | 590841         |        |  |              |            |
| 2.0 S16 | 100            | ORGA 09427 | ORGA 09456 |            |       |  |                |        |  |              |            |
| 1.9 D   | 51             | ORGA 09457 |            | 02.09      |       | 24.3728-0833.2                           | 590833         |        |  |              |            |
| 1.4 HDi | 50             | ORGA 09922 |            | 02.09      |       | 24.3728-0849.2                           | 590849         |        |  |              |            |
| 1.4 HDi | 51             | ORGA 09922 |            | 02.09      |       |  |                |        |  |              |            |
| 2.0 HDi | 66             | ORGA 09922 |            | 02.09      |       |  |                |        |  |              |            |
| 2.0 RC  | 130            |            |            | 07.03      | 02.09 |  |                |        |  |              |            |
| 2.0 S16 | 100            | ORGA 09922 |            | 02.09      |       |  |                |        |  |              |            |

**PEUGEOT 206 CC (00-07)**

|             |             |            |            |            |                |  |                |        |       |           |            |
|-------------|-------------|------------|------------|------------|----------------|--|----------------|--------|-------|-----------|------------|
|             | 1.6 16V     | 80         | ORGA 09820 | 09.00      |                | - ABS/ + Schaltgetriebe <sup>1)</sup>    | 03.7750-1832.4 | 300111 |       | 9"        | <b>ATE</b> |
|             | 1.6 16V     | 80         | ORGA 09456 | 09.00      |                | + ABS/ + Schaltgetriebe <sup>3)</sup>    |                |        |       |           |            |
|             | 1.6 16V     | 80         | ORGA 09821 |            | 01.07          | - ABS/ + Schaltgetriebe <sup>1)</sup>    | 03.7750-6232.4 | 300215 |       |           |            |
|             | 1.6 16V     | 80         | ORGA 09457 | ORGA 09740 |                | + ABS/ + Schaltgetriebe <sup>3)</sup>    | 03.7853-1602.4 | 300167 |       |           |            |
|             | 1.6 16V     | 80         | ORGA 09820 | 09.00      |                | - ABS/ + Automatikgetriebe <sup>2)</sup> | 03.7750-2232.4 | 300112 |       |           |            |
|             | 1.6 16V     | 80         | ORGA 09456 | 09.00      |                | + ABS/ + Schaltgetriebe <sup>3)</sup>    |                |        |       |           |            |
|             | 1.6 16V     | 80         | ORGA 09821 |            | 01.07          | - ABS/ + Automatikgetriebe <sup>2)</sup> | 03.7750-6332.4 | 300226 |       |           |            |
|             | 1.6 16V     | 80         | ORGA 09741 |            | 01.07          | + ABS/ + Schaltgetriebe <sup>3)</sup>    | 03.7853-2602.4 | 300196 |       |           |            |
|             | 1.6 HDi 110 | 80         |            | 04.05      | 01.07          | (N) (S) (RH)                             |                |        |       |           |            |
|             | 1.6 16V     | 80         | ORGA 09741 |            | 01.07          | + ABS/ + Automatikgetriebe <sup>4)</sup> | 03.7853-2702.4 | 300269 |       |           |            |
| 1.6 HDi 110 | 80          |            | 04.05      | 01.07      | + (N) (S) (RH) |  |                |        |       |           |            |
| 2.0 16V     | 100         |            | ORGA 09456 | 09.00      |                | 03.7760-5302.4                           | 300179         |        |       |           |            |
| 2.0 16V     | 100         | ORGA 09457 |            | 01.07      |                | 03.7863-6502.4                           | 300232         |        |       |           |            |
|             | 1.6 16V     | 80         |            | 09.00      | 01.07          | + Schaltgetriebe <sup>5)</sup>           | 03.2122-1356.3 | 010529 | - ABS | THz 22,20 | <b>ATE</b> |
|             |             |            |            |            |                |  | 03.2122-1351.3 | 010528 | - ESP | THz 22,20 | <b>ATE</b> |
|             |             |            |            |            |                |  | 03.2122-1942.3 | 010700 | + ESP | THz 22,20 | <b>ATE</b> |

<sup>1)</sup> - ABS/ + manual transmission / - ABS/+ scatola camb.velocità / - ABS/ + transmission mécanique / - ABS/ + cambio de velocidad

<sup>2)</sup> - ABS/ + autom.transmission / - ABS/+ scatola cambio autom. / - ABS/ + transmission automatique / - ABS/ + cambio automático

<sup>3)</sup> + ABS/ + manual transm. / + ABS/+ scatola camb.velocità / + ABS/ + transmission mécanique / + ABS/ + cambio de velocidad

<sup>4)</sup> + ABS/ + autom.transmission / + ABS/+ scatola cambio autom. / + ABS/ + transmission automatique / + ABS/ + cambio automático

<sup>5)</sup> + manual transmission / + scatola cambio velocità / + transmission mécanique / + cambio de velocidad

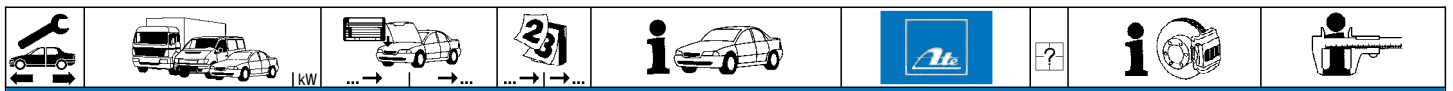

**PEUGEOT 206 CC (00-07)**

|  |             |     |            |       |       |                                   |   |                         |                                     |                   |
|--|-------------|-----|------------|-------|-------|-----------------------------------|---|-------------------------|-------------------------------------|-------------------|
|  | 1.6 16V     | 80  |            | 09.00 | 01.07 | + Automatikgetriebe <sup>1)</sup> | 03.4122-0031.3 010611<br>03.4122-0041.3 010612<br>03.4122-0054.3 010813 | - ABS<br>- ESP<br>+ ESP | THz 22,20<br>THz 22,20<br>THz 22,20 | ATE<br>ATE<br>ATE |
|  | 1.6 HDi 110 | 80  |            | 04.05 | 01.07 | + (N) (S) (FR)                    | 03.4122-0041.3 010612<br>03.4122-0054.3 010813                          | - ESP<br>+ ESP          | THz 22,20<br>THz 22,20              | ATE<br>ATE        |
|  | 1.6 HDi 110 | 80  |            | 04.05 | 01.07 | - (N) (S) (FR)                    | 03.2122-1351.3 010528<br>03.2122-1942.3 010700                          | - ESP<br>+ ESP          | THz 22,20<br>THz 22,20              | ATE<br>ATE        |
|  | 1.6 16V     | 80  | ORGA 08777 | 09.00 |       |                                   | 24.3541-1767.5 240237<br>24.3541-1768.5 240238                          |                         | D=54, - Halter                      | BOS               |
|  | 2.0 16V     | 100 | ORGA 08777 | 09.00 |       |                                   |   |                         | D=54, - Halter                      | BOS               |
|  | 1.6 16V     | 80  | ORGA 09079 |       |       |                                   | 24.3541-1771.5 240239<br>24.3541-1772.5 240240                          |                         | D=54, - Halter                      | BOS               |
|  | 1.6 HDi 110 | 80  | ORGA 10949 | 04.05 | 01.07 |                                   |   |                         | D=54, - Halter                      | BOS               |
|  | 2.0 16V     | 100 | ORGA 09079 | 01.07 |       |                                   |   |                         |                                     |                   |
|  | 1.6 16V     | 80  |            | 09.00 | 01.07 |                                   | 24.5111-0306.3 330596   | 2                       | L=305                               |                   |
|  | 1.6 HDi 110 | 80  |            | 04.05 | 01.07 |                                   |   |                         |                                     |                   |
|  | 2.0 16V     | 100 |            | 09.00 | 01.07 |                                   |   |                         |                                     |                   |
|  | 1.6 16V     | 80  | ORGA 09155 | 09.00 |       |                                   | 24.5229-0240.3 330400<br>24.5229-0200.3 330572                          |                         | L=242<br>L=200                      |                   |
|  | 2.0 16V     | 100 | ORGA 09155 | 09.00 |       |                                   |   |                         |                                     |                   |
|  | 1.6 16V     | 80  | ORGA 09156 |       | 01.07 |                                   | 24.5229-0200.3 330572   | 2                       | L=200                               |                   |
|  | 1.6 HDi 110 | 80  |            | 04.05 | 01.07 |                                   |   |                         |                                     |                   |
|  | 2.0 16V     | 100 | ORGA 09156 | 01.07 |       |                                   |   |                         |                                     |                   |
|  | 1.6 16V     | 80  | ORGA 11108 | 09.00 |       |                                   | 24.3727-0833.2 580833   | 2                       | L=1707                              |                   |
|  | 1.6 HDi 110 | 80  | ORGA 11108 | 04.05 |       |                                   |   |                         |                                     |                   |
|  | 2.0 16V     | 100 | ORGA 11108 | 09.00 |       |                                   |   |                         |                                     |                   |
|  | 1.6 16V     | 80  | ORGA 09456 | 09.00 |       |                                   | 24.3728-0845.2 590845   |                         | L=660, + AUT                        |                   |
|  | 1.6 16V     | 80  | ORGA 09457 |       |       |                                   | 24.3728-0832.2 590832   |                         | L=580, + AUT                        |                   |
|  | 1.6 16V     | 80  | ORGA 09922 |       | 01.07 |                                   | 24.3728-0848.2 590848   |                         | L=580, + AUT                        |                   |
|  | 2.0 16V     | 100 | ORGA 09426 | 09.00 |       |                                   | 24.3728-0827.2 590827   |                         | L=910, + AUT                        |                   |
|  | 2.0 16V     | 100 | ORGA 09427 |       |       |                                   | 24.3728-0841.2 590841   |                         | L=910, + AUT                        |                   |
|  | 2.0 16V     | 100 | ORGA 09457 |       |       |                                   | 24.3728-0833.2 590833   |                         | L=823, + AUT                        |                   |
|  | 2.0 16V     | 100 | ORGA 09922 |       | 01.07 |                                   | 24.3728-0849.2 590849   |                         | L=828, + AUT                        |                   |

**PEUGEOT 206 SW (02-07)**

|  |             |     |            |       |       |  |  |                                  |  |                          |
|--|-------------|-----|------------|-------|-------|--|--|----------------------------------|--|--------------------------|
|  | 1.4         | 55  | ORGA 09820 | 07.02 |       | - ABS/ + Schaltgetriebe <sup>2)</sup>    | 03.7750-0532.4 300110  |                                  | 9"   | ATE                      |
|  | 1.4 HDi     | 50  | ORGA 09820 | 07.02 |       | - ABS                                    |  |                                  |  |                          |
|  | 1.1         | 44  | ORGA 09456 | 07.02 |       | + ABS                                    | 03.7750-1832.4 300111  |                                  | 9"   | ATE                      |
|  | 1.4         | 55  | ORGA 09456 | 07.02 |       | + ABS/ + Schaltgetriebe <sup>3)</sup>    |  |                                  |  |                          |
|  | 1.4 HDi     | 50  | ORGA 09456 | 07.02 |       | + ABS                                    |  |                                  |  |                          |
|  | 1.6 16V     | 80  | ORGA 09820 | 07.02 |       | + ABS/ + Schaltgetriebe <sup>3)</sup>    |  |                                  |  |                          |
|  | 1.6 16V     | 80  | ORGA 09456 | 07.02 |       | + ABS/ + Schaltgetriebe <sup>3)</sup>    |  |                                  |  |                          |
|  | 1.6 16V     | 80  | ORGA 09821 |       | 05.07 | - ABS/ + Schaltgetriebe <sup>2)</sup>    | 03.7750-6232.4 300215  |                                  | 9"   | ATE                      |
|  | 1.1         | 44  | ORGA 09457 |       |       | + ABS                                    | 03.7853-1602.4 300167  |                                  | 9"   | ATE                      |
|  | 1.4         | 55  | ORGA 09457 |       |       | + ABS/ + Schaltgetriebe <sup>3)</sup>    |  |                                  |  |                          |
|  | 1.4 HDi     | 50  | ORGA 09457 |       |       | + ABS                                    |  |                                  |  |                          |
|  | 1.6 16V     | 80  | ORGA 09457 |       |       | + ABS/ + Schaltgetriebe <sup>3)</sup>    |  |                                  |  |                          |
|  | 1.4         | 55  | ORGA 09820 | 07.02 |       | - ABS/ + Automatikgetriebe <sup>4)</sup> | 03.7750-2232.4 300112  |                                  | 9"   | ATE                      |
|  | 1.4         | 55  | ORGA 09456 | 07.02 |       | + ABS/ + Automatikgetriebe <sup>5)</sup> |  |                                  |  |                          |
|  | 1.6 16V     | 80  | ORGA 09820 | 07.02 |       | - ABS/ + Automatikgetriebe <sup>4)</sup> |  |                                  |  |                          |
|  | 1.6 16V     | 80  | ORGA 09456 | 07.02 |       | + ABS/ + Automatikgetriebe <sup>5)</sup> |  |                                  |  |                          |
|  | 1.1         | 44  | ORGA 09741 |       | 05.07 | + ABS                                    | 03.7853-2602.4 300196  |                                  | 9"   | ATE                      |
|  | 1.4         | 55  | ORGA 09741 |       | 05.07 | + ABS/ + Schaltgetriebe <sup>3)</sup>    |  |                                  |  |                          |
|  | 1.4 16V     | 65  |            | 10.03 | 05.07 | + ABS                                    |  |                                  |  |                          |
|  | 1.4 HDi     | 50  | ORGA 09821 |       | 05.07 | + ABS                                    |  |                                  |  |                          |
|  | 1.6 16V     | 80  | ORGA 09741 |       | 05.07 | + ABS/ + Schaltgetriebe <sup>3)</sup>    |  |                                  |  |                          |
|  | 1.6 HDi 110 | 80  |            | 05.04 | 05.07 | + ABS/ - (N) (S) (FR)                    |  |                                  |  |                          |
|  | 1.4         | 55  | ORGA 09741 |       | 05.07 | + ABS/ + Automatikgetriebe <sup>5)</sup> | 03.7853-2702.4 300269  |                                  | 9"   | ATE                      |
|  | 1.6 16V     | 80  | ORGA 09741 |       | 05.07 | + ABS/ + Automatikgetriebe <sup>5)</sup> |  |                                  |  |                          |
|  | 1.6 HDi 110 | 80  |            | 05.04 | 05.07 | + ABS/ + (N) (S) (FR)                    |  |                                  |  |                          |
|  | 1.4         | 55  | ORGA 09821 |       | 05.07 | - ABS/ + Automatikgetriebe <sup>4)</sup> | 03.7750-6332.4 300226  |                                  | 9"   | ATE                      |
|  | 1.6 16V     | 80  | ORGA 09821 |       | 05.07 | - ABS/ + Automatikgetriebe <sup>4)</sup> |  |                                  |  |                          |
|  | 2.0 HDi     | 66  | ORGA 09820 | 07.02 |       | - ABS                                    | 03.7750-1832.4 300111  | - (N) (S) (FR)                   | 9"   | ATE                      |
|  | 2.0 HDi     | 66  | ORGA 09456 | 07.02 |       | + ABS                                    | 03.7750-2232.4 300112  | + (N) (S) (FR)                   | 9"   | ATE                      |
|  | 2.0 HDi     | 66  | ORGA 09821 |       | 05.07 | - ABS                                    | 03.7750-6232.4 300215  | - (N) (S) (FR)                   | 9"   | ATE                      |
|  |             |     |            |       |       |  | 03.7750-6332.4 300226  | + (N) (S) (FR)                   | 9"   | ATE                      |
|  | 2.0 HDi     | 66  | ORGA 09457 |       |       | + ABS                                    | 03.7853-1602.4 300167  | - (N) (S) (FR)                   | 9"   | ATE                      |
|  | 2.0 HDi     | 66  | ORGA 09821 |       | 05.07 | + ABS                                    | 03.7853-2602.4 300196  | - (N) (S) (FR)                   | 9"   | ATE                      |
|  |             |     |            |       |       |  | 03.7853-2702.4 300269  | + (N) (S) (FR)                   | 9"   | ATE                      |
|  | 2.0 S16     | 100 | ORGA 09456 | 07.02 |       |  | 03.7760-5302.4 300179  |                                  | 10"  | ATE                      |
|  | 2.0 S16     | 100 | ORGA 09457 |       | 05.07 |  | 03.7863-6502.4 300232  |                                  | 10"  | ATE                      |
|  | 1.1         | 44  |            | 07.02 | 05.07 |  | 03.2120-4321.3 010525  | - ABS                            | THz 20,64  | ATE                      |
|  | 1.4         | 55  |            | 07.02 | 05.07 | + Schaltgetriebe <sup>6)</sup>           | 24.2120-1737.3 010757<br>03.2122-1351.3 010528   | - ABS<br>- ABS<br>+ ABS          | THz 20,64<br>THz 22,20                           | ATE<br>ATE               |
|  | 1.4 HDi     | 50  |            | 07.02 | 05.07 |  | 03.2120-4321.3 010525<br>24.2120-1737.3 010757<br>03.2122-1351.3 010528<br>03.2122-1942.3 010700 | - ABS<br>- ABS<br>- ESP<br>+ ESP | THz 20,64<br>THz 20,64<br>THz 22,20<br>THz 22,20 | ATE<br>ATE<br>ATE<br>ATE |
|  | 1.4         | 55  |            | 07.02 | 05.07 | + Automatikgetriebe <sup>1)</sup>        | 03.4122-0031.3 010611  | - ABS                            | THz 22,20  | ATE                      |
|  | 1.6 16V     | 80  |            | 07.02 | 05.07 | + Automatikgetriebe <sup>1)</sup>        | 03.4122-0041.3 010612  | - ESP                            | THz 22,20  | ATE                      |
|  | 2.0 HDi     | 66  |            | 07.02 | 05.07 | + (N) (S) (FR)                           | 03.4122-0054.3 010813  | + ESP                            | THz 22,20  | ATE                      |

1) + autom.transmission / + scatola cambio automatico / + transmission automatique / + cambio automático  
 2) - ABS/ + manual transmission / - ABS/+ scatola camb.velocità / - ABS/ + transmission mécanique / - ABS/ + cambio de velocidad  
 3) + ABS/ + manual transm. / + ABS/+ scatola camb.velocità / + ABS/ + transmission mécanique / + ABS/ + cambio de velocidad  
 4) - ABS/ + autom.transmission / - ABS/ + scatola cambio autom. / - ABS/ + transmission automatique / - ABS/ + cambio automático  
 5) + ABS/ + autom.transmission / + ABS/ + scatola cambio autom. / + ABS/ + transmission automatique / + ABS/ + cambio automático  
 6) + manual transmission / + scatola cambio velocità / + transmission mécanique / + cambio de velocidad



























| PEUGEOT 206 SW (02-07)   |                |            |            |       |       |                                    |                |        |                |                |     |
|--------------------------|----------------|------------|------------|-------|-------|------------------------------------|----------------|--------|----------------|----------------|-----|
|                          | 1.4 16V        | 65         |            | 10.03 | 05.07 |                                    | 03.2122-1356.3 | 010529 | - ABS          | THz 22,20      | ATE |
|                          | 1.6 16V        | 80         |            | 07.02 | 05.07 | + Schaltgetriebe <sup>1)</sup>     | 03.2122-1351.3 | 010528 | - ESP          | THz 22,20      | ATE |
|                          | 2.0 HDi        | 66         |            | 07.02 | 05.07 | - (N) (S) (FR)                     | 03.2122-1942.3 | 010700 | + ESP          | THz 22,20      | ATE |
|                          | 1.6 HDi 110    | 80         |            | 05.04 | 05.07 | - (N) (S) (FR)                     | 03.2122-1351.3 | 010528 | - ESP          | THz 22,20      | ATE |
|                          | 1.6 HDi 110    | 80         |            | 05.04 | 05.07 | + (N) (S) (FR)                     | 03.2122-1942.3 | 010700 | + ESP          | THz 22,20      | ATE |
| 2.0 S16                  | 100            |            | 07.02      | 05.07 |       | 03.4122-0041.3                     | 010612         | - ESP  | THz 22,20      | ATE            |     |
|                          |                |            |            |       |       | 03.4122-0054.3                     | 010813         | + ESP  | THz 22,20      | ATE            |     |
|                          | 1.1            | 44         |            | 07.02 | 05.07 |                                    | 24.3481-1771.5 | 240375 |                | D=48, - Halter | BOS |
|                          | 1.4            | 55         |            | 07.02 | 05.07 |                                    | 24.3481-1772.5 | 240376 |                | D=48, - Halter | BOS |
|                          | 1.4 16V        | 65         |            | 10.03 | 05.07 |                                    |                |        |                |                |     |
|                          | 1.4 HDi        | 50         |            | 07.02 | 05.07 | - belüftete Scheiben <sup>2)</sup> |                |        |                |                |     |
|                          | 1.4 HDi        | 50         |            | 07.02 | 05.07 | + belüftete Scheiben <sup>3)</sup> | 24.3481-1769.5 | 240373 |                | D=48, - Halter | BOS |
|                          |                |            |            |       |       |                                    | 24.3481-1770.5 | 240374 |                | D=48, - Halter | BOS |
|                          | 1.6 16V        | 80         | ORGA 10808 | 07.02 | 05.07 |                                    | 24.3541-1771.5 | 240239 |                | D=54, - Halter | BOS |
| 1.6 HDi 110              | 80             |            | 05.04      | 05.07 |       | 24.3541-1772.5                     | 240240         |        | D=54, - Halter | BOS            |     |
| 2.0 HDi                  | 66             | ORGA 10808 | 07.02      | 05.07 |       |                                    |                |        |                |                |     |
| 2.0 S16                  | 100            |            | 07.02      | 05.07 |       |                                    |                |        |                |                |     |
|                          | 1.1            | 44         |            | 07.02 | 05.07 |                                    | 24.5111-0306.3 | 330596 | 2              | L=305          |     |
|                          | 1.4            | 55         |            | 07.02 | 05.07 |                                    |                |        |                |                |     |
|                          | 1.4 16V        | 65         |            | 10.03 | 05.07 |                                    |                |        |                |                |     |
|                          | 1.4 HDi        | 50         |            | 07.02 | 05.07 |                                    |                |        |                |                |     |
|                          | 1.6 16V        | 80         |            | 07.02 | 05.07 |                                    |                |        |                |                |     |
|                          | 1.6 HDi 110    | 80         |            | 05.04 | 05.07 |                                    |                |        |                |                |     |
|                          | 2.0 HDi        | 66         |            | 07.02 | 05.07 |                                    |                |        |                |                |     |
|                          | 2.0 S16        | 100        |            | 07.02 | 05.07 |                                    |                |        |                |                |     |
|                          | 1.1            | 44         | ORGA 09155 | 07.02 | 05.07 |                                    | 24.5229-0240.3 | 330400 |                | L=242          |     |
|                          | 1.4            | 55         | ORGA 09155 | 07.02 | 05.07 |                                    | 24.5229-0200.3 | 330572 |                | L=200          |     |
| 1.4 HDi                  | 50             | ORGA 09155 | 07.02      | 05.07 |       |                                    |                |        |                |                |     |
| 1.6 16V                  | 80             | ORGA 09155 | 07.02      | 05.07 |       |                                    |                |        |                |                |     |
| 2.0 HDi                  | 66             | ORGA 09155 | 07.02      | 05.07 |       |                                    |                |        |                |                |     |
| 2.0 S16                  | 100            | ORGA 09155 | 07.02      | 05.07 |       |                                    |                |        |                |                |     |
|                          | 1.1            | 44         | ORGA 09156 | 07.02 | 05.07 |                                    | 24.5229-0200.3 | 330572 | 2              | L=200          |     |
|                          | 1.4            | 55         | ORGA 09156 | 07.02 | 05.07 |                                    |                |        |                |                |     |
|                          | 1.4 16V        | 65         |            | 10.03 | 05.07 |                                    |                |        |                |                |     |
|                          | 1.4 HDi        | 50         | ORGA 09156 | 07.02 | 05.07 |                                    |                |        |                |                |     |
|                          | 1.6 16V        | 80         | ORGA 09156 | 07.02 | 05.07 |                                    |                |        |                |                |     |
|                          | 1.6 HDi 110    | 80         |            | 05.04 | 05.07 |                                    |                |        |                |                |     |
|                          | 2.0 HDi        | 66         | ORGA 09156 | 07.02 | 05.07 |                                    |                |        |                |                |     |
| 2.0 S16                  | 100            | ORGA 09156 | 07.02      | 05.07 |       |                                    |                |        |                |                |     |
|                          | 1.1            | 44         |            | 07.02 | 05.07 |                                    | 24.3220-1717.3 | 020430 |                | Rz 20,64       | LUC |
|                          | 1.4            | 55         |            | 07.02 | 05.07 |                                    |                |        |                |                |     |
|                          | 1.4 HDi        | 50         |            | 07.02 | 05.07 |                                    |                |        |                |                |     |
|                          | 2.0 HDi        | 66         |            | 07.02 | 05.07 |                                    |                |        |                |                |     |
|                          | 1.1            | 44         | ORGA 11108 | 07.02 | 05.07 |                                    | 24.3727-0830.2 | 580830 | 2              | L=1638         |     |
|                          | 1.4            | 55         | ORGA 11108 | 07.02 | 05.07 |                                    |                |        |                |                |     |
|                          | 1.4 HDi        | 50         | ORGA 11108 | 07.02 | 05.07 |                                    |                |        |                |                |     |
|                          | 2.0 HDi        | 66         | ORGA 11108 | 07.02 | 05.07 |                                    |                |        |                |                |     |
|                          | 1.4 16V        | 65         | ORGA 11108 | 10.03 | 05.07 |                                    | 24.3727-0833.2 | 580833 | 2              | L=1707         |     |
|                          | 1.6 16V        | 80         |            | 07.02 | 05.07 |                                    |                |        |                |                |     |
| 1.6 HDi 110              | 80             |            | 05.04      | 05.07 |       |                                    |                |        |                |                |     |
| 2.0 S16                  | 100            |            | 07.02      | 05.07 |       |                                    |                |        |                |                |     |
|                          | 1.1            | 44         | ORGA 09456 | 07.02 | 05.07 |                                    | 24.3728-0845.2 | 590845 |                | L=660, + AUT   |     |
|                          | 1.4            | 55         | ORGA 09456 | 07.02 | 05.07 |                                    |                |        |                |                |     |
|                          | 1.6 16V        | 80         | ORGA 09456 | 07.02 | 05.07 |                                    |                |        |                |                |     |
|                          | 1.1            | 44         | ORGA 09457 | 07.02 | 05.07 |                                    | 24.3728-0832.2 | 590832 |                | L=580, + AUT   |     |
|                          | 1.4            | 55         | ORGA 09457 | 07.02 | 05.07 |                                    |                |        |                |                |     |
|                          | 1.4 16V        | 65         | ORGA 09457 | 10.03 | 05.07 |                                    |                |        |                |                |     |
|                          | 1.6 16V        | 80         | ORGA 09457 | 07.02 | 05.07 |                                    |                |        |                |                |     |
|                          | 1.1            | 44         | ORGA 09922 | 07.02 | 05.07 |                                    | 24.3728-0848.2 | 590848 |                | L=580, + AUT   |     |
|                          | 1.4            | 55         | ORGA 09922 | 07.02 | 05.07 |                                    |                |        |                |                |     |
|                          | 1.4 16V        | 65         | ORGA 09922 | 10.03 | 05.07 |                                    |                |        |                |                |     |
|                          | 1.6 16V        | 80         | ORGA 09922 | 07.02 | 05.07 |                                    |                |        |                |                |     |
|                          | 1.4 HDi        | 50         | ORGA 09456 | 07.02 | 05.07 |                                    | 24.3728-0827.2 | 590827 |                | L=910, + AUT   |     |
|                          | 2.0 HDi        | 66         | ORGA 09456 | 07.02 | 05.07 |                                    |                |        |                |                |     |
|                          | 2.0 S16        | 100        | ORGA 09426 | 07.02 | 05.07 |                                    |                |        |                |                |     |
|                          | 2.0 S16        | 100        | ORGA 09427 | 07.02 | 05.07 |                                    | 24.3728-0841.2 | 590841 |                | L=910, + AUT   |     |
| 1.4 HDi                  | 50             | ORGA 09457 | 07.02      | 05.07 |       | 24.3728-0833.2                     | 590833         |        | L=823, + AUT   |                |     |
| 2.0 HDi                  | 66             | ORGA 09457 | 07.02      | 05.07 |       |                                    |                |        |                |                |     |
| 2.0 S16                  | 100            | ORGA 09457 | 07.02      | 05.07 |       |                                    |                |        |                |                |     |
| 1.4 HDi                  | 50             | ORGA 09922 | 07.02      | 05.07 |       | 24.3728-0849.2                     | 590849         |        | L=828, + AUT   |                |     |
| 2.0 HDi                  | 66             | ORGA 09922 | 07.02      | 05.07 |       |                                    |                |        |                |                |     |
| 2.0 S16                  | 100            | ORGA 09922 | 07.02      | 05.07 |       |                                    |                |        |                |                |     |
| PEUGEOT 206 PLUS (09-13) |                |            |            |       |       |                                    |                |        |                |                |     |
|                          | 1.1            | 44         |            | 01.09 | 05.13 |                                    | 03.7853-2602.4 | 300196 | + ABS          | 9"             | ATE |
|                          | 1.4 HDi eco 70 | 50         |            | 01.09 | 05.13 |                                    |                |        |                |                |     |
|                          | 1.4 i          | 54         |            | 09.10 | 05.13 |                                    |                |        |                |                |     |
|                          | 1.4 i          | 55         |            | 01.09 | 05.13 |                                    |                |        |                |                |     |

<sup>1)</sup> + manual transmission / + scatola cambio velocità / + transmission mécanique / + cambio de velocidad

<sup>2)</sup> - ventilated discs / - dischi ventilati / - disques ventilés / - disco ventilado

<sup>3)</sup> + ventilated discs / + dischi ventilati / + disques ventilés / + disco ventilado

|     |  |  |  |  |  |  |  |  |                |     |
|--|--|--|--|--|---|--|--|--|----------------|-----|
| <b>PEUGEOT 206 PLUS (09-13)</b>  |  |  |  |  |   |  |  |  |                |     |
|    | 1.1  | 44   |  | 01.09  | 05.13   | 03.2120-4321.3   | 010525   | - ABS  | THz 20,64      | ATE |
|  | 1.4 HDi eco 70   | 50   |  | 01.09  | 05.13   | 24.2120-1737.3   | 010757   | - ABS  | THz 20,64      |     |
|  | 1.4 i  | 54   |  | 09.10  | 05.13   | 03.2122-1351.3   | 010528   | + ABS  | THz 22,20      | ATE |
|  | 1.4 i  | 55   |  | 01.09  | 05.13   | 03.2122-1942.3   | 010700   | + ESP  | THz 22,20      | ATE |
|    | 1.1  | 44   |  | 01.09  | 05.13   | 24.3481-1769.5   | 240373   |  | D=48, - Halter | BOS |
|  | 1.4 HDi eco 70   | 50   |  | 01.09  | 05.13   | 24.3481-1770.5   | 240374   |  | D=48, - Halter | BOS |
|  | 1.4 i  | 54   |  | 09.10  | 05.13   |  |  |  |                |     |
|  | 1.4 i  | 55   |  | 01.09  | 05.13   |  |  |  |                |     |
|    | 1.1  | 44   |  | 01.09  | 05.13   | 24.3481-1771.5   | 240375   |  | D=48, - Halter | BOS |
|  | 1.4 HDi eco 70   | 50   |  | 01.09  | 05.13   | 24.3481-1772.5   | 240376   |  | D=48, - Halter | BOS |
|  | 1.4 i  | 54   |  | 09.10  | 05.13   |  |  |  |                |     |
|  | 1.4 i  | 55   |  | 01.09  | 05.13   |  |  |  |                |     |
|    | 1.1  | 44   |  | 01.09  | 05.13   | 24.5111-0306.3   | 330596   |  | L=305          |     |
|  | 1.4 HDi eco 70   | 50   |  | 01.09  | 05.13   |  |  |  |                |     |
|  | 1.4 i  | 54   |  | 09.10  | 05.13   |  |  |  |                |     |
|  | 1.4 i  | 55   |  | 01.09  | 05.13   |  |  |  |                |     |
|    | 1.1  | 44   |  | 01.09  | 05.13   | 24.5229-0200.3   | 330572   |  | L=200          |     |
|  | 1.4 HDi eco 70   | 50   |  | 01.09  | 05.13   |  |  |  |                |     |
|  | 1.4 i  | 54   |  | 09.10  | 05.13   |  |  |  |                |     |
|  | 1.4 i  | 55   |  | 01.09  | 05.13   |  |  |  |                |     |
|    | 1.1  | 44   |  | 01.09  | 05.13   | 24.3220-1717.3   | 020430   |  | Rz 20,64       | LUC |
|  | 1.4 HDi eco 70   | 50   |  | 01.09  | 05.13   |  |  |  |                |     |
|  | 1.4 i  | 54   |  | 09.10  | 05.13   |  |  |  |                |     |
|  | 1.4 i  | 55   |  | 01.09  | 05.13   |  |  |  |                |     |
|    | 1.1  | 44   |  | 01.09  | 05.13   | 24.3220-1617.3   | 020244   |  | RzR 20,64      | BDX |
|  | 1.4 HDi eco 70   | 50   |  | 01.09  | 05.13   | 24.3220-1618.3   | 020245   |  | RzR 20,64      | BDX |
|  | 1.4 i  | 54   |  | 09.10  | 05.13   |  |  |  |                |     |
|  | 1.4 i  | 55   |  | 01.09  | 05.13   |  |  |  |                |     |
|    | 1.1  | 44   |  | 01.09  | 05.13   | 24.3219-1112.3   | 020311   |  | Rz 19,05       | BDX |
|  | 1.4 HDi eco 70   | 50   |  | 01.09  | 05.13   |  |  |  |                |     |
|  | 1.4 i  | 54   |  | 09.10  | 05.13   |  |  |  |                |     |
|  | 1.4 i  | 55   |  | 01.09  | 05.13   |  |  |  |                |     |
|    | 1.1  | 44   |  | 01.09  | 05.13   | 24.3727-0830.2   | 580830   |  | L=1638         |     |
|  | 1.4 HDi eco 70   | 50   |  | 01.09  | 05.13   |  |  |  |                |     |
|  | 1.4 i  | 54   |  | 09.10  | 05.13   |  |  |  |                |     |
|  | 1.4 i  | 55   |  | 01.09  | 05.13   |  |  |  |                |     |
|    | 1.4 HDi eco 70   | 50   |  | 01.09  | 05.13   | 24.3728-0849.2   | 590849   |  | L=828, + AUT   |     |
|  | 1.1  | 44   |  | 01.09  | 05.13   | 24.3728-0848.2   | 590848   |  | L=580, + AUT   |     |
|  | 1.4 i  | 54   |  | 09.10  | 05.13   |  |  |  |                |     |
|  | 1.4 i  | 55   |  | 01.09  | 05.13   |  |  |  |                |     |
| <b>PEUGEOT 207 Limousine (06-12)</b>   |  |  |  |  |   |  |  |  |                |     |
|  | 1.4  | 53   |  | 02.06  | 06.12   | 24.4122-1704.3   | 010847   | - ESP  | THz 22,20      | LUC |
|  | 1.4  | 55   |  | 09.07  | 06.12   | 24.4122-1703.3   | 010843   | + ESP  | THz 22,20      | LUC |
|  | 1.4 16V  | 65   |  | 02.06  | 06.12   |  |  |  |                |     |
|  | 1.4 16V VTi  | 70   |  | 08.07  | 06.12   |  |  |  |                |     |
|  | 1.4 HDi  | 50   |  | 02.06  | 06.12   |  |  |  |                |     |
|  | 1.6 16V  | 80   |  | 02.06  | 06.12   |  |  |  |                |     |
|  | 1.6 HDi  | 66   |  | 02.06  | 06.12   |  |  |  |                |     |
|  | 1.6 16V RC   | 128  |  | 10.06  | 06.12   | 24.4123-1705.3   | 010832   | - ESP  | THz 23,81      | LUC |
|  | 1.6 16V Turbo  | 110  |  | 02.06  | 06.12   | 24.4123-1704.3   | 010828   | + ESP  | THz 23,81      | LUC |
|  | 1.6 16V Turbo  | 115  |  | 01.10  | 06.12   |  |  |  |                |     |
|  | 1.6 16V VTi  | 88   |  | 10.06  | 06.12   |  |  |  |                |     |
|  | 1.6 HDi  | 68   |  | 11.09  | 06.12   |  |  |  |                |     |
|  | 1.4  | 53   |  | 02.06  | 06.12   | 24.3541-1771.5   | 240239   |  | D=54, - Halter | BOS |
|  | 1.4  | 55   |  | 09.07  | 06.12   | 24.3541-1772.5   | 240240   |  | D=54, - Halter | BOS |
|  | 1.4 16V  | 65   |  | 02.06  | 06.12   |  |  |  |                |     |
|  | 1.4 HDi  | 50   |  | 02.06  | 06.12   |  |  |  |                |     |
|  | 1.6 HDi  | 66   |  | 02.06  | 06.12   |  |  |  |                |     |
|  | 1.6 HDi  | 68   |  | 11.09  | 06.12   |  |  |  |                |     |
|  | 1.4 16V VTi  | 70   |  | 08.07  | 06.12   | 24.3541-1761.5   | 240233   |  | D=54, - Halter | BOS |
|  | 1.6 16V  | 80   |  | 02.06  | 06.12   | 24.3541-1762.5   | 240234   |  | D=54, - Halter | BOS |
|  | 1.6 16V Turbo  | 110  |  | 02.06  | 06.12   |  |  |  |                |     |
|  | 1.6 16V Turbo  | 115  |  | 01.10  | 06.12   |  |  |  |                |     |
|  | 1.6 16V VTi  | 88   |  | 10.06  | 06.12   |  |  |  |                |     |
|  | 1.6 HDi  | 66   |  | 02.06  | 06.12   |  |  |  |                |     |
|  | 1.6 HDi  | 80   |  | 02.06  | 06.12   |  |  |  |                |     |
|  | 1.6 HDi 110  | 82   |  | 08.09  | 06.12   |  |  |  |                |     |
|  | 1.6 16V RC   | 128  |  | 10.06  | 06.12   | 11.9571-9765.2   | 220663   |  | D=57, - Halter | ATE |
|  |  |  |  |  |   | 11.9571-9766.2   | 220664   |  | D=57, - Halter | ATE |
|  |  |  |  |  |   | 11.8116-0351.1   | 390538   |  | Haltefeder     | ATE |
|  |  |  |  |  |   | 11.0101-5704.2   | 260095   |  | Hülensatz      | ATE |
|  |  |  |  |  |   | 11.8171-0008.1   | 990049   |  | Führungsbolzen | ATE |
|  |  |  |  |  |   |  |  |  |                |     |
|  | 1.4  | 53   |  | 02.06  | 06.12   | 24.5144-0480.3   | 330961   |  | L=480          |     |
|  | 1.4  | 55   |  | 09.07  | 06.12   |  |  |  |                |     |
|  | 1.4 16V  | 65   |  | 02.06  | 06.12   |  |  |  |                |     |
|  | 1.4 16V VTi  | 70   |  | 08.07  | 06.12   |  |  |  |                |     |
|  | 1.4 HDi  | 50   |  | 02.06  | 06.12   |  |  |  |                |     |
|  | 1.6 16V  | 80   |  | 02.06  | 06.12   |  |  |  |                |     |
|  | 1.6 16V RC   | 128  |  | 10.06  | 06.12   |  |  |  |                |     |
|  | 1.6 16V Turbo  | 110  |  | 02.06  | 06.12   |  |  |  |                |     |
|  | 1.6 16V Turbo  | 115  |  | 10.09  | 06.12   |  |  |  |                |     |
| 1.6 16V VTi  | 88   |  | 10.06  | 06.12  |   |  |  |  |                |     |

1) + ABS/+ electr.br.force distribution / + ABS/+ ripartiz.eletr.di frenata / + ABS/+ répartition électr.de freinage / + ABS/+ distrib.electr.la carga frenado

2) - ABS/ + brake press.regulator / - ABS/ + correttore di frenata / - ABS/ + correcteur de freinage / - ABS/ + corrector de frenado

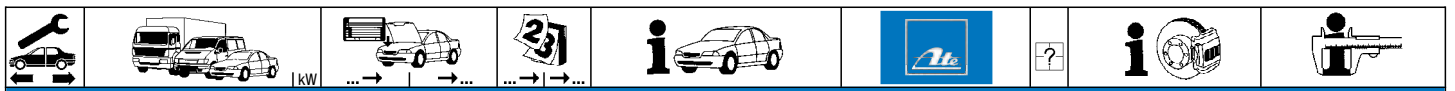

**PEUGEOT 207 Limousine (06-12)**

|  |               |     |            |       |       |                |        |   |  |           |
|--|---------------|-----|------------|-------|-------|----------------|--------|---|--|-----------|
|  | 1.6 HDi       | 66  |            | 02.06 | 06.12 | 24.5144-0480.3 | 330961 | 2 |  | L=480     |
|  | 1.6 HDi       | 68  |            | 11.09 | 06.12 |                |        |   |  |           |
|  | 1.6 HDi       | 80  |            | 02.06 | 06.12 |                |        |   |  |           |
|  | 1.6 HDi 110   | 82  |            | 08.09 | 06.12 |                |        |   |  |           |
|  | 1.4           | 53  |            | 02.06 | 06.12 | 24.5239-0190.3 | 330966 | 2 |  | L=190     |
|  | 1.4           | 55  |            | 09.07 | 06.12 |                |        |   |  |           |
|  | 1.4 16V       | 65  |            | 02.06 | 06.12 |                |        |   |  |           |
|  | 1.4 16V VTi   | 70  |            | 08.07 | 06.12 |                |        |   |  |           |
|  | 1.4 HDi       | 50  |            | 02.06 | 06.12 |                |        |   |  |           |
|  | 1.6 16V       | 80  |            | 02.06 | 06.12 |                |        |   |  |           |
|  | 1.6 16V RC    | 128 |            | 10.06 | 06.12 |                |        |   |  |           |
|  | 1.6 16V Turbo | 110 |            | 02.06 | 06.12 |                |        |   |  |           |
|  | 1.6 16V Turbo | 115 |            | 10.09 | 06.12 |                |        |   |  |           |
|  | 1.6 16V VTi   | 88  |            | 10.06 | 06.12 |                |        |   |  |           |
|  | 1.6 HDi       | 66  |            | 02.06 | 06.12 |                |        |   |  |           |
|  | 1.6 HDi       | 68  |            | 11.09 | 06.12 |                |        |   |  |           |
|  | 1.6 HDi       | 80  |            | 02.06 | 06.12 |                |        |   |  |           |
|  | 1.6 HDi 110   | 82  |            | 08.09 | 06.12 |                |        |   |  |           |
|  | 1.4           | 53  |            | 02.06 | 06.12 | 24.3220-1611.3 | 020238 |   |  | RzR 20,64 |
|  | 1.4           | 55  |            | 09.07 | 06.12 | 24.3220-1612.3 | 020239 |   |  | RzR 20,64 |
|  | 1.4 HDi       | 50  |            | 02.06 | 06.12 |                |        |   |  |           |
|  | 1.4           | 53  |            | 02.06 | 06.12 | 24.3220-1732.3 | 020514 |   |  | Rz 20,64  |
|  | 1.4           | 55  |            | 09.07 | 06.12 |                |        |   |  |           |
|  | 1.4 16V       | 65  |            | 02.06 | 06.12 |                |        |   |  |           |
|  | 1.4 16V VTi   | 70  |            | 08.07 | 06.12 |                |        |   |  |           |
|  | 1.4 HDi       | 50  |            | 02.06 | 06.12 |                |        |   |  |           |
|  | 1.6 HDi       | 66  |            | 02.06 | 06.12 |                |        |   |  |           |
|  | 1.6 HDi       | 68  |            | 11.09 | 06.12 |                |        |   |  |           |
|  | 1.4           | 53  |            | 02.06 | 06.12 | 24.3727-0846.2 | 580846 | 2 |  | L=1796    |
|  | 1.4           | 55  |            | 09.07 | 06.12 |                |        |   |  |           |
|  | 1.4 16V       | 65  |            | 02.06 | 06.12 |                |        |   |  |           |
|  | 1.4 16V VTi   | 70  |            | 08.07 | 06.12 |                |        |   |  |           |
|  | 1.4 HDi       | 50  |            | 02.06 | 06.12 |                |        |   |  |           |
|  | 1.6 HDi       | 66  |            | 02.06 | 06.12 |                |        |   |  |           |
|  | 1.6 HDi       | 68  |            | 11.09 | 06.12 |                |        |   |  |           |
|  | 1.6 16V       | 80  | ORGA 11634 | 02.06 |       | 24.3727-0845.2 | 580845 | 2 |  | L=1905    |
|  | 1.6 16V RC    | 128 | ORGA 11634 | 10.06 |       |                |        |   |  |           |
|  | 1.6 16V Turbo | 110 | ORGA 11634 | 02.06 |       |                |        |   |  |           |
|  | 1.6 16V Turbo | 115 | ORGA 11634 | 10.09 |       |                |        |   |  |           |
|  | 1.6 16V VTi   | 88  | ORGA 11634 | 10.06 |       |                |        |   |  |           |
|  | 1.6 HDi       | 66  | ORGA 11634 | 02.06 |       |                |        |   |  |           |
|  | 1.6 HDi       | 80  | ORGA 11634 | 02.06 |       |                |        |   |  |           |
|  | 1.6 HDi 110   | 82  | ORGA 11634 | 08.09 |       |                |        |   |  |           |
|  | 1.6 16V       | 80  | ORGA 11635 | 06.12 |       | 24.3727-0855.2 | 580855 | 2 |  | L=1910    |
|  | 1.6 16V RC    | 128 | ORGA 11635 | 06.12 |       |                |        |   |  |           |
|  | 1.6 16V Turbo | 110 | ORGA 11635 | 06.12 |       |                |        |   |  |           |
|  | 1.6 16V Turbo | 115 | ORGA 11635 | 06.12 |       |                |        |   |  |           |
|  | 1.6 16V VTi   | 88  | ORGA 11635 | 06.12 |       |                |        |   |  |           |
|  | 1.6 HDi       | 66  | ORGA 11635 | 06.12 |       |                |        |   |  |           |
|  | 1.6 HDi       | 80  | ORGA 11635 | 06.12 |       |                |        |   |  |           |
|  | 1.6 HDi 110   | 82  | ORGA 11635 | 06.12 |       |                |        |   |  |           |

**PEUGEOT 207 CC (07-)**

|  |               |     |              |       |  |                |        |   |       |                |     |
|--|---------------|-----|--------------|-------|--|----------------|--------|---|-------|----------------|-----|
|  | 1.6 16V       | 88  |              | 02.07 |  | 24.4123-1705.3 | 010832 |   | - ESP | THz 23,81      | LUC |
|  | 1.6 16V Turbo | 110 |              | 02.07 |  | 24.4123-1704.3 | 010828 |   | + ESP | THz 23,81      | LUC |
|  | 1.6 16V Turbo | 115 |              | 10.09 |  |                |        |   |       |                |     |
|  | 1.6 HDi       | 80  |              | 02.07 |  |                |        |   |       |                |     |
|  | 1.6 HDi       | 82  |              | 08.09 |  |                |        |   |       |                |     |
|  | 1.6 16V       | 88  |              | 02.07 |  | 24.3541-1761.5 | 240233 |   |       | D=54, - Halter | BOS |
|  | 1.6 16V Turbo | 110 |              | 02.07 |  | 24.3541-1762.5 | 240234 |   |       | D=54, - Halter | BOS |
|  | 1.6 16V Turbo | 115 |              | 10.09 |  |                |        |   |       |                |     |
|  | 1.6 HDi       | 80  |              | 02.07 |  |                |        |   |       |                |     |
|  | 1.6 HDi       | 82  |              | 08.09 |  |                |        |   |       |                |     |
|  | 1.6 16V       | 88  |              | 02.07 |  | 24.5144-0480.3 | 330961 | 2 |       | L=480          |     |
|  | 1.6 16V Turbo | 110 |              | 02.07 |  |                |        |   |       |                |     |
|  | 1.6 16V Turbo | 115 |              | 10.09 |  |                |        |   |       |                |     |
|  | 1.6 HDi       | 80  |              | 02.07 |  |                |        |   |       |                |     |
|  | 1.6 HDi       | 82  |              | 08.09 |  |                |        |   |       |                |     |
|  | 1.6 16V       | 88  |              | 02.07 |  | 24.5239-0190.3 | 330966 | 2 |       | L=190          |     |
|  | 1.6 16V Turbo | 110 |              | 02.07 |  |                |        |   |       |                |     |
|  | 1.6 16V Turbo | 115 |              | 10.09 |  |                |        |   |       |                |     |
|  | 1.6 HDi       | 80  |              | 02.07 |  |                |        |   |       |                |     |
|  | 1.6 HDi       | 82  |              | 08.09 |  |                |        |   |       |                |     |
|  | 1.6 16V       | 88  | ORGA 1163482 | 02.07 |  | 24.3727-0845.2 | 580845 | 2 |       | L=1905         |     |
|  | 1.6 16V Turbo | 110 | ORGA 1163482 | 02.07 |  |                |        |   |       |                |     |
|  | 1.6 16V Turbo | 115 | ORGA 1163482 | 10.09 |  |                |        |   |       |                |     |
|  | 1.6 HDi       | 80  | ORGA 1163482 | 02.07 |  |                |        |   |       |                |     |
|  | 1.6 HDi       | 82  | ORGA 1163482 | 08.09 |  |                |        |   |       |                |     |
|  | 1.6 16V       | 88  | ORGA 1163582 | 06.12 |  | 24.3727-0855.2 | 580855 | 2 |       | L=1910         |     |
|  | 1.6 16V Turbo | 110 | ORGA 1163582 | 06.12 |  |                |        |   |       |                |     |
|  | 1.6 16V Turbo | 115 | ORGA 1163582 | 06.12 |  |                |        |   |       |                |     |
|  | 1.6 HDi       | 80  | ORGA 1163582 | 06.12 |  |                |        |   |       |                |     |
|  | 1.6 HDi       | 82  | ORGA 1163582 | 06.12 |  |                |        |   |       |                |     |





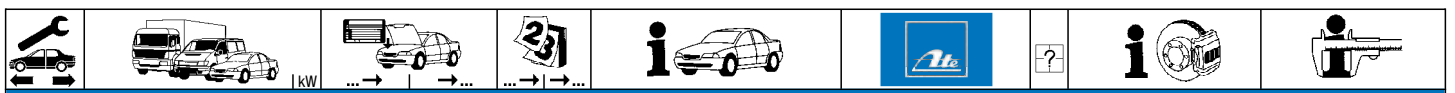

| PEUGEOT 207 SW (07-) |                 |              |              |                    |                     |                |        |   |       |                |     |
|----------------------|-----------------|--------------|--------------|--------------------|---------------------|----------------|--------|---|-------|----------------|-----|
|                      | 1.4 i           | 54           |              | 06.07              |                     | 24.4122-1704.3 | 010847 |   | - ESP | THz 22,20      | LUC |
|                      | 1.4 i 16V       | 70           |              | 06.07              |                     | 24.4122-1703.3 | 010843 |   | + ESP | THz 22,20      | LUC |
|                      | 1.6 HDi FAP 90  | 66           |              | 06.07              |                     |                |        |   |       |                |     |
|                      | 1.6 16V RC      | 128          |              | 11.07              |                     | 24.4123-1705.3 | 010832 |   | - ESP | THz 23,81      | LUC |
|                      | 1.6 HDi         | 68           |              | 11.09              |                     | 24.4123-1704.3 | 010828 |   | + ESP | THz 23,81      | LUC |
|                      | 1.6 HDi         | 82           |              | 08.09              |                     |                |        |   |       |                |     |
| 1.6 HDi FAP 110      | 80              |              | 06.07        |                    |                     |                |        |   |       |                |     |
| 1.6 i 16V            | 88              |              | 06.07        |                    |                     |                |        |   |       |                |     |
|                      | 1.4 i           | 54           |              | 06.07              |                     | 24.3541-1771.5 | 240239 |   |       | D=54, - Halter | BOS |
|                      | 1.4 i 16V       | 70           |              | 06.07              |                     | 24.3541-1772.5 | 240240 |   |       | D=54, - Halter | BOS |
|                      | 1.6 HDi         | 68           |              | 11.09              |                     | 24.3541-1761.5 | 240233 |   |       | D=54, - Halter | BOS |
|                      | 1.6 HDi         | 82           |              | 08.09              |                     | 24.3541-1762.5 | 240234 |   |       | D=54, - Halter | BOS |
|                      | 1.6 HDi FAP 110 | 80           |              | 06.07              |                     |                |        |   |       |                |     |
|                      | 1.6 HDi FAP 90  | 66           |              | 06.07              |                     |                |        |   |       |                |     |
| 1.6 i 16V            | 88              |              | 06.07        |                    |                     |                |        |   |       |                |     |
|                      | 1.6 16V RC      | 128          |              | 11.07              |                     | 11.9571-9765.2 | 220663 |   |       | D=57, - Halter | ATE |
|                      |                 |              |              |                    |                     | 11.9571-9766.2 | 220664 |   |       | D=57, - Halter | ATE |
|                      |                 |              |              |                    |                     | 11.0101-5704.2 | 260095 |   |       | Hülzensatz     | ATE |
|                      |                 |              |              |                    |                     | 11.8171-0008.1 | 990049 |   |       | Führungsbolzen | ATE |
|                      |                 |              |              |                    |                     | 11.8116-0351.1 | 390538 |   |       | Haltefeder     | ATE |
|                      |                 |              |              |                    |                     |                |        | 2 |       |                |     |
|                      | 1.4 i           | 54           |              | 06.07              |                     | 24.5144-0480.3 | 330961 |   |       | L=480          |     |
|                      | 1.4 i 16V       | 70           |              | 06.07              |                     |                |        |   |       |                |     |
|                      | 1.6 16V RC      | 128          |              | 11.07              |                     |                |        |   |       |                |     |
|                      | 1.6 HDi         | 68           |              | 11.09              |                     |                |        |   |       |                |     |
|                      | 1.6 HDi         | 82           |              | 08.09              |                     |                |        |   |       |                |     |
|                      | 1.6 HDi FAP 110 | 80           |              | 06.07              |                     |                |        |   |       |                |     |
| 1.6 HDi FAP 90       | 66              |              | 06.07        |                    |                     |                |        |   |       |                |     |
| 1.6 i 16V            | 88              |              | 06.07        |                    |                     |                |        |   |       |                |     |
|                      | 1.4 i           | 54           |              | 06.07              |                     | 24.5239-0190.3 | 330966 |   |       | L=190          |     |
|                      | 1.4 i 16V       | 70           |              | 06.07              |                     |                |        |   |       |                |     |
|                      | 1.6 16V RC      | 128          |              | 11.07              |                     |                |        |   |       |                |     |
|                      | 1.6 HDi         | 68           |              | 11.09              |                     |                |        |   |       |                |     |
|                      | 1.6 HDi         | 82           |              | 08.09              |                     |                |        |   |       |                |     |
|                      | 1.6 HDi FAP 110 | 80           |              | 06.07              |                     |                |        |   |       |                |     |
| 1.6 HDi FAP 90       | 66              |              | 06.07        |                    |                     |                |        |   |       |                |     |
| 1.6 i 16V            | 88              |              | 06.07        |                    |                     |                |        |   |       |                |     |
|                      | 1.4 i           | 54           |              | 06.07              |                     | 24.3220-1611.3 | 020238 |   | - ABS | RzR 20,64      | BDX |
|                      | 1.6 HDi FAP 90  | 66           |              | 06.07              |                     | 24.3220-1612.3 | 020239 |   | - ABS | RzR 20,64      | BDX |
|                      | 1.4 i           | 54           |              | 06.07              |                     | 24.3220-1611.3 | 020238 |   | + ABS | RzR 20,64      | BDX |
|                      | 1.4 i 16V       | 70           |              | 06.07              |                     |                |        |   |       |                |     |
|                      | 1.6 HDi         | 68           |              | 11.09              |                     |                |        |   |       |                |     |
|                      | 1.6 HDi FAP 90  | 66           |              | 06.07              |                     |                |        |   |       |                |     |
|                      | 1.6 16V RC      | 128          | ORGA 1163482 | 11.07              |                     | 24.3727-0845.2 | 580845 | 2 |       | L=1905         |     |
|                      | 1.6 HDi         | 68           | ORGA 1163482 | 11.09              | + Scheibenbremse 1) |                |        |   |       |                |     |
|                      | 1.6 HDi         | 82           | ORGA 1163482 | 08.09              |                     |                |        |   |       |                |     |
|                      | 1.6 HDi FAP 110 | 80           | ORGA 1163482 | 06.07              |                     |                |        |   |       |                |     |
|                      | 1.6 HDi FAP 90  | 66           | ORGA 1163482 | 06.07              | + Scheibenbremse 1) |                |        |   |       |                |     |
|                      | 1.6 i 16V       | 88           | ORGA 1163482 | 06.07              |                     |                |        |   |       |                |     |
|                      | 1.4 i           | 54           |              | 06.07              |                     | 24.3727-0846.2 | 580846 | 2 |       | L=1796         |     |
|                      | 1.4 i 16V       | 70           |              | 06.07              |                     |                |        |   |       |                |     |
|                      | 1.6 16V RC      | 128          | ORGA 1163582 |                    |                     | 24.3727-0855.2 | 580855 | 2 |       | L=1910         |     |
|                      | 1.6 HDi         | 68           | ORGA 1163582 |                    | + Trommelbremse 2)  |                |        |   |       |                |     |
|                      | 1.6 HDi         | 82           | ORGA 1163582 |                    |                     |                |        |   |       |                |     |
|                      | 1.6 HDi FAP 110 | 80           | ORGA 1163582 |                    |                     |                |        |   |       |                |     |
| 1.6 HDi FAP 90       | 66              | ORGA 1163582 |              | + Trommelbremse 2) |                     |                |        |   |       |                |     |
| 1.6 i 16V            | 88              | ORGA 1163582 |              |                    |                     |                |        |   |       |                |     |

| PEUGEOT 208 (12-) |           |     |       |                                  |                                  |                |        |   |       |                |     |
|-------------------|-----------|-----|-------|----------------------------------|----------------------------------|----------------|--------|---|-------|----------------|-----|
|                   | 1.4 HDi   | 50  |       | 01.12                            | + Trommelbremse 2)               | 24.4122-1703.3 | 010843 |   | + DSC | THz 22,20      | LUC |
|                   | 1.4 VTi   | 70  |       | 01.12                            | + Trommelbremse 2)               | 24.4122-1704.3 | 010847 |   | - DSC | THz 22,20      | LUC |
|                   | 1.6 e-HDi | 68  |       | 01.12                            | + Trommelbremse 2)               |                |        |   |       |                |     |
|                   | 1.6 e-HDi | 84  |       | 01.12                            | + Trommelbremse 2)               |                |        |   |       |                |     |
|                   | 1.6 THP   | 115 |       | 01.12                            | + Trommelbremse 2)               |                |        |   |       |                |     |
|                   | 1.6 VTi   | 88  |       | 01.12                            | + Trommelbremse 2)               |                |        |   |       |                |     |
|                   | 1.0 VTi   | 50  |       | 01.12                            | + Scheibenbremse 1)              | 24.4123-1704.3 | 010828 |   | + DSC | THz 23,81      | LUC |
|                   | 1.2 VTi   | 60  |       | 01.12                            | + Scheibenbremse 1)              | 24.4123-1705.3 | 010832 |   | - DSC | THz 23,81      | LUC |
|                   | 1.4 HDi   | 50  |       | 01.12                            | + Scheibenbremse 1)              |                |        |   |       |                |     |
|                   | 1.4 VTi   | 70  |       | 01.12                            | + Scheibenbremse 1)              |                |        |   |       |                |     |
|                   | 1.6 e-HDi | 68  |       | 01.12                            | + Scheibenbremse 1)              |                |        |   |       |                |     |
|                   | 1.6 e-HDi | 84  |       | 01.12                            | + Scheibenbremse 1)              |                |        |   |       |                |     |
| 1.6 GTi           | 147       |     | 03.13 |                                  |                                  |                |        |   |       |                |     |
| 1.6 THP           | 115       |     | 01.12 | + Scheibenbremse 1)              |                                  |                |        |   |       |                |     |
| 1.6 VTi           | 88        |     | 01.12 | + Scheibenbremse 1)              |                                  |                |        |   |       |                |     |
|                   | 1.0 VTi   | 50  |       | 01.12                            | + Bremsscheibendurchm. 266 mm 3) | 24.3541-1771.5 | 240239 |   |       | D=54, - Halter | BOS |
|                   | 1.2 VTi   | 60  |       | 01.12                            | + Bremsscheibendurchm. 266 mm 3) | 24.3541-1772.5 | 240240 |   |       | D=54, - Halter | BOS |
|                   | 1.4 HDi   | 50  |       | 01.12                            | + Bremsscheibendurchm. 266 mm 3) |                |        |   |       |                |     |
|                   | 1.4 VTi   | 70  |       | 01.12                            | + Bremsscheibendurchm. 266 mm 3) |                |        |   |       |                |     |
|                   | 1.6 e-HDi | 68  |       | 01.12                            | + Bremsscheibendurchm. 266 mm 3) |                |        |   |       |                |     |
|                   | 1.6 e-HDi | 84  |       | 01.12                            | + Bremsscheibendurchm. 266 mm 3) |                |        |   |       |                |     |
| 1.6 THP           | 115       |     | 01.12 | + Bremsscheibendurchm. 266 mm 3) |                                  |                |        |   |       |                |     |
| 1.6 VTi           | 88        |     | 01.12 | + Bremsscheibendurchm. 266 mm 3) |                                  |                |        |   |       |                |     |
|                   | 1.0 VTi   | 50  |       | 01.12                            | + Bremsscheibendurchm. 302 mm 4) | 11.0101-5704.2 | 260095 |   |       | Hülzensatz     | ATE |
|                   | 1.2 VTi   | 60  |       | 01.12                            | + Bremsscheibendurchm. 302 mm 4) | 11.8171-0008.1 | 990049 |   |       | Führungsbolzen | ATE |
|                   | 1.4 HDi   | 50  |       | 01.12                            | + Bremsscheibendurchm. 302 mm 4) | 11.8116-0356.1 | 390586 | 2 |       | Haltefeder     | ATE |

1) + disc brake / + disco freno / + disques de frein / + disco de freno  
 2) + drum brake / + freno a tamburo / + freins à tambour / + tambores de freno  
 3) + brake disc diameter 266 mm / + disco fr.diam. 266mm / + disques fr.diam. 266mm / + disco fr.diam. 266mm  
 4) + brake disc diameter 302 mm / + disco fr.diam. 302mm / + disques fr.diam. 302mm / + disco fr.diam. 302mm





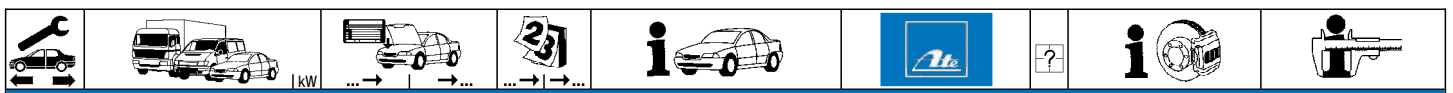











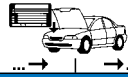

| PEUGEOT 208 (12-) |           |     |  |       |   |                |        |   |  |                |     |
|-------------------|-----------|-----|--|-------|---|----------------|--------|---|--|----------------|-----|
|                   | 1.4 VTi   | 70  |  | 01.12 | + Bremsscheibendurchm. 302 mm <sup>1)</sup> | 11.0101-5704.2 | 260095 |   |  | Hülsensatz     | ATE |
|                   | 1.6 e-HDi | 68  |  | 01.12 | + Bremsscheibendurchm. 302 mm <sup>1)</sup> | 11.8171-0008.1 | 990049 |   |  | Führungsbolzen | ATE |
|                   | 1.6 e-HDi | 84  |  | 01.12 | + Bremsscheibendurchm. 302 mm <sup>1)</sup> | 11.8116-0356.1 | 390586 | 2 |  | Haltefeder     | ATE |
|                   | 1.6 THP   | 115 |  | 01.12 | + Bremsscheibendurchm. 302 mm <sup>1)</sup> |                |        |   |  |                |     |
|                   | 1.6 VTi   | 88  |  | 01.12 | + Bremsscheibendurchm. 302 mm <sup>1)</sup> |                |        |   |  |                |     |
|                   | 1.6 GTi   | 147 |  | 03.13 |   | 11.0101-5704.2 | 260095 |   |  | Hülsensatz     | ATE |
|                   |           |     |  |       |   | 11.8171-0008.1 | 990049 |   |  | Führungsbolzen | ATE |
|                   |           |     |  |       |   | 11.8116-0356.1 | 390586 | 2 |  | Haltefeder     | ATE |
|                   | 1.0 VTi   | 50  |  | 01.12 | + Bremsscheibendurchm. 302 mm <sup>1)</sup> | 24.5144-0480.3 | 330961 | 2 |  | L=480          |     |
|                   | 1.2 VTi   | 60  |  | 01.12 | + Bremsscheibendurchm. 302 mm <sup>1)</sup> |                |        |   |  |                |     |
|                   | 1.4 HDi   | 50  |  | 01.12 | + Bremsscheibendurchm. 302 mm <sup>1)</sup> |                |        |   |  |                |     |
|                   | 1.4 VTi   | 70  |  | 01.12 | + Bremsscheibendurchm. 302 mm <sup>1)</sup> |                |        |   |  |                |     |
|                   | 1.6 e-HDi | 68  |  | 01.12 | + Bremsscheibendurchm. 302 mm <sup>1)</sup> |                |        |   |  |                |     |
|                   | 1.6 e-HDi | 84  |  | 01.12 | + Bremsscheibendurchm. 302 mm <sup>1)</sup> |                |        |   |  |                |     |
|                   | 1.6 GTi   | 147 |  | 03.13 | + Bremsscheibendurchm. 302 mm <sup>1)</sup> |                |        |   |  |                |     |
|                   | 1.6 THP   | 115 |  | 01.12 | + Bremsscheibendurchm. 302 mm <sup>1)</sup> |                |        |   |  |                |     |
|                   | 1.6 VTi   | 88  |  | 01.12 | + Bremsscheibendurchm. 302 mm <sup>1)</sup> |                |        |   |  |                |     |
|                   | 1.0 VTi   | 50  |  | 01.12 |   | 24.5239-0190.3 | 330966 | 2 |  | L=190          |     |
|                   | 1.2 VTi   | 60  |  | 01.12 |   |                |        |   |  |                |     |

| PEUGEOT 301 (12-) |             |    |  |       |  |                |        |   |                                    |                |     |
|-------------------|-------------|----|--|-------|--|----------------|--------|---|------------------------------------|----------------|-----|
|                   | 1.6 HDi 92  | 68 |  | 11.12 |  | 24.4122-1703.3 | 010843 |   | + ESP                              | THz 22,20      | LUC |
|                   | 1.2 VTi 72  | 53 |  | 11.12 |  | 24.3541-1771.5 | 240239 |   | + belüftete Scheiben <sup>2)</sup> | D=54, - Halter | BOS |
|                   | 1.6 HDi 92  | 68 |  | 11.12 |  | 24.3541-1772.5 | 240240 |   | + belüftete Scheiben <sup>2)</sup> | D=54, - Halter | BOS |
|                   | 1.6 VTi 115 | 85 |  | 11.12 |  |                |        |   |                                    |                |     |
|                   | 1.2 VTi 72  | 53 |  | 11.12 |  | 24.5239-0190.3 | 330966 | 2 |                                    | L=190          |     |
|                   | 1.6 HDi 92  | 68 |  | 11.12 |  |                |        |   |                                    |                |     |
|                   | 1.6 VTi 115 | 85 |  | 11.12 |  |                |        |   |                                    |                |     |
|                   | 1.2 VTi 72  | 53 |  | 11.12 |  | 24.3220-1617.3 | 020244 |   | - ABS                              | RzR 20,64      | BDX |
|                   | 1.6 HDi 92  | 68 |  | 11.12 |  | 24.3220-1618.3 | 020245 |   | - ABS                              | RzR 20,64      | BDX |
|                   | 1.6 VTi 115 | 85 |  | 11.12 |  |                |        |   |                                    |                |     |

| PEUGEOT 306 Limousine (3/5-türig) (93-01) |         |            |            |             |  |                |        |  |    |           |     |
|---|---------|------------|------------|-------------|--|----------------|--------|--|----|-----------|-----|
|   | 1.4     | 55         |            | 05.97       | 05.01 - ABS  | 03.7750-9302.4 | 300116 |  |    | 9"        | ATE |
|   | 1.6     | 65         |            | 05.97       | 10.00 - ABS  |                |        |  |    |           |     |
|   | 1.6     | 72         |            | 10.00       | 05.01 - ABS  |                |        |  |    |           |     |
|   | 1.8     | 74         |            | 05.97       | 05.01 - ABS  |                |        |  |    |           |     |
|   | 1.8 16V | 81         |            | 05.97       | 05.01 - ABS  |                |        |  |    |           |     |
|   | 1.8 D   | 43         |            | 05.97       | 05.01 - ABS  |                |        |  |    |           |     |
|   | 1.9 D   | 66         |            | 05.97       | 05.01 - ABS  |                |        |  |    |           |     |
|   | 2.0     | 89         |            | 05.97       | 05.01 - ABS  |                |        |  |    |           |     |
|   | 2.0 16V | 81         |            | 05.97       | 05.01 - ABS  |                |        |  |    |           |     |
|   | 2.0 HDi | 66         |            | 06.99       | 05.01 - ABS  |                |        |  |    |           |     |
|   | 2.0 S16 | 110        |            | 05.97       | 05.01 - ABS  |                |        |  |    |           |     |
|   | 2.0 S16 | 112        |            | 05.97       | 05.01 - ABS  |                |        |  |    |           |     |
|   | 1.1     | 44         |            | 03.94       | 04.97 + ABS  | 03.7750-9402.4 | 300117 |  |    | 9"        | ATE |
|   | 1.4     | 55         | ORGA 08575 | 03.93       | + ABS  |                |        |  |    |           |     |
|   | 1.6     | 65         | ORGA 08575 | 03.93       | + ABS  |                |        |  |    |           |     |
|   | 1.8     | 74         | ORGA 08575 | 03.93       | + ABS  |                |        |  |    |           |     |
| 1.8 16V                                   | 81      | ORGA 08575 | 03.97      | + ABS       |  |                |        |  |    |           |     |
| 1.8 D                                     | 43      |            | 03.93      | 05.01 + ABS |  |                |        |  |    |           |     |
| 1.9 D                                     | 47      |            | 05.93      | 05.01 + ABS |  |                |        |  |    |           |     |
| 1.9 D                                     | 50      |            | 06.94      | 05.01 + ABS |  |                |        |  |    |           |     |
| 1.9 D                                     | 51      | ORGA 08575 | 09.98      | + ABS       |  |                |        |  |    |           |     |
| 1.9 D                                     | 55      |            | 03.98      | 05.01 + ABS |  |                |        |  |    |           |     |
| 1.9 TD                                    | 66      | ORGA 08575 | 10.93      | + ABS       |  |                |        |  |    |           |     |
| 2.0                                       | 89      | ORGA 08575 | 03.94      | + ABS       |  |                |        |  |    |           |     |
| 2.0 16V                                   | 81      | ORGA 08575 | 03.97      | + ABS       |  |                |        |  |    |           |     |
| 2.0 HDi                                   | 66      | ORGA 08575 | 06.99      | + ABS       |  |                |        |  |    |           |     |
| 2.0 S16                                   | 110     | ORGA 08575 | 03.94      | + ABS       |  |                |        |  |    |           |     |
| 2.0 S16                                   | 112     | ORGA 08575 | 07.94      | + ABS       |  |                |        |  |    |           |     |
| 1.6                                       | 65      |            | 03.93      | 04.97 + ABS | 03.7750-2232.4                                     | 300112         |        |  | 9" | ATE       |     |
|   | 1.1     | 44         |            | 03.94       | 04.97 - ABS/ + 3 türig <sup>3)</sup>               | 24.2120-1704.3 | 010429 |  |    | THz 20,64 | BDX |
|   | 1.4     | 55         |            | 03.93       | 04.97 - ABS/ + Fahrschule/ + 3 türig <sup>4)</sup> |                |        |  |    |           |     |
|   | 1.1     | 44         |            | 03.94       | 04.97 - ABS/ + 5 türig <sup>5)</sup>               | 03.2119-3391.3 | 010058 |  |    | THz 19,05 | ATE |
|   | 1.4     | 55         |            | 03.93       | 04.97 - ABS/ - Fahrschule/ + 5 türig <sup>6)</sup> | 24.2119-1702.3 | 010435 |  |    | THz 19,05 | BDX |
|   | 1.4     | 55         |            | 05.97       | 05.01 - ABS  | 03.2120-4321.3 | 010525 |  |    | THz 20,64 | ATE |
|   | 1.6     | 65         |            | 05.97       | 10.00 - ABS  | 24.2120-1726.3 | 010564 |  |    | THz 20,64 | BDX |
|   | 1.6     | 72         |            | 10.00       | 05.01 - ABS  |                |        |  |    |           |     |
|   | 1.8     | 74         |            | 05.97       | 05.01 - ABS  |                |        |  |    |           |     |
|   | 1.8 D   | 43         |            | 05.97       | 05.01 - ABS  |                |        |  |    |           |     |
|   | 1.9 D   | 43         |            | 05.97       | 05.01 - ABS  |                |        |  |    |           |     |
|   | 1.6     | 65         |            | 03.93       | 04.97 - ABS  | 03.2120-1897.3 | 010103 |  |    | THz 20,64 | ATE |
|   | 1.8     | 74         |            | 03.93       | 04.97 - ABS  | 24.2120-1704.3 | 010429 |  |    | THz 20,64 | BDX |
|   | 1.8 16V | 81         |            | 03.97       | 04.97 - ABS  |                |        |  |    |           |     |

<sup>1)</sup> + brake disc diameter 302 mm / + disco fr.diam. 302mm / + disques fr.diam. 302mm / + disco fr.diam. 302mm  
<sup>2)</sup> + ventilated discs / + dischi ventilati / + disques ventilés / + disco ventilado  
<sup>3)</sup> - ABS/ + 3 door / - ABS/ + 3 porte / - ABS/ + 3 portes / - ABS/ + 3 puertas  
<sup>4)</sup> - ABS/ + driving school/ + 3 door / - ABS/ + scuola guida/ + 3 porte / - ABS/ + auto école/ + 3 portes / - ABS/ + autoescuela/ + 3 puertas  
<sup>5)</sup> - ABS/ + 5 door / - ABS/ + 5 porte / - ABS/ + 5 portes / - ABS/ + 5 puertas  
<sup>6)</sup> - ABS/ - driving school/ + 5 door / - ABS/ - scuola guida/ + 5 porte / - ABS/ - auto école/ + 5 portes / - ABS/ - autoescuela/ + 5 puertas

|          |         |            |            |       |       |                |                |        |   |           |                |     |
|--|---------|------------|------------|-------|-------|----------------|----------------|--------|---|-----------|----------------|-----|
| PEUGEOT 306 Limousine (3/5-türig) (93-01)  |         |            |            |       |       |                |                |        |   |           |                |     |
|    | 1.8 D   | 43         |            | 03.93 | 04.97 | - ABS          | 03.2120-1897.3 | 010103 |   |           | THz 20,64      | ATE |
|  | 1.9 D   |            |            | 05.93 | 04.97 | - ABS          | 24.2120-1704.3 | 010429 |   |           | THz 20,64      | BDX |
|  | 1.9 TD  | 66         |            | 10.93 | 04.97 | - ABS          |                |        |   |           |                |     |
|  | 2.0     | 89         |            | 03.94 | 04.97 | - ABS          |                |        |   |           |                |     |
|  | 2.0 16V |            |            | 03.97 | 04.97 | - ABS          |                |        |   |           |                |     |
|  | 2.0 S16 | 110        |            | 03.94 | 04.97 | - ABS          |                |        |   |           |                |     |
| 2.0 S16  | 112     |            | 07.94      | 04.97 | - ABS |                |                |        |   |           |                |     |
|  | 1.8 16V | 81         |            | 05.97 | 05.01 | - ABS          | 03.2122-1356.3 | 010529 |   |           | THz 22,20      | ATE |
|  | 1.9 TD  | 66         |            | 05.97 | 05.01 | - ABS          |                |        |   |           |                |     |
|  | 2.0     | 89         |            | 05.97 | 05.01 | - ABS          |                |        |   |           |                |     |
|  | 2.0 16V |            |            | 05.97 | 05.01 | - ABS          |                |        |   |           |                |     |
|  | 2.0 HDi | 66         |            | 06.99 | 05.01 | - ABS          |                |        |   |           |                |     |
|  | 2.0 S16 | 110        |            | 05.97 | 05.01 | - ABS          |                |        |   |           |                |     |
| 2.0 S16  | 112     |            | 05.97      | 05.01 | - ABS |                |                |        |   |           |                |     |
|  | 1.4     | 55         | ORGA 08575 | 05.97 |       | + ABS          | 03.2122-1351.3 | 010528 |   |           | THz 22,20      | ATE |
|  | 1.6     | 65         | ORGA 08575 | 05.97 |       | + ABS          | 24.2122-1733.3 | 010668 |   |           | THz 22,20      | BOS |
|  | 1.8     | 74         | ORGA 08575 | 05.97 |       | + ABS          |                |        |   |           |                |     |
|  | 1.8 16V | 81         | ORGA 08575 | 05.97 |       | + ABS          |                |        |   |           |                |     |
|  | 1.8 D   | 43         | ORGA 08575 | 05.97 |       | + ABS          |                |        |   |           |                |     |
|  | 1.9 D   |            | ORGA 08575 | 05.97 |       | + ABS          |                |        |   |           |                |     |
|  | 1.9 TD  | 66         | ORGA 08575 | 05.97 |       | + ABS          |                |        |   |           |                |     |
|  | 2.0     | 89         | ORGA 08575 | 05.97 |       | + ABS          |                |        |   |           |                |     |
|  | 2.0 16V |            | ORGA 08575 | 05.97 |       | + ABS          |                |        |   |           |                |     |
|  | 2.0 HDi | 66         | ORGA 08575 | 06.99 |       | + ABS          |                |        |   |           |                |     |
|  | 2.0 S16 | 110        | ORGA 08575 | 05.97 |       | + ABS          |                |        |   |           |                |     |
|  | 2.0 S16 | 112        | ORGA 08575 | 05.97 |       | + ABS          |                |        |   |           |                |     |
|  | 1.4     | 55         | ORGA 08576 |       | 10.00 | + ABS          | 24.2123-1715.3 | 010520 |   |           | THz 23,81      | BDX |
|  | 1.6     | 65         | ORGA 08576 |       | 10.00 | + ABS          |                |        |   |           |                |     |
|  | 1.6     | 72         |            |       | 10.00 | + ABS          |                |        |   |           |                |     |
|  | 1.8     | 74         | ORGA 08576 |       | 10.00 | + ABS          |                |        |   |           |                |     |
|  | 1.8 16V | 81         | ORGA 08576 |       | 10.00 | + ABS          |                |        |   |           |                |     |
|  | 1.8 D   | 43         | ORGA 08576 |       | 10.00 | + ABS          |                |        |   |           |                |     |
|  | 1.9 D   |            | ORGA 08576 |       | 10.00 | + ABS          |                |        |   |           |                |     |
|  | 1.9 TD  | 66         | ORGA 08576 |       | 10.00 | + ABS          |                |        |   |           |                |     |
|  | 2.0     | 89         | ORGA 08576 |       | 10.00 | + ABS          |                |        |   |           |                |     |
|  | 2.0 16V |            | ORGA 08576 |       | 10.00 | + ABS          |                |        |   |           |                |     |
|  | 2.0 HDi | 66         | ORGA 08576 |       | 10.00 | + ABS          |                |        |   |           |                |     |
|  | 2.0 S16 | 110        | ORGA 08576 |       | 10.00 | + ABS          |                |        |   |           |                |     |
| 2.0 S16  | 112     | ORGA 08576 |            | 10.00 | + ABS |                |                |        |   |           |                |     |
| 2.0 S16  | 120     |            | 03.96      | 05.01 | + ABS |                |                |        |   |           |                |     |
|  | 1.8     | 74         |            | 03.93 | 05.01 | - ABS          | 03.2120-4246.3 | 010614 |   |           | THz 20,64      | ATE |
|  | 1.8 D   | 43         |            | 03.93 | 05.01 | - ABS          | 24.2120-1722.3 | 010544 |   |           | THz 20,64      | BDX |
|  | 1.9 D   | 47         |            | 05.93 | 05.01 | - ABS          |                |        |   |           |                |     |
|  | 1.9 D   | 50         |            | 06.94 | 05.01 | - ABS          |                |        |   |           |                |     |
|  | 1.9 D   | 51         |            | 09.98 | 05.01 | - ABS          | 03.2122-1461.3 | 010610 |   |           | THz 22,20      | ATE |
|  | 1.8 16V | 81         |            | 03.97 | 05.01 | - ABS          | 03.2122-1421.3 | 010615 |   |           | THz 22,20      | ATE |
|  | 1.9 TD  | 66         |            | 10.93 | 05.01 | - ABS          |                |        |   |           |                |     |
|  | 2.0     | 89         |            | 03.94 | 05.01 | - ABS          |                |        |   |           |                |     |
|  | 2.0 16V |            |            | 03.97 | 05.01 | - ABS          |                |        |   |           |                |     |
|  | 2.0 HDi | 66         |            | 06.99 | 05.01 | - ABS          |                |        |   |           |                |     |
|  | 2.0 S16 | 110        |            | 03.94 | 05.01 | - ABS          |                |        |   |           |                |     |
| 2.0 S16  | 112     |            | 07.94      | 05.01 | - ABS |                |                |        |   |           |                |     |
|  | 1.1     | 44         | S 30209025 |       |       | + ABS          | 24.2122-1705.3 | 010434 |   |           | THz 22,20      |     |
|  | 1.4     | 55         | S 30209025 |       |       | + ABS          |                |        |   |           |                |     |
|  | 1.6     | 65         | S 30209025 |       |       | + ABS          |                |        |   |           |                |     |
|  | 1.8     | 74         | S 30209025 |       |       | + ABS          |                |        |   |           |                |     |
|  | 1.8 16V | 81         |            | 03.97 | 04.97 | + ABS          |                |        |   |           |                |     |
|  | 1.8 D   | 43         | S 30209025 |       |       | + ABS          |                |        |   |           |                |     |
|  | 1.9 D   |            | S 30209025 |       |       | + ABS          |                |        |   |           |                |     |
|  | 1.9 TD  | 66         |            | 10.93 | 04.97 | + ABS          |                |        |   |           |                |     |
|  | 2.0     | 89         |            | 03.94 | 04.97 | + ABS          |                |        |   |           |                |     |
|  | 2.0 16V |            |            | 03.97 | 04.97 | + ABS          |                |        |   |           |                |     |
|  | 2.0 S16 | 110        |            | 03.94 | 04.97 | + ABS          |                |        |   |           |                |     |
|  | 2.0 S16 | 112        |            | 07.94 | 04.97 | + ABS          |                |        |   |           |                |     |
|  | 1.9 D   | 51         | ORGA 08575 | 05.97 |       | + ABS          | 03.2122-1461.3 | 010610 |   |           | THz 22,20      | ATE |
|  | 1.4     | 55         | ORGA 08575 | 05.97 |       | + ABS          | 03.2122-1296.3 | 010609 |   |           | THz 22,20      | ATE |
|  | 1.6     | 65         | ORGA 08575 | 05.97 |       | + ABS          |                |        |   |           |                |     |
|  | 1.8     | 74         | ORGA 08575 | 05.97 |       | + ABS          |                |        |   |           |                |     |
|  | 1.8 16V | 81         | ORGA 08575 | 05.97 |       | + ABS          |                |        |   |           |                |     |
|  | 1.8 D   | 43         | ORGA 08575 | 05.97 |       | + ABS          |                |        |   |           |                |     |
|  | 1.9 D   | 47         | ORGA 08575 | 05.97 |       | + ABS          |                |        |   |           |                |     |
|  | 1.9 D   | 50         | ORGA 08575 | 05.97 |       | + ABS          |                |        |   |           |                |     |
|  | 1.9 D   | 55         | ORGA 08575 | 03.98 |       | + ABS          |                |        |   |           |                |     |
|  | 1.9 TD  | 66         | ORGA 08575 | 05.97 |       | + ABS          |                |        |   |           |                |     |
|  | 2.0     | 89         | ORGA 08575 | 05.97 |       | + ABS          |                |        |   |           |                |     |
|  | 2.0 16V |            | ORGA 08575 | 05.97 |       | + ABS          |                |        |   |           |                |     |
| 2.0 HDi  | 66      | ORGA 08575 | 06.99      |       | + ABS |                |                |        |   |           |                |     |
| 2.0 S16  | 110     | ORGA 08575 | 05.97      |       | + ABS |                |                |        |   |           |                |     |
| 2.0 S16  | 112     | ORGA 08575 | 05.97      |       | + ABS |                |                |        |   |           |                |     |
| 2.0 S16  | 120     |            | 03.96      | 05.01 | - ABS | 24.2123-1714.3 | 010587         |        |   | THz 23,81 | BDX            |     |
|    | 1.4     | 55         |            | 05.97 | 05.01 | - ABS          | 24.3481-1741.5 | 240245 |  |           | D=48, - Halter | BOS |
|  |         |            |            |       |       |                | 24.3481-1742.5 | 240246 |  |           | D=48, - Halter | BOS |

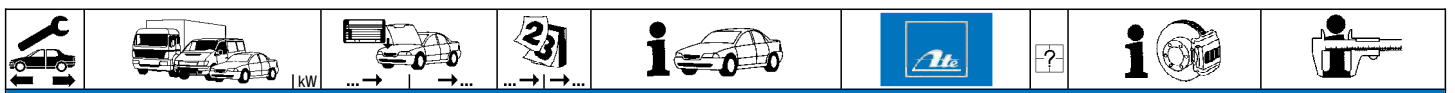

**PEUGEOT 306 Limousine (3/5-türig) (93-01)**

|                         |                         |            |            |       |  |  |                |        |   |                              |   |
|-------------------------|-------------------------|------------|------------|-------|--|--|----------------|--------|---|------------------------------|---|
|                         | 1.1                     | 44         |            | 03.94 | 04.97  | + ABS  | 11.3481-9833.2 | 220561 | 2 | ATE                          | D=48, - Halter<br>D=48, - Halter<br>D=48, - Halter<br>D=48, - Halter<br>Dichtungssatz<br>Hülzensatz<br>Führungsbolzen<br>Haltefeder |
|                         | 1.4                     | 55         | ORGA 08575 | 03.93 | 04.97  | + ABS / - Entreprise                         | 11.3481-9834.2 | 220562 |   |                              |   |
|                         | 1.4 <b>Entreprise</b>   | 55         |            | 03.93 | 05.01  |  | 24.3481-9833.5 | 240479 |   |                              |   |
|                         | 1.6                     | 65         |            | 03.93 | 05.01  |  | 24.3481-9834.5 | 240480 |   |                              |   |
|                         | 1.6                     | 65         | ORGA 08576 |       | 10.00  | - ABS  | 11.0441-4811.2 | 250024 |   |                              |   |
|                         | 1.6                     | 72         |            | 10.00 | 05.01  | - ABS  | 11.0101-5407.2 | 260011 |   |                              |   |
|                         | 1.8                     | 74         |            | 03.93 | 05.01  |  | 11.8171-0008.1 | 990049 |   |                              |   |
|                         | 1.8                     | 74         | ORGA 08576 |       | 05.01  | - ABS  | 11.8116-0129.1 | 390591 |   |                              |   |
|                         | 1.8 D                   | 43         |            | 03.93 | 05.01  |  |                |        |   |                              |   |
|                         | 1.9 D                   | 47         |            | 05.93 | 05.01  |  |                |        |   |                              |   |
|                         | 1.9 D                   | 50         |            | 06.94 | 05.01  |  |                |        |   |                              |   |
|                         | 1.9 D                   | 51         |            | 09.98 |  |  |                |        |   |                              |   |
|                         | 1.9 D                   | 51         | ORGA 08576 |       | 05.01  | - ABS  |                |        |   |                              |   |
|                         | 1.9 D                   | 55         |            | 03.98 | 05.01  |  |                |        |   |                              |   |
|                         | 1.9 D <b>Entreprise</b> |            |            | 09.98 | 10.00  | + ABS  |                |        |   |                              |   |
|                         | 1.9 TD                  | 66         |            | 10.93 | 05.01  |  |                |        |   |                              |   |
|                         | 1.4                     | 55         | ORGA 08576 |       | 05.01  | + ABS  | 24.3541-1767.5 | 240237 |   |                              |   |
|                         | 1.6                     | 65         | ORGA 08576 |       | 10.00  | + ABS  | 24.3541-1768.5 | 240238 |   |                              |   |
|                         | 1.6                     | 72         |            | 10.00 | 05.01  | + ABS  | 24.3541-1757.7 | 220483 |   |                              |   |
|                         | 1.8                     | 74         | ORGA 08576 |       | 05.01  | + ABS  | 24.3541-1758.7 | 220484 |   |                              |   |
| 1.8 16V                 | 81                      |            | 03.97      | 05.01 |  |  |                |        |   |                              |   |
| 1.9 D                   | 51                      | ORGA 08576 |            | 05.01 | + ABS  |  |                |        |   |                              |   |
| 1.9 D <b>Entreprise</b> |                         |            | 10.00      | 05.01 | + ABS  |  |                |        |   |                              |   |
| 2.0                     | 89                      |            | 05.97      | 05.01 |  |  |                |        |   |                              |   |
| 2.0 16V                 |                         |            | 05.97      | 05.01 |  |  |                |        |   |                              |   |
| 2.0 HDi                 | 66                      |            | 06.99      | 05.01 |  |  |                |        |   |                              |   |
| 2.0 S16                 | 110                     |            | 05.97      | 05.01 |  |  |                |        |   |                              |   |
| 2.0 S16                 | 112                     |            | 05.97      | 05.01 |  |  |                |        |   |                              |   |
| 2.0                     | 89                      |            | 03.94      | 04.97 | - Niveauregulierung <sup>1)</sup>            | 24.0101-3601.2                               | 260044         |        |   |                              |   |
| 2.0 16V                 |                         |            | 03.97      | 04.97 | - Niveauregulierung <sup>1)</sup>            |  |                |        |   |                              |   |
| 2.0 S16                 | 110                     |            | 03.94      | 04.97 |  | 24.3571-1729.5                               | 240317         |        |   |                              |   |
| 2.0 S16                 | 112                     |            | 07.94      | 04.97 |  |  |                |        |   |                              |   |
| 2.0 S16                 | 120                     |            | 03.96      | 05.01 |  |  |                |        |   |                              |   |
|                         | 1.1                     | 44         |            | 03.94 | 04.97  | - ABS  | 24.5111-0495.3 | 330505 | 2 |                              | L=495   |
|                         | 1.4                     | 55         |            | 03.93 | 04.97  | - ABS  |                |        |   |                              |   |
|                         | 1.1                     | 44         |            | 03.94 | 04.97  | + ABS  | 24.5111-0495.3 | 330505 | 2 | Länge beachten <sup>2)</sup> | L=495   |
|                         | 1.4                     | 55         |            | 05.97 | 05.01  |  | 24.5111-0520.3 | 330506 | 2 | Länge beachten <sup>2)</sup> | L=519   |
|                         | 1.4                     | 55         |            | 03.93 | 04.97  | + ABS  |                |        |   |                              |   |
|                         | 1.6                     | 65         |            | 03.93 | 10.00  |  |                |        |   |                              |   |
|                         | 1.6                     | 72         |            | 10.00 | 05.01  |  |                |        |   |                              |   |
|                         | 1.8                     | 74         |            | 03.93 | 05.01  |  |                |        |   |                              |   |
|                         | 1.8 16V                 | 81         |            | 03.97 | 05.01  |  |                |        |   |                              |   |
|                         | 1.8 D                   | 43         |            | 03.93 | 05.01  |  |                |        |   |                              |   |
|                         | 1.9 D                   |            |            | 05.93 | 05.01  |  |                |        |   |                              |   |
|                         | 1.9 TD                  | 66         |            | 10.93 | 05.01  |  |                |        |   |                              |   |
|                         | 2.0                     | 89         |            | 03.94 | 05.01  |  |                |        |   |                              |   |
|                         | 2.0 16V                 |            |            | 03.97 | 05.01  |  |                |        |   |                              |   |
|                         | 2.0 HDi                 | 66         |            | 06.99 | 05.01  |  |                |        |   |                              |   |
|                         | 2.0 S16                 | 110        |            | 03.94 | 05.01  |  |                |        |   |                              |   |
| 2.0 S16                 | 112                     |            | 07.94      | 05.01 |  |  |                |        |   |                              |   |
| 2.0 S16                 | 120                     |            | 03.96      | 05.01 |  |  |                |        |   |                              |   |
|                         | 1.1                     | 44         |            | 03.94 | 04.97  | - ABS  | 24.5228-0195.3 | 330469 | 2 |                              | L=202   |
|                         | 1.4                     | 55         |            | 03.93 | 04.97  | - ABS  |                |        |   |                              |   |
|                         | 1.1                     | 44         |            | 03.94 | 04.97  | + ABS  | 24.5228-0195.3 | 330469 |   |                              | L=202   |
|                         | 1.4                     | 55         |            | 05.97 | 05.01  |  | 24.5228-0245.3 | 330531 |   |                              | L=245   |
|                         | 1.4                     | 55         |            | 03.93 | 04.97  | + ABS  |                |        |   |                              |   |
|                         | 1.6                     | 65         |            | 03.93 | 10.00  |  |                |        |   |                              |   |
|                         | 1.6                     | 72         |            | 10.00 | 05.01  |  |                |        |   |                              |   |
|                         | 1.8                     | 74         |            | 03.93 | 05.01  |  |                |        |   |                              |   |
|                         | 1.8 16V                 | 81         |            | 03.97 | 05.01  |  |                |        |   |                              |   |
|                         | 1.8 D                   | 43         |            | 03.93 | 05.01  |  |                |        |   |                              |   |
|                         | 1.9 D                   |            |            | 05.93 | 05.01  |  |                |        |   |                              |   |
|                         | 1.9 TD                  | 66         |            | 10.93 | 05.01  |  |                |        |   |                              |   |
|                         | 2.0                     | 89         |            | 03.94 | 05.01  |  |                |        |   |                              |   |
|                         | 2.0 16V                 |            |            | 03.97 | 05.01  |  |                |        |   |                              |   |
|                         | 2.0 HDi                 | 66         |            | 06.99 | 05.01  |  |                |        |   |                              |   |
|                         | 2.0 S16                 | 110        |            | 03.94 | 05.01  |  |                |        |   |                              |   |
| 2.0 S16                 | 112                     |            | 07.94      | 05.01 |  |  |                |        |   |                              |   |
| 2.0 S16                 | 120                     |            | 03.96      | 05.01 |  |  |                |        |   |                              |   |
|                         | 1.1                     | 44         |            | 03.94 | 04.97  | - ABS  | 24.3220-1617.3 | 020244 | 2 | BDX                          | RzR 20,64<br>RzR 20,64<br>RzR 20,64<br>RzR 20,64  |
|                         | 1.4                     | 55         |            | 05.97 | 05.01  | - ABS  | 24.3220-1618.3 | 020245 |   |                              |   |
|                         | 1.4                     | 55         |            | 03.93 | 04.97  | - ABS/-verst.Fahrw./+ 5 türig <sup>3)</sup>  | 24.3220-1615.3 | 020242 |   |                              |   |
|                         | 1.6                     | 65         |            | 03.93 | 10.00  | - ABS  | 24.3220-1616.3 | 020243 |   |                              |   |
|                         | 1.6                     | 72         |            | 10.00 | 05.01  | - ABS  |                |        |   |                              |   |
|                         | 1.8                     | 74         |            | 03.93 | 05.01  | - ABS  |                |        |   |                              |   |
|                         | 1.8 D                   | 43         |            | 05.97 | 05.01  | - ABS  |                |        |   |                              |   |
|                         | 1.8 D                   | 43         |            | 03.93 | 04.97  | - ABS/-verst.Fahrw./+ 5 türig <sup>3)</sup>  |                |        |   |                              |   |
|                         | 1.9 D                   |            |            | 05.97 | 05.01  | - ABS  |                |        |   |                              |   |
|                         | 1.9 D                   |            |            | 05.93 | 04.97  | - ABS/-verst.Fahrw./+ 5 türig <sup>3)</sup>  |                |        |   |                              |   |
|                         | 1.9 TD                  | 66         |            | 10.93 | 05.01  | - ABS/-verst.Fahrw./+ 5 türig <sup>3)</sup>  |                |        |   |                              |   |
|                         | 1.1                     | 44         |            | 03.94 | 04.97  | + ABS  | 24.3220-1702.3 | 020375 |   |                              |   |
|                         | 1.4                     | 55         |            | 03.93 | 04.97  | + ABS / - verstärktes Fahrwerk <sup>4)</sup> |                |        |   |                              |   |
|                         | 1.4                     | 55         |            | 03.93 | 04.97  | - ABS/+ verst.Fahrw./+ 3 türig <sup>5)</sup> |                |        |   |                              |   |
|                         | 1.4 <b>Entreprise</b>   | 55         |            | 05.97 | 05.01  |  |                |        |   |                              |   |
|                         | 1.8 D                   | 43         |            | 03.93 | 04.97  | + ABS / - verstärktes Fahrwerk <sup>4)</sup> |                |        |   |                              |   |
| 1.8 D                   | 43                      |            | 03.93      | 04.97 | - ABS/+ verst.Fahrw./+ 3 türig <sup>5)</sup> |  |                |        |   |                              |   |

<sup>1)</sup> - suspension level control / - correttore assetto / - correcteur d'assiette / - regulación altura suspensión

<sup>2)</sup> notice length / attenzione lunghezza / faire attention longueur / atención largo

<sup>3)</sup> -ABS/- reinforced susp./+ 5 door / - ABS/- sospens.rinforzata/+ 5 porte / - ABS/- châssis renforcé/+ 5 portes / - ABS/- suspens.reforzada/+ 5 puertas

<sup>4)</sup> + ABS/ - reinforced suspension / + ABS/ - sospensione rinforzata / + ABS/ - châssis renforcé / + ABS/ - suspensión reforzada

<sup>5)</sup> - ABS/+ reinforced susp./+3 door / - ABS/+ sospens.rinforzata/ + 3 porte / - ABS/ + châssis renforcé/+ 3 portes / - ABS/+ suspensión reforzada/+3 puertas

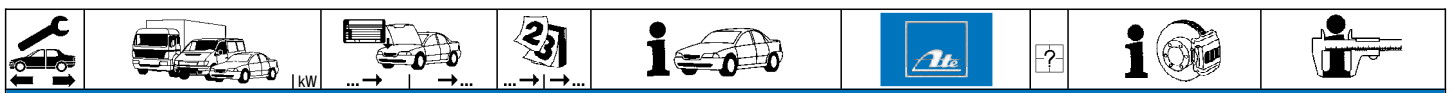

**PEUGEOT 306 Limousine (3/5-türig) (93-01)**

|         |                         |            |            |       |                            |  |                            |                |                          |               |            |  |
|---------|-------------------------|------------|------------|-------|----------------------------|--|----------------------------|----------------|--------------------------|---------------|------------|--|
|         | 1.8 D <b>Entreprise</b> | 43         |            | 05.97 | 05.01                      |  | 24.3220-1702.3             | 020375         |                          | Rz 20,64      | <b>BDX</b> |  |
|         | 1.9 D                   |            |            | 05.93 | 04.97                      | + ABS/ - verstärktes Fahrwerk <sup>1)</sup>  |                            |                |                          |               |            |  |
|         | 1.9 D                   |            |            | 05.93 | 04.97                      | - ABS/+ verst.Fahrw./+ 3 türig <sup>2)</sup> |                            |                |                          |               |            |  |
|         | 1.9 D <b>Entreprise</b> |            |            | 05.97 | 05.01                      |  |                            |                |                          |               |            |  |
|         | 1.9 TD                  | 66         |            | 10.93 | 05.01                      | + ABS/ - verstärktes Fahrwerk <sup>1)</sup>  |                            |                |                          |               |            |  |
|         | 1.9 TD                  | 66         |            | 10.93 | 05.01                      | - ABS/+ verst.Fahrw./+ 3 türig <sup>2)</sup> |                            |                |                          |               |            |  |
|         | 1.1                     | 44         |            | 03.94 | 08.95                      | + ABS  | 24.3220-1619.3             | 020246         |                          | Rz 20,64      | <b>LUC</b> |  |
|         | 1.4                     | 55         |            | 03.93 | 08.95                      | + ABS  |                            |                |                          |               |            |  |
|         | 1.6                     | 65         |            | 03.93 | 08.95                      | + ABS  |                            |                |                          |               |            |  |
|         | 1.8                     | 74         |            | 03.93 | 08.95                      | + ABS  |                            |                |                          |               |            |  |
|         | 1.8 D                   | 43         |            | 03.93 | 08.95                      | + ABS  |                            |                |                          |               |            |  |
|         | 1.9 D                   |            |            | 05.93 | 08.95                      | + ABS  |                            |                |                          |               |            |  |
|         | 1.9 TD                  | 66         |            | 10.93 | 08.95                      | + ABS  |                            |                |                          |               |            |  |
|         | 1.1                     | 44         |            | 09.95 |                            | + ABS  | 24.3220-1711.3             | 020409         |                          | Rz 20,64      | <b>LUC</b> |  |
|         | 1.4                     | 55         | ORGA 08729 | 09.95 |                            | + ABS  |                            |                |                          |               |            |  |
|         | 1.6                     | 65         | ORGA 08729 | 09.95 |                            | + ABS  |                            |                |                          |               |            |  |
|         | 1.8                     | 74         | ORGA 08729 | 09.95 |                            | + ABS  |                            |                |                          |               |            |  |
|         | 1.8 D                   | 43         | ORGA 08729 | 09.95 |                            | + ABS  |                            |                |                          |               |            |  |
|         | 1.9 D                   |            | ORGA 08729 | 09.95 |                            | + ABS  |                            |                |                          |               |            |  |
|         | 1.9 TD                  | 66         | ORGA 08729 | 09.95 |                            | + ABS  |                            |                |                          |               |            |  |
|         | 1.4                     | 55         | ORGA 08730 |       | 05.01                      | + ABS  | 24.3220-1717.3             | 020430         |                          | Rz 20,64      | <b>LUC</b> |  |
| 1.6     | 72                      | ORGA 08730 |            | 05.01 | + ABS                      |  |                            |                |                          |               |            |  |
| 1.8     | 74                      | ORGA 08730 |            | 05.01 | + ABS                      |  |                            |                |                          |               |            |  |
| 1.8 D   | 43                      | ORGA 08730 |            | 05.01 | + ABS                      |  |                            |                |                          |               |            |  |
| 1.9 D   |                         | ORGA 08730 |            | 05.01 | + ABS                      |  |                            |                |                          |               |            |  |
| 1.9 TD  | 66                      | ORGA 08730 |            | 05.01 | + ABS                      |  |                            |                |                          |               |            |  |
|         | 1.1                     | 44         |            | 03.94 | 04.97                      |  | 24.3727-0818.2             | 580818         | <input type="checkbox"/> | L=1656        |            |  |
|         | 1.4                     | 55         |            | 03.93 | 05.01                      | - Entreprise                                 | 24.3727-0819.2             | 580819         | <input type="checkbox"/> | L=1561        |            |  |
|         | 1.6                     | 65         |            | 03.93 | 10.00                      |  |                            |                |                          |               |            |  |
|         | 1.6                     | 72         |            | 10.00 | 05.01                      |  |                            |                |                          |               |            |  |
|         | 1.8                     | 74         |            | 03.93 | 05.01                      |  |                            |                |                          |               |            |  |
|         | 1.8 D                   | 43         |            | 03.93 | 05.01                      | - Entreprise                                 |                            |                |                          |               |            |  |
|         | 1.9 D                   |            |            | 05.93 | 05.01                      | - Entreprise                                 |                            |                |                          |               |            |  |
|         | 1.9 TD                  | 66         |            | 10.93 | 05.01                      |  |                            |                |                          |               |            |  |
|         | 1.4 <b>Entreprise</b>   | 55         |            | 03.93 | 05.01                      |  | 24.3727-0823.2             | 580823         | <input type="checkbox"/> | L=1690        |            |  |
|         | 1.8 D <b>Entreprise</b> | 43         |            | 03.93 | 05.01                      |  | 24.3727-0822.2             | 580822         | <input type="checkbox"/> | L=1608, + Zub |            |  |
|         | 1.9 D <b>Entreprise</b> |            |            | 05.93 | 05.01                      |  |                            |                |                          |               |            |  |
|         | 1.8 16V                 | 81         |            | 03.97 | 05.01                      |  | 24.3727-0812.2             | 580812         | <input type="checkbox"/> | L=1696        |            |  |
|         | 2.0                     | 89         |            | 03.94 | 05.01                      |  | 24.3727-0813.2             | 580813         | <input type="checkbox"/> | L=1614        |            |  |
|         | 2.0 16V                 |            |            | 03.97 | 05.01                      |  |                            |                |                          |               |            |  |
|         | 2.0 HDi                 | 66         |            | 06.99 | 05.01                      |  |                            |                |                          |               |            |  |
| 2.0 S16 | 110                     |            | 03.94      | 05.01 |                            |  |                            |                |                          |               |            |  |
| 2.0 S16 | 112                     |            | 07.94      | 05.01 |                            |  |                            |                |                          |               |            |  |
| 2.0 S16 | 120                     |            | 03.96      | 05.01 |                            |  |                            |                |                          |               |            |  |
|         | 1.1                     | 44         |            | 03.94 | 04.97                      | + ABS  | 24.6042-1701.3             | 320149         |                          | BRE 2/20      |            |  |
|         | 1.4                     | 55         |            | 03.93 | 04.97                      | + ABS  |                            |                |                          |               |            |  |
|         | 1.6                     | 65         |            | 03.93 | 04.97                      | + ABS  |                            |                |                          |               |            |  |
|         | 1.8 D                   | 43         |            | 03.93 | 04.97                      | + ABS  |                            |                |                          |               |            |  |
|         | 1.9 D                   | 47         |            | 05.93 | 04.97                      | + ABS  |                            |                |                          |               |            |  |
|         | 1.9 D                   | 50         |            | 06.94 | 04.97                      | + ABS  |                            |                |                          |               |            |  |
|         | 2.0                     | 89         |            | 03.94 | 04.97                      |  | 24.6043-1703.3             | 320152         |                          | BRE 3/30      |            |  |
|         | 2.0 16V                 |            |            | 03.97 | 04.97                      |  |                            |                |                          |               |            |  |
|         | 2.0 S16                 | 110        |            | 03.94 | 04.97                      |  |                            |                |                          |               |            |  |
|         | 2.0 S16                 | 112        |            | 07.94 | 04.97                      |  |                            |                |                          |               |            |  |
|         |                         | 1.1        | 44         |       | 03.94                      | 04.97  |                            | 24.3728-0822.2 | 590822                   |               | L=676      |  |
|         |                         | 1.4        | 55         |       | 03.93                      | 08.99  | + Fahrschule <sup>3)</sup> |                |                          |               |            |  |
|         |                         | 1.4        | 55         |       | 03.93                      | 08.99  | - Fahrschule <sup>4)</sup> |                |                          |               |            |  |
|         |                         | 1.6        | 65         |       | 03.93                      | 08.99  | + Fahrschule <sup>3)</sup> |                |                          |               |            |  |
|         |                         | 1.6        | 65         |       | 03.93                      | 08.99  | - Fahrschule <sup>4)</sup> |                |                          |               |            |  |
| 1.4     |                         | 55         |            | 09.99 | 05.01                      |  | 24.3728-0834.2             | 590834         |                          | L=620, + AUT  |            |  |
| 1.6     |                         | 65         |            | 09.99 | 10.00                      |  |                            |                |                          |               |            |  |
| 1.6     |                         | 72         |            | 10.00 | 05.01                      |  |                            |                |                          |               |            |  |
| 1.8     |                         | 74         | ORGA 08336 | 03.93 |                            |  | 24.3728-0835.2             | 590835         |                          | L=655, + AUT  |            |  |
| 1.8 16V |                         | 81         | ORGA 08336 | 03.97 |                            |  |                            |                |                          |               |            |  |
| 1.8 D   |                         | 43         | ORGA 07972 | 03.93 |                            |  |                            |                |                          |               |            |  |
| 1.9 D   |                         |            | ORGA 08336 | 05.93 |                            | - Fahrschule <sup>4)</sup>                   |                            |                |                          |               |            |  |
| 2.0     |                         | 89         | ORGA 08336 | 02.96 |                            |  |                            |                |                          |               |            |  |
| 2.0 HDi |                         | 66         | ORGA 08336 | 06.99 |                            |  |                            |                |                          |               |            |  |
| 1.8     |                         | 74         | ORGA 08337 |       | 05.01                      |  | 24.3728-0823.2             | 590823         |                          | L=625, + AUT  |            |  |
| 1.8 16V | 81                      | ORGA 08337 |            | 05.01 |                            |  |                            |                |                          |               |            |  |
| 1.8 D   | 43                      | ORGA 08337 |            | 05.01 |                            |  |                            |                |                          |               |            |  |
| 1.9 D   |                         | ORGA 08337 |            | 05.01 | - Fahrschule <sup>4)</sup> |  |                            |                |                          |               |            |  |
| 2.0     | 89                      | ORGA 08337 |            | 05.01 |                            |  |                            |                |                          |               |            |  |
| 2.0 HDi | 66                      | ORGA 08337 |            | 05.01 |                            |  |                            |                |                          |               |            |  |
| 1.9 TD  | 66                      | ORGA 08337 |            | 05.01 |                            | 24.3728-0825.2                               | 590825                     |                | L=694, + AUT             |               |            |  |
| 2.0 16V |                         | ORGA 08337 |            | 05.01 |                            |  |                            |                |                          |               |            |  |
| 2.0 S16 | 110                     | ORGA 08337 |            | 05.01 |                            |  |                            |                |                          |               |            |  |
| 2.0 S16 | 112                     | ORGA 08337 |            | 05.01 |                            |  |                            |                |                          |               |            |  |
| 2.0 S16 | 120                     | ORGA 08337 |            | 05.01 |                            |  |                            |                |                          |               |            |  |

1) + ABS/ - reinforced suspension / + ABS/ - sospensione rinforzata / + ABS/ - châssis renforcé / + ABS/ - suspensión reforzada  
2) - ABS/+reinforced susp./+3 door / - ABS/+ sospens.rinforzata/ + 3 porte / - ABS/ + châssis renforcé/+ 3 portes / - ABS/+suspensión reforzada/+3 puertas  
3) + driving school / + scuola guida / + auto école / + autoescuela  
4) - driving school / - scuola guida / - auto école / - autoescuela



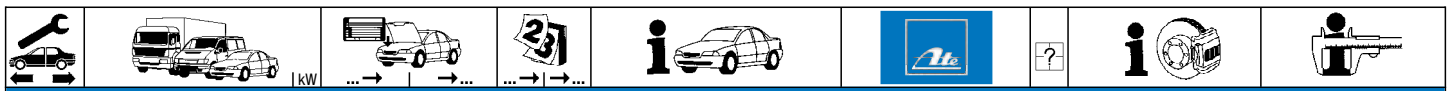

**PEUGEOT 306 Limousine (4-türig) (94-01)**

|  |         |     |            |       |       |       |                |        |                        |           |     |
|--|---------|-----|------------|-------|-------|-------|----------------|--------|------------------------|-----------|-----|
|  | 1.4     | 55  |            | 05.97 | 05.01 | - ABS | 03.7750-9302.4 | 300116 |                        | 9"        | ATE |
|  | 1.6     | 65  |            | 05.97 | 10.00 | - ABS |                |        |                        |           |     |
|  | 1.6     | 72  |            | 10.00 | 05.01 | - ABS |                |        |                        |           |     |
|  | 1.8     | 74  |            | 05.97 | 05.01 | - ABS |                |        |                        |           |     |
|  | 1.8 16V | 81  |            | 05.97 | 05.01 | - ABS |                |        |                        |           |     |
|  | 1.9 D   | 66  |            | 05.97 | 05.01 | - ABS |                |        |                        |           |     |
|  | 1.9 TD  | 66  |            | 05.97 | 05.01 | - ABS |                |        |                        |           |     |
|  | 2.0     | 89  |            | 05.97 | 05.01 | - ABS |                |        |                        |           |     |
|  | 2.0 16V | 97  |            | 05.97 | 05.01 | - ABS |                |        |                        |           |     |
|  | 2.0 HDi | 66  |            | 06.99 | 05.01 | - ABS |                |        |                        |           |     |
|  | 2.0 S16 | 110 |            | 05.97 | 05.01 | - ABS |                |        |                        |           |     |
|  | 2.0 S16 | 112 |            | 05.97 | 05.01 | - ABS |                |        |                        |           |     |
|  | 1.4     | 55  | ORGA 08575 | 10.94 |       | + ABS | 03.7750-9402.4 | 300117 |                        | 9"        | ATE |
|  | 1.6     | 65  | ORGA 08575 | 10.94 |       | + ABS |                |        |                        |           |     |
|  | 1.8     | 74  | ORGA 08575 | 04.94 |       | + ABS |                |        |                        |           |     |
|  | 1.8 16V | 81  | ORGA 08575 | 03.97 |       | + ABS |                |        |                        |           |     |
|  | 1.9 D   | 47  |            | 10.94 | 05.01 | + ABS |                |        |                        |           |     |
|  | 1.9 D   | 50  |            | 10.94 | 05.01 | + ABS |                |        |                        |           |     |
|  | 1.9 D   | 51  | ORGA 08575 | 09.98 |       | + ABS |                |        |                        |           |     |
|  | 1.9 D   | 55  |            | 03.98 | 05.01 | + ABS |                |        |                        |           |     |
|  | 1.9 TD  | 66  |            | 10.94 | 05.01 | + ABS |                |        |                        |           |     |
|  | 2.0     | 89  | ORGA 08575 | 04.94 |       | + ABS |                |        |                        |           |     |
|  | 2.0 16V | 97  | ORGA 08575 | 03.97 |       | + ABS |                |        |                        |           |     |
|  | 2.0 HDi | 66  | ORGA 08575 | 06.99 |       | + ABS |                |        |                        |           |     |
|  | 2.0 S16 | 110 | ORGA 08575 | 06.94 |       | + ABS |                |        |                        |           |     |
|  | 2.0 S16 | 112 | ORGA 08575 | 07.94 |       | + ABS |                |        |                        |           |     |
|  | 1.6     | 65  |            | 10.94 | 04.97 | + ABS | 03.7750-2232.4 | 300112 |                        | 9"        | ATE |
|  | 1.4     | 55  |            | 10.94 | 04.97 |       | 03.2119-3391.3 | 010058 | - ABS/ - Fahrschule 1) | THz 19,05 | ATE |
|  |         |     |            |       |       |       | 24.2119-1702.3 | 010435 | - ABS/ - Fahrschule 1) | THz 19,05 | BDX |
|  |         |     |            |       |       |       | 24.2120-1704.3 | 010429 | - ABS/ + Fahrschule 2) | THz 20,64 | BDX |
|  | 1.6     | 65  |            | 10.94 | 04.97 | - ABS | 03.2120-1897.3 | 010103 |                        | THz 20,64 | ATE |
|  | 1.8     | 74  |            | 10.94 | 04.97 | - ABS | 24.2120-1704.3 | 010429 |                        | THz 20,64 | BDX |
|  | 1.8 16V | 81  |            | 03.97 | 04.97 | - ABS |                |        |                        |           |     |
|  | 1.9 D   | 66  |            | 10.94 | 04.97 | - ABS |                |        |                        |           |     |
|  | 1.9 TD  | 66  |            | 10.94 | 04.97 | - ABS |                |        |                        |           |     |
|  | 2.0     | 89  |            | 10.94 | 04.97 | - ABS |                |        |                        |           |     |
|  | 2.0 16V | 97  |            | 03.97 | 04.97 | - ABS |                |        |                        |           |     |
|  | 2.0 S16 | 110 |            | 06.94 | 04.97 | - ABS |                |        |                        |           |     |
|  | 2.0 S16 | 112 |            | 07.94 | 04.97 | - ABS |                |        |                        |           |     |
|  | 1.4     | 55  |            | 05.97 | 05.01 | - ABS | 03.2120-4321.3 | 010525 |                        | THz 20,64 | ATE |
|  | 1.6     | 65  |            | 05.97 | 10.00 | - ABS | 24.2120-1726.3 | 010564 |                        | THz 20,64 | BDX |
|  | 1.6     | 72  |            | 10.00 | 05.01 | - ABS |                |        |                        |           |     |
|  | 1.8     | 74  |            | 05.97 | 05.01 | - ABS |                |        |                        |           |     |
|  | 1.9 D   | 66  |            | 05.97 | 05.01 | - ABS |                |        |                        |           |     |
|  | 1.8 16V | 81  |            | 05.97 | 05.01 | - ABS | 03.2122-1356.3 | 010529 |                        | THz 22,20 | ATE |
|  | 1.9 TD  | 66  |            | 05.97 | 05.01 | - ABS |                |        |                        |           |     |
|  | 2.0     | 89  |            | 05.97 | 05.01 | - ABS |                |        |                        |           |     |
|  | 2.0 16V | 97  |            | 05.97 | 05.01 | - ABS |                |        |                        |           |     |
|  | 2.0 HDi | 66  |            | 06.99 | 05.01 | - ABS |                |        |                        |           |     |
|  | 2.0 S16 | 110 |            | 05.97 | 05.01 | - ABS |                |        |                        |           |     |
|  | 2.0 S16 | 112 |            | 05.97 | 05.01 | - ABS |                |        |                        |           |     |
|  | 1.8     | 74  |            | 10.94 | 05.01 | - ABS | 03.2120-4246.3 | 010614 |                        | THz 20,64 | ATE |
|  | 1.9 D   | 47  |            | 10.94 | 05.01 | - ABS | 24.2120-1722.3 | 010544 |                        | THz 20,64 | BDX |
|  | 1.9 D   | 50  |            | 10.94 | 05.01 | - ABS |                |        |                        |           |     |
|  | 1.9 D   | 55  |            | 03.98 | 05.01 | - ABS |                |        |                        |           |     |
|  | 1.9 D   | 51  |            | 09.98 | 05.01 | - ABS | 03.2122-1461.3 | 010610 |                        | THz 22,20 | ATE |
|  | 1.8 16V | 81  |            | 05.97 | 05.01 | - ABS | 03.2122-1421.3 | 010615 |                        | THz 22,20 | ATE |
|  | 1.9 TD  | 66  |            | 05.97 | 05.01 | - ABS |                |        |                        |           |     |
|  | 2.0     | 89  |            | 05.97 | 05.01 | - ABS |                |        |                        |           |     |
|  | 2.0 16V | 97  |            | 05.97 | 05.01 | - ABS |                |        |                        |           |     |
|  | 2.0 HDi | 66  |            | 06.99 | 05.01 | - ABS |                |        |                        |           |     |
|  | 2.0 S16 | 110 |            | 05.97 | 05.01 | - ABS |                |        |                        |           |     |
|  | 2.0 S16 | 112 |            | 05.97 | 05.01 | - ABS |                |        |                        |           |     |
|  | 1.4     | 55  | S 30209025 |       | 04.97 | + ABS | 24.2122-1705.3 | 010434 |                        | THz 22,20 |     |
|  | 1.6     | 65  | S 30209025 |       | 04.97 | + ABS |                |        |                        |           |     |
|  | 1.8     | 74  | S 30209025 |       | 04.97 | + ABS |                |        |                        |           |     |
|  | 1.8 16V | 81  |            | 03.97 | 04.97 | + ABS |                |        |                        |           |     |
|  | 1.9 D   | 66  | S 30209025 |       | 04.97 | + ABS |                |        |                        |           |     |
|  | 1.9 TD  | 66  |            | 10.94 | 04.97 | + ABS |                |        |                        |           |     |
|  | 2.0     | 89  |            | 04.94 | 04.97 | + ABS |                |        |                        |           |     |
|  | 2.0 16V | 97  |            | 03.97 | 04.97 | + ABS |                |        |                        |           |     |
|  | 2.0 S16 | 110 |            | 06.94 | 04.97 | + ABS |                |        |                        |           |     |
|  | 2.0 S16 | 112 |            | 07.94 | 04.97 | + ABS |                |        |                        |           |     |
|  | 1.4     | 55  | ORGA 08575 | 05.97 |       | + ABS | 03.2122-1351.3 | 010528 |                        | THz 22,20 | ATE |
|  | 1.6     | 65  | ORGA 08575 | 05.97 |       | + ABS |                |        |                        |           |     |
|  | 1.8     | 74  | ORGA 08575 | 05.97 |       | + ABS |                |        |                        |           |     |
|  | 1.8 16V | 81  | ORGA 08575 | 05.97 |       | + ABS |                |        |                        |           |     |
|  | 1.9 D   | 66  | ORGA 08575 | 05.97 |       | + ABS |                |        |                        |           |     |
|  | 1.9 TD  | 66  | ORGA 08575 | 05.97 |       | + ABS |                |        |                        |           |     |
|  | 2.0     | 89  | ORGA 08575 | 05.97 |       | + ABS |                |        |                        |           |     |
|  | 2.0 16V | 97  | ORGA 08575 | 05.97 |       | + ABS |                |        |                        |           |     |
|  | 2.0 S16 | 110 | ORGA 08575 | 05.97 |       | + ABS |                |        |                        |           |     |
|  | 2.0 S16 | 112 | ORGA 08575 | 05.97 |       | + ABS |                |        |                        |           |     |
|  | 1.4     | 55  | ORGA 08576 |       | 05.01 | + ABS | 24.2123-1715.3 | 010520 |                        | THz 23,81 | BDX |
|  | 1.6     | 65  | ORGA 08576 |       | 10.00 | + ABS |                |        |                        |           |     |

1) - ABS/ - driving school / - ABS/ - scuola guida / - ABS/ - auto-école / - ABS/ - autoescuela  
 2) - ABS/ + driving school / - ABS/ + scuola guida / - ABS/ + auto école / - ABS/ + autoescuela

| <b>PEUGEOT 306 Limousine (4-türig) (94-01)</b> |         |     |            |       |       |                                   |  |                |        |   |                              |                |            |
|--|---------|-----|------------|-------|-------|-----------------------------------|--|----------------|--------|---|------------------------------|----------------|------------|
|  | 1.6     | 72  |            | 10.00 | 05.01 | + ABS                             |  | 24.2123-1715.3 | 010520 |   |                              | THz 23,81      | <b>BDX</b> |
|  | 1.8     | 74  | ORGA 08576 |       | 05.01 | + ABS                             |  |                |        |   |                              |                |            |
|  | 1.8 16V | 81  | ORGA 08576 |       | 05.01 | + ABS                             |  |                |        |   |                              |                |            |
|  | 1.9 D   |     | ORGA 08576 |       | 05.01 | + ABS                             |  |                |        |   |                              |                |            |
|  | 1.9 TD  | 66  | ORGA 08576 |       | 05.01 | + ABS                             |  |                |        |   |                              |                |            |
|  | 2.0     | 89  | ORGA 08576 |       | 05.01 | + ABS                             |  |                |        |   |                              |                |            |
|  | 2.0 16V | 97  | ORGA 08576 |       | 05.01 | + ABS                             |  |                |        |   |                              |                |            |
|  | 2.0 HDi | 66  |            | 06.99 | 05.01 | + ABS                             |  |                |        |   |                              |                |            |
|  | 2.0 S16 | 110 | ORGA 08576 |       | 05.01 | + ABS                             |  |                |        |   |                              |                |            |
|  | 2.0 S16 | 112 | ORGA 08576 |       | 05.01 | + ABS                             |  |                |        |   |                              |                |            |
|  | 1.4     | 55  | ORGA 08575 | 05.97 |       | + ABS                             |  | 03.2122-1296.3 | 010609 |   |                              | THz 22,20      | <b>ATE</b> |
|  | 1.6     | 65  | ORGA 08575 | 05.97 |       | + ABS                             |  |                |        |   |                              |                |            |
|  | 1.8     | 74  | ORGA 08575 | 05.97 |       | + ABS                             |  |                |        |   |                              |                |            |
|  | 1.8 16V | 81  | ORGA 08575 | 05.97 |       | + ABS                             |  |                |        |   |                              |                |            |
|  | 1.9 D   | 47  | ORGA 08576 | 05.97 |       | + ABS                             |  |                |        |   |                              |                |            |
|  | 1.9 D   | 50  | ORGA 08575 | 05.97 |       | + ABS                             |  |                |        |   |                              |                |            |
|  | 1.9 D   | 55  | ORGA 08575 | 03.98 |       | + ABS                             |  |                |        |   |                              |                |            |
|  | 1.9 TD  | 66  | ORGA 08575 | 05.97 |       | + ABS                             |  |                |        |   |                              |                |            |
|  | 2.0     | 89  | ORGA 08575 | 05.97 |       | + ABS                             |  |                |        |   |                              |                |            |
|  | 2.0 16V | 97  | ORGA 08575 | 05.97 |       | + ABS                             |  |                |        |   |                              |                |            |
|  | 2.0 S16 | 110 | ORGA 08575 | 05.97 |       | + ABS                             |  |                |        |   |                              |                |            |
|  | 2.0 S16 | 112 | ORGA 08575 | 05.97 |       | + ABS                             |  |                |        |   |                              |                |            |
|  | 1.9 D   | 51  | ORGA 08575 | 05.97 |       | + ABS                             |  | 03.2122-1461.3 | 010610 |   |                              | THz 22,20      | <b>ATE</b> |
|  | 1.4     | 55  |            | 05.97 | 05.01 | - ABS                             |  | 24.3481-1741.5 | 240245 |   |                              | D=48, - Halter | <b>BOS</b> |
|  |         |     |            |       |       |                                   |  | 24.3481-1742.5 | 240246 |   |                              | D=48, - Halter | <b>BOS</b> |
|  | 1.4     | 55  | ORGA 08575 | 10.94 |       | + ABS                             |  | 11.3481-9833.2 | 220561 |   |                              | D=48, - Halter | <b>ATE</b> |
|  | 1.6     | 65  | ORGA 08575 | 10.94 |       | + ABS                             |  | 11.3481-9834.2 | 220562 |   |                              | D=48, - Halter | <b>ATE</b> |
|  | 1.6     | 65  | ORGA 08576 |       | 10.00 | - ABS                             |  | 24.3481-9833.5 | 240479 |   |                              | D=48, - Halter | <b>ATE</b> |
|  | 1.6     | 72  |            |       | 10.00 | - ABS                             |  | 24.3481-9834.5 | 240480 |   |                              | D=48, - Halter | <b>ATE</b> |
|  | 1.8     | 74  | ORGA 08575 | 04.94 |       |                                   |  | 11.0441-4811.2 | 250024 |   |                              | Dichtungssatz  | <b>ATE</b> |
|  | 1.8     | 74  | ORGA 08576 |       | 05.01 | - ABS                             |  | 11.0101-5407.2 | 260011 |   |                              | HülSENSatz     | <b>ATE</b> |
|  | 1.9 D   | 47  |            | 10.94 | 05.01 |                                   |  | 11.8171-0008.1 | 990049 |   |                              | Führungsbolzen | <b>ATE</b> |
|  | 1.9 D   | 50  |            | 10.94 | 05.01 |                                   |  | 11.8116-0129.1 | 390591 | 2 |                              | Haltefeder     | <b>ATE</b> |
|  | 1.9 D   | 51  | ORGA 08575 | 09.98 |       |                                   |  |                |        |   |                              |                |            |
|  | 1.9 D   | 51  | ORGA 08576 |       | 05.01 | - ABS                             |  |                |        |   |                              |                |            |
|  | 1.9 TD  | 66  |            | 10.94 | 05.01 |                                   |  |                |        |   |                              |                |            |
|  | 1.4     | 55  | ORGA 08576 |       | 05.01 | + ABS                             |  | 24.3541-1767.5 | 240237 |   |                              | D=54, - Halter | <b>BOS</b> |
|  | 1.6     | 65  | ORGA 08576 |       | 10.00 | + ABS                             |  | 24.3541-1768.5 | 240238 |   |                              | D=54, - Halter | <b>BOS</b> |
|  | 1.6     | 72  |            |       | 10.00 | + ABS                             |  | 24.3541-1757.7 | 220483 |   |                              | D=54, - Halter | <b>LUC</b> |
|  | 1.8     | 74  | ORGA 08576 |       | 05.01 | + ABS                             |  | 24.3541-1758.7 | 220484 |   |                              | D=54, - Halter | <b>LUC</b> |
|  | 1.8 16V | 81  |            | 03.97 | 05.01 |                                   |  |                |        |   |                              |                |            |
|  | 1.9 D   | 51  | ORGA 08576 |       | 05.01 | + ABS                             |  |                |        |   |                              |                |            |
|  | 2.0     | 89  |            | 05.97 | 05.01 |                                   |  |                |        |   |                              |                |            |
|  | 2.0 16V | 97  |            | 05.97 | 05.01 |                                   |  |                |        |   |                              |                |            |
|  | 2.0 HDi | 66  |            | 06.99 | 05.01 |                                   |  |                |        |   |                              |                |            |
|  | 2.0 S16 | 110 |            | 06.94 | 05.01 |                                   |  |                |        |   |                              |                |            |
|  | 2.0 S16 | 112 |            | 07.94 | 05.01 |                                   |  |                |        |   |                              |                |            |
|  | 2.0     | 89  |            | 04.94 | 04.97 | - Niveauregulierung <sup>1)</sup> |  | 24.0101-3601.2 | 260044 |   |                              | Einbausatz     | <b>LUC</b> |
|  | 2.0 16V | 97  |            | 03.97 | 04.97 | - Niveauregulierung <sup>1)</sup> |  |                |        |   |                              |                |            |
|  | 1.4     | 55  |            | 10.94 | 04.97 | - ABS                             |  | 24.5111-0495.3 | 330505 | 2 |                              | L=495          |            |
|  | 1.4     | 55  |            | 05.97 | 05.01 |                                   |  | 24.5111-0495.3 | 330505 | 2 | Länge beachten <sup>2)</sup> | L=495          |            |
|  | 1.4     | 55  |            | 10.94 | 04.97 | + ABS                             |  | 24.5111-0520.3 | 330506 | 2 | Länge beachten <sup>2)</sup> | L=519          |            |
|  | 1.6     | 65  |            | 10.94 | 10.00 |                                   |  |                |        |   |                              |                |            |
|  | 1.6     | 72  |            | 10.00 | 05.01 |                                   |  |                |        |   |                              |                |            |
|  | 1.8     | 74  |            | 04.94 | 05.01 |                                   |  |                |        |   |                              |                |            |
|  | 1.8 16V | 81  |            | 03.97 | 05.01 |                                   |  |                |        |   |                              |                |            |
|  | 1.9 D   |     |            | 10.94 | 05.01 |                                   |  |                |        |   |                              |                |            |
|  | 1.9 TD  | 66  |            | 10.94 | 05.01 |                                   |  |                |        |   |                              |                |            |
|  | 2.0     | 89  |            | 04.94 | 05.01 |                                   |  |                |        |   |                              |                |            |
|  | 2.0 16V | 97  |            | 03.97 | 05.01 |                                   |  |                |        |   |                              |                |            |
|  | 2.0 HDi | 66  |            | 06.99 | 05.01 |                                   |  |                |        |   |                              |                |            |
|  | 2.0 S16 | 110 |            | 06.94 | 05.01 |                                   |  |                |        |   |                              |                |            |
|  | 2.0 S16 | 112 |            | 07.94 | 05.01 |                                   |  |                |        |   |                              |                |            |
|  | 1.4     | 55  |            | 10.94 | 04.97 | - ABS                             |  | 24.5228-0195.3 | 330469 | 2 |                              | L=202          |            |
|  | 1.4     | 55  |            | 05.97 | 05.01 |                                   |  | 24.5228-0195.3 | 330469 |   |                              | L=202          |            |
|  | 1.4     | 55  |            | 10.94 | 04.97 | + ABS                             |  | 24.5228-0245.3 | 330531 |   |                              | L=245          |            |
|  | 1.6     | 65  |            | 10.94 | 10.00 |                                   |  |                |        |   |                              |                |            |
|  | 1.6     | 72  |            | 10.00 | 05.01 |                                   |  |                |        |   |                              |                |            |
|  | 1.8     | 74  |            | 04.94 | 05.01 |                                   |  |                |        |   |                              |                |            |
|  | 1.8 16V | 81  |            | 03.97 | 05.01 |                                   |  |                |        |   |                              |                |            |
|  | 1.9 D   |     |            | 10.94 | 05.01 |                                   |  |                |        |   |                              |                |            |
|  | 1.9 TD  | 66  |            | 10.94 | 05.01 |                                   |  |                |        |   |                              |                |            |
|  | 2.0     | 89  |            | 04.94 | 05.01 |                                   |  |                |        |   |                              |                |            |
|  | 2.0 16V | 97  |            | 03.97 | 05.01 |                                   |  |                |        |   |                              |                |            |
|  | 2.0 HDi | 66  |            | 06.99 | 05.01 |                                   |  |                |        |   |                              |                |            |
|  | 2.0 S16 | 110 |            | 06.94 | 05.01 |                                   |  |                |        |   |                              |                |            |
|  | 2.0 S16 | 112 |            | 07.94 | 05.01 |                                   |  |                |        |   |                              |                |            |
|  | 1.4     | 55  |            | 10.94 | 05.01 | - ABS                             |  | 24.3220-1617.3 | 020244 |   |                              | RzR 20,64      | <b>BDX</b> |
|  | 1.6     | 65  |            | 10.94 | 10.00 | - ABS                             |  | 24.3220-1618.3 | 020245 |   |                              | RzR 20,64      | <b>BDX</b> |
|  | 1.6     | 72  |            | 10.00 | 05.01 | - ABS                             |  | 24.3220-1615.3 | 020242 |   |                              | RzR 20,64      | <b>LUC</b> |
|  | 1.8     | 74  |            | 04.94 | 05.01 | - ABS                             |  | 24.3220-1616.3 | 020243 |   |                              | RzR 20,64      | <b>LUC</b> |
|  | 1.9 D   |     |            | 10.94 | 05.01 | - ABS                             |  |                |        |   |                              |                |            |
|  | 1.9 TD  | 66  |            | 10.94 | 05.01 | - ABS                             |  |                |        |   |                              |                |            |
|  | 1.4     | 55  |            | 10.94 | 05.01 | + ABS                             |  | 24.3220-1702.3 | 020375 |   |                              | Rz 20,64       | <b>BDX</b> |
|  | 1.6     | 65  |            | 10.94 | 10.00 | + ABS                             |  |                |        |   |                              |                |            |

<sup>1)</sup> - suspension level control / - correttore assetto / - correcteur d'assiette / - regulación altura suspensión

<sup>2)</sup> notice length / attenzione lunghezza / faire attention longueur / atención largo



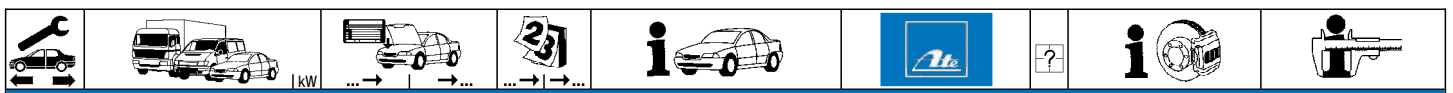

### PEUGEOT 306 Limousine (4-türig) (94-01)

|         |         |            |            |       |                            |   |                |        |                                     |              |     |
|---------|---------|------------|------------|-------|----------------------------|---|----------------|--------|-------------------------------------|--------------|-----|
|         | 1.8     | 74         |            | 04.94 | 05.01                      | + ABS                                       | 24.3220-1702.3 | 020375 |                                     | Rz 20,64     | BDX |
|         | 1.9 D   |            |            | 10.94 | 05.01                      | + ABS                                       |                |        |                                     |              |     |
|         | 1.9 TD  | 66         |            | 10.94 | 05.01                      | + ABS                                       |                |        |                                     |              |     |
|         | 1.4     | 55         |            | 10.94 | 08.95                      | + ABS                                       | 24.3220-1619.3 | 020246 |                                     | Rz 20,64     | LUC |
|         | 1.6     | 65         |            | 10.94 | 08.95                      | + ABS                                       |                |        |                                     |              |     |
|         | 1.8     | 74         |            | 04.94 | 08.95                      | + ABS                                       |                |        |                                     |              |     |
|         | 1.9 D   |            |            | 10.94 | 08.95                      | + ABS                                       |                |        |                                     |              |     |
|         | 1.9 TD  | 66         |            | 10.94 | 08.95                      | + ABS                                       |                |        |                                     |              |     |
|         | 1.4     | 55         | ORGA 08729 | 09.95 |                            | + ABS                                       | 24.3220-1711.3 | 020409 |                                     | Rz 20,64     | LUC |
|         | 1.6     | 65         | ORGA 08729 | 09.95 |                            | + ABS                                       |                |        |                                     |              |     |
| 1.8     | 74      | ORGA 08729 | 09.95      |       | + ABS                      |   |                |        |                                     |              |     |
| 1.9 D   |         | ORGA 08729 | 09.95      |       | + ABS                      |   |                |        |                                     |              |     |
| 1.9 TD  | 66      | ORGA 08729 | 09.95      |       | + ABS                      |   |                |        |                                     |              |     |
| 1.4     | 55      | ORGA 08730 |            | 05.01 | + ABS                      | 24.3220-1717.3                              | 020430         |        | Rz 20,64                            | LUC          |     |
| 1.6     | 65      | ORGA 08730 |            | 10.00 | + ABS                      |   |                |        |                                     |              |     |
| 1.6     | 72      | ORGA 08730 |            | 05.01 | + ABS                      |   |                |        |                                     |              |     |
| 1.8     | 74      | ORGA 08730 |            | 05.01 | + ABS                      |   |                |        |                                     |              |     |
| 1.9 D   |         | ORGA 08730 |            | 05.01 | + ABS                      |   |                |        |                                     |              |     |
| 1.9 TD  | 66      | ORGA 08730 |            | 05.01 | + ABS                      |   |                |        |                                     |              |     |
|         | 1.4     | 55         |            | 10.94 | 05.01                      |   | 24.3727-0818.2 | 580818 | <input type="checkbox"/>            | L=1656       |     |
|         | 1.6     | 65         |            | 10.00 | 05.01                      |   | 24.3727-0819.2 | 580819 | <input checked="" type="checkbox"/> | L=1561       |     |
|         | 1.6     | 65         |            | 10.94 | 10.00                      |   |                |        |                                     |              |     |
|         | 1.8     | 74         |            | 10.94 | 05.01                      |   |                |        |                                     |              |     |
|         | 1.9 D   |            |            | 10.94 | 05.01                      |   |                |        |                                     |              |     |
|         | 1.9 TD  | 66         |            | 10.94 | 05.01                      |   |                |        |                                     |              |     |
|         | 1.8 16V | 81         |            | 03.97 | 05.01                      |   | 24.3727-0812.2 | 580812 | <input type="checkbox"/>            | L=1696       |     |
|         | 2.0     | 89         |            | 10.94 | 05.01                      |   | 24.3727-0813.2 | 580813 | <input checked="" type="checkbox"/> | L=1614       |     |
|         | 2.0 16V | 97         |            | 03.97 | 05.01                      |   |                |        |                                     |              |     |
|         | 2.0 HDi | 66         |            | 06.99 | 05.01                      |   |                |        |                                     |              |     |
| 2.0 S16 | 110     |            | 06.94      | 05.01 |                            |   |                |        |                                     |              |     |
| 2.0 S16 | 112     |            | 07.94      | 05.01 |                            |   |                |        |                                     |              |     |
|         | 1.4     | 55         |            | 10.94 | 04.97                      | + ABS/ - verstärktes Fahrwerk <sup>1)</sup> | 24.6042-1701.3 | 320149 |                                     | BRE 2/20     |     |
|         | 1.6     | 65         |            | 10.94 | 04.97                      | + ABS/ - verstärktes Fahrwerk <sup>1)</sup> |                |        |                                     |              |     |
|         | 1.8     | 74         |            | 10.94 | 04.97                      | + ABS/ - verstärktes Fahrwerk <sup>1)</sup> |                |        |                                     |              |     |
|         | 1.8 16V | 81         |            | 03.97 | 04.97                      | - verstärktes Fahrwerk <sup>2)</sup>        |                |        |                                     |              |     |
|         | 1.9 D   | 47         |            | 10.94 | 04.97                      | + ABS/ - verstärktes Fahrwerk <sup>1)</sup> |                |        |                                     |              |     |
|         | 1.9 D   | 50         |            | 10.94 | 04.97                      | + ABS/ - verstärktes Fahrwerk <sup>1)</sup> |                |        |                                     |              |     |
|         | 2.0     | 89         |            | 10.94 | 04.97                      | - verstärktes Fahrwerk <sup>2)</sup>        |                |        |                                     |              |     |
|         | 2.0 16V | 97         |            | 03.97 | 04.97                      |   |                |        |                                     |              |     |
|         | 2.0 S16 | 110        |            | 06.94 | 04.97                      | - ABS                                       | 24.6043-1703.3 | 320152 |                                     | BRE 3/30     |     |
|         | 2.0 S16 | 112        |            | 07.94 | 04.97                      | - ABS                                       |                |        |                                     |              |     |
|         | 1.4     | 55         |            | 10.94 | 08.99                      | + Fahrschule <sup>3)</sup>                  | 24.3728-0822.2 | 590822 |                                     | L=676        |     |
|         | 1.4     | 55         |            | 10.94 | 05.01                      | - Fahrschule <sup>4)</sup>                  |                |        |                                     |              |     |
|         | 1.6     | 65         |            | 10.94 | 08.99                      | + Fahrschule <sup>3)</sup>                  |                |        |                                     |              |     |
|         | 1.6     | 65         |            | 10.94 | 10.00                      | - Fahrschule <sup>4)</sup>                  |                |        |                                     |              |     |
|         | 1.6     | 72         |            | 10.00 | 05.01                      | - Fahrschule <sup>4)</sup>                  |                |        |                                     |              |     |
|         | 1.4     | 55         |            | 09.99 | 05.01                      | + Fahrschule <sup>3)</sup>                  | 24.3728-0834.2 | 590834 |                                     | L=620, + AUT |     |
|         | 1.6     | 65         |            | 09.99 | 10.00                      | + Fahrschule <sup>3)</sup>                  |                |        |                                     |              |     |
|         | 1.6     | 72         |            | 10.00 | 05.01                      | + Fahrschule <sup>3)</sup>                  |                |        |                                     |              |     |
|         | 1.8     | 74         | ORGA 08336 | 04.94 |                            |   | 24.3728-0835.2 | 590835 |                                     | L=655, + AUT |     |
|         | 1.8 16V | 81         | ORGA 08336 | 03.97 |                            |   |                |        |                                     |              |     |
| 1.9 D   | 89      | ORGA 08336 | 10.94      |       | - Fahrschule <sup>4)</sup> |   |                |        |                                     |              |     |
| 2.0     | 89      | ORGA 08336 | 04.94      |       |                            |   |                |        |                                     |              |     |
| 2.0 HDi | 66      | ORGA 08336 | 06.99      |       |                            |   |                |        |                                     |              |     |
| 1.8     | 74      | ORGA 08337 |            | 05.01 |                            | 24.3728-0823.2                              | 590823         |        | L=625, + AUT                        |              |     |
| 1.8 16V | 81      | ORGA 08337 |            | 05.01 |                            |   |                |        |                                     |              |     |
| 1.9 D   | 89      | ORGA 08337 |            | 05.01 | - Fahrschule <sup>4)</sup> |   |                |        |                                     |              |     |
| 2.0     | 89      | ORGA 08337 |            | 05.01 |                            |   |                |        |                                     |              |     |
| 2.0 HDi | 66      | ORGA 08337 |            | 05.01 |                            |   |                |        |                                     |              |     |
| 1.9 TD  | 66      | ORGA 08337 |            | 05.01 |                            | 24.3728-0825.2                              | 590825         |        | L=694, + AUT                        |              |     |
| 2.0     | 89      | ORGA 08337 |            | 05.01 |                            |   |                |        |                                     |              |     |
| 2.0 16V | 97      | ORGA 08337 |            | 05.01 |                            |   |                |        |                                     |              |     |
| 2.0 S16 | 110     | ORGA 08337 |            | 05.01 |                            |   |                |        |                                     |              |     |
| 2.0 S16 | 112     | ORGA 08337 |            | 05.01 |                            |   |                |        |                                     |              |     |

### PEUGEOT 306 Cabriolet (94-03)

|         |         |            |            |       |       |       |                |        |  |           |     |
|---------|---------|------------|------------|-------|-------|-------|----------------|--------|--|-----------|-----|
|         | 1.6     | 65         | ORGA 08575 | 04.96 |       |       | 03.7750-9402.4 | 300117 |  | 9"        | ATE |
|         | 1.8     | 74         | ORGA 08575 | 03.94 |       |       |                |        |  |           |     |
|         | 2.0     | 89         | ORGA 08575 | 03.94 |       |       |                |        |  |           |     |
|         | 2.0 16V | 97         | ORGA 08575 | 03.97 |       |       |                |        |  |           |     |
|         | 1.6     | 65         |            | 04.96 | 10.00 |       | 03.7750-2232.4 | 300112 |  | 9"        | ATE |
|         | 1.6     | 65         | ORGA 07737 | 04.96 |       | - ABS | 03.2120-4241.3 | 010524 |  | THz 20,64 | ATE |
|         | 1.8     | 74         |            | 03.94 | 10.00 | - ABS | 24.2120-1722.3 | 010544 |  | THz 20,64 | BDX |
|         | 2.0     | 89         | ORGA 07744 | 03.94 |       | - ABS | 24.2120-1722.3 | 010544 |  | THz 20,64 | BDX |
|         | 2.0 16V | 97         | ORGA 07744 | 03.97 |       | - ABS | 24.2122-1705.3 | 010434 |  | THz 22,20 |     |
|         | 1.8 16V | 81         | ORGA 07745 |       | 07.03 | - ABS | 03.2122-1291.3 | 010527 |  | THz 22,20 | ATE |
|         | 2.0 16V | 97         | ORGA 07745 |       | 10.00 | - ABS |                |        |  |           |     |
|         | 1.6     | 65         | S30209024  | 04.96 |       | + ABS | 03.2122-1291.3 | 010527 |  | THz 22,20 | ATE |
|         | 1.8     | 74         | S30209024  | 03.94 |       | + ABS |                |        |  |           |     |
|         | 1.6     | 65         | ORGA 08575 | 04.96 |       | + ABS | 03.2122-1351.3 | 010528 |  | THz 22,20 | ATE |
| 1.8     | 74      | ORGA 08575 | 03.94      |       | + ABS |       |                |        |  |           |     |
| 2.0     | 89      | ORGA 08575 | 03.94      | 04.97 | + ABS |       |                |        |  |           |     |
| 2.0 16V | 97      | ORGA 08575 | 03.97      |       | + ABS |       |                |        |  |           |     |

<sup>1)</sup> + ABS/ - reinforced suspension / + ABS/ - sospensione rinforzata / + ABS/ - châssis renforcé / + ABS/ - suspensión reforzada

<sup>2)</sup> - reinforced suspension / - sospensione rinforzata / - châssis renforcé / - suspensión reforzada

<sup>3)</sup> + driving school / + scuola guida / + auto école / + autoescuela

<sup>4)</sup> - driving school / - scuola guida / - auto école / - autoescuela

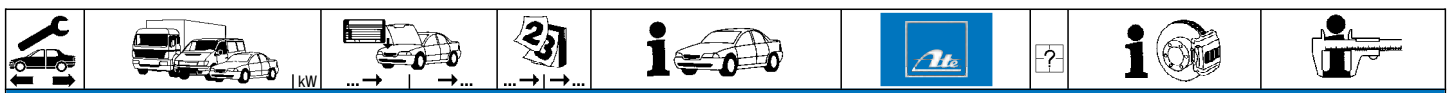

**PEUGEOT 306 Cabriolet (94-03)**

|         |         |            |            |            |       |                                   |                |                          |                          |                              |                |     |
|---------|---------|------------|------------|------------|-------|-----------------------------------|----------------|--------------------------|--------------------------|------------------------------|----------------|-----|
|         | 1.6     | 65         | ORGA 08576 |            | 10.00 | + ABS                             | 24.2123-1715.3 | 010520                   |                          | Thz 23,81                    | BDX            |     |
|         | 1.6     | 72         |            |            | 10.00 | + ABS                             |                |                          |                          |                              |                |     |
|         | 1.8     | 74         | ORGA 08576 |            | 10.00 | + ABS                             |                |                          |                          |                              |                |     |
|         | 1.8 16V | 81         |            |            | 07.00 | + ABS                             |                |                          |                          |                              |                |     |
|         | 2.0 16V | 97         | ORGA 08576 |            | 10.00 | + ABS                             |                |                          |                          |                              |                |     |
|         | 1.6     | 65         | ORGA 08575 | 04.96      |       | + ABS                             | 03.2122-1296.3 | 010609                   |                          | Thz 22,20                    | ATE            |     |
|         | 1.8     | 74         | ORGA 08575 | 03.94      |       | + ABS                             |                |                          |                          |                              |                |     |
|         | 2.0     | 89         |            | 03.94      | 04.97 | + ABS                             |                |                          |                          |                              |                |     |
|         | 2.0 16V | 97         | ORGA 08575 | 03.97      |       | + ABS                             |                |                          |                          |                              |                |     |
|         |         | 1.6        | 65         | ORGA 08575 | 04.96 | 10.00                             | - ABS          | 11.3481-9833.2           | 220561                   | <input type="checkbox"/>     | D=48, - Halter | ATE |
| 1.6     |         | 65         |            | 05.00      | 10.00 | - ABS                             | 11.3481-9834.2 | 220562                   | <input type="checkbox"/> | D=48, - Halter               | ATE            |     |
| 1.8     |         | 74         | ORGA 08575 | 03.94      | 10.00 | - ABS                             | 24.3481-9833.5 | 240479                   | <input type="checkbox"/> | D=48, - Halter               | ATE            |     |
| 1.8     |         | 74         |            | 05.00      | 10.00 | - ABS                             | 24.3481-9834.5 | 240480                   | <input type="checkbox"/> | D=48, - Halter               | ATE            |     |
|         |         |            |            |            |       |                                   | 11.0441-4811.2 | 250024                   |                          | Dichtungssatz                | ATE            |     |
|         |         |            |            |            |       |                                   | 11.0101-5407.2 | 260011                   |                          | Hülssensatz                  | ATE            |     |
|         |         |            |            |            |       |                                   | 11.8171-0008.1 | 990049                   |                          | Führungsbolzen               | ATE            |     |
|         |         |            |            |            |       |                                   | 11.8116-0129.1 | 390591                   | 2                        | Haltefeder                   | ATE            |     |
| 1.6     |         | 65         | ORGA 08576 |            | 10.00 | + ABS                             | 24.3541-1767.5 | 240237                   | <input type="checkbox"/> | D=54, - Halter               | BOS            |     |
| 1.6     |         | 72         |            |            | 10.00 | 07.03                             | 24.3541-1768.5 | 240238                   | <input type="checkbox"/> | D=54, - Halter               | BOS            |     |
| 1.8     | 74      | ORGA 08576 |            | 10.00      | + ABS | 24.3541-1757.7                    | 220483         | <input type="checkbox"/> | D=54, - Halter           | LUC                          |                |     |
| 1.8 16V | 81      |            |            | 07.00      | 07.03 | 24.3541-1758.7                    | 220484         | <input type="checkbox"/> | D=54, - Halter           | LUC                          |                |     |
| 2.0     | 89      |            |            | 03.94      | 04.97 | - Niveauregulierung <sup>1)</sup> | 24.0101-3601.2 | 260044                   |                          | Einbausatz                   | LUC            |     |
| 2.0 16V | 97      |            |            | 03.97      | 04.97 | - Niveauregulierung <sup>1)</sup> |                |                          |                          |                              |                |     |
| 2.0 16V | 97      |            |            | 05.97      | 10.00 |                                   | 24.3541-1767.5 | 240237                   | <input type="checkbox"/> | D=54, - Halter               | BOS            |     |
|         |         |            |            |            |       |                                   | 24.3541-1768.5 | 240238                   | <input type="checkbox"/> | D=54, - Halter               | BOS            |     |
|         | 1.6     | 65         |            | 04.96      | 10.00 |                                   | 24.5111-0495.3 | 330505                   | 2                        | Länge beachten <sup>2)</sup> | L=495          |     |
|         | 1.6     | 72         |            | 10.00      | 07.03 |                                   | 24.5111-0520.3 | 330506                   | 2                        | Länge beachten <sup>2)</sup> | L=519          |     |
|         | 1.8     | 74         |            | 03.94      | 10.00 |                                   |                |                          |                          |                              |                |     |
|         | 1.8 16V | 81         |            | 07.00      | 07.03 |                                   |                |                          |                          |                              |                |     |
|         | 2.0 16V | 97         |            | 03.94      | 04.97 |                                   |                |                          |                          |                              |                |     |
|         | 1.6     | 65         |            | 04.96      | 10.00 |                                   | 24.5228-0195.3 | 330469                   | <input type="checkbox"/> |                              | L=202          |     |
|         | 1.6     | 72         |            | 10.00      | 07.03 |                                   | 24.5228-0245.3 | 330531                   | <input type="checkbox"/> |                              | L=245          |     |
|         | 1.8     | 74         |            | 03.94      | 10.00 |                                   |                |                          |                          |                              |                |     |
|         | 1.8 16V | 81         |            | 07.00      | 07.03 |                                   |                |                          |                          |                              |                |     |
|         | 2.0 16V | 97         |            | 03.94      | 04.97 |                                   |                |                          |                          |                              |                |     |
|         | 1.6     | 65         |            | 04.96      | 10.00 | - ABS                             | 24.3220-1617.3 | 020244                   | <input type="checkbox"/> | RzR 20,64                    | BDX            |     |
|         | 1.6     | 72         |            | 10.00      | 07.03 | - ABS                             | 24.3220-1618.3 | 020245                   | <input type="checkbox"/> | RzR 20,64                    | BDX            |     |
|         | 1.8     | 74         |            | 03.94      | 10.00 | - ABS                             | 24.3220-1615.3 | 020242                   | <input type="checkbox"/> | RzR 20,64                    | LUC            |     |
|         |         |            |            |            |       |                                   | 24.3220-1616.3 | 020243                   | <input type="checkbox"/> | RzR 20,64                    | LUC            |     |
|         | 1.6     | 65         | ORGA 08575 | 04.96      |       | + ABS                             | 24.3220-1702.3 | 020375                   |                          | Rz 20,64                     | BDX            |     |
|         | 1.8     | 74         |            | 03.94      | 10.00 | + ABS                             |                |                          |                          |                              |                |     |
|         | 1.8     | 74         |            | 03.94      | 08.95 | + ABS                             | 24.3220-1619.3 | 020246                   |                          | Rz 20,64                     | LUC            |     |
|         | 1.6     | 65         | ORGA 08729 | 04.96      |       | + ABS                             | 24.3220-1711.3 | 020409                   |                          | Rz 20,64                     | LUC            |     |
|         | 1.8     | 74         | ORGA 08729 | 09.95      |       | + ABS                             |                |                          |                          |                              |                |     |
|         | 1.6     | 65         | ORGA 08730 |            | 10.00 | + ABS                             | 24.3220-1717.3 | 020430                   |                          | Rz 20,64                     | LUC            |     |
| 1.6     | 72      |            |            | 10.00      | 07.03 | + ABS                             |                |                          |                          |                              |                |     |
| 1.8     | 74      | ORGA 08730 |            | 10.00      | + ABS |                                   |                |                          |                          |                              |                |     |
|         | 1.6     | 65         |            | 04.96      | 10.00 |                                   | 24.3727-0307.2 | 580307                   | <input type="checkbox"/> | L=1585                       |                |     |
|         | 1.6     | 72         |            | 10.00      | 07.03 |                                   | 24.3727-0306.2 | 580306                   | <input type="checkbox"/> | L=1493                       |                |     |
|         | 1.8     | 74         |            | 05.97      | 10.00 |                                   |                |                          |                          |                              |                |     |
|         | 1.8     | 74         |            | 03.94      | 04.97 |                                   | 24.3727-0814.2 | 580814                   | <input type="checkbox"/> | L=1621                       |                |     |
|         |         |            |            |            |       |                                   | 24.3727-0815.2 | 580815                   | <input type="checkbox"/> | L=1531                       |                |     |
|         | 1.8 16V | 81         |            | 07.00      | 07.03 |                                   | 24.3727-0304.2 | 580304                   | <input type="checkbox"/> | L=1612                       |                |     |
|         | 2.0     | 89         |            | 03.94      | 04.97 |                                   | 24.3727-0305.2 | 580305                   | <input type="checkbox"/> | L=1533                       |                |     |
|         | 2.0 16V | 97         |            | 03.97      | 10.00 |                                   |                |                          |                          |                              |                |     |
|         |         | 1.6        | 65         |            | 04.96 | 10.00                             |                | 24.3728-0822.2           | 590822                   |                              | L=676          |     |
|         |         | 1.6        | 72         |            | 10.00 | 07.03                             |                |                          |                          |                              |                |     |
| 1.8     |         | 74         | ORGA 08336 | 03.94      |       |                                   | 24.3728-0835.2 | 590835                   |                          | L=655, + AUT                 |                |     |
| 2.0     |         | 89         |            | 02.96      | 04.97 |                                   |                |                          |                          |                              |                |     |
| 1.8     |         | 74         | ORGA 08337 |            | 10.00 |                                   | 24.3728-0823.2 | 590823                   |                          | L=625, + AUT                 |                |     |
| 1.8 16V | 81      |            | 07.00      | 07.03      |       |                                   |                |                          |                          |                              |                |     |
| 2.0 16V | 97      | ORGA 08337 |            | 10.00      |       | 24.3728-0825.2                    | 590825         |                          | L=694, + AUT             |                              |                |     |





















**PEUGEOT 306 Kombi (97-02)**

|         |         |    |       |       |       |       |                |        |  |           |     |
|---------|---------|----|-------|-------|-------|-------|----------------|--------|--|-----------|-----|
|         | 1.4     | 55 |       | 03.97 | 03.02 | - ABS | 03.7750-9302.4 | 300116 |  | 9"        | ATE |
|         | 1.6     | 65 |       | 03.97 | 10.00 | - ABS |                |        |  |           |     |
|         | 1.6     | 72 |       | 10.00 | 03.02 | - ABS |                |        |  |           |     |
|         | 1.8 D   | 74 |       | 03.97 | 03.02 | - ABS |                |        |  |           |     |
|         | 1.9 D   | 51 |       | 03.97 | 03.02 | - ABS |                |        |  |           |     |
|         | 1.4     | 55 |       | 03.97 | 03.02 | - ABS | 03.2122-1356.3 | 010529 |  | Thz 22,20 | ATE |
|         | 1.6     | 65 |       | 03.97 | 10.00 | - ABS |                |        |  |           |     |
|         | 1.6     | 72 |       | 10.00 | 03.02 | - ABS |                |        |  |           |     |
|         | 1.8 D   | 74 |       | 03.97 | 03.02 | - ABS |                |        |  |           |     |
|         | 1.9 D   | 51 |       | 03.97 | 03.02 | - ABS |                |        |  |           |     |
|         | 1.9 TD  | 66 |       | 03.97 | 03.02 | - ABS |                |        |  |           |     |
|         | 1.8     | 74 |       | 03.97 | 03.02 | - ABS | 24.2123-1714.3 | 010587 |  | Thz 23,81 | BDX |
|         | 1.8 16V | 81 |       | 03.97 | 03.02 | - ABS |                |        |  |           |     |
|         | 1.9 TD  | 66 |       | 03.97 | 03.02 | - ABS |                |        |  |           |     |
|         | 2.0 16V | 97 |       | 03.97 | 03.02 | - ABS |                |        |  |           |     |
| 2.0 HDi | 66      |    | 06.99 | 03.02 | - ABS |       |                |        |  |           |     |
|         | 1.4     | 55 |       | 03.97 | 03.02 | + ABS | 24.2123-1715.3 | 010520 |  | Thz 23,81 | BDX |
|         | 1.6     | 65 |       | 03.97 | 10.00 | + ABS |                |        |  |           |     |

<sup>1)</sup> - suspension level control / - correttore assetto / - correcteur d'assiette / - regulación altura suspensión

<sup>2)</sup> notice length / attenzione lunghezza / faire attention longueur / atención largo



|     |  kW |  |  |  |  |  |  |  |                              |               |
|--|---|--|--|--|---|--|--|--|------------------------------|---------------|
| <b>PEUGEOT 306 Kombi (97-02)</b>   |   |  |  |  |   |  |  |  |                              |               |
|    | 1.6   | 72   |  | 10.00  | 03.02 + ABS   | 24.2123-1715.3   | 010520   |  | Thz 23,81                    | <b>BDX</b>    |
|  | 1.8   | 74   |  | 03.97  | 03.02 + ABS   |  |  |  |                              |               |
|  | 1.8 16V   | 81   |  | 03.97  | 03.02 + ABS   |  |  |  |                              |               |
|  | 1.8 D   |  |  | 03.97  | 03.02 + ABS   |  |  |  |                              |               |
|  | 1.9 D   | 51   |  | 03.97  | 03.02 + ABS   |  |  |  |                              |               |
|  | 1.9 TD  | 66   |  | 03.97  | 03.02 + ABS   |  |  |  |                              |               |
|  | 2.0 16V   | 97   |  | 03.97  | 03.02 + ABS   |  |  |  |                              |               |
|  | 2.0 HDi   | 66   |  | 06.99  | 03.02 + ABS   |  |  |  |                              |               |
|    | 1.8 D   |  |  | 03.97  | 03.02 - ABS   | 03.2122-1421.3   | 010615   |  | Thz 22,20                    | <b>ATE</b>    |
|  | 1.9 D   | 51   |  | 03.97  | 03.02 - ABS   |  |  |  |                              |               |
|    | 1.9 TD  | 66   |  | 03.97  | 03.02 - ABS   |  |  |  |                              |               |
|  | 1.4   | 55   |  | 03.97  | 03.02 - ABS   | 11.3481-9833.2   | 220561   | <input type="checkbox"/>   | D=48, - Halter               | <b>ATE</b>    |
|    | 1.6   | 65   |  | 03.97  | 10.00 - ABS   | 11.3481-9834.2   | 220562   | <input type="checkbox"/>   | D=48, - Halter               | <b>ATE</b>    |
|  | 1.6   | 72   |  | 10.00  | 03.02 - ABS   | 24.3481-9833.5   | 240479   | <input type="checkbox"/>   | D=48, - Halter               | <b>ATE</b>    |
|  | 1.8 D   |  |  | 03.97  | 03.02 - ABS   | 24.3481-9834.5   | 240480   | <input type="checkbox"/>   | D=48, - Halter               | <b>ATE</b>    |
|  | 1.9 D   | 51   |  | 03.97  | 03.02 - ABS   | 11.0441-4811.2   | 250024   | <input type="checkbox"/>   | Dichtungssatz                | <b>ATE</b>    |
|  | 1.4   | 55   |  | 03.97  | 03.02 + ABS   | 11.0101-5407.2   | 260011   | <input type="checkbox"/>   | Hülensatz                    | <b>ATE</b>    |
|  | 1.6   | 65   |  | 03.97  | 03.02 + ABS   | 11.8171-0008.1   | 990049   | <input type="checkbox"/>   | Führungsbolzen               | <b>ATE</b>    |
|  | 1.6   | 72   |  | 10.00  | 03.02 + ABS   | 11.8116-0129.1   | 390591   | <input type="checkbox"/>   | Haltefeder                   | <b>ATE</b>    |
|  | 1.8   | 74   |  | 03.97  | 03.02 + ABS   |  |  | <input type="checkbox"/>   |                              |               |
|  | 1.8 16V   | 81   |  | 03.97  | 03.02   | 24.3541-1767.5   | 240237   | <input type="checkbox"/>   | D=54, - Halter               | <b>BOS</b>    |
|  | 1.8 D   |  |  | 03.97  | 03.02 + ABS   | 24.3541-1768.5   | 240238   | <input type="checkbox"/>   | D=54, - Halter               | <b>BOS</b>    |
|  | 1.9 D   | 51   |  | 03.97  | 03.02 + ABS   | 24.3541-1757.7   | 220483   | <input type="checkbox"/>   | D=54, - Halter               | <b>LUC</b>    |
|  | 1.9 TD  | 66   |  | 03.97  | 03.02 + ABS   | 24.3541-1758.7   | 220484   | <input type="checkbox"/>   | D=54, - Halter               | <b>LUC</b>    |
|  | 2.0 16V   | 97   |  | 03.97  | 03.02   |  |  |  |                              |               |
|  | 2.0 HDi   | 66   |  | 06.99  | 03.02   |  |  |  |                              |               |
|   | 1.4   | 55   |  | 03.97  | 03.02   | 24.5111-0495.3   | 330505   | 2  | Länge beachten <sup>1)</sup> | L=495         |
|  | 1.6   | 65   |  | 03.97  | 10.00   | 24.5111-0520.3   | 330506   | 2  | Länge beachten <sup>1)</sup> | L=519         |
|  | 1.6   | 72   |  | 10.00  | 03.02   |  |  |  |                              |               |
|  | 1.8   | 74   |  | 03.97  | 03.02   |  |  |  |                              |               |
|  | 1.8 16V   | 81   |  | 03.97  | 03.02   |  |  |  |                              |               |
|  | 1.8 D   |  |  | 03.97  | 03.02   |  |  |  |                              |               |
|  | 1.9 D   | 51   |  | 03.97  | 03.02   |  |  |  |                              |               |
|  | 1.9 TD  | 66   |  | 03.97  | 03.02   |  |  |  |                              |               |
|  | 2.0 16V   | 97   |  | 03.97  | 03.02   |  |  |  |                              |               |
|  | 2.0 HDi   | 66   |  | 06.99  | 03.02   |  |  |  |                              |               |
|  | 1.4   | 55   |  | 03.97  | 03.02   | 24.5228-0195.3   | 330469   | <input type="checkbox"/>   |                              | L=202         |
|  | 1.6   | 65   |  | 03.97  | 10.00   | 24.5228-0245.3   | 330531   | <input type="checkbox"/>   |                              | L=245         |
|  | 1.6   | 72   |  | 10.00  | 03.02   |  |  |  |                              |               |
|  | 1.8   | 74   |  | 03.97  | 03.02   |  |  |  |                              |               |
|  | 1.8 16V   | 81   |  | 03.97  | 03.02   |  |  |  |                              |               |
|  | 1.8 D   |  |  | 03.97  | 03.02   |  |  |  |                              |               |
|  | 1.9 D   | 51   |  | 03.97  | 03.02   |  |  |  |                              |               |
|  | 1.9 TD  | 66   |  | 03.97  | 03.02   |  |  |  |                              |               |
|  | 2.0 16V   | 97   |  | 03.97  | 03.02   |  |  |  |                              |               |
|  | 2.0 HDi   | 66   |  | 06.99  | 03.02   |  |  |  |                              |               |
|  | 1.4   | 55   |  | 03.97  | 03.02 - ABS   | 24.3220-1702.3   | 020375   |  |                              | Rz 20,64      |
|  | 1.6   | 65   |  | 03.97  | 10.00 - ABS   |  |  |  |                              |               |
|  | 1.6   | 72   |  | 10.00  | 03.02 - ABS   |  |  |  |                              |               |
|  | 1.8 D   |  |  | 03.97  | 03.02 - ABS   |  |  |  |                              |               |
|  | 1.9 D   | 51   |  | 03.97  | 03.02 - ABS   |  |  |  |                              |               |
|  | 1.4   | 55   |  | 03.97  | 03.02 + ABS   | 24.3222-1714.3   | 020432   |  |                              | Rz 22,00      |
|  | 1.6   | 65   |  | 03.97  | 10.00 + ABS   |  |  |  |                              |               |
|  | 1.6   | 72   |  | 10.00  | 03.02 + ABS   |  |  |  |                              |               |
|  | 1.8   | 74   |  | 03.97  | 03.02   |  |  |  |                              |               |
|  | 1.8 D   |  |  | 03.97  | 03.02 + ABS   |  |  |  |                              |               |
|  | 1.9 D   | 51   |  | 03.97  | 03.02 + ABS   |  |  |  |                              |               |
|  | 1.9 TD  | 66   |  | 03.97  | 03.02   |  |  |  |                              |               |
|  | 1.4   | 55   |  | 03.97  | 03.02   | 24.3727-0823.2   | 580823   | <input type="checkbox"/>   |                              | L=1690        |
|  | 1.6   | 65   |  | 03.97  | 10.00   | 24.3727-0822.2   | 580822   | <input type="checkbox"/>   |                              | L=1608, + Zub |
|  | 1.6   | 72   |  | 10.00  | 03.02   |  |  |  |                              |               |
|  | 1.8   | 74   |  | 03.97  | 03.02   |  |  |  |                              |               |
|  | 1.8 D   |  |  | 03.97  | 03.02   |  |  |  |                              |               |
|  | 1.9 D   | 51   |  | 03.97  | 03.02   |  |  |  |                              |               |
|  | 1.9 TD  | 66   |  | 03.97  | 03.02   |  |  |  |                              |               |
|  | 1.8 16V   | 81   |  | 03.97  | 03.02   | 24.3727-0812.2   | 580812   | <input type="checkbox"/>   |                              | L=1696        |
|  | 2.0 16V   | 97   |  | 03.97  | 03.02   | 24.3727-0813.2   | 580813   | <input type="checkbox"/>   |                              | L=1614        |
|  | 2.0 HDi   | 66   |  | 06.99  | 03.02   |  |  |  |                              |               |
|  | 1.4   | 55   |  | 03.97  | 08.99 + Fahrschule <sup>2)</sup>  | 24.3728-0822.2   | 590822   |  |                              | L=676         |
|  | 1.4   | 55   |  | 03.97  | 03.02 - Fahrschule <sup>3)</sup>  |  |  |  |                              |               |
|  | 1.6   | 65   |  | 03.97  | 08.99 + Fahrschule <sup>2)</sup>  |  |  |  |                              |               |
|  | 1.6   | 65   |  | 03.97  | 10.00 - Fahrschule <sup>3)</sup>  |  |  |  |                              |               |
|  | 1.6   | 72   |  | 10.00  | 03.02 - Fahrschule <sup>3)</sup>  |  |  |  |                              |               |
|  | 1.4   | 55   |  | 09.99  | 03.02 + Fahrschule <sup>2)</sup>  | 24.3728-0834.2   | 590834   |  |                              | L=620, + AUT  |
|  | 1.6   | 65   |  | 09.99  | 10.00 + Fahrschule <sup>2)</sup>  |  |  |  |                              |               |
|  | 1.6   | 72   |  | 10.00  | 03.02 + Fahrschule <sup>2)</sup>  |  |  |  |                              |               |
|  | 1.8   | 74   |  | 03.97  | 08.99 + Fahrschule <sup>2)</sup>  | 24.3728-0835.2   | 590835   |  |                              | L=655, + AUT  |
|  | 1.8 16V   | 81   |  | 03.97  | 03.02   |  |  |  |                              |               |
|  | 1.8 D   |  |  | 03.97  | 03.02   |  |  |  |                              |               |
|  | 1.9 D   | 51   |  | 03.97  | 03.02   |  |  |  |                              |               |
|  | 2.0 HDi   | 66   |  | 06.99  | 03.02   |  |  |  |                              |               |
|  | 1.8   | 74   | ORGA 08337   |  | 03.02   | 24.3728-0823.2   | 590823   |  |                              | L=625, + AUT  |
|  | 1.8 16V   | 81   | ORGA 08337   |  | 03.02   |  |  |  |                              |               |

<sup>1)</sup> notice length / attenzione lunghezza / faire attention longueur / atención largo

<sup>2)</sup> + driving school / + scuola guida / + auto école / + autoescuela

<sup>3)</sup> - driving school / - scuola guida / - auto école / - autoescuela

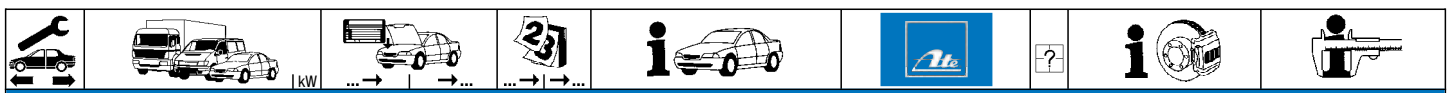

**PEUGEOT 306 Kombi (97-02)**

|  |         |    |            |       |  |                |        |  |  |              |
|--|---------|----|------------|-------|--|----------------|--------|--|--|--------------|
|  | 1.8 D   | 51 | ORGA 08337 | 03.02 |  | 24.3728-0823.2 | 590823 |  |  | L=625, + AUT |
|  | 1.9 D   | 51 | ORGA 08337 | 03.02 |  |                |        |  |  |              |
|  | 2.0 HDi | 66 | ORGA 08337 | 03.02 |  |                |        |  |  |              |
|  | 1.9 TD  | 66 | ORGA 08337 | 03.02 |  | 24.3728-0825.2 | 590825 |  |  | L=694, + AUT |
|  | 2.0 16V | 97 | ORGA 08337 | 03.02 |  |                |        |  |  |              |

**PEUGEOT 307 Limousine (00-07)**





























|             |             |            |            |       |                            |                |        |   |                |                |     |
|-------------|-------------|------------|------------|-------|----------------------------|----------------|--------|---|----------------|----------------|-----|
|             | 1.4 16V     | 65         | ORGA 11192 | 11.03 |                            | 24.4123-1706.3 | 010848 |   | + ESP          | THz 23,81      | BOS |
|             | 1.6 16V     | 80         | ORGA 11192 | 08.00 |                            |                |        |   |                |                |     |
|             | 1.6 HDi 110 | 80         | ORGA 11192 | 02.04 |                            |                |        |   |                |                |     |
|             | 1.6 HDi 90  | 66         | ORGA 11192 | 04.05 |                            |                |        |   |                |                |     |
|             | 2.0 16V     | 100        |            | 08.00 | 07.07                      |                |        |   |                |                |     |
|             | 2.0 16V     | 103        | ORGA 11192 | 03.05 |                            |                |        |   |                |                |     |
|             | 2.0 16V     | 130        | ORGA 11192 | 06.05 |                            |                |        |   |                |                |     |
|             | 2.0 HDi 135 | 100        | ORGA 11192 | 10.03 |                            |                |        |   |                |                |     |
|             | 2.0 HDi 90  | 66         |            | 08.00 | 07.07                      |                |        |   |                |                |     |
|             | 1.4         | 55         |            | 08.00 | 07.07                      | 24.3541-1771.5 | 240239 |   |                | D=54, - Halter | BOS |
|             | 1.4 16V     | 65         | ORGA 10551 | 07.07 | + ESP                      | 24.3541-1772.5 | 240240 |   |                | D=54, - Halter | BOS |
|             | 1.4 16V     | 65         |            | 11.03 | 07.07                      |                |        |   |                |                |     |
|             | 1.4 HDi     | 50         |            | 10.01 | 07.07                      |                |        |   |                |                |     |
|             | 1.6 16V     | 80         | ORGA 10551 | 07.07 | + ESP/ + Schaltgetriebe 1) |                |        |   |                |                |     |
|             | 1.6 16V     | 80         |            | 08.00 | 07.07                      |                |        |   |                |                |     |
|             | 1.6 HDi 90  | 66         | ORGA 10551 | 07.07 | + ESP                      |                |        |   |                |                |     |
|             | 1.6 HDi 90  | 66         |            | 04.05 | 07.07                      |                |        |   |                |                |     |
|             | 2.0 HDi 90  | 66         |            | 08.00 | 07.07                      |                |        |   |                |                |     |
|             | 1.4 16V     | 65         | ORGA 10550 | 11.03 | + ESP                      | 24.3541-1761.5 | 240233 |   |                | D=54, - Halter | BOS |
|             | 1.6 16V     | 80         | ORGA 10550 | 08.00 | + ESP/ + Schaltgetriebe 1) | 24.3541-1762.5 | 240234 |   |                | D=54, - Halter | BOS |
|             | 1.6 16V     | 80         |            | 08.00 | 07.07                      |                |        |   |                |                |     |
| 1.6 HDi 110 | 80          |            | 02.04      | 07.07 |                            |                |        |   |                |                |     |
| 1.6 HDi 90  | 66          | ORGA 10550 | 04.05      | + ESP |                            |                |        |   |                |                |     |
| 2.0 16V     | 100         |            | 08.00      | 07.07 |                            |                |        |   |                |                |     |
| 2.0 16V     | 103         |            | 03.05      | 07.07 |                            |                |        |   |                |                |     |
| 2.0 HDi 110 | 79          |            | 08.00      | 07.07 |                            |                |        |   |                |                |     |
| 2.0 16V     | 130         | ORGA 10487 | 06.05      |       | 11.9571-9765.2             | 220663         |        |   | D=57, - Halter | ATE            |     |
| 2.0 HDi 135 | 100         | ORGA 10487 | 10.03      |       | 11.9571-9766.2             | 220664         |        |   | D=57, - Halter | ATE            |     |
|             |             |            |            |       | 11.8116-0351.1             | 390538         | 2      |   | Haltefeder     | ATE            |     |
|             |             |            |            |       | 11.0101-5704.2             | 260095         |        |   | Hülzensatz     | ATE            |     |
|             |             |            |            |       | 11.8171-0008.1             | 990049         |        |   | Führungsbolzen | ATE            |     |
| 2.0 16V     | 130         | ORGA 10488 | 07.07      |       | 11.9571-9765.2             | 220663         |        |   | D=57, - Halter | ATE            |     |
| 2.0 HDi 135 | 100         | ORGA 10488 | 07.07      |       | 11.9571-9766.2             | 220664         |        |   | D=57, - Halter | ATE            |     |
|             |             |            |            |       | 11.8116-0351.1             | 390538         | 2      |   | Haltefeder     | ATE            |     |
|             |             |            |            |       | 11.0101-5704.2             | 260095         |        |   | Hülzensatz     | ATE            |     |
|             |             |            |            |       | 11.8171-0008.1             | 990049         |        |   | Führungsbolzen | ATE            |     |
|             | 1.4         | 55         |            | 08.00 | 07.07                      | 24.5111-0420.3 | 330682 | 2 |                | L=420          |     |
|             | 1.4 16V     | 65         |            | 11.03 | 07.07                      |                |        |   |                |                |     |
|             | 1.4 HDi     | 50         |            | 10.01 | 07.07                      |                |        |   |                |                |     |
|             | 1.6 16V     | 80         |            | 08.00 | 07.07                      |                |        |   |                |                |     |
|             | 1.6 HDi 110 | 80         |            | 02.04 | 07.07                      |                |        |   |                |                |     |
|             | 1.6 HDi 90  | 66         |            | 04.05 | 07.07                      |                |        |   |                |                |     |
|             | 2.0 16V     | 100        |            | 08.00 | 07.07                      |                |        |   |                |                |     |
|             | 2.0 16V     | 103        |            | 03.05 | 07.07                      |                |        |   |                |                |     |
|             | 2.0 16V     | 130        |            | 06.05 | 07.07                      |                |        |   |                |                |     |
|             | 2.0 HDi 110 | 79         |            | 03.04 | 07.07                      |                |        |   |                |                |     |
|             | 2.0 HDi 135 | 100        |            | 10.03 | 07.07                      |                |        |   |                |                |     |
|             | 2.0 HDi 90  | 66         |            | 08.00 | 07.07                      |                |        |   |                |                |     |
|             | 1.4         | 55         |            | 03.04 | 07.07                      | 24.3387-1709.7 | 220743 |   |                | D=38, - Halter | LUC |
|             | 1.4 16V     | 65         |            | 11.03 | 07.07                      | 24.3387-1710.7 | 220744 |   |                | D=38, - Halter | LUC |
|             | 1.4 HDi     | 50         |            | 03.04 | 07.07                      |                |        |   |                |                |     |
|             | 1.6 16V     | 80         |            | 03.04 | 07.07                      |                |        |   |                |                |     |
|             | 1.6 HDi 110 | 80         |            | 02.04 | 07.07                      |                |        |   |                |                |     |
|             | 1.6 HDi 90  | 66         |            | 04.05 | 07.07                      |                |        |   |                |                |     |
|             | 2.0 16V     | 100        |            | 03.04 | 07.07                      |                |        |   |                |                |     |
|             | 2.0 16V     | 103        |            | 03.05 | 07.07                      |                |        |   |                |                |     |
|             | 2.0 16V     | 130        |            | 06.05 | 07.07                      |                |        |   |                |                |     |
|             | 2.0 HDi 110 | 79         |            | 03.04 | 07.07                      |                |        |   |                |                |     |
|             | 2.0 HDi 135 | 100        |            | 10.03 | 07.07                      |                |        |   |                |                |     |
|             | 2.0 HDi 90  | 66         |            | 03.04 | 07.07                      |                |        |   |                |                |     |
|             | 1.4         | 55         |            | 08.00 | 07.07                      | 24.5246-0190.3 | 330697 | 2 |                | L=190          |     |
|             | 1.4 16V     | 65         |            | 11.03 | 07.07                      |                |        |   |                |                |     |
|             | 1.4 HDi     | 50         |            | 10.01 | 07.07                      |                |        |   |                |                |     |
|             | 1.6 16V     | 80         |            | 08.00 | 07.07                      |                |        |   |                |                |     |
|             | 1.6 HDi 110 | 80         |            | 02.04 | 07.07                      |                |        |   |                |                |     |
|             | 1.6 HDi 90  | 66         |            | 04.05 | 07.07                      |                |        |   |                |                |     |
|             | 2.0 16V     | 100        |            | 08.00 | 07.07                      |                |        |   |                |                |     |
|             | 2.0 16V     | 103        |            | 03.05 | 07.07                      |                |        |   |                |                |     |
|             | 2.0 16V     | 130        |            | 06.05 | 07.07                      |                |        |   |                |                |     |
|             | 2.0 HDi 110 | 79         |            | 08.00 | 07.07                      |                |        |   |                |                |     |
|             | 2.0 HDi 135 | 100        |            | 10.03 | 07.07                      |                |        |   |                |                |     |
|             | 2.0 HDi 90  | 66         |            | 08.00 | 07.07                      |                |        |   |                |                |     |
|             | 1.4         | 55         |            | 08.00 | 07.07                      | 24.3727-0832.2 | 580832 | 2 |                | L=2035         |     |
|             | 1.4 16V     | 65         |            | 11.03 | 07.07                      |                |        |   |                |                |     |
|             | 1.4 HDi     | 50         |            | 10.01 | 07.07                      |                |        |   |                |                |     |
|             | 1.6 16V     | 80         |            | 08.00 | 07.07                      |                |        |   |                |                |     |
|             | 1.6 HDi 110 | 80         |            | 02.04 | 07.07                      |                |        |   |                |                |     |
|             | 1.6 HDi 90  | 66         |            | 04.05 | 07.07                      |                |        |   |                |                |     |
|             | 2.0 16V     | 100        |            | 08.00 | 07.07                      |                |        |   |                |                |     |
|             | 2.0 16V     | 103        |            | 03.05 | 07.07                      |                |        |   |                |                |     |











1) + ESP/ + manual transm. / + ESP/+ scatola cambio velocità / + ESP/ + transmission mécanique / + ESP/ + cambio de velocidad

2) - ESP/ + manual transm. / - ESP/+ scatola cambio velocità / - ESP/ + transmission mécanique / - ESP/ + cambio de velocidad



























3) + autom.transmission / + scatola cambio automatico / + transmission automatique / + cambio automático



|     |   |  |    |                                   |                                  |      |  |   |  |
|--|---|--|--|---|---|--|--|---|--|
| <b>PEUGEOT 307 Limousine (00-07)</b>   |   |  |  |   |   |  |  |   |  |
|    | 2.0 16V<br>2.0 HDi 110<br>2.0 HDi 135<br>2.0 HDi 90   | 130<br>79<br>100<br>66   |  | 06.05<br>08.00<br>10.03<br>08.00  | 07.07<br>07.07<br>07.07<br>07.07  | 24.3727-0832.2   | 580832   | 2 ↓   | L=2035   |
| <b>PEUGEOT 307 Break (02-08)</b>   |   |  |  |   |   |  |  |   |  |
|    | 1.4<br>1.4 16V<br>1.6 16V<br>1.6 BioFlex<br>1.6 HDi 110<br>1.6 HDi 90<br>2.0 16V<br>2.0 16V<br>2.0 16V<br>2.0 HDi 135<br>2.0 HDi 90                           | 55<br>65<br>80<br>80<br>80<br>66<br>100<br>103<br>130<br>100<br>66               | ORGA 11192<br>ORGA 11192<br>ORGA 11192<br>ORGA 11192<br>ORGA 11192<br>ORGA 11192<br>ORGA 11192<br>ORGA 11192<br>ORGA 11192   | 04.02<br>11.03<br>03.02<br>09.07<br>02.04<br>04.05<br>03.02<br>03.05<br>06.05<br>02.04<br>09.05                   | 09.03 + ESP<br>+ ESP<br>+ ESP<br>+ ESP<br>+ ESP<br>+ ESP<br>+ ESP<br>+ ESP<br>+ ESP<br>+ ESP<br>+ ESP             | 24.4123-1706.3   | 010848   |   | Thz 23,81<br><b>BOS</b>  |
|    | 1.4<br>1.4 16V<br>1.4 16V<br>1.4 HDi  | 55<br>65 ORGA 10551<br>65<br>50  |  | 04.02<br>11.03<br>03.02   | 09.03 - ESP<br>04.08 + ESP<br>04.08 - ESP<br>04.08  | 24.3541-1771.5<br>24.3541-1772.5   | 240239<br>240240   | <br>      | D=54, - Halter<br>D=54, - Halter<br><b>BOS</b><br><b>BOS</b>   |
|    | 1.4<br>1.4 16V<br>1.6 16V<br>1.6 BioFlex<br>1.6 HDi 110<br>1.6 HDi 90<br>2.0 16V<br>2.0 16V<br>2.0 HDi 110<br>2.0 HDi 90                                      | 55<br>65<br>80<br>80<br>80<br>66<br>100<br>103<br>79<br>66                       | ORGA 10550<br>ORGA 10550<br>ORGA 10550<br>ORGA 10550<br>ORGA 10550<br>ORGA 12053<br>ORGA 12053   | 04.02<br>11.03<br>03.02<br>09.07<br>02.04<br>04.05<br>03.02<br>03.05<br>03.02<br>03.02                            | + ESP<br>+ ESP<br>04.08<br>04.08<br>04.08<br>04.08<br>04.08   | 24.3541-1761.5<br>24.3541-1762.5   | 240233<br>240234   | <br>      | D=54, - Halter<br>D=54, - Halter<br><b>BOS</b><br><b>BOS</b>   |
|    | 2.0 16V<br>2.0 HDi 135  | 130<br>100   | ORGA 10487<br>ORGA 10487   | 06.05<br>02.04  |   | 11.9571-9765.2<br>11.9571-9766.2<br>11.8116-0351.1<br>11.0101-5704.2<br>11.8171-0008.1 | 220663<br>220664<br>390538<br>260095<br>990049                                     | <br><br>2 | D=57, - Halter<br>D=57, - Halter<br>Haltefeder<br>Hülzensatz<br>Führungsbolzen<br><b>ATE</b><br><b>ATE</b><br><b>ATE</b><br><b>ATE</b><br><b>ATE</b> |
|    | 2.0 16V<br>2.0 HDi 135  | 130 ORGA 10488<br>100 ORGA 10488   |  | 04.08<br>04.08  |   | 11.9571-9765.2<br>11.9571-9766.2<br>11.8116-0351.1<br>11.0101-5704.2<br>11.8171-0008.1 | 220663<br>220664<br>390538<br>260095<br>990049                                     | <br><br>2 | D=57, - Halter<br>D=57, - Halter<br>Haltefeder<br>Hülzensatz<br>Führungsbolzen<br><b>ATE</b><br><b>ATE</b><br><b>ATE</b><br><b>ATE</b><br><b>ATE</b> |
|  | 1.4<br>1.4 16V<br>1.4 HDi<br>1.6 16V<br>1.6 BioFlex<br>1.6 HDi 110<br>1.6 HDi 90<br>2.0 16V<br>2.0 16V<br>2.0 16V<br>2.0 HDi 110<br>2.0 HDi 135<br>2.0 HDi 90 | 55<br>65<br>50<br>80<br>80<br>80<br>66<br>100<br>103<br>130<br>79<br>100<br>66   |  | 04.02<br>11.03<br>03.02<br>03.02<br>09.07<br>02.04<br>04.05<br>03.02<br>03.05<br>06.05<br>03.02<br>02.04<br>03.02 | 09.03<br>04.08<br>04.08<br>04.08<br>04.08<br>04.08<br>04.08<br>04.08<br>04.08<br>04.08<br>04.08<br>04.08<br>04.08 | 24.5111-0420.3   | 330682   | 2   | L=420  |
|  | 1.4<br>1.4 16V<br>1.4 HDi<br>1.6 16V<br>1.6 HDi 110<br>1.6 HDi 90<br>2.0 16V<br>2.0 16V<br>2.0 16V<br>2.0 HDi 110<br>2.0 HDi 135<br>2.0 HDi 90                | 55<br>65<br>50<br>80<br>80<br>66<br>100<br>103<br>130<br>79<br>100<br>66         | ORGA 12056<br>ORGA 12056<br>ORGA 12056<br>ORGA 12056<br>ORGA 12056<br>ORGA 12056<br>ORGA 12056<br>ORGA 12056<br>ORGA 12056<br>ORGA 12056<br>ORGA 12056<br>ORGA 12056 | 04.02<br>11.03<br>03.02<br>03.02<br>02.04<br>04.05<br>03.02<br>03.05<br>06.05<br>03.02<br>02.04<br>03.02          |   | 24.3387-1709.7<br>24.3387-1710.7   | 220743<br>220744   | <br>  | D=38, - Halter<br>D=38, - Halter<br><b>LUC</b><br><b>LUC</b>   |
|  | 1.4<br>1.4 16V<br>1.4 HDi<br>1.6 16V<br>1.6 HDi 110<br>1.6 HDi 90<br>2.0 16V<br>2.0 16V<br>2.0 16V<br>2.0 HDi 110<br>2.0 HDi 135<br>2.0 HDi 90                | 55<br>65<br>50<br>80<br>80<br>66<br>100<br>103<br>130<br>79<br>100<br>66         |  | 04.02<br>11.03<br>03.02<br>03.02<br>02.04<br>04.05<br>03.02<br>03.05<br>06.05<br>03.02<br>02.04<br>03.02          | 09.03<br>04.08<br>04.08<br>04.08<br>04.08<br>04.08<br>04.08<br>04.08<br>04.08<br>04.08<br>04.08<br>04.08          | 24.5246-0190.3   | 330697   | 2   | L=190  |
|  | 1.4<br>1.4 16V<br>1.4 HDi<br>1.6 16V<br>1.6 HDi 110<br>1.6 HDi 90<br>2.0 16V<br>2.0 16V<br>2.0 16V  | 55<br>65<br>50<br>80<br>80<br>66<br>100<br>103<br>130                            | ORGA 10933<br>ORGA 10933<br>ORGA 10933<br>ORGA 10933<br>ORGA 10933<br>ORGA 10933<br>ORGA 10933<br>ORGA 10933<br>ORGA 10933   | 04.02<br>11.03<br>03.02<br>03.02<br>02.04<br>04.05<br>03.02<br>03.05<br>06.05                                     |   | 24.3727-0839.2   | 580839   | 2 ↓   | L=2115   |

| PEUGEOT 307 Break (02-08)  |             |     |            |       |       |                |        |   |   |  |                    |
|--|-------------|-----|------------|-------|-------|----------------|--------|---|---|--|--------------------|
|     | 2.0 HdI 110 | 79  | ORGA 10933 | 03.02 |       | 24.3727-0839.2 | 580839 | 2 | ↓ |  | L=2115             |
|  | 2.0 HdI 135 | 100 | ORGA 10933 | 02.04 |       |                |        |   |   |  |                    |
|  | 2.0 HdI 90  | 66  | ORGA 10933 | 03.02 |       |                |        |   |   |  |                    |
| PEUGEOT 307 CC (03-09)   |             |     |            |       |       |                |        |   |   |  |                    |
|    | CC 110      | 80  | ORGA 11192 | 03.05 | 02.09 | 24.4123-1706.3 | 010848 |   |   |  | Thz 23,81 BOS      |
|  | CC 135      | 100 |            | 10.03 | 02.09 |                |        |   |   |  |                    |
|  | CC 140      | 103 | ORGA 11192 | 03.05 |       |                |        |   |   |  |                    |
|  | CC 180      | 130 | ORGA 11192 | 10.03 |       |                |        |   |   |  |                    |
|  | CC HdI 135  | 100 | ORGA 11192 | 06.05 |       |                |        |   |   |  |                    |
|    | CC 110      | 80  |            | 03.05 | 02.09 | 24.3541-1761.5 | 240233 |   | ☐ |  | D=54, - Halter BOS |
|  | CC 135      | 100 |            | 10.03 | 02.09 | 24.3541-1762.5 | 240234 |   | ☐ |  | D=54, - Halter BOS |
|  | CC 140      | 103 | ORGA 12053 | 03.05 |       |                |        |   |   |  |                    |
|  | CC 180      | 130 | ORGA 10487 | 10.03 |       | 11.9571-9765.2 | 220663 |   | ☐ |  | D=57, - Halter ATE |
|  | CC HdI 135  | 100 | ORGA 10487 | 06.05 |       | 11.9571-9766.2 | 220664 |   | ☐ |  | D=57, - Halter ATE |
|  |             |     |            |       |       | 11.8116-0351.1 | 390538 | 2 |   |  | Haltefeder ATE     |
|  |             |     |            |       |       | 11.0101-5704.2 | 260095 |   |   |  | Hülzensatz ATE     |
|  |             |     |            |       |       | 11.8171-0008.1 | 990049 |   |   |  | Führungsbolzen ATE |
|  | CC 180      | 130 | ORGA 10488 |       | 02.09 | 11.9571-9765.2 | 220663 |   | ☐ |  | D=57, - Halter ATE |
|  | CC HdI 135  | 100 | ORGA 10488 |       | 02.09 | 11.9571-9766.2 | 220664 |   | ☐ |  | D=57, - Halter ATE |
|  |             |     |            |       |       | 11.8116-0351.1 | 390538 | 2 |   |  | Haltefeder ATE     |
|  |             |     |            |       |       | 11.0101-5704.2 | 260095 |   |   |  | Hülzensatz ATE     |
|  |             |     |            |       |       | 11.8171-0008.1 | 990049 |   |   |  | Führungsbolzen ATE |
|    | CC 110      | 80  |            | 03.05 | 02.09 | 24.5111-0420.3 | 330682 | 2 |   |  | L=420              |
|  | CC 135      | 100 |            | 10.03 | 02.09 |                |        |   |   |  |                    |
|  | CC 140      | 103 |            | 03.05 | 02.09 |                |        |   |   |  |                    |
|  | CC 180      | 130 |            | 10.03 | 02.09 |                |        |   |   |  |                    |
|  | CC HdI 135  | 100 |            | 06.05 | 02.09 |                |        |   |   |  |                    |
|    | CC 110      | 80  | ORGA 12056 | 03.05 |       | 24.3387-1709.7 | 220743 |   | ☐ |  | D=38, - Halter LUC |
|  | CC 135      | 100 | ORGA 12056 | 10.03 |       | 24.3387-1710.7 | 220744 |   | ☐ |  | D=38, - Halter LUC |
|  | CC 140      | 103 | ORGA 12056 | 03.05 |       |                |        |   |   |  |                    |
|  | CC 180      | 130 | ORGA 12056 | 10.03 |       |                |        |   |   |  |                    |
|  | CC HdI 135  | 100 | ORGA 12056 | 06.05 |       |                |        |   |   |  |                    |
|    | CC 110      | 80  |            | 03.05 | 02.09 | 24.5246-0190.3 | 330697 | 2 |   |  | L=190              |
|  | CC 135      | 100 |            | 10.03 | 02.09 |                |        |   |   |  |                    |
|  | CC 140      | 103 |            | 03.05 | 02.09 |                |        |   |   |  |                    |
|  | CC 180      | 130 |            | 10.03 | 02.09 |                |        |   |   |  |                    |
|  | CC HdI 135  | 100 |            | 06.05 | 02.09 |                |        |   |   |  |                    |
|   | CC 110      | 80  |            | 03.05 | 02.09 | 24.3727-0832.2 | 580832 | 2 | ↓ |  | L=2035             |
|  | CC 135      | 100 |            | 10.03 | 02.09 |                |        |   |   |  |                    |
|  | CC 140      | 103 |            | 03.05 | 02.09 |                |        |   |   |  |                    |
|  | CC 180      | 130 |            | 10.03 | 02.09 |                |        |   |   |  |                    |
|  | CC HdI 135  | 100 |            | 06.05 | 02.09 |                |        |   |   |  |                    |
| PEUGEOT 307 SW (02-08)   |             |     |            |       |       |                |        |   |   |  |                    |
|  | 1.4         | 55  |            | 04.02 | 09.03 | 24.4123-1706.3 | 010848 |   |   |  | Thz 23,81 BOS      |
|  | 1.4 16V     | 65  | ORGA 11192 | 11.03 |       |                |        |   |   |  |                    |
|  | 1.6 16V     | 80  | ORGA 11192 | 03.02 |       |                |        |   |   |  |                    |
|  | 1.6 BioFlex | 80  | ORGA 11192 | 09.07 |       |                |        |   |   |  |                    |
|  | 1.6 D       | 66  | ORGA 11192 | 12.06 |       |                |        |   |   |  |                    |
|  | 1.6 HdI 110 | 80  | ORGA 11192 | 02.04 |       |                |        |   |   |  |                    |
|  | 2.0 16V     | 100 |            | 03.02 | 04.08 |                |        |   |   |  |                    |
|  | 2.0 16V     | 103 | ORGA 11192 | 03.05 |       |                |        |   |   |  |                    |
|  | 2.0 HdI 135 | 100 | ORGA 11192 | 02.04 |       |                |        |   |   |  |                    |
|  | 2.0 HdI 90  | 66  |            | 09.05 | 04.08 |                |        |   |   |  |                    |
|  | 1.4         | 55  |            | 04.02 | 09.03 | 24.3541-1771.5 | 240239 |   | ☐ |  | D=54, - Halter BOS |
|  | 1.4 16V     | 65  | ORGA 10551 | 04.08 |       | 24.3541-1772.5 | 240240 |   | ☐ |  | D=54, - Halter BOS |
|  | 1.4 16V     | 65  |            | 11.03 | 04.08 |                |        |   |   |  |                    |
|  | 1.4 HdI     | 50  |            | 03.02 | 01.05 |                |        |   |   |  |                    |
|  | 1.4         | 55  | ORGA 10550 | 04.02 |       | 24.3541-1761.5 | 240233 |   | ☐ |  | D=54, - Halter BOS |
|  | 1.4 16V     | 65  | ORGA 10550 | 11.03 |       | 24.3541-1762.5 | 240234 |   | ☐ |  | D=54, - Halter BOS |
|  | 1.6 16V     | 80  |            | 03.02 | 04.08 |                |        |   |   |  |                    |
|  | 1.6 BioFlex | 80  |            | 09.07 | 04.08 |                |        |   |   |  |                    |
|  | 1.6 D       | 66  |            | 12.06 | 04.08 |                |        |   |   |  |                    |
|  | 1.6 HdI 110 | 80  |            | 02.04 | 04.08 |                |        |   |   |  |                    |
|  | 2.0 16V     | 100 |            | 03.02 | 04.08 |                |        |   |   |  |                    |
|  | 2.0 16V     | 103 | ORGA 12053 | 03.05 |       |                |        |   |   |  |                    |
|  | 2.0 HdI 110 | 79  | ORGA 12053 | 03.02 |       |                |        |   |   |  |                    |
|  | 2.0 HdI 90  | 66  |            | 03.02 | 04.08 |                |        |   |   |  |                    |
|  | 2.0 HdI 135 | 100 | ORGA 10487 | 02.04 |       | 11.9571-9765.2 | 220663 |   | ☐ |  | D=57, - Halter ATE |
|  |             |     |            |       |       | 11.9571-9766.2 | 220664 |   | ☐ |  | D=57, - Halter ATE |
|  |             |     |            |       |       | 11.8116-0351.1 | 390538 | 2 |   |  | Haltefeder ATE     |
|  |             |     |            |       |       | 11.0101-5704.2 | 260095 |   |   |  | Hülzensatz ATE     |
|  |             |     |            |       |       | 11.8171-0008.1 | 990049 |   |   |  | Führungsbolzen ATE |
|  | 2.0 HdI 135 | 100 | ORGA 10488 |       | 04.08 | 11.9571-9765.2 | 220663 |   | ☐ |  | D=57, - Halter ATE |
|  |             |     |            |       |       | 11.9571-9766.2 | 220664 |   | ☐ |  | D=57, - Halter ATE |
|  |             |     |            |       |       | 11.8116-0351.1 | 390538 | 2 |   |  | Haltefeder ATE     |
|  |             |     |            |       |       | 11.0101-5704.2 | 260095 |   |   |  | Hülzensatz ATE     |
|  |             |     |            |       |       | 11.8171-0008.1 | 990049 |   |   |  | Führungsbolzen ATE |
|  | 1.4         | 55  |            | 04.02 | 09.03 | 24.5111-0420.3 | 330682 | 2 |   |  | L=420              |
|  | 1.4 16V     | 65  |            | 11.03 | 04.08 |                |        |   |   |  |                    |
|  | 1.4 HdI     | 50  |            | 03.02 | 01.05 |                |        |   |   |  |                    |
|  | 1.6 16V     | 80  |            | 03.02 | 04.08 |                |        |   |   |  |                    |
|  | 1.6 BioFlex | 80  |            | 09.07 | 04.08 |                |        |   |   |  |                    |
|  | 1.6 D       | 66  |            | 12.06 | 04.08 |                |        |   |   |  |                    |
|  | 1.6 HdI 110 | 80  |            | 02.04 | 04.08 |                |        |   |   |  |                    |



|     |    |                |    |   |                         |      |  |    |   |                                 |
|--|--|--|--|---|--|--|--|--|---|---------------------------------|
| <b>PEUGEOT 307 SW (02-08)</b>  |  |  |  |   |  |  |  |  |   |                                 |
|    | 2.0 16V<br>2.0 16V<br>2.0 HDi 110<br>2.0 HDi 135<br>2.0 HDi 90   | 100<br>103<br>79<br>100<br>66  |  | 03.02<br>03.05<br>03.02<br>02.04<br>03.02   | 04.08<br>04.08<br>04.08<br>04.08<br>04.08  | 24.5111-0420.3   | 330682   | 2  | L=420   |                                 |
|    | 1.4<br>1.4 16V<br>1.4 HDi<br>1.6 16V<br>1.6 BioFlex<br>1.6 D<br>1.6 HDi 110<br>2.0 16V<br>2.0 16V<br>2.0 HDi 110<br>2.0 HDi 135<br>2.0 HDi 90  | 55<br>65<br>50<br>80<br>80<br>66<br>80<br>100<br>103<br>79<br>100<br>66                        | ORGA 12056<br>ORGA 12056<br>ORGA 12056<br>ORGA 12056<br>ORGA 12056<br>ORGA 12056<br>ORGA 12056<br>ORGA 12056<br>ORGA 12056<br>ORGA 12056<br>ORGA 12056<br>ORGA 12056 | 04.02<br>11.03<br>03.02<br>03.02<br>09.07<br>12.06<br>02.04<br>03.02<br>03.05<br>03.02<br>02.04<br>03.02                            | 01.05  | 24.3387-1709.7<br>24.3387-1710.7   | 220743<br>220744   | <br>   | D=38, - Halter<br>D=38, - Halter  | LUC<br>LUC                      |
|    | 1.4<br>1.4 16V<br>1.4 HDi<br>1.6 16V<br>1.6 BioFlex<br>1.6 D<br>1.6 HDi 110<br>2.0 16V<br>2.0 16V<br>2.0 HDi 110<br>2.0 HDi 135<br>2.0 HDi 90  | 55<br>65<br>50<br>80<br>80<br>66<br>80<br>100<br>103<br>79<br>100<br>66                        |  | 04.02<br>11.03<br>03.02<br>03.02<br>09.07<br>12.06<br>02.04<br>03.02<br>03.05<br>03.02<br>02.04<br>03.02                            | 09.03<br>04.08<br>01.05<br>04.08<br>04.08<br>04.08<br>04.08<br>04.08<br>04.08<br>04.08<br>04.08<br>04.08 | 24.5246-0190.3   | 330697   | 2  | L=190   |                                 |
|    | 1.4<br>1.4 16V<br>1.4 HDi<br>1.6 16V<br>1.6 BioFlex<br>1.6 D<br>1.6 HDi 110<br>2.0 16V<br>2.0 16V<br>2.0 HDi 110<br>2.0 HDi 135<br>2.0 HDi 90  | 55<br>65<br>50<br>80<br>80<br>66<br>80<br>100<br>103<br>79<br>100<br>66                        | ORGA 10933<br>ORGA 10933<br>ORGA 10933<br>ORGA 10933<br>ORGA 10933<br>ORGA 10933<br>ORGA 10933<br>ORGA 10933<br>ORGA 10933<br>ORGA 10933<br>ORGA 10933<br>ORGA 10933 | 04.02<br>11.03<br>03.02<br>03.02<br>09.07<br>12.06<br>02.04<br>03.02<br>03.05<br>03.02<br>02.04<br>03.02                            | 01.05  | 24.3727-0839.2   | 580839   | 2   | L=2115  |                                 |
| <b>PEUGEOT 308 Limousine (07-)</b>   |  |  |  |   |  |  |  |  |   |                                 |
|  | 1.6 16V<br>1.6 175 THP<br>2.0 HDi 135<br>2.0 HDi FAP 140   | 115<br>128<br>100<br>103   |  | 10.09<br>03.08<br>08.07<br>12.08  |  | 11.9571-9765.2<br>11.9571-9766.2<br>11.8116-0351.1<br>11.0101-5704.2<br>11.8171-0008.1 | 220663<br>220664<br>390538<br>260095<br>990049                                     | <br><br>2<br> | D=57, - Halter<br>D=57, - Halter<br>Haltefeder<br>Hülzensatz<br>Führungsbolzen    | ATE<br>ATE<br>ATE<br>ATE<br>ATE |
|  | 1.6 GTi  | 147  |  | 07.10   |  | 11.9601-9883.2<br>11.9601-9884.2<br>11.0101-5407.2<br>11.8171-0008.1<br>11.0441-6008.2 | 220917<br>220918<br>260011<br>990049<br>250038                                     |   | D=60, - Halter<br>D=60, - Halter<br>Hülzensatz<br>Führungsbolzen<br>Dichtungssatz | ATE<br>ATE<br>ATE<br>ATE<br>ATE |
|  | 2.0 HDi 163  | 120  |  | 04.12   |  | 11.0101-5704.2<br>11.8116-0356.1   | 260095<br>390586   | 2  | Hülzensatz<br>Haltefeder  | ATE<br>ATE                      |
|  | 1.4 16V<br>1.4 VTi<br>1.6 140 THP<br>1.6 150 THP<br>1.6 16V<br>1.6 175 THP<br>1.6 BioFlex<br>1.6 GTi<br>1.6 HDi 110<br>1.6 HDi 115<br>1.6 HDi 90<br>1.6 VTi<br>2.0 HDi 135<br>2.0 HDi 163<br>2.0 HDi FAP 140 | 72<br>70<br>103<br>110<br>115<br>128<br>80<br>147<br>80<br>84<br>66<br>88<br>100<br>120<br>103 |  | 12.09<br>08.07<br>08.07<br>08.07<br>10.09<br>03.08<br>04.08<br>07.10<br>08.07<br>03.13<br>08.07<br>08.07<br>08.07<br>04.12<br>12.08 |  | 24.5246-0190.3   | 330697   | 2  | L=190   |                                 |
| <b>PEUGEOT 308 SW (08-)</b>  |  |  |  |   |  |  |  |  |   |                                 |
|  | 1.6 16V<br>1.6 16V<br>1.6 16V<br>2.0 BioFlex<br>2.0 HDi<br>2.0 HDi<br>2.0 HDi  | 103<br>128<br>103<br>110<br>120  |  | 05.08<br>05.08<br>05.08<br>05.08<br>04.11<br>06.09  |  | 11.9571-9765.2<br>11.9571-9766.2<br>11.8116-0351.1<br>11.0101-5704.2<br>11.8171-0008.1 | 220663<br>220664<br>390538<br>260095<br>990049                                     | <br><br>2  | D=57, - Halter<br>D=57, - Halter<br>Haltefeder<br>Hülzensatz<br>Führungsbolzen    | ATE<br>ATE<br>ATE<br>ATE<br>ATE |
|  | 1.4 16V<br>1.4 16V<br>1.6 16V<br>1.6 16V<br>1.6 16V<br>1.6 16V<br>1.6 Bioflex<br>1.6 HDi   | 70<br>72<br>103<br>128<br>82   |  | 05.08<br>12.09<br>05.08<br>05.08<br>05.08<br>05.08<br>03.09<br>05.08  |  | 24.5246-0190.3   | 330697   | 2  | L=190   |                                 |

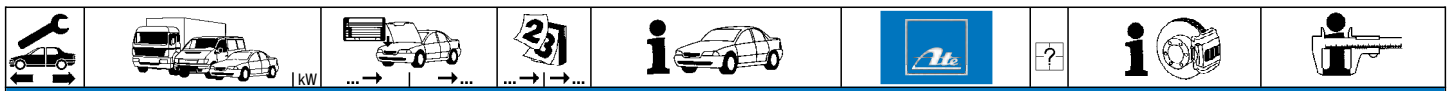

| PEUGEOT 308 SW (08-)      |                 |     |  |       |   |                                   |        |   |                          |                   |     |
|---------------------------|-----------------|-----|--|-------|---|-----------------------------------|--------|---|--------------------------|-------------------|-----|
|                           | 1.6 HDi         | 80  |  | 05.08 |   | 24.5246-0190.3                    | 330697 | 2 |                          | L=190             |     |
|                           | 1.6 HDi 115     | 84  |  | 03.13 |   |                                   |        |   |                          |                   |     |
|                           | 2.0 BioFlex     | 103 |  | 05.08 |   |                                   |        |   |                          |                   |     |
|                           | 2.0 HDi         |     |  | 05.08 |   |                                   |        |   |                          |                   |     |
|                           | 2.0 HDi         | 110 |  | 04.11 |   |                                   |        |   |                          |                   |     |
|                           | 2.0 HDi         | 120 |  | 06.09 |   |                                   |        |   |                          |                   |     |
| PEUGEOT 308 CC (09-)      |                 |     |  |       |   |                                   |        |   |                          |                   |     |
|                           | 1.6 16V         | 103 |  | 06.09 |   | 11.8116-0356.1                    | 390586 | 2 |                          | Haltefeder        | ATE |
|                           | 1.6 16V         | 115 |  | 09.09 |   | 11.0101-5704.2                    | 260095 |   |                          | Hülensatz         | ATE |
|                           | 1.6 THP         | 110 |  | 06.09 |   | 11.8171-0008.1                    | 990049 | 2 |                          | Führungsbolzen    | ATE |
|                           | 2.0 HDi         | 100 |  | 04.09 |   |                                   |        |   |                          |                   |     |
|                           | 2.0 HDi         | 120 |  | 06.09 |   |                                   |        |   |                          |                   |     |
|                           | 2.0 HDi FAP 140 | 103 |  | 03.09 |   |                                   |        |   |                          |                   |     |
|                           | 1.6 THP         | 147 |  | 10.10 |   | 11.9601-9883.2                    | 220917 |   | <input type="checkbox"/> | D=60, - Halter    | ATE |
|                           |                 |     |  |       |   | 11.9601-9884.2                    | 220918 |   | <input type="checkbox"/> | D=60, - Halter    | ATE |
|                           |                 |     |  |       |   | 11.0441-6008.2                    | 250038 |   |                          | Dichtungssatz     | ATE |
|                           |                 |     |  |       |   | 11.0101-5407.2                    | 260011 |   |                          | Hülensatz         | ATE |
|                           |                 |     |  |       |   | 11.8171-0008.1                    | 990049 | 2 |                          | Führungsbolzen    | ATE |
|                           | 1.6 16V         | 103 |  | 06.09 |   | 24.5246-0190.3                    | 330697 | 2 |                          | L=190             |     |
|                           | 1.6 16V         | 115 |  | 09.09 |   |                                   |        |   |                          |                   |     |
|                           | 1.6 HDi         | 82  |  | 03.09 |   |                                   |        |   |                          |                   |     |
|                           | 1.6 HDi 115     | 84  |  | 03.13 |   |                                   |        |   |                          |                   |     |
|                           | 1.6 THP         | 110 |  | 06.09 |   |                                   |        |   |                          |                   |     |
|                           | 1.6 THP         | 147 |  | 10.10 |   |                                   |        |   |                          |                   |     |
|                           | 1.6 VTi         | 88  |  | 03.09 |   |                                   |        |   |                          |                   |     |
|                           | 2.0 HDi         | 100 |  | 04.09 |   |                                   |        |   |                          |                   |     |
|                           | 2.0 HDi         | 120 |  | 06.09 |   |                                   |        |   |                          |                   |     |
|                           | 2.0 HDi FAP 140 | 103 |  | 03.09 |   |                                   |        |   |                          |                   |     |
| PEUGEOT 308 II (T9) (13-) |                 |     |  |       |   |                                   |        |   |                          |                   |     |
|                           | 1.2 VTi 82      | 60  |  | 09.13 | + Bremsscheibendurchm. 304 mm <sup>1)</sup> | 11.8171-0008.1                    | 990049 |   |                          | Führungsbolzen    | ATE |
|                           | 1.6 HDi 115     | 85  |  | 09.13 | + Bremsscheibendurchm. 304 mm <sup>1)</sup> | 11.0101-5407.2                    | 260011 |   |                          | Hülensatz         | ATE |
|                           | 1.6 HDi 92      | 68  |  | 09.13 | + Bremsscheibendurchm. 304 mm <sup>1)</sup> |                                   |        |   |                          |                   |     |
|                           | 1.6 THP 125     | 92  |  | 09.13 | + Bremsscheibendurchm. 304 mm <sup>1)</sup> |                                   |        |   |                          |                   |     |
|                           | 1.6 THP 155     | 115 |  | 09.13 | + Bremsscheibendurchm. 304 mm <sup>1)</sup> |                                   |        |   |                          |                   |     |
|                           | 1.2 VTi 82      | 60  |  | 09.13 | - elektrische Feststellbremse <sup>2)</sup> | 11.8171-0008.1                    | 990049 |   |                          | Führungsbolzen    | ATE |
|                           | 1.6 HDi 115     | 85  |  | 09.13 | - elektrische Feststellbremse <sup>2)</sup> | 11.8116-0340.1                    | 390595 | 2 |                          | Haltefeder        | ATE |
|                           | 1.6 HDi 92      | 68  |  | 09.13 | - elektrische Feststellbremse <sup>2)</sup> |                                   |        |   |                          |                   |     |
|                           | 1.6 THP 125     | 92  |  | 09.13 | - elektrische Feststellbremse <sup>2)</sup> |                                   |        |   |                          |                   |     |
|                           | 1.6 THP 155     | 115 |  | 09.13 | - elektrische Feststellbremse <sup>2)</sup> |                                   |        |   |                          |                   |     |
| PEUGEOT 309 (85-93)       |                 |     |  |       |   |                                   |        |   |                          |                   |     |
|                           | 1.1             |     |  | 09.85 | 12.93                                       | 03.2119-3389.3                    | 010057 |   |                          | THz 19,05         | ATE |
|                           | 1.3             | 47  |  | 09.85 | 07.89                                       | 03.3517-5100.1                    | 390326 |   |                          | Verschlußschraube | ATE |
|                           | 1.4             |     |  | 03.89 | 12.93                                       |                                   |        |   |                          |                   |     |
|                           | 1.5             |     |  | 06.87 | 12.89                                       |                                   |        |   |                          |                   |     |
|                           | 1.6             |     |  | 09.85 | 12.93                                       |                                   |        |   |                          |                   |     |
|                           | 1.8 D           | 44  |  | 07.89 | 12.93                                       |                                   |        |   |                          |                   |     |
|                           | 1.8 TD          | 57  |  | 07.89 | 12.93                                       |                                   |        |   |                          |                   |     |
|                           | 1.9             | 75  |  | 10.85 | 07.89                                       |                                   |        |   |                          |                   |     |
|                           | 1.9 D           |     |  | 06.86 | 12.93                                       |                                   |        |   |                          |                   |     |
|                           | 1.9 GTi         | 88  |  | 09.88 | 12.93                                       | 03.2120-2031.3                    | 010106 |   |                          | THz 20,64         | ATE |
|                           | 1.9 GTi         | 94  |  | 10.86 | 07.89                                       |                                   |        |   |                          |                   |     |
|                           | 1.9 GTi         | 96  |  | 10.86 | 12.93                                       |                                   |        |   |                          |                   |     |
|                           | 1.9 GTi 16V     |     |  | 08.89 | 12.93                                       |                                   |        |   |                          |                   |     |
|                           | 1.9 i           | 72  |  | 03.86 | 12.93                                       |                                   |        |   |                          |                   |     |
|                           | 1.9 i           | 80  |  | 07.88 | 12.93                                       |                                   |        |   |                          |                   |     |
|                           | 1.1             |     |  | 09.85 | 12.93                                       | 24.3481-1609.7                    | 220197 |   | <input type="checkbox"/> | D=48, + Halter    | LUC |
|                           | 1.3             | 47  |  | 09.85 | 07.89                                       | 24.3481-1610.7                    | 220198 |   | <input type="checkbox"/> | D=48, + Halter    | LUC |
|                           | 1.4             |     |  | 03.89 | 12.93                                       |                                   |        |   |                          |                   |     |
|                           | 1.5             |     |  | 06.87 | 12.89                                       |                                   |        |   |                          |                   |     |
|                           | 1.6             |     |  | 09.88 | 12.93                                       | + Automatikgetriebe <sup>3)</sup> |        |   |                          |                   |     |
|                           | 1.6             |     |  | 09.85 | 12.93                                       | + Schaltgetriebe <sup>4)</sup>    |        |   |                          |                   |     |
|                           | 1.8 D           | 44  |  | 07.89 | 12.93                                       |                                   |        |   |                          |                   |     |
|                           | 1.8 TD          | 57  |  | 07.89 | 12.93                                       |                                   |        |   |                          |                   |     |
|                           | 1.9             | 75  |  | 10.85 | 07.89                                       |                                   |        |   |                          |                   |     |
|                           | 1.9 D           |     |  | 06.86 | 12.92                                       |                                   |        |   |                          |                   |     |
|                           | 1.9 i           | 72  |  | 03.86 | 09.88                                       |                                   |        |   |                          |                   |     |
|                           | 1.9 i           | 80  |  | 07.88 | 12.93                                       |                                   |        |   |                          |                   |     |
|                           | 1.6 GTi         | 76  |  | 11.85 | 09.88                                       | 24.3481-1615.5                    | 240031 |   | <input type="checkbox"/> | D=48, - Halter    | LUC |
|                           |                 |     |  |       |   | 24.3481-1616.5                    | 240032 |   | <input type="checkbox"/> | D=48, - Halter    | LUC |
|                           |                 |     |  |       |   | 24.0101-4806.2                    | 260052 |   | <input type="checkbox"/> | Einbausatz        | LUC |

<sup>1)</sup> + brake disc diameter 304 mm / + disco fr.diam. 304mm / + disques fr.diam. 304mm / + disco fr.diam. 304mm

<sup>2)</sup> - electric parking brake / - freno a mano elettrico / - frein à main électrique / - freno de mano eléctrico

<sup>3)</sup> + autom.transmission / + scatola cambio automatico / + transmission automatique / + cambio automático

<sup>4)</sup> + manual transmission / + scatola cambio velocità / + transmission mécanique / + cambio de velocidad



| PEUGEOT 309 (85-93) |             | kW |  | ...   |       | ... |  | ...            |        | ... |                                  | ...            |     | ... |  | ... |  |
|---------------------|-------------|----|--|-------|-------|-----|--|----------------|--------|-----|----------------------------------|----------------|-----|-----|--|-----|--|
|                     | 1.9 GTI     | 88 |  | 09.88 | 12.93 | + ⊕ |  | 24.3481-1615.5 | 240031 |     |                                  | D=48, - Halter | LUC |     |  |     |  |
|                     | 1.9 GTi     | 94 |  | 10.86 | 07.89 | + ⊕ |  | 24.3481-1616.5 | 240032 |     |                                  | D=48, - Halter | LUC |     |  |     |  |
|                     | 1.9 GTi     | 96 |  | 10.86 | 12.93 | - ⊖ |  | 24.0101-4806.2 | 260052 |     |                                  | Einbausatz     | LUC |     |  |     |  |
|                     | 1.9 GTi 16V |    |  | 08.89 | 12.93 |     |  |                |        |     |                                  |                |     |     |  |     |  |
|                     | 1.1         |    |  | 09.85 | 08.89 |     |  | 24.5112-0327.3 | 330417 | 2   |                                  | L=325          |     |     |  |     |  |
|                     | 1.3         | 47 |  | 09.85 | 07.89 |     |  |                |        |     |                                  |                |     |     |  |     |  |
|                     | 1.4         |    |  | 03.89 | 08.89 |     |  |                |        |     |                                  |                |     |     |  |     |  |
|                     | 1.5         |    |  | 06.87 | 08.89 |     |  |                |        |     |                                  |                |     |     |  |     |  |
|                     | 1.6         |    |  | 09.85 | 08.89 |     |  |                |        |     |                                  |                |     |     |  |     |  |
|                     | 1.8 D       | 44 |  | 07.89 | 08.89 |     |  |                |        |     |                                  |                |     |     |  |     |  |
|                     | 1.8 TD      | 57 |  | 07.89 | 08.89 |     |  |                |        |     |                                  |                |     |     |  |     |  |
|                     | 1.9         | 75 |  | 10.85 | 07.89 |     |  |                |        |     |                                  |                |     |     |  |     |  |
|                     | 1.9 D       |    |  | 06.86 | 08.89 |     |  |                |        |     |                                  |                |     |     |  |     |  |
|                     | 1.9 i       | 72 |  | 03.86 | 08.89 |     |  |                |        |     |                                  |                |     |     |  |     |  |
|                     | 1.9 i       | 80 |  | 07.88 | 08.89 |     |  |                |        |     |                                  |                |     |     |  |     |  |
|                     | 1.1         |    |  | 09.89 | 12.93 |     |  | 24.5112-0327.3 | 330417 | 2   | Länge beachten <sup>1)</sup>     | L=325          |     |     |  |     |  |
|                     | 1.4         |    |  | 09.89 | 12.93 |     |  | 24.5112-0405.3 | 330428 | 2   | Länge beachten <sup>1)</sup>     | L=405          |     |     |  |     |  |
|                     | 1.5         |    |  | 09.89 | 12.89 |     |  |                |        |     |                                  |                |     |     |  |     |  |
|                     | 1.6         |    |  | 09.89 | 12.93 |     |  |                |        |     |                                  |                |     |     |  |     |  |
|                     | 1.8 D       | 44 |  | 09.89 | 12.93 |     |  |                |        |     |                                  |                |     |     |  |     |  |
|                     | 1.8 TD      | 57 |  | 09.89 | 12.93 |     |  |                |        |     |                                  |                |     |     |  |     |  |
|                     | 1.9 D       |    |  | 09.89 | 12.93 |     |  |                |        |     |                                  |                |     |     |  |     |  |
|                     | 1.9 i       | 72 |  | 09.89 | 12.93 |     |  |                |        |     |                                  |                |     |     |  |     |  |
|                     | 1.9 i       | 80 |  | 09.89 | 12.93 |     |  |                |        |     |                                  |                |     |     |  |     |  |
|                     | 1.9 GTi     | 88 |  | 09.88 | 12.93 | + ⊕ |  | 24.5112-0405.3 | 330428 | 2   |                                  | L=405          |     |     |  |     |  |
|                     | 1.9 GTi     | 94 |  | 10.86 | 07.89 | + ⊕ |  |                |        |     |                                  |                |     |     |  |     |  |
|                     | 1.9 GTi     | 96 |  | 10.86 | 12.93 | - ⊖ |  |                |        |     |                                  |                |     |     |  |     |  |
|                     | 1.9 GTi 16V |    |  | 08.89 | 12.93 |     |  |                |        |     |                                  |                |     |     |  |     |  |
|                     | 1.9 i       | 80 |  | 07.88 | 08.89 |     |  |                |        |     |                                  |                |     |     |  |     |  |
|                     | 1.1         |    |  | 09.85 | 08.89 |     |  | 24.5112-0230.3 | 330508 |     |                                  | L=230          |     |     |  |     |  |
|                     | 1.3         | 47 |  | 09.85 | 07.89 |     |  | 24.5228-0255.3 | 330409 |     |                                  | L=255          |     |     |  |     |  |
|                     | 1.4         |    |  | 03.89 | 08.89 |     |  |                |        |     |                                  |                |     |     |  |     |  |
|                     | 1.5         |    |  | 06.87 | 08.89 |     |  |                |        |     |                                  |                |     |     |  |     |  |
|                     | 1.6         |    |  | 09.85 | 08.89 |     |  |                |        |     |                                  |                |     |     |  |     |  |
|                     | 1.8 D       | 44 |  | 07.89 | 08.89 |     |  |                |        |     |                                  |                |     |     |  |     |  |
|                     | 1.8 TD      | 57 |  | 07.89 | 08.89 |     |  |                |        |     |                                  |                |     |     |  |     |  |
|                     | 1.9         | 75 |  | 09.85 | 07.89 |     |  |                |        |     |                                  |                |     |     |  |     |  |
|                     | 1.9 D       |    |  | 06.86 | 08.89 |     |  |                |        |     |                                  |                |     |     |  |     |  |
|                     | 1.9 i       | 72 |  | 03.86 | 08.89 |     |  |                |        |     |                                  |                |     |     |  |     |  |
|                     | 1.9 i       | 80 |  | 07.88 | 08.89 |     |  |                |        |     |                                  |                |     |     |  |     |  |
|                     | 1.1         |    |  | 09.89 | 12.93 |     |  | 24.5228-0255.3 | 330409 | 2   |                                  | L=255          |     |     |  |     |  |
|                     | 1.4         |    |  | 09.89 | 12.93 |     |  |                |        |     |                                  |                |     |     |  |     |  |
|                     | 1.5         |    |  | 09.89 | 12.89 |     |  |                |        |     |                                  |                |     |     |  |     |  |
|                     | 1.6         |    |  | 09.89 | 12.93 |     |  |                |        |     |                                  |                |     |     |  |     |  |
|                     | 1.8 D       | 44 |  | 09.89 | 12.93 |     |  |                |        |     |                                  |                |     |     |  |     |  |
|                     | 1.8 TD      | 57 |  | 09.89 | 12.93 |     |  |                |        |     |                                  |                |     |     |  |     |  |
|                     | 1.9 D       |    |  | 09.89 | 12.93 |     |  |                |        |     |                                  |                |     |     |  |     |  |
|                     | 1.9 i       | 72 |  | 09.89 | 12.93 |     |  |                |        |     |                                  |                |     |     |  |     |  |
|                     | 1.9 i       | 80 |  | 09.89 | 12.93 |     |  |                |        |     |                                  |                |     |     |  |     |  |
|                     | 1.9 GTi     | 88 |  | 09.88 | 12.93 | + ⊕ |  | 24.5228-0255.3 | 330409 |     |                                  | L=255          |     |     |  |     |  |
|                     | 1.9 GTi     | 94 |  | 10.86 | 07.89 | + ⊕ |  | 24.5112-0155.3 | 330507 |     |                                  | L=155          |     |     |  |     |  |
|                     | 1.9 GTi     | 96 |  | 10.86 | 12.93 | - ⊖ |  |                |        |     |                                  |                |     |     |  |     |  |
|                     | 1.9 GTi 16V |    |  | 08.89 | 12.93 |     |  |                |        |     |                                  |                |     |     |  |     |  |
|                     | 1.1         |    |  | 09.85 | 08.89 |     |  | 24.3217-1116.3 | 020178 |     |                                  | Rz 17,46       | BDX |     |  |     |  |
|                     | 1.3         | 47 |  | 09.85 | 07.89 |     |  | 24.3217-1117.3 | 020179 |     |                                  | Rz 17,46       | BDX |     |  |     |  |
|                     | 1.5         |    |  | 06.87 | 08.89 |     |  |                |        |     |                                  |                |     |     |  |     |  |
|                     | 1.1         |    |  | 09.89 | 12.93 |     |  | 24.3220-1609.3 | 020236 |     |                                  | RzR 20,64      | BDX |     |  |     |  |
|                     | 1.4         |    |  | 03.89 | 12.93 |     |  | 24.3220-1610.3 | 020237 |     |                                  | RzR 20,64      | BDX |     |  |     |  |
|                     | 1.5         |    |  | 09.89 | 12.89 |     |  | 24.3220-1607.3 | 020234 |     |                                  | RzR 20,64      | LUC |     |  |     |  |
|                     |             |    |  |       |       |     |  | 24.3220-1608.3 | 020235 |     |                                  | RzR 20,64      | LUC |     |  |     |  |
|                     | 1.6         |    |  | 09.85 | 08.89 |     |  | 24.3222-1709.3 | 020111 |     |                                  | Rz 22,20       | BDX |     |  |     |  |
|                     | 1.9         | 72 |  | 03.87 | 08.89 |     |  | 24.3222-1710.3 | 020112 |     |                                  | Rz 22,20       | BDX |     |  |     |  |
|                     | 1.9         | 75 |  | 10.85 | 07.89 |     |  | 24.3222-1106.3 | 020261 |     |                                  | Rz 22,20       | LUC |     |  |     |  |
|                     | 1.9 D       |    |  | 06.86 | 08.89 |     |  | 24.3222-1107.3 | 020262 |     |                                  | Rz 22,20       | LUC |     |  |     |  |
|                     | 1.9 i       | 80 |  | 07.88 | 08.89 |     |  |                |        |     |                                  |                |     |     |  |     |  |
|                     | 1.6         |    |  | 09.89 | 12.93 |     |  | 24.3220-1607.3 | 020234 |     |                                  | RzR 20,64      | LUC |     |  |     |  |
|                     | 1.9         | 72 |  | 09.89 | 12.93 |     |  | 24.3220-1608.3 | 020235 |     |                                  | RzR 20,64      | LUC |     |  |     |  |
|                     | 1.9 D       |    |  | 09.89 | 12.93 |     |  |                |        |     |                                  |                |     |     |  |     |  |
|                     | 1.9 i       | 80 |  | 09.89 | 12.93 |     |  |                |        |     |                                  |                |     |     |  |     |  |
|                     | 1.8 D       | 44 |  | 07.89 | 08.89 |     |  | 24.3222-1709.3 | 020111 |     |                                  | Rz 22,20       | BDX |     |  |     |  |
|                     | 1.8 TD      | 57 |  | 07.89 | 08.89 |     |  | 24.3222-1710.3 | 020112 |     |                                  | Rz 22,20       | BDX |     |  |     |  |
|                     | 1.8 D       | 44 |  | 09.89 | 12.93 |     |  | 24.3220-1619.3 | 020246 |     |                                  | Rz 20,64       | LUC |     |  |     |  |
|                     | 1.8 TD      | 57 |  | 09.89 | 12.93 |     |  |                |        |     |                                  |                |     |     |  |     |  |
|                     | 1.1         |    |  | 09.85 | 12.93 |     |  | 24.3727-0806.2 | 580806 |     | + HA-Trommelbremse <sup>2)</sup> | L=1426         |     |     |  |     |  |
|                     | 1.3         | 47 |  | 09.85 | 07.89 |     |  | 24.3727-0805.2 | 580805 |     | + HA-Trommelbremse <sup>2)</sup> | L=1445         |     |     |  |     |  |
|                     | 1.4         |    |  | 03.89 | 12.93 |     |  |                |        |     |                                  |                |     |     |  |     |  |
|                     | 1.5         |    |  | 06.87 | 12.89 |     |  |                |        |     |                                  |                |     |     |  |     |  |
|                     | 1.6         |    |  | 09.85 | 12.93 |     |  |                |        |     |                                  |                |     |     |  |     |  |
|                     | 1.8 D       | 44 |  | 07.89 | 12.93 |     |  |                |        |     |                                  |                |     |     |  |     |  |
|                     | 1.8 TD      | 57 |  | 07.89 | 12.93 |     |  |                |        |     |                                  |                |     |     |  |     |  |
|                     | 1.9         | 75 |  | 09.85 | 07.89 |     |  |                |        |     |                                  |                |     |     |  |     |  |
|                     | 1.9 D       |    |  | 06.86 | 12.93 |     |  |                |        |     |                                  |                |     |     |  |     |  |
|                     | 1.9 i       | 72 |  | 03.86 | 12.93 |     |  |                |        |     |                                  |                |     |     |  |     |  |
|                     | 1.9 i       | 80 |  | 07.88 | 12.93 |     |  |                |        |     |                                  |                |     |     |  |     |  |

<sup>1)</sup> notice length / attenzione lunghezza / faire attention longueur / atención largo  
<sup>2)</sup> + RA drum brake / + P freno a tamburo / + frein à tambour essieu AR / + ET-tambores de freno



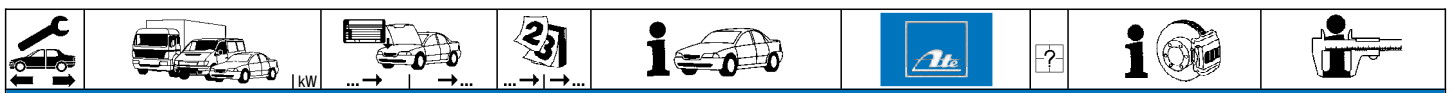

**PEUGEOT 309 (85-93)**

|         |           |              |       |       |                              |  |                |        |          |        |
|---------|-----------|--------------|-------|-------|------------------------------|--|----------------|--------|----------|--------|
|         | 1.1       | S 2815520    |       | 08.90 |                              | 24.6042-1701.3                           | 320149         |        | BRE 2/20 |        |
|         | 1.3       | 47 S 2815520 |       | 07.89 |                              |  |                |        |          |        |
|         | 1.4       |              |       | 03.89 | 08.90                        |  |                |        |          |        |
|         | 1.5       | S 2815520    |       | 12.89 |                              |  |                |        |          |        |
|         | 1.6       | S 2815520    |       | 08.90 |                              |  |                |        |          |        |
|         | 1.8 D     | 44           |       | 07.89 | 08.90                        | - ABS                                    |                |        |          |        |
|         | 1.8 TD    | 57           |       | 07.89 | 08.90                        | - ABS                                    |                |        |          |        |
|         | 1.9       | 72 S 2815520 |       | 07.88 | 08.90                        | - ABS                                    |                |        |          |        |
|         | 1.9       | 75 S 2815520 |       | 07.89 | 08.90                        | - ABS                                    |                |        |          |        |
|         | 1.9       | 80 S 2815520 |       | 08.90 | 08.90                        | - ABS                                    |                |        |          |        |
| 1.9 D   | S 2815520 |              | 08.90 |       |                              |  |                |        |          |        |
| 1.9 GTi | 88        | S 2851976    | 09.88 |       |                              | 24.6043-1701.3                           | 320150         |        | BRE 3/15 |        |
| 1.9 GTi | 94        | S 2851976    | 10.86 |       |                              |  |                |        |          |        |
| 1.9 GTi | 96        | S 2851976    | 10.86 |       |                              |  |                |        |          |        |
| 1.9 GTi | 88        | S 2851977    |       | 12.93 |                              | 24.6042-1702.3                           | 320154         |        | BRE 2/25 |        |
| 1.9 GTi | 94        | S 2851977    |       | 07.89 |                              |  |                |        |          |        |
| 1.9 GTi | 96        | S 2851977    |       | 12.93 |                              |  |                |        |          |        |
|         | 1.1       |              |       | 09.85 | 07.89                        | + MA-Getriebe <sup>1)</sup>              | 24.3728-0807.2 | 590807 |          | L=1262 |
|         | 1.4       |              |       | 03.89 | 07.89                        | + MA-Getriebe <sup>1)</sup>              |                |        |          |        |
|         | 1.1       |              |       | 08.89 | 12.93                        | + MA-Getriebe <sup>1)</sup>              | 24.3728-0810.2 | 590810 |          | L=625  |
|         | 1.4       | 49           |       | 08.89 | 12.93                        | + MA-Getriebe <sup>1)</sup>              |                |        |          |        |
|         | 1.4 i     | 55           |       | 08.89 | 12.93                        | + MA-Getriebe <sup>1)</sup>              |                |        |          |        |
|         | 1.6       |              |       | 08.89 | 12.93                        | + MA-Getriebe <sup>1)</sup>              |                |        |          |        |
|         | 1.8 D     | 44           |       | 08.89 | 12.93                        | + MA-Getriebe <sup>1)</sup>              |                |        |          |        |
|         | 1.8 TD    | 57           |       | 08.89 | 12.93                        | + MA-Getriebe <sup>1)</sup>              |                |        |          |        |
|         | 1.9       |              |       | 08.89 | 12.93                        | + MA-Getriebe <sup>1)</sup>              |                |        |          |        |
|         | 1.4 i     | 62           |       | 03.89 | 12.93                        | + MA-Getriebe <sup>1)</sup>              | 24.3728-0811.2 | 590811 |          | L=1271 |
|         | 1.6       |              |       | 09.85 | 07.88                        | + XU-Motor/ + BE1-Getriebe <sup>2)</sup> | 24.3728-0803.2 | 590803 |          | L=705  |
|         | 1.9       |              |       | 09.85 | 07.88                        | + XU-Motor/ + BE1-Getriebe <sup>2)</sup> |                |        |          |        |
|         | 1.6       |              |       | 08.88 | 12.93                        |  | 24.3728-0806.2 | 590806 |          | L=710  |
|         | 1.9       |              |       | 08.88 | 12.93                        |  |                |        |          |        |
|         | 1.5       |              |       | 06.87 | 12.89                        | + BE3-Getriebe <sup>3)</sup>             | 24.3728-0813.2 | 590813 |          | L=660  |
| 1.6     |           |              | 09.85 | 12.93 | + BE3-Getriebe <sup>3)</sup> |  |                |        |          |        |
| 1.8 TD  | 57        |              | 07.89 | 12.93 | + BE3-Getriebe <sup>3)</sup> |  |                |        |          |        |
| 1.9     |           |              | 09.85 | 12.93 | + BE3-Getriebe <sup>3)</sup> |  |                |        |          |        |

**PEUGEOT 405 (93-95)**

|            |            |            |       |       |       |       |                |                |        |                              |           |
|------------|------------|------------|-------|-------|-------|-------|----------------|----------------|--------|------------------------------|-----------|
|            | 1.4 i      | 55         |       | 09.92 | 10.95 | - ABS | 24.2120-1701.3 | 010427         |        | THz 20,64                    |           |
|            | 1.6        | 65         |       | 09.92 | 10.95 | - ABS |                |                |        |                              |           |
|            | 1.8 i      | 74         |       | 09.92 | 10.95 | - ABS |                |                |        |                              |           |
|            | 1.4 i      | 55         |       | 09.92 | 10.95 | + ABS | 24.2122-1704.3 | 010423         |        | THz 22,20                    |           |
|            | 1.6        | 65         |       | 09.92 | 10.95 | + ABS |                |                |        |                              |           |
|            | 1.8 i      | 74         |       | 09.92 | 10.95 | + ABS |                |                |        |                              |           |
|            | 1.9 D      | 93         |       | 09.92 | 12.93 | + ABS |                |                |        |                              |           |
|            | 1.9 TD     | 66         |       | 09.92 | 10.95 | + ABS |                |                |        |                              |           |
| 2.0 16V    | 144        |            | 09.92 | 10.95 | + ABS |       |                |                |        |                              |           |
| 2.0 i      | 89         |            | 09.92 | 10.95 | + ABS |       |                |                |        |                              |           |
|            | 1.8 i      | 74         |       | 09.92 | 10.95 | - ABS | 24.3481-1707.5 | 240073         |        | D=48, - Halter               | LUC       |
|            | 1.9 D      | 66         |       | 09.92 | 10.95 | - ABS | 24.3481-1708.5 | 240074         |        | D=48, - Halter               | LUC       |
|            | 1.9 TD     | 66         |       | 09.92 | 10.95 | - ABS | 24.0101-3601.2 | 260044         |        | Einbausatz                   | LUC       |
|            | 1.8 i      | 74         |       | 09.92 | 10.95 | + ABS | 24.0101-3601.2 | 260044         |        |                              | LUC       |
|            | 1.9        | 93         |       | 09.92 | 12.93 |       |                |                |        |                              |           |
|            | 1.9 D      | 66         |       | 09.92 | 10.95 | + ABS |                |                |        |                              |           |
|            | 1.9 TD     | 66         |       | 09.92 | 10.95 | + ABS |                |                |        |                              |           |
|            | 2.0 16V    | 144        |       | 09.92 | 10.95 |       |                |                |        |                              |           |
| 2.0 i      | 89         |            | 09.92 | 10.95 |       |       |                |                |        |                              |           |
| 2.0 i X4   | 89         |            | 09.92 | 10.95 |       |       |                |                |        |                              |           |
|            | 1.4 i      | 55         |       | 09.92 | 10.95 |       | 24.5118-0420.3 | 330444         | 2      |                              | L=420     |
|            | 1.6        | 65         |       | 09.92 | 10.95 |       |                |                |        |                              |           |
|            | 1.8 i      | 74         |       | 09.92 | 10.95 |       |                |                |        |                              |           |
|            | 1.9        | 93         |       | 09.92 | 12.93 |       |                |                |        |                              |           |
|            | 1.9 D      | 66         |       | 09.92 | 10.95 |       |                |                |        |                              |           |
|            | 1.9 TD     | 66         |       | 09.92 | 10.95 |       |                |                |        |                              |           |
|            | 2.0 16V    | 144        |       | 09.92 | 10.95 |       |                |                |        |                              |           |
|            | 2.0 i      | 89         |       | 09.92 | 10.95 |       |                |                |        |                              |           |
|            | 1.9        | 93         |       | 09.92 | 12.93 |       | 24.3384-1605.5 | 240295         |        | D=38, - Halter               | LUC       |
|            | 1.9 TD     | 66         |       | 09.92 | 10.95 | + ABS | 24.3384-1606.5 | 240296         |        | D=38, - Halter               | LUC       |
|            | 2.0 16V    | 144        |       | 09.92 | 10.95 |       |                |                |        |                              |           |
|            | 2.0 i      | 89         |       | 09.92 | 10.95 |       |                |                |        |                              |           |
|            |            | 1.4 i      | 55    |       | 09.92 | 10.95 |                | 24.5229-0181.3 | 330533 | 2                            |           |
| 1.6        |            | 65         |       | 09.92 | 10.95 |       |                |                |        |                              |           |
| 1.8 i      |            | 74         |       | 09.92 | 10.95 |       |                |                |        |                              |           |
| 1.9 D      |            | 66         |       | 09.92 | 10.95 |       |                |                |        |                              |           |
| 1.9        |            | 93         |       | 09.92 | 12.93 |       | 24.5229-0181.3 | 330533         | 2      | Länge beachten <sup>4)</sup> | L=180     |
| 1.9 TD     |            | 66         |       | 09.92 | 10.95 |       | 24.5111-0235.3 | 330477         | 2      | Länge beachten <sup>4)</sup> | L=234     |
| 2.0 16V    |            | 144        |       | 09.92 | 10.95 |       |                |                |        |                              |           |
| 2.0 i      |            | 89         |       | 09.92 | 10.95 |       |                |                |        |                              |           |
|            | 2.0 i X4   | 89         |       | 09.92 | 10.95 | - ABS | 24.5111-0235.3 | 330477         | 2      |                              | L=234     |
|            | 2.0 T16 X4 | 144        |       | 07.93 | 10.95 | - ABS |                |                |        |                              |           |
|            |            | 1.4 i Lim. | 55    |       | 09.92 | 10.95 | - ABS          | 24.3220-1611.3 | 020238 |                              | RzR 20,64 |
| 1.6 Lim.   |            | 65         |       | 09.92 | 10.95 | - ABS | 24.3220-1612.3 | 020239         |        | RzR 20,64                    | BDX       |
| 1.8 i Lim. |            | 74         |       | 09.92 | 10.95 | - ABS |                |                |        |                              |           |
| 1.9 D Lim. |            |            |       | 09.92 | 10.95 | - ABS |                |                |        |                              |           |

1) + MA transmission / + scatola cambio MA / + boîte de vitesse MA / + cambio MA  
2) + XU engine/ + BE1 transmission / + motore XU/ + scatola cambio BE1 / + moteur XU/ + boîte vitesse BE1 / + motor de XU/ + cambio BE1  
3) + BE3 transmission / + scatola cambio BE3 / + boîte de vitesse BE3 / + cambio BE3  
4) notice length / attenzione lunghezza / faire attention longueur / atención largo



| PEUGEOT 405 (93-95)                  |                 | kW         |            | ...        |       | ...            |                         | ...            |                | ...    |                          | ...                      |               | ... |  | ... |  | ... |  |
|--------------------------------------|-----------------|------------|------------|------------|-------|----------------|-------------------------|----------------|----------------|--------|--------------------------|--------------------------|---------------|-----|--|-----|--|-----|--|
|                                      | 1.4 i Kombi     | 55         | S 71211990 | S 71211989 | 09.92 | 10.95          | - ABS<br>+ ABS (Bendix) | 24.3220-0905.3 | 020207         |        |                          | Rz 20,64                 | LUC           |     |  |     |  |     |  |
|                                      | 1.4 i Kombi     | 55         |            |            | 09.92 | 10.95          | + ABS (Bendix)          |                |                |        |                          |                          |               |     |  |     |  |     |  |
|                                      | 1.4 i Lim.      | 55         |            |            | 09.92 | 10.95          |                         |                |                |        |                          |                          |               |     |  |     |  |     |  |
|                                      | 1.6 Kombi       | 65         |            | S 71211989 | 09.92 | 10.95          | - ABS<br>+ ABS (Bendix) |                |                |        |                          |                          |               |     |  |     |  |     |  |
|                                      | 1.6 Kombi       | 65         | S 71211990 |            | 09.92 | 10.95          | + ABS (Bendix)          |                |                |        |                          |                          |               |     |  |     |  |     |  |
|                                      | 1.6 Lim.        | 65         |            |            | 09.92 | 10.95          | + ABS (Bendix)          |                |                |        |                          |                          |               |     |  |     |  |     |  |
|                                      | 1.8 i Kombi     | 74         |            | S 71211989 | 09.92 | 10.95          | - ABS<br>+ ABS (Bendix) |                |                |        |                          |                          |               |     |  |     |  |     |  |
|                                      | 1.8 i Kombi     | 74         | S 71211990 |            | 09.92 | 10.95          | + ABS (Bendix)          |                |                |        |                          |                          |               |     |  |     |  |     |  |
|                                      | 1.8 i Lim.      | 74         |            |            | 09.92 | 10.95          | + ABS (Bendix)          |                |                |        |                          |                          |               |     |  |     |  |     |  |
|                                      | 1.9 D Kombi     |            |            | S 71211989 | 09.92 | 10.95          | - ABS<br>+ ABS (Bendix) |                |                |        |                          |                          |               |     |  |     |  |     |  |
| 1.9 D Kombi                          |                 | S 71211990 |            | 09.92      | 10.95 | + ABS (Bendix) |                         |                |                |        |                          |                          |               |     |  |     |  |     |  |
| 1.9 D Lim.                           |                 |            |            | 09.92      | 10.95 | + ABS (Bendix) |                         |                |                |        |                          |                          |               |     |  |     |  |     |  |
|                                      | 1.4 i Kombi     | 55         | S 71211990 |            | 09.92 | 10.95          | - ABS<br>+ ABS (Bosch)  | 24.3220-1715.3 | 020412         |        |                          | Rz 20,64                 | LUC           |     |  |     |  |     |  |
|                                      | 1.4 i Kombi     | 55         |            |            | 09.92 | 10.95          | + ABS (Bosch)           |                |                |        |                          |                          |               |     |  |     |  |     |  |
|                                      | 1.6 Kombi       | 65         | S 71211990 |            | 09.92 | 10.95          | - ABS                   |                |                |        |                          |                          |               |     |  |     |  |     |  |
|                                      | 1.6 Kombi       | 65         |            |            | 09.92 | 10.95          | + ABS (Bosch)           |                |                |        |                          |                          |               |     |  |     |  |     |  |
|                                      | 1.8 i Kombi     | 74         | S 71211990 |            | 09.92 | 10.95          | - ABS                   |                |                |        |                          |                          |               |     |  |     |  |     |  |
|                                      | 1.8 i Kombi     | 74         |            |            | 09.92 | 10.95          | + ABS (Bosch)           |                |                |        |                          |                          |               |     |  |     |  |     |  |
|                                      | 1.9 D Kombi     |            | S 71211990 |            | 09.92 | 10.95          | - ABS<br>+ ABS (Bosch)  |                |                |        |                          |                          |               |     |  |     |  |     |  |
|                                      | 1.9 D Kombi     |            |            |            | 09.92 | 10.95          | + ABS (Bosch)           |                |                |        |                          |                          |               |     |  |     |  |     |  |
|                                      | 1.9 TD Kombi    | 66         |            |            | 09.92 | 10.95          | - ABS                   |                |                |        |                          |                          |               |     |  |     |  |     |  |
|                                      |                 | 1.4 i      | 55         |            |       | 09.92          | 10.95                   |                | 24.3727-0831.2 | 580831 | 1                        | <input type="checkbox"/> | L=1842        |     |  |     |  |     |  |
| 1.6                                  |                 | 65         |            |            | 09.92 | 10.95          |                         | 24.3727-0804.2 | 580804         |        | <input type="checkbox"/> | L=855                    |               |     |  |     |  |     |  |
| 1.8 i                                |                 | 74         |            |            | 09.92 | 10.95          |                         | 24.3727-0803.2 | 580803         |        | <input type="checkbox"/> | L=550                    |               |     |  |     |  |     |  |
| 1.9 D                                |                 |            |            |            | 09.92 | 10.95          |                         |                |                |        |                          |                          |               |     |  |     |  |     |  |
| 1.9 TD                               |                 | 66         |            |            | 09.92 | 10.95          | + HA-Trommelbremse 1)   |                |                |        |                          |                          |               |     |  |     |  |     |  |
| 1.9                                  |                 | 93         |            |            | 09.92 | 12.93          |                         | 24.3727-0831.2 | 580831         | 1      | <input type="checkbox"/> | L=1842                   |               |     |  |     |  |     |  |
| 1.9 TD                               |                 | 66         |            |            | 09.92 | 10.95          | + HA-Scheibenbremse 2)  | 24.3727-0809.2 | 580809         |        | <input type="checkbox"/> | L=872                    |               |     |  |     |  |     |  |
| 2.0 16V                              |                 | 144        |            |            | 09.92 | 10.95          |                         | 24.3727-0808.2 | 580808         |        | <input type="checkbox"/> | L=558                    |               |     |  |     |  |     |  |
| 2.0 i                                |                 | 89         |            |            | 09.92 | 10.95          |                         |                |                |        |                          |                          |               |     |  |     |  |     |  |
|                                      |                 | 1.4 i      | 55         |            |       | 09.92          | 10.95                   |                | 03.6583-0037.3 | 320107 |                          |                          | BRL 8/3 (4)   | ATE |  |     |  |     |  |
|                                      | 1.6             | 65         |            |            | 09.92 | 10.95          |                         |                |                |        |                          |                          |               |     |  |     |  |     |  |
|                                      | 1.8 i           | 74         |            |            | 09.92 | 10.95          |                         |                |                |        |                          |                          |               |     |  |     |  |     |  |
|                                      | 1.9             | 93         |            |            | 09.92 | 12.93          |                         |                |                |        |                          |                          |               |     |  |     |  |     |  |
|                                      | 1.9 D           |            |            |            | 09.92 | 10.95          |                         |                |                |        |                          |                          |               |     |  |     |  |     |  |
|                                      | 1.9 TD          | 66         |            |            | 09.92 | 10.95          |                         |                |                |        |                          |                          |               |     |  |     |  |     |  |
|                                      | 2.0 16V         | 144        |            |            | 09.92 | 10.95          |                         |                |                |        |                          |                          |               |     |  |     |  |     |  |
|                                      | 2.0 i           | 89         |            |            | 09.92 | 10.95          |                         |                |                |        |                          |                          |               |     |  |     |  |     |  |
|                                      |                 | 1.6        | 65         |            |       | 09.92          | 10.95                   |                | 24.3728-0843.2 | 590843 |                          |                          | L=1443, + AUT |     |  |     |  |     |  |
|                                      |                 | 1.8 i      | 74         |            |       | 09.92          | 10.95                   |                |                |        |                          |                          |               |     |  |     |  |     |  |
| 1.9                                  |                 | 93         |            |            | 09.92 | 12.93          |                         |                |                |        |                          |                          |               |     |  |     |  |     |  |
| 1.9 D                                |                 |            |            |            | 09.92 | 10.95          |                         |                |                |        |                          |                          |               |     |  |     |  |     |  |
| 2.0 i                                |                 | 89         |            |            | 09.92 | 10.95          |                         |                |                |        |                          |                          |               |     |  |     |  |     |  |
| <b>PEUGEOT 406 Limousine (95-04)</b> |                 |            |            |            |       |                |                         |                |                |        |                          |                          |               |     |  |     |  |     |  |
|                                      | 1.6 i           | 65         | ORGA 08701 |            | 04.04 | 10.00          |                         | 03.7863-2202.4 | 300127         |        |                          | 10"                      | ATE           |     |  |     |  |     |  |
|                                      | 1.8 16V         | 81         | ORGA 08701 |            | 10.00 | 10.00          |                         |                |                |        |                          |                          |               |     |  |     |  |     |  |
|                                      | 1.8 16V         | 85         |            |            | 05.01 | 04.04          | - ESP                   |                |                |        |                          |                          |               |     |  |     |  |     |  |
|                                      | 2.0 16V         | 97         | ORGA 08701 |            | 04.04 | 04.04          | - ESP                   |                |                |        |                          |                          |               |     |  |     |  |     |  |
|                                      | 2.0 16V         | 100        | ORGA 08701 |            | 04.04 | 04.04          | - ESP                   |                |                |        |                          |                          |               |     |  |     |  |     |  |
|                                      | 2.0 16V HPi     | 103        |            |            | 05.01 | 04.04          | - ESP                   |                |                |        |                          |                          |               |     |  |     |  |     |  |
|                                      | 2.0 HDi 110     | 80         | ORGA 08701 |            | 08.01 | 08.01          | - ESP                   |                |                |        |                          |                          |               |     |  |     |  |     |  |
|                                      | 2.0 HDi 110 FAP | 79         |            |            | 08.01 | 04.04          | - ESP                   |                |                |        |                          |                          |               |     |  |     |  |     |  |
|                                      | 2.0 HDi 90      | 66         | ORGA 08701 |            | 04.04 | 04.04          | - ESP                   |                |                |        |                          |                          |               |     |  |     |  |     |  |
|                                      | 2.0 Turbo       | 108        | ORGA 08701 |            | 04.04 | 04.04          | - ESP                   |                |                |        |                          |                          |               |     |  |     |  |     |  |
|                                      | 2.2 HDi         | 98         | ORGA 08701 |            | 04.04 | 04.04          | - ESP                   |                |                |        |                          |                          |               |     |  |     |  |     |  |
|                                      | 2.2 i           | 116        | ORGA 08701 |            | 04.04 | 04.04          | - ESP                   |                |                |        |                          |                          |               |     |  |     |  |     |  |
|                                      | 2.0 16V         | 97         | ORGA 08701 |            | 04.04 | 04.04          | + ESP                   | 03.7863-2802.4 | 300188         |        |                          | 10"                      | ATE           |     |  |     |  |     |  |
|                                      | 2.0 16V         | 100        | ORGA 08701 |            | 04.04 | 04.04          | + ESP                   |                |                |        |                          |                          |               |     |  |     |  |     |  |
|                                      | 2.0 16V HPi     | 103        |            |            | 05.01 | 04.04          | + ESP                   |                |                |        |                          |                          |               |     |  |     |  |     |  |
| 2.0 HDi 110                          | 80              | ORGA 08701 |            | 08.01      | 08.01 | + ESP          |                         |                |                |        |                          |                          |               |     |  |     |  |     |  |
| 2.0 HDi 110 FAP                      | 79              |            |            | 08.01      | 04.04 | + ESP          |                         |                |                |        |                          |                          |               |     |  |     |  |     |  |
| 2.0 HDi 90                           | 66              | ORGA 08701 |            | 04.04      | 04.04 | + ESP          |                         |                |                |        |                          |                          |               |     |  |     |  |     |  |
| 2.0 Turbo                            | 108             | ORGA 08701 |            | 04.04      | 04.04 | + ESP          |                         |                |                |        |                          |                          |               |     |  |     |  |     |  |
| 2.2 HDi                              | 98              | ORGA 08701 |            | 04.04      | 04.04 | + ESP          |                         |                |                |        |                          |                          |               |     |  |     |  |     |  |
| 2.2 i                                | 116             | ORGA 08701 |            | 04.04      | 04.04 | + ESP          |                         |                |                |        |                          |                          |               |     |  |     |  |     |  |
| 2.0 16V HPi                          | 103             |            |            | 05.01      | 04.04 | - ESP          | 03.7863-2602.4          | 300183         |                |        | 10"                      | ATE                      |               |     |  |     |  |     |  |
|                                      | 1.6 i           | 65         |            |            | 10.95 | 01.99          |                         | 24.2123-1710.3 | 010504         |        | - ABS                    | THz 23,81                | BOS           |     |  |     |  |     |  |
|                                      | 1.8 16V         | 81         |            |            | 10.95 | 01.99          |                         | 24.2123-1713.3 | 010505         |        | + ABS                    | THz 23,81                | BOS           |     |  |     |  |     |  |
|                                      | 1.8 i           | 66         |            |            | 05.97 | 01.99          |                         |                |                |        |                          |                          |               |     |  |     |  |     |  |
|                                      | 1.9 D           | 55         |            |            | 10.96 | 01.99          |                         |                |                |        |                          |                          |               |     |  |     |  |     |  |
|                                      | 1.9 TD          | 66         |            |            | 01.96 | 01.99          |                         |                |                |        |                          |                          |               |     |  |     |  |     |  |
|                                      | 1.9 TD          | 68         |            |            | 01.96 | 01.99          |                         |                |                |        |                          |                          |               |     |  |     |  |     |  |
|                                      | 2.0 16V         | 97         |            |            | 10.95 | 01.99          |                         |                |                |        |                          |                          |               |     |  |     |  |     |  |
|                                      | 2.0 Turbo       | 108        |            |            | 04.96 | 01.99          |                         |                |                |        |                          |                          |               |     |  |     |  |     |  |
|                                      | 2.1 TD          | 80         |            |            | 10.95 | 01.99          |                         |                |                |        |                          |                          |               |     |  |     |  |     |  |
|                                      | 3.0 24V         | 140        |            |            | 10.96 | 01.99          |                         |                |                |        |                          |                          |               |     |  |     |  |     |  |
|                                      | 1.6 i           | 65         | ORGA 08700 |            | 02.99 |                |                         | 24.2123-1751.3 | 010698         |        | - ABS                    | THz 23,81                |               |     |  |     |  |     |  |
|                                      | 1.8 16V         | 81         | ORGA 08700 |            | 02.99 |                |                         | 24.2123-1741.3 | 010681         |        | + ABS                    | THz 23,81                |               |     |  |     |  |     |  |
|                                      | 1.8 i           | 66         | ORGA 08700 |            | 02.99 |                |                         |                |                |        |                          |                          |               |     |  |     |  |     |  |
|                                      | 1.9 D           | 55         | ORGA 08700 |            | 02.99 |                |                         |                |                |        |                          |                          |               |     |  |     |  |     |  |
|                                      | 1.9 TD          | 66         | ORGA 08700 |            | 02.99 |                |                         |                |                |        |                          |                          |               |     |  |     |  |     |  |
| 1.9 TD                               | 68              | ORGA 08700 |            | 02.99      |       |                |                         |                |                |        |                          |                          |               |     |  |     |  |     |  |
| 2.0 16V                              | 97              | ORGA 08700 |            | 02.99      |       |                |                         |                |                |        |                          |                          |               |     |  |     |  |     |  |
| 2.0 16V                              | 99              |            |            | 02.99      | 08.00 |                |                         |                |                |        |                          |                          |               |     |  |     |  |     |  |
| 2.0 16V                              | 100             | ORGA 08700 |            | 08.00      |       |                |                         |                |                |        |                          |                          |               |     |  |     |  |     |  |

1) + RA drum brake / + P freno a tamburo / + frein à tambour essieu AR / + ET-tambores de freno

2) + RA disc brake / + P disco freno / + frein à disque essieu AR / + ET-disco de freno

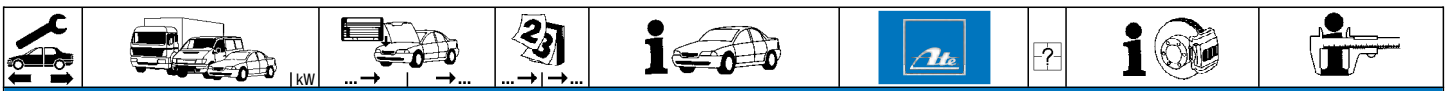

**PEUGEOT 406 Limousine (95-04)**

|  |   |   |  |  |   |                                  |                  |                |                                  |            |
|--|---|---|--|--|---|----------------------------------|------------------|----------------|----------------------------------|------------|
|  | 2.0 HDi 110<br>2.0 HDi 90<br>2.0 Turbo<br>2.1 TD<br>2.2 HDi<br>2.2 i<br>3.0 24V<br>3.0 V6   | 80<br>66<br>108<br>80<br>98<br>116<br>140<br>152  | ORGA 08700<br>ORGA 08700<br>ORGA 08700<br>ORGA 08700<br>ORGA 08700<br>ORGA 08700<br>ORGA 08700<br>ORGA 08700 | 02.99<br>02.99<br>02.99<br>02.99<br>03.00<br>07.00<br>02.99<br>03.00   |   | 24.2123-1751.3<br>24.2123-1741.3 | 010698<br>010681 | - ABS<br>+ ABS | THz 23,81<br>THz 23,81           |            |
|  | 1.6 i<br>1.8 16V<br>1.8 16V<br>1.8 i<br>1.9 D<br>1.9 TD<br>1.9 TD<br>2.0 16V<br>2.0 16V<br>2.0 16V HPi<br>2.0 HDi 110<br>2.0 HDi 110 FAP<br>2.0 HDi 90<br>2.2 HDi<br>2.2 i<br>3.0 24V<br>3.0 V6                                   | 65 ORGA 08701<br>81 ORGA 08701<br>85<br>66 ORGA 08701<br>55 ORGA 08701<br>66 ORGA 08701<br>68 ORGA 08701<br>97 ORGA 08701<br>100 ORGA 08701<br>103<br>80 ORGA 08701<br>79<br>66 ORGA 08701<br>98 ORGA 08701<br>116 ORGA 08701<br>140 ORGA 08701<br>152 ORGA 08701 |  | 04.04<br>10.00<br>10.00 - ESP<br>04.04<br>04.04<br>04.04<br>04.04 - ESP<br>04.04 - ESP<br>04.04 - ESP<br>08.01<br>08.01 - ESP<br>04.04 - ESP<br>04.04 - ESP<br>04.04 - ESP<br>04.04<br>04.04 | 03.2123-2581.3  | 010613                           |                  | THz 23,81      | ATE                              |            |
|  | 1.8 16V<br>2.0 16V<br>2.0 16V<br>2.0 16V HPi<br>2.0 HDi 110<br>2.0 HDi 110 FAP<br>2.0 HDi 90<br>2.2 HDi<br>2.2 i  | 85<br>97 ORGA 08701<br>100 ORGA 08701<br>103<br>80 ORGA 08701<br>79<br>66 ORGA 08701<br>98 ORGA 08701<br>116 ORGA 08701   |  | 10.00<br>04.04 + ESP<br>04.04 + ESP<br>04.04 + ESP<br>05.01<br>04.04 + ESP<br>08.01<br>04.04 + ESP<br>04.04 + ESP<br>04.04 + ESP<br>04.04 + ESP  | 03.2123-2561.3  | 010629                           |                  | THz 23,81      | ATE                              |            |
|  | 1.6 i<br>1.8 16V<br>1.8 16V<br>1.8 i<br>1.9 D   | 65<br>81<br>85<br>66<br>55  |  | 10.95<br>10.95<br>10.00<br>10.95<br>10.96  | 04.04<br>04.04<br>04.04<br>04.04<br>04.04   | 24.3571-1717.5<br>24.3571-1718.5 | 240227<br>240228 | <br>           | D=57, - Halter<br>D=57, - Halter | LUC<br>LUC |
|  | 1.9 TD<br>1.9 TD<br>2.0 16V<br>2.0 16V<br>2.0 16V<br>2.0 16V HPi<br>2.0 HDi 110<br>2.0 HDi 110 FAP<br>2.0 HDi 90<br>2.0 Turbo<br>2.1 TD<br>2.2 HDi<br>2.2 i<br>3.0 24V<br>3.0 V6  | 66<br>68<br>97<br>99<br>100<br>103<br>80<br>79<br>66<br>108<br>80<br>98<br>116<br>140<br>152  |  | 01.96<br>01.96<br>10.95<br>02.99<br>08.00<br>05.01<br>02.99<br>08.01<br>08.01<br>02.99<br>04.96<br>10.95<br>03.00<br>07.00<br>10.96<br>03.00   | 04.04<br>04.04<br>04.04<br>04.04<br>04.04<br>04.04<br>08.01<br>04.04<br>04.04<br>04.04<br>04.04<br>04.04<br>04.04<br>04.04<br>04.04<br>04.04  | 24.3571-1715.5<br>24.3571-1716.5 | 240225<br>240226 | <br>           | D=57, - Halter<br>D=57, - Halter | LUC<br>LUC |
|  | 1.6 i<br>1.8 16V<br>1.8 16V<br>1.8 i<br>1.9 D<br>1.9 TD<br>1.9 TD<br>2.0 16V<br>2.0 16V<br>2.0 16V<br>2.0 16V HPi<br>2.0 HDi 110<br>2.0 HDi 110 FAP<br>2.0 HDi 90<br>2.0 Turbo<br>2.1 TD<br>2.2 HDi<br>2.2 i<br>3.0 24V<br>3.0 V6 | 65<br>81<br>85<br>66<br>55<br>66<br>68<br>97<br>99<br>100<br>103<br>80<br>79<br>66<br>108<br>80<br>98<br>116<br>140<br>152  |  | 10.95<br>10.95<br>10.00<br>05.97<br>10.96<br>10.95<br>01.96<br>10.95<br>01.99<br>08.00<br>05.01<br>02.99<br>08.01<br>08.01<br>02.99<br>04.96<br>10.95<br>03.00<br>07.00<br>10.96<br>03.00    | 04.04<br>04.04<br>04.04<br>04.04<br>04.04<br>04.04<br>04.04<br>04.04<br>04.04<br>04.04<br>04.04<br>08.01<br>04.04<br>04.04<br>04.04<br>04.04<br>04.04<br>04.04<br>04.04<br>04.04<br>04.04 | 24.5130-0527.3<br>24.5130-0526.3 | 330585<br>330584 | <br>           | L=530<br>L=530                   |            |
|  | 2.0 16V<br>2.0 16V<br>2.0 16V HPi<br>2.2 HDi<br>3.0 24V<br>3.0 V6   | 97 ORGA 08638<br>99 ORGA 08638<br>103<br>98 ORGA 08338<br>140 ORGA 08338<br>152 ORGA 08338  | ORGA 08882   | 05.01  | + ABS<br>08.00 + ABS<br>04.04 + ABS<br>+ ABS<br>+ ABS<br>+ ABS  | 24.5130-0527.3<br>24.5130-0526.3 | 330585<br>330584 | <br>           | L=530<br>L=530                   |            |
|  | 2.0 16V<br>2.0 16V<br>2.0 16V HPi<br>2.2 HDi<br>3.0 24V<br>3.0 V6   | 97 ORGA 08883<br>100 ORGA 08883<br>103<br>98 ORGA 08883<br>140 ORGA 08883<br>152 ORGA 08883   |  | 05.01  | 04.04 + ABS<br>04.04 + ABS<br>04.04 + ABS<br>04.04 + ABS<br>04.04 + ABS<br>04.04 + ABS  | 24.5111-0535.3                   | 330684           | 2              | L=535                            |            |







**PEUGEOT 406 Limousine (95-04)**

|  |                 |     |            |       |       |                |        |                          |   |                |     |
|--|-----------------|-----|------------|-------|-------|----------------|--------|--------------------------|---|----------------|-----|
|  | 1.8 16V         | 85  |            | 10.00 | 04.04 | 11.3331-0037.2 | 220395 | <input type="checkbox"/> |   | D=33, - Halter | ATE |
|  | 2.0 16V         | 97  |            | 10.95 | 04.04 | 11.3331-0038.2 | 220396 | <input type="checkbox"/> |   | D=33, - Halter | ATE |
|  | 2.0 16V         | 99  |            | 01.99 | 08.00 | 24.3331-0037.5 | 240547 | <input type="checkbox"/> |   | D=33, - Halter | ATE |
|  | 2.0 16V         | 100 |            | 08.00 | 04.04 | 24.3331-0038.5 | 240548 | <input type="checkbox"/> |   | D=33, - Halter | ATE |
|  | 2.0 16V HPi     | 103 |            | 05.01 | 04.04 | 11.0441-3305.2 | 250006 | <input type="checkbox"/> |   | Dichtungssatz  | ATE |
|  | 2.0 HDi 110     | 80  |            | 02.99 | 08.01 |                |        |                          |   |                |     |
|  | 2.0 HDi 110 FAP | 79  |            | 08.01 | 04.04 |                |        |                          |   |                |     |
|  | 2.0 HDi 90      | 66  |            | 02.99 | 04.04 |                |        |                          |   |                |     |
|  | 2.0 Turbo       | 108 |            | 04.96 | 04.04 |                |        |                          |   |                |     |
|  | 2.1 TD          | 80  |            | 10.95 | 04.04 |                |        |                          |   |                |     |
|  | 2.2 HDi         | 98  |            | 03.00 | 04.04 |                |        |                          |   |                |     |
|  | 2.2 i           | 116 |            | 07.00 | 04.04 |                |        |                          |   |                |     |
|  | 3.0 24V         | 140 |            | 10.96 | 04.04 |                |        |                          |   |                |     |
|  | 3.0 V6          | 152 |            | 03.00 | 04.04 |                |        |                          |   |                |     |
|  | 1.6 i           | 65  |            | 10.95 | 04.04 | 24.5228-0280.3 | 330532 | 2                        |   | L=280          |     |
|  | 1.8 16V         | 81  |            | 10.95 | 10.00 |                |        |                          |   |                |     |
|  | 1.8 16V         | 85  |            | 10.00 | 04.04 |                |        |                          |   |                |     |
|  | 1.8 i           | 66  |            | 05.97 | 04.04 |                |        |                          |   |                |     |
|  | 1.9 D           | 55  |            | 10.96 | 04.04 |                |        |                          |   |                |     |
|  | 1.9 TD          | 66  |            | 10.95 | 04.04 |                |        |                          |   |                |     |
|  | 1.9 TD          | 68  |            | 01.96 | 04.04 |                |        |                          |   |                |     |
|  | 2.0 16V         | 97  |            | 10.95 | 04.04 |                |        |                          |   |                |     |
|  | 2.0 16V         | 99  |            | 01.99 | 08.00 |                |        |                          |   |                |     |
|  | 2.0 16V         | 100 |            | 08.00 | 04.04 |                |        |                          |   |                |     |
|  | 2.0 16V HPi     | 103 |            | 05.01 | 04.04 |                |        |                          |   |                |     |
|  | 2.0 HDi 110     | 80  |            | 02.99 | 08.01 |                |        |                          |   |                |     |
|  | 2.0 HDi 110 FAP | 79  |            | 08.01 | 04.04 |                |        |                          |   |                |     |
|  | 2.0 HDi 90      | 66  |            | 02.99 | 04.04 |                |        |                          |   |                |     |
|  | 2.0 Turbo       | 108 |            | 04.96 | 04.04 |                |        |                          |   |                |     |
|  | 2.1 TD          | 80  |            | 10.95 | 04.04 |                |        |                          |   |                |     |
|  | 2.2 HDi         | 98  |            | 03.00 | 04.04 |                |        |                          |   |                |     |
|  | 2.2 i           | 116 |            | 07.00 | 04.04 |                |        |                          |   |                |     |
|  | 3.0 24V         | 140 |            | 10.96 | 04.04 |                |        |                          |   |                |     |
|  | 3.0 V6          | 152 |            | 03.00 | 04.04 |                |        |                          |   |                |     |
|  | 1.6 i           | 65  |            | 10.95 | 04.04 | 24.3220-1707.3 | 020402 | <input type="checkbox"/> |   | RzR 20,64      | BDX |
|  | 1.8 16V         | 81  |            | 10.95 | 10.00 | 24.3220-1708.3 | 020403 | <input type="checkbox"/> |   | RzR 20,64      | BDX |
|  | 1.8 i           | 66  |            | 05.97 | 04.04 | 24.3220-1709.3 | 020404 | <input type="checkbox"/> |   | Rz 20,64       | BDX |
|  | 1.9 D           | 55  |            | 10.96 | 04.04 | 24.3220-1710.3 | 020405 | <input type="checkbox"/> |   | Rz 20,64       | BDX |
|  | 1.9 TD          | 66  |            | 10.95 | 04.04 |                |        |                          |   |                |     |
|  | 1.9 TD          | 68  |            | 01.96 | 04.04 |                |        |                          |   |                |     |
|  | 1.6 i           | 65  |            | 10.95 | 04.04 | 24.3220-1709.3 | 020404 | <input type="checkbox"/> |   | Rz 20,64       | BDX |
|  | 1.8 16V         | 81  |            | 10.95 | 10.00 | 24.3220-1710.3 | 020405 | <input type="checkbox"/> |   | Rz 20,64       | BDX |
|  | 1.8 i           | 66  |            | 05.97 | 04.04 |                |        |                          |   |                |     |
|  | 1.9 D           | 55  |            | 10.96 | 04.04 |                |        |                          |   |                |     |
|  | 1.9 TD          | 66  |            | 10.95 | 04.04 |                |        |                          |   |                |     |
|  | 1.9 TD          | 68  |            | 01.96 | 04.04 |                |        |                          |   |                |     |
|  | 1.6 i           | 65  | ORGA 08511 | 10.95 |       | 24.3727-0834.2 | 580834 | 1                        | Einstellung nach unten <sup>1)</sup>              | L=1700         |     |
|  | 1.8 16V         | 81  | ORGA 08511 | 10.95 |       | 24.3727-0851.2 | 580851 | 1                        | Einstellung nach oben/ ORGA -08574 <sup>2)</sup>  | L=1756         |     |
|  | 1.8 i           | 66  | ORGA 08511 | 05.97 |       | 24.3727-0852.2 | 580852 | 1                        | Einstellung nach oben/ ORGA 08575- <sup>3)</sup>  | L=1656         |     |
|  | 1.9 D           | 55  | ORGA 08511 | 10.96 |       | 24.3727-0824.2 | 580824 | <input type="checkbox"/> |   | L=824          |     |
|  | 1.9 TD          | 66  | ORGA 08511 | 10.95 |       | 24.3727-0825.2 | 580825 | <input type="checkbox"/> |   | L=750          |     |
|  | 1.6 i           | 65  | ORGA 08512 |       | 04.04 | 24.3727-0834.2 | 580834 | 1                        | Einstellung nach unten/ ORGA 08575- <sup>4)</sup> | L=1700         |     |
|  | 1.8 16V         | 81  | ORGA 08512 |       | 10.00 | 24.3727-0851.2 | 580851 | 1                        | Einstellung nach oben/ ORGA -08574 <sup>2)</sup>  | L=1756         |     |
|  | 1.8 i           | 66  | ORGA 08512 |       | 04.04 | 24.3727-0852.2 | 580852 | 1                        | Einstellung nach oben/ ORGA 08575- <sup>3)</sup>  | L=1656         |     |
|  | 1.9 D           | 55  | ORGA 08512 |       | 04.04 | 24.3727-0835.2 | 580835 | <input type="checkbox"/> |   | L=824          |     |
|  | 1.9 TD          | 66  | ORGA 08512 |       | 04.04 | 24.3727-0836.2 | 580836 | <input type="checkbox"/> |   | L=751          |     |
|  | 1.8 16V         | 85  |            | 10.00 | 04.04 | 24.3727-0834.2 | 580834 | 1                        | Einstellung nach unten <sup>1)</sup>              | L=1700         |     |
|  | 2.0 16V         | 97  |            | 10.95 | 04.04 | 24.3727-0826.2 | 580826 | <input type="checkbox"/> |   | L=695          |     |
|  | 2.0 16V         | 99  |            | 01.99 | 08.00 | 24.3727-0827.2 | 580827 | <input type="checkbox"/> |   | L=642          |     |
|  | 2.0 16V         | 100 |            | 08.00 | 04.04 |                |        |                          |   |                |     |
|  | 2.0 16V HPi     | 103 |            | 05.01 | 04.04 |                |        |                          |   |                |     |
|  | 2.0 HDi 110     | 80  |            | 02.99 | 08.01 |                |        |                          |   |                |     |
|  | 2.0 HDi 110 FAP | 79  |            | 08.01 | 04.04 |                |        |                          |   |                |     |
|  | 2.0 HDi 90      | 66  |            | 02.99 | 04.04 |                |        |                          |   |                |     |
|  | 2.0 Turbo       | 108 |            | 04.96 | 04.04 |                |        |                          |   |                |     |
|  | 2.1 TD          | 80  |            | 10.95 | 04.04 |                |        |                          |   |                |     |
|  | 2.2 HDi         | 98  |            | 03.00 | 04.04 |                |        |                          |   |                |     |
|  | 2.2 i           | 116 |            | 07.00 | 04.04 |                |        |                          |   |                |     |
|  | 3.0 24V         | 140 |            | 10.96 | 04.04 |                |        |                          |   |                |     |
|  | 3.0 V6          | 152 |            | 03.00 | 04.04 |                |        |                          |   |                |     |
|  | 1.8 16V         | 85  | ORGA 08574 | 10.00 |       | 24.3727-0851.2 | 580851 | 1                        | Einstellung nach oben <sup>5)</sup>               | L=1756         |     |
|  | 2.0 16V         | 97  | ORGA 08574 | 10.95 |       | 24.3727-0826.2 | 580826 | <input type="checkbox"/> |   | L=695          |     |
|  | 2.0 16V         | 99  | ORGA 08574 | 01.99 |       | 24.3727-0827.2 | 580827 | <input type="checkbox"/> |   | L=642          |     |
|  | 2.0 16V         | 100 | ORGA 08574 | 08.00 |       |                |        |                          |   |                |     |
|  | 2.0 16V HPi     | 103 | ORGA 08574 | 05.01 |       |                |        |                          |   |                |     |
|  | 2.0 HDi 110     | 80  | ORGA 08574 | 02.99 |       |                |        |                          |   |                |     |
|  | 2.0 HDi 110 FAP | 79  | ORGA 08574 | 08.01 |       |                |        |                          |   |                |     |
|  | 2.0 HDi 90      | 66  | ORGA 08574 | 02.99 |       |                |        |                          |   |                |     |
|  | 2.0 Turbo       | 108 | ORGA 08574 | 04.96 |       |                |        |                          |   |                |     |
|  | 2.1 TD          | 80  | ORGA 08574 | 10.95 |       |                |        |                          |   |                |     |
|  | 2.2 HDi         | 98  | ORGA 08574 | 03.00 |       |                |        |                          |   |                |     |
|  | 2.2 i           | 116 | ORGA 08574 | 07.00 |       |                |        |                          |   |                |     |
|  | 3.0 24V         | 140 | ORGA 08574 | 10.96 |       |                |        |                          |   |                |     |
|  | 3.0 V6          | 152 | ORGA 08574 | 03.00 |       |                |        |                          |   |                |     |















<sup>1)</sup> Adjust down / Regolazione verso il basso / Réglage vers le bas / Ajuste hacia abajo

<sup>2)</sup> Adjust up/ ORGA -08574 / Regolazione verso l'alto/ ORGA -08574 / Réglage vers le haut/ ORGA -08574 / Ajuste hacia arriba/ ORGA -08574

<sup>3)</sup> Adjust up/ ORGA 08575- / Regolazione verso l'alto / Réglage vers le haut/ ORGA 08575- / Ajuste hacia arriba/ ORGA 08575-

<sup>4)</sup> Adjust down/ ORGA 08575- / Regolazione verso il basso/ ORGA 08575- / Réglage vers le bas/ ORGA 08575- / Ajuste hacia abajo/ ORGA 08575-

<sup>5)</sup> Adjust up / Regolazione verso l'alto / Réglage vers le haut / Ajuste hacia arriba

|     |    |    |  |    |  |                |   |  |                   |
|--|--|--|--|--|---|--|---|--|-------------------|
| <b>PEUGEOT 406 Limousine (95-04)</b>   |  |  |  |  |   |  |   |  |                   |
|    | 1.8 16V<br>2.0 16V<br>2.0 16V<br>2.0 16V<br>2.0 16V HPi<br>2.0 HDi 110<br>2.0 HDi 110 FAP<br>2.0 HDi 90<br>2.0 Turbo<br>2.1 TD<br>2.2 HDi<br>2.2 i<br>3.0 24V<br>3.0 V6  | 85 ORGA 08575<br>97 ORGA 08575<br>99 ORGA 08575<br>100 ORGA 08575<br>103 ORGA 08575<br>80 ORGA 08575<br>79 ORGA 08575<br>66 ORGA 08575<br>108 ORGA 08575<br>80 ORGA 08575<br>98 ORGA 08575<br>116 ORGA 08575<br>140 ORGA 08575<br>152 ORGA 08575   |  | 04.04<br>04.04<br>08.00<br>04.04<br>04.04<br>08.01<br>04.04<br>04.04<br>04.04<br>04.04<br>04.04<br>04.04<br>04.04  |   | 24.3727-0852.2 580852<br>24.3727-0826.2 580826<br>24.3727-0827.2 580827                          | 1  Einstellung nach oben <sup>1)</sup><br><input type="checkbox"/><br><input type="checkbox"/> | L=1656<br>L=695<br>L=642   |                   |
|    | 1.6 i<br>1.8 16V<br>1.8 16V<br>1.8 i<br>1.9 D<br>1.9 TD  | 65<br>81<br>85<br>66<br>55<br>66   |  | 10.95 04.04<br>10.95 10.00<br>10.00 04.04<br>05.97 04.04<br>10.96 04.04<br>10.95 04.04   |   | 03.6583-0070.3 320148  |   | BRL 8/3 (4) ATE  |                   |
|  | 2.0 16V<br>2.0 16V<br>2.0 16V<br>2.0 16V HPi<br>2.0 HDi 110<br>2.0 HDi 110 FAP<br>2.0 HDi 90<br>2.0 Turbo<br>2.1 TD<br>2.2 HDi<br>2.2 i<br>3.0 24V<br>3.0 V6   | 97<br>99<br>100<br>103<br>80<br>79<br>66<br>108<br>80<br>98<br>116<br>140<br>152   |  | 10.95 04.04<br>01.99 08.00<br>08.00 04.04<br>05.01 04.04<br>02.99 08.01<br>08.01 04.04<br>02.99 04.04<br>04.96 04.04<br>10.95 04.04<br>03.00 04.04<br>07.00 04.04<br>10.96 04.04<br>03.00 04.04  |   | 03.6583-0069.3 320147  |   | BRL 8/3 (4) ATE  |                   |
|    | 1.6 i<br>1.8 16V<br>1.8 16V<br>1.8 i<br>1.9 D<br>1.9 TD<br>2.0 16V   | 65<br>81<br>85<br>66<br>55<br>66<br>97   |  | 10.95 04.04<br>10.95 10.00<br>10.00 04.04<br>05.97 04.04<br>10.96 04.04<br>10.95 04.04<br>10.95 04.04  |   | 24.3728-0846.2 590846<br>24.3728-0840.2 590840<br>24.3728-0847.2 590847                          |   | L=805, + AUT<br>L=800, + AUT<br>L=847, + AUT                                       |                   |
| <b>PEUGEOT 406 Kombi (96-04)</b>   |  |  |  |  |   |  |   |  |                   |
|  | 1.8<br>1.8 16V<br>1.8 16V<br>1.9 D<br>1.9 TD<br>2.0 16V<br>2.0 16V<br>2.0 16V<br>2.0 HDi 110<br>2.0 HDi 110 FAP<br>2.0 HDi 90<br>2.0 Turbo<br>2.2<br>2.2 HDi<br>2.0 16V<br>2.0 16V<br>2.0 16V<br>2.0 16V HPi<br>2.0 HDi 110<br>2.0 HDi 110 FAP<br>2.0 HDi 90<br>2.0 Turbo<br>2.2<br>2.2 HDi<br>2.0 16V HPi | 66 ORGA 08701<br>81 ORGA 08701<br>85<br>55 ORGA 08701<br>66 ORGA 08701<br>97 ORGA 08701<br>99 ORGA 08701<br>100<br>80 ORGA 08701<br>79<br>66 ORGA 08701<br>108 ORGA 08701<br>116 ORGA 08701<br>98 ORGA 08701<br>97 ORGA 08701<br>99 ORGA 08701<br>100<br>103<br>80 ORGA 08701<br>79<br>66 ORGA 08701<br>108 ORGA 08701<br>116 ORGA 08701<br>98 ORGA 08701<br>103 |  | 04.04<br>10.00<br>04.04<br>04.04<br>04.04<br>04.04 - ESP<br>10.00 - ESP<br>04.04 - ESP<br>08.01 - ESP<br>04.04 - ESP<br>04.04 - ESP<br>04.04 - ESP<br>04.04 - ESP<br>04.04 + ESP<br>10.00 + ESP<br>04.04 + ESP<br>05.01 04.04 + ESP<br>08.01 08.01 + ESP<br>04.04 + ESP<br>04.04 + ESP<br>04.04 + ESP<br>04.04 + ESP<br>04.04 + ESP<br>04.04 - ESP |   | 03.7863-2202.4 300127<br>03.7863-2802.4 300188<br>03.7863-2602.4 300183                          |   | 10"<br>10"<br>10"  | ATE<br>ATE<br>ATE |
|  | 1.8<br>1.8 16V<br>1.9 D<br>1.9 TD<br>2.0 16V<br>2.0 Turbo<br>2.1 TD<br>3.0 24V<br>1.8<br>1.8 16V<br>1.9 D<br>1.9 TD<br>2.0 16V<br>2.0 16V<br>2.0 HDi 110<br>2.0 HDi 90<br>2.0 Turbo<br>2.1 TD<br>2.2   | 66<br>81<br>55<br>66<br>97<br>108<br>80<br>140<br>66<br>81<br>55<br>66<br>97<br>99<br>80<br>66<br>108<br>80<br>116   |  | 05.97 01.99<br>10.95 01.99<br>10.96 01.99<br>10.95 01.99<br>10.95 01.99<br>10.96 01.99<br>10.96 01.99<br>10.96 01.99<br>02.99<br>02.99<br>02.99<br>02.99<br>01.99<br>02.99<br>02.99<br>02.99<br>02.99<br>07.00   |   | 24.2123-1710.3 010504<br>24.2123-1713.3 010505<br>24.2123-1751.3 010698<br>24.2123-1741.3 010681 | - ABS<br>+ ABS  | THz 23,81<br>THz 23,81<br>THz 23,81<br>THz 23,81                                   | BOS<br>BOS        |

<sup>1)</sup> Adjust up / Regolazione verso l'alto / Réglage vers le haut / Ajuste hacia arriba



**PEUGEOT 406 Kombi (96-04)**

|  |  |  |  |  |   |                                  |                  |  |                                  |            |
|--|--|--|--|--|---|----------------------------------|------------------|--|----------------------------------|------------|
|  | 2.2 HDi<br>3.0 24V<br>3.0 V6   | 98<br>140<br>152   | ORGA 08700<br>ORGA 08700<br>ORGA 08700   | 03.00<br>02.99<br>03.00  |   | 24.2123-1751.3<br>24.2123-1741.3 | 010698<br>010681 | - ABS<br>+ ABS   | THz 23,81<br>THz 23,81           |            |
|  | 1.8<br>1.8 16V<br>1.8 16V<br>1.9 D<br>1.9 TD<br>2.0 16V<br>2.0 16V<br>2.0 16V<br>2.0 16V HPI<br>2.0 HDi 110<br>2.0 HDi 110 FAP<br>2.0 HDi 90<br>2.0 Turbo<br>2.1 TD<br>2.2<br>2.2 HDi<br>3.0 24V<br>3.0 V6 | 66<br>81<br>85<br>55<br>66<br>97<br>99<br>100<br>103<br>80<br>79<br>66<br>108<br>80<br>116<br>98<br>140<br>152 | ORGA 08701<br>ORGA 08701<br><br>ORGA 08701<br>ORGA 08701<br>ORGA 08701<br>ORGA 08701<br><br>ORGA 08701<br>ORGA 08701<br>ORGA 08701<br>ORGA 08701<br>ORGA 08701<br>ORGA 08701<br>ORGA 08701<br>ORGA 08701<br>ORGA 08701<br>ORGA 08701 | <br><br>10.00<br>04.04<br>04.04<br>10.00<br>05.01<br>08.01<br>08.01<br>04.04<br>04.04<br>04.04<br>04.04<br>04.04<br>04.04<br>04.04                             | 04.04<br>10.00<br>- ESP<br>04.04<br>04.04<br>- ESP<br>- ESP<br>- ESP<br>- ESP<br>- ESP<br>- ESP<br>- ESP<br>- ESP<br>- ESP<br>- ESP<br>- ESP<br>- ESP<br>- ESP          | 03.2123-2581.3                   | 010613           |  | THz 23,81                        | ATE        |
|  | 1.8 16V<br>2.0 16V<br>2.0 16V<br>2.0 16V<br>2.0 16V HPI<br>2.0 HDi 110<br>2.0 HDi 110 FAP<br>2.0 HDi 90<br>2.0 Turbo<br>2.1 TD<br>2.2<br>2.2 HDi   | 85<br>97<br>99<br>100<br>103<br>80<br>79<br>66<br>108<br>80<br>116<br>98                                       | ORGA 08701<br>ORGA 08701<br><br>ORGA 08701<br>ORGA 08701<br>ORGA 08701<br>ORGA 08701<br>ORGA 08701<br>ORGA 08701<br>ORGA 08701<br>ORGA 08701<br>ORGA 08701<br>ORGA 08701   | 10.00<br>04.04<br>10.00<br>05.01<br>08.01<br>08.01<br>04.04<br>04.04<br>04.04<br>04.04<br>04.04<br>04.04<br>04.04  | + ESP<br>+ ESP<br>+ ESP<br>+ ESP<br>+ ESP<br>+ ESP<br>+ ESP<br>+ ESP<br>+ ESP<br>+ ESP<br>+ ESP<br>+ ESP<br>+ ESP   | 03.2123-2561.3                   | 010629           |  | THz 23,81                        | ATE        |
|  | 1.8<br>1.8 16V<br>1.8 16V<br>1.9 D   | 66<br>81<br>85<br>55   |  | 05.97<br>10.95<br>10.96<br>10.96   | 04.04<br>10.00<br>04.04<br>04.04  | 24.3571-1717.5<br>24.3571-1718.5 | 240227<br>240228 | <input checked="" type="checkbox"/><br><input checked="" type="checkbox"/> | D=57, - Halter<br>D=57, - Halter | LUC<br>LUC |
|  | 1.9 TD<br>2.0 16V<br>2.0 16V<br>2.0 16V<br>2.0 16V HPI<br>2.0 HDi 110<br>2.0 HDi 110 FAP<br>2.0 HDi 90<br>2.0 Turbo<br>2.1 TD<br>2.2<br>2.2 HDi<br>3.0 24V<br>3.0 V6                                       | 66<br>97<br>99<br>100<br>103<br>80<br>79<br>66<br>108<br>80<br>116<br>98<br>140<br>152                         |  | 10.95<br>10.96<br>01.99<br>10.00<br>05.01<br>02.99<br>08.01<br>02.99<br>10.96<br>10.96<br>07.00<br>03.00<br>10.96<br>03.00                                     | 04.04<br>04.04<br>10.00<br>04.04<br>04.04<br>08.01<br>04.04<br>04.04<br>04.04<br>04.04<br>04.04<br>04.04<br>04.04<br>04.04  | 24.3571-1715.5<br>24.3571-1716.5 | 240225<br>240226 | <input checked="" type="checkbox"/><br><input checked="" type="checkbox"/> | D=57, - Halter<br>D=57, - Halter | LUC<br>LUC |
|  | 1.8<br>1.8 16V<br>1.8 16V<br>1.9 D<br>1.9 TD<br>2.0 16V<br>2.0 16V<br>2.0 16V<br>2.0 16V HPI<br>2.0 HDi 110<br>2.0 HDi 110 FAP<br>2.0 HDi 90<br>2.0 Turbo<br>2.1 TD<br>2.2<br>2.2 HDi<br>3.0 24V<br>3.0 V6 | 66<br>81<br>85<br>55<br>66<br>97<br>99<br>100<br>103<br>80<br>79<br>66<br>108<br>80<br>116<br>98<br>140<br>152 |  | 05.97<br>10.96<br>10.00<br>10.96<br>10.96<br>10.96<br>01.99<br>10.00<br>05.01<br>02.99<br>08.01<br>02.99<br>10.96<br>10.96<br>07.00<br>03.00<br>10.96<br>03.00 | 04.04<br>10.00<br>- ABS<br>04.04<br>04.04<br>- ABS<br>- ABS<br>- ABS<br>- ABS<br>- ABS<br>- ABS<br>- ABS<br>- ABS<br>- ABS<br>- ABS<br>- ABS<br>- ABS<br>- ABS<br>- ABS | 24.5130-0527.3<br>24.5130-0526.3 | 330585<br>330584 | <input checked="" type="checkbox"/><br><input checked="" type="checkbox"/> | L=530<br>L=530                   |            |
|  | 1.8 16V<br>2.0 16V<br>2.0 16V<br>2.0 16V<br>2.0 HDi 110<br>2.0 HDi 90<br>2.0 Turbo<br>2.1 TD<br>2.2<br>2.2 HDi<br>3.0 24V<br>3.0 V6  | 85<br>97<br>99<br>100<br>80<br>66<br>108<br>80<br>116<br>98<br>140<br>152                                      | ORGA 08882<br>ORGA 08882<br>ORGA 08882<br>ORGA 08882<br>ORGA 08882<br>ORGA 08882<br>ORGA 08882<br>ORGA 08882<br>ORGA 08882<br>ORGA 08882<br>ORGA 08882<br>ORGA 08882   | 10.00<br>10.96<br>01.99<br>10.00<br>02.99<br>02.99<br>10.96<br>10.96<br>07.00<br>03.00<br>10.96<br>03.00   | + ABS<br>+ ABS<br>+ ABS<br>+ ABS<br>+ ABS<br>+ ABS<br>+ ABS<br>+ ABS<br>+ ABS<br>+ ABS<br>+ ABS<br>+ ABS  | 24.5130-0527.3<br>24.5130-0526.3 | 330585<br>330584 | <input checked="" type="checkbox"/><br><input checked="" type="checkbox"/> | L=530<br>L=530                   |            |
|  | 1.8 16V<br>2.0 16V<br>2.0 16V<br>2.0 16V HPI<br>2.0 HDi 110  | 85<br>97<br>100<br>103<br>80   | ORGA 08883<br>ORGA 08883<br>ORGA 08883<br>ORGA 08883<br>ORGA 08883   | <br>04.04<br>04.04<br>04.04<br>04.04<br>08.01  | + ABS<br>+ ABS<br>+ ABS<br>+ ABS<br>+ ABS   | 24.5111-0535.3                   | 330684           | 2  | L=535                            |            |



**PEUGEOT 406 Kombi (96-04)**

|  |  |  |  |  |  |  |  |  |   |                          |
|--|--|--|--|--|--|--|--|--|---|--------------------------|
|  | 2.0 HDi 110 FAP<br>2.0 HDi 90<br>2.0 Turbo<br>2.1 TD<br>2.2<br>2.2 HDi<br>3.0 24V<br>3.0 V6  | 79 ORGA 08883<br>66 ORGA 08883<br>108 ORGA 08883<br>80 ORGA 08883<br>116 ORGA 08883<br>98 ORGA 08883<br>140 ORGA 08883<br>152 ORGA 08883 |  | 04.04 + ABS<br>04.04 + ABS<br>04.04 + ABS<br>04.04 + ABS<br>04.04 + ABS<br>04.04 + ABS<br>04.04 + ABS  | 24.5111-0535.3   | 330684   | 2  |  | L=535   |                          |
|  | 1.8 16V<br>2.0 16V<br>2.0 16V<br>2.0 16V<br>2.0 16V HPi<br>2.0 HDi 110<br>2.0 HDi 110 FAP<br>2.0 HDi 90<br>2.0 Turbo<br>2.1 TD<br>2.2<br>2.2 HDi<br>3.0 24V<br>3.0 V6                                      | 85<br>97<br>99<br>100<br>103<br>80<br>79<br>66<br>108<br>80<br>116<br>98<br>140<br>152   |  | 10.00 04.04<br>10.96 04.04<br>01.99 10.00<br>10.00 04.04<br>05.01 04.04<br>02.99 08.01<br>08.01 04.04<br>02.99 04.04<br>10.96 04.04<br>10.96 04.04<br>07.00 04.04<br>03.00 04.04<br>10.96 04.04<br>03.00 04.04   | 11.3331-0037.2<br>11.3331-0038.2<br>24.3331-0037.5<br>24.3331-0038.5<br>11.0441-3305.2 | 220395<br>220396<br>240547<br>240548<br>250006 | <input type="checkbox"/><br><input type="checkbox"/><br><input type="checkbox"/><br><input type="checkbox"/> |  | D=33, - Halter<br>D=33, - Halter<br>D=33, - Halter<br>D=33, - Halter<br>Dichtungssatz | ATE<br>ATE<br>ATE<br>ATE |
|  | 1.8<br>1.8 16V<br>1.8 16V<br>1.9 D<br>1.9 TD<br>2.0 16V<br>2.0 16V<br>2.0 16V<br>2.0 16V HPi<br>2.0 HDi 110<br>2.0 HDi 110 FAP<br>2.0 HDi 90<br>2.0 Turbo<br>2.1 TD<br>2.2<br>2.2 HDi<br>3.0 24V<br>3.0 V6 | 66<br>81<br>85<br>55<br>66<br>97<br>99<br>100<br>103<br>80<br>79<br>66<br>108<br>80<br>116<br>98<br>140<br>152                           |  | 05.97 04.04<br>10.96 10.00<br>10.00 04.04<br>10.96 04.04<br>10.95 04.04<br>10.96 04.04<br>01.99 10.00<br>10.00 04.04<br>05.01 04.04<br>02.99 08.01<br>08.01 04.04<br>02.99 04.04<br>10.96 04.04<br>10.96 04.04<br>07.00 04.04<br>03.00 04.04<br>10.96 04.04<br>03.00 04.04 | 24.5228-0280.3   | 330532   | 2  |  | L=280   |                          |
|  | 1.8<br>1.8 16V<br>1.9 D<br>1.9 TD  | 66<br>81<br>55<br>66   |  | 05.97 04.04 - ABS<br>10.95 10.00 - ABS<br>10.96 04.04 - ABS<br>10.96 04.04 - ABS   | 24.3220-1707.3<br>24.3220-1708.3<br>24.3220-1709.3<br>24.3220-1710.3                   | 020402<br>020403<br>020404<br>020405           | <input type="checkbox"/><br><input type="checkbox"/><br><input type="checkbox"/><br><input type="checkbox"/> |  | RzR 20,64<br>RzR 20,64<br>Rz 20,64<br>Rz 20,64  | BDX<br>BDX<br>BDX<br>BDX |
|  | 1.8<br>1.8 16V<br>1.9 D<br>1.9 TD  | 66<br>81<br>55<br>66   | ORGA 08511<br>ORGA 08511<br>ORGA 08511<br>ORGA 08511 | 05.97 04.04 + ABS<br>10.95 10.00 + ABS<br>10.96 04.04 + ABS<br>10.96 04.04 + ABS   | 24.3220-1709.3<br>24.3220-1710.3   | 020404<br>020405                               | <input type="checkbox"/><br><input type="checkbox"/>   |  | Rz 20,64<br>Rz 20,64  | BDX<br>BDX               |
|  | 1.8<br>1.8 16V<br>1.9 D<br>1.9 TD  | 66<br>81<br>55<br>66   | ORGA 08511<br>ORGA 08511<br>ORGA 08511<br>ORGA 08511 | 05.97 04.04<br>10.95 04.04<br>10.96 04.04<br>10.96 04.04   | 24.3727-0834.2<br>24.3727-0824.2<br>24.3727-0825.2                                     | 580834<br>580824<br>580825                     | 1 <input type="checkbox"/><br><input type="checkbox"/><br><input type="checkbox"/>                           |  | L=1700<br>L=824<br>L=750  |                          |
|  | 1.8<br>1.8 16V<br>1.9 D<br>1.9 TD  | 66 ORGA 08512<br>81 ORGA 08512<br>55 ORGA 08512<br>66 ORGA 08512   |  | 04.04<br>04.04<br>04.04<br>04.04   | 24.3727-0834.2<br>24.3727-0835.2<br>24.3727-0836.2                                     | 580834<br>580835<br>580836                     | 1 <input type="checkbox"/><br><input type="checkbox"/><br><input type="checkbox"/>                           |  | L=1700<br>L=824<br>L=751  |                          |
|  | 1.8 16V<br>2.0 16V<br>2.0 16V<br>2.0 16V<br>2.0 16V HPi<br>2.0 HDi 110<br>2.0 HDi 110 FAP<br>2.0 HDi 90<br>2.0 Turbo<br>2.1 TD<br>2.2<br>2.2 HDi<br>3.0 24V<br>3.0 V6                                      | 85<br>97<br>99<br>100<br>103<br>80<br>79<br>66<br>108<br>80<br>116<br>98<br>140<br>152   |  | 10.00 04.04<br>10.96 04.04<br>01.99 10.00<br>10.00 04.04<br>05.01 04.04<br>02.99 08.01<br>08.01 04.04<br>02.99 04.04<br>10.96 04.04<br>10.96 04.04<br>07.00 04.04<br>03.00 04.04<br>10.96 04.04<br>03.00 04.04   | 24.3727-0834.2<br>24.3727-0826.2<br>24.3727-0827.2                                     | 580834<br>580826<br>580827                     | 1 <input type="checkbox"/><br><input type="checkbox"/><br><input type="checkbox"/>                           |  | L=1700<br>L=695<br>L=642  |                          |
|  | 1.8<br>1.8 16V<br>1.9 D<br>1.9 TD  | 66<br>81<br>55<br>66   |  | 05.97 04.04<br>10.95 10.00<br>10.96 04.04<br>10.96 04.04   | 03.6583-0070.3   | 320148   |  |  | BRL 8/3 (4)   | ATE                      |
|  | 1.8 16V<br>2.0 16V<br>2.0 16V<br>2.0 16V<br>2.0 16V HPi<br>2.0 HDi 110<br>2.0 HDi 110 FAP<br>2.0 HDi 90<br>2.0 Turbo<br>2.1 TD<br>2.2<br>2.2 HDi   | 85<br>97<br>99<br>100<br>103<br>80<br>79<br>66<br>108<br>80<br>116<br>98   |  | 10.00 04.04<br>10.96 04.04<br>01.99 10.00<br>10.00 04.04<br>05.01 04.04<br>02.99 08.01<br>08.01 04.04<br>02.99 04.04<br>10.96 04.04<br>10.96 04.04<br>07.00 04.04<br>03.00 04.04   | 03.6583-0069.3   | 320147   |  |  | BRL 8/3 (4)   | ATE                      |



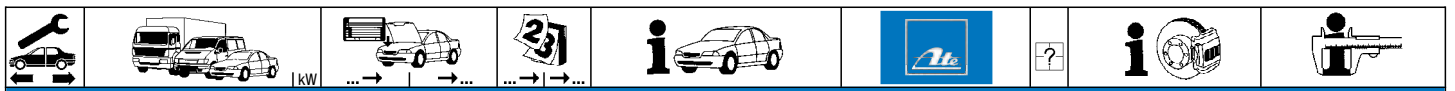

**PEUGEOT 406 Kombi (96-04)**

|  |   |                                  |  |  |   |                |        |  |              |     |
|--|---|----------------------------------|--|--|---|----------------|--------|--|--------------|-----|
|  | 3.0 24V<br>3.0 V6                                       | 140<br>152                       |  | 10.96<br>03.00                                     | 04.04<br>04.04                            | 03.6583-0069.3 | 320147 |  | BRL 8/3 (4)  | ATE |
|  | 1.8<br>1.8 16V<br>1.8 16V<br>1.9 D<br>1.9 TD<br>2.0 16V | 66<br>81<br>85<br>55<br>66<br>97 |  | 05.97<br>10.95<br>10.00<br>10.96<br>10.96<br>10.96 | 04.04<br>10.00<br>04.04<br>04.04<br>04.04 | 24.3728-0846.2 | 590846 |  | L=805, + AUT |     |
|  |   |                                  |  |  |   | 24.3728-0840.2 | 590840 |  | L=800, + AUT |     |
|  |   |                                  |  |  |   | 24.3728-0847.2 | 590847 |  | L=847, + AUT |     |

**PEUGEOT 406 Coupe (97-05)**

|  |  |   |  |   |   |  |  |   |   |                                 |
|--|--|---|--|---|---|--|--|---|---|---------------------------------|
|  | 2.0 16V<br>2.0 16V<br>2.0 16V<br>2.2<br>2.2 HDi                      | 97 ORGA 08701<br>99 ORGA 08701<br>100<br>116<br>98 ORGA 08701                                     |  | 09.05<br>10.00<br>03.02                                     | - ESP<br>- ESP<br>09.05 - ESP<br>09.05 - ESP<br>09.05 - ESP | 03.7863-2202.4   | 300127   |   | 10"   | ATE                             |
|  | 2.0 16V<br>2.0 16V<br>2.0 16V<br>2.2<br>2.2 HDi                      | 97 ORGA 08701<br>99 ORGA 08701<br>100<br>116<br>98 ORGA 08701                                     |  | 09.05<br>10.00<br>03.02                                     | + ESP<br>+ ESP<br>09.05 + ESP<br>09.05 + ESP<br>09.05 + ESP | 03.7863-2802.4   | 300188   |   | 10"   | ATE                             |
|  | 2.0 16V<br>3.0 24V   | 97<br>140   |  | 03.97<br>03.97  | 01.99<br>01.99  | 24.2123-1710.3<br>24.2123-1713.3   | 010504<br>010505                               | - ABS<br>+ ABS  | Thz 23,81<br>Thz 23,81  | BOS<br>BOS                      |
|  | 2.0 16V<br>2.0 16V<br>2.2 HDi<br>3.0 24V<br>3.0 V6                   | 97<br>99<br>98<br>140<br>152  | ORGA 08700<br>ORGA 08700<br>ORGA 08700<br>ORGA 08700<br>ORGA 08700 | 02.99<br>01.99<br>03.00<br>02.99<br>03.00                   |   | 24.2123-1751.3<br>24.2123-1741.3   | 010698<br>010681                               | - ABS<br>+ ABS  | Thz 23,81<br>Thz 23,81  |                                 |
|  | 2.0 16V<br>2.0 16V<br>2.0 16V<br>2.2<br>2.2 HDi<br>3.0 24V<br>3.0 V6 | 97 ORGA 08701<br>99 ORGA 08701<br>100<br>116<br>98 ORGA 08701<br>140 ORGA 08701<br>152 ORGA 08701 |  | 09.05<br>10.00<br>03.02                                     | - ESP<br>- ESP<br>09.05 - ESP<br>09.05 - ESP<br>09.05       | 03.2123-2581.3   | 010613   |   | Thz 23,81   | ATE                             |
|  | 2.0 16V<br>2.0 16V<br>2.0 16V<br>2.2<br>2.2 HDi                      | 97 ORGA 08701<br>99 ORGA 08701<br>100<br>116<br>98 ORGA 08701                                     |  | 09.05<br>10.00<br>03.02                                     | + ESP<br>+ ESP<br>09.05 + ESP<br>09.05 + ESP                | 03.2123-2561.3   | 010629   |   | Thz 23,81   | ATE                             |
|  | 2.0 16V<br>2.0 16V<br>2.0 16V<br>2.2<br>2.2 HDi                      | 97<br>99<br>100<br>116<br>98  |  | 03.97<br>01.99<br>10.00<br>03.02<br>06.02                   | 09.05<br>10.00<br>09.05<br>09.05<br>09.05                   | 24.3571-1715.5<br>24.3571-1716.5   | 240225<br>240226                               | <input checked="" type="checkbox"/><br><input checked="" type="checkbox"/>  | D=57, - Halter<br>D=57, - Halter  | LUC<br>LUC                      |
|  | 2.0 16V<br>2.0 16V<br>2.0 16V<br>2.2<br>2.2 HDi<br>3.0 24V<br>3.0 V6 | 97<br>99<br>100<br>116<br>98<br>140<br>152  |  | 03.97<br>01.99<br>10.00<br>03.02<br>03.00<br>03.97<br>03.00 | 09.05<br>10.00<br>09.05<br>09.05<br>09.05<br>09.05<br>09.05 | 11.3331-0037.2<br>11.3331-0038.2<br>24.3331-0037.5<br>24.3331-0038.5<br>11.0441-3305.2 | 220395<br>220396<br>240547<br>240548<br>250006 | <input checked="" type="checkbox"/><br><input checked="" type="checkbox"/><br><input checked="" type="checkbox"/><br><input checked="" type="checkbox"/><br><input checked="" type="checkbox"/> | D=33, - Halter<br>D=33, - Halter<br>D=33, - Halter<br>D=33, - Halter<br>Dichtungssatz | ATE<br>ATE<br>ATE<br>ATE<br>ATE |
|  | 2.0 16V<br>2.0 16V<br>2.0 16V<br>2.2<br>2.2 HDi<br>3.0 24V<br>3.0 V6 | 97<br>99<br>100<br>116<br>98<br>140<br>152  |  | 03.97<br>01.99<br>10.00<br>03.02<br>03.00<br>03.97<br>03.00 | 09.05<br>10.00<br>09.05<br>09.05<br>09.05<br>09.05<br>09.05 | 24.5228-0280.3   | 330532   | 2   | L=280   |                                 |
|  | 2.0 16V<br>2.0 16V<br>2.0 16V<br>2.2 HDi<br>3.0 24V<br>3.0 V6        | 97<br>99<br>100<br>98<br>140<br>152   |  | 03.97<br>01.99<br>10.00<br>03.00<br>03.97<br>03.00          | 09.05<br>10.00<br>09.05<br>09.05<br>09.05<br>09.05          | 24.3727-0834.2<br>24.3727-0828.2<br>24.3727-0829.2                                     | 580834<br>580828<br>580829                     | 1 <input checked="" type="checkbox"/><br><input checked="" type="checkbox"/><br><input checked="" type="checkbox"/>   | L=1700<br>L=706<br>L=644  |                                 |
|  | 2.2  | 116   |  | 03.02   | 09.05   | 24.3727-0834.2<br>24.3727-0826.2<br>24.3727-0827.2                                     | 580834<br>580826<br>580827                     | 1 <input checked="" type="checkbox"/><br><input checked="" type="checkbox"/><br><input checked="" type="checkbox"/>   | L=1700<br>L=695<br>L=642  |                                 |
|  | 2.0 16V<br>2.0 16V<br>2.0 16V<br>2.2 HDi<br>3.0 24V<br>3.0 V6        | 97<br>99<br>100<br>98<br>140<br>152   |  | 03.97<br>01.99<br>10.00<br>03.00<br>03.97<br>03.00          | 09.05<br>10.00<br>09.05<br>09.05<br>09.05<br>09.05          | 03.6583-0182.3   | 320240   |   | BRL 8/3 (4)   | ATE                             |
|  | 2.2  | 116   |  | 03.02   | 09.05   | 03.6583-0069.3   | 320147   |   | BRL 8/3 (4)   | ATE                             |
|  | 2.0 16V  | 97  |  | 03.97   | 09.05   | 24.3728-0847.2   | 590847   |   | L=847, + AUT  |                                 |

**PEUGEOT 407 Limousine / SW (04-11)**

|  |   |                              |  |   |                |                |        |  |     |     |
|--|---|------------------------------|--|---|----------------|----------------|--------|--|-----|-----|
|  | 1.6 HDi 110<br>1.8 16V<br>1.8 16V<br>2.0 16V<br>2.0 16V | 80<br>85<br>92<br>100<br>103 | ORGA 11192<br>ORGA 11192<br>ORGA 11192 | 05.04<br>05.04<br>09.05<br>05.04<br>09.05 | 02.11<br>02.11 | 03.7860-3402.4 | 300217 |  | 10" | ATE |
|--|---|------------------------------|--|---|----------------|----------------|--------|--|-----|-----|



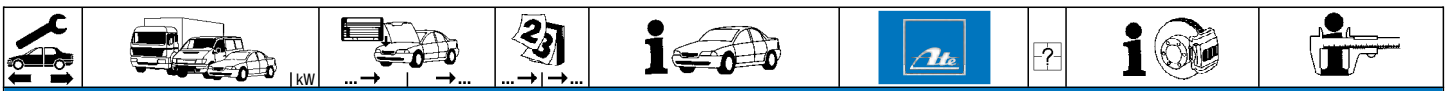

**PEUGEOT 407 Limousine / SW (04-11)**

|             |                |                |            |       |                |                |                          |                          |                          |     |
|-------------|----------------|----------------|------------|-------|----------------|----------------|--------------------------|--------------------------|--------------------------|-----|
|             | 2.0 Bioflex    | 103            | ORGA 11192 | 09.07 |                | 03.7860-3402.4 | 300217                   |                          | 10"                      | ATE |
|             | 2.0 HDi 135    | 100            | ORGA 11192 | 05.04 |                |                |                          |                          |                          |     |
|             | 2.2 16V        | 116            | ORGA 11283 | 05.04 |                |                |                          |                          |                          |     |
|             | 2.2 16V        | 120            | ORGA 11283 | 09.05 |                |                |                          |                          |                          |     |
|             | 2.2 HDi 170    | 125            | ORGA 11192 | 05.06 |                |                |                          |                          |                          |     |
|             | 2.7 HDi        | 150            | ORGA 11073 | 10.05 |                |                |                          |                          |                          |     |
|             | 3.0 V6         | 155            | ORGA 11192 | 05.04 |                |                |                          |                          |                          |     |
|             | 1.6 HDi 110    | 80 ORGA 11193  | ORGA 12046 |       |                | 03.7860-5102.4 | 300218                   |                          | 10"                      | ATE |
|             | 1.8 16V        | 92 ORGA 11193  | ORGA 12046 |       |                |                |                          |                          |                          |     |
|             | 2.0 16V        | 103 ORGA 11193 | ORGA 12046 |       |                |                |                          |                          |                          |     |
| 2.0 Bioflex | 103 ORGA 11193 | ORGA 12046     |            |       |                |                |                          |                          |                          |     |
| 2.0 HDi 135 | 100 ORGA 11193 | ORGA 12046     |            |       |                |                |                          |                          |                          |     |
| 2.0 HDi 140 | 103            | ORGA 12046     | 08.08      |       |                |                |                          |                          |                          |     |
| 2.2 16V     | 116 ORGA 11284 |                |            | 02.11 |                |                |                          |                          |                          |     |
| 2.2 16V     | 120 ORGA 11284 |                |            | 02.11 |                |                |                          |                          |                          |     |
| 2.2 HDi     | 120            | ORGA 12046     | 06.08      |       |                |                |                          |                          |                          |     |
| 2.2 HDi 170 | 125 ORGA 11193 | ORGA 12046     |            |       |                |                |                          |                          |                          |     |
| 2.7 HDi     | 150 ORGA 11074 |                |            | 02.11 |                |                |                          |                          |                          |     |
| 3.0 V6      | 155 ORGA 11193 | ORGA 12046     |            |       |                |                |                          |                          |                          |     |
| 1.6 HDi 110 | 80 ORGA 12047  |                |            | 02.11 | 03.7860-8002.4 | 300258         |                          | 10"                      | ATE                      |     |
| 1.8 16V     | 92 ORGA 12047  |                |            | 02.11 |                |                |                          |                          |                          |     |
| 2.0 16V     | 103 ORGA 12047 |                |            | 02.11 |                |                |                          |                          |                          |     |
| 2.0 Bioflex | 103 ORGA 12047 |                |            | 02.11 |                |                |                          |                          |                          |     |
| 2.0 HDi     | 110            |                | 02.10      | 02.11 |                |                |                          |                          |                          |     |
| 2.0 HDi     | 120            |                | 07.09      | 02.11 |                |                |                          |                          |                          |     |
| 2.0 HDi 135 | 100 ORGA 12047 |                |            | 02.11 |                |                |                          |                          |                          |     |
| 2.0 HDi 140 | 103 ORGA 12047 |                |            | 02.11 |                |                |                          |                          |                          |     |
| 2.2 HDi     | 120 ORGA 12047 |                |            | 02.11 |                |                |                          |                          |                          |     |
| 2.2 HDi 170 | 125 ORGA 12047 |                |            | 02.11 |                |                |                          |                          |                          |     |
| 3.0 V6      | 155 ORGA 12047 |                |            | 02.11 |                |                |                          |                          |                          |     |
|             | 1.6 HDi 110    | 80             |            | 05.04 | 02.11          | 03.2122-2023.3 | 010798                   |                          | Thz 22,20                | ATE |
|             | 1.8 16V        | 85             |            | 05.04 | 02.11          |                |                          |                          |                          |     |
|             | 1.8 16V        | 92             |            | 09.05 | 02.11          |                |                          |                          |                          |     |
|             | 2.0 16V        | 100            |            | 05.04 | 02.11          |                |                          |                          |                          |     |
|             | 2.0 16V        | 103            |            | 09.05 | 02.11          |                |                          |                          |                          |     |
|             | 2.0 Bioflex    | 103            |            | 09.07 | 02.11          |                |                          |                          |                          |     |
|             | 2.0 HDi 135    | 100            | ORGA 11682 | 05.04 |                |                |                          |                          |                          |     |
|             | 2.0 HDi        | 110            | ORGA 12347 | 02.10 |                | 03.2123-3123.3 | 010806                   |                          | Thz 23,81                | ATE |
|             | 2.0 HDi        | 120            | ORGA 12347 | 07.09 |                |                |                          |                          |                          |     |
|             | 2.0 HDi 135    | 100 ORGA 11683 | ORGA 12347 |       |                |                |                          |                          |                          |     |
| 2.0 HDi 140 | 103            | ORGA 12347     | 08.08      |       |                |                |                          |                          |                          |     |
| 2.2 16V     | 116            |                | 05.04      | 02.11 |                |                |                          |                          |                          |     |
| 2.2 16V     | 120            |                | 09.05      | 02.11 |                |                |                          |                          |                          |     |
| 2.2 HDi     | 120            | ORGA 12347     | 06.08      |       |                |                |                          |                          |                          |     |
| 2.2 HDi 170 | 125            | ORGA 12347     | 05.06      |       |                |                |                          |                          |                          |     |
| 2.7 HDi     | 150            |                | 10.05      | 02.11 |                |                |                          |                          |                          |     |
| 3.0 V6      | 155            | ORGA 12347     | 05.04      |       |                |                |                          |                          |                          |     |
|             | 1.6 HDi 110    | 80             |            | 05.04 | 02.11          | 24.3571-1745.7 | 220689                   | <input type="checkbox"/> | D=57, - Halter           | LUC |
|             | 1.8 16V        | 85             |            | 05.04 | 02.11          | 24.3571-1746.7 | 220690                   | <input type="checkbox"/> | D=57, - Halter           | LUC |
|             | 1.8 16V        | 92             |            | 09.05 | 02.11          | 24.0101-3802.2 | 260100                   | <input type="checkbox"/> | Einbausatz               | LUC |
|             | 2.0 16V        | 100            |            | 05.04 | 02.11          |                |                          |                          |                          |     |
|             | 2.0 16V        | 103            |            | 09.05 | 02.11          |                |                          |                          |                          |     |
|             | 2.0 Bioflex    | 103            |            | 09.07 | 02.11          |                |                          |                          |                          |     |
|             | 2.0 HDi 135    | 100            | ORGA 11682 | 05.04 |                |                |                          |                          |                          |     |
|             | 2.0 HDi 140    | 103            |            | 08.08 | 02.11          |                |                          |                          |                          |     |
|             | 2.2 16V        | 116            |            | 05.04 | 02.11          | 24.3451-1719.7 | 220763                   | <input type="checkbox"/> | D=45/45, - Halter        | LUC |
|             | 2.2 16V        | 120            |            | 09.05 | 02.11          | 24.3451-1720.7 | 220764                   | <input type="checkbox"/> | D=45/45, - Halter        | LUC |
| 2.2 HDi     | 120            |                | 06.08      | 02.11 | 24.0101-3802.2 | 260100         | <input type="checkbox"/> | Einbausatz               | LUC                      |     |
| 2.2 HDi 170 | 125            |                | 05.06      | 02.11 |                |                |                          |                          |                          |     |
| 2.7 HDi     | 150            |                | 10.05      | 02.11 |                |                |                          |                          |                          |     |
| 3.0 V6      | 155            | ORGA 12410     | 05.04      |       |                |                |                          |                          |                          |     |
| 2.0 HDi     | 110            |                | 02.10      | 02.11 | 11.9601-9731.2 | 220853         | <input type="checkbox"/> | D=60, - Halter           | ATE                      |     |
| 2.0 HDi     | 120            |                | 07.09      | 02.11 | 11.9601-9732.2 | 220854         | <input type="checkbox"/> | D=60, - Halter           | ATE                      |     |
| 2.0 HDi 135 | 100 ORGA 11683 |                |            | 02.11 | 11.0101-5407.2 | 260011         | <input type="checkbox"/> | Hülzensatz               | ATE                      |     |
| 2.0 HDi 140 | 103            |                | 08.08      | 02.11 | 11.0441-6008.2 | 250038         | <input type="checkbox"/> | Dichtungssatz            | ATE                      |     |
|             |                |                |            |       | 11.8116-0356.1 | 390586         | 2                        | Haltefeder               | ATE                      |     |
| 3.0 V6      | 155 ORGA 12411 |                |            | 02.11 | 11.9601-9883.2 | 220917         | <input type="checkbox"/> | D=60, - Halter           | ATE                      |     |
|             |                |                |            |       | 11.9601-9884.2 | 220918         | <input type="checkbox"/> | D=60, - Halter           | ATE                      |     |
|             |                |                |            |       | 11.0101-5407.2 | 260011         | <input type="checkbox"/> | Hülzensatz               | ATE                      |     |
|             |                |                |            |       | 11.0441-6008.2 | 250038         | <input type="checkbox"/> | Dichtungssatz            | ATE                      |     |
|             | 1.6 HDi 110    | 80 ORGA 10332  | ORGA 11125 |       |                | 24.5161-0315.3 | 331186                   | <input type="checkbox"/> | L=310/275, + Rohrleitung |     |
|             | 1.8 16V        | 85 ORGA 10332  | ORGA 11125 |       |                | 24.5161-0316.3 | 331187                   | <input type="checkbox"/> | L=310/275, + Rohrleitung |     |
|             | 1.8 16V        | 92             | ORGA 11125 | 09.05 |                |                |                          |                          |                          |     |
|             | 2.0 16V        | 100 ORGA 10332 | ORGA 11125 |       |                |                |                          |                          |                          |     |
|             | 2.0 16V        | 103            | ORGA 11125 | 09.05 |                |                |                          |                          |                          |     |
|             | 2.0 HDi 135    | 100 ORGA 10332 | ORGA 11125 |       |                |                |                          |                          |                          |     |
|             | 2.2 16V        | 116 ORGA 10332 | ORGA 11125 |       |                |                |                          |                          |                          |     |
|             | 2.2 16V        | 120            | ORGA 11125 | 09.05 |                |                |                          |                          |                          |     |
|             | 2.2 HDi 170    | 125            | ORGA 11125 | 05.06 |                |                |                          |                          |                          |     |
|             | 2.7 HDi        | 150            | ORGA 11125 | 10.05 |                |                |                          |                          |                          |     |
| 3.0 V6      | 155 ORGA 10332 | ORGA 11125     |            |       |                |                |                          |                          |                          |     |
| 1.6 HDi 110 | 80 ORGA 11126  |                |            | 02.11 | 24.5161-0314.3 | 331220         | <input type="checkbox"/> | L=310/275, + Rohrleitung |                          |     |
| 1.8 16V     | 85 ORGA 11126  |                |            | 02.11 | 24.5161-0313.3 | 331219         | <input type="checkbox"/> | L=310/275, + Rohrleitung |                          |     |
| 1.8 16V     | 92 ORGA 11126  |                |            | 02.11 |                |                |                          |                          |                          |     |
| 2.0 16V     | 100 ORGA 11126 |                |            | 02.11 |                |                |                          |                          |                          |     |
| 2.0 16V     | 103 ORGA 11126 |                |            | 02.11 |                |                |                          |                          |                          |     |





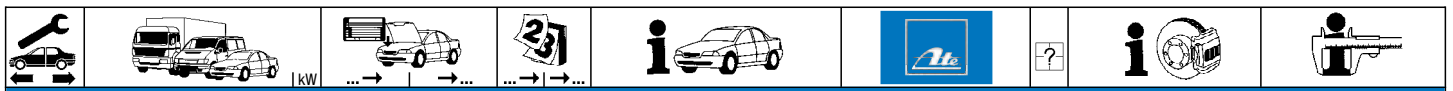

**PEUGEOT 407 Limousine / SW (04-11)**

|  |   |   |  |  |  |  |  |                            |  |  |  |                   |
|--|---|---|--|--|--|--|--|----------------------------|--|--|--|-------------------|
|  | 2.0 Bioflex<br>2.0 HDi<br>2.0 HDi<br>2.0 HDi 135<br>2.0 HDi 140<br>2.2 16V<br>2.2 16V<br>2.2 HDi<br>2.2 HDi 170<br>2.7 HDi<br>3.0 V6  | 103<br>110<br>120<br>100 ORGA 11126<br>103<br>116 ORGA 11126<br>120 ORGA 11126<br>120<br>125 ORGA 11126<br>150 ORGA 11126<br>155 ORGA 11126 |  | 09.07<br>02.10<br>07.09<br>08.08<br>06.08  | 02.11<br>02.11<br>02.11<br>02.11<br>02.11<br>02.11<br>02.11<br>02.11<br>02.11<br>02.11   |  | 24.5161-0314.3<br>24.5161-0313.3                   | 331220<br>331219           |  |  | L=310/275, + Rohrleitung<br>L=310/275, + Rohrleitung |                   |
|  | 1.6 HDi 110<br>1.8 16V<br>1.8 16V<br>2.0 16V<br>2.0 16V<br>2.0 Bioflex<br>2.0 HDi<br>2.0 HDi<br>2.0 HDi 135<br>2.0 HDi 140<br>2.2 16V<br>2.2 16V<br>2.2 HDi<br>2.2 HDi 170<br>2.7 HDi<br>3.0 V6 | 80<br>85<br>92<br>100<br>103<br>103<br>110<br>120<br>100<br>103<br>116<br>120<br>120<br>125<br>150<br>155                                   |  | 05.04<br>05.04<br>09.05<br>05.04<br>09.05<br>09.07<br>02.10<br>07.09<br>05.04<br>08.08<br>05.04<br>09.05<br>06.08<br>05.06<br>10.05<br>05.04 | 02.11<br>02.11<br>02.11<br>02.11<br>02.11<br>02.11<br>02.11<br>02.11<br>02.11<br>02.11<br>02.11<br>02.11<br>02.11<br>02.11<br>02.11<br>02.11 |  | 24.3387-1707.7<br>24.3387-1708.7<br>24.0101-3803.2 | 220701<br>220702<br>260101 |  |  | D=38, - Halter<br>D=38, - Halter<br>Einbausatz       | LUC<br>LUC<br>LUC |
|  | 1.6 HDi 110<br>1.8 16V<br>1.8 16V<br>2.0 16V<br>2.0 16V<br>2.0 HDi 135<br>2.0 HDi 140<br>2.2 16V<br>2.2 16V<br>2.2 HDi<br>2.2 HDi 170<br>2.7 HDi<br>3.0 V6                                      | 80<br>85<br>92<br>100<br>103<br>100<br>103<br>116<br>120<br>120<br>125<br>150<br>155  | ORGA 11710<br>ORGA 11710<br>ORGA 11710<br>ORGA 11710<br>ORGA 11710<br>ORGA 11710<br>ORGA 11710<br>ORGA 11710<br>ORGA 11710<br>ORGA 11710<br>ORGA 11710<br>ORGA 11710<br>ORGA 11710 | 05.04<br>05.04<br>09.05<br>05.04<br>09.05<br>05.04<br>08.08<br>05.04<br>09.05<br>06.08<br>05.06<br>10.05<br>05.04                            |  |  | 24.5151-0583.3<br>24.5151-0584.3                   | 331019<br>331020           |  |  | L=584<br>L=584                                       |                   |
|  | 1.6 HDi 110<br>1.8 16V<br>1.8 16V<br>2.0 16V<br>2.0 16V<br>2.0 HDi 135<br>2.0 HDi 140<br>2.2 16V<br>2.2 16V<br>2.2 HDi<br>2.2 HDi 170<br>2.7 HDi<br>3.0 V6                                      | 80<br>85<br>92<br>100<br>103<br>100<br>103<br>116<br>120<br>120<br>125<br>150<br>155  | ORGA 11711<br>ORGA 11711<br>ORGA 11711<br>ORGA 11711<br>ORGA 11711<br>ORGA 11711<br>ORGA 11711<br>ORGA 11711<br>ORGA 11711<br>ORGA 11711<br>ORGA 11711<br>ORGA 11711<br>ORGA 11711 | 09.07  | 02.11<br>02.11<br>02.11<br>02.11<br>02.11<br>02.11<br>02.11<br>02.11<br>02.11<br>02.11<br>02.11<br>02.11<br>02.11                            |  | 24.5151-0638.3<br>24.5151-0639.3                   | 331141<br>331142           |  |  | L=638<br>L=638                                       |                   |
|  | 1.6 HDi 110<br>1.8 16V<br>1.8 16V<br>2.0 16V<br>2.0 16V<br>2.0 Bioflex<br>2.0 HDi<br>2.0 HDi<br>2.0 HDi 135<br>2.0 HDi 140<br>2.2 16V<br>2.2 16V<br>2.2 HDi<br>2.2 HDi 170<br>2.7 HDi<br>3.0 V6 | 80<br>85<br>92<br>100<br>103<br>103<br>110<br>120<br>100<br>103<br>116<br>120<br>120<br>125<br>150<br>155                                   |  | 05.04<br>05.04<br>09.05<br>05.04<br>09.05<br>09.07<br>02.10<br>07.09<br>05.04<br>08.08<br>05.04<br>09.05<br>06.08<br>05.06<br>10.05<br>05.04 | 02.11<br>02.11<br>02.11<br>02.11<br>02.11<br>02.11<br>02.11<br>02.11<br>02.11<br>02.11<br>02.11<br>02.11<br>02.11<br>02.11<br>02.11<br>02.11 |  | 24.3727-0844.2                                     | 580844                     |  |  | L=2155   |                   |

**PEUGEOT 407 Coupe (05-11)**



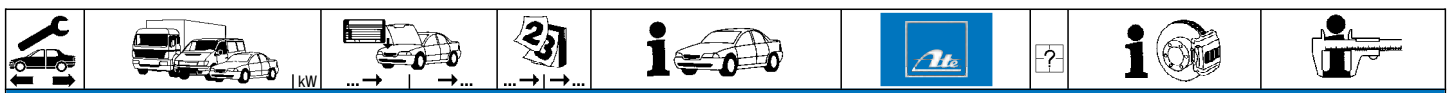















|  |  |  |  |                                  |   |  |                |        |  |  |     |     |
|--|--|--|--|----------------------------------|---|--|----------------|--------|--|--|-----|-----|
|  | 2.0 HDi 135<br>2.2 16V<br>2.7 HDi<br>3.0 V6            | #100<br>#120<br>#150<br>#155   | ORGA 11192<br>ORGA 11283<br>ORGA 11073<br>ORGA 11192 | 07.07<br>10.05<br>10.05<br>10.05 |   |  | 03.7860-3402.4 | 300217 |  |  | 10" | ATE |
|  | 2.0 HDi 135<br>2.2 16V<br>2.7 HDi<br>3.0 V6            | #100 ORGA 11193<br>#120 ORGA 11284<br>#150 ORGA 11074<br>#155 ORGA 11193 | ORGA 12046<br>ORGA 12046                             |                                  | 12.11<br>12.11                            |  | 03.7860-5102.4 | 300218 |  |  | 10" | ATE |
|  | 2.0 HDi<br>2.0 HDi<br>2.0 HDi 135<br>3.0 HDi<br>3.0 V6 | #110<br>#120<br>#100 ORGA 12047<br>#177<br>#155 ORGA 12047               |  | 02.10<br>06.09<br>06.09          | 12.11<br>12.11<br>12.11<br>12.11<br>12.11 |  | 03.7860-8002.4 | 300258 |  |  | 10" | ATE |

























| PEUGEOT 407 Coupe (05-11) |             |     |            |       |       |                |        |   |                          |     |
|---------------------------|-------------|-----|------------|-------|-------|----------------|--------|---|--------------------------|-----|
|                           | 2.0 HDi     | 120 | ORGA 12347 | 06.09 |       | 03.2123-3123.3 | 010806 |   | THz 23,81                | ATE |
|                           | 2.0 HDi 135 | 100 | ORGA 12347 | 07.07 |       |                |        |   |                          |     |
|                           | 2.2 16V     | 120 | ORGA 12347 | 10.05 |       |                |        |   |                          |     |
|                           | 2.7 HDi     | 150 |            | 10.05 | 12.11 |                |        |   |                          |     |
|                           | 3.0 HDi     | 177 | ORGA 12347 | 06.09 |       |                |        |   |                          |     |
|                           | 3.0 V6      | 155 | ORGA 12347 | 10.05 |       |                |        |   |                          |     |
|                           | 2.0 HDi 135 | 100 |            | 07.07 | 12.11 | 24.3451-1719.7 | 220763 |   | D=45/45, - Halter        | LUC |
|                           | 2.2 16V     | 120 |            | 10.05 | 12.11 | 24.3451-1720.7 | 220764 |   | D=45/45, - Halter        | LUC |
|                           | 2.7 HDi     | 150 |            | 10.05 | 12.11 | 24.0101-3802.2 | 260100 |   | Einbausatz               | LUC |
|                           | 3.0 V6      | 155 | ORGA 12410 | 10.05 |       |                |        |   |                          |     |
|                           | 2.0 HDi     | 110 |            | 02.10 | 12.11 | 11.9601-9731.2 | 220853 |   | D=60, - Halter           | ATE |
|                           | 2.0 HDi     | 120 |            | 06.09 | 12.11 | 11.9601-9732.2 | 220854 |   | D=60, - Halter           | ATE |
|                           |             |     |            |       |       | 11.0101-5407.2 | 260011 |   | Hülsensatz               | ATE |
|                           |             |     |            |       |       | 11.0441-6008.2 | 250038 |   | Dichtungssatz            | ATE |
|                           |             |     |            |       |       | 11.8116-0356.1 | 390586 | 2 | Haltefeder               | ATE |
|                           | 3.0 HDi     | 177 |            | 06.09 | 12.11 | 11.9601-9883.2 | 220917 |   | D=60, - Halter           | ATE |
|                           | 3.0 V6      | 155 | ORGA 12411 |       | 12.11 | 11.9601-9884.2 | 220918 |   | D=60, - Halter           | ATE |
|                           |             |     |            |       |       | 11.0101-5407.2 | 260011 |   | Hülsensatz               | ATE |
|                           |             |     |            |       |       | 11.0441-6008.2 | 250038 |   | Dichtungssatz            | ATE |
|                           | 2.2 16V     | 120 | ORGA 11125 | 10.05 |       | 24.5161-0315.3 | 331186 |   | L=310/275, + Rohrleitung |     |
|                           | 2.7 HDi     | 150 | ORGA 11125 | 10.05 |       | 24.5161-0316.3 | 331187 |   | L=310/275, + Rohrleitung |     |
|                           | 3.0 V6      | 155 | ORGA 11125 | 10.05 |       |                |        |   |                          |     |
|                           | 2.0 HDi     | 110 |            | 02.10 | 02.11 | 24.5161-0314.3 | 331220 |   | L=310/275, + Rohrleitung |     |
|                           | 2.0 HDi     | 120 |            | 06.09 | 12.11 | 24.5161-0313.3 | 331219 |   | L=310/275, + Rohrleitung |     |
|                           | 2.0 HDi 135 | 100 |            | 07.07 | 12.11 |                |        |   |                          |     |
|                           | 2.2 16V     | 120 | ORGA 11126 |       | 12.11 |                |        |   |                          |     |
|                           | 2.7 HDi     | 150 | ORGA 11126 |       | 12.11 |                |        |   |                          |     |
|                           | 3.0 V6      | 155 | ORGA 11126 |       | 12.11 |                |        |   |                          |     |
|                           | 2.0 HDi     | 110 |            | 02.10 | 12.11 | 24.3387-1707.7 | 220701 |   | D=38, - Halter           | LUC |
|                           | 2.0 HDi     | 120 |            | 06.09 | 12.11 | 24.3387-1708.7 | 220702 |   | D=38, - Halter           | LUC |
|                           | 2.0 HDi 135 | 100 |            | 07.07 | 12.11 | 24.0101-3803.2 | 260101 |   | Einbausatz               | LUC |
|                           | 2.2 16V     | 120 |            | 10.05 | 12.11 |                |        |   |                          |     |
|                           | 2.7 HDi     | 150 |            | 10.05 | 12.11 |                |        |   |                          |     |
|                           | 3.0 HDi     | 177 |            | 06.09 | 12.11 |                |        |   |                          |     |
|                           | 3.0 V6      | 155 |            | 10.05 | 12.11 |                |        |   |                          |     |
|                           | 2.0 HDi 135 | 100 | ORGA 11710 | 07.07 |       | 24.5151-0583.3 | 331019 |   | L=584                    |     |
|                           | 2.2 16V     | 120 | ORGA 11710 | 10.05 |       | 24.5151-0584.3 | 331020 |   | L=584                    |     |
|                           | 2.7 HDi     | 150 | ORGA 11710 | 10.05 |       |                |        |   |                          |     |
|                           | 3.0 V6      | 155 | ORGA 11710 | 10.05 |       |                |        |   |                          |     |
|                           | 2.0 HDi     | 110 |            | 02.10 | 12.11 | 24.5151-0638.3 | 331141 |   | L=638                    |     |
|                           | 2.0 HDi     | 120 |            | 06.09 | 12.11 | 24.5151-0639.3 | 331142 |   | L=638                    |     |
|                           | 2.0 HDi 135 | 100 | ORGA 11711 |       | 12.11 |                |        |   |                          |     |
|                           | 2.2 16V     | 120 | ORGA 11711 |       | 12.11 |                |        |   |                          |     |
|                           | 2.7 HDi     | 150 | ORGA 11711 |       | 12.11 |                |        |   |                          |     |
|                           | 3.0 HDi     | 177 |            | 06.09 | 12.11 |                |        |   |                          |     |
|                           | 3.0 V6      | 155 | ORGA 11711 |       | 12.11 |                |        |   |                          |     |
|                           | 2.0 HDi     | 110 |            | 02.10 | 12.11 | 24.3727-0844.2 | 580844 | 2 | L=2155                   |     |
|                           | 2.0 HDi     | 120 |            | 06.09 | 12.11 |                |        |   |                          |     |
|                           | 2.0 HDi 135 | 100 |            | 07.07 | 12.11 |                |        |   |                          |     |
|                           | 2.2 16V     | 120 |            | 10.05 | 12.11 |                |        |   |                          |     |
|                           | 2.7 HDi     | 150 |            | 10.05 | 12.11 |                |        |   |                          |     |
|                           | 3.0 HDi     | 177 |            | 06.09 | 12.11 |                |        |   |                          |     |
|                           | 3.0 V6      | 155 |            | 10.05 | 12.11 |                |        |   |                          |     |

| PEUGEOT 505 (79-93) |               |  |  |       |       |                |        |   |               |     |
|---------------------|---------------|--|--|-------|-------|----------------|--------|---|---------------|-----|
|                     | 1.8           |  |  | 01.82 | 10.86 | 03.2120-1122.3 | 010084 |   | THz 20,64     | ATE |
|                     | 2.0 Lim.      |  |  | 11.80 | 10.86 |                |        |   |               |     |
|                     | 2.0 Ti/STi    |  |  | 08.79 | 10.86 |                |        |   |               |     |
|                     | 2.2 GTi Lim.  |  |  | 08.83 | 12.93 |                |        |   |               |     |
|                     | 2.2 i Lim.    |  |  | 05.81 | 12.93 |                |        |   |               |     |
|                     | 2.2 Ti        |  |  | 03.84 | 10.88 |                |        |   |               |     |
|                     | 2.3 TD        |  |  | 09.80 | 06.86 |                |        |   |               |     |
|                     | 2.5 D Lim.    |  |  | 06.81 | 12.93 |                |        |   |               |     |
|                     | 2.5 TD Lim.   |  |  | 10.83 | 12.93 |                |        |   |               |     |
|                     | 2.8 V6        |  |  | 06.86 | 12.93 |                |        |   |               |     |
|                     | 2.0 Kombi     |  |  | 04.82 | 11.87 | 03.2120-1681.3 | 010097 |   | THz 20,64     | ATE |
|                     | 2.2 GTi Kombi |  |  | 09.85 | 12.86 | 03.2122-5801.3 | 010147 |   | THz 22,20     | ATE |
|                     | 2.2 i Kombi   |  |  | 01.86 | 12.93 |                |        |   |               |     |
|                     | 2.5 D Kombi   |  |  | 08.83 | 12.93 |                |        |   |               |     |
|                     | 2.5 TD Kombi  |  |  | 10.85 | 12.93 |                |        |   |               |     |
|                     | 1.8           |  |  | 01.82 | 10.86 | 11.0441-5401.2 | 250027 |   | Dichtungssatz | ATE |
|                     | 2.0           |  |  | 11.80 | 11.87 |                |        |   |               |     |
|                     | 2.0 Ti/STi    |  |  | 08.79 | 10.86 |                |        |   |               |     |
|                     | 2.2 GTi       |  |  | 08.83 | 12.93 |                |        |   |               |     |
|                     | 2.2 i         |  |  | 05.81 | 12.93 |                |        |   |               |     |
|                     | 2.3 TD        |  |  | 09.80 | 06.86 |                |        |   |               |     |
|                     | 2.5 D         |  |  | 06.81 | 12.93 |                |        |   |               |     |
|                     | 2.5 TD        |  |  | 10.83 | 12.93 |                |        |   |               |     |
|                     | 2.2 Ti        |  |  | 03.84 | 10.88 | 11.0441-5401.2 | 250027 |   | Dichtungssatz | ATE |
|                     | 2.8 V6        |  |  | 06.86 | 12.93 |                |        |   |               |     |
|                     | 1.8           |  |  | 01.82 | 10.86 | 24.5112-0381.3 | 330711 | 2 | L=380         |     |
|                     | 2.0           |  |  | 11.80 | 11.87 |                |        |   |               |     |
|                     | 2.0 Ti/STi    |  |  | 08.79 | 10.86 |                |        |   |               |     |
|                     | 2.2 GTi       |  |  | 08.83 | 12.93 |                |        |   |               |     |
|                     | 2.2 i         |  |  | 05.81 | 12.93 |                |        |   |               |     |
|                     | 2.2 Ti        |  |  | 03.84 | 10.88 |                |        |   |               |     |













|     |    |  |  |   |    |  |  |    |                      |            |
|--|--|--|--|---|---|--|--|--|----------------------|------------|
| <b>PEUGEOT 505 (79-93)</b>   |  |  |  |   |   |  |  |  |                      |            |
|    | 2.3 TD<br>2.5 D<br>2.5 TD<br>2.8 V6  |  |  | 09.80<br>06.81<br>10.83<br>06.86  | 06.86<br>12.93<br>12.93<br>12.93  | 24.5112-0381.3   | 330711   | 2  | L=380                |            |
|    | 1.8<br>2.0 Lim.<br>2.0 Ti/STi<br>2.2 GTi Lim.<br>2.2 i Lim.<br>2.2 Ti<br>2.3 TD<br>2.5 D Lim.<br>2.5 TD Lim.<br>2.8 V6   |  |  | 01.82<br>11.80<br>08.79<br>08.83<br>05.81<br>03.84<br>09.80<br>06.81<br>10.83<br>06.86  | 10.86<br>10.86<br>10.86<br>12.93<br>12.93<br>10.88<br>06.86<br>12.93<br>12.93<br>12.93  | 24.5228-0216.3   | 330908   | 2  | L=216                |            |
|    | 2.0 Lim.<br>2.0 Ti/STi<br>2.2 i Lim.<br>2.3 TD<br>2.5 D Lim.   |  | 1.214.334<br>1.214.334<br>1.214.334<br>1.214.334<br>1.214.334                    | 11.80<br>08.79<br>05.81<br>09.80<br>06.81   |   | 24.3222-1106.3<br>24.3222-1107.3   | 020261<br>020262   | <br> | Rz 22,20<br>Rz 22,20 | LUC<br>LUC |
|  | 1.8<br>2.0 Lim.<br>2.0 Ti/STi<br>2.2 i Lim.<br>2.3 TD<br>2.5 D Lim.<br>2.5 TD Lim.   | 1.214.335<br>1.214.335<br>1.214.335<br>1.214.335<br>1.214.335                    |  | 01.82<br>10.86<br>10.86<br>12.93<br>06.86<br>12.93<br>10.83   | 10.86<br>10.86<br>12.93<br>06.86<br>12.93<br>12.93  | 24.3220-1619.3   | 020246   |  | Rz 20,64             | LUC        |
|  | 2.0 Kombi<br>2.2 i Kombi<br>2.5 D Kombi<br>2.5 TD Kombi  |  |  | 04.82<br>01.86<br>08.83<br>10.85  | 11.87<br>12.93<br>12.93<br>12.93  | 24.3222-1615.3   | 020285   |  | Rz 22,20             | LUC        |
|    | 1.8<br>2.0 Lim.<br>2.0 Ti/STi<br>2.2 GTi Lim.<br>2.2 i Lim.<br>2.2 Ti<br>2.3 TD<br>2.5 D Lim.<br>2.5 TD Lim.<br>2.8 V6   |  |  | 01.82<br>11.80<br>08.79<br>08.83<br>05.81<br>03.84<br>09.80<br>06.81<br>10.83<br>06.86  | 10.86<br>10.86<br>10.86<br>12.93<br>12.93<br>10.88<br>06.86<br>12.93<br>12.93<br>12.93  | 03.6515-1000.3   | 320089   |  | BRL 1/5 (3)          | ATE        |
|  | 2.0 Kombi<br>2.2 GTi Kombi<br>2.2 i Kombi<br>2.5 D Kombi<br>2.5 TD Kombi   |  |  | 04.82<br>09.85<br>01.86<br>08.83<br>10.85   | 11.87<br>12.86<br>12.93<br>12.93<br>12.93   | 03.6515-0600.3   | 320088   |  | BRL 1/5 (2)          | ATE        |
|  | 1.8<br>2.0<br>2.0 Ti/STi<br>2.2 GTi<br>2.2 i<br>2.2 Ti<br>2.3 TD<br>2.5 D<br>2.5 TD<br>2.8 V6  |  |  | 01.82<br>11.80<br>08.79<br>08.83<br>05.81<br>03.84<br>09.80<br>06.81<br>10.83<br>06.86  | 10.86<br>11.87<br>10.86<br>12.93<br>12.93<br>10.88<br>06.86<br>12.93<br>12.93<br>12.93  | 24.2419-0929.3   | 030057   |  | Gz 19,05             |            |
|  | 1.8<br>2.0<br>2.0 Ti/STi<br>2.2 GTi<br>2.2 i<br>2.2 Ti<br>2.3 TD<br>2.5 D  |  |  | 01.82<br>11.80<br>08.79<br>08.83<br>05.81<br>03.84<br>09.80<br>06.81  | 10.86<br>11.87<br>10.86<br>12.93<br>12.93<br>10.88<br>06.86<br>12.93  | 24.2528-1601.3   | 040063   |  | Nz 28,57             |            |
|  | 1.8<br>2.0 Kombi<br>2.0 Lim.<br>2.0 Ti/STi<br>2.2 GTi Kombi<br>2.2 GTi Lim.<br>2.2 i Kombi<br>2.2 i Lim.<br>2.2 Ti<br>2.3 TD<br>2.5 D Kombi<br>2.5 D Lim.<br>2.5 TD Kombi<br>2.5 TD Lim.<br>2.8 V6 |  |  | 01.82<br>04.82<br>11.80<br>08.79<br>09.85<br>08.83<br>01.86<br>05.81<br>03.84<br>09.80<br>08.83<br>06.81<br>10.85<br>10.83<br>06.86 | 10.86<br>11.87<br>10.86<br>10.86<br>12.86<br>12.93<br>12.93<br>12.93<br>10.88<br>06.86<br>12.93<br>12.93<br>12.93<br>12.93<br>12.93 | 24.5228-0216.3   | 330908   |  | L=216                |            |
|  | 2.3 TD<br>2.5 D Lim.   |  | 1.292.000<br>1.292.000   | 09.80<br>06.81  |   | 24.5112-0381.3   | 330711   |  | L=380                |            |

|     |  |  |  |                    |  |  |  |  |           |  |
|--|--|--|--|--|---|--|--|--|-----------|--|
| <b>PEUGEOT 508 (10-)</b>   |  |  |  |  |   |  |  |  |           |  |
|    | 1.6 HDi  | 82   | 11.10  |  | 03.7860-7802.4  | 300280   | + DSC/ - Start/Stop-Anlage <sup>1)</sup>   | 10"  | ATE       |  |
|  | 1.6 HDi  | 84   | 02.12  |  |   |  |  |  |           |  |
|  | 1.6 THP  | 115  | 11.10  |  | 03.7860-7802.4  | 300280   | + DSC  | 10"  | ATE       |  |
|  | 1.6 VTi  | 88   | 11.10  |  |   |  |  |  |           |  |
|  | 2.0 HDi  | 103  | 11.10  |  |   |  |  |  |           |  |
|  | 2.0 HDi AWC  | 120  | 11.10  |  |   |  |  |  |           |  |
|  | 2.2 HDi  | 150  | 11.10  |  |   |  |  |  |           |  |
|    | 1.6 HDi  | 82   | 11.10  | + Bremsscheibendurchm. 340 mm / + Bremsscheibendicke 30 mm <sup>2)</sup>                           | 11.9601-9883.2  | 220917   | <input type="checkbox"/> - Bremssattel lackiert <sup>3)</sup>                      | D=60, - Halter<br>D=60, - Halter<br>Hülzensatz<br>Führungsbolzen<br>Dichtungssatz  | ATE       |  |
|  | 1.6 HDi  | 84   | 02.12  | + Bremsscheibendurchm. 340 mm / + Bremsscheibendicke 30 mm <sup>2)</sup>                           | 11.9601-9884.2  | 220918   | <input type="checkbox"/> - Bremssattel lackiert <sup>3)</sup>                      |  | ATE       |  |
|  | 1.6 THP  | 115  | 11.10  | + Bremsscheibendurchm. 340 mm / + Bremsscheibendicke 30 mm <sup>2)</sup>                           | 11.0101-5407.2  | 260011   |  |  | ATE       |  |
|  | 1.6 VTi  | 88   | 11.10  | + Bremsscheibendurchm. 340 mm / + Bremsscheibendicke 30 mm <sup>2)</sup>                           | 11.8171-0008.1  | 990049   |  |  | ATE       |  |
|  | 2.0 HDi  | 103  | 11.10  | + Bremsscheibendurchm. 340 mm / + Bremsscheibendicke 30 mm <sup>2)</sup>                           | 11.0441-6008.2  | 250038   |  |  | ATE       |  |
|  | 2.0 HDi  | 120  | 11.10  | + Bremsscheibendurchm. 340 mm / + Bremsscheibendicke 30 mm <sup>2)</sup>                           |   |  |  |  |           |  |
|  | 2.0 HDi AWC  | 120  | 11.10  | + Bremsscheibendurchm. 340 mm / + Bremsscheibendicke 30 mm <sup>2)</sup>                           |   |  |  |  |           |  |
|  | Hybrid4  | 147  | 06.12  | + Bremsscheibendurchm. 340 mm / + Bremsscheibendicke 30 mm <sup>2)</sup>                           |   |  |  |  |           |  |
|    | 1.6 HDi  | 82   | 11.10  |  | 24.5151-0638.3  | 331141   | <input type="checkbox"/>   | L=638<br>L=638   |           |  |
|  | 1.6 HDi  | 84   | 02.12  |  | 24.5151-0639.3  | 331142   | <input type="checkbox"/>   |  |           |  |
|  | 1.6 THP  | 115  | 11.10  |  |   |  |  |  |           |  |
|  | 1.6 VTi  | 88   | 11.10  |  |   |  |  |  |           |  |
|  | 2.0 HDi  | 103  | 11.10  |  |   |  |  |  |           |  |
|  | 2.0 HDi AWC  | 120  | 11.10  |  |   |  |  |  |           |  |
|  | 2.2 HDi  | 150  | 11.10  |  |   |  |  |  |           |  |
| <b>PEUGEOT 508 SW (10-)</b>  |  |  |  |  |   |  |  |  |           |  |
|    | 1.6 HDi  | 82   | 11.10  |  | 03.7860-7802.4  | 300280   | + DSC/ - Start/Stop-Anlage <sup>1)</sup>   | 10"  | ATE       |  |
|  | 1.6 HDi  | 84   | 02.12  |  |   |  |  |  |           |  |
|  | 1.6 THP  | 115  | 11.10  |  | 03.7860-7802.4  | 300280   | + DSC  | 10"  | ATE       |  |
|  | 1.6 VTi  | 88   | 11.10  |  |   |  |  |  |           |  |
|  | 2.0 HDi  | 103  | 11.10  |  |   |  |  |  |           |  |
|  | 2.0 HDi RXH Hybrid   | 147  | 12.11  |  |   |  |  |  |           |  |
|  | 2.2 HDi  | 150  | 11.10  |  |   |  |  |  |           |  |
|    | 1.6 HDi  | 82   | 11.10  | + Bremsscheibendurchm. 340 mm / + Bremsscheibendicke 30 mm <sup>2)</sup>                           | 11.9601-9883.2  | 220917   | <input type="checkbox"/>   | D=60, - Halter<br>D=60, - Halter<br>Hülzensatz<br>Führungsbolzen<br>Dichtungssatz  | ATE       |  |
|  | 1.6 HDi  | 84   | 02.12  | + Bremsscheibendurchm. 340 mm / + Bremsscheibendicke 30 mm <sup>2)</sup>                           | 11.9601-9884.2  | 220918   | <input type="checkbox"/>   |  | ATE       |  |
|  | 1.6 THP  | 115  | 11.10  | + Bremsscheibendurchm. 340 mm / + Bremsscheibendicke 30 mm <sup>2)</sup>                           | 11.0101-5407.2  | 260011   |  |  | ATE       |  |
|  | 1.6 VTi  | 88   | 11.10  | + Bremsscheibendurchm. 340 mm / + Bremsscheibendicke 30 mm <sup>2)</sup>                           | 11.8171-0008.1  | 990049   |  |  | ATE       |  |
|  | 2.0 HDi  | 103  | 11.10  | + Bremsscheibendurchm. 340 mm / + Bremsscheibendicke 30 mm <sup>2)</sup>                           | 11.0441-6008.2  | 250038   |  |  | ATE       |  |
|  | 2.0 HDi  | 120  | 11.10  | + Bremsscheibendurchm. 340 mm / + Bremsscheibendicke 30 mm <sup>2)</sup>                           |   |  |  |  |           |  |
|  | 2.0 HDi RXH Hybrid   | 147  | 12.11  | + Bremsscheibendurchm. 340 mm / + Bremsscheibendicke 30 mm <sup>2)</sup>                           |   |  |  |  |           |  |
|  | 2.2 HDi  | 150  | 11.10  | + Bremsscheibendurchm. 340 mm / + Bremsscheibendicke 30 mm <sup>2)</sup>                           |   |  |  |  |           |  |
|  | 1.6 HDi  | 82   | 11.10  |  | 24.5151-0638.3  | 331141   | <input type="checkbox"/>   | L=638<br>L=638   |           |  |
|  | 1.6 HDi  | 84   | 02.12  |  | 24.5151-0639.3  | 331142   | <input type="checkbox"/>   |  |           |  |
|  | 1.6 THP  | 115  | 11.10  |  |   |  |  |  |           |  |
|  | 1.6 VTi  | 88   | 11.10  |  |   |  |  |  |           |  |
|  | 2.0 HDi  | 103  | 11.10  |  |   |  |  |  |           |  |
|  | 2.0 HDi AWC  | 120  | 11.10  |  |   |  |  |  |           |  |
|  | 2.2 HDi  | 150  | 11.10  |  |   |  |  |  |           |  |
| <b>PEUGEOT 605 (90-99)</b>   |  |  |  |  |   |  |  |  |           |  |
|  | 2.0  |  | 04.90  | 12.99 - ABS/ -  | 24.2122-1703.3  | 010422   |  | THz 22,20  |           |  |
|  | 2.0 16V  | 97   | 09.94  | - ABS  |   |  |  |  |           |  |
|  | 2.0 i  | 89   | 04.90  | 12.99 - ABS  |   |  |  |  |           |  |
|  | 2.1 D  | 60   | 04.90  | 08.94 - ABS  |   |  |  |  |           |  |
|  | 2.1 TD   | 80   | 10.90  | 12.99 - ABS  |   |  |  |  |           |  |
|  | 3.0 V6   | 123  | 04.90  | 08.94 - ABS  |   |  |  |  |           |  |
|  | 2.0  |  | 04.90  | 12.99 + ABS/ -  | 24.2122-1708.3  | 010437   |  |  | THz 22,20 |  |
|  | 2.0 16V  | 97   | 09.94  | + ABS  |   |  |  |  |           |  |
|  | 2.0 16V  | 97 ORGA 07693  |  | 12.99  |   |  |  |  |           |  |
|  | 2.0 i  | 89   | 04.90  | 12.99 + ABS  |   |  |  |  |           |  |
| 2.1 D  | 60   | 04.90  | 08.94 + ABS  |  |   |  |  |  |           |  |
| 2.1 TD   | 80   | 10.90  | 12.99 + ABS  |  |   |  |  |  |           |  |
| 2.0 Turbo  | 104  | 12.92  | 08.94 + ABS  | 03.2123-0921.3   | 010174  |  | THz 23,81 (MKIV)   | ATE  |           |  |
| 2.0 Turbo  | 108  | 09.94  | 12.99 + ABS  |  |   |  |  |  |           |  |
| 2.5 TD   | 95   | 09.94  | 12.99 + ABS  |  |   |  |  |  |           |  |
| 3.0 V6   | 123  | 04.90  | 12.99 + ABS/ - ASR   |  |   |  |  |  |           |  |
| 3.0 V6   | 140  | 04.97  | 12.99  |  |   |  |  |  |           |  |
| 3.0 V6   | 147  | 04.90  | 12.99 + ABS/ - ASR   |  |   |  |  |  |           |  |
|  | 2.0  | S 90807684   | 09.94  | 12.99 -         | 24.3571-1723.5  | 240307   | <input type="checkbox"/>   | D=57, - Halter   | BDX       |  |
|  | 2.0 16V  | 97   | 09.94  | 12.99  |   |  |  |  |           |  |
|  | 2.0 i  | 89 S 90807684  |  | 12.99  |   |  |  |  |           |  |
|  | 2.0 Turbo  | 104 S 90807684   |  | 08.94  |   |  |  |  |           |  |
|  | 2.0 Turbo  | 108  | 09.94  | 12.99  |   |  |  |  |           |  |
|  | 2.1 D  | 60 S 90807684  |  | 08.94  |   |  |  |  |           |  |
|  | 2.1 TD   | 80 S 90807684  |  | 12.99  |   |  |  |  |           |  |
|  | 3.0 V6   | 123 S 90807684   |  | 12.99  |   |  |  |  |           |  |
| 3.0 V6   | 140  | 04.97  | 12.99  | 11.0441-5703.2   | 250145  |  | Dichtungssatz  | ATE  |           |  |
| 3.0 V6   | 147 S 90807684   |  | 12.99  | 11.0101-5407.2   | 260011  |  |  | ATE  |           |  |
|  |  |  |  | 11.8171-0008.1   | 990049  |  |  | ATE  |           |  |
|  |  |  |  | 11.8116-0143.1   | 390513  | 2  |  | ATE  |           |  |
|  |  |  |  | 24.5118-0520.3   | 330600  | 2  |  |  |           |  |
|  | 2.0  |  | 04.90  | 12.99 -         |   |  |  | L=520  |           |  |
|  | 2.0 16V  | 97   | 09.94  | 12.99  |   |  |  |  |           |  |
|  | 2.0 i  | 89   | 04.90  | 12.99  |   |  |  |  |           |  |
|  | 2.0 Turbo  | 104  | 12.92  | 08.94  |   |  |  |  |           |  |

<sup>1)</sup> + DSC/ - start/stop system / + DSC/ - impianto start/stop / + DSC/ - unité marche/arrêt / + DSC/ - instalac ión de arranque/paro

<sup>2)</sup> + br.disc diam. 340mm /+ br.disc thickness 30mm / + disco fr.diam. 340mm /+ disco fr.spessore 30mm / + disques fr.diam. 340mm /+ disques fr.épaisseur 30mm / + disco fr.diám. 340mm /+ disco fr.esesor 30mm

<sup>3)</sup> - brake caliper, painted / - pinza freno, verniciata / - étrier de frein, verni / - pinza de freno, pintada

| PEUGEOT 605 (90-99)  |   |           |       |                |                |                |                |                              |                   |                              |                   |         |         |       |       |       |                |                |        |                              |       |                   |       |         |       |       |       |  |        |    |       |           |     |       |         |     |       |        |     |       |       |           |     |       |       |         |        |       |       |       |  |            |     |       |       |  |            |     |       |       |  |        |    |       |       |  |  |         |     |       |       |        |    |       |       |  |  |  |             |     |       |        |     |       |       |  |  |  |  |            |     |        |       |       |       |  |  |  |  |  |  |        |     |       |       |  |  |  |  |  |  |
|--|---|-----------|-------|----------------|----------------|----------------|----------------|------------------------------|-------------------|------------------------------|-------------------|---------|---------|-------|-------|-------|----------------|----------------|--------|------------------------------|-------|-------------------|-------|---------|-------|-------|-------|--|--------|----|-------|-----------|-----|-------|---------|-----|-------|--------|-----|-------|-------|-----------|-----|-------|-------|---------|--------|-------|-------|-------|--|------------|-----|-------|-------|--|------------|-----|-------|-------|--|--------|----|-------|-------|--|--|---------|-----|-------|-------|--------|----|-------|-------|--|--|--|-------------|-----|-------|--------|-----|-------|-------|--|--|--|--|------------|-----|--------|-------|-------|-------|--|--|--|--|--|--|--------|-----|-------|-------|--|--|--|--|--|--|
|     | <table border="1"> <tr><td>2.0 Turbo</td><td>108</td><td>09.94</td><td>12.99</td><td>24.5118-0520.3</td><td>330600</td><td>2</td><td></td><td>L=520</td></tr> <tr><td>2.1 D</td><td>60</td><td>04.90</td><td>08.94</td><td></td><td></td><td></td><td></td><td></td></tr> <tr><td>2.1 TD</td><td>80</td><td>10.90</td><td>12.99</td><td></td><td></td><td></td><td></td><td></td></tr> <tr><td>2.5 TD</td><td>95</td><td>09.94</td><td>12.99</td><td></td><td></td><td></td><td></td><td></td></tr> <tr><td>3.0 V6</td><td>123</td><td>04.90</td><td>12.99</td><td></td><td></td><td></td><td></td><td></td></tr> <tr><td>3.0 V6</td><td>147</td><td>04.90</td><td>12.99</td><td></td><td></td><td></td><td></td><td></td></tr> </table>  | 2.0 Turbo | 108   | 09.94          | 12.99          | 24.5118-0520.3 | 330600         | 2                            |                   | L=520                        | 2.1 D             | 60      | 04.90   | 08.94 |       |       |                |                |        | 2.1 TD                       | 80    | 10.90             | 12.99 |         |       |       |       |  | 2.5 TD | 95 | 09.94 | 12.99     |     |       |         |     |       | 3.0 V6 | 123 | 04.90 | 12.99 |           |     |       |       |         | 3.0 V6 | 147   | 04.90 | 12.99 |  |            |     |       |       |  |            |     |       |       |  |        |    |       |       |  |  |         |     |       |       |        |    |       |       |  |  |  |             |     |       |        |     |       |       |  |  |  |  |            |     |        |       |       |       |  |  |  |  |  |  |        |     |       |       |  |  |  |  |  |  |
| 2.0 Turbo  | 108   | 09.94     | 12.99 | 24.5118-0520.3 | 330600         | 2              |                | L=520                        |                   |                              |                   |         |         |       |       |       |                |                |        |                              |       |                   |       |         |       |       |       |  |        |    |       |           |     |       |         |     |       |        |     |       |       |           |     |       |       |         |        |       |       |       |  |            |     |       |       |  |            |     |       |       |  |        |    |       |       |  |  |         |     |       |       |        |    |       |       |  |  |  |             |     |       |        |     |       |       |  |  |  |  |            |     |        |       |       |       |  |  |  |  |  |  |        |     |       |       |  |  |  |  |  |  |
| 2.1 D  | 60  | 04.90     | 08.94 |                |                |                |                |                              |                   |                              |                   |         |         |       |       |       |                |                |        |                              |       |                   |       |         |       |       |       |  |        |    |       |           |     |       |         |     |       |        |     |       |       |           |     |       |       |         |        |       |       |       |  |            |     |       |       |  |            |     |       |       |  |        |    |       |       |  |  |         |     |       |       |        |    |       |       |  |  |  |             |     |       |        |     |       |       |  |  |  |  |            |     |        |       |       |       |  |  |  |  |  |  |        |     |       |       |  |  |  |  |  |  |
| 2.1 TD   | 80  | 10.90     | 12.99 |                |                |                |                |                              |                   |                              |                   |         |         |       |       |       |                |                |        |                              |       |                   |       |         |       |       |       |  |        |    |       |           |     |       |         |     |       |        |     |       |       |           |     |       |       |         |        |       |       |       |  |            |     |       |       |  |            |     |       |       |  |        |    |       |       |  |  |         |     |       |       |        |    |       |       |  |  |  |             |     |       |        |     |       |       |  |  |  |  |            |     |        |       |       |       |  |  |  |  |  |  |        |     |       |       |  |  |  |  |  |  |
| 2.5 TD   | 95  | 09.94     | 12.99 |                |                |                |                |                              |                   |                              |                   |         |         |       |       |       |                |                |        |                              |       |                   |       |         |       |       |       |  |        |    |       |           |     |       |         |     |       |        |     |       |       |           |     |       |       |         |        |       |       |       |  |            |     |       |       |  |            |     |       |       |  |        |    |       |       |  |  |         |     |       |       |        |    |       |       |  |  |  |             |     |       |        |     |       |       |  |  |  |  |            |     |        |       |       |       |  |  |  |  |  |  |        |     |       |       |  |  |  |  |  |  |
| 3.0 V6   | 123   | 04.90     | 12.99 |                |                |                |                |                              |                   |                              |                   |         |         |       |       |       |                |                |        |                              |       |                   |       |         |       |       |       |  |        |    |       |           |     |       |         |     |       |        |     |       |       |           |     |       |       |         |        |       |       |       |  |            |     |       |       |  |            |     |       |       |  |        |    |       |       |  |  |         |     |       |       |        |    |       |       |  |  |  |             |     |       |        |     |       |       |  |  |  |  |            |     |        |       |       |       |  |  |  |  |  |  |        |     |       |       |  |  |  |  |  |  |
| 3.0 V6   | 147   | 04.90     | 12.99 |                |                |                |                |                              |                   |                              |                   |         |         |       |       |       |                |                |        |                              |       |                   |       |         |       |       |       |  |        |    |       |           |     |       |         |     |       |        |     |       |       |           |     |       |       |         |        |       |       |       |  |            |     |       |       |  |            |     |       |       |  |        |    |       |       |  |  |         |     |       |       |        |    |       |       |  |  |  |             |     |       |        |     |       |       |  |  |  |  |            |     |        |       |       |       |  |  |  |  |  |  |        |     |       |       |  |  |  |  |  |  |
|    | <table border="1"> <tr><td>2.0</td><td></td><td>04.90</td><td>12.99</td><td>- (D)</td><td>11.0441-3305.2</td><td>250006</td><td></td><td>Dichtungssatz</td><td>ATE</td></tr> <tr><td>2.0 16V</td><td>97</td><td>09.94</td><td>12.99</td><td></td><td></td><td></td><td></td><td></td><td></td></tr> <tr><td>2.0 i</td><td>89</td><td>04.90</td><td>12.99</td><td></td><td></td><td></td><td></td><td></td><td></td></tr> <tr><td>2.0 Turbo</td><td>104</td><td>12.92</td><td>08.94</td><td></td><td></td><td></td><td></td><td></td><td></td></tr> <tr><td>2.0 Turbo</td><td>108</td><td>09.94</td><td>12.99</td><td></td><td></td><td></td><td></td><td></td><td></td></tr> <tr><td>2.1 D</td><td>60</td><td>04.90</td><td>08.94</td><td></td><td></td><td></td><td></td><td></td><td></td></tr> <tr><td>2.1 TD</td><td>80</td><td>10.90</td><td>12.99</td><td></td><td></td><td></td><td></td><td></td><td></td></tr> <tr><td>2.5 TD</td><td>95</td><td>09.94</td><td>12.99</td><td></td><td></td><td></td><td></td><td></td><td></td></tr> <tr><td>3.0 V6</td><td>123</td><td>04.90</td><td>12.99</td><td></td><td></td><td></td><td></td><td></td><td></td></tr> <tr><td>3.0 V6</td><td>140</td><td>04.97</td><td>12.99</td><td></td><td></td><td></td><td></td><td></td><td></td></tr> <tr><td>3.0 V6</td><td>147</td><td>04.90</td><td>12.99</td><td></td><td></td><td></td><td></td><td></td><td></td></tr> </table>   | 2.0       |       | 04.90          | 12.99          | - (D)          | 11.0441-3305.2 | 250006                       |                   | Dichtungssatz                | ATE               | 2.0 16V | 97      | 09.94 | 12.99 |       |                |                |        |                              |       | 2.0 i             | 89    | 04.90   | 12.99 |       |       |  |        |    |       | 2.0 Turbo | 104 | 12.92 | 08.94   |     |       |        |     |       |       | 2.0 Turbo | 108 | 09.94 | 12.99 |         |        |       |       |       |  | 2.1 D      | 60  | 04.90 | 08.94 |  |            |     |       |       |  | 2.1 TD | 80 | 10.90 | 12.99 |  |  |         |     |       |       | 2.5 TD | 95 | 09.94 | 12.99 |  |  |  |             |     |       | 3.0 V6 | 123 | 04.90 | 12.99 |  |  |  |  |            |     | 3.0 V6 | 140   | 04.97 | 12.99 |  |  |  |  |  |  | 3.0 V6 | 147 | 04.90 | 12.99 |  |  |  |  |  |  |
| 2.0  |   | 04.90     | 12.99 | - (D)          | 11.0441-3305.2 | 250006         |                | Dichtungssatz                | ATE               |                              |                   |         |         |       |       |       |                |                |        |                              |       |                   |       |         |       |       |       |  |        |    |       |           |     |       |         |     |       |        |     |       |       |           |     |       |       |         |        |       |       |       |  |            |     |       |       |  |            |     |       |       |  |        |    |       |       |  |  |         |     |       |       |        |    |       |       |  |  |  |             |     |       |        |     |       |       |  |  |  |  |            |     |        |       |       |       |  |  |  |  |  |  |        |     |       |       |  |  |  |  |  |  |
| 2.0 16V  | 97  | 09.94     | 12.99 |                |                |                |                |                              |                   |                              |                   |         |         |       |       |       |                |                |        |                              |       |                   |       |         |       |       |       |  |        |    |       |           |     |       |         |     |       |        |     |       |       |           |     |       |       |         |        |       |       |       |  |            |     |       |       |  |            |     |       |       |  |        |    |       |       |  |  |         |     |       |       |        |    |       |       |  |  |  |             |     |       |        |     |       |       |  |  |  |  |            |     |        |       |       |       |  |  |  |  |  |  |        |     |       |       |  |  |  |  |  |  |
| 2.0 i  | 89  | 04.90     | 12.99 |                |                |                |                |                              |                   |                              |                   |         |         |       |       |       |                |                |        |                              |       |                   |       |         |       |       |       |  |        |    |       |           |     |       |         |     |       |        |     |       |       |           |     |       |       |         |        |       |       |       |  |            |     |       |       |  |            |     |       |       |  |        |    |       |       |  |  |         |     |       |       |        |    |       |       |  |  |  |             |     |       |        |     |       |       |  |  |  |  |            |     |        |       |       |       |  |  |  |  |  |  |        |     |       |       |  |  |  |  |  |  |
| 2.0 Turbo  | 104   | 12.92     | 08.94 |                |                |                |                |                              |                   |                              |                   |         |         |       |       |       |                |                |        |                              |       |                   |       |         |       |       |       |  |        |    |       |           |     |       |         |     |       |        |     |       |       |           |     |       |       |         |        |       |       |       |  |            |     |       |       |  |            |     |       |       |  |        |    |       |       |  |  |         |     |       |       |        |    |       |       |  |  |  |             |     |       |        |     |       |       |  |  |  |  |            |     |        |       |       |       |  |  |  |  |  |  |        |     |       |       |  |  |  |  |  |  |
| 2.0 Turbo  | 108   | 09.94     | 12.99 |                |                |                |                |                              |                   |                              |                   |         |         |       |       |       |                |                |        |                              |       |                   |       |         |       |       |       |  |        |    |       |           |     |       |         |     |       |        |     |       |       |           |     |       |       |         |        |       |       |       |  |            |     |       |       |  |            |     |       |       |  |        |    |       |       |  |  |         |     |       |       |        |    |       |       |  |  |  |             |     |       |        |     |       |       |  |  |  |  |            |     |        |       |       |       |  |  |  |  |  |  |        |     |       |       |  |  |  |  |  |  |
| 2.1 D  | 60  | 04.90     | 08.94 |                |                |                |                |                              |                   |                              |                   |         |         |       |       |       |                |                |        |                              |       |                   |       |         |       |       |       |  |        |    |       |           |     |       |         |     |       |        |     |       |       |           |     |       |       |         |        |       |       |       |  |            |     |       |       |  |            |     |       |       |  |        |    |       |       |  |  |         |     |       |       |        |    |       |       |  |  |  |             |     |       |        |     |       |       |  |  |  |  |            |     |        |       |       |       |  |  |  |  |  |  |        |     |       |       |  |  |  |  |  |  |
| 2.1 TD   | 80  | 10.90     | 12.99 |                |                |                |                |                              |                   |                              |                   |         |         |       |       |       |                |                |        |                              |       |                   |       |         |       |       |       |  |        |    |       |           |     |       |         |     |       |        |     |       |       |           |     |       |       |         |        |       |       |       |  |            |     |       |       |  |            |     |       |       |  |        |    |       |       |  |  |         |     |       |       |        |    |       |       |  |  |  |             |     |       |        |     |       |       |  |  |  |  |            |     |        |       |       |       |  |  |  |  |  |  |        |     |       |       |  |  |  |  |  |  |
| 2.5 TD   | 95  | 09.94     | 12.99 |                |                |                |                |                              |                   |                              |                   |         |         |       |       |       |                |                |        |                              |       |                   |       |         |       |       |       |  |        |    |       |           |     |       |         |     |       |        |     |       |       |           |     |       |       |         |        |       |       |       |  |            |     |       |       |  |            |     |       |       |  |        |    |       |       |  |  |         |     |       |       |        |    |       |       |  |  |  |             |     |       |        |     |       |       |  |  |  |  |            |     |        |       |       |       |  |  |  |  |  |  |        |     |       |       |  |  |  |  |  |  |
| 3.0 V6   | 123   | 04.90     | 12.99 |                |                |                |                |                              |                   |                              |                   |         |         |       |       |       |                |                |        |                              |       |                   |       |         |       |       |       |  |        |    |       |           |     |       |         |     |       |        |     |       |       |           |     |       |       |         |        |       |       |       |  |            |     |       |       |  |            |     |       |       |  |        |    |       |       |  |  |         |     |       |       |        |    |       |       |  |  |  |             |     |       |        |     |       |       |  |  |  |  |            |     |        |       |       |       |  |  |  |  |  |  |        |     |       |       |  |  |  |  |  |  |
| 3.0 V6   | 140   | 04.97     | 12.99 |                |                |                |                |                              |                   |                              |                   |         |         |       |       |       |                |                |        |                              |       |                   |       |         |       |       |       |  |        |    |       |           |     |       |         |     |       |        |     |       |       |           |     |       |       |         |        |       |       |       |  |            |     |       |       |  |            |     |       |       |  |        |    |       |       |  |  |         |     |       |       |        |    |       |       |  |  |  |             |     |       |        |     |       |       |  |  |  |  |            |     |        |       |       |       |  |  |  |  |  |  |        |     |       |       |  |  |  |  |  |  |
| 3.0 V6   | 147   | 04.90     | 12.99 |                |                |                |                |                              |                   |                              |                   |         |         |       |       |       |                |                |        |                              |       |                   |       |         |       |       |       |  |        |    |       |           |     |       |         |     |       |        |     |       |       |           |     |       |       |         |        |       |       |       |  |            |     |       |       |  |            |     |       |       |  |        |    |       |       |  |  |         |     |       |       |        |    |       |       |  |  |  |             |     |       |        |     |       |       |  |  |  |  |            |     |        |       |       |       |  |  |  |  |  |  |        |     |       |       |  |  |  |  |  |  |
|    | <table border="1"> <tr><td>2.0</td><td></td><td>04.90</td><td>12.99</td><td>- (D)</td><td>24.5229-0181.3</td><td>330533</td><td>2</td><td>Länge beachten <sup>1)</sup></td><td>L=180</td></tr> <tr><td>2.0 16V</td><td>97</td><td>09.94</td><td>12.99</td><td></td><td>24.5111-0201.3</td><td>330498</td><td>2</td><td>Länge beachten <sup>1)</sup></td><td>L=200</td></tr> <tr><td>2.0 i</td><td>89</td><td>04.90</td><td>12.99</td><td></td><td></td><td></td><td></td><td></td><td></td></tr> <tr><td>2.0 Turbo</td><td>104</td><td>12.92</td><td>08.94</td><td></td><td></td><td></td><td></td><td></td><td></td></tr> <tr><td>2.0 Turbo</td><td>108</td><td>09.94</td><td>12.99</td><td></td><td></td><td></td><td></td><td></td><td></td></tr> <tr><td>2.1 D</td><td>60</td><td>04.90</td><td>08.94</td><td></td><td></td><td></td><td></td><td></td><td></td></tr> <tr><td>2.1 TD</td><td>80</td><td>10.90</td><td>12.99</td><td></td><td></td><td></td><td></td><td></td><td></td></tr> <tr><td>2.5 TD</td><td>95</td><td>09.94</td><td>12.99</td><td></td><td></td><td></td><td></td><td></td><td></td></tr> <tr><td>3.0 V6</td><td>123</td><td>04.90</td><td>12.99</td><td></td><td></td><td></td><td></td><td></td><td></td></tr> <tr><td>3.0 V6</td><td>140</td><td>04.97</td><td>12.99</td><td></td><td></td><td></td><td></td><td></td><td></td></tr> <tr><td>3.0 V6</td><td>147</td><td>04.90</td><td>12.99</td><td></td><td></td><td></td><td></td><td></td><td></td></tr> </table> | 2.0       |       | 04.90          | 12.99          | - (D)          | 24.5229-0181.3 | 330533                       | 2                 | Länge beachten <sup>1)</sup> | L=180             | 2.0 16V | 97      | 09.94 | 12.99 |       | 24.5111-0201.3 | 330498         | 2      | Länge beachten <sup>1)</sup> | L=200 | 2.0 i             | 89    | 04.90   | 12.99 |       |       |  |        |    |       | 2.0 Turbo | 104 | 12.92 | 08.94   |     |       |        |     |       |       | 2.0 Turbo | 108 | 09.94 | 12.99 |         |        |       |       |       |  | 2.1 D      | 60  | 04.90 | 08.94 |  |            |     |       |       |  | 2.1 TD | 80 | 10.90 | 12.99 |  |  |         |     |       |       | 2.5 TD | 95 | 09.94 | 12.99 |  |  |  |             |     |       | 3.0 V6 | 123 | 04.90 | 12.99 |  |  |  |  |            |     | 3.0 V6 | 140   | 04.97 | 12.99 |  |  |  |  |  |  | 3.0 V6 | 147 | 04.90 | 12.99 |  |  |  |  |  |  |
| 2.0  |   | 04.90     | 12.99 | - (D)          | 24.5229-0181.3 | 330533         | 2              | Länge beachten <sup>1)</sup> | L=180             |                              |                   |         |         |       |       |       |                |                |        |                              |       |                   |       |         |       |       |       |  |        |    |       |           |     |       |         |     |       |        |     |       |       |           |     |       |       |         |        |       |       |       |  |            |     |       |       |  |            |     |       |       |  |        |    |       |       |  |  |         |     |       |       |        |    |       |       |  |  |  |             |     |       |        |     |       |       |  |  |  |  |            |     |        |       |       |       |  |  |  |  |  |  |        |     |       |       |  |  |  |  |  |  |
| 2.0 16V  | 97  | 09.94     | 12.99 |                | 24.5111-0201.3 | 330498         | 2              | Länge beachten <sup>1)</sup> | L=200             |                              |                   |         |         |       |       |       |                |                |        |                              |       |                   |       |         |       |       |       |  |        |    |       |           |     |       |         |     |       |        |     |       |       |           |     |       |       |         |        |       |       |       |  |            |     |       |       |  |            |     |       |       |  |        |    |       |       |  |  |         |     |       |       |        |    |       |       |  |  |  |             |     |       |        |     |       |       |  |  |  |  |            |     |        |       |       |       |  |  |  |  |  |  |        |     |       |       |  |  |  |  |  |  |
| 2.0 i  | 89  | 04.90     | 12.99 |                |                |                |                |                              |                   |                              |                   |         |         |       |       |       |                |                |        |                              |       |                   |       |         |       |       |       |  |        |    |       |           |     |       |         |     |       |        |     |       |       |           |     |       |       |         |        |       |       |       |  |            |     |       |       |  |            |     |       |       |  |        |    |       |       |  |  |         |     |       |       |        |    |       |       |  |  |  |             |     |       |        |     |       |       |  |  |  |  |            |     |        |       |       |       |  |  |  |  |  |  |        |     |       |       |  |  |  |  |  |  |
| 2.0 Turbo  | 104   | 12.92     | 08.94 |                |                |                |                |                              |                   |                              |                   |         |         |       |       |       |                |                |        |                              |       |                   |       |         |       |       |       |  |        |    |       |           |     |       |         |     |       |        |     |       |       |           |     |       |       |         |        |       |       |       |  |            |     |       |       |  |            |     |       |       |  |        |    |       |       |  |  |         |     |       |       |        |    |       |       |  |  |  |             |     |       |        |     |       |       |  |  |  |  |            |     |        |       |       |       |  |  |  |  |  |  |        |     |       |       |  |  |  |  |  |  |
| 2.0 Turbo  | 108   | 09.94     | 12.99 |                |                |                |                |                              |                   |                              |                   |         |         |       |       |       |                |                |        |                              |       |                   |       |         |       |       |       |  |        |    |       |           |     |       |         |     |       |        |     |       |       |           |     |       |       |         |        |       |       |       |  |            |     |       |       |  |            |     |       |       |  |        |    |       |       |  |  |         |     |       |       |        |    |       |       |  |  |  |             |     |       |        |     |       |       |  |  |  |  |            |     |        |       |       |       |  |  |  |  |  |  |        |     |       |       |  |  |  |  |  |  |
| 2.1 D  | 60  | 04.90     | 08.94 |                |                |                |                |                              |                   |                              |                   |         |         |       |       |       |                |                |        |                              |       |                   |       |         |       |       |       |  |        |    |       |           |     |       |         |     |       |        |     |       |       |           |     |       |       |         |        |       |       |       |  |            |     |       |       |  |            |     |       |       |  |        |    |       |       |  |  |         |     |       |       |        |    |       |       |  |  |  |             |     |       |        |     |       |       |  |  |  |  |            |     |        |       |       |       |  |  |  |  |  |  |        |     |       |       |  |  |  |  |  |  |
| 2.1 TD   | 80  | 10.90     | 12.99 |                |                |                |                |                              |                   |                              |                   |         |         |       |       |       |                |                |        |                              |       |                   |       |         |       |       |       |  |        |    |       |           |     |       |         |     |       |        |     |       |       |           |     |       |       |         |        |       |       |       |  |            |     |       |       |  |            |     |       |       |  |        |    |       |       |  |  |         |     |       |       |        |    |       |       |  |  |  |             |     |       |        |     |       |       |  |  |  |  |            |     |        |       |       |       |  |  |  |  |  |  |        |     |       |       |  |  |  |  |  |  |
| 2.5 TD   | 95  | 09.94     | 12.99 |                |                |                |                |                              |                   |                              |                   |         |         |       |       |       |                |                |        |                              |       |                   |       |         |       |       |       |  |        |    |       |           |     |       |         |     |       |        |     |       |       |           |     |       |       |         |        |       |       |       |  |            |     |       |       |  |            |     |       |       |  |        |    |       |       |  |  |         |     |       |       |        |    |       |       |  |  |  |             |     |       |        |     |       |       |  |  |  |  |            |     |        |       |       |       |  |  |  |  |  |  |        |     |       |       |  |  |  |  |  |  |
| 3.0 V6   | 123   | 04.90     | 12.99 |                |                |                |                |                              |                   |                              |                   |         |         |       |       |       |                |                |        |                              |       |                   |       |         |       |       |       |  |        |    |       |           |     |       |         |     |       |        |     |       |       |           |     |       |       |         |        |       |       |       |  |            |     |       |       |  |            |     |       |       |  |        |    |       |       |  |  |         |     |       |       |        |    |       |       |  |  |  |             |     |       |        |     |       |       |  |  |  |  |            |     |        |       |       |       |  |  |  |  |  |  |        |     |       |       |  |  |  |  |  |  |
| 3.0 V6   | 140   | 04.97     | 12.99 |                |                |                |                |                              |                   |                              |                   |         |         |       |       |       |                |                |        |                              |       |                   |       |         |       |       |       |  |        |    |       |           |     |       |         |     |       |        |     |       |       |           |     |       |       |         |        |       |       |       |  |            |     |       |       |  |            |     |       |       |  |        |    |       |       |  |  |         |     |       |       |        |    |       |       |  |  |  |             |     |       |        |     |       |       |  |  |  |  |            |     |        |       |       |       |  |  |  |  |  |  |        |     |       |       |  |  |  |  |  |  |
| 3.0 V6   | 147   | 04.90     | 12.99 |                |                |                |                |                              |                   |                              |                   |         |         |       |       |       |                |                |        |                              |       |                   |       |         |       |       |       |  |        |    |       |           |     |       |         |     |       |        |     |       |       |           |     |       |       |         |        |       |       |       |  |            |     |       |       |  |            |     |       |       |  |        |    |       |       |  |  |         |     |       |       |        |    |       |       |  |  |  |             |     |       |        |     |       |       |  |  |  |  |            |     |        |       |       |       |  |  |  |  |  |  |        |     |       |       |  |  |  |  |  |  |
|    | <table border="1"> <tr><td>2.0</td><td></td><td>04.90</td><td>12.99</td><td>- (D)</td><td>03.6583-0031.3</td><td>320106</td><td></td><td>BRL 8/3 (4)</td><td>ATE</td></tr> <tr><td>2.0 16V</td><td>97</td><td>09.94</td><td>12.99</td><td></td><td></td><td></td><td></td><td></td><td></td></tr> <tr><td>2.0 i</td><td>89</td><td>04.90</td><td>12.99</td><td></td><td></td><td></td><td></td><td></td><td></td></tr> <tr><td>2.0 Turbo</td><td>104</td><td>12.92</td><td>08.94</td><td></td><td></td><td></td><td></td><td></td><td></td></tr> <tr><td>2.0 Turbo</td><td>108</td><td>09.94</td><td>12.99</td><td></td><td></td><td></td><td></td><td></td><td></td></tr> <tr><td>2.1 D</td><td>60</td><td>04.90</td><td>08.94</td><td></td><td></td><td></td><td></td><td></td><td></td></tr> <tr><td>2.1 TD</td><td>80</td><td>10.90</td><td>12.99</td><td></td><td></td><td></td><td></td><td></td><td></td></tr> <tr><td>2.5 TD</td><td>95</td><td>09.94</td><td>12.99</td><td></td><td></td><td></td><td></td><td></td><td></td></tr> <tr><td>3.0 V6</td><td>123</td><td>04.90</td><td>12.99</td><td></td><td></td><td></td><td></td><td></td><td></td></tr> <tr><td>3.0 V6</td><td>140</td><td>04.97</td><td>12.99</td><td></td><td></td><td></td><td></td><td></td><td></td></tr> <tr><td>3.0 V6</td><td>147</td><td>04.90</td><td>12.99</td><td></td><td></td><td></td><td></td><td></td><td></td></tr> </table>   | 2.0       |       | 04.90          | 12.99          | - (D)          | 03.6583-0031.3 | 320106                       |                   | BRL 8/3 (4)                  | ATE               | 2.0 16V | 97      | 09.94 | 12.99 |       |                |                |        |                              |       | 2.0 i             | 89    | 04.90   | 12.99 |       |       |  |        |    |       | 2.0 Turbo | 104 | 12.92 | 08.94   |     |       |        |     |       |       | 2.0 Turbo | 108 | 09.94 | 12.99 |         |        |       |       |       |  | 2.1 D      | 60  | 04.90 | 08.94 |  |            |     |       |       |  | 2.1 TD | 80 | 10.90 | 12.99 |  |  |         |     |       |       | 2.5 TD | 95 | 09.94 | 12.99 |  |  |  |             |     |       | 3.0 V6 | 123 | 04.90 | 12.99 |  |  |  |  |            |     | 3.0 V6 | 140   | 04.97 | 12.99 |  |  |  |  |  |  | 3.0 V6 | 147 | 04.90 | 12.99 |  |  |  |  |  |  |
| 2.0  |   | 04.90     | 12.99 | - (D)          | 03.6583-0031.3 | 320106         |                | BRL 8/3 (4)                  | ATE               |                              |                   |         |         |       |       |       |                |                |        |                              |       |                   |       |         |       |       |       |  |        |    |       |           |     |       |         |     |       |        |     |       |       |           |     |       |       |         |        |       |       |       |  |            |     |       |       |  |            |     |       |       |  |        |    |       |       |  |  |         |     |       |       |        |    |       |       |  |  |  |             |     |       |        |     |       |       |  |  |  |  |            |     |        |       |       |       |  |  |  |  |  |  |        |     |       |       |  |  |  |  |  |  |
| 2.0 16V  | 97  | 09.94     | 12.99 |                |                |                |                |                              |                   |                              |                   |         |         |       |       |       |                |                |        |                              |       |                   |       |         |       |       |       |  |        |    |       |           |     |       |         |     |       |        |     |       |       |           |     |       |       |         |        |       |       |       |  |            |     |       |       |  |            |     |       |       |  |        |    |       |       |  |  |         |     |       |       |        |    |       |       |  |  |  |             |     |       |        |     |       |       |  |  |  |  |            |     |        |       |       |       |  |  |  |  |  |  |        |     |       |       |  |  |  |  |  |  |
| 2.0 i  | 89  | 04.90     | 12.99 |                |                |                |                |                              |                   |                              |                   |         |         |       |       |       |                |                |        |                              |       |                   |       |         |       |       |       |  |        |    |       |           |     |       |         |     |       |        |     |       |       |           |     |       |       |         |        |       |       |       |  |            |     |       |       |  |            |     |       |       |  |        |    |       |       |  |  |         |     |       |       |        |    |       |       |  |  |  |             |     |       |        |     |       |       |  |  |  |  |            |     |        |       |       |       |  |  |  |  |  |  |        |     |       |       |  |  |  |  |  |  |
| 2.0 Turbo  | 104   | 12.92     | 08.94 |                |                |                |                |                              |                   |                              |                   |         |         |       |       |       |                |                |        |                              |       |                   |       |         |       |       |       |  |        |    |       |           |     |       |         |     |       |        |     |       |       |           |     |       |       |         |        |       |       |       |  |            |     |       |       |  |            |     |       |       |  |        |    |       |       |  |  |         |     |       |       |        |    |       |       |  |  |  |             |     |       |        |     |       |       |  |  |  |  |            |     |        |       |       |       |  |  |  |  |  |  |        |     |       |       |  |  |  |  |  |  |
| 2.0 Turbo  | 108   | 09.94     | 12.99 |                |                |                |                |                              |                   |                              |                   |         |         |       |       |       |                |                |        |                              |       |                   |       |         |       |       |       |  |        |    |       |           |     |       |         |     |       |        |     |       |       |           |     |       |       |         |        |       |       |       |  |            |     |       |       |  |            |     |       |       |  |        |    |       |       |  |  |         |     |       |       |        |    |       |       |  |  |  |             |     |       |        |     |       |       |  |  |  |  |            |     |        |       |       |       |  |  |  |  |  |  |        |     |       |       |  |  |  |  |  |  |
| 2.1 D  | 60  | 04.90     | 08.94 |                |                |                |                |                              |                   |                              |                   |         |         |       |       |       |                |                |        |                              |       |                   |       |         |       |       |       |  |        |    |       |           |     |       |         |     |       |        |     |       |       |           |     |       |       |         |        |       |       |       |  |            |     |       |       |  |            |     |       |       |  |        |    |       |       |  |  |         |     |       |       |        |    |       |       |  |  |  |             |     |       |        |     |       |       |  |  |  |  |            |     |        |       |       |       |  |  |  |  |  |  |        |     |       |       |  |  |  |  |  |  |
| 2.1 TD   | 80  | 10.90     | 12.99 |                |                |                |                |                              |                   |                              |                   |         |         |       |       |       |                |                |        |                              |       |                   |       |         |       |       |       |  |        |    |       |           |     |       |         |     |       |        |     |       |       |           |     |       |       |         |        |       |       |       |  |            |     |       |       |  |            |     |       |       |  |        |    |       |       |  |  |         |     |       |       |        |    |       |       |  |  |  |             |     |       |        |     |       |       |  |  |  |  |            |     |        |       |       |       |  |  |  |  |  |  |        |     |       |       |  |  |  |  |  |  |
| 2.5 TD   | 95  | 09.94     | 12.99 |                |                |                |                |                              |                   |                              |                   |         |         |       |       |       |                |                |        |                              |       |                   |       |         |       |       |       |  |        |    |       |           |     |       |         |     |       |        |     |       |       |           |     |       |       |         |        |       |       |       |  |            |     |       |       |  |            |     |       |       |  |        |    |       |       |  |  |         |     |       |       |        |    |       |       |  |  |  |             |     |       |        |     |       |       |  |  |  |  |            |     |        |       |       |       |  |  |  |  |  |  |        |     |       |       |  |  |  |  |  |  |
| 3.0 V6   | 123   | 04.90     | 12.99 |                |                |                |                |                              |                   |                              |                   |         |         |       |       |       |                |                |        |                              |       |                   |       |         |       |       |       |  |        |    |       |           |     |       |         |     |       |        |     |       |       |           |     |       |       |         |        |       |       |       |  |            |     |       |       |  |            |     |       |       |  |        |    |       |       |  |  |         |     |       |       |        |    |       |       |  |  |  |             |     |       |        |     |       |       |  |  |  |  |            |     |        |       |       |       |  |  |  |  |  |  |        |     |       |       |  |  |  |  |  |  |
| 3.0 V6   | 140   | 04.97     | 12.99 |                |                |                |                |                              |                   |                              |                   |         |         |       |       |       |                |                |        |                              |       |                   |       |         |       |       |       |  |        |    |       |           |     |       |         |     |       |        |     |       |       |           |     |       |       |         |        |       |       |       |  |            |     |       |       |  |            |     |       |       |  |        |    |       |       |  |  |         |     |       |       |        |    |       |       |  |  |  |             |     |       |        |     |       |       |  |  |  |  |            |     |        |       |       |       |  |  |  |  |  |  |        |     |       |       |  |  |  |  |  |  |
| 3.0 V6   | 147   | 04.90     | 12.99 |                |                |                |                |                              |                   |                              |                   |         |         |       |       |       |                |                |        |                              |       |                   |       |         |       |       |       |  |        |    |       |           |     |       |         |     |       |        |     |       |       |           |     |       |       |         |        |       |       |       |  |            |     |       |       |  |            |     |       |       |  |        |    |       |       |  |  |         |     |       |       |        |    |       |       |  |  |  |             |     |       |        |     |       |       |  |  |  |  |            |     |        |       |       |       |  |  |  |  |  |  |        |     |       |       |  |  |  |  |  |  |
| PEUGEOT 607 (00-10)  |   |           |       |                |                |                |                |                              |                   |                              |                   |         |         |       |       |       |                |                |        |                              |       |                   |       |         |       |       |       |  |        |    |       |           |     |       |         |     |       |        |     |       |       |           |     |       |       |         |        |       |       |       |  |            |     |       |       |  |            |     |       |       |  |        |    |       |       |  |  |         |     |       |       |        |    |       |       |  |  |  |             |     |       |        |     |       |       |  |  |  |  |            |     |        |       |       |       |  |  |  |  |  |  |        |     |       |       |  |  |  |  |  |  |
|  | <table border="1"> <tr><td>2.0</td><td>100</td><td>02.00</td><td>11.04</td><td></td><td>24.2122-1748.3</td><td>010721</td><td></td><td>- ESP</td><td>THz 22,20</td></tr> <tr><td>2.0 HDi</td><td>79</td><td>03.01</td><td>07.04</td><td></td><td></td><td></td><td></td><td></td><td></td></tr> <tr><td>2.0 HDi</td><td>80</td><td>05.00</td><td>11.04</td><td></td><td></td><td></td><td></td><td></td><td></td></tr> <tr><td>2.2 16V</td><td>116</td><td>02.00</td><td>11.04</td><td></td><td></td><td></td><td></td><td></td><td></td></tr> <tr><td>2.2 HDi</td><td>98</td><td>02.00</td><td>11.04</td><td></td><td></td><td></td><td></td><td></td><td></td></tr> <tr><td>3.0 V6 24V</td><td>152</td><td>02.00</td><td>11.04</td><td></td><td></td><td></td><td></td><td></td><td></td></tr> </table>   | 2.0       | 100   | 02.00          | 11.04          |                | 24.2122-1748.3 | 010721                       |                   | - ESP                        | THz 22,20         | 2.0 HDi | 79      | 03.01 | 07.04 |       |                |                |        |                              |       | 2.0 HDi           | 80    | 05.00   | 11.04 |       |       |  |        |    |       | 2.2 16V   | 116 | 02.00 | 11.04   |     |       |        |     |       |       | 2.2 HDi   | 98  | 02.00 | 11.04 |         |        |       |       |       |  | 3.0 V6 24V | 152 | 02.00 | 11.04 |  |            |     |       |       |  |        |    |       |       |  |  |         |     |       |       |        |    |       |       |  |  |  |             |     |       |        |     |       |       |  |  |  |  |            |     |        |       |       |       |  |  |  |  |  |  |        |     |       |       |  |  |  |  |  |  |
| 2.0  | 100   | 02.00     | 11.04 |                | 24.2122-1748.3 | 010721         |                | - ESP                        | THz 22,20         |                              |                   |         |         |       |       |       |                |                |        |                              |       |                   |       |         |       |       |       |  |        |    |       |           |     |       |         |     |       |        |     |       |       |           |     |       |       |         |        |       |       |       |  |            |     |       |       |  |            |     |       |       |  |        |    |       |       |  |  |         |     |       |       |        |    |       |       |  |  |  |             |     |       |        |     |       |       |  |  |  |  |            |     |        |       |       |       |  |  |  |  |  |  |        |     |       |       |  |  |  |  |  |  |
| 2.0 HDi  | 79  | 03.01     | 07.04 |                |                |                |                |                              |                   |                              |                   |         |         |       |       |       |                |                |        |                              |       |                   |       |         |       |       |       |  |        |    |       |           |     |       |         |     |       |        |     |       |       |           |     |       |       |         |        |       |       |       |  |            |     |       |       |  |            |     |       |       |  |        |    |       |       |  |  |         |     |       |       |        |    |       |       |  |  |  |             |     |       |        |     |       |       |  |  |  |  |            |     |        |       |       |       |  |  |  |  |  |  |        |     |       |       |  |  |  |  |  |  |
| 2.0 HDi  | 80  | 05.00     | 11.04 |                |                |                |                |                              |                   |                              |                   |         |         |       |       |       |                |                |        |                              |       |                   |       |         |       |       |       |  |        |    |       |           |     |       |         |     |       |        |     |       |       |           |     |       |       |         |        |       |       |       |  |            |     |       |       |  |            |     |       |       |  |        |    |       |       |  |  |         |     |       |       |        |    |       |       |  |  |  |             |     |       |        |     |       |       |  |  |  |  |            |     |        |       |       |       |  |  |  |  |  |  |        |     |       |       |  |  |  |  |  |  |
| 2.2 16V  | 116   | 02.00     | 11.04 |                |                |                |                |                              |                   |                              |                   |         |         |       |       |       |                |                |        |                              |       |                   |       |         |       |       |       |  |        |    |       |           |     |       |         |     |       |        |     |       |       |           |     |       |       |         |        |       |       |       |  |            |     |       |       |  |            |     |       |       |  |        |    |       |       |  |  |         |     |       |       |        |    |       |       |  |  |  |             |     |       |        |     |       |       |  |  |  |  |            |     |        |       |       |       |  |  |  |  |  |  |        |     |       |       |  |  |  |  |  |  |
| 2.2 HDi  | 98  | 02.00     | 11.04 |                |                |                |                |                              |                   |                              |                   |         |         |       |       |       |                |                |        |                              |       |                   |       |         |       |       |       |  |        |    |       |           |     |       |         |     |       |        |     |       |       |           |     |       |       |         |        |       |       |       |  |            |     |       |       |  |            |     |       |       |  |        |    |       |       |  |  |         |     |       |       |        |    |       |       |  |  |  |             |     |       |        |     |       |       |  |  |  |  |            |     |        |       |       |       |  |  |  |  |  |  |        |     |       |       |  |  |  |  |  |  |
| 3.0 V6 24V   | 152   | 02.00     | 11.04 |                |                |                |                |                              |                   |                              |                   |         |         |       |       |       |                |                |        |                              |       |                   |       |         |       |       |       |  |        |    |       |           |     |       |         |     |       |        |     |       |       |           |     |       |       |         |        |       |       |       |  |            |     |       |       |  |            |     |       |       |  |        |    |       |       |  |  |         |     |       |       |        |    |       |       |  |  |  |             |     |       |        |     |       |       |  |  |  |  |            |     |        |       |       |       |  |  |  |  |  |  |        |     |       |       |  |  |  |  |  |  |
|  | <table border="1"> <tr><td>2.0</td><td>100</td><td>12.04</td><td>12.10</td><td></td><td>03.2123-3281.3</td><td>010758</td><td></td><td></td><td>THz 23,81</td><td>ATE</td></tr> <tr><td>2.0 HDi</td><td>80</td><td>12.04</td><td>12.10</td><td></td><td></td><td></td><td></td><td></td><td></td><td></td></tr> <tr><td>2.0 HDi</td><td>100</td><td>09.05</td><td>12.10</td><td></td><td></td><td></td><td></td><td></td><td></td><td></td></tr> <tr><td>2.2 16V</td><td>116</td><td>12.04</td><td>12.10</td><td></td><td></td><td></td><td></td><td></td><td></td><td></td></tr> <tr><td>2.2 16V</td><td>120</td><td>09.05</td><td>12.10</td><td></td><td></td><td></td><td></td><td></td><td></td><td></td></tr> <tr><td>2.2 HDi</td><td>98</td><td>12.04</td><td>12.10</td><td></td><td></td><td></td><td></td><td></td><td></td><td></td></tr> <tr><td>2.2 HDi</td><td>125</td><td>05.06</td><td>12.10</td><td></td><td></td><td></td><td></td><td></td><td></td><td></td></tr> <tr><td>2.7 HDi 24V</td><td>150</td><td>12.04</td><td>12.10</td><td></td><td></td><td></td><td></td><td></td><td></td><td></td></tr> <tr><td>3.0 V6 24V</td><td>155</td><td>03.04</td><td>12.10</td><td></td><td></td><td></td><td></td><td></td><td></td><td></td></tr> </table>   | 2.0       | 100   | 12.04          | 12.10          |                | 03.2123-3281.3 | 010758                       |                   |                              | THz 23,81         | ATE     | 2.0 HDi | 80    | 12.04 | 12.10 |                |                |        |                              |       |                   |       | 2.0 HDi | 100   | 09.05 | 12.10 |  |        |    |       |           |     |       | 2.2 16V | 116 | 12.04 | 12.10  |     |       |       |           |     |       |       | 2.2 16V | 120    | 09.05 | 12.10 |       |  |            |     |       |       |  | 2.2 HDi    | 98  | 12.04 | 12.10 |  |        |    |       |       |  |  | 2.2 HDi | 125 | 05.06 | 12.10 |        |    |       |       |  |  |  | 2.7 HDi 24V | 150 | 12.04 | 12.10  |     |       |       |  |  |  |  | 3.0 V6 24V | 155 | 03.04  | 12.10 |       |       |  |  |  |  |  |  |        |     |       |       |  |  |  |  |  |  |
| 2.0  | 100   | 12.04     | 12.10 |                | 03.2123-3281.3 | 010758         |                |                              | THz 23,81         | ATE                          |                   |         |         |       |       |       |                |                |        |                              |       |                   |       |         |       |       |       |  |        |    |       |           |     |       |         |     |       |        |     |       |       |           |     |       |       |         |        |       |       |       |  |            |     |       |       |  |            |     |       |       |  |        |    |       |       |  |  |         |     |       |       |        |    |       |       |  |  |  |             |     |       |        |     |       |       |  |  |  |  |            |     |        |       |       |       |  |  |  |  |  |  |        |     |       |       |  |  |  |  |  |  |
| 2.0 HDi  | 80  | 12.04     | 12.10 |                |                |                |                |                              |                   |                              |                   |         |         |       |       |       |                |                |        |                              |       |                   |       |         |       |       |       |  |        |    |       |           |     |       |         |     |       |        |     |       |       |           |     |       |       |         |        |       |       |       |  |            |     |       |       |  |            |     |       |       |  |        |    |       |       |  |  |         |     |       |       |        |    |       |       |  |  |  |             |     |       |        |     |       |       |  |  |  |  |            |     |        |       |       |       |  |  |  |  |  |  |        |     |       |       |  |  |  |  |  |  |
| 2.0 HDi  | 100   | 09.05     | 12.10 |                |                |                |                |                              |                   |                              |                   |         |         |       |       |       |                |                |        |                              |       |                   |       |         |       |       |       |  |        |    |       |           |     |       |         |     |       |        |     |       |       |           |     |       |       |         |        |       |       |       |  |            |     |       |       |  |            |     |       |       |  |        |    |       |       |  |  |         |     |       |       |        |    |       |       |  |  |  |             |     |       |        |     |       |       |  |  |  |  |            |     |        |       |       |       |  |  |  |  |  |  |        |     |       |       |  |  |  |  |  |  |
| 2.2 16V  | 116   | 12.04     | 12.10 |                |                |                |                |                              |                   |                              |                   |         |         |       |       |       |                |                |        |                              |       |                   |       |         |       |       |       |  |        |    |       |           |     |       |         |     |       |        |     |       |       |           |     |       |       |         |        |       |       |       |  |            |     |       |       |  |            |     |       |       |  |        |    |       |       |  |  |         |     |       |       |        |    |       |       |  |  |  |             |     |       |        |     |       |       |  |  |  |  |            |     |        |       |       |       |  |  |  |  |  |  |        |     |       |       |  |  |  |  |  |  |
| 2.2 16V  | 120   | 09.05     | 12.10 |                |                |                |                |                              |                   |                              |                   |         |         |       |       |       |                |                |        |                              |       |                   |       |         |       |       |       |  |        |    |       |           |     |       |         |     |       |        |     |       |       |           |     |       |       |         |        |       |       |       |  |            |     |       |       |  |            |     |       |       |  |        |    |       |       |  |  |         |     |       |       |        |    |       |       |  |  |  |             |     |       |        |     |       |       |  |  |  |  |            |     |        |       |       |       |  |  |  |  |  |  |        |     |       |       |  |  |  |  |  |  |
| 2.2 HDi  | 98  | 12.04     | 12.10 |                |                |                |                |                              |                   |                              |                   |         |         |       |       |       |                |                |        |                              |       |                   |       |         |       |       |       |  |        |    |       |           |     |       |         |     |       |        |     |       |       |           |     |       |       |         |        |       |       |       |  |            |     |       |       |  |            |     |       |       |  |        |    |       |       |  |  |         |     |       |       |        |    |       |       |  |  |  |             |     |       |        |     |       |       |  |  |  |  |            |     |        |       |       |       |  |  |  |  |  |  |        |     |       |       |  |  |  |  |  |  |
| 2.2 HDi  | 125   | 05.06     | 12.10 |                |                |                |                |                              |                   |                              |                   |         |         |       |       |       |                |                |        |                              |       |                   |       |         |       |       |       |  |        |    |       |           |     |       |         |     |       |        |     |       |       |           |     |       |       |         |        |       |       |       |  |            |     |       |       |  |            |     |       |       |  |        |    |       |       |  |  |         |     |       |       |        |    |       |       |  |  |  |             |     |       |        |     |       |       |  |  |  |  |            |     |        |       |       |       |  |  |  |  |  |  |        |     |       |       |  |  |  |  |  |  |
| 2.7 HDi 24V  | 150   | 12.04     | 12.10 |                |                |                |                |                              |                   |                              |                   |         |         |       |       |       |                |                |        |                              |       |                   |       |         |       |       |       |  |        |    |       |           |     |       |         |     |       |        |     |       |       |           |     |       |       |         |        |       |       |       |  |            |     |       |       |  |            |     |       |       |  |        |    |       |       |  |  |         |     |       |       |        |    |       |       |  |  |  |             |     |       |        |     |       |       |  |  |  |  |            |     |        |       |       |       |  |  |  |  |  |  |        |     |       |       |  |  |  |  |  |  |
| 3.0 V6 24V   | 155   | 03.04     | 12.10 |                |                |                |                |                              |                   |                              |                   |         |         |       |       |       |                |                |        |                              |       |                   |       |         |       |       |       |  |        |    |       |           |     |       |         |     |       |        |     |       |       |           |     |       |       |         |        |       |       |       |  |            |     |       |       |  |            |     |       |       |  |        |    |       |       |  |  |         |     |       |       |        |    |       |       |  |  |  |             |     |       |        |     |       |       |  |  |  |  |            |     |        |       |       |       |  |  |  |  |  |  |        |     |       |       |  |  |  |  |  |  |
|  | <table border="1"> <tr><td>2.0</td><td>100</td><td>02.00</td><td>11.04</td><td></td><td>24.3571-1727.7</td><td>220601</td><td></td><td></td><td>D=57, - Halter</td><td>LUC</td></tr> <tr><td>2.0 HDi</td><td>79</td><td>03.01</td><td>07.04</td><td></td><td></td><td></td><td></td><td></td><td></td><td></td></tr> <tr><td>2.0 HDi</td><td>80</td><td>05.00</td><td>11.04</td><td></td><td></td><td></td><td></td><td></td><td></td><td></td></tr> <tr><td>2.2 16V</td><td>116</td><td>02.00</td><td>11.04</td><td></td><td></td><td></td><td></td><td></td><td></td><td></td></tr> <tr><td>2.2 HDi</td><td>98</td><td>02.00</td><td>11.04</td><td></td><td></td><td></td><td></td><td></td><td></td><td></td></tr> </table>  | 2.0       | 100   | 02.00          | 11.04          |                | 24.3571-1727.7 | 220601                       |                   |                              | D=57, - Halter    | LUC     | 2.0 HDi | 79    | 03.01 | 07.04 |                |                |        |                              |       |                   |       | 2.0 HDi | 80    | 05.00 | 11.04 |  |        |    |       |           |     |       | 2.2 16V | 116 | 02.00 | 11.04  |     |       |       |           |     |       |       | 2.2 HDi | 98     | 02.00 | 11.04 |       |  |            |     |       |       |  |            |     |       |       |  |        |    |       |       |  |  |         |     |       |       |        |    |       |       |  |  |  |             |     |       |        |     |       |       |  |  |  |  |            |     |        |       |       |       |  |  |  |  |  |  |        |     |       |       |  |  |  |  |  |  |
| 2.0  | 100   | 02.00     | 11.04 |                | 24.3571-1727.7 | 220601         |                |                              | D=57, - Halter    | LUC                          |                   |         |         |       |       |       |                |                |        |                              |       |                   |       |         |       |       |       |  |        |    |       |           |     |       |         |     |       |        |     |       |       |           |     |       |       |         |        |       |       |       |  |            |     |       |       |  |            |     |       |       |  |        |    |       |       |  |  |         |     |       |       |        |    |       |       |  |  |  |             |     |       |        |     |       |       |  |  |  |  |            |     |        |       |       |       |  |  |  |  |  |  |        |     |       |       |  |  |  |  |  |  |
| 2.0 HDi  | 79  | 03.01     | 07.04 |                |                |                |                |                              |                   |                              |                   |         |         |       |       |       |                |                |        |                              |       |                   |       |         |       |       |       |  |        |    |       |           |     |       |         |     |       |        |     |       |       |           |     |       |       |         |        |       |       |       |  |            |     |       |       |  |            |     |       |       |  |        |    |       |       |  |  |         |     |       |       |        |    |       |       |  |  |  |             |     |       |        |     |       |       |  |  |  |  |            |     |        |       |       |       |  |  |  |  |  |  |        |     |       |       |  |  |  |  |  |  |
| 2.0 HDi  | 80  | 05.00     | 11.04 |                |                |                |                |                              |                   |                              |                   |         |         |       |       |       |                |                |        |                              |       |                   |       |         |       |       |       |  |        |    |       |           |     |       |         |     |       |        |     |       |       |           |     |       |       |         |        |       |       |       |  |            |     |       |       |  |            |     |       |       |  |        |    |       |       |  |  |         |     |       |       |        |    |       |       |  |  |  |             |     |       |        |     |       |       |  |  |  |  |            |     |        |       |       |       |  |  |  |  |  |  |        |     |       |       |  |  |  |  |  |  |
| 2.2 16V  | 116   | 02.00     | 11.04 |                |                |                |                |                              |                   |                              |                   |         |         |       |       |       |                |                |        |                              |       |                   |       |         |       |       |       |  |        |    |       |           |     |       |         |     |       |        |     |       |       |           |     |       |       |         |        |       |       |       |  |            |     |       |       |  |            |     |       |       |  |        |    |       |       |  |  |         |     |       |       |        |    |       |       |  |  |  |             |     |       |        |     |       |       |  |  |  |  |            |     |        |       |       |       |  |  |  |  |  |  |        |     |       |       |  |  |  |  |  |  |
| 2.2 HDi  | 98  | 02.00     | 11.04 |                |                |                |                |                              |                   |                              |                   |         |         |       |       |       |                |                |        |                              |       |                   |       |         |       |       |       |  |        |    |       |           |     |       |         |     |       |        |     |       |       |           |     |       |       |         |        |       |       |       |  |            |     |       |       |  |            |     |       |       |  |        |    |       |       |  |  |         |     |       |       |        |    |       |       |  |  |  |             |     |       |        |     |       |       |  |  |  |  |            |     |        |       |       |       |  |  |  |  |  |  |        |     |       |       |  |  |  |  |  |  |
|  | <table border="1"> <tr><td>2.0</td><td>100</td><td>12.04</td><td>12.10</td><td></td><td>24.3451-1719.7</td><td>220763</td><td></td><td></td><td>D=45/45, - Halter</td><td>LUC</td></tr> <tr><td>2.0 HDi</td><td>80</td><td>12.04</td><td>12.10</td><td></td><td>24.3451-1720.7</td><td>220764</td><td></td><td></td><td>D=45/45, - Halter</td><td>LUC</td></tr> <tr><td>2.0 HDi</td><td>100</td><td>09.05</td><td>12.10</td><td></td><td></td><td></td><td></td><td></td><td></td><td></td></tr> <tr><td>2.2 16V</td><td>116</td><td>12.04</td><td>12.10</td><td></td><td></td><td></td><td></td><td></td><td></td><td></td></tr> <tr><td>2.2 16V</td><td>120</td><td>09.05</td><td>12.10</td><td></td><td></td><td></td><td></td><td></td><td></td><td></td></tr> <tr><td>2.2 HDi</td><td>98</td><td>12.04</td><td>12.10</td><td></td><td></td><td></td><td></td><td></td><td></td><td></td></tr> <tr><td>2.2 HDi</td><td>125</td><td>05.06</td><td>12.10</td><td></td><td></td><td></td><td></td><td></td><td></td><td></td></tr> <tr><td>2.7 HDi 24V</td><td>150</td><td>12.04</td><td>12.10</td><td></td><td></td><td></td><td></td><td></td><td></td><td></td></tr> <tr><td>3.0 V6 24V</td><td>155</td><td>03.04</td><td>12.10</td><td></td><td></td><td></td><td></td><td></td><td></td><td></td></tr> </table>   | 2.0       | 100   | 12.04          | 12.10          |                | 24.3451-1719.7 | 220763                       |                   |                              | D=45/45, - Halter | LUC     | 2.0 HDi | 80    | 12.04 | 12.10 |                | 24.3451-1720.7 | 220764 |                              |       | D=45/45, - Halter | LUC   | 2.0 HDi | 100   | 09.05 | 12.10 |  |        |    |       |           |     |       | 2.2 16V | 116 | 12.04 | 12.10  |     |       |       |           |     |       |       | 2.2 16V | 120    | 09.05 | 12.10 |       |  |            |     |       |       |  | 2.2 HDi    | 98  | 12.04 | 12.10 |  |        |    |       |       |  |  | 2.2 HDi | 125 | 05.06 | 12.10 |        |    |       |       |  |  |  | 2.7 HDi 24V | 150 | 12.04 | 12.10  |     |       |       |  |  |  |  | 3.0 V6 24V | 155 | 03.04  | 12.10 |       |       |  |  |  |  |  |  |        |     |       |       |  |  |  |  |  |  |
| 2.0  | 100   | 12.04     | 12.10 |                | 24.3451-1719.7 | 220763         |                |                              | D=45/45, - Halter | LUC                          |                   |         |         |       |       |       |                |                |        |                              |       |                   |       |         |       |       |       |  |        |    |       |           |     |       |         |     |       |        |     |       |       |           |     |       |       |         |        |       |       |       |  |            |     |       |       |  |            |     |       |       |  |        |    |       |       |  |  |         |     |       |       |        |    |       |       |  |  |  |             |     |       |        |     |       |       |  |  |  |  |            |     |        |       |       |       |  |  |  |  |  |  |        |     |       |       |  |  |  |  |  |  |
| 2.0 HDi  | 80  | 12.04     | 12.10 |                | 24.3451-1720.7 | 220764         |                |                              | D=45/45, - Halter | LUC                          |                   |         |         |       |       |       |                |                |        |                              |       |                   |       |         |       |       |       |  |        |    |       |           |     |       |         |     |       |        |     |       |       |           |     |       |       |         |        |       |       |       |  |            |     |       |       |  |            |     |       |       |  |        |    |       |       |  |  |         |     |       |       |        |    |       |       |  |  |  |             |     |       |        |     |       |       |  |  |  |  |            |     |        |       |       |       |  |  |  |  |  |  |        |     |       |       |  |  |  |  |  |  |
| 2.0 HDi  | 100   | 09.05     | 12.10 |                |                |                |                |                              |                   |                              |                   |         |         |       |       |       |                |                |        |                              |       |                   |       |         |       |       |       |  |        |    |       |           |     |       |         |     |       |        |     |       |       |           |     |       |       |         |        |       |       |       |  |            |     |       |       |  |            |     |       |       |  |        |    |       |       |  |  |         |     |       |       |        |    |       |       |  |  |  |             |     |       |        |     |       |       |  |  |  |  |            |     |        |       |       |       |  |  |  |  |  |  |        |     |       |       |  |  |  |  |  |  |
| 2.2 16V  | 116   | 12.04     | 12.10 |                |                |                |                |                              |                   |                              |                   |         |         |       |       |       |                |                |        |                              |       |                   |       |         |       |       |       |  |        |    |       |           |     |       |         |     |       |        |     |       |       |           |     |       |       |         |        |       |       |       |  |            |     |       |       |  |            |     |       |       |  |        |    |       |       |  |  |         |     |       |       |        |    |       |       |  |  |  |             |     |       |        |     |       |       |  |  |  |  |            |     |        |       |       |       |  |  |  |  |  |  |        |     |       |       |  |  |  |  |  |  |
| 2.2 16V  | 120   | 09.05     | 12.10 |                |                |                |                |                              |                   |                              |                   |         |         |       |       |       |                |                |        |                              |       |                   |       |         |       |       |       |  |        |    |       |           |     |       |         |     |       |        |     |       |       |           |     |       |       |         |        |       |       |       |  |            |     |       |       |  |            |     |       |       |  |        |    |       |       |  |  |         |     |       |       |        |    |       |       |  |  |  |             |     |       |        |     |       |       |  |  |  |  |            |     |        |       |       |       |  |  |  |  |  |  |        |     |       |       |  |  |  |  |  |  |
| 2.2 HDi  | 98  | 12.04     | 12.10 |                |                |                |                |                              |                   |                              |                   |         |         |       |       |       |                |                |        |                              |       |                   |       |         |       |       |       |  |        |    |       |           |     |       |         |     |       |        |     |       |       |           |     |       |       |         |        |       |       |       |  |            |     |       |       |  |            |     |       |       |  |        |    |       |       |  |  |         |     |       |       |        |    |       |       |  |  |  |             |     |       |        |     |       |       |  |  |  |  |            |     |        |       |       |       |  |  |  |  |  |  |        |     |       |       |  |  |  |  |  |  |
| 2.2 HDi  | 125   | 05.06     | 12.10 |                |                |                |                |                              |                   |                              |                   |         |         |       |       |       |                |                |        |                              |       |                   |       |         |       |       |       |  |        |    |       |           |     |       |         |     |       |        |     |       |       |           |     |       |       |         |        |       |       |       |  |            |     |       |       |  |            |     |       |       |  |        |    |       |       |  |  |         |     |       |       |        |    |       |       |  |  |  |             |     |       |        |     |       |       |  |  |  |  |            |     |        |       |       |       |  |  |  |  |  |  |        |     |       |       |  |  |  |  |  |  |
| 2.7 HDi 24V  | 150   | 12.04     | 12.10 |                |                |                |                |                              |                   |                              |                   |         |         |       |       |       |                |                |        |                              |       |                   |       |         |       |       |       |  |        |    |       |           |     |       |         |     |       |        |     |       |       |           |     |       |       |         |        |       |       |       |  |            |     |       |       |  |            |     |       |       |  |        |    |       |       |  |  |         |     |       |       |        |    |       |       |  |  |  |             |     |       |        |     |       |       |  |  |  |  |            |     |        |       |       |       |  |  |  |  |  |  |        |     |       |       |  |  |  |  |  |  |
| 3.0 V6 24V   | 155   | 03.04     | 12.10 |                |                |                |                |                              |                   |                              |                   |         |         |       |       |       |                |                |        |                              |       |                   |       |         |       |       |       |  |        |    |       |           |     |       |         |     |       |        |     |       |       |           |     |       |       |         |        |       |       |       |  |            |     |       |       |  |            |     |       |       |  |        |    |       |       |  |  |         |     |       |       |        |    |       |       |  |  |  |             |     |       |        |     |       |       |  |  |  |  |            |     |        |       |       |       |  |  |  |  |  |  |        |     |       |       |  |  |  |  |  |  |
|  | <table border="1"> <tr><td>2.0</td><td>100</td><td>02.00</td><td>11.04</td><td></td><td>11.0441-3305.2</td><td>250006</td><td></td><td></td><td>Dichtungssatz</td><td>ATE</td></tr> <tr><td>2.0 HDi</td><td>79</td><td>03.01</td><td>07.04</td><td></td><td></td><td></td><td></td><td></td><td></td><td></td></tr> <tr><td>2.0 HDi</td><td>80</td><td>05.00</td><td>11.04</td><td></td><td></td><td></td><td></td><td></td><td></td><td></td></tr> <tr><td>2.2 16V</td><td>116</td><td>02.00</td><td>11.04</td><td></td><td></td><td></td><td></td><td></td><td></td><td></td></tr> <tr><td>2.2 HDi</td><td>98</td><td>02.00</td><td>11.04</td><td></td><td></td><td></td><td></td><td></td><td></td><td></td></tr> <tr><td>3.0 V6 24V</td><td>152</td><td>02.00</td><td>11.04</td><td></td><td></td><td></td><td></td><td></td><td></td><td></td></tr> </table>   | 2.0       | 100   | 02.00          | 11.04          |                | 11.0441-3305.2 | 250006                       |                   |                              | Dichtungssatz     | ATE     | 2.0 HDi | 79    | 03.01 | 07.04 |                |                |        |                              |       |                   |       | 2.0 HDi | 80    | 05.00 | 11.04 |  |        |    |       |           |     |       | 2.2 16V | 116 | 02.00 | 11.04  |     |       |       |           |     |       |       | 2.2 HDi | 98     | 02.00 | 11.04 |       |  |            |     |       |       |  | 3.0 V6 24V | 152 | 02.00 | 11.04 |  |        |    |       |       |  |  |         |     |       |       |        |    |       |       |  |  |  |             |     |       |        |     |       |       |  |  |  |  |            |     |        |       |       |       |  |  |  |  |  |  |        |     |       |       |  |  |  |  |  |  |
| 2.0  | 100   | 02.00     | 11.04 |                | 11.0441-3305.2 | 250006         |                |                              | Dichtungssatz     | ATE                          |                   |         |         |       |       |       |                |                |        |                              |       |                   |       |         |       |       |       |  |        |    |       |           |     |       |         |     |       |        |     |       |       |           |     |       |       |         |        |       |       |       |  |            |     |       |       |  |            |     |       |       |  |        |    |       |       |  |  |         |     |       |       |        |    |       |       |  |  |  |             |     |       |        |     |       |       |  |  |  |  |            |     |        |       |       |       |  |  |  |  |  |  |        |     |       |       |  |  |  |  |  |  |
| 2.0 HDi  | 79  | 03.01     | 07.04 |                |                |                |                |                              |                   |                              |                   |         |         |       |       |       |                |                |        |                              |       |                   |       |         |       |       |       |  |        |    |       |           |     |       |         |     |       |        |     |       |       |           |     |       |       |         |        |       |       |       |  |            |     |       |       |  |            |     |       |       |  |        |    |       |       |  |  |         |     |       |       |        |    |       |       |  |  |  |             |     |       |        |     |       |       |  |  |  |  |            |     |        |       |       |       |  |  |  |  |  |  |        |     |       |       |  |  |  |  |  |  |
| 2.0 HDi  | 80  | 05.00     | 11.04 |                |                |                |                |                              |                   |                              |                   |         |         |       |       |       |                |                |        |                              |       |                   |       |         |       |       |       |  |        |    |       |           |     |       |         |     |       |        |     |       |       |           |     |       |       |         |        |       |       |       |  |            |     |       |       |  |            |     |       |       |  |        |    |       |       |  |  |         |     |       |       |        |    |       |       |  |  |  |             |     |       |        |     |       |       |  |  |  |  |            |     |        |       |       |       |  |  |  |  |  |  |        |     |       |       |  |  |  |  |  |  |
| 2.2 16V  | 116   | 02.00     | 11.04 |                |                |                |                |                              |                   |                              |                   |         |         |       |       |       |                |                |        |                              |       |                   |       |         |       |       |       |  |        |    |       |           |     |       |         |     |       |        |     |       |       |           |     |       |       |         |        |       |       |       |  |            |     |       |       |  |            |     |       |       |  |        |    |       |       |  |  |         |     |       |       |        |    |       |       |  |  |  |             |     |       |        |     |       |       |  |  |  |  |            |     |        |       |       |       |  |  |  |  |  |  |        |     |       |       |  |  |  |  |  |  |
| 2.2 HDi  | 98  | 02.00     | 11.04 |                |                |                |                |                              |                   |                              |                   |         |         |       |       |       |                |                |        |                              |       |                   |       |         |       |       |       |  |        |    |       |           |     |       |         |     |       |        |     |       |       |           |     |       |       |         |        |       |       |       |  |            |     |       |       |  |            |     |       |       |  |        |    |       |       |  |  |         |     |       |       |        |    |       |       |  |  |  |             |     |       |        |     |       |       |  |  |  |  |            |     |        |       |       |       |  |  |  |  |  |  |        |     |       |       |  |  |  |  |  |  |
| 3.0 V6 24V   | 152   | 02.00     | 11.04 |                |                |                |                |                              |                   |                              |                   |         |         |       |       |       |                |                |        |                              |       |                   |       |         |       |       |       |  |        |    |       |           |     |       |         |     |       |        |     |       |       |           |     |       |       |         |        |       |       |       |  |            |     |       |       |  |            |     |       |       |  |        |    |       |       |  |  |         |     |       |       |        |    |       |       |  |  |  |             |     |       |        |     |       |       |  |  |  |  |            |     |        |       |       |       |  |  |  |  |  |  |        |     |       |       |  |  |  |  |  |  |
|  | <table border="1"> <tr><td>2.0</td><td>100</td><td>12.04</td><td>12.10</td><td></td><td>24.3387-1715.7</td><td>220755</td><td></td><td></td><td>D=38, - Halter</td><td>LUC</td></tr> <tr><td>2.0 HDi</td><td>80</td><td>12.04</td><td>12.10</td><td></td><td>24.3387-1716.7</td><td>220756</td><td></td><td></td><td>D=38, - Halter</td><td>LUC</td></tr> <tr><td>2.0 HDi</td><td>100</td><td>09.05</td><td>12.10</td><td></td><td></td><td></td><td></td><td></td><td></td><td></td></tr> <tr><td>2.2 16V</td><td>116</td><td>12.04</td><td>12.10</td><td></td><td></td><td></td><td></td><td></td><td></td><td></td></tr> <tr><td>2.2 16V</td><td>120</td><td>09.05</td><td>12.10</td><td></td><td></td><td></td><td></td><td></td><td></td><td></td></tr> <tr><td>2.2 HDi</td><td>98</td><td>12.04</td><td>12.10</td><td></td><td></td><td></td><td></td><td></td><td></td><td></td></tr> <tr><td>2.2 HDi</td><td>125</td><td>05.06</td><td>12.10</td><td></td><td></td><td></td><td></td><td></td><td></td><td></td></tr> <tr><td>2.7 HDi 24V</td><td>150</td><td>12.04</td><td>12.10</td><td></td><td></td><td></td><td></td><td></td><td></td><td></td></tr> <tr><td>3.0 V6 24V</td><td>155</td><td>03.04</td><td>12.10</td><td></td><td></td><td></td><td></td><td></td><td></td><td></td></tr> </table>   | 2.0       | 100   | 12.04          | 12.10          |                | 24.3387-1715.7 | 220755                       |                   |                              | D=38, - Halter    | LUC     | 2.0 HDi | 80    | 12.04 | 12.10 |                | 24.3387-1716.7 | 220756 |                              |       | D=38, - Halter    | LUC   | 2.0 HDi | 100   | 09.05 | 12.10 |  |        |    |       |           |     |       | 2.2 16V | 116 | 12.04 | 12.10  |     |       |       |           |     |       |       | 2.2 16V | 120    | 09.05 | 12.10 |       |  |            |     |       |       |  | 2.2 HDi    | 98  | 12.04 | 12.10 |  |        |    |       |       |  |  | 2.2 HDi | 125 | 05.06 | 12.10 |        |    |       |       |  |  |  | 2.7 HDi 24V | 150 | 12.04 | 12.10  |     |       |       |  |  |  |  | 3.0 V6 24V | 155 | 03.04  | 12.10 |       |       |  |  |  |  |  |  |        |     |       |       |  |  |  |  |  |  |
| 2.0  | 100   | 12.04     | 12.10 |                | 24.3387-1715.7 | 220755         |                |                              | D=38, - Halter    | LUC                          |                   |         |         |       |       |       |                |                |        |                              |       |                   |       |         |       |       |       |  |        |    |       |           |     |       |         |     |       |        |     |       |       |           |     |       |       |         |        |       |       |       |  |            |     |       |       |  |            |     |       |       |  |        |    |       |       |  |  |         |     |       |       |        |    |       |       |  |  |  |             |     |       |        |     |       |       |  |  |  |  |            |     |        |       |       |       |  |  |  |  |  |  |        |     |       |       |  |  |  |  |  |  |
| 2.0 HDi  | 80  | 12.04     | 12.10 |                | 24.3387-1716.7 | 220756         |                |                              | D=38, - Halter    | LUC                          |                   |         |         |       |       |       |                |                |        |                              |       |                   |       |         |       |       |       |  |        |    |       |           |     |       |         |     |       |        |     |       |       |           |     |       |       |         |        |       |       |       |  |            |     |       |       |  |            |     |       |       |  |        |    |       |       |  |  |         |     |       |       |        |    |       |       |  |  |  |             |     |       |        |     |       |       |  |  |  |  |            |     |        |       |       |       |  |  |  |  |  |  |        |     |       |       |  |  |  |  |  |  |
| 2.0 HDi  | 100   | 09.05     | 12.10 |                |                |                |                |                              |                   |                              |                   |         |         |       |       |       |                |                |        |                              |       |                   |       |         |       |       |       |  |        |    |       |           |     |       |         |     |       |        |     |       |       |           |     |       |       |         |        |       |       |       |  |            |     |       |       |  |            |     |       |       |  |        |    |       |       |  |  |         |     |       |       |        |    |       |       |  |  |  |             |     |       |        |     |       |       |  |  |  |  |            |     |        |       |       |       |  |  |  |  |  |  |        |     |       |       |  |  |  |  |  |  |
| 2.2 16V  | 116   | 12.04     | 12.10 |                |                |                |                |                              |                   |                              |                   |         |         |       |       |       |                |                |        |                              |       |                   |       |         |       |       |       |  |        |    |       |           |     |       |         |     |       |        |     |       |       |           |     |       |       |         |        |       |       |       |  |            |     |       |       |  |            |     |       |       |  |        |    |       |       |  |  |         |     |       |       |        |    |       |       |  |  |  |             |     |       |        |     |       |       |  |  |  |  |            |     |        |       |       |       |  |  |  |  |  |  |        |     |       |       |  |  |  |  |  |  |
| 2.2 16V  | 120   | 09.05     | 12.10 |                |                |                |                |                              |                   |                              |                   |         |         |       |       |       |                |                |        |                              |       |                   |       |         |       |       |       |  |        |    |       |           |     |       |         |     |       |        |     |       |       |           |     |       |       |         |        |       |       |       |  |            |     |       |       |  |            |     |       |       |  |        |    |       |       |  |  |         |     |       |       |        |    |       |       |  |  |  |             |     |       |        |     |       |       |  |  |  |  |            |     |        |       |       |       |  |  |  |  |  |  |        |     |       |       |  |  |  |  |  |  |
| 2.2 HDi  | 98  | 12.04     | 12.10 |                |                |                |                |                              |                   |                              |                   |         |         |       |       |       |                |                |        |                              |       |                   |       |         |       |       |       |  |        |    |       |           |     |       |         |     |       |        |     |       |       |           |     |       |       |         |        |       |       |       |  |            |     |       |       |  |            |     |       |       |  |        |    |       |       |  |  |         |     |       |       |        |    |       |       |  |  |  |             |     |       |        |     |       |       |  |  |  |  |            |     |        |       |       |       |  |  |  |  |  |  |        |     |       |       |  |  |  |  |  |  |
| 2.2 HDi  | 125   | 05.06     | 12.10 |                |                |                |                |                              |                   |                              |                   |         |         |       |       |       |                |                |        |                              |       |                   |       |         |       |       |       |  |        |    |       |           |     |       |         |     |       |        |     |       |       |           |     |       |       |         |        |       |       |       |  |            |     |       |       |  |            |     |       |       |  |        |    |       |       |  |  |         |     |       |       |        |    |       |       |  |  |  |             |     |       |        |     |       |       |  |  |  |  |            |     |        |       |       |       |  |  |  |  |  |  |        |     |       |       |  |  |  |  |  |  |
| 2.7 HDi 24V  | 150   | 12.04     | 12.10 |                |                |                |                |                              |                   |                              |                   |         |         |       |       |       |                |                |        |                              |       |                   |       |         |       |       |       |  |        |    |       |           |     |       |         |     |       |        |     |       |       |           |     |       |       |         |        |       |       |       |  |            |     |       |       |  |            |     |       |       |  |        |    |       |       |  |  |         |     |       |       |        |    |       |       |  |  |  |             |     |       |        |     |       |       |  |  |  |  |            |     |        |       |       |       |  |  |  |  |  |  |        |     |       |       |  |  |  |  |  |  |
| 3.0 V6 24V   | 155   | 03.04     | 12.10 |                |                |                |                |                              |                   |                              |                   |         |         |       |       |       |                |                |        |                              |       |                   |       |         |       |       |       |  |        |    |       |           |     |       |         |     |       |        |     |       |       |           |     |       |       |         |        |       |       |       |  |            |     |       |       |  |            |     |       |       |  |        |    |       |       |  |  |         |     |       |       |        |    |       |       |  |  |  |             |     |       |        |     |       |       |  |  |  |  |            |     |        |       |       |       |  |  |  |  |  |  |        |     |       |       |  |  |  |  |  |  |

<sup>1)</sup> notice length / attenzione lunghezza / faire attention longueur / atención largo

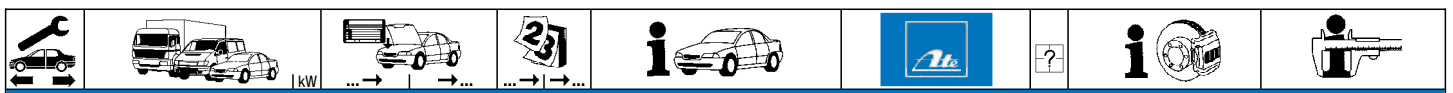

**PEUGEOT 607 (00-10)**

|  |             |     |  |       |       |                |        |                          |  |       |
|--|-------------|-----|--|-------|-------|----------------|--------|--------------------------|--|-------|
|  | 2.0         | 100 |  | 02.00 | 11.04 | 24.5111-0201.3 | 330498 | 2                        |  | L=200 |
|  | 2.0 HDi     | 79  |  | 03.01 | 07.04 |                |        |                          |  |       |
|  | 2.0 HDi     | 80  |  | 05.00 | 11.04 |                |        |                          |  |       |
|  | 2.2 16V     | 116 |  | 02.00 | 11.04 |                |        |                          |  |       |
|  | 2.2 HDi     | 98  |  | 02.00 | 11.04 |                |        |                          |  |       |
|  | 3.0 V6 24V  | 152 |  | 02.00 | 11.04 |                |        |                          |  |       |
|  | 2.0         | 100 |  | 12.04 | 12.10 | 24.5257-0480.3 | 330823 | 2                        |  | L=480 |
|  | 2.0 HDi     | 80  |  | 12.04 | 12.10 |                |        |                          |  |       |
|  | 2.0 HDi     | 100 |  | 09.05 | 12.10 |                |        |                          |  |       |
|  | 2.2 16V     | 116 |  | 12.04 | 12.10 |                |        |                          |  |       |
|  | 2.2 16V     | 120 |  | 09.05 | 12.10 |                |        |                          |  |       |
|  | 2.2 HDi     | 98  |  | 12.04 | 12.10 |                |        |                          |  |       |
|  | 2.2 HDi     | 125 |  | 05.06 | 12.10 |                |        |                          |  |       |
|  | 2.7 HDi 24V | 150 |  | 12.04 | 12.10 |                |        |                          |  |       |
|  | 3.0 V6 24V  | 155 |  | 03.04 | 12.10 |                |        |                          |  |       |
|  | 2.0         | 100 |  | 02.00 | 11.04 | 24.3727-0837.2 | 580837 | <input type="checkbox"/> |  | L=724 |
|  | 2.0 HDi     | 79  |  | 03.01 | 07.04 | 24.3727-0838.2 | 580838 | <input type="checkbox"/> |  | L=713 |
|  | 2.0 HDi     | 80  |  | 05.00 | 11.04 |                |        |                          |  |       |
|  | 2.2 16V     | 116 |  | 02.00 | 11.04 |                |        |                          |  |       |
|  | 2.2 HDi     | 98  |  | 02.00 | 11.04 |                |        |                          |  |       |
|  | 3.0 V6 24V  | 152 |  | 02.00 | 11.04 |                |        |                          |  |       |
|  | 2.0         | 100 |  | 12.04 | 12.10 | 24.3727-0840.2 | 580840 | <input type="checkbox"/> |  | L=815 |
|  | 2.0 HDi     | 80  |  | 12.04 | 12.10 | 24.3727-0841.2 | 580841 | <input type="checkbox"/> |  | L=794 |
|  | 2.0 HDi     | 100 |  | 09.05 | 12.10 |                |        |                          |  |       |
|  | 2.2 16V     | 116 |  | 12.04 | 12.10 |                |        |                          |  |       |
|  | 2.2 16V     | 120 |  | 09.05 | 12.10 |                |        |                          |  |       |
|  | 2.2 HDi     | 98  |  | 12.04 | 12.10 |                |        |                          |  |       |
|  | 2.2 HDi     | 125 |  | 05.06 | 12.10 |                |        |                          |  |       |
|  | 2.7 HDi 24V | 150 |  | 12.04 | 12.10 |                |        |                          |  |       |
|  | 3.0 V6 24V  | 155 |  | 03.04 | 12.10 |                |        |                          |  |       |

**PEUGEOT 806 (94-02)**

|  |           |     |            |       |       |                |        |                          |                              |                |
|--|-----------|-----|------------|-------|-------|----------------|--------|--------------------------|------------------------------|----------------|
|  | 1.8 i     | 73  | ORGA 08206 | 10.96 |       | 24.2122-1703.3 | 010422 |                          | - ABS                        | THz 22,20      |
|  |           |     |            |       |       | 24.2122-1708.3 | 010437 |                          | + ABS                        | THz 22,20      |
|  | 1.8 i     | 73  | ORGA 08207 | 06.02 |       | 24.2122-1741.3 | 010695 |                          | - ABS                        | THz 22,20      |
|  |           |     |            |       |       | 24.2122-1742.3 | 010696 |                          | + ABS                        | THz 22,20      |
|  | 1.9 TD    |     | ORGA 08206 | 07.95 |       | 24.2123-1707.3 | 010492 |                          | - ABS                        | THz 23,81      |
|  | 2.0 16V   |     | ORGA 08206 | 10.98 |       | 24.2123-1708.3 | 010493 |                          | + ABS                        | THz 23,81      |
|  | 2.0 i     | 89  | ORGA 08206 | 08.94 |       |                |        |                          |                              |                |
|  | 2.0 Turbo | 108 | ORGA 08206 | 08.94 |       |                |        |                          |                              |                |
|  | 2.1 TD    | 80  | ORGA 08206 | 06.96 |       |                |        |                          |                              |                |
|  | 1.9 TD    |     | ORGA 08207 | 06.02 |       | 24.2123-1738.3 | 010658 |                          | - ABS                        | THz 23,81      |
|  | 2.0 16V   |     | ORGA 08207 | 06.02 |       | 24.2123-1733.3 | 010657 |                          | + ABS                        | THz 23,81      |
|  | 2.0 HDi   | 80  |            | 08.99 | 06.02 |                |        |                          |                              |                |
|  | 2.0 i     | 89  | ORGA 08207 | 06.02 |       |                |        |                          |                              |                |
|  | 2.0 Turbo | 108 | ORGA 08207 | 06.02 |       |                |        |                          |                              |                |
|  | 2.1 TD    | 80  | ORGA 08207 | 06.02 |       |                |        |                          |                              |                |
|  | 1.8 i     | 73  |            | 10.96 | 06.02 | 24.3571-1711.5 | 240159 | <input type="checkbox"/> |                              | D=57, - Halter |
|  |           |     |            |       |       | 24.3571-1712.5 | 240160 | <input type="checkbox"/> |                              | Halter         |
|  | 1.9 TD    |     |            | 07.95 | 06.02 | 24.3571-1709.5 | 240153 | <input type="checkbox"/> |                              | D=57, - Halter |
|  | 2.0 16V   |     |            | 10.98 | 06.02 | 24.3571-1710.5 | 240154 | <input type="checkbox"/> |                              | Halter         |
|  | 2.0 HDi   | 80  |            | 08.99 | 06.02 |                |        |                          |                              |                |
|  | 2.0 i     | 89  |            | 08.94 | 06.02 |                |        |                          |                              |                |
|  | 2.0 Turbo | 108 |            | 08.94 | 06.02 |                |        |                          |                              |                |
|  | 2.1 TD    | 80  |            | 06.96 | 06.02 |                |        |                          |                              |                |
|  | 1.8 i     | 73  |            | 10.96 | 06.02 | 24.5118-0471.3 | 330528 | 2                        |                              | L=473          |
|  | 1.9 TD    |     |            | 07.95 | 06.02 |                |        |                          |                              |                |
|  | 2.0 16V   |     |            | 10.98 | 06.02 |                |        |                          |                              |                |
|  | 2.0 HDi   | 80  |            | 08.99 | 06.02 |                |        |                          |                              |                |
|  | 2.0 i     | 89  |            | 08.94 | 06.02 |                |        |                          |                              |                |
|  | 2.0 Turbo | 108 |            | 08.94 | 06.02 |                |        |                          |                              |                |
|  | 2.1 TD    | 80  |            | 06.96 | 06.02 |                |        |                          |                              |                |
|  | 1.8 i     | 73  |            | 10.96 | 06.02 | 11.3361-9975.2 | 220281 | <input type="checkbox"/> |                              | D=36, - Halter |
|  | 1.9 TD    |     |            | 07.95 | 06.02 | 11.3361-9976.2 | 220282 | <input type="checkbox"/> |                              | Halter         |
|  | 2.0 16V   |     |            | 10.98 | 06.02 | 11.0441-3602.2 | 250008 |                          |                              | Dichtungssatz  |
|  | 2.0 HDi   | 80  |            | 08.99 | 06.02 | 11.0101-5407.2 | 260011 |                          |                              | Hülzensatz     |
|  | 2.0 i     | 89  |            | 08.94 | 06.02 | 11.8116-0073.1 | 390498 | 2                        |                              | Haltefeder     |
|  | 2.0 Turbo | 108 |            | 08.94 | 06.02 | 24.3361-9975.5 | 240541 | <input type="checkbox"/> |                              | D=36, - Halter |
|  | 2.1 TD    | 80  |            | 06.96 | 06.02 | 24.3361-9976.5 | 240542 | <input type="checkbox"/> |                              | Halter         |
|  | 1.8 i     | 73  |            | 10.96 | 06.02 | 24.5229-0251.3 | 330535 | 2                        |                              | L=250          |
|  | 1.9 TD    |     |            | 07.95 | 06.02 |                |        |                          |                              |                |
|  | 2.0 HDi   | 80  |            | 08.99 | 06.02 |                |        |                          |                              |                |
|  | 2.0 i     | 89  |            | 08.94 | 06.02 |                |        |                          |                              |                |
|  | 1.8 i     | 73  |            | 10.96 | 06.02 | 24.5229-0251.3 | 330535 | 2                        | Länge beachten <sup>3)</sup> | L=250          |
|  | 1.9 TD    |     |            | 07.95 | 06.02 | 24.5111-0301.3 | 330499 | 2                        | Länge beachten <sup>3)</sup> | L=300          |
|  | 2.0 16V   |     |            | 10.98 | 06.02 |                |        |                          |                              |                |
|  | 2.0 HDi   | 80  |            | 08.99 | 06.02 |                |        |                          |                              |                |
|  | 2.0 i     | 89  |            | 08.94 | 06.02 |                |        |                          |                              |                |
|  | 2.0 Turbo | 108 |            | 08.94 | 06.02 |                |        |                          |                              |                |
|  | 2.1 TD    | 80  |            | 06.96 | 06.02 |                |        |                          |                              |                |
|  | 1.8 i     | 73  |            | 10.96 | 06.02 | 24.3219-1704.3 | 020374 |                          |                              | Rz 19,05       |
|  | 1.9 TD    |     |            | 07.95 | 06.02 |                |        |                          |                              |                |
|  | 2.0 HDi   | 80  |            | 08.99 | 06.02 |                |        |                          |                              |                |
|  | 2.0 i     | 89  |            | 08.94 | 06.02 |                |        |                          |                              |                |

<sup>1)</sup> + RA drum brake / + P freno a tamburo / + frein à tambour essieu AR / + ET-tambores de freno

<sup>2)</sup> + RA disc brake / + P disco freno / + frein à disque essieu AR / + ET-disco de freno

<sup>3)</sup> notice length / attenzione lunghezza / faire attention longueur / atención largo





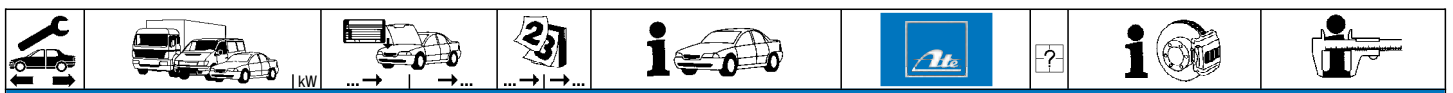

**PEUGEOT 806 (94-02)**

|  |           |     |  |  |              |  |                       |        |                          |                          |               |
|--|-----------|-----|--|--|--------------|--|-----------------------|--------|--------------------------|--------------------------|---------------|
|  | 1.8 i     | 73  |  |  | <b>10.96</b> | <b>06.02</b> + HA-Trommelbremse <sup>1)</sup>  | <b>24.3727-0532.2</b> | 580532 | <input type="checkbox"/> |                          | L=1063        |
|  | 1.9 TD    | 81  |  |  | <b>07.95</b> | <b>06.02</b> + HA-Trommelbremse <sup>1)</sup>  | <b>24.3727-0531.2</b> | 580531 | <input type="checkbox"/> |                          | L=2286        |
|  | 2.0 HDi   | 80  |  |  | <b>08.99</b> | <b>06.02</b> + HA-Trommelbremse <sup>1)</sup>  |                       |        |                          |                          |               |
|  | 2.0 i     | 89  |  |  | <b>08.94</b> | <b>06.02</b> + HA-Trommelbremse <sup>1)</sup>  |                       |        |                          |                          |               |
|  | 1.8 i     | 73  |  |  | <b>10.96</b> | <b>06.02</b> + HA-Trommelbremse <sup>1)</sup>  | <b>24.3727-0532.2</b> | 580532 | <input type="checkbox"/> |                          | L=1063        |
|  | 1.9 TD    | 81  |  |  | <b>07.95</b> | <b>06.02</b> + HA-Trommelbremse <sup>1)</sup>  |                       |        |                          |                          |               |
|  | 2.0 HDi   | 80  |  |  | <b>08.99</b> | <b>06.02</b> + HA-Trommelbremse <sup>1)</sup>  |                       |        |                          |                          |               |
|  | 2.0 i     | 89  |  |  | <b>08.94</b> | <b>06.02</b> + HA-Trommelbremse <sup>1)</sup>  |                       |        |                          |                          |               |
|  | 1.8 i     | 73  |  |  | <b>10.96</b> | <b>06.02</b> + HA-Scheibenbremse <sup>2)</sup> | <b>24.3727-0336.2</b> | 580336 | <input type="checkbox"/> | <input type="checkbox"/> | L=500         |
|  | 1.9 TD    | 81  |  |  | <b>07.95</b> | <b>06.02</b> + HA-Scheibenbremse <sup>2)</sup> | <b>24.3727-0530.2</b> | 580530 | <input type="checkbox"/> | <input type="checkbox"/> | L=1255        |
|  | 2.0 16V   | 81  |  |  | <b>10.98</b> | <b>06.02</b>                                   | <b>24.3727-0529.2</b> | 580529 | <input type="checkbox"/> | <input type="checkbox"/> | L=2205        |
|  | 2.0 HDi   | 80  |  |  | <b>08.99</b> | <b>06.02</b> + HA-Scheibenbremse <sup>2)</sup> |                       |        |                          |                          |               |
|  | 2.0 i     | 89  |  |  | <b>08.94</b> | <b>06.02</b> + HA-Scheibenbremse <sup>2)</sup> |                       |        |                          |                          |               |
|  | 2.1 TD    | 80  |  |  | <b>06.96</b> | <b>06.02</b>                                   |                       |        |                          |                          |               |
|  | 1.8 i     | 73  |  |  | <b>10.96</b> | <b>06.02</b>                                   | <b>24.6582-1715.3</b> | 320205 |                          |                          | BRL (4)       |
|  | 2.0 i     | 89  |  |  | <b>08.94</b> | <b>06.02</b>                                   |                       |        |                          |                          |               |
|  | 1.8 i     | 73  |  |  | <b>10.96</b> | <b>06.02</b>                                   | <b>24.3728-0341.2</b> | 590341 |                          |                          | L=738, + AUT  |
|  | 2.0 i     | 89  |  |  | <b>08.94</b> | <b>06.02</b>                                   |                       |        |                          |                          |               |
|  | 1.9 TD    | 81  |  |  | <b>07.95</b> | <b>06.02</b> + ME-Getriebe <sup>3)</sup>       | <b>24.3728-0342.2</b> | 590342 |                          |                          | L=863, + AUT  |
|  | 2.0 Turbo | 108 |  |  | <b>08.94</b> | <b>06.02</b> + ME-Getriebe <sup>3)</sup>       |                       |        |                          |                          |               |
|  | 2.0 16V   | 81  |  |  | <b>10.98</b> | <b>06.02</b>                                   | <b>24.3728-0336.2</b> | 590336 |                          |                          | L=973, + AUT  |
|  | 1.9 TD    | 81  |  |  | <b>07.95</b> | <b>06.02</b> + ML5-Getriebe <sup>4)</sup>      | <b>24.3728-0340.2</b> | 590340 |                          |                          | L=1088, + AUT |
|  | 2.0 Turbo | 108 |  |  | <b>08.94</b> | <b>06.02</b> + ML5-Getriebe <sup>4)</sup>      |                       |        |                          |                          |               |
|  | 2.1 TD    | 80  |  |  | <b>06.96</b> | <b>06.02</b> + ML5-Getriebe <sup>4)</sup>      |                       |        |                          |                          |               |

**PEUGEOT 807 (02-)**

|         |               |                |            |              |              |              |                       |        |                          |                          |                |     |
|---------|---------------|----------------|------------|--------------|--------------|--------------|-----------------------|--------|--------------------------|--------------------------|----------------|-----|
|         | 2.0 16V       | 100 ORGA 10528 |            |              |              |              | <b>03.7860-2002.4</b> | 300216 |                          |                          | 10"            | ATE |
|         | 2.0 16V       | 103 ORGA 10528 | ORGA 10919 |              |              |              |                       |        |                          |                          |                |     |
|         | 2.0 HDi       | 79 ORGA 10528  | ORGA 10919 |              |              |              |                       |        |                          |                          |                |     |
|         | 2.0 HDi       | 80 ORGA 10528  | ORGA 10919 |              |              |              |                       |        |                          |                          |                |     |
|         | 2.0 HDi       | 88 ORGA 10528  | ORGA 10919 |              |              |              |                       |        |                          |                          |                |     |
|         | 2.0 HDi       | 100 ORGA 10528 |            |              |              |              |                       |        |                          |                          |                |     |
|         | 2.2 16V       | 116 ORGA 10528 |            |              |              |              |                       |        |                          |                          |                |     |
|         | 2.2 HDi       | 94 ORGA 10528  | ORGA 10919 |              |              |              |                       |        |                          |                          |                |     |
|         | 2.0 16V       | 103 ORGA 10920 |            |              |              |              | <b>03.7860-4302.4</b> | 300231 |                          |                          | 10"            | ATE |
|         | 2.0 HDi       | 79 ORGA 10920  |            |              | <b>05.06</b> |              |                       |        |                          |                          |                |     |
|         | 2.0 HDi       | 80 ORGA 10920  |            |              |              |              |                       |        |                          |                          |                |     |
|         | 2.0 HDi       | 88 ORGA 10920  |            |              |              |              |                       |        |                          |                          |                |     |
|         | 2.2 HDi       | 94 ORGA 10920  |            |              |              |              |                       |        |                          |                          |                |     |
|         | 2.0 16V       | 100 ORGA 10528 |            |              |              |              | <b>03.2122-2163.3</b> | 010800 |                          |                          | Thz 22,20      | ATE |
|         | 2.0 16V       | 103            |            |              | <b>09.05</b> |              |                       |        |                          |                          |                |     |
|         | 2.0 HDi       | 79 ORGA 10528  |            |              |              |              |                       |        |                          |                          |                |     |
|         | 2.0 HDi       | 80 ORGA 10528  |            |              | <b>05.06</b> |              |                       |        |                          |                          |                |     |
|         | 2.0 HDi       | 88 ORGA 10528  |            |              |              |              |                       |        |                          |                          |                |     |
|         | 2.0 HDi       | 100            |            |              | <b>06.06</b> |              |                       |        |                          |                          |                |     |
|         | 2.2 16V       | 116 ORGA 10528 |            |              |              |              |                       |        |                          |                          |                |     |
| 2.2 HDi | 94 ORGA 10528 |                |            |              |              |              |                       |        |                          |                          |                |     |
|         | 2.0 HDi       | 120            |            |              | <b>06.09</b> |              | <b>03.2123-3421.3</b> | 010933 |                          |                          | Thz 23,81      | ATE |
|         | 2.2 HDi       | 125            |            |              | <b>10.07</b> |              |                       |        |                          |                          |                |     |
|         | 2.0 16V       | 100            |            |              | <b>06.02</b> |              | <b>24.3601-1711.7</b> | 220607 | <input type="checkbox"/> | <input type="checkbox"/> | D=60, - Halter | LUC |
|         | 2.0 16V       | 103            |            |              | <b>09.05</b> |              | <b>24.3601-1712.7</b> | 220608 | <input type="checkbox"/> | <input type="checkbox"/> | D=60, - Halter | LUC |
|         | 2.0 HDi       | 79             |            |              | <b>06.02</b> |              |                       |        |                          |                          |                |     |
|         | 2.0 HDi       | 80             |            |              | <b>04.04</b> | <b>05.06</b> |                       |        |                          |                          |                |     |
|         | 2.0 HDi       | 88             |            |              | <b>11.06</b> |              |                       |        |                          |                          |                |     |
|         | 2.0 HDi       | 100            |            |              | <b>06.06</b> |              |                       |        |                          |                          |                |     |
|         | 2.2 16V       | 116            |            |              | <b>06.02</b> |              |                       |        |                          |                          |                |     |
| 2.2 HDi | 94            |                |            | <b>06.02</b> |              |              |                       |        |                          |                          |                |     |
|         | 2.0 16V       | 100            |            |              | <b>06.02</b> |              | <b>24.5111-0462.3</b> | 330555 | 2                        |                          | L=460          |     |
|         | 2.0 16V       | 103            |            |              | <b>09.05</b> |              |                       |        |                          |                          |                |     |
|         | 2.0 HDi       | 79             |            |              | <b>06.02</b> |              |                       |        |                          |                          |                |     |
|         | 2.0 HDi       | 80             |            |              | <b>04.04</b> | <b>05.06</b> |                       |        |                          |                          |                |     |
|         | 2.0 HDi       | 88             |            |              | <b>11.06</b> |              |                       |        |                          |                          |                |     |
|         | 2.0 HDi       | 100            |            |              | <b>06.06</b> |              |                       |        |                          |                          |                |     |
|         | 2.0 HDi       | 120            |            |              | <b>06.09</b> |              | <b>24.5144-0500.3</b> | 331169 | 2                        |                          | L=500          |     |
|         | 2.2 HDi       | 125            |            |              | <b>10.07</b> |              |                       |        |                          |                          |                |     |
|         | 2.0 16V       | 100            |            |              | <b>06.02</b> |              | <b>24.3384-1761.7</b> | 220671 | <input type="checkbox"/> | <input type="checkbox"/> | D=38, - Halter | LUC |
|         | 2.0 16V       | 103            |            |              | <b>09.05</b> |              | <b>24.3384-1762.7</b> | 220672 | <input type="checkbox"/> | <input type="checkbox"/> | D=38, - Halter | LUC |
|         | 2.0 HDi       | 79             |            |              | <b>06.02</b> |              |                       |        |                          |                          |                |     |
|         | 2.0 HDi       | 80             |            |              | <b>04.04</b> | <b>05.06</b> |                       |        |                          |                          |                |     |
|         | 2.0 HDi       | 88             |            |              | <b>11.06</b> |              |                       |        |                          |                          |                |     |
|         | 2.0 HDi       | 100            |            |              | <b>06.06</b> |              |                       |        |                          |                          |                |     |
|         | 2.0 HDi       | 120            |            |              | <b>06.09</b> |              |                       |        |                          |                          |                |     |
|         | 2.2 16V       | 116            |            |              | <b>06.02</b> |              |                       |        |                          |                          |                |     |
|         | 2.2 HDi       | 94             |            |              | <b>06.02</b> |              |                       |        |                          |                          |                |     |
|         | 2.2 HDi       | 125            |            |              | <b>10.07</b> |              |                       |        |                          |                          |                |     |
|         | 3.0 V6        | 150            |            |              | <b>06.02</b> |              |                       |        |                          |                          |                |     |
|         | 2.0 16V       | 100            |            |              | <b>06.02</b> |              | <b>24.5229-0251.3</b> | 330535 | 2                        |                          | L=250          |     |
|         | 2.0 16V       | 103            |            |              | <b>09.05</b> |              |                       |        |                          |                          |                |     |
|         | 2.0 HDi       | 79             |            |              | <b>06.02</b> |              |                       |        |                          |                          |                |     |
|         | 2.0 HDi       | 80             |            |              | <b>04.04</b> | <b>05.06</b> |                       |        |                          |                          |                |     |
|         | 2.0 HDi       | 88             |            |              | <b>11.06</b> |              |                       |        |                          |                          |                |     |

1) + RA drum brake / + P freno a tamburo / + frein à tambour essieu AR / + ET-tambores de freno  
 2) + RA disc brake / + P disco freno / + frein à disque essieu AR / + ET-disco de freno  
 3) + ME transmission / + scatola cambio ME / + boîte de vitesse ME / + cambio ME  
 4) + ML5 transmission / + scatola cambio ML5 / + boîte de vitesse ML5 / + cambio ML5



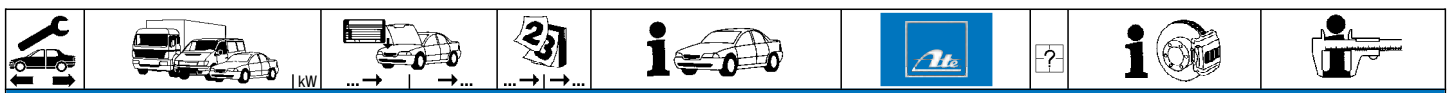







































**PEUGEOT 807 (02-)**

|  |         |      |            |       |       |                |        |                          |  |        |
|--|---------|------|------------|-------|-------|----------------|--------|--------------------------|--|--------|
|  | 2.0 HDi | 100  |            | 06.06 |       | 24.5229-0251.3 | 330535 | 2                        |  | L=250  |
|  | 2.0 HDi | 120  |            | 06.09 |       |                |        |                          |  |        |
|  | 2.2 16V | 116  |            | 06.02 |       |                |        |                          |  |        |
|  | 2.2 HDi | 94   |            | 06.02 |       |                |        |                          |  |        |
|  | 2.2 HDi | 125  |            | 10.07 |       |                |        |                          |  |        |
|  | 3.0 V6  | 150  |            | 06.02 |       |                |        |                          |  |        |
|  | 2.0 16V | 1100 | ORGA 10284 | 06.02 |       | 24.3727-0847.2 | 580847 | <input type="checkbox"/> |  | L=1068 |
|  | 2.0 16V | 1103 | ORGA 10284 | 09.05 |       | 24.3727-0848.2 | 580848 | <input type="checkbox"/> |  | L=2360 |
|  | 2.0 HDi | 79   | ORGA 10284 | 06.02 |       |                |        |                          |  |        |
|  | 2.0 HDi | 80   | ORGA 10284 | 05.06 |       |                |        |                          |  |        |
|  | 2.0 HDi | 88   | ORGA 10284 | 11.06 |       |                |        |                          |  |        |
|  | 2.0 HDi | 1100 | ORGA 10284 | 06.06 |       |                |        |                          |  |        |
|  | 2.2 16V | 1116 | ORGA 10284 | 06.02 |       |                |        |                          |  |        |
|  | 2.2 HDi | 94   | ORGA 10284 | 06.02 |       |                |        |                          |  |        |
|  | 2.2 HDi | 125  | ORGA 10284 | 10.07 |       |                |        |                          |  |        |
|  | 3.0 V6  | 150  | ORGA 10284 | 06.02 |       |                |        |                          |  |        |
|  | 2.0 16V | 1100 | ORGA 10285 |       | 05.06 | 24.3727-0850.2 | 580850 | <input type="checkbox"/> |  | L=1041 |
|  | 2.0 16V | 1103 | ORGA 10285 |       |       | 24.3727-0849.2 | 580849 | <input type="checkbox"/> |  | L=2308 |
|  | 2.0 HDi | 79   | ORGA 10285 |       |       |                |        |                          |  |        |
|  | 2.0 HDi | 80   | ORGA 10285 |       |       |                |        |                          |  |        |
|  | 2.0 HDi | 88   | ORGA 10285 |       |       |                |        |                          |  |        |
|  | 2.0 HDi | 1100 | ORGA 10285 |       |       |                |        |                          |  |        |
|  | 2.0 HDi | 120  |            | 06.09 |       |                |        |                          |  |        |
|  | 2.2 16V | 1116 | ORGA 10285 |       |       |                |        |                          |  |        |
|  | 2.2 HDi | 94   | ORGA 10285 |       |       |                |        |                          |  |        |
|  | 2.2 HDi | 125  | ORGA 10285 |       |       |                |        |                          |  |        |
|  | 3.0 V6  | 150  | ORGA 10285 |       |       |                |        |                          |  |        |
|  | 2.0 16V | 1100 | ORGA 10284 | 06.02 |       | 24.3727-0848.2 | 580848 | <input type="checkbox"/> |  | L=2360 |
|  | 2.0 16V | 1103 | ORGA 10284 | 09.05 |       | 24.3727-0847.2 | 580847 | <input type="checkbox"/> |  | L=1068 |
|  | 2.0 HDi | 79   | ORGA 10284 | 06.02 |       |                |        |                          |  |        |
|  | 2.0 HDi | 80   | ORGA 10284 | 04.04 |       |                |        |                          |  |        |
|  | 2.0 HDi | 88   | ORGA 10284 | 11.06 |       |                |        |                          |  |        |
|  | 2.0 HDi | 1100 | ORGA 10284 | 06.06 |       |                |        |                          |  |        |
|  | 2.2 16V | 1116 | ORGA 10284 | 06.02 |       |                |        |                          |  |        |
|  | 2.2 HDi | 94   | ORGA 10284 | 06.02 |       |                |        |                          |  |        |
|  | 2.2 HDi | 125  | ORGA 10284 | 10.07 |       |                |        |                          |  |        |
|  | 3.0 V6  | 150  | ORGA 10284 | 06.02 |       |                |        |                          |  |        |
|  | 2.0 16V | 1100 | ORGA 10285 |       | 05.06 | 24.3727-0849.2 | 580849 | <input type="checkbox"/> |  | L=2308 |
|  | 2.0 16V | 1103 | ORGA 10285 |       |       | 24.3727-0850.2 | 580850 | <input type="checkbox"/> |  | L=1041 |
|  | 2.0 HDi | 79   | ORGA 10285 |       |       |                |        |                          |  |        |
|  | 2.0 HDi | 80   | ORGA 10285 |       |       |                |        |                          |  |        |
|  | 2.0 HDi | 88   | ORGA 10285 |       |       |                |        |                          |  |        |
|  | 2.0 HDi | 1100 | ORGA 10285 |       |       |                |        |                          |  |        |
|  | 2.0 HDi | 120  |            | 06.09 |       |                |        |                          |  |        |
|  | 2.2 16V | 1116 | ORGA 10285 |       |       |                |        |                          |  |        |
|  | 2.2 HDi | 94   | ORGA 10285 |       |       |                |        |                          |  |        |
|  | 2.2 HDi | 125  | ORGA 10285 |       |       |                |        |                          |  |        |
|  | 3.0 V6  | 150  | ORGA 10285 |       |       |                |        |                          |  |        |

**PEUGEOT 1007 (05-11)**















|  |             |    |            |       |       |                |        |                          |       |                |            |
|--|-------------|----|------------|-------|-------|----------------|--------|--------------------------|-------|----------------|------------|
|  | 1.4         | 54 | ORGA 11009 | 04.05 |       | 24.2122-1764.3 | 010851 |                          | - DSC | THz 22,20      | <b>BOS</b> |
|  | 1.4 16V     | 65 | ORGA 11009 | 10.05 |       | 24.2122-1766.3 | 010840 |                          | - DSC | THz 22,20      | <b>LUC</b> |
|  | 1.4 HDi     | 50 | ORGA 11009 | 04.05 |       | 24.2122-1767.3 | 010841 |                          | + DSC | THz 22,20      | <b>LUC</b> |
|  | 1.6 16V     | 80 | ORGA 11009 | 04.05 |       |                |        |                          |       |                |            |
|  | 1.4         | 54 | ORGA 11010 |       | 02.11 | 24.4122-1704.3 | 010847 |                          | - DSC | THz 22,20      | <b>LUC</b> |
|  | 1.4 16V     | 65 | ORGA 11010 |       | 02.11 | 24.4122-1703.3 | 010843 |                          | + DSC | THz 22,20      | <b>LUC</b> |
|  | 1.4 HDi     | 50 | ORGA 11010 |       | 02.11 |                |        |                          |       |                |            |
|  | 1.6 16V     | 80 | ORGA 11010 |       | 02.11 |                |        |                          |       |                |            |
|  | 1.6 HDi 110 | 80 |            | 04.07 | 02.11 |                |        |                          |       |                |            |
|  | 1.4         | 54 |            | 04.05 | 02.11 | 24.3541-1771.5 | 240239 | <input type="checkbox"/> |       | D=54, - Halter | <b>BOS</b> |
|  | 1.4 16V     | 65 |            | 10.05 | 02.11 | 24.3541-1772.5 | 240240 | <input type="checkbox"/> |       | D=54, - Halter | <b>BOS</b> |
|  | 1.4 HDi     | 50 |            | 04.05 | 02.11 |                |        |                          |       |                |            |
|  | 1.6 16V     | 80 |            | 04.05 | 02.11 |                |        |                          |       |                |            |
|  | 1.6 HDi 110 | 80 |            | 04.07 | 02.11 | 24.3541-1761.5 | 240233 | <input type="checkbox"/> |       | D=54, - Halter | <b>BOS</b> |
|  |             |    |            |       |       | 24.3541-1762.5 | 240234 | <input type="checkbox"/> |       | D=54, - Halter | <b>BOS</b> |
|  | 1.4         | 54 |            | 04.05 | 02.11 | 24.5111-0446.3 | 331055 | 2                        |       | L=445          |            |
|  | 1.4 16V     | 65 |            | 10.05 | 02.11 |                |        |                          |       |                |            |
|  | 1.4 HDi     | 50 |            | 04.05 | 02.11 |                |        |                          |       |                |            |
|  | 1.6 16V     | 80 |            | 04.05 | 02.11 |                |        |                          |       |                |            |
|  | 1.6 HDi 110 | 80 |            | 04.07 | 02.11 | 24.5111-0460.3 | 330603 | 2                        |       | L=460          |            |
|  | 1.6 16V     | 80 |            | 04.05 | 02.11 | 24.3387-1705.7 | 220675 | <input type="checkbox"/> |       | D=38, - Halter | <b>LUC</b> |
|  | 1.6 HDi 110 | 80 |            | 04.07 | 02.11 | 24.3387-1706.7 | 220676 | <input type="checkbox"/> |       | D=38, - Halter | <b>LUC</b> |
|  | 1.4         | 54 | ORGA 10583 | 04.05 |       | 24.5246-0185.3 | 330881 | 2                        |       | L=185          |            |
|  | 1.4 16V     | 65 | ORGA 10583 | 10.05 |       |                |        |                          |       |                |            |
|  | 1.4 HDi     | 50 | ORGA 10583 | 04.05 |       |                |        |                          |       |                |            |
|  | 1.6 16V     | 80 | ORGA 10583 | 04.05 |       |                |        |                          |       |                |            |
|  | 1.4         | 54 | ORGA 10584 |       | 02.11 | 24.5246-0190.3 | 330697 | 2                        |       | L=190          |            |
|  | 1.4 16V     | 65 | ORGA 10584 |       | 02.11 |                |        |                          |       |                |            |
|  | 1.4 HDi     | 50 | ORGA 10584 |       | 02.11 |                |        |                          |       |                |            |
|  | 1.6 16V     | 80 | ORGA 10584 |       | 02.11 |                |        |                          |       |                |            |
|  | 1.6 HDi 110 | 80 |            | 04.07 | 02.11 |                |        |                          |       |                |            |



|     |              |  |  |  |  |   |                        |   |   |  |  |
|--|--|--|--|--|---|---|--|---|---|--|--|
| <b>PEUGEOT 1007 (05-11)</b>  |  |  |  |  |   |   |  |   |   |  |  |
|    | 1.4<br>1.4 16V<br>1.4 HDi  | 54<br>65<br>50   |  | 04.05<br>10.05<br>04.05  | 02.11<br>02.11<br>02.11   | 24.3220-1724.3<br>24.3220-1717.3  | 020476<br>020430   |   | Rz 20,64<br>Rz 20,64  | <b>BOS</b><br><b>LUC</b>   |  |
|    | 1.4<br>1.4 16V<br>1.4 HDi  | 54<br>65<br>50   |  | 04.05<br>10.05<br>04.05  | 02.11<br>02.11<br>02.11   | 24.3727-0843.2  | 580843   | 2 ↓   | L=1612  |  |  |
| <b>PEUGEOT 2008 (13-)</b>  |  |  |  |  |   |   |  |   |   |  |  |
|    | 1.4 HDi 68<br>1.6 e-HDi 115<br>1.6 e-HDi 92<br>1.6 VTI 120                                   | 50<br>84<br>68<br>88   |  | 03.13<br>03.13<br>03.13<br>03.13   |   | 24.4123-1704.3  | 010828   |   | THz 23,81   | <b>LUC</b>   |  |
|    | 1.2 VTI 82<br>1.4 HDi 68<br>1.6 e-HDi 115<br>1.6 e-HDi 92<br>1.6 VTI 120                     | 60<br>50<br>84<br>68<br>88   |  | 03.13<br>03.13<br>03.13<br>03.13<br>03.13  |   | + Bremsscheibendurchm. 266 mm <sup>1)</sup><br>+ Bremsscheibendurchm. 266 mm <sup>1)</sup><br>+ Bremsscheibendurchm. 266 mm <sup>1)</sup><br>+ Bremsscheibendurchm. 266 mm <sup>1)</sup><br>+ Bremsscheibendurchm. 266 mm <sup>1)</sup> | 24.3541-1771.5<br>24.3541-1772.5   | 240239<br>240240  | <br>          | D=54, - Halter<br>D=54, - Halter   | <b>BOS</b><br><b>BOS</b>   |
|    | 1.2 VTI 82<br>1.4 HDi 68<br>1.6 e-HDi 115<br>1.6 e-HDi 92<br>1.6 VTI 120                     | 60<br>50<br>84<br>68<br>88   |  | 03.13<br>03.13<br>03.13<br>03.13<br>03.13  |   |   | 24.5239-0190.3   | 330966  | 2   | L=190  |  |
| <b>PEUGEOT 3008 (09-)</b>  |  |  |  |  |   |   |  |   |   |  |  |
|    | 1.6 HDi<br>1.6 HDi<br>1.6 HDi 115<br>1.6 THP<br>1.6 VTI<br>2.0 HDi<br>2.0 HDi<br>2.0 Hybrid4 | 80<br>82<br>84<br>88<br>88<br>100<br>100<br>120                                  |  | 06.09<br>08.10<br>11.12<br>06.09<br>06.09<br>06.09<br>09.11<br>02.11             |   | 03.4153-0173.3  | 010815   |   |   | THz 23,81  | <b>ATE</b>   |
|    | 1.6 THP<br>2.0 HDi<br>2.0 HDi<br>2.0 Hybrid4   | 100<br>100<br>120  |  | 06.09<br>06.09<br>09.11<br>02.11   |   |   | 11.0101-5704.2<br>11.8116-0356.1<br>11.8171-0008.1   | 260095<br>390586<br>990049  | 2   | Hülensatz<br>Haltefeder<br>Führungsbolzen  | <b>ATE</b><br><b>ATE</b><br><b>ATE</b>   |
|  | 1.6 HDi<br>1.6 HDi<br>1.6 HDi 115<br>1.6 THP<br>1.6 VTI<br>2.0 HDi<br>2.0 HDi                | 80<br>82<br>84<br>88<br>88<br>100<br>100   |  | 06.09<br>08.10<br>11.12<br>06.09<br>06.09<br>06.09<br>09.11                      |   |   | 11.9601-9717.2<br>11.9601-9718.2<br>11.8171-0008.1<br>11.0101-5704.2<br>11.0441-6008.2<br>11.8116-0356.1 | 220901<br>220902<br>990049<br>260095<br>250038<br>390586  | 2   | D=60, - Halter<br>D=60, - Halter<br>Führungsbolzen<br>Hülensatz<br>Dichtungssatz<br>Haltefeder | <b>ATE</b><br><b>ATE</b><br><b>ATE</b><br><b>ATE</b><br><b>ATE</b><br><b>ATE</b> |
|  | 1.6 HDi<br>1.6 HDi<br>1.6 HDi 115<br>1.6 THP<br>1.6 VTI<br>2.0 HDi<br>2.0 HDi                | 80<br>82<br>84<br>88<br>88<br>100<br>100   |  | 06.09<br>08.10<br>11.12<br>06.09<br>06.09<br>06.09<br>09.11                      |   |   | 24.5246-0190.3   | 330697  | 2   | L=190  |  |
| <b>PEUGEOT 4007 (07-12)</b>  |  |  |  |  |   |   |  |   |   |  |  |
|  | 2.0<br>2.0 4x4<br>2.2 HDi 4x4<br>2.4 16V 4x4   | 108<br>108<br>115<br>125   |  | 11.10<br>11.10<br>02.07<br>07.07   | 11.12<br>11.12<br>11.12<br>11.12  | 24.5286-0600.3<br>24.5286-0601.3  | 331173<br>331174   | <br>      |   | L=600<br>L=600   |  |
|  | 2.2 HDi 4x4<br>2.4 16V 4x4   | 115<br>125   | ORGA 12718<br>ORGA 12718   | 02.07<br>07.07   |   | 24.5112-0280.3<br>24.5247-0275.3<br>24.5247-0276.3  | 331200<br>331244<br>331245   | 2<br><br> | am Bremssattel <sup>2)</sup>  | L=280<br>L=275<br>L=275  |  |
|  | 2.2 HDi 4x4<br>2.4 16V 4x4   | 115<br>125   | ORGA 12719<br>ORGA 12719   |  | 11.12<br>11.12  | 24.5247-0275.3<br>24.5247-0276.3  | 331244<br>331245   | <br>      |   | L=275<br>L=275   |  |
| <b>PEUGEOT 5008 (09-)</b>  |  |  |  |  |   |   |  |   |   |  |  |
|  | 1.6 16V<br>1.6 16V<br>1.6 HDi<br>1.6 HDi<br>1.6 HDi 115<br>2.0 HDi<br>2.0 HDi<br>2.0 HDi     | 88<br>115<br>80<br>82<br>84<br>100<br>110<br>120                                 |  | 09.09<br>09.09<br>09.09<br>08.10<br>11.12<br>02.12<br>09.09<br>09.09             |   | 03.4153-0173.3  | 010815   |   |   | THz 23,81  | <b>ATE</b>   |
|  | 1.6 16V<br>1.6 HDi<br>1.6 HDi<br>1.6 HDi 115   | 88<br>80<br>82<br>84   |  | 09.09<br>09.09<br>08.10<br>11.12   |   |   | 11.9601-9717.2<br>11.9601-9718.2<br>11.0441-6008.2<br>11.8171-0008.1                                     | 220901<br>220902<br>250038<br>990049  | 2<br><br> | D=60, - Halter<br>D=60, - Halter<br>Dichtungssatz<br>Führungsbolzen                            | <b>ATE</b><br><b>ATE</b><br><b>ATE</b><br><b>ATE</b>                             |
|  | 1.6 16V<br>1.6 HDi<br>1.6 HDi<br>1.6 HDi 115   | 88<br>80<br>82<br>84   |  | 09.09<br>09.09<br>08.10<br>11.12   |   |   | 11.8116-0356.1<br>11.0101-5704.2   | 390586<br>260095  | 2   | Haltefeder<br>Hülensatz  | <b>ATE</b><br><b>ATE</b>   |
|  | 1.6 16V<br>2.0 HDi<br>2.0 HDi<br>2.0 HDi   | 115<br>100<br>110<br>120   |  | 09.09<br>02.12<br>09.09<br>09.09   |   |   | 11.9601-9717.2<br>11.9601-9718.2<br>11.0441-6008.2<br>11.8171-0008.1                                     | 220901<br>220902<br>250038<br>990049  | 2<br><br> | D=60, - Halter<br>D=60, - Halter<br>Dichtungssatz<br>Führungsbolzen                            | <b>ATE</b><br><b>ATE</b><br><b>ATE</b><br><b>ATE</b>                             |
|  | 1.6 16V<br>1.6 16V<br>1.6 HDi<br>1.6 HDi<br>1.6 HDi 115<br>2.0 HDi                           | 88<br>115<br>80<br>82<br>84<br>100   |  | 09.09<br>09.09<br>09.09<br>08.10<br>11.12<br>02.12                               |   |   | 11.8116-0356.1<br>11.0101-5704.2   | 390586<br>260095  | 2   | Haltefeder<br>Hülensatz  | <b>ATE</b><br><b>ATE</b>   |
|  | 1.6 16V<br>1.6 16V<br>1.6 HDi<br>1.6 HDi<br>1.6 HDi 115<br>2.0 HDi                           | 88<br>115<br>80<br>82<br>84<br>100   |  | 09.09<br>09.09<br>09.09<br>08.10<br>11.12<br>02.12                               |   |   | 24.5246-0216.3   | 331022  | 2   | L=216  |  |

<sup>1)</sup> + brake disc diameter 266 mm / + disco fr.diam. 266mm / + disques fr.diam. 266mm / + disco fr.diam. 266mm

<sup>2)</sup> on the brake caliper / sulla pinza freno / sur l'étrier de frein / a la pinza de freno

|     |   |  |    |                                   |                         |  |  |  |
|--|---|--|--|---|--|--|--|--|
| <b>PEUGEOT 5008 (09-)</b>  |   |  |  |   |  |  |  |  |
|    | 2.0 HDi<br>2.0 HDi  | 110<br>120   |  | 09.09<br>09.09  |  | 24.5246-0216.3   | 331022   | 2<br>L=216   |
| <b>PEUGEOT BIPPER (08-)</b>  |   |  |  |   |  |  |  |  |
|    | 1.3 HDi 75<br>1.4 HDi<br>1.4 i  | 55<br>50<br>54   |  | 10.10<br>02.08<br>02.08   |  | 24.5228-0181.3   | 331279   | 2<br>L=180   |
|    | 1.3 HDi 75<br>1.4 HDi<br>1.4 i  | 55<br>50<br>54   |  | 10.10<br>02.08<br>02.08   |  | 24.3220-1728.3   | 020509   | Rz 20,64   |
| <b>PEUGEOT BOXER Bus (94-02)</b>   |   |  |  |   |  |  |  |  |
|    | 1.9 D (10)<br>1.9 TD (10/14)<br>1.9 TD (10/14)<br>2.0 i (10/14)<br>2.5 D (14)<br>2.5 TD (14)  | 51<br>66<br>68<br>80<br>63<br>76   | S 15064995<br>S 15064995<br>S 15064995<br>S 15064995<br>S 15064995<br>S 15064995   | 02.94<br>08.94<br>02.94<br>02.94<br>08.94<br>08.94  | - ABS<br>- ABS<br>- ABS<br>- ABS<br>- ABS<br>- ABS   | 24.2122-1715.3   | 010481   | THz 22,20  |
|  | 1.9 D (10)<br>1.9 TD (10/14)<br>1.9 TD (10/14)<br>2.0 i (10/14)<br>2.0 i (18)<br>2.5 D (14)<br>2.5 D (18)<br>2.5 TD (14)<br>2.5 TD (18)<br>2.5 TDi (14)<br>2.5 TDi (18)<br>2.8 HDi (14)<br>2.8 HDi (18) | 51<br>66<br>68<br>80<br>80<br>63<br>63<br>76<br>76<br>79<br>79<br>94<br>94       | S 15064996<br>S 15064996<br>S 15064996<br>S 15064996<br>S 16205352<br>S 15064996<br>S 16205352<br>S 16205352<br>S 16205352<br>S 16205352<br>S 16205352<br>S 16205352<br>S 16205352 | 02.94<br>08.94<br>08.94<br>08.94<br>01.97<br>11.00<br>11.00   | - ABS<br>- ABS<br>- ABS<br>- ABS<br>- ABS<br>- ABS<br>- ABS<br>- ABS<br>- ABS<br>- ABS<br>- ABS<br>- ABS | 24.2125-1703.3   | 010483   | THz 25,40  |
|  | 1.9 D (10)<br>1.9 TD (10/14)<br>1.9 TD (10/14)<br>2.0 i (10/14)<br>2.0 i (18)<br>2.5 D (14)<br>2.5 D (18)<br>2.5 TD (14)<br>2.5 TD (18)<br>2.5 TDi (14)<br>2.5 TDi (18)<br>2.8 HDi (14)<br>2.8 HDi (18) | 51<br>66<br>68<br>80<br>80<br>63<br>63<br>76<br>76<br>79<br>79<br>94<br>94       | S 16205755<br>S 16205755<br>S 16205755<br>S 16205755<br>S 16205353<br>S 16205755<br>S 16205353<br>S 16205755<br>S 16205353<br>S 16205755<br>S 16205353<br>S 16205755<br>S 16205353 | 03.02<br>03.02<br>03.02<br>03.02<br>03.02<br>03.02<br>03.02<br>03.02<br>03.02<br>03.02<br>03.02<br>03.02<br>03.02 | - ABS<br>- ABS<br>- ABS<br>- ABS<br>- ABS<br>- ABS<br>- ABS<br>- ABS<br>- ABS<br>- ABS<br>- ABS<br>- ABS | 24.2125-1725.3   | 010717   | THz 25,40  |
|  | 1.9 D (10)<br>1.9 TD (10/14)<br>1.9 TD (10/14)<br>2.0 i (10/14)<br>2.5 D (14)<br>2.5 TD (14)  | 51<br>66<br>68<br>80<br>63<br>76   | S 15064995<br>S 15064995<br>S 15064995<br>S 15064995<br>S 15064995<br>S 15064995   | 02.94<br>08.94<br>02.94<br>02.94<br>08.94<br>08.94  | + ABS<br>+ ABS<br>+ ABS<br>+ ABS<br>+ ABS<br>+ ABS   | 24.2122-1714.3   | 010480   | THz 22,20  |
|  | 1.9 D (10)<br>1.9 TD (10/14)<br>1.9 TD (10/14)<br>2.0 i (10/14)<br>2.0 i (18)<br>2.5 D (14)<br>2.5 D (18)<br>2.5 TD (14)<br>2.5 TD (18)<br>2.5 TDi (14)<br>2.5 TDi (18)<br>2.8 HDi (14)<br>2.8 HDi (18) | 51<br>66<br>68<br>80<br>80<br>63<br>63<br>76<br>76<br>79<br>79<br>94<br>94       | S 15064996<br>S 16206253<br>S 15064996<br>S 16206253<br>S 16194399<br>S 15064996<br>S 16194399<br>S 16206253<br>S 16194399<br>S 16206253<br>S 16194399<br>S 16206253<br>S 16194399 | 02.94<br>08.94<br>08.94<br>01.97<br>01.97<br>11.00<br>11.00   | + ABS<br>+ ABS<br>+ ABS<br>+ ABS<br>+ ABS<br>+ ABS<br>+ ABS<br>+ ABS<br>+ ABS<br>+ ABS<br>+ ABS<br>+ ABS | 24.2125-1702.3   | 010482   | THz 25,40  |
|  | 1.9 D (10)<br>1.9 TD (10/14)<br>1.9 TD (10/14)<br>2.0 i (10/14)<br>2.0 i (18)<br>2.5 D (14)<br>2.5 D (18)<br>2.5 TD (14)<br>2.5 TD (18)<br>2.5 TDi (14)<br>2.5 TDi (18)<br>2.8 HDi (14)<br>2.8 HDi (18) | 51<br>66<br>68<br>80<br>80<br>63<br>63<br>76<br>76<br>79<br>79<br>94<br>94       | S 16206254<br>S 16206254<br>S 16206254<br>S 16206254<br>S 16194400<br>S 16206254<br>S 16194400<br>S 16206254<br>S 16194400<br>S 16206254<br>S 16194400<br>S 16206254<br>S 16194400 | 03.02<br>03.02<br>03.02<br>03.02<br>03.02<br>03.02<br>03.02<br>03.02<br>03.02<br>03.02<br>03.02<br>03.02<br>03.02 | + ABS<br>+ ABS<br>+ ABS<br>+ ABS<br>+ ABS<br>+ ABS<br>+ ABS<br>+ ABS<br>+ ABS<br>+ ABS<br>+ ABS<br>+ ABS | 24.2125-1726.3   | 010718   | THz 25,40  |
|  | 1.9 D (10)<br>1.9 TD (10/14)<br>1.9 TD (10/14)<br>2.0 i (10/14)<br>2.5 D (14)   | 51<br>66<br>68<br>80<br>63   |  | 02.94<br>08.94<br>02.94<br>02.94<br>08.94   | 10.01<br>10.01<br>10.01<br>10.01<br>10.01  | 24.0101-4804.2   | 260050   | + ABS<br>+ ABS<br>+ ABS<br>+ ABS<br>+ ABS<br>Einbausatz LUC                        |

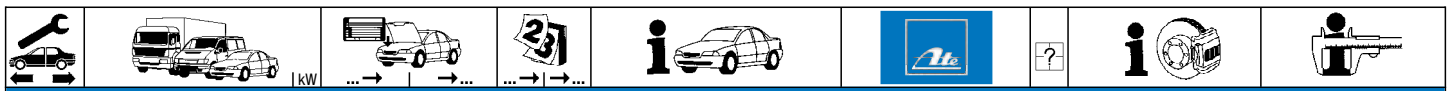

**PEUGEOT BOXER Bus (94-02)**

|                  |                  |    |            |       |                |                |        |   |                                      |                |
|------------------|------------------|----|------------|-------|----------------|----------------|--------|---|--------------------------------------|----------------|
|                  | 1.9 D (10)       | 51 | S 15866409 | 02.94 |                | 24.5112-0466.3 | 330579 | 2 |                                      | L=462          |
|                  | 1.9 TD (10/14)   | 66 | S 15866409 | 08.94 |                | 24.5112-0465.3 | 330526 | 2 |                                      | L=465, + Clip  |
|                  | 1.9 TD (10/14)   | 68 | S 15866409 | 02.94 |                |                |        |   |                                      |                |
|                  | 2.0 i (10/14/18) | 80 | S 15866409 | 02.94 |                |                |        |   |                                      |                |
|                  | 2.5 D (14/18)    | 63 | S 15866409 | 08.94 |                |                |        |   |                                      |                |
|                  | 2.5 TD (14/18)   | 76 | S 15866409 | 08.94 |                |                |        |   |                                      |                |
|                  | 2.5 TDi (14/18)  | 79 | S 15866409 | 01.97 |                |                |        |   |                                      |                |
|                  | 2.8 HDi (14/18)  |    | S 15866409 | 11.00 |                |                |        |   |                                      |                |
|                  | 1.9 D (10)       | 51 | S 15866410 |       | 10.01          | 24.5112-0466.3 | 330579 | 2 |                                      | L=462          |
|                  | 1.9 TD (10/14)   | 66 | S 15866410 |       | 10.01          | 24.5112-0461.3 | 330616 | 2 |                                      | L=460, + Clip  |
|                  | 1.9 TD (10/14)   | 68 | S 15866410 |       | 10.01          |                |        |   |                                      |                |
|                  | 2.0 i (10/14/18) | 80 | S 15866410 |       | 10.01          |                |        |   |                                      |                |
|                  | 2.5 D (14/18)    | 63 | S 15866410 |       | 10.01          |                |        |   |                                      |                |
|                  | 2.5 TD (14/18)   | 76 | S 15866410 |       | 10.01          |                |        |   |                                      |                |
|                  | 2.5 TDi (14/18)  | 79 | S 15866410 |       | 10.01          |                |        |   |                                      |                |
|                  | 2.8 HDi (14/18)  |    | S 15866410 |       | 10.01          |                |        |   |                                      |                |
|                  | 1.9 D (10)       | 51 |            | 11.01 | 03.02          | 83.6401-0471.3 | 330750 | 2 |                                      | L=470          |
|                  | 1.9 TD (10/14)   | 66 |            | 11.01 | 03.02          | 83.6401-0469.3 | 330749 | 2 |                                      | L=468          |
|                  | 1.9 TD (10/14)   | 68 |            | 11.01 | 03.02          |                |        |   |                                      |                |
|                  | 2.0 i (10/14/18) | 80 |            | 11.01 | 03.02          |                |        |   |                                      |                |
|                  | 2.5 D (14/18)    | 63 |            | 11.01 | 03.02          |                |        |   |                                      |                |
|                  | 2.5 TD (14/18)   | 76 |            | 11.01 | 03.02          |                |        |   |                                      |                |
|                  | 2.5 TDi (14/18)  | 79 |            | 11.01 | 03.02          |                |        |   |                                      |                |
|                  | 2.8 HDi (14/18)  |    |            | 11.01 | 03.02          |                |        |   |                                      |                |
|                  | 1.9 D (10)       | 51 |            | 11.01 | 03.02          | 24.3461-1701.5 | 240449 |   |                                      | D=46, - Halter |
|                  | 1.9 TD (10/14)   | 66 |            | 11.01 | 03.02          | 24.3461-1702.5 | 240450 |   |                                      | D=46, - Halter |
|                  | 1.9 TD (10/14)   | 68 |            | 11.01 | 03.02          |                |        |   |                                      |                |
|                  | 2.0 i (10/14/18) | 80 |            | 11.01 | 03.02          |                |        |   |                                      |                |
|                  | 2.5 D (14/18)    | 63 |            | 11.01 | 03.02          |                |        |   |                                      |                |
|                  | 2.5 TD (14/18)   | 76 |            | 11.01 | 03.02          |                |        |   |                                      |                |
|                  | 2.5 TDi (14/18)  | 79 |            | 11.01 | 03.02          |                |        |   |                                      |                |
|                  | 2.8 HDi (14/18)  |    |            | 11.01 | 03.02          |                |        |   |                                      |                |
|                  | 1.9 D (10)       | 51 |            | 02.94 | 10.01          | 24.5112-0340.3 | 330511 | 1 | - verstärktes Fahrwerk <sup>1)</sup> | L=340          |
|                  | 1.9 TD (10/14)   | 66 |            | 08.94 | 10.01          | 24.5112-0361.3 | 330649 | 1 | + verstärktes Fahrwerk <sup>2)</sup> | L=360          |
|                  | 1.9 TD (10/14)   | 68 |            | 02.94 | 10.01          |                |        |   |                                      |                |
|                  | 2.0 i (10/14/18) | 80 |            | 02.94 | 10.01          |                |        |   |                                      |                |
|                  | 2.5 D (14/18)    | 63 |            | 08.94 | 10.01          |                |        |   |                                      |                |
|                  | 2.5 TD (14/18)   | 76 |            | 08.94 | 10.01          |                |        |   |                                      |                |
|                  | 2.5 TDi (14/18)  | 79 |            | 01.97 | 10.01          |                |        |   |                                      |                |
|                  | 2.8 HDi (14/18)  |    |            | 11.00 | 10.01          |                |        |   |                                      |                |
|                  | 1.9 D (10)       | 51 |            | 11.01 | 03.02          | 24.5112-0361.3 | 330649 | 1 | + HA-Trommelbremse <sup>3)</sup>     | L=360          |
|                  | 1.9 TD (10/14)   | 66 |            | 11.01 | 03.02          | 83.6401-0159.3 | 330746 | 2 | + HA-Scheibenbremse <sup>4)</sup>    | L=160          |
|                  | 1.9 TD (10/14)   | 68 |            | 11.01 | 03.02          |                |        |   |                                      |                |
|                  | 2.0 i (10/14/18) | 80 |            | 11.01 | 03.02          |                |        |   |                                      |                |
|                  | 2.5 D (14/18)    | 63 |            | 11.01 | 03.02          |                |        |   |                                      |                |
|                  | 2.5 TD (14/18)   | 76 |            | 11.01 | 03.02          |                |        |   |                                      |                |
|                  | 2.5 TDi (14/18)  | 79 |            | 11.01 | 03.02          |                |        |   |                                      |                |
|                  | 2.8 HDi (14/18)  |    |            | 11.01 | 03.02          |                |        |   |                                      |                |
| 1.9 D (10)       | 51               |    | 02.94      | 10.01 | 24.5112-0315.3 | 330509         |        |   | L=315                                |                |
| 1.9 TD (10/14)   | 66               |    | 08.94      | 10.01 | 24.5112-0363.3 | 330650         |        |   | L=360                                |                |
| 1.9 TD (10/14)   | 68               |    | 02.94      | 10.01 |                |                |        |   |                                      |                |
| 2.0 i (10/14/18) | 80               |    | 02.94      | 10.01 |                |                |        |   |                                      |                |
| 2.5 D (14/18)    | 63               |    | 08.94      | 10.01 |                |                |        |   |                                      |                |
| 2.5 TD (14/18)   | 76               |    | 08.94      | 10.01 |                |                |        |   |                                      |                |
| 2.5 TDi (14/18)  | 79               |    | 01.97      | 10.01 |                |                |        |   |                                      |                |
| 2.8 HDi (14/18)  |                  |    | 11.00      | 10.01 |                |                |        |   |                                      |                |
| 1.9 D (10)       | 51               |    | 11.01      | 03.02 | 24.5112-0363.3 | 330650         |        |   | L=360                                |                |
| 1.9 TD (10/14)   | 66               |    | 11.01      | 03.02 | 83.6401-0159.3 | 330746         | 2      |   | L=160                                |                |
| 1.9 TD (10/14)   | 68               |    | 11.01      | 03.02 |                |                |        |   |                                      |                |
| 2.0 i (10/14/18) | 80               |    | 11.01      | 03.02 |                |                |        |   |                                      |                |
| 2.5 D (14/18)    | 63               |    | 11.01      | 03.02 |                |                |        |   |                                      |                |
| 2.5 TD (14/18)   | 76               |    | 11.01      | 03.02 |                |                |        |   |                                      |                |
| 2.5 TDi (14/18)  | 79               |    | 11.01      | 03.02 |                |                |        |   |                                      |                |
| 2.8 HDi (14/18)  |                  |    | 11.01      | 03.02 |                |                |        |   |                                      |                |
|                  | 1.9 D (10)       | 51 |            | 02.94 | 10.01          | 24.3225-1701.3 | 020399 |   |                                      | Rz 25,40       |
|                  | 1.9 TD (10/14)   | 66 |            | 08.94 | 10.01          |                |        |   |                                      |                |
|                  | 1.9 TD (10/14)   | 68 |            | 02.94 | 10.01          |                |        |   |                                      |                |
|                  | 2.0 i (10/14)    | 80 |            | 02.94 | 10.01          |                |        |   |                                      |                |
|                  | 2.5 D (14)       | 63 |            | 08.94 | 10.01          |                |        |   |                                      |                |
|                  | 2.5 TD (14)      | 76 |            | 08.94 | 10.01          | 24.3226-1702.3 | 020469 |   |                                      | Rz 26,99       |
|                  | 2.5 TDi (14)     | 79 |            | 01.97 | 10.01          |                |        |   |                                      |                |
|                  | 2.8 HDi (14)     | 94 |            | 11.00 | 10.01          |                |        |   |                                      |                |
| 1.9 D (10)       | 51               |    | 11.01      | 03.02 | 24.3226-1702.3 | 020469         |        |   | Rz 26,99                             |                |
| 1.9 TD (10/14)   | 66               |    | 11.01      | 03.02 |                |                |        |   |                                      |                |
| 1.9 TD (10/14)   | 68               |    | 11.01      | 03.02 |                |                |        |   |                                      |                |
| 2.0 i (10/14)    | 80               |    | 11.01      | 03.02 |                |                |        |   |                                      |                |
| 2.5 D (14)       | 63               |    | 11.01      | 03.02 |                |                |        |   |                                      |                |
| 2.5 TD (14)      | 76               |    | 11.01      | 03.02 |                |                |        |   |                                      |                |
| 2.5 TDi (14)     | 79               |    | 11.01      | 03.02 |                |                |        |   |                                      |                |
| 2.8 HDi (14)     | 94               |    | 11.01      | 03.02 |                |                |        |   |                                      |                |
| 2.0 i (18)       | 80               |    | 02.94      | 10.01 | 24.3228-1701.3 | 020401         |        |   | Rz 28,57                             |                |
| 2.5 D (18)       | 63               |    | 08.94      | 10.01 |                |                |        |   |                                      |                |
| 2.5 TD (18)      | 76               |    | 08.94      | 10.01 |                |                |        |   |                                      |                |
| 2.5 TDi (18)     | 79               |    | 01.97      | 10.01 |                |                |        |   |                                      |                |
| 2.8 HDi (18)     | 94               |    | 11.00      | 10.01 |                |                |        |   |                                      |                |

1) - reinforced suspension / - sospensione rinforzata / - châssis renforcé / - suspensión reforzada  
2) + reinforced suspension / + sospensione rinforzata / + châssis renforcé / + suspensión reforzada  
3) + RA drum brake / + P freno a tamburo / + frein à tambour essieu AR / + ET-tambores de freno  
4) + RA disc brake / + P disco freno / + frein à disque essieu AR / + ET-disco de freno

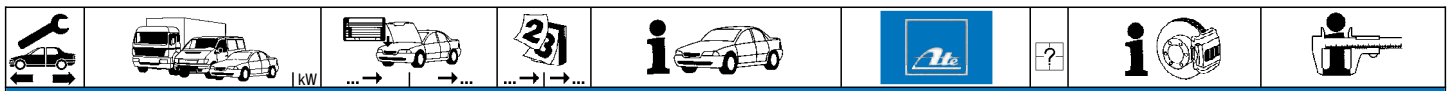

**PEUGEOT BOXER Bus (94-02)**

|                      |                  |             |             |                                     |                                    |                |                |        |   |         |        |
|----------------------|------------------|-------------|-------------|-------------------------------------|------------------------------------|----------------|----------------|--------|---|---------|--------|
|                      | 1.9 D (10)       | 51          | S 16158427  | 02.94                               |                                    | 24.3727-0345.2 | 580345         | 1 ↓    |   | L=3045  |        |
|                      | 1.9 TD (10/14)   | 66          | S 16158427  | 08.94                               |                                    |                |                |        |   |         |        |
|                      | 1.9 TD (10/14)   | 68          | S 16158427  | 02.94                               |                                    |                |                |        |   |         |        |
|                      | 2.0 i (10/14/18) | 80          | S 16158427  | 02.94                               |                                    |                |                |        |   |         |        |
|                      | 2.5 D (14/18)    | 63          | S 16158427  | 08.94                               |                                    |                |                |        |   |         |        |
|                      | 2.5 TD (14/18)   | 76          | S 16158427  | 08.94                               |                                    |                |                |        |   |         |        |
|                      | 2.5 TDi (14/18)  | 79          | S 16158427  | 01.97                               |                                    |                |                |        |   |         |        |
|                      | 2.8 HDi (14/18)  |             | S 16158427  | 11.00                               |                                    |                |                |        |   |         |        |
|                      | 1.9 D (10)       | 51          | S 16158428  |                                     | 03.02                              |                | 24.3727-0350.2 | 580350 | 1 ↓   |         | L=2827 |
|                      | 1.9 TD (10/14)   | 66          | S 16158428  |                                     | 03.02                              |                |                |        |   |         |        |
| 1.9 TD (10/14)       | 68               | S 16158428  |             | 03.02                               |                                    |                |                |        |   |         |        |
| 2.0 i (10/14/18)     | 80               | S 16158428  |             | 03.02                               |                                    |                |                |        |   |         |        |
| 2.5 D (14/18)        | 63               | S 16158428  |             | 03.02                               |                                    |                |                |        |   |         |        |
| 2.5 TD (14/18)       | 76               | S 16158428  |             | 03.02                               |                                    |                |                |        |   |         |        |
| 2.5 TDi (14/18)      | 79               | S 16158428  |             | 03.02                               |                                    |                |                |        |   |         |        |
| 2.8 HDi (14/18)      |                  | S 16158428  |             | 03.02                               |                                    |                |                |        |   |         |        |
| 1.9 TD 4x4 (10/14)   | 68               |             |             | 07.96                               | 03.02                              | 24.3727-0842.2 | 580842         | 1 ↓    |   | L=4100  |        |
| 2.0 i 4x4 (10/14/18) | 80               |             |             | 07.96                               | 03.02                              |                |                |        |   |         |        |
| 2.5 D 4x4 (14/18)    | 63               |             |             | 07.96                               | 03.02                              |                |                |        |   |         |        |
| 2.5 TD 4x4 (14/18)   | 76               |             |             | 07.96                               | 03.02                              |                |                |        |   |         |        |
| 2.5 TDi 4x4 (14/18)  | 79               |             |             | 01.97                               | 03.02                              |                |                |        |   |         |        |
|                      | 1.9 D (10)       | 51          | S 16206244  | 02.94                               |                                    | 24.6512-1701.3 | 320153         |        | - ABS                                       | BRL (2) |        |
|                      | 1.9 TD (10/14)   | 66          | S 16206244  | 08.94                               |                                    |                |                |        |   |         |        |
|                      | 1.9 TD (10/14)   | 68          | S 16206244  | 02.94                               |                                    |                |                |        |   |         |        |
|                      | 2.0 i (10/14/18) | 80          | S 16206244  | 02.94                               |                                    |                |                |        |   |         |        |
|                      | 2.5 TD (14/18)   | 76          | S 16206244  | 08.94                               |                                    |                |                |        |   |         |        |
|                      | 2.5 TD (14/18)   | 76          | S 16206244  | 08.94                               |                                    |                |                |        |   |         |        |
|                      | 2.5 TDi (14/18)  | 79          | S 16206244  | 01.97                               |                                    |                |                |        |   |         |        |
|                      | 2.8 HDi (14/18)  |             | S 16206244  | 11.00                               |                                    |                |                |        |   |         |        |
|                      | 1.9 D (10)       | 51          | S 15445357  | 02.94                               |                                    | 24.6512-1703.3 | 320159         |        | + ABS                                       | BRL (4) |        |
|                      | 1.9 TD (10/14)   | 66          | S 15445357  | 08.94                               |                                    |                |                |        |   |         |        |
| 1.9 TD (10/14)       | 68               | S 15445357  | 02.94       |                                     |                                    |                |                |        |   |         |        |
| 2.0 i (10/14/18)     | 80               | S 15445357  | 02.94       |                                     |                                    |                |                |        |   |         |        |
| 2.5 D (14/18)        | 63               | S 15445357  | 08.94       |                                     |                                    |                |                |        |   |         |        |
| 2.5 TD (14/18)       | 76               | S 15445357  | 08.94       |                                     |                                    |                |                |        |   |         |        |
| 2.5 TDi (14/18)      | 79               | S 15445357  | 01.97       |                                     |                                    |                |                |        |   |         |        |
|                      | 1.9 D (10)       | 51          | S 116205353 |                                     | 03.02                              | 24.6512-1712.3 | 320273         |        | - ABS/ + verstärktes Fahrwerk <sup>1)</sup> | BRL (2) |        |
|                      | 1.9 TD (10/14)   | 66          | S 116205353 |                                     | 03.02                              |                |                |        |   |         |        |
|                      | 1.9 TD (10/14)   | 68          | S 116205353 |                                     | 03.02                              |                |                |        |   |         |        |
|                      | 2.0 i (10/14)    | 80          | S 116205353 |                                     | 03.02                              |                |                |        |   |         |        |
|                      | 2.5 D (14)       | 63          | S 116205353 |                                     | 03.02                              |                |                |        |   |         |        |
|                      | 2.5 TD (14)      | 76          | S 116205353 |                                     | 03.02                              |                |                |        |   |         |        |
|                      | 2.5 TDi (14)     | 79          | S 116205353 |                                     | 03.02                              |                |                |        |   |         |        |
|                      | 2.8 HDi (14)     | 94          | S 116205353 |                                     | 03.02                              |                |                |        |   |         |        |
|                      | 2.0 i (18)       | 80          | S 116205353 |                                     | 03.02                              | 24.6512-1709.3 | 320270         |        | - ABS/ + verstärktes Fahrwerk <sup>1)</sup> | BRL (2) |        |
|                      | 2.5 D (18)       | 63          | S 116205353 |                                     | 03.02                              |                |                |        |   |         |        |
| 2.5 TD (18)          | 76               | S 116205353 |             | 03.02                               |                                    |                |                |        |   |         |        |
| 2.5 TDi (18)         | 79               | S 116205353 |             | 03.02                               |                                    |                |                |        |   |         |        |
| 2.8 HDi (18)         | 94               | S 116205353 |             | 03.02                               |                                    |                |                |        |   |         |        |
|                      | 1.9 D (10)       | 51          |             | 02.94                               | 03.02 + ML5-Getriebe <sup>2)</sup> | 24.3728-0300.2 | 590300         |        |   | L=1478  |        |
|                      | 1.9 TD (10/14)   | 66          |             | 08.94                               | 03.02 + ML5-Getriebe <sup>2)</sup> |                |                |        |   |         |        |
|                      | 1.9 TD (10/14)   | 68          |             | 02.94                               | 03.02 + ML5-Getriebe <sup>2)</sup> |                |                |        |   |         |        |
|                      | 1.9 TD (10/14)   | 66          |             | 08.94                               | 03.02 + ME-Getriebe <sup>3)</sup>  | 24.3728-0337.2 | 590337         |        |   | L=1058  |        |
|                      | 1.9 TD (10/14)   | 68          |             | 02.94                               | 03.02 + ME-Getriebe <sup>3)</sup>  |                |                |        |   |         |        |
|                      | 1.9 D (10)       | 51          |             | 02.94                               | 03.02 + ME-Getriebe <sup>3)</sup>  | 24.3728-0518.2 | 590518         |        |   | L=1034  |        |
|                      | 2.0 i (10/14/18) | 80          |             | 08.94                               | 03.02 + ME-Getriebe <sup>3)</sup>  |                |                |        |   |         |        |
|                      | 2.5 D (14/18)    | 63          |             | 02.94                               | 03.02 + ME-Getriebe <sup>3)</sup>  |                |                |        |   |         |        |
|                      | 2.0 i (10/14/18) | 80          |             | 02.94                               | 03.02 + ML5-Getriebe <sup>2)</sup> | 24.3728-0335.2 | 590335         |        |   | L=1435  |        |
|                      | 2.5 D (14/18)    | 63          |             | 08.94                               | 03.02 + ML5-Getriebe <sup>2)</sup> |                |                |        |   |         |        |
| 2.8 HDi (14/18)      |                  |             | 11.00       | 03.02 + ML5-Getriebe <sup>2)</sup>  |                                    |                |                |        |   |         |        |
| 2.0 i (10/14/18)     | 80               |             | 02.94       | 03.02 + MG5T-Getriebe <sup>4)</sup> | 24.3728-0519.2                     | 590519         |                |        | L=1090                                      |         |        |
| 2.5 D (14/18)        | 63               |             | 08.94       | 03.02 + MG5T-Getriebe <sup>4)</sup> |                                    |                |                |        |   |         |        |
| 2.5 TD (14/18)       | 76               |             | 08.94       | 03.02 + MG5T-Getriebe <sup>4)</sup> |                                    |                |                |        |   |         |        |
| 2.5 TDi (14/18)      | 79               |             | 01.97       | 03.02 + MG5T-Getriebe <sup>4)</sup> |                                    |                |                |        |   |         |        |
| 2.8 HDi (14/18)      |                  |             | 11.00       | 03.02 + MG5T-Getriebe <sup>4)</sup> |                                    |                |                |        |   |         |        |

**PEUGEOT BOXER Kasten (94-02)**

|              |                |            |            |       |       |                |        |  |  |           |
|--------------|----------------|------------|------------|-------|-------|----------------|--------|--|--|-----------|
|              | 1.9 D (10)     | 51         | S 15064995 | 02.94 | - ABS | 24.2122-1715.3 | 010481 |  |  | Thz 22,20 |
|              | 1.9 TD (10/14) | 68         | S 15064995 | 02.94 | - ABS |                |        |  |  |           |
|              | 2.0 i (10/14)  | 80         | S 15064995 | 02.94 | - ABS |                |        |  |  |           |
|              | 2.5 D (14)     | 63         | S 15064995 | 02.94 | - ABS |                |        |  |  |           |
|              | 2.5 TD (14)    | 76         | S 15064995 | 02.94 | - ABS |                |        |  |  |           |
|              | 1.9 D (10)     | 50         | S 16205754 | 07.99 | - ABS | 24.2125-1703.3 | 010483 |  |  | Thz 25,40 |
|              | 1.9 D (10)     | 51         | S 15064996 |       | - ABS |                |        |  |  |           |
|              | 1.9 TD (10/14) | 66         | S 16205754 | 07.99 | - ABS |                |        |  |  |           |
|              | 1.9 TD (10/14) | 68         | S 16205754 |       | - ABS |                |        |  |  |           |
|              | 2.0 i (10/14)  | 80         | S 16205754 |       | - ABS |                |        |  |  |           |
| 2.0 i (18)   | 80             | S 16205352 | 02.94      | - ABS |       |                |        |  |  |           |
| 2.5 D (14)   | 63             | S 16205754 |            | - ABS |       |                |        |  |  |           |
| 2.5 D (18)   | 63             | S 16205352 | 02.94      | - ABS |       |                |        |  |  |           |
| 2.5 TD (14)  | 76             | S 16205754 |            | - ABS |       |                |        |  |  |           |
| 2.5 TD (18)  | 76             | S 16205352 | 02.94      | - ABS |       |                |        |  |  |           |
| 2.5 TDi (14) | 79             | S 16205754 | 01.97      | - ABS |       |                |        |  |  |           |
| 2.5 TDi (18) | 79             | S 16205352 | 01.97      | - ABS |       |                |        |  |  |           |
| 2.8 HDi (14) | 94             | S 16205754 | 11.00      | - ABS |       |                |        |  |  |           |

<sup>1)</sup> - ABS/ + reinforced suspension / - ABS/ + sospensione rinforzata / - ABS/ + châssis renforcé / - ABS/ + suspensión reforzada  
<sup>2)</sup> + ML5 transmission / + scatola cambio ML5 / + boîte de vitesse ML5 / + cambio ML5  
<sup>3)</sup> + ME transmission / + scatola cambio ME / + boîte de vitesse ME / + cambio ME  
<sup>4)</sup> + MG5T transmission / + scatola cambio MG5T / + boîte de vitesse MG5T / + cambio MG5T





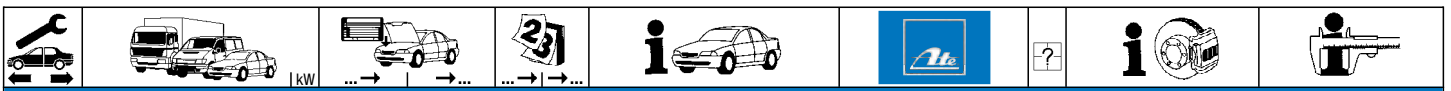

**PEUGEOT BOXER Kasten (94-02)**

|  |                     |               |            |              |                    |                       |        |   |                       |
|--|---------------------|---------------|------------|--------------|--------------------|-----------------------|--------|---|-----------------------|
|  | <b>2.8 HDi (18)</b> | 94            | S 16205352 | <b>11.00</b> | - ABS              | <b>24.2125-1703.3</b> | 010483 |   | THz 25,40             |
|  | 1.9 D (10)          | 50 S 16205755 |            |              | <b>03.02</b> - ABS | <b>24.2125-1725.3</b> | 010717 |   | THz 25,40             |
|  | 1.9 D (10)          | 51 S 16205755 |            |              | <b>03.02</b> - ABS |                       |        |   |                       |
|  | 1.9 TD (10/14)      | 66 S 16205755 |            |              | <b>03.02</b> - ABS |                       |        |   |                       |
|  | 1.9 TD (10/14)      | 68 S 16205755 |            |              | <b>03.02</b> - ABS |                       |        |   |                       |
|  | 2.0 HDi (10/14/18)  | 62            |            | <b>08.01</b> | <b>03.02</b> - ABS |                       |        |   |                       |
|  | 2.0 i (10/14)       | 80 S 16205755 |            |              | <b>03.02</b> - ABS |                       |        |   |                       |
|  | 2.0 i (18)          | 80 S 16205353 |            |              | <b>03.02</b> - ABS |                       |        |   |                       |
|  | 2.5 D (14)          | 63 S 16205755 |            |              | <b>03.02</b> - ABS |                       |        |   |                       |
|  | 2.5 D (18)          | 63 S 16205353 |            |              | <b>03.02</b> - ABS |                       |        |   |                       |
|  | 2.5 TD (14)         | 76 S 16205755 |            |              | <b>03.02</b> - ABS |                       |        |   |                       |
|  | 2.5 TD (18)         | 76 S 16205353 |            |              | <b>03.02</b> - ABS |                       |        |   |                       |
|  | 2.5 TDi (14)        | 79 S 16205755 |            |              | <b>03.02</b> - ABS |                       |        |   |                       |
|  | 2.5 TDi (18)        | 79 S 16205353 |            |              | <b>03.02</b> - ABS |                       |        |   |                       |
|  | 2.8 HDi (14)        | 94 S 16205755 |            |              | <b>03.02</b> - ABS |                       |        |   |                       |
|  | 2.8 HDi (18)        | 94 S 16205353 |            |              | <b>03.02</b> - ABS |                       |        |   |                       |
|  | 1.9 D (10)          | 51            | S 15064995 | <b>02.94</b> | + ABS              | <b>24.2122-1714.3</b> | 010480 |   | THz 22,20             |
|  | 1.9 TD (10/14)      | 68            | S 15064995 | <b>02.94</b> | + ABS              |                       |        |   |                       |
|  | 2.0 i (10/14)       | 80            | S 15064995 | <b>02.94</b> | + ABS              |                       |        |   |                       |
|  | 2.5 D (14)          | 63            | S 15064995 | <b>02.94</b> | + ABS              |                       |        |   |                       |
|  | 2.5 TD (14)         | 76            | S 15064995 | <b>02.94</b> | + ABS              |                       |        |   |                       |
|  | 1.9 D (10)          | 50            | S 16206253 | <b>07.99</b> | + ABS              | <b>24.2125-1702.3</b> | 010482 |   | THz 25,40             |
|  | 1.9 D (10)          | 51 S 15064996 | S 16206253 |              | + ABS              |                       |        |   |                       |
|  | 1.9 TD (10/14)      | 66            | S 16206253 | <b>07.99</b> | + ABS              |                       |        |   |                       |
|  | 1.9 TD (10/14)      | 68 S 15064996 | S 16206253 |              | + ABS              |                       |        |   |                       |
|  | 2.0 i (10/14)       | 80 S 15064996 | S 16206253 |              | + ABS              |                       |        |   |                       |
|  | 2.0 i (18)          | 80            | S 16194399 | <b>02.94</b> | + ABS              |                       |        |   |                       |
|  | 2.5 D (14)          | 63 S 15064996 | S 16206253 |              | + ABS              |                       |        |   |                       |
|  | 2.5 D (18)          | 63            | S 16194399 | <b>02.94</b> | + ABS              |                       |        |   |                       |
|  | 2.5 TD (14)         | 76 S 15064996 | S 16206253 |              | + ABS              |                       |        |   |                       |
|  | 2.5 TD (18)         | 76            | S 16194399 | <b>02.94</b> | + ABS              |                       |        |   |                       |
|  | 2.5 TDi (14)        | 79            | S 16206253 | <b>01.97</b> | + ABS              |                       |        |   |                       |
|  | 2.5 TDi (18)        | 79            | S 16194399 | <b>01.97</b> | + ABS              |                       |        |   |                       |
|  | 2.8 HDi (14)        | 94            | S 16206253 | <b>11.00</b> | + ABS              |                       |        |   |                       |
|  | 2.8 HDi (18)        | 94            | S 16194399 | <b>11.00</b> | + ABS              |                       |        |   |                       |
|  | 1.9 D (10)          | 50 S 16206254 |            |              | <b>03.02</b> + ABS | <b>24.2125-1726.3</b> | 010718 |   | THz 25,40             |
|  | 1.9 D (10)          | 51 S 16206254 |            |              | <b>03.02</b> + ABS |                       |        |   |                       |
|  | 1.9 TD (10/14)      | 66 S 16206254 |            |              | <b>03.02</b> + ABS |                       |        |   |                       |
|  | 1.9 TD (10/14)      | 68 S 16206254 |            |              | <b>03.02</b> + ABS |                       |        |   |                       |
|  | 2.0 HDi (10/14/18)  | 62            |            | <b>08.01</b> | <b>03.02</b> + ABS |                       |        |   |                       |
|  | 2.0 i (10/14)       | 80 S 16206254 |            |              | <b>03.02</b> + ABS |                       |        |   |                       |
|  | 2.0 i (18)          | 80 S 16194400 |            |              | <b>03.02</b> + ABS |                       |        |   |                       |
|  | 2.5 D (14)          | 63 S 16206254 |            |              | <b>03.02</b> + ABS |                       |        |   |                       |
|  | 2.5 D (18)          | 63 S 16194400 |            |              | <b>03.02</b> + ABS |                       |        |   |                       |
|  | 2.5 TD (14)         | 76 S 16206254 |            |              | <b>03.02</b> + ABS |                       |        |   |                       |
|  | 2.5 TD (18)         | 76 S 16194400 |            |              | <b>03.02</b> + ABS |                       |        |   |                       |
|  | 2.5 TDi (14)        | 79 S 16206254 |            |              | <b>03.02</b> + ABS |                       |        |   |                       |
|  | 2.5 TDi (18)        | 79 S 16194400 |            |              | <b>03.02</b> + ABS |                       |        |   |                       |
|  | 2.8 HDi (14)        | 94 S 16206254 |            |              | <b>03.02</b> + ABS |                       |        |   |                       |
|  | 2.8 HDi (18)        | 94 S 16194400 |            |              | <b>03.02</b> + ABS |                       |        |   |                       |
|  | 1.9 D (10)          | 50            |            | <b>07.99</b> | <b>10.01</b> + ABS | <b>24.0101-4804.2</b> | 260050 |   | Einbausatz <b>LUC</b> |
|  | 1.9 D (10)          | 51            |            | <b>02.94</b> | <b>10.01</b> + ABS |                       |        |   |                       |
|  | 1.9 TD (10/14)      | 66            |            | <b>07.99</b> | <b>10.01</b> + ABS |                       |        |   |                       |
|  | 1.9 TD (10/14)      | 68            |            | <b>02.94</b> | <b>10.01</b> + ABS |                       |        |   |                       |
|  | 2.0 HDi (10/14)     | 62            |            | <b>08.01</b> | <b>10.01</b> + ABS |                       |        |   |                       |
|  | 2.0 i (10/14)       | 80            |            | <b>02.94</b> | <b>10.01</b> + ABS |                       |        |   |                       |
|  | 2.5 D (14)          | 63            |            | <b>02.94</b> | <b>10.01</b> + ABS |                       |        |   |                       |
|  | 1.9 D (10)          | 50            | S 15866409 | <b>07.99</b> |                    | <b>24.5112-0466.3</b> | 330579 | 2 | L=462                 |
|  | 1.9 D (10)          | 51            | S 15866409 | <b>02.94</b> |                    | <b>24.5112-0465.3</b> | 330526 | 2 | L=465, + Clip         |
|  | 1.9 TD (10/14)      | 66            | S 15866409 | <b>07.99</b> |                    |                       |        |   |                       |
|  | 1.9 TD (10/14)      | 68            | S 15866409 | <b>02.94</b> |                    |                       |        |   |                       |
|  | 2.0 i (10/14/18)    | 80            | S 15866409 | <b>02.94</b> |                    |                       |        |   |                       |
|  | 2.5 D (14/18)       | 63            | S 15866409 | <b>02.94</b> |                    |                       |        |   |                       |
|  | 2.5 TD (14/18)      | 76            | S 15866409 | <b>02.94</b> |                    |                       |        |   |                       |
|  | 2.5 TDi (14/18)     | 79            | S 15866409 | <b>01.97</b> |                    |                       |        |   |                       |
|  | 2.8 HDi (14/18)     |               | S 15866409 | <b>11.00</b> |                    |                       |        |   |                       |
|  | 1.9 D (10)          | 50 S 15866410 |            |              | <b>10.01</b>       | <b>24.5112-0466.3</b> | 330579 | 2 | L=462                 |
|  | 1.9 D (10)          | 51 S 15866410 |            |              | <b>10.01</b>       | <b>24.5112-0461.3</b> | 330616 | 2 | L=460, + Clip         |
|  | 1.9 TD (10/14)      | 66 S 15866410 |            |              | <b>10.01</b>       |                       |        |   |                       |
|  | 1.9 TD (10/14)      | 68 S 15866410 |            |              | <b>10.01</b>       |                       |        |   |                       |
|  | 2.0 HDi (10/14/18)  | 62            |            | <b>08.01</b> | <b>10.01</b>       |                       |        |   |                       |
|  | 2.0 i (10/14/18)    | 80 S 15866410 |            |              | <b>10.01</b>       |                       |        |   |                       |
|  | 2.5 D (14/18)       | 63 S 15866410 |            |              | <b>10.01</b>       |                       |        |   |                       |
|  | 2.5 TD (14/18)      | 76 S 15866410 |            |              | <b>10.01</b>       |                       |        |   |                       |
|  | 2.5 TDi (14/18)     | 79 S 15866410 |            |              | <b>10.01</b>       |                       |        |   |                       |
|  | 2.8 HDi (14/18)     |               | S 15866410 |              | <b>10.01</b>       |                       |        |   |                       |
|  | 1.9 D (10)          | 50            |            | <b>11.01</b> | <b>03.02</b>       | <b>83.6401-0471.3</b> | 330750 | 2 | L=470                 |
|  | 1.9 D (10)          | 51            |            | <b>11.01</b> | <b>03.02</b>       | <b>83.6401-0469.3</b> | 330749 | 2 | L=468                 |
|  | 1.9 TD (10/14)      | 66            |            | <b>11.01</b> | <b>03.02</b>       |                       |        |   |                       |
|  | 1.9 TD (10/14)      | 68            |            | <b>11.01</b> | <b>03.02</b>       |                       |        |   |                       |
|  | 2.0 HDi (10/14/18)  | 62            |            | <b>11.01</b> | <b>03.02</b>       |                       |        |   |                       |
|  | 2.0 i (10/14/18)    | 80            |            | <b>11.01</b> | <b>03.02</b>       |                       |        |   |                       |
|  | 2.5 D (14/18)       | 63            |            | <b>11.01</b> | <b>03.02</b>       |                       |        |   |                       |
|  | 2.5 TD (14/18)      | 76            |            | <b>11.01</b> | <b>03.02</b>       |                       |        |   |                       |
|  | 2.5 TDi (14/18)     | 79            |            | <b>11.01</b> | <b>03.02</b>       |                       |        |   |                       |
|  | 2.8 HDi (14/18)     |               |            | <b>11.01</b> | <b>03.02</b>       |                       |        |   |                       |

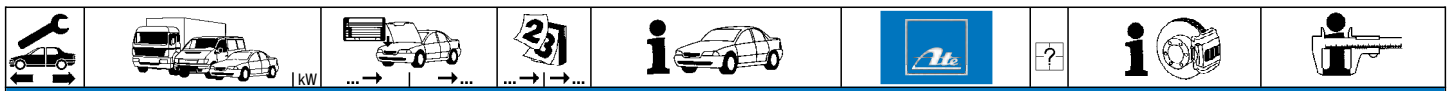

**PEUGEOT BOXER Kasten (94-02)**

|  |                    |    |            |            |       |       |                |        |   |                                      |                |
|--|--------------------|----|------------|------------|-------|-------|----------------|--------|---|--------------------------------------|----------------|
|  | 1.9 D (10)         | 50 |            | 11.01      | 03.02 |       | 24.3461-1701.5 | 240449 |   |                                      | D=46, - Halter |
|  | 1.9 D (10)         | 51 |            | 11.01      | 03.02 |       | 24.3461-1702.5 | 240450 |   |                                      | D=46, - Halter |
|  | 1.9 TD (10/14)     | 66 |            | 11.01      | 03.02 |       |                |        |   |                                      |                |
|  | 1.9 TD (10/14)     | 68 |            | 11.01      | 03.02 |       |                |        |   |                                      |                |
|  | 2.0 HDi (10/14/18) | 62 |            | 11.01      | 03.02 |       |                |        |   |                                      |                |
|  | 2.0 i (10/14/18)   | 80 |            | 11.01      | 03.02 |       |                |        |   |                                      |                |
|  | 2.5 D (14/18)      | 63 |            | 11.01      | 03.02 |       |                |        |   |                                      |                |
|  | 2.5 TDi (14/18)    | 79 |            | 11.01      | 03.02 |       |                |        |   |                                      |                |
|  | 2.5 TDi (14/18)    | 79 |            | 11.01      | 03.02 |       |                |        |   |                                      |                |
|  | 2.8 HDi (14/18)    | 79 |            | 11.01      | 03.02 |       |                |        |   |                                      |                |
|  | 1.9 D (10)         | 50 |            | 07.99      | 10.01 | - ABS | 24.5112-0340.3 | 330511 | 1 | - verstärktes Fahrwerk <sup>1)</sup> | L=340          |
|  | 1.9 D (10)         | 51 |            | 02.94      | 10.01 | - ABS | 24.5112-0361.3 | 330649 | 1 | + verstärktes Fahrwerk <sup>2)</sup> | L=360          |
|  | 1.9 TD (10/14)     | 66 |            | 07.99      | 10.01 | - ABS |                |        |   |                                      |                |
|  | 1.9 TD (10/14)     | 68 |            | 02.94      | 10.01 | - ABS |                |        |   |                                      |                |
|  | 2.0 HDi (10/14/18) | 62 |            | 08.01      | 10.01 | - ABS |                |        |   |                                      |                |
|  | 2.0 i (10/14/18)   | 80 |            | 02.94      | 10.01 | - ABS |                |        |   |                                      |                |
|  | 2.5 D (14/18)      | 63 |            | 02.94      | 10.01 | - ABS |                |        |   |                                      |                |
|  | 2.5 TD (14/18)     | 76 |            | 02.94      | 10.01 | - ABS |                |        |   |                                      |                |
|  | 2.5 TDi (14/18)    | 79 |            | 01.97      | 10.01 | - ABS |                |        |   |                                      |                |
|  | 2.8 HDi (14/18)    | 79 |            | 11.00      | 10.01 | - ABS |                |        |   |                                      |                |
|  | 1.9 D (10)         | 50 |            | 11.01      | 03.02 | - ABS | 24.5112-0361.3 | 330649 | 1 | + HA-Trommelbremse <sup>3)</sup>     | L=360          |
|  | 1.9 D (10)         | 51 |            | 11.01      | 03.02 | - ABS | 83.6401-0159.3 | 330746 | 2 | + HA-Scheibenbremse <sup>4)</sup>    | L=160          |
|  | 1.9 TD (10/14)     | 66 |            | 11.01      | 03.02 | - ABS |                |        |   |                                      |                |
|  | 1.9 TD (10/14)     | 68 |            | 11.01      | 03.02 | - ABS |                |        |   |                                      |                |
|  | 2.0 HDi (10/14/18) | 62 |            | 11.01      | 03.02 | - ABS |                |        |   |                                      |                |
|  | 2.0 i (10/14/18)   | 80 |            | 11.01      | 03.02 | - ABS |                |        |   |                                      |                |
|  | 2.5 D (14/18)      | 63 |            | 11.01      | 03.02 | - ABS |                |        |   |                                      |                |
|  | 2.5 TD (14/18)     | 76 |            | 11.01      | 03.02 | - ABS |                |        |   |                                      |                |
|  | 2.5 TDi (14/18)    | 79 |            | 11.01      | 03.02 | - ABS |                |        |   |                                      |                |
|  | 2.8 HDi (14/18)    | 79 |            | 11.01      | 03.02 | - ABS |                |        |   |                                      |                |
|  | 1.9 D (10)         | 50 |            | 07.99      | 10.01 | + ABS | 24.5112-0315.3 | 330509 |   | - verstärktes Fahrwerk <sup>1)</sup> | L=315          |
|  | 1.9 D (10)         | 51 |            | 02.94      | 10.01 | + ABS | 24.5112-0363.3 | 330650 |   | + verstärktes Fahrwerk <sup>2)</sup> | L=360          |
|  | 1.9 TD (10/14)     | 66 |            | 07.99      | 10.01 | + ABS |                |        |   |                                      |                |
|  | 1.9 TD (10/14)     | 68 |            | 02.94      | 10.01 | + ABS |                |        |   |                                      |                |
|  | 2.0 HDi (10/14/18) | 62 |            | 08.01      | 10.01 | + ABS |                |        |   |                                      |                |
|  | 2.0 i (10/14/18)   | 80 |            | 02.94      | 10.01 | + ABS |                |        |   |                                      |                |
|  | 2.5 D (14/18)      | 63 |            | 02.94      | 10.01 | + ABS |                |        |   |                                      |                |
|  | 2.5 TD (14/18)     | 76 |            | 02.94      | 10.01 | + ABS |                |        |   |                                      |                |
|  | 2.5 TDi (14/18)    | 79 |            | 01.97      | 10.01 | + ABS |                |        |   |                                      |                |
|  | 2.8 HDi (14/18)    | 79 |            | 11.00      | 10.01 | + ABS |                |        |   |                                      |                |
|  | 1.9 D (10)         | 50 |            | 11.01      | 03.02 | + ABS | 24.5112-0363.3 | 330650 |   | + HA-Trommelbremse <sup>3)</sup>     | L=360          |
|  | 1.9 D (10)         | 51 |            | 11.01      | 03.02 | + ABS | 83.6401-0159.3 | 330746 | 2 | + HA-Scheibenbremse <sup>4)</sup>    | L=160          |
|  | 1.9 TD (10/14)     | 66 |            | 11.01      | 03.02 | + ABS |                |        |   |                                      |                |
|  | 1.9 TD (10/14)     | 68 |            | 11.01      | 03.02 | + ABS |                |        |   |                                      |                |
|  | 2.0 HDi (10/14/18) | 62 |            | 11.01      | 03.02 | + ABS |                |        |   |                                      |                |
|  | 2.0 i (10/14/18)   | 80 |            | 11.01      | 03.02 | + ABS |                |        |   |                                      |                |
|  | 2.5 D (14/18)      | 63 |            | 11.01      | 03.02 | + ABS |                |        |   |                                      |                |
|  | 2.5 TD (14/18)     | 76 |            | 11.01      | 03.02 | + ABS |                |        |   |                                      |                |
|  | 2.5 TDi (14/18)    | 79 |            | 11.01      | 03.02 | + ABS |                |        |   |                                      |                |
|  | 2.8 HDi (14/18)    | 79 |            | 11.01      | 03.02 | + ABS |                |        |   |                                      |                |
|  | 1.9 D (10)         | 50 |            | 07.99      | 10.01 |       | 24.3225-1701.3 | 020399 |   |                                      | Rz 25,40       |
|  | 1.9 D (10)         | 51 |            | 02.94      | 10.01 |       |                |        |   |                                      |                |
|  | 1.9 TD (10/14)     | 66 |            | 07.99      | 10.01 |       |                |        |   |                                      |                |
|  | 1.9 TD (10/14)     | 68 |            | 02.94      | 10.01 |       |                |        |   |                                      |                |
|  | 2.0 HDi (10/14)    | 62 |            | 08.01      | 10.01 |       |                |        |   |                                      |                |
|  | 2.0 i (10/14)      | 80 |            | 02.94      | 10.01 |       |                |        |   |                                      |                |
|  | 2.5 D (14)         | 63 |            | 02.94      | 10.01 |       |                |        |   |                                      |                |
|  | 2.5 TD (14)        | 76 |            | 02.94      | 10.01 |       | 24.3226-1702.3 | 020469 |   |                                      | Rz 26,99       |
|  | 2.5 TDi (14)       | 79 |            | 01.97      | 10.01 |       |                |        |   |                                      |                |
|  | 2.8 HDi (14)       | 94 |            | 11.00      | 10.01 |       |                |        |   |                                      |                |
|  | 1.9 D (10)         | 50 |            | 11.01      | 03.02 |       | 24.3226-1702.3 | 020469 |   |                                      | Rz 26,99       |
|  | 1.9 D (10)         | 51 |            | 11.01      | 03.02 |       |                |        |   |                                      |                |
|  | 1.9 TD (10/14)     | 66 |            | 11.01      | 03.02 |       |                |        |   |                                      |                |
|  | 1.9 TD (10/14)     | 68 |            | 11.01      | 03.02 |       |                |        |   |                                      |                |
|  | 2.0 HDi (10/14)    | 62 |            | 11.01      | 03.02 |       |                |        |   |                                      |                |
|  | 2.0 i (10/14)      | 80 |            | 11.01      | 03.02 |       |                |        |   |                                      |                |
|  | 2.5 D (14)         | 63 |            | 11.01      | 03.02 |       |                |        |   |                                      |                |
|  | 2.5 TD (14)        | 76 |            | 11.01      | 03.02 |       |                |        |   |                                      |                |
|  | 2.5 TDi (14)       | 79 |            | 11.01      | 03.02 |       |                |        |   |                                      |                |
|  | 2.8 HDi (14)       | 94 |            | 11.01      | 03.02 |       |                |        |   |                                      |                |
|  | 2.0 HDi (18)       | 62 |            | 08.01      | 10.01 |       | 24.3228-1701.3 | 020401 |   |                                      | Rz 28,57       |
|  | 2.0 i (18)         | 80 |            | 02.94      | 10.01 |       |                |        |   |                                      |                |
|  | 2.5 D (18)         | 63 |            | 02.94      | 10.01 |       |                |        |   |                                      |                |
|  | 2.5 TD (18)        | 76 |            | 02.94      | 10.01 |       |                |        |   |                                      |                |
|  | 2.5 TDi (18)       | 79 |            | 01.97      | 10.01 |       |                |        |   |                                      |                |
|  | 2.8 HDi (18)       | 94 |            | 11.00      | 10.01 |       |                |        |   |                                      |                |
|  | 1.9 D (10)         | 50 | S 16158427 | 07.99      |       |       | 24.3727-0340.2 | 580340 | 1 |                                      | L=3025         |
|  | 1.9 D (10)         | 51 | S 16158427 | 02.94      |       |       |                |        |   |                                      |                |
|  | 1.9 TD (10/14)     | 66 | S 16158427 | 07.99      |       |       |                |        |   |                                      |                |
|  | 1.9 TD (10/14)     | 68 | S 16158427 | 02.94      |       |       |                |        |   |                                      |                |
|  | 2.0 i (10/14/18)   | 80 | S 16158427 | 02.94      |       |       |                |        |   |                                      |                |
|  | 2.5 D (14/18)      | 63 | S 16158427 | 02.94      |       |       |                |        |   |                                      |                |
|  | 2.5 TD (14/18)     | 76 | S 16158427 | 02.94      |       |       |                |        |   |                                      |                |
|  | 2.5 TDi (14/18)    | 79 | S 16158427 | 01.97      |       |       |                |        |   |                                      |                |
|  | 2.8 HDi (14/18)    | 79 | S 16158427 | 11.00      |       |       |                |        |   |                                      |                |
|  | 1.9 D (10)         | 50 | S 16158428 | S 16194399 |       |       | 24.3727-0344.2 | 580344 | 1 |                                      | L=2806         |

1) - reinforced suspension / - sospensione rinforzata / - châssis renforcé / - suspensión reforzada  
 2) + reinforced suspension / + sospensione rinforzata / + châssis renforcé / + suspensión reforzada  
 3) + RA drum brake / + P freno a tamburo / + frein à tambour essieu AR / + ET-tambores de freno  
 4) + RA disc brake / + P disco freno / + frein à disque essieu AR / + ET-disco de freno





**PEUGEOT BOXER Kasten (94-02)**

|                     |                    |                |            |       |                |                |                |        |   |                              |        |
|---------------------|--------------------|----------------|------------|-------|----------------|----------------|----------------|--------|---|------------------------------|--------|
|                     | 1.9 D (10)         | 51 S 16158428  | S 16194399 |       |                | 24.3727-0344.2 | 580344         | 1 ↓    |   | L=2806                       |        |
|                     | 1.9 TD (10/14)     | 66 S 16158428  | S 16194399 |       |                |                |                |        |   |                              |        |
|                     | 1.9 TD (10/14)     | 68 S 16158428  | S 16194399 |       |                |                |                |        |   |                              |        |
|                     | 2.0 i (10/14/18)   | 80 S 16158428  | S 16194399 |       |                |                |                |        |   |                              |        |
|                     | 2.5 D (14/18)      | 63 S 16158428  | S 16194399 |       |                |                |                |        |   |                              |        |
|                     | 2.5 TD (14/18)     | 76 S 16158428  | S 16194399 |       |                |                |                |        |   |                              |        |
|                     | 2.5 TDi (14/18)    | 79 S 16158428  | S 16194399 |       |                |                |                |        |   |                              |        |
|                     | 2.8 HDi (14/18)    | S 16158428     | S 16194399 |       |                |                |                |        |   |                              |        |
|                     | 1.9 D (10)         | 50 S 16194400  |            | 03.02 |                | 24.3727-0343.2 | 580343         | 1 ↓    | + HA-Trommelbremse <sup>1)</sup>            | L=2827                       |        |
|                     | 1.9 D (10)         | 51 S 16194400  |            | 03.02 |                | 24.3727-0348.2 | 580348         | 1 ↓    | + HA-Scheibenbremse <sup>2)</sup>           | L=2715                       |        |
| 1.9 TD (10/14)      | 66 S 16194400      |                | 03.02      |       |                |                |                |        |   |                              |        |
| 1.9 TD (10/14)      | 68 S 16194400      |                | 03.02      |       |                |                |                |        |   |                              |        |
| 2.0 HDi (10/14/18)  | 62                 |                | 08.01      | 03.02 |                |                |                |        |   |                              |        |
| 2.0 i (10/14/18)    | 80 S 16194400      |                |            | 03.02 |                |                |                |        |   |                              |        |
| 2.5 D (14/18)       | 63 S 16194400      |                |            | 03.02 |                |                |                |        |   |                              |        |
| 2.5 TD (14/18)      | 76 S 16194400      |                |            | 03.02 |                |                |                |        |   |                              |        |
| 2.5 TDi (14/18)     | 79 S 16194400      |                |            | 03.02 |                |                |                |        |   |                              |        |
| 2.8 HDi (14/18)     | S 16194400         |                |            | 03.02 |                |                |                |        |   |                              |        |
| 2.5 D 4x4 (14/18)   | 63                 |                | 07.99      | 03.02 | 24.3727-0842.2 | 580842         | 1 ↓            |        | L=4100                                      |                              |        |
| 2.5 TDi 4x4 (14/18) | 79                 |                | 07.99      | 03.02 |                |                |                |        |   |                              |        |
|                     | 1.9 D (10)         | 50             | S 16206244 | 07.99 |                | 24.6512-1701.3 | 320153         |        | - ABS                                       | BRL (2)                      |        |
|                     | 1.9 D (10)         | 51             | S 16206244 | 02.94 |                |                |                |        |   |                              |        |
|                     | 1.9 TD (10/14)     | 66             | S 16206244 | 07.99 |                |                |                |        |   |                              |        |
|                     | 1.9 TD (10/14)     | 68             | S 16206244 | 02.94 |                |                |                |        |   |                              |        |
|                     | 2.0 HDi (10/14/18) | 62             | S 16206244 | 08.01 |                |                |                |        |   |                              |        |
|                     | 2.0 i (10/14/18)   | 80             | S 16206244 | 02.94 |                |                |                |        |   |                              |        |
|                     | 2.5 D (14/18)      | 63             | S 16206244 | 02.94 |                |                |                |        |   |                              |        |
|                     | 2.5 TD (14/18)     | 76             | S 16206244 | 02.94 |                |                |                |        |   |                              |        |
|                     | 2.5 TDi (14/18)    | 79             | S 16206244 | 01.97 |                |                |                |        |   |                              |        |
|                     | 2.8 HDi (14/18)    |                | S 16206244 | 11.00 |                |                |                |        |   |                              |        |
|                     | 1.9 D (10)         | 50             | S 15445357 | 07.99 |                | 24.6512-1703.3 | 320159         |        | + ABS                                       | BRL (4)                      |        |
|                     | 1.9 D (10)         | 51             | S 15445357 | 02.94 |                |                |                |        |   |                              |        |
|                     | 1.9 TD (10/14)     | 66             | S 15445357 | 07.99 |                |                |                |        |   |                              |        |
|                     | 1.9 TD (10/14)     | 68             | S 15445357 | 02.94 |                |                |                |        |   |                              |        |
|                     | 2.0 i (10/14/18)   | 80             | S 15445357 | 02.94 |                |                |                |        |   |                              |        |
|                     | 2.5 D (14/18)      | 63             | S 15445357 | 02.94 |                |                |                |        |   |                              |        |
|                     | 2.5 TD (14/18)     | 76             | S 15445357 | 02.94 |                |                |                |        |   |                              |        |
|                     | 2.5 TDi (14/18)    | 79             | S 15445357 | 01.97 |                |                |                |        |   |                              |        |
|                     | 1.9 D (10)         | 50 S 16205353  |            | 03.02 |                | 24.6512-1712.3 | 320273         |        | - ABS/ + verstärktes Fahrwerk <sup>3)</sup> | BRL (2)                      |        |
|                     | 1.9 D (10)         | 51 S 16205353  |            | 03.02 |                |                |                |        |   |                              |        |
| 1.9 TD (14)         | 66 S 16205353      |                | 03.02      |       |                |                |                |        |   |                              |        |
| 1.9 TD (14)         | 68 S 16205353      |                | 03.02      |       |                |                |                |        |   |                              |        |
| 2.0 HDi (14)        | 62 S 16205353      |                | 03.02      |       |                |                |                |        |   |                              |        |
| 2.0 i (14)          | 80 S 16205353      |                | 03.02      |       |                |                |                |        |   |                              |        |
| 2.5 D (14)          | 63 S 16205353      |                | 03.02      |       |                |                |                |        |   |                              |        |
| 2.5 TD (14)         | 76 S 16205353      |                | 03.02      |       |                |                |                |        |   |                              |        |
| 2.5 TDi (14)        | 79 S 16205353      |                | 03.02      |       |                |                |                |        |   |                              |        |
| 2.8 HDi (14)        | 94 S 16205353      |                | 03.02      |       |                |                |                |        |   |                              |        |
|                     | 2.0 HDi (18)       | 62 S 16205353  |            | 03.02 |                | 24.6512-1709.3 | 320270         |        | - ABS/ + verstärktes Fahrwerk <sup>3)</sup> | BRL (2)                      |        |
|                     | 2.0 i (18)         | 80 S 16205353  |            | 03.02 |                |                |                |        |   |                              |        |
|                     | 2.5 D (18)         | 63 S 16205353  |            | 03.02 |                |                |                |        |   |                              |        |
|                     | 2.5 TD (18)        | 76 S 16205353  |            | 03.02 |                |                |                |        |   |                              |        |
|                     | 2.5 TDi (18)       | 79 S 16205353  |            | 03.02 |                |                |                |        |   |                              |        |
|                     | 2.8 HDi (18)       | 94 S 16205353  |            | 03.02 |                |                |                |        |   |                              |        |
|                     |                    | 1.9 D (10)     | 50         |       | 07.99          | 03.02          | 24.3728-0300.2 | 590300 |   | + ML5-Getriebe <sup>4)</sup> | L=1478 |
|                     |                    | 1.9 D (10)     | 51         |       | 02.94          | 03.02          |                |        |   | + ML5-Getriebe <sup>4)</sup> |        |
|                     |                    | 1.9 TD (10/14) | 66         |       | 07.99          | 03.02          |                |        |   | + ML5-Getriebe <sup>4)</sup> |        |
|                     |                    | 1.9 TD (10/14) | 68         |       | 02.94          | 03.02          |                |        |   | + ML5-Getriebe <sup>4)</sup> |        |
| 1.9 TD (10/14)      |                    | 66             |            | 07.99 | 03.02          | 24.3728-0337.2 | 590337         |        | + ME-Getriebe <sup>5)</sup>                 | L=1058                       |        |
| 1.9 TD (10/14)      |                    | 68             |            | 02.94 | 03.02          |                |                |        | + ME-Getriebe <sup>5)</sup>                 |                              |        |
| 1.9 D (10)          |                    | 50             |            | 07.99 | 03.02          | 24.3728-0518.2 | 590518         |        | + ME-Getriebe <sup>5)</sup>                 | L=1034                       |        |
| 1.9 D (10)          |                    | 51             |            | 02.94 | 03.02          |                |                |        | + ME-Getriebe <sup>5)</sup>                 |                              |        |
| 2.0 i (10/14/18)    |                    | 80             |            | 02.94 | 03.02          |                |                |        | + ME-Getriebe <sup>5)</sup>                 |                              |        |
| 2.5 D (14/18)       |                    | 63             |            | 02.94 | 03.02          |                |                |        | + ME-Getriebe <sup>5)</sup>                 |                              |        |
|                     | 2.0 i (10/14/18)   | 80             |            | 02.94 | 03.02          | 24.3728-0519.2 | 590519         |        | + MG5T-Getriebe <sup>6)</sup>               | L=1090                       |        |
|                     | 2.5 D (14/18)      | 63             |            | 02.94 | 03.02          |                |                |        | + MG5T-Getriebe <sup>6)</sup>               |                              |        |
|                     | 2.5 TD (14/18)     | 76             |            | 02.94 | 03.02          |                |                |        | + MG5T-Getriebe <sup>6)</sup>               |                              |        |
|                     | 2.5 TDi (14/18)    | 79             |            | 01.97 | 03.02          |                |                |        | + MG5T-Getriebe <sup>6)</sup>               |                              |        |
|                     | 2.8 HDi (14/18)    |                |            | 11.00 | 03.02          |                |                |        | + MG5T-Getriebe <sup>6)</sup>               |                              |        |
|                     | 2.0 i (10/14/18)   | 80             |            | 02.94 | 03.02          | 24.3728-0335.2 | 590335         |        | + ML5-Getriebe <sup>4)</sup>                | L=1435                       |        |
|                     | 2.5 D (14/18)      | 63             |            | 02.94 | 03.02          |                |                |        | + ML5-Getriebe <sup>4)</sup>                |                              |        |
|                     | 2.8 HDi (14/18)    |                |            | 11.00 | 03.02          |                |                |        | + ML5-Getriebe <sup>4)</sup>                |                              |        |

**PEUGEOT BOXER Pritsche/Fahrgestell (94-02)**

|             |                |               |            |       |  |                |        |       |       |           |
|-------------|----------------|---------------|------------|-------|--|----------------|--------|-------|-------|-----------|
|             | 2.0 i (10/14)  | 80            | S 15064995 | 06.94 |  | 24.2122-1715.3 | 010481 |       | - ABS | Thz 22,20 |
|             | 2.5 D (14)     | 63            | S 15064995 | 02.94 |  |                |        |       | - ABS |           |
|             | 2.5 TD (14)    | 76            | S 15064995 | 02.94 |  |                |        |       | - ABS |           |
|             | 1.9 TD (10/14) | 66            | S 16205754 | 12.98 |  | 24.2125-1703.3 | 010483 |       | - ABS | Thz 25,40 |
|             | 1.9 TD (10/14) | 68            | S 16205754 | 07.96 |  |                |        |       | - ABS |           |
|             | 2.0 i (10/14)  | 80 S 15064996 | S 16205754 |       |  |                |        |       | - ABS |           |
|             | 2.0 i (18)     | 80            | S 16205352 | 06.94 |  |                |        |       | - ABS |           |
|             | 2.5 D (14)     | 63 S 15064996 | S 16205754 |       |  |                |        |       | - ABS |           |
|             | 2.5 D (18)     | 63            | S 16205352 | 02.94 |  |                |        |       | - ABS |           |
|             | 2.5 TD (14)    | 76 S 15064996 | S 16205754 |       |  |                |        |       | - ABS |           |
| 2.5 TD (18) | 76             | S 16205352    | 02.94      |       |  |                |        | - ABS |       |           |

<sup>1)</sup> + RA drum brake / + P freno a tamburo / + frein à tambour essieu AR / + ET-tambores de freno  
<sup>2)</sup> + RA disc brake / + P disco freno / + frein à disque essieu AR / + ET-disco de freno  
<sup>3)</sup> - ABS/ + reinforced suspension / - ABS/ + sospensione rinforzata / - ABS/ + châssis renforcé / - ABS/ + suspensión reforzada  
<sup>4)</sup> + ML5 transmission / + scatola cambio ML5 / + boîte de vitesse ML5 / + cambio ML5  
<sup>5)</sup> + ME transmission / + scatola cambio ME / + boîte de vitesse ME / + cambio ME  
<sup>6)</sup> + MG5T transmission / + scatola cambio MG5T / + boîte de vitesse MG5T / + cambio MG5T



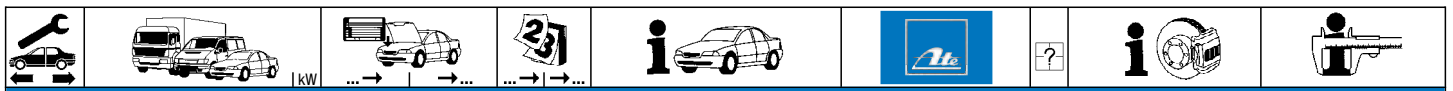

**PEUGEOT BOXER Pritsche/Fahrgestell (94-02)**

|                  |                  |            |              |              |              |                |                |           |                       |                                      |
|------------------|------------------|------------|--------------|--------------|--------------|----------------|----------------|-----------|-----------------------|--------------------------------------|
|                  | 2.5 TDi (14)     | 79         | S 16205754   | <b>01.97</b> | - ABS        | 24.2125-1703.3 | 010483         |           | THz 25,40             |                                      |
|                  | 2.5 TDi (18)     | 79         | S 16205352   | <b>01.97</b> | - ABS        |                |                |           |                       |                                      |
|                  | 2.8 HDi (14)     | 94         | S 16205754   | <b>11.00</b> | - ABS        |                |                |           |                       |                                      |
|                  | 2.8 HDi (18)     | 94         | S 16205352   | <b>11.00</b> | - ABS        |                |                |           |                       |                                      |
|                  | 1.9 TD (10/14)   | 66         | S 16205755   |              | <b>03.02</b> | - ABS          | 24.2125-1725.3 | 010717    | THz 25,40             |                                      |
|                  | 1.9 TD (10/14)   | 68         | S 16205755   |              | <b>03.02</b> | - ABS          |                |           |                       |                                      |
|                  | 2.0 i (10/14)    | 80         | S 16205755   |              | <b>03.02</b> | - ABS          |                |           |                       |                                      |
|                  | 2.0 i (18)       | 80         | S 16205353   |              | <b>03.02</b> | - ABS          |                |           |                       |                                      |
|                  | 2.5 D (14)       | 63         | S 16205755   |              | <b>03.02</b> | - ABS          |                |           |                       |                                      |
|                  | 2.5 D (18)       | 63         | S 16205353   |              | <b>03.02</b> | - ABS          |                |           |                       |                                      |
|                  | 2.5 TD (14)      | 76         | S 16205755   |              | <b>03.02</b> | - ABS          |                |           |                       |                                      |
|                  | 2.5 TD (18)      | 76         | S 16205353   |              | <b>03.02</b> | - ABS          |                |           |                       |                                      |
|                  | 2.5 TDi (14)     | 79         | S 16205755   |              | <b>03.02</b> | - ABS          |                |           |                       |                                      |
|                  | 2.5 TDi (18)     | 79         | S 16205353   |              | <b>03.02</b> | - ABS          |                |           |                       |                                      |
|                  | 2.8 HDi (14)     | 94         | S 16205755   |              | <b>03.02</b> | - ABS          |                |           |                       |                                      |
| 2.8 HDi (18)     | 94               | S 16205353 |              | <b>03.02</b> | - ABS        |                |                |           |                       |                                      |
| 2.0 i (10/14)    | 80               | S 15064995 |              | <b>06.94</b> | + ABS        | 24.2122-1714.3 | 010480         | THz 22,20 |                       |                                      |
| 2.5 D (14)       | 63               | S 15064995 |              | <b>02.94</b> | + ABS        |                |                |           |                       |                                      |
| 2.5 TD (14)      | 76               | S 15064995 |              | <b>02.94</b> | + ABS        |                |                |           |                       |                                      |
| 1.9 TD (10/14)   | 66               | S 16206253 |              | <b>12.98</b> | + ABS        | 24.2125-1702.3 | 010482         | THz 25,40 |                       |                                      |
| 1.9 TD (10/14)   | 68               | S 16206253 |              | <b>07.96</b> | + ABS        |                |                |           |                       |                                      |
| 2.0 i (10/14)    | 80               | S 15064996 |              |              | + ABS        |                |                |           |                       |                                      |
| 2.0 i (18)       | 80               | S 16194399 |              | <b>06.94</b> | + ABS        |                |                |           |                       |                                      |
| 2.5 D (14)       | 63               | S 15064996 |              |              | + ABS        |                |                |           |                       |                                      |
| 2.5 D (18)       | 63               | S 16194399 |              | <b>02.94</b> | + ABS        |                |                |           |                       |                                      |
| 2.5 TD (14)      | 76               | S 16206253 |              |              | + ABS        |                |                |           |                       |                                      |
| 2.5 TD (18)      | 76               | S 16194399 |              | <b>02.94</b> | + ABS        |                |                |           |                       |                                      |
| 2.5 TDi (14)     | 79               | S 16206253 |              | <b>01.97</b> | + ABS        |                |                |           |                       |                                      |
| 2.5 TDi (18)     | 79               | S 16194399 |              | <b>01.97</b> | + ABS        |                |                |           |                       |                                      |
| 2.8 HDi (14)     | 94               | S 16206253 |              | <b>11.00</b> | + ABS        |                |                |           |                       |                                      |
| 2.8 HDi (18)     | 94               | S 16194399 |              | <b>11.00</b> | + ABS        |                |                |           |                       |                                      |
| 1.9 TD (10/14)   | 66               | S 16206254 |              | <b>03.02</b> | + ABS        | 24.2125-1726.3 | 010718         | THz 25,40 |                       |                                      |
| 1.9 TD (10/14)   | 68               | S 16206254 |              | <b>03.02</b> | + ABS        |                |                |           |                       |                                      |
| 2.0 i (10/14)    | 80               | S 16206254 |              | <b>03.02</b> | + ABS        |                |                |           |                       |                                      |
| 2.0 i (18)       | 80               | S 16194400 |              | <b>03.02</b> | + ABS        |                |                |           |                       |                                      |
| 2.5 D (14)       | 63               | S 16206254 |              | <b>03.02</b> | + ABS        |                |                |           |                       |                                      |
| 2.5 D (18)       | 63               | S 16194400 |              | <b>03.02</b> | + ABS        |                |                |           |                       |                                      |
| 2.5 TD (14)      | 76               | S 16206254 |              | <b>03.02</b> | + ABS        |                |                |           |                       |                                      |
| 2.5 TD (18)      | 76               | S 16194400 |              | <b>03.02</b> | + ABS        |                |                |           |                       |                                      |
| 2.5 TDi (14)     | 79               | S 16206254 |              | <b>03.02</b> | + ABS        |                |                |           |                       |                                      |
| 2.5 TDi (18)     | 79               | S 16194400 |              | <b>03.02</b> | + ABS        |                |                |           |                       |                                      |
| 2.8 HDi (14)     | 94               | S 16206254 |              | <b>03.02</b> | + ABS        |                |                |           |                       |                                      |
| 2.8 HDi (18)     | 94               | S 16194400 |              | <b>03.02</b> | + ABS        |                |                |           |                       |                                      |
|                  | 1.9 TD (10/14)   | 66         |              | <b>12.98</b> | + ABS        | 24.0101-4804.2 | 260050         |           | Einbausatz <b>LUC</b> |                                      |
|                  | 1.9 TD (10/14)   | 68         |              | <b>07.96</b> | + ABS        |                |                |           |                       |                                      |
|                  | 2.0 i (10/14)    | 80         |              | <b>06.94</b> | + ABS        |                |                |           |                       |                                      |
|                  | 2.5 D (14)       | 63         |              | <b>02.94</b> | + ABS        |                |                |           |                       |                                      |
|                  | 1.9 TD (10/14)   | 66         | S 15866409   | <b>12.98</b> |              | 24.5112-0466.3 | 330579         | 2         | L=462                 |                                      |
|                  | 1.9 TD (10/14)   | 68         | S 15866409   | <b>07.96</b> |              |                |                |           |                       |                                      |
|                  | 2.0 i (10/14/18) | 80         | S 15866409   | <b>06.94</b> |              |                |                |           |                       |                                      |
|                  | 2.5 D (14/18)    | 63         | S 15866409   | <b>02.94</b> |              |                |                |           |                       |                                      |
|                  | 2.5 TD (14/18)   | 76         | S 15866409   | <b>02.94</b> |              |                |                |           |                       |                                      |
|                  | 2.5 TDi (14/18)  | 79         | S 15866409   | <b>01.97</b> |              |                |                |           |                       |                                      |
|                  | 2.8 HDi (14/18)  |            | S 15866409   | <b>11.00</b> |              |                |                |           |                       |                                      |
|                  | 1.9 TD (10/14)   | 66         | S 15866410   |              | <b>10.01</b> |                | 24.5112-0466.3 | 330579    | 2                     | L=462                                |
|                  | 1.9 TD (10/14)   | 68         | S 15866410   |              | <b>10.01</b> |                |                |           |                       |                                      |
|                  | 2.0 i (10/14/18) | 80         | S 15866410   |              | <b>10.01</b> |                |                |           |                       |                                      |
|                  | 2.5 D (14/18)    | 63         | S 15866410   |              | <b>10.01</b> |                |                |           |                       |                                      |
|                  | 2.5 TD (14/18)   | 76         | S 15866410   |              | <b>10.01</b> |                |                |           |                       |                                      |
| 2.5 TDi (14/18)  | 79               | S 15866410 |              | <b>10.01</b> |              |                |                |           |                       |                                      |
| 2.8 HDi (14/18)  |                  | S 15866410 |              | <b>10.01</b> |              |                |                |           |                       |                                      |
| 1.9 TD (10/14)   | 66               |            | <b>11.01</b> | <b>03.02</b> |              | 83.6401-0471.3 | 330750         | 2         | L=470                 |                                      |
| 1.9 TD (10/14)   | 68               |            | <b>11.01</b> | <b>03.02</b> |              |                |                |           |                       |                                      |
| 2.0 i (10/14/18) | 80               |            | <b>11.01</b> | <b>03.02</b> |              |                |                |           |                       |                                      |
| 2.5 D (14/18)    | 63               |            | <b>11.01</b> | <b>03.02</b> |              |                |                |           |                       |                                      |
| 2.5 TD (14/18)   | 76               |            | <b>11.01</b> | <b>03.02</b> |              |                |                |           |                       |                                      |
| 2.5 TDi (14/18)  | 79               |            | <b>11.01</b> | <b>03.02</b> |              |                |                |           |                       |                                      |
| 2.8 HDi (14/18)  |                  |            | <b>11.01</b> | <b>03.02</b> |              |                |                |           |                       |                                      |
| 2.8 HDi (14/18)  |                  |            | <b>11.01</b> | <b>03.02</b> |              |                |                |           |                       |                                      |
|                  | 1.9 TD (10/14)   | 66         |              | <b>11.01</b> | <b>03.02</b> | 24.3461-1701.5 | 240449         |           | D=46, - Halter        |                                      |
|                  | 1.9 TD (10/14)   | 68         |              | <b>11.01</b> | <b>03.02</b> |                |                |           |                       |                                      |
|                  | 2.0 i (10/14/18) | 80         |              | <b>11.01</b> | <b>03.02</b> | 24.3461-1702.5 | 240450         |           |                       |                                      |
|                  | 2.5 D (14/18)    | 63         |              | <b>11.01</b> | <b>03.02</b> |                |                |           |                       |                                      |
|                  | 2.5 TD (14/18)   | 76         |              | <b>11.01</b> | <b>03.02</b> |                |                |           |                       |                                      |
|                  | 2.5 TD (14/18)   | 76         |              | <b>11.01</b> | <b>03.02</b> |                |                |           |                       |                                      |
|                  | 2.5 TDi (14/18)  | 79         |              | <b>11.01</b> | <b>03.02</b> |                |                |           |                       |                                      |
|                  | 2.8 HDi (14/18)  |            |              | <b>11.01</b> | <b>03.02</b> |                |                |           |                       |                                      |
|                  | 1.9 TD (10/14)   | 66         |              | <b>12.98</b> | <b>10.01</b> | - ABS          | 24.5112-0340.3 | 330511    | 1                     | - verstärktes Fahrwerk <sup>1)</sup> |
|                  | 1.9 TD (10/14)   | 68         |              | <b>07.96</b> | <b>10.01</b> | - ABS          |                |           |                       |                                      |
|                  | 2.0 i (10/14/18) | 80         |              | <b>06.94</b> | <b>10.01</b> | - ABS          |                |           |                       |                                      |
|                  | 2.5 D (14/18)    | 63         |              | <b>02.94</b> | <b>10.01</b> | - ABS          |                |           |                       |                                      |
|                  | 2.5 TD (14/18)   | 76         |              | <b>02.94</b> | <b>10.01</b> | - ABS          |                |           |                       |                                      |
|                  | 2.5 TDi (14/18)  | 79         |              | <b>01.97</b> | <b>10.01</b> | - ABS          |                |           |                       |                                      |
|                  | 2.8 HDi (14/18)  |            |              | <b>11.00</b> | <b>10.01</b> | - ABS          |                |           |                       |                                      |
|                  | 1.9 TD (10/14)   | 66         |              | <b>11.01</b> | <b>03.02</b> | - ABS          | 24.5112-0361.3 | 330649    | 1                     | + verstärktes Fahrwerk <sup>2)</sup> |
|                  | 1.9 TD (10/14)   | 68         |              | <b>11.01</b> | <b>03.02</b> | - ABS          |                |           |                       |                                      |
|                  | 2.0 i (10/14/18) | 80         |              | <b>11.01</b> | <b>03.02</b> | - ABS          |                |           |                       |                                      |
|                  | 2.5 D (14/18)    | 63         |              | <b>11.01</b> | <b>03.02</b> | - ABS          |                |           |                       |                                      |
|                  | 2.5 TD (14/18)   | 76         |              | <b>11.01</b> | <b>03.02</b> | - ABS          |                |           |                       |                                      |
| 2.5 TDi (14/18)  | 79               |            | <b>11.01</b> | <b>03.02</b> | - ABS        |                |                |           |                       |                                      |
|                  | 1.9 TD (10/14)   | 66         |              | <b>11.01</b> | <b>03.02</b> | - ABS          | 24.5112-0361.3 | 330649    | 1                     | + HA-Trommelbremse <sup>3)</sup>     |
|                  | 1.9 TD (10/14)   | 68         |              | <b>11.01</b> | <b>03.02</b> | - ABS          |                |           |                       |                                      |
|                  | 2.0 i (10/14/18) | 80         |              | <b>11.01</b> | <b>03.02</b> | - ABS          | 83.6401-0159.3 | 330746    |                       |                                      |
|                  | 2.5 D (14/18)    | 63         |              | <b>11.01</b> | <b>03.02</b> | - ABS          |                |           |                       |                                      |

1) - reinforced suspension / - sospensione rinforzata / - châssis renforcé / - suspensión reforzada  
 2) + reinforced suspension / + sospensione rinforzata / + châssis renforcé / + suspensión reforzada  
 3) + RA drum brake / + P freno a tamburo / + frein à tambour essieu AR / + ET-tambores de freno  
 4) + RA disc brake / + P disco freno / + frein à disque essieu AR / + ET-disco de freno



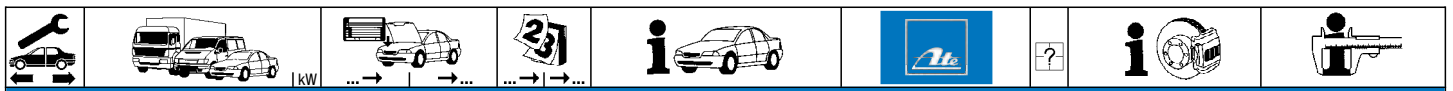

**PEUGEOT BOXER Pritsche/Fahrgestell (94-02)**

|                  |                     |                  |              |              |                    |                       |                       |        |   |          |        |
|------------------|---------------------|------------------|--------------|--------------|--------------------|-----------------------|-----------------------|--------|---|----------|--------|
|                  | 2.5 TD (14/18)      | 76               |              | <b>11.01</b> | <b>03.02</b> - ABS | <b>24.5112-0361.3</b> | 330649                | 1      | + HA-Trommelbremse <sup>1)</sup>            | L=360    |        |
|                  | 2.5 TDi (14/18)     | 79               |              | <b>11.01</b> | <b>03.02</b> - ABS | <b>83.6401-0159.3</b> | 330746                | 2      | + HA-Scheibenbremse <sup>2)</sup>           | L=160    |        |
|                  | 2.8 HDi (14/18)     |                  |              | <b>11.01</b> | <b>03.02</b> - ABS |                       |                       |        |   |          |        |
|                  | 1.9 TD (10/14)      | 66               |              | <b>12.98</b> | <b>10.01</b> + ABS | <b>24.5112-0315.3</b> | 330509                |        | - verstärktes Fahrwerk <sup>3)</sup>        | L=315    |        |
|                  | 1.9 TD (10/14)      | 68               |              | <b>07.96</b> | <b>10.01</b> + ABS | <b>24.5112-0363.3</b> | 330650                |        | + verstärktes Fahrwerk <sup>4)</sup>        | L=360    |        |
|                  | 2.0 i (10/14/18)    | 80               |              | <b>06.94</b> | <b>10.01</b> + ABS |                       |                       |        |   |          |        |
|                  | 2.5 D (14/18)       | 63               |              | <b>02.94</b> | <b>10.01</b> + ABS |                       |                       |        |   |          |        |
|                  | 2.5 TD (14/18)      | 76               |              | <b>02.94</b> | <b>10.01</b> + ABS |                       |                       |        |   |          |        |
|                  | 2.5 TDi (14/18)     | 79               |              | <b>01.97</b> | <b>10.01</b> + ABS |                       |                       |        |   |          |        |
|                  | 2.8 HDi (14/18)     |                  |              | <b>11.00</b> | <b>10.01</b> + ABS |                       |                       |        |   |          |        |
|                  | 1.9 TD (10/14)      | 66               |              | <b>11.01</b> | <b>03.02</b> + ABS | <b>24.5112-0363.3</b> | 330650                |        | + HA-Trommelbremse <sup>1)</sup>            | L=360    |        |
|                  | 1.9 TD (10/14)      | 68               |              | <b>11.01</b> | <b>03.02</b> + ABS | <b>83.6401-0159.3</b> | 330746                | 2      | + HA-Scheibenbremse <sup>2)</sup>           | L=160    |        |
|                  | 2.0 i (10/14/18)    | 80               |              | <b>11.01</b> | <b>03.02</b> + ABS |                       |                       |        |   |          |        |
|                  | 2.5 D (14/18)       | 63               |              | <b>11.01</b> | <b>03.02</b> + ABS |                       |                       |        |   |          |        |
|                  | 2.5 TD (14/18)      | 76               |              | <b>11.01</b> | <b>03.02</b> + ABS |                       |                       |        |   |          |        |
|                  | 2.5 TDi (14/18)     | 79               |              | <b>11.01</b> | <b>03.02</b> + ABS |                       |                       |        |   |          |        |
|                  | 2.8 HDi (14/18)     |                  |              | <b>11.01</b> | <b>03.02</b> + ABS |                       |                       |        |   |          |        |
|                  | 1.9 TD (10/14)      | 66               |              | <b>11.01</b> | <b>03.02</b>       |                       |                       |        |   |          |        |
|                  | 1.9 TD (10/14)      | 68               |              | <b>11.01</b> | <b>03.02</b>       |                       |                       |        |   |          |        |
|                  | 2.0 i (10/14)       | 80               |              | <b>11.01</b> | <b>03.02</b>       |                       |                       |        |   |          |        |
|                  | 2.5 D (14)          | 63               |              | <b>11.01</b> | <b>03.02</b>       |                       |                       |        |   |          |        |
|                  | 2.5 TD (14)         | 76               |              | <b>11.01</b> | <b>03.02</b>       |                       |                       |        |   |          |        |
|                  | 2.5 TDi (14)        | 79               |              | <b>11.01</b> | <b>03.02</b>       |                       |                       |        |   |          |        |
|                  | 2.8 HDi (14)        | 94               |              | <b>11.01</b> | <b>03.02</b>       |                       |                       |        |   |          |        |
|                  | 1.9 TD (10/14)      | 66               |              | <b>11.01</b> | <b>03.02</b>       |                       |                       |        |   |          |        |
|                  | 1.9 TD (10/14)      | 68               |              | <b>11.01</b> | <b>03.02</b>       |                       |                       |        |   |          |        |
|                  | 2.0 i (10/14)       | 80               |              | <b>11.01</b> | <b>03.02</b>       |                       |                       |        |   |          |        |
|                  | 2.5 D (14)          | 63               |              | <b>11.01</b> | <b>03.02</b>       |                       |                       |        |   |          |        |
|                  | 2.5 TD (14)         | 76               |              | <b>11.01</b> | <b>03.02</b>       |                       |                       |        |   |          |        |
|                  | 2.5 TDi (14)        | 79               |              | <b>11.01</b> | <b>03.02</b>       |                       |                       |        |   |          |        |
| 2.8 HDi (14)     | 94                  |                  | <b>11.01</b> | <b>03.02</b> |                    |                       |                       |        |   |          |        |
|                  | 2.0 i (18)          | 80               |              | <b>06.94</b> | <b>10.01</b>       | <b>24.3228-1701.3</b> | 020401                |        |   | Rz 28,57 |        |
|                  | 2.5 D (18)          | 63               |              | <b>02.94</b> | <b>10.01</b>       |                       |                       |        |   |          |        |
|                  | 2.5 TD (18)         | 76               |              | <b>02.94</b> | <b>10.01</b>       |                       |                       |        |   |          |        |
|                  | 2.5 TDi (18)        | 79               |              | <b>01.97</b> | <b>10.01</b>       |                       |                       |        |   |          |        |
|                  | 2.8 HDi (18)        | 94               |              | <b>11.00</b> | <b>10.01</b>       |                       |                       |        |   |          |        |
|                  |                     | 1.9 TD (10/14)   | 66           | S 16158427   | <b>12.98</b>       |                       | <b>24.3727-0340.2</b> | 580340 | 1   |          | L=3025 |
|                  |                     | 1.9 TD (10/14)   | 68           | S 16158427   | <b>07.96</b>       |                       |                       |        |   |          |        |
|                  |                     | 2.0 i (10/14/18) | 80           | S 16158427   | <b>06.94</b>       |                       |                       |        |   |          |        |
|                  |                     | 2.5 D (14/18)    | 63           | S 16158427   | <b>02.94</b>       |                       |                       |        |   |          |        |
|                  |                     | 2.5 TD (14/18)   | 76           | S 16158427   | <b>02.94</b>       |                       |                       |        |   |          |        |
| 2.5 TDi (14/18)  |                     | 79               | S 16158427   | <b>01.97</b> |                    |                       |                       |        |   |          |        |
| 2.8 HDi (14/18)  |                     |                  | S 16158427   | <b>11.00</b> |                    |                       |                       |        |   |          |        |
| 1.9 TD (10/14)   |                     | 66               | S 16158428   |              |                    | <b>24.3727-0344.2</b> | 580344                | 1      |   | L=2806   |        |
| 1.9 TD (10/14)   |                     | 68               | S 16158428   |              |                    |                       |                       |        |   |          |        |
| 2.0 i (10/14/18) |                     | 80               | S 16158428   |              |                    |                       |                       |        |   |          |        |
|                  | 2.5 D (14/18)       | 63               | S 16158428   |              |                    |                       |                       |        |   |          |        |
|                  | 2.5 TD (14/18)      | 76               | S 16158428   |              |                    |                       |                       |        |   |          |        |
|                  | 2.5 TDi (14/18)     | 79               | S 16158428   |              |                    |                       |                       |        |   |          |        |
|                  | 2.8 HDi (14/18)     |                  | S 16158428   |              |                    |                       |                       |        |   |          |        |
|                  | 1.9 TD (10/14)      | 66               | S 16194400   |              | <b>03.02</b>       | <b>24.3727-0343.2</b> | 580343                | 1      | + HA-Trommelbremse <sup>1)</sup>            | L=2827   |        |
|                  | 1.9 TD (10/14)      | 68               | S 16194400   |              | <b>03.02</b>       | <b>24.3727-0348.2</b> | 580348                | 1      | + HA-Scheibenbremse <sup>2)</sup>           | L=2715   |        |
|                  | 2.0 i (10/14/18)    | 80               | S 16194400   |              | <b>03.02</b>       |                       |                       |        |   |          |        |
|                  | 2.5 D (14/18)       | 63               | S 16194400   |              | <b>03.02</b>       |                       |                       |        |   |          |        |
|                  | 2.5 TD (14/18)      | 76               | S 16194400   |              | <b>03.02</b>       |                       |                       |        |   |          |        |
|                  | 2.5 TDi (14/18)     | 79               | S 16194400   |              | <b>03.02</b>       |                       |                       |        |   |          |        |
| 2.8 HDi (14/18)  |                     | S 16194400       |              | <b>03.02</b> |                    |                       |                       |        |   |          |        |
|                  | 2.5 D 4x4 (14/18)   | 63               |              | <b>07.99</b> | <b>03.02</b>       | <b>24.3727-0842.2</b> | 580842                | 1      |   | L=4100   |        |
|                  | 2.5 TDi 4x4 (14/18) | 79               |              | <b>07.99</b> | <b>03.02</b>       |                       |                       |        |   |          |        |
|                  | 1.9 TD (10/14)      | 66               | S 16206244   | <b>12.98</b> |                    | <b>24.6512-1701.3</b> | 320153                |        | - ABS                                       | BRL (2)  |        |
|                  | 1.9 TD (10/14)      | 68               | S 16206244   | <b>07.96</b> |                    |                       |                       |        |   |          |        |
|                  | 2.0 i (10/14/18)    | 80               | S 16206244   | <b>06.94</b> |                    |                       |                       |        |   |          |        |
|                  | 2.5 D (14/18)       | 63               | S 16206244   | <b>02.94</b> |                    |                       |                       |        |   |          |        |
|                  | 2.5 TD (14/18)      | 76               | S 16206244   | <b>02.94</b> |                    |                       |                       |        |   |          |        |
|                  | 2.5 TDi (14/18)     | 79               | S 16206244   | <b>01.97</b> |                    |                       |                       |        |   |          |        |
|                  | 2.8 HDi (14/18)     |                  | S 16206244   | <b>11.00</b> |                    |                       |                       |        |   |          |        |
|                  | 1.9 TD (10/14)      | 66               | S 15445357   | <b>12.98</b> |                    | <b>24.6512-1703.3</b> | 320159                |        | + ABS                                       | BRL (4)  |        |
|                  | 1.9 TD (10/14)      | 68               | S 15445357   | <b>07.96</b> |                    |                       |                       |        |   |          |        |
|                  | 2.0 i (10/14/18)    | 80               | S 15445357   | <b>06.94</b> |                    |                       |                       |        |   |          |        |
|                  | 2.5 D (14/18)       | 63               | S 15445357   | <b>02.94</b> |                    |                       |                       |        |   |          |        |
|                  | 2.5 TD (14/18)      | 76               | S 15445357   | <b>02.94</b> |                    |                       |                       |        |   |          |        |
|                  | 2.5 TDi (14/18)     | 79               | S 15445357   | <b>01.97</b> |                    |                       |                       |        |   |          |        |
|                  | 1.9 TD (10/14)      | 66               | S 16205353   |              | <b>03.02</b>       | <b>24.6512-1712.3</b> | 320273                |        | - ABS/ + verstärktes Fahrwerk <sup>5)</sup> | BRL (2)  |        |
|                  | 1.9 TD (10/14)      | 68               | S 16205353   |              | <b>03.02</b>       |                       |                       |        |   |          |        |
|                  | 2.0 i (10/14)       | 80               | S 16205353   |              | <b>03.02</b>       |                       |                       |        |   |          |        |
|                  | 2.5 D (14)          | 63               | S 16205353   |              | <b>03.02</b>       |                       |                       |        |   |          |        |
|                  | 2.5 TD (14)         | 76               | S 16205353   |              | <b>03.02</b>       |                       |                       |        |   |          |        |
|                  | 2.5 TDi (14)        | 79               | S 16205353   |              | <b>03.02</b>       |                       |                       |        |   |          |        |
|                  | 2.8 HDi (14)        | 94               | S 16205353   |              | <b>03.02</b>       |                       |                       |        |   |          |        |
|                  | 2.0 i (18)          | 80               | S 16205353   |              | <b>03.02</b>       | <b>24.6512-1709.3</b> | 320270                |        | - ABS/ + verstärktes Fahrwerk <sup>5)</sup> | BRL (2)  |        |
|                  | 2.5 D (18)          | 63               | S 16205353   |              | <b>03.02</b>       |                       |                       |        |   |          |        |
|                  | 2.5 TD (18)         | 76               | S 16205353   |              | <b>03.02</b>       |                       |                       |        |   |          |        |
|                  | 2.5 TDi (18)        | 79               | S 16205353   |              | <b>03.02</b>       |                       |                       |        |   |          |        |
| 2.8 HDi (18)     | 94                  | S 16205353       |              | <b>03.02</b> |                    |                       |                       |        |   |          |        |

1) + RA drum brake / + P freno a tamburo / + frein à tambour essieu AR / + ET-tambores de freno  
2) + RA disc brake / + P disco freno / + frein à disque essieu AR / + ET-disco de freno  
3) - reinforced suspension / - sospensione rinforzata / - châssis renforcé / - suspensión reforzada  
4) + reinforced suspension / + sospensione rinforzata / + châssis renforcé / + suspensión reforzada  
5) - ABS/ + reinforced suspension / - ABS/ + sospensione rinforzata / - ABS/ + châssis renforcé / - ABS/ + suspensión reforzada







### PEUGEOT BOXER Pritsche/Fahrgestell (94-02)

|  |                  |    |  |       |       |                               |                |        |  |        |
|--|------------------|----|--|-------|-------|-------------------------------|----------------|--------|--|--------|
|  | 1.9 TD (10/14)   | 66 |  | 12.98 | 03.02 | + ML5-Getriebe <sup>1)</sup>  | 24.3728-0300.2 | 590300 |  | L=1478 |
|  | 1.9 TD (10/14)   | 68 |  | 07.96 | 03.02 | + ML5-Getriebe <sup>1)</sup>  |                |        |  |        |
|  | 1.9 TD (10/14)   | 66 |  | 12.98 | 03.02 | + ME-Getriebe <sup>2)</sup>   | 24.3728-0337.2 | 590337 |  | L=1058 |
|  | 1.9 TD (10/14)   | 68 |  | 07.96 | 03.02 | + ME-Getriebe <sup>2)</sup>   |                |        |  |        |
|  | 2.0 i (10/14/18) | 80 |  | 06.94 | 03.02 | + ME-Getriebe <sup>2)</sup>   |                |        |  |        |
|  | 2.5 D (14/18)    | 63 |  | 02.94 | 03.02 | + ME-Getriebe <sup>2)</sup>   |                |        |  |        |
|  | 2.0 i (10/14/18) | 80 |  | 06.94 | 03.02 | + ML5-Getriebe <sup>1)</sup>  | 24.3728-0335.2 | 590335 |  | L=1435 |
|  | 2.5 D (14/18)    | 63 |  | 02.94 | 03.02 | + ML5-Getriebe <sup>1)</sup>  |                |        |  |        |
|  | 2.8 HDi (14/18)  | 74 |  | 11.00 | 03.02 | + ML5-Getriebe <sup>1)</sup>  |                |        |  |        |
|  | 2.0 i (10/14/18) | 80 |  | 06.94 | 03.02 | + MG5T-Getriebe <sup>3)</sup> | 24.3728-0519.2 | 590519 |  | L=1090 |
|  | 2.5 D (14/18)    | 63 |  | 02.94 | 03.02 | + MG5T-Getriebe <sup>3)</sup> |                |        |  |        |
|  | 2.5 TD (14/18)   | 76 |  | 02.94 | 03.02 | + MG5T-Getriebe <sup>3)</sup> |                |        |  |        |
|  | 2.5 TDi (14/18)  | 79 |  | 01.97 | 03.02 | + MG5T-Getriebe <sup>3)</sup> |                |        |  |        |
|  | 2.8 HDi (14/18)  | 74 |  | 11.00 | 03.02 | + MG5T-Getriebe <sup>3)</sup> |                |        |  |        |

### PEUGEOT BOXER (02-06)

|  |                       |    |            |       |       |   |                |        |                          |                                   |
|--|-----------------------|----|------------|-------|-------|---|----------------|--------|--------------------------|-----------------------------------|
|  | 2.0 HDi (10/14/18)    | 62 |            | 04.02 | 03.06 |   | 24.2125-1725.3 | 010717 | - ABS                    | Thz 25,40                         |
|  | 2.0 i (10/14/18)      | 81 |            | 04.02 | 03.06 |   | 24.2125-1726.3 | 010718 | + ABS                    | Thz 25,40                         |
|  | 2.2 HDi (10/14/18)    | 74 |            | 04.02 | 03.06 |   |                |        |                          |                                   |
|  | 2.8 HDi (10/14/18)    | 74 |            | 04.02 | 03.06 |   |                |        |                          |                                   |
|  | 2.0 HDi (10/14/18)    | 62 |            | 04.02 | 03.06 |   | 83.6401-0471.3 | 330750 |                          | L=470                             |
|  | 2.0 i (10/14/18)      | 81 |            | 04.02 | 03.06 |   | 83.6401-0469.3 | 330749 |                          | L=468                             |
|  | 2.2 HDi (10/14/18)    | 74 |            | 04.02 | 03.06 |   |                |        |                          |                                   |
|  | 2.8 HDi (10/14/18)    | 74 |            | 04.02 | 03.06 |   |                |        |                          |                                   |
|  | 2.0 HDi (10/14/18)    | 62 |            | 04.02 | 03.06 |   | 24.3461-1701.5 | 240449 | <input type="checkbox"/> | D=46, - Halter                    |
|  | 2.0 i (10/14/18)      | 81 |            | 04.02 | 03.06 |   | 24.3461-1702.5 | 240450 | <input type="checkbox"/> | D=46, - Halter                    |
|  | 2.2 HDi (10/14/18)    | 74 |            | 04.02 | 03.06 |   |                |        |                          |                                   |
|  | 2.8 HDi (10/14/18)    | 74 |            | 04.02 | 03.06 |   |                |        |                          |                                   |
|  | 2.0 HDi (10/14/18)    | 62 |            | 04.02 | 03.06 | - ABS                                       | 24.5112-0361.3 | 330649 | 1                        | + HA-Trommelbremse <sup>4)</sup>  |
|  | 2.0 i (10/14/18)      | 81 |            | 04.02 | 03.06 | - ABS                                       | 83.6401-0159.3 | 330746 | 2                        | + HA-Scheibenbremse <sup>5)</sup> |
|  | 2.2 HDi (10/14/18)    | 74 |            | 04.02 | 03.06 | - ABS                                       |                |        |                          |                                   |
|  | 2.8 HDi (10/14/18)    | 74 |            | 04.02 | 03.06 | - ABS                                       |                |        |                          |                                   |
|  | 2.0 HDi (10/14/18)    | 62 |            | 04.02 | 03.06 | + ABS                                       | 24.5112-0363.3 | 330650 | <input type="checkbox"/> | + HA-Trommelbremse <sup>4)</sup>  |
|  | 2.0 i (10/14/18)      | 81 |            | 04.02 | 03.06 | + ABS                                       | 83.6401-0159.3 | 330746 | 2                        | + HA-Scheibenbremse <sup>5)</sup> |
|  | 2.2 HDi (10/14/18)    | 74 |            | 04.02 | 03.06 | + ABS                                       |                |        |                          |                                   |
|  | 2.8 HDi (10/14/18)    | 74 |            | 04.02 | 03.06 | + ABS                                       |                |        |                          |                                   |
|  | 2.0 HDi (10/14)       | 62 |            | 04.02 | 03.06 |   | 24.3226-1702.3 | 020469 |                          | Rz 26,99                          |
|  | 2.0 i (10/14)         | 81 |            | 04.02 | 03.06 |   |                |        |                          |                                   |
|  | 2.2 HDi (10/14)       | 74 |            | 04.02 | 03.06 |   |                |        |                          |                                   |
|  | 2.8 HDi (10/14)       | 74 |            | 04.02 | 03.06 |   |                |        |                          |                                   |
|  | 2.0 HDi (10/14/18)    | 62 |            | 04.02 | 03.06 |   | 24.3727-0300.2 | 580300 | 1                        | L=1078                            |
|  | 2.0 i (10/14/18)      | 81 |            | 04.02 | 03.06 |   | 24.3727-0343.2 | 580343 | 1                        | L=2827                            |
|  | 2.2 HDi (10/14/18)    | 74 |            | 04.02 | 03.06 |   |                |        |                          |                                   |
|  | 2.8 HDi (10/14/18)    | 74 |            | 04.02 | 03.06 |   |                |        |                          |                                   |
|  | 2.0 HDi (10/14/18)    | 62 | S 17103012 | 04.02 |       |   | 24.3727-0300.2 | 580300 | 1                        | L=1078                            |
|  | 2.0 i (10/14/18)      | 81 | S 17103012 | 04.02 |       |   | 24.3727-0348.2 | 580348 | 1                        | L=2715                            |
|  | 2.2 HDi (10/14/18)    | 74 | S 17103012 | 04.02 |       |   |                |        |                          |                                   |
|  | 2.8 HDi (10/14/18)    | 74 | S 17103012 | 04.02 |       |   |                |        |                          |                                   |
|  | 2.0 HDi (10/14/18)    | 62 | S 17103013 |       | 03.06 |   | 24.3727-0300.2 | 580300 | 1                        | L=1078                            |
|  | 2.0 i (10/14/18)      | 81 | S 17103013 |       | 03.06 |   |                |        |                          |                                   |
|  | 2.2 HDi (10/14/18)    | 74 | S 17103013 |       | 03.06 |   |                |        |                          |                                   |
|  | 2.8 HDi (10/14/18)    | 74 | S 17103013 |       | 03.06 |   |                |        |                          |                                   |
|  | 2.8 HDi 4x4(10/14/18) |    | S 17103012 | 04.02 |       |   | 24.3727-0562.2 | 580562 | 1                        | L=1059                            |
|  | 2.8 HDi 4x4(10/14/18) |    | S 17103012 | 04.02 |       |   | 24.3727-0348.2 | 580348 | 1                        | L=2715                            |
|  | 2.8 HDi 4x4(10/14/18) |    | S 17103013 |       | 03.06 |   | 24.3727-0562.2 | 580562 | 1                        | L=1059                            |
|  | 2.8 HDi 4x4(10/14/18) |    | S 17103013 |       | 03.06 |   |                |        |                          |                                   |
|  | 2.0 HDi (10/14)       | 62 |            | 04.02 | 03.06 | - ABS/ + verstärktes Fahrwerk <sup>6)</sup> | 24.6512-1712.3 | 320273 |                          | BRL (2)                           |
|  | 2.0 HDi (10/14)       | 62 |            | 04.02 | 03.06 | - ABS/ + verstärktes Fahrwerk <sup>6)</sup> |                |        |                          |                                   |
|  | 2.0 HDi (10/14)       | 62 |            | 04.02 | 03.06 | - ABS/ + verstärktes Fahrwerk <sup>6)</sup> |                |        |                          |                                   |
|  | 2.8 HDi (10/14)       | 62 |            | 04.02 | 03.06 | - ABS/ + verstärktes Fahrwerk <sup>6)</sup> |                |        |                          |                                   |
|  | 2.0 HDi (18)          | 62 |            | 04.02 | 03.06 | - ABS/ + verstärktes Fahrwerk <sup>6)</sup> | 24.6512-1709.3 | 320270 |                          | BRL (2)                           |
|  | 2.0 i (18)            | 81 |            | 04.02 | 03.06 | - ABS/ + verstärktes Fahrwerk <sup>6)</sup> |                |        |                          |                                   |
|  | 2.2 HDi (18)          | 74 |            | 04.02 | 03.06 | - ABS/ + verstärktes Fahrwerk <sup>6)</sup> |                |        |                          |                                   |
|  | 2.8 HDi (18)          | 74 |            | 04.02 | 03.06 | - ABS/ + verstärktes Fahrwerk <sup>6)</sup> |                |        |                          |                                   |
|  | 2.8 HDi 4x4(10/14/18) |    |            | 04.02 | 03.06 | - ABS/ + verstärktes Fahrwerk <sup>6)</sup> | 24.6512-1701.3 | 320153 | - ABS                    | BRL (2)                           |
|  | 2.8 HDi 4x4(10/14/18) |    |            | 04.02 | 03.06 | - ABS/ + verstärktes Fahrwerk <sup>6)</sup> | 24.6512-1703.3 | 320159 | + ABS                    | BRL (4)                           |

### PEUGEOT BOXER (06-)

|             |             |     |       |       |                                |                                |                |        |       |                          |
|-------------|-------------|-----|-------|-------|--------------------------------|--------------------------------|----------------|--------|-------|--------------------------|
|             | 2.2 HDi 100 | 74  |       | 04.06 |                                | Nutzlast 120/140 <sup>7)</sup> | 24.4125-1702.3 | 010872 | - DSC | Thz 25,40 + Behälter BOS |
|             | 2.2 HDi 110 | 81  |       | 03.11 |                                | Nutzlast 120/140 <sup>7)</sup> | 24.4126-1701.3 | 010868 | + DSC | Thz 26,99 + Behälter BOS |
|             | 2.2 HDi 120 | 88  |       | 04.06 |                                | Nutzlast 120/140 <sup>7)</sup> |                |        |       |                          |
|             | 2.2 HDi 130 | 96  |       | 03.11 |                                | Nutzlast 120/140 <sup>7)</sup> |                |        |       |                          |
|             | 2.2 HDi 150 | 110 |       | 03.11 |                                | Nutzlast 120/140 <sup>7)</sup> |                |        |       |                          |
|             | 3.0 HDi 145 | 107 |       | 04.10 |                                | Nutzlast 120/140 <sup>7)</sup> |                |        |       |                          |
|             | 3.0 HDi 160 | 116 |       | 04.06 |                                | Nutzlast 120/140 <sup>7)</sup> |                |        |       |                          |
|             | 3.0 HDi 175 | 130 |       | 03.11 |                                | Nutzlast 120/140 <sup>7)</sup> |                |        |       |                          |
|             | 2.2 HDi 100 | 74  |       | 04.06 |                                | Nutzlast 160/200 <sup>8)</sup> | 24.4125-1701.3 | 010867 | + DSC | Thz 25,40 + Behälter BOS |
|             | 2.2 HDi 110 | 81  |       | 03.11 |                                | Nutzlast 160/200 <sup>8)</sup> |                |        |       |                          |
| 2.2 HDi 120 | 88          |     | 04.06 |       | Nutzlast 160/200 <sup>8)</sup> |                                |                |        |       |                          |
| 2.2 HDi 130 | 96          |     | 03.11 |       | Nutzlast 160/200 <sup>8)</sup> |                                |                |        |       |                          |
| 2.2 HDi 150 | 110         |     | 03.11 |       | Nutzlast 160/200 <sup>8)</sup> |                                |                |        |       |                          |
| 3.0 HDi 145 | 107         |     | 04.10 |       | Nutzlast 160/200 <sup>8)</sup> |                                |                |        |       |                          |
| 3.0 HDi 160 | 116         |     | 04.06 |       | Nutzlast 160/200 <sup>8)</sup> |                                |                |        |       |                          |
| 3.0 HDi 175 | 130         |     | 03.11 |       | Nutzlast 160/200 <sup>8)</sup> |                                |                |        |       |                          |

<sup>1)</sup> + ML5 transmission / + scatola cambio ML5 / + boîte de vitesse ML5 / + cambio ML5

<sup>2)</sup> + ME transmission / + scatola cambio ME / + boîte de vitesse ME / + cambio ME

<sup>3)</sup> + MG5T transmission / + scatola cambio MG5T / + boîte de vitesse MG5T / + cambio MG5T

<sup>4)</sup> + RA drum brake / + P freno a tamburo / + frein à tambour essieu AR / + ET-tambores de freno

<sup>5)</sup> + RA disc brake / + P disco freno / + frein à disque essieu AR / + ET-disco de freno

<sup>6)</sup> - ABS/ + reinforced suspension / - ABS/ + sospensione rinforzata / - ABS/ + châssis renforcé / - ABS/ + suspensión reforzada

<sup>7)</sup> payload 120/140 / carico utile 120/140 / charge utile 120/140 / carga útil 120/140

<sup>8)</sup> payload 160/200 / carico utile 160/200 / charge utile 160/200 / carga útil 160/200



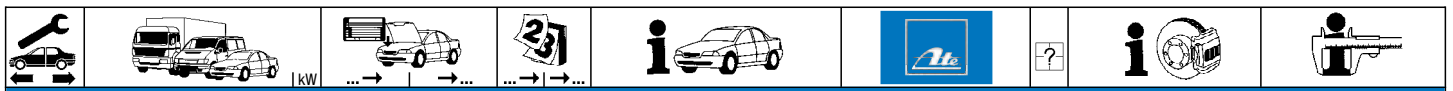

**PEUGEOT BOXER (06-)**





























|  |             |     |  |       |                |        |   |                                 |       |
|--|-------------|-----|--|-------|----------------|--------|---|---------------------------------|-------|
|  | 2.2 HDi 100 | 74  |  | 04.06 | 24.5112-0492.3 | 331217 | 2 |                                 | L=492 |
|  | 2.2 HDi 110 | 81  |  | 03.11 |                |        |   |                                 |       |
|  | 2.2 HDi 120 | 88  |  | 04.06 |                |        |   |                                 |       |
|  | 2.2 HDi 130 | 96  |  | 03.11 |                |        |   |                                 |       |
|  | 2.2 HDi 150 | 110 |  | 03.11 |                |        |   |                                 |       |
|  | 3.0 HDi 145 | 107 |  | 04.10 |                |        |   |                                 |       |
|  | 3.0 HDi 160 | 116 |  | 04.06 |                |        |   |                                 |       |
|  | 3.0 HDi 175 | 130 |  | 03.11 |                |        |   |                                 |       |
|  | 2.2 HDi 100 | 74  |  | 04.06 | 83.7101-9414.3 | 330905 | 2 | + kurzer Radstand <sup>1)</sup> | L=414 |
|  | 2.2 HDi 110 | 81  |  | 03.11 |                |        |   |                                 |       |
|  | 2.2 HDi 120 | 88  |  | 04.06 |                |        |   |                                 |       |
|  | 2.2 HDi 130 | 96  |  | 03.11 |                |        |   |                                 |       |
|  | 2.2 HDi 150 | 110 |  | 03.11 |                |        |   |                                 |       |
|  | 3.0 HDi 145 | 107 |  | 04.10 |                |        |   |                                 |       |
|  | 3.0 HDi 160 | 116 |  | 04.06 |                |        |   |                                 |       |
|  | 3.0 HDi 175 | 130 |  | 03.11 |                |        |   |                                 |       |

**PEUGEOT EXPERT Kombi (95-06)**

|         |         |            |            |            |                |        |   |                                 |                |                |                |        |                |  |       |
|---------|---------|------------|------------|------------|----------------|--------|---|---------------------------------|----------------|----------------|----------------|--------|----------------|--|-------|
|         | 1.6     | 58         | ORGA 08206 | 10.95      | 24.2122-1703.3 | 010422 |   | - ABS/ + 0,8 t                  | THz 22,20      |                |                |        |                |  |       |
|         | 1.8     | 74         | ORGA 08206 | 10.96      |                |        |   |                                 |                |                |                |        |                |  |       |
|         | 1.9 D   | 51         | ORGA 08206 | 10.95      |                |        |   |                                 |                |                |                |        |                |  |       |
|         | 1.9 TD  | 66         | ORGA 08206 | 10.95      |                |        |   |                                 |                |                |                |        |                |  |       |
|         | 1.9 TD  | 68         | ORGA 08206 | 04.96      |                |        |   |                                 |                |                |                |        |                |  |       |
|         | 1.9 TD  | 68         | ORGA 08206 | 04.96      |                |        |   |                                 |                |                |                |        |                |  |       |
|         | 1.6     | 58         | ORGA 08207 | 12.06      | 24.2122-1741.3 | 010695 |   | - ABS/ + 0,8 t                  | THz 22,20      |                |                |        |                |  |       |
|         | 1.8     | 74         | ORGA 08207 | 12.06      |                |        |   |                                 |                |                |                |        |                |  |       |
|         | 1.9 D   | 51         | ORGA 08207 | 12.06      |                |        |   |                                 |                |                |                |        |                |  |       |
|         | 1.9 TD  | 66         | ORGA 08207 | 12.06      |                |        |   |                                 |                |                |                |        |                |  |       |
|         | 1.9 TD  | 68         | ORGA 08207 | 12.06      |                |        |   |                                 |                |                |                |        |                |  |       |
|         | 1.9 TD  | 68         | ORGA 08207 | 12.06      |                |        |   |                                 |                |                |                |        |                |  |       |
|         | 2.0 16V | 100        |            | 07.00      | 24.2123-1738.3 | 010658 |   | - ABS                           | THz 23,81      |                |                |        |                |  |       |
|         | 2.0 HDi | 69         |            | 07.00      |                |        |   |                                 |                |                |                |        |                |  |       |
|         | 2.0 HDi | 80         |            | 07.00      |                |        |   |                                 |                |                |                |        |                |  |       |
|         | 1.6     | 58         | ORGA 09792 | 10.95      | 24.3571-1709.5 | 240153 |   |                                 | D=57, - Halter |                |                |        |                |  |       |
|         | 1.8     | 74         | ORGA 09792 | 10.96      |                |        |   |                                 |                |                |                |        |                |  |       |
|         | 1.9 D   | 51         | ORGA 09155 | 10.95      |                |        |   |                                 |                |                |                |        |                |  |       |
|         | 1.9 TD  | 66         | ORGA 09792 | 10.95      |                |        |   |                                 |                |                |                |        |                |  |       |
|         | 1.9 TD  | 68         | ORGA 09792 | 04.96      |                |        |   |                                 |                |                |                |        |                |  |       |
|         | 2.0 16V | 100        | ORGA 09792 | 07.00      |                |        |   |                                 |                |                |                |        |                |  |       |
|         | 2.0 HDi | 69         | ORGA 09792 | 07.00      |                |        |   |                                 |                |                |                |        |                |  |       |
|         | 2.0 HDi | 80         | ORGA 09792 | 07.00      |                |        |   |                                 |                |                |                |        |                |  |       |
|         | 1.9 D   | 51         | ORGA 09156 | 12.06      |                |        |   |                                 |                | 24.3571-1711.5 | 240159         |        | D=57, - Halter |  |       |
|         | 1.9 D   | 51         | ORGA 09156 | 12.06      |                |        |   |                                 |                |                |                |        |                |  |       |
|         | 1.6     | 58         | ORGA 09793 | 12.06      | 24.3601-1711.7 | 220607 |   |                                 | D=60, - Halter |                |                |        |                |  |       |
|         | 1.8     | 74         | ORGA 09793 | 12.06      |                |        |   |                                 |                |                |                |        |                |  |       |
|         | 1.9 TD  | 66         | ORGA 09793 | 12.06      |                |        |   |                                 |                |                |                |        |                |  |       |
|         | 1.9 TD  | 68         | ORGA 09793 | 12.06      |                |        |   |                                 |                |                |                |        |                |  |       |
|         | 2.0 16V | 100        | ORGA 09793 | 12.06      |                |        |   |                                 |                |                |                |        |                |  |       |
|         | 2.0 HDi | 69         | ORGA 09793 | 12.06      |                |        |   |                                 |                |                |                |        |                |  |       |
| 2.0 HDi | 80      | ORGA 09793 | 12.06      |            |                |        |   |                                 |                |                |                |        |                |  |       |
|         | 1.6     | 58         | ORGA 09792 | 10.95      | 24.5118-0471.3 | 330528 | 2 |                                 | L=473          |                |                |        |                |  |       |
|         | 1.8     | 74         | ORGA 09792 | 10.96      |                |        |   |                                 |                |                |                |        |                |  |       |
|         | 1.9 D   | 51         | ORGA 09792 | 10.95      |                |        |   |                                 |                |                |                |        |                |  |       |
|         | 1.9 TD  | 66         | ORGA 09792 | 10.95      |                |        |   |                                 |                |                |                |        |                |  |       |
|         | 1.9 TD  | 68         | ORGA 09792 | 04.96      |                |        |   |                                 |                |                |                |        |                |  |       |
|         | 2.0 16V | 100        | ORGA 09792 | 07.00      |                |        |   |                                 |                |                |                |        |                |  |       |
|         | 2.0 HDi | 69         | ORGA 09792 | 07.00      |                |        |   |                                 |                |                |                |        |                |  |       |
|         | 2.0 HDi | 80         | ORGA 09792 | 07.00      |                |        |   |                                 |                |                |                |        |                |  |       |
|         |         | 1.6        | 58         | ORGA 09793 |                |        |   |                                 |                | 12.06          | 24.5111-0462.3 | 330555 | 2              |  | L=460 |
|         |         | 1.8        | 74         | ORGA 09793 |                |        |   |                                 |                | 12.06          |                |        |                |  |       |
| 1.9 D   |         | 51         | ORGA 09793 | 12.06      |                |        |   |                                 |                |                |                |        |                |  |       |
| 1.9 TD  |         | 66         | ORGA 09793 | 12.06      |                |        |   |                                 |                |                |                |        |                |  |       |
| 1.9 TD  |         | 68         | ORGA 09793 | 12.06      |                |        |   |                                 |                |                |                |        |                |  |       |
| 2.0 16V |         | 100        | ORGA 09793 | 12.06      |                |        |   |                                 |                |                |                |        |                |  |       |
| 2.0 HDi |         | 69         | ORGA 09793 | 12.06      |                |        |   |                                 |                |                |                |        |                |  |       |
| 2.0 HDi |         | 80         | ORGA 09793 | 12.06      |                |        |   |                                 |                |                |                |        |                |  |       |
|         | 1.6     | 58         |            | 10.95      | 24.5229-0251.3 | 330535 | 2 |                                 | L=250          |                |                |        |                |  |       |
|         | 1.8     | 74         |            | 10.96      |                |        |   |                                 |                |                |                |        |                |  |       |
|         | 1.9 D   | 51         |            | 10.95      |                |        |   |                                 |                |                |                |        |                |  |       |
|         | 1.9 TD  | 66         |            | 10.95      |                |        |   |                                 |                |                |                |        |                |  |       |
|         | 1.9 TD  | 68         |            | 04.96      |                |        |   |                                 |                |                |                |        |                |  |       |
|         | 2.0 16V | 100        |            | 07.00      |                |        |   |                                 |                |                |                |        |                |  |       |
|         | 2.0 HDi | 69         |            | 07.00      |                |        |   |                                 |                |                |                |        |                |  |       |
|         | 2.0 HDi | 80         |            | 07.00      |                |        |   |                                 |                |                |                |        |                |  |       |
|         | 1.6     | 58         |            | 10.95      | 24.3219-1704.3 | 020374 |   |                                 | Rz 19,05       |                |                |        |                |  |       |
|         | 1.8     | 74         |            | 10.96      |                |        |   |                                 |                |                |                |        |                |  |       |
|         | 1.9 D   | 51         |            | 10.95      |                |        |   |                                 |                |                |                |        |                |  |       |
|         | 1.9 TD  | 66         |            | 10.95      |                |        |   |                                 |                |                |                |        |                |  |       |
|         | 1.9 TD  | 68         |            | 04.96      |                |        |   |                                 |                |                |                |        |                |  |       |
|         | 2.0 16V | 100        |            | 07.00      |                |        |   |                                 |                |                |                |        |                |  |       |
|         | 2.0 HDi | 69         |            | 07.00      |                |        |   |                                 |                |                |                |        |                |  |       |
|         | 2.0 HDi | 80         |            | 07.00      |                |        |   |                                 |                |                |                |        |                |  |       |
|         | 1.6     | 58         |            | 10.95      | 24.3727-0336.2 | 580336 | 1 | - langer Radstand <sup>3)</sup> | L=500          |                |                |        |                |  |       |
|         | 1.8     | 74         |            | 10.96      |                |        |   |                                 |                |                |                |        |                |  |       |
|         | 1.9 D   | 51         |            | 10.95      |                |        |   |                                 |                |                |                |        |                |  |       |
|         | 1.9 TD  | 66         |            | 10.95      |                |        |   |                                 |                |                |                |        |                |  |       |
|         | 1.9 TD  | 68         |            | 04.96      |                |        |   |                                 |                |                |                |        |                |  |       |
|         | 2.0 16V | 100        |            | 07.00      |                |        |   |                                 |                |                |                |        |                |  |       |

1) + short wheel base / + passo lungo / + empattement court / + distancia corta entre ejes  
 2) + long wheel base / + passo lungo / + empattement long / + distancia larga entre ejes  
 3) - long wheel base / - passo lungo / - empattement long / - distancia larga entre ejes



|     |  |  |  |  |  |  |                              |    |                               |
|--|--|--|--|--|---|--|--|--|-------------------------------|
| <b>PEUGEOT EXPERT Kombi (95-06)</b>  |  |  |  |  |   |  |  |  |                               |
|    | 2.0 HDi  | 69   |  | 07.00  | 12.06   | 24.3727-0336.2   | 580336   | 1  - langer Radstand <sup>1)</sup>                        | L=500                         |
|  | 2.0 HDi  | 80   |  | 07.00  | 12.06   | 24.3727-0341.2   | 580341   | 1  + langer Radstand <sup>2)</sup>                        | L=900                         |
|  |  |  |  |  |   | 24.3727-0532.2   | 580532   | <input type="checkbox"/>  - langer Radstand <sup>2)</sup> | L=1063                        |
|  |  |  |  |  |   | 24.3727-0531.2   | 580531   | <input type="checkbox"/>                                  | L=2286                        |
|  | 1.6  | 58   |  | 10.95  | 12.06   | 24.3727-0336.2   | 580336   | 1  - langer Radstand <sup>1)</sup>                        | L=500                         |
|  | 1.8  | 74   |  | 10.96  | 12.06   | 24.3727-0341.2   | 580341   | 1  + langer Radstand <sup>2)</sup>                        | L=900                         |
|  | 1.9 D  | 51   |  | 10.95  | 12.06   | 24.3727-0532.2   | 580532   | <input type="checkbox"/>                                  | L=1063                        |
|  | 1.9 TD   | 66   |  | 10.95  | 12.06   |  |  |  |                               |
|  | 1.9 TD   | 68   |  | 04.96  | 12.06   |  |  |  |                               |
| 2.0 16V  | 100  |  | 07.00  | 12.06  |   |  |  |  |                               |
| 2.0 HDi  | 69   |  | 07.00  | 12.06  |   |  |  |  |                               |
| 2.0 HDi  | 80   |  | 07.00  | 12.06  |   |  |  |  |                               |
|    | 1.6  | 58   | ORGA 08420   | 10.95  | 12.06   | 24.6582-1715.3   | 320205   |  | BRL (4)                       |
|  | 1.6  | 58   |  | 10.95  | 12.06   |  |  |  |                               |
|  | 1.8  | 74   | ORGA 08420   | 10.96  | 12.06   |  |  |  |                               |
|  | 1.8  | 74   |  | 10.96  | 12.06   |  |  |  |                               |
|  | 1.9 D  | 51   | ORGA 08420   | 10.95  | 12.06   |  |  |  |                               |
|  | 1.9 D  | 51   |  | 10.95  | 12.06   |  |  |  |                               |
|  | 1.9 TD   | 66   | ORGA 08420   | 10.95  | 12.06   |  |  |  |                               |
|  | 1.9 TD   | 66   |  | 10.95  | 12.06   |  |  |  |                               |
|  | 1.9 TD   | 68   | ORGA 08420   | 04.96  | 12.06   |  |  |  |                               |
| 1.9 TD   | 68   |  | 04.96  | 12.06  |   |  |  |  |                               |
|    | 1.6  | 58   |  | 10.95  | 12.06   | 24.3728-0341.2   | 590341   |  | L=738, + AUT                  |
|  | 1.8  | 74   |  | 10.96  | 12.06   |  |  |  |                               |
|  | 1.9 D  | 51   |  | 10.95  | 12.06   | 24.3728-0336.2   | 590336   |  | L=973, + AUT                  |
|  | 2.0 16V  | 100  |  | 07.00  | 12.06   |  |  |  | + BE4-Getriebe <sup>3)</sup>  |
|  | 1.9 TD   | 66   |  | 10.95  | 12.06   | 24.3728-0342.2   | 590342   |  | + ME5K-Getriebe <sup>4)</sup> |
|  | 1.9 TD   | 68   |  | 04.96  | 12.06   | 24.3728-0340.2   | 590340   |  | + ML5T-Getriebe <sup>5)</sup> |
|  | 2.0 HDi  | 69   |  | 07.00  | 12.06   | 24.3728-0333.2   | 590333   |  | L=1003, + AUT                 |
| 2.0 HDi  | 80   |  | 07.00  | 12.06  |   |  |  |  |                               |
| <b>PEUGEOT EXPERT Kasten (95-06)</b>   |  |  |  |  |   |  |  |  |                               |
|    | 1.6  | 58   | ORGA 08206   | 10.95  | 12.06   | 24.2122-1703.3   | 010422   |  | - ABS/ + 0,8 t                |
|  | 1.8  | 74   | ORGA 08206   | 10.96  | 12.06   | 24.2122-1708.3   | 010437   |  | + ABS/ + 0,8 t                |
|  | 1.9 D  | 51   | ORGA 08206   | 10.95  | 12.06   | 24.2123-1707.3   | 010492   |  | - ABS/ + 0,9 t                |
|  | 1.9 TD   | 66   | ORGA 08206   | 10.95  | 12.06   | 24.2123-1708.3   | 010493   |  | + ABS/ + 0,9 t                |
|  | 1.9 TD   | 68   | ORGA 08206   | 04.96  | 12.06   |  |  |  |                               |
|  | 1.6  | 58   | ORGA 08207   |  | 12.06   | 24.2122-1741.3   | 010695   |  | - ABS/ + 0,8 t                |
|  | 1.8  | 74   | ORGA 08207   |  | 12.06   | 24.2122-1742.3   | 010696   |  | + ABS/ + 0,8 t                |
|  | 1.9 D  | 51   | ORGA 08207   |  | 12.06   | 24.2123-1738.3   | 010658   |  | - ABS/ + 0,9 t                |
|  | 1.9 TD   | 66   | ORGA 08207   |  | 12.06   | 24.2123-1733.3   | 010657   |  | + ABS/ + 0,9 t                |
|  | 1.9 TD   | 68   | ORGA 08207   |  | 12.06   |  |  |  |                               |
| 2.0 16V  | 100  |  | 07.00  | 12.06  | 24.2123-1738.3  | 010658   |  | - ABS  |                               |
| 2.0 HDi  | 69   |  | 07.00  | 12.06  | 24.2123-1733.3  | 010657   |  | + ABS  |                               |
| 2.0 HDi  | 80   |  | 07.00  | 12.06  |   |  |  |  |                               |
|  | 1.6  | 58   | ORGA 09792   | 10.95  | 12.06   | 24.3571-1709.5   | 240153   | <input type="checkbox"/>                                | D=57, - Halter                |
|  | 1.8  | 74   | ORGA 09792   | 10.96  | 12.06   | 24.3571-1710.5   | 240154   | <input type="checkbox"/>                                | LUC                           |
|  | 1.9 D  | 51   | ORGA 09155   | 10.95  | 12.06   |  |  |  |                               |
|  | 1.9 TD   | 66   | ORGA 09792   | 10.95  | 12.06   |  |  |  |                               |
|  | 1.9 TD   | 68   | ORGA 09792   | 04.96  | 12.06   |  |  |  |                               |
|  | 2.0 16V  | 100  | ORGA 09792   | 07.00  | 12.06   |  |  |  |                               |
|  | 2.0 HDi  | 69   | ORGA 09792   | 07.00  | 12.06   |  |  |  |                               |
|  | 2.0 HDi  | 80   | ORGA 09792   | 07.00  | 12.06   |  |  |  |                               |
|  | 1.9 D  | 51   | ORGA 09156   |  | 12.06   | 24.3571-1711.5   | 240159   | <input type="checkbox"/>                                | D=57, - Halter                |
|  |  |  |  |  |   | 24.3571-1712.5   | 240160   | <input type="checkbox"/>                                | BDX                           |
| 1.6  | 58   | ORGA 09793   |  | 12.06  | 24.3601-1711.7  | 220607   | <input type="checkbox"/>  | D=60, - Halter   |                               |
| 1.8  | 74   | ORGA 09793   |  | 12.06  | 24.3601-1712.7  | 220608   | <input type="checkbox"/>  | LUC  |                               |
| 1.9 TD   | 66   | ORGA 09793   |  | 12.06  |   |  |  |  |                               |
| 1.9 TD   | 68   | ORGA 09793   |  | 12.06  |   |  |  |  |                               |
| 2.0 16V  | 100  | ORGA 09793   |  | 12.06  |   |  |  |  |                               |
| 2.0 HDi  | 69   | ORGA 09793   |  | 12.06  |   |  |  |  |                               |
| 2.0 HDi  | 80   | ORGA 09793   |  | 12.06  |   |  |  |  |                               |
|  | 1.6  | 58   | ORGA 09792   | 10.95  | 12.06   | 24.5118-0471.3   | 330528   | 2  | L=473                         |
|  | 1.8  | 74   | ORGA 09792   | 10.96  | 12.06   |  |  |  |                               |
|  | 1.9 D  | 51   | ORGA 09792   | 10.95  | 12.06   |  |  |  |                               |
|  | 1.9 TD   | 66   | ORGA 09792   | 10.95  | 12.06   |  |  |  |                               |
|  | 1.9 TD   | 68   | ORGA 09792   | 04.96  | 12.06   |  |  |  |                               |
|  | 2.0 16V  | 100  | ORGA 09792   | 07.00  | 12.06   |  |  |  |                               |
|  | 2.0 HDi  | 69   | ORGA 09792   | 07.00  | 12.06   |  |  |  |                               |
|  | 2.0 HDi  | 80   | ORGA 09792   | 07.00  | 12.06   |  |  |  |                               |
|  | 1.6  | 58   | ORGA 09793   |  | 12.06   | 24.5111-0462.3   | 330555   | 2  | L=460                         |
|  | 1.8  | 74   | ORGA 09793   |  | 12.06   |  |  |  |                               |
| 1.9 D  | 51   | ORGA 09793   |  | 12.06  |   |  |  |  |                               |
| 1.9 TD   | 66   | ORGA 09793   |  | 12.06  |   |  |  |  |                               |
| 1.9 TD   | 68   | ORGA 09793   |  | 12.06  |   |  |  |  |                               |
| 2.0 16V  | 100  | ORGA 09793   |  | 12.06  |   |  |  |  |                               |
| 2.0 HDi  | 69   | ORGA 09793   |  | 12.06  |   |  |  |  |                               |
| 2.0 HDi  | 80   | ORGA 09793   |  | 12.06  |   |  |  |  |                               |
|  | 1.6  | 58   |  | 10.95  | 12.06   | 24.5229-0251.3   | 330535   | 2  | L=250                         |
|  | 1.8  | 74   |  | 10.96  | 12.06   |  |  |  |                               |
|  | 1.9 D  | 51   |  | 10.95  | 12.06   |  |  |  |                               |
|  | 1.9 TD   | 66   |  | 10.95  | 12.06   |  |  |  |                               |
|  | 1.9 TD   | 68   |  | 04.96  | 12.06   |  |  |  |                               |
|  | 2.0 16V  | 100  |  | 07.00  | 12.06   |  |  |  |                               |
|  | 2.0 HDi  | 69   |  | 07.00  | 12.06   |  |  |  |                               |

<sup>1)</sup> - long wheel base / - passo lungo / - empattement long / - distancia larga entre ejes  
<sup>2)</sup> + long wheel base / + passo lungo / + empattement long / + distancia larga entre ejes  
<sup>3)</sup> + BE4 transmission / + scatola cambio BE4 / + boîte de vitesse BE4 / + cambio BE4  
<sup>4)</sup> + ME5K transmission / + scatola cambio ME5K / + boîte de vitesse ME5K / + cambio ME5K  
<sup>5)</sup> + ML5T transmission / + scatola cambio ML5T / + boîte de vitesse ML5T / + cambio ML5T

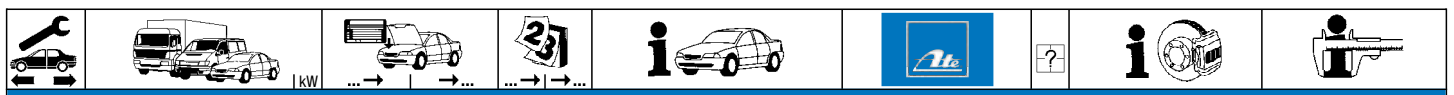



























**PEUGEOT EXPERT Kasten (95-06)**

|  |         |     |            |       |       |       |                |        |   |                               |               |
|--|---------|-----|------------|-------|-------|-------|----------------|--------|---|-------------------------------|---------------|
|  | 2.0 HDi | 80  |            | 07.00 | 12.06 |       | 24.5229-0251.3 | 330535 | 2 |                               | L=250         |
|  | 1.6     | 58  |            | 10.95 | 12.06 |       | 24.3219-1704.3 | 020374 |   |                               | Rz 19,05      |
|  | 1.8     | 74  |            | 10.96 | 12.06 |       |                |        |   |                               |               |
|  | 1.9 D   | 51  |            | 10.95 | 12.06 |       |                |        |   |                               |               |
|  | 1.9 TD  | 66  |            | 10.95 | 12.06 |       |                |        |   |                               |               |
|  | 1.9 TD  | 68  |            | 04.96 | 12.06 |       |                |        |   |                               |               |
|  | 2.0 16V | 100 |            | 07.00 | 12.06 |       |                |        |   |                               |               |
|  | 2.0 HDi | 69  |            | 07.00 | 12.06 |       |                |        |   |                               |               |
|  | 2.0 HDi | 80  |            | 07.00 | 12.06 |       |                |        |   |                               |               |
|  | 1.6     | 58  |            | 10.95 | 12.06 |       | 24.3727-0336.2 | 580336 | 1 |                               | L=500         |
|  | 1.8     | 74  |            | 10.96 | 12.06 |       | 24.3727-0341.2 | 580341 | 1 |                               | L=900         |
|  | 1.9 D   | 51  |            | 10.95 | 12.06 |       | 24.3727-0532.2 | 580532 |   |                               | L=1063        |
|  | 1.9 TD  | 66  |            | 10.95 | 12.06 |       | 24.3727-0531.2 | 580531 |   |                               | L=2286        |
|  | 1.9 TD  | 68  |            | 04.96 | 12.06 |       |                |        |   |                               |               |
|  | 2.0 16V | 100 |            | 07.00 | 12.06 |       |                |        |   |                               |               |
|  | 2.0 HDi | 69  |            | 07.00 | 12.06 |       |                |        |   |                               |               |
|  | 2.0 HDi | 80  |            | 07.00 | 12.06 |       |                |        |   |                               |               |
|  | 1.6     | 58  | ORGA 08420 | 10.95 | 12.06 | + ABS | 24.6582-1715.3 | 320205 |   |                               | BRL (4)       |
|  | 1.6     | 58  |            | 10.95 | 12.06 | - ABS |                |        |   |                               |               |
|  | 1.8     | 74  | ORGA 08420 | 10.96 | 12.06 | + ABS |                |        |   |                               |               |
|  | 1.8     | 74  |            | 10.96 | 12.06 | - ABS |                |        |   |                               |               |
|  | 1.9 D   | 51  | ORGA 08420 | 10.95 | 12.06 | + ABS |                |        |   |                               |               |
|  | 1.9 D   | 51  |            | 10.95 | 12.06 | - ABS |                |        |   |                               |               |
|  | 1.9 TD  | 66  | ORGA 08420 | 10.95 | 12.06 | + ABS |                |        |   |                               |               |
|  | 1.9 TD  | 66  |            | 10.95 | 12.06 | - ABS |                |        |   |                               |               |
|  | 1.9 TD  | 68  | ORGA 08420 | 04.96 | 12.06 | + ABS |                |        |   |                               |               |
|  | 1.9 TD  | 68  |            | 04.96 | 12.06 | - ABS |                |        |   |                               |               |
|  | 1.6     | 58  |            | 10.95 | 12.06 |       | 24.3728-0341.2 | 590341 |   |                               | L=738, + AUT  |
|  | 1.8     | 74  |            | 10.96 | 12.06 |       |                |        |   |                               |               |
|  | 1.9 TD  | 66  |            | 10.95 | 12.06 |       | 24.3728-0342.2 | 590342 |   | + ME5K-Getriebe <sup>3)</sup> | L=863, + AUT  |
|  | 1.9 TD  | 68  |            | 04.96 | 12.06 |       | 24.3728-0340.2 | 590340 |   | + ML5T-Getriebe <sup>4)</sup> | L=1088, + AUT |
|  | 1.9 D   | 51  |            | 10.95 | 12.06 |       | 24.3728-0333.2 | 590333 |   |                               | L=1003, + AUT |
|  | 2.0 16V | 100 |            | 07.00 | 12.06 |       |                |        |   |                               |               |
|  | 2.0 HDi | 69  |            | 07.00 | 12.06 |       |                |        |   |                               |               |
|  | 2.0 HDi | 80  |            | 07.00 | 12.06 |       |                |        |   |                               |               |
|  | 1.6     | 58  |            | 10.95 | 12.06 |       | 24.3728-0341.2 | 590341 |   |                               | L=738, + AUT  |
|  | 1.8     | 74  |            | 10.96 | 12.06 |       |                |        |   |                               |               |
|  | 1.9 D   | 51  |            | 10.95 | 12.06 |       |                |        |   |                               |               |

**PEUGEOT EXPERT Pritsche/Fahrgestell (95-06)**

|  |        |    |            |       |       |  |                |        |   |                |                |
|--|--------|----|------------|-------|-------|--|----------------|--------|---|----------------|----------------|
|  | 1.6    | 58 | ORGA 08206 | 10.95 |       |  | 24.2122-1703.3 | 010422 |   | - ABS/ + 0,8 t | THz 22,20      |
|  | 1.9 D  | 51 | ORGA 08206 | 10.95 |       |  | 24.2122-1708.3 | 010437 |   | + ABS/ + 0,8 t | THz 22,20      |
|  | 1.9 TD | 66 | ORGA 08206 | 10.95 |       |  | 24.2123-1707.3 | 010492 |   | - ABS/ + 0,9 t | THz 23,81      |
|  | 1.9 TD | 68 | ORGA 08206 | 04.96 |       |  | 24.2123-1708.3 | 010493 |   | + ABS/ + 0,9 t | THz 23,81      |
|  | 1.6    | 58 | ORGA 08207 |       | 12.06 |  | 24.2122-1741.3 | 010695 |   | - ABS/ + 0,8 t | THz 22,20      |
|  | 1.9 D  | 51 | ORGA 08207 |       | 12.06 |  | 24.2122-1742.3 | 010696 |   | + ABS/ + 0,8 t | THz 22,20      |
|  | 1.9 TD | 66 | ORGA 08207 |       | 12.06 |  | 24.2123-1738.3 | 010658 |   | - ABS/ + 0,9 t | THz 23,81      |
|  | 1.9 TD | 68 | ORGA 08207 |       | 12.06 |  | 24.2123-1733.3 | 010657 |   | + ABS/ + 0,9 t | THz 23,81      |
|  | 1.6    | 58 | ORGA 09792 | 10.95 |       |  | 24.3571-1709.5 | 240153 |   |                | D=57, - Halter |
|  | 1.9 D  | 51 | ORGA 09792 | 10.95 |       |  | 24.3571-1710.5 | 240154 |   |                | D=57, - Halter |
|  | 1.9 TD | 66 | ORGA 09792 | 10.95 |       |  |                |        |   |                | LUC            |
|  | 1.9 TD | 68 | ORGA 09792 | 04.96 |       |  |                |        |   |                | LUC            |
|  | 1.6    | 58 | ORGA 09793 |       | 12.06 |  | 24.3601-1711.7 | 220607 |   |                | D=60, - Halter |
|  | 1.9 D  | 51 | ORGA 09793 |       | 12.06 |  | 24.3601-1712.7 | 220608 |   |                | D=60, - Halter |
|  | 1.9 TD | 66 | ORGA 09793 |       | 12.06 |  |                |        |   |                | LUC            |
|  | 1.9 TD | 68 | ORGA 09793 |       | 12.06 |  |                |        |   |                | LUC            |
|  | 1.6    | 58 | ORGA 09792 | 10.95 |       |  | 24.5118-0471.3 | 330528 | 2 |                | L=473          |
|  | 1.9 D  | 51 | ORGA 09792 | 10.95 |       |  |                |        |   |                |                |
|  | 1.9 TD | 66 | ORGA 09792 | 10.95 |       |  |                |        |   |                |                |
|  | 1.9 TD | 68 | ORGA 09792 | 04.96 |       |  |                |        |   |                |                |
|  | 1.6    | 58 | ORGA 09793 |       | 12.06 |  | 24.5111-0462.3 | 330555 | 2 |                | L=460          |
|  | 1.9 D  | 51 | ORGA 09793 |       | 12.06 |  |                |        |   |                |                |
|  | 1.9 TD | 66 | ORGA 09793 |       | 12.06 |  |                |        |   |                |                |
|  | 1.9 TD | 68 | ORGA 09793 |       | 12.06 |  |                |        |   |                |                |
|  | 1.6    | 58 |            | 10.95 | 12.06 |  | 24.5229-0251.3 | 330535 | 2 |                | L=250          |
|  | 1.9 D  | 51 |            | 10.95 | 12.06 |  |                |        |   |                |                |
|  | 1.9 TD | 66 |            | 10.95 | 12.06 |  |                |        |   |                |                |
|  | 1.9 TD | 68 |            | 04.96 | 12.06 |  |                |        |   |                |                |
|  | 1.6    | 58 |            | 10.95 | 12.06 |  | 24.3219-1704.3 | 020374 |   |                | Rz 19,05       |
|  | 1.9 D  | 51 |            | 10.95 | 12.06 |  |                |        |   |                |                |
|  | 1.9 TD | 66 |            | 10.95 | 12.06 |  |                |        |   |                |                |
|  | 1.9 TD | 68 |            | 04.96 | 12.06 |  |                |        |   |                |                |

1) - long wheel base / - passo lungo / - empattement long / - distancia larga entre ejes  
 2) + long wheel base / + passo lungo / + empattement long / + distancia larga entre ejes  
 3) + ME5K transmission / + scatola cambio ME5K / + boîte de vitesse ME5K / + cambio ME5K  
 4) + ML5T transmission / + scatola cambio ML5T / + boîte de vitesse ML5T / + cambio ML5T

|     |  |  |  |  |  |  |  |                                     |                                 |          |     |
|--|--|--|--|--|---|--|--|---|---------------------------------|----------|-----|
| <b>PEUGEOT EXPERT Pritsche/Fahrgestell (95-06)</b>                                 |  |  |  |  |   |  |  |   |                                 |          |     |
|    | 1.6  | 58   |  | 10.95  | 12.06   | 24.3727-0336.2   | 580336   | 1  - langer Radstand <sup>1)</sup> | L=500                           |          |     |
|  | 1.9 D  | 51   |  | 10.95  | 12.06   | 24.3727-0341.2   | 580341   | 1  + langer Radstand <sup>2)</sup> | L=900                           |          |     |
|  | 1.9 TD   | 66   |  | 10.95  | 12.06   | 24.3727-0532.2   | 580532   | <input type="checkbox"/>  | L=1063                          |          |     |
|  | 1.9 TD   | 68   |  | 04.96  | 12.06   | 24.3727-0531.2   | 580531   | <input type="checkbox"/>  | L=2286                          |          |     |
|    | 1.6  | 58   |  | 10.95  | 12.06   | 24.3727-0336.2   | 580336   | 1  - langer Radstand <sup>1)</sup> | L=500                           |          |     |
|  | 1.9 D  | 51   |  | 10.95  | 12.06   | 24.3727-0341.2   | 580341   | 1  + langer Radstand <sup>2)</sup> | L=900                           |          |     |
|  | 1.9 TD   | 66   |  | 10.95  | 12.06   | 24.3727-0532.2   | 580532   | <input type="checkbox"/>  | L=1063                          |          |     |
|  | 1.9 TD   | 68   |  | 04.96  | 12.06   |  |  |   |                                 |          |     |
|    | 1.6  | 58   | ORGA 08420   | 10.95  |   | 24.6582-1715.3   | 320205   |   | BRL (4)                         |          |     |
|  | 1.6  | 58   |  | 10.95  | 12.06   |  |  |   |                                 |          |     |
|  | 1.9 D  | 51   | ORGA 08420   | 10.95  |   |  |  |   |                                 |          |     |
|  | 1.9 D  | 51   |  | 10.95  | 12.06   |  |  |   |                                 |          |     |
|  | 1.9 TD   | 66   | ORGA 08420   | 10.95  |   |  |  |   |                                 |          |     |
|  | 1.9 TD   | 66   |  | 10.95  | 12.06   |  |  |   |                                 |          |     |
|    | 1.9 D  | 51   |  | 10.95  | 12.06   | 24.3728-0336.2   | 590336   |   | L=973, + AUT                    |          |     |
|  | 1.9 TD   | 66   |  | 10.95  | 12.06   | 24.3728-0342.2   | 590342   | + ME5K-Getriebe <sup>3)</sup>   | L=863, + AUT                    |          |     |
|  |  |  |  |  |   | 24.3728-0340.2   | 590340   | + ML5T-Getriebe <sup>4)</sup>   | L=1088, + AUT                   |          |     |
| <b>PEUGEOT EXPERT / Expert Tepee (07-)</b>   |  |  |  |  |   |  |  |   |                                 |          |     |
|    | 1.6 HDi 90   | 66   |  | 01.07  |   | 03.2125-0298.3   | 010818   | - ESP   | THz 25,40                       | ATE      |     |
|  | 2.0 HDi 100  | 72   |  | 03.11  |   | 03.2125-0293.3   | 010817   | + ESP   | THz 25,40                       | ATE      |     |
|  | 2.0 HDi 120  | 88   |  | 01.07  |   |  |  |   |                                 |          |     |
|  | 2.0 HDi 120 4x4  | 88   |  | 01.07  |   |  |  |   |                                 |          |     |
|  | 2.0 HDi 130  | 94   |  | 03.11  |   |  |  |   |                                 |          |     |
|  | 2.0 HDi 140  | 100  |  | 01.07  |   |  |  |   |                                 |          |     |
|  | 2.0 HDi 165  | 120  |  | 09.09  |   |  |  |   |                                 |          |     |
|  | 2.0 i 16V  | 103  |  | 01.07  |   |  |  |   |                                 |          |     |
|    | 1.6 HDi 90   | 66   |  | 01.07  |   | 24.5144-0455.3   | 331201   | 2   | L=455                           |          |     |
|  | 2.0 HDi 100  | 72   |  | 03.11  |   |  |  |   |                                 |          |     |
|  | 2.0 HDi 120  | 88   |  | 01.07  |   |  |  |   |                                 |          |     |
|  | 2.0 HDi 120 4x4  | 88   |  | 01.07  |   |  |  |   |                                 |          |     |
|  | 2.0 HDi 130  | 94   |  | 03.11  |   |  |  |   |                                 |          |     |
|  | 2.0 HDi 140  | 100  |  | 01.07  |   |  |  |   |                                 |          |     |
|  | 2.0 HDi 165  | 120  |  | 09.09  |   |  |  |   |                                 |          |     |
|  | 2.0 i 16V  | 103  |  | 01.07  |   |  |  |   |                                 |          |     |
|   | 1.6 HDi 90   | 66   |  | 01.07  |   | 24.3414-1715.5   | 240589   | <input type="checkbox"/>  | D=41, - Halter                  | LUC      |     |
|  | 2.0 HDi 100  | 72   |  | 03.11  |   | 24.3414-1716.5   | 240590   | <input type="checkbox"/>  | D=41, - Halter                  | LUC      |     |
|  | 2.0 HDi 120  | 88   |  | 01.07  |   |  |  |   |                                 |          |     |
|  | 2.0 HDi 120 4x4  | 88   |  | 01.07  |   |  |  |   |                                 |          |     |
|  | 2.0 HDi 130  | 94   |  | 03.11  |   |  |  |   |                                 |          |     |
|  | 2.0 HDi 140  | 100  |  | 01.07  |   |  |  |   |                                 |          |     |
|  | 2.0 HDi 165  | 120  |  | 09.09  |   |  |  |   |                                 |          |     |
|  | 2.0 i 16V  | 103  |  | 01.07  |   |  |  |   |                                 |          |     |
|  | 1.6 HDi 90   | 66   | ORGA 10933   | 01.07  |   | 24.5239-0260.3   | 331171   | 2   | - langer Radstand <sup>1)</sup> | L=260    |     |
|  | 2.0 HDi 100  | 72   | ORGA 10933   | 03.11  |   | 24.5239-0365.3   | 331281   | 2   | + langer Radstand <sup>2)</sup> | L=365    |     |
|  | 2.0 HDi 120  | 88   | ORGA 10933   | 01.07  |   |  |  |   |                                 |          |     |
|  | 2.0 HDi 120 4x4  | 88   | ORGA 10933   | 01.07  |   |  |  |   |                                 |          |     |
|  | 2.0 HDi 130  | 94   | ORGA 10933   | 03.11  |   |  |  |   |                                 |          |     |
|  | 2.0 HDi 140  | 100  | ORGA 10933   | 01.07  |   |  |  |   |                                 |          |     |
|  | 2.0 HDi 165  | 120  | ORGA 10933   | 09.09  |   |  |  |   |                                 |          |     |
|  | 2.0 i 16V  | 103  | ORGA 10933   | 01.07  |   |  |  |   |                                 |          |     |
|  | 1.6 HDi 90   | 66   | ORGA 10934   |  |   | 24.5239-0240.3   | 331170   | 2   | - langer Radstand <sup>1)</sup> | L=240    |     |
|  | 2.0 HDi 100  | 72   | ORGA 10934   |  |   | 24.5239-0355.3   | 331243   | 2   | + langer Radstand <sup>2)</sup> | L=355    |     |
|  | 2.0 HDi 120  | 88   | ORGA 10934   |  |   |  |  |   |                                 |          |     |
|  | 2.0 HDi 120 4x4  | 88   | ORGA 10934   |  |   |  |  |   |                                 |          |     |
|  | 2.0 HDi 130  | 94   | ORGA 10934   |  |   |  |  |   |                                 |          |     |
|  | 2.0 HDi 140  | 100  | ORGA 10934   |  |   |  |  |   |                                 |          |     |
|  | 2.0 HDi 165  | 120  | ORGA 10934   |  |   |  |  |   |                                 |          |     |
|  | 2.0 i 16V  | 103  | ORGA 10934   |  |   |  |  |   |                                 |          |     |
|  | 1.6 HDi 90   | 66   |  | 01.07  |   | 24.3222-1726.3   | 020518   |   | + kurzer Radstand <sup>5)</sup> | Rz 22,20 | LUC |
| <b>PEUGEOT PARTNER Kombi (96-08)</b>   |  |  |  |  |   |  |  |   |                                 |          |     |
|  | 1.1 i  | 44   | ORGA 08609   | 07.96  |   | 24.2123-1710.3   | 010504   |   | THz 23,81                       | BOS      |     |
|  | 1.4 i  | 55   | ORGA 08609   | 07.96  |   |  |  |   |                                 |          |     |
|  | 1.8 i  | 66   | ORGA 08609   | 05.97  |   |  |  |   |                                 |          |     |
|  | 1.9 D  | 50   | ORGA 08609   | 07.96  |   |  |  |   |                                 |          |     |
|  | 1.9 D  | 51   | ORGA 08609   | 12.98  |   |  |  |   |                                 |          |     |
|  | 1.1 i  | 44   | ORGA 08609   | 07.96  |   | 24.2123-1713.3   | 010505   |   | THz 23,81                       | BOS      |     |
|  | 1.4 i  | 55   | ORGA 08609   | 07.96  |   |  |  |   |                                 |          |     |
|  | 1.8 i  | 66   | ORGA 08609   | 05.97  |   |  |  |   |                                 |          |     |
|  | 1.9 D  | 50   | ORGA 08609   | 07.96  |   |  |  |   |                                 |          |     |
|  | 1.9 D  | 51   | ORGA 08609   | 12.98  |   |  |  |   |                                 |          |     |
|  | 1.1 i  | 44   | ORGA 08610   | 03.08  |   | 03.2123-2781.3   | 010631   | - ABS   | THz 23,81                       | ATE      |     |
|  | 1.4 i  | 55   | ORGA 08610   | 03.08  |   | 24.2123-1714.3   | 010587   | - ABS   | THz 23,81                       | BDX      |     |
|  | 1.6 16V  | 80   |  | 07.01  | 03.08   | 24.2123-1715.3   | 010520   | + ABS   | THz 23,81                       | BDX      |     |
|  | 1.6 HDi 75   | 55   |  | 02.06  | 03.08   |  |  |   |                                 |          |     |
|  | 1.6 HDi 90   | 66   |  | 02.06  | 03.08   |  |  |   |                                 |          |     |
|  | 1.8 i  | 66   | ORGA 08610   | 03.08  |   |  |  |   |                                 |          |     |
|  | 1.9 D  | 50   | ORGA 08610   | 03.08  |   |  |  |   |                                 |          |     |
|  | 1.9 D  | 51   | ORGA 08610   | 03.08  |   |  |  |   |                                 |          |     |
| 2.0 HDi 90   | 66   |  | 02.00  | 03.08  |   |  | - ESP  |   |                                 |          |     |

<sup>1)</sup> - long wheel base / - passo lungo / - empattement long / - distancia larga entre ejes  
<sup>2)</sup> + long wheel base / + passo lungo / + empattement long / + distancia larga entre ejes  
<sup>3)</sup> + ME5K transmission / + scatola cambio ME5K / + boîte de vitesse ME5K / + cambio ME5K  
<sup>4)</sup> + ML5T transmission / + scatola cambio ML5T / + boîte de vitesse ML5T / + cambio ML5T  
<sup>5)</sup> + short wheel base / + passo lungo / + empattement court / + distancia corta entre ejes

| PEUGEOT PARTNER Kombi (96-08) |            |            |            |       |                |                |                |                       |                        |                           |                |     |
|-------------------------------|------------|------------|------------|-------|----------------|----------------|----------------|-----------------------|------------------------|---------------------------|----------------|-----|
|                               | 1.1 i      | 44         |            | 07.96 | 09.02          | 24.3541-1777.5 | 240247         |                       |                        | D=54, - Halter            | LUC            |     |
|                               | 1.4 i      | 55         |            | 07.96 | 09.02          | 24.3541-1778.5 | 240248         |                       |                        | D=54, - Halter            | LUC            |     |
|                               | 1.6 16V    | 80         | ORGA 09127 | 07.01 |                | 24.3541-1757.7 | 220483         |                       |                        | D=54, - Halter            | LUC            |     |
|                               | 1.8 i      | 66         | ORGA 09127 | 05.97 |                | 24.3541-1758.7 | 220484         |                       |                        | D=54, - Halter            | LUC            |     |
|                               | 1.9 D      | 50         | ORGA 09127 | 07.96 |                |                |                |                       |                        |                           |                |     |
|                               | 1.9 D      | 51         | ORGA 09127 | 12.98 |                |                |                |                       |                        |                           |                |     |
|                               | 2.0 HDi 90 | 66         | ORGA 09127 | 02.00 |                |                |                |                       |                        |                           |                |     |
|                               | Electric   | 28         |            | 01.98 | 12.01          |                |                |                       |                        |                           |                |     |
|                               | 1.1 i      | 44         |            | 10.02 | 03.08          | 24.3541-1771.5 | 240239         |                       |                        | D=54, - Halter            | BOS            |     |
|                               | 1.4 i      | 55         |            | 10.02 | 03.08          | 24.3541-1772.5 | 240240         |                       |                        | D=54, - Halter            | BOS            |     |
| 1.6 16V                       | 80         | ORGA 09128 |            | 03.08 |                |                |                |                       |                        |                           |                |     |
| 1.6 HDi 75                    | 55         |            | 02.06      | 03.08 |                |                |                |                       |                        |                           |                |     |
| 1.6 HDi 90                    | 66         |            | 02.06      | 03.08 |                |                |                |                       |                        |                           |                |     |
| 1.8 i                         | 66         | ORGA 09128 |            | 03.08 |                |                |                |                       |                        |                           |                |     |
| 1.9 D                         | 50         | ORGA 09128 |            | 03.08 |                |                |                |                       |                        |                           |                |     |
| 1.9 D                         | 51         | ORGA 09128 |            | 03.08 |                |                |                |                       |                        |                           |                |     |
| 2.0 HDi 90                    | 66         | ORGA 09128 |            | 03.08 |                |                |                |                       |                        |                           |                |     |
| 1.6 16V                       | 80         | ORGA 09128 |            | 03.08 | + ESP          | 24.3541-1761.5 | 240233         |                       |                        | D=54, - Halter            | BOS            |     |
| 1.6 HDi 75                    | 55         |            | 02.06      | 03.08 | + ESP          | 24.3541-1762.5 | 240234         |                       |                        | D=54, - Halter            | BOS            |     |
| 1.6 HDi 90                    | 66         |            | 02.06      | 03.08 | + ESP          |                |                |                       |                        |                           |                |     |
| 2.0 HDi 90                    | 66         | ORGA 09128 |            | 03.08 | + ESP          |                |                |                       |                        |                           |                |     |
|                               | 1.1 i      | 44         |            | 07.96 | 03.08          | 24.5111-0438.3 | 330568         |                       | 2                      | L=445                     |                |     |
|                               | 1.4 i      | 55         |            | 07.96 | 03.08          |                |                |                       |                        |                           |                |     |
|                               | 1.6 16V    | 80         |            | 07.01 | 03.08          |                |                |                       |                        |                           |                |     |
|                               | 1.6 HDi 75 | 55         |            | 02.06 | 03.08          |                |                |                       |                        |                           |                |     |
|                               | 1.6 HDi 90 | 66         |            | 02.06 | 03.08          |                |                |                       |                        |                           |                |     |
|                               | 1.8 i      | 66         |            | 05.97 | 03.08          |                |                |                       |                        |                           |                |     |
|                               | 1.9 D      | 50         |            | 07.96 | 03.08          |                |                |                       |                        |                           |                |     |
|                               | 1.9 D      | 51         |            | 12.98 | 03.08          |                |                |                       |                        |                           |                |     |
|                               | 2.0 HDi 90 | 66         |            | 02.00 | 03.08          |                |                |                       |                        |                           |                |     |
|                               | 1.6 16V    | 80         |            | 07.01 | 03.08          | + ESP          | 24.5111-0460.3 | 330603                |                        | 2                         | L=460          |     |
| 1.6 HDi 75                    | 55         |            | 02.06      | 03.08 | + ESP          |                |                |                       |                        |                           |                |     |
| 1.6 HDi 90                    | 66         |            | 02.06      | 03.08 | + ESP          |                |                |                       |                        |                           |                |     |
| 2.0 HDi 90                    | 66         |            | 02.00      | 03.08 | + ESP          |                |                |                       |                        |                           |                |     |
|                               | 1.6 16V    | 80         |            | 07.01 | 03.08          | + ESP          | 24.3387-1711.7 | 220747                |                        |                           | D=38, - Halter | LUC |
|                               | 1.6 HDi 75 | 55         |            | 02.06 | 03.08          | + ESP          | 24.3387-1712.7 | 220748                |                        |                           | D=38, - Halter | LUC |
|                               | 1.6 HDi 90 | 66         |            | 02.06 | 03.08          | + ESP          |                |                       |                        |                           |                |     |
|                               | 2.0 HDi 90 | 66         |            | 02.00 | 03.08          | + ESP          |                |                       |                        |                           |                |     |
|                               | 1.1 i      | 44         | ORGA 09533 | 07.96 |                | 24.5229-0255.3 | 330581         |                       | 2                      | L=255                     |                |     |
|                               | 1.4 i      | 55         | ORGA 09533 | 07.96 |                |                |                |                       |                        |                           |                |     |
|                               | 1.6 16V    | 80         | ORGA 09533 | 07.01 |                |                |                |                       |                        |                           |                |     |
|                               | 1.8 i      | 66         | ORGA 09533 | 05.97 |                |                |                |                       |                        |                           |                |     |
|                               | 1.9 D      | 50         | ORGA 09533 | 07.96 |                |                |                |                       |                        |                           |                |     |
|                               | 1.9 D      | 51         | ORGA 09533 | 12.98 |                |                |                |                       |                        |                           |                |     |
|                               | 2.0 HDi 90 | 66         | ORGA 09533 | 02.00 |                |                |                |                       |                        |                           |                |     |
|                               | 1.1 i      | 44         | ORGA 09534 |       | 03.08          | 24.5246-0260.3 | 330782         |                       | 2                      | L=260                     |                |     |
|                               | 1.4 i      | 55         | ORGA 09534 |       | 03.08          |                |                |                       |                        |                           |                |     |
|                               | 1.6 16V    | 80         | ORGA 09534 |       | 03.08          |                |                |                       |                        |                           |                |     |
| 1.6 HDi 75                    | 55         |            | 02.06      | 03.08 |                |                |                |                       |                        |                           |                |     |
| 1.6 HDi 90                    | 66         |            | 02.06      | 03.08 |                |                |                |                       |                        |                           |                |     |
| 1.8 i                         | 66         | ORGA 09534 |            | 03.08 |                |                |                |                       |                        |                           |                |     |
| 1.9 D                         | 50         | ORGA 09534 |            | 03.08 |                |                |                |                       |                        |                           |                |     |
| 1.9 D                         | 51         | ORGA 09534 |            | 03.08 |                |                |                |                       |                        |                           |                |     |
| 2.0 HDi 90                    | 66         | ORGA 09534 |            | 03.08 |                |                |                |                       |                        |                           |                |     |
|                               | 1.1 i      | 44         |            | 07.96 | 03.08          | 24.3222-1711.3 | 020413         |                       |                        | Rz 22,20                  | LUC            |     |
|                               | 1.4 i      | 55         |            | 07.96 | 03.08          | 24.3222-1734.3 | 020539         |                       |                        | Rz 22,20                  | LUC            |     |
|                               | 1.6 16V    | 80         |            | 07.01 | 03.08          |                |                |                       |                        |                           |                |     |
|                               | 1.6 HDi 75 | 55         |            | 02.06 | 03.08          |                |                |                       |                        |                           |                |     |
|                               | 1.6 HDi 90 | 66         |            | 02.06 | 03.08          |                |                |                       |                        |                           |                |     |
|                               | 1.8 i      | 66         |            | 05.97 | 03.08          |                |                |                       |                        |                           |                |     |
|                               | 1.9 D      | 50         |            | 07.96 | 03.08          |                |                |                       |                        |                           |                |     |
|                               | 1.9 D      | 51         |            | 12.98 | 03.08          |                |                |                       |                        |                           |                |     |
|                               | 2.0 HDi 90 | 66         |            | 02.00 | 03.08          |                |                |                       |                        |                           |                |     |
|                               | 1.1 i      | 44         | ORGA 08393 | 07.96 |                | 24.3727-0314.2 | 580314         |                       | + HA-Trommelbremse 1)  |                           | L=1745         |     |
| 1.4 i                         | 55         | ORGA 08393 | 07.96      |       | 24.3727-0315.2 | 580315         |                | + HA-Trommelbremse 1) |                        | L=1818                    |                |     |
| 1.8 i                         | 66         | ORGA 08393 | 05.97      |       |                |                |                |                       |                        |                           |                |     |
| 1.9 D                         | 50         | ORGA 08393 | 07.96      |       |                |                |                |                       |                        |                           |                |     |
| 1.9 D                         | 51         | ORGA 08393 | 12.98      |       |                |                |                |                       |                        |                           |                |     |
| 1.1 i                         | 44         | ORGA 08394 |            | 03.08 | + A            | 24.3727-0314.2 | 580314         |                       | + HA-Trommelbremse 1)  | L=1745                    |                |     |
| 1.4 i                         | 55         | ORGA 08394 |            | 03.08 |                | 24.3727-0339.2 | 580339         |                       | + HA-Trommelbremse 1)  | L=1850                    |                |     |
| 1.6 16V                       | 80         |            | 07.01      | 03.08 |                |                |                |                       |                        |                           |                |     |
| 1.6 HDi 75                    | 55         |            | 02.06      | 03.08 |                |                |                |                       |                        |                           |                |     |
| 1.6 HDi 90                    | 66         |            | 02.06      | 03.08 |                |                |                |                       |                        |                           |                |     |
| 1.8 i                         | 66         | ORGA 08394 |            | 03.08 |                |                |                |                       |                        |                           |                |     |
| 1.9 D                         | 50         | ORGA 08394 |            | 03.08 |                |                |                |                       |                        |                           |                |     |
| 1.9 D                         | 51         | ORGA 08394 |            | 03.08 |                |                |                |                       |                        |                           |                |     |
| 2.0 HDi 90                    | 66         |            | 02.00      | 03.08 |                |                |                |                       |                        |                           |                |     |
| 1.6 16V                       | 80         |            | 07.01      | 03.08 | + ESP          | 24.3727-0349.2 | 580349         |                       | + HA-Scheibenbremse 2) | L=1820                    |                |     |
| 1.6 HDi 75                    | 55         |            | 02.06      | 03.08 | + ESP          | 24.3727-0347.2 | 580347         |                       | + HA-Scheibenbremse 2) | L=1923                    |                |     |
| 1.6 HDi 90                    | 66         |            | 02.06      | 03.08 | + ESP          |                |                |                       |                        |                           |                |     |
| 2.0 HDi 90                    | 66         |            | 02.00      | 03.08 | + ESP          |                |                |                       |                        |                           |                |     |
|                               | 1.1 i      | 44         |            | 07.96 | 03.08          | 03.6582-0010.3 | 320145         |                       |                        | - verstärktes Fahrwerk 3) | ATE            |     |
|                               | 1.4 i      | 55         |            | 07.96 | 03.08          | 03.6582-0011.3 | 320232         |                       |                        | + verstärktes Fahrwerk 4) | ATE            |     |
|                               | 1.6 16V    | 80         |            | 07.01 | 03.08          |                |                |                       |                        |                           |                |     |
|                               | 1.6 HDi 75 | 55         |            | 02.06 | 03.08          |                |                |                       |                        |                           |                |     |

1) + RA drum brake / + P freno a tamburo / + frein à tambour essieu AR / + ET-tambores de freno  
2) + RA disc brake / + P disco freno / + frein à disque essieu AR / + ET-disco de freno  
3) - reinforced suspension / - sospensione rinforzata / - châssis renforcé / - suspensión reforzada  
4) + reinforced suspension / + sospensione rinforzata / + châssis renforcé / + suspensión reforzada



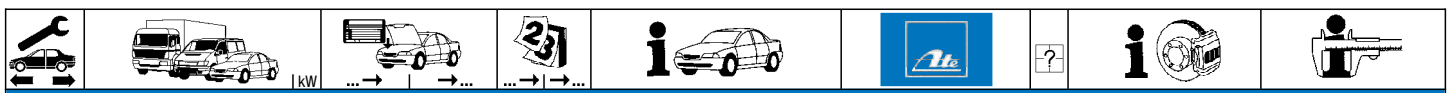

### PEUGEOT PARTNER Kombi (96-08)

|            |            |            |            |       |                              |                |                              |  |                                |            |                |        |                              |               |     |
|------------|------------|------------|------------|-------|------------------------------|----------------|------------------------------|--|--------------------------------|------------|----------------|--------|------------------------------|---------------|-----|
|            | 1.6 HDi 90 | 66         |            | 02.06 | 03.08                        | 03.6582-0010.3 | 320145                       | - verstärktes Fahrwerk <sup>1)</sup><br>+ verstärktes Fahrwerk <sup>2)</sup> | BRL 8/1,5 (4)<br>BRL 8/1,5 (4) | ATE<br>ATE |                |        |                              |               |     |
|            | 1.8 i      | 66         |            | 05.97 | 03.08                        |                |                              |  |                                |            |                |        |                              |               |     |
|            | 1.9 D      | 50         |            | 07.96 | 03.08                        |                |                              |  |                                |            |                |        |                              |               |     |
|            | 1.9 D      | 51         |            | 12.98 | 03.08                        |                |                              |  |                                |            |                |        |                              |               |     |
|            | 2.0 HDi 90 | 66         |            | 02.00 | 03.08                        |                |                              |  |                                |            |                |        |                              |               |     |
|            | Electric   | 28         |            | 01.98 | 12.01                        |                |                              |  |                                |            | 03.6582-0015.3 | 320227 |                              | BRL 8/1,5 (4) | ATE |
|            | 1.1 i      | 44         |            | 07.96 | 03.08                        | 24.3728-0328.2 | 590328                       |  | L=617                          |            |                |        |                              |               |     |
|            | 1.4 i      | 55         |            | 07.96 | 03.08                        |                |                              |  |                                |            |                |        |                              |               |     |
|            | 1.6 16V    | 80         |            | 07.01 | 03.08                        |                |                              |  |                                |            | 24.3728-0850.2 | 590850 |                              | L=899, + AUT  |     |
|            | 1.6 HDi 75 | 55         |            | 02.06 | 03.08                        |                |                              |  |                                |            |                |        |                              |               |     |
|            | 2.0 HDi 90 | 66         |            | 02.00 | 03.08                        |                |                              |  |                                |            |                |        |                              |               |     |
|            | 1.6 HDi 90 | 66         | ORGA 11129 | 02.06 | 03.08                        |                |                              |  |                                |            | 24.3728-0850.2 | 590850 | + BE4-Getriebe <sup>3)</sup> | L=899, + AUT  |     |
|            | 1.9 D      | 50         | ORGA 11129 | 07.96 |                              |                |                              |  |                                |            |                |        |                              |               |     |
|            | 1.9 D      | 51         | ORGA 11129 | 12.98 |                              |                |                              |  |                                |            |                |        |                              |               |     |
|            | 2.0 HDi 90 | 66         | ORGA 11129 | 02.00 |                              |                |                              |  |                                |            |                |        |                              |               |     |
|            | 1.6 HDi 90 | 66         | ORGA 11130 |       | 03.08                        |                |                              |  |                                |            | 24.3728-0343.2 | 590343 | + BE4-Getriebe <sup>3)</sup> | L=882, + AUT  |     |
|            | 1.9 D      | 50         | ORGA 11130 |       | 03.08                        |                |                              |  |                                |            |                |        |                              |               |     |
|            | 1.9 D      | 51         | ORGA 11130 |       | 03.08                        |                |                              |  |                                |            |                |        |                              |               |     |
| 2.0 HDi 90 | 66         | ORGA 11130 |            | 03.08 |                              |                |                              |  |                                |            |                |        |                              |               |     |
| 1.9 D      | 50         |            | 07.96      | 03.08 | 24.3728-0329.2               | 590329         | + BE3-Getriebe <sup>4)</sup> | L=653, + AUT   |                                |            |                |        |                              |               |     |
| 1.9 D      | 51         |            | 12.98      | 03.08 | + BE3-Getriebe <sup>4)</sup> |                |                              |  |                                |            |                |        |                              |               |     |
| 1.8 i      | 66         |            | 05.97      | 03.08 | 24.3728-0338.2               | 590338         |                              | L=653, + AUT   |                                |            |                |        |                              |               |     |

### PEUGEOT PARTNER Kasten (96-08)

|            |            |            |            |       |       |                |                |                          |                                     |                   |                |                |                |                          |                          |                |
|------------|------------|------------|------------|-------|-------|----------------|----------------|--------------------------|-------------------------------------|-------------------|----------------|----------------|----------------|--------------------------|--------------------------|----------------|
|            | 1.1 i      | 44         | ORGA 08609 | 07.96 |       | 24.2123-1710.3 | 010504         |                          | THz 23,81                           | BOS               |                |                |                |                          |                          |                |
|            | 1.4 i      | 55         | ORGA 08609 | 07.96 |       |                |                |                          |                                     |                   |                |                |                |                          |                          |                |
|            | 1.8 D      | 43         | ORGA 08609 | 07.96 |       |                |                |                          |                                     |                   |                |                |                |                          |                          |                |
|            | 1.8 D      | 44         | ORGA 08609 | 11.96 |       |                |                |                          |                                     |                   |                |                |                |                          |                          |                |
|            | 1.9 D      | 51         | ORGA 08609 | 07.96 |       |                |                |                          |                                     |                   |                |                |                |                          |                          |                |
|            | 1.1 i      | 44         | ORGA 08609 | 07.96 | + ABS |                |                |                          |                                     |                   | 24.2123-1713.3 | 010505         |                | THz 23,81                | BOS                      |                |
|            | 1.4 i      | 55         | ORGA 08609 | 07.96 | + ABS |                |                |                          |                                     |                   |                |                |                |                          |                          |                |
|            | 1.8 D      | 43         | ORGA 08609 | 07.96 | + ABS |                |                |                          |                                     |                   |                |                |                |                          |                          |                |
|            | 1.8 D      | 44         | ORGA 08609 | 11.96 | + ABS |                |                |                          |                                     |                   |                |                |                |                          |                          |                |
|            | 1.9 D      | 51         | ORGA 08609 | 07.96 | + ABS |                |                |                          |                                     |                   |                |                |                |                          |                          |                |
|            | 1.1 i      | 44         | ORGA 08610 |       | 03.08 | 03.2123-2781.3 | 010631         | - ABS<br>- ABS<br>+ ABS  | THz 23,81<br>THz 23,81<br>THz 23,81 | ATE<br>BDX<br>BDX |                |                |                |                          |                          |                |
|            | 1.4 i      | 55         | ORGA 08610 |       | 03.08 |                |                |                          |                                     |                   |                |                |                |                          |                          |                |
|            | 1.6 HDi 75 | 55         |            | 02.06 | 03.08 |                |                |                          |                                     |                   | 24.2123-1714.3 | 010587         |                |                          |                          |                |
|            | 1.6 HDi 90 | 66         |            | 02.06 | 03.08 |                |                |                          |                                     |                   | 24.2123-1715.3 | 010520         |                |                          |                          |                |
|            | 1.8 D      | 43         | ORGA 08610 |       | 03.08 |                |                |                          |                                     |                   |                |                |                |                          |                          |                |
|            | 1.8 D      | 44         | ORGA 08610 |       | 11.96 |                |                |                          |                                     |                   |                |                |                |                          |                          |                |
|            | 1.9 D      | 51         | ORGA 08610 |       | 03.08 |                |                |                          |                                     |                   |                |                |                |                          |                          |                |
|            | 2.0 HDi 90 | 66         |            | 04.00 | 03.08 |                |                |                          |                                     |                   |                |                |                |                          |                          |                |
|            |            | 1.1 i      | 44         |       | 07.96 |                |                |                          |                                     |                   | 03.08          | 24.3541-1777.5 | 240247         | <input type="checkbox"/> | D=54, - Halter           | LUC            |
|            |            | 1.4 i      | 55         |       | 07.96 |                |                |                          |                                     |                   | 09.02          |                |                |                          |                          |                |
| 1.8 D      |            | 43         | ORGA 09127 | 07.96 |       | 24.3541-1757.7 | 220483         | <input type="checkbox"/> | D=54, - Halter                      | LUC               |                |                |                |                          |                          |                |
| 1.8 D      |            | 44         | ORGA 09127 | 11.96 |       | 24.3541-1758.7 | 220484         | <input type="checkbox"/> | D=54, - Halter                      | LUC               |                |                |                |                          |                          |                |
| 1.9 D      |            | 51         | ORGA 09127 | 07.96 |       |                |                |                          |                                     |                   |                |                |                |                          |                          |                |
| 2.0 HDi 90 |            | 66         | ORGA 09127 | 04.00 |       |                |                |                          |                                     |                   |                |                |                |                          |                          |                |
| 1.1 i      |            | 44         |            | 10.02 | 03.08 | 24.3541-1771.5 | 240239         | <input type="checkbox"/> | D=54, - Halter                      | BOS               |                |                |                |                          |                          |                |
| 1.4 i      |            | 55         |            | 10.02 | 03.08 | 24.3541-1772.5 | 240240         | <input type="checkbox"/> | D=54, - Halter                      | BOS               |                |                |                |                          |                          |                |
| 1.6 HDi 75 |            | 55         |            | 02.06 | 03.08 |                |                |                          |                                     |                   |                |                |                |                          |                          |                |
| 1.6 HDi 90 |            | 66         |            | 02.06 | 03.08 |                |                |                          |                                     |                   |                |                |                |                          |                          |                |
| 1.8 D      | 43         | ORGA 09128 |            | 03.08 |       |                |                |                          |                                     |                   |                |                |                |                          |                          |                |
| 1.8 D      | 44         | ORGA 09128 |            | 02.98 |       |                |                |                          |                                     |                   |                |                |                |                          |                          |                |
| 1.9 D      | 51         | ORGA 09128 |            | 03.08 |       |                |                |                          |                                     |                   |                |                |                |                          |                          |                |
| 2.0 HDi 90 | 66         | ORGA 09128 |            | 03.08 | - ESP |                |                |                          |                                     |                   |                |                |                |                          |                          |                |
| 2.0 HDi 90 | 66         | ORGA 09128 |            | 03.08 | + ESP | 24.3541-1761.5 | 240233         | <input type="checkbox"/> | D=54, - Halter                      | BOS               |                |                |                |                          |                          |                |
|            | 1.1 i      | 44         |            | 07.96 | 03.08 | 24.5111-0438.3 | 330568         | 2                        | L=445                               |                   |                |                |                |                          |                          |                |
|            | 1.4 i      | 55         |            | 07.96 | 03.08 |                |                |                          |                                     |                   |                |                |                |                          |                          |                |
|            | 1.6 HDi 75 | 55         |            | 02.06 | 03.08 |                |                |                          |                                     |                   |                |                |                |                          |                          |                |
|            | 1.6 HDi 90 | 66         |            | 02.06 | 03.08 |                |                |                          |                                     |                   |                |                |                |                          |                          |                |
|            | 1.8 D      | 43         |            | 07.96 | 03.08 |                |                |                          |                                     |                   |                |                |                |                          |                          |                |
|            | 1.8 D      | 44         |            | 11.96 | 02.98 |                |                |                          |                                     |                   |                |                |                |                          |                          |                |
|            | 1.9 D      | 51         |            | 07.96 | 03.08 |                |                |                          |                                     |                   |                |                |                |                          |                          |                |
|            | 2.0 HDi 90 | 66         |            | 04.00 | 03.08 |                |                |                          |                                     |                   | - ESP          |                |                |                          |                          |                |
|            | 2.0 HDi 90 | 66         |            | 04.00 | 03.08 |                |                |                          |                                     |                   | + ESP          | 24.5111-0460.3 | 330603         | 2                        | L=460                    |                |
|            |            | 2.0 HDi 90 | 66         |       | 04.00 |                |                |                          |                                     |                   | 03.08          | + ESP          | 24.3387-1711.7 | 220747                   | <input type="checkbox"/> | D=38, - Halter |
|            |            |            |            |       |       |                | 24.3387-1712.7 | 220748                   | <input type="checkbox"/>            | D=38, - Halter    | LUC            |                |                |                          |                          |                |
|            | 1.1 i      | 44         | ORGA 09533 | 07.96 |       | 24.5229-0255.3 | 330581         | 2                        | L=255                               |                   |                |                |                |                          |                          |                |
|            | 1.4 i      | 55         | ORGA 09533 | 07.96 |       |                |                |                          |                                     |                   |                |                |                |                          |                          |                |
|            | 1.8 D      | 43         | ORGA 09533 | 07.96 |       |                |                |                          |                                     |                   |                |                |                |                          |                          |                |
|            | 1.8 D      | 44         | ORGA 09533 | 11.96 |       |                |                |                          |                                     |                   |                |                |                |                          |                          |                |
|            | 1.9 D      | 51         | ORGA 09533 | 07.96 |       |                |                |                          |                                     |                   |                |                |                |                          |                          |                |
|            | 2.0 HDi 90 | 66         | ORGA 09533 | 04.00 |       |                |                |                          |                                     |                   |                |                |                |                          |                          |                |
|            | 1.1 i      | 44         | ORGA 09534 |       | 03.08 |                |                |                          |                                     |                   | 24.5246-0260.3 | 330782         | 2              | L=260                    |                          |                |
|            | 1.4 i      | 55         | ORGA 09534 |       | 03.08 |                |                |                          |                                     |                   |                |                |                |                          |                          |                |
|            | 1.6 HDi 75 | 55         |            | 02.06 | 03.08 |                |                |                          |                                     |                   |                |                |                |                          |                          |                |
|            | 1.6 HDi 90 | 66         |            | 02.06 | 03.08 |                |                |                          |                                     |                   |                |                |                |                          |                          |                |
| 1.8 D      | 43         | ORGA 09534 |            | 03.08 |       |                |                |                          |                                     |                   |                |                |                |                          |                          |                |
| 1.8 D      | 44         | ORGA 09534 |            | 02.98 |       |                |                |                          |                                     |                   |                |                |                |                          |                          |                |
| 1.9 D      | 51         | ORGA 09534 |            | 03.08 |       |                |                |                          |                                     |                   |                |                |                |                          |                          |                |
| 2.0 HDi 90 | 66         | ORGA 09534 |            | 03.08 |       |                |                |                          |                                     |                   |                |                |                |                          |                          |                |

1) - reinforced suspension / - sospensione rinforzata / - châssis renforcé / - suspensión reforzada  
2) + reinforced suspension / + sospensione rinforzata / + châssis renforcé / + suspensión reforzada  
3) + BE4 transmission / + scatola cambio BE4 / + boîte de vitesse BE4 / + cambio BE4  
4) + BE3 transmission / + scatola cambio BE3 / + boîte de vitesse BE3 / + cambio BE3





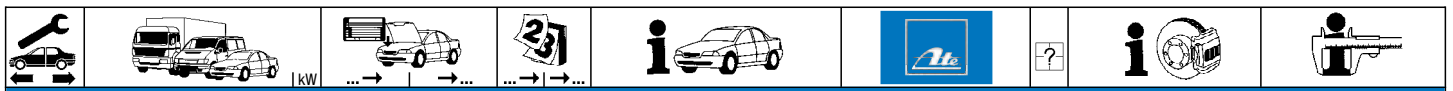

**PEUGEOT PARTNER Kasten (96-08)**

|            |            |            |            |       |       |                              |                |        |                          |                                      |               |          |
|------------|------------|------------|------------|-------|-------|------------------------------|----------------|--------|--------------------------|--------------------------------------|---------------|----------|
|            | 1.1 i      | 44         |            | 07.96 | 03.08 |                              | 24.3222-1711.3 | 020413 |                          |                                      | Rz 22,20      | LUC      |
|            | 1.4 i      | 55         |            | 07.96 | 03.08 |                              | 24.3222-1734.3 | 020539 |                          |                                      | Rz 22,20      | LUC      |
|            | 1.6 HDi 75 | 55         |            | 02.06 | 03.08 |                              |                |        |                          |                                      |               |          |
|            | 1.6 HDi 90 | 66         |            | 02.06 | 03.08 |                              |                |        |                          |                                      |               |          |
|            | 1.8 D      | 43         |            | 07.96 | 03.08 |                              |                |        |                          |                                      |               |          |
|            | 1.8 D      | 44         |            | 11.96 | 02.98 |                              |                |        |                          |                                      |               |          |
|            | 1.9 D      | 51         |            | 07.96 | 03.08 |                              |                |        |                          |                                      |               |          |
|            | 2.0 HDi 90 | 66         |            | 04.00 | 03.08 | - ESP                        |                |        |                          |                                      |               |          |
|            | Electric   | 25         |            | 01.98 | 12.01 |                              | 24.3222-1711.3 | 020413 |                          |                                      |               | Rz 22,20 |
|            |            |            |            |       |       | 24.3222-1734.3               | 020539         |        |                          |                                      | Rz 22,20      | LUC      |
|            | 1.1 i      | 44         | ORGA 08393 | 07.96 |       |                              | 24.3727-0314.2 | 580314 | <input type="checkbox"/> |                                      | L=1745        |          |
|            | 1.4 i      | 55         | ORGA 08393 | 07.96 |       |                              | 24.3727-0315.2 | 580315 | <input type="checkbox"/> |                                      | L=1818        |          |
|            | 1.8 D      | 43         | ORGA 08393 | 07.96 |       |                              |                |        |                          |                                      |               |          |
|            | 1.8 D      | 44         | ORGA 08393 | 11.96 |       |                              |                |        |                          |                                      |               |          |
|            | 1.9 D      | 51         | ORGA 08393 | 07.96 |       |                              |                |        |                          |                                      |               |          |
|            | 1.1 i      | 44         | ORGA 08394 |       | 03.08 |                              | 24.3727-0314.2 | 580314 | <input type="checkbox"/> |                                      | L=1745        |          |
|            | 1.4 i      | 55         | ORGA 08394 |       | 03.08 |                              | 24.3727-0339.2 | 580339 | <input type="checkbox"/> |                                      | L=1850        |          |
|            | 1.6 HDi 75 | 55         |            | 02.06 | 03.08 |                              |                |        |                          |                                      |               |          |
|            | 1.6 HDi 90 | 66         |            | 02.06 | 03.08 |                              |                |        |                          |                                      |               |          |
|            | 1.8 D      | 43         | ORGA 08394 |       | 03.08 |                              |                |        |                          |                                      |               |          |
|            | 1.8 D      | 44         | ORGA 08394 |       | 02.98 |                              |                |        |                          |                                      |               |          |
|            | 1.9 D      | 51         | ORGA 08394 |       | 03.08 |                              |                |        |                          |                                      |               |          |
|            | 2.0 HDi 90 | 66         |            | 04.00 | 03.08 |                              |                |        |                          |                                      |               |          |
|            |            |            |            |       |       |                              |                |        |                          |                                      |               |          |
|            | 1.1 i      | 44         |            | 07.96 | 03.08 | + 0,5/0,6 t                  | 03.6582-0009.3 | 320143 |                          | - verstärktes Fahrwerk <sup>1)</sup> | BRL 8/1,5 (4) | ATE      |
|            | 1.4 i      | 55         |            | 07.96 | 03.08 | + 0,5/0,6 t                  | 03.6582-0012.3 | 320233 |                          | + verstärktes Fahrwerk <sup>2)</sup> | BRL 8/1,5 (4) | ATE      |
|            | 1.6 HDi 75 | 55         |            | 02.06 | 03.08 | + 0,6 t                      |                |        |                          |                                      |               |          |
|            | 1.6 HDi 90 | 66         |            | 02.06 | 03.08 | + 0,6 t                      |                |        |                          |                                      |               |          |
|            | 1.8 D      | 43         |            | 07.96 | 03.08 | + 0,6 t                      |                |        |                          |                                      |               |          |
|            | 1.8 D      | 44         |            | 11.96 | 02.98 | + 0,6 t                      |                |        |                          |                                      |               |          |
|            | 1.9 D      | 51         |            | 07.96 | 03.08 | + 0,6 t                      |                |        |                          |                                      |               |          |
|            | 2.0 HDi 90 | 66         |            | 04.00 | 03.08 | + 0,6 t                      |                |        |                          |                                      |               |          |
|            |            |            |            |       |       |                              |                |        |                          |                                      |               |          |
|            | 1.6 HDi 75 | 55         |            | 02.06 | 03.08 | + 0,8 t                      | 03.6582-0015.3 | 320227 |                          | - verstärktes Fahrwerk <sup>1)</sup> | BRL 8/1,5 (4) | ATE      |
|            | 1.6 HDi 90 | 66         |            | 02.06 | 03.08 | + 0,8 t                      |                |        |                          |                                      |               |          |
|            | 1.8 D      | 43         |            | 07.96 | 03.08 | + 0,8 t                      |                |        |                          |                                      |               |          |
|            | 1.8 D      | 44         |            | 11.96 | 02.98 | + 0,8 t                      |                |        |                          |                                      |               |          |
|            | 1.9 D      | 51         |            | 07.96 | 03.08 | + 0,8 t                      |                |        |                          |                                      |               |          |
|            | 2.0 HDi 90 | 66         |            | 04.00 | 03.08 | + 0,8 t                      |                |        |                          |                                      |               |          |
|            |            |            |            |       |       |                              |                |        |                          |                                      |               |          |
|            |            |            |            |       |       |                              |                |        |                          |                                      |               |          |
|            |            |            |            |       |       |                              |                |        |                          |                                      |               |          |
|            | 1.1 i      | 44         |            | 07.96 | 03.08 |                              | 24.3728-0328.2 | 590328 |                          |                                      | L=617         |          |
|            | 1.4 i      | 55         |            | 07.96 | 03.08 |                              |                |        |                          |                                      |               |          |
|            | 1.8 D      | 43         |            | 07.96 | 03.08 |                              | 24.3728-0329.2 | 590329 |                          |                                      | L=653, + AUT  |          |
|            | 1.8 D      | 44         |            | 11.96 | 02.98 |                              |                |        |                          |                                      |               |          |
|            | 1.9 D      | 51         |            | 07.96 | 03.08 | + BE3-Getriebe <sup>3)</sup> |                |        |                          |                                      |               |          |
|            | 1.6 HDi 75 | 55         |            | 02.06 | 03.08 |                              | 24.3728-0850.2 | 590850 |                          |                                      | L=899, + AUT  |          |
|            | 2.0 HDi 90 | 66         |            | 04.00 | 03.08 |                              |                |        |                          |                                      |               |          |
|            | 1.6 HDi 90 | 66         | ORGA 11129 | 02.06 |       |                              | 24.3728-0850.2 | 590850 |                          | + BE4-Getriebe <sup>4)</sup>         | L=899, + AUT  |          |
|            | 1.9 D      | 51         | ORGA 11129 | 07.96 |       |                              |                |        |                          |                                      |               |          |
| 2.0 HDi 90 | 66         | ORGA 11129 | 04.00      |       |       |                              |                |        |                          |                                      |               |          |
|            | 1.6 HDi 90 | 66         | ORGA 11130 |       | 03.08 |                              | 24.3728-0343.2 | 590343 |                          | + BE4-Getriebe <sup>4)</sup>         | L=882, + AUT  |          |
|            | 1.9 D      | 51         | ORGA 11130 |       | 03.08 |                              |                |        |                          |                                      |               |          |
|            | 2.0 HDi 90 | 66         | ORGA 11130 |       | 03.08 |                              |                |        |                          |                                      |               |          |

**PEUGEOT PARTNER Tepee/Kasten (B9) (08-)**

|           |             |    |       |       |  |  |                |        |                          |       |                |     |
|-----------|-------------|----|-------|-------|--|--|----------------|--------|--------------------------|-------|----------------|-----|
|           | 1.6         | 72 |       | 08.10 |  |  | 03.2123-3421.3 | 010933 |                          | - ESP | Thz 23,81      | ATE |
|           | 1.6         | 88 |       | 04.10 |  |  |                |        |                          |       |                |     |
|           | 1.6 HDi     | 55 |       | 04.08 |  |  |                |        |                          |       |                |     |
|           | 1.6 HDi     | 66 |       | 04.08 |  |  |                |        |                          |       |                |     |
|           | 1.6 HDi     | 80 |       | 04.08 |  |  |                |        |                          |       |                |     |
|           | 1.6 HDi     | 82 |       | 08.10 |  |  |                |        |                          |       |                |     |
|           | 1.6 HDi 115 | 84 |       | 03.13 |  |  |                |        |                          |       |                |     |
|           | 1.6 HDi 4x4 | 66 |       | 04.12 |  |  |                |        |                          |       |                |     |
|           | 1.6 i 16V   | 66 |       | 04.08 |  |  |                |        |                          |       |                |     |
| 1.6 i 16V | 80          |    | 04.08 |       |  |  |                |        |                          |       |                |     |
|           | 1.6         | 72 |       | 08.10 |  |  | 11.9601-9717.2 | 220901 | <input type="checkbox"/> |       | D=60, - Halter | ATE |
|           | 1.6         | 88 |       | 04.10 |  |  | 11.9601-9718.2 | 220902 | <input type="checkbox"/> |       | D=60, - Halter | ATE |
|           | 1.6 HDi     | 55 |       | 04.08 |  |  | 11.8171-0008.1 | 990049 |                          |       | Führungsbolzen | ATE |
|           | 1.6 HDi     | 66 |       | 04.08 |  |  | 11.0101-5704.2 | 260095 |                          |       | Hülzensatz     | ATE |
|           | 1.6 HDi     | 80 |       | 04.08 |  |  | 11.0441-6008.2 | 250038 |                          |       | Dichtungssatz  | ATE |
|           | 1.6 HDi     | 82 |       | 08.10 |  |  | 11.8116-0356.1 | 390586 | 2                        |       | Haltefeder     | ATE |
|           | 1.6 HDi 115 | 84 |       | 03.13 |  |  |                |        |                          |       |                |     |
|           | 1.6 HDi 4x4 | 66 |       | 04.12 |  |  |                |        |                          |       |                |     |
|           | 1.6 i 16V   | 66 |       | 04.08 |  |  |                |        |                          |       |                |     |
| 1.6 i 16V | 80          |    | 04.08 |       |  |  |                |        |                          |       |                |     |
|           | 1.6         | 72 |       | 08.10 |  |  | 24.5111-0424.3 | 331014 | 2                        |       | L=424          |     |
|           | 1.6         | 88 |       | 04.10 |  |  |                |        |                          |       |                |     |
|           | 1.6 HDi     | 55 |       | 04.08 |  |  |                |        |                          |       |                |     |
|           | 1.6 HDi     | 66 |       | 04.08 |  |  |                |        |                          |       |                |     |
|           | 1.6 HDi     | 80 |       | 04.08 |  |  |                |        |                          |       |                |     |
|           | 1.6 HDi     | 82 |       | 08.10 |  |  |                |        |                          |       |                |     |
|           | 1.6 HDi 115 | 84 |       | 03.13 |  |  |                |        |                          |       |                |     |
|           | 1.6 HDi 4x4 | 66 |       | 04.12 |  |  |                |        |                          |       |                |     |
|           | 1.6 i 16V   | 66 |       | 04.08 |  |  |                |        |                          |       |                |     |
| 1.6 i 16V | 80          |    | 04.08 |       |  |  |                |        |                          |       |                |     |

<sup>1)</sup> - reinforced suspension / - sospensione rinforzata / - châssis renforcé / - suspensión reforzada

<sup>2)</sup> + reinforced suspension / + sospensione rinforzata / + châssis renforcé / + suspensión reforzada

<sup>3)</sup> + BE3 transmission / + scatola cambio BE3 / + boîte de vitesse BE3 / + cambio BE3

<sup>4)</sup> + BE4 transmission / + scatola cambio BE4 / + boîte de vitesse BE4 / + cambio BE4

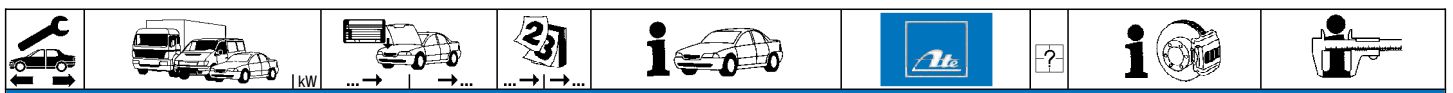

### PEUGEOT PARTNER Tepee/Kasten (B9) (08-)

|  |             |    |       |  |                |        |   |  |        |
|--|-------------|----|-------|--|----------------|--------|---|--|--------|
|  | 1.6         | 72 | 08.10 |  | 24.5246-0216.3 | 331022 | 2 |  | L=216  |
|  | 1.6         | 88 | 04.10 |  |                |        |   |  |        |
|  | 1.6 HDi     | 55 | 04.08 |  |                |        |   |  |        |
|  | 1.6 HDi     | 66 | 04.08 |  |                |        |   |  |        |
|  | 1.6 HDi     | 80 | 04.08 |  |                |        |   |  |        |
|  | 1.6 HDi     | 82 | 08.10 |  |                |        |   |  |        |
|  | 1.6 HDi 115 | 84 | 03.13 |  |                |        |   |  |        |
|  | 1.6 HDi 4x4 | 66 | 04.12 |  |                |        |   |  |        |
|  | 1.6 i 16V   | 66 | 04.08 |  |                |        |   |  |        |
|  | 1.6 i 16V   | 80 | 04.08 |  |                |        |   |  |        |
|  | 1.6         | 72 | 08.10 |  | 24.3727-0853.2 | 580853 | 2 |  | L=2402 |
|  | 1.6         | 88 | 04.10 |  |                |        |   |  |        |
|  | 1.6 HDi     | 55 | 04.08 |  |                |        |   |  |        |
|  | 1.6 HDi     | 66 | 04.08 |  |                |        |   |  |        |
|  | 1.6 HDi     | 80 | 04.08 |  |                |        |   |  |        |
|  | 1.6 HDi     | 82 | 08.10 |  |                |        |   |  |        |
|  | 1.6 HDi 115 | 84 | 03.13 |  |                |        |   |  |        |
|  | 1.6 HDi 4x4 | 66 | 04.12 |  |                |        |   |  |        |
|  | 1.6 i 16V   | 66 | 04.08 |  |                |        |   |  |        |
|  | 1.6 i 16V   | 80 | 04.08 |  |                |        |   |  |        |

### PEUGEOT RCZ (10-)

|  |         |     |       |                         |                |        |   |  |                |     |
|--|---------|-----|-------|-------------------------|----------------|--------|---|--|----------------|-----|
|  | 1.6 16V | 115 | 03.10 |                         | 11.0101-5704.2 | 260095 |   |  | Hülsensatz     | ATE |
|  | 2.0 HDi | 120 | 03.10 | + 18" Rad <sup>1)</sup> | 11.8171-0008.1 | 990049 |   |  | Führungsbolzen | ATE |
|  |         |     |       |                         | 11.8116-0356.1 | 390586 | 2 |  | Haltefeder     | ATE |
|  | 1.6 16V | 147 | 06.10 |                         | 11.9601-9883.2 | 220917 |   |  | D=60, - Halter | ATE |
|  | 2.0 HDi | 120 | 03.10 | + 19" Rad <sup>3)</sup> | 11.9601-9884.2 | 220918 |   |  | D=60, - Halter | ATE |
|  |         |     |       |                         | 11.0101-5407.2 | 260011 |   |  | Hülsensatz     | ATE |
|  |         |     |       |                         | 11.8171-0008.1 | 990049 |   |  | Führungsbolzen | ATE |
|  |         |     |       |                         | 11.0441-6008.2 | 250038 |   |  | Dichtungssatz  | ATE |
|  | 1.6 16V | 115 | 03.10 |                         | 24.5246-0190.3 | 330697 | 2 |  | L=190          |     |
|  | 1.6 16V | 147 | 06.10 |                         |                |        |   |  |                |     |
|  | 2.0 HDi | 120 | 03.10 |                         |                |        |   |  |                |     |

### PORSCHE 911 CABRIO (964) (89-94)

|  |               |     |       |       |                |        |   |  |       |
|--|---------------|-----|-------|-------|----------------|--------|---|--|-------|
|  | 3.6 CARRERA   | 184 | 07.89 | 05.94 | 83.6220-0296.3 | 330324 | 2 |  | L=295 |
|  | 3.6 CARRERA 4 | 184 | 05.89 | 05.94 |                |        |   |  |       |
|  | 3.6 CARRERA   | 184 | 07.89 | 05.94 | 83.6205-0252.3 | 330315 | 2 |  | L=250 |
|  | 3.6 CARRERA 4 | 184 | 05.89 | 05.94 |                |        |   |  |       |

### PORSCHE 911 (993) (93-97)

|  |                  |     |       |       |                |        |   |  |       |
|--|------------------|-----|-------|-------|----------------|--------|---|--|-------|
|  | 3.6 CARRERA      |     | 10.93 | 09.97 | 83.6220-0296.3 | 330324 | 2 |  | L=295 |
|  | 3.6 CARRERA 4    |     | 07.94 | 09.97 |                |        |   |  |       |
|  | 3.6 TURBO 4      | 300 | 03.95 | 09.97 |                |        |   |  |       |
|  | 3.6 TURBO GT2    | 316 | 03.95 | 09.97 |                |        |   |  |       |
|  | 3.6 TURBO GT2 4  |     | 08.95 | 09.97 |                |        |   |  |       |
|  | 3.8 CARRERA      | 210 | 06.95 | 09.97 |                |        |   |  |       |
|  | 3.8 CARRERA 4    | 210 | 06.95 | 09.97 |                |        |   |  |       |
|  | 3.8 CARRERA RS   | 221 | 06.95 | 09.97 |                |        |   |  |       |
|  | 3.8 CARRERA RS 4 | 221 | 08.95 | 09.97 |                |        |   |  |       |
|  | 3.6 CARRERA      |     | 01.95 | 09.97 | 83.6116-0226.3 | 330454 | 2 |  | L=230 |
|  | 3.6 CARRERA 4    |     | 01.95 | 09.97 |                |        |   |  |       |
|  | 3.6 TURBO 4      | 300 | 03.95 | 09.97 |                |        |   |  |       |
|  | 3.6 TURBO GT2    | 316 | 03.95 | 09.97 |                |        |   |  |       |
|  | 3.6 TURBO GT2 4  |     | 08.95 | 09.97 |                |        |   |  |       |
|  | 3.8 CARRERA      | 210 | 06.95 | 09.97 |                |        |   |  |       |
|  | 3.8 CARRERA 4    | 210 | 06.95 | 09.97 |                |        |   |  |       |
|  | 3.8 CARRERA RS   | 221 | 06.95 | 09.97 |                |        |   |  |       |
|  | 3.8 CARRERA RS 4 | 221 | 08.95 | 09.97 |                |        |   |  |       |

### PORSCHE 911 TARGA (993) (95-97)

|  |             |     |       |       |                |        |   |  |       |
|--|-------------|-----|-------|-------|----------------|--------|---|--|-------|
|  | 3.6 CARRERA | 210 | 08.95 | 09.97 | 83.6220-0296.3 | 330324 | 2 |  | L=295 |
|  | 3.6 CARRERA | 210 | 08.95 | 09.97 | 83.6116-0226.3 | 330454 | 2 |  | L=230 |

### PORSCHE 911 CABRIO (993) (94-97)

|  |                  |     |       |       |                |        |   |  |       |
|--|------------------|-----|-------|-------|----------------|--------|---|--|-------|
|  | 3.6 CARRERA      |     | 07.94 | 09.97 | 83.6220-0296.3 | 330324 | 2 |  | L=295 |
|  | 3.6 CARRERA 4    |     | 07.94 | 09.97 |                |        |   |  |       |
|  | 3.8 CARRERA      | 210 | 06.95 | 09.97 |                |        |   |  |       |
|  | 3.8 CARRERA 4    | 210 | 06.95 | 09.97 |                |        |   |  |       |
|  | 3.8 CARRERA RS   | 221 | 08.95 | 09.97 |                |        |   |  |       |
|  | 3.8 CARRERA RS 4 | 221 | 08.95 | 09.97 |                |        |   |  |       |
|  | 3.6 CARRERA      |     | 01.95 | 09.97 | 83.6116-0226.3 | 330454 | 2 |  | L=230 |
|  | 3.6 CARRERA 4    |     | 01.95 | 09.97 |                |        |   |  |       |
|  | 3.8 CARRERA      | 210 | 06.95 | 09.97 |                |        |   |  |       |
|  | 3.8 CARRERA 4    | 210 | 06.95 | 09.97 |                |        |   |  |       |
|  | 3.8 CARRERA RS   | 221 | 08.95 | 09.97 |                |        |   |  |       |
|  | 3.8 CARRERA RS 4 | 221 | 08.95 | 09.97 |                |        |   |  |       |

<sup>1)</sup> + 18" wheel / + ruota 18" / + roue 18" / + rueda 18"

<sup>2)</sup> - brake caliper, painted / - pinza freno, verniciata / - étrier de frein, verni / - pinza de freno, pintada

<sup>3)</sup> + 19" wheel / + ruota 19" / + roue 19" / + rueda 19"



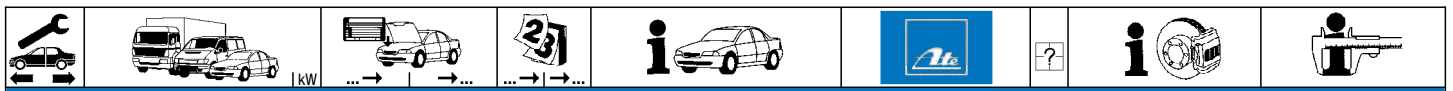

**PORSCHE 911 (996) (97-05)**

|             |               |       |       |       |                |        |   |           |
|-------------|---------------|-------|-------|-------|----------------|--------|---|-----------|
|             | 3.4 CARRERA   |       | 09.97 | 09.01 | 24.2123-1717.3 | 010521 |   | THz 23,81 |
|             | 3.6 CARRERA   |       | 10.01 | 08.05 |                |        |   |           |
|             | 3.4 CARRERA 4 |       | 06.97 | 09.01 | 24.2123-1730.3 | 010620 |   | THz 23,81 |
|             | 3.6 CARRERA 4 |       | 10.01 | 08.05 |                |        |   |           |
|             | 3.4 CARRERA   |       | 09.97 | 09.01 | 83.6239-0297.3 | 330643 | 2 | L=295     |
|             | 3.4 CARRERA 4 |       | 06.97 | 09.01 |                |        |   |           |
|             | 3.6 CARRERA   |       | 10.01 | 08.05 |                |        |   |           |
|             | 3.6 CARRERA 4 |       | 10.01 | 08.05 |                |        |   |           |
|             | 3.6 GT2       |       | 04.01 | 08.05 |                |        |   |           |
|             | 3.6 GT3       |       | 03.99 | 08.05 |                |        |   |           |
| 3.6 TURBO 4 |               | 06.00 | 08.05 |       |                |        |   |           |
|             | 3.4 CARRERA   |       | 09.97 | 09.01 | 83.6239-0297.3 | 330643 | 2 | L=295     |
|             | 3.4 CARRERA 4 |       | 06.97 | 09.01 |                |        |   |           |
|             | 3.6 CARRERA   |       | 10.01 | 08.05 |                |        |   |           |
|             | 3.6 CARRERA 4 |       | 10.01 | 08.05 |                |        |   |           |
|             | 3.6 GT2       |       | 04.01 | 08.05 |                |        |   |           |
|             | 3.6 GT3       |       | 03.99 | 08.05 |                |        |   |           |
| 3.6 TURBO 4 |               | 06.00 | 08.05 |       |                |        |   |           |

**PORSCHE 911 TARGA (996) (01-05)**

|  |     |     |       |       |                |        |   |           |
|--|-----|-----|-------|-------|----------------|--------|---|-----------|
|  | 3.6 | 235 | 12.01 | 08.05 | 24.2123-1717.3 | 010521 |   | THz 23,81 |
|  | 3.6 | 235 | 12.01 | 08.05 | 83.6239-0297.3 | 330643 | 2 | L=295     |
|  | 3.6 | 235 | 12.01 | 08.05 | 83.6239-0297.3 | 330643 | 2 | L=295     |

























**PORSCHE 911 CABRIO (996) (98-05)**

|  |               |  |       |       |                |        |   |           |
|--|---------------|--|-------|-------|----------------|--------|---|-----------|
|  | 3.4 CARRERA   |  | 02.98 | 09.01 | 24.2123-1717.3 | 010521 |   | THz 23,81 |
|  | 3.6 CARRERA   |  | 10.01 | 08.05 |                |        |   |           |
|  | 3.4 CARRERA 4 |  | 02.98 | 09.01 | 24.2123-1730.3 | 010620 |   | THz 23,81 |
|  | 3.6 CARRERA 4 |  | 10.01 | 08.05 |                |        |   |           |
|  | 3.4 CARRERA   |  | 02.98 | 09.01 | 83.6239-0297.3 | 330643 | 2 | L=295     |
|  | 3.4 CARRERA 4 |  | 02.98 | 09.01 |                |        |   |           |
|  | 3.6 CARRERA   |  | 10.01 | 08.05 |                |        |   |           |
|  | 3.6 CARRERA 4 |  | 10.01 | 08.05 |                |        |   |           |
|  | 3.6 TURBO 4   |  | 10.03 | 08.05 | 83.6239-0297.3 | 330643 | 2 | L=295     |
|  | 3.4 CARRERA   |  | 02.98 | 09.01 |                |        |   |           |
|  | 3.4 CARRERA 4 |  | 02.98 | 09.01 |                |        |   |           |
|  | 3.6 CARRERA   |  | 10.01 | 08.05 |                |        |   |           |
|  | 3.6 CARRERA 4 |  | 10.01 | 08.05 | 83.6239-0297.3 | 330643 | 2 | L=295     |
|  | 3.6 CARRERA 4 |  | 10.01 | 08.05 |                |        |   |           |
|  | 3.6 CARRERA 4 |  | 10.01 | 08.05 |                |        |   |           |
|  | 3.6 TURBO 4   |  | 10.03 | 08.05 |                |        |   |           |

**PORSCHE 911 COUPE (997) (04-)**





















|              |                  |       |       |  |                |        |   |           |     |
|--------------|------------------|-------|-------|--|----------------|--------|---|-----------|-----|
|              | 3.6 Carrera      | 239   | 07.04 |  | 24.2123-1766.3 | 010825 |   | THz 23,81 | LUC |
|              | 3.6 Carrera      | 239   | 07.04 |  | 83.6239-0297.3 | 330643 | 2 | L=295     |     |
|              | 3.6 Carrera      | 254   | 06.08 |  |                |        |   |           |     |
|              | 3.6 Carrera 4    | 239   | 07.04 |  |                |        |   |           |     |
|              | 3.6 Carrera 4    | 254   | 06.08 |  |                |        |   |           |     |
|              | 3.6 GT 2         | 390   | 09.07 |  |                |        |   |           |     |
|              | 3.6 GT2 RS       | 456   | 05.10 |  |                |        |   |           |     |
|              | 3.6 GT3          | 305   | 03.06 |  |                |        |   |           |     |
|              | 3.6 Turbo        | 353   | 03.06 |  |                |        |   |           |     |
|              | 3.8 Carrera 4GTS | 300   | 06.09 |  |                |        |   |           |     |
|              | 3.8 Carrera 4S   | 261   | 07.04 |  |                |        |   |           |     |
|              | 3.8 Carrera 4S   | 280   | 08.05 |  |                |        |   |           |     |
|              | 3.8 Carrera 4S   | 283   | 06.08 |  |                |        |   |           |     |
|              | 3.8 Carrera GTS  | 300   | 06.09 |  |                |        |   |           |     |
|              | 3.8 Carrera S    | 261   | 07.04 |  |                |        |   |           |     |
|              | 3.8 Carrera S    | 280   | 08.05 |  |                |        |   |           |     |
|              | 3.8 Carrera S    | 283   | 06.08 |  |                |        |   |           |     |
| 3.8 GT3      | 320              | 05.09 |       |  |                |        |   |           |     |
| 3.8 GT3 RS   | 331              | 08.09 |       |  |                |        |   |           |     |
| 3.8 Turbo    | 368              | 09.09 |       |  |                |        |   |           |     |
| 3.8 Turbo 4S | 390              | 02.10 |       |  |                |        |   |           |     |
| 4.0 GT3 RS   | 368              | 07.11 |       |  |                |        |   |           |     |
|              | 3.6 Carrera      | 239   | 07.04 |  | 83.6239-0297.3 | 330643 | 2 | L=295     |     |
|              | 3.6 Carrera      | 254   | 06.08 |  |                |        |   |           |     |
|              | 3.6 Carrera 4    | 239   | 07.04 |  |                |        |   |           |     |
|              | 3.6 Carrera 4    | 254   | 06.08 |  |                |        |   |           |     |
|              | 3.6 GT 2         | 390   | 09.07 |  |                |        |   |           |     |
|              | 3.6 GT2 RS       | 456   | 05.10 |  |                |        |   |           |     |
|              | 3.6 GT3          | 305   | 03.06 |  |                |        |   |           |     |
|              | 3.6 Turbo        | 353   | 03.06 |  |                |        |   |           |     |
|              | 3.8 Carrera 4GTS | 300   | 06.09 |  |                |        |   |           |     |
|              | 3.8 Carrera 4S   | 261   | 07.04 |  |                |        |   |           |     |
|              | 3.8 Carrera 4S   | 280   | 08.05 |  |                |        |   |           |     |
|              | 3.8 Carrera 4S   | 283   | 06.08 |  |                |        |   |           |     |
|              | 3.8 Carrera GTS  | 300   | 06.09 |  |                |        |   |           |     |
|              | 3.8 Carrera S    | 261   | 07.04 |  |                |        |   |           |     |
|              | 3.8 Carrera S    | 280   | 08.05 |  |                |        |   |           |     |
|              | 3.8 Carrera S    | 283   | 06.08 |  |                |        |   |           |     |
| 3.8 GT3      | 320              | 05.09 |       |  |                |        |   |           |     |
| 3.8 GT3 RS   | 331              | 08.09 |       |  |                |        |   |           |     |
| 3.8 Turbo    | 368              | 09.09 |       |  |                |        |   |           |     |
| 3.8 Turbo 4S | 390              | 02.10 |       |  |                |        |   |           |     |
| 4.0 GT3 RS   | 368              | 07.11 |       |  |                |        |   |           |     |



|     |  |  |  |  |  |  |  |  |  |       |
|--|--|--|--|--|---|--|--|--|--|-------|
| <b>PORSCHE 911 COUPE (997) (04-)</b>   |  |  |  |  |   |  |  |  |  |       |
|    | 3.8 Carrera S  | 283  |  | 06.08  |   | 83.6239-0297.3   | 330643   | 2  | L=295                                    |       |
|  | 3.8 GT3  | 320  |  | 05.09  |   |  |  |  |  |       |
|  | 3.8 GT3 RS   | 331  |  | 08.09  |   |  |  |  |  |       |
|  | 3.8 Turbo  | 368  |  | 09.09  |   |  |  |  |  |       |
|  | 3.8 Turbo 4S   | 390  |  | 02.10  |   |  |  |  |  |       |
|  | 4.0 GT3 RS   | 368  |  | 07.11  |   |  |  |  |  |       |
| <b>PORSCHE 911 CABRIO (997) (05-)</b>  |  |  |  |  |   |  |  |  |  |       |
|    | 3.6 Carrera  | 254  |  | 06.08  |   | 24.2123-1766.3   | 010825   |  | THz 23,81 LUC                            |       |
|  | 3.6 Carrera  | 239  |  | 04.05  |   |  |  |  |  |       |
|  | 3.6 Carrera 4  | 239  |  | 04.05  |   |  |  |  |  |       |
|  | 3.6 Carrera 4  | 254  |  | 06.08  |   |  |  |  |  |       |
|    | 3.6 Carrera  | 254  |  | 06.08  |   | 83.6239-0297.3   | 330643   | 2  | L=295                                    |       |
|  | 3.6 Carrera  | 239  |  | 04.05  |   |  |  |  |  |       |
|  | 3.6 Carrera 4  | 239  |  | 04.05  |   |  |  |  |  |       |
|  | 3.6 Carrera 4  | 254  |  | 06.08  |   |  |  |  |  |       |
|  | 3.6 Turbo  | 353  |  | 09.07  |   |  |  |  |  |       |
|  | 3.8 Carrera 4S   | 261  |  | 04.05  |   |  |  |  |  |       |
|  | 3.8 Carrera 4S   | 280  |  | 08.05  |   |  |  |  |  |       |
|  | 3.8 Carrera 4S   | 283  |  | 06.08  |   |  |  |  |  |       |
|  | 3.8 Carrera S  | 261  |  | 04.05  |   |  |  |  |  |       |
|  | 3.8 Carrera S  | 280  |  | 08.05  |   |  |  |  |  |       |
|  | 3.8 Carrera S  | 283  |  | 06.08  |   |  |  |  |  |       |
|  | 3.8 Turbo 4S   | 390  |  | 02.10  |   |  |  |  |  |       |
|    | 3.6 Carrera  | 254  |  | 06.08  |   | 83.6239-0297.3   | 330643   | 2  | L=295                                    |       |
|  | 3.6 Carrera  | 239  |  | 04.05  |   |  |  |  |  |       |
|  | 3.6 Carrera 4  | 239  |  | 04.05  |   |  |  |  |  |       |
|  | 3.6 Carrera 4  | 254  |  | 06.08  |   |  |  |  |  |       |
|  | 3.6 Turbo  | 353  |  | 09.07  |   |  |  |  |  |       |
|  | 3.8 Carrera 4S   | 261  |  | 04.05  |   |  |  |  |  |       |
|  | 3.8 Carrera 4S   | 280  |  | 08.05  |   |  |  |  |  |       |
|  | 3.8 Carrera 4S   | 283  |  | 06.08  |   |  |  |  |  |       |
|  | 3.8 Carrera S  | 261  |  | 04.05  |   |  |  |  |  |       |
|  | 3.8 Carrera S  | 280  |  | 08.05  |   |  |  |  |  |       |
|  | 3.8 Carrera S  | 283  |  | 06.08  |   |  |  |  |  |       |
|  | 3.8 Turbo 4S   | 390  |  | 02.10  |   |  |  |  |  |       |
| <b>PORSCHE 911 TARGA (997) (06-)</b>   |  |  |  |  |   |  |  |  |  |       |
|   | 3.6 Carrera 4  | 239  |  | 11.06  |   | 83.6239-0297.3   | 330643   | 2  | L=295                                    |       |
|  | 3.6 TARGA 4  | 254  |  | 06.08  |   |  |  |  |  |       |
|  | 3.8 Carrera 4S   | 261  |  | 11.06  |   |  |  |  |  |       |
|  | 3.8 TARGA 4S   | 283  |  | 06.08  |   |  |  |  |  |       |
|  | 3.6 Carrera 4  | 239  |  | 11.06  |   | 83.6239-0297.3   | 330643   | 2  | L=295                                    |       |
|  | 3.6 TARGA 4  | 254  |  | 06.08  |   |  |  |  |  |       |
|  | 3.8 Carrera 4S   | 261  |  | 11.06  |   |  |  |  |  |       |
|  | 3.8 TARGA 4S   | 283  |  | 06.08  |   |  |  |  |  |       |
| <b>PORSCHE 968 COUPE (91-95)</b>   |  |  |  |  |   |  |  |  |  |       |
|  | 3.0  | 176  |  | 06.91  | 11.95   | 03.7750-5702.4   | 300083   |  | 9" ATE                                   |       |
|  | 3.0  | 176  |  | 06.91  | 11.95   | 03.2023-0542.3<br>03.3517-0101.2   | 010024<br>390322   |  | THz 23,81/20,64<br>Verschlusschraube ATE |       |
|  | 3.0  | 176  |  | 06.91  | 11.95   | - Sportfahrwerk <sup>1)</sup>  | 83.6101-0413.3   | 330213   | 2  | L=415 |
|  | 3.0  | 176  |  | 06.91  | 11.95   | + Sportfahrwerk <sup>2)</sup>  | 83.6251-0301.3   | 330556   | 2  | L=300 |
|  | 3.0  | 176  |  | 06.91  | 11.95   |  | 83.6201-0175.3   | 330663   | 2  | L=175 |
| <b>PORSCHE 968 CABRIO (91-95)</b>  |  |  |  |  |   |  |  |  |  |       |
|  | 3.0  | 176  |  | 06.91  | 11.95   | 03.7750-5702.4   | 300083   |  | 9" ATE                                   |       |
|  | 3.0  | 176  |  | 06.91  | 11.95   | 03.2023-0542.3<br>03.3517-0101.2   | 010024<br>390322   |  | THz 23,81/20,64<br>Verschlusschraube ATE |       |
|  | 3.0  | 176  |  | 06.91  | 11.95   | - Sportfahrwerk <sup>1)</sup>  | 83.6101-0413.3   | 330213   | 2  | L=415 |
|  | 3.0  | 176  |  | 06.91  | 11.95   | + Sportfahrwerk <sup>2)</sup>  | 83.6251-0301.3   | 330556   | 2  | L=300 |
|  | 3.0  | 176  |  | 06.91  | 11.95   |  | 83.6201-0175.3   | 330663   | 2  | L=175 |
| <b>PORSCHE BOXSTER (986) (96-04)</b>   |  |  |  |  |   |  |  |  |  |       |
|  | 2.5  | 150  |  | 09.96  | 07.99   | 24.2123-1717.3   | 010521   |  | THz 23,81                                |       |
|  | 2.7  | 162  |  | 08.99  | 12.00   |  |  |  |  |       |
|  | 3.2 S  | 185  |  | 08.99  | 12.00   |  |  |  |  |       |
|  | 2.7  | 162  |  | 12.01  | 06.02   | 24.2123-1730.3   | 010620   |  | THz 23,81                                |       |
|  | 2.7  | 168  |  | 07.02  | 12.04   |  |  |  |  |       |
|  | 3.2 S  | 185  |  | 12.01  | 06.02   |  |  |  |  |       |
|  | 3.2 S  | 191  |  | 07.02  | 12.04   |  |  |  |  |       |
|  | 3.2 S  | 196  |  | 01.04  | 12.04   |  |  |  |  |       |

<sup>1)</sup> - sports suspension / - sospensione sportiva / - châssis de sport / - suspensión deportiva

<sup>2)</sup> + sports suspension / + sospensione sportiva / + châssis de sport / + suspensión deportiva

|     |  |  |  |  |  |  |  |  |   |                               |              |     |
|--|--|--|--|--|---|--|--|--|---|-------------------------------|--------------|-----|
| <b>PORSCHE BOXSTER (986) (96-04)</b>   |  |  |  |  |   |  |  |  |   |                               |              |     |
|    | 2.5  | 150  |  | 09.96  | 07.99   |  | 83.6239-0297.3   | 330643   | 2 |                               | L=295        |     |
|  | 2.7  | 162  |  | 08.99  | 06.02   |  |  |  |   |                               |              |     |
|  | 2.7  | 168  |  | 07.02  | 12.04   |  |  |  |   |                               |              |     |
|  | 3.2 S  | 185  |  | 08.99  | 06.02   |  |  |  |   |                               |              |     |
|  | 3.2 S  | 191  |  | 07.02  | 12.04   |  |  |  |   |                               |              |     |
|  | 3.2 S  | 196  |  | 01.04  | 12.04   |  |  |  |   |                               |              |     |
|    | 2.5  | 150  |  | 09.96  | 07.99   |  | 83.6239-0297.3   | 330643   | 2 |                               | L=295        |     |
|  | 2.7  | 162  |  | 08.99  | 06.02   |  |  |  |   |                               |              |     |
|  | 2.7  | 168  |  | 07.02  | 12.04   |  |  |  |   |                               |              |     |
|  | 3.2 S  | 185  |  | 08.99  | 06.02   |  |  |  |   |                               |              |     |
|  | 3.2 S  | 191  |  | 07.02  | 12.04   |  |  |  |   |                               |              |     |
|  | 3.2 S  | 196  |  | 01.04  | 12.04   |  |  |  |   |                               |              |     |
|    | 2.5  | 150  |  | 09.96  | 07.99   |  | 03.2522-4300.3   | 040085   |   |                               | Nz 22,20     |     |
|  | 2.7  | 162  |  | 08.99  | 06.02   |  |  |  |   |                               |              |     |
|  | 2.7  | 168  |  | 07.02  | 12.04   |  |  |  |   |                               |              |     |
|  | 3.2 S  | 185  |  | 08.99  | 06.02   |  |  |  |   |                               |              |     |
|  | 3.2 S  | 191  |  | 07.02  | 12.04   |  |  |  |   |                               |              |     |
|  | 3.2 S  | 196  |  | 01.04  | 12.04   |  |  |  |   |                               |              |     |
| <b>PORSCHE BOXSTER (987) (05-11)</b>   |  |  |  |  |   |  |  |  |   |                               |              |     |
|    | 2.7  | 176  |  | 11.04  | 07.06   |  | 24.2123-1766.3   | 010825   |   | - Keramikbremse <sup>1)</sup> | THz 23,81    | LUC |
|  | 2.7  | 180  |  | 06.06  | 09.11   |  |  |  |   |                               |              |     |
|  | 2.9  | 188  |  | 06.09  | 09.11   |  |  |  |   |                               |              |     |
|  | 3.2 S  | 206  |  | 11.04  | 07.06   |  |  |  |   |                               |              |     |
|  | 3.4 S  | 217  |  | 06.06  | 09.11   |  |  |  |   |                               |              |     |
|  | 3.4 S  | 228  |  | 06.09  | 09.11   |  |  |  |   |                               |              |     |
|  | 3.4 S RS SPYDER  | 223  |  | 08.08  | 09.11   |  |  |  |   |                               |              |     |
|    | 2.7  | 176  |  | 11.04  | 07.06   |  | 83.6239-0297.3   | 330643   | 2 |                               | L=295        |     |
|  | 2.7  | 180  |  | 06.06  | 09.11   |  |  |  |   |                               |              |     |
|  | 2.9  | 188  |  | 06.09  | 09.11   |  |  |  |   |                               |              |     |
|  | 3.2 S  | 206  |  | 11.04  | 07.06   |  |  |  |   |                               |              |     |
|  | 3.4 S  | 217  |  | 06.06  | 09.11   |  |  |  |   |                               |              |     |
|  | 3.4 S  | 228  |  | 06.09  | 09.11   |  |  |  |   |                               |              |     |
|  | 3.4 S RS SPYDER  | 223  |  | 08.08  | 09.11   |  |  |  |   |                               |              |     |
| <b>PORSCHE CAYENNE I (03-10)</b>   |  |  |  |  |   |  |  |  |   |                               |              |     |
|    | 3.0 TDI  | 176  |  | 02.09  | 04.10   |  | 03.7868-4102.4   | 300250   |   |                               | 10/8" Tandem | ATE |
|  | 3.6  | 213  |  | 01.07  | 04.10   |  |  |  |   |                               |              |     |
|  | S 4.8  | 283  |  | 01.07  | 04.10   |  |  |  |   |                               |              |     |
|  | Turbo S 4.8  | 368  |  | 01.07  | 04.10   |  |  |  |   |                               |              |     |
|  | 3.0 TDI  | 176  |  | 02.09  | 04.10   |  | 03.2126-3014.3   | 010811   |   |                               | 10/8" Tandem | ATE |
|  | 3.2  | 177  |  | 08.03  | 04.10   |  |  |  |   |                               |              |     |
|  | 3.2  | 184  |  | 10.03  | 12.06   |  |  |  |   |                               |              |     |
|  | 3.6  | 213  |  | 01.07  | 04.10   |  |  |  |   |                               |              |     |
|  | GTS 4.8  | 298  |  | 10.07  | 04.10   |  |  |  |   |                               |              |     |
|  | S 4.5  | 250  |  | 09.02  | 12.06   |  |  |  |   |                               |              |     |
|  | S 4.8  | 283  |  | 01.07  | 04.10   |  |  |  |   |                               |              |     |
|  | Turbo 4.5  | 331  |  | 09.02  | 12.06   |  |  |  |   |                               |              |     |
|  | Turbo S 4.5  | 368  |  | 01.04  | 04.10   |  |  |  |   |                               |              |     |
|  | Turbo S 4.5  | 383  |  | 01.04  | 04.10   |  |  |  |   |                               |              |     |
|  | Turbo S 4.8  | 368  |  | 01.07  | 04.10   |  |  |  |   |                               |              |     |
|  | Turbo S 4.8  | 397  |  | 02.07  | 04.10   |  |  |  |   |                               |              |     |
|  | Turbo S 4.8  | 404  |  | 08.08  | 04.10   |  |  |  |   |                               |              |     |
|  | 3.2  | 184  |  | 10.03  | 12.06   |  | 83.6213-0515.3   | 330866   | 2 |                               | L=515        |     |
|  | S 4.5  | 250  |  | 09.02  | 12.06   |  |  |  |   |                               |              |     |
|  | Turbo 4.5  | 331  |  | 09.02  | 12.06   |  |  |  |   |                               |              |     |
|  | 3.6  | 213  |  | 01.07  | 04.10   |  | 83.6213-0515.3   | 330866   | 2 |                               | L=515        |     |
|  | GTS 4.8  | 298  |  | 10.07  | 04.10   |  |  |  |   |                               |              |     |
|  | S 4.8  | 283  |  | 01.07  | 04.10   |  |  |  |   |                               |              |     |
|  | Turbo S 4.8  | 368  |  | 01.07  | 04.10   |  |  |  |   |                               |              |     |
|  | 3.2  | 184  |  | 10.03  | 12.06   |  | 83.7812-0400.3   | 331214   | 2 |                               | L=400        |     |
|  | S 4.5  | 250  |  | 09.02  | 12.06   |  |  |  |   |                               |              |     |
|  | Turbo 4.5  | 331  |  | 09.02  | 12.06   |  |  |  |   |                               |              |     |
|  | 3.6  | 213  |  | 01.07  | 04.10   |  | 83.7812-0400.3   | 331214   | 2 |                               | L=400        |     |
|  | GTS 4.8  | 298  |  | 10.07  | 04.10   |  |  |  |   |                               |              |     |
|  | S 4.8  | 283  |  | 01.07  | 04.10   |  |  |  |   |                               |              |     |
|  | Turbo S 4.8  | 368  |  | 01.07  | 04.10   |  |  |  |   |                               |              |     |
| <b>PORSCHE CAYMAN (987C) (05-12)</b>   |  |  |  |  |   |  |  |  |   |                               |              |     |
|  | 2.7  | 180  |  | 05.06  | 05.12   |  | 24.2123-1766.3   | 010825   |   | - Keramikbremse <sup>1)</sup> | THz 23,81    | LUC |
|  | 2.9  | 195  |  | 02.09  | 05.12   |  |  |  |   |                               |              |     |
|  | 3.4 S  | 217  |  | 11.05  | 05.12   |  |  |  |   |                               |              |     |
|  | 3.4 S  | 235  |  | 02.09  | 05.12   |  |  |  |   |                               |              |     |
|  | 3.4 S Sport  | 223  |  | 08.08  | 05.12   |  |  |  |   |                               |              |     |
|  | R 3.4  | 243  |  | 11.10  | 05.12   |  |  |  |   |                               |              |     |
|  | 2.7  | 180  |  | 05.06  | 05.12   |  | 83.6239-0297.3   | 330643   | 2 |                               | L=295        |     |
|  | 2.9  | 195  |  | 02.09  | 05.12   |  |  |  |   |                               |              |     |
|  | 3.4 S  | 217  |  | 11.05  | 05.12   |  |  |  |   |                               |              |     |
|  | 3.4 S  | 235  |  | 02.09  | 05.12   |  |  |  |   |                               |              |     |
|  | 3.4 S Sport  | 223  |  | 08.08  | 05.12   |  |  |  |   |                               |              |     |
|  | R 3.4  | 243  |  | 11.10  | 05.12   |  |  |  |   |                               |              |     |

<sup>1)</sup> - ceramic brake / - freno in ceramica / - frein de céramique / - freno de cerámica

| PROTON PERSONA 400 (94-00) |  | PROTON WIRA (00-05)   |  | RENAULT AVANTIME (01-03)   |  | RENAULT CAPTUR (J87) (13-)                         |                | RENAULT CLIO I Limousine (B/C 57_) (90-98) |                  |  |           |  |            |
|----------------------------|--|---|--|--|--|--|----------------|--|------------------|--|-----------|--|------------|
|                            | 1.5 GLi<br>2.0 TD  | 66<br>60  |  | 01.94<br>09.96   | 07.00<br>07.00   |  |                | 24.3219-1752.3                             | 020505           |  |           | Rz 19,05                               |            |
|                            | 1.3 i 12V<br>1.5 i 12V   | 55<br>64  |  | 08.00<br>08.00   | 09.05<br>09.05   |  |                | 24.5205-0205.3                             | 330780           | 2  |           | L=205                                  |            |
|                            | 1.3 i 12V<br>1.5 i 12V   | 55<br>64  |  | 08.00<br>08.00   | 09.05<br>09.05   |  |                | 24.3219-1752.3                             | 020505           |  |           | Rz 19,05                               |            |
|                            | 2.0 16V Turbo<br>2.2 dCi<br>3.0 V6   | 120<br>110<br>152   |  | 11.01<br>05.02<br>09.01  | 06.03<br>06.03<br>06.03  |  |                | 03.2123-1486.3                             | 010488           |  |           | THz 23,81                              | ATE        |
|                            | 2.2 dCi<br>3.0 V6  | 110<br>152  |  | 05.02<br>09.01   | 06.03<br>06.03   | + ASR<br>+ ASR                                     |                | 03.2123-2621.3                             | 010701           |  |           | THz 23,81                              | ATE        |
|                            | 2.0 16V Turbo<br>2.2 dCi<br>3.0 V6   | 120<br>110<br>152   |  | 11.01<br>05.02<br>09.01  | 06.03<br>06.03<br>06.03  |  |                | 24.3451-1713.7<br>24.3451-1714.7           | 220737<br>220738 | <input type="checkbox"/><br><input type="checkbox"/> |           | D=40/45, - Halter<br>D=40/45, - Halter | LUC<br>LUC |
|                            | 2.0 16V Turbo<br>2.2 dCi<br>3.0 V6   | 120<br>110<br>152   |  | 11.01<br>05.02<br>09.01  | 06.03<br>06.03<br>06.03  |  |                | 24.5229-0185.3                             | 330397           | 2 <input type="checkbox"/>                           |           | L=185                                  |            |
|                            | 0.9 TCe 90<br>1.2 TCe<br>1.5 dCi   | 66<br>88<br>66  |  | 06.13<br>06.13<br>06.13  |  |  |                | 24.3541-1823.5<br>24.3541-1824.5           | 240417<br>240418 | <input type="checkbox"/><br><input type="checkbox"/> |           | D=54, - Halter<br>D=54, - Halter       |            |
|                            | 0.9 TCe 90   | 66  |  | 06.13  |  |  |                | 24.3219-1761.3<br>24.3222-1729.3           | 020536<br>020526 |  |           | Rz 19,05<br>Rz 22,20                   |            |
|                            | 1.1<br>1.2<br>1.2 (5/357F/J/L/R)<br>1.2 (5/357K.5/357Y)<br>1.2 (5/357K.5/357Y)<br>1.2 (B/C 577)<br>1.2 (B/C 57A/S)<br>1.2 (B/C 57R)<br>1.4<br>1.4<br>1.4 (B/C 57J)<br>1.4 (B/C 57J)<br>1.4 (B/C 57T/Y)<br>1.4 (B/C 57T/Y)<br>1.7<br>1.8<br>1.8 (B/C 578)<br>1.8 (B/C 57C/U)<br>1.8 16V<br>1.8 Rsi (B/C 579)<br>1.8 Rsi (B/C 57H)<br>1.9 D<br>1.9 D<br>Electric<br>Williams (B/C 57M) | 34<br>44<br>43<br>40<br>43<br>40<br>43<br>40<br>59<br>59<br>55<br>55<br>58<br>58<br>68<br>70<br>66<br>65<br>99<br>80<br>79<br>40<br>47<br>21<br>108 |  | 01.91<br>05.90<br>10.94<br>01.96<br>01.96<br>01.96<br>01.96<br>01.91<br>01.91<br>01.91<br>01.91<br>01.91<br>01.91<br>01.91<br>01.91<br>08.94<br>01.91<br>08.91<br>01.93<br>08.95<br>01.97<br>01.91<br>05.96<br>01.94 | 09.98<br>03.96<br>09.98<br>09.98<br>09.98<br>12.96<br>09.98<br>01.96<br>09.98<br>09.98<br>09.98<br>09.98<br>04.95<br>09.98<br>09.98<br>09.98<br>09.98<br>06.94<br>08.95<br>09.98<br>09.98<br>09.98<br>02.98<br>09.98 |  |                | 03.2120-2031.3                             | 010106           |  |           | THz 20,64                              | ATE        |
|                            | 1.2<br>1.2 (5/357F/J/L/R)<br>1.2 (5/357K.5/357Y)<br>1.2 (5/357K.5/357Y)<br>1.2 (B/C 577)<br>1.2 (B/C 57A/S)<br>1.2 (B/C 57R)<br>1.4 RTI/S<br>1.4 RTI/S (B/C 57J)<br>1.4 RTI/S (B/C 57T/Y)<br>1.8<br>1.8 (B/C 578)<br>1.8 (B/C 57C/U)<br>1.8 16V<br>1.8 Rsi (B/C 579)<br>1.8 Rsi (B/C 57H)<br>1.9 D<br>1.9 D  | 44<br>43<br>40<br>43<br>40<br>43<br>40<br>59<br>55<br>58<br>70<br>66<br>65<br>99<br>80<br>79<br>40<br>47  |  | 05.90<br>10.94<br>01.96<br>01.96<br>01.96<br>05.90<br>01.91<br>01.91<br>01.91<br>01.91<br>01.91<br>08.94<br>01.91<br>08.91<br>01.93<br>08.95<br>01.97<br>01.91   | 03.96<br>09.98<br>09.98<br>09.98<br>12.96<br>09.98<br>01.96<br>09.98<br>09.98<br>09.98<br>09.98<br>09.98<br>09.98<br>06.94<br>08.95<br>09.98<br>09.98  |  | 03.2119-3389.3 | 010057                                     |                  |  | THz 19,05 | ATE                                    |            |
|                            | 1.2<br>1.2 (5/357F/J/L/R)<br>1.2 (5/357K.5/357Y)<br>1.2 (5/357K.5/357Y)<br>1.2 (B/C 577)<br>1.2 (B/C 57A/S)<br>1.2 (B/C 57R)<br>1.9 D  | 44<br>43<br>40<br>43<br>40<br>43<br>40  |  | 05.90<br>10.94<br>01.96<br>01.96<br>01.96<br>05.90<br>01.91  | 03.96<br>09.98<br>09.98<br>09.98<br>12.96<br>09.98<br>01.96  | + ABS<br>+ ABS<br>+ ABS<br>+ ABS<br>+ ABS<br>+ ABS | 24.2120-1725.3 | 010579                                     |                  |  | THz 20,64 | BDX                                    |            |

1) - ABS/ - driving school / - ABS/ - scuola guida / - ABS/ - auto-école / - ABS/ - autoescuela  
2) - ABS/ + driving school / - ABS/ + scuola guida / - ABS/ + auto école / - ABS/ + autoescuela

























| RENAULT CLIO I Limousine (B/C 57_) (90-98) |                     | kW  |       | 23    |                                    | i              |        | Atc |  | ? |  | i |                | i          |  |
|--|---------------------|-----|-------|-------|------------------------------------|----------------|--------|-----|--|---|--|---|----------------|------------|--|
|  | 1.4 (B/C 57J)       | 59  | 01.91 | 09.98 | + ABS                              | 24.2120-1725.3 | 010579 |     |  |   |  |   | Thz 20,64      | <b>BDX</b> |  |
|  | 1.4 (B/C 57T/Y)     | 58  | 01.91 | 09.98 | + ABS                              |                |        |     |  |   |  |   |                |            |  |
|  | 1.7                 | 68  | 01.91 | 04.95 | + ABS                              |                |        |     |  |   |  |   |                |            |  |
|  | 1.8                 | 70  | 01.91 | 09.98 | + ABS                              |                |        |     |  |   |  |   |                |            |  |
|  | 1.8 (B/C 578)       | 66  | 08.94 | 09.98 | + ABS                              |                |        |     |  |   |  |   |                |            |  |
|  | 1.8 (B/C 57C/U)     | 65  | 01.91 | 09.98 | + ABS                              |                |        |     |  |   |  |   |                |            |  |
|  | 1.8 16V             | 99  | 08.91 | 06.94 | + ABS                              |                |        |     |  |   |  |   |                |            |  |
|  | 1.8 Rsi (B/C 579)   | 80  | 01.93 | 08.95 | + ABS                              |                |        |     |  |   |  |   |                |            |  |
|  | 1.8 Rsi (B/C 57H)   | 79  | 08.95 | 09.98 | + ABS                              |                |        |     |  |   |  |   |                |            |  |
|  | 1.9 D               | 40  | 01.97 | 09.98 | + ABS                              |                |        |     |  |   |  |   |                |            |  |
|  | 1.9 D               | 47  | 01.91 | 09.98 | + ABS                              |                |        |     |  |   |  |   |                |            |  |
|  | 1.1                 | 34  | 01.91 | 04.92 |                                    | 24.3451-1501.5 | 240263 |     |  |   |  |   | D=45, - Halter | <b>BDX</b> |  |
|  |                     |     |       |       |                                    | 24.3451-1502.5 | 240264 |     |  |   |  |   | D=45, - Halter | <b>BDX</b> |  |
|  |                     |     |       |       |                                    | 24.3481-1611.5 | 240029 |     |  |   |  |   | D=48, - Halter | <b>LUC</b> |  |
|  |                     |     |       |       |                                    | 24.3481-1612.5 | 240030 |     |  |   |  |   | D=48, - Halter | <b>LUC</b> |  |
|  |                     |     |       |       |                                    | 24.0101-4807.2 | 260053 |     |  |   |  |   | Einbausatz     | <b>LUC</b> |  |
|  | 1.1                 | 34  | 05.92 | 09.98 |                                    | 24.3481-1505.5 | 240047 |     |  |   |  |   | D=48, - Halter | <b>BDX</b> |  |
|  | 1.2                 | 44  | 05.90 | 03.96 |                                    | 24.3481-1506.5 | 240048 |     |  |   |  |   | D=48, - Halter | <b>BDX</b> |  |
|  | 1.2 (5/357F/J/L/R)  | 43  | 10.94 | 09.98 |                                    | 24.3481-1611.5 | 240029 |     |  |   |  |   | D=48, - Halter | <b>LUC</b> |  |
|  | 1.2 (5/357K.5/357Y) | 40  | 01.96 | 09.98 |                                    | 24.3481-1612.5 | 240030 |     |  |   |  |   | D=48, - Halter | <b>LUC</b> |  |
|  | 1.2 (5/357K.5/357Y) | 43  | 01.96 | 09.98 |                                    | 24.0101-4803.2 | 260049 |     |  |   |  |   | Einbausatz     | <b>BDX</b> |  |
|  | 1.2 (B/C 577)       | 40  | 01.96 | 12.96 |                                    | 24.0101-4807.2 | 260053 |     |  |   |  |   | Einbausatz     | <b>LUC</b> |  |
|  | 1.2 (B/C 57A/S)     | 43  | 05.90 | 09.98 |                                    |                |        |     |  |   |  |   |                |            |  |
|  | 1.2 (B/C 57R)       | 40  | 01.91 | 01.96 |                                    |                |        |     |  |   |  |   |                |            |  |
|  | 1.4                 | 59  | 01.91 | 09.98 | + Automatikgetriebe <sup>1)</sup>  |                |        |     |  |   |  |   |                |            |  |
|  | 1.4 (B/C 57J)       | 55  | 01.91 | 09.98 | + Automatikgetriebe <sup>1)</sup>  |                |        |     |  |   |  |   |                |            |  |
|  | 1.4 (B/C 57T/Y)     | 58  | 01.91 | 09.98 | + Automatikgetriebe <sup>1)</sup>  |                |        |     |  |   |  |   |                |            |  |
|  | 1.9 D (B/C 576)     | 47  | 01.91 | 01.94 |                                    |                |        |     |  |   |  |   |                |            |  |
|  | Electric            | 21  | 05.96 | 02.98 |                                    |                |        |     |  |   |  |   |                |            |  |
|  | 1.4                 | 59  | 01.91 | 09.98 | + Schaltgetriebe <sup>2)</sup>     | 24.3481-1611.5 | 240029 |     |  |   |  |   | D=48, - Halter | <b>LUC</b> |  |
|  | 1.4 (B/C 57J)       | 55  | 01.91 | 09.98 | + Schaltgetriebe <sup>2)</sup>     | 24.3481-1612.5 | 240030 |     |  |   |  |   | D=48, - Halter | <b>LUC</b> |  |
|  | 1.4 (B/C 57T/Y)     | 58  | 01.91 | 09.98 | + Schaltgetriebe <sup>2)</sup>     | 24.0101-4807.2 | 260053 |     |  |   |  |   | Einbausatz     | <b>LUC</b> |  |
|  | 1.9 D (B/C 57I)     | 47  | 07.92 | 01.94 |                                    |                |        |     |  |   |  |   |                |            |  |
|  | 1.9 D (B/C 57L)     | 47  | 01.91 | 01.94 |                                    |                |        |     |  |   |  |   |                |            |  |
|  | 1.4                 | 59  | 04.96 | 09.98 | + Automatikgetriebe <sup>1)</sup>  | 24.3481-1505.5 | 240047 |     |  |   |  |   | D=48, - Halter | <b>BDX</b> |  |
|  | 1.4 (B/C 57J)       | 55  | 04.96 | 09.98 | + Automatikgetriebe <sup>1)</sup>  | 24.3481-1506.5 | 240048 |     |  |   |  |   | D=48, - Halter | <b>BDX</b> |  |
|  | 1.4 (B/C 57T/Y)     | 58  | 04.96 | 09.98 | + Automatikgetriebe <sup>1)</sup>  | 24.3481-1615.5 | 240031 |     |  |   |  |   | D=48, - Halter | <b>LUC</b> |  |
|  | 1.4 S               | 59  | 01.91 | 09.98 |                                    | 24.3481-1616.5 | 240032 |     |  |   |  |   | D=48, - Halter | <b>LUC</b> |  |
|  | 1.4 S (B/C 57J)     | 55  | 01.91 | 09.98 |                                    | 24.0101-4807.2 | 260053 |     |  |   |  |   | Einbausatz     | <b>LUC</b> |  |
|  | 1.4 S (B/C 57T/Y)   | 58  | 01.91 | 09.98 |                                    |                |        |     |  |   |  |   |                |            |  |
|  | 1.7                 | 68  | 01.91 | 04.95 |                                    |                |        |     |  |   |  |   |                |            |  |
|  | 1.8                 | 70  | 01.91 | 09.98 |                                    |                |        |     |  |   |  |   |                |            |  |
|  | 1.8 (B/C 578)       | 66  | 08.94 | 09.98 |                                    |                |        |     |  |   |  |   |                |            |  |
|  | 1.8 (B/C 57C/U)     | 65  | 01.91 | 09.98 |                                    |                |        |     |  |   |  |   |                |            |  |
|  | 1.8 16V             | 99  | 08.91 | 08.94 |                                    |                |        |     |  |   |  |   |                |            |  |
|  | 1.8 Rsi (B/C 579)   | 80  | 01.93 | 08.95 |                                    |                |        |     |  |   |  |   |                |            |  |
|  | 1.8 Rsi (B/C 57H)   | 79  | 08.95 | 09.98 |                                    |                |        |     |  |   |  |   |                |            |  |
|  | 1.9 D               | 40  | 01.97 | 09.98 |                                    |                |        |     |  |   |  |   |                |            |  |
|  | 1.9 D (B/C 576)     | 47  | 02.94 | 09.98 |                                    |                |        |     |  |   |  |   |                |            |  |
|  | 1.9 D (B/C 57I)     | 47  | 02.94 | 09.98 |                                    |                |        |     |  |   |  |   |                |            |  |
|  | 1.9 D (B/C 57L)     | 47  | 02.94 | 09.98 |                                    |                |        |     |  |   |  |   |                |            |  |
|  | Williams (B/C 57M)  | 108 | 01.94 | 09.98 |                                    |                |        |     |  |   |  |   |                |            |  |
|  | 1.1                 | 34  | 01.91 | 09.98 |                                    | 24.5111-0241.3 | 330680 | 2   |  |   |  |   | L=242          |            |  |
|  | 1.2                 | 44  | 05.90 | 03.96 |                                    |                |        |     |  |   |  |   |                |            |  |
|  | 1.2 (5/357F/J/L/R)  | 43  | 10.94 | 09.98 |                                    |                |        |     |  |   |  |   |                |            |  |
|  | 1.2 (5/357K.5/357Y) | 40  | 01.96 | 09.98 |                                    |                |        |     |  |   |  |   |                |            |  |
|  | 1.2 (5/357K.5/357Y) | 43  | 01.96 | 09.98 |                                    |                |        |     |  |   |  |   |                |            |  |
|  | 1.2 (B/C 577)       | 40  | 01.96 | 12.96 |                                    |                |        |     |  |   |  |   |                |            |  |
|  | 1.2 (B/C 57A/S)     | 43  | 05.90 | 09.98 |                                    |                |        |     |  |   |  |   |                |            |  |
|  | 1.2 (B/C 57R)       | 40  | 01.91 | 01.96 |                                    |                |        |     |  |   |  |   |                |            |  |
|  | 1.4                 | 59  | 01.91 | 09.98 |                                    |                |        |     |  |   |  |   |                |            |  |
|  | 1.4 (B/C 57J)       | 55  | 01.91 | 09.98 |                                    |                |        |     |  |   |  |   |                |            |  |
|  | 1.4 (B/C 57T/Y)     | 58  | 01.91 | 09.98 |                                    |                |        |     |  |   |  |   |                |            |  |
|  | 1.7                 | 68  | 01.91 | 04.95 |                                    |                |        |     |  |   |  |   |                |            |  |
|  | 1.8                 | 70  | 01.91 | 09.98 |                                    |                |        |     |  |   |  |   |                |            |  |
|  | 1.8 (B/C 578)       | 66  | 08.94 | 09.98 |                                    |                |        |     |  |   |  |   |                |            |  |
|  | 1.8 (B/C 57C/U)     | 65  | 01.91 | 09.98 |                                    |                |        |     |  |   |  |   |                |            |  |
|  | 1.8 Rsi (B/C 579)   | 80  | 01.93 | 08.95 |                                    |                |        |     |  |   |  |   |                |            |  |
|  | 1.8 Rsi (B/C 57H)   | 79  | 08.95 | 09.98 |                                    |                |        |     |  |   |  |   |                |            |  |
|  | 1.9 D               | 40  | 01.97 | 09.98 |                                    |                |        |     |  |   |  |   |                |            |  |
|  | 1.9 D               | 47  | 01.91 | 09.98 |                                    |                |        |     |  |   |  |   |                |            |  |
|  | Electric            | 21  | 05.96 | 02.98 |                                    |                |        |     |  |   |  |   |                |            |  |
|  | 1.1                 | 34  | 01.91 | 09.98 |                                    | 24.5229-0265.3 | 330540 | 2   |  |   |  |   | L=265          |            |  |
|  | 1.2                 | 44  | 05.90 | 03.96 | - ABS                              |                |        |     |  |   |  |   |                |            |  |
|  | 1.2 (5/357F/J/L/R)  | 43  | 10.94 | 09.98 | - ABS                              |                |        |     |  |   |  |   |                |            |  |
|  | 1.2 (5/357K.5/357Y) | 40  | 01.96 | 09.98 | - ABS                              |                |        |     |  |   |  |   |                |            |  |
|  | 1.2 (5/357K.5/357Y) | 43  | 01.96 | 09.98 | - ABS                              |                |        |     |  |   |  |   |                |            |  |
|  | 1.2 (B/C 577)       | 40  | 01.96 | 12.96 | - ABS                              |                |        |     |  |   |  |   |                |            |  |
|  | 1.2 (B/C 57A/S)     | 43  | 05.90 | 09.98 | - ABS                              |                |        |     |  |   |  |   |                |            |  |
|  | 1.2 (B/C 57R)       | 40  | 01.91 | 01.96 | - ABS                              |                |        |     |  |   |  |   |                |            |  |
|  | 1.4                 | 59  | 01.91 | 09.98 | - ABS                              |                |        |     |  |   |  |   |                |            |  |
|  | 1.4 (B/C 57J)       | 55  | 01.91 | 09.98 | - ABS                              |                |        |     |  |   |  |   |                |            |  |
|  | 1.4 (B/C 57T/Y)     | 58  | 01.91 | 09.98 | - ABS                              |                |        |     |  |   |  |   |                |            |  |
|  | 1.7                 | 68  | 01.91 | 04.95 | - ABS/ - Klimaanlage <sup>3)</sup> |                |        |     |  |   |  |   |                |            |  |
|  | 1.7                 | 68  | 01.91 | 11.93 | - ABS/ + Klimaanlage <sup>4)</sup> |                |        |     |  |   |  |   |                |            |  |
|  | 1.8 (B/C 57C)       | 65  | 01.91 | 11.93 | - ABS/ + Klimaanlage <sup>4)</sup> |                |        |     |  |   |  |   |                |            |  |

<sup>1)</sup> + autom.transmission / + scatola cambio automatico / + transmission automatique / + cambio automático

<sup>2)</sup> + manual transmission / + scatola cambio velocità / + transmission mécanique / + cambio de velocidad

<sup>3)</sup> - ABS/ - air conditioning / - ABS/ - aria condizionata / - ABS/ - air conditionné / - ABS/ - aire acondicionado

<sup>4)</sup> - ABS/ + air conditioning / - ABS/ + aria condizionata / - ABS/ + air conditionné / - ABS/ + aire acondicionado

| RENAULT CLIO I Limousine (B/C 57_) (90-98)                                       |  |  |  |  |   |  |  |   |           |            |
|--|--|--|--|--|---|--|--|---|-----------|------------|
|   |  |  |  |  |  |  |  |     |           |            |
|  | 1.8 (B/C 57C)  | 65   | 01.91  | 09.98  | - ABS/ - Klimaanlage 1)   | 24.5229-0265.3   | 330540   | 2   | L=265     |            |
|  | 1.8 (B/C 57U)  | 65   | 01.91  | 11.93  | - ABS/ + Klimaanlage 2)   |  |  |   |           |            |
|  | 1.8 (B/C 57U)  | 65   | 01.91  | 09.98  | - ABS/ - Klimaanlage 1)   |  |  |   |           |            |
|  | 1.9 D  | 40   | 01.97  | 09.98  | - ABS   |  |  |   |           |            |
|  | 1.9 D  | 47   | 01.91  | 09.98  | - ABS   |  |  |   |           |            |
|  | Electric   | 21   | 05.96  | 02.98  |   |  |  |   |           |            |
|  | 1.2  | 44   | 05.90  | 03.96  | + ABS   | 24.5229-0220.3   | 330399   | 2   | L=220     |            |
|  | 1.2 (5/357F/J/L/R)   | 43   | 10.94  | 09.98  | + ABS   |  |  |   |           |            |
|  | 1.2 (5/357K.5/357Y)  | 40   | 01.96  | 09.98  | + ABS   |  |  |   |           |            |
|  | 1.2 (5/357K.5/357Y)  | 43   | 01.96  | 09.98  | + ABS   |  |  |   |           |            |
|  | 1.2 (B/C 577)  | 40   | 01.96  | 12.96  | + ABS   |  |  |   |           |            |
|  | 1.2 (B/C 57A/S)  | 43   | 05.90  | 09.98  | + ABS   |  |  |   |           |            |
|  | 1.2 (B/C 57R)  | 40   | 01.91  | 01.96  | + ABS   |  |  |   |           |            |
|  | 1.4  | 59   | 01.91  | 09.98  | + ABS   |  |  |   |           |            |
|  | 1.4 (B/C 57J)  | 55   | 01.91  | 09.98  | + ABS   |  |  |   |           |            |
|  | 1.4 (B/C 57T/Y)  | 58   | 01.91  | 09.98  | + ABS   |  |  |   |           |            |
|  | 1.7  | 68   | 01.91  | 04.95  | + ABS   |  |  |   |           |            |
|  | 1.7  | 68   | 12.93  | 04.95  | - ABS/ + Klimaanlage 2)   |  |  |   |           |            |
|  | 1.8  | 70   | 01.91  | 09.98  |   |  |  |   |           |            |
|  | 1.8 (B/C 57C)  | 65   | 01.91  | 09.98  | + ABS   |  |  |   |           |            |
|  | 1.8 (B/C 57C)  | 65   | 12.93  | 09.98  | - ABS/ + Klimaanlage 2)   |  |  |   |           |            |
|  | 1.8 (B/C 57U)  | 65   | 01.91  | 09.98  | + ABS   |  |  |   |           |            |
|  | 1.8 (B/C 57U)  | 65   | 12.93  | 09.98  | - ABS/ + Klimaanlage 2)   |  |  |   |           |            |
|  | 1.8 Rsi (B/C 579)  | 80   | 01.93  | 08.95  |   |  |  |   |           |            |
|  | 1.8 Rsi (B/C 57H)  | 79   | 08.95  | 09.98  |   |  |  |   |           |            |
|  | 1.9 D  | 40   | 01.97  | 09.98  | + ABS   |  |  |   |           |            |
|  | 1.9 D  | 47   | 01.91  | 09.98  | + ABS   |  |  |   |           |            |
|  | Williams (B/C 57M)   | 108  | 01.94  | 09.98  |   |  |  |   |           |            |
|  | 1.1  | 34   | 01.91  | 03.91  |   | 24.3220-1624.3   | 020354   |    | RzR 20,64 | <b>BDX</b> |
|  | 1.2  | 44   | 05.90  | 03.91  | - ABS   | 24.3220-1623.3   | 020353   |    | RzR 20,64 | <b>BDX</b> |
|  | 1.2 (B/C 57A/S)  | 43   | 05.90  | 03.91  | - ABS   | 24.3220-1714.3   | 020411   |    | RzR 20,64 | <b>LUC</b> |
|  | 1.2 (B/C 57R)  | 40   | 01.91  | 03.91  | - ABS   | 24.3220-1713.3   | 020410   |    | RzR 20,64 | <b>LUC</b> |
|  | 1.4  | 59   | 01.91  | 03.91  | - ABS   |  |  |   |           |            |
|  | 1.4 (B/C 57J)  | 55   | 01.91  | 03.91  | - ABS   |  |  |   |           |            |
|  | 1.4 (B/C 57T/Y)  | 58   | 01.91  | 03.91  | - ABS   |  |  |   |           |            |
|  | 1.7  | 68   | 01.91  | 03.91  | - ABS   |  |  |   |           |            |
|  | 1.8 (B/C 57C)  | 65   | 01.91  | 03.91  | - ABS   |  |  |   |           |            |
|  | 1.9 D (B/C 576)  | 47   | 01.91  | 03.91  | - ABS   |  |  |   |           |            |
|  | 1.9 D (B/C 57L)  | 47   | 01.91  | 03.91  | - ABS   |  |  |   |           |            |
|  | Electric   | 21   | 05.96  | 02.98  |   |  |  |   |           |            |
|  | 1.1  | 34   | 04.91  | 09.98  |   | 24.3220-1623.3   | 020353   |   | RzR 20,64 | <b>BDX</b> |
|  | 1.2  | 44   | 04.91  | 03.96  | - ABS   | 24.3220-1624.3   | 020354   |  | RzR 20,64 | <b>BDX</b> |
|  | 1.2 (5/357K.5/357Y)  | 40   | 01.96  | 09.98  | - ABS   | 24.3220-1713.3   | 020410   |  | RzR 20,64 | <b>LUC</b> |
|  | 1.2 (5/357K.5/357Y)  | 43   | 01.96  | 09.98  | - ABS   | 24.3220-1714.3   | 020411   |  | RzR 20,64 | <b>LUC</b> |
|  | 1.2 (B 57N)  | 43   | 09.91  | 04.96  |   |  |  |   |           |            |
|  | 1.2 (B/C 577)  | 40   | 01.96  | 12.96  | - ABS   |  |  |   |           |            |
|  | 1.2 (B/C 57A/S)  | 43   | 04.91  | 09.98  | - ABS   |  |  |   |           |            |
|  | 1.2 (B/C 57R)  | 40   | 04.91  | 01.96  | - ABS   |  |  |   |           |            |
|  | 1.4  | 59   | 04.91  | 04.96  | - ABS   |  |  |   |           |            |
|  | 1.4 (B/C 57J)  | 55   | 04.91  | 04.96  | - ABS   |  |  |   |           |            |
|  | 1.4 (B/C 57T/Y)  | 58   | 04.91  | 04.96  | - ABS   |  |  |   |           |            |
|  | 1.7  | 68   | 04.91  | 04.95  | - ABS   |  |  |   |           |            |
|  | 1.8 (357A)   | 70   | 10.94  | 04.96  | - ABS   |  |  |   |           |            |
|  | 1.8 (357D)   | 70   | 10.94  | 04.96  | - ABS   |  |  |   |           |            |
|  | 1.8 (557A)   | 70   | 08.94  | 04.96  | - ABS   |  |  |   |           |            |
|  | 1.8 (557D)   | 70   | 08.94  | 04.96  | - ABS   |  |  |   |           |            |
|  | 1.8 (B/C 578)  | 66   | 08.94  | 04.96  | - ABS   |  |  |   |           |            |
|  | 1.8 (B/C 57C)  | 65   | 04.91  | 04.96  | - ABS   |  |  |   |           |            |
|  | 1.8 (B/C 57U)  | 65   | 01.91  | 11.96  | - ABS   |  |  |   |           |            |
|  | 1.9 D (B/C 576)  | 47   | 04.91  | 04.96  | - ABS   |  |  |   |           |            |
|  | 1.9 D (B/C 57I)  | 47   | 07.92  | 04.96  | - ABS   |  |  |   |           |            |
|  | 1.9 D (B/C 57L)  | 47   | 04.91  | 04.96  | - ABS   |  |  |   |           |            |
|  | 1.2 (5/357G)   | 43   | 01.94  | 04.96  |   | 24.3220-1623.3   | 020353   |  | RzR 20,64 | <b>BDX</b> |
|  | 1.2 (B 57N)  | 43   | 05.96  | 09.98  |   | 24.3220-1624.3   | 020354   |  | RzR 20,64 | <b>BDX</b> |
|  | 1.4  | 59   | 05.96  | 09.98  | - ABS   |  |  |   |           |            |
|  | 1.4 (B/C 57J)  | 55   | 05.96  | 09.98  | - ABS   |  |  |   |           |            |
|  | 1.4 (B/C 57T/Y)  | 58   | 05.96  | 09.98  | - ABS   |  |  |   |           |            |
|  | 1.8 (557U)   | 70   | 09.96  | 09.98  | - ABS   |  |  |   |           |            |
|  | 1.8 (B/C 578)  | 66   | 05.96  | 09.98  | - ABS   |  |  |   |           |            |
|  | 1.8 (B/C 57C)  | 65   | 05.96  | 09.98  | - ABS   |  |  |   |           |            |
|  | 1.9 D  | 40   | 01.97  | 09.98  | - ABS   |  |  |   |           |            |
|  | 1.9 D (B/C 576)  | 47   | 05.96  | 09.98  | - ABS   |  |  |   |           |            |
|  | 1.9 D (B/C 57I)  | 47   | 05.96  | 09.98  | - ABS   |  |  |   |           |            |
|  | 1.9 D (B/C 57L)  | 47   | 05.96  | 09.98  | - ABS   |  |  |   |           |            |
|  | 1.2 (B 57N)  | 43   | 05.96  | 09.98  |   | 24.3220-1713.3   | 020410   |  | RzR 20,64 | <b>LUC</b> |
|  | 1.4  | 59   | 05.96  | 09.98  | - ABS   | 24.3220-1714.3   | 020411   |  | RzR 20,64 | <b>LUC</b> |
|  | 1.4 (B/C 57J)  | 55   | 05.96  | 09.98  | - ABS   |  |  |   |           |            |
|  | 1.4 (B/C 57T/Y)  | 58   | 05.96  | 09.98  | - ABS   |  |  |   |           |            |
|  | 1.8 (557U)   | 70   | 09.96  | 09.98  | - ABS   |  |  |   |           |            |
|  | 1.8 (B/C 578)  | 66   | 05.96  | 09.98  | - ABS   |  |  |   |           |            |
|  | 1.8 (B/C 57C)  | 65   | 05.96  | 09.98  | - ABS   |  |  |   |           |            |
|  | 1.9 D  | 40   | 01.97  | 09.98  | - ABS   |  |  |   |           |            |
|  | 1.9 D (B/C 576)  | 47   | 09.96  | 09.98  | - ABS   |  |  |   |           |            |
|  | 1.9 D (B/C 57I)  | 47   | 09.96  | 09.98  | - ABS   |  |  |   |           |            |
|  | 1.9 D (B/C 57L)  | 47   | 09.96  | 09.98  | - ABS   |  |  |   |           |            |

1) - ABS/ - air conditioning / - ABS/ - aria condizionata / - ABS/ - air conditionné / - ABS/ - aire acondicionado  
2) - ABS/ + air conditioning / - ABS/ + aria condizionata / - ABS/ + air conditionné / - ABS/ + aire acondicionado

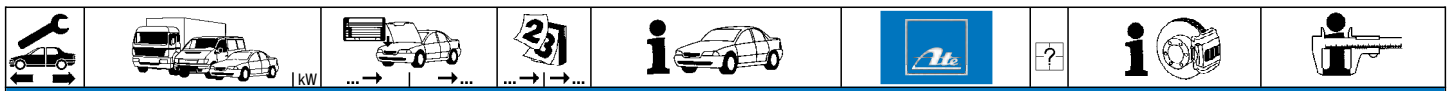

**RENAULT CLIO I Limousine (B/C 57\_) (90-98)**

|  |                     |    |       |       |                |        |     |  |        |
|--|---------------------|----|-------|-------|----------------|--------|-----|--|--------|
|  | 1.1                 | 34 | 01.91 | 09.98 | 24.3727-1008.2 | 581008 | 2 ↓ |  | L=1430 |
|  | 1.2                 | 44 | 05.90 | 03.96 |                |        |     |  |        |
|  | 1.2 (5/357F/J/L/R)  | 43 | 10.94 | 09.98 |                |        |     |  |        |
|  | 1.2 (5/357K.5/357Y) | 40 | 01.96 | 09.98 |                |        |     |  |        |
|  | 1.2 (5/357K.5/357Y) | 43 | 01.96 | 09.98 |                |        |     |  |        |
|  | 1.2 (B/C 577)       | 40 | 01.96 | 12.96 |                |        |     |  |        |
|  | 1.2 (B/C 57A/S)     | 43 | 05.90 | 09.98 |                |        |     |  |        |
|  | 1.2 (B/C 57R)       | 40 | 01.91 | 01.96 |                |        |     |  |        |
|  | 1.4                 | 59 | 01.91 | 09.98 |                |        |     |  |        |
|  | 1.4 (B/C 57J)       | 55 | 01.91 | 09.98 |                |        |     |  |        |
|  | 1.4 (B/C 57T/Y)     | 58 | 01.91 | 09.98 |                |        |     |  |        |
|  | 1.7                 | 68 | 01.91 | 04.95 |                |        |     |  |        |
|  | 1.8 (B/C 57C/U)     | 65 | 01.91 | 09.98 |                |        |     |  |        |
|  | 1.9 D               | 40 | 01.97 | 09.98 |                |        |     |  |        |
|  | 1.9 D               | 47 | 01.97 | 09.98 |                |        |     |  |        |
|  | Electric            | 21 | 05.96 | 02.98 |                |        |     |  |        |

|  |                       |     |       |       |                |        |     |  |        |
|--|-----------------------|-----|-------|-------|----------------|--------|-----|--|--------|
|  | 1.2                   | 44  | 05.90 | 03.96 | 24.3727-1009.2 | 581009 | 2 ↓ |  | L=1480 |
|  | 1.2 (5/357F/J/L/R)    | 43  | 10.94 | 09.98 |                |        |     |  |        |
|  | 1.2 (5/357G)          | 43  | 01.94 | 04.96 |                |        |     |  |        |
|  | 1.2 (5/357K.5/357Y)   | 40  | 01.96 | 09.98 |                |        |     |  |        |
|  | 1.2 (5/357K.5/357Y)   | 43  | 01.96 | 09.98 |                |        |     |  |        |
|  | 1.2 (B 57N)           | 43  | 09.91 | 09.98 |                |        |     |  |        |
|  | 1.2 (B/C 577)         | 40  | 01.96 | 12.96 |                |        |     |  |        |
|  | 1.2 (B/C 57A/S)       | 43  | 05.90 | 09.98 |                |        |     |  |        |
|  | 1.2 (B/C 57R)         | 40  | 01.91 | 01.96 |                |        |     |  |        |
|  | 1.4                   | 59  | 01.91 | 09.98 |                |        |     |  |        |
|  | 1.4 (B/C 57J)         | 55  | 01.91 | 09.98 |                |        |     |  |        |
|  | 1.4 (B/C 57T/Y)       | 58  | 01.91 | 09.98 |                |        |     |  |        |
|  | 1.4 RTI/S             | 59  | 01.91 | 09.98 |                |        |     |  |        |
|  | 1.4 RTI/S (B/C 57J)   | 55  | 01.91 | 09.98 |                |        |     |  |        |
|  | 1.4 RTI/S (B/C 57T/Y) | 58  | 01.91 | 09.98 |                |        |     |  |        |
|  | 1.4 S                 | 59  | 01.91 | 09.98 |                |        |     |  |        |
|  | 1.4 S (B/C 57J)       | 55  | 01.91 | 09.98 |                |        |     |  |        |
|  | 1.4 S (B/C 57T/Y)     | 58  | 01.91 | 09.98 |                |        |     |  |        |
|  | 1.7                   | 68  | 01.91 | 04.95 |                |        |     |  |        |
|  | 1.8 (357A)            | 70  | 10.94 | 09.98 |                |        |     |  |        |
|  | 1.8 (357E)            | 70  | 10.94 | 04.96 |                |        |     |  |        |
|  | 1.8 (557A)            | 70  | 08.94 | 09.98 |                |        |     |  |        |
|  | 1.8 (557U)            | 70  | 09.96 | 09.98 |                |        |     |  |        |
|  | 1.8 (B/C 578)         | 66  | 08.94 | 09.98 |                |        |     |  |        |
|  | 1.8 (B/C 57C/U)       | 65  | 01.91 | 09.98 |                |        |     |  |        |
|  | 1.8 16V               | 99  | 08.91 | 06.94 |                |        |     |  |        |
|  | 1.8 Rsi (B/C 579)     | 80  | 01.93 | 08.95 |                |        |     |  |        |
|  | 1.8 Rsi (B/C 57H)     | 79  | 08.95 | 09.98 |                |        |     |  |        |
|  | Williams (B/C 57M)    | 108 | 01.94 | 09.98 |                |        |     |  |        |

|  |                     |     |       |       |                |        |  |  |       |
|--|---------------------|-----|-------|-------|----------------|--------|--|--|-------|
|  | 1.1                 | 34  | 01.91 | 09.98 | 24.3728-1004.2 | 591004 |  |  | L=992 |
|  | 1.2                 | 44  | 05.90 | 03.96 |                |        |  |  |       |
|  | 1.2 (5/357F/J/L/R)  | 43  | 10.94 | 09.98 |                |        |  |  |       |
|  | 1.2 (5/357K.5/357Y) | 40  | 01.96 | 09.98 |                |        |  |  |       |
|  | 1.2 (5/357K.5/357Y) | 43  | 01.96 | 09.98 |                |        |  |  |       |
|  | 1.2 (B/C 577)       | 40  | 01.96 | 12.96 |                |        |  |  |       |
|  | 1.2 (B/C 57A/S)     | 43  | 05.90 | 09.98 |                |        |  |  |       |
|  | 1.2 (B/C 57R)       | 40  | 01.91 | 01.96 |                |        |  |  |       |
|  | 1.4                 | 59  | 01.91 | 09.98 |                |        |  |  |       |
|  | 1.4 (B/C 57J)       | 55  | 01.91 | 09.98 |                |        |  |  |       |
|  | 1.4 (B/C 57T/Y)     | 58  | 01.91 | 09.98 |                |        |  |  |       |
|  | 1.7                 | 68  | 01.91 | 04.95 |                |        |  |  |       |
|  | 1.8                 | 70  | 01.91 | 09.98 |                |        |  |  |       |
|  | 1.8 (B/C 578)       | 66  | 08.94 | 09.98 |                |        |  |  |       |
|  | 1.8 (B/C 57C/U)     | 65  | 01.91 | 09.98 |                |        |  |  |       |
|  | 1.8 16V             | 99  | 08.91 | 06.94 |                |        |  |  |       |
|  | 1.8 Rsi (B/C 579)   | 80  | 01.93 | 08.95 |                |        |  |  |       |
|  | 1.8 Rsi (B/C 57H)   | 79  | 08.95 | 09.98 |                |        |  |  |       |
|  | 1.9 D               | 40  | 01.97 | 09.98 |                |        |  |  |       |
|  | 1.9 D               | 47  | 01.91 | 09.98 |                |        |  |  |       |
|  | Williams (B/C 57M)  | 108 | 01.94 | 09.98 |                |        |  |  |       |

**RENAULT CLIO I Kasten (S 57\_) (91-98)**

|  |       |    |       |       |                |        |  |           |     |
|--|-------|----|-------|-------|----------------|--------|--|-----------|-----|
|  | 1.1   | 34 | 01.91 | 09.98 | 03.2120-2031.3 | 010106 |  | Thz 20,64 | ATE |
|  | 1.2   | 40 | 01.91 | 09.98 |                |        |  |           |     |
|  | 1.2   | 44 | 01.91 | 09.98 |                |        |  |           |     |
|  | 1.9 D | 48 | 01.91 | 09.98 |                |        |  |           |     |
|  | 1.2   | 40 | 01.91 | 09.98 | 03.2119-3389.3 | 010057 |  | Thz 19,05 | ATE |
|  | 1.2   | 44 | 01.91 | 09.98 |                |        |  |           |     |
|  | 1.9 D | 48 | 01.91 | 09.98 |                |        |  |           |     |
|  | 1.2   | 40 | 01.91 | 09.98 | 24.2120-1725.3 | 010579 |  | Thz 20,64 | BDX |
|  | 1.2   | 44 | 01.91 | 09.98 |                |        |  |           |     |
|  | 1.9 D | 48 | 01.91 | 09.98 |                |        |  |           |     |

|  |     |    |       |       |                |        |  |                |     |
|--|-----|----|-------|-------|----------------|--------|--|----------------|-----|
|  | 1.1 | 34 | 01.91 | 04.92 | 24.3451-1501.5 | 240263 |  | D=45, - Halter | BDX |
|  |     |    |       |       | 24.3451-1502.5 | 240264 |  | D=45, - Halter | BDX |
|  |     |    |       |       | 24.3481-1611.5 | 240029 |  | D=48, - Halter | LUC |
|  |     |    |       |       | 24.3481-1612.5 | 240030 |  | D=48, - Halter | LUC |
|  |     |    |       |       | 24.0101-4807.2 | 260053 |  | Einbausatz     | LUC |

1) - ABS/ - driving school / - ABS/ - scuola guida / - ABS/ - auto-école / - ABS/ - autoescuela  
 2) - ABS/ + driving school / - ABS/ + scuola guida / - ABS/ + auto école / - ABS/ + autoescuela





### RENAULT CLIO I Kasten (S 57\_) (91-98)

|  |       |    |  |       |       |                |        |   |   |                |     |
|--|-------|----|--|-------|-------|----------------|--------|---|---|----------------|-----|
|  | 1.1   | 34 |  | 05.92 | 09.98 | 24.3481-1505.5 | 240047 | ☐ |   | D=48, - Halter | BDX |
|  | 1.2   | 40 |  | 01.91 | 09.98 | 24.3481-1506.5 | 240048 |   |   |                |     |
|  | 1.2   | 44 |  | 01.91 | 09.98 | 24.3481-1611.5 | 240029 | ☐ |   | D=48, - Halter | LUC |
|  | 1.9 D | 48 |  | 01.91 | 01.94 | 24.3481-1612.5 | 240030 |   |   |                |     |
|  | 1.9 D | 48 |  | 01.91 | 01.94 | 24.0101-4803.2 | 260049 |   |   |                |     |
|  | 1.9 D | 48 |  | 01.91 | 01.94 | 24.0101-4807.2 | 260053 | ☐ |   | D=48, - Halter | BDX |
|  | 1.9 D | 48 |  | 02.94 | 09.98 | 24.3481-1505.5 | 240047 |   |   |                |     |
|  | 1.1   | 34 |  | 01.91 | 09.98 | 24.3481-1506.5 | 240048 | ☐ |   | D=48, - Halter | BDX |
|  | 1.2   | 40 |  | 01.91 | 09.98 | 24.3481-1615.5 | 240031 |   |   |                |     |
|  | 1.2   | 44 |  | 01.91 | 09.98 | 24.3481-1616.5 | 240032 |   |   |                |     |
|  | 1.9 D | 48 |  | 01.91 | 09.98 | 24.0101-4803.2 | 260049 |   |   |                |     |
|  | 1.9 D | 48 |  | 01.91 | 09.98 | 24.0101-4806.2 | 260052 | ☐ |   | D=48, - Halter | LUC |
|  | 1.9 D | 48 |  | 01.91 | 09.98 | 24.0101-4806.2 | 260052 |   |   |                |     |
|  | 1.1   | 34 |  | 01.91 | 09.98 | 24.5111-0241.3 | 330680 | 2 |   | L=242          |     |
|  | 1.2   | 40 |  | 01.91 | 09.98 |                |        |   |   |                |     |
|  | 1.2   | 44 |  | 01.91 | 09.98 |                |        |   |   |                |     |
|  | 1.9 D | 48 |  | 01.91 | 09.98 |                |        |   |   |                |     |
|  | 1.1   | 34 |  | 01.91 | 09.98 | 24.5229-0265.3 | 330540 | 2 |   | L=265          |     |
|  | 1.2   | 40 |  | 01.91 | 09.98 |                |        |   |   |                |     |
|  | 1.2   | 44 |  | 01.91 | 09.98 |                |        |   |   |                |     |
|  | 1.9 D | 48 |  | 01.91 | 09.98 |                |        |   |   |                |     |
|  | 1.2   | 40 |  | 01.91 | 09.98 | 24.5229-0220.3 | 330399 | 2 |   | L=220          |     |
|  | 1.2   | 44 |  | 01.91 | 09.98 |                |        |   |   |                |     |
|  | 1.9 D | 48 |  | 01.91 | 09.98 |                |        |   |   |                |     |
|  | 1.9 D | 48 |  | 01.91 | 09.98 |                |        |   |   |                |     |
|  | 1.1   | 34 |  | 01.91 | 03.91 | 24.3220-1624.3 | 020354 | ☐ |   | RzR 20,64      | BDX |
|  | 1.2   | 40 |  | 01.91 | 03.91 | 24.3220-1623.3 | 020353 |   |   |                |     |
|  | 1.2   | 44 |  | 01.91 | 03.91 | 24.3220-1713.3 | 020410 |   |   |                |     |
|  | 1.9 D | 48 |  | 01.91 | 03.91 | 24.3220-1714.3 | 020411 |   |   |                |     |
|  | 1.1   | 34 |  | 04.91 | 09.98 | 24.3220-1623.3 | 020353 |   |   |                |     |
|  | 1.2   | 40 |  | 04.91 | 09.98 | 24.3220-1624.3 | 020354 |   |   |                |     |
|  | 1.2   | 44 |  | 04.91 | 09.98 | 24.3220-1713.3 | 020410 |   |   |                |     |
|  | 1.9 D | 48 |  | 04.91 | 04.96 | 24.3220-1714.3 | 020411 |   |   |                |     |
|  | 1.9 D | 48 |  | 05.96 | 09.98 | 24.3220-1623.3 | 020353 |   |   |                |     |
|  | 1.9 D | 48 |  | 05.96 | 09.98 | 24.3220-1624.3 | 020354 |   |   |                |     |
|  | 1.9 D | 48 |  | 09.96 | 11.96 | 24.3220-1713.3 | 020410 | ☐ |   | RzR 20,64      | LUC |
|  | 1.9 D | 48 |  | 09.96 | 11.96 | 24.3220-1714.3 | 020411 |   |   |                |     |
|  | 1.9 D | 48 |  | 12.96 | 09.98 | 24.3220-1713.3 | 020410 | ☐ |   | RzR 20,64      | LUC |
|  | 1.9 D | 48 |  | 12.96 | 09.98 | 24.3220-1714.3 | 020411 |   |   |                |     |
|  | 1.1   | 34 |  | 01.91 | 09.98 | 24.3727-1008.2 | 581008 | 2 | ↓ | L=1430         |     |
|  | 1.2   | 40 |  | 01.91 | 09.98 |                |        |   |   |                |     |
|  | 1.2   | 44 |  | 01.91 | 09.98 |                |        |   |   |                |     |
|  | 1.9 D | 48 |  | 01.91 | 09.98 |                |        |   |   |                |     |
|  | 1.1   | 34 |  | 01.91 | 09.98 | 24.3728-1004.2 | 591004 |   |   | L=992          |     |
|  | 1.2   | 40 |  | 01.91 | 09.98 |                |        |   |   |                |     |
|  | 1.2   | 44 |  | 01.91 | 09.98 |                |        |   |   |                |     |
|  | 1.9 D | 48 |  | 01.91 | 09.98 |                |        |   |   |                |     |

### RENAULT CLIO II Limousine (BB\_/CB\_) (98-12)

|         |         |         |       |       |       |                |                |   |  |    |     |
|---------|---------|---------|-------|-------|-------|----------------|----------------|---|--|----|-----|
|         | 1.0     | 40      |       | 02.00 | 05.01 | 03.7750-1332.4 | 300155         | ☐ |  | 9" | ATE |
|         | 1.2     | 43      |       | 09.98 | 12.12 |                |                |   |  |    |     |
|         | 1.2     | 44      |       | 03.99 | 05.01 |                |                |   |  |    |     |
|         | 1.2 16V | 55      |       | 06.01 | 10.03 |                |                |   |  |    |     |
|         | 1.4     | 55      |       | 09.98 | 05.05 |                |                |   |  |    |     |
|         | 1.4 16V | 70      |       | 10.99 | 07.00 |                |                |   |  |    |     |
|         | 1.4 16V | 72      |       | 08.00 | 12.12 |                |                |   |  |    |     |
|         | 1.5 dCi | 47      |       | 06.05 | 12.12 |                |                |   |  |    |     |
|         | 1.5 dCi | 48      |       | 06.01 | 12.12 |                |                |   |  |    |     |
|         | 1.5 dCi | 50      |       | 08.04 | 12.12 |                |                |   |  |    |     |
|         | 1.5 dCi | 59      |       | 06.01 | 10.03 |                |                |   |  |    |     |
|         | 1.5 dCi | 60      |       | 06.01 | 12.12 |                |                |   |  |    |     |
|         | 1.5 dCi | 62      |       | 02.07 | 12.12 |                |                |   |  |    |     |
|         | 1.5 dCi | 74      |       | 01.04 | 12.12 |                |                |   |  |    |     |
|         | 1.6     | 66      |       | 09.98 | 05.05 |                |                |   |  |    |     |
|         | 1.6 16V | 79      |       | 09.98 | 12.12 |                |                |   |  |    |     |
|         | 1.9 D   | 47      |       | 09.98 | 05.05 |                |                |   |  |    |     |
|         | 1.9 D   | 48      |       | 02.00 | 05.05 |                |                |   |  |    |     |
|         | 1.9 dTi | 59      |       | 02.00 | 05.05 |                |                |   |  |    |     |
|         |         | 1.2 16V | 55    |       | 06.01 | 10.03          | 03.7853-1502.4 |   |  |    |     |
| 1.4 16V |         | 70      |       | 10.99 | 07.00 | 03.7853-0702.4 | 300195         |   |  |    |     |
| 1.4 16V |         | 72      |       | 08.00 | 12.12 |                |                |   |  |    |     |
| 1.5 dCi |         | 48      |       | 06.01 | 12.12 |                |                |   |  |    |     |
| 1.5 dCi |         | 50      |       | 08.04 | 12.12 |                |                |   |  |    |     |
| 1.5 dCi |         | 59      |       | 06.01 | 10.03 |                |                |   |  |    |     |
| 1.5 dCi |         | 60      |       | 06.01 | 12.12 |                |                |   |  |    |     |
| 1.5 dCi | 62      |         | 02.07 | 12.12 |       |                |                |   |  |    |     |
|         | 1.5 dCi | 74      |       | 01.04 | 12.12 |                |                |   |  |    |     |
|         | 1.0     | 40      |       | 02.00 | 05.01 | 03.2120-4381.3 | 010526         |   |  |    |     |
|         | 1.2     | 43      |       | 09.98 | 12.12 | 03.2120-4461.3 | 010571         |   |  |    |     |
|         | 1.2     | 44      |       | 03.99 | 05.01 | 03.2120-4468.3 | 010789         |   |  |    |     |
|         | 1.2 16V | 55      |       | 06.01 | 10.03 |                |                |   |  |    |     |
|         | 1.4     | 55      |       | 09.98 | 05.05 |                |                |   |  |    |     |
|         | 1.4 16V | 70      |       | 10.99 | 07.00 |                |                |   |  |    |     |
|         | 1.4 16V | 72      |       | 08.00 | 12.12 |                |                |   |  |    |     |
|         | 1.5 dCi | 47      |       | 06.05 | 12.12 |                |                |   |  |    |     |
|         | 1.5 dCi | 48      |       | 06.01 | 12.12 |                |                |   |  |    |     |
| 1.5 dCi | 50      |         | 08.04 | 12.12 |       |                |                |   |  |    |     |
| 1.5 dCi | 59      |         | 06.01 | 10.03 |       |                |                |   |  |    |     |

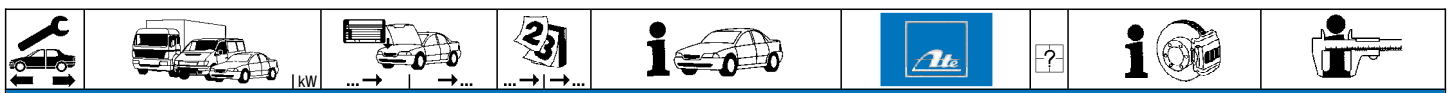

**RENAULT CLIO II Limousine (BB\_/CB\_) (98-12)**

|               |               |       |       |                                    |  |        |                                  |  |                   |        |  |                   |
|---------------|---------------|-------|-------|------------------------------------|--|--------|----------------------------------|--|-------------------|--------|--|-------------------|
|               | 1.5 dCi       | 60    | 06.01 | 12.12                              | 03.2120-4381.3                           | 010526 | - ABS<br>+ ABS<br>+ ESP          | THz 20,64<br>THz 20,64<br>THz 20,64            | ATE<br>ATE<br>ATE |        |  |                   |
|               | 1.5 dCi       | 62    | 02.07 | 12.12                              | 03.2120-4461.3                           | 010571 |                                  |  |                   |        |  |                   |
|               | 1.5 dCi       | 74    | 01.04 | 12.12                              | 03.2120-4468.3                           | 010789 |                                  |  |                   |        |  |                   |
|               | 1.6           | 66    | 09.98 | 05.05                              |  |        |                                  |  |                   |        |  |                   |
|               | 1.6 16V       | 79    | 09.98 | 12.12                              |  |        |                                  |  |                   |        |  |                   |
|               | 1.9 D         | 47    | 09.98 | 05.05                              |  |        |                                  |  |                   |        |  |                   |
|               | 1.9 D         | 48    | 02.00 | 05.05                              |  |        |                                  |  |                   |        |  |                   |
|               | 1.9 dTi       | 59    | 02.00 | 05.05                              |  |        |                                  |  |                   |        |  |                   |
|               | 2.0 16V Sport | 124   | 02.00 | 12.12                              | 03.2122-1926.3                           | 010916 |                                  |  |                   |        | THz 22,20                                      | ATE               |
|               | 2.0 16V Sport | 132   | 01.04 | 12.12                              |  |        |                                  |  |                   |        |  |                   |
|               | 1.0           | 40    | 02.00 | 05.01                              | 24.3481-1611.5                           | 240029 | ☐<br>☐                           | D=48, - Halter<br>D=48, - Halter<br>Einbausatz | LUC<br>LUC<br>LUC |        |  |                   |
|               | 1.2           | 43    | 09.98 | 06.05                              | 24.3481-1612.5                           | 240030 |                                  |  |                   |        |  |                   |
|               | 1.2           | 44    | 03.99 | 05.01                              | 24.0101-4807.2                           | 260053 |                                  |  |                   |        |  |                   |
|               | 1.2 16V       | 55    | 06.01 | 12.12                              |  |        |                                  |  |                   |        |  |                   |
|               | 1.4           | 55    | 09.98 | 06.05                              | - ABS/ + Schaltgetriebe <sup>1)</sup>    |        |                                  |  |                   |        |  |                   |
|               | 1.9 D         | 47    | 09.98 | 06.05                              | - ABS/ - Klimaanlage <sup>2)</sup>       |        |                                  |  |                   |        |  |                   |
|               | 1.9 D         | 48    | 02.00 | 06.05                              | - ABS/ - Klimaanlage <sup>2)</sup>       |        |                                  |  |                   |        |  |                   |
|               | 1.0           | 40    | 02.00 | 05.01                              | 24.3481-1615.5                           | 240031 |                                  |  |                   | ☐<br>☐ | D=48, - Halter<br>D=48, - Halter<br>Einbausatz | LUC<br>LUC<br>LUC |
|               | 1.2           | 43    | 09.98 | 06.05                              | 24.3481-1616.5                           | 240032 |                                  |  |                   |        |  |                   |
|               | 1.2           | 44    | 03.99 | 05.01                              | 24.0101-4806.2                           | 260052 |                                  |  |                   |        |  |                   |
|               | 1.2 16V       | 55    | 06.01 | 12.12                              |  |        |                                  |  |                   |        |  |                   |
|               | 1.4           | 55    | 09.98 | 06.05                              | + ABS/ + Automatikgetriebe <sup>3)</sup> |        |                                  |  |                   |        |  |                   |
|               | 1.4           | 55    | 09.98 | 06.05                              | + ABS/ + Schaltgetriebe <sup>4)</sup>    |        |                                  |  |                   |        |  |                   |
|               | 1.4 16V       | 70    | 10.99 | 07.00                              |  |        |                                  |  |                   |        |  |                   |
|               | 1.4 16V       | 72    | 08.00 | 06.05                              |  |        |                                  |  |                   |        |  |                   |
|               | 1.5 dCi       | 47    | 06.05 | 12.12                              |  |        |                                  |  |                   |        |  |                   |
|               | 1.5 dCi       | 48    | 06.01 | 06.05                              |  |        |                                  |  |                   |        |  |                   |
|               | 1.5 dCi       | 50    | 08.04 | 06.05                              |  |        |                                  |  |                   |        |  |                   |
|               | 1.5 dCi       | 59    | 06.01 | 10.03                              |  |        |                                  |  |                   |        |  |                   |
|               | 1.5 dCi       | 60    | 06.01 | 06.05                              |  |        |                                  |  |                   |        |  |                   |
| 1.5 dCi       | 62            | 02.07 | 12.12 |                                    |  |        |                                  |  |                   |        |  |                   |
| 1.5 dCi       | 74            | 01.04 | 06.05 |                                    |  |        |                                  |  |                   |        |  |                   |
| 1.6           | 66            | 09.98 | 06.05 |                                    |  |        |                                  |  |                   |        |  |                   |
| 1.6 16V       | 79            | 09.98 | 06.05 |                                    |  |        |                                  |  |                   |        |  |                   |
| 1.9 D         | 47            | 09.98 | 06.05 | + ABS/ + Klimaanlage <sup>5)</sup> |  |        |                                  |  |                   |        |  |                   |
| 1.9 D         | 48            | 02.00 | 06.05 | + ABS/ + Klimaanlage <sup>5)</sup> |  |        |                                  |  |                   |        |  |                   |
| 1.9 dTi       | 59            | 02.00 | 06.05 |                                    |  |        |                                  |  |                   |        |  |                   |
| 2.0 16V Sport | 124           | 02.00 | 06.05 | 24.3541-1749.5                     | 240427                                   | ☐<br>☐ | D=54, - Halter<br>D=54, - Halter | LUC<br>LUC                                     |                   |        |  |                   |
| 2.0 16V Sport | 132           | 01.04 | 06.05 | 24.3541-1750.5                     | 240428                                   |        |                                  |  |                   |        |  |                   |
|               | 1.0           | 40    | 02.00 | 05.01                              | 24.5111-0321.3                           | 330597 | 2                                | L=320  |                   |        |  |                   |
|               | 1.2           | 43    | 09.98 | 12.12                              |  |        |                                  |  |                   |        |  |                   |
|               | 1.2           | 44    | 03.99 | 05.01                              |  |        |                                  |  |                   |        |  |                   |
|               | 1.2 16V       | 55    | 06.01 | 12.12                              |  |        |                                  |  |                   |        |  |                   |
|               | 1.4           | 55    | 09.98 | 05.05                              |  |        |                                  |  |                   |        |  |                   |
|               | 1.4 16V       | 70    | 10.99 | 07.00                              |  |        |                                  |  |                   |        |  |                   |
|               | 1.4 16V       | 72    | 08.00 | 12.12                              |  |        |                                  |  |                   |        |  |                   |
|               | 1.5 dCi       | 48    | 06.01 | 12.12                              |  |        |                                  |  |                   |        |  |                   |
|               | 1.5 dCi       | 50    | 08.04 | 12.12                              |  |        |                                  |  |                   |        |  |                   |
|               | 1.5 dCi       | 59    | 06.01 | 10.03                              |  |        |                                  |  |                   |        |  |                   |
|               | 1.5 dCi       | 60    | 06.01 | 12.12                              |  |        |                                  |  |                   |        |  |                   |
|               | 1.5 dCi       | 62    | 02.07 | 12.12                              |  |        |                                  |  |                   |        |  |                   |
|               | 1.5 dCi       | 74    | 01.04 | 12.12                              |  |        |                                  |  |                   |        |  |                   |
|               | 1.6           | 66    | 09.98 | 05.05                              |  |        |                                  |  |                   |        |  |                   |
|               | 1.6 16V       | 79    | 09.98 | 12.12                              |  |        |                                  |  |                   |        |  |                   |
|               | 1.9 D         | 47    | 09.98 | 05.05                              |  |        |                                  |  |                   |        |  |                   |
|               | 1.9 D         | 48    | 02.00 | 05.05                              |  |        |                                  |  |                   |        |  |                   |
|               | 1.9 dTi       | 59    | 02.00 | 05.05                              |  |        |                                  |  |                   |        |  |                   |
|               | 3.0 V6 Sport  | 166   | 11.00 | 11.02                              |  |        |                                  |  |                   |        |  |                   |
|               | 3.0 V6 Sport  | 187   | 12.02 | 12.12                              |  |        |                                  |  |                   |        |  |                   |
| 2.0 16V Sport | 124           | 02.00 | 12.12 | 24.5111-0335.3                     | 330778                                   | 2      | L=335                            |  |                   |        |  |                   |
| 2.0 16V Sport | 132           | 01.04 | 12.12 |                                    |  |        |                                  |  |                   |        |  |                   |
|               | 1.0           | 40    | 02.00 | 05.01                              | 24.5239-0165.3                           | 330606 | 2                                | L=165  |                   |        |  |                   |
|               | 1.2           | 43    | 09.98 | 12.12                              |  |        |                                  |  |                   |        |  |                   |
|               | 1.2           | 44    | 03.99 | 05.01                              |  |        |                                  |  |                   |        |  |                   |
|               | 1.2 16V       | 55    | 06.01 | 12.12                              |  |        |                                  |  |                   |        |  |                   |
|               | 1.4           | 55    | 09.98 | 05.05                              |  |        |                                  |  |                   |        |  |                   |
|               | 1.4 16V       | 70    | 10.99 | 07.00                              |  |        |                                  |  |                   |        |  |                   |
|               | 1.4 16V       | 72    | 08.00 | 12.12                              |  |        |                                  |  |                   |        |  |                   |
|               | 1.5 dCi       | 47    | 06.05 | 12.12                              |  |        |                                  |  |                   |        |  |                   |
|               | 1.5 dCi       | 48    | 06.01 | 12.12                              |  |        |                                  |  |                   |        |  |                   |
|               | 1.5 dCi       | 50    | 08.04 | 12.12                              |  |        |                                  |  |                   |        |  |                   |
|               | 1.5 dCi       | 59    | 06.01 | 10.03                              |  |        |                                  |  |                   |        |  |                   |
|               | 1.5 dCi       | 60    | 06.01 | 12.12                              |  |        |                                  |  |                   |        |  |                   |
|               | 1.5 dCi       | 62    | 02.07 | 12.12                              |  |        |                                  |  |                   |        |  |                   |
|               | 1.5 dCi       | 74    | 01.04 | 12.12                              |  |        |                                  |  |                   |        |  |                   |
|               | 1.6           | 66    | 09.98 | 05.05                              |  |        |                                  |  |                   |        |  |                   |
|               | 1.6 16V       | 79    | 09.98 | 05.05                              |  |        |                                  |  |                   |        |  |                   |
|               | 1.9 D         | 47    | 09.98 | 05.05                              |  |        |                                  |  |                   |        |  |                   |
|               | 1.9 D         | 48    | 02.00 | 05.05                              |  |        |                                  |  |                   |        |  |                   |
|               | 1.9 dTi       | 59    | 02.00 | 05.05                              |  |        |                                  |  |                   |        |  |                   |
|               | 2.0 16V Sport | 124   | 02.00 | 12.12                              |  |        |                                  |  |                   |        |  |                   |
| 2.0 16V Sport | 132           | 01.04 | 12.12 |                                    |  |        |                                  |  |                   |        |  |                   |
| 3.0 V6 Sport  | 166           | 11.00 | 11.02 | 24.5111-0321.3                     | 330597                                   | 2      | L=320                            |  |                   |        |  |                   |
| 3.0 V6 Sport  | 187           | 12.02 | 12.12 |                                    |  |        |                                  |  |                   |        |  |                   |

<sup>1)</sup> - ABS/ + manual transmission / - ABS/+ scatola camb.velocità / - ABS/ + transmission mécanique / - ABS/ + cambio de velocidad

<sup>2)</sup> - ABS/ - air conditioning / - ABS/ - aria condizionata / - ABS/ - air conditionné / - ABS/ - aire acondicionado

<sup>3)</sup> + ABS/ + autom.transmission / + ABS/ + scatola cambio autom. / + ABS/ + transmission automatique / + ABS/ + cambio automatico

<sup>4)</sup> + ABS/ + manual transm. / + ABS/+ scatola camb.velocità / + ABS/ + transmission mécanique / + ABS/ + cambio de velocidad

<sup>5)</sup> + ABS/ + air conditioning / + ABS/ + aria condizionata / + ABS/ + air conditionné / + ABS/ + aire acondicionado

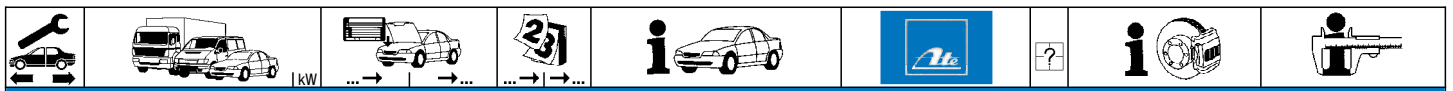

**RENAULT CLIO II Limousine (BB /CB\_) (98-12)**

|         |         |       |       |  |  |                |        |                          |          |            |
|---------|---------|-------|-------|--|--|----------------|--------|--------------------------|----------|------------|
|         | 1.0     | 40    | 02.00 | 05.01                                    | - ABS                                    | 24.3219-1722.3 | 020426 |                          | Rz 19,05 | <b>BDX</b> |
|         | 1.2     | 43    | 09.98 | 12.12                                    | - ABS                                    |                |        |                          |          |            |
|         | 1.2     | 44    | 03.99 | 05.01                                    | - ABS                                    |                |        |                          |          |            |
|         | 1.2 16V | 55    | 06.01 | 12.12                                    | - ABS                                    |                |        |                          |          |            |
|         | 1.4     | 55    | 09.98 | 05.05                                    | - ABS/ + Schaltgetriebe <sup>1)</sup>    |                |        |                          |          |            |
|         | 1.4     | 55    | 09.98 | 05.05                                    | - ABS                                    |                |        |                          |          |            |
|         | 1.9 D   | 47    | 09.98 | 05.05                                    | - ABS/ - Klimaanlage <sup>2)</sup>       |                |        |                          |          |            |
|         | 1.9 D   | 48    | 02.00 | 05.05                                    | - ABS/ - Klimaanlage <sup>2)</sup>       |                |        |                          |          |            |
|         | 1.0     | 40    | 02.00 | 05.01                                    | + ABS                                    |                |        |                          |          |            |
|         | 1.2     | 43    | 09.98 | 12.12                                    | + ABS                                    |                |        |                          |          |            |
| 1.2     | 44      | 03.99 | 05.01 | + ABS                                    |  |                |        |                          |          |            |
| 1.2 16V | 55      | 06.01 | 12.12 | + ABS                                    |  |                |        |                          |          |            |
| 1.4     | 55      | 09.98 | 05.05 | + ABS/ + Schaltgetriebe <sup>3)</sup>    |  |                |        |                          |          |            |
| 1.4     | 55      | 09.98 | 05.05 | + ABS/ + Automatikgetriebe <sup>4)</sup> |  |                |        |                          |          |            |
| 1.4 16V | 70      | 10.99 | 07.00 |  |  |                |        |                          |          |            |
| 1.4 16V | 72      | 08.00 | 12.12 |  |  |                |        |                          |          |            |
| 1.5 dCi | 47      | 06.05 | 12.12 |  |  |                |        |                          |          |            |
| 1.5 dCi | 48      | 06.01 | 12.12 |  |  |                |        |                          |          |            |
| 1.5 dCi | 50      | 08.04 | 12.12 |  |  |                |        |                          |          |            |
| 1.5 dCi | 59      | 06.01 | 10.03 |  |  |                |        |                          |          |            |
| 1.5 dCi | 60      | 06.01 | 12.12 |  |  |                |        |                          |          |            |
| 1.5 dCi | 62      | 02.07 | 12.12 |  |  |                |        |                          |          |            |
| 1.5 dCi | 74      | 01.04 | 12.12 |  |  |                |        |                          |          |            |
| 1.6     | 66      | 09.98 | 05.05 |  |  |                |        |                          |          |            |
| 1.6 16V | 79      | 09.98 | 12.12 |  |  |                |        |                          |          |            |
| 1.9 D   | 47      | 09.98 | 05.05 | + ABS/ + Klimaanlage <sup>5)</sup>       |  |                |        |                          |          |            |
| 1.9 D   | 48      | 02.00 | 05.05 | + ABS/ + Klimaanlage <sup>5)</sup>       |  |                |        |                          |          |            |
| 1.9 dTi | 59      | 02.00 | 05.05 |  |  |                |        |                          |          |            |
| 1.0     | 40      | 02.00 | 05.01 | + ABS                                    |  |                |        |                          |          |            |
| 1.2     | 43      | 09.98 | 10.07 | + ABS                                    |  |                |        |                          |          |            |
| 1.2     | 44      | 03.99 | 05.01 | + ABS                                    |  |                |        |                          |          |            |
| 1.2 16V | 55      | 06.01 | 10.07 | + ABS                                    |  |                |        |                          |          |            |
| 1.4     | 55      | 09.98 | 05.05 | + ABS/ + Schaltgetriebe <sup>3)</sup>    |  |                |        |                          |          |            |
| 1.4     | 55      | 09.98 | 05.05 | + ABS/ + Automatikgetriebe <sup>4)</sup> |  |                |        |                          |          |            |
| 1.4 16V | 70      | 10.99 | 07.00 |  |  |                |        |                          |          |            |
| 1.4 16V | 72      | 08.00 | 10.07 |  |  |                |        |                          |          |            |
| 1.5 dCi | 47      | 06.05 | 10.07 |  |  |                |        |                          |          |            |
| 1.5 dCi | 48      | 06.01 | 10.07 |  |  |                |        |                          |          |            |
| 1.5 dCi | 50      | 08.04 | 10.07 |  |  |                |        |                          |          |            |
| 1.5 dCi | 59      | 06.01 | 10.03 |  |  |                |        |                          |          |            |
| 1.5 dCi | 60      | 06.01 | 10.07 |  |  |                |        |                          |          |            |
| 1.5 dCi | 62      | 02.07 | 10.07 |  |  |                |        |                          |          |            |
| 1.5 dCi | 74      | 01.04 | 10.07 |  |  |                |        |                          |          |            |
| 1.6     | 66      | 09.98 | 05.05 |  |  |                |        |                          |          |            |
| 1.6 16V | 79      | 09.98 | 10.07 |  |  |                |        |                          |          |            |
| 1.9 D   | 47      | 09.98 | 05.05 | + ABS/ + Klimaanlage <sup>5)</sup>       |  |                |        |                          |          |            |
| 1.9 D   | 48      | 02.00 | 05.05 | + ABS/ + Klimaanlage <sup>5)</sup>       |  |                |        |                          |          |            |
| 1.9 dTi | 59      | 02.00 | 05.05 |  |  |                |        |                          |          |            |
| 1.2     | 43      | 11.07 | 12.12 | + ABS                                    |  |                |        |                          |          |            |
| 1.2 16V | 55      | 11.07 | 12.12 | + ABS                                    |  |                |        |                          |          |            |
| 1.4 16V | 72      | 11.07 | 12.12 |  |  |                |        |                          |          |            |
| 1.5 dCi | 47      | 11.07 | 12.12 |  |  |                |        |                          |          |            |
| 1.5 dCi | 48      | 11.07 | 12.12 |  |  |                |        |                          |          |            |
| 1.5 dCi | 50      | 11.07 | 12.12 |  |  |                |        |                          |          |            |
| 1.5 dCi | 60      | 11.07 | 12.12 |  |  |                |        |                          |          |            |
| 1.5 dCi | 62      | 11.07 | 12.12 |  |  |                |        |                          |          |            |
| 1.5 dCi | 74      | 11.07 | 12.12 |  |  |                |        |                          |          |            |
| 1.6 16V | 79      | 11.07 | 12.12 |  |  |                |        |                          |          |            |
|         | 1.0     | 40    | 02.00 | 05.01                                    | - ABS                                    | 24.3727-1049.2 | 581049 | <input type="checkbox"/> | L=1263   |            |
|         | 1.2     | 43    | 09.98 | 12.12                                    | - ABS                                    |                |        |                          |          |            |
|         | 1.2     | 44    | 03.99 | 05.01                                    | - ABS                                    |                |        |                          |          |            |
|         | 1.4     | 55    | 09.98 | 05.05                                    | - ABS/ + Schaltgetriebe <sup>1)</sup>    |                |        |                          |          |            |
|         | 1.4     | 55    | 09.98 | 05.05                                    | - ABS                                    |                |        |                          |          |            |
|         | 1.9 D   | 47    | 09.98 | 05.05                                    | - ABS/ - Klimaanlage <sup>2)</sup>       |                |        |                          |          |            |
|         | 1.9 D   | 48    | 02.00 | 12.12                                    | - ABS/ - Klimaanlage <sup>2)</sup>       |                |        |                          |          |            |
|         | 1.0     | 40    | 02.00 | 05.01                                    | + ABS                                    |                |        |                          |          |            |
|         | 1.2     | 43    | 09.98 | 12.12                                    | + ABS                                    |                |        |                          |          |            |
|         | 1.2     | 44    | 03.99 | 05.01                                    | + ABS                                    |                |        |                          |          |            |
|         | 1.4     | 55    | 09.98 | 05.05                                    | - ABS/ + Automatikgetriebe <sup>6)</sup> |                |        |                          |          |            |
|         | 1.4     | 55    | 09.98 | 05.05                                    | + ABS                                    |                |        |                          |          |            |
|         | 1.4 16V | 70    | 10.99 | 07.00                                    |  |                |        |                          |          |            |
|         | 1.4 16V | 72    | 08.00 | 12.12                                    |  |                |        |                          |          |            |
|         | 1.6     | 66    | 09.98 | 05.05                                    |  |                |        |                          |          |            |
|         | 1.6 16V | 79    | 09.98 | 12.12                                    |  |                |        |                          |          |            |
|         | 1.9 D   | 47    | 09.98 | 05.05                                    | + ABS/ + Klimaanlage <sup>5)</sup>       |                |        |                          |          |            |
|         | 1.9 D   | 48    | 02.00 | 05.05                                    | + ABS/ + Klimaanlage <sup>5)</sup>       |                |        |                          |          |            |
|         | 1.9 dTi | 59    | 02.00 | 05.05                                    |  |                |        |                          |          |            |
|         | 1.2 16V | 55    | 06.01 | 12.12                                    | - ABS                                    |                |        |                          |          |            |
| 1.5 dCi | 48      | 06.01 | 12.12 | - ABS                                    |  |                |        |                          |          |            |
| 1.5 dCi | 50      | 08.04 | 12.12 | - ABS                                    |  |                |        |                          |          |            |
| 1.5 dCi | 59      | 06.01 | 10.03 | + ABS                                    |  |                |        |                          |          |            |
| 1.5 dCi | 60      | 06.01 | 12.12 | + ABS                                    |  |                |        |                          |          |            |
| 1.5 dCi | 74      | 01.04 | 12.12 | + ABS                                    |  |                |        |                          |          |            |
| 1.2 16V | 55      | 06.01 | 12.12 | - ESP                                    |  |                |        |                          |          |            |
| 1.5 dCi | 48      | 06.01 | 12.12 | - ESP                                    |  |                |        |                          |          |            |
| 1.5 dCi | 50      | 08.04 | 12.12 | - ESP                                    |  |                |        |                          |          |            |
|         | 1.0     | 40    | 02.00 | 05.01                                    | - ABS                                    | 24.3727-1048.2 | 581048 | <input type="checkbox"/> | L=1343   |            |
|         | 1.2     | 43    | 09.98 | 12.12                                    | - ABS                                    |                |        |                          |          |            |
|         | 1.2     | 44    | 03.99 | 05.01                                    | - ABS                                    |                |        |                          |          |            |
|         | 1.4     | 55    | 09.98 | 05.05                                    | - ABS/ + Schaltgetriebe <sup>1)</sup>    |                |        |                          |          |            |
|         | 1.4     | 55    | 09.98 | 05.05                                    | - ABS                                    |                |        |                          |          |            |
|         | 1.9 D   | 47    | 09.98 | 05.05                                    | - ABS/ - Klimaanlage <sup>2)</sup>       |                |        |                          |          |            |
|         | 1.9 D   | 48    | 02.00 | 12.12                                    | - ABS/ - Klimaanlage <sup>2)</sup>       |                |        |                          |          |            |
|         | 1.0     | 40    | 02.00 | 05.01                                    | + ABS                                    |                |        |                          |          |            |
|         | 1.2     | 43    | 09.98 | 12.12                                    | + ABS                                    |                |        |                          |          |            |
|         | 1.2     | 44    | 03.99 | 05.01                                    | + ABS                                    |                |        |                          |          |            |
| 1.4     | 55      | 09.98 | 05.05 | - ABS/ + Automatikgetriebe <sup>6)</sup> |  |                |        |                          |          |            |
| 1.4     | 55      | 09.98 | 05.05 | + ABS                                    |  |                |        |                          |          |            |
| 1.4 16V | 70      | 10.99 | 07.00 |  |  |                |        |                          |          |            |
| 1.4 16V | 72      | 08.00 | 12.12 |  |  |                |        |                          |          |            |
| 1.6     | 66      | 09.98 | 05.05 |  |  |                |        |                          |          |            |
| 1.6 16V | 79      | 09.98 | 12.12 |  |  |                |        |                          |          |            |
| 1.9 D   | 47      | 09.98 | 05.05 | + ABS/ + Klimaanlage <sup>5)</sup>       |  |                |        |                          |          |            |
| 1.9 D   | 48      | 02.00 | 05.05 | + ABS/ + Klimaanlage <sup>5)</sup>       |  |                |        |                          |          |            |
| 1.9 dTi | 59      | 02.00 | 05.05 |  |  |                |        |                          |          |            |
| 1.2 16V | 55      | 06.01 | 12.12 | - ABS                                    |  |                |        |                          |          |            |
| 1.5 dCi | 48      | 06.01 | 12.12 | - ABS                                    |  |                |        |                          |          |            |
| 1.5 dCi | 50      | 08.04 | 12.12 | - ABS                                    |  |                |        |                          |          |            |
| 1.5 dCi | 59      | 06.01 | 10.03 | + ABS                                    |  |                |        |                          |          |            |
| 1.5 dCi | 60      | 06.01 | 12.12 | + ABS                                    |  |                |        |                          |          |            |
| 1.5 dCi | 74      | 01.04 | 12.12 | + ABS                                    |  |                |        |                          |          |            |
| 1.2 16V | 55      | 06.01 | 12.12 | - ESP                                    |  |                |        |                          |          |            |
| 1.5 dCi | 48      | 06.01 | 12.12 | - ESP                                    |  |                |        |                          |          |            |
| 1.5 dCi | 50      | 08.04 | 12.12 | - ESP                                    |  |                |        |                          |          |            |

<sup>1)</sup> - ABS/ + manual transmission / - ABS/ + scatola camb.velocità / - ABS/ + transmission mécanique / - ABS/ + cambio de velocidad

<sup>2)</sup> - ABS/ - air conditioning / - ABS/ - aria condizionata / - ABS/ - air conditionné / - ABS/ - aire acondicionado

<sup>3)</sup> + ABS/ + manual transm. / + ABS/ + scatola camb.velocità / + ABS/ + transmission mécanique / + ABS/ + cambio de velocidad

<sup>4)</sup> + ABS/ + autom.transmission / + ABS/ + scatola cambio autom. / + ABS/ + transmission automatique / + ABS/ + cambio automático

<sup>5)</sup> + ABS/ + air conditioning / + ABS/ + aria condizionata / + ABS/ + air conditionné / + ABS/ + aire acondicionado

<sup>6)</sup> - ABS/ + autom.transmission / - ABS/ + scatola cambio autom. / - ABS/ + transmission automatique / - ABS/ + cambio automático





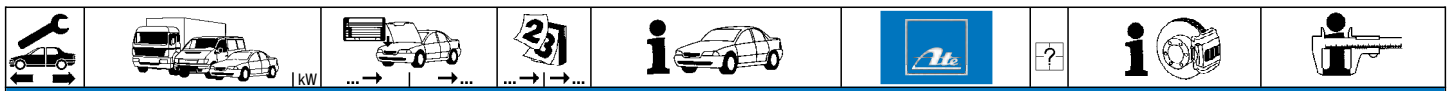

**RENAULT CLIO II Limousine (BB\_/CB\_) (98-12)**

|         |         |       |       |       |       |                |        |                          |                    |
|---------|---------|-------|-------|-------|-------|----------------|--------|--------------------------|--------------------|
|         | 1.5 dCi | 59    | 06.01 | 10.03 | - ABS | 24.3727-1061.2 | 581061 | <input type="checkbox"/> | L=1335<br>L=1415   |
|         | 1.5 dCi | 60    | 06.01 | 12.12 | - ABS | 24.3727-1060.2 | 581060 | <input type="checkbox"/> |                    |
|         | 1.5 dCi | 74    | 01.04 | 12.12 | - ABS |                |        |                          |                    |
|         | 1.0     | 40    | 02.00 | 05.01 |       | 24.6582-1721.3 | 320212 | - ABS                    | BRL (4) weiss/lila |
|         | 1.2     | 43    | 09.98 | 12.12 |       |                |        |                          |                    |
|         | 1.2     | 44    | 03.99 | 05.01 |       |                |        |                          |                    |
|         | 1.2 16V | 55    | 06.01 | 12.12 |       |                |        |                          |                    |
|         | 1.4     | 55    | 09.98 | 05.05 |       |                |        |                          |                    |
|         | 1.4 16V | 70    | 10.99 | 07.00 |       |                |        |                          |                    |
|         | 1.4 16V | 72    | 08.00 | 12.12 |       |                |        |                          |                    |
|         | 1.5 dCi | 47    | 06.05 | 12.12 |       |                |        |                          |                    |
|         | 1.5 dCi | 48    | 06.01 | 12.12 |       |                |        |                          |                    |
|         | 1.5 dCi | 50    | 08.04 | 12.12 |       |                |        |                          |                    |
|         | 1.5 dCi | 59    | 06.01 | 10.03 |       |                |        |                          |                    |
|         | 1.5 dCi | 60    | 06.01 | 12.12 |       |                |        |                          |                    |
|         | 1.5 dCi | 62    | 02.07 | 12.12 |       |                |        |                          |                    |
|         | 1.5 dCi | 74    | 01.04 | 12.12 |       |                |        |                          |                    |
|         | 1.6     | 66    | 09.98 | 05.05 |       |                |        |                          |                    |
|         | 1.6 16V | 79    | 09.98 | 12.12 |       |                |        |                          |                    |
| 1.9 D   | 47      | 09.98 | 05.05 |       |       |                |        |                          |                    |
| 1.9 D   | 48      | 02.00 | 05.05 |       |       |                |        |                          |                    |
| 1.9 dTi | 59      | 02.00 | 05.05 |       |       |                |        |                          |                    |
|         | 1.0     | 40    | 02.00 | 05.01 |       | 24.3728-1023.2 | 591023 |                          | L=960              |
|         | 1.2     | 43    | 09.98 | 12.12 |       |                |        |                          |                    |
|         | 1.2     | 44    | 03.99 | 05.01 |       |                |        |                          |                    |
|         | 1.2 16V | 55    | 06.01 | 12.12 |       |                |        |                          |                    |
|         | 1.4     | 55    | 09.98 | 05.05 |       |                |        |                          |                    |
|         | 1.4 16V | 70    | 10.99 | 07.00 |       |                |        |                          |                    |
|         | 1.4 16V | 72    | 08.00 | 12.12 |       |                |        |                          |                    |
|         | 1.5 dCi | 47    | 06.05 | 12.12 |       |                |        |                          |                    |
|         | 1.5 dCi | 48    | 06.01 | 12.12 |       |                |        |                          |                    |
|         | 1.5 dCi | 50    | 08.04 | 12.12 |       |                |        |                          |                    |
|         | 1.5 dCi | 59    | 06.01 | 10.03 |       |                |        |                          |                    |
|         | 1.5 dCi | 60    | 06.01 | 12.12 |       |                |        |                          |                    |
|         | 1.5 dCi | 62    | 02.07 | 12.12 |       |                |        |                          |                    |
|         | 1.5 dCi | 74    | 01.04 | 12.12 |       |                |        |                          |                    |
|         | 1.6     | 66    | 09.98 | 05.05 |       |                |        |                          |                    |
|         | 1.6 16V | 79    | 09.98 | 12.12 |       |                |        |                          |                    |
| 1.9 D   | 47      | 09.98 | 05.05 |       |       |                |        |                          |                    |
| 1.9 D   | 48      | 02.00 | 05.05 |       |       |                |        |                          |                    |
| 1.9 dTi | 59      | 02.00 | 05.05 |       |       |                |        |                          |                    |

**RENAULT CLIO II Kasten (SB\_) (98-12)**

|            |            |       |       |       |       |                |        |                          |                |     |                |
|------------|------------|-------|-------|-------|-------|----------------|--------|--------------------------|----------------|-----|----------------|
|            | 1.2        | 43    | 09.98 | 12.12 |       | 03.7750-1332.4 | 300155 |                          | 9"             | ATE |                |
|            | 1.2        | 44    | 03.99 | 10.03 |       |                |        |                          |                |     |                |
|            | 1.5 dCi    | 48    | 06.01 | 12.12 | - ABS |                |        |                          |                |     |                |
|            | 1.5 dCi    | 59    | 06.01 | 10.04 | - ABS |                |        |                          |                |     |                |
|            | 1.5 dCi    | 60    | 11.03 | 12.12 | - ABS |                |        |                          |                |     |                |
|            | 1.9 D      | 40    | 03.99 | 01.00 |       |                |        |                          |                |     |                |
|            | 1.9 D      | 47    | 09.98 | 12.12 |       |                |        |                          |                |     |                |
|            | 1.9 D (SB) | 48    | 02.00 | 05.01 |       |                |        |                          |                |     |                |
|            | 1.9 dTi    | 59    | 02.00 | 05.01 |       |                |        |                          |                |     |                |
|            | 1.5 dCi    | 48    | 06.01 | 12.12 |       | 03.7853-1502.4 | 300200 | - ESP                    | 9"             | ATE |                |
|            | 1.5 dCi    | 59    | 06.01 | 10.04 |       | 03.7853-0702.4 | 300195 | + ESP                    | 9"             | ATE |                |
|            | 1.5 dCi    | 60    | 11.03 | 12.12 |       |                |        |                          |                |     |                |
|            | 1.2        | 43    | 09.98 | 12.12 |       | 03.2120-4381.3 | 010526 | - ABS                    | THz 20,64      | ATE |                |
|            | 1.2        | 44    | 03.99 | 10.03 |       | 03.2120-4461.3 | 010571 | - ESP                    |                |     |                |
|            | 1.5 dCi    | 48    | 06.01 | 12.12 |       | 03.2120-4468.3 | 010789 | + ESP                    |                |     |                |
|            | 1.5 dCi    | 59    | 06.01 | 10.04 |       |                |        |                          |                |     |                |
|            | 1.5 dCi    | 60    | 11.03 | 12.12 |       |                |        |                          |                |     |                |
|            | 1.9 D      | 40    | 03.99 | 01.00 |       |                |        |                          |                |     |                |
|            | 1.9 D      | 47    | 09.98 | 12.12 |       |                |        |                          |                |     |                |
|            | 1.9 D (SB) | 48    | 02.00 | 05.01 |       |                |        |                          |                |     |                |
| 1.9 dTi    | 59         | 02.00 | 05.01 |       |       |                |        |                          |                |     |                |
|            | 1.2        | 43    | 09.98 | 12.12 | - ABS | 24.3481-1611.5 | 240029 | <input type="checkbox"/> | D=48, - Halter | LUC |                |
|            | 1.2        | 44    | 03.99 | 10.03 | - ABS | 24.3481-1612.5 | 240030 | <input type="checkbox"/> |                |     | D=48, - Halter |
|            |            |       |       |       |       | 24.0101-4807.2 | 260053 | <input type="checkbox"/> |                |     | Einbausatz     |
|            | 1.2        | 43    | 09.98 | 12.12 | + ABS | 24.3481-1615.5 | 240031 | <input type="checkbox"/> |                |     | D=48, - Halter |
|            | 1.2        | 44    | 03.99 | 10.03 | + ABS | 24.3481-1616.5 | 240032 | <input type="checkbox"/> |                |     | D=48, - Halter |
|            | 1.5 dCi    | 48    | 06.01 | 12.12 |       | 24.0101-4806.2 | 260052 | <input type="checkbox"/> |                |     | Einbausatz     |
|            | 1.5 dCi    | 59    | 06.01 | 10.04 |       |                |        |                          |                |     |                |
|            | 1.5 dCi    | 60    | 11.03 | 12.12 |       |                |        |                          |                |     |                |
|            | 1.9 D      | 40    | 03.99 | 01.00 |       |                |        |                          |                |     |                |
|            | 1.9 D      | 47    | 09.98 | 12.12 |       |                |        |                          |                |     |                |
| 1.9 D (SB) | 48         | 02.00 | 05.01 |       |       |                |        |                          |                |     |                |
| 1.9 dTi    | 59         | 02.00 | 05.01 |       |       |                |        |                          |                |     |                |
|            | 1.2        | 43    | 09.98 | 12.12 |       | 24.5111-0321.3 | 330597 | 2                        | L=320          |     |                |
|            | 1.2        | 44    | 03.99 | 10.03 |       |                |        |                          |                |     |                |
|            | 1.5 dCi    | 48    | 06.01 | 12.12 |       |                |        |                          |                |     |                |
|            | 1.5 dCi    | 59    | 06.01 | 10.04 |       |                |        |                          |                |     |                |
|            | 1.5 dCi    | 60    | 11.03 | 12.12 |       |                |        |                          |                |     |                |
|            | 1.9 D      | 40    | 03.99 | 01.00 |       |                |        |                          |                |     |                |
|            | 1.9 D      | 47    | 09.98 | 12.12 |       |                |        |                          |                |     |                |
|            | 1.9 D (SB) | 48    | 02.00 | 05.01 |       |                |        |                          |                |     |                |
|            | 1.9 dTi    | 59    | 02.00 | 05.01 |       |                |        |                          |                |     |                |



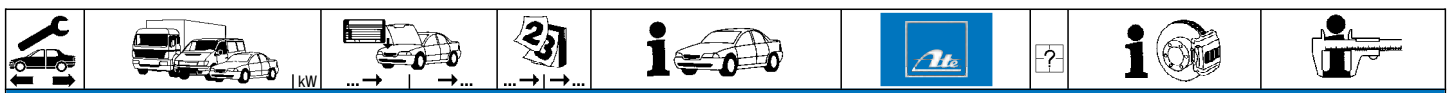





















**RENAULT CLIO II Kasten (SB\_) (98-12)**

|            |            |       |       |       |                |        |                          |          |            |                |        |                          |          |            |                |        |                          |        |  |                |        |                          |        |  |                |        |  |                    |  |
|------------|------------|-------|-------|-------|----------------|--------|--------------------------|----------|------------|----------------|--------|--------------------------|----------|------------|----------------|--------|--------------------------|--------|--|----------------|--------|--------------------------|--------|--|----------------|--------|--|--------------------|--|
|            | 1.2        | 43    | 09.98 | 12.12 | 24.5239-0165.3 | 330606 | 2                        |          | L=165      |                |        |                          |          |            |                |        |                          |        |  |                |        |                          |        |  |                |        |  |                    |  |
|            | 1.2        | 44    | 03.99 | 10.03 |                |        |                          |          |            |                |        |                          |          |            |                |        |                          |        |  |                |        |                          |        |  |                |        |  |                    |  |
|            | 1.5 dCi    | 48    | 06.01 | 12.12 |                |        |                          |          |            |                |        |                          |          |            |                |        |                          |        |  |                |        |                          |        |  |                |        |  |                    |  |
|            | 1.5 dCi    | 59    | 06.01 | 10.04 |                |        |                          |          |            |                |        |                          |          |            |                |        |                          |        |  |                |        |                          |        |  |                |        |  |                    |  |
|            | 1.5 dCi    | 60    | 11.03 | 12.12 |                |        |                          |          |            |                |        |                          |          |            |                |        |                          |        |  |                |        |                          |        |  |                |        |  |                    |  |
|            | 1.9 D      | 40    | 03.99 | 01.00 |                |        |                          |          |            |                |        |                          |          |            |                |        |                          |        |  |                |        |                          |        |  |                |        |  |                    |  |
|            | 1.9 D      | 47    | 09.98 | 12.12 |                |        |                          |          |            |                |        |                          |          |            |                |        |                          |        |  |                |        |                          |        |  |                |        |  |                    |  |
|            | 1.9 D (SB) | 48    | 02.00 | 05.01 |                |        |                          |          |            |                |        |                          |          |            |                |        |                          |        |  |                |        |                          |        |  |                |        |  |                    |  |
|            | 1.9 dTi    | 59    | 02.00 | 12.12 |                |        |                          |          |            |                |        |                          |          |            |                |        |                          |        |  |                |        |                          |        |  |                |        |  |                    |  |
|            | 1.2        | 43    | 09.98 | 12.12 | 24.3219-1722.3 | 020426 |                          | Rz 19,05 | <b>BDX</b> |                |        |                          |          |            |                |        |                          |        |  |                |        |                          |        |  |                |        |  |                    |  |
|            | 1.2        | 44    | 03.99 | 10.03 |                |        |                          |          |            |                |        |                          |          |            |                |        |                          |        |  |                |        |                          |        |  |                |        |  |                    |  |
|            | 1.9 D (SJ) | 47    | 09.98 | 12.12 |                |        |                          |          |            |                |        |                          |          |            |                |        |                          |        |  |                |        |                          |        |  |                |        |  |                    |  |
|            | 1.2        | 43    | 09.98 | 12.12 |                |        |                          |          |            | 24.3217-1710.3 | 020420 |                          | Rz 17,78 | <b>LUC</b> |                |        |                          |        |  |                |        |                          |        |  |                |        |  |                    |  |
|            | 1.5 dCi    | 48    | 06.01 | 12.12 |                |        |                          |          |            |                |        |                          |          |            |                |        |                          |        |  |                |        |                          |        |  |                |        |  |                    |  |
|            | 1.5 dCi    | 59    | 06.01 | 10.04 |                |        |                          |          |            |                |        |                          |          |            |                |        |                          |        |  |                |        |                          |        |  |                |        |  |                    |  |
|            | 1.5 dCi    | 60    | 11.03 | 12.12 |                |        |                          |          |            |                |        |                          |          |            |                |        |                          |        |  |                |        |                          |        |  |                |        |  |                    |  |
|            | 1.9 D      | 40    | 03.99 | 01.00 |                |        |                          |          |            |                |        |                          |          |            |                |        |                          |        |  |                |        |                          |        |  |                |        |  |                    |  |
|            | 1.9 D      | 47    | 09.98 | 12.12 |                |        |                          |          |            |                |        |                          |          |            |                |        |                          |        |  |                |        |                          |        |  |                |        |  |                    |  |
| 1.9 D (SB) | 48         | 02.00 | 05.01 |       |                |        |                          |          |            |                |        |                          |          |            |                |        |                          |        |  |                |        |                          |        |  |                |        |  |                    |  |
| 1.9 dTi    | 59         | 02.00 | 05.01 |       |                |        |                          |          |            |                |        |                          |          |            |                |        |                          |        |  |                |        |                          |        |  |                |        |  |                    |  |
|            | 1.2        | 43    | 09.98 | 12.12 | 24.3727-1049.2 | 581049 | <input type="checkbox"/> | L=1263   |            |                |        |                          |          |            |                |        |                          |        |  |                |        |                          |        |  |                |        |  |                    |  |
|            | 1.9 D (SJ) | 47    | 09.98 | 12.12 |                |        |                          |          |            |                |        |                          |          |            |                |        |                          |        |  |                |        |                          |        |  |                |        |  |                    |  |
|            | 1.2        | 43    | 09.98 | 12.12 |                |        |                          |          |            | 24.3727-1047.2 | 581047 | <input type="checkbox"/> | L=1277   |            |                |        |                          |        |  |                |        |                          |        |  |                |        |  |                    |  |
|            | 1.9 D      | 40    | 03.99 | 01.00 |                |        |                          |          |            |                |        |                          |          |            |                |        |                          |        |  |                |        |                          |        |  |                |        |  |                    |  |
|            | 1.9 D (SB) | 48    | 02.00 | 05.01 |                |        |                          |          |            |                |        |                          |          |            |                |        |                          |        |  |                |        |                          |        |  |                |        |  |                    |  |
|            | 1.9 D (SJ) | 47    | 09.98 | 12.12 |                |        |                          |          |            |                |        |                          |          |            |                |        |                          |        |  |                |        |                          |        |  |                |        |  |                    |  |
|            | 1.9 dTi    | 59    | 02.00 | 05.01 |                |        |                          |          |            |                |        |                          |          |            |                |        |                          |        |  |                |        |                          |        |  |                |        |  |                    |  |
|            | 1.5 dCi    | 48    | 06.01 | 12.12 |                |        |                          |          |            |                |        |                          |          |            | 24.3727-1067.2 | 581067 | <input type="checkbox"/> | L=1321 |  |                |        |                          |        |  |                |        |  |                    |  |
|            | 1.5 dCi    | 59    | 06.01 | 10.04 |                |        |                          |          |            |                |        |                          |          |            |                |        |                          |        |  |                |        |                          |        |  |                |        |  |                    |  |
|            | 1.5 dCi    | 60    | 11.03 | 12.12 |                |        |                          |          |            |                |        |                          |          |            |                |        |                          |        |  |                |        |                          |        |  |                |        |  |                    |  |
|            | 1.5 dCi    | 48    | 06.01 | 12.12 |                |        |                          |          |            |                |        |                          |          |            |                |        |                          |        |  | 24.3727-1061.2 | 581061 | <input type="checkbox"/> | L=1335 |  |                |        |  |                    |  |
|            | 1.5 dCi    | 59    | 06.01 | 10.04 |                |        |                          |          |            |                |        |                          |          |            |                |        |                          |        |  |                |        |                          |        |  |                |        |  |                    |  |
|            | 1.5 dCi    | 60    | 11.03 | 12.12 |                |        |                          |          |            |                |        |                          |          |            |                |        |                          |        |  |                |        |                          |        |  |                |        |  |                    |  |
|            | 1.2        | 43    | 09.98 | 12.12 |                |        |                          |          |            |                |        |                          |          |            |                |        |                          |        |  |                |        |                          |        |  | 24.6582-1721.3 | 320212 |  | BRL (4) weiss/lila |  |
|            | 1.5 dCi    | 48    | 06.01 | 12.12 |                |        |                          |          |            |                |        |                          |          |            |                |        |                          |        |  |                |        |                          |        |  |                |        |  |                    |  |
| 1.5 dCi    | 59         | 06.01 | 10.04 |       |                |        |                          |          |            |                |        |                          |          |            |                |        |                          |        |  |                |        |                          |        |  |                |        |  |                    |  |
| 1.5 dCi    | 60         | 11.03 | 12.12 |       |                |        |                          |          |            |                |        |                          |          |            |                |        |                          |        |  |                |        |                          |        |  |                |        |  |                    |  |
| 1.9 D      | 40         | 03.99 | 01.00 |       |                |        |                          |          |            |                |        |                          |          |            |                |        |                          |        |  |                |        |                          |        |  |                |        |  |                    |  |
| 1.9 D      | 47         | 09.98 | 12.12 |       |                |        |                          |          |            |                |        |                          |          |            |                |        |                          |        |  |                |        |                          |        |  |                |        |  |                    |  |
| 1.9 D (SB) | 48         | 02.00 | 05.01 |       |                |        |                          |          |            |                |        |                          |          |            |                |        |                          |        |  |                |        |                          |        |  |                |        |  |                    |  |
| 1.9 dTi    | 59         | 02.00 | 05.01 |       |                |        |                          |          |            |                |        |                          |          |            |                |        |                          |        |  |                |        |                          |        |  |                |        |  |                    |  |
|            | 1.2        | 43    | 09.98 | 12.12 | 24.3728-1023.2 | 591023 |                          | L=960    |            |                |        |                          |          |            |                |        |                          |        |  |                |        |                          |        |  |                |        |  |                    |  |
|            | 1.5 dCi    | 48    | 06.01 | 12.12 |                |        |                          |          |            |                |        |                          |          |            |                |        |                          |        |  |                |        |                          |        |  |                |        |  |                    |  |
|            | 1.5 dCi    | 59    | 06.01 | 10.04 |                |        |                          |          |            |                |        |                          |          |            |                |        |                          |        |  |                |        |                          |        |  |                |        |  |                    |  |
|            | 1.5 dCi    | 60    | 11.03 | 12.12 |                |        |                          |          |            |                |        |                          |          |            |                |        |                          |        |  |                |        |                          |        |  |                |        |  |                    |  |
|            | 1.9 D      | 40    | 03.99 | 01.00 |                |        |                          |          |            |                |        |                          |          |            |                |        |                          |        |  |                |        |                          |        |  |                |        |  |                    |  |
|            | 1.9 D      | 47    | 09.98 | 12.12 |                |        |                          |          |            |                |        |                          |          |            |                |        |                          |        |  |                |        |                          |        |  |                |        |  |                    |  |
|            | 1.9 D (SB) | 48    | 02.00 | 05.01 |                |        |                          |          |            |                |        |                          |          |            |                |        |                          |        |  |                |        |                          |        |  |                |        |  |                    |  |
|            | 1.9 dTi    | 59    | 02.00 | 05.01 |                |        |                          |          |            |                |        |                          |          |            |                |        |                          |        |  |                |        |                          |        |  |                |        |  |                    |  |

**RENAULT CLIO III (BR\_/CR\_) (05-12)**

|                 |         |         |       |       |                |        |  |       |           |            |
|-----------------|---------|---------|-------|-------|----------------|--------|--|-------|-----------|------------|
|                 | 1.2 16V | 48      | 06.05 | 11.07 | 03.7863-4502.4 | 300230 |  | + ABS | 10"       | <b>ATE</b> |
|                 | 1.2 16V | 55      | 06.05 | 11.07 |                |        |  |       |           |            |
|                 | 1.2 16V | 58      | 06.05 | 11.07 |                |        |  |       |           |            |
|                 | 1.2 16V | 74      | 05.07 | 11.07 |                |        |  |       |           |            |
|                 | 1.4 16V | 72      | 06.05 | 11.07 |                |        |  |       |           |            |
|                 | 1.5 dCi | 48      | 05.05 | 10.06 |                |        |  |       |           |            |
|                 | 1.5 dCi | 50      | 06.05 | 11.07 |                |        |  |       |           |            |
|                 | 1.5 dCi | 63      | 06.05 | 11.07 |                |        |  |       |           |            |
|                 | 1.5 dCi | 76      | 06.05 | 11.07 |                |        |  |       |           |            |
|                 | 1.5 dCi | 78      | 06.05 | 11.07 |                |        |  |       |           |            |
|                 | 1.6 16V | 65      | 06.05 | 11.07 |                |        |  |       |           |            |
|                 | 1.6 16V | 82      | 06.05 | 11.07 |                |        |  |       |           |            |
|                 | 2.0 16V | 102     | 09.06 | 11.07 |                |        |  |       |           |            |
|                 |         | 1.2 16V | 48    | 06.05 |                |        |  |       |           |            |
| 1.2 16V         |         | 55      | 06.05 | 12.12 |                |        |  |       |           |            |
| 1.2 16V         |         | 58      | 06.05 | 12.12 |                |        |  |       |           |            |
| 1.2 16V         |         | 74      | 05.07 | 12.12 |                |        |  |       |           |            |
| 1.2 16V         |         | 76      | 09.10 | 12.12 |                |        |  |       |           |            |
| 1.2 16V Hi-Flex |         | 55      | 07.08 | 12.12 |                |        |  |       |           |            |
| 1.4 16V         |         | 72      | 06.05 | 12.12 |                |        |  |       |           |            |
| 1.5 dCi         |         | 48      | 05.05 | 10.06 |                |        |  |       |           |            |
| 1.5 dCi         |         | 50      | 06.05 | 12.12 |                |        |  |       |           |            |
| 1.5 dCi         |         | 55      | 08.10 | 12.12 |                |        |  |       |           |            |
| 1.5 dCi         |         | 63      | 06.05 | 12.12 |                |        |  |       |           |            |
| 1.5 dCi         |         | 65      | 08.10 | 12.12 |                |        |  |       |           |            |
| 1.5 dCi         |         | 76      | 06.05 | 12.12 |                |        |  |       |           |            |
| 1.5 dCi         |         | 78      | 06.05 | 12.12 |                |        |  |       |           |            |
| 1.6 16V         |         | 65      | 06.05 | 12.12 |                |        |  |       |           |            |
| 1.6 16V         |         | 82      | 06.05 | 12.12 |                |        |  |       |           |            |
| 1.6 16V GT      |         | 94      | 04.09 | 12.12 |                |        |  |       |           |            |
| 2.0 16V         |         | 102     | 09.06 | 12.12 |                |        |  |       |           |            |
| 2.0 16V Sport   | 145     | 02.06   | 12.12 |       |                |        |  |       |           |            |
| 2.0 16V Sport   | 148     | 09.08   | 12.12 |       |                |        |  |       |           |            |
|                 | 1.2 16V | 48      | 06.05 | 11.07 | 03.2123-3241.3 | 010882 |  | - ESP | Thz 23,81 | <b>ATE</b> |
|                 | 1.2 16V | 55      | 06.05 | 11.07 |                |        |  |       |           |            |



|     |    kW |  |  |  |  |  |     |     |                |     |
|--|---|--|--|--|---|--|---|---|----------------|-----|
| <b>RENAULT CLIO III (BR_/CR_) (05-12)</b>  |   |  |  |  |   |  |   |   |                |     |
|    | 1.2 16V   | 58   |  | 06.05  | 11.07   | 03.2123-3241.3   | 010882  | - ESP   | THz 23,81      | ATE |
|  | 1.2 16V   | 74   |  | 05.07  | 11.07   | 03.2123-3493.3   | 010792  | + ESP   | THz 23,81      | ATE |
|  | 1.4 16V   | 72   |  | 06.05  | 11.07   |  |   |   |                |     |
|  | 1.5 dCi   | 48   |  | 05.05  | 10.06   |  |   |   |                |     |
|  | 1.5 dCi   | 50   |  | 06.05  | 11.07   |  |   |   |                |     |
|  | 1.5 dCi   | 63   |  | 06.05  | 11.07   |  |   |   |                |     |
|  | 1.5 dCi   | 76   |  | 06.05  | 11.07   |  |   |   |                |     |
|  | 1.5 dCi   | 78   |  | 06.05  | 11.07   |  |   |   |                |     |
|  | 1.6 16V   | 65   |  | 06.05  | 11.07   |  |   |   |                |     |
|  | 1.6 16V   | 82   |  | 06.05  | 11.07   |  |   |   |                |     |
| 2.0 16V  | 102   |  | 09.06  | 11.07  |   |  |   |   |                |     |
|    | 1.2 16V   | 48   |  | 12.07  | 12.12   | 03.2123-2863.3   | 010790  | - ESP   | THz 23,81      | ATE |
|  | 1.2 16V   | 55   |  | 12.07  | 12.12   | 03.2123-2923.3   | 010791  | + ESP   | THz 23,81      | ATE |
|  | 1.2 16V   | 58   |  | 12.07  | 12.12   |  |   |   |                |     |
|  | 1.2 16V   | 74   |  | 12.07  | 12.12   |  |   |   |                |     |
|  | 1.2 16V   | 76   |  | 09.10  | 12.12   |  |   |   |                |     |
|  | 1.2 16V Hi-Flex   | 55   |  | 07.08  | 12.12   |  |   |   |                |     |
|  | 1.4 16V   | 72   |  | 12.07  | 12.12   |  |   |   |                |     |
|  | 1.5 dCi   | 50   |  | 12.07  | 12.12   |  |   |   |                |     |
|  | 1.5 dCi   | 55   |  | 08.10  | 12.12   |  |   |   |                |     |
|  | 1.5 dCi   | 63   |  | 12.07  | 12.12   |  |   |   |                |     |
|  | 1.5 dCi   | 65   |  | 08.10  | 12.12   |  |   |   |                |     |
|  | 1.5 dCi   | 76   |  | 12.07  | 12.12   |  |   |   |                |     |
|  | 1.5 dCi   | 78   |  | 12.07  | 12.12   |  |   |   |                |     |
|  | 1.6 16V   | 65   |  | 12.07  | 12.12   |  |   |   |                |     |
|  | 1.6 16V   | 82   |  | 12.07  | 12.12   |  |   |   |                |     |
|  | 1.6 16V GT  | 94   |  | 04.09  | 12.12   |  |   |   |                |     |
|  | 2.0 16V   | 102  |  | 12.07  | 12.12   |  |   |   |                |     |
|  | 2.0 16V Sport   | 145  |  | 02.06  | 12.12   | 03.2123-3493.3   | 010792  |   | THz 23,81      | ATE |
| 2.0 16V Sport  | 148   |  | 09.08  | 12.12  |   |  |   |   |                |     |
|    | 1.2 16V   | 48   |  | 06.05  | 12.12   | 24.3541-1823.5   | 240417  |    | D=54, - Halter |     |
|  | 1.2 16V   | 55   |  | 06.05  | 12.12   | 24.3541-1824.5   | 240418  |    | D=54, - Halter |     |
|  | 1.2 16V   | 58   |  | 06.05  | 12.12   |  |   |   |                |     |
|  | 1.2 16V   | 74   |  | 05.07  | 12.12   |  |   |   |                |     |
|  | 1.2 16V   | 76   |  | 09.10  | 12.12   |  |   |   |                |     |
|  | 1.2 16V Hi-Flex   | 55   |  | 07.08  | 12.12   |  |   |   |                |     |
|  | 1.4 16V   | 72   |  | 06.05  | 12.12   |  |   |   |                |     |
|  | 1.5 dCi   | 47   |  | 06.05  | 12.12   |  |   |   |                |     |
|  | 1.5 dCi   | 48   |  | 05.05  | 10.06   |  |   |   |                |     |
|  | 1.5 dCi   | 50   |  | 06.05  | 12.12   |  |   |   |                |     |
|  | 1.5 dCi   | 55   |  | 08.10  | 12.12   |  |   |   |                |     |
|  | 1.5 dCi   | 63   |  | 06.05  | 12.12   |  |   |   |                |     |
|  | 1.5 dCi   | 65   |  | 08.10  | 12.12   |  |   |   |                |     |
|  | 1.5 dCi   | 76   |  | 06.05  | 12.12   |  |   |   |                |     |
|  | 1.5 dCi   | 78   |  | 06.05  | 12.12   |  |   |   |                |     |
|  | 1.6 16V   | 65   |  | 06.05  | 12.12   |  |   |   |                |     |
|  | 1.6 16V   | 82   |  | 06.05  | 12.12   |  |   |   |                |     |
| 1.6 16V GT   | 94  |  | 04.09  | 12.12  |   |  |   |   |                |     |
| 2.0 16V  | 102   |  | 09.06  | 12.12  | 11.9541-9545.2  | 220625   |  | D=54, - Halter  | ATE            |     |
| 2.0 16V  | 110   |  | 11.07  | 12.12  | 11.9541-9546.2  | 220626   |  | D=54, - Halter  | ATE            |     |
|  |   |  |  |  | 11.8116-0301.1  | 390610   | 2   | Haltefeder  | ATE            |     |
|  | 1.2 16V   | 48   |  | 06.05  | 12.12   | 24.5111-0455.3   | 330914  | 2   | L=455          |     |
|  | 1.2 16V   | 55   |  | 06.05  | 12.12   |  |   |   |                |     |
|  | 1.2 16V   | 58   |  | 06.05  | 12.12   |  |   |   |                |     |
|  | 1.2 16V   | 74   |  | 05.07  | 12.12   |  |   |   |                |     |
|  | 1.2 16V   | 76   |  | 09.10  | 12.12   |  |   |   |                |     |
|  | 1.2 16V Hi-Flex   | 55   |  | 07.08  | 12.12   |  |   |   |                |     |
|  | 1.4 16V   | 72   |  | 06.05  | 12.12   |  |   |   |                |     |
|  | 1.5 dCi   | 47   |  | 06.05  | 12.12   |  |   |   |                |     |
|  | 1.5 dCi   | 48   |  | 05.05  | 10.06   |  |   |   |                |     |
|  | 1.5 dCi   | 50   |  | 06.05  | 12.12   |  |   |   |                |     |
|  | 1.5 dCi   | 55   |  | 08.10  | 12.12   |  |   |   |                |     |
|  | 1.5 dCi   | 63   |  | 06.05  | 12.12   |  |   |   |                |     |
|  | 1.5 dCi   | 65   |  | 08.12  | 12.12   |  |   |   |                |     |
|  | 1.5 dCi   | 76   |  | 06.05  | 12.12   |  |   |   |                |     |
|  | 1.5 dCi   | 78   |  | 06.05  | 12.12   |  |   |   |                |     |
|  | 1.6 16V   | 65   |  | 06.05  | 12.12   |  |   |   |                |     |
|  | 1.6 16V   | 82   |  | 06.05  | 12.12   |  |   |   |                |     |
| 1.6 16V GT   | 94  |  | 04.09  | 12.12  |   |  |   |   |                |     |
|  | 1.2 16V   | 48   |  | 06.05  | 12.12   | 24.3347-1703.7   | 220685  |  | D=34, - Halter | LUC |
|  | 1.2 16V   | 55   |  | 06.05  | 12.12   | 24.3347-1704.7   | 220686  |  | D=34, - Halter | LUC |
|  | 1.2 16V   | 58   |  | 06.05  | 12.12   | 24.0101-3803.2   | 260101  |   | Einbausatz     | LUC |
|  | 1.2 16V   | 74   |  | 05.07  | 12.12   |  |   |   |                |     |
|  | 1.2 16V   | 76   |  | 09.10  | 12.12   |  |   |   |                |     |
|  | 1.2 16V Hi-Flex   | 55   |  | 07.08  | 12.12   |  |   |   |                |     |
|  | 1.4 16V   | 72   |  | 06.05  | 12.12   |  |   |   |                |     |
|  | 1.5 dCi   | 48   |  | 05.05  | 10.06   |  |   |   |                |     |
|  | 1.5 dCi   | 50   |  | 06.05  | 12.12   |  |   |   |                |     |
|  | 1.5 dCi   | 55   |  | 08.10  | 12.12   |  |   |   |                |     |
|  | 1.5 dCi   | 63   |  | 06.05  | 12.12   |  |   |   |                |     |
|  | 1.5 dCi   | 65   |  | 08.10  | 12.12   |  |   |   |                |     |
|  | 1.5 dCi   | 76   |  | 06.05  | 12.12   |  |   |   |                |     |
|  | 1.5 dCi   | 78   |  | 06.05  | 12.12   |  |   |   |                |     |
|  | 1.6 16V   | 65   |  | 06.05  | 12.12   |  |   |   |                |     |
|  | 1.6 16V   | 82   |  | 06.05  | 12.12   |  |   |   |                |     |
|  | 1.6 16V GT  | 94   |  | 04.09  | 12.12   |  |   |   |                |     |
| 2.0 16V  | 102   |  | 09.06  | 12.12  |   |  |   |   |                |     |



### RENAULT CLIO III (BR\_/CR\_) (05-12)

















|  |   |  |  |   |   |   |                                  |                  |  |  |                                  |            |
|--|---|--|--|---|---|---|----------------------------------|------------------|--|--|----------------------------------|------------|
|  | 2.0 16V Sport<br>2.0 16V Sport  | 145<br>148   |  | 02.06<br>04.09  | 12.12<br>12.12  |   | 24.3387-1721.7<br>24.3387-1722.7 | 220781<br>220782 | <input type="checkbox"/><br><input type="checkbox"/>   |  | D=38, - Halter<br>D=38, - Halter | LUC<br>LUC |
|  | 1.2 16V<br>1.2 16V<br>1.2 16V<br>1.2 16V<br>1.2 16V Hi-Flex<br>1.4 16V<br>1.5 dCi<br>1.5 dCi<br>1.5 dCi<br>1.5 dCi<br>1.5 dCi<br>1.5 dCi<br>1.5 dCi<br>1.6 16V<br>1.6 16V<br>1.6 16V GT<br>2.0 16V Sport<br>2.0 16V Sport | 48<br>55<br>58<br>74<br>55<br>72<br>48<br>50<br>55<br>63<br>76<br>78<br>65<br>82<br>94<br>145<br>148 |  | 06.05<br>06.05<br>06.05<br>05.07<br>07.08<br>06.05<br>05.05<br>06.05<br>08.10<br>06.05<br>06.05<br>06.05<br>06.05<br>06.05<br>04.09<br>02.06<br>04.09 | 12.12<br>12.12<br>12.12<br>12.12<br>12.12<br>12.12<br>10.06<br>12.12<br>12.12<br>12.12<br>12.12<br>12.12<br>12.12<br>12.12<br>12.12<br>12.12<br>12.12 |   | 24.5229-0193.3<br>24.5229-0185.3 | 330571<br>330397 | 2<br>2   |  | L=193<br>L=185                   |            |
|  | 1.2 16V<br>1.2 16V<br>1.2 16V<br>1.2 16V<br>1.2 16V<br>1.2 16V Hi-Flex<br>1.4 16V<br>1.5 dCi<br>1.5 dCi<br>1.5 dCi<br>1.5 dCi<br>1.5 dCi<br>1.5 dCi<br>1.5 dCi<br>1.6 16V<br>2.0 16V Sport<br>2.0 16V Sport               | 48<br>55<br>58<br>74<br>76<br>55<br>72<br>48<br>50<br>55<br>63<br>65<br>76                           |  | 06.05<br>06.05<br>06.05<br>05.07<br>09.10<br>07.08<br>06.05<br>05.05<br>06.05<br>08.10<br>06.05<br>08.10<br>06.05                                     | 12.12<br>12.12<br>12.12<br>12.12<br>12.12<br>12.12<br>12.12<br>10.06<br>12.12<br>12.12<br>12.12<br>12.12<br>12.12                                     | - ESP<br>- ESP<br>- ESP<br>- ESP<br>- ESP<br>- ESP<br>- ESP<br>- ESP<br>- ESP<br>- ESP<br>- ESP<br>- ESP                            | 24.3219-1755.3                   | 020508           |  |  | Rz 19,05                         |            |
|  | 1.2 16V<br>1.2 16V<br>1.2 16V<br>1.2 16V<br>1.2 16V<br>1.2 16V Hi-Flex<br>1.4 16V<br>1.5 dCi<br>1.5 dCi<br>1.5 dCi<br>1.5 dCi<br>1.5 dCi<br>1.5 dCi<br>1.5 dCi<br>1.6 16V GT<br>2.0 16V Sport<br>2.0 16V Sport            | 48<br>55<br>58<br>74<br>76<br>55<br>72<br>48<br>50<br>55<br>63<br>65<br>76<br>94<br>145<br>148       |  | 06.05<br>06.05<br>06.05<br>05.07<br>09.10<br>07.08<br>06.05<br>05.05<br>06.05<br>08.10<br>06.05<br>08.10<br>06.05<br>04.09<br>02.06<br>04.09          | 12.12<br>12.12<br>12.12<br>12.12<br>12.12<br>12.12<br>12.12<br>10.06<br>12.12<br>12.12<br>12.12<br>12.12<br>12.12<br>12.12<br>12.12<br>12.12          | - ESP<br>- ESP<br>- ESP<br>- ESP<br>- ESP<br>- ESP<br>- ESP<br>- ESP<br>- ESP<br>- ESP<br>- ESP<br>- ESP<br>- ESP<br>- ABS<br>- ABS | 24.3727-1078.2<br>24.3727-1079.2 | 581078<br>581079 | <input type="checkbox"/><br><input type="checkbox"/>   |  | L=1451<br>L=1587                 |            |
|  | 1.2 16V<br>1.5 dCi<br>1.5 dCi   | 76<br>55<br>65   |  | 09.10<br>08.10<br>08.10   | 12.12<br>12.12<br>12.12   |   | 24.3727-1091.2<br>24.3727-1090.2 | 581091<br>581090 | <input type="checkbox"/> + 16" Rad <sup>1)</sup><br><input type="checkbox"/> + 16" Rad <sup>1)</sup> |  | L=1440<br>L=1572                 |            |

### RENAULT CLIO III Grandtour (KR\_) (08-12)































|  |   |  |  |   |   |  |                                  |                  |                |  |                        |            |
|--|---|--|--|---|---|--|----------------------------------|------------------|----------------|--|------------------------|------------|
|  | 1.2 16V<br>1.2 16V<br>1.2 16V<br>1.2 16V Hi-Flex<br>1.4 16V<br>1.5 dCi<br>1.5 dCi<br>1.5 dCi<br>1.5 dCi<br>1.5 dCi<br>1.5 dCi<br>1.6 16V<br>1.6 16V | 55<br>57<br>74<br>55<br>72<br>48<br>50<br>63<br>76<br>78<br>82<br>94 |  | 02.08<br>02.08<br>02.08<br>07.08<br>02.10<br>02.08<br>02.08<br>02.08<br>02.08<br>02.08<br>02.08<br>02.08<br>11.08 | 12.12<br>12.12<br>12.12<br>12.12<br>12.12<br>12.12<br>12.12<br>12.12<br>12.12<br>12.12<br>12.12<br>12.12<br>12.12 |  | 03.7863-4502.4                   | 300230           | + ABS          |  | 10"                    | ATE        |
|  | 1.2 16V<br>1.2 16V<br>1.2 16V<br>1.2 16V Hi-Flex<br>1.5 dCi<br>1.5 dCi<br>1.5 dCi<br>1.5 dCi<br>1.5 dCi<br>1.5 dCi<br>1.6 16V                       | 55<br>57<br>74<br>55<br>48<br>50<br>63<br>76<br>78<br>82             |  | 02.08<br>02.08<br>02.08<br>07.08<br>02.08<br>02.08<br>02.08<br>02.08<br>02.08<br>02.08                            | 12.12<br>12.12<br>12.12<br>12.12<br>12.12<br>12.12<br>12.12<br>12.12<br>12.12<br>12.12                            |  | 03.2123-2821.3                   | 010944           | - ABS          |  | THz 23,81              | ATE        |
|  | 1.2 16V<br>1.2 16V<br>1.2 16V<br>1.2 16V Hi-Flex<br>1.4 16V<br>1.5 dCi<br>1.5 dCi<br>1.5 dCi<br>1.5 dCi<br>1.5 dCi<br>1.6 16V                       | 55<br>57<br>74<br>55<br>72<br>48<br>50<br>63<br>76<br>78<br>82       |  | 02.08<br>02.08<br>02.08<br>07.08<br>02.10<br>02.08<br>02.08<br>02.08<br>02.08<br>02.08                            | 12.12<br>12.12<br>12.12<br>12.12<br>12.12<br>12.12<br>12.12<br>12.12<br>12.12<br>12.12                            |  | 03.2123-3241.3<br>03.2123-3493.3 | 010882<br>010792 | - ESP<br>+ ESP |  | THz 23,81<br>THz 23,81 | ATE<br>ATE |

<sup>1)</sup> + 16" wheel / + ruota 16" / + roue 16" / + rueda 16"



| RENAULT CLIO III Grandtour (KR_) (08-12)   |  |  |  |  |   |  |  |                                  |                  |                          |                         |                |
|--|--|--|--|--|---|--|--|----------------------------------|------------------|--------------------------|-------------------------|----------------|
|     |  |  |  |  |  |  |  |                                  |                  |                          |                         |                |
|    | 1.6 16V  | 94   |  | 11.08  | 12.12   |  |  | 03.2123-2863.3<br>03.2123-2923.3 | 010790<br>010791 | - ESP<br>+ ESP           | THz 23,81<br>THz 23,81  | ATE<br>ATE     |
|    | 1.2 16V  | 55   |  | 02.08  | 12.12   |  |  | 24.3541-1823.5                   | 240417           | <input type="checkbox"/> |                         | D=54, - Halter |
|  | 1.2 16V  | 57   |  | 02.08  | 12.12   |  |  | 24.3541-1824.5                   | 240418           | <input type="checkbox"/> |                         | D=54, - Halter |
|  | 1.2 16V  | 74   |  | 02.08  | 12.12   |  |  |                                  |                  |                          |                         |                |
|  | 1.2 16V Hi-Flex  | 55   |  | 07.08  | 12.12   |  |  |                                  |                  |                          |                         |                |
|  | 1.4 16V  | 72   |  | 02.10  | 12.12   |  |  |                                  |                  |                          |                         |                |
|  | 1.5 dCi  | 48   |  | 02.08  | 12.12   |  |  |                                  |                  |                          |                         |                |
|  | 1.5 dCi  | 50   |  | 02.08  | 12.12   |  |  |                                  |                  |                          |                         |                |
|  | 1.5 dCi  | 63   |  | 02.08  | 12.12   |  |  |                                  |                  |                          |                         |                |
|  | 1.5 dCi  | 76   |  | 02.08  | 12.12   |  |  |                                  |                  |                          |                         |                |
|  | 1.5 dCi  | 78   |  | 02.08  | 12.12   |  |  |                                  |                  |                          |                         |                |
|  | 1.6 16V  | 82   |  | 02.08  | 12.12   |  |  |                                  |                  |                          |                         |                |
|  | 1.6 16V  | 94   |  | 11.08  | 12.12   |  |  |                                  |                  |                          |                         |                |
|    | 1.2 16V  | 55   |  | 02.08  | 12.12   |  |  | 24.5111-0455.3                   | 330914           | 2                        |                         | L=455          |
|  | 1.2 16V  | 57   |  | 02.08  | 12.12   |  |  |                                  |                  |                          |                         |                |
|  | 1.2 16V  | 74   |  | 02.08  | 12.12   |  |  |                                  |                  |                          |                         |                |
|  | 1.2 16V Hi-Flex  | 55   |  | 07.08  | 12.12   |  |  |                                  |                  |                          |                         |                |
|  | 1.4 16V  | 72   |  | 02.10  | 12.12   |  |  |                                  |                  |                          |                         |                |
|  | 1.5 dCi  | 48   |  | 02.08  | 12.12   |  |  |                                  |                  |                          |                         |                |
|  | 1.5 dCi  | 50   |  | 02.08  | 12.12   |  |  |                                  |                  |                          |                         |                |
|  | 1.5 dCi  | 63   |  | 02.08  | 12.12   |  |  |                                  |                  |                          |                         |                |
|  | 1.5 dCi  | 76   |  | 02.08  | 12.12   |  |  |                                  |                  |                          |                         |                |
|  | 1.5 dCi  | 78   |  | 02.08  | 12.12   |  |  |                                  |                  |                          |                         |                |
|  | 1.6 16V  | 82   |  | 02.08  | 12.12   |  |  |                                  |                  |                          |                         |                |
|  | 1.6 16V  | 94   |  | 11.08  | 12.12   |  |  |                                  |                  |                          |                         |                |
|    | 1.2 16V  | 55   |  | 02.08  | 12.12   | + ESP  |  | 24.3347-1703.7                   | 220685           | <input type="checkbox"/> |                         | D=34, - Halter |
|  | 1.2 16V  | 57   |  | 02.08  | 12.12   | + ESP  |  | 24.3347-1704.7                   | 220686           | <input type="checkbox"/> |                         | D=34, - Halter |
|  | 1.2 16V  | 74   |  | 02.08  | 12.12   | + ESP  |  | 24.0101-3803.2                   | 260101           | <input type="checkbox"/> |                         | Einbausatz     |
|  | 1.2 16V Hi-Flex  | 55   |  | 07.08  | 12.12   | + ESP  |  |                                  |                  |                          |                         |                |
|  | 1.4 16V  | 72   |  | 02.10  | 12.12   | + ESP  |  |                                  |                  |                          |                         |                |
|  | 1.5 dCi  | 48   |  | 02.08  | 12.12   | + ESP  |  |                                  |                  |                          |                         |                |
|  | 1.5 dCi  | 50   |  | 02.08  | 12.12   | + ESP  |  |                                  |                  |                          |                         |                |
|  | 1.5 dCi  | 63   |  | 02.08  | 12.12   | + ESP  |  |                                  |                  |                          |                         |                |
|  | 1.5 dCi  | 76   |  | 02.08  | 12.12   | + ESP  |  |                                  |                  |                          |                         |                |
|  | 1.5 dCi  | 78   |  | 02.08  | 12.12   | + ESP  |  |                                  |                  |                          |                         |                |
|  | 1.6 16V  | 82   |  | 02.08  | 12.12   | + ESP  |  |                                  |                  |                          |                         |                |
|  | 1.6 16V  | 94   |  | 11.08  | 12.12   | + ESP  |  |                                  |                  |                          |                         |                |
|   | 1.2 16V  | 55   |  | 02.08  | 12.12   |  |  | 24.5229-0185.3                   | 330397           | 2                        |                         | L=185          |
|  | 1.2 16V  | 57   |  | 02.08  | 12.12   |  |  |                                  |                  |                          |                         |                |
|  | 1.2 16V  | 74   |  | 02.08  | 12.12   |  |  |                                  |                  |                          |                         |                |
|  | 1.2 16V Hi-Flex  | 55   |  | 07.08  | 12.12   |  |  |                                  |                  |                          |                         |                |
|  | 1.4 16V  | 72   |  | 02.10  | 12.12   |  |  |                                  |                  |                          |                         |                |
|  | 1.5 dCi  | 48   |  | 02.08  | 12.12   |  |  |                                  |                  |                          |                         |                |
|  | 1.5 dCi  | 50   |  | 02.08  | 12.12   |  |  |                                  |                  |                          |                         |                |
|  | 1.5 dCi  | 63   |  | 02.08  | 12.12   |  |  |                                  |                  |                          |                         |                |
|  | 1.5 dCi  | 76   |  | 02.08  | 12.12   |  |  |                                  |                  |                          |                         |                |
|  | 1.5 dCi  | 78   |  | 02.08  | 12.12   |  |  |                                  |                  |                          |                         |                |
|  | 1.6 16V  | 82   |  | 02.08  | 12.12   |  |  |                                  |                  |                          |                         |                |
|  | 1.6 16V  | 94   |  | 11.08  | 12.12   |  |  |                                  |                  |                          |                         |                |
|  | 1.2 16V  | 55   |  | 02.08  | 12.12   |  |  | 24.3219-1755.3                   | 020508           |                          | - ESP                   | Rz 19,05       |
|  | 1.2 16V  | 57   |  | 02.08  | 12.12   |  |  |                                  |                  |                          |                         |                |
|  | 1.2 16V  | 74   |  | 02.08  | 12.12   |  |  |                                  |                  |                          |                         |                |
|  | 1.2 16V Hi-Flex  | 55   |  | 07.08  | 12.12   |  |  |                                  |                  |                          |                         |                |
|  | 1.4 16V  | 72   |  | 02.10  | 12.12   |  |  |                                  |                  |                          |                         |                |
|  | 1.5 dCi  | 48   |  | 02.08  | 12.12   |  |  |                                  |                  |                          |                         |                |
|  | 1.5 dCi  | 50   |  | 02.08  | 12.12   |  |  |                                  |                  |                          |                         |                |
|  | 1.5 dCi  | 63   |  | 02.08  | 12.12   |  |  |                                  |                  |                          |                         |                |
|  | 1.5 dCi  | 76   |  | 02.08  | 12.12   |  |  |                                  |                  |                          |                         |                |
|  | 1.5 dCi  | 78   |  | 02.08  | 12.12   |  |  |                                  |                  |                          |                         |                |
|  | 1.6 16V  | 82   |  | 02.08  | 12.12   |  |  |                                  |                  |                          |                         |                |
|  | 1.6 16V  | 94   |  | 11.08  | 12.12   |  |  |                                  |                  |                          |                         |                |
|  | 1.2 16V  | 55   |  | 02.08  | 12.12   |  |  | 24.3727-1078.2                   | 581078           | <input type="checkbox"/> | - ESP                   | L=1451         |
|  | 1.2 16V  | 57   |  | 02.08  | 12.12   |  |  | 24.3727-1079.2                   | 581079           | <input type="checkbox"/> | - ESP                   | L=1587         |
|  | 1.2 16V  | 74   |  | 02.08  | 12.12   |  |  |                                  |                  |                          |                         |                |
|  | 1.2 16V Hi-Flex  | 55   |  | 07.08  | 12.12   |  |  |                                  |                  |                          |                         |                |
|  | 1.4 16V  | 72   |  | 02.10  | 12.12   |  |  |                                  |                  |                          |                         |                |
|  | 1.5 dCi  | 50   |  | 02.08  | 12.12   |  |  |                                  |                  |                          |                         |                |
|  | 1.5 dCi  | 76   |  | 02.08  | 12.12   |  |  |                                  |                  |                          |                         |                |
|  | 1.5 dCi  | 78   |  | 02.08  | 12.12   |  |  |                                  |                  |                          |                         |                |
|  | 1.6 16V  | 82   |  | 02.08  | 12.12   |  |  |                                  |                  |                          |                         |                |
|  | 1.5 dCi  | 48   |  | 02.08  | 12.12   |  |  | 24.3727-1091.2                   | 581091           | <input type="checkbox"/> | - ESP                   | L=1440         |
|  | 1.5 dCi  | 63   |  | 02.08  | 12.12   |  |  | 24.3727-1090.2                   | 581090           | <input type="checkbox"/> | - ESP                   | L=1572         |
|  | 1.6 16V  | 94   |  | 11.08  | 12.12   |  |  |                                  |                  |                          |                         |                |
| RENAULT CLIO IV (B98_) (12-)   |  |  |  |  |   |  |  |                                  |                  |                          |                         |                |
|  | 0.9 TCe 90   | 66   |  | 09.12  |   |  |  | 24.3541-1823.5                   | 240417           | <input type="checkbox"/> | + 17" Rad <sup>1)</sup> | D=54, - Halter |
|  | 1.2 16V 75   | 54   |  | 09.12  |   |  |  | 24.3541-1824.5                   | 240418           | <input type="checkbox"/> | + 17" Rad <sup>1)</sup> | D=54, - Halter |
|  | 1.5 dCi 75   | 55   |  | 09.12  |   |  |  |                                  |                  |                          |                         |                |
|  | 1.5 dCi 90   | 66   |  | 09.12  |   |  |  |                                  |                  |                          |                         |                |
|  | 1.2 TCe 120  | 88   |  | 03.13  |   |  |  | 24.3541-1823.5                   | 240417           | <input type="checkbox"/> |                         | D=54, - Halter |
|  |  |  |  |  |   |  |  | 24.3541-1824.5                   | 240418           | <input type="checkbox"/> |                         | D=54, - Halter |

<sup>1)</sup> + 17" wheel / + ruota 17" / + roue 17" / + rueda 17"

|     |  |  |  |  |  |  |  |     |                |            |                |
|--|--|--|--|--|---|--|--|---|----------------|------------|----------------|
| <b>RENAULT CLIO IV (B98_) (12-)</b>  |  |  |  |  |   |  |  |   |                |            |                |
|    | 0.9 TCe 90   | 66   |  | 09.12  |   | 24.3217-1711.3   | 020449   | - 17" Rad <sup>1)</sup>   | Rz 17,78       | <b>BOS</b> |                |
|  | 1.2 16V 75   | 54   |  | 09.12  |   | 24.3219-1761.3   | 020536   | + 17" Rad <sup>2)</sup>   | Rz 19,05       |            |                |
|  | 1.5 dCi 75   | 55   |  | 09.12  | + Schaltgetriebe <sup>3)</sup>  |  |  |   |                |            |                |
|  | 1.5 dCi 90   | 66   |  | 09.12  | + Schaltgetriebe <sup>3)</sup>  |  |  |   |                |            |                |
|  | 1.2 TCe 120  | 88   |  | 03.13  |   | 24.3219-1761.3   | 020536   |   | Rz 19,05       |            |                |
|    | 1.5 dCi 75   | 55   |  | 09.12  | + Automatikgetriebe <sup>4)</sup>   |  |  |   |                |            |                |
|  | 1.5 dCi 90   | 66   |  | 09.12  | + Automatikgetriebe <sup>4)</sup>   |  |  |   |                |            |                |
|  |  |  |  |  |   |  |  |   |                |            |                |
| <b>RENAULT CLIO IV Grandtour (K98_) (12-)</b>                                      |  |  |  |  |   |  |  |   |                |            |                |
|    | 0.9 TCe 90   | 66   |  | 11.12  |   | 24.3541-1823.5   | 240417   |    | D=54, - Halter |            |                |
|  | 1.2 16V  | 54   |  | 11.12  |   | 24.3541-1824.5   | 240418   |   | D=54, - Halter |            |                |
|  | 1.2 TCe 120  | 88   |  | 03.13  |   |  |  |   |                |            |                |
|  | 1.5 dCi 75   | 55   |  | 11.12  |   |  |  |   |                |            |                |
|  | 1.5 dCi 90   | 66   |  | 11.12  |   |  |  |   |                |            |                |
|    | 0.9 TCe 90   | 66   |  | 11.12  |   | 24.3219-1761.3   | 020536   |   | Rz 19,05       |            |                |
|  | 1.2 16V  | 54   |  | 11.12  |   |  |  |   |                |            |                |
|  | 1.2 TCe 120  | 88   |  | 03.13  |   |  |  |   |                |            |                |
|  | 1.5 dCi 75   | 55   |  | 11.12  |   |  |  |   |                |            |                |
|  | 1.5 dCi 90   | 66   |  | 11.12  |   |  |  |   |                |            |                |
| <b>RENAULT DOKKER (K67/F67) (12-)</b>  |  |  |  |  |   |  |  |   |                |            |                |
|    | 1.5 dCi 75   | 55   |  | 11.12  | - ESP   | 24.3541-1823.5   | 240417   |    | D=54, - Halter |            |                |
|  | 1.5 dCi 90   | 66   |  | 11.12  | - ESP   | 24.3541-1824.5   | 240418   |   | D=54, - Halter |            |                |
|  | 1.6 MPI  | 61   |  | 11.12  | - ESP   |  |  |   |                |            |                |
|    | 1.2 TCe 115  | 85   |  | 01.13  |   | 11.9541-9950.2   | 220843   |    | D=54, - Halter | <b>ATE</b> |                |
|  | 1.5 dCi 75   | 55   |  | 11.12  | + ESP   | 11.9541-9951.2   | 220844   |   | D=54, - Halter |            |                |
|  | 1.5 dCi 90   | 66   |  | 11.12  | + ESP   | 11.8116-0356.1   | 390586   |   | 2              |            | Haltefeder     |
|  | 1.6 MPI  | 61   |  | 11.12  | + ESP   |  |  |   |                |            |                |
| <b>RENAULT DUSTER (HS-) (11-)</b>  |  |  |  |  |   |  |  |   |                |            |                |
|    | 1.5 dCi  | 66   |  | 06.11  |   | 03.2122-2031.3   | 010938   | + ABS   | Thz 22,20      | <b>ATE</b> |                |
|  | 1.5 dCi 4x4  | 66   |  | 06.11  |   |  |  |   |                |            |                |
|  | 1.6 16V  | 75   |  | 06.11  |   |  |  |   |                |            |                |
|  | 1.6 16V 4x4  | 75   |  | 06.11  |   |  |  |   |                |            |                |
|  | 2.0  | 98   |  | 02.12  |   |  |  |   |                |            |                |
|  | 2.0 4x4  | 98   |  | 02.12  |   |  |  |   |                |            |                |
|    | 1.5 dCi  | 66   |  | 06.11  | - ABS   | 24.3541-1823.5   | 240417   |    | D=54, - Halter |            |                |
|  | 1.6 16V  | 75   |  | 06.11  | - ESP   | 24.3541-1824.5   | 240418   |   | D=54, - Halter |            |                |
|  | 1.6 16V 4x4  | 75   |  | 06.11  | - ESP   |  |  |   |                |            |                |
|  | 2.0  | 98   |  | 02.12  | - ABS   |  |  |   |                |            |                |
|  | 1.5 dCi  | 66   |  | 06.11  | + ABS   | 11.9541-9950.2   | 220843   |   | 2              |            | D=54, - Halter |
|  | 1.5 dCi 4x4  | 66   |  | 06.11  | + ABS   | 11.9541-9951.2   | 220844   |   |                |            | D=54, - Halter |
| 1.6 16V  | 75   |  | 06.11  | + ESP  | 11.8116-0356.1  | 390586   | Haltefeder   |   |                |            |                |
|  | 1.6 16V 4x4  | 75   |  | 06.11  | + ESP   |  |  |   |                |            |                |
|  | 2.0  | 98   |  | 02.12  | + ABS   |  |  |   |                |            |                |
|  | 2.0 4x4  | 98   |  | 02.12  | + ABS   |  |  |   |                |            |                |
|  | 1.5 dCi  | 66   |  | 06.11  |   | 24.5229-0285.3   | 330032   | 2   | L=285          |            |                |
|  | 1.5 dCi 4x4  | 66   |  | 06.11  |   |  |  |   |                |            |                |
|  | 1.6 16V  | 75   |  | 06.11  |   |  |  |   |                |            |                |
|  | 1.6 16V 4x4  | 75   |  | 06.11  |   |  |  |   |                |            |                |
|  | 2.0  | 98   |  | 02.12  |   |  |  |   |                |            |                |
|  | 2.0 4x4  | 98   |  | 02.12  |   |  |  |   |                |            |                |
|  | 1.5 dCi  | 66   |  | 06.11  |   | 24.3219-1761.3   | 020536   |   | Rz 19,05       |            |                |
|  | 1.6 16V  | 75   |  | 06.11  |   |  |  |   |                |            |                |
|  | 2.0  | 98   |  | 02.12  |   |  |  |   |                |            |                |
|  | 1.5 dCi 4x4  | 66   |  | 06.11  |   | 24.3219-1763.3   | 020543   |  | Rz 19,05       |            |                |
|  | 1.6 16V 4x4  | 75   |  | 06.11  |   | 24.3219-1764.3   | 020544   |   | Rz 19,05       |            |                |
|  | 2.0 4x4  | 98   |  | 02.12  |   |  |  |   |                |            |                |
|  |  |  |  |  |   |  |  |   |                |            |                |
| <b>RENAULT ESPACE II (J/S 63_) (91-96)</b>   |  |  |  |  |   |  |  |   |                |            |                |
|  | 2.0 (J/- 636)  | 76   |  | 01.91  | 10.96   | 03.6750-2902.4   | 300037   |   | 9"             | <b>ATE</b> |                |
|  | 2.1 RTDT Quadra  | 65   |  | 01.91  | 05.92   |  |  |   |                |            |                |
|  | 2.1 TD (J633-635,63D)  | 65   |  | 01.91  | 10.96   |  |  |   |                |            |                |
|  | 2.1 TD (J63E)  | 66   |  | 11.94  | 10.96   |  |  |   |                |            |                |
|  | 2.2 (J/S637,J63G)  | 79   |  | 01.91  | 10.96   |  |  |   |                |            |                |
|  | 2.2 4x4 (J/S637,J63G)  | 79   |  | 03.91  | 12.96   |  |  |   |                |            |                |
|  | 2.0 (J/- 636)  | 76   |  | 01.91  | 10.96   | - ABS/ - Niveauregulierung <sup>5)</sup>   | 03.2120-2682.3   | 010118  | Thz 20,64      | <b>ATE</b> |                |
|  | 2.1 RTDT Quadra  | 65   |  | 01.91  | 05.92   | - Niveauregulierung <sup>6)</sup>  |  |   |                |            |                |
|  | 2.1 TD (J633-635,63D)  | 65   |  | 01.91  | 10.96   | - Niveauregulierung <sup>6)</sup>  |  |   |                |            |                |
|  | 2.2 (J/S637,J63G)  | 79   |  | 01.91  | 10.96   | - ABS/ - Niveauregulierung <sup>5)</sup>   |  |   |                |            |                |
|  | 2.2 4x4 (J/S637,J63G)  | 79   |  | 03.91  | 12.96   | - ABS/ - Niveauregulierung <sup>5)</sup>   |  |   |                |            |                |
|  |  |  |  |  |   |  |  |   |                |            |                |
|  | 2.0 (J/- 636)  | 76   |  | 01.91  | 10.96   | - ABS  | 03.2122-9631.3   | 010160  | Thz 22,20      | <b>ATE</b> |                |
|  | 2.1 RTDT Quadra  | 65   |  | 01.91  | 05.92   | - ABS  |  |   |                |            |                |
|  | 2.1 TD (J633-635,63D)  | 65   |  | 01.91  | 10.96   | - ABS  |  |   |                |            |                |
|  | 2.1 TD (J63E)  | 66   |  | 11.94  | 10.96   | - ABS  |  |   |                |            |                |
|  | 2.2 (J/S637,J63G)  | 79   |  | 01.91  | 10.96   | - ABS  |  |   |                |            |                |
|  | 2.2 4x4 (J/S637,J63G)  | 79   |  | 03.91  | 12.96   | - ABS  |  |   |                |            |                |
|  | 2.0 (J/- 636)  | 76   |  | 07.93  | 10.96   | + ABS  | 03.2122-0626.3   | 010539  | Thz 22,20      | <b>ATE</b> |                |
|  | 2.1 TD (J633-635,63D)  | 65   |  | 07.93  | 10.96   | + ABS  |  |   |                |            |                |
|  | 2.1 TD (J63E)  | 66   |  | 11.94  | 10.96   | + ABS  |  |   |                |            |                |
|  | 2.2 (J/S637,J63G)  | 79   |  | 07.93  | 10.96   | + ABS  |  |   |                |            |                |
|  | 2.2 4x4 (J/S637,J63G)  | 79   |  | 07.93  | 12.96   | + ABS  |  |   |                |            |                |
|  |  |  |  |  |   |  |  |   |                |            |                |
|  | 2.8 V6 (J638,J63J)   | 110  |  | 01.91  | 10.96   |  | 24.2123-1701.3   | 010424  | Thz 23,81      |            |                |
|  |  |  |  |  |   |  |  |   |                |            |                |

<sup>1)</sup> - 17" wheel / - ruota 17" / - roue 17" / - rueda 17"

<sup>2)</sup> + 17" wheel / + ruota 17" / + roue 17" / + rueda 17"























<sup>3)</sup> + manual transmission / + scatola cambio velocità / + transmission mécanique / + cambio de velocidad

<sup>4)</sup> + autom.transmission / + scatola cambio automatico / + transmission automatique / + cambio automático

<sup>5)</sup> - ABS/ - suspens.level control / - ABS/ - correttore assetto / - ABS/ - correcteur d'assiette / - ABS/ - regul.alt. suspensión

<sup>6)</sup> - suspension level control / - correttore assetto / - correcteur d'assiette / - regulaci3n altura suspens3n



|     |    |  |  |  |   |  |  |  |  |                |
|--|--|--|--|--|--|--|--|--|--|----------------|
| <b>RENAULT ESPACE II (J/S 63_) (91-96)</b>   |  |  |  |  |  |  |  |  |  |                |
|    | 2.0 (J/- 636)<br>2.1 RTDT Quadra<br>2.1 TD (J633-635,63D)<br>2.1 TD (J63E)<br>2.2 (J/S637,J63G)<br>2.2 4x4 (J/S637,J63G)                       | 76<br>65<br>65<br>66<br>79<br>79   |  | 01.91<br>01.91<br>01.91<br>11.94<br>01.91<br>03.91                               | 10.96<br>05.92<br>10.96<br>10.96<br>10.96<br>12.96   | 24.3541-1625.5<br>24.3541-1626.5   | 240045<br>240046   | D=54, - Halter<br>D=54, - Halter   | LUC<br>LUC   |                |
|    | 2.0 (J/- 636)<br>2.1 RTDT Quadra<br>2.1 TD (J633-635,63D)<br>2.1 TD (J63E)<br>2.2 (J/S637,J63G)<br>2.2 4x4 (J/S637,J63G)                       | 76<br>65<br>65<br>66<br>79<br>79   |  | 01.91<br>01.91<br>01.91<br>11.94<br>01.91<br>03.91                               | 10.96<br>05.92<br>10.96<br>10.96<br>10.96<br>12.96   | 24.5111-0396.3   | 330609   | 2  | L=395  |                |
|    | 2.0 (J/- 636)<br>2.1 RTDT Quadra<br>2.1 TD (J633-635,63D)<br>2.1 TD (J63E)<br>2.2 (J/S637,J63G)<br>2.2 4x4 (J/S637,J63G)<br>2.8 V6 (J638,J63J) | 76<br>65<br>65<br>66<br>79<br>79<br>110  |  | 01.91<br>01.91<br>01.91<br>11.94<br>01.91<br>05.93<br>01.91                      | 10.96 + ABS/ + Niveauregulierung <sup>1)</sup><br>05.92 + Niveauregulierung <sup>2)</sup><br>10.96 + Niveauregulierung <sup>2)</sup><br>10.96 + Niveauregulierung <sup>2)</sup><br>10.96 + ABS/ + Niveauregulierung <sup>1)</sup><br>12.96 + ABS/ + Niveauregulierung <sup>1)</sup><br>10.96 | 24.3367-1501.7<br>24.3367-1502.7   | 220271<br>220272   | D=36, - Halter<br>D=36, - Halter   | BDX<br>BDX   |                |
|    | 2.0 (J/- 636)<br>2.1 RTDT Quadra<br>2.1 TD (J633-635,63D)<br>2.1 TD (J63E)<br>2.2 (J/S637,J63G)<br>2.2 4x4 (J/S637,J63G)<br>2.8 V6 (J638,J63J) | 76<br>65<br>65<br>66<br>79<br>79<br>110  |  | 01.91<br>01.91<br>01.91<br>11.94<br>05.93<br>05.93<br>01.91                      | 10.96<br>05.92<br>10.96<br>10.96<br>10.96<br>12.96<br>10.96  | 24.5112-0220.3<br>24.5228-0350.3   | 330613<br>330396   | 2<br>2   | Länge beachten <sup>3)</sup><br>Länge beachten <sup>3)</sup> | L=220<br>L=350 |
|    | 2.0 (J/- 636)<br>2.1 RTDT Quadra<br>2.1 TD (J633-635,63D)<br>2.1 TD (J63E)<br>2.2 (J/S637,J63G)<br>2.2 4x4 (J/S637,J63G)                       | 76<br>65<br>65<br>66<br>79<br>79   |  | 01.91<br>01.91<br>01.91<br>11.94<br>01.91<br>03.91                               | 10.96 - ABS/ - Niveauregulierung <sup>4)</sup><br>05.92 - Niveauregulierung <sup>5)</sup><br>10.96 - Niveauregulierung <sup>5)</sup><br>10.96 - Niveauregulierung <sup>5)</sup><br>10.96 - ABS/ - Niveauregulierung <sup>4)</sup><br>12.96 - ABS/ - Niveauregulierung <sup>4)</sup>          | 24.3222-1118.3   | 020315   |  | Rz 22,20   | BDX            |
|    | 2.0 (J/- 636)<br>2.1 RTDT Quadra<br>2.1 TD (J633-635,63D)<br>2.1 TD (J63E)<br>2.2 (J/S637,J63G)<br>2.2 4x4 (J/S637,J63G)                       | 76<br>65<br>65<br>66<br>79<br>79   |  | 01.91<br>01.91<br>01.91<br>11.94<br>01.91<br>03.91                               | 10.96 - ABS/ - Niveauregulierung <sup>4)</sup><br>05.92 - Niveauregulierung <sup>5)</sup><br>10.96 - Niveauregulierung <sup>5)</sup><br>10.96 - Niveauregulierung <sup>5)</sup><br>10.96 - ABS/ - Niveauregulierung <sup>4)</sup><br>12.96 - ABS/ - Niveauregulierung <sup>4)</sup>          | 24.3222-1615.3   | 020285   |  | Rz 22,20   | LUC            |
|   | 2.0 (J/- 636)<br>2.1 RTDT Quadra<br>2.1 TD (J633-635,63D)<br>2.1 TD (J63E)<br>2.2 (J/S637,J63G)<br>2.2 4x4 (J/S637,J63G)                       | 76<br>65<br>65<br>66<br>79<br>79   |  | 01.91<br>01.91<br>01.91<br>11.94<br>01.91<br>03.91                               | 10.96 - ABS/ - Niveauregulierung <sup>4)</sup><br>05.92 - Niveauregulierung <sup>5)</sup><br>10.96 - Niveauregulierung <sup>5)</sup><br>10.96 - Niveauregulierung <sup>5)</sup><br>10.96 - ABS/ - Niveauregulierung <sup>4)</sup><br>12.96 - ABS/ - Niveauregulierung <sup>4)</sup>          | 24.3727-1031.2   | 581031   | 1  | L=1984/1045  |                |
|  | 2.0 (J/- 636)<br>2.1 RTDT Quadra<br>2.1 TD (J633-635,63D)<br>2.1 TD (J63E)<br>2.2 (J/S637,J63G)<br>2.2 4x4 (J/S637,J63G)<br>2.8 V6 (J638,J63J) | 76<br>65<br>65<br>66<br>79<br>79<br>110  |  | 01.91<br>01.91<br>01.91<br>11.94<br>01.91<br>03.91<br>01.91                      | 10.96 + ABS/ + Niveauregulierung <sup>1)</sup><br>05.92 + Niveauregulierung <sup>2)</sup><br>10.96 + Niveauregulierung <sup>2)</sup><br>10.96 + Niveauregulierung <sup>2)</sup><br>10.96 + ABS/ + Niveauregulierung <sup>1)</sup><br>12.96 + ABS/ + Niveauregulierung <sup>1)</sup><br>10.96 | 24.3727-1024.2   | 581024   | 1  | L=1285/1891  |                |
|  | 2.0 (J/- 636)<br>2.1 RTDT Quadra<br>2.1 TD (J633-635,63D)<br>2.1 TD (J63E)<br>2.2 (J/S637,J63G)<br>2.2 4x4 (J/S637,J63G)                       | 76<br>65<br>65<br>66<br>79<br>79   |  | 01.91<br>01.91<br>01.91<br>11.94<br>01.91<br>03.91                               | 01.95<br>05.92<br>01.95<br>01.95<br>01.95<br>01.95   | 24.3728-1015.2   | 591015   |  | L=1330   |                |
|  | 2.0 (J/- 636)<br>2.1 TD (J633-635,63D)<br>2.1 TD (J63E)<br>2.2 (J/S637,J63G)<br>2.2 4x4 (J/S637,J63G)  | 76<br>65<br>66<br>79<br>79   |  | 02.95<br>02.95<br>02.95<br>02.95<br>02.95  | 10.96<br>10.96<br>10.96<br>10.96<br>12.96  | 24.3728-1026.2   | 591026   |  | L=1318, + AUT  |                |
| <b>RENAULT ESPACE III (JE_) (96-02)</b>  |  |  |  |  |  |  |  |  |  |                |
|  | 1.9 dTi<br>2.0<br>2.0<br>2.0 16V   | 72<br>84<br>102<br>103   |  | 02.99<br>11.96<br>09.01<br>10.98   | 10.02<br>10.00<br>10.02<br>10.02   | 03.7760-4202.4   | 300145   |  | 10"  | ATE            |
|  | 1.9 dTi<br>2.0<br>2.0<br>2.0 16V   | 72<br>84<br>102<br>103   |  | 02.99<br>11.96<br>09.01<br>10.98   | 10.02 - ABS<br>10.00 - ABS<br>10.02 - ABS<br>10.02 - ABS   | 03.2123-1546.3   | 010536   |  | THz 23,81  | ATE            |
|  | 2.2 D<br>2.2 dCi<br>2.2 dT<br>3.0 V6<br>3.0 V6   | 84<br>85<br>83<br>123<br>140   |  | 11.97<br>07.00<br>11.96<br>11.96<br>10.98  | 01.00 - ABS<br>10.02<br>10.00 - ABS<br>10.98 - ABS<br>10.02 - ABS  | 03.2123-1741.3   | 010537   |  | THz 23,81  | ATE            |
|  | 1.9 dTi<br>2.0<br>2.0<br>2.0 16V<br>2.2 D<br>2.2 dCi   | 72<br>84<br>102<br>103<br>84<br>95   |  | 02.99<br>11.96<br>09.01<br>10.98<br>11.97<br>10.00                               | 10.02 + ABS<br>10.00 + ABS<br>10.02 + ABS<br>10.02 + ABS<br>01.00 + ABS<br>10.02   | 03.2123-1486.3   | 010488   |  | THz 23,81  | ATE            |

<sup>1)</sup> + ABS/ + suspens.level control / + ABS/ + correttore d'assetto / + ABS/ + correcteur d'assiette / + ABS/ + regul. alt.suspension

<sup>2)</sup> + suspension level control / + correttore assetto / + correcteur d'assiette / + regulacion altura suspension

<sup>3)</sup> notice length / attenzione lunghezza / faire attention longueur / atención largo

<sup>4)</sup> - ABS/ - suspens.level control / - ABS/ - correttore assetto / - ABS/ - correcteur d'assiette / - ABS/ - regul.alt. suspension

<sup>5)</sup> - suspension level control / - correttore assetto / - correcteur d'assiette / - regulacion altura suspension

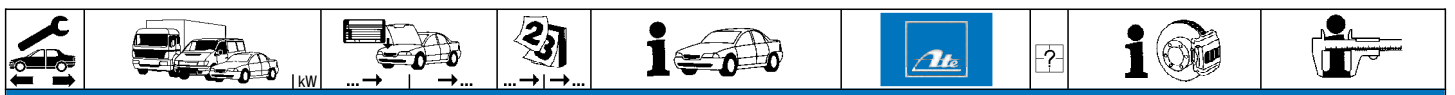

### RENAULT ESPACE III (JE\_) (96-02)













|  |         |     |       |       |       |                |        |   |                                 |             |
|--|---------|-----|-------|-------|-------|----------------|--------|---|---------------------------------|-------------|
|  | 2.2 dT  | 83  | 11.96 | 10.00 | + ABS | 03.2123-1486.3 | 010488 |   | THz 23,81                       | ATE         |
|  | 3.0 V6  | 123 | 11.96 | 10.98 | + ABS |                |        |   |                                 |             |
|  | 3.0 V6  | 140 | 10.98 | 10.02 | + ABS |                |        |   |                                 |             |
|  | 1.9 dTi | 72  | 02.99 | 10.02 |       | 24.3541-1749.5 | 240427 |   | D=54, - Halter                  | LUC         |
|  | 2.0     | 84  | 11.96 | 10.00 |       | 24.3541-1750.5 | 240428 |   | D=54, - Halter                  | LUC         |
|  | 2.0     | 102 | 09.01 | 10.02 |       |                |        |   |                                 |             |
|  | 2.0 16V | 103 | 10.98 | 10.02 |       |                |        |   |                                 |             |
|  | 2.2 D   | 84  | 11.97 | 01.00 |       | 24.3601-1707.5 | 240229 |   | D=60, - Halter                  | LUC         |
|  | 2.2 dCi | 85  | 07.00 | 10.02 |       | 24.3601-1708.5 | 240230 |   | D=60, - Halter                  | LUC         |
|  | 2.2 dT  | 83  | 11.96 | 10.00 |       |                |        |   |                                 |             |
|  | 3.0 V6  | 123 | 11.96 | 10.98 |       |                |        |   |                                 |             |
|  | 2.2 dCi | 95  | 10.00 | 10.02 |       | 24.3451-1713.7 | 220737 |   | D=40/45, - Halter               | LUC         |
|  | 3.0 V6  | 140 | 07.00 | 10.02 |       | 24.3451-1714.7 | 220738 |   | D=40/45, - Halter               | LUC         |
|  | 1.9 dTi | 72  | 02.99 | 10.02 |       | 24.5111-0490.3 | 330598 | 2 | L=490                           |             |
|  | 2.0     | 84  | 11.96 | 10.00 |       |                |        |   |                                 |             |
|  | 2.0     | 102 | 09.01 | 10.02 |       |                |        |   |                                 |             |
|  | 2.0 16V | 103 | 10.98 | 10.02 |       |                |        |   |                                 |             |
|  | 2.2 D   | 84  | 11.97 | 01.00 |       |                |        |   |                                 |             |
|  | 2.2 dCi | 85  | 07.00 | 10.02 |       |                |        |   |                                 |             |
|  | 2.2 dT  | 83  | 11.96 | 10.00 |       |                |        |   |                                 |             |
|  | 3.0 V6  | 123 | 11.96 | 10.98 |       |                |        |   |                                 |             |
|  | 3.0 V6  | 140 | 10.98 | 10.02 |       |                |        |   |                                 |             |
|  | 1.9 dTi | 72  | 02.99 | 10.02 |       | 24.5229-0185.3 | 330397 | 2 | L=185                           |             |
|  | 2.0     | 84  | 11.96 | 10.00 |       |                |        |   |                                 |             |
|  | 2.0     | 102 | 09.01 | 10.02 |       |                |        |   |                                 |             |
|  | 2.0 16V | 103 | 10.98 | 10.02 |       |                |        |   |                                 |             |
|  | 2.2 D   | 84  | 11.97 | 01.00 |       |                |        |   |                                 |             |
|  | 2.2 dCi | 85  | 07.00 | 10.02 |       |                |        |   |                                 |             |
|  | 2.2 dCi | 95  | 10.00 | 10.02 |       |                |        |   |                                 |             |
|  | 2.2 dT  | 83  | 11.96 | 10.00 |       |                |        |   |                                 |             |
|  | 3.0 V6  | 123 | 11.96 | 10.98 |       |                |        |   |                                 |             |
|  | 3.0 V6  | 140 | 10.98 | 10.02 |       |                |        |   |                                 |             |
|  | 2.0 16V | 103 | 10.98 | 10.02 |       | 24.5111-0260.3 | 330408 | 2 | L=260                           |             |
|  | 3.0 V6  | 123 | 11.96 | 10.98 |       |                |        |   |                                 |             |
|  | 3.0 V6  | 140 | 10.98 | 10.02 |       |                |        |   |                                 |             |
|  | 1.9 dTi | 72  | 02.99 | 10.02 |       | 24.3222-1615.3 | 020285 |   | Rz 22,20                        | LUC         |
|  | 2.0     | 84  | 11.96 | 10.00 |       |                |        |   |                                 |             |
|  | 2.2 D   | 84  | 11.97 | 01.00 |       |                |        |   |                                 |             |
|  | 2.2 dCi | 85  | 07.00 | 10.02 |       |                |        |   |                                 |             |
|  | 2.2 dT  | 83  | 11.96 | 10.00 |       |                |        |   |                                 |             |
|  | 1.9 dTi | 72  | 02.99 | 10.02 |       | 24.3727-1058.2 | 581058 | 1 | + Radstand 2702mm <sup>1)</sup> | L=1520/1583 |
|  | 2.0     | 84  | 11.96 | 10.00 |       | 24.3727-1059.2 | 581059 | 1 | + Radstand 2874mm <sup>2)</sup> | L=1675/1740 |
|  | 2.2 D   | 84  | 11.97 | 01.00 |       |                |        |   |                                 |             |
|  | 2.2 dCi | 85  | 07.00 | 10.02 |       |                |        |   |                                 |             |
|  | 2.2 dT  | 83  | 11.96 | 10.00 |       |                |        |   |                                 |             |
|  | 2.0     | 84  | 11.96 | 10.00 |       | 24.3728-1027.2 | 591027 |   | L=1072, + AUT                   |             |
|  | 2.0     | 102 | 09.01 | 10.02 |       |                |        |   |                                 |             |
|  | 2.0 16V | 103 | 10.98 | 10.02 |       |                |        |   |                                 |             |





### RENAULT ESPACE IV (JK\_) (02-)

|  |             |     |       |       |  |                |        |       |              |     |
|--|-------------|-----|-------|-------|--|----------------|--------|-------|--------------|-----|
|  | 1.9 dCi     | 85  | 04.03 | 02.05 |  | 03.7868-1602.4 | 300220 |       | 10/8" Tandem | ATE |
|  | 1.9 dCi     | 88  | 11.02 |       |  |                |        |       |              |     |
|  | 2.0         | 98  | 11.02 | 02.05 |  |                |        |       |              |     |
|  | 2.0 dCi     | 96  | 01.06 |       |  |                |        |       |              |     |
|  | 2.0 dCi 110 | 110 | 01.06 |       |  |                |        |       |              |     |
|  | 2.0 dCi 130 | 127 | 01.06 |       |  |                |        |       |              |     |
|  | 2.0 i       | 100 | 11.02 |       |  |                |        |       |              |     |
|  | 2.0 Turbo   | 120 | 11.02 |       |  |                |        |       |              |     |
|  | 2.0 Turbo   | 125 | 04.05 |       |  |                |        |       |              |     |
|  | 2.2 dCi     | 102 | 02.06 |       |  |                |        |       |              |     |
|  | 2.2 dCi     | 110 | 11.02 |       |  |                |        |       |              |     |
|  | 3.0 dCi     | 130 | 11.02 |       |  |                |        |       |              |     |
|  | 3.0 dCi     | 133 | 01.06 |       |  |                |        |       |              |     |
|  | 3.5 V6      | 177 | 11.02 |       |  |                |        |       |              |     |
|  | 1.9 dCi     | 85  | 04.03 | 02.05 |  | 03.4125-0021.3 | 010888 | - ESP | THz 25,40    | ATE |
|  | 1.9 dCi     | 88  | 11.02 |       |  |                |        |       |              |     |
|  | 2.0         | 98  | 11.02 | 02.05 |  |                |        |       |              |     |
|  | 2.0 dCi     | 96  | 01.06 |       |  |                |        |       |              |     |
|  | 2.0 dCi 110 | 110 | 01.06 |       |  |                |        |       |              |     |
|  | 2.0 dCi 130 | 127 | 01.06 |       |  |                |        |       |              |     |
|  | 2.0 i       | 100 | 11.02 |       |  |                |        |       |              |     |
|  | 2.0 Turbo   | 120 | 11.02 |       |  |                |        |       |              |     |
|  | 2.0 Turbo   | 125 | 04.05 |       |  |                |        |       |              |     |
|  | 2.2 dCi     | 102 | 02.06 |       |  |                |        |       |              |     |
|  | 2.2 dCi     | 110 | 11.02 |       |  |                |        |       |              |     |
|  | 3.0 dCi     | 130 | 11.02 |       |  |                |        |       |              |     |
|  | 3.0 dCi     | 133 | 01.06 |       |  |                |        |       |              |     |
|  | 3.5 V6      | 177 | 11.02 |       |  |                |        |       |              |     |
|  | 1.9 dCi     | 85  | 04.03 | 12.04 |  | 03.4125-0014.3 | 010794 | + ESP | THz 25,40    | ATE |
|  | 1.9 dCi     | 88  | 11.02 | 12.04 |  |                |        |       |              |     |
|  | 2.0         | 98  | 11.02 | 12.04 |  |                |        |       |              |     |
|  | 2.0 i       | 100 | 11.02 | 12.04 |  |                |        |       |              |     |
|  | 2.0 Turbo   | 120 | 11.02 | 12.04 |  |                |        |       |              |     |
|  | 2.2 dCi     | 110 | 11.02 | 12.04 |  |                |        |       |              |     |
|  | 3.0 dCi     | 130 | 11.02 | 12.04 |  |                |        |       |              |     |
|  | 3.5 V6      | 177 | 11.02 | 12.04 |  |                |        |       |              |     |

<sup>1)</sup> + wheel base 2702 mm / + passo 2702 mm / + empattement 2702 mm / + distancia entre rueda 2702mm

<sup>2)</sup> + wheel base 2874 mm / + passo 2874 mm / + empattement 2874 mm / + distancia entre rueda 2874mm

| RENAULT ESPACE IV (JK_) (02-)  |              |     |  |       |       |  |                |        |   |       |                |     |
|--|--------------|-----|--|-------|-------|--|----------------|--------|---|-------|----------------|-----|
|    | 1.9 dCi      | 85  |  | 01.05 | 02.05 |  | 03.4155-0043.3 | 010795 |   | + ESP | THz 25,40      | ATE |
|  | 1.9 dCi      | 88  |  | 01.05 |       |  |                |        |   |       |                |     |
|  | 2.0          | 98  |  | 01.05 | 02.05 |  |                |        |   |       |                |     |
|  | 2.0 dCi      | 96  |  | 01.06 |       |  |                |        |   |       |                |     |
|  | 2.0 dCi 110  | 110 |  | 01.06 |       |  |                |        |   |       |                |     |
|  | 2.0 dCi 130  | 127 |  | 01.06 |       |  |                |        |   |       |                |     |
|  | 2.0 i        | 100 |  | 01.05 |       |  |                |        |   |       |                |     |
|  | 2.0 Turbo    | 120 |  | 01.05 |       |  |                |        |   |       |                |     |
|  | 2.0 Turbo    | 125 |  | 04.05 |       |  |                |        |   |       |                |     |
|  | 2.2 dCi      | 102 |  | 02.06 |       |  |                |        |   |       |                |     |
|  | 2.2 dCi      | 110 |  | 01.05 |       |  |                |        |   |       |                |     |
|  | 3.0 dCi      | 130 |  | 01.05 |       |  |                |        |   |       |                |     |
|  | 3.0 dCi      | 133 |  | 01.06 |       |  |                |        |   |       |                |     |
|  | 3.5 V6       | 177 |  | 01.05 |       |  |                |        |   |       |                |     |
|    | 1.9 dCi      | 85  |  | 04.03 | 02.05 |  | 11.9601-9787.2 | 220585 |    |       | D=60, - Halter | ATE |
|  | 1.9 dCi      | 88  |  | 11.02 |       |  | 11.9601-9788.2 | 220586 |    |       | D=60, - Halter | ATE |
|  | 2.0          | 98  |  | 11.02 | 02.05 |  | 24.3601-9787.5 | 240505 |    |       | D=60, - Halter | ATE |
|  | 2.0 dCi      | 96  |  | 01.06 |       |  | 24.3601-9788.5 | 240506 |    |       | D=60, - Halter | ATE |
|  | 2.0 dCi 110  | 110 |  | 01.06 |       |  | 11.0101-5407.2 | 260011 |   |       | Hülzensatz     | ATE |
|  | 2.0 dCi 130  | 127 |  | 01.06 |       |  | 11.8171-0008.1 | 990049 |   |       | Führungsbolzen | ATE |
|  | 2.0 i        | 100 |  | 11.02 |       |  | 11.8116-0301.1 | 390610 | 2   |       | Haltefeder     | ATE |
|  | 2.0 Turbo    | 120 |  | 11.02 |       |  |                |        |   |       |                |     |
|  | 2.0 Turbo    | 125 |  | 04.05 |       |  |                |        |   |       |                |     |
|  | 2.2 dCi      | 102 |  | 02.06 |       |  |                |        |   |       |                |     |
|  | 2.2 dCi      | 110 |  | 11.02 |       |  |                |        |   |       |                |     |
|  | 3.0 dCi      | 130 |  | 11.02 |       |  |                |        |   |       |                |     |
|  | 3.0 dCi      | 133 |  | 01.06 |       |  |                |        |   |       |                |     |
|  | 3.5 V6       | 177 |  | 11.02 |       |  |                |        |   |       |                |     |
|    | 1.9 dCi      | 85  |  | 04.03 | 02.05 |  | 24.5252-0390.3 | 330702 | 2   |       | L=390          |     |
|  | 1.9 dCi      | 88  |  | 11.02 |       |  |                |        |   |       |                |     |
|  | 2.0          | 98  |  | 11.02 | 02.05 |  |                |        |   |       |                |     |
|  | 2.0 dCi      | 96  |  | 01.06 |       |  |                |        |   |       |                |     |
|  | 2.0 dCi 110  | 110 |  | 01.06 |       |  |                |        |   |       |                |     |
|  | 2.0 dCi 130  | 127 |  | 01.06 |       |  |                |        |   |       |                |     |
|  | 2.0 i        | 100 |  | 11.02 |       |  |                |        |   |       |                |     |
|  | 2.0 Turbo    | 120 |  | 11.02 |       |  |                |        |   |       |                |     |
|  | 2.0 Turbo    | 125 |  | 04.05 |       |  |                |        |   |       |                |     |
|  | 2.2 dCi      | 102 |  | 02.06 |       |  |                |        |   |       |                |     |
|  | 2.2 dCi      | 110 |  | 11.02 |       |  |                |        |   |       |                |     |
|  | 3.0 dCi      | 130 |  | 11.02 |       |  |                |        |   |       |                |     |
|  | 3.0 dCi      | 133 |  | 01.06 |       |  |                |        |   |       |                |     |
|  | 3.5 V6       | 177 |  | 11.02 |       |  |                |        |   |       |                |     |
|  | 1.9 dCi      | 85  |  | 04.03 | 02.05 |  | 11.9387-7001.2 | 220397 |  |       | D=38, - Halter | ATE |
|  | 1.9 dCi      | 88  |  | 11.02 |       |  | 11.9387-7002.2 | 220398 |  |       | D=38, - Halter | ATE |
|  | 2.0          | 98  |  | 11.02 | 02.05 |  | 11.8116-0340.1 | 390595 | 2   |       | Haltefeder     | ATE |
|  | 2.0 dCi      | 96  |  | 01.06 |       |  |                |        |   |       |                |     |
|  | 2.0 dCi 110  | 110 |  | 01.06 |       |  |                |        |   |       |                |     |
|  | 2.0 dCi 130  | 127 |  | 01.06 |       |  |                |        |   |       |                |     |
|  | 2.0 i        | 100 |  | 11.02 |       |  |                |        |   |       |                |     |
|  | 2.0 Turbo    | 120 |  | 11.02 |       |  |                |        |   |       |                |     |
|  | 2.0 Turbo    | 125 |  | 04.05 |       |  |                |        |   |       |                |     |
|  | 2.2 dCi      | 102 |  | 02.06 |       |  |                |        |   |       |                |     |
|  | 2.2 dCi      | 110 |  | 11.02 |       |  |                |        |   |       |                |     |
|  | 3.0 dCi      | 130 |  | 11.02 |       |  |                |        |   |       |                |     |
|  | 3.0 dCi      | 133 |  | 01.06 |       |  |                |        |   |       |                |     |
|  | 3.5 V6       | 177 |  | 11.02 |       |  |                |        |   |       |                |     |
|  | 1.9 dCi      | 85  |  | 04.03 | 02.05 |  | 24.5251-0185.3 | 330701 | 2   |       | L=185          |     |
|  | 1.9 dCi      | 88  |  | 11.02 |       |  |                |        |   |       |                |     |
|  | 2.0          | 98  |  | 11.02 | 02.05 |  |                |        |   |       |                |     |
|  | 2.0 dCi      | 96  |  | 01.06 |       |  |                |        |   |       |                |     |
|  | 2.0 dCi 110  | 110 |  | 01.06 |       |  |                |        |   |       |                |     |
|  | 2.0 dCi 130  | 127 |  | 01.06 |       |  |                |        |   |       |                |     |
|  | 2.0 i        | 100 |  | 11.02 |       |  |                |        |   |       |                |     |
|  | 2.0 Turbo    | 120 |  | 11.02 |       |  |                |        |   |       |                |     |
|  | 2.0 Turbo    | 125 |  | 04.05 |       |  |                |        |   |       |                |     |
|  | 2.2 dCi      | 102 |  | 02.06 |       |  |                |        |   |       |                |     |
|  | 2.2 dCi      | 110 |  | 11.02 |       |  |                |        |   |       |                |     |
|  | 3.0 dCi      | 130 |  | 11.02 |       |  |                |        |   |       |                |     |
|  | 3.0 dCi      | 133 |  | 01.06 |       |  |                |        |   |       |                |     |
|  | 3.5 V6       | 177 |  | 11.02 |       |  |                |        |   |       |                |     |
| RENAULT EXPRESS/RAPID (F40_) (85-98)   |              |     |  |       |       |  |                |        |   |       |                |     |
|  | 1.0 (F400)   | 27  |  | 01.86 | 05.92 |  | 24.2117-1503.3 | 010400 |   |       | THz 17,46      | BDX |
|  | 1.0 (F400)   | 27  |  | 01.86 | 05.92 |  | 03.2119-3389.3 | 010057 |   |       | THz 19,05      | ATE |
|  | 1.1 (F401)   | 33  |  | 07.85 | 04.95 |  |                |        |   |       |                |     |
|  | 1.1 (F40H)   | 33  |  | 06.87 | 06.90 |  |                |        |   |       |                |     |
|  | 1.1 (F40T)   | 33  |  | 09.91 | 09.96 |  |                |        |   |       |                |     |
|  | 1.4 (F402)   | 43  |  | 01.86 | 06.90 |  |                |        |   |       |                |     |
|  | 1.4 (F40M)   | 44  |  | 06.87 | 06.90 |  |                |        |   |       |                |     |
|  | 1.4 i (F407) | 43  |  | 01.86 | 08.91 |  |                |        |   |       |                |     |
|  | 1.6 (F404)   | 40  |  | 01.86 | 08.91 |  |                |        |   |       |                |     |
|  | 1.9 (F40E)   | 47  |  | 09.92 | 03.98 |  |                |        |   |       |                |     |
|  | 1.1 (F40T)   | 33  |  | 10.96 | 03.98 |  | 03.2120-2031.3 | 010106 |   |       | THz 20,64      | ATE |
|  | 1.2 (F406)   | 40  |  | 10.92 | 03.98 |  |                |        |   |       |                |     |
|  | 1.2 (F40F)   | 40  |  | 06.90 | 03.98 |  |                |        |   |       |                |     |
|  | 1.4 (F40A)   | 43  |  | 06.90 | 03.98 |  |                |        |   |       |                |     |





| RENAULT EXPRESS/RAPID (F40_) (85-98)   |              |    |  |       |       |                       |                |        |   |                |     |
|--|--------------|----|--|-------|-------|-----------------------|----------------|--------|---|----------------|-----|
|    | 1.4 (F40Y)   | 43 |  | 09.91 | 03.98 |                       | 03.2120-2031.3 | 010106 |   | Thz 20,64      | ATE |
|  | 1.4 i (F407) | 43 |  | 09.91 | 03.98 |                       |                |        |   |                |     |
|  | 1.4 i (F40D) | 58 |  | 09.94 | 03.98 |                       |                |        |   |                |     |
|  | 1.4 i (F40U) | 55 |  | 09.91 | 03.98 |                       |                |        |   |                |     |
|  | 1.4 i (F40V) | 55 |  | 09.91 | 03.98 |                       |                |        |   |                |     |
|  | 1.6 (F404)   | 40 |  | 09.91 | 08.98 |                       |                |        |   |                |     |
|  | 1.9 (F40N)   | 47 |  | 06.90 | 03.98 |                       |                |        |   |                |     |
|  | 1.9 (F40P)   | 47 |  | 09.91 | 03.98 |                       |                |        |   |                |     |
|  | 1.9 (F40R)   | 40 |  | 09.94 | 03.98 |                       |                |        |   |                |     |
|  | 1.9 D (G40B) | 40 |  | 09.95 | 03.98 |                       |                |        |   |                |     |
|  | 1.9 D (G40C) | 40 |  | 09.95 | 03.98 |                       |                |        |   |                |     |
|    | 1.0 (F400)   | 27 |  | 01.86 | 05.88 |                       | 24.3451-1501.5 | 240263 | ☐ | D=45, - Halter | BDX |
|  | 1.1 (F401)   | 33 |  | 07.85 | 05.88 | - (i)                 | 24.3451-1502.5 | 240264 | ☐ | D=45, - Halter | BDX |
|  | 1.1 (F40H)   | 33 |  | 06.87 | 05.88 |                       |                |        |   |                |     |
|  | 1.6 (F404)   | 40 |  | 01.86 | 05.86 | + (e)                 |                |        |   |                |     |
|  | 1.0 (F400)   | 27 |  | 06.88 | 05.92 |                       | 24.3481-1505.5 | 240047 | ☐ | D=48, - Halter | BDX |
|  | 1.1 (F401)   | 33 |  | 06.88 | 04.95 |                       | 24.3481-1506.5 | 240048 | ☐ | D=48, - Halter | BDX |
|  | 1.1 (F401)   | 33 |  | 07.85 | 05.88 | + (i)                 | 24.3481-1611.5 | 240029 | ☐ | D=48, - Halter | LUC |
|  | 1.1 (F40H)   | 33 |  | 06.88 | 06.90 |                       | 24.3481-1612.5 | 240030 | ☐ | D=48, - Halter | LUC |
|  | 1.1 (F40T)   | 33 |  | 09.91 | 03.98 |                       | 24.0101-4803.2 | 260049 | ☐ | Einbausatz     | BDX |
|  | 1.2 (F406)   | 40 |  | 10.92 | 03.98 |                       | 24.0101-4807.2 | 260053 |   | Einbausatz     | LUC |
|  | 1.2 (F40F)   | 40 |  | 06.90 | 09.91 |                       |                |        |   |                |     |
|  | 1.4 (F402)   | 43 |  | 01.86 | 06.90 |                       |                |        |   |                |     |
|  | 1.4 (F40A)   | 43 |  | 06.90 | 03.98 |                       |                |        |   |                |     |
|  | 1.4 (F40M)   | 44 |  | 06.87 | 06.90 |                       |                |        |   |                |     |
|  | 1.4 (F40Y)   | 43 |  | 09.91 | 03.98 |                       |                |        |   |                |     |
|  | 1.4 i (F407) | 43 |  | 01.86 | 03.98 |                       |                |        |   |                |     |
|  | 1.4 i (F40D) | 58 |  | 09.94 | 03.98 |                       |                |        |   |                |     |
|  | 1.4 i (F40U) | 55 |  | 09.91 | 03.98 |                       |                |        |   |                |     |
|  | 1.4 i (F40V) | 55 |  | 09.91 | 03.98 |                       |                |        |   |                |     |
|  | 1.6 (F404)   | 40 |  | 06.86 | 08.98 | + (e)                 |                |        |   |                |     |
|  | 1.6 (F404)   | 40 |  | 01.86 | 08.98 | - (e)                 |                |        |   |                |     |
|  | 1.9 (F40E)   | 47 |  | 09.92 | 03.98 |                       |                |        |   |                |     |
|  | 1.9 (F40N)   | 47 |  | 06.90 | 03.98 |                       |                |        |   |                |     |
|  | 1.9 (F40P)   | 47 |  | 09.91 | 03.98 |                       |                |        |   |                |     |
|  | 1.9 (F40R)   | 40 |  | 09.94 | 03.98 |                       | 24.3481-1505.5 | 240047 | ☐ | D=48, - Halter | BDX |
|  | 1.9 D (G40B) | 40 |  | 09.95 | 03.98 |                       | 24.3481-1506.5 | 240048 | ☐ | D=48, - Halter | BDX |
|  | 1.9 D (G40C) | 40 |  | 09.95 | 03.98 |                       | 24.0101-4803.2 | 260049 |   | Einbausatz     | BDX |
|   | 1.0 (F400)   | 27 |  | 01.86 | 05.92 |                       | 24.5111-0300.3 | 330407 | 2 | L=300          |     |
|  | 1.1 (F401)   | 33 |  | 07.85 | 04.95 |                       |                |        |   |                |     |
|  | 1.1 (F40H)   | 33 |  | 06.87 | 06.90 |                       |                |        |   |                |     |
|  | 1.1 (F40T)   | 33 |  | 09.91 | 03.98 |                       |                |        |   |                |     |
|  | 1.2 (F406)   | 40 |  | 10.92 | 03.98 |                       |                |        |   |                |     |
|  | 1.2 (F40F)   | 40 |  | 06.90 | 03.98 |                       |                |        |   |                |     |
|  | 1.4 (F402)   | 43 |  | 01.86 | 08.91 |                       |                |        |   |                |     |
|  | 1.4 (F40A)   | 43 |  | 06.90 | 03.98 |                       |                |        |   |                |     |
|  | 1.4 (F40M)   | 44 |  | 06.87 | 08.91 |                       |                |        |   |                |     |
|  | 1.4 (F40Y)   | 43 |  | 09.91 | 03.98 |                       |                |        |   |                |     |
|  | 1.4 i (F407) | 43 |  | 01.86 | 03.98 |                       |                |        |   |                |     |
|  | 1.4 i (F40D) | 58 |  | 09.94 | 03.98 |                       |                |        |   |                |     |
|  | 1.4 i (F40U) | 55 |  | 09.91 | 03.98 |                       |                |        |   |                |     |
|  | 1.4 i (F40V) | 55 |  | 09.91 | 03.98 |                       |                |        |   |                |     |
|  | 1.6 (F404)   | 40 |  | 01.86 | 08.98 |                       |                |        |   |                |     |
|  | 1.9 (F40E)   | 47 |  | 09.92 | 03.98 |                       |                |        |   |                |     |
|  | 1.9 (F40N)   | 47 |  | 06.90 | 03.98 |                       |                |        |   |                |     |
|  | 1.9 (F40P)   | 47 |  | 09.91 | 03.98 |                       |                |        |   |                |     |
|  | 1.9 (F40R)   | 40 |  | 09.94 | 03.98 |                       |                |        |   |                |     |
|  | 1.9 D (G40B) | 40 |  | 09.95 | 03.98 |                       |                |        |   |                |     |
|  | 1.9 D (G40C) | 40 |  | 09.95 | 03.98 |                       |                |        |   |                |     |
|  | 1.0 (F400)   | 27 |  | 01.86 | 05.92 |                       | 24.5229-0240.3 | 330400 | 2 | L=242          |     |
|  | 1.1 (F401)   | 33 |  | 07.85 | 04.95 |                       |                |        |   |                |     |
|  | 1.1 (F40H)   | 33 |  | 06.87 | 06.90 |                       |                |        |   |                |     |
|  | 1.1 (F40T)   | 33 |  | 09.91 | 03.98 |                       |                |        |   |                |     |
|  | 1.2 (F406)   | 40 |  | 10.92 | 03.98 |                       |                |        |   |                |     |
|  | 1.2 (F40F)   | 40 |  | 06.90 | 03.98 |                       |                |        |   |                |     |
|  | 1.4 (F402)   | 43 |  | 01.86 | 08.91 |                       |                |        |   |                |     |
|  | 1.4 (F40A)   | 43 |  | 06.90 | 03.98 | - erhöhte Zuladung 1) |                |        |   |                |     |
|  | 1.4 (F40M)   | 44 |  | 06.87 | 08.91 |                       |                |        |   |                |     |
|  | 1.4 i (F407) | 43 |  | 01.86 | 03.98 |                       |                |        |   |                |     |
|  | 1.4 i (F40D) | 58 |  | 09.94 | 03.98 | - erhöhte Zuladung 1) |                |        |   |                |     |
|  | 1.4 i (F40U) | 55 |  | 09.91 | 03.98 | - erhöhte Zuladung 1) |                |        |   |                |     |
|  | 1.4 i (F40V) | 55 |  | 09.91 | 03.98 | - erhöhte Zuladung 1) |                |        |   |                |     |
|  | 1.6 (F404)   | 40 |  | 07.86 | 08.98 | - erhöhte Zuladung 1) |                |        |   |                |     |
|  | 1.9 (F40E)   | 47 |  | 09.92 | 03.98 | - erhöhte Zuladung 1) |                |        |   |                |     |
|  | 1.9 (F40N)   | 47 |  | 06.90 | 03.98 | - erhöhte Zuladung 1) |                |        |   |                |     |
|  | 1.9 (F40P)   | 47 |  | 09.91 | 03.98 | - erhöhte Zuladung 1) |                |        |   |                |     |
|  | 1.9 (F40R)   | 40 |  | 09.94 | 03.98 | - erhöhte Zuladung 1) |                |        |   |                |     |
|  | 1.9 D (G40B) | 40 |  | 09.95 | 03.98 | - erhöhte Zuladung 1) |                |        |   |                |     |
|  | 1.9 D (G40C) | 40 |  | 09.95 | 03.98 | - erhöhte Zuladung 1) |                |        |   |                |     |
|  | 1.4 (F40A)   | 43 |  | 06.90 | 03.98 | + erhöhte Zuladung 2) | 24.5229-0285.3 | 330032 | 2 | L=285          |     |
|  | 1.4 (F40Y)   | 43 |  | 09.91 | 03.98 |                       |                |        |   |                |     |
|  | 1.4 i (F40D) | 58 |  | 09.94 | 03.98 | + erhöhte Zuladung 2) |                |        |   |                |     |
|  | 1.4 i (F40U) | 55 |  | 09.91 | 03.98 | + erhöhte Zuladung 2) |                |        |   |                |     |
|  | 1.4 i (F40V) | 55 |  | 09.91 | 03.98 | + erhöhte Zuladung 2) |                |        |   |                |     |
|  | 1.6 (F404)   | 40 |  | 07.86 | 08.98 | + erhöhte Zuladung 2) |                |        |   |                |     |
|  | 1.9 (F40E)   | 47 |  | 09.92 | 03.98 | + erhöhte Zuladung 2) |                |        |   |                |     |
|  | 1.9 (F40N)   | 47 |  | 06.90 | 03.98 | + erhöhte Zuladung 2) |                |        |   |                |     |

1) - increased payload / - carico utile maggiorato / - charge utile augmentée / - incremento de carga  
2) + increased payload / + carico utile maggiorato / + charge utile augmentée / + incremento de carga



| RENAULT EXPRESS/RAPID (F40_) (85-98) |  | kW   |  | 23   |  | i  |  | ate  |                                      | ?  |     | i |  | i                        |             |     |
|--------------------------------------|--|--|--|--|--|--|--|--|--------------------------------------|--|-----|---|--|--------------------------|-------------|-----|
|                                      | 1.9 (F40P)<br>1.9 (F40R)<br>1.9 D (G40B)<br>1.9 D (G40C)   | 47<br>40<br>40<br>40   |  | 09.91<br>09.94<br>09.95<br>09.95   | 03.98<br>03.98<br>03.98<br>03.98   | + erhöhte Zuladung <sup>1)</sup><br>+ erhöhte Zuladung <sup>1)</sup><br>+ erhöhte Zuladung <sup>1)</sup><br>+ erhöhte Zuladung <sup>1)</sup>   |  | 24.5229-0285.3   | 330032                               | 2  |     |   |  | L=285                    |             |     |
|                                      | 1.0 (F400)<br>1.1 (F40H)<br>1.1 (F40T)   | 27<br>33<br>33   |  | 01.86<br>06.87<br>09.91  | 05.92<br>06.90<br>09.96  |  |  | 24.3222-1709.3<br>24.3222-1710.3<br>24.3222-1106.3<br>24.3222-1107.3 | 020111<br>020112<br>020261<br>020262 | <input type="checkbox"/><br><input type="checkbox"/><br><input type="checkbox"/><br><input type="checkbox"/> |     |   | Rz 22,20<br>Rz 22,20<br>Rz 22,20<br>Rz 22,20 | BDX<br>BDX<br>LUC<br>LUC |             |     |
|                                      | 1.1 (F401)<br>1.6 (F404)   | 33<br>40   |  | 07.85<br>01.86   | 04.95<br>06.86   | - (I)<br>+ (E)   |  | 24.3222-1709.3<br>24.3222-1710.3                                     | 020111<br>020112                     | <input type="checkbox"/><br><input type="checkbox"/>   |     |   | Rz 22,20<br>Rz 22,20                         | BDX<br>BDX               |             |     |
|                                      | 1.1 (F401)<br>1.4 (F402)<br>1.4 (F40M)<br>1.4 i (F407)<br>1.6 (F404)   | 33<br>43<br>44<br>43<br>40   |  | 07.85<br>01.86<br>06.87<br>01.86<br>01.86  | 04.95<br>06.90<br>08.91<br>03.98<br>06.86  | + (I)<br><br><br>- (F)   |  | 24.3220-1118.3<br>24.3220-1119.3<br>24.3222-1611.3<br>24.3222-1612.3 | 020226<br>020227<br>020281<br>020282 | <input type="checkbox"/><br><input type="checkbox"/><br><input type="checkbox"/><br><input type="checkbox"/> |     |   | Rz 20,64<br>Rz 20,64<br>Rz 22,20<br>Rz 22,00 | BDX<br>BDX<br>BDX<br>BDX |             |     |
|                                      | 1.1 (F401)<br>1.6 (F404)   | 33<br>40   |  | 07.85<br>01.86   | 04.95<br>06.86   |  |  | 24.3222-1106.3<br>24.3222-1107.3                                     | 020261<br>020262                     | <input type="checkbox"/><br><input type="checkbox"/>   |     |   | Rz 22,20<br>Rz 22,20                         | LUC<br>LUC               |             |     |
|                                      | 1.1 (F40T)<br>1.2 (F406)<br>1.2 (F40F)<br>1.4 (F40A)<br>1.4 i (F40D)<br>1.4 i (F40U)<br>1.4 i (F40V)<br>1.6 (F404)<br>1.9 (F40E)<br>1.9 (F40N)<br>1.9 (F40P)<br>1.9 (F40R)<br>1.9 D (G40B)<br>1.9 D (G40C) | 33<br>40<br>40<br>43<br>58<br>55<br>55<br>40<br>47<br>47<br>47<br>40<br>40<br>40   |  | 10.96<br>10.92<br>06.90<br>06.90<br>09.94<br>09.91<br>09.91<br>07.86<br>09.92<br>06.90<br>09.91<br>09.94<br>09.95<br>09.95 | 03.98<br>03.98<br>03.98<br>03.98<br>03.98<br>03.98<br>03.98<br>08.98<br>03.98<br>03.98<br>03.98<br>03.98<br>03.98<br>03.98                   |  |  | 24.3220-1118.3<br>24.3220-1119.3                                     | 020226<br>020227                     | <input type="checkbox"/><br><input type="checkbox"/>   |     |   | Rz 20,64<br>Rz 20,64                         | BDX<br>BDX               |             |     |
|                                      | 1.4 (F40A)<br>1.4 i (F40D)<br>1.4 i (F40U)<br>1.4 i (F40V)<br>1.6 (F404)<br>1.9 (F40E)<br>1.9 (F40N)<br>1.9 (F40P)<br>1.9 (F40R)<br>1.9 D (G40B)<br>1.9 D (G40C)   | 43<br>43<br>58<br>55<br>55<br>40<br>47<br>47<br>40<br>40<br>40<br>40   |  | 09.91<br>09.91<br>09.91<br>09.91<br>07.86<br>09.92<br>09.91<br>09.91<br>09.94<br>09.95<br>09.95                            | 03.98<br>03.98<br>03.98<br>03.98<br>08.98<br>03.98<br>03.98<br>03.98<br>03.98<br>03.98<br>03.98<br>03.98                                     | + erhöhte Zuladung <sup>1)</sup><br><br>+ erhöhte Zuladung <sup>1)</sup><br>+ erhöhte Zuladung <sup>1)</sup><br>+ erhöhte Zuladung <sup>1)</sup><br>+ erhöhte Zuladung <sup>1)</sup><br>+ erhöhte Zuladung <sup>1)</sup><br>+ erhöhte Zuladung <sup>1)</sup><br>+ erhöhte Zuladung <sup>1)</sup><br>+ erhöhte Zuladung <sup>1)</sup><br>+ erhöhte Zuladung <sup>1)</sup><br>+ erhöhte Zuladung <sup>1)</sup> |  | 24.3222-1615.3   | 020285                               | <input type="checkbox"/>   |     |   | Rz 22,20                                     | LUC                      |             |     |
|                                      |  | 1.0 (F400)<br>1.1 (F401)<br>1.1 (F40H)<br>1.4 (F402)<br>1.4 (F40M)<br>1.4 i (F407)<br>1.6 (F404)   | 27<br>33<br>33<br>43<br>44<br>43<br>40   |  | 01.86<br>07.85<br>06.87<br>01.86<br>06.87<br>01.86<br>01.86  | 05.92<br>08.91<br>06.90<br>06.90<br>08.91<br>08.91   |  |  | 24.3727-1005.2                       | 581005   | 2 ↘ |   |  | L=1330                   |             |     |
|                                      |  | 1.1 (F401)<br>1.1 (F40T)<br>1.2 (F406)<br>1.2 (F40F)<br>1.4 (F40A)<br>1.4 i (F407)<br>1.4 i (F40D)<br>1.4 i (F40U)<br>1.4 i (F40V)<br>1.6 (F404)<br>1.9 (F40E)<br>1.9 (F40N)<br>1.9 (F40P)<br>1.9 (F40R)<br>1.9 D (G40B)<br>1.9 D (G40C) | 33<br>33<br>40<br>40<br>43<br>43<br>58<br>55<br>55<br>40<br>47<br>47<br>47<br>40<br>40<br>40 |  | 09.91<br>09.91<br>10.92<br>06.90<br>06.90<br>09.91<br>09.94<br>09.91<br>09.91<br>09.91<br>09.92<br>06.90<br>09.91<br>09.94<br>09.95<br>09.95 | 04.95<br>03.98<br>03.98<br>03.98<br>03.98<br>03.98<br>03.98<br>03.98<br>03.98<br>08.98<br>03.98<br>03.98<br>03.98<br>03.98<br>03.98<br>03.98   | - erhöhte Zuladung <sup>2)</sup><br><br>- erhöhte Zuladung <sup>2)</sup><br>- erhöhte Zuladung <sup>2)</sup><br>- erhöhte Zuladung <sup>2)</sup><br>- erhöhte Zuladung <sup>2)</sup><br>- erhöhte Zuladung <sup>2)</sup><br>- erhöhte Zuladung <sup>2)</sup><br>- erhöhte Zuladung <sup>2)</sup><br>- erhöhte Zuladung <sup>2)</sup><br>- erhöhte Zuladung <sup>2)</sup><br>- erhöhte Zuladung <sup>2)</sup><br>- erhöhte Zuladung <sup>2)</sup><br>- erhöhte Zuladung <sup>2)</sup><br>- erhöhte Zuladung <sup>2)</sup><br>- erhöhte Zuladung <sup>2)</sup> |  | 24.3727-1035.2                       | 581035   | 2 ↘ |   |  | L=1469                   |             |     |
|                                      |  | 1.0 (F400)<br>1.1 (F401)<br>1.1 (F40H)<br>1.4 (F402)<br>1.4 (F40M)<br>1.4 i (F407)<br>1.6 (F404)   | 27<br>33<br>33<br>43<br>44<br>43<br>40   |  | 01.86<br>07.85<br>06.87<br>01.86<br>06.87<br>01.86<br>01.86  | 08.91<br>08.91<br>08.91<br>08.91<br>08.91  |  |  | 03.6583-0006.3                       | 320100   |     |   |  |                          | BRL 8/3 (4) | ATE |
|                                      |  | 1.0 (F400)<br>1.1 (F401)<br>1.1 (F40T)<br>1.2 (F406)<br>1.2 (F40F)<br>1.4 (F40A)<br>1.4 i (F407)<br>1.4 i (F40D)<br>1.4 i (F40U)<br>1.4 i (F40V)<br>1.6 (F404)<br>1.9 (F40E)<br>1.9 (F40N)   | 27<br>33<br>33<br>40<br>40<br>43<br>43<br>58<br>55<br>55<br>40<br>47<br>47                   |  | 09.91<br>09.91<br>09.91<br>10.92<br>06.90<br>06.90<br>09.91<br>09.94<br>09.91<br>09.91<br>09.91<br>09.92<br>06.90                            | 05.92<br>04.95<br>03.98<br>03.98<br>03.98<br>03.98<br>03.98<br>03.98<br>03.98<br>03.98<br>08.98<br>03.98<br>03.98  | - erhöhte Zuladung <sup>2)</sup><br><br>- erhöhte Zuladung <sup>2)</sup><br>- erhöhte Zuladung <sup>2)</sup><br>- erhöhte Zuladung <sup>2)</sup><br>- erhöhte Zuladung <sup>2)</sup><br>- erhöhte Zuladung <sup>2)</sup><br>- erhöhte Zuladung <sup>2)</sup><br>- erhöhte Zuladung <sup>2)</sup><br>- erhöhte Zuladung <sup>2)</sup><br>- erhöhte Zuladung <sup>2)</sup><br>- erhöhte Zuladung <sup>2)</sup><br>- erhöhte Zuladung <sup>2)</sup>   |  | 24.6583-1704.3                       | 320139   |     |   |  |                          | BRL (4)     |     |

1) + increased payload / + carico utile maggiorato / + charge utile augmentée / + incremento de carga  
2) - increased payload / - carico utile maggiorato / - charge utile augmentée / - incremento de carga

| RENAULT EXPRESS/RAPID (F40_) (85-98)   |   |   |  |  |                            |   |  |                   |
|--|---|---|--|--|----------------------------|---|--|-------------------|
|     | 1.9 (F40P) 47<br>1.9 (F40R) 40<br>1.9 D (G40B) 40<br>1.9 D (G40C) 40  | 09.91 03.98<br>09.94 03.98<br>09.95 03.98<br>09.95 03.98  | - erhöhte Zuladung <sup>1)</sup><br>- erhöhte Zuladung <sup>1)</sup><br>- erhöhte Zuladung <sup>1)</sup><br>- erhöhte Zuladung <sup>1)</sup> | 24.6583-1704.3                                     | 320139                     |   | BRL (4)  |                   |
|    | 1.0 (F400) 27<br>1.1 (F401) 33<br>1.1 (F40H) 33<br>1.1 (F40T) 33<br>1.2 (F406) 40<br>1.2 (F40F) 40<br>1.4 (F402) 43<br>1.4 (F40A) 43<br>1.4 (F40M) 44<br>1.4 (F40Y) 43<br>1.4 i (F407) 43<br>1.4 i (F40D) 58<br>1.4 i (F40U) 55<br>1.4 i (F40V) 55<br>1.6 (F404) 40<br>1.9 (F40E) 47<br>1.9 (F40N) 47<br>1.9 (F40P) 47<br>1.9 (F40R) 40<br>1.9 D (G40B) 40<br>1.9 D (G40C) 40 | 01.86 05.92<br>07.85 04.95<br>06.87 09.91<br>09.91 03.98<br>10.92 03.98<br>06.90 03.98<br>01.86 08.91<br>06.90 03.98<br>06.87 08.91<br>09.91 03.98<br>01.86 03.98<br>09.94 03.98<br>09.91 03.98<br>09.91 03.98<br>01.86 08.98<br>09.92 03.98<br>06.90 03.98<br>09.91 03.98<br>09.94 03.98<br>09.95 03.98<br>09.95 03.98 |  | 24.3728-1006.2                                     | 591006                     |   | L=1050   |                   |
| RENAULT FLUENCE (L30_) (10-)   |   |   |  |  |                            |   |  |                   |
|    | 1.5 dCi 63<br>1.5 dCi 66<br>1.5 dCi 78<br>1.5 dCi 81<br>1.6 16V 81<br>1.6 16V 82<br>2.0 16V 101<br>2.0 16V 103<br>Z.E. 70   | 02.10 06.13<br>02.10 06.13<br>02.10 06.13<br>02.10 06.13<br>02.10 06.13<br>02.10 06.13<br>05.11 06.13<br>02.10 06.13<br>02.12   |  | 11.9541-9950.2<br>11.9541-9951.2<br>11.8116-0356.1 | 220843<br>220844<br>390586 | <input type="checkbox"/><br><input type="checkbox"/><br>2 | D=54, - Halter<br>D=54, - Halter<br>Haltefeder | ATE<br>ATE<br>ATE |
|    | 1.5 dCi 63<br>1.5 dCi 66<br>1.5 dCi 78<br>1.5 dCi 81<br>1.6 16V 81<br>1.6 16V 82<br>2.0 16V 103   | 02.10 06.13<br>02.10 06.13<br>02.10 06.13<br>02.10 06.13<br>02.10 06.13<br>02.10 06.13<br>02.10 06.13   |  | 24.3219-1755.3                                     | 020508                     |   | Rz 19,05                                       |                   |
| RENAULT KANGOO I (KC_) (98-07)   |   |   |  |  |                            |   |  |                   |
|  | 1.2 43<br>1.2 16V 55<br>1.4 55<br>1.5 dCi 45<br>1.5 dCi (KC07) 48<br>1.5 dCi (KC08/09) 60<br>1.6 16V 70<br>1.6 16V 4x4 70<br>1.9 D 47<br>1.9 D (KC0D) 40<br>1.9 dCi 4x4 (KC0V) 59<br>1.9 dTi (KC0U) 59<br>1.9 RXED 48   | 03.98 12.07<br>06.01 12.07<br>03.98 12.07<br>04.05 12.07<br>12.01 12.07<br>07.02 12.07<br>06.01 12.07<br>10.01 12.07<br>03.98 12.07<br>03.98 12.07<br>10.01 12.07<br>02.00 12.07<br>09.99 06.01   | - ABS<br>- ABS<br>- ABS<br>- ABS<br>- ABS<br>- ABS<br>- ABS<br>- ABS<br>- ABS<br>- ABS<br>- ABS<br>- ABS<br>- ABS                            | 24.2122-1727.3                                     | 010586                     |   | Thz 22,20                                      | BDX               |
|  | 1.2 43<br>1.2 16V 55<br>1.4 55<br>1.5 dCi 45<br>1.5 dCi (KC07) 48<br>1.5 dCi (KC08/09) 60<br>1.6 16V 70<br>1.6 16V 4x4 70<br>1.9 D 47<br>1.9 D (KC0D) 40<br>1.9 dCi 4x4 (KC0V) 59<br>1.9 dTi (KC0U) 59<br>1.9 RXED 48   | 03.98 12.07<br>06.01 12.07<br>03.98 12.07<br>04.05 12.07<br>12.01 12.07<br>07.02 12.07<br>06.01 12.07<br>10.01 12.07<br>03.98 12.07<br>03.98 12.07<br>10.01 12.07<br>02.00 12.07<br>09.99 06.01   | + ABS<br>+ ABS<br>+ ABS<br>+ ABS<br>+ ABS<br>+ ABS<br>+ ABS<br>+ ABS<br>+ ABS<br>+ ABS<br>+ ABS<br>+ ABS<br>+ ABS                            | 24.2122-1745.3                                     | 010715                     |   | Thz 22,20                                      |                   |
|  | 1.2 43<br>1.2 16V 55<br>1.4 55<br>1.5 dCi (KC07) 48<br>1.5 dCi (KC08/09) 60<br>1.6 16V 70<br>1.6 16V 4x4 70<br>1.9 D 47<br>1.9 D (KC0D) 40<br>1.9 dCi 4x4 (KC0V) 59<br>1.9 dTi (KC0U) 59<br>1.9 RXED 48   | 03.98 12.07<br>06.01 12.07<br>03.98 12.07<br>12.01 12.07<br>07.02 12.07<br>06.01 12.07<br>10.01 12.07<br>03.98 12.07<br>03.98 12.07<br>10.01 12.07<br>02.00 12.07<br>09.99 06.01  | + ABS<br>+ ABS<br>+ ABS<br>+ ABS<br>+ ABS<br>+ ABS<br>+ ABS<br>+ ABS<br>+ ABS<br>+ ABS<br>+ ABS<br>+ ABS                                     | 24.2122-1744.3                                     | 010697                     |   | Thz 22,20                                      |                   |

<sup>1)</sup> - increased payload / - carico utile maggiorato / - charge utile augmentée / - incremento de carga



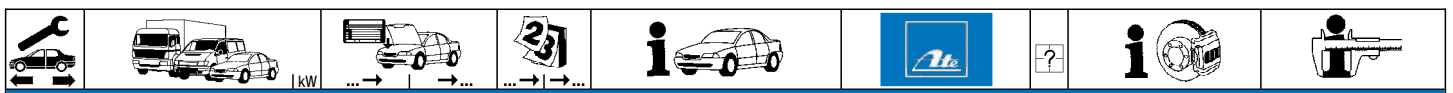

**RENAULT KANGOO I (KC\_) (98-07)**

|                |                      |    |       |       |  |  |                |        |                          |  |                |            |
|----------------|----------------------|----|-------|-------|--|--|----------------|--------|--------------------------|--|----------------|------------|
|                | 1.2                  | 43 |       | 03.98 | 12.07  |  | 24.3541-1765.5 | 240235 | <input type="checkbox"/> |  | D=54, - Halter | <b>BOS</b> |
|                | 1.2 16V              | 55 |       | 06.01 | 12.07  |  | 24.3541-1766.5 | 240236 | <input type="checkbox"/> |  | D=54, - Halter | <b>BOS</b> |
|                | 1.4                  | 55 |       | 03.98 | 12.07  |  |                |        |                          |  |                |            |
|                | 1.5 dCi              | 42 |       | 07.03 | 12.07  |  |                |        |                          |  |                |            |
|                | 1.5 dCi              | 45 |       | 04.05 | 12.07  |  |                |        |                          |  |                |            |
|                | 1.5 dCi              | 62 |       | 06.05 | 12.07  |  |                |        |                          |  |                |            |
|                | 1.5 dCi (KC07)       | 48 |       | 12.01 | 12.07  |  |                |        |                          |  |                |            |
|                | 1.5 dCi (KC08/09)    | 60 |       | 07.02 | 12.07  |  |                |        |                          |  |                |            |
|                | 1.6 16V 2WD          | 70 |       | 06.01 | 12.07  |  |                |        |                          |  |                |            |
|                | 1.6 16V bivalent     | 60 |       | 06.05 | 12.07  |  |                |        |                          |  |                |            |
|                | 1.9 D                | 47 |       | 03.98 | 12.07  |  |                |        |                          |  |                |            |
|                | 1.9 D (KC0D)         | 40 |       | 03.98 | 12.07  |  |                |        |                          |  |                |            |
|                | 1.9 dTi (KC0U)       | 59 |       | 02.00 | 12.07  |  |                |        |                          |  |                |            |
|                | 1.9 RXED             | 48 |       | 09.99 | 06.01  |  |                |        |                          |  |                |            |
| Elektro        | 22                   |    | 01.02 | 12.04 |  |  |                |        |                          |  |                |            |
|                | 1.2                  | 43 |       | 03.98 | 12.07  |  | 24.5111-0325.3 | 330109 | <input type="checkbox"/> |  | L=325          |            |
|                | 1.2 16V              | 55 |       | 06.01 | 12.07  |  | 24.5111-0336.3 | 330570 | <input type="checkbox"/> |  | L=335          |            |
|                | 1.4                  | 55 |       | 03.98 | 12.07  |  |                |        |                          |  |                |            |
|                | 1.5 dCi              | 42 |       | 07.03 | 12.07  |  |                |        |                          |  |                |            |
|                | 1.5 dCi              | 45 |       | 04.05 | 12.07  |  |                |        |                          |  |                |            |
|                | 1.5 dCi              | 62 |       | 06.05 | 12.07  |  |                |        |                          |  |                |            |
|                | 1.5 dCi (KC07)       | 48 |       | 12.01 | 12.07  |  |                |        |                          |  |                |            |
|                | 1.5 dCi (KC08/09)    | 60 |       | 07.02 | 12.07  |  |                |        |                          |  |                |            |
|                | 1.6 16V              | 70 |       | 06.01 | 12.07  |  |                |        |                          |  |                |            |
|                | 1.6 16V 4x4          | 70 |       | 10.01 | 12.07  |  |                |        |                          |  |                |            |
|                | 1.6 16V bivalent     | 60 |       | 06.05 | 12.07  |  |                |        |                          |  |                |            |
|                | 1.9 D                | 47 |       | 03.98 | 12.07  |  |                |        |                          |  |                |            |
|                | 1.9 D (KC0D)         | 40 |       | 03.98 | 12.07  |  |                |        |                          |  |                |            |
|                | 1.9 dCi 4x4 (KC0V)   | 59 |       | 10.01 | 12.07  |  |                |        |                          |  |                |            |
| 1.9 dTi (KC0U) | 59                   |    | 02.00 | 12.07 |  |  |                |        |                          |  |                |            |
| 1.9 RXED       | 48                   |    | 09.99 | 06.01 |  |  |                |        |                          |  |                |            |
| Elektro        | 22                   |    | 01.02 | 12.04 |  |  |                |        |                          |  |                |            |
|                | 1.2                  | 43 |       | 03.98 | 12.07  |  | 24.5111-0336.3 | 330570 | <input type="checkbox"/> |  | L=335          |            |
|                | 1.2 16V              | 55 |       | 06.01 | 12.07  |  | 24.5229-0193.3 | 330571 | <input type="checkbox"/> |  | L=193          |            |
|                | 1.4                  | 55 |       | 03.98 | 12.07  |  |                |        |                          |  |                |            |
|                | 1.5 dCi              | 45 |       | 04.05 | 12.07  |  |                |        |                          |  |                |            |
|                | 1.5 dCi (KC07)       | 48 |       | 12.01 | 12.07  |  |                |        |                          |  |                |            |
|                | 1.5 dCi (KC08/09)    | 60 |       | 07.02 | 12.07  |  |                |        |                          |  |                |            |
|                | 1.6 16V              | 70 |       | 06.01 | 12.07  |  |                |        |                          |  |                |            |
|                | 1.6 16V 4x4          | 70 |       | 10.01 | 12.07  |  |                |        |                          |  |                |            |
|                | 1.6 16V bivalent     | 60 |       | 06.05 | 12.07  |  |                |        |                          |  |                |            |
|                | 1.9 D                | 47 |       | 03.98 | 12.07  |  |                |        |                          |  |                |            |
|                | 1.9 D (KC0D)         | 40 |       | 03.98 | 12.07  |  |                |        |                          |  |                |            |
|                | 1.9 dCi 4x4 (KC0V)   | 59 |       | 10.01 | 12.07  |  |                |        |                          |  |                |            |
|                | 1.9 dTi (KC0U)       | 59 |       | 02.00 | 12.07  |  |                |        |                          |  |                |            |
|                | 1.9 RXED             | 48 |       | 09.99 | 06.01  |  |                |        |                          |  |                |            |
|                | 1.2 (KC01/OA/OF)     | 43 |       | 03.98 | 12.07  | - verstärktes Fahrwerk <sup>1)</sup>               | 24.3222-1716.3 | 020434 |                          |  | Rz 22,00       | <b>BDX</b> |
|                | 1.2 16V (KC05/OT/OW) | 55 |       | 06.01 | 12.07  | - verstärktes Fahrwerk <sup>1)</sup>               |                |        |                          |  |                |            |
|                | 1.4                  | 55 |       | 03.98 | 12.07  | - verstärktes Fahrwerk <sup>1)</sup>               |                |        |                          |  |                |            |
|                | 1.5 dCi              | 42 |       | 07.03 | 12.07  | - verstärktes Fahrwerk <sup>1)</sup>               |                |        |                          |  |                |            |
|                | 1.5 dCi              | 45 |       | 04.05 | 12.07  | - verstärktes Fahrwerk <sup>1)</sup>               |                |        |                          |  |                |            |
|                | 1.5 dCi              | 62 |       | 06.05 | 12.07  | - verstärktes Fahrwerk <sup>1)</sup>               |                |        |                          |  |                |            |
|                | 1.5 dCi (KC07)       | 48 |       | 12.01 | 12.07  | - verstärktes Fahrwerk <sup>1)</sup>               |                |        |                          |  |                |            |
|                | 1.5 dCi (KC08/09)    | 60 |       | 07.02 | 12.07  | - verstärktes Fahrwerk <sup>1)</sup>               |                |        |                          |  |                |            |
|                | 1.6 16V 2WD          | 70 |       | 06.01 | 12.07  | - verstärktes Fahrwerk <sup>1)</sup>               |                |        |                          |  |                |            |
|                | 1.9 D                | 47 |       | 03.98 | 12.07  | - verstärktes Fahrwerk <sup>1)</sup>               |                |        |                          |  |                |            |
|                | 1.9 D (KC0D)         | 40 |       | 03.98 | 12.07  | - verstärktes Fahrwerk <sup>1)</sup>               |                |        |                          |  |                |            |
|                | 1.9 dTi (KC0U)       | 59 |       | 02.00 | 12.07  | - verstärktes Fahrwerk <sup>1)</sup>               |                |        |                          |  |                |            |
|                | 1.9 RXED             | 48 |       | 09.99 | 06.01  | - verstärktes Fahrwerk <sup>1)</sup>               |                |        |                          |  |                |            |
|                | Elektro              | 22 |       | 01.02 | 12.04  |  |                |        |                          |  |                |            |
|                | 1.2 (KC01/OA/OF)     | 43 |       | 03.98 | 12.07  | + verstärktes Fahrwerk <sup>2)</sup>               | 24.3222-1715.3 | 020433 |                          |  | Rz 22,00       | <b>BDX</b> |
|                | 1.2 (KC0K)           | 43 |       | 03.98 | 12.07  |  |                |        |                          |  |                |            |
|                | 1.2 16V (KC05/OT/OW) | 55 |       | 06.01 | 12.07  | + verstärktes Fahrwerk <sup>2)</sup>               |                |        |                          |  |                |            |
|                | 1.2 16V (KC06)       | 55 |       | 06.01 | 12.07  |  |                |        |                          |  |                |            |
|                | 1.4                  | 55 |       | 03.98 | 12.07  | + verstärktes Fahrwerk <sup>2)</sup>               |                |        |                          |  |                |            |
|                | 1.5 dCi              | 42 |       | 07.03 | 12.07  | + verstärktes Fahrwerk <sup>2)</sup>               |                |        |                          |  |                |            |
|                | 1.5 dCi              | 62 |       | 06.05 | 12.07  | + verstärktes Fahrwerk <sup>2)</sup>               |                |        |                          |  |                |            |
|                | 1.5 dCi (KC07)       | 48 |       | 12.01 | 12.07  | + verstärktes Fahrwerk <sup>2)</sup>               |                |        |                          |  |                |            |
|                | 1.5 dCi (KC08/09)    | 60 |       | 07.02 | 12.07  | + verstärktes Fahrwerk <sup>2)</sup>               |                |        |                          |  |                |            |
|                | 1.6 16V 2WD          | 70 |       | 06.01 | 12.07  | + verstärktes Fahrwerk <sup>2)</sup>               |                |        |                          |  |                |            |
|                | 1.9 D                | 47 |       | 03.98 | 12.07  | + verstärktes Fahrwerk <sup>2)</sup>               |                |        |                          |  |                |            |
|                | 1.9 D (KC0D)         | 40 |       | 03.98 | 12.07  | + verstärktes Fahrwerk <sup>2)</sup>               |                |        |                          |  |                |            |
|                | 1.9 dTi (KC0U)       | 59 |       | 02.00 | 12.07  | + verstärktes Fahrwerk <sup>2)</sup>               |                |        |                          |  |                |            |
|                | 1.9 RXED             | 48 |       | 09.99 | 06.01  | + verstärktes Fahrwerk <sup>2)</sup>               |                |        |                          |  |                |            |
| Elektro        | 22                   |    | 01.02 | 12.04 |  |  |                |        |                          |  |                |            |
|                | 1.2                  | 43 |       | 03.98 | 12.07  | - erhöhte Zuladung/ - verst.Fahrwerk <sup>3)</sup> | 24.3727-1041.2 | 581041 | <input type="checkbox"/> |  | L=1423         |            |
|                | 1.2 16V (KC05/OT/OW) | 55 |       | 06.01 | 12.07  | - erhöhte Zuladung/ - verst.Fahrwerk <sup>3)</sup> | 24.3727-1042.2 | 581042 | <input type="checkbox"/> |  | L=1421         |            |
|                | 1.4                  | 55 |       | 03.98 | 12.07  | - erhöhte Zuladung/ - verst.Fahrwerk <sup>3)</sup> |                |        |                          |  |                |            |
|                | 1.5 dCi              | 45 |       | 04.05 | 12.07  | - erhöhte Zuladung/ - verst.Fahrwerk <sup>3)</sup> |                |        |                          |  |                |            |
|                | 1.5 dCi (KC07)       | 48 |       | 12.01 | 12.07  | - erhöhte Zuladung/ - verst.Fahrwerk <sup>3)</sup> |                |        |                          |  |                |            |
|                | 1.5 dCi (KC08/09)    | 60 |       | 07.02 | 12.07  | - erhöhte Zuladung/ - verst.Fahrwerk <sup>3)</sup> |                |        |                          |  |                |            |
|                | 1.6 16V              | 70 |       | 06.01 | 12.07  | - erhöhte Zuladung/ - verst.Fahrwerk <sup>3)</sup> |                |        |                          |  |                |            |
|                | 1.9 D (KC0D)         | 40 |       | 03.98 | 12.07  | - erhöhte Zuladung/ - verst.Fahrwerk <sup>3)</sup> |                |        |                          |  |                |            |
|                | 1.9 D (KC0E/OJ/ON)   | 47 |       | 03.98 | 12.07  | - erhöhte Zuladung/ - verst.Fahrwerk <sup>3)</sup> |                |        |                          |  |                |            |
|                | 1.9 dTi (KC0U)       | 59 |       | 02.00 | 12.07  | - erhöhte Zuladung/ - verst.Fahrwerk <sup>3)</sup> |                |        |                          |  |                |            |
| 1.9 RXED       | 48                   |    | 09.99 | 06.01 | - erhöhte Zuladung/ - verst.Fahrwerk <sup>3)</sup> |  |                |        |                          |  |                |            |

<sup>1)</sup> - reinforced suspension / - sospensione rinforzata / - châssis renforcé / - suspensión reforzada

<sup>2)</sup> + reinforced suspension / + sospensione rinforzata / + châssis renforcé / + suspensión reforzada

<sup>3)</sup> - increas.payl./-reinforced susp. / - car.util.maggl./ - sospens.rinforzata / - charg.util.augm./ - châss.renf. / - incr.d.carga/-susp.reforzada

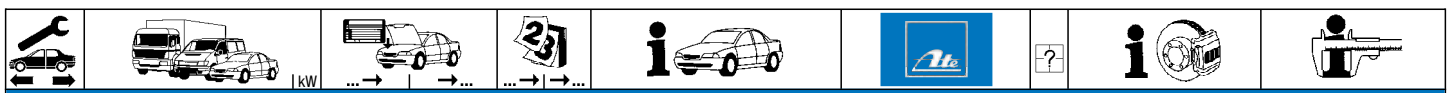

### RENAULT KANGOO I (KC\_) (98-07)

|                 |                      |       |       |  |  |                |        |                          |       |                  |
|-----------------|----------------------|-------|-------|--|--|----------------|--------|--------------------------|-------|------------------|
|                 | 1.2                  | 43    | 03.98 | 12.07  | + erhöhte Zuladung/ + verst.Fahrwerk <sup>1)</sup> | 24.3727-1043.2 | 581043 | <input type="checkbox"/> |       | L=1432<br>L=1442 |
|                 | 1.2 16V (KC03/06)    | 55    | 06.01 | 12.07  |  | 24.3727-1044.2 | 581044 | <input type="checkbox"/> |       |                  |
|                 | 1.2 16V (KC05/0T/0W) | 55    | 06.01 | 12.07  | + erhöhte Zuladung/ + verst.Fahrwerk <sup>1)</sup> |                |        |                          |       |                  |
|                 | 1.4                  | 55    | 03.98 | 12.07  | + erhöhte Zuladung/ + verst.Fahrwerk <sup>1)</sup> |                |        |                          |       |                  |
|                 | 1.5 dCi (KC07)       | 48    | 12.01 | 12.07  | + erhöhte Zuladung/ + verst.Fahrwerk <sup>1)</sup> |                |        |                          |       |                  |
|                 | 1.5 dCi (KC08/09)    | 60    | 07.02 | 12.07  | + erhöhte Zuladung/ + verst.Fahrwerk <sup>1)</sup> |                |        |                          |       |                  |
|                 | 1.6 16V              | 70    | 06.01 | 12.07  | + erhöhte Zuladung/ + verst.Fahrwerk <sup>1)</sup> |                |        |                          |       |                  |
|                 | 1.9 D (KC02)         | 47    | 03.98 | 12.07  |  |                |        |                          |       |                  |
|                 | 1.9 D (KC0D)         | 40    | 03.98 | 12.07  | + erhöhte Zuladung/ + verst.Fahrwerk <sup>1)</sup> |                |        |                          |       |                  |
|                 | 1.9 D (KC0E/0J/0N)   | 47    | 03.98 | 12.07  | + erhöhte Zuladung/ + verst.Fahrwerk <sup>1)</sup> |                |        |                          |       |                  |
| 1.9 dTi (KC0U)  | 59                   | 02.00 | 12.07 | + erhöhte Zuladung/ + verst.Fahrwerk <sup>1)</sup> |  |                |        |                          |       |                  |
| 1.9 RXED        | 48                   | 09.99 | 06.01 | + erhöhte Zuladung/ + verst.Fahrwerk <sup>1)</sup> |  |                |        |                          |       |                  |
|                 | 1.2 (KC01/0K)        | 43    | 03.98 | 12.07  |  | 24.3728-1016.2 | 591016 |                          |       | L=969            |
|                 | 1.2 (KC0A/0F)        | 43    | 03.98 | 12.07  |  |                |        |                          |       |                  |
|                 | 1.2 16V (KC03/06/0T) | 55    | 06.01 | 12.07  |  |                |        |                          |       |                  |
|                 | 1.2 16V (KC05/0W)    | 55    | 06.01 | 12.07  |  |                |        |                          |       |                  |
|                 | 1.4 (KC0B/0H/0M)     | 55    | 03.98 | 12.07  |  |                |        |                          |       |                  |
|                 | 1.4 (KC0C)           | 55    | 03.98 | 12.07  |  |                |        |                          |       |                  |
|                 | 1.6 16V (KC0L)       | 70    | 06.01 | 12.07  |  |                |        |                          |       |                  |
|                 | 1.6 16V (KC0P/0S)    | 70    | 06.01 | 12.07  |  |                |        |                          |       |                  |
|                 | 1.6 16V 4x4          | 70    | 10.01 | 12.07  |  |                |        |                          |       |                  |
|                 | 1.9 D (KC02/0N)      | 47    | 03.98 | 12.07  |  |                |        |                          |       |                  |
| 1.9 D (KC0D)    | 40                   | 03.98 | 12.07 |  |  |                |        |                          |       |                  |
| 1.9 D (KC0E/0J) | 47                   | 03.98 | 12.07 |  |  |                |        |                          |       |                  |
| 1.9 RXED        | 48                   | 09.99 | 06.01 |  |  |                |        |                          |       |                  |
| 1.5 dCi         | 45                   | 04.05 | 12.07 |  | 24.3728-1023.2                                     | 591023         |        |                          | L=960 |                  |
| 1.5 dCi (KC07)  | 48                   | 12.01 | 12.07 |  |  |                |        |                          |       |                  |
| 1.5 dCi (KC08)  | 60                   | 07.02 | 12.07 |  |  |                |        |                          |       |                  |
| 1.5 dCi (KC09)  | 60                   | 07.02 | 12.07 |  |  |                |        |                          |       |                  |

### RENAULT KANGOO II (KW\_) (08-)

|                 |                 |             |       |       |  |                |                |                            |  |       |
|-----------------|-----------------|-------------|-------|-------|--|----------------|----------------|----------------------------|--|-------|
|                 | 1.5 dCi         | 50          | 02.08 |       |  | 24.5229-0185.3 | 330397         | 2 <input type="checkbox"/> |  | L=185 |
|                 | 1.5 dCi         | 63          | 02.08 |       |  |                |                |                            |  |       |
|                 | 1.5 dCi         | 76          | 02.08 |       |  |                |                |                            |  |       |
|                 | 1.5 dCi 110     | 80          | 09.10 |       |  |                |                |                            |  |       |
|                 | 1.5 dCi 75      | 55          | 11.12 |       |  |                |                |                            |  |       |
|                 | 1.5 dCi 90      | 66          | 11.12 |       |  |                |                |                            |  |       |
|                 | 1.6             | 64          | 02.08 |       |  |                |                |                            |  |       |
|                 | 1.6 16V         | 78          | 02.08 |       |  |                |                |                            |  |       |
|                 | 1.6 16V Hi-Flex | 78          | 02.08 |       |  |                |                |                            |  |       |
|                 |                 | 1.2 TCe 115 | 84    | 05.13 |  |                | 24.3727-1082.2 | 581082                     |  |       |
| 1.5 dCi         |                 | 50          | 02.08 |       |  |                |                |                            |  |       |
| 1.5 dCi         |                 | 63          | 02.08 |       |  |                |                |                            |  |       |
| 1.5 dCi         |                 | 76          | 02.08 |       |  |                |                |                            |  |       |
| 1.5 dCi 110     |                 | 80          | 09.10 |       |  |                |                |                            |  |       |
| 1.5 dCi 75      |                 | 55          | 11.12 |       |  |                |                |                            |  |       |
| 1.5 dCi 90      |                 | 66          | 11.12 |       |  |                |                |                            |  |       |
| 1.6             |                 | 64          | 02.08 |       |  |                |                |                            |  |       |
| 1.6 16V         |                 | 78          | 02.08 |       |  |                |                |                            |  |       |
| 1.6 16V Hi-Flex |                 | 78          | 02.08 |       |  |                |                |                            |  |       |

### RENAULT KANGOO Be Bop (KWO\_) (09-10)

|  |         |    |       |       |                             |                |        |  |  |                                  |
|--|---------|----|-------|-------|-----------------------------|----------------|--------|--|--|----------------------------------|
|  | 1.5 dCi | 55 | 09.10 | 12.10 | + 14" Rad <sup>3)</sup>     | 24.3541-1823.3 | 240417 | <input type="checkbox"/>                                   |  | D=54, - Halter<br>D=54, - Halter |
|  | 1.5 dCi | 66 | 06.09 | 12.10 | + 14" Rad <sup>3)</sup>     | 24.3541-1824.5 | 240418 | <input type="checkbox"/>                                   |  |                                  |
|  | 1.5 dCi | 76 | 02.09 | 12.10 | + 14" Rad <sup>3)</sup>     |                |        |  |  |                                  |
|  | 1.5 dCi | 80 | 06.09 | 12.10 | + 14" Rad <sup>3)</sup>     |                |        |  |  |                                  |
|  | 1.6 16V | 78 | 02.09 | 12.10 | + 14" Rad <sup>3)</sup>     |                |        |  |  |                                  |
|  | 1.5 dCi | 55 | 09.10 | 12.10 |                             | 24.5229-0185.3 | 330397 | 2 <input type="checkbox"/>                                 |  | L=185                            |
|  | 1.5 dCi | 66 | 06.09 | 12.10 |                             |                |        |  |  |                                  |
|  | 1.5 dCi | 76 | 02.09 | 12.10 |                             |                |        |  |  |                                  |
|  | 1.5 dCi | 80 | 06.09 | 12.10 |                             |                |        |  |  |                                  |
|  | 1.6 16V | 78 | 02.09 | 12.10 |                             |                |        |  |  |                                  |
|  | 1.5 dCi | 55 | 09.10 | 12.10 | + 14" Rad <sup>3)</sup>     | 24.3222-1729.3 | 020526 |  |  | Rz 22,20                         |
|  | 1.5 dCi | 66 | 06.09 | 12.10 | + 14" Rad <sup>3)</sup>     |                |        |  |  |                                  |
|  | 1.5 dCi | 76 | 02.09 | 12.10 | + 14" Rad <sup>3)</sup>     |                |        |  |  |                                  |
|  | 1.5 dCi | 80 | 06.09 | 12.10 | + 14" Rad <sup>3)</sup>     |                |        |  |  |                                  |
|  | 1.6 16V | 78 | 02.09 | 12.10 | + 14" Rad <sup>3)</sup>     |                |        |  |  |                                  |
|  | 1.5 dCi | 55 | 09.10 | 12.10 | + 15"/16" Rad <sup>2)</sup> | 24.3727-1082.2 | 581082 | 2 <input type="checkbox"/> + langer Radstand <sup>4)</sup> |  | L=2015                           |
|  | 1.5 dCi | 66 | 06.09 | 12.10 | + 15"/16" Rad <sup>2)</sup> |                |        |  |  |                                  |
|  | 1.5 dCi | 76 | 02.09 | 12.10 | + 15"/16" Rad <sup>2)</sup> |                |        |  |  |                                  |
|  | 1.5 dCi | 80 | 06.09 | 12.10 | + 15"/16" Rad <sup>2)</sup> |                |        |  |  |                                  |
|  | 1.6 16V | 78 | 02.09 | 12.10 | + 15"/16" Rad <sup>2)</sup> |                |        |  |  |                                  |

### RENAULT KANGOO Express/Rapid (FC\_) (98-07)

|  |                   |    |       |       |       |                |        |  |  |                         |
|--|-------------------|----|-------|-------|-------|----------------|--------|--|--|-------------------------|
|  | 1.0               | 40 | 07.03 | 12.07 | - ABS | 24.2122-1727.3 | 010586 |  |  | THz 22,20<br><b>BDX</b> |
|  | 1.2               | 43 | 03.98 | 12.07 | - ABS |                |        |  |  |                         |
|  | 1.2               | 44 | 07.98 | 07.01 | - ABS |                |        |  |  |                         |
|  | 1.2 16V           | 55 | 10.01 | 12.07 | - ABS |                |        |  |  |                         |
|  | 1.4               | 55 | 03.98 | 12.07 | - ABS |                |        |  |  |                         |
|  | 1.5 dCi           | 42 | 12.02 | 12.07 | - ABS |                |        |  |  |                         |
|  | 1.5 dCi           | 50 | 06.05 | 12.07 | - ABS |                |        |  |  |                         |
|  | 1.5 dCi           | 62 | 06.05 | 12.07 | - ABS |                |        |  |  |                         |
|  | 1.5 dCi (FC07)    | 48 | 12.01 | 12.07 | - ABS |                |        |  |  |                         |
|  | 1.5 dCi (FC08/09) | 60 | 04.03 | 12.07 | - ABS |                |        |  |  |                         |
|  | 1.6 16V           | 70 | 10.01 | 12.07 | - ABS |                |        |  |  |                         |
|  | 1.9 D             | 47 | 03.98 | 12.07 | - ABS |                |        |  |  |                         |
|  | 1.9 D             | 48 | 09.99 | 06.03 | - ABS |                |        |  |  |                         |

<sup>1)</sup> + increased payload/reinforced susp. / + car.util.maggl. / + sospens.rinforzata / + charg.util.augm. / + chäss.renf. / + incr.d.carga/ + susp.reforzada

<sup>2)</sup> + 15"/16" wheel / + ruota 15"/16" / + roue 15"/16" / + rueda 15"/16"

<sup>3)</sup> + 14" wheel / + ruota 14" / + roue 14" / + rueda 14"

<sup>4)</sup> + long wheel base / + passo lungo / + empattement long / + distancia larga entre ejes

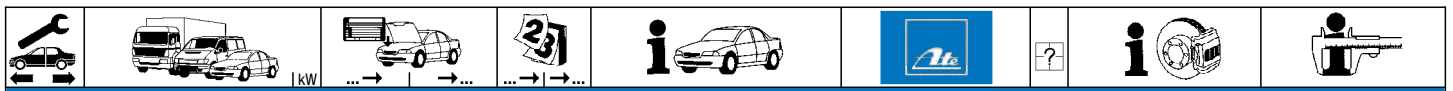

**RENAULT KANGOO Express/Rapid (FC\_) (98-07)**

|  |                    |    |  |       |       |       |                |        |                          |                                      |                |            |
|--|--------------------|----|--|-------|-------|-------|----------------|--------|--------------------------|--------------------------------------|----------------|------------|
|  | 1.9 D (FCOD)       | 40 |  | 03.98 | 12.07 | - ABS | 24.2122-1727.3 | 010586 |                          |                                      | THz 22,20      | <b>BDX</b> |
|  | 1.9 dCi 4x4 (FCOV) | 59 |  | 10.01 | 12.07 | - ABS |                |        |                          |                                      |                |            |
|  | 1.9 dTi (FCOU)     | 59 |  | 02.00 | 12.07 | - ABS |                |        |                          |                                      |                |            |
|  | 1.0                | 40 |  | 07.03 | 12.07 | + ABS | 24.2122-1745.3 | 010715 |                          |                                      | THz 22,20      |            |
|  | 1.2                | 43 |  | 03.98 | 12.07 | + ABS |                |        |                          |                                      |                |            |
|  | 1.2                | 44 |  | 07.98 | 07.01 | + ABS |                |        |                          |                                      |                |            |
|  | 1.2 16V            | 55 |  | 10.01 | 12.07 | + ABS |                |        |                          |                                      |                |            |
|  | 1.4                | 55 |  | 03.98 | 12.07 | + ABS |                |        |                          |                                      |                |            |
|  | 1.5 dCi            | 42 |  | 12.02 | 12.07 | + ABS |                |        |                          |                                      |                |            |
|  | 1.5 dCi            | 50 |  | 06.05 | 12.07 | + ABS |                |        |                          |                                      |                |            |
|  | 1.5 dCi            | 62 |  | 06.05 | 12.07 | + ABS |                |        |                          |                                      |                |            |
|  | 1.5 dCi (FC07)     | 48 |  | 12.01 | 12.07 | + ABS |                |        |                          |                                      |                |            |
|  | 1.5 dCi (FC08/09)  | 60 |  | 04.03 | 12.07 | + ABS |                |        |                          |                                      |                |            |
|  | 1.6 16V            | 70 |  | 10.01 | 12.07 | + ABS |                |        |                          |                                      |                |            |
|  | 1.9 D              | 47 |  | 03.98 | 12.07 | + ABS |                |        |                          |                                      |                |            |
|  | 1.9 D              | 48 |  | 09.99 | 06.03 | + ABS |                |        |                          |                                      |                |            |
|  | 1.9 D (FCOD)       | 40 |  | 03.98 | 12.07 | + ABS |                |        |                          |                                      |                |            |
|  | 1.9 dCi 4x4 (FCOV) | 59 |  | 10.01 | 12.07 | + ABS |                |        |                          |                                      |                |            |
|  | 1.9 dTi (FCOU)     | 59 |  | 02.00 | 12.07 | + ABS |                |        |                          |                                      |                |            |
|  | 1.0                | 40 |  | 07.03 | 12.07 | + ABS | 24.2122-1744.3 | 010697 |                          |                                      | THz 22,20      |            |
|  | 1.2                | 43 |  | 03.98 | 12.07 | + ABS |                |        |                          |                                      |                |            |
|  | 1.2                | 44 |  | 07.98 | 07.01 | + ABS |                |        |                          |                                      |                |            |
|  | 1.2 16V            | 55 |  | 10.01 | 12.07 | + ABS |                |        |                          |                                      |                |            |
|  | 1.4                | 55 |  | 03.98 | 12.07 | + ABS |                |        |                          |                                      |                |            |
|  | 1.5 dCi            | 42 |  | 12.02 | 12.07 | + ABS |                |        |                          |                                      |                |            |
|  | 1.5 dCi            | 50 |  | 06.05 | 12.07 | + ABS |                |        |                          |                                      |                |            |
|  | 1.5 dCi            | 62 |  | 06.05 | 12.07 | + ABS |                |        |                          |                                      |                |            |
|  | 1.5 dCi (FC07)     | 48 |  | 12.01 | 12.07 | + ABS |                |        |                          |                                      |                |            |
|  | 1.5 dCi (FC08/09)  | 60 |  | 04.03 | 12.07 | + ABS |                |        |                          |                                      |                |            |
|  | 1.6 16V            | 70 |  | 10.01 | 12.07 | + ABS |                |        |                          |                                      |                |            |
|  | 1.9 D              | 47 |  | 03.98 | 12.07 | + ABS |                |        |                          |                                      |                |            |
|  | 1.9 D              | 48 |  | 09.99 | 06.03 | + ABS |                |        |                          |                                      |                |            |
|  | 1.9 D (FCOD)       | 40 |  | 03.98 | 12.07 | + ABS |                |        |                          |                                      |                |            |
|  | 1.9 dCi 4x4 (FCOV) | 59 |  | 10.01 | 12.07 | + ABS |                |        |                          |                                      |                |            |
|  | 1.9 dTi (FCOU)     | 59 |  | 02.00 | 12.07 | + ABS |                |        |                          |                                      |                |            |
|  | 1.0                | 40 |  | 07.03 | 12.07 |       | 24.3541-1765.5 | 240235 | <input type="checkbox"/> |                                      | D=54, - Halter | <b>BOS</b> |
|  | 1.2                | 43 |  | 03.98 | 12.07 |       | 24.3541-1766.5 | 240236 | <input type="checkbox"/> |                                      | D=54, - Halter | <b>BOS</b> |
|  | 1.2                | 44 |  | 07.98 | 07.01 |       |                |        |                          |                                      |                |            |
|  | 1.2 16V            | 55 |  | 10.01 | 12.07 |       |                |        |                          |                                      |                |            |
|  | 1.4                | 55 |  | 03.98 | 12.07 |       |                |        |                          |                                      |                |            |
|  | 1.5 dCi            | 42 |  | 12.02 | 12.07 |       |                |        |                          |                                      |                |            |
|  | 1.5 dCi            | 50 |  | 06.05 | 12.07 |       |                |        |                          |                                      |                |            |
|  | 1.5 dCi            | 62 |  | 06.05 | 12.07 |       |                |        |                          |                                      |                |            |
|  | 1.5 dCi (FC07)     | 48 |  | 12.01 | 12.07 |       |                |        |                          |                                      |                |            |
|  | 1.5 dCi (FC08/09)  | 60 |  | 04.03 | 12.07 |       |                |        |                          |                                      |                |            |
|  | 1.6 16V            | 70 |  | 10.01 | 12.07 |       |                |        |                          |                                      |                |            |
|  | 1.9 D              | 47 |  | 03.98 | 12.07 |       |                |        |                          |                                      |                |            |
|  | 1.9 D              | 48 |  | 09.99 | 06.03 |       |                |        |                          |                                      |                |            |
|  | 1.9 D (FCOD)       | 40 |  | 03.98 | 12.07 |       |                |        |                          |                                      |                |            |
|  | 1.9 dTi (FCOU)     | 59 |  | 02.00 | 12.07 |       |                |        |                          |                                      |                |            |
|  | 1.0                | 40 |  | 07.03 | 12.07 |       | 24.5111-0325.3 | 330109 | <input type="checkbox"/> |                                      | L=325          |            |
|  | 1.2                | 43 |  | 03.98 | 12.07 |       | 24.5111-0336.3 | 330570 | <input type="checkbox"/> |                                      | L=335          |            |
|  | 1.2                | 44 |  | 07.98 | 07.01 |       |                |        |                          |                                      |                |            |
|  | 1.2 16V            | 55 |  | 10.01 | 12.07 |       |                |        |                          |                                      |                |            |
|  | 1.4                | 55 |  | 03.98 | 12.07 |       |                |        |                          |                                      |                |            |
|  | 1.5 dCi            | 42 |  | 12.02 | 12.07 |       |                |        |                          |                                      |                |            |
|  | 1.5 dCi            | 50 |  | 06.05 | 12.07 |       |                |        |                          |                                      |                |            |
|  | 1.5 dCi            | 62 |  | 06.05 | 12.07 |       |                |        |                          |                                      |                |            |
|  | 1.5 dCi (FC07)     | 48 |  | 12.01 | 12.07 |       |                |        |                          |                                      |                |            |
|  | 1.5 dCi (FC08/09)  | 60 |  | 04.03 | 12.07 |       |                |        |                          |                                      |                |            |
|  | 1.6 16V            | 70 |  | 10.01 | 12.07 |       |                |        |                          |                                      |                |            |
|  | 1.9 D              | 47 |  | 03.98 | 12.07 |       |                |        |                          |                                      |                |            |
|  | 1.9 D              | 48 |  | 09.99 | 06.03 |       |                |        |                          |                                      |                |            |
|  | 1.9 D (FCOD)       | 40 |  | 03.98 | 12.07 |       |                |        |                          |                                      |                |            |
|  | 1.9 dCi 4x4 (FCOV) | 59 |  | 10.01 | 12.07 |       |                |        |                          |                                      |                |            |
|  | 1.9 dTi (FCOU)     | 59 |  | 02.00 | 12.07 |       |                |        |                          |                                      |                |            |
|  | 1.0                | 40 |  | 07.03 | 12.07 |       | 24.5111-0336.3 | 330570 | <input type="checkbox"/> |                                      | L=335          |            |
|  | 1.2                | 43 |  | 03.98 | 12.07 |       | 24.5229-0193.3 | 330571 | <input type="checkbox"/> |                                      | L=193          |            |
|  | 1.2                | 44 |  | 07.98 | 07.01 |       |                |        |                          |                                      |                |            |
|  | 1.2 16V            | 55 |  | 10.01 | 12.07 |       |                |        |                          |                                      |                |            |
|  | 1.4                | 55 |  | 03.98 | 12.07 |       |                |        |                          |                                      |                |            |
|  | 1.5 dCi            | 42 |  | 12.02 | 12.07 |       |                |        |                          |                                      |                |            |
|  | 1.5 dCi            | 50 |  | 06.05 | 12.07 |       |                |        |                          |                                      |                |            |
|  | 1.5 dCi            | 62 |  | 06.05 | 12.07 |       |                |        |                          |                                      |                |            |
|  | 1.5 dCi (FC07)     | 48 |  | 12.01 | 12.07 |       |                |        |                          |                                      |                |            |
|  | 1.5 dCi (FC08/09)  | 60 |  | 04.03 | 12.07 |       |                |        |                          |                                      |                |            |
|  | 1.6 16V            | 70 |  | 10.01 | 12.07 |       |                |        |                          |                                      |                |            |
|  | 1.9 D              | 47 |  | 03.98 | 12.07 |       |                |        |                          |                                      |                |            |
|  | 1.9 D              | 48 |  | 09.99 | 06.03 |       |                |        |                          |                                      |                |            |
|  | 1.9 D (FCOD)       | 40 |  | 03.98 | 12.07 |       |                |        |                          |                                      |                |            |
|  | 1.9 dCi 4x4 (FCOV) | 59 |  | 10.01 | 12.07 |       |                |        |                          |                                      |                |            |
|  | 1.9 dTi (FCOU)     | 59 |  | 02.00 | 12.07 |       |                |        |                          |                                      |                |            |
|  | 1.0                | 40 |  | 07.03 | 12.07 |       | 24.3222-1716.3 | 020434 |                          | - verstärktes Fahrwerk <sup>1)</sup> | Rz 22,00       | <b>BDX</b> |
|  | 1.2                | 43 |  | 03.98 | 12.07 |       | 24.3222-1715.3 | 020433 |                          | + verstärktes Fahrwerk <sup>2)</sup> | Rz 22,00       | <b>BDX</b> |
|  | 1.2                | 44 |  | 07.98 | 07.01 |       |                |        |                          |                                      |                |            |
|  | 1.2 16V            | 55 |  | 10.01 | 12.07 |       |                |        |                          |                                      |                |            |
|  | 1.4                | 55 |  | 03.98 | 12.07 |       |                |        |                          |                                      |                |            |

1) - reinforced suspension / - sospensione rinforzata / - châssis renforcé / - suspensión reforzada  
 2) + reinforced suspension / + sospensione rinforzata / + châssis renforcé / + suspensión reforzada



| RENAULT KANGOO Express/Rapid (FC_) (98-07) |                    |    |       |       |       |                             |  |                |        |   |                          |   |                |     |  |  |  |
|--|--------------------|----|-------|-------|-------|-----------------------------|--|----------------|--------|---|--------------------------|---|----------------|-----|--|--|--|
|  | 1.5 dCi            | 42 |       | 12.02 | 12.07 |                             |  | 24.3222-1716.3 | 020434 |   |                          | - verstärktes Fahrwerk <sup>1)</sup>                          | Rz 22,00       | BDX |  |  |  |
|  | 1.5 dCi            | 50 |       | 06.05 | 12.07 |                             |  | 24.3222-1715.3 | 020433 |   |                          | + verstärktes Fahrwerk <sup>2)</sup>                          | Rz 22,00       |     |  |  |  |
|  | 1.5 dCi            | 62 |       | 06.05 | 12.07 |                             |  |                |        |   |                          |   |                |     |  |  |  |
|  | 1.5 dCi (FC07)     | 48 |       | 12.01 | 12.07 |                             |  |                |        |   |                          |   |                |     |  |  |  |
|  | 1.5 dCi (FC08/09)  | 60 |       | 04.03 | 12.07 |                             |  |                |        |   |                          |   |                |     |  |  |  |
|  | 1.6 16V            | 70 |       | 10.01 | 12.07 |                             |  |                |        |   |                          |   |                |     |  |  |  |
|  | 1.9 D              | 47 |       | 03.98 | 12.07 |                             |  |                |        |   |                          |   |                |     |  |  |  |
|  | 1.9 D              | 48 |       | 09.99 | 06.03 |                             |  |                |        |   |                          |   |                |     |  |  |  |
|  | 1.9 D (FC0D)       | 40 |       | 03.98 | 12.07 |                             |  |                |        |   |                          |   |                |     |  |  |  |
|  | 1.9 dTi (FC0U)     | 59 |       | 02.00 | 12.07 |                             |  |                |        |   |                          |   |                |     |  |  |  |
|  | 1.0                | 40 |       | 07.03 | 12.07 |                             |  | 24.3727-1041.2 | 581041 |   |                          | <input type="checkbox"/> - verstärktes Fahrwerk <sup>1)</sup> | L=1423         |     |  |  |  |
|  | 1.2                | 43 |       | 03.98 | 12.07 |                             |  | 24.3727-1042.2 | 581042 |   |                          | <input type="checkbox"/> - verstärktes Fahrwerk <sup>1)</sup> | L=1421         |     |  |  |  |
|  | 1.2                | 44 |       | 07.98 | 07.01 |                             |  | 24.3727-1043.2 | 581043 |   |                          | <input type="checkbox"/> + verstärktes Fahrwerk <sup>2)</sup> | L=1432         |     |  |  |  |
|  | 1.2 16V            | 55 |       | 10.01 | 12.07 |                             |  | 24.3727-1044.2 | 581044 |   |                          | <input type="checkbox"/> + verstärktes Fahrwerk <sup>2)</sup> | L=1442         |     |  |  |  |
|  | 1.4                | 55 |       | 03.98 | 12.07 |                             |  |                |        |   |                          |   |                |     |  |  |  |
|  | 1.5 dCi            | 42 |       | 12.02 | 12.07 |                             |  |                |        |   |                          |   |                |     |  |  |  |
|  | 1.5 dCi            | 50 |       | 06.05 | 12.07 |                             |  |                |        |   |                          |   |                |     |  |  |  |
|  | 1.5 dCi            | 62 |       | 06.05 | 12.07 |                             |  |                |        |   |                          |   |                |     |  |  |  |
|  | 1.5 dCi (FC07)     | 48 |       | 12.01 | 12.07 |                             |  |                |        |   |                          |   |                |     |  |  |  |
|  | 1.5 dCi (FC08/09)  | 60 |       | 04.03 | 12.07 |                             |  |                |        |   |                          |   |                |     |  |  |  |
|  | 1.6 16V            | 70 |       | 10.01 | 12.07 |                             |  |                |        |   |                          |   |                |     |  |  |  |
|  | 1.9 D              | 47 |       | 03.98 | 12.07 |                             |  |                |        |   |                          |   |                |     |  |  |  |
|  | 1.9 D              | 48 |       | 09.99 | 06.03 |                             |  |                |        |   |                          |   |                |     |  |  |  |
|  | 1.9 D (FC0D)       | 40 |       | 03.98 | 12.07 |                             |  |                |        |   |                          |   |                |     |  |  |  |
| 1.9 dTi (FC0U)                             | 59                 |    | 02.00 | 12.07 |       |                             |  |                |        |   |                          |   |                |     |  |  |  |
|  | 1.0                | 40 |       | 07.03 | 12.07 |                             |  | 24.3728-1016.2 | 591016 |   |                          |   | L=969          |     |  |  |  |
|  | 1.2                | 44 |       | 07.98 | 07.01 |                             |  |                |        |   |                          |   |                |     |  |  |  |
|  | 1.2 (FC0A/0F)      | 43 |       | 03.98 | 12.07 |                             |  |                |        |   |                          |   |                |     |  |  |  |
|  | 1.2 16V            | 55 |       | 10.01 | 12.07 |                             |  |                |        |   |                          |   |                |     |  |  |  |
|  | 1.4 (FC0C/0H)      | 55 |       | 03.98 | 12.07 |                             |  |                |        |   |                          |   |                |     |  |  |  |
|  | 1.6 16V (FC0L/0S)  | 70 |       | 10.01 | 12.07 |                             |  |                |        |   |                          |   |                |     |  |  |  |
|  | 1.6 16V (FC0P/0R)  | 70 |       | 10.01 | 12.07 |                             |  |                |        |   |                          |   |                |     |  |  |  |
|  | 1.9 D              | 48 |       | 09.99 | 06.03 |                             |  |                |        |   |                          |   |                |     |  |  |  |
|  | 1.9 D (FC0D)       | 40 |       | 03.98 | 12.07 |                             |  |                |        |   |                          |   |                |     |  |  |  |
|  | 1.9 D (FC0E)       | 47 |       | 03.98 | 12.07 |                             |  |                |        |   |                          |   |                |     |  |  |  |
| 1.9 dTi (FC0U)                             | 59                 |    | 02.00 | 12.07 |       |                             |  |                |        |   |                          |   |                |     |  |  |  |
|  | 1.5 dCi            | 42 |       | 12.02 | 12.07 |                             |  | 24.3728-1023.2 | 591023 |   |                          |   | L=960          |     |  |  |  |
|  | 1.5 dCi            | 50 |       | 06.05 | 12.07 |                             |  |                |        |   |                          |   |                |     |  |  |  |
|  | 1.5 dCi            | 62 |       | 06.05 | 12.07 |                             |  |                |        |   |                          |   |                |     |  |  |  |
|  | 1.5 dCi (FC07)     | 48 |       | 12.01 | 12.07 |                             |  |                |        |   |                          |   |                |     |  |  |  |
|  | 1.5 dCi (FC08/09)  | 60 |       | 04.03 | 12.07 |                             |  |                |        |   |                          |   |                |     |  |  |  |
|  | 1.9 dCi 4x4 (FC0V) | 59 |       | 10.01 | 12.07 |                             |  |                |        |   |                          |   |                |     |  |  |  |
| RENAULT KANGOO Express/Rapid (FW_) (08-)   |                    |    |       |       |       |                             |  |                |        |   |                          |   |                |     |  |  |  |
|  | 1.2 TCe 115        | 84 |       | 05.13 |       | + 14" Rad <sup>3)</sup>     |  | 24.3541-1823.5 | 240417 |   |                          | <input type="checkbox"/> + belüftete Scheiben <sup>4)</sup>   | D=54, - Halter |     |  |  |  |
|  | 1.5 dCi            | 50 |       | 02.08 |       | + 14" Rad <sup>3)</sup>     |  | 24.3541-1824.5 | 240418 |   |                          | <input type="checkbox"/> + belüftete Scheiben <sup>4)</sup>   | D=54, - Halter |     |  |  |  |
|  | 1.5 dCi            | 76 |       | 02.08 |       | + 14" Rad <sup>3)</sup>     |  |                |        |   |                          |   |                |     |  |  |  |
|  | 1.5 dCi 110        | 80 |       | 09.10 |       | + 14" Rad <sup>3)</sup>     |  |                |        |   |                          |   |                |     |  |  |  |
|  | 1.5 dCi 75         | 55 |       | 09.10 |       | + 14" Rad <sup>3)</sup>     |  |                |        |   |                          |   |                |     |  |  |  |
|  | 1.5 dCi 85         | 63 |       | 02.08 |       | + 14" Rad <sup>3)</sup>     |  |                |        |   |                          |   |                |     |  |  |  |
|  | 1.5 dCi 90         | 66 |       | 06.09 |       | + 14" Rad <sup>3)</sup>     |  |                |        |   |                          |   |                |     |  |  |  |
|  | 1.6                | 64 |       | 02.08 |       | + 14" Rad <sup>3)</sup>     |  |                |        |   |                          |   |                |     |  |  |  |
|  | 1.6 16V            | 78 |       | 02.08 |       | + 14" Rad <sup>3)</sup>     |  |                |        |   |                          |   |                |     |  |  |  |
|  | 1.6 16V LPG        | 72 |       | 02.08 |       | + 14" Rad <sup>3)</sup>     |  |                |        |   |                          |   |                |     |  |  |  |
|  | Z.E.               | 44 |       | 10.11 |       | + 14" Rad <sup>3)</sup>     |  |                |        |   |                          |   |                |     |  |  |  |
|  | 1.5 dCi            | 50 |       | 02.08 |       |                             |  | 24.5229-0185.3 | 330397 | 2 | <input type="checkbox"/> |   | L=185          |     |  |  |  |
|  | 1.5 dCi            | 76 |       | 02.08 |       |                             |  |                |        |   |                          |   |                |     |  |  |  |
|  | 1.5 dCi 110        | 80 |       | 09.10 |       |                             |  |                |        |   |                          |   |                |     |  |  |  |
|  | 1.5 dCi 75         | 55 |       | 09.10 |       |                             |  |                |        |   |                          |   |                |     |  |  |  |
|  | 1.5 dCi 85         | 63 |       | 02.08 |       |                             |  |                |        |   |                          |   |                |     |  |  |  |
|  | 1.5 dCi 90         | 66 |       | 06.09 |       |                             |  |                |        |   |                          |   |                |     |  |  |  |
|  | 1.6                | 64 |       | 02.08 |       |                             |  |                |        |   |                          |   |                |     |  |  |  |
|  | 1.6 16V            | 78 |       | 02.08 |       |                             |  |                |        |   |                          |   |                |     |  |  |  |
|  | 1.6 16V LPG        | 72 |       | 02.08 |       |                             |  |                |        |   |                          |   |                |     |  |  |  |
|  | Z.E.               | 44 |       | 10.11 |       |                             |  |                |        |   |                          |   |                |     |  |  |  |
|  | 1.2 TCe 115        | 84 |       | 05.13 |       | + 14" Rad <sup>3)</sup>     |  | 24.3222-1729.3 | 020526 |   |                          |   | Rz 22,20       |     |  |  |  |
|  | 1.5 dCi            | 50 |       | 02.08 |       | + 14" Rad <sup>3)</sup>     |  |                |        |   |                          |   |                |     |  |  |  |
|  | 1.5 dCi            | 76 |       | 02.08 |       | + 14" Rad <sup>3)</sup>     |  |                |        |   |                          |   |                |     |  |  |  |
|  | 1.5 dCi 110        | 80 |       | 09.10 |       | + 14" Rad <sup>3)</sup>     |  |                |        |   |                          |   |                |     |  |  |  |
|  | 1.5 dCi 75         | 55 |       | 09.10 |       | + 14" Rad <sup>3)</sup>     |  |                |        |   |                          |   |                |     |  |  |  |
|  | 1.5 dCi 85         | 63 |       | 02.08 |       | + 14" Rad <sup>3)</sup>     |  |                |        |   |                          |   |                |     |  |  |  |
|  | 1.5 dCi 90         | 66 |       | 06.09 |       | + 14" Rad <sup>3)</sup>     |  |                |        |   |                          |   |                |     |  |  |  |
|  | 1.6                | 64 |       | 02.08 |       | + 14" Rad <sup>3)</sup>     |  |                |        |   |                          |   |                |     |  |  |  |
|  | 1.6 16V            | 78 |       | 02.08 |       | + 14" Rad <sup>3)</sup>     |  |                |        |   |                          |   |                |     |  |  |  |
|  | 1.6 16V LPG        | 72 |       | 02.08 |       | + 14" Rad <sup>3)</sup>     |  |                |        |   |                          |   |                |     |  |  |  |
|  | Z.E.               | 44 |       | 10.11 |       | + 14" Rad <sup>3)</sup>     |  |                |        |   |                          |   |                |     |  |  |  |
|  | 1.2 TCe 115        | 84 |       | 05.13 |       | + 15"/16" Rad <sup>5)</sup> |  | 24.3727-1082.2 | 581082 | 2 | <input type="checkbox"/> |   | L=2015         |     |  |  |  |
|  | 1.5 dCi            | 50 |       | 02.08 |       | + 15"/16" Rad <sup>5)</sup> |  |                |        |   |                          |   |                |     |  |  |  |
|  | 1.5 dCi            | 76 |       | 02.08 |       | + 15"/16" Rad <sup>5)</sup> |  |                |        |   |                          |   |                |     |  |  |  |
|  | 1.5 dCi 110        | 80 |       | 09.10 |       | + 15"/16" Rad <sup>5)</sup> |  |                |        |   |                          |   |                |     |  |  |  |
|  | 1.5 dCi 75         | 55 |       | 09.10 |       | + 15"/16" Rad <sup>5)</sup> |  |                |        |   |                          |   |                |     |  |  |  |
|  | 1.5 dCi 85         | 63 |       | 02.08 |       | + 15"/16" Rad <sup>5)</sup> |  |                |        |   |                          |   |                |     |  |  |  |
|  | 1.5 dCi 90         | 66 |       | 06.09 |       | + 15"/16" Rad <sup>5)</sup> |  |                |        |   |                          |   |                |     |  |  |  |
|  | 1.6                | 64 |       | 02.08 |       | + 15"/16" Rad <sup>5)</sup> |  |                |        |   |                          |   |                |     |  |  |  |
|  | 1.6 16V            | 78 |       | 02.08 |       | + 15"/16" Rad <sup>5)</sup> |  |                |        |   |                          |   |                |     |  |  |  |
|  | 1.6 16V LPG        | 72 |       | 02.08 |       | + 15"/16" Rad <sup>5)</sup> |  |                |        |   |                          |   |                |     |  |  |  |
|  | Z.E.               | 44 |       | 10.11 |       | + 15"/16" Rad <sup>5)</sup> |  |                |        |   |                          |   |                |     |  |  |  |

<sup>1)</sup> - reinforced suspension / - sospensione rinforzata / - châssis renforcé / - suspensión reforzada

<sup>2)</sup> + reinforced suspension / + sospensione rinforzata / + châssis renforcé / + suspensión reforzada

<sup>3)</sup> + 14" wheel / + ruota 14" / + roue 14" / + rueda 14"

<sup>4)</sup> + ventilated discs / + dischi ventilati / + disques ventilés / + disco ventilado

<sup>5)</sup> + 15"/16" wheel / + ruota 15"/16" / + roue 15"/16" / + rueda 15"/16"















### RENAULT KOLEOS (HYO\_) (08-)

|  |             |     |  |       |  |                |        |                          |   |        |
|--|-------------|-----|--|-------|--|----------------|--------|--------------------------|---|--------|
|  | 2.0 dCi     | 110 |  | 09.08 |  | 24.3727-1087.2 | 581087 | <input type="checkbox"/> | - elektrische Feststellbremse <sup>1)</sup> | L=1760 |
|  | 2.0 dCi     | 130 |  | 09.08 |  | 24.3727-1088.2 | 581088 | <input type="checkbox"/> | - elektrische Feststellbremse <sup>1)</sup> | L=1760 |
|  | 2.0 dCi 4x4 | 110 |  | 09.08 |  |                |        |                          |   |        |
|  | 2.0 dCi 4x4 | 127 |  | 09.08 |  |                |        |                          |   |        |
|  | 2.5 16V     | 126 |  | 09.08 |  |                |        |                          |   |        |
|  | 2.5 16V 4x4 | 126 |  | 09.08 |  |                |        |                          |   |        |

### RENAULT LAGUNA I Limousine (B56/556\_) (93-00)

|  |                      |     |  |       |       |       |                |        |                                     |  |                  |     |
|--|----------------------|-----|--|-------|-------|-------|----------------|--------|-------------------------------------|--|------------------|-----|
|  | 1.8                  | 69  |  | 04.95 | 02.01 | - ABS | 03.2122-1001.3 | 010562 |                                     |  | THz 22,20        | ATE |
|  | 1.8 (B56A/B)         | 66  |  | 11.93 | 02.01 | - ABS |                |        |                                     |  |                  |     |
|  | 2.2 D (B56F/2)       | 61  |  | 11.93 | 02.01 | - ABS |                |        |                                     |  |                  |     |
|  | 1.6 16V              | 79  |  | 11.97 | 01.99 |       | 24.2123-1725.3 | 010549 |                                     |  | THz 23,81        |     |
|  | 1.8                  | 69  |  | 02.97 | 02.01 | + ABS |                |        |                                     |  |                  |     |
|  | 1.8 (B56A/B)         | 66  |  | 02.97 | 02.01 | + ABS |                |        |                                     |  |                  |     |
|  | 1.8 (B56S/T/0)       | 66  |  | 02.97 | 02.01 | + ABS |                |        |                                     |  |                  |     |
|  | 1.8 16V (B563,B564)  | 88  |  | 04.98 | 01.99 |       |                |        |                                     |  |                  |     |
|  | 1.9 dTi              | 72  |  | 10.97 | 01.99 |       |                |        |                                     |  |                  |     |
|  | 2.0 (B56C/H/N)       | 83  |  | 02.97 | 02.01 | + ABS |                |        |                                     |  |                  |     |
|  | 2.0 (B56C/H/N)       | 83  |  | 11.93 | 02.01 | - ABS |                |        |                                     |  |                  |     |
|  | 2.0 (L)              | 70  |  | 02.97 | 01.99 | + ABS |                |        |                                     |  |                  |     |
|  | 2.0 (L)              | 70  |  | 06.95 | 02.01 | - ABS |                |        |                                     |  |                  |     |
|  | 2.0 16V (B56D/M)     | 102 |  | 02.97 | 01.99 | + ABS |                |        |                                     |  |                  |     |
|  | 2.0 16V (B56D/M)     | 102 |  | 05.95 | 02.01 | - ABS |                |        |                                     |  |                  |     |
|  | 2.2 D (B56F/2)       | 61  |  | 02.97 | 02.01 | + ABS |                |        |                                     |  |                  |     |
|  | 2.2 dT               | 83  |  | 02.97 | 01.99 | + ABS |                |        |                                     |  |                  |     |
|  | 2.2 dT               | 83  |  | 03.96 | 02.01 | - ABS |                |        |                                     |  |                  |     |
|  | 3.0 V6               | 140 |  | 03.97 | 01.99 |       |                |        |                                     |  |                  |     |
|  | 3.0 V6 (B56E/R,B565) | 123 |  | 02.97 | 02.01 |       |                |        |                                     |  |                  |     |
|  | 1.6 16V              | 79  |  | 02.99 | 02.01 |       | 24.2123-1701.3 | 010424 |                                     |  | THz 23,81        |     |
|  | 1.8 (B56S/T/0)       | 66  |  | 02.99 | 02.01 | + ABS |                |        |                                     |  |                  |     |
|  | 1.8 16V (B563,B564)  | 88  |  | 02.99 | 02.01 |       |                |        |                                     |  |                  |     |
|  | 1.9 dCi              | 79  |  | 09.99 | 02.01 |       |                |        |                                     |  |                  |     |
|  | 1.9 dTi              | 72  |  | 02.99 | 02.01 |       |                |        |                                     |  |                  |     |
|  | 2.0 (L)              | 70  |  | 02.99 | 02.01 | + ABS |                |        |                                     |  |                  |     |
|  | 2.0 (U)              | 80  |  | 03.99 | 02.01 |       |                |        |                                     |  |                  |     |
|  | 2.0 16V (556A/B)     | 103 |  | 09.99 | 02.01 |       |                |        |                                     |  |                  |     |
|  | 2.0 16V (B56D/M)     | 102 |  | 02.99 | 02.01 | + ABS |                |        |                                     |  |                  |     |
|  | 2.2 dT               | 83  |  | 02.99 | 02.01 | + ABS |                |        |                                     |  |                  |     |
|  | 3.0 V6               | 140 |  | 02.99 | 02.01 |       |                |        |                                     |  |                  |     |
|  | 1.8                  | 69  |  | 04.95 | 01.97 | + ABS | 10.6123-0312.3 | 010457 |                                     |  | THz 23,81 (MKIV) | ATE |
|  | 1.8 (B56A/B)         | 66  |  | 11.93 | 01.97 | + ABS |                |        |                                     |  |                  |     |
|  | 2.0                  | 84  |  | 11.93 | 01.97 | + ABS |                |        |                                     |  |                  |     |
|  | 2.0 16V (B56D/M)     | 102 |  | 05.95 | 02.01 | + ABS |                |        |                                     |  |                  |     |
|  | 2.2 D (B56F/2)       | 61  |  | 11.93 | 01.97 | + ABS |                |        |                                     |  |                  |     |
|  | 2.2 dT               | 83  |  | 03.96 | 01.97 | + ABS |                |        |                                     |  |                  |     |
|  | 3.0 V6 (B56E/R,B565) | 123 |  | 11.93 | 01.97 | + ABS |                |        |                                     |  |                  |     |
|  | 1.8 (B56A/B)         | 66  |  | 11.93 | 09.94 | - ABS | 24.3481-1755.5 | 240297 | <input checked="" type="checkbox"/> |  | D=48, - Halter   | LUC |
|  | 1.8 (B56S/T/0)       | 66  |  | 11.93 | 09.94 | - ABS |                |        |                                     |  |                  |     |
|  | 2.2 D (B56F/2)       | 61  |  | 11.93 | 02.94 | - ABS |                |        |                                     |  |                  |     |
|  | 1.8                  | 69  |  | 04.95 | 02.01 |       | 24.3541-1741.5 | 240215 | <input checked="" type="checkbox"/> |  | D=54, - Halter   | LUC |
|  | 1.8 (B56A/B)         | 66  |  | 10.94 | 02.01 |       | 24.3541-1742.5 | 240216 | <input checked="" type="checkbox"/> |  | D=54, - Halter   | LUC |
|  | 1.8 (B56S/T/0)       | 66  |  | 10.94 | 04.98 |       |                |        |                                     |  |                  |     |
|  | 2.0 (B56C/H/N)       | 83  |  | 11.93 | 02.01 |       |                |        |                                     |  |                  |     |
|  | 2.0 (L)              | 70  |  | 06.95 | 04.98 |       |                |        |                                     |  |                  |     |
|  | 2.2 D (B56F/2)       | 61  |  | 11.93 | 02.01 |       |                |        |                                     |  |                  |     |
|  | 1.6 16V              | 79  |  | 11.97 | 02.01 |       | 24.3541-1749.5 | 240427 | <input checked="" type="checkbox"/> |  | D=54, - Halter   | LUC |
|  | 1.8 (B56S/T/0)       | 66  |  | 05.98 | 02.01 |       | 24.3541-1750.5 | 240428 | <input checked="" type="checkbox"/> |  | D=54, - Halter   | LUC |
|  | 1.8 16V (B563,B564)  | 88  |  | 04.98 | 02.01 |       |                |        |                                     |  |                  |     |
|  | 1.9 dCi              | 79  |  | 09.99 | 02.01 |       |                |        |                                     |  |                  |     |
|  | 1.9 dTi              | 72  |  | 10.97 | 02.01 |       |                |        |                                     |  |                  |     |
|  | 2.0 (L)              | 70  |  | 05.98 | 02.01 |       |                |        |                                     |  |                  |     |
|  | 2.0 (U)              | 80  |  | 03.99 | 02.01 |       |                |        |                                     |  |                  |     |
|  | 2.0 16V (556A/B)     | 103 |  | 09.99 | 02.01 |       |                |        |                                     |  |                  |     |
|  | 2.0 16V (B56D/M)     | 102 |  | 11.98 | 02.01 |       |                |        |                                     |  |                  |     |
|  | 2.0 16V (B56D/M)     | 102 |  | 05.95 | 10.98 |       | 24.3601-1707.5 | 240229 | <input checked="" type="checkbox"/> |  | D=60, - Halter   | LUC |
|  | 2.2 dT               | 83  |  | 03.96 | 02.01 |       | 24.3601-1708.5 | 240230 | <input checked="" type="checkbox"/> |  | D=60, - Halter   | LUC |
|  | 3.0 V6               | 140 |  | 03.97 | 02.01 |       |                |        |                                     |  |                  |     |
|  | 3.0 V6 (B56E/R,B565) | 123 |  | 11.93 | 02.01 |       |                |        |                                     |  |                  |     |
|  | 1.6 16V              | 79  |  | 11.97 | 02.01 |       | 24.5111-0445.3 | 330504 | 2                                   |  | L=445            |     |
|  | 1.8                  | 69  |  | 04.95 | 02.01 |       |                |        |                                     |  |                  |     |
|  | 1.8 (B56A/B)         | 66  |  | 11.93 | 02.01 |       |                |        |                                     |  |                  |     |
|  | 1.8 (B56S/T/0)       | 66  |  | 08.95 | 02.01 |       |                |        |                                     |  |                  |     |
|  | 1.8 16V (B563,B564)  | 88  |  | 04.98 | 02.01 |       |                |        |                                     |  |                  |     |
|  | 1.9 dCi              | 79  |  | 09.99 | 02.01 |       |                |        |                                     |  |                  |     |
|  | 1.9 dTi              | 72  |  | 10.97 | 02.01 |       |                |        |                                     |  |                  |     |
|  | 2.0                  | 84  |  | 11.93 | 02.01 |       |                |        |                                     |  |                  |     |
|  | 2.0 (U)              | 80  |  | 03.99 | 02.01 |       |                |        |                                     |  |                  |     |
|  | 2.0 16V (556A/B)     | 103 |  | 09.99 | 02.01 |       |                |        |                                     |  |                  |     |
|  | 2.0 16V (B56D/M)     | 102 |  | 05.95 | 02.01 |       |                |        |                                     |  |                  |     |
|  | 2.2 D (B56F/2)       | 61  |  | 11.93 | 02.01 |       |                |        |                                     |  |                  |     |
|  | 2.2 dT               | 83  |  | 03.96 | 02.01 |       |                |        |                                     |  |                  |     |
|  | 3.0 V6               | 140 |  | 03.97 | 02.01 |       |                |        |                                     |  |                  |     |
|  | 3.0 V6 (B56E/R,B565) | 123 |  | 11.93 | 02.01 |       |                |        |                                     |  |                  |     |

<sup>1)</sup> - electric parking brake / - freno a mano elettrico / - frein à main électrique / - freno de mano eléctrico

|     |  |  |  |  |  |  |  |  |
|--|--|--|--|--|---|--|--|--|
| <b>RENAULT LAGUNA I Limousine (B56/556_) (93-00)</b>                               |  |  |  |  |   |  |  |  |
|    | 1.6 16V  | 79   | 11.97  | 02.01  | 24.5229-0285.3  | 330032   | 2  | L=285  |
|  | 1.8  | 69   | 04.95  | 02.01  |   |  |  |  |
|  | 1.8 (B56A/B)   | 66   | 11.93  | 02.01  | - ABS   |  |  |  |
|  | 1.8 (B56S/T/0)   | 66   | 08.95  | 02.01  | - ABS   |  |  |  |
|  | 1.8 16V (B563,B564)  | 88   | 04.98  | 02.01  | - Initiale  |  |  |  |
|  | 1.9 dCi  | 79   | 09.99  | 02.01  |   |  |  |  |
|  | 1.9 dTi  | 72   | 10.97  | 02.01  |   |  |  |  |
|  | 2.0 (B56C/H/N)   | 83   | 11.93  | 02.01  | - ABS   |  |  |  |
|  | 2.0 (U)  | 80   | 03.99  | 02.01  |   |  |  |  |
|  | 2.0 16V (556A/B)   | 103  | 09.99  | 02.01  |   |  |  |  |
|  | 2.0 16V (B56D/M)   | 102  | 05.95  | 02.01  |   |  |  |  |
|  | 2.2 D (B56F/2)   | 61   | 11.93  | 02.01  | - ABS   |  |  |  |
|  | 2.2 dT   | 83   | 03.96  | 02.01  |   |  |  |  |
|  | 3.0 V6   | 140  | 03.97  | 02.01  |   |  |  |  |
|  | 3.0 V6 (B56E/R,B565)   | 123  | 11.93  | 02.01  |   |  |  |  |
|  | 1.8  | 69   | 04.95  | 02.01  | + ABS   | 24.5111-0150.3   | 330497   | L=150  |
|  | 1.8 (B56A/B)   | 66   | 11.93  | 02.01  | + ABS   |  |  |  |
|  | 1.8 (B56S/T/0)   | 66   | 08.95  | 02.01  | + ABS   |  |  |  |
|  | 1.8 16V (B563,B564)  | 88   | 04.98  | 02.01  | + Initiale  |  |  |  |
|  | 2.0 (B56C/H/N)   | 83   | 11.93  | 02.99  | + Baccara   |  |  |  |
|  | 2.0 (B56C/H/N)   | 83   | 11.93  | 02.01  | + ABS/ - Baccara  |  |  |  |
|  | 2.0 (L)  | 70   | 06.95  | 02.99  |   |  |  |  |
|  | 2.0 16V (B56D/M)   | 102  | 05.95  | 02.01  |   |  |  |  |
|  | 2.2 D (B56F/2)   | 61   | 11.93  | 02.01  | + ABS   |  |  |  |
|  | 2.2 dT   | 83   | 03.96  | 02.99  |   |  |  |  |
|  | 3.0 V6   | 140  | 03.97  | 02.99  |   |  |  |  |
|  | 3.0 V6 (B56E/R,B565)   | 123  | 11.93  | 02.01  |   |  |  |  |
|    | 1.8  | 69   | 07.95  | 02.01  | 24.3219-1611.3  | 020367   |  | Rz 19,05   |
|  | 1.8  | 69   | 04.95  | 06.95  | - ABS   |  |  |  |
|  | 1.8 (B56A/B)   | 66   | 11.93  | 02.01  | - ABS   |  |  |  |
|  | 1.8 (B56S/T/0)   | 66   | 08.95  | 04.98  |   |  |  |  |
|  | 2.0  | 84   | 11.93  | 02.01  | - ABS   |  |  |  |
|  | 2.0 (B56C/H/N)   | 83   | 07.95  | 02.01  |   |  |  |  |
|  | 2.0 (B56C/H/N)   | 83   | 07.95  | 02.01  | - Baccara/Initiale  |  |  |  |
|  | 2.0 (B56C/H/N)   | 83   | 11.93  | 06.95  | - ABS   |  |  |  |
|  | 2.0 (L)  | 70   | 07.95  | 02.01  | - Baccara/Initiale  |  |  |  |
|  | 2.2 D (B56F/2)   | 61   | 11.93  | 06.95  | - ABS   |  |  |  |
|  | 1.6 16V  | 79   | 11.97  | 02.01  | 24.3220-1711.3  | 020409   |  | Rz 20,64 LUC   |
|  | 1.8 (B56S/T/0)   | 66   | 05.98  | 02.01  |   |  |  |  |
|  | 1.8 16V (B563,B564)  | 88   | 04.98  | 02.01  | - Fairway/Initiale  |  |  |  |
|  | 1.9 dTi  | 72   | 10.97  | 02.01  | - Concorde  |  |  |  |
|  | 2.0 (U)  | 80   | 03.99  | 02.01  | - Fairway   |  |  |  |
|  | 1.6 16V  | 79   | 11.97  | 02.01  | 24.3727-1032.2  | 581032   | 2  | L=1187   |
|  | 1.8  | 69   | 05.95  | 02.01  |   |  |  |  |
|  | 1.8  | 69   | 08.94  | 04.95  | - ABS   |  |  |  |
|  | 1.8 (B56A/B)   | 66   | 05.95  | 02.01  | - ABS   |  |  |  |
|  | 1.8 (B56A/B)   | 66   | 11.93  | 04.95  | - ABS   |  |  |  |
|  | 1.8 (B56S/T/0)   | 66   | 08.95  | 02.01  | - Initiale  |  |  |  |
|  | 1.8 16V (B563,B564)  | 88   | 04.98  | 02.01  | - Initiale  |  |  |  |
|  | 1.9 dTi  | 72   | 10.97  | 02.01  |   |  |  |  |
|  | 2.0 (B56C/H/N)   | 83   | 05.95  | 02.01  | - Baccara   |  |  |  |
|  | 2.0 (B56C/H/N)   | 83   | 11.93  | 04.95  | - ABS/ - Baccara  |  |  |  |
|  | 2.0 (L)  | 70   | 06.95  | 02.01  | - Baccara/Initiale  |  |  |  |
|  | 2.0 (U)  | 80   | 03.99  | 02.01  | - ABS   |  |  |  |
|  | 2.2 D (B56F/2)   | 61   | 11.93  | 02.01  | - ABS   |  |  |  |
|  | 1.8  | 69   | 08.94  | 04.95  | + ABS   | 24.3727-1033.2   | 581033   | L=1247   |
|  | 1.8 (B56A/B)   | 66   | 11.93  | 04.95  | + ABS   |  |  |  |
|  | 2.0 (B56C/H/N)   | 83   | 11.93  | 01.97  | + Baccara   |  |  |  |
|  | 2.0 (B56C/H/N)   | 83   | 11.93  | 04.95  | + ABS/ - Baccara  |  |  |  |
|  | 2.0 (L)  | 70   | 06.95  | 01.97  | + Initiale  |  |  |  |
|  | 2.0 16V (B56D/M)   | 102  | 05.95  | 01.97  | + ABS   |  |  |  |
|  | 2.0 16V (B56D/M)   | 102  | 05.95  | 02.01  | - ABS   |  |  |  |
|  | 2.2 D (B56F/2)   | 61   | 11.93  | 02.01  | + ABS   |  |  |  |
|  | 2.2 dT   | 83   | 03.96  | 01.97  | + ABS   |  |  |  |
|  | 2.2 dT   | 83   | 03.96  | 02.01  | - ABS   |  |  |  |
|  | 3.0 V6 (B56E/R,B565)   | 123  | 11.93  | 01.97  |   |  |  |  |
|  | 1.8 16V (B563,B564)  | 88   | 04.98  | 02.01  | + Initiale  | 24.3727-1053.2   | 581053   | L=1183   |
|  | 1.9 dCi  | 79   | 09.99  | 02.01  |   |  |  |  |
|  | 2.0 (B56C/H/N)   | 83   | 02.97  | 02.01  | + Baccara   |  |  |  |
|  | 2.0 (L)  | 70   | 02.97  | 02.01  | + Baccara/Initiale  |  |  |  |
|  | 2.0 16V (556A/B)   | 103  | 09.99  | 02.01  |   |  |  |  |
|  | 2.0 16V (B56D/M)   | 102  | 02.97  | 02.01  | + ABS   |  |  |  |
|  | 2.2 dT   | 83   | 02.97  | 02.01  | + ABS   |  |  |  |
|  | 3.0 V6   | 140  | 03.97  | 02.01  |   |  |  |  |
|  | 3.0 V6 (B56E/R,B565)   | 123  | 02.97  | 02.01  |   |  |  |  |
|  | 1.8  | 69   | 08.94  | 04.95  | + ABS   | 24.6583-1730.3   | 320178   | BRL (4) rot/schwarz  |
|  | 1.8 (B56A/B)   | 66   | 11.93  | 04.95  | + ABS   |  |  |  |
|  | 2.0 (B56C/H/N)   | 83   | 11.93  | 01.97  | + Baccara   |  |  |  |
|  | 2.0 (L)  | 70   | 06.95  | 01.97  | + Baccara/Initiale  |  |  |  |
|  | 2.2 D (B56F/2)   | 61   | 11.93  | 04.95  | + ABS   |  |  |  |
|  | 2.0 16V (B56D/M)   | 102  | 05.95  | 02.01  |   | 24.6583-1724.3   | 320257   | BRL (4)  |
|  | 3.0 V6 (B56E/R,B565)   | 123  | 11.93  | 02.01  |   |  |  |  |



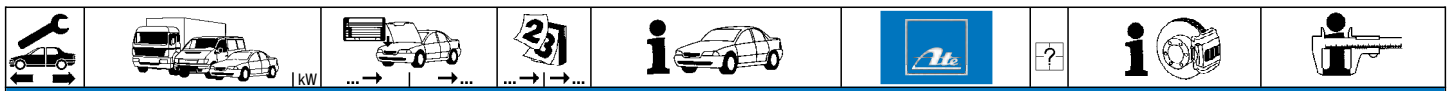

**RENAULT LAGUNA I Limousine (B56/556\_) (93-00)**

|                  |                      |       |       |       |                |        |  |  |        |                |        |  |               |
|------------------|----------------------|-------|-------|-------|----------------|--------|--|--|--------|----------------|--------|--|---------------|
|                  | 1.8                  | 69    | 04.95 | 02.01 | 24.3728-1022.2 | 591022 |  |  | L=1248 |                |        |  |               |
|                  | 1.8 (B56A/B)         | 66    | 11.93 | 02.01 |                |        |  |  |        |                |        |  |               |
|                  | 1.8 (B56S/T/O)       | 66    | 08.95 | 02.01 |                |        |  |  |        |                |        |  |               |
|                  | 2.0 (B56C/H/N)       | 83    | 11.93 | 02.01 |                |        |  |  |        |                |        |  |               |
|                  | 2.0 (L)              | 70    | 06.95 | 04.98 |                |        |  |  |        |                |        |  |               |
|                  | 3.0 V6 (B56E/R,B565) | 123   | 08.96 | 02.01 |                |        |  |  |        |                |        |  |               |
|                  | 1.6 16V              | 79    | 10.98 | 02.01 |                |        |  |  |        | 24.3728-1030.2 | 591030 |  | L=1125, + AUT |
|                  | 1.8 (B56S/T/O)       | 66    | 10.98 | 02.01 |                |        |  |  |        |                |        |  |               |
|                  | 1.8 16V (B563,B564)  | 88    | 10.98 | 02.01 |                |        |  |  |        |                |        |  |               |
|                  | 1.9 dTi              | 72    | 10.98 | 02.01 |                |        |  |  |        |                |        |  |               |
| 2.0 (L)          | 70                   | 10.98 | 02.01 |       |                |        |  |  |        |                |        |  |               |
| 2.0 16V (556A/B) | 103                  | 09.99 | 02.01 |       |                |        |  |  |        |                |        |  |               |

**RENAULT LAGUNA I Grandtour (K56\_) (95-00)**

|             |             |       |             |             |                |        |  |  |                           |                |        |  |  |                           |                |        |  |  |                             |
|-------------|-------------|-------|-------------|-------------|----------------|--------|--|--|---------------------------|----------------|--------|--|--|---------------------------|----------------|--------|--|--|-----------------------------|
|             | 1.6 16V     | 79    | 11.97       | 01.99       | 24.2123-1725.3 | 010549 |  |  | THz 23,81                 |                |        |  |  |                           |                |        |  |  |                             |
|             | 1.8 (O)     | 66    | 02.97       | 01.99 + ABS |                |        |  |  |                           |                |        |  |  |                           |                |        |  |  |                             |
|             | 1.8 (O)     | 66    | 06.95       | 02.01 - ABS |                |        |  |  |                           |                |        |  |  |                           |                |        |  |  |                             |
|             | 1.8 (S)     | 66    | 02.97       | 02.01 + ABS |                |        |  |  |                           |                |        |  |  |                           |                |        |  |  |                             |
|             | 1.8 (S)     | 66    | 06.95       | 02.01 - ABS |                |        |  |  |                           |                |        |  |  |                           |                |        |  |  |                             |
|             | 1.8 (T)     | 66    | 02.97       | 02.01 + ABS |                |        |  |  |                           |                |        |  |  |                           |                |        |  |  |                             |
|             | 1.8 (T)     | 66    | 07.95       | 02.01 - ABS |                |        |  |  |                           |                |        |  |  |                           |                |        |  |  |                             |
|             | 1.8 (Z)     | 69    | 02.97       | 02.01 + ABS |                |        |  |  |                           |                |        |  |  |                           |                |        |  |  |                             |
|             | 1.8 (Z)     | 69    | 07.95       | 02.01 - ABS |                |        |  |  |                           |                |        |  |  |                           |                |        |  |  |                             |
|             | 1.8 16V     | 88    | 04.98       | 01.99       |                |        |  |  |                           |                |        |  |  |                           |                |        |  |  |                             |
|             | 1.9 dTi     | 72    | 10.97       | 01.99       |                |        |  |  |                           |                |        |  |  |                           |                |        |  |  |                             |
|             | 2.0         | 84    | 10.98       | 02.01 - ABS |                |        |  |  |                           |                |        |  |  |                           |                |        |  |  |                             |
|             | 2.0 (C)     | 83    | 02.97       | 02.01 + ABS |                |        |  |  |                           |                |        |  |  |                           |                |        |  |  |                             |
|             | 2.0 (C)     | 83    | 06.95       | 02.01 - ABS |                |        |  |  |                           |                |        |  |  |                           |                |        |  |  |                             |
|             | 2.0 (H)     | 83    | 02.97       | 02.01 + ABS |                |        |  |  |                           |                |        |  |  |                           |                |        |  |  |                             |
|             | 2.0 (H)     | 83    | 06.95       | 02.01 - ABS |                |        |  |  |                           |                |        |  |  |                           |                |        |  |  |                             |
|             | 2.0 (L)     | 70    | 02.97       | 01.99 + ABS |                |        |  |  |                           |                |        |  |  |                           |                |        |  |  |                             |
|             | 2.0 (L)     | 70    | 11.95       | 02.01 - ABS |                |        |  |  |                           |                |        |  |  |                           |                |        |  |  |                             |
|             | 2.0 (N)     | 83    | 09.95       | 02.01       |                |        |  |  |                           |                |        |  |  |                           |                |        |  |  |                             |
|             | 2.0 16V (D) | 102   | 09.95       | 02.01 - ABS |                |        |  |  |                           |                |        |  |  |                           |                |        |  |  |                             |
|             | 2.0 16V (M) | 102   | 02.97       | 01.99       |                |        |  |  |                           |                |        |  |  |                           |                |        |  |  |                             |
|             | 2.0 16V (M) | 102   | 09.95       | 02.01 - ABS |                |        |  |  |                           |                |        |  |  |                           |                |        |  |  |                             |
|             | 2.2 D       |       | 02.97       | 02.01 + ABS |                |        |  |  |                           |                |        |  |  |                           |                |        |  |  |                             |
|             | 2.2 D       |       | 06.95       | 02.01 - ABS |                |        |  |  |                           |                |        |  |  |                           |                |        |  |  |                             |
|             | 2.2 dT      |       | 02.97       | 01.99 + ABS |                |        |  |  |                           |                |        |  |  |                           |                |        |  |  |                             |
|             | 2.2 dT      |       | 03.96       | 02.01 - ABS |                |        |  |  |                           |                |        |  |  |                           |                |        |  |  |                             |
|             | 3.0 V6      | 140   | 03.97       | 01.99       |                |        |  |  |                           |                |        |  |  |                           |                |        |  |  |                             |
|             | 3.0 V6 (5)  | 123   | 02.97       | 02.01       |                |        |  |  |                           |                |        |  |  |                           |                |        |  |  |                             |
|             | 1.6 16V     | 79    | 02.99       | 02.01       |                |        |  |  |                           | 24.2123-1701.3 | 010424 |  |  | THz 23,81                 |                |        |  |  |                             |
|             | 1.8 (O)     | 66    | 02.99       | 02.01 + ABS |                |        |  |  |                           |                |        |  |  |                           |                |        |  |  |                             |
|             | 1.8 16V     | 88    | 02.99       | 02.01       |                |        |  |  |                           |                |        |  |  |                           |                |        |  |  |                             |
|             | 1.9 dCi     | 79    | 09.99       | 02.01       |                |        |  |  |                           |                |        |  |  |                           |                |        |  |  |                             |
|             | 1.9 dTi     | 72    | 02.99       | 02.01       |                |        |  |  |                           |                |        |  |  |                           |                |        |  |  |                             |
|             | 2.0 (L)     | 70    | 02.99       | 02.01 + ABS |                |        |  |  |                           |                |        |  |  |                           |                |        |  |  |                             |
|             | 2.0 16V (A) | 102   | 09.99       | 02.01       |                |        |  |  |                           |                |        |  |  |                           |                |        |  |  |                             |
|             | 2.0 16V (B) | 102   | 09.99       | 02.01       |                |        |  |  |                           |                |        |  |  |                           |                |        |  |  |                             |
|             | 2.0 16V (M) | 102   | 02.99       | 02.01 + ABS |                |        |  |  |                           |                |        |  |  |                           |                |        |  |  |                             |
|             | 2.2 dT      |       | 02.99       | 02.01 + ABS |                |        |  |  |                           |                |        |  |  |                           |                |        |  |  |                             |
|             | 3.0 V6      | 140   | 02.99       | 02.01       |                |        |  |  |                           |                |        |  |  |                           |                |        |  |  |                             |
|             | 1.8 (O)     | 66    | 06.95       | 01.97 + ABS |                |        |  |  |                           |                |        |  |  |                           | 10.6123-0312.3 | 010457 |  |  | THz 23,81 (MKIV) <b>ATE</b> |
|             | 1.8 (S)     | 66    | 06.95       | 01.97 + ABS |                |        |  |  |                           |                |        |  |  |                           |                |        |  |  |                             |
|             | 1.8 (T)     | 66    | 07.95       | 01.97 + ABS |                |        |  |  |                           |                |        |  |  |                           |                |        |  |  |                             |
|             | 1.8 (Z)     | 69    | 07.95       | 01.97 + ABS |                |        |  |  |                           |                |        |  |  |                           |                |        |  |  |                             |
|             | 2.0         | 84    | 10.98       | 02.01 + ABS |                |        |  |  |                           |                |        |  |  |                           |                |        |  |  |                             |
|             | 2.0 (C)     | 83    | 06.95       | 01.97 + ABS |                |        |  |  |                           |                |        |  |  |                           |                |        |  |  |                             |
| 2.0 (H)     | 83          | 06.95 | 01.97 + ABS |             |                |        |  |  |                           |                |        |  |  |                           |                |        |  |  |                             |
| 2.0 (L)     | 70          | 11.95 | 01.97 + ABS |             |                |        |  |  |                           |                |        |  |  |                           |                |        |  |  |                             |
| 2.0 (N)     | 83          | 09.95 | 02.01 + ABS |             |                |        |  |  |                           |                |        |  |  |                           |                |        |  |  |                             |
| 2.0 16V (D) | 102         | 09.95 | 02.01 + ABS |             |                |        |  |  |                           |                |        |  |  |                           |                |        |  |  |                             |
| 2.0 16V (M) | 102         | 09.95 | 01.97 + ABS |             |                |        |  |  |                           |                |        |  |  |                           |                |        |  |  |                             |
| 2.2 D       |             | 06.95 | 01.97 + ABS |             |                |        |  |  |                           |                |        |  |  |                           |                |        |  |  |                             |
| 2.2 dT      |             | 03.96 | 01.97 + ABS |             |                |        |  |  |                           |                |        |  |  |                           |                |        |  |  |                             |
| 3.0 V6 (5)  | 123         | 03.96 | 01.97 + ABS |             |                |        |  |  |                           |                |        |  |  |                           |                |        |  |  |                             |
| 3.0 V6 (R)  | 123         | 02.96 | 02.01 + ABS |             |                |        |  |  |                           |                |        |  |  |                           |                |        |  |  |                             |
|             | 1.8 (O)     | 66    | 06.95       | 04.98       | 24.3541-1741.5 | 240215 |  |  | D=54, - Halter <b>LUC</b> |                |        |  |  |                           |                |        |  |  |                             |
|             | 1.8 (S)     | 66    | 06.95       | 02.01       |                |        |  |  |                           |                |        |  |  |                           |                |        |  |  |                             |
|             | 1.8 (T)     | 66    | 07.95       | 02.01       |                |        |  |  |                           |                |        |  |  |                           |                |        |  |  |                             |
|             | 1.8 (Z)     | 69    | 07.95       | 02.01       |                |        |  |  |                           |                |        |  |  |                           |                |        |  |  |                             |
|             | 2.0         | 84    | 10.98       | 02.01       |                |        |  |  |                           |                |        |  |  |                           |                |        |  |  |                             |
|             | 2.0 (C)     | 83    | 06.95       | 02.01       |                |        |  |  |                           |                |        |  |  |                           |                |        |  |  |                             |
|             | 2.0 (H)     | 83    | 06.95       | 02.01       |                |        |  |  |                           |                |        |  |  |                           |                |        |  |  |                             |
|             | 2.0 (L)     | 70    | 11.95       | 04.98       |                |        |  |  |                           |                |        |  |  |                           |                |        |  |  |                             |
|             | 2.0 (N)     | 83    | 09.95       | 02.01       |                |        |  |  |                           |                |        |  |  |                           |                |        |  |  |                             |
|             | 2.2 D       |       | 06.95       | 02.01       |                |        |  |  |                           |                |        |  |  |                           |                |        |  |  |                             |
|             | 1.6 16V     | 79    | 11.97       | 02.01       |                |        |  |  |                           | 24.3541-1749.5 | 240427 |  |  | D=54, - Halter <b>LUC</b> |                |        |  |  |                             |
|             | 1.8 (O)     | 66    | 05.98       | 02.01       |                |        |  |  |                           |                |        |  |  |                           |                |        |  |  |                             |
|             | 1.8 16V (3) | 88    | 02.99       | 02.01       |                |        |  |  |                           |                |        |  |  |                           |                |        |  |  |                             |
|             | 1.8 16V (4) | 88    | 04.98       | 02.01       |                |        |  |  |                           |                |        |  |  |                           |                |        |  |  |                             |
|             | 1.8 16V (Y) | 88    | 05.99       | 02.01       |                |        |  |  |                           |                |        |  |  |                           |                |        |  |  |                             |
| 1.9 dCi     | 79          | 09.99 | 02.01       |             |                |        |  |  |                           |                |        |  |  |                           |                |        |  |  |                             |
| 1.9 dTi     | 72          | 10.97 | 02.01       |             |                |        |  |  |                           |                |        |  |  |                           |                |        |  |  |                             |
| 2.0 (L)     | 70          | 05.98 | 02.01       |             |                |        |  |  |                           |                |        |  |  |                           |                |        |  |  |                             |
|             |             |       |             |             |                |        |  |  |                           |                |        |  |  |                           |                |        |  |  |                             |



| RENAULT LAGUNA I Grandtour (K56_) (95-00) |              |     |       |       |                |        |   |                |     |
|---|--------------|-----|-------|-------|----------------|--------|---|----------------|-----|
|   | 2.0 16V (A)  | 102 | 09.99 | 02.01 | 24.3601-1707.5 | 240229 |   | D=60, - Halter | LUC |
|   | 2.0 16V (B)  | 102 | 09.99 | 02.01 | 24.3601-1708.5 | 240230 |   | D=60, - Halter | LUC |
|   | 2.0 16V (D)  | 102 | 09.95 | 02.01 |                |        |   |                |     |
|   | 2.0 16V (M)  | 102 | 09.95 | 02.01 |                |        |   |                |     |
|   | 2.2 dT       |     | 03.96 | 02.01 |                |        |   |                |     |
|   | 3.0 V6       | 123 | 02.96 | 02.01 |                |        |   |                |     |
|   | 3.0 V6       | 140 | 03.97 | 02.01 |                |        |   |                |     |
|   | 1.6 16V      | 79  | 11.97 | 02.01 | 24.5111-0445.3 | 330504 | 2 | L=445          |     |
|   | 1.8 (O)      | 66  | 06.95 | 02.01 |                |        |   |                |     |
|   | 1.8 (S)      | 66  | 06.95 | 02.01 |                |        |   |                |     |
|   | 1.8 (T)      | 66  | 07.95 | 02.01 |                |        |   |                |     |
|   | 1.8 (Z)      | 69  | 07.95 | 02.01 |                |        |   |                |     |
|   | 1.8 16V      | 88  | 04.98 | 02.01 |                |        |   |                |     |
|   | 1.9 dCi      | 79  | 09.99 | 02.01 |                |        |   |                |     |
|   | 1.9 dTi      | 72  | 10.97 | 02.01 |                |        |   |                |     |
|   | 2.0          | 83  | 06.95 | 02.01 |                |        |   |                |     |
|   | 2.0          | 84  | 10.98 | 02.01 |                |        |   |                |     |
|   | 2.0 16V      | 102 | 09.95 | 02.01 |                |        |   |                |     |
|   | 2.2 D        |     | 06.95 | 02.01 |                |        |   |                |     |
|   | 2.2 dT       |     | 03.96 | 02.01 |                |        |   |                |     |
|   | 3.0 V6       | 123 | 02.96 | 02.01 |                |        |   |                |     |
|   | 3.0 V6       | 140 | 03.97 | 02.01 |                |        |   |                |     |
|   | 1.6 16V      | 79  | 11.97 | 02.01 | 24.5229-0285.3 | 330032 | 2 | L=285          |     |
|   | 1.8 (O)      | 66  | 06.95 | 02.01 |                |        |   |                |     |
|   | 1.8 (S)      | 66  | 06.95 | 02.01 |                |        |   |                |     |
|   | 1.8 (T)      | 66  | 07.95 | 02.01 |                |        |   |                |     |
|   | 1.8 (Z)      | 69  | 07.95 | 02.01 |                |        |   |                |     |
|   | 2.0          | 83  | 06.95 | 02.01 |                |        |   |                |     |
|   | 2.0          | 84  | 10.98 | 02.01 |                |        |   |                |     |
|   | 2.0 16V      | 102 | 09.95 | 02.01 |                |        |   |                |     |
|   | 2.2 D        |     | 06.95 | 02.01 |                |        |   |                |     |
|   | 2.2 dT       |     | 03.96 | 02.01 |                |        |   |                |     |
|   | 3.0 V6       | 123 | 02.96 | 02.01 |                |        |   |                |     |
|   | 3.0 V6       | 140 | 03.97 | 02.01 |                |        |   |                |     |
|   | 1.8 (O)      | 66  | 06.95 | 02.01 | 24.5111-0150.3 | 330497 | 2 | L=150          |     |
|   | 1.8 (S)      | 66  | 06.95 | 02.01 |                |        |   |                |     |
|   | 1.8 (T)      | 66  | 07.95 | 02.01 |                |        |   |                |     |
|   | 1.8 (Z)      | 69  | 07.95 | 02.01 |                |        |   |                |     |
|   | 2.0          | 83  | 06.95 | 02.01 |                |        |   |                |     |
|   | 2.0          | 84  | 10.98 | 02.01 |                |        |   |                |     |
|   | 2.0 16V (D)  | 102 | 09.95 | 02.01 |                |        |   |                |     |
|   | 2.0 16V (M)  | 102 | 09.95 | 02.99 |                |        |   |                |     |
|   | 2.2 D        |     | 06.95 | 02.01 |                |        |   |                |     |
|   | 2.2 dT       |     | 03.96 | 02.99 |                |        |   |                |     |
|   | 3.0 V6       | 123 | 02.96 | 02.01 |                |        |   |                |     |
|   | 3.0 V6       | 140 | 03.97 | 02.99 |                |        |   |                |     |
|   | 1.8 (O)      | 66  | 06.96 | 04.98 | 24.3220-1711.3 | 020409 |   | Rz 20,64       | LUC |
|   | 1.8 (O)      | 66  | 06.95 | 05.96 |                |        |   |                |     |
|   | 1.8 (S)      | 66  | 06.96 | 02.01 |                |        |   |                |     |
|   | 1.8 (S)      | 66  | 06.95 | 05.96 |                |        |   |                |     |
|   | 1.8 (T)      | 66  | 06.96 | 02.01 |                |        |   |                |     |
|   | 1.8 (T)      | 66  | 07.95 | 05.96 |                |        |   |                |     |
|   | 1.8 (Z)      | 69  | 06.96 | 02.01 |                |        |   |                |     |
|   | 1.8 (Z)      | 69  | 07.95 | 05.96 |                |        |   |                |     |
|   | 2.0 (C)      | 83  | 06.96 | 02.01 |                |        |   |                |     |
|   | 2.0 (C)      | 83  | 06.95 | 05.96 |                |        |   |                |     |
|   | 2.0 (H)      | 83  | 06.96 | 02.01 |                |        |   |                |     |
|   | 2.0 (H)      | 83  | 06.95 | 05.96 |                |        |   |                |     |
|   | 2.0 (L)      | 70  | 06.96 | 04.98 |                |        |   |                |     |
|   | 2.0 (L)      | 70  | 11.95 | 05.96 |                |        |   |                |     |
|   | 2.0 (N)      | 83  | 09.95 | 02.01 |                |        |   |                |     |
|   | 2.2 D        |     | 06.96 | 02.01 |                |        |   |                |     |
|   | 2.2 D        |     | 06.95 | 05.96 |                |        |   |                |     |
|   | 1.6 16V      | 79  | 11.97 | 02.01 | 24.3222-1713.3 | 020431 |   | Rz 22,20       | LUC |
|   | 1.8 (O)      | 66  | 05.98 | 02.01 |                |        |   |                |     |
|   | 1.8 16V (4)  | 88  | 04.98 | 02.01 |                |        |   |                |     |
|   | 1.9 dTi (KJ) | 72  | 10.97 | 02.01 |                |        |   |                |     |
|   | 1.9 dTi (SJ) | 72  | 10.97 | 02.01 |                |        |   |                |     |
|   | 2.0          | 84  | 10.98 | 01.01 |                |        |   |                |     |
|   | 2.0 (L)      | 70  | 05.98 | 02.01 |                |        |   |                |     |
|   | 1.6 16V      | 79  | 11.97 | 02.01 | 24.3727-1040.2 | 581040 | 2 | L=1190         |     |
|   | 1.8 (O)      | 66  | 06.96 | 02.01 |                |        |   |                |     |
|   | 1.8 (O)      | 66  | 06.95 | 05.96 |                |        |   |                |     |
|   | 1.8 (S)      | 66  | 06.96 | 02.01 |                |        |   |                |     |
|   | 1.8 (S)      | 66  | 06.95 | 05.96 |                |        |   |                |     |
|   | 1.8 (T)      | 66  | 06.96 | 02.01 |                |        |   |                |     |
|   | 1.8 (T)      | 66  | 07.95 | 05.96 |                |        |   |                |     |
|   | 1.8 (Z)      | 69  | 06.96 | 02.01 |                |        |   |                |     |
|   | 1.8 (Z)      | 69  | 07.95 | 05.96 |                |        |   |                |     |
|   | 1.8 16V      | 88  | 04.98 | 02.01 |                |        |   |                |     |
|   | 1.9 dTi      | 72  | 10.97 | 02.01 |                |        |   |                |     |
|   | 2.0          | 84  | 10.98 | 02.01 |                |        |   |                |     |
|   | 2.0 (C)      | 83  | 06.96 | 02.01 |                |        |   |                |     |
|   | 2.0 (C)      | 83  | 06.95 | 05.96 |                |        |   |                |     |

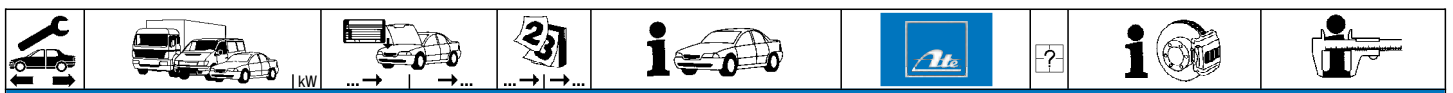

**RENAULT LAGUNA I Grandtour (K56\_) (95-00)**

|              |             |       |             |  |                |        |        |         |                |        |  |               |
|--------------|-------------|-------|-------------|--|----------------|--------|--------|---------|----------------|--------|--|---------------|
|              | 2.0 (H)     | 83    | 06.96       | 02.01  | 24.3727-1040.2 | 581040 | 2 ↓    | L=1190  |                |        |  |               |
|              | 2.0 (H)     | 83    | 06.95       | 05.96 - ABS                                    |                |        |        |         |                |        |  |               |
|              | 2.0 (L)     | 70    | 11.95       | 05.96 - ABS                                    |                |        |        |         |                |        |  |               |
|              | 2.0 (N)     | 83    | 09.95       | 02.01  |                |        |        |         |                |        |  |               |
|              | 2.2 D       |       | 06.96       | 02.01  |                |        |        |         |                |        |  |               |
|              | 2.2 D       |       | 06.95       | 05.96 - ABS                                    |                |        |        |         |                |        |  |               |
|              | 1.8 (0)     | 66    | 06.95       | 05.96 + ABS                                    | 24.3727-1033.2 | 581033 | 2 ↓    | L=1247  |                |        |  |               |
|              | 1.8 (S)     | 66    | 06.95       | 05.96 + ABS                                    |                |        |        |         |                |        |  |               |
|              | 1.8 (T)     | 66    | 07.95       | 05.96 + ABS                                    |                |        |        |         |                |        |  |               |
|              | 1.8 (Z)     | 69    | 07.95       | 05.96 + ABS                                    |                |        |        |         |                |        |  |               |
|              | 2.0         | 84    | 10.98       | 02.01 + ABS                                    |                |        |        |         |                |        |  |               |
|              | 2.0 (C)     | 83    | 06.95       | 05.96 + ABS                                    |                |        |        |         |                |        |  |               |
|              | 2.0 (H)     | 83    | 06.95       | 05.96 + ABS                                    |                |        |        |         |                |        |  |               |
|              | 2.0 (L)     | 70    | 11.95       | 05.96 + ABS                                    |                |        |        |         |                |        |  |               |
| 2.0 16V (D)  | 102         | 09.95 | 02.01       |  |                |        |        |         |                |        |  |               |
| 2.0 16V (M)  | 102         | 09.95 | 01.97       |  |                |        |        |         |                |        |  |               |
| 2.2 D        |             | 06.95 | 05.96 + ABS |  |                |        |        |         |                |        |  |               |
| 2.2 dT       |             | 03.96 | 01.97       |  |                |        |        |         |                |        |  |               |
| 3.0 V6 (5)   | 123         | 03.96 | 01.97       |  |                |        |        |         |                |        |  |               |
| 3.0 V6 (R)   | 123         | 02.96 | 02.01       |  |                |        |        |         |                |        |  |               |
| 1.9 dCi      | 79          | 09.99 | 02.01       | 24.3727-1053.2                                 | 581053         | 2 ↓    | L=1183 |         |                |        |  |               |
| 2.0 16V (A)  | 102         | 09.99 | 02.01       |  |                |        |        |         |                |        |  |               |
| 2.0 16V (B)  | 102         | 09.99 | 02.01       |  |                |        |        |         |                |        |  |               |
| 2.0 16V (M)  | 102         | 02.97 | 02.01       |  |                |        |        |         |                |        |  |               |
| 2.2 dT       |             | 02.97 | 02.01       |  |                |        |        |         |                |        |  |               |
| 3.0 V6       | 140         | 03.97 | 02.01       |  |                |        |        |         |                |        |  |               |
| 3.0 V6 (5)   | 123         | 02.97 | 02.01       |  |                |        |        |         |                |        |  |               |
|              | 1.8 (0)     | 66    | 06.95       | 05.96 + ABS/ - Niveauregulierung <sup>1)</sup> | 24.6583-1740.3 | 320264 |        | BRL (4) |                |        |  |               |
|              | 1.8 (S)     | 66    | 06.95       | 05.96 + ABS/ - Niveauregulierung <sup>1)</sup> |                |        |        |         |                |        |  |               |
|              | 1.8 (T)     | 66    | 07.95       | 05.96 + ABS/ - Niveauregulierung <sup>1)</sup> |                |        |        |         |                |        |  |               |
|              | 1.8 (Z)     | 69    | 07.95       | 05.96 + ABS/ - Niveauregulierung <sup>1)</sup> |                |        |        |         |                |        |  |               |
|              | 2.0         | 83    | 06.95       | 05.96 + ABS/ - Niveauregulierung <sup>1)</sup> |                |        |        |         |                |        |  |               |
|              | 2.0         | 84    | 10.98       | 02.01 + ABS/ - Niveauregulierung <sup>1)</sup> |                |        |        |         |                |        |  |               |
|              | 2.0 16V (D) | 102   | 09.95       | 02.01 - Niveauregulierung <sup>2)</sup>        |                |        |        |         |                |        |  |               |
|              | 2.0 16V (M) | 102   | 09.95       | 01.97 + ABS/ - Niveauregulierung <sup>1)</sup> |                |        |        |         |                |        |  |               |
|              | 2.0 16V (M) | 102   | 09.95       | 02.01 - ABS/ - Niveauregulierung <sup>3)</sup> |                |        |        |         |                |        |  |               |
|              | 3.0 V6 (5)  | 123   | 03.96       | 01.97 - Niveauregulierung <sup>2)</sup>        |                |        |        |         |                |        |  |               |
|              | 3.0 V6 (R)  | 123   | 02.96       | 02.01 - Niveauregulierung <sup>2)</sup>        |                |        |        |         |                |        |  |               |
|              | 1.8 (0)     | 66    | 06.95       | 04.98  | 24.3728-1022.2 | 591022 |        | L=1248  |                |        |  |               |
|              | 1.8 (S)     | 66    | 06.95       | 02.01  |                |        |        |         |                |        |  |               |
|              | 1.8 (T)     | 66    | 06.95       | 02.01  |                |        |        |         |                |        |  |               |
|              | 1.8 (Z)     | 69    | 07.95       | 02.01  |                |        |        |         |                |        |  |               |
|              | 2.0         | 84    | 10.98       | 02.01  |                |        |        |         |                |        |  |               |
|              | 2.0 (C)     | 83    | 06.95       | 02.01  |                |        |        |         |                |        |  |               |
|              | 2.0 (H)     | 83    | 06.95       | 02.01  |                |        |        |         |                |        |  |               |
|              | 2.0 (L)     | 70    | 11.95       | 04.98  |                |        |        |         |                |        |  |               |
|              | 2.0 (N)     | 83    | 09.95       | 02.01  |                |        |        |         |                |        |  |               |
|              | 1.6 16V     | 79    | 09.98       | 02.01  |                |        |        |         | 24.3728-1030.2 | 591030 |  | L=1125, + AUT |
|              | 1.8 (0)     | 66    | 09.98       | 02.01  |                |        |        |         |                |        |  |               |
| 1.8 16V      | 88          | 09.98 | 02.01       |  |                |        |        |         |                |        |  |               |
| 1.9 dTi (KJ) | 72          | 09.98 | 02.01       |  |                |        |        |         |                |        |  |               |
| 1.9 dTi (SJ) | 72          | 09.98 | 02.01       |  |                |        |        |         |                |        |  |               |
| 2.0 (L)      | 70          | 09.98 | 02.01       |  |                |        |        |         |                |        |  |               |
| 2.0 16V (A)  | 102         | 09.99 | 02.01       |  |                |        |        |         |                |        |  |               |
| 2.0 16V (B)  | 102         | 09.99 | 02.01       |  |                |        |        |         |                |        |  |               |





**RENAULT LAGUNA II Limousine (BG\_) (01-07)**

|                     |                     |       |       |       |                |        |  |     |     |                |        |  |     |     |
|---------------------|---------------------|-------|-------|-------|----------------|--------|--|-----|-----|----------------|--------|--|-----|-----|
|                     | 1.6 16V             | 79    | 03.01 | 05.01 | 03.7873-0202.4 | 300152 |  | 11" | ATE |                |        |  |     |     |
|                     | 1.8 16V (04/06/0V)  | 89    | 03.01 | 05.01 |                |        |  |     |     |                |        |  |     |     |
|                     | 1.8 16V (0B/0C/0M)  | 88    | 03.01 | 05.01 |                |        |  |     |     |                |        |  |     |     |
|                     | 1.8 16V (0J)        | 85    | 03.01 | 05.01 |                |        |  |     |     |                |        |  |     |     |
|                     | 1.9 dCi (08/10)     | 68    | 03.01 | 05.01 |                |        |  |     |     |                |        |  |     |     |
|                     | 1.9 dCi (0G)        | 88    | 03.01 | 05.01 |                |        |  |     |     |                |        |  |     |     |
|                     | 2.0 16V (00/0K/0W)  | 99    | 04.01 | 05.01 |                |        |  |     |     |                |        |  |     |     |
|                     | 2.0 16V IDE (0N/0P) | 103   | 04.01 | 05.01 |                |        |  |     |     |                |        |  |     |     |
|                     | 2.2 dCi             | 110   | 03.01 | 05.01 |                |        |  |     |     |                |        |  |     |     |
|                     | 3.0 V6              | 152   | 03.01 | 05.01 |                |        |  |     |     |                |        |  |     |     |
|                     | 1.6 16V             | 79    | 06.01 | 06.07 |                |        |  |     |     | 03.7873-1202.4 | 300197 |  | 11" | ATE |
|                     | 1.6 16V             | 82    | 02.05 | 06.07 |                |        |  |     |     |                |        |  |     |     |
|                     | 1.8 16V (04/06/0V)  | 89    | 06.01 | 06.07 |                |        |  |     |     |                |        |  |     |     |
| 1.8 16V (0B/0C/0M)  | 88                  | 06.01 | 06.07 |       |                |        |  |     |     |                |        |  |     |     |
| 1.8 16V (0J)        | 85                  | 06.01 | 06.07 |       |                |        |  |     |     |                |        |  |     |     |
| 1.9 dCi             | 79                  | 03.01 | 06.07 |       |                |        |  |     |     |                |        |  |     |     |
| 1.9 dCi             | 81                  | 01.05 | 06.07 |       |                |        |  |     |     |                |        |  |     |     |
| 1.9 dCi             | 96                  | 05.05 | 06.07 |       |                |        |  |     |     |                |        |  |     |     |
| 1.9 dCi (08/10)     | 68                  | 03.04 | 06.07 |       |                |        |  |     |     |                |        |  |     |     |
| 1.9 dCi (0E)        | 77                  | 06.01 | 06.07 |       |                |        |  |     |     |                |        |  |     |     |
| 1.9 dCi (0G)        | 88                  | 06.01 | 06.07 |       |                |        |  |     |     |                |        |  |     |     |
| 1.9 dCi (0R)        | 74                  | 10.01 | 06.07 |       |                |        |  |     |     |                |        |  |     |     |
| 2.0 16V             | 125                 | 01.05 | 06.07 |       |                |        |  |     |     |                |        |  |     |     |
| 2.0 16V (00/0K/0W)  | 99                  | 08.02 | 06.07 |       |                |        |  |     |     |                |        |  |     |     |
| 2.0 16V IDE (0N/0P) | 103                 | 06.01 | 06.07 |       |                |        |  |     |     |                |        |  |     |     |
| 2.0 16V Sport       | 150                 | 01.05 | 06.07 |       |                |        |  |     |     |                |        |  |     |     |
| 2.0 16V Turbo       | 120                 | 01.03 | 06.07 |       |                |        |  |     |     |                |        |  |     |     |
| 2.0 dCi             | 110                 | 08.05 | 06.07 |       |                |        |  |     |     |                |        |  |     |     |
| 2.0 dCi 130         | 127                 | 01.06 | 06.07 |       |                |        |  |     |     |                |        |  |     |     |
| 2.2 dCi             | 102                 | 05.05 | 06.07 |       |                |        |  |     |     |                |        |  |     |     |

<sup>1)</sup> + ABS/ - suspens.level control / + ABS/ - correttore assetto / + ABS/ - correcteur d'assiette / + ABS/ - regul.alt. suspensión

<sup>2)</sup> - suspension level control / - correttore assetto / - correcteur d'assiette / - regulación altura suspensión

<sup>3)</sup> - ABS/ - suspens.level control / - ABS/ - correttore assetto / - ABS/ - correcteur d'assiette / - ABS/ - regul.alt. suspensión

| RENAULT LAGUNA II Limousine (BG_) (01-07)  |  |   |  |   |  |  |  |  |  |   |
|--|--|---|--|---|--|--|--|--|--|---|
|     | 2.2 dCi<br>3.0 V6  | #110<br>#152  |  | 10.01<br>06.01  | 06.07<br>06.07   | 03.7873-1202.4   | 300197   |  | 11"  | ATE   |
|    | 1.6 16V<br>1.8 16V (04/06/0V)<br>1.8 16V (0B/0C/0M)<br>1.8 16V (0J)<br>1.9 dCi<br>1.9 dCi<br>1.9 dCi (08/10)<br>1.9 dCi (0E)<br>1.9 dCi (0G)<br>1.9 dCi (0R)<br>2.0 16V<br>2.0 16V (00/0K/0W)<br>2.0 16V IDE (0N/0P)<br>2.0 16V Sport<br>2.2 dCi<br>3.0 V6   | 79<br>89<br>88<br>85<br>79<br>81<br>68<br>77<br>88<br>74<br>125<br>99<br>103<br>150<br>110<br>152   |  | 03.01<br>03.01<br>03.01<br>03.01<br>03.01<br>01.05<br>03.04<br>06.01<br>03.01<br>10.01<br>01.05<br>08.02<br>04.01<br>01.05<br>10.01<br>03.01  | 06.07<br>03.05<br>03.05<br>03.05<br>03.05<br>03.05<br>03.05<br>03.05<br>03.05<br>03.05<br>03.05<br>03.05<br>03.05<br>03.05<br>03.05<br>03.05   | 03.4123-0081.3<br>03.3517-0300.1   | 010585<br>390323   | - ESP  | THz 23,81<br>Verschlusschraube   | ATE   |
|  | 1.6 16V<br>1.6 16V<br>1.8 16V (04/06/0V)<br>1.8 16V (0B/0C/0M)<br>1.8 16V (0J)<br>1.9 dCi<br>1.9 dCi<br>1.9 dCi<br>1.9 dCi (08/10)<br>1.9 dCi (0E)<br>1.9 dCi (0G)<br>1.9 dCi (0R)<br>2.0 16V<br>2.0 16V (00/0K/0W)<br>2.0 16V IDE (0N/0P)<br>2.0 16V Sport<br>2.0 16V Turbo<br>2.0 dCi<br>2.0 dCi 130<br>2.2 dCi<br>2.2 dCi<br>3.0 V6 | 79<br>82<br>89<br>88<br>85<br>79<br>81<br>96<br>68<br>77<br>88<br>74<br>125<br>99<br>103<br>150<br>120<br>110<br>127<br>102<br>110<br>152 |  | 04.05<br>02.05<br>04.05<br>04.05<br>04.05<br>04.05<br>04.05<br>04.05<br>04.05<br>04.05<br>04.05<br>04.05<br>04.05<br>04.05<br>04.05<br>01.03<br>08.05<br>01.06<br>05.05<br>04.05<br>04.05 | 06.07<br>06.07<br>06.07<br>06.07<br>06.07<br>06.07<br>06.07<br>06.07<br>06.07<br>06.07<br>06.07<br>06.07<br>06.07<br>06.07<br>06.07<br>06.07<br>06.07<br>06.07<br>06.07<br>06.07<br>06.07<br>06.07 | 03.4153-0063.3   | 010773   |  | THz 23,81  | ATE   |
|  | 1.6 16V<br>1.6 16V<br>1.8 16V (04/06/0V)<br>1.8 16V (0B/0C/0M)<br>1.8 16V (0J)<br>1.9 dCi<br>1.9 dCi<br>1.9 dCi (08/10)<br>1.9 dCi (0E)<br>1.9 dCi (0G)<br>1.9 dCi (0R)<br>2.0 16V (00/0K/0W)<br>2.0 16V IDE (0N/0P)<br>2.2 dCi<br>2.2 dCi<br>2.2 dCi  | 79<br>82<br>89<br>88<br>85<br>79<br>81<br>96<br>68<br>77<br>88<br>74<br>103<br>102<br>110<br>110  |  | 03.01<br>02.05<br>03.01<br>03.01<br>03.01<br>03.01<br>01.05<br>05.05<br>03.04<br>06.01<br>03.01<br>10.01<br>08.02<br>04.01<br>05.05<br>05.05<br>10.01                                     | 06.07<br>06.07<br>06.07<br>06.07<br>06.07<br>06.07<br>06.07<br>06.07<br>06.07<br>06.07<br>06.07<br>06.07<br>06.07<br>06.07<br>06.07<br>06.07<br>06.07<br>06.07                                     | 11.9571-9861.2<br>11.9571-9862.2<br>11.9571-9841.2<br>11.9571-9842.2<br>11.8116-0301.1<br>24.3571-9841.5<br>24.3571-9842.5<br>11.0101-5407.2<br>11.8171-0008.1 | 220403<br>220404<br>220401<br>220402<br>390610<br>240501<br>240502<br>260011<br>990049 | <ul style="list-style-type: none"> <li>☐ + 16" Rad/ + Stahlfelgen <sup>1)</sup></li> <li>☐ + 16" Rad/ + Stahlfelgen <sup>1)</sup></li> <li>☐ + 16"/17"Rad/ + Leichtmetallfelgen</li> <li>☐ + 16"/17"Rad/ + Leichtmetallfelgen</li> <li>☐ + 16"/17"Rad/ + Leichtmetallfelgen</li> <li>☐ + 16"/17"Rad/ + Leichtmetallfelgen</li> <li>☐ + 16"/17"Rad/ + Leichtmetallfelgen</li> </ul> | D=57, - Halter<br>D=57, - Halter<br>D=57, - Halter<br>D=57, - Halter<br>Haltefeder<br>D=57, - Halter<br>D=57, - Halter<br>Hülzensatz<br>Führungsbolzen | ATE<br>ATE<br>ATE<br>ATE<br>ATE<br>ATE<br>ATE<br>ATE<br>ATE |
|  | 2.2 dCi<br>2.2 dCi<br>2.2 dCi  | 102<br>110<br>110   |  | 05.05<br>05.05<br>10.01   | 06.07<br>06.07<br>11.01  | 11.9571-9841.2<br>11.9571-9842.2<br>24.3571-9841.5<br>24.3571-9842.5<br>11.0101-5407.2<br>11.8171-0008.1<br>11.8116-0301.1                                     | 220401<br>220402<br>240501<br>240502<br>260011<br>990049<br>390610                     | <ul style="list-style-type: none"> <li>☐</li> <li>☐</li> <li>☐</li> <li>☐</li> </ul>   | D=57, - Halter<br>D=57, - Halter<br>D=57, - Halter<br>D=57, - Halter<br>Hülzensatz<br>Führungsbolzen<br>Haltefeder                                     | ATE<br>ATE<br>ATE<br>ATE<br>ATE<br>ATE<br>ATE               |
|  | 2.0 16V<br>2.0 16V Sport<br>2.0 16V Turbo<br>2.0 dCi<br>2.0 dCi 130<br>2.2 dCi<br>3.0 V6   | 125<br>150<br>120<br>110<br>127<br>110<br>152   |  | 01.05<br>01.05<br>01.03<br>08.05<br>01.06<br>12.01<br>03.01   | 06.07<br>06.07<br>06.07<br>06.07<br>06.07<br>04.05<br>06.07  | 11.9601-9787.2<br>11.9601-9788.2<br>24.3601-9787.5<br>24.3601-9788.5<br>11.0441-6008.2<br>11.0101-5407.2<br>11.8171-0008.1<br>11.8116-0301.1                   | 220585<br>220586<br>240505<br>240506<br>250038<br>260011<br>990049<br>390610           | <ul style="list-style-type: none"> <li>☐</li> <li>☐</li> <li>☐</li> <li>☐</li> </ul>   | D=60, - Halter<br>D=60, - Halter<br>D=60, - Halter<br>D=60, - Halter<br>Dichtungssatz<br>Hülzensatz<br>Führungsbolzen<br>Haltefeder                    | ATE<br>ATE<br>ATE<br>ATE<br>ATE<br>ATE<br>ATE<br>ATE        |
|  | 1.6 16V<br>1.6 16V<br>1.8 16V (04/06/0V)<br>1.8 16V (0B/0C/0M)<br>1.8 16V (0J)<br>1.9 dCi<br>1.9 dCi<br>1.9 dCi<br>1.9 dCi (08/10)<br>1.9 dCi (0E)<br>1.9 dCi (0G)<br>1.9 dCi (0R)<br>2.0 16V<br>2.0 16V (00/0K/0W)<br>2.0 16V IDE (0N/0P)<br>2.0 16V Sport<br>2.0 16V Turbo   | 79<br>82<br>89<br>88<br>85<br>79<br>81<br>96<br>68<br>77<br>88<br>74<br>125<br>99<br>103<br>150<br>120                                    |  | 03.01<br>02.05<br>03.01<br>03.01<br>03.01<br>03.01<br>01.05<br>05.05<br>03.04<br>06.01<br>03.01<br>10.01<br>01.05<br>08.02<br>04.01<br>01.05<br>01.03                                     | 06.07<br>06.07<br>06.07<br>06.07<br>06.07<br>06.07<br>06.07<br>06.07<br>06.07<br>06.07<br>06.07<br>06.07<br>06.07<br>06.07<br>06.07<br>06.07<br>06.07  | 24.5252-0390.3   | 330702   | 2  | L=390  |   |

<sup>1)</sup> + 16" wheel, + steel rims / + ruota 16", + cerchione i.acc. / + roue 16", + jante en acier / + rueda 16", + Llanta da acero



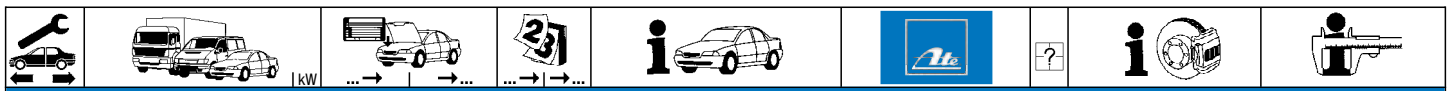













**RENAULT LAGUNA II Limousine (BG\_) (01-07)**

|  |                     |     |       |       |                |        |   |  |                |     |
|--|---------------------|-----|-------|-------|----------------|--------|---|--|----------------|-----|
|  | 2.0 dCi             | 110 | 08.05 | 06.07 | 24.5252-0390.3 | 330702 | 2 |  | L=390          |     |
|  | 2.0 dCi 130         | 127 | 01.06 | 06.07 |                |        |   |  |                |     |
|  | 2.2 dCi             | 102 | 05.05 | 06.07 |                |        |   |  |                |     |
|  | 2.2 dCi             | 110 | 10.01 | 06.07 |                |        |   |  |                |     |
|  | 3.0 V6              | 152 | 03.01 | 06.07 |                |        |   |  |                |     |
|  | 1.6 16V             | 79  | 03.01 | 06.07 | 11.9387-7001.2 | 220397 |   |  | D=38, - Halter | ATE |
|  | 1.6 16V             | 82  | 02.05 | 06.07 |                | 220398 |   |  | D=38, - Halter | ATE |
|  | 1.8 16V (04/06/0V)  | 89  | 03.01 | 06.07 | 11.8116-0340.1 | 390595 | 2 |  | Haltefeder     | ATE |
|  | 1.8 16V (0B/0C/0M)  | 88  | 03.01 | 06.07 |                |        |   |  |                |     |
|  | 1.8 16V (0J)        | 85  | 03.01 | 06.07 |                |        |   |  |                |     |
|  | 1.9 dCi             | 79  | 03.01 | 06.07 |                |        |   |  |                |     |
|  | 1.9 dCi             | 81  | 01.05 | 06.07 |                |        |   |  |                |     |
|  | 1.9 dCi             | 96  | 05.05 | 06.07 |                |        |   |  |                |     |
|  | 1.9 dCi (08/10)     | 68  | 03.04 | 06.07 |                |        |   |  |                |     |
|  | 1.9 dCi (0E)        | 77  | 06.01 | 06.07 |                |        |   |  |                |     |
|  | 1.9 dCi (0G)        | 88  | 03.01 | 06.07 |                |        |   |  |                |     |
|  | 1.9 dCi (0R)        | 74  | 10.01 | 06.07 |                |        |   |  |                |     |
|  | 2.0 16V             | 125 | 01.05 | 06.07 |                |        |   |  |                |     |
|  | 2.0 16V (00/0K/0W)  | 99  | 08.02 | 06.07 |                |        |   |  |                |     |
|  | 2.0 16V IDE (0N/0P) | 103 | 04.01 | 06.07 |                |        |   |  |                |     |
|  | 2.0 16V Sport       | 150 | 01.05 | 06.07 |                |        |   |  |                |     |
|  | 2.0 16V Turbo       | 120 | 01.03 | 06.07 |                |        |   |  |                |     |
|  | 2.0 dCi             | 110 | 08.05 | 06.07 |                |        |   |  |                |     |
|  | 2.0 dCi 130         | 127 | 01.06 | 06.07 |                |        |   |  |                |     |
|  | 2.2 dCi             | 102 | 05.05 | 06.07 |                |        |   |  |                |     |
|  | 2.2 dCi             | 110 | 10.01 | 06.07 |                |        |   |  |                |     |
|  | 3.0 V6              | 152 | 03.01 | 06.07 |                |        |   |  |                |     |
|  | 1.6 16V             | 79  | 03.01 | 06.07 | 24.5251-0185.3 | 330701 | 2 |  | L=185          |     |
|  | 1.6 16V             | 82  | 02.05 | 06.07 |                |        |   |  |                |     |
|  | 1.8 16V (04/06/0V)  | 89  | 03.01 | 06.07 |                |        |   |  |                |     |
|  | 1.8 16V (0B/0C/0M)  | 88  | 03.01 | 06.07 |                |        |   |  |                |     |
|  | 1.8 16V (0J)        | 85  | 03.01 | 06.07 |                |        |   |  |                |     |
|  | 1.9 dCi             | 79  | 03.01 | 06.07 |                |        |   |  |                |     |
|  | 1.9 dCi             | 81  | 01.05 | 06.07 |                |        |   |  |                |     |
|  | 1.9 dCi             | 96  | 05.05 | 06.07 |                |        |   |  |                |     |
|  | 1.9 dCi (08/10)     | 68  | 03.04 | 06.07 |                |        |   |  |                |     |
|  | 1.9 dCi (0E)        | 77  | 06.01 | 06.07 |                |        |   |  |                |     |
|  | 1.9 dCi (0G)        | 88  | 03.01 | 06.07 |                |        |   |  |                |     |
|  | 1.9 dCi (0R)        | 74  | 10.01 | 06.07 |                |        |   |  |                |     |
|  | 2.0 16V             | 125 | 01.05 | 06.07 |                |        |   |  |                |     |
|  | 2.0 16V (00/0K/0W)  | 99  | 08.02 | 06.07 |                |        |   |  |                |     |
|  | 2.0 16V IDE (0N/0P) | 103 | 04.01 | 06.07 |                |        |   |  |                |     |
|  | 2.0 16V Sport       | 150 | 01.05 | 06.07 |                |        |   |  |                |     |
|  | 2.0 16V Turbo       | 120 | 01.03 | 06.07 |                |        |   |  |                |     |
|  | 2.0 dCi             | 110 | 08.05 | 06.07 |                |        |   |  |                |     |
|  | 2.0 dCi 130         | 127 | 01.06 | 06.07 |                |        |   |  |                |     |
|  | 2.2 dCi             | 102 | 05.05 | 06.07 |                |        |   |  |                |     |
|  | 2.2 dCi             | 110 | 10.01 | 06.07 |                |        |   |  |                |     |
|  | 3.0 V6              | 152 | 03.01 | 06.07 |                |        |   |  |                |     |
|  | 1.6 16V             | 79  | 03.01 | 06.07 | 24.3727-1062.2 | 581062 | 2 |  | L=2220         |     |
|  | 1.6 16V             | 82  | 02.05 | 06.07 |                |        |   |  |                |     |
|  | 1.8 16V (04/06/0V)  | 89  | 03.01 | 06.07 |                |        |   |  |                |     |
|  | 1.8 16V (0B/0C/0M)  | 88  | 03.01 | 06.07 |                |        |   |  |                |     |
|  | 1.8 16V (0J)        | 85  | 03.01 | 06.07 |                |        |   |  |                |     |
|  | 1.9 dCi             | 79  | 03.01 | 06.07 |                |        |   |  |                |     |
|  | 1.9 dCi             | 81  | 01.05 | 06.07 |                |        |   |  |                |     |
|  | 1.9 dCi             | 96  | 05.05 | 06.07 |                |        |   |  |                |     |
|  | 1.9 dCi (08/10)     | 68  | 03.04 | 06.07 |                |        |   |  |                |     |
|  | 1.9 dCi (0E)        | 77  | 06.01 | 06.07 |                |        |   |  |                |     |
|  | 1.9 dCi (0G)        | 88  | 03.01 | 06.07 |                |        |   |  |                |     |
|  | 1.9 dCi (0R)        | 74  | 10.01 | 06.07 |                |        |   |  |                |     |
|  | 2.0 16V             | 125 | 01.05 | 06.07 |                |        |   |  |                |     |
|  | 2.0 16V (00/0K/0W)  | 99  | 08.02 | 06.07 |                |        |   |  |                |     |
|  | 2.0 16V IDE (0N/0P) | 103 | 04.01 | 06.07 |                |        |   |  |                |     |
|  | 2.0 16V Sport       | 150 | 01.05 | 06.07 |                |        |   |  |                |     |
|  | 2.0 16V Turbo       | 120 | 01.03 | 06.07 |                |        |   |  |                |     |
|  | 2.0 dCi             | 110 | 08.05 | 06.07 |                |        |   |  |                |     |
|  | 2.0 dCi 130         | 127 | 01.06 | 06.07 |                |        |   |  |                |     |
|  | 2.2 dCi             | 102 | 05.05 | 06.07 |                |        |   |  |                |     |
|  | 2.2 dCi             | 110 | 10.01 | 06.07 |                |        |   |  |                |     |
|  | 3.0 V6              | 152 | 03.01 | 06.07 |                |        |   |  |                |     |

**RENAULT LAGUNA II Grandtour (KG\_) (01-07)**

|  |                     |     |       |       |                |        |  |  |     |     |
|--|---------------------|-----|-------|-------|----------------|--------|--|--|-----|-----|
|  | 1.6 16V             | 79  | 03.01 | 05.01 | 03.7873-0202.4 | 300152 |  |  | 11" | ATE |
|  | 1.8 16V (04/06/0V)  | 89  | 03.01 | 05.01 |                |        |  |  |     |     |
|  | 1.8 16V (0B/0C/0M)  | 88  | 03.01 | 05.01 |                |        |  |  |     |     |
|  | 1.8 16V (0J)        | 85  | 03.01 | 05.01 |                |        |  |  |     |     |
|  | 1.9 dCi (0G)        | 88  | 03.01 | 05.01 |                |        |  |  |     |     |
|  | 2.0 16V IDE (0N/0P) | 103 | 04.01 | 05.01 |                |        |  |  |     |     |
|  | 3.0 V6              | 152 | 03.01 | 05.01 |                |        |  |  |     |     |
|  | 1.6 16V             | 79  | 06.01 | 06.07 | 03.7873-1202.4 | 300197 |  |  | 11" | ATE |
|  | 1.6 FlexFuel        | 76  | 06.01 | 10.03 |                |        |  |  |     |     |
|  | 1.8 16V (04/06/0V)  | 89  | 06.01 | 06.07 |                |        |  |  |     |     |
|  | 1.8 16V (0B/0C/0M)  | 88  | 06.01 | 06.07 |                |        |  |  |     |     |
|  | 1.8 16V (0J)        | 85  | 06.01 | 06.07 |                |        |  |  |     |     |
|  | 1.9 dCi             | 79  | 03.01 | 06.07 |                |        |  |  |     |     |
|  | 1.9 dCi             | 81  | 01.05 | 06.07 |                |        |  |  |     |     |



|     |  |  |  |  |  |  |  |  |
|--|--|--|--|--|---|--|--|--|
| <b>RENAULT LAGUNA II Grandtour (KG_) (01-07)</b>                                   |  |  |  |  |   |  |  |  |
|    | 1.9 dCi  | 96   | 05.05  | 06.07  | 03.7873-1202.4  | 300197   |  | 11" ATE  |
|  | 1.9 dCi (08/10)  | 68   | 03.04  | 06.07  |   |  |  |  |
|  | 1.9 dCi (0E)   | 77   | 06.01  | 06.07  |   |  |  |  |
|  | 1.9 dCi (0G)   | 88   | 06.01  | 06.07  |   |  |  |  |
|  | 1.9 dCi (0R)   | 74   | 10.01  | 06.07  |   |  |  |  |
|  | 2.0 16V  | 125  | 01.05  | 06.07  |   |  |  |  |
|  | 2.0 16V (00/0K/0W)   | 99   | 08.02  | 06.07  |   |  |  |  |
|  | 2.0 16V IDE (0N/0P)  | 103  | 06.01  | 06.07  |   |  |  |  |
|  | 2.0 16V Sport  | 150  | 01.05  | 06.07  |   |  |  |  |
|  | 2.0 16V Turbo  | 120  | 01.03  | 06.07  |   |  |  |  |
|  | 2.0 dCi  | 110  | 08.05  | 06.07  |   |  |  |  |
|  | 2.0 dCi 130  | 127  | 01.06  | 06.07  |   |  |  |  |
|  | 2.2 dCi  | 102  | 05.05  | 06.07  |   |  |  |  |
|  | 2.2 dCi  | 110  | 10.01  | 06.07  |   |  |  |  |
|  | 3.0 V6   | 152  | 06.01  | 06.07  |   |  |  |  |
|    | 1.6 16V  | 79   | 03.01  | 03.05  | 03.4123-0081.3  | 010585   |  | Thz 23,81 ATE  |
|  | 1.6 FlexFuel   | 76   | 06.01  | 10.03  | 03.3517-0300.1  | 390323   | - ESP  | Verschlußschraube  |
|  | 1.8 16V (04/06/0V)   | 89   | 03.01  | 03.05  |   |  |  |  |
|  | 1.8 16V (0B/0C/0M)   | 88   | 03.01  | 03.05  |   |  |  |  |
|  | 1.8 16V (0J)   | 85   | 03.01  | 03.05  |   |  |  |  |
|  | 1.9 dCi  | 79   | 03.01  | 03.05  |   |  |  |  |
|  | 1.9 dCi  | 81   | 01.05  | 03.05  |   |  |  |  |
|  | 1.9 dCi (08/10)  | 68   | 03.04  | 03.05  |   |  |  |  |
|  | 1.9 dCi (0E)   | 77   | 06.01  | 03.05  |   |  |  |  |
|  | 1.9 dCi (0G)   | 88   | 03.01  | 03.05  |   |  |  |  |
|  | 1.9 dCi (0R)   | 74   | 10.01  | 03.05  |   |  |  |  |
|  | 2.0 16V (00/0K/0W)   | 99   | 08.02  | 03.05  |   |  |  |  |
|  | 2.0 16V IDE (0N/0P)  | 103  | 04.01  | 03.05  |   |  |  |  |
|  | 2.2 dCi  | 110  | 10.01  | 03.05  |   |  |  |  |
|  | 3.0 V6   | 152  | 03.01  | 03.05  |   |  |  |  |
|  | 1.6 16V  | 79   | 04.05  | 06.07  | 03.4153-0063.3  | 010773   |  | Thz 23,81 ATE  |
|  | 1.8 16V (04/06/0V)   | 89   | 04.05  | 06.07  |   |  |  |  |
|  | 1.8 16V (0B/0C/0M)   | 88   | 04.05  | 06.07  |   |  |  |  |
|  | 1.8 16V (0J)   | 85   | 04.05  | 06.07  |   |  |  |  |
|  | 1.9 dCi  | 79   | 04.05  | 06.07  |   |  |  |  |
|  | 1.9 dCi  | 81   | 01.05  | 06.07  |   |  |  |  |
|  | 1.9 dCi  | 96   | 05.05  | 06.07  |   |  |  |  |
|  | 1.9 dCi (08/10)  | 68   | 04.05  | 06.07  |   |  |  |  |
|  | 1.9 dCi (0E)   | 77   | 04.05  | 06.07  |   |  |  |  |
|  | 1.9 dCi (0G)   | 88   | 04.05  | 06.07  |   |  |  |  |
|  | 1.9 dCi (0R)   | 74   | 04.05  | 06.07  |   |  |  |  |
|  | 2.0 16V  | 125  | 01.05  | 06.07  |   |  |  |  |
|  | 2.0 16V (00/0K/0W)   | 99   | 04.05  | 06.07  |   |  |  |  |
|  | 2.0 16V IDE (0N/0P)  | 103  | 04.05  | 06.07  |   |  |  |  |
|  | 2.0 16V Sport  | 150  | 01.05  | 06.07  |   |  |  |  |
|  | 2.0 16V Turbo  | 120  | 01.03  | 06.07  |   |  |  |  |
|  | 2.0 dCi  | 110  | 08.05  | 06.07  |   |  |  |  |
|  | 2.0 dCi 130  | 127  | 01.06  | 06.07  |   |  |  |  |
|  | 2.2 dCi  | 102  | 05.05  | 06.07  |   |  |  |  |
|  | 2.2 dCi  | 110  | 04.05  | 06.07  |   |  |  |  |
|  | 3.0 V6   | 152  | 04.05  | 06.07  |   |  |  |  |
|  | 1.6 16V  | 79   | 03.01  | 06.07  | 11.9571-9861.2  | 220403   | + 16" Rad/ + Stahlfelgen 1)  | D=57, - Halter ATE   |
|  | 1.6 FlexFuel   | 76   | 06.01  | 10.03  | 11.9571-9862.2  | 220404   | + 16" Rad/ + Stahlfelgen 1)  | D=57, - Halter ATE   |
|  | 1.8 16V (04/06/0V)   | 89   | 03.01  | 06.07  | 11.9571-9841.2  | 220401   | + 16"/17"Rad/ + Leichtmetallfelgen   | D=57, - Halter ATE   |
|  | 1.8 16V (0B/0C/0M)   | 88   | 03.01  | 06.07  | 11.9571-9842.2  | 220402   | + 16"/17"Rad/ + Leichtmetallfelgen   | D=57, - Halter ATE   |
|  | 1.8 16V (0J)   | 85   | 03.01  | 06.07  | 11.8116-0301.1  | 390610   | 2 Haltefeder   | ATE  |
|  | 1.9 dCi  | 79   | 03.01  | 06.07  | 24.3571-9841.5  | 240501   | + 16"/17"Rad/ + Leichtmetallfelgen   | D=57, - Halter ATE   |
|  | 1.9 dCi  | 81   | 01.05  | 06.07  | 24.3571-9842.5  | 240502   | + 16"/17"Rad/ + Leichtmetallfelgen   | D=57, - Halter ATE   |
|  | 1.9 dCi  | 96   | 05.05  | 06.07  | 11.0101-5407.2  | 260011   | Hülsensatz   | ATE  |
|  | 1.9 dCi (08/10)  | 68   | 03.04  | 06.07  | 11.8171-0008.1  | 990049   | Führungsbolzen   | ATE  |
|  | 1.9 dCi (0E)   | 77   | 06.01  | 06.07  |   |  |  |  |
|  | 1.9 dCi (0G)   | 88   | 03.01  | 06.07  |   |  |  |  |
|  | 1.9 dCi (0R)   | 74   | 10.01  | 06.07  |   |  |  |  |
|  | 2.0 16V (00/0K/0W)   | 99   | 08.02  | 06.07  |   |  |  |  |
|  | 2.0 16V IDE (0N/0P)  | 103  | 04.01  | 06.07  |   |  |  |  |
|  | 2.2 dCi  | 102  | 05.05  | 06.07  | 11.9571-9841.2  | 220401   | + 16"/17"Rad/ + Leichtmetallfelgen   | D=57, - Halter ATE   |
|  | 2.2 dCi  | 110  | 05.05  | 06.07  | 11.9571-9842.2  | 220402   | + 16"/17"Rad/ + Leichtmetallfelgen   | D=57, - Halter ATE   |
|  | 2.2 dCi  | 110  | 10.01  | 11.01  | 24.3571-9841.5  | 240501   | + 16"/17"Rad/ + Leichtmetallfelgen   | D=57, - Halter ATE   |
|  |  |  |  |  | 24.3571-9842.5  | 240502   | + 16"/17"Rad/ + Leichtmetallfelgen   | D=57, - Halter ATE   |
|  |  |  |  |  | 11.8116-0301.1  | 390610   | 2 Haltefeder   | ATE  |
|  |  |  |  |  | 11.0101-5407.2  | 260011   | Hülsensatz   | ATE  |
|  |  |  |  |  | 11.8171-0008.1  | 990049   | Führungsbolzen   | ATE  |
|  | 2.0 16V  | 125  | 01.05  | 06.07  | 11.9601-9787.2  | 220585   | + 16"/17"Rad/ + Leichtmetallfelgen   | D=60, - Halter ATE   |
|  | 2.0 16V Sport  | 150  | 01.05  | 06.07  | 11.9601-9788.2  | 220586   | + 16"/17"Rad/ + Leichtmetallfelgen   | D=60, - Halter ATE   |
|  | 2.0 16V Turbo  | 120  | 01.03  | 06.07  | 24.3601-9787.5  | 240505   | + 16"/17"Rad/ + Leichtmetallfelgen   | D=60, - Halter ATE   |
|  | 2.0 dCi  | 110  | 08.05  | 06.07  | 24.3601-9788.5  | 240506   | + 16"/17"Rad/ + Leichtmetallfelgen   | D=60, - Halter ATE   |
|  | 2.0 dCi 130  | 127  | 01.06  | 06.07  | 11.0441-6008.2  | 250038   | Dichtungssatz  | ATE  |
|  | 2.2 dCi  | 110  | 12.01  | 04.05  | 11.0101-5407.2  | 260011   | Hülsensatz   | ATE  |
|  | 3.0 V6   | 152  | 03.01  | 06.07  | 11.8171-0008.1  | 990049   | Führungsbolzen   | ATE  |
|  | 1.6 16V  | 79   | 03.01  | 06.07  | 24.5252-0390.3  | 330702   | 2  | L=390  |
|  | 1.6 FlexFuel   | 76   | 06.01  | 10.03  |   |  |  |  |
|  | 1.8 16V (04/06/0V)   | 89   | 03.01  | 06.07  |   |  |  |  |
|  | 1.8 16V (0B/0C/0M)   | 88   | 03.01  | 06.07  |   |  |  |  |
|  | 1.8 16V (0J)   | 85   | 03.01  | 06.07  |   |  |  |  |
|  | 1.9 dCi  | 79   | 03.01  | 06.07  |   |  |  |  |
|  | 1.9 dCi  | 81   | 01.05  | 06.07  |   |  |  |  |
|  | 1.9 dCi  | 96   | 05.05  | 06.07  |   |  |  |  |

1) + 16" wheel, + steel rims / + ruota 16", + cerchione i.acc. / + roue 16", + jante en acier / + rueda 16", + Llanta da acero



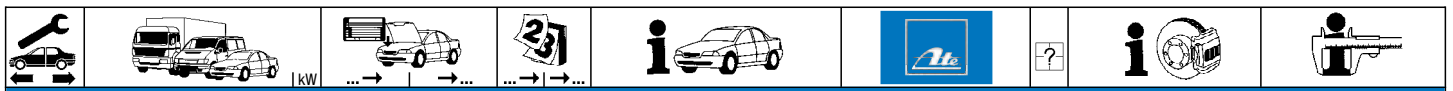

**RENAULT LAGUNA II Grandtour (KG\_) (01-07)**

|  |  |  |  |   |   |  |  |                   |
|--|--|--|--|---|---|--|--|-------------------|
|  | 1.9 dCi (08/10) 68<br>1.9 dCi (0E) 77<br>1.9 dCi (0G) 88<br>1.9 dCi (0R) 74<br>2.0 16V 125<br>2.0 16V (00/OK/OW) 99<br>2.0 16V IDE (ON/OP) 103<br>2.0 16V Sport 150<br>2.0 16V Turbo 120<br>2.0 dCi 110<br>2.0 dCi 130 127<br>2.2 dCi 102<br>2.2 dCi 110<br>3.0 V6 152   |  | 03.04 06.07<br>06.01 06.07<br>03.01 06.07<br>10.01 06.07<br>01.05 06.07<br>08.02 06.07<br>04.01 06.07<br>01.05 06.07<br>01.03 06.07<br>08.05 06.07<br>01.06 06.07<br>05.05 06.07<br>10.01 06.07<br>03.01 06.07   | 24.5252-0390.3 330702   | 2 |  | L=390  |                   |
|  | 1.6 16V 79<br>1.6 FlexFuel 76<br>1.8 16V (04/06/0V) 89<br>1.8 16V (0B/0C/0M) 88<br>1.8 16V (0J) 85<br>1.9 dCi 79<br>1.9 dCi 81<br>1.9 dCi 96<br>1.9 dCi (08/10) 68<br>1.9 dCi (0E) 77<br>1.9 dCi (0G) 88<br>1.9 dCi (0R) 74<br>2.0 16V 125<br>2.0 16V (00/OK/OW) 99<br>2.0 16V IDE (ON/OP) 103<br>2.0 16V Sport 150<br>2.0 16V Turbo 120<br>2.0 dCi 110<br>2.0 dCi 130 127<br>2.2 dCi 102<br>2.2 dCi 110<br>3.0 V6 152 |  | 03.01 06.07<br>06.01 10.03<br>03.01 06.07<br>03.01 06.07<br>03.01 06.07<br>03.01 06.07<br>01.05 06.07<br>05.05 06.07<br>03.04 06.07<br>06.01 06.07<br>03.01 06.07<br>10.01 06.07<br>01.05 06.07<br>08.02 06.07<br>04.01 06.07<br>01.05 06.07<br>01.03 06.07<br>08.05 06.07<br>01.06 06.07<br>05.05 06.07<br>10.01 06.07<br>03.01 06.07 | 11.9387-7001.2 220397<br>11.9387-7002.2 220398<br>11.8116-0340.1 390595 | 2 | <input type="checkbox"/><br><input type="checkbox"/> | D=38, - Halter<br>D=38, - Halter<br>Haltefeder | ATE<br>ATE<br>ATE |
|  | 1.6 16V 79<br>1.6 FlexFuel 76<br>1.8 16V (04/06/0V) 89<br>1.8 16V (0B/0C/0M) 88<br>1.8 16V (0J) 85<br>1.9 dCi 79<br>1.9 dCi 81<br>1.9 dCi 96<br>1.9 dCi (08/10) 68<br>1.9 dCi (0E) 77<br>1.9 dCi (0G) 88<br>1.9 dCi (0R) 74<br>2.0 16V 125<br>2.0 16V (00/OK/OW) 99<br>2.0 16V IDE (ON/OP) 103<br>2.0 16V Sport 150<br>2.0 16V Turbo 120<br>2.0 dCi 110<br>2.0 dCi 130 127<br>2.2 dCi 102<br>2.2 dCi 110<br>3.0 V6 152 |  | 03.01 06.07<br>06.01 10.03<br>03.01 06.07<br>03.01 06.07<br>03.01 06.07<br>03.01 06.07<br>01.05 06.07<br>05.05 06.07<br>03.04 06.07<br>06.01 06.07<br>03.01 06.07<br>10.01 06.07<br>01.05 06.07<br>08.02 06.07<br>04.01 06.07<br>01.05 06.07<br>01.03 06.07<br>08.05 06.07<br>01.06 06.07<br>05.05 06.07<br>10.01 06.07<br>03.01 06.07 | 24.5251-0185.3 330701   | 2 |  | L=185  |                   |
|  | 1.6 16V 79<br>1.6 FlexFuel 76<br>1.8 16V (04/06/0V) 89<br>1.8 16V (0B/0C/0M) 88<br>1.8 16V (0J) 85<br>1.9 dCi 79<br>1.9 dCi 81<br>1.9 dCi 96<br>1.9 dCi (08/10) 68<br>1.9 dCi (0E) 77<br>1.9 dCi (0G) 88<br>1.9 dCi (0R) 74<br>2.0 16V 125<br>2.0 16V (00/OK/OW) 99<br>2.0 16V IDE (ON/OP) 103<br>2.0 16V Sport 150<br>2.0 16V Turbo 120<br>2.0 dCi 110<br>2.0 dCi 130 127<br>2.2 dCi 102<br>2.2 dCi 110<br>3.0 V6 152 |  | 03.01 06.07<br>06.01 10.03<br>03.01 06.07<br>03.01 06.07<br>03.01 06.07<br>03.01 06.07<br>01.05 06.07<br>05.05 06.07<br>03.04 06.07<br>06.01 06.07<br>03.01 06.07<br>10.01 06.07<br>01.05 06.07<br>08.02 06.07<br>04.01 06.07<br>01.05 06.07<br>01.03 06.07<br>08.05 06.07<br>01.06 06.07<br>05.05 06.07<br>10.01 06.07<br>03.01 06.07 | 24.3727-1062.2 581062   | 2 | <input type="checkbox"/>                             | L=2220   |                   |

**RENAULT LAGUNA III Limousine (BT0/1) (07-)**

|  |                          |  |                |   |   |  |  |                   |
|--|--------------------------|--|----------------|---|---|--|--|-------------------|
|  | 1.5 dCi 81<br>1.6 16V 81 |  | 09.07<br>09.07 | 11.9571-9757.2 220857<br>11.9571-9758.2 220858<br>11.8116-0301.1 390610 | 2 | <input type="checkbox"/><br><input type="checkbox"/> | D=57, - Halter<br>D=57, - Halter<br>Haltefeder | ATE<br>ATE<br>ATE |
|--|--------------------------|--|----------------|---|---|--|--|-------------------|

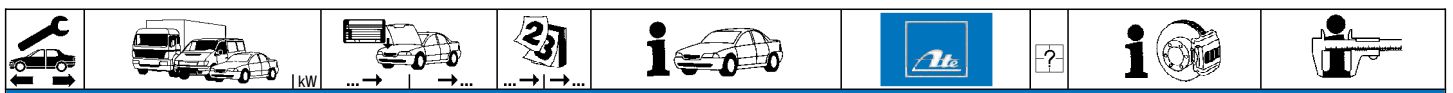

### RENAULT LAGUNA III Limousine (BT0/1) (07-)

|                  |                  |         |                               |                               |                |                |   |  |  |                   |        |   |   |        |  |
|------------------|------------------|---------|-------------------------------|-------------------------------|----------------|----------------|---|--|--|-------------------|--------|---|---|--------|--|
|                  | 2.0 16V          | 103     | 09.07                         |                               | 11.9571-9775.2 | 220859         | 2 |  | D=57, - Halter<br>D=57, - Halter<br>Haltefeder | ATE<br>ATE<br>ATE |        |   |   |        |  |
|                  | 2.0 16V Hi-Flex  | 103     | 09.07                         |                               | 11.9571-9776.2 | 220860         |   |  |  |                   |        |   |   |        |  |
|                  | 2.0 16V Turbo    | 125     | 09.07                         |                               | 11.8116-0351.1 | 390538         |   |  |  |                   |        |   |   |        |  |
|                  | 2.0 dCi          | 96      | 09.07                         | - 4-Rad Lenkung <sup>1)</sup> |                |                |   |  |  |                   |        |   |   |        |  |
|                  | 2.0 dCi          | 110     | 09.07                         | - 4-Rad Lenkung <sup>1)</sup> |                |                |   |  |  |                   |        |   |   |        |  |
|                  | 2.0 dCi          | 127     | 01.08                         | - 4-Rad Lenkung <sup>1)</sup> |                |                |   |  |  |                   |        |   |   |        |  |
|                  | 2.0 dCi GT       | 131     | 03.08                         | - 4-Rad Lenkung <sup>1)</sup> |                |                |   |  |  |                   |        |   |   |        |  |
|                  | 2.0 16V Turbo GT | 150     | 03.08                         |                               | 11.8116-0351.1 | 390538         |   |  |  |                   |        |   |   |        |  |
|                  | 2.0 dCi          | 96      | 09.07                         | + 4-Rad Lenkung <sup>2)</sup> | 11.0441-6008.2 | 250038         |   |  |  |                   |        |   |   |        |  |
|                  | 2.0 dCi          | 110     | 09.07                         | + 4-Rad Lenkung <sup>2)</sup> |                |                |   |  |  |                   |        |   |   |        |  |
| 2.0 dCi          | 127              | 09.07   | + 4-Rad Lenkung <sup>2)</sup> |                               |                |                |   |  |  |                   |        |   |   |        |  |
| 2.0 dCi GT       | 131              | 03.08   | + 4-Rad Lenkung <sup>2)</sup> |                               |                |                |   |  |  |                   |        |   |   |        |  |
| 3.0 dCi          | 173              | 09.08   |                               |                               |                |                |   |  |  |                   |        |   |   |        |  |
| 3.5 V6           | 175              | 04.08   |                               |                               |                |                |   |  |  |                   |        |   |   |        |  |
|                  | 1.5 dCi          | 81      | 09.07                         |                               | 24.5144-0410.3 | 331242         | 2 |  | L=410  |                   |        |   |   |        |  |
|                  | 1.6 16V          | 81      | 09.07                         |                               |                |                |   |  |  |                   |        |   |   |        |  |
|                  | 2.0 16V          | 103     | 09.07                         |                               |                |                |   |  |  |                   |        |   |   |        |  |
|                  | 2.0 16V Hi-Flex  | 103     | 09.07                         |                               |                |                |   |  |  |                   |        |   |   |        |  |
|                  | 2.0 16V Turbo    | 125     | 09.07                         |                               |                |                |   |  |  |                   |        |   |   |        |  |
|                  | 2.0 16V Turbo GT | 150     | 03.08                         |                               |                |                |   |  |  |                   |        |   |   |        |  |
|                  | 2.0 dCi          | 96      | 09.07                         |                               |                |                |   |  |  |                   |        |   |   |        |  |
|                  | 2.0 dCi          | 110     | 09.07                         |                               |                |                |   |  |  |                   |        |   |   |        |  |
|                  | 2.0 dCi          | 127     | 01.08                         |                               |                |                |   |  |  |                   |        |   |   |        |  |
|                  | 2.0 dCi GT       | 131     | 03.08                         |                               |                |                |   |  |  |                   |        |   |   |        |  |
| 3.0 dCi          | 173              | 09.08   |                               |                               |                |                |   |  |  |                   |        |   |   |        |  |
| 3.5 V6           | 175              | 04.08   |                               |                               |                |                |   |  |  |                   |        |   |   |        |  |
|                  | 1.5 dCi          | 81      | 09.07                         |                               | 11.9387-7027.2 | 220893         | 2 |  | D=38, - Halter<br>D=38, - Halter<br>Haltefeder | ATE<br>ATE<br>ATE |        |   |   |        |  |
|                  | 1.6 16V          | 81      | 09.07                         |                               | 11.9387-7028.2 | 220894         |   |  |  |                   |        |   |   |        |  |
|                  | 2.0 16V          | 103     | 09.07                         |                               | 11.8116-0340.1 | 390595         |   |  |  |                   |        |   |   |        |  |
|                  | 2.0 16V Hi-Flex  | 103     | 09.07                         |                               |                |                |   |  |  |                   |        |   |   |        |  |
|                  | 2.0 16V Turbo    | 125     | 09.07                         |                               |                |                |   |  |  |                   |        |   |   |        |  |
|                  | 2.0 16V Turbo GT | 150     | 03.08                         |                               |                |                |   |  |  |                   |        |   |   |        |  |
|                  | 2.0 dCi          | 96      | 09.07                         |                               |                |                |   |  |  |                   |        |   |   |        |  |
|                  | 2.0 dCi          | 110     | 09.07                         |                               |                |                |   |  |  |                   |        |   |   |        |  |
|                  | 2.0 dCi          | 127     | 01.08                         |                               |                |                |   |  |  |                   |        |   |   |        |  |
|                  | 2.0 dCi GT       | 131     | 03.08                         |                               |                |                |   |  |  |                   |        |   |   |        |  |
| 3.0 dCi          | 173              | 09.08   |                               |                               |                |                |   |  |  |                   |        |   |   |        |  |
| 3.5 V6           | 175              | 04.08   |                               |                               |                |                |   |  |  |                   |        |   |   |        |  |
|                  | 1.5 dCi          | 81      | 09.07                         |                               | 24.5251-0185.3 | 330701         | 2 |  | L=185  |                   |        |   |   |        |  |
|                  | 1.6 16V          | 81      | 09.07                         |                               |                |                |   |  |  |                   |        |   |   |        |  |
|                  | 2.0 16V          | 103     | 09.07                         |                               |                |                |   |  |  |                   |        |   |   |        |  |
|                  | 2.0 16V Hi-Flex  | 103     | 09.07                         |                               |                |                |   |  |  |                   |        |   |   |        |  |
|                  | 2.0 16V Turbo    | 125     | 09.07                         |                               |                |                |   |  |  |                   |        |   |   |        |  |
|                  | 2.0 16V Turbo GT | 150     | 03.08                         |                               |                |                |   |  |  |                   |        |   |   |        |  |
|                  | 2.0 dCi          | 96      | 09.07                         | - 4-Rad Lenkung <sup>1)</sup> |                |                |   |  |  |                   |        |   |   |        |  |
|                  | 2.0 dCi          | 110     | 09.07                         | - 4-Rad Lenkung <sup>1)</sup> |                |                |   |  |  |                   |        |   |   |        |  |
|                  | 2.0 dCi          | 127     | 01.08                         | - 4-Rad Lenkung <sup>1)</sup> |                |                |   |  |  |                   |        |   |   |        |  |
|                  | 2.0 dCi GT       | 131     | 03.08                         | - 4-Rad Lenkung <sup>1)</sup> |                |                |   |  |  |                   |        |   |   |        |  |
| 3.0 dCi          | 173              | 09.08   |                               |                               |                |                |   |  |  |                   |        |   |   |        |  |
| 3.5 V6           | 175              | 04.08   |                               |                               |                |                |   |  |  |                   |        |   |   |        |  |
|                  | 2.0 16V Turbo GT | 150     | 03.08                         |                               | 24.5251-0185.3 | 330701         | 2 |  | L=185  |                   |        |   |   |        |  |
|                  | 2.0 dCi          | 96      | 09.07                         | + 4-Rad Lenkung <sup>2)</sup> |                |                |   |  |  |                   |        |   |   |        |  |
|                  | 2.0 dCi          | 110     | 09.07                         | + 4-Rad Lenkung <sup>2)</sup> |                |                |   |  |  |                   |        |   |   |        |  |
|                  | 2.0 dCi          | 127     | 01.08                         | + 4-Rad Lenkung <sup>2)</sup> |                |                |   |  |  |                   |        |   |   |        |  |
|                  | 2.0 dCi GT       | 131     | 03.08                         | + 4-Rad Lenkung <sup>2)</sup> |                |                |   |  |  |                   |        |   |   |        |  |
|                  | 3.0 dCi          | 173     | 09.08                         |                               |                |                |   |  |  |                   |        |   |   |        |  |
|                  | 3.5 V6           | 175     | 04.08                         |                               |                |                |   |  |  |                   |        |   |   |        |  |
|                  |                  | 1.5 dCi | 81                            | 09.07                         |                | 24.3727-1089.2 |   |  |  |                   | 581089 | 2 | ↓ | L=2224 |  |
|                  |                  | 1.6 16V | 81                            | 09.07                         |                |                |   |  |  |                   |        |   |   |        |  |
|                  |                  | 2.0 16V | 103                           | 09.07                         |                |                |   |  |  |                   |        |   |   |        |  |
| 2.0 16V Hi-Flex  |                  | 103     | 09.07                         |                               |                |                |   |  |  |                   |        |   |   |        |  |
| 2.0 16V Turbo    |                  | 125     | 09.07                         |                               |                |                |   |  |  |                   |        |   |   |        |  |
| 2.0 16V Turbo GT |                  | 150     | 03.08                         |                               |                |                |   |  |  |                   |        |   |   |        |  |
| 2.0 dCi          |                  | 96      | 09.07                         |                               |                |                |   |  |  |                   |        |   |   |        |  |
| 2.0 dCi          |                  | 110     | 09.07                         |                               |                |                |   |  |  |                   |        |   |   |        |  |
| 2.0 dCi          |                  | 127     | 01.08                         |                               |                |                |   |  |  |                   |        |   |   |        |  |
| 2.0 dCi GT       |                  | 131     | 03.08                         |                               |                |                |   |  |  |                   |        |   |   |        |  |
| 3.0 dCi          | 173              | 09.08   |                               |                               |                |                |   |  |  |                   |        |   |   |        |  |
| 3.5 V6           | 175              | 04.08   |                               |                               |                |                |   |  |  |                   |        |   |   |        |  |

### RENAULT LAGUNA III Coupe (DT0/1) (07-)

|         |                  |       |       |                               |                |        |   |  |  |                   |
|---------|------------------|-------|-------|-------------------------------|----------------|--------|---|--|--|-------------------|
|         | 2.0 16V Turbo    | 125   | 09.08 |                               | 11.9571-9775.2 | 220859 | 2 |  | D=57, - Halter<br>D=57, - Halter<br>Haltefeder | ATE<br>ATE<br>ATE |
|         | 2.0 dCi          | 110   | 10.07 | - 4-Rad Lenkung <sup>1)</sup> | 11.9571-9776.2 | 220860 |   |  |  |                   |
|         | 2.0 dCi          | 127   | 09.08 | - 4-Rad Lenkung <sup>1)</sup> | 11.8116-0351.1 | 390538 |   |  |  |                   |
|         | 2.0 dCi GT       | 131   | 03.08 | - 4-Rad Lenkung <sup>1)</sup> |                |        |   |  |  |                   |
|         | 1.5 dCi          | 81    | 03.12 |                               | 11.9571-9757.2 | 220857 | 2 |  | D=57, - Halter<br>D=57, - Halter<br>Haltefeder | ATE<br>ATE<br>ATE |
|         |                  |       |       |                               | 11.9571-9758.2 | 220858 |   |  |  |                   |
|         |                  |       |       |                               | 11.8116-0301.1 | 390610 |   |  |  |                   |
|         | 2.0 16V Turbo GT | 150   | 03.08 |                               | 11.0441-6008.2 | 250038 |   |  |  |                   |
|         | 2.0 dCi          | 110   | 10.07 | + 4-Rad Lenkung <sup>2)</sup> | 11.8116-0351.1 | 390538 |   |  |  |                   |
|         | 2.0 dCi          | 127   | 09.08 | + 4-Rad Lenkung <sup>2)</sup> |                |        |   |  |  |                   |
|         | 2.0 dCi GT       | 131   | 03.08 | + 4-Rad Lenkung <sup>2)</sup> |                |        |   |  |  |                   |
|         | 3.0 dCi          | 173   | 09.08 |                               |                |        |   |  |  |                   |
| 3.0 dCi | 177              | 01.12 |       |                               |                |        |   |  |  |                   |
| 3.5 V6  | 175              | 09.08 |       |                               |                |        |   |  |  |                   |

<sup>1)</sup> - 4 wheel steering / - 4 ruote sterzanti / - 4 roues directionnelles / + dirección sobre cuatro ruedas

<sup>2)</sup> + 4 wheel steering / + 4 ruote sterzanti / + 4 roues directionnelles / + dirección sobre cuatro ruedas

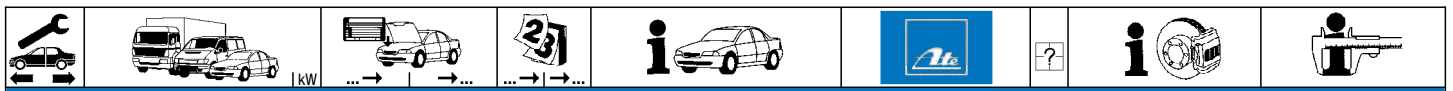

**RENAULT LAGUNA III Coupe (DT0/1) (07-)**

|        |                  |       |       |  |                |        |   |  |                |     |
|--------|------------------|-------|-------|--|----------------|--------|---|--|----------------|-----|
|        | 1.5 dCi          | 81    | 03.12 |  | 24.5144-0410.3 | 331242 | 2 |  | L=410          |     |
|        | 2.0 16V Turbo    | 125   | 09.08 |  |                |        |   |  |                |     |
|        | 2.0 16V Turbo GT | 150   | 03.08 |  |                |        |   |  |                |     |
|        | 2.0 dCi          | 110   | 10.07 |  |                |        |   |  |                |     |
|        | 2.0 dCi          | 127   | 09.08 |  |                |        |   |  |                |     |
|        | 2.0 dCi GT       | 131   | 03.08 |  |                |        |   |  |                |     |
|        | 3.0 dCi          | 173   | 09.08 |  |                |        |   |  |                |     |
|        | 3.0 dCi          | 177   | 01.12 |  |                |        |   |  |                |     |
| 3.5 V6 | 175              | 09.08 |       |  |                |        |   |  |                |     |
|        | 1.5 dCi          | 81    | 03.12 |  | 11.9387-7027.2 | 220893 |   |  | D=38, - Halter | ATE |
|        | 2.0 16V Turbo    | 125   | 09.08 |  | 11.9387-7028.2 | 220894 |   |  | D=38, - Halter | ATE |
|        | 2.0 16V Turbo GT | 150   | 03.08 |  | 11.8116-0340.1 | 390595 | 2 |  | Haltefeder     | ATE |
|        | 2.0 dCi          | 110   | 10.07 |  |                |        |   |  |                |     |
|        | 2.0 dCi          | 127   | 09.08 |  |                |        |   |  |                |     |
|        | 2.0 dCi GT       | 131   | 03.08 |  |                |        |   |  |                |     |
|        | 3.0 dCi          | 173   | 09.08 |  |                |        |   |  |                |     |
|        | 3.0 dCi          | 177   | 01.12 |  |                |        |   |  |                |     |
| 3.5 V6 | 175              | 09.08 |       |  |                |        |   |  |                |     |
|        | 1.5 dCi          | 81    | 03.12 |  | 24.5251-0185.3 | 330701 | 2 |  | L=185          |     |
|        | 2.0 16V Turbo    | 125   | 09.08 |  |                |        |   |  |                |     |
|        | 2.0 16V Turbo GT | 150   | 03.08 |  |                |        |   |  |                |     |
|        | 2.0 dCi          | 110   | 10.07 |  |                |        |   |  |                |     |
|        | 2.0 dCi          | 127   | 09.08 |  |                |        |   |  |                |     |
|        | 2.0 dCi GT       | 131   | 03.08 |  |                |        |   |  |                |     |
|        | 3.0 dCi          | 173   | 09.08 |  |                |        |   |  |                |     |
|        | 3.0 dCi          | 177   | 01.12 |  |                |        |   |  |                |     |
| 3.5 V6 | 175              | 09.08 |       |  |                |        |   |  |                |     |
|        | 1.5 dCi          | 81    | 03.12 |  | 24.3727-1089.2 | 581089 | 2 |  | L=2224         |     |
|        | 2.0 16V Turbo    | 125   | 09.08 |  |                |        |   |  |                |     |
|        | 2.0 16V Turbo GT | 150   | 03.08 |  |                |        |   |  |                |     |
|        | 2.0 dCi          | 110   | 10.07 |  |                |        |   |  |                |     |
|        | 2.0 dCi          | 127   | 09.08 |  |                |        |   |  |                |     |
|        | 2.0 dCi GT       | 131   | 03.08 |  |                |        |   |  |                |     |
|        | 3.0 dCi          | 173   | 09.08 |  |                |        |   |  |                |     |
|        | 3.0 dCi          | 177   | 01.12 |  |                |        |   |  |                |     |
| 3.5 V6 | 175              | 09.08 |       |  |                |        |   |  |                |     |

**RENAULT LAGUNA III Grandtour (KT0/1) (07-)**

|                  |                  |       |                               |                               |                |        |   |               |                |     |
|------------------|------------------|-------|-------------------------------|-------------------------------|----------------|--------|---|---------------|----------------|-----|
|                  | 1.5 dCi          | 81    | 09.07                         |                               | 11.9571-9757.2 | 220857 |   |               | D=57, - Halter | ATE |
|                  | 1.6 16V          | 81    | 09.07                         |                               | 11.9571-9758.2 | 220858 |   |               | D=57, - Halter | ATE |
|                  |                  |       |                               |                               | 11.8116-0301.1 | 390610 | 2 |               | Haltefeder     | ATE |
|                  | 2.0 16V          | 103   | 09.07                         |                               | 11.9571-9775.2 | 220859 |   |               | D=57, - Halter | ATE |
|                  | 2.0 16V Hi-Flex  | 103   | 09.07                         |                               | 11.9571-9776.2 | 220860 |   |               | D=57, - Halter | ATE |
|                  | 2.0 16V Turbo    | 125   | 09.07                         |                               | 11.8116-0351.1 | 390538 | 2 |               | Haltefeder     | ATE |
|                  | 2.0 dCi          | 96    | 09.07                         | - 4-Rad Lenkung <sup>1)</sup> |                |        |   |               |                |     |
|                  | 2.0 dCi          | 110   | 09.07                         | - 4-Rad Lenkung <sup>1)</sup> |                |        |   |               |                |     |
| 2.0 dCi          | 127              | 09.07 | - 4-Rad Lenkung <sup>1)</sup> |                               |                |        |   |               |                |     |
| 2.0 dCi GT       | 131              | 03.08 | - 4-Rad Lenkung <sup>1)</sup> |                               |                |        |   |               |                |     |
| 2.0 16V Turbo GT | 150              | 03.08 |                               | 11.0441-6008.2                | 250038         |        |   | Dichtungssatz | ATE            |     |
| 2.0 dCi          | 96               | 09.07 | + 4-Rad Lenkung <sup>2)</sup> | 11.8116-0351.1                | 390538         | 2      |   | Haltefeder    | ATE            |     |
| 2.0 dCi          | 110              | 09.07 | + 4-Rad Lenkung <sup>2)</sup> |                               |                |        |   |               |                |     |
| 2.0 dCi          | 127              | 09.07 | + 4-Rad Lenkung <sup>2)</sup> |                               |                |        |   |               |                |     |
| 2.0 dCi GT       | 131              | 03.08 | + 4-Rad Lenkung <sup>2)</sup> |                               |                |        |   |               |                |     |
| 3.0 dCi V6       | 173              | 09.08 |                               |                               |                |        |   |               |                |     |
| 3.5 V6           | 175              | 04.08 |                               |                               |                |        |   |               |                |     |
|                  | 1.5 dCi          | 81    | 09.07                         |                               | 24.5144-0410.3 | 331242 | 2 |               | L=410          |     |
|                  | 1.6 16V          | 81    | 09.07                         |                               |                |        |   |               |                |     |
|                  | 2.0 16V          | 103   | 09.07                         |                               |                |        |   |               |                |     |
|                  | 2.0 16V Hi-Flex  | 103   | 09.07                         |                               |                |        |   |               |                |     |
|                  | 2.0 16V Turbo    | 125   | 09.07                         |                               |                |        |   |               |                |     |
|                  | 2.0 16V Turbo GT | 150   | 03.08                         |                               |                |        |   |               |                |     |
|                  | 2.0 dCi          | 96    | 09.07                         |                               |                |        |   |               |                |     |
|                  | 2.0 dCi          | 110   | 09.07                         |                               |                |        |   |               |                |     |
|                  | 2.0 dCi          | 127   | 09.07                         |                               |                |        |   |               |                |     |
|                  | 2.0 dCi GT       | 131   | 03.08                         |                               |                |        |   |               |                |     |
|                  | 3.0 dCi V6       | 173   | 09.08                         |                               |                |        |   |               |                |     |
| 3.5 V6           | 175              | 04.08 |                               |                               |                |        |   |               |                |     |
|                  | 1.5 dCi          | 81    | 09.07                         |                               | 11.9387-7027.2 | 220893 |   |               | D=38, - Halter | ATE |
|                  | 1.6 16V          | 81    | 09.07                         |                               | 11.9387-7028.2 | 220894 |   |               | D=38, - Halter | ATE |
|                  | 2.0 16V          | 103   | 09.07                         |                               | 11.8116-0340.1 | 390595 | 2 |               | Haltefeder     | ATE |
|                  | 2.0 16V Hi-Flex  | 103   | 09.07                         |                               |                |        |   |               |                |     |
|                  | 2.0 16V Turbo    | 125   | 09.07                         |                               |                |        |   |               |                |     |
|                  | 2.0 16V Turbo GT | 150   | 03.08                         |                               |                |        |   |               |                |     |
|                  | 2.0 dCi          | 96    | 09.07                         |                               |                |        |   |               |                |     |
|                  | 2.0 dCi          | 110   | 09.07                         |                               |                |        |   |               |                |     |
|                  | 2.0 dCi          | 127   | 09.07                         |                               |                |        |   |               |                |     |
|                  | 2.0 dCi GT       | 131   | 03.08                         |                               |                |        |   |               |                |     |
|                  | 3.0 dCi V6       | 173   | 09.08                         |                               |                |        |   |               |                |     |
| 3.5 V6           | 175              | 04.08 |                               |                               |                |        |   |               |                |     |
|                  | 1.5 dCi          | 81    | 09.07                         |                               | 24.5251-0185.3 | 330701 | 2 |               | L=185          |     |
|                  | 1.6 16V          | 81    | 09.07                         |                               |                |        |   |               |                |     |
|                  | 2.0 16V          | 103   | 09.07                         |                               |                |        |   |               |                |     |
|                  | 2.0 16V Hi-Flex  | 103   | 09.07                         |                               |                |        |   |               |                |     |
|                  | 2.0 16V Turbo    | 125   | 09.07                         |                               |                |        |   |               |                |     |
|                  | 2.0 dCi          | 96    | 09.07                         | - 4-Rad Lenkung <sup>1)</sup> |                |        |   |               |                |     |
| 2.0 dCi          | 110              | 09.07 | - 4-Rad Lenkung <sup>1)</sup> |                               |                |        |   |               |                |     |

<sup>1)</sup> - 4 wheel steering / - 4 route sterzanti / - 4 roues directionnelles / + dirección sobre cuatro ruedas  
<sup>2)</sup> + 4 wheel steering / + 4 ruote sterzanti / + 4 roues directionnelles / + dirección sobre cuatro ruedas



| RENAULT LAGUNA III Grandtour (KT0/1) (07-) |                  |       |             |                               |                |        |   |  |  |  |   |
|--|------------------|-------|-------------|-------------------------------|----------------|--------|---|--|--|--|---|
|  | 2.0 dCi          | 127   | 09.07       | - 4-Rad Lenkung <sup>1)</sup> | 24.5251-0185.3 | 330701 | 2 |  |  |  | L=185   |
|  | 2.0 dCi GT       | 131   | 03.08       | - 4-Rad Lenkung <sup>1)</sup> |                |        |   |  |  |  |   |
|  | 2.0 16V Turbo GT | 150   | 03.08       |                               | 24.5251-0185.3 | 330701 | 2 |  |  |  |   |
|  | 2.0 dCi          | 96    | 09.07       | + 4-Rad Lenkung <sup>2)</sup> |                |        |   |  |  |  |   |
|  | 2.0 dCi          | 110   | 09.07       | + 4-Rad Lenkung <sup>2)</sup> |                |        |   |  |  |  |   |
|  | 2.0 dCi          | 127   | 09.07       | + 4-Rad Lenkung <sup>2)</sup> |                |        |   |  |  |  |   |
|  | 2.0 dCi GT       | 131   | 03.08       | + 4-Rad Lenkung <sup>2)</sup> |                |        |   |  |  |  |   |
|  | 3.0 dCi V6       | 173   | 09.08       |                               |                |        |   |  |  |  |   |
| 3.5 V6                                     | 175              | 04.08 |             |                               |                |        |   |  |  |  |   |
|  | 1.5 dCi          | 81    | 09.07       |                               | 24.3727-1089.2 | 581089 | 2 |  |  |  | L=2224  |
|  | 1.6 16V          | 81    | 09.07       |                               |                |        |   |  |  |  |   |
|  | 2.0 16V          | 103   | 09.07       |                               |                |        |   |  |  |  |   |
|  | 2.0 16V Hi-Flex  | 103   | 09.07       |                               |                |        |   |  |  |  |   |
|  | 2.0 16V Turbo    | 125   | 09.07       |                               |                |        |   |  |  |  |   |
|  | 2.0 16V Turbo GT | 150   | 03.08       |                               |                |        |   |  |  |  |   |
|  | 2.0 dCi          | 96    | 09.07       |                               |                |        |   |  |  |  |   |
|  | 2.0 dCi          | 110   | 09.07       |                               |                |        |   |  |  |  |   |
|  | 2.0 dCi          | 127   | 09.07       |                               |                |        |   |  |  |  |   |
|  | 2.0 dCi GT       | 131   | 03.08       |                               |                |        |   |  |  |  |   |
|  | 3.0 dCi V6       | 173   | 09.08       |                               |                |        |   |  |  |  |   |
|  | 3.5 V6           | 175   | 04.08       |                               |                |        |   |  |  |  |   |
| RENAULT LATITUDE (L70_) (11-13)            |                  |       |             |                               |                |        |   |  |  |  |   |
|  | 1.5 dCi          | 81    | 02.11       | 06.13                         | 11.9571-9775.2 | 220859 | 2 |  |  |  | D=57, - Halter<br>D=57, - Halter<br>Hülensatz<br>Haltefeder |
|  | 2.0 16V          | 103   | 02.11       | 06.13                         | 11.9571-9776.2 | 220860 |   |  |  |  |   |
|  | 2.0 16V eco2     | 103   | 02.11       | 06.13                         | 11.0101-5704.2 | 260095 |   |  |  |  |   |
|  | 2.0 dCi          | 130   | 02.11       | 06.13                         | 11.8116-0351.1 | 390538 |   |  |  |  |   |
|  | 2.0 dCi 150      | 110   | 02.11       | 06.13                         |                |        |   |  |  |  |   |
|  | 2.0 dCi 175      | 127   | 05.11       | 06.13                         |                |        |   |  |  |  |   |
|  | 2.5 dCi          |       | 05.11       | 06.13                         |                |        |   |  |  |  |   |
| 3.0 dCi 240                                | 177              | 02.11 | 06.13       | 11.8116-0351.1                | 390538         | 2      |   |  |  | Haltefeder<br>Hülensatz<br>Dichtungssatz |   |
|  |                  |       |             | 11.0101-5704.2                | 260095         |        |   |  |  |  | ATE<br>ATE<br>ATE<br>ATE                                    |
|  |                  |       |             | 11.0441-6008.2                | 250038         |        |   |  |  |  | ATE<br>ATE<br>ATE   |
| RENAULT LOGAN (LS_) (04-13)                |                  |       |             |                               |                |        |   |  |  |  |   |
|  | 1.4              | 55    | 09.04       | 10.09 + ABS                   | 03.7750-8532.4 | 300264 |   |  |  |  | 9"  |
|  | 1.5 dCi          | 50    | 04.07       | 10.09 + ABS                   |                |        |   |  |  |  |   |
|  | 1.5 dCi          | 63    | 02.08       | 10.09 + ABS                   |                |        |   |  |  |  |   |
|  | 1.6              | 64    | 09.04       | 10.09 + ABS                   |                |        |   |  |  |  |   |
|  | 1.6              | 77    | 04.07       | 10.09 + ABS                   |                |        |   |  |  |  |   |
|  | 1.4              | 55    | 11.09       | 04.13 + ABS                   | 03.7853-4102.4 | 300271 |   |  |  |  |   |
| 1.5 dCi                                    | 50               | 11.09 | 04.13 + ABS |                               |                |        |   |  |  |  |   |
| 1.5 dCi                                    | 63               | 11.09 | 04.13 + ABS |                               |                |        |   |  |  |  |   |
| 1.6  | 64               | 11.09 | 04.13 + ABS |                               |                |        |   |  |  |  |   |
| 1.6  | 77               | 11.09 | 04.13 + ABS |                               |                |        |   |  |  |  |   |
|  | 1.4              | 55    | 09.04       | 04.13 + ABS                   | 24.2120-1754.3 | 010949 |   |  |  |  | THz 20,64   |
|  | 1.5 dCi          | 50    | 04.07       | 04.13 + ABS                   |                |        |   |  |  |  |   |
|  | 1.5 dCi          | 63    | 02.08       | 04.13 + ABS                   |                |        |   |  |  |  |   |
|  | 1.6              | 64    | 09.04       | 04.13 + ABS                   |                |        |   |  |  |  |   |
|  | 1.6              | 77    | 04.07       | 04.13 + ABS                   |                |        |   |  |  |  |   |
|  | 1.4              | 55    | 09.04       | 04.13                         | 24.3481-1611.5 | 240029 | 2 |  |  |  | D=48, - Halter<br>D=48, - Halter                            |
|  | 1.6              | 64    | 09.04       | 04.13                         | 24.3481-1612.5 | 240030 |   |  |  |  |   |
|  | 1.5 dCi          | 50    | 04.07       | 04.13                         | 24.3481-1615.5 | 240031 |   |  |  |  |   |
|  | 1.5 dCi          | 63    | 02.08       | 04.13                         | 24.3481-1616.5 | 240032 |   |  |  |  |   |
| 1.6  | 77               | 04.07 | 04.13       |                               |                |        |   |  |  |  | D=48, - Halter<br>D=48, - Halter                            |
|  | 1.4              | 55    | 09.04       | 04.13                         | 24.5111-0300.3 | 330407 | 2 |  |  |  | L=300   |
|  | 1.5 dCi          | 50    | 04.07       | 04.13                         |                |        |   |  |  |  |   |
|  | 1.5 dCi          | 63    | 02.08       | 04.13                         |                |        |   |  |  |  |   |
|  | 1.6              | 64    | 09.04       | 04.13                         |                |        |   |  |  |  |   |
|  | 1.6              | 77    | 04.07       | 04.13                         |                |        |   |  |  |  |   |
|  | 1.4              | 55    | 09.04       | 04.13                         | 24.5229-0285.3 | 330032 | 2 |  |  |  | L=285   |
|  | 1.5 dCi          | 50    | 04.07       | 04.13                         |                |        |   |  |  |  |   |
|  | 1.5 dCi          | 63    | 02.08       | 04.13                         |                |        |   |  |  |  |   |
|  | 1.6              | 64    | 09.04       | 04.13                         |                |        |   |  |  |  |   |
|  | 1.6              | 77    | 04.07       | 04.13                         |                |        |   |  |  |  |   |
|  | 1.4              | 55    | 09.04       | 04.13                         | 24.3219-1722.3 | 020426 | 2 |  |  |  | Rz 19,05<br>Rz 17,78  |
|  | 1.5 dCi          | 50    | 04.07       | 04.13                         | 24.3217-1710.3 | 020420 |   |  |  |  |   |
|  | 1.5 dCi          | 63    | 02.08       | 04.13                         |                |        |   |  |  |  |   |
|  | 1.6              | 64    | 09.04       | 04.13                         |                |        |   |  |  |  |   |
|  | 1.6              | 77    | 04.07       | 04.13                         |                |        |   |  |  |  |   |
|  | 1.4              | 55    | 09.04       | 04.13                         | 24.3727-1073.2 | 581073 | 2 |  |  |  | L=1680  |
|  | 1.5 dCi          | 50    | 04.07       | 04.13                         |                |        |   |  |  |  |   |
|  | 1.5 dCi          | 63    | 02.08       | 04.13                         |                |        |   |  |  |  |   |
|  | 1.6              | 64    | 09.04       | 04.13                         |                |        |   |  |  |  |   |
|  | 1.6              | 77    | 04.07       | 04.13                         |                |        |   |  |  |  |   |
|  | 1.4              | 55    | 09.04       | 04.13                         | 24.3728-1031.2 | 591031 | 2 |  |  |  | L=1033  |
|  | 1.5 dCi          | 50    | 04.07       | 04.13                         |                |        |   |  |  |  |   |
|  | 1.5 dCi          | 63    | 02.08       | 04.13                         |                |        |   |  |  |  |   |
|  | 1.6              | 64    | 09.04       | 04.13                         |                |        |   |  |  |  |   |
|  | 1.6              | 77    | 04.07       | 04.13                         |                |        |   |  |  |  |   |

<sup>1)</sup> - 4 wheel steering / - 4 ruote sterzanti / - 4 roues directionnelles / + dirección sobre cuatro ruedas

<sup>2)</sup> + 4 wheel steering / + 4 ruote sterzanti / + 4 roues directionnelles / + dirección sobre cuatro ruedas

| RENAULT LOGAN Kombi (KS_) (04-13) |              |    |  |       |       |            |                |        |     |                                  |           |     |  |
|-----------------------------------|--------------|----|--|-------|-------|------------|----------------|--------|-----|----------------------------------|-----------|-----|--|
|                                   | 1.4          | 55 |  | 10.07 | 10.09 | + ABS      | 03.7750-8532.4 | 300264 |     |                                  | 9"        | ATE |  |
|                                   | 1.5 dCi      | 50 |  | 04.07 | 10.09 | + ABS      |                |        |     |                                  |           |     |  |
|                                   | 1.5 dCi      | 63 |  | 02.08 | 10.09 | + ABS      |                |        |     |                                  |           |     |  |
|                                   | 1.6          | 64 |  | 04.07 | 10.09 | + ABS      |                |        |     |                                  |           |     |  |
|                                   | 1.6          | 77 |  | 04.07 | 10.09 | + ABS      |                |        |     |                                  |           |     |  |
|                                   | 1.4          | 55 |  | 11.09 | 04.13 | + ABS      | 03.7853-4102.4 | 300271 |     |                                  | 9"        | ATE |  |
|                                   | 1.5 dCi      | 50 |  | 11.09 | 04.13 | + ABS      |                |        |     |                                  |           |     |  |
|                                   | 1.5 dCi      | 63 |  | 11.09 | 04.13 | + ABS      |                |        |     |                                  |           |     |  |
|                                   | 1.6          | 64 |  | 11.09 | 04.13 | + ABS      |                |        |     |                                  |           |     |  |
|                                   | 1.6          | 77 |  | 11.09 | 04.13 | + ABS      |                |        |     |                                  |           |     |  |
|                                   | 1.4          | 55 |  | 10.07 | 04.13 | + ABS      | 24.2120-1754.3 | 010949 |     |                                  | THz 20,64 |     |  |
|                                   | 1.5 dCi      | 50 |  | 04.07 | 04.13 | + ABS      |                |        |     |                                  |           |     |  |
|                                   | 1.5 dCi      | 63 |  | 02.08 | 04.13 | + ABS      |                |        |     |                                  |           |     |  |
|                                   | 1.6          | 64 |  | 04.07 | 04.13 | + ABS      |                |        |     |                                  |           |     |  |
|                                   | 1.6          | 77 |  | 04.07 | 04.13 | + ABS      |                |        |     |                                  |           |     |  |
|                                   | 1.4          | 55 |  | 10.07 | 04.13 |            | 24.3481-1611.5 | 240029 |     | D=48, - Halter                   | LUC       |     |  |
|                                   | 1.5 dCi      | 50 |  | 04.07 | 04.13 |            |                |        |     |                                  |           |     |  |
|                                   | 1.6          | 64 |  | 04.07 | 04.13 |            |                |        |     |                                  |           |     |  |
|                                   | 1.5 dCi      | 63 |  | 02.08 | 04.13 |            |                |        |     |                                  |           |     |  |
|                                   | 1.6          | 77 |  | 04.07 | 04.13 |            |                |        |     |                                  |           |     |  |
|                                   | 1.4          | 55 |  | 10.07 | 04.13 |            | 24.3481-1615.5 | 240031 |     | D=48, - Halter                   | LUC       |     |  |
|                                   | 1.5 dCi      | 50 |  | 04.07 | 04.13 |            |                |        |     |                                  |           |     |  |
|                                   | 1.6          | 64 |  | 04.07 | 04.13 |            |                |        |     |                                  |           |     |  |
|                                   | 1.5 dCi      | 63 |  | 02.08 | 04.13 |            |                |        |     |                                  |           |     |  |
|                                   | 1.6          | 77 |  | 04.07 | 04.13 |            |                |        |     |                                  |           |     |  |
|                                   | 1.4          | 55 |  | 10.07 | 04.13 |            | 24.5111-0300.3 | 330407 | 2   |                                  | L=300     |     |  |
|                                   | 1.5 dCi      | 50 |  | 04.07 | 04.13 |            |                |        |     |                                  |           |     |  |
|                                   | 1.5 dCi      | 63 |  | 02.08 | 04.13 |            |                |        |     |                                  |           |     |  |
|                                   | 1.6          | 64 |  | 04.07 | 04.13 |            |                |        |     |                                  |           |     |  |
|                                   | 1.6          | 77 |  | 04.07 | 04.13 |            |                |        |     |                                  |           |     |  |
|                                   | 1.4          | 55 |  | 10.07 | 04.13 |            | 24.5229-0285.3 | 330032 | 2   |                                  | L=285     |     |  |
|                                   | 1.5 dCi      | 50 |  | 04.07 | 04.13 |            |                |        |     |                                  |           |     |  |
|                                   | 1.5 dCi      | 63 |  | 02.08 | 04.13 |            |                |        |     |                                  |           |     |  |
|                                   | 1.6          | 64 |  | 04.07 | 04.13 |            |                |        |     |                                  |           |     |  |
|                                   | 1.6          | 77 |  | 04.07 | 04.13 |            |                |        |     |                                  |           |     |  |
|                                   | 1.4          | 55 |  | 10.07 | 04.13 |            | 24.3219-1722.3 | 020426 |     | Rz 19,05                         | BDX       |     |  |
|                                   | 1.5 dCi      | 50 |  | 04.07 | 04.13 |            |                |        |     |                                  |           |     |  |
|                                   | 1.5 dCi      | 63 |  | 02.08 | 04.13 |            |                |        |     |                                  |           |     |  |
|                                   | 1.6          | 64 |  | 04.07 | 04.13 |            |                |        |     |                                  |           |     |  |
|                                   | 1.6          | 77 |  | 04.07 | 04.13 |            |                |        |     |                                  |           |     |  |
|                                   | 1.4          | 55 |  | 10.07 | 04.13 |            | 24.3217-1710.3 | 020420 |     | Rz 17,78                         | LUC       |     |  |
|                                   | 1.5 dCi      | 50 |  | 04.07 | 04.13 |            |                |        |     |                                  |           |     |  |
|                                   | 1.5 dCi      | 63 |  | 02.08 | 04.13 |            |                |        |     |                                  |           |     |  |
|                                   | 1.6          | 64 |  | 04.07 | 04.13 |            |                |        |     |                                  |           |     |  |
|                                   | 1.6          | 77 |  | 04.07 | 04.13 |            |                |        |     |                                  |           |     |  |
|                                   | 1.4          | 55 |  | 10.07 | 04.13 |            | 24.3727-1073.2 | 581073 | 2 ↓ |                                  | L=1680    |     |  |
|                                   | 1.5 dCi      | 50 |  | 04.07 | 04.13 |            |                |        |     |                                  |           |     |  |
|                                   | 1.5 dCi      | 63 |  | 02.08 | 04.13 |            |                |        |     |                                  |           |     |  |
|                                   | 1.6          | 64 |  | 04.07 | 04.13 |            |                |        |     |                                  |           |     |  |
|                                   | 1.6          | 77 |  | 04.07 | 04.13 |            |                |        |     |                                  |           |     |  |
|                                   | 1.4          | 55 |  | 10.07 | 04.13 |            | 24.3728-1031.2 | 591031 |     |                                  | L=1033    |     |  |
|                                   | 1.5 dCi      | 50 |  | 04.07 | 04.13 |            |                |        |     |                                  |           |     |  |
|                                   | 1.5 dCi      | 63 |  | 02.08 | 04.13 |            |                |        |     |                                  |           |     |  |
|                                   | 1.6          | 64 |  | 04.07 | 04.13 |            |                |        |     |                                  |           |     |  |
|                                   | 1.6          | 77 |  | 04.07 | 04.13 |            |                |        |     |                                  |           |     |  |
| RENAULT LOGAN Express (07-)       |              |    |  |       |       |            |                |        |     |                                  |           |     |  |
|                                   | 1.5 dCi      | 50 |  | 04.07 | 04.13 |            | 03.7750-8532.4 | 300264 |     | + ABS                            | 9"        | ATE |  |
|                                   | 1.6          | 64 |  | 04.07 | 04.13 |            |                |        |     |                                  |           |     |  |
|                                   | 1.5 dCi      | 50 |  | 09.07 | 04.13 |            | 03.2122-2031.3 | 010938 |     | + ABS                            | THz 22,20 | ATE |  |
|                                   | 1.6          | 64 |  | 09.07 | 04.13 |            |                |        |     |                                  |           |     |  |
|                                   | 1.5 dCi      | 50 |  | 04.07 | 04.13 |            | 24.3541-1823.5 | 240417 |     | D=54, - Halter                   |           |     |  |
|                                   | 1.6          | 64 |  | 04.07 | 04.13 |            |                |        |     |                                  |           |     |  |
|                                   | 1.5 dCi      | 50 |  | 04.07 | 11.08 |            | 24.5111-0300.3 | 330407 | 2   |                                  | L=300     |     |  |
|                                   | 1.6          | 64 |  | 04.07 | 11.08 |            |                |        |     |                                  |           |     |  |
|                                   | 1.5 dCi      | 50 |  | 04.07 | 04.13 |            | 24.5229-0285.3 | 330032 | 2   |                                  | L=285     |     |  |
|                                   | 1.6          | 64 |  | 04.07 | 04.13 |            |                |        |     |                                  |           |     |  |
|                                   | 1.5 dCi      | 50 |  | 04.07 | 04.13 |            | 24.3219-1761.3 | 020536 |     | - erhöhte Zuladung <sup>1)</sup> | Rz 19,05  |     |  |
|                                   | 1.6          | 64 |  | 04.07 | 04.13 |            |                |        |     |                                  |           |     |  |
|                                   | 1.5 dCi      | 50 |  | 04.07 | 04.13 |            | 24.3222-1729.3 | 020526 |     | + erhöhte Zuladung <sup>2)</sup> | Rz 22,20  |     |  |
|                                   | 1.6          | 64 |  | 04.07 | 04.13 |            |                |        |     |                                  |           |     |  |
|                                   | 1.5 dCi      | 50 |  | 04.07 | 04.13 |            | 24.3727-1074.2 | 581074 | 2 ↓ |                                  | L=1993    |     |  |
|                                   | 1.6          | 64 |  | 04.07 | 04.13 |            |                |        |     |                                  |           |     |  |
| RENAULT MASTER I Bus (80-98)      |              |    |  |       |       |            |                |        |     |                                  |           |     |  |
|                                   | 2.0 (Q--)    | 58 |  | 10.86 | 07.98 | - CH (N S) | 24.2125-1704.3 | 010446 |     |                                  | THz 25,40 | LUC |  |
|                                   | 2.0 (Q--)    | 59 |  | 08.80 | 09.86 | - CH (N S) |                |        |     |                                  |           |     |  |
|                                   | 2.0 (R--)    | 58 |  | 10.86 | 08.94 |            |                |        |     |                                  |           |     |  |
|                                   | 2.0 (R--)    | 59 |  | 08.80 | 09.86 |            |                |        |     |                                  |           |     |  |
|                                   | 2.1 D (Q--)  | 44 |  | 08.80 | 07.98 |            |                |        |     |                                  |           |     |  |
|                                   | 2.1 D (R--)  | 44 |  | 08.80 | 08.94 |            |                |        |     |                                  |           |     |  |
|                                   | 2.2 (Q--)    | 67 |  | 08.80 | 07.98 |            |                |        |     |                                  |           |     |  |
|                                   | 2.2 (R--)    | 67 |  | 08.80 | 08.94 |            |                |        |     |                                  |           |     |  |
|                                   | 2.4 D        | 53 |  | 09.86 | 10.89 |            |                |        |     |                                  |           |     |  |
|                                   | 2.4 D (Q--)  | 52 |  | 08.80 | 08.89 | - CH (N S) |                |        |     |                                  |           |     |  |
|                                   | 2.4 D (R--)  | 52 |  | 08.80 | 08.89 |            |                |        |     |                                  |           |     |  |
|                                   | 2.5 D (Q--)  | 55 |  | 08.89 | 07.98 | - CH (N S) |                |        |     |                                  |           |     |  |
|                                   | 2.5 D (R--)  | 55 |  | 08.89 | 08.94 |            |                |        |     |                                  |           |     |  |
|                                   | 2.5 TD (Q--) | 69 |  | 08.89 | 07.98 |            |                |        |     |                                  |           |     |  |
|                                   | 2.5 TD (Q--) | 72 |  | 08.89 | 07.98 |            |                |        |     |                                  |           |     |  |

<sup>1)</sup> - increased payload / - carico utile maggiorato / - charge utile augmentée / - incremento de carga  
<sup>2)</sup> + increased payload / + carico utile maggiorato / + charge utile augmentée / + incremento de carga

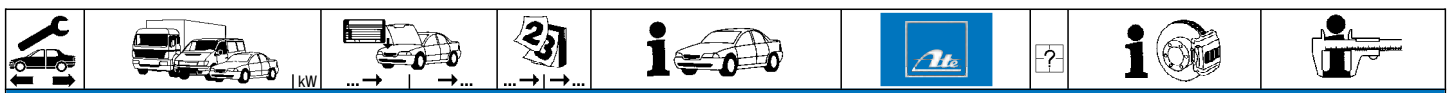

**RENAULT MASTER I Bus (80-98)**

|  |              |    |  |       |       |  |                |        |   |   |           |     |
|--|--------------|----|--|-------|-------|--|----------------|--------|---|---|-----------|-----|
|  | 2.5 TD (R--) | 69 |  | 08.89 | 08.94 |  | 24.2125-1704.3 | 010446 |   |   | THz 25,40 | LUC |
|  | 2.5 TD (R--) | 72 |  | 08.89 | 08.94 |  |                |        |   |   |           |     |
|  | 2.0          | 58 |  | 10.86 | 07.98 |  | 24.5112-0455.3 | 330527 | 2 |   | L=455     |     |
|  | 2.0          | 59 |  | 08.80 | 09.86 |  |                |        |   |   |           |     |
|  | 2.1 D        | 44 |  | 08.80 | 07.98 |  |                |        |   |   |           |     |
|  | 2.2          | 67 |  | 08.80 | 07.98 |  |                |        |   |   |           |     |
|  | 2.4 D        | 52 |  | 08.80 | 08.89 |  |                |        |   |   |           |     |
|  | 2.4 D        | 53 |  | 09.86 | 10.89 |  |                |        |   |   |           |     |
|  | 2.5 D        | 55 |  | 08.89 | 07.98 |  |                |        |   |   |           |     |
|  | 2.5 TD       | 69 |  | 08.89 | 07.98 |  |                |        |   |   |           |     |
|  | 2.5 TD       | 72 |  | 08.89 | 07.98 |  |                |        |   |   |           |     |
|  | 2.0          | 58 |  | 10.86 | 07.98 |  | 24.5112-0315.3 | 330509 | 2 | ■ | L=315     |     |
|  | 2.0          | 59 |  | 08.80 | 09.86 |  |                |        |   |   |           |     |
|  | 2.1 D        | 44 |  | 08.80 | 07.98 |  |                |        |   |   |           |     |
|  | 2.2          | 67 |  | 08.80 | 07.98 |  |                |        |   |   |           |     |
|  | 2.4 D        | 52 |  | 08.80 | 08.89 |  |                |        |   |   |           |     |
|  | 2.4 D        | 53 |  | 09.86 | 10.89 |  |                |        |   |   |           |     |
|  | 2.5 D        | 55 |  | 08.89 | 07.98 |  |                |        |   |   |           |     |
|  | 2.5 TD       | 69 |  | 08.89 | 07.98 |  |                |        |   |   |           |     |
|  | 2.5 TD       | 72 |  | 08.89 | 07.98 |  |                |        |   |   |           |     |
|  | 2.0          | 58 |  | 10.86 | 07.98 |  | 24.3225-1101.3 | 020294 |   |   | Rz 25,40  | LUC |
|  | 2.0          | 59 |  | 08.80 | 09.86 |  |                |        |   |   |           |     |
|  | 2.1 D        | 44 |  | 08.80 | 07.98 |  |                |        |   |   |           |     |
|  | 2.2          | 67 |  | 08.80 | 07.98 |  |                |        |   |   |           |     |
|  | 2.4 D        | 52 |  | 08.80 | 08.89 |  |                |        |   |   |           |     |
|  | 2.4 D        | 53 |  | 09.86 | 10.89 |  |                |        |   |   |           |     |
|  | 2.5 D        | 55 |  | 08.89 | 07.98 |  |                |        |   |   |           |     |
|  | 2.5 TD       | 69 |  | 08.89 | 07.98 |  |                |        |   |   |           |     |
|  | 2.5 TD       | 72 |  | 08.89 | 07.98 |  |                |        |   |   |           |     |

**RENAULT MASTER I Kasten (80-98)**

























|  |              |    |  |       |       |                |                |        |   |   |           |     |
|--|--------------|----|--|-------|-------|----------------|----------------|--------|---|---|-----------|-----|
|  | 2.0 (Q--)    | 58 |  | 10.86 | 07.98 | - (CH) (N) (S) | 24.2125-1704.3 | 010446 |   |   | THz 25,40 | LUC |
|  | 2.0 (Q--)    | 59 |  | 08.80 | 09.86 | - (CH) (N) (S) |                |        |   |   |           |     |
|  | 2.0 (R--)    | 58 |  | 10.86 | 07.98 |                |                |        |   |   |           |     |
|  | 2.0 (R--)    | 59 |  | 08.80 | 09.86 |                |                |        |   |   |           |     |
|  | 2.1 D (Q--)  | 44 |  | 08.80 | 07.98 |                |                |        |   |   |           |     |
|  | 2.1 D (R--)  | 44 |  | 08.80 | 07.98 |                |                |        |   |   |           |     |
|  | 2.2 (Q--)    | 67 |  | 08.80 | 07.98 |                |                |        |   |   |           |     |
|  | 2.2 (R--)    | 67 |  | 08.80 | 07.98 |                |                |        |   |   |           |     |
|  | 2.4 D (Q--)  | 52 |  | 08.80 | 08.89 | - (CH) (N) (S) |                |        |   |   |           |     |
|  | 2.4 D (R--)  | 52 |  | 08.80 | 08.89 |                |                |        |   |   |           |     |
|  | 2.5 D (Q--)  | 55 |  | 08.89 | 07.98 | - (CH) (N) (S) |                |        |   |   |           |     |
|  | 2.5 D (R--)  | 55 |  | 08.89 | 07.98 |                |                |        |   |   |           |     |
|  | 2.5 TD (Q--) | 69 |  | 08.89 | 07.98 |                |                |        |   |   |           |     |
|  | 2.5 TD (Q--) | 72 |  | 08.89 | 07.98 |                |                |        |   |   |           |     |
|  | 2.5 TD (R--) | 69 |  | 08.89 | 07.98 |                |                |        |   |   |           |     |
|  | 2.5 TD (R--) | 72 |  | 08.89 | 07.98 |                |                |        |   |   |           |     |
|  | 2.0          | 58 |  | 10.86 | 07.98 |                | 24.5112-0455.3 | 330527 | 2 |   | L=455     |     |
|  | 2.0          | 59 |  | 08.80 | 09.86 |                |                |        |   |   |           |     |
|  | 2.1 D        | 44 |  | 08.80 | 07.98 |                |                |        |   |   |           |     |
|  | 2.2          | 67 |  | 08.80 | 07.98 |                |                |        |   |   |           |     |
|  | 2.4 D        | 52 |  | 08.80 | 08.89 |                |                |        |   |   |           |     |
|  | 2.5 D        | 55 |  | 08.89 | 07.98 |                |                |        |   |   |           |     |
|  | 2.5 TD       | 69 |  | 08.89 | 07.98 |                |                |        |   |   |           |     |
|  | 2.5 TD       | 72 |  | 08.89 | 07.98 |                |                |        |   |   |           |     |
|  | 2.0          | 58 |  | 10.86 | 07.98 |                | 24.5112-0315.3 | 330509 | 1 | ■ | L=315     |     |
|  | 2.0          | 59 |  | 08.80 | 09.86 |                |                |        |   |   |           |     |
|  | 2.1 D        | 44 |  | 08.80 | 07.98 |                |                |        |   |   |           |     |
|  | 2.2          | 67 |  | 08.80 | 07.98 |                |                |        |   |   |           |     |
|  | 2.4 D        | 52 |  | 08.80 | 08.89 |                |                |        |   |   |           |     |
|  | 2.5 D        | 55 |  | 08.89 | 07.98 |                |                |        |   |   |           |     |
|  | 2.5 TD       | 69 |  | 08.89 | 07.98 |                |                |        |   |   |           |     |
|  | 2.5 TD       | 72 |  | 08.89 | 07.98 |                |                |        |   |   |           |     |
|  | 2.0          | 58 |  | 10.86 | 07.98 |                | 24.3225-1101.3 | 020294 |   |   | Rz 25,40  | LUC |
|  | 2.0          | 59 |  | 08.80 | 09.86 |                |                |        |   |   |           |     |
|  | 2.1 D        | 44 |  | 08.80 | 07.98 |                |                |        |   |   |           |     |
|  | 2.2          | 67 |  | 08.80 | 07.98 |                |                |        |   |   |           |     |
|  | 2.4 D        | 52 |  | 08.80 | 08.89 |                |                |        |   |   |           |     |
|  | 2.5 D        | 55 |  | 08.89 | 07.98 |                |                |        |   |   |           |     |
|  | 2.5 TD       | 69 |  | 08.89 | 07.98 |                |                |        |   |   |           |     |
|  | 2.5 TD       | 72 |  | 08.89 | 07.98 |                |                |        |   |   |           |     |

**RENAULT MASTER I Pritsche/Fahrgestell (80-98)**

|  |             |    |  |       |       |                |                |        |   |  |           |     |
|--|-------------|----|--|-------|-------|----------------|----------------|--------|---|--|-----------|-----|
|  | 2.0 (Q--)   | 58 |  | 10.86 | 07.98 | - (CH) (N) (S) | 24.2125-1704.3 | 010446 |   |  | THz 25,40 | LUC |
|  | 2.0 (Q--)   | 59 |  | 10.82 | 09.86 | - (CH) (N) (S) |                |        |   |  |           |     |
|  | 2.0 (R--)   | 58 |  | 10.86 | 07.98 |                |                |        |   |  |           |     |
|  | 2.0 (R--)   | 59 |  | 10.82 | 09.86 |                |                |        |   |  |           |     |
|  | 2.5 D (Q--) | 55 |  | 08.89 | 07.98 | - (CH) (N) (S) |                |        |   |  |           |     |
|  | 2.5 D (R--) | 55 |  | 08.89 | 07.98 |                |                |        |   |  |           |     |
|  | 2.0         | 58 |  | 10.86 | 07.98 |                | 24.5112-0455.3 | 330527 | 2 |  | L=455     |     |
|  | 2.0         | 59 |  | 10.82 | 09.86 |                |                |        |   |  |           |     |
|  | 2.5 D       | 55 |  | 08.89 | 07.98 |                |                |        |   |  |           |     |





































|     |       |  |  |  |  |  |  |      |  |
|--|---|--|--|--|---|--|--|--|--|
| <b>RENAULT MASTER I Pritsche/Fahrgestell (80-98)</b>                               |   |  |  |  |   |  |  |  |  |
|    | 2.0<br>2.0<br>2.5 D   | 58<br>59<br>55   |  | 10.86<br>10.82<br>08.89  | 07.98<br>09.86<br>07.98   | 24.5112-0315.3   | 330509   | 1 <input type="checkbox"/>   | L=315  |
|    | 2.0<br>2.0<br>2.5 D   | 58<br>59<br>55   |  | 10.86<br>10.82<br>08.89  | 07.98<br>09.86<br>07.98   | 24.3225-1101.3   | 020294   |  | Rz 25,40 <b>LUC</b>                                    |
|    | 2.0<br>2.1 D<br>2.2   | 60<br>46<br>71   |  | 11.89<br>11.89<br>08.93  | 12.95<br>07.93<br>02.98   | 24.3728-1032.2   | 591032   |  | L=1335   |
| <b>RENAULT MASTER II Bus (JD/ND_) (98-06)</b>                                      |   |  |  |  |   |  |  |  |  |
|    | 1.9 dCi 80<br>1.9 dTi<br>2.2 dCi 90<br>2.5 D<br>2.5 dCi 120<br>2.8 dTi                | 60<br>59<br>66<br>59<br>84<br>84   |  | 11.01<br>09.00<br>09.00<br>07.98<br>10.01<br>07.98                               | 10.03<br>10.03<br>10.03<br>01.01<br>10.03<br>10.01                                | 24.2025-1708.3<br>24.2025-1706.3   | 010692<br>010676   | - ABS<br>+ ABS   | THz 25,40<br>THz 25,40                                 |
|    | 1.9 dCi 80<br>1.9 dTi<br>2.2 dCi 90<br>2.5 dCi 100<br>2.5 dCi 120                     | 60<br>59<br>66<br>73<br>84   |  | 11.03<br>11.03<br>11.03<br>10.03<br>11.03  | 08.06<br>08.06<br>08.06<br>08.06<br>08.06   | 24.2025-1708.3<br>24.2123-1759.3   | 010692<br>010768   | - ABS<br>+ ABS   | THz 25,40<br>THz 23,81 <b>BOS</b>                      |
|    | 2.5 D<br>2.8 dTi  | 59<br>84   |  | 07.98<br>07.98   | 07.00<br>07.00  | 24.5134-0562.3<br>24.5134-0518.3   | 330706<br>330705   | 2 <input type="checkbox"/><br>2 <input type="checkbox"/>                               | L=568<br>L=518   |
|    | 1.9 dCi 80<br>1.9 dTi<br>2.2 dCi 90<br>2.5 D<br>2.5 dCi 100<br>2.5 dCi 120<br>2.8 dTi | 60<br>59<br>66<br>59<br>73<br>84<br>84   |  | 11.01<br>09.00<br>09.00<br>08.00<br>10.03<br>10.01<br>08.00                      | 08.06<br>08.06<br>08.06<br>01.01<br>08.06<br>08.06<br>10.01                       | 24.5134-0468.3<br>24.5134-0457.3   | 330704<br>330752   | 2 <input type="checkbox"/><br>2 <input type="checkbox"/>                               | L=468<br>L=457   |
|    | 1.9 dCi 80<br>1.9 dTi<br>2.2 dCi 90<br>2.5 dCi 120                                    | 60<br>59<br>66<br>84   |  | 11.01<br>09.00<br>09.00<br>10.01   | 10.03<br>10.03<br>10.03<br>10.03  | 24.5134-0468.3<br>24.5134-0457.3   | 330704<br>330752   | 2 <input type="checkbox"/><br>2 <input type="checkbox"/>                               | L=468<br>L=457   |
|  | 1.9 dCi 80<br>1.9 dTi<br>2.2 dCi 90<br>2.5 dCi 100<br>2.5 dCi 120                     | 60<br>59<br>66<br>73<br>84   |  | 11.03<br>11.03<br>11.03<br>10.03<br>11.03  | 08.06<br>08.06<br>08.06<br>08.06<br>08.06   | 24.5111-0510.3   | 330819   | 2  | L=510  |
|  | 1.9 dCi 80<br>1.9 dTi<br>2.2 dCi 90<br>2.5 D<br>2.5 dCi 100<br>2.5 dCi 120<br>2.8 dTi | 60<br>59<br>66<br>59<br>73<br>84<br>84   |  | 11.01<br>09.00<br>09.00<br>07.98<br>10.03<br>10.01<br>07.98                      | 08.06<br>08.06<br>08.06<br>01.01<br>08.06<br>08.06<br>10.01                       | 24.3424-1701.5<br>24.3424-1702.5   | 240561<br>240562   | <input type="checkbox"/><br><input type="checkbox"/>                                   | D=42, - Halter <b>BOS</b><br>D=42, - Halter <b>BOS</b> |
|  | 1.9 dCi 80<br>1.9 dTi<br>2.2 dCi 90<br>2.5 D<br>2.5 dCi 100<br>2.5 dCi 120<br>2.8 dTi | 60<br>59<br>66<br>59<br>73<br>84<br>84   |  | 11.01<br>09.00<br>09.00<br>07.98<br>10.03<br>10.01<br>07.98                      | 11.03<br>11.03<br>11.03<br>01.01<br>11.03<br>11.03<br>10.01                       | 24.5111-0410.3<br>24.5111-0326.3   | 330681<br>330766   | 1 <input type="checkbox"/><br>2 <input type="checkbox"/>                               | L=410<br>L=326   |
|  | 1.9 dCi 80<br>1.9 dTi<br>2.2 dCi 90<br>2.5 dCi 100<br>2.5 dCi 120                     | 60<br>59<br>66<br>73<br>84   |  | 12.03<br>12.03<br>12.03<br>12.03   | 08.06<br>08.06<br>08.06<br>08.06  | 24.5258-0450.3<br>24.5251-0465.3   | 330824<br>330822   | <input type="checkbox"/><br><input type="checkbox"/>                                   | L=450<br>L=465   |
|  | 2.5 D<br>2.8 dTi  | 59<br>84   |  | 07.98<br>07.98   | 07.00<br>07.00  | 24.3223-1707.3<br>24.3223-1708.3   | 020435<br>020436   | <input type="checkbox"/><br><input type="checkbox"/>                                   | Rz 23,81 <b>BDX</b><br>Rz 23,81 <b>BDX</b>             |
|  | 1.9 dCi 80<br>1.9 dTi<br>2.2 dCi 90<br>2.5 D<br>2.5 dCi 100<br>2.5 dCi 120<br>2.8 dTi | 60<br>59<br>66<br>59<br>73<br>84<br>84   |  | 11.01<br>09.00<br>09.00<br>07.98<br>10.03<br>10.01<br>07.98                      | 08.06<br>08.06<br>08.06<br>01.01<br>08.06<br>08.06<br>10.01                       | 24.3727-0762.2<br>24.3727-1072.2<br>24.3727-1000.2                                 | 580762<br>581072<br>581000   | 1 <input type="checkbox"/><br>2 <input type="checkbox"/><br>2 <input type="checkbox"/> | L=1175<br>L=1420<br>L=1737                             |
|  | 1.9 dCi 80<br>1.9 dTi<br>2.2 dCi 90<br>2.5 D<br>2.5 dCi 100<br>2.5 dCi 120<br>2.8 dTi | 60<br>59<br>66<br>59<br>73<br>84<br>84   |  | 11.01<br>09.00<br>09.00<br>02.99<br>10.03<br>10.01<br>02.99                      | 08.06<br>08.06<br>08.06<br>01.01<br>08.06<br>08.06<br>10.01                       | 24.2415-1710.3   | 030124   |  | Gz 15,87   |
| <b>RENAULT MASTER II Kasten (FD_) (98-06)</b>                                      |   |  |  |  |   |  |  |  |  |
|  | 1.9 dCi 80<br>1.9 dTi<br>2.2 dCi 90<br>2.5 D<br>2.5 dCi 120<br>2.8 dTi                | 60<br>59<br>65<br>59<br>84<br>84   |  | 11.01<br>09.00<br>09.00<br>07.98<br>10.01<br>07.98                               | 10.03<br>10.03<br>10.03<br>01.01<br>10.03<br>10.01                                | 24.2025-1708.3<br>24.2025-1706.3   | 010692<br>010676   | - ABS<br>+ ABS   | THz 25,40<br>THz 25,40                                 |

1) on the brake caliper / sulla pinza freno / sur l'étrier de frein / a la pinza de freno

2) notice length / attenzione lunghezza / faire attention longueur / atención largo

| RENAULT MASTER II Kasten (FD_) (98-06)   |  |  |  |  |   |  |  |  |   |                |
|--|--|--|--|--|---|--|--|--|---|----------------|
|     |  |  |  |  |  |  |  |  |   |                |
|    | 1.9 dCi 80   | 60   |  | 11.03  | 08.06   | 24.2025-1708.3   | 010692   | - ABS  |   | THz 25,40      |
|  | 1.9 dTi  | 59   |  | 11.03  | 08.06   | 24.2123-1759.3   | 010768   | + ABS  |   | THz 23,81      |
|  | 2.2 dCi 90   | 65   |  | 11.03  | 08.06   |  |  |  |   | <b>BOS</b>     |
|  | 2.5 dCi 100  | 73   |  | 10.03  | 08.06   |  |  |  |   |                |
|  | 2.5 dCi 120  | 84   |  | 11.03  | 08.06   |  |  |  |   |                |
|  | 3.0 dCi 120  | 85   |  | 06.05  | 08.06   |  |  |  |   |                |
|  | 3.0 dCi 140  | 100  |  | 10.03  | 08.06   |  |  |  |   |                |
|  | 3.0 dCi 160  | 115  |  | 06.05  | 08.06   |  |  |  |   |                |
|    | 2.5 D  | 59   |  | 07.98  | 01.01   | 24.5134-0562.3   | 330706   |  | 2      | L=568          |
|  | 2.8 dTi  | 84   |  | 07.98  | 07.00   | 24.5134-0518.3   | 330705   |  | 2      | L=518          |
|  | 1.9 dCi 80   | 60   |  | 11.01  | 08.06   | 24.5134-0468.3   | 330704   | - ABS  | 2      | L=468          |
|  | 1.9 dTi  | 59   |  | 09.00  | 08.06   | 24.5134-0457.3   | 330752   | - ABS  | 2      | L=457          |
|  | 2.2 dCi 90   | 65   |  | 09.00  | 08.06   |  |  | - ABS  |   |                |
|  | 2.5 D  | 59   |  | 08.00  | 01.01   |  |  |  |   |                |
|  | 2.5 dCi 100  | 73   |  | 10.03  | 08.06   |  |  | - ABS  |   |                |
|  | 2.5 dCi 120  | 84   |  | 10.01  | 08.06   |  |  | - ABS  |   |                |
|  | 2.8 dTi  | 84   |  | 08.00  | 10.01   |  |  |  |   |                |
|  | 3.0 dCi 120  | 85   |  | 06.05  | 08.06   |  |  | - ABS  |   |                |
|  | 3.0 dCi 140  | 100  |  | 10.03  | 08.06   |  |  | - ABS  |   |                |
|  | 3.0 dCi 160  | 115  |  | 06.05  | 08.06   |  |  | - ABS  |   |                |
|  | 1.9 dCi 80   | 60   |  | 11.01  | 10.03   | 24.5134-0468.3   | 330704   | + ABS  | 2      | L=468          |
|  | 1.9 dTi  | 59   |  | 09.00  | 10.03   | 24.5134-0457.3   | 330752   | + ABS  | 2      | L=457          |
|  | 2.2 dCi 90   | 65   |  | 09.00  | 10.03   |  |  | + ABS  |   |                |
|  | 2.5 D  | 59   |  | 08.00  | 01.01   |  |  |  |   |                |
|  | 2.5 dCi 120  | 84   |  | 10.01  | 10.03   |  |  | + ABS  |   |                |
|  | 2.8 dTi  | 84   |  | 08.00  | 10.01   |  |  |  |   |                |
|  | 1.9 dCi 80   | 60   |  | 11.03  | 08.06   | 24.5111-0510.3   | 330819   | + ABS  | 2   | L=510          |
|  | 1.9 dTi  | 59   |  | 11.03  | 08.06   |  |  | + ABS  |   |                |
|  | 2.2 dCi 90   | 65   |  | 11.03  | 08.06   |  |  | + ABS  |   |                |
|  | 2.5 dCi 100  | 73   |  | 10.03  | 08.06   |  |  | + ABS  |   |                |
|  | 2.5 dCi 120  | 84   |  | 11.03  | 08.06   |  |  | + ABS  |   |                |
|  | 3.0 dCi 120  | 85   |  | 06.05  | 08.06   |  |  | + ABS  |   |                |
|  | 3.0 dCi 140  | 100  |  | 10.03  | 08.06   |  |  | + ABS  |   |                |
|  | 3.0 dCi 160  | 115  |  | 06.05  | 08.06   |  |  | + ABS  |   |                |
|    | 1.9 dCi 80   | 60   |  | 11.01  | 08.06   | 24.3424-1701.5   | 240561   |  |      | D=42, - Halter |
|  | 1.9 dTi  | 59   |  | 09.00  | 08.06   | 24.3424-1702.5   | 240562   |  |      | D=42, - Halter |
|  | 2.2 dCi 90   | 65   |  | 09.00  | 08.06   |  |  |  |   | <b>BOS</b>     |
|  | 2.5 D  | 59   |  | 08.00  | 01.01   |  |  |  |   | <b>BOS</b>     |
|  | 2.5 dCi 100  | 73   |  | 10.03  | 08.06   |  |  |  |   |                |
|  | 2.5 dCi 120  | 84   |  | 10.01  | 08.06   |  |  |  |   |                |
|  | 2.8 dTi  | 84   |  | 08.00  | 10.01   |  |  |  |   |                |
|  | 3.0 dCi 120  | 85   |  | 06.05  | 08.06   |  |  |  |   |                |
|  | 3.0 dCi 140  | 100  |  | 10.03  | 08.06   |  |  |  |   |                |
|  | 3.0 dCi 160  | 115  |  | 06.05  | 08.06   |  |  |  |   |                |
|  | 1.9 dCi 80   | 60   |  | 11.01  | 11.03   | 24.5111-0410.3   | 330681   |  | 1  | L=410          |
|  | 1.9 dTi  | 59   |  | 09.00  | 11.03   | 24.5111-0326.3   | 330766   |  | 2  | L=326          |
|  | 2.2 dCi 90   | 65   |  | 09.00  | 11.03   |  |  |  |   |                |
|  | 2.5 D  | 59   |  | 07.98  | 01.01   |  |  |  |   |                |
|  | 2.5 dCi 100  | 73   |  | 10.03  | 11.03   |  |  |  |   |                |
|  | 2.5 dCi 120  | 84   |  | 10.01  | 11.03   |  |  |  |   |                |
|  | 2.8 dTi  | 84   |  | 07.98  | 10.01   |  |  |  |   |                |
|  | 3.0 dCi 140  | 100  |  | 10.03  | 11.03   |  |  |  |   |                |
|  | 1.9 dCi 80   | 60   |  | 12.03  | 08.06   | 24.5258-0450.3   | 330824   |  |    | L=450          |
|  | 1.9 dTi  | 59   |  | 12.03  | 08.06   | 24.5251-0465.3   | 330822   |  |    | L=465          |
|  | 2.2 dCi 90   | 65   |  | 12.03  | 08.06   |  |  |  |   |                |
|  | 2.5 dCi 100  | 73   |  | 12.03  | 08.06   |  |  |  |   |                |
|  | 2.5 dCi 120  | 84   |  | 12.03  | 08.06   |  |  |  |   |                |
|  | 3.0 dCi 120  | 85   |  | 06.05  | 08.06   |  |  |  |   |                |
|  | 3.0 dCi 140  | 100  |  | 12.03  | 08.06   |  |  |  |   |                |
|  | 3.0 dCi 160  | 115  |  | 06.05  | 08.06   |  |  |  |   |                |
|  | 2.5 D  | 59   |  | 07.98  | 07.00   | 24.3223-1707.3   | 020435   |  |    | Rz 23,81       |
|  | 2.8 dTi  | 84   |  | 07.98  | 07.00   | 24.3223-1708.3   | 020436   |  |    | Rz 23,81       |
|  | 1.9 dCi 80   | 60   |  | 11.01  | 08.06   | 24.3727-0762.2   | 580762   |  | 1  | L=1175         |
|  | 1.9 dTi  | 59   |  | 09.00  | 08.06   | 24.3727-1072.2   | 581072   |  | 2  | L=1420         |
|  | 2.2 dCi 90   | 65   |  | 09.00  | 08.06   | 24.3727-1000.2   | 581000   |  | 2  | L=1737         |
|  | 2.5 D  | 59   |  | 08.00  | 01.01   |  |  |  |   |                |
|  | 2.5 dCi 100  | 73   |  | 10.03  | 08.06   |  |  |  |   |                |
|  | 2.5 dCi 120  | 84   |  | 10.01  | 08.06   |  |  |  |   |                |
|  | 2.8 dTi  | 84   |  | 08.00  | 10.01   |  |  |  |   |                |
|  | 3.0 dCi 120  | 85   |  | 06.05  | 08.06   |  |  |  |   |                |
|  | 3.0 dCi 140  | 100  |  | 10.03  | 08.06   |  |  |  |   |                |
|  | 3.0 dCi 160  | 115  |  | 06.05  | 08.06   |  |  |  |   |                |
|  | 1.9 dCi 80   | ≠ 60   |  | 11.01  | 08.06   | 24.2415-1710.3   | 030124   |  |   | Gz 15,87       |
|  | 1.9 dTi  | ≠ 59   |  | 09.00  | 08.06   |  |  |  |   |                |
|  | 2.2 dCi 90   | ≠ 65   |  | 09.00  | 08.06   |  |  |  |   |                |
|  | 2.5 D  | ≠ 59   |  | 02.99  | 01.01   |  |  |  |   |                |
|  | 2.5 dCi 100  | ≠ 73   |  | 10.03  | 08.06   |  |  |  |   |                |
|  | 2.5 dCi 120  | ≠ 84   |  | 10.01  | 08.06   |  |  |  |   |                |
|  | 2.8 dTi  | ≠ 84   |  | 02.99  | 10.01   |  |  |  |   |                |
|  | 3.0 dCi 120  | ≠ 85   |  | 06.05  | 08.06   |  |  |  |   |                |
|  | 3.0 dCi 140  | ≠ 100  |  | 10.03  | 08.06   |  |  |  |   |                |
|  | 3.0 dCi 160  | ≠ 115  |  | 06.05  | 08.06   |  |  |  |   |                |

1) on the brake caliper / sulla pinza freno / sur l'étrier de frein / a la pinza de freno

2) notice length / attenzione lunghezza / faire attention longueur / atención largo

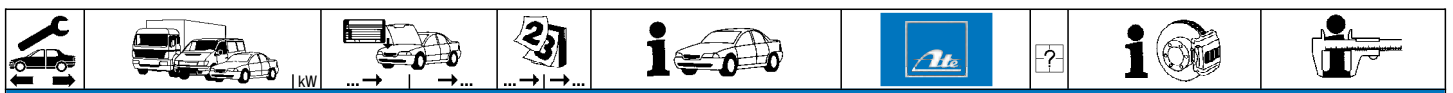

### RENAULT MASTER II Pritsche/Fahrgestell (ED/HD/UD\_) (98-06)

|             |             |       |       |       |                |        |       |                |            |
|-------------|-------------|-------|-------|-------|----------------|--------|-------|----------------|------------|
|             | 2.2 dCi 90  | 66    | 09.00 | 10.03 | 24.2025-1708.3 | 010692 | - ABS | THz 25,40      |            |
|             | 2.5 D       | 59    | 07.98 | 01.01 | 24.2025-1706.3 | 010676 | + ABS | THz 25,40      |            |
|             | 2.5 dCi 120 | 84    | 10.01 | 10.03 |                |        |       |                |            |
|             | 2.8 dTi     | 84    | 07.98 | 10.01 |                |        |       |                |            |
|             | 2.2 dCi 90  | 66    | 11.03 | 08.06 | 24.2025-1708.3 | 010692 | - ABS | THz 25,40      | <b>BOS</b> |
|             | 2.5 dCi 100 | 73    | 10.03 | 08.06 | 24.2123-1759.3 | 010768 | + ABS | THz 23,81      |            |
|             | 2.5 dCi 120 | 84    | 11.03 | 08.06 |                |        |       |                |            |
| 3.0 dCi 120 | 85          | 06.05 | 08.06 |       |                |        |       |                |            |
| 3.0 dCi 140 | 100         | 10.03 | 08.06 |       |                |        |       |                |            |
| 3.0 dCi 160 | 115         | 06.05 | 08.06 |       |                |        |       |                |            |
|             | 2.5 D       | 59    | 07.98 | 07.00 | 24.5134-0562.3 | 330706 | 2     | L=568          |            |
|             | 2.8 dTi     | 84    | 07.98 | 07.00 | 24.5134-0518.3 | 330705 | 2     | L=518          |            |
|             | 2.2 dCi 90  | 66    | 09.00 | 08.06 | 24.5134-0468.3 | 330704 | 2     | L=468          |            |
|             | 2.5 D       | 59    | 08.00 | 01.01 | 24.5134-0457.3 | 330752 | 2     | L=457          |            |
|             | 2.5 dCi 100 | 73    | 10.03 | 08.06 |                |        |       |                |            |
|             | 2.5 dCi 120 | 84    | 10.01 | 08.06 |                |        |       |                |            |
|             | 2.8 dTi     | 84    | 08.00 | 10.01 |                |        |       |                |            |
|             | 3.0 dCi 120 | 85    | 06.05 | 08.06 |                |        |       |                |            |
|             | 3.0 dCi 140 | 100   | 10.03 | 08.06 |                |        |       |                |            |
|             | 3.0 dCi 160 | 115   | 06.05 | 08.06 |                |        |       |                |            |
|             | 2.2 dCi 90  | 66    | 09.00 | 10.03 | 24.5134-0468.3 | 330704 | 2     | L=468          |            |
|             | 2.5 dCi 120 | 84    | 10.01 | 10.03 | 24.5134-0457.3 | 330752 | 2     | L=457          |            |
|             | 2.2 dCi 90  | 66    | 11.03 | 08.06 | 24.5111-0510.3 | 330819 | 2     | L=510          |            |
|             | 2.5 dCi 100 | 73    | 10.03 | 08.06 |                |        |       |                |            |
| 2.5 dCi 120 | 84          | 11.03 | 08.06 |       |                |        |       |                |            |
| 3.0 dCi 120 | 85          | 06.05 | 08.06 |       |                |        |       |                |            |
| 3.0 dCi 140 | 100         | 10.03 | 08.06 |       |                |        |       |                |            |
| 3.0 dCi 160 | 115         | 06.05 | 08.06 |       |                |        |       |                |            |
|             | 2.2 dCi 90  | 66    | 09.00 | 08.06 | 24.3424-1701.5 | 240561 |       | D=42, - Halter | <b>BOS</b> |
|             | 2.5 D       | 59    | 08.00 | 01.01 | 24.3424-1702.5 | 240562 |       | D=42, - Halter | <b>BOS</b> |
|             | 2.5 dCi 100 | 73    | 10.03 | 08.06 |                |        |       |                |            |
|             | 2.5 dCi 120 | 84    | 10.01 | 08.06 |                |        |       |                |            |
|             | 2.8 dTi     | 84    | 08.00 | 10.01 |                |        |       |                |            |
|             | 3.0 dCi 120 | 85    | 06.05 | 08.06 |                |        |       |                |            |
|             | 3.0 dCi 140 | 100   | 10.03 | 08.06 |                |        |       |                |            |
| 3.0 dCi 160 | 115         | 06.05 | 08.06 |       |                |        |       |                |            |
|             | 2.2 dCi 90  | 66    | 09.00 | 11.03 | 24.5111-0410.3 | 330681 | 1     | L=410          |            |
|             | 2.5 D       | 59    | 07.98 | 01.01 | 24.5111-0326.3 | 330766 | 2     | L=326          |            |
|             | 2.5 dCi 100 | 73    | 10.03 | 11.03 |                |        |       |                |            |
|             | 2.5 dCi 120 | 84    | 10.01 | 11.03 |                |        |       |                |            |
|             | 2.8 dTi     | 84    | 07.98 | 10.01 |                |        |       |                |            |
|             | 3.0 dCi 140 | 100   | 10.03 | 11.03 |                |        |       |                |            |
|             | 2.2 dCi 90  | 66    | 12.03 | 08.06 | 24.5258-0450.3 | 330824 |       | L=450          |            |
|             | 2.5 dCi 100 | 73    | 12.03 | 08.06 | 24.5251-0465.3 | 330822 |       | L=465          |            |
|             | 2.5 dCi 120 | 84    | 12.03 | 08.06 |                |        |       |                |            |
|             | 3.0 dCi 120 | 85    | 06.05 | 08.06 |                |        |       |                |            |
| 3.0 dCi 140 | 100         | 11.03 | 08.06 |       |                |        |       |                |            |
| 3.0 dCi 160 | 115         | 06.05 | 08.06 |       |                |        |       |                |            |
|             | 2.5 D       | 59    | 07.98 | 07.00 | 24.3223-1707.3 | 020435 |       | Rz 23,81       | <b>BDX</b> |
|             | 2.8 dTi     | 84    | 07.98 | 07.00 | 24.3223-1708.3 | 020436 |       | Rz 23,81       | <b>BDX</b> |
|             | 2.2 dCi 90  | 66    | 09.00 | 08.06 | 24.3727-0762.2 | 580762 | 2     | L=1175         |            |
|             | 2.5 D       | 59    | 07.98 | 01.01 | 24.3727-1072.2 | 581072 | 2     | L=1420         |            |
|             | 2.5 dCi 100 | 73    | 10.03 | 08.06 | 24.3727-1000.2 | 581000 | 2     | L=1737         |            |
|             | 2.5 dCi 120 | 84    | 10.01 | 08.06 |                |        |       |                |            |
|             | 2.8 dTi     | 84    | 07.98 | 10.01 |                |        |       |                |            |
|             | 3.0 dCi 120 | 85    | 06.05 | 08.06 |                |        |       |                |            |
|             | 3.0 dCi 140 | 100   | 10.03 | 08.06 |                |        |       |                |            |
| 3.0 dCi 160 | 115         | 06.05 | 08.06 |       |                |        |       |                |            |
|             | 2.2 dCi 90  | 66    | 09.00 | 08.06 | 24.2415-1710.3 | 030124 |       | Gz 15,87       |            |
|             | 2.5 D       | 59    | 02.99 | 01.01 |                |        |       |                |            |
|             | 2.5 dCi 100 | 73    | 10.03 | 08.06 |                |        |       |                |            |
|             | 2.5 dCi 120 | 84    | 10.01 | 08.06 |                |        |       |                |            |
|             | 2.8 dTi     | 84    | 02.99 | 10.01 |                |        |       |                |            |
|             | 3.0 dCi 120 | 85    | 06.05 | 08.06 |                |        |       |                |            |
|             | 3.0 dCi 140 | 100   | 10.03 | 08.06 |                |        |       |                |            |
| 3.0 dCi 160 | 115         | 06.05 | 08.06 |       |                |        |       |                |            |

### RENAULT MASTER II Bus (JD\_) (06-10)

|  |         |     |       |       |                |        |   |                |            |
|--|---------|-----|-------|-------|----------------|--------|---|----------------|------------|
|  | 2.5 dCi | 74  | 08.06 | 12.10 | 24.2025-1708.3 | 010692 |   | THz 25,40      |            |
|  | 2.5 dCi | 88  | 08.06 | 12.10 |                |        |   |                |            |
|  | 2.5 dCi | 107 | 08.06 | 12.10 |                |        |   |                |            |
|  | 2.5 dCi | 74  | 08.06 | 12.10 | 24.5134-0468.3 | 330704 | 2 | L=468          |            |
|  | 2.5 dCi | 88  | 08.06 | 12.10 | 24.5134-0457.3 | 330752 | 2 | L=457          |            |
|  | 2.5 dCi | 107 | 08.06 | 12.10 |                |        |   |                |            |
|  | 2.5 dCi | 74  | 08.06 | 12.10 | 24.5111-0510.3 | 330819 | 2 | L=510          |            |
|  | 2.5 dCi | 88  | 08.06 | 12.10 |                |        |   |                |            |
|  | 2.5 dCi | 107 | 08.06 | 12.10 |                |        |   |                |            |
|  | 2.5 dCi | 74  | 08.06 | 12.10 | 24.3424-1701.5 | 240561 |   | D=42, - Halter | <b>BOS</b> |
|  | 2.5 dCi | 88  | 08.06 | 12.10 | 24.3424-1702.5 | 240562 |   | D=42, - Halter | <b>BOS</b> |
|  | 2.5 dCi | 107 | 08.06 | 12.10 |                |        |   |                |            |

<sup>1)</sup> on the brake caliper / sulla pinza freno / sur l'étrier de frein / a la pinza de freno

<sup>2)</sup> notice length / attenzione lunghezza / faire attention longueur / atención largo

| <b>RENAULT MASTER II Bus (JD_) (06-10)</b>                        |                     |       |       |                                  |                 |                |        |                   |                |
|---|---------------------|-------|-------|----------------------------------|-----------------|----------------|--------|-------------------|----------------|
|   | 2.5 dCi             | 74    | 08.06 | 12.10                            | - ABS           | 24.5111-0410.3 | 330681 | 1                 | L=410          |
|   | 2.5 dCi             | 88    | 08.06 | 12.10                            | - ABS           | 24.5111-0326.3 | 330766 | 2                 | L=326          |
|   | 2.5 dCi             | 107   | 08.06 | 12.10                            | - ABS           |                |        | am Bremssattel 1) |                |
|   | 2.5 dCi             | 74    | 08.06 | 12.10                            | + ABS           | 24.5258-0450.3 | 330824 |                   | L=450          |
|   | 2.5 dCi             | 88    | 08.06 | 12.10                            | + ABS           | 24.5251-0465.3 | 330822 |                   | L=465          |
|   | 2.5 dCi             | 107   | 08.06 | 12.10                            | + ABS           |                |        |                   |                |
|   | 2.5 dCi             | 74    | 08.06 | 12.10                            |                 | 24.3727-0762.2 | 580762 | 1                 | L=1175         |
|   | 2.5 dCi             | 88    | 08.06 | 12.10                            |                 | 24.3727-1000.2 | 581000 | 2                 | L=1737         |
|   | 2.5 dCi             | 107   | 08.06 | 12.10                            |                 |                |        |                   |                |
| <b>RENAULT MASTER II Kasten (FD_) (06-10)</b>                     |                     |       |       |                                  |                 |                |        |                   |                |
|   | 2.5 dCi             | 74    | 08.06 | 12.10                            | - ABS           | 24.2025-1708.3 | 010692 |                   | THz 25,40      |
|   | 2.5 dCi             | 88    | 08.06 | 12.10                            | - ABS           |                |        |                   |                |
|   | 2.5 dCi             | 107   | 08.06 | 12.10                            | - ABS           |                |        |                   |                |
|   | 2.5 dCi             | 74    | 08.06 | 12.10                            | - ABS           | 24.5134-0468.3 | 330704 | 2                 | L=468          |
|   | 2.5 dCi             | 88    | 08.06 | 12.10                            | - ABS           | 24.5134-0457.3 | 330752 | 2                 | L=457          |
|   | 2.5 dCi             | 107   | 08.06 | 12.10                            | - ABS           |                |        | am Bremssattel 1) |                |
|   | 2.5 dCi             | 74    | 08.06 | 12.10                            | + ABS           | 24.5111-0510.3 | 330819 | 2                 | L=510          |
|   | 2.5 dCi             | 88    | 08.06 | 12.10                            | + ABS           |                |        |                   |                |
|   | 2.5 dCi             | 107   | 08.06 | 12.10                            | + ABS           |                |        |                   |                |
|   | 2.5 dCi             | 74    | 08.06 | 12.10                            |                 | 24.3424-1701.5 | 240561 |                   | D=42, - Halter |
|   | 2.5 dCi             | 88    | 08.06 | 12.10                            |                 | 24.3424-1702.5 | 240562 |                   | D=42, - Halter |
|   | 2.5 dCi             | 107   | 08.06 | 12.10                            |                 |                |        |                   | BOS            |
|   | 2.5 dCi             | 74    | 08.06 | 12.10                            | - ABS           | 24.5111-0410.3 | 330681 | 1                 | L=410          |
|   | 2.5 dCi             | 88    | 08.06 | 12.10                            | - ABS           | 24.5111-0326.3 | 330766 | 2                 | L=326          |
|   | 2.5 dCi             | 107   | 08.06 | 12.10                            | - ABS           |                |        | am Bremssattel 1) |                |
|   | 2.5 dCi             | 74    | 08.06 | 12.10                            | + ABS           | 24.5258-0450.3 | 330824 |                   | L=450          |
|   | 2.5 dCi             | 88    | 08.06 | 12.10                            | + ABS           | 24.5251-0465.3 | 330822 |                   | L=465          |
|   | 2.5 dCi             | 107   | 08.06 | 12.10                            | + ABS           |                |        |                   |                |
|   | 2.5 dCi             | 74    | 08.06 | 12.10                            |                 | 24.3727-0762.2 | 580762 | 1                 | L=1175         |
|   | 2.5 dCi             | 88    | 08.06 | 12.10                            |                 | 24.3727-1000.2 | 581000 | 2                 | L=1737         |
|   | 2.5 dCi             | 107   | 08.06 | 12.10                            |                 |                |        |                   |                |
| <b>RENAULT MASTER II Pritsche/Fahrgestell (ED/HD/UD_) (06-10)</b> |                     |       |       |                                  |                 |                |        |                   |                |
|   | 2.5 dCi             | 74    | 08.06 | 12.10                            | - ABS           | 24.2025-1708.3 | 010692 |                   | THz 25,40      |
|   | 2.5 dCi             | 88    | 08.06 | 12.10                            | - ABS           |                |        |                   |                |
|   | 2.5 dCi             | 107   | 08.06 | 12.10                            | - ABS           |                |        |                   |                |
|   | 2.5 dCi             | 74    | 08.06 | 12.10                            | - ABS           | 24.5134-0468.3 | 330704 | 2                 | L=468          |
|   | 2.5 dCi             | 88    | 08.06 | 12.10                            | - ABS           | 24.5134-0457.3 | 330752 | 2                 | L=457          |
|   | 2.5 dCi             | 107   | 08.06 | 12.10                            | - ABS           |                |        | am Bremssattel 1) |                |
|   | 2.5 dCi             | 74    | 08.06 | 12.10                            | + ABS           | 24.5111-0510.3 | 330819 | 2                 | L=510          |
|   | 2.5 dCi             | 88    | 08.06 | 12.10                            | + ABS           |                |        |                   |                |
|   | 2.5 dCi             | 107   | 08.06 | 12.10                            | + ABS           |                |        |                   |                |
|   | 2.5 dCi             | 74    | 08.06 | 12.10                            |                 | 24.3424-1701.5 | 240561 |                   | D=42, - Halter |
|   | 2.5 dCi             | 88    | 08.06 | 12.10                            |                 | 24.3424-1702.5 | 240562 |                   | D=42, - Halter |
|   | 2.5 dCi             | 107   | 08.06 | 12.10                            |                 |                |        |                   | BOS            |
|   | 2.5 dCi             | 74    | 08.06 | 12.10                            | - ABS           | 24.5111-0410.3 | 330681 | 1                 | L=410          |
|   | 2.5 dCi             | 88    | 08.06 | 12.10                            | - ABS           | 24.5111-0326.3 | 330766 | 2                 | L=326          |
|   | 2.5 dCi             | 107   | 08.06 | 12.10                            | - ABS           |                |        | am Bremssattel 1) |                |
|   | 2.5 dCi             | 74    | 08.06 | 12.10                            | + ABS           | 24.5258-0450.3 | 330824 |                   | L=450          |
|   | 2.5 dCi             | 88    | 08.06 | 12.10                            | + ABS           | 24.5251-0465.3 | 330822 |                   | L=465          |
|   | 2.5 dCi             | 107   | 08.06 | 12.10                            | + ABS           |                |        |                   |                |
|   | 2.5 dCi             | 74    | 08.06 | 12.10                            |                 | 24.3727-0762.2 | 580762 | 1                 | L=1175         |
|   | 2.5 dCi             | 88    | 08.06 | 12.10                            |                 | 24.3727-1000.2 | 581000 | 2                 | L=1737         |
|   | 2.5 dCi             | 107   | 08.06 | 12.10                            |                 |                |        |                   |                |
| <b>RENAULT MEGANE I Limousine 3/5-türig (BA/SA_) (96-02)</b>      |                     |       |       |                                  |                 |                |        |                   |                |
|   | 1.4 e (E)           | 55    | 01.96 | 12.02                            | - ABS           | 03.7750-4702.4 | 300153 |                   | 9"             |
|   | 1.4 e (V)           | 55    | 06.98 | 02.99                            | - ABS           |                |        |                   | ATE            |
|   | 1.4 Eco (T)         | 52    | 01.96 | 03.99                            | - ABS           |                |        |                   |                |
|   | 1.6 e (F)           | 66    | 01.96 | 03.99                            | - ABS           |                |        |                   |                |
|   | 1.6 e (S)           | 66    | 01.96 | 03.99                            | - ABS           |                |        |                   |                |
|   | 1.6 i               | 55    | 01.96 | 03.99                            | - ABS           |                |        |                   |                |
|   | 1.9 D (B9)          | 47    | 01.96 | 12.02                            |                 |                |        |                   |                |
|   | 1.9 D (BA/U)        | 47    | 01.96 | 12.02                            | - Fahrschule 2) |                |        |                   |                |
|   | 1.9 D (S9)          | 47    | 01.96 | 12.02                            | - ABS           |                |        |                   |                |
|   | 1.9 D (SA/U)        | 47    | 01.96 | 12.02                            | - ABS           |                |        |                   |                |
|   | 1.9 dT (BY)         | 66    | 01.96 | 12.02                            |                 |                |        |                   |                |
|   | 1.9 dT (K)          | 66    | 03.96 | 12.02                            |                 |                |        |                   |                |
|   | 1.9 dT (SY)         | 66    | 01.96 | 12.02                            | - ABS           |                |        |                   |                |
|   | 1.9 dTi (B)         | 72    | 03.97 | 02.01                            |                 |                |        |                   |                |
|   | 1.9 dTi (BAON/SAON) | 72    | 03.97 | 02.99                            |                 |                |        |                   |                |
|   | 2.0 i (7)           | 84    | 01.96 | 12.02                            |                 |                |        |                   |                |
|   | 2.0 i (G)           | 84    | 01.96 | 12.02                            |                 |                |        |                   |                |
|   | 1.4 16V             | 70    | 06.98 | 12.02                            | - ABS           | 03.7760-5602.4 | 300121 |                   | 10"            |
|   | 1.4 e (V)           | 55    | 03.99 | 12.02                            | - ABS           |                |        |                   | ATE            |
|   | 1.6 16V (11)        | 79    | 03.99 | 12.02                            | - ABS           |                |        |                   |                |
| 1.6 16V (1J)  | 79                  | 03.99 | 12.02 | - ABS                            |                 |                |        |                   |                |
| 1.6 16V (4)   | 79                  | 04.98 | 12.02 | - ABS/ + verstärktes Fahrwerk 3) |                 |                |        |                   |                |
| 1.9 D (R)   | 47                  | 06.98 | 12.02 | - ABS                            |                 |                |        |                   |                |
| 1.9 dCi (5)   | 75                  | 09.98 | 12.02 | - ABS                            |                 |                |        |                   |                |
| 1.4 16V (D)   | 70                  | 03.99 | 12.02 | + ABS                            | 03.7863-2002.4  | 300126         |        | 10"               |                |
| 1.6 16V (4)   | 79                  | 04.98 | 12.02 | + ABS/ - verstärktes Fahrwerk 4) | 03.7760-5102.4  | 300140         |        | 10"               |                |
| 1.9 dCi (5)   | 75                  | 09.98 | 12.02 | + ABS                            |                 |                |        | ATE               |                |

1) on the brake caliper / sulla pinza freno / sur l'étrier de frein / a la pinza de freno

2) - driving school / - scuola guida / - auto école / - autoescuela

3) - ABS/ + reinforced suspension / - ABS/ + sospensione rinforzata / - ABS/ + châssis renforcé / - ABS/ + suspensión reforzada



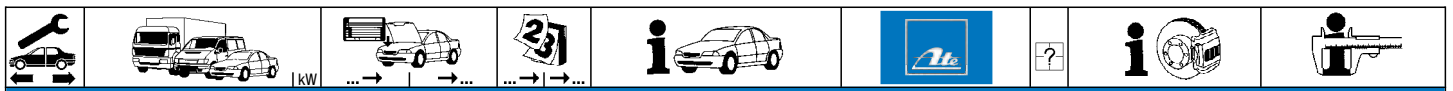













































4) + ABS/ - reinforced suspension / + ABS/ - sospensione rinforzata / + ABS/ - châssis renforcé / + ABS/ - suspensión reforzada



**RENAULT MEGANE I Limousine 3/5-türig (BA/SA\_) (96-02)**

|                |                     |         |             |   |                |                |           |           |
|----------------|---------------------|---------|-------------|---|----------------|----------------|-----------|-----------|
|                | 1.9 dTi (BAON/SAON) | 72      | 03.99       | 02.01   | 03.7760-5102.4 | 300140         | 10"       | ATE       |
|                | 1.4 16V (W)         | 70      | 06.98       | 12.02 + ABS                                       | 03.7760-5502.4 | 300151         | 10"       | ATE       |
|                | 1.4 e (E)           | 55      | 03.99       | 12.02 + ABS                                       |                |                |           |           |
|                | 1.6 16V (11)        | 79      | 03.99       | 12.02 + ABS                                       |                |                |           |           |
|                | 1.6 16V (1J)        | 79      | 03.99       | 12.02 + ABS                                       |                |                |           |           |
|                | 1.6 16V (4)         | 79      | 04.98       | 12.02 + ABS/ + verstärktes Fahrzeug <sup>1)</sup> |                |                |           |           |
|                | 1.9 D (R)           | 47      | 06.98       | 12.02 + ABS                                       |                |                |           |           |
|                | 1.6 16V (B)         | 79      | 03.99       | 12.02 + ABS                                       | 03.7863-2002.4 | 300126         | 10"       | ATE       |
|                | 1.8 16V             | 85      | 01.01       | 12.02   |                |                |           |           |
|                | 1.9 dCi (F)         | 75      | 02.01       | 12.02 + ABS                                       |                |                |           |           |
|                | 1.9 dTi (1U)        | 59      | 02.01       | 12.02 + ABS                                       |                |                |           |           |
|                | 1.4 e (E)           | 55      | 01.96       | 12.02 - ABS                                       | 03.2120-2031.3 | 010106         | THz 20,64 | ATE       |
|                | 1.4 e (V)           | 55      | 06.98       | 02.99 - ABS                                       |                |                |           |           |
|                | 1.4 Eco (T)         | 52      | 01.96       | 03.99 - ABS                                       |                |                |           |           |
|                | 1.6 e (F)           | 66      | 01.96       | 03.99 - ABS                                       |                |                |           |           |
|                | 1.6 e (S)           | 66      | 01.96       | 03.99 - ABS                                       |                |                |           |           |
|                | 1.6 i               | 55      | 01.96       | 03.99 - ABS                                       |                |                |           |           |
|                | 1.9 D (9)           | 47      | 01.96       | 12.02 - ABS                                       |                |                |           |           |
|                | 1.9 D (BA/U)        | 47      | 01.96       | 12.02 - ABS                                       |                |                |           |           |
|                | 1.9 D (BA/U)        | 47      | 01.96       | 12.02 - ABS/ - Fahrschule <sup>2)</sup>           |                |                |           |           |
|                | 1.9 D (SA/U)        | 47      | 01.96       | 12.02 - ABS                                       |                |                |           |           |
|                | 1.9 dT (K)          | 66      | 03.96       | 12.02 - ABS                                       |                |                |           |           |
|                | 1.9 dT (Y)          | 66      | 01.96       | 12.02 - ABS                                       |                |                |           |           |
|                | 1.9 dTi             | 72      | 03.97       | 02.01 - ABS                                       |                |                |           |           |
|                | 1.9 TDI             | 69      | 09.96       | 12.02 - ABS                                       |                |                |           |           |
|                | 2.0 i (7)           | 84      | 01.96       | 12.02   |                |                |           |           |
|                | 2.0 i (G)           | 84      | 01.96       | 12.02 - ABS                                       |                |                |           |           |
|                |                     | 1.4 16V | 70          | 06.98   | 12.02 - ABS    | 03.2122-1541.3 | 010511    | THz 22,20 |
| 1.4 e (V)      |                     | 55      | 03.99       | 12.02 - ABS                                       |                |                |           |           |
| 1.6 16V (11)   |                     | 79      | 03.99       | 12.02 - ABS                                       |                |                |           |           |
| 1.6 16V (1J)   |                     | 79      | 03.99       | 12.02 - ABS                                       |                |                |           |           |
| 1.6 16V (4)    |                     | 79      | 04.98       | 12.02 - ABS/ + verstärktes Fahrwerk <sup>3)</sup> |                |                |           |           |
| 1.9 D (R)      |                     | 47      | 06.98       | 12.02 - ABS                                       |                |                |           |           |
| 1.9 dCi (5)    |                     | 75      | 09.98       | 12.02 - ABS                                       |                |                |           |           |
| 1.9 dT (Y)     |                     | 66      | 01.96       | 12.02 - ABS                                       |                |                |           |           |
| 1.9 dTi (BAON) |                     | 72      | 03.97       | 02.01 - ABS                                       |                |                |           |           |
| 2.0 i (G)      |                     | 84      | 01.96       | 12.02 - ABS                                       |                |                |           |           |
|                | 1.4 e (E)           | 55      | 01.96       | 12.02 + ABS                                       | 24.2120-1723.3 | 010545         | THz 20,64 | BDX       |
|                | 1.4 Eco (T)         | 52      | 01.96       | 03.99 + ABS                                       |                |                |           |           |
|                | 1.6 e (F)           | 66      | 01.96       | 03.99 + ABS                                       |                |                |           |           |
|                | 1.6 e (S)           | 66      | 01.96       | 03.99 + ABS                                       |                |                |           |           |
|                | 1.6 i               | 55      | 01.96       | 03.99 + ABS                                       |                |                |           |           |
|                | 1.9 D (9)           | 47      | 01.96       | 12.02 + ABS                                       |                |                |           |           |
|                | 1.9 D (BA/U)        | 47      | 01.96       | 12.02 + ABS/ - Fahrschule <sup>4)</sup>           |                |                |           |           |
|                | 1.9 D (SA/U)        | 47      | 01.96       | 12.02 + ABS                                       |                |                |           |           |
|                | 1.9 dT (K)          | 66      | 01.96       | 12.02 + ABS                                       |                |                |           |           |
|                | 1.9 dT (Y)          | 66      | 01.96       | 12.02 + ABS                                       |                |                |           |           |
|                | 1.9 dTi (8)         | 72      | 03.97       | 02.01 + ABS                                       |                |                |           |           |
|                | 1.9 dTi (BAON)      | 72      | 03.97       | 02.99 + ABS                                       |                |                |           |           |
|                | 1.9 dTi (SAON)      | 72      | 03.97       | 02.99 + ABS                                       |                |                |           |           |
|                | 1.9 TDI             | 69      | 09.96       | 12.02 + ABS                                       |                |                |           |           |
| 2.0 i (G)      | 84                  | 01.96   | 12.02 + ABS |   |                |                |           |           |
|                | 1.4 16V             | 70      | 06.98       | 12.02   | 03.2120-4441.3 | 010510         | THz 20,64 | ATE       |
|                | 1.4 e (V)           | 55      | 06.98       | 02.99 + ABS                                       |                |                |           |           |
|                | 1.9 D (9)           | 47      | 01.96       | 12.02 + ABS                                       |                |                |           |           |
|                | 1.9 D (BA/U)        | 47      | 01.96       | 12.02 + ABS/ - Fahrschule <sup>4)</sup>           |                |                |           |           |
|                | 1.9 D (R)           | 47      | 06.98       | 12.02   |                |                |           |           |
|                | 1.9 D (SA/U)        | 47      | 01.96       | 12.02 + ABS                                       |                |                |           |           |
|                | 1.9 dT (K)          | 66      | 01.96       | 12.02 + ABS                                       |                |                |           |           |
|                | 1.9 dT (Y)          | 66      | 01.96       | 12.02 + ABS                                       |                |                |           |           |
|                | 1.9 dTi (8)         | 72      | 03.97       | 02.01 + ABS                                       |                |                |           |           |
|                | 1.9 dTi (BAON)      | 72      | 03.97       | 02.99 + ABS                                       |                |                |           |           |
|                | 1.9 dTi (SAON)      | 72      | 03.97       | 02.99 + ABS                                       |                |                |           |           |
| 2.0 i (G)      | 84                  | 01.96   | 12.02 + ABS |   |                |                |           |           |
|                | 1.6 16V (4)         | 79      | 04.98       | 12.02 + ABS/ - verstärktes Fahrwerk <sup>5)</sup> | 03.2123-2146.3 | 010572         | THz 23,81 | ATE       |
|                | 1.6 16V (B)         | 79      | 03.99       | 12.02 + ABS                                       |                |                |           |           |
|                | 1.8 16V             | 85      | 01.01       | 12.02   |                |                |           |           |
|                | 1.9 dCi             | 75      | 09.98       | 12.02 + ABS                                       |                |                |           |           |
|                | 1.9 dTi (1U)        | 59      | 02.01       | 12.02 + ABS                                       |                |                |           |           |
|                | 1.9 dTi (BAON)      | 72      | 03.99       | 02.01 + ABS                                       |                |                |           |           |
|                | 1.9 dTi (SAON)      | 72      | 03.99       | 02.01 + ABS                                       |                |                |           |           |
|                | 1.4 16V             | 70      | 03.99       | 12.02 + ABS                                       | 03.2122-1521.3 | 010494         | THz 22,20 | ATE       |
|                | 1.4 e (V)           | 55      | 03.99       | 12.02 + ABS                                       |                |                |           |           |
|                | 1.6 16V (11)        | 79      | 03.99       | 12.02 + ABS                                       |                |                |           |           |
|                | 1.6 16V (1J)        | 79      | 03.99       | 12.02 + ABS                                       |                |                |           |           |
|                | 1.6 16V (4)         | 79      | 04.98       | 12.02 + ABS/ + verstärktes Fahrwerk <sup>6)</sup> |                |                |           |           |
|                | 1.9 D (R)           | 47      | 06.98       | 12.02 + ABS                                       |                |                |           |           |
|                | 1.9 dT (BY)         | 66      | 03.99       | 12.02 + ABS                                       |                |                |           |           |
|                | 1.9 dTi (BAON)      | 72      | 03.97       | 02.01 + ABS                                       |                |                |           |           |
| 2.0 i (G)      | 84                  | 01.96   | 12.02 + ABS |   |                |                |           |           |
|                | 1.4 e               | 55      | 01.96       | 12.02 + ABS                                       | 24.2120-1725.3 | 010579         | THz 20,64 | BDX       |
|                | 1.6 e (F)           | 66      | 01.96       | 03.99 + ABS                                       |                |                |           |           |
|                | 1.9 D (9)           | 47      | 01.96       | 12.02 + ABS                                       |                |                |           |           |
|                | 1.9 D (A/U)         | 47      | 01.96       | 03.99 + ABS                                       |                |                |           |           |
|                | 1.9 dT (Y)          | 66      | 01.96       | 12.02 + ABS                                       |                |                |           |           |
|                | 1.9 dTi (8)         | 72      | 03.97       | 02.01 + ABS                                       |                |                |           |           |

<sup>1)</sup> + ABS/ + reinforced vehicle / + ABS/ + veicolo rinforzato / + ABS/ + véhicule renforcé / + ABS/ + vehiculo reforzada  
<sup>2)</sup> - ABS/ - driving school / - ABS/ - scuola guida / - ABS/ - auto-école / - ABS/ - autoescuela  
<sup>3)</sup> - ABS/ + reinforced suspension / - ABS/ + sospensione rinforzata / - ABS/ + châssis renforcé / - ABS/ + suspensión reforzada  
<sup>4)</sup> + ABS/ - driving school / + ABS/ - scuola guida / + ABS/ - auto école / + ABS/ - autoescuela  
<sup>5)</sup> + ABS/ - reinforced suspension / + ABS/ - sospensione rinforzata / + ABS/ - châssis renforcé / + ABS/ - suspensión reforzada  
<sup>6)</sup> + ABS/ + reinforced suspens. / + ABS/ + sospensione rinforzata / + ABS/ + châssis renforcé / + ABS/ + suspensión reforzada

|     |  |  |  |  |  |  |  |    |                              |            |
|--|--|--|--|--|---|--|--|--|------------------------------|------------|
| <b>RENAULT MEGANE I Limousine 3/5-türig (BA/SA ) (96-02)</b>                       |  |  |  |  |   |  |  |  |                              |            |
|    | 1.9 dTi (BAON)   | 72   | 03.97  | 02.99  | + ABS   | 24.2120-1725.3   | 010579   |  | THz 20,64                    | <b>BDX</b> |
|  | 2.0 i (G)  | 84   | 01.96  | 12.02  | + ABS   |  |  |  |                              |            |
|    | 1.9 D (BA/U)   | 47   | 01.96  | 12.02  | - ABS/ + Fahrschule <sup>1)</sup>   | 03.2119-3389.3   | 010057   |  | THz 19,05                    | <b>ATE</b> |
|  | 2.0 16V  | 108  | 07.96  | 12.02  |   | 24.2123-1701.3   | 010424   |  | THz 23,81                    |            |
|    | 1.4 e (E)  | 55   | 01.96  | 10.97  |   | 24.3481-1611.5   | 240029   |   | D=48, - Halter               | <b>LUC</b> |
|  | 1.4 Eco (T)  | 52   | 01.96  | 10.97  |   | 24.3481-1612.5   | 240030   |   | D=48, - Halter<br>Einbausatz | <b>LUC</b> |
|    | 1.6 i  | 55   | 01.96  | 10.97  |   | 24.0101-4807.2   | 260053   |  |                              | <b>LUC</b> |
|  | 1.9 D (A)  | 47   | 01.96  | 10.97  |   |  |  |  |                              |            |
|    | 1.9 D (U)  | 47   | 01.96  | 10.97  |   |  |  |  |                              |            |
|  | 1.4 16V (D)  | 70   | 03.99  | 12.02  |   | 24.3481-1615.5   | 240031   |   | D=48, - Halter               | <b>LUC</b> |
|    | 1.4 16V (W)  | 70   | 06.98  | 12.02  |   | 24.3481-1616.5   | 240032   |   | D=48, - Halter<br>Einbausatz | <b>LUC</b> |
|  | 1.4 e (E)  | 55   | 11.97  | 12.02  |   | 24.0101-4806.2   | 260052   |  |                              | <b>LUC</b> |
|    | 1.4 e (V)  | 55   | 06.98  | 12.02  |   |  |  |  |                              |            |
|  | 1.4 Eco (T)  | 52   | 11.97  | 03.99  |   |  |  |  |                              |            |
|    | 1.6 16V (4)  | 79   | 04.98  | 12.02  | + verstärktes Fahrwerk <sup>2)</sup>  |  |  |  |                              |            |
|  | 1.6 e  | 66   | 01.96  | 03.99  |   |  |  |  |                              |            |
|    | 1.6 i  | 55   | 11.97  | 03.99  |   |  |  |  |                              |            |
|  | 1.9 D (9)  | 47   | 01.96  | 12.02  |   |  |  |  |                              |            |
|    | 1.9 D (A)  | 47   | 11.97  | 12.02  |   |  |  |  |                              |            |
|  | 1.9 D (R)  | 47   | 06.98  | 12.02  |   |  |  |  |                              |            |
|    | 1.9 D (U)  | 47   | 11.97  | 12.02  |   |  |  |  |                              |            |
|  | 1.9 dT   | 66   | 01.96  | 01.98  |   |  |  |  |                              |            |
|    | 1.9 dTi (8)  | 72   | 03.97  | 02.01  |   |  |  |  |                              |            |
|  | 1.9 dTi (BAON/SAON)  | 72   | 03.97  | 02.99  |   |  |  |  |                              |            |
|   | 1.9 TDI  | 69   | 09.96  | 12.02  |   |  |  |  |                              |            |
|  | 2.0 i  | 84   | 01.96  | 12.02  |   |  |  |  |                              |            |
|  | 1.6 16V (11)   | 79   | 03.99  | 12.02  |   | 24.3541-1749.5   | 240427   |   | D=54, - Halter               | <b>LUC</b> |
|  | 1.6 16V (1J)   | 79   | 03.99  | 12.02  |   | 24.3541-1750.5   | 240428   |   | D=54, - Halter               | <b>LUC</b> |
|  | 1.6 16V (4)  | 79   | 04.98  | 12.02  | + verstärktes Fahrwerk <sup>3)</sup>  |  |  |  |                              |            |
|  | 1.6 16V (B)  | 79   | 03.99  | 12.02  |   |  |  |  |                              |            |
|  | 1.8 16V  | 85   | 01.01  | 12.02  |   |  |  |  |                              |            |
|  | 1.9 dCi  | 66   | 09.98  | 12.02  |   |  |  |  |                              |            |
|  | 1.9 dTi (1U)   | 59   | 02.01  | 12.02  |   |  |  |  |                              |            |
|  | 1.9 dTi (BAON/SAON)  | 72   | 03.99  | 02.01  |   |  |  |  |                              |            |
|  | 2.0 16V  | 108  | 10.98  | 12.02  |   |  |  |  |                              |            |
|  | 2.0 16V  | 108  | 07.96  | 09.98  |   | 24.3541-1741.5   | 240215   |   | D=54, - Halter               | <b>LUC</b> |
|  | 2.0 16V  | 108  | 07.96  | 09.98  |   | 24.3541-1742.5   | 240216   |  | D=54, - Halter               | <b>LUC</b> |
|  | 1.4 16V  | 70   | 06.98  | 12.02  |   | 24.5111-0390.3   | 330566   | 2  | L=390                        |            |
|  | 1.4 e  | 55   | 01.96  | 12.02  |   |  |  |  |                              |            |
|  | 1.4 Eco (T)  | 52   | 01.96  | 03.99  |   |  |  |  |                              |            |
|  | 1.6 16V  | 79   | 04.98  | 12.02  |   |  |  |  |                              |            |
|  | 1.6 e  | 66   | 01.96  | 03.99  |   |  |  |  |                              |            |
|  | 1.6 i  | 55   | 01.96  | 03.99  |   |  |  |  |                              |            |
|  | 1.8 16V  | 85   | 01.01  | 12.02  |   |  |  |  |                              |            |
|  | 1.9 D  | 47   | 01.96  | 12.02  |   |  |  |  |                              |            |
|  | 1.9 dCi  | 66   | 09.98  | 12.02  |   |  |  |  |                              |            |
|  | 1.9 dT   | 66   | 01.96  | 12.02  |   |  |  |  |                              |            |
|  | 1.9 dTi (1U)   | 59   | 02.01  | 12.02  |   |  |  |  |                              |            |
|  | 1.9 dTi (8)  | 72   | 03.97  | 02.01  |   |  |  |  |                              |            |
|  | 1.9 dTi (SAON)   | 72   | 03.97  | 02.01  |   |  |  |  |                              |            |
|  | 1.9 TDI  | 69   | 09.96  | 12.02  |   |  |  |  |                              |            |
|  | 2.0 16V  | 108  | 07.96  | 12.02  |   |  |  |  |                              |            |
|  | 2.0 i (7)  | 84   | 01.96  | 12.02  |   |  |  |  |                              |            |
|  | 1.9 dTi (BAON)   | 72   | 03.97  | 02.01  |   | 24.5111-0390.3   | 330566   | 2  | Länge beachten <sup>4)</sup> | L=390      |
|  | 2.0 i (G)  | 84   | 01.96  | 12.02  |   |  |  |  |                              |            |
|  | 1.4 16V  | 70   | 06.98  | 12.02  |   | 24.5229-0265.3   | 330540   | 2  |                              | L=265      |
|  | 1.4 e  | 55   | 01.96  | 12.02  |   |  |  |  |                              |            |
|  | 1.4 Eco (T)  | 52   | 01.96  | 03.99  |   |  |  |  |                              |            |
|  | 1.6 16V  | 79   | 04.98  | 12.02  |   |  |  |  |                              |            |
|  | 1.6 e  | 66   | 01.96  | 03.99  |   |  |  |  |                              |            |
|  | 1.6 i  | 55   | 01.96  | 03.99  |   |  |  |  |                              |            |
|  | 1.8 16V  | 85   | 01.01  | 12.02  |   |  |  |  |                              |            |
|  | 1.9 D  | 47   | 01.96  | 12.02  |   |  |  |  |                              |            |
|  | 1.9 dCi  | 66   | 09.98  | 12.02  |   |  |  |  |                              |            |
|  | 1.9 dT   | 66   | 01.96  | 12.02  |   |  |  |  |                              |            |
|  | 1.9 dTi (1U)   | 59   | 02.01  | 12.02  |   |  |  |  |                              |            |
|  | 1.9 dTi (8)  | 72   | 03.97  | 02.01  |   |  |  |  |                              |            |
|  | 1.9 dTi (SAON)   | 72   | 03.97  | 02.01  |   |  |  |  |                              |            |
|  | 1.9 TDI  | 69   | 09.96  | 12.02  |   |  |  |  |                              |            |
|  | 2.0 16V  | 108  | 07.96  | 12.02  |   |  |  |  |                              |            |
|  | 2.0 i (7)  | 84   | 01.96  | 12.02  |   |  |  |  |                              |            |
|  | 1.9 dTi (BAON)   | 72   | 03.97  | 02.01  |   | 24.5229-0265.3   | 330540   | 2  | Länge beachten <sup>4)</sup> | L=265      |
|  | 2.0 i (G)  | 84   | 01.96  | 12.02  |   |  |  |  |                              |            |
|  | 1.4 16V  | 70   | 06.98  | 12.02  | - ABS   | 24.3217-1705.3   | 020020   |  |                              | Rz 17,46   |
|  | 1.4 e (E)  | 55   | 01.96  | 12.02  | + ABS   |  |  |  |                              |            |
|  | 1.4 e (V)  | 55   | 06.98  | 02.99  | + ABS   |  |  |  |                              |            |
|  | 1.4 e (V)  | 55   | 06.98  | 12.02  | - ABS   |  |  |  |                              |            |
|  | 1.4 Eco (T)  | 52   | 01.96  | 03.99  |   |  |  |  |                              |            |
|  | 1.6 16V (11)   | 79   | 03.99  | 12.02  | - ABS   |  |  |  |                              |            |
|  | 1.6 16V (1J)   | 79   | 03.99  | 12.02  |   |  |  |  |                              |            |
|  | 1.6 16V (4)  | 79   | 04.98  | 12.02  | - ABS   |  |  |  |                              |            |
|  | 1.6 16V (B)  | 79   | 03.99  | 12.02  | - ABS   |  |  |  |                              |            |
|  | 1.6 e  | 66   | 01.96  | 03.99  |   |  |  |  |                              |            |
|  | 1.6 i  | 55   | 01.96  | 03.99  |   |  |  |  |                              |            |
|  | 1.9 D (9)  | 47   | 01.96  | 12.02  |   |  |  |  |                              |            |
|  | 1.9 D (A)  | 47   | 01.96  | 12.02  |   |  |  |  |                              |            |

<sup>1)</sup> - ABS/ + driving school / - ABS/ + scuola guida / - ABS/ + auto école / - ABS/ + autoescuela

<sup>2)</sup> + reinforced suspension / + sospensione rinforzata / + châssis renforcé / + suspensión reforzada

<sup>3)</sup> - reinforced suspension / - sospensione rinforzata / - châssis renforcé / - suspensión reforzada

<sup>4)</sup> notice length / attenzione lunghezza / faire attention longueur / atención largo



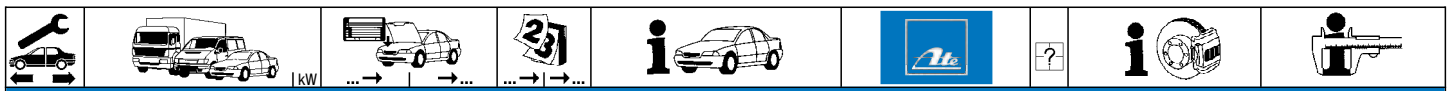

**RENAULT MEGANE I Limousine 3/5-türig (BA/SA ) (96-02)**

|                     |                     |       |       |                                      |                                      |                |        |     |          |
|---------------------|---------------------|-------|-------|--------------------------------------|--------------------------------------|----------------|--------|-----|----------|
|                     | 1.9 D (R)           | 47    | 06.98 | 12.02                                | - ABS                                | 24.3217-1705.3 | 020020 |     | Rz 17,46 |
|                     | 1.9 D (U)           | 47    | 01.96 | 12.02                                |                                      |                |        |     |          |
|                     | 1.9 dCi             |       | 09.98 | 12.02                                | - ABS                                |                |        |     |          |
|                     | 1.9 dT              | 66    | 01.96 | 12.02                                |                                      |                |        |     |          |
|                     | 1.9 dTi (1U)        | 59    | 02.01 | 12.02                                |                                      |                |        |     |          |
|                     | 1.9 dTi (8)         | 72    | 03.97 | 02.01                                |                                      |                |        |     |          |
|                     | 1.9 dTi (BAON/SAON) | 72    | 03.97 | 02.99                                | + ABS                                |                |        |     |          |
|                     | 1.9 dTi (BAON/SAON) | 72    | 03.97 | 02.01                                | - ABS                                |                |        |     |          |
|                     | 1.9 TDI             | 69    | 09.96 | 12.02                                |                                      |                |        |     |          |
|                     | 2.0 i               |       | 01.96 | 12.02                                |                                      |                |        |     |          |
|                     | 1.4 16V (D)         | 70    | 03.99 | 12.02                                | + ABS/ - ASR                         |                |        |     |          |
|                     | 1.4 16V (W)         | 70    | 06.98 | 12.02                                | + ABS                                |                |        |     |          |
|                     | 1.4 e (V)           | 55    | 06.98 | 12.02                                | + ABS                                |                |        |     |          |
|                     | 1.6 16V (4)         | 79    | 04.98 | 12.02                                | + ABS                                |                |        |     |          |
| 1.6 16V (B)         | 79                  | 03.99 | 12.02 | + ABS/ - ASR                         |                                      |                |        |     |          |
| 1.8 16V (12)        | 85                  | 01.01 | 12.02 | + ABS/ - ASR                         |                                      |                |        |     |          |
| 1.8 16V (1M)        | 85                  | 01.01 | 12.02 | + ABS/ - ASR                         |                                      |                |        |     |          |
| 1.9 D (R)           | 47                  | 06.98 | 12.02 | + ABS                                |                                      |                |        |     |          |
| 1.9 dCi (5)         | 75                  | 09.98 | 12.02 | + ABS                                |                                      |                |        |     |          |
| 1.9 dCi (F)         | 75                  | 02.01 | 12.02 | + ABS/ - ASR                         |                                      |                |        |     |          |
| 1.9 dTi (BAON/SAON) | 72                  | 03.99 | 02.01 | + ABS                                |                                      |                |        |     |          |
|                     | 1.4 16V (W)         | 70    | 06.98 | 12.02                                |                                      | 24.3727-1050.2 | 581050 | 2 ↓ | L=1440   |
|                     | 1.4 e               | 55    | 01.96 | 12.02                                |                                      |                |        |     |          |
|                     | 1.4 Eco (T)         | 52    | 01.96 | 03.99                                |                                      |                |        |     |          |
|                     | 1.6 16V (11)        | 79    | 03.99 | 12.02                                | + verstärktes Fahrwerk <sup>1)</sup> |                |        |     |          |
|                     | 1.6 16V (1J)        | 79    | 03.99 | 12.02                                | + verstärktes Fahrwerk <sup>1)</sup> |                |        |     |          |
|                     | 1.6 16V (4)         | 79    | 04.98 | 12.02                                | + verstärktes Fahrwerk <sup>1)</sup> |                |        |     |          |
|                     | 1.6 e               | 66    | 01.96 | 03.99                                |                                      |                |        |     |          |
|                     | 1.6 i               | 55    | 01.96 | 03.99                                |                                      |                |        |     |          |
|                     | 1.9 D (A)           | 47    | 01.96 | 12.02                                |                                      |                |        |     |          |
|                     | 1.9 D (R)           | 47    | 06.98 | 12.02                                |                                      |                |        |     |          |
|                     | 1.9 D (U)           | 47    | 01.96 | 12.02                                |                                      |                |        |     |          |
|                     | 1.9 dTi (BAON)      | 72    | 03.97 | 02.01                                | + verstärktes Fahrwerk <sup>1)</sup> |                |        |     |          |
|                     | 2.0 i (G)           | 84    | 01.96 | 12.02                                | + verstärktes Fahrwerk <sup>1)</sup> |                |        |     |          |
|                     | 1.4 16V (D)         | 70    | 03.99 | 12.02                                |                                      |                |        |     |          |
| 1.6 16V (11)        | 79                  | 03.99 | 12.02 | - verstärktes Fahrwerk <sup>2)</sup> |                                      |                |        |     |          |
| 1.6 16V (1J)        | 79                  | 03.99 | 12.02 | - verstärktes Fahrwerk <sup>2)</sup> |                                      |                |        |     |          |
| 1.6 16V (4)         | 79                  | 04.98 | 12.02 | - verstärktes Fahrwerk <sup>2)</sup> |                                      |                |        |     |          |
| 1.6 16V (B)         | 79                  | 03.99 | 12.02 |                                      |                                      |                |        |     |          |
| 1.9 D (9)           | 47                  | 01.96 | 12.02 |                                      |                                      |                |        |     |          |
| 1.9 dCi             |                     | 09.98 | 12.02 |                                      |                                      |                |        |     |          |
| 1.9 dT              | 66                  | 01.96 | 12.02 |                                      |                                      |                |        |     |          |
| 1.9 dTi (1U)        | 59                  | 02.01 | 12.02 | - verstärktes Fahrwerk <sup>2)</sup> |                                      |                |        |     |          |
| 1.9 dTi (8)         | 72                  | 03.97 | 02.01 |                                      |                                      |                |        |     |          |
| 1.9 dTi (BAON)      | 72                  | 03.97 | 02.01 | - verstärktes Fahrwerk <sup>2)</sup> |                                      |                |        |     |          |
| 1.9 dTi (SAON)      | 72                  | 03.97 | 02.01 |                                      |                                      |                |        |     |          |
| 1.9 TDI             | 69                  | 09.96 | 12.02 |                                      |                                      |                |        |     |          |
| 2.0 i (7)           | 84                  | 01.96 | 12.02 |                                      |                                      |                |        |     |          |
| 2.0 i (G)           | 84                  | 01.96 | 12.02 | - verstärktes Fahrwerk <sup>2)</sup> |                                      |                |        |     |          |
|                     | 1.4 16V             | 70    | 06.98 | 12.02                                |                                      | 24.6582-1706.3 | 320191 |     | BRL (4)  |
|                     | 1.4 e (E)           | 55    | 10.98 | 12.02                                |                                      |                |        |     |          |
|                     | 1.4 e (E)           | 55    | 01.96 | 09.98                                | - verstärktes Fahrwerk <sup>2)</sup> |                |        |     |          |
|                     | 1.4 e (V)           | 55    | 06.98 | 12.02                                |                                      |                |        |     |          |
|                     | 1.4 Eco (T)         | 52    | 01.96 | 03.99                                |                                      |                |        |     |          |
|                     | 1.6 16V (11)        | 79    | 03.99 | 12.02                                |                                      |                |        |     |          |
|                     | 1.6 16V (1J)        | 79    | 03.99 | 12.02                                |                                      |                |        |     |          |
|                     | 1.6 16V (4)         | 79    | 04.98 | 12.02                                | + verstärktes Fahrwerk <sup>1)</sup> |                |        |     |          |
|                     | 1.6 16V (B)         | 79    | 03.99 | 12.02                                | + verstärktes Fahrwerk <sup>1)</sup> |                |        |     |          |
|                     | 1.6 e (F)           | 66    | 10.98 | 03.99                                |                                      |                |        |     |          |
|                     | 1.6 e (F)           | 66    | 01.96 | 09.98                                | - verstärktes Fahrwerk <sup>2)</sup> |                |        |     |          |
|                     | 1.6 e (S)           | 66    | 10.98 | 03.99                                |                                      |                |        |     |          |
|                     | 1.6 i               | 55    | 01.96 | 03.99                                |                                      |                |        |     |          |
|                     | 1.8 16V             | 85    | 01.01 | 12.02                                | + verstärktes Fahrwerk <sup>1)</sup> |                |        |     |          |
| 1.9 D (A/R)         | 47                  | 01.96 | 12.02 |                                      |                                      |                |        |     |          |
| 1.9 D (BU)          | 47                  | 10.98 | 12.02 |                                      |                                      |                |        |     |          |
| 1.9 D (BU)          | 47                  | 01.96 | 09.98 | - verstärktes Fahrwerk <sup>2)</sup> |                                      |                |        |     |          |
| 1.9 D (SA)          | 47                  | 01.96 | 12.02 |                                      |                                      |                |        |     |          |
| 1.9 D (SU)          | 47                  | 01.96 | 12.02 |                                      |                                      |                |        |     |          |
| 2.0 16V             | 108                 | 10.98 | 12.02 |                                      |                                      |                |        |     |          |
| 2.0 i (7)           | 84                  | 10.98 | 12.02 |                                      |                                      |                |        |     |          |
| 2.0 i (G)           | 84                  | 10.98 | 12.02 | + verstärktes Fahrwerk <sup>1)</sup> |                                      |                |        |     |          |
|                     | 1.4 16V             | 70    | 06.98 | 12.02                                |                                      | 24.3728-1018.2 | 591018 |     | L=972    |
|                     | 1.4 e               | 55    | 01.96 | 12.02                                |                                      |                |        |     |          |
|                     | 1.4 Eco (T)         | 52    | 01.96 | 03.99                                |                                      |                |        |     |          |
|                     | 1.6 16V (11)        | 79    | 03.99 | 12.02                                |                                      |                |        |     |          |
|                     | 1.6 16V (1J)        | 79    | 03.99 | 12.02                                |                                      |                |        |     |          |
|                     | 1.6 16V (4)         | 79    | 04.98 | 12.02                                |                                      |                |        |     |          |
|                     | 1.6 e (F)           | 66    | 01.96 | 03.99                                |                                      |                |        |     |          |
|                     | 1.6 e (S)           | 66    | 01.96 | 03.99                                |                                      |                |        |     |          |
|                     | 1.6 i               | 55    | 01.96 | 03.99                                |                                      |                |        |     |          |
|                     | 1.9 D               | 47    | 01.96 | 12.02                                |                                      |                |        |     |          |
|                     | 1.9 D (SR)          | 47    | 12.98 | 12.02                                |                                      |                |        |     |          |
|                     | 1.9 dT (K)          | 66    | 03.96 | 12.02                                |                                      |                |        |     |          |
|                     | 1.9 dT (Y)          | 66    | 03.96 | 12.02                                |                                      |                |        |     |          |
|                     | 1.9 dTi (1U)        | 59    | 02.01 | 12.02                                |                                      |                |        |     |          |
| 2.0 i (7)           | 84                  | 12.97 | 12.02 |                                      |                                      |                |        |     |          |
| 2.0 i (G)           | 84                  | 01.96 | 12.02 |                                      |                                      |                |        |     |          |

<sup>1)</sup> + reinforced suspension / + sospensione rinforzata / + châssis renforcé / + suspensión reforzada  
<sup>2)</sup> - reinforced suspension / - sospensione rinforzata / - châssis renforcé / - suspensión reforzada

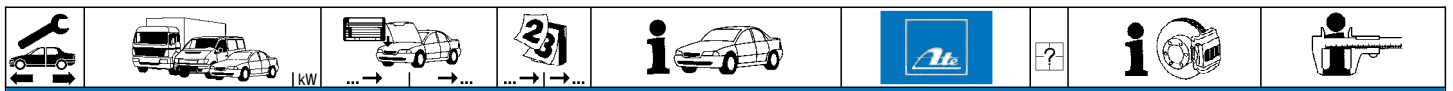

**RENAULT MEGANE I Limousine 3/5-türig (BA/SA\_) (96-02)**

|  |                |    |       |       |                |        |  |  |       |
|--|----------------|----|-------|-------|----------------|--------|--|--|-------|
|  | 1.9 dCi        |    | 09.98 | 12.02 | 24.3728-1024.2 | 591024 |  |  | L=973 |
|  | 1.9 dTi (8)    | 72 | 03.97 | 02.01 |                |        |  |  |       |
|  | 1.9 dTi (BAON) | 72 | 03.97 | 02.01 |                |        |  |  |       |
|  | 1.9 dTi (SAON) | 72 | 03.97 | 02.01 |                |        |  |  |       |
|  | 1.9 TDI        | 69 | 09.96 | 12.02 |                |        |  |  |       |

**RENAULT MEGANE I Classic (LA\_) (96-02)**

|              |              |       |       |                |                |        |  |           |           |                |                |        |  |           |           |     |
|--------------|--------------|-------|-------|----------------|----------------|--------|--|-----------|-----------|----------------|----------------|--------|--|-----------|-----------|-----|
|              | 1.4 16V (OD) | 70    | 03.99 | 12.02          | 03.7760-5602.4 | 300121 |  |           | 10"       | ATE            |                |        |  |           |           |     |
|              | 1.4 16V (OW) | 70    | 06.98 | 12.02          |                |        |  |           |           |                |                |        |  |           |           |     |
|              | 1.4 e (OV)   | 55    | 04.98 | 12.02          |                |        |  |           |           |                |                |        |  |           |           |     |
|              | 1.6 16V (11) | 79    | 09.99 | 12.02          |                |        |  |           |           |                |                |        |  |           |           |     |
|              | 1.6 16V (1C) | 79    | 09.99 | 12.02          |                |        |  |           |           |                |                |        |  |           |           |     |
|              | 1.6 16V (O4) | 79    | 04.98 | 12.02          |                |        |  |           |           |                |                |        |  |           |           |     |
|              | 1.6 e (OF)   | 66    | 09.96 | 12.02          |                |        |  |           |           |                |                |        |  |           |           |     |
|              | 1.9 D (OR)   | 47    | 09.98 | 12.02          |                |        |  |           |           |                |                |        |  |           |           |     |
|              | 1.9 dTi (ON) | 72    | 03.97 | 02.01          |                |        |  |           |           |                |                |        |  |           |           |     |
|              | 1.9 TDI      | 69    | 09.96 | 12.02          |                |        |  |           |           |                |                |        |  |           |           |     |
|              | 2.0 i (OG)   | 84    | 09.96 | 12.02          |                |        |  |           |           |                |                |        |  |           |           |     |
|              | 1.4 e (OE)   | 55    | 09.96 | 12.02          |                |        |  |           |           |                | 03.7750-4702.4 | 300153 |  |           | 9"        | ATE |
|              | 1.4 e (OV)   | 55    | 04.98 | 02.99          |                |        |  |           |           |                |                |        |  |           |           |     |
| 1.6 e (OF)   | 66           | 09.96 | 02.99 |                |                |        |  |           |           |                |                |        |  |           |           |     |
| 1.6 e (OF)   | 66           | 09.96 | 02.99 |                |                |        |  |           |           |                |                |        |  |           |           |     |
| 1.6 e (OS)   | 66           | 09.96 | 12.02 |                |                |        |  |           |           |                |                |        |  |           |           |     |
| 1.9 D (OA)   | 47           | 09.96 | 12.02 |                |                |        |  |           |           |                |                |        |  |           |           |     |
| 1.9 D (OU)   | 47           | 09.96 | 12.02 |                |                |        |  |           |           |                |                |        |  |           |           |     |
| 1.9 D (OU)   | 47           | 12.97 | 12.02 |                |                |        |  |           |           |                |                |        |  |           |           |     |
| 1.9 dT (OK)  | 66           | 09.96 | 01.98 |                |                |        |  |           |           |                |                |        |  |           |           |     |
| 1.9 dT (OY)  | 66           | 09.96 | 12.02 |                |                |        |  |           |           |                |                |        |  |           |           |     |
| 1.9 dTi (O8) | 72           | 03.97 | 02.01 |                |                |        |  |           |           |                |                |        |  |           |           |     |
| 1.9 dTi (ON) | 72           | 03.97 | 02.99 |                |                |        |  |           |           |                |                |        |  |           |           |     |
| 2.0 i (O7)   | 84           | 09.96 | 12.02 |                |                |        |  |           |           |                |                |        |  |           |           |     |
| 2.0 i (OG)   | 84           | 09.96 | 12.02 |                |                |        |  |           |           |                |                |        |  |           |           |     |
| 1.4 16V (OD) | 70           | 03.99 | 12.02 | 03.7863-2002.4 | 300126         |        |  | 10"       | ATE       |                |                |        |  |           |           |     |
| 1.6 16V (O4) | 79           | 04.98 | 12.02 |                |                |        |  |           |           |                |                |        |  |           |           |     |
| 1.9 dCi (O5) | 75           | 09.98 | 12.02 |                |                |        |  |           |           |                |                |        |  |           |           |     |
| 1.9 dTi (ON) | 72           | 03.99 | 12.02 | 03.7760-5102.4 | 300140         |        |  | 10"       | ATE       |                |                |        |  |           |           |     |
| 1.4 16V (OW) | 70           | 06.98 | 12.02 |                |                |        |  |           |           |                |                |        |  |           |           |     |
| 1.4 e (OE)   | 55           | 09.98 | 12.02 |                |                |        |  |           |           |                |                |        |  |           |           |     |
| 1.6 16V (11) | 79           | 09.99 | 12.02 |                |                |        |  |           |           |                |                |        |  |           |           |     |
| 1.6 16V (1C) | 79           | 09.99 | 12.02 |                |                |        |  |           |           |                |                |        |  |           |           |     |
| 1.6 16V (O4) | 79           | 04.98 | 12.02 |                |                |        |  |           |           |                |                |        |  |           |           |     |
| 1.6 e (OF)   | 66           | 09.96 | 03.99 |                |                |        |  |           |           |                |                |        |  |           |           |     |
| 1.9 D (OR)   | 47           | 09.98 | 12.02 |                |                |        |  |           |           |                |                |        |  |           |           |     |
| 1.9 dTi (ON) | 72           | 03.99 | 12.02 |                |                |        |  |           |           |                |                |        |  |           |           |     |
| 1.9 TDI      | 69           | 09.96 | 12.02 |                |                |        |  |           |           |                |                |        |  |           |           |     |
| 2.0 i (OG)   | 84           | 09.98 | 12.02 |                |                |        |  |           |           |                |                |        |  |           |           |     |
| 1.8 16V      | 85           | 01.01 | 12.02 |                |                |        |  |           |           | 03.7863-2002.4 | 300126         |        |  | 10"       | ATE       |     |
| 1.9 dCi (1F) | 75           | 02.01 | 12.02 |                |                |        |  |           |           |                |                |        |  |           |           |     |
| 1.9 dTi (O8) | 72           | 03.97 | 02.01 |                |                |        |  |           |           |                |                |        |  |           |           |     |
|              | 1.4 e (OE)   | 55    | 09.96 | 12.02          | 03.2120-2031.3 | 010106 |  |           | THz 20,64 | ATE            |                |        |  |           |           |     |
|              | 1.6 e        | 66    | 09.96 | 03.99          |                |        |  |           |           |                |                |        |  |           |           |     |
|              | 1.6 i        | 55    | 09.96 | 03.99          |                |        |  |           |           |                |                |        |  |           |           |     |
|              | 1.9 D (OA)   | 47    | 09.96 | 12.02          |                |        |  |           |           |                |                |        |  |           |           |     |
|              | 1.9 D (OU)   | 47    | 09.96 | 12.02          |                |        |  |           |           |                |                |        |  |           |           |     |
|              | 1.9 dT       | 66    | 09.96 | 12.02          |                |        |  |           |           |                |                |        |  |           |           |     |
|              | 1.9 dTi      | 72    | 03.97 | 02.01          |                |        |  |           |           |                |                |        |  |           |           |     |
|              | 2.0 i (O7)   | 84    | 09.96 | 12.02          |                |        |  |           |           |                |                |        |  |           |           |     |
|              | 2.0 i (OG)   | 84    | 09.96 | 12.02          |                |        |  |           |           |                |                |        |  |           |           |     |
|              | 1.4 16V (OD) | 70    | 03.99 | 12.02          |                |        |  |           |           |                | 03.2122-1541.3 | 010511 |  |           | THz 22,20 | ATE |
|              | 1.4 16V (OW) | 70    | 06.98 | 12.02          |                |        |  |           |           |                |                |        |  |           |           |     |
|              | 1.4 e (OV)   | 55    | 04.98 | 12.02          |                |        |  |           |           |                |                |        |  |           |           |     |
|              | 1.6 16V (11) | 79    | 09.99 | 12.02          |                |        |  |           |           |                |                |        |  |           |           |     |
| 1.6 16V (1C) | 79           | 09.99 | 12.02 |                |                |        |  |           |           |                |                |        |  |           |           |     |
| 1.6 16V (O4) | 79           | 04.98 | 12.02 |                |                |        |  |           |           |                |                |        |  |           |           |     |
| 1.9 D (OR)   | 47           | 09.98 | 12.02 |                |                |        |  |           |           |                |                |        |  |           |           |     |
| 1.9 dCi (O5) | 75           | 09.98 | 12.02 |                |                |        |  |           |           |                |                |        |  |           |           |     |
| 1.9 dTi (ON) | 72           | 03.99 | 02.01 |                |                |        |  |           |           |                |                |        |  |           |           |     |
| 1.9 TDI      | 69           | 09.96 | 12.02 |                |                |        |  |           |           |                |                |        |  |           |           |     |
| 2.0 i (OG)   | 84           | 03.99 | 12.02 |                |                |        |  |           |           |                |                |        |  |           |           |     |
| 1.4 16V (OD) | 70           | 03.99 | 12.02 | 03.2120-4441.3 | 010510         |        |  | THz 20,64 | ATE       |                |                |        |  |           |           |     |
| 1.4 16V (OW) | 70           | 06.98 | 12.02 |                |                |        |  |           |           |                |                |        |  |           |           |     |
| 1.4 e (OE)   | 55           | 09.96 | 03.99 |                |                |        |  |           |           |                |                |        |  |           |           |     |
| 1.6 e (OF)   | 66           | 09.96 | 03.99 |                |                |        |  |           |           |                |                |        |  |           |           |     |
| 1.6 i        | 55           | 09.96 | 03.99 |                |                |        |  |           |           |                |                |        |  |           |           |     |
| 1.9 D (OA)   | 47           | 09.96 | 12.02 |                |                |        |  |           |           |                |                |        |  |           |           |     |
| 1.9 D (OU)   | 47           | 09.96 | 12.02 |                |                |        |  |           |           |                |                |        |  |           |           |     |
| 1.9 dT (OK)  | 66           | 09.96 | 12.02 |                |                |        |  |           |           |                |                |        |  |           |           |     |
| 1.9 dT (OY)  | 66           | 09.96 | 12.02 |                |                |        |  |           |           |                |                |        |  |           |           |     |
| 1.9 dTi (O8) | 72           | 03.97 | 02.01 |                |                |        |  |           |           |                |                |        |  |           |           |     |
| 1.9 dTi (ON) | 72           | 03.97 | 02.01 |                |                |        |  |           |           |                |                |        |  |           |           |     |
| 2.0 i (OG)   | 84           | 09.96 | 12.02 |                |                |        |  |           |           |                |                |        |  |           |           |     |
| 1.4 e (OE)   | 55           | 09.96 | 12.02 |                |                |        |  |           |           | 24.2120-1723.3 | 010545         |        |  | THz 20,64 | BDX       |     |
| 1.4 e (OV)   | 55           | 09.98 | 02.99 |                |                |        |  |           |           |                |                |        |  |           |           |     |
| 1.6 e (OF)   | 66           | 09.96 | 03.99 |                |                |        |  |           |           |                |                |        |  |           |           |     |
| 1.6 i        | 55           | 09.96 | 03.99 |                |                |        |  |           |           |                |                |        |  |           |           |     |
| 1.9 D (OA)   | 47           | 09.96 | 12.02 |                |                |        |  |           |           |                |                |        |  |           |           |     |

1) - ABS/ + reinforced suspension / - ABS/ + sospensione rinforzata / - ABS/ + châssis renforcé / - ABS/ + suspensión reforzada  
 2) + reinforced suspension / + sospensione rinforzata / + châssis renforcé / + suspensión reforzada  
 3) + ABS/ - reinforced suspension / + ABS/ - sospensione rinforzata / + ABS/ - châssis renforcé / + ABS/ - suspensión reforzada  
 4) + ABS/ + reinforced suspens. / + ABS/ + sospensione rinforzata / + ABS/ + châssis renforcé / + ABS/ + suspensión reforzada





**RENAULT MEGANE I Classic (LA\_) (96-02)**

|              |              |    |       |       |   |                |                |        |                              |            |                |                |        |                              |            |            |
|--------------|--------------|----|-------|-------|---|----------------|----------------|--------|------------------------------|------------|----------------|----------------|--------|------------------------------|------------|------------|
|              | 1.9 D (OU)   | 47 |       | 09.96 | 12.02                                       | + ABS          | 24.2120-1723.3 | 010545 |                              | THz 20,64  | <b>BDX</b>     |                |        |                              |            |            |
|              | 1.9 dT (OK)  | 66 |       | 09.96 | 12.02                                       | + ABS          |                |        |                              |            |                |                |        |                              |            |            |
|              | 1.9 dT (OY)  | 66 |       | 09.96 | 12.02                                       | + ABS          |                |        |                              |            |                |                |        |                              |            |            |
|              | 1.9 dTi (08) | 72 |       | 03.97 | 02.01                                       | + ABS          |                |        |                              |            |                |                |        |                              |            |            |
|              | 1.9 dTi (ON) | 72 |       | 03.97 | 02.01                                       | + ABS          |                |        |                              |            |                |                |        |                              |            |            |
|              | 2.0 i (0G)   | 84 |       | 09.96 | 12.02                                       | + ABS          |                |        |                              |            |                |                |        |                              |            |            |
|              | 1.4 16V (OD) | 70 |       | 03.99 | 12.02                                       | + ABS          |                |        |                              |            |                | 03.2122-1521.3 | 010494 |                              | THz 22,20  | <b>ATE</b> |
|              | 1.4 16V (OW) | 70 |       | 06.98 | 12.02                                       | + ABS          |                |        |                              |            |                |                |        |                              |            |            |
|              | 1.4 e (OV)   | 55 |       | 03.99 | 12.02                                       | + ABS          |                |        |                              |            |                |                |        |                              |            |            |
|              | 1.6 16V (11) | 79 |       | 09.99 | 12.02                                       |                |                |        |                              |            |                |                |        |                              |            |            |
| 1.6 16V (1C) | 79           |    | 09.99 | 12.02 |   |                |                |        |                              |            |                |                |        |                              |            |            |
| 1.6 16V (04) | 79           |    | 04.98 | 12.02 | + ABS/ + verstärktes Fahrwerk <sup>1)</sup> |                |                |        |                              |            |                |                |        |                              |            |            |
| 1.9 D (OR)   | 47           |    | 09.98 | 12.02 | + ABS                                       |                |                |        |                              |            |                |                |        |                              |            |            |
| 1.9 dTi (ON) | 72           |    | 08.99 | 02.01 | + ABS/ + verstärktes Fahrwerk <sup>1)</sup> |                |                |        |                              |            |                |                |        |                              |            |            |
| 1.9 TDI      | 69           |    | 09.96 | 12.02 | + ABS                                       |                |                |        |                              |            |                |                |        |                              |            |            |
| 2.0 i (0G)   | 84           |    | 08.99 | 12.02 | + ABS                                       |                |                |        |                              |            |                |                |        |                              |            |            |
| 1.6 16V (04) | 79           |    | 04.98 | 12.02 | + ABS/ - verstärktes Fahrwerk <sup>2)</sup> | 03.2123-2146.3 | 010572         |        | THz 23,81                    | <b>ATE</b> |                |                |        |                              |            |            |
| 1.8 16V      | 85           |    | 01.01 | 12.02 | + ABS                                       |                |                |        |                              |            |                |                |        |                              |            |            |
| 1.9 dCi (1F) | 75           |    | 02.01 | 12.02 | + ABS                                       |                |                |        |                              |            |                |                |        |                              |            |            |
| 1.9 dTi (08) | 72           |    | 03.97 | 02.01 | + ABS                                       |                |                |        |                              |            |                |                |        |                              |            |            |
| 1.9 dTi (ON) | 72           |    | 03.97 | 02.01 | + ABS/ - verstärktes Fahrwerk <sup>2)</sup> |                |                |        |                              |            |                |                |        |                              |            |            |
| 1.6 e (OF)   | 66           |    | 09.96 | 03.99 | + ABS                                       | 24.2120-1725.3 | 010579         |        | THz 20,64                    | <b>BDX</b> |                |                |        |                              |            |            |
| 1.9 D (OA)   | 47           |    | 09.96 | 12.02 | + ABS                                       |                |                |        |                              |            |                |                |        |                              |            |            |
| 1.9 dT (OY)  | 66           |    | 09.96 | 12.02 | + ABS                                       |                |                |        |                              |            |                |                |        |                              |            |            |
| 1.9 dTi (08) | 72           |    | 03.97 | 02.01 | + ABS                                       |                |                |        |                              |            |                |                |        |                              |            |            |
| 1.9 dTi (ON) | 72           |    | 03.97 | 02.99 | + ABS                                       |                |                |        |                              |            |                |                |        |                              |            |            |
| 2.0 i (0G)   | 84           |    | 09.96 | 12.02 | + ABS                                       |                |                |        |                              |            |                |                |        |                              |            |            |
| 1.6 16V (04) | 79           |    | 03.99 | 12.02 | + ABS                                       | 03.2123-2181.3 | 010608         |        | THz 23,81                    | <b>ATE</b> |                |                |        |                              |            |            |
| 1.6 16V (OB) | 79           |    | 09.99 | 12.02 | + ABS                                       |                |                |        |                              |            |                |                |        |                              |            |            |
| 1.8 16V      | 85           |    | 01.01 | 12.02 | + ABS                                       |                |                |        |                              |            |                |                |        |                              |            |            |
| 1.9 D (OA)   | 47           |    | 09.96 | 12.02 | + ABS                                       |                |                |        |                              |            |                |                |        |                              |            |            |
| 1.9 dCi      | 75           |    | 09.98 | 12.02 | + ABS                                       |                |                |        |                              |            |                |                |        |                              |            |            |
| 1.9 dT (OY)  | 66           |    | 09.96 | 12.02 | + ABS                                       |                |                |        |                              |            |                |                |        |                              |            |            |
| 1.9 dTi (ON) | 72           |    | 03.99 | 02.01 | + ABS                                       |                |                |        |                              |            |                |                |        |                              |            |            |
| 2.0 i (0G)   | 84           |    | 09.96 | 12.02 | + ABS                                       |                |                |        |                              |            |                |                |        |                              |            |            |
| 1.4 e (OE)   | 55           |    | 09.96 | 10.97 |   |                |                |        |                              |            | 24.3481-1611.5 | 240029         |        | D=48, - Halter               | <b>LUC</b> |            |
| 1.6 i        | 55           |    | 09.96 | 10.97 |   |                |                |        |                              |            |                |                |        |                              |            |            |
| 1.9 D (OA)   | 47           |    | 09.96 | 10.97 |   |                |                |        |                              |            |                |                |        |                              |            |            |
| 1.9 D (OU)   | 47           |    | 09.96 | 10.97 |   |                |                |        |                              |            |                |                |        |                              |            |            |
| 1.4 16V (OD) | 70           |    | 03.99 | 12.02 |   |                |                |        |                              |            | 24.3481-1615.5 | 240031         |        | D=48, - Halter               | <b>LUC</b> |            |
| 1.4 16V (OW) | 70           |    | 06.98 | 12.02 |   |                |                |        |                              |            |                |                |        |                              |            |            |
| 1.4 e (OE)   | 55           |    | 11.97 | 12.02 | + ABS                                       |                |                |        |                              |            |                |                |        |                              |            |            |
| 1.4 e (OV)   | 55           |    | 04.98 | 12.02 |   |                |                |        |                              |            |                |                |        |                              |            |            |
| 1.6 16V (1C) | 79           |    | 03.99 | 12.02 |   | 24.0101-4806.2 | 260052         |        | D=48, - Halter<br>Einbausatz | <b>LUC</b> |                |                |        |                              |            |            |
| 1.6 16V (04) | 79           |    | 04.98 | 12.02 | + verstärktes Fahrwerk <sup>3)</sup>        |                |                |        |                              |            |                |                |        |                              |            |            |
| 1.6 e        | 66           |    | 09.96 | 03.99 |   |                |                |        |                              |            |                |                |        |                              |            |            |
| 1.6 i        | 55           |    | 11.97 | 03.99 |   |                |                |        |                              |            |                |                |        |                              |            |            |
| 1.9 D (OA)   | 47           |    | 11.97 | 12.02 |   |                |                |        |                              |            |                |                |        |                              |            |            |
| 1.9 D (OR)   | 47           |    | 09.98 | 12.02 |   |                |                |        |                              |            |                |                |        |                              |            |            |
| 1.9 D (OU)   | 47           |    | 11.97 | 12.02 |   |                |                |        |                              |            |                |                |        |                              |            |            |
| 1.9 dT       | 66           |    | 09.96 | 12.02 |   |                |                |        |                              |            |                |                |        |                              |            |            |
| 1.9 dTi (1U) | 59           |    | 02.01 | 12.02 |   |                |                |        |                              |            |                |                |        |                              |            |            |
| 1.9 dTi (08) | 72           |    | 03.97 | 02.01 |   |                |                |        |                              |            |                |                |        |                              |            |            |
| 1.9 dTi (ON) | 72           |    | 03.97 | 02.99 |   |                |                |        |                              |            |                |                |        |                              |            |            |
| 1.9 TDI      | 69           |    | 09.96 | 12.02 |   |                |                |        |                              |            |                |                |        |                              |            |            |
| 2.0 i (0G)   | 84           |    | 09.96 | 02.99 |   |                |                |        |                              |            |                |                |        |                              |            |            |
| 1.4 16V (OD) | 70           |    | 03.99 | 12.02 |   |                |                |        |                              |            | 24.3541-1749.5 | 240427         |        | D=54, - Halter               | <b>LUC</b> |            |
| 1.6 16V (11) | 79           |    | 03.99 | 12.02 |   |                |                |        |                              |            |                |                |        |                              |            |            |
| 1.6 16V (1J) | 79           |    | 03.99 | 12.02 |   |                |                |        |                              |            |                |                |        |                              |            |            |
| 1.6 16V (04) | 79           |    | 04.98 | 12.02 | - verstärktes Fahrwerk <sup>4)</sup>        |                |                |        |                              |            |                |                |        |                              |            |            |
| 1.6 16V (OB) | 79           |    | 03.99 | 12.02 |   |                |                |        |                              |            |                |                |        |                              |            |            |
| 1.8 16V      | 85           |    | 01.01 | 12.02 |   |                |                |        |                              |            |                |                |        |                              |            |            |
| 1.9 dCi      | 75           |    | 09.98 | 12.02 |   |                |                |        |                              |            |                |                |        |                              |            |            |
| 1.9 dTi (1U) | 59           |    | 02.01 | 12.02 |   |                |                |        |                              |            |                |                |        |                              |            |            |
| 1.9 dTi (08) | 72           |    | 03.97 | 02.01 |   |                |                |        |                              |            |                |                |        |                              |            |            |
| 1.9 dTi (ON) | 72           |    | 03.99 | 02.01 |   |                |                |        |                              |            |                |                |        |                              |            |            |
| 2.0 i (07)   | 84           |    | 09.96 | 12.02 |   |                |                |        |                              |            |                |                |        |                              |            |            |
| 2.0 i (0G)   | 84           |    | 03.99 | 12.02 |   |                |                |        |                              |            |                |                |        |                              |            |            |
| 1.4 16V      | 70           |    | 06.98 | 12.02 |   | 24.5111-0390.3 | 330566         | 2      |                              | L=390      |                |                |        |                              |            |            |
| 1.4 e        | 55           |    | 09.96 | 12.02 |   |                |                |        |                              |            |                |                |        |                              |            |            |
| 1.6 16V (04) | 79           |    | 04.98 | 12.02 |   |                |                |        |                              |            |                |                |        |                              |            |            |
| 1.6 16V (OB) | 79           |    | 09.98 | 12.02 |   |                |                |        |                              |            |                |                |        |                              |            |            |
| 1.6 e        | 66           |    | 09.96 | 03.99 |   |                |                |        |                              |            |                |                |        |                              |            |            |
| 1.6 i        | 55           |    | 09.96 | 03.99 |   |                |                |        |                              |            |                |                |        |                              |            |            |
| 1.8 16V      | 85           |    | 01.01 | 12.02 |   |                |                |        |                              |            |                |                |        |                              |            |            |
| 1.9 D        | 47           |    | 09.96 | 12.02 |   |                |                |        |                              |            |                |                |        |                              |            |            |
| 1.9 dCi (1F) | 75           |    | 02.01 | 12.02 |   |                |                |        |                              |            |                |                |        |                              |            |            |
| 1.9 dCi (05) | 75           |    | 02.01 | 12.02 |   |                |                |        |                              |            |                |                |        |                              |            |            |
| 1.9 dT       | 66           |    | 09.96 | 12.02 |   |                |                |        |                              |            |                |                |        |                              |            |            |
| 1.9 dTi (1U) | 59           |    | 02.01 | 12.02 |   |                |                |        |                              |            |                |                |        |                              |            |            |
| 1.9 dTi (08) | 72           |    | 03.97 | 02.01 |   |                |                |        |                              |            |                |                |        |                              |            |            |
| 1.9 TDI      | 69           |    | 09.96 | 12.02 |   |                |                |        |                              |            |                |                |        |                              |            |            |
| 2.0 i (07)   | 84           |    | 09.96 | 12.02 |   |                |                |        |                              |            |                |                |        |                              |            |            |
| 1.9 dTi (ON) | 72           |    | 03.97 | 02.01 |   |                |                |        |                              |            | 24.5111-0390.3 | 330566         | 2      | Länge beachten <sup>5)</sup> | L=390      |            |
| 2.0 i (0G)   | 84           |    | 09.96 | 12.02 |   |                |                |        |                              |            |                |                |        |                              |            |            |

<sup>1)</sup> + ABS/ + reinforced suspens. / + ABS/ + sospensione rinforzata / + ABS/ + châssis renforcé / + ABS/ + suspensión reforzada

<sup>2)</sup> + ABS/ - reinforced suspension / + ABS/ - sospensione rinforzata / + ABS/ - châssis renforcé / + ABS/ - suspensión reforzada

<sup>3)</sup> + reinforced suspension / + sospensione rinforzata / + châssis renforcé / + suspensión reforzada

<sup>4)</sup> - reinforced suspension / - sospensione rinforzata / - châssis renforcé / - suspensión reforzada

<sup>5)</sup> notice length / attenzione lunghezza / faire attention longueur / atención largo

| RENAULT MEGANE I Classic (LA_) (96-02) |              |              |       |                |                |                |                              |        |          |
|--|--------------|--------------|-------|----------------|----------------|----------------|------------------------------|--------|----------|
|  | 1.4 16V      | 70           | 06.98 | 12.02          | 24.5229-0265.3 | 330540         | 2                            |        | L=265    |
|  | 1.4 e        | 55           | 09.96 | 12.02          |                |                |                              |        |          |
|  | 1.6 16V (04) | 79           | 04.98 | 12.02          |                |                |                              |        |          |
|  | 1.6 16V (0B) | 79           | 09.98 | 12.02          |                |                |                              |        |          |
|  | 1.6 e        | 66           | 09.96 | 03.99          |                |                |                              |        |          |
|  | 1.6 i        | 55           | 09.96 | 03.99          |                |                |                              |        |          |
|  | 1.8 16V      | 85           | 01.01 | 12.02          |                |                |                              |        |          |
|  | 1.9 D        | 47           | 09.96 | 12.02          |                |                |                              |        |          |
|  | 1.9 dT       | 66           | 09.96 | 12.02          |                |                |                              |        |          |
|  | 1.9 dTi (1U) | 59           | 02.01 | 12.02          |                |                |                              |        |          |
|  | 1.9 dTi (08) | 72           | 03.97 | 02.01          |                |                |                              |        |          |
|  | 1.9 TDI      | 69           | 09.96 | 12.02          |                |                |                              |        |          |
|  | 2.0 i (07)   | 84           | 09.96 | 12.02          |                |                |                              |        |          |
| 1.9 dTi (0N)                           | 72           | 03.97        | 02.01 | 24.5229-0265.3 | 330540         | 2              | Länge beachten <sup>1)</sup> | L=265  |          |
| 2.0 i (0G)                             | 84           | 09.96        | 12.02 |                |                |                |                              |        |          |
|  | 1.4 16V (0D) | 70           | 03.99 | 12.02          | 24.3217-1705.3 | 020020         |                              |        | Rz 17,46 |
|  | 1.4 16V (0W) | 70           | 06.98 | 12.02          |                |                |                              |        |          |
|  | 1.4 e (0E)   | 55           | 09.96 | 12.02          |                |                |                              |        |          |
|  | 1.4 e (0V)   | 55           | 04.98 | 02.99          |                |                |                              |        |          |
|  | 1.4 e (0V)   | 55           | 04.98 | 12.02          |                |                |                              |        |          |
|  | 1.6 16V (11) | 79           | 09.99 | 12.02          |                |                |                              |        |          |
|  | 1.6 16V (1C) | 79           | 09.99 | 12.02          |                |                |                              |        |          |
|  | 1.6 16V (04) | 79           | 04.98 | 12.02          |                |                |                              |        |          |
|  | 1.6 e        | 66           | 09.96 | 03.99          |                |                |                              |        |          |
|  | 1.6 i        | 55           | 09.96 | 03.99          |                |                |                              |        |          |
|  | 1.9 D        | 47           | 09.96 | 12.02          |                |                |                              |        |          |
|  | 1.9 dCi      | 75           | 09.98 | 12.02          |                |                |                              |        |          |
|  | 1.9 dT       | 66           | 09.96 | 12.02          |                |                |                              |        |          |
|  | 1.9 dTi (1U) | 59           | 02.01 | 12.02          |                |                |                              |        |          |
|  | 1.9 dTi (08) | 72           | 03.97 | 02.01          |                |                |                              |        |          |
|  | 1.9 dTi (0N) | 72           | 03.97 | 02.99          |                |                |                              |        |          |
|  | 1.9 dTi (0N) | 72           | 03.97 | 02.01          |                |                |                              |        |          |
|  | 2.0 i (07)   | 84           | 09.96 | 12.02          |                |                |                              |        |          |
|  | 2.0 i (0G)   | 84           | 09.96 | 02.99          |                |                |                              |        |          |
|  | 2.0 i (0G)   | 84           | 09.96 | 12.02          |                |                |                              |        |          |
|  | 1.4 16V (0D) | 70           | 03.99 | 12.02          | 24.3219-1728.3 | 020452         |                              |        | Rz 19,05 |
|  | 1.4 16V (0W) | 70           | 06.98 | 12.02          |                |                |                              |        |          |
|  | 1.4 e (0V)   | 55           | 03.99 | 12.02          |                |                |                              |        |          |
|  | 1.6 16V (04) | 79           | 04.98 | 12.02          |                |                |                              |        |          |
|  | 1.8 16V (12) | 85           | 01.01 | 12.02          |                |                |                              |        |          |
|  | 1.8 16V (1M) | 85           | 01.01 | 12.02          |                |                |                              |        |          |
|  | 1.9 dCi      | 75           | 09.98 | 12.02          |                |                |                              |        |          |
|  | 1.9 dTi (1U) | 59           | 02.01 | 12.02          |                |                |                              |        |          |
|  | 1.9 dTi (08) | 72           | 03.97 | 02.01          |                |                |                              |        |          |
|  | 1.9 dTi (0N) | 72           | 03.99 | 02.01          |                |                |                              |        |          |
|  | 2.0 i (0G)   | 84           | 03.99 | 12.02          |                |                |                              |        |          |
|  | 1.9 TDI      | 69           | 09.96 | 12.02          | 24.3220-1711.3 | 020409         |                              |        | Rz 20,64 |
|  |              | 1.4 16V (0D) | 70    | 03.99          | 12.02          | 24.3727-1057.2 | 581057                       | 2      | ↓        |
| 1.4 16V (0W)                           |              | 70           | 06.98 | 12.02          |                |                |                              |        |          |
| 1.4 e (0E)                             |              | 55           | 09.96 | 12.02          |                |                |                              |        |          |
| 1.4 e (0V)                             |              | 55           | 04.98 | 12.02          |                |                |                              |        |          |
| 1.6 16V (04)                           |              | 79           | 04.98 | 12.02          |                |                |                              |        |          |
| 1.6 16V (0B)                           |              | 79           | 09.98 | 12.02          |                |                |                              |        |          |
| 1.6 e (0F)                             |              | 66           | 09.96 | 03.99          |                |                |                              |        |          |
| 1.6 i                                  |              | 55           | 09.96 | 03.99          |                |                |                              |        |          |
| 1.8 16V                                |              | 85           | 01.01 | 12.02          |                |                |                              |        |          |
| 1.9 D                                  |              | 47           | 09.96 | 12.02          |                |                |                              |        |          |
| 1.9 dT                                 |              | 66           | 09.96 | 12.02          |                |                |                              |        |          |
| 1.9 dTi (1U)                           |              | 59           | 02.01 | 12.02          |                |                |                              |        |          |
| 1.9 dTi (08)                           |              | 72           | 03.97 | 02.01          |                |                |                              |        |          |
| 1.9 dTi (0N)                           | 72           | 03.97        | 02.01 |                |                |                |                              |        |          |
| 2.0 i (0G)                             | 84           | 09.96        | 12.02 |                |                |                |                              |        |          |
|  | 1.4 16V (0W) | 70           | 06.98 | 12.02          | 24.3727-1050.2 | 581050         | 2                            | ↓      | L=1440   |
|  | 1.4 e (0E)   | 55           | 09.96 | 12.02          |                |                |                              |        |          |
|  | 1.6 16V (11) | 79           | 09.99 | 12.02          |                |                |                              |        |          |
|  | 1.6 16V (1C) | 79           | 09.99 | 12.02          |                |                |                              |        |          |
|  | 1.6 16V (04) | 79           | 04.98 | 12.02          |                |                |                              |        |          |
|  | 1.6 e (0F)   | 66           | 09.96 | 03.99          |                |                |                              |        |          |
|  | 1.6 e (0S)   | 66           | 09.96 | 03.99          |                |                |                              |        |          |
|  | 1.9 D        | 47           | 09.96 | 12.02          |                |                |                              |        |          |
|  | 1.9 dTi (1U) | 59           | 02.01 | 12.02          |                |                |                              |        |          |
|  | 1.9 dTi (0N) | 72           | 03.97 | 02.01          |                |                |                              |        |          |
| 2.0 i (07)                             | 84           | 09.96        | 12.02 |                |                |                |                              |        |          |
| 1.9 TDI                                | 69           | 09.96        | 12.02 | 24.3727-1063.2 | 581063         | 2              | ↓                            | L=1456 |          |
|  | 1.4 e (0E)   | 55           | 09.96 | 12.02          | 24.6582-1701.3 | 320171         |                              |        | BRL (4)  |
|  | 1.6 e (0F)   | 66           | 09.96 | 03.99          |                |                |                              |        |          |
|  | 1.6 i        | 55           | 09.96 | 03.99          |                |                |                              |        |          |
|  | 1.9 D (0A)   | 47           | 09.96 | 12.02          |                |                |                              |        |          |
|  | 1.4 16V (0D) | 70           | 03.99 | 12.02          | 24.6582-1706.3 | 320191         |                              |        | BRL (4)  |
|  | 1.4 16V (0W) | 70           | 06.98 | 12.02          |                |                |                              |        |          |
|  | 1.4 e (0E)   | 55           | 10.98 | 12.02          |                |                |                              |        |          |
|  | 1.6 16V (11) | 79           | 09.99 | 12.02          |                |                |                              |        |          |
|  | 1.6 16V (1C) | 79           | 09.99 | 12.02          |                |                |                              |        |          |
|  | 1.6 16V (04) | 79           | 04.98 | 12.02          |                |                |                              |        |          |
|  | 1.6 16V (0B) | 79           | 09.98 | 12.02          |                |                |                              |        |          |
|  | 1.6 e (0F)   | 66           | 10.98 | 03.99          |                |                |                              |        |          |

<sup>1)</sup> notice length / attenzione lunghezza / faire attention longueur / atención largo

<sup>2)</sup> - reinforced suspension / - sospensione rinforzata / - châssis renforcé / - suspensión reforzada

<sup>3)</sup> + reinforced suspension / + sospensione rinforzata / + châssis renforcé / + suspensión reforzada

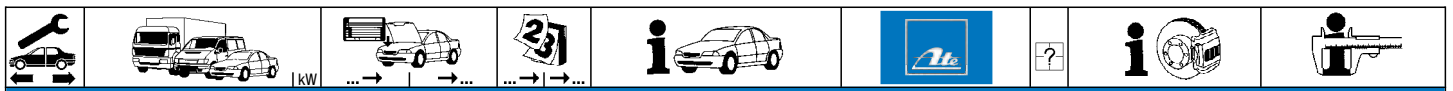













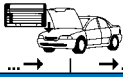













### RENAULT MEGANE I Classic (LA\_) (96-02)

|              |              |       |       |       |                                      |                |        |  |         |
|--------------|--------------|-------|-------|-------|--------------------------------------|----------------|--------|--|---------|
|              | 1.6 e (0S)   | 66    | 10.98 | 03.99 |                                      | 24.6582-1706.3 | 320191 |  | BRL (4) |
|              | 1.8 16V (1A) | 85    | 01.01 | 12.02 | + verstärktes Fahrwerk <sup>1)</sup> |                |        |  |         |
|              | 1.8 16V (1M) | 85    | 01.01 | 12.02 | + verstärktes Fahrwerk <sup>1)</sup> |                |        |  |         |
|              | 1.9 D        | 47    | 10.98 | 12.02 | + verstärktes Fahrwerk <sup>1)</sup> |                |        |  |         |
|              | 1.9 dTi (0N) | 72    | 03.99 | 02.01 |                                      |                |        |  |         |
|              | 2.0 i (07)   | 84    | 10.98 | 12.02 |                                      |                |        |  |         |
|              | 2.0 i (0G)   | 84    | 10.98 | 12.02 | + verstärktes Fahrwerk <sup>1)</sup> |                |        |  |         |
| 1.9 TDI      | 69           | 09.96 | 12.02 |       |                                      | 24.6582-1702.3 | 320172 |  | BRL (4) |
|              | 1.4 16V (0W) | 70    | 06.98 | 12.02 |                                      | 24.3728-1018.2 | 591018 |  | L=972   |
|              | 1.4 e        | 55    | 09.96 | 12.02 |                                      |                |        |  |         |
|              | 1.6 16V (11) | 79    | 09.99 | 12.02 |                                      |                |        |  |         |
|              | 1.6 16V (1C) | 79    | 09.99 | 12.02 |                                      |                |        |  |         |
|              | 1.6 16V (04) | 79    | 04.98 | 12.02 |                                      |                |        |  |         |
|              | 1.6 e (0F)   | 66    | 09.96 | 03.99 |                                      |                |        |  |         |
|              | 1.6 i        | 55    | 09.96 | 03.99 |                                      |                |        |  |         |
|              | 1.9 D (0A)   | 47    | 09.96 | 12.02 |                                      |                |        |  |         |
|              | 1.9 D (0R)   | 47    | 09.98 | 12.02 |                                      |                |        |  |         |
|              | 1.9 D (0U)   | 47    | 09.96 | 12.02 |                                      |                |        |  |         |
|              | 1.9 dT (0K)  | 66    | 09.96 | 12.02 |                                      |                |        |  |         |
|              | 1.9 dT (0Y)  | 66    | 09.96 | 12.02 |                                      |                |        |  |         |
|              | 1.9 TDI      | 69    | 09.96 | 12.02 |                                      |                |        |  |         |
|              | 2.0 i (07)   | 84    | 09.96 | 12.02 |                                      |                |        |  |         |
| 2.0 i (0G)   | 84           | 09.96 | 12.02 |       |                                      |                |        |  |         |
| 1.9 dCi (05) | 75           | 09.98 | 12.02 |       |                                      | 24.3728-1024.2 | 591024 |  | L=973   |
| 1.9 dTi      | 72           | 03.97 | 02.01 |       |                                      |                |        |  |         |

### RENAULT MEGANE I Coach (DA\_) (95-03)

|              |              |              |       |       |                |                |                |                |                |           |     |
|--------------|--------------|--------------|-------|-------|----------------|----------------|----------------|----------------|----------------|-----------|-----|
|              | 1.4 16V (0W) | 70           | 06.98 | 02.03 | - ABS          | 03.7760-5602.4 | 300121         |                | 10"            | ATE       |     |
|              | 1.6 16V (0B) | 79           | 10.00 | 02.03 | - ABS          |                |                |                |                |           |     |
|              | 2.0 16V (0P) | 103          | 10.00 | 02.03 | - ABS          |                |                |                |                |           |     |
|              | 1.6 e        | 66           | 09.95 | 02.03 |                | 03.7750-4702.4 | 300153         |                | 9"             | ATE       |     |
|              | 1.9 dTi      | 72           | 05.97 | 02.99 |                |                |                |                |                |           |     |
|              | 2.0 i        | 84           | 09.95 | 02.03 |                |                |                |                |                |           |     |
|              | 1.4 16V (0W) | 70           | 06.98 | 02.03 | + ABS          | 03.7760-5502.4 | 300151         |                | 10"            | ATE       |     |
|              | 1.4 16V (0D) | 70           | 10.00 | 02.03 | + ABS          | 03.7863-2002.4 | 300126         |                | 10"            | ATE       |     |
|              | 1.6 16V (0B) | 79           | 10.00 | 02.03 | + ABS          |                |                |                |                |           |     |
|              | 1.9 dCi (1F) | 75           | 10.00 | 02.03 | + ABS          |                |                |                |                |           |     |
| 2.0 16V (0P) | 103          | 10.00        | 02.03 | + ABS |                |                |                |                |                |           |     |
|              | 1.6 16V (04) | 79           | 04.98 | 02.03 | + ABS          | 03.7760-5102.4 | 300140         |                | 10"            | ATE       |     |
|              | 1.9 dCi (05) | 75           | 10.00 | 02.03 | + ABS          |                |                |                |                |           |     |
|              | 1.9 dTi      | 72           | 03.99 | 02.03 |                |                |                |                |                |           |     |
|              | 2.0 16V (03) | 103          | 07.98 | 02.03 |                |                |                |                |                |           |     |
|              | 2.0 16V (0H) | 108          | 03.99 | 02.03 |                |                |                |                |                |           |     |
|              |              | 1.4 16V      | 70    | 06.98 | 02.03          | - ABS          | 03.2122-1541.3 | 010511         |                | Thz 22,20 | ATE |
|              |              | 1.6 16V (0B) | 79    | 10.00 | 02.03          | - ABS          |                |                |                |           |     |
|              |              | 1.9 dCi (1F) | 75    | 10.00 | 02.03          | - ABS          |                |                |                |           |     |
|              |              | 2.0 16V (0P) | 103   | 10.00 | 02.03          | - ABS          |                |                |                |           |     |
|              |              | 1.6 e        | 66    | 09.95 | 02.03          | - ABS          | 03.2120-2031.3 | 010106         |                | Thz 20,64 | ATE |
| 1.9 dTi      |              | 72           | 05.97 | 02.03 | - ABS          |                |                |                |                |           |     |
| 2.0 i        |              | 84           | 09.95 | 02.03 | - ABS          |                |                |                |                |           |     |
| 2.0 16V (0H) |              | 108          | 09.95 | 02.99 |                | 24.2123-1701.3 | 010424         |                | Thz 23,81      |           |     |
| 1.4 16V (0W) |              | 70           | 06.98 | 02.03 | + ABS          | 03.2122-1521.3 | 010494         |                | Thz 22,20      | ATE       |     |
| 1.6 e        |              | 66           | 09.95 | 02.03 | + ABS          | 03.2120-4441.3 | 010510         |                | Thz 20,64      | ATE       |     |
| 1.9 dTi      | 72           | 05.97        | 02.99 | + ABS |                |                |                |                |                |           |     |
| 2.0 i        | 84           | 09.95        | 02.03 | + ABS |                |                |                |                |                |           |     |
|              | 1.4 16V (0D) | 70           | 10.00 | 02.03 | + ABS          | 03.2123-2146.3 | 010572         |                | Thz 23,81      | ATE       |     |
|              | 1.6 16V (0B) | 79           | 10.00 | 02.03 | + ABS          |                |                |                |                |           |     |
|              | 1.9 dCi (1F) | 75           | 10.00 | 02.03 | + ABS          |                |                |                |                |           |     |
|              | 2.0 16V (0P) | 103          | 10.00 | 02.03 | + ABS          |                |                |                |                |           |     |
|              | 1.6 16V (04) | 79           | 04.98 | 02.03 | + ABS          | 03.2123-2146.3 | 010572         |                | Thz 23,81      | ATE       |     |
|              | 1.9 dCi (05) | 75           | 10.00 | 02.03 | + ABS          |                |                |                |                |           |     |
|              | 1.9 dTi      | 72           | 03.99 | 02.03 | + ABS          |                |                |                |                |           |     |
|              | 2.0 16V (03) | 103          | 07.98 | 02.03 |                |                |                |                |                |           |     |
|              | 2.0 16V (0H) | 108          | 03.99 | 02.03 |                |                |                |                |                |           |     |
|              | 1.6 e        | 66           | 09.95 | 02.03 | + ABS          | 24.2120-1723.3 | 010545         |                | Thz 20,64      | BDX       |     |
| 1.9 dTi      | 72           | 05.97        | 02.99 | + ABS |                |                |                |                |                |           |     |
| 2.0 i        | 84           | 09.95        | 02.03 | + ABS |                |                |                |                |                |           |     |
|              | 1.6 e        | 66           | 09.95 | 02.03 | + ABS          | 24.2120-1725.3 | 010579         |                | Thz 20,64      | BDX       |     |
|              | 2.0 i        | 84           | 09.95 | 02.03 | + ABS          |                |                |                |                |           |     |
|              | 1.4 16V (0W) | 70           | 06.98 | 02.03 |                | 03.2120-4441.3 | 010510         |                | Thz 20,64      | ATE       |     |
|              | 1.6 e        | 66           | 09.95 | 02.03 | + ABS          |                |                |                |                |           |     |
|              | 2.0 i        | 84           | 09.95 | 02.03 | + ABS          |                |                |                |                |           |     |
|              | 1.4 16V (0D) | 70           | 10.00 | 02.03 | + ABS          | 03.2123-2181.3 | 010608         |                | Thz 23,81      | ATE       |     |
|              | 1.6 16V      | 79           | 04.98 | 02.03 | + ABS          |                |                |                |                |           |     |
|              | 1.9 dCi (1F) | 75           | 10.00 | 02.03 | + ABS          |                |                |                |                |           |     |
|              | 2.0 16V (03) | 103          | 07.98 | 02.03 |                |                |                |                |                |           |     |
|              | 2.0 16V (0H) | 108          | 03.99 | 02.03 |                |                |                |                |                |           |     |
| 2.0 16V (0P) | 103          | 10.00        | 02.03 | + ABS |                |                |                |                |                |           |     |
|              | 1.4 16V (0W) | 70           | 06.98 | 02.03 |                | 24.3481-1615.5 | 240031         |                | D=48, - Halter | LUC       |     |
|              | 1.6 e        | 66           | 09.95 | 02.03 |                | 24.3481-1616.5 | 240032         |                | D=48, - Halter | LUC       |     |
|              | 1.9 dTi      | 72           | 05.97 | 02.99 |                | 24.0101-4806.2 | 260052         |                | Einbausatz     | LUC       |     |
|              | 2.0 i        | 84           | 09.95 | 02.03 |                |                |                |                |                |           |     |
|              | 1.4 16V (0D) | 70           | 10.00 | 02.03 |                | 24.3541-1749.5 | 240427         |                | D=54, - Halter | LUC       |     |
| 1.6 16V      | 79           | 04.98        | 02.03 |       | 24.3541-1750.5 | 240428         |                | D=54, - Halter | LUC            |           |     |



















<sup>1)</sup> + reinforced suspension / + sospensione rinforzata / + châssis renforcé / + suspensión reforzada

|     |     |  |  |  |  |  |   |  |     |
|--|---|--|--|--|---|--|---|--|-----|
| <b>RENAULT MEGANE I Coach (DA_) (95-03)</b>  |   |  |  |  |   |  |   |  |     |
|    | 1.9 dCi   | 72   | 10.00  | 02.03  | 24.3541-1749.5  | 240427   |  | D=54, - Halter   | LUC |
|  | 1.9 dTi   | 103  | 03.99  | 02.03  | 24.3541-1750.5  | 240428   |  | D=54, - Halter   | LUC |
|  | 2.0 16V (03)  | 103  | 07.98  | 02.03  |   |  |   |  |     |
|  | 2.0 16V (OH)  | 108  | 09.98  | 02.03  |   |  |   |  |     |
|  | 2.0 16V (OP)  | 103  | 10.00  | 02.03  |   |  |   |  |     |
|  | 2.0 16V (OH)  | 108  | 09.95  | 08.98  | 24.3541-1741.5  | 240215   |  | D=54, - Halter   | LUC |
|  |   |  |  |  | 24.3541-1742.5  | 240216   |  | D=54, - Halter   | LUC |
|  | 2.0 16V (OH)  | 108  | 09.95  | 08.98  | 24.3601-1707.5  | 240229   |  | D=60, - Halter   | LUC |
|  |   |  |  |  | 24.3601-1708.5  | 240230   |  | D=60, - Halter   | LUC |
|    | 1.4 16V   | 70   | 06.98  | 02.03  | 24.5111-0390.3  | 330566   | 2   | L=390  |     |
|  | 1.6 16V   | 79   | 04.98  | 02.03  |   |  |   |  |     |
|  | 1.6 e   | 66   | 09.95  | 02.03  |   |  |   |  |     |
|  | 1.9 dCi   | 72   | 10.00  | 02.03  |   |  |   |  |     |
|  | 1.9 dTi   | 103  | 05.97  | 02.03  |   |  |   |  |     |
|  | 2.0 16V (03)  | 103  | 07.98  | 02.03  |   |  |   |  |     |
|  | 2.0 16V (OH)  | 108  | 09.95  | 02.03  |   |  |   |  |     |
|  | 2.0 16V (OP)  | 103  | 10.00  | 02.03  |   |  |   |  |     |
|  | 2.0 i   |  | 09.95  | 02.03  |   |  |   |  |     |
|  |   |  |  |  |   |  |   |  |     |
|    | 1.4 16V   | 70   | 06.98  | 02.03  | 24.5229-0265.3  | 330540   | 2   | L=265  |     |
|  | 1.6 16V   | 79   | 04.98  | 02.03  |   |  |   |  |     |
|  | 1.6 e   | 66   | 09.95  | 02.03  |   |  |   |  |     |
|  | 1.9 dCi   | 72   | 10.00  | 02.03  |   |  |   |  |     |
|  | 1.9 dTi   | 103  | 05.97  | 02.03  |   |  |   |  |     |
|  | 2.0 16V (03)  | 103  | 07.98  | 02.03  |   |  |   |  |     |
|  | 2.0 16V (OH)  | 108  | 09.95  | 02.03  |   |  |   |  |     |
|  | 2.0 16V (OP)  | 103  | 10.00  | 02.03  |   |  |   |  |     |
|  | 2.0 i   |  | 09.95  | 02.03  |   |  |   |  |     |
|  |   |  |  |  |   |  |   |  |     |
|    | 1.4 16V (0W)  | 70   | 06.98  | 02.03  | 24.3217-1705.3  | 020020   |   | Rz 17,46   |     |
|  | 1.6 16V (04)  | 79   | 04.98  | 02.03  |   |  |   |  |     |
|  | 1.6 e   | 66   | 09.95  | 02.03  |   |  |   |  |     |
|  | 1.9 dCi (05)  | 75   | 07.98  | 02.03  |   |  |   |  |     |
|  | 1.9 dTi   | 72   | 03.99  | 02.03  |   |  |   |  |     |
|  | 1.9 dTi   | 72   | 05.97  | 02.99  |   |  |   |  |     |
|  | 2.0 i   |  | 09.95  | 02.03  |   |  |   |  |     |
|  | 1.4 16V (0D)  | 70   | 10.00  | 02.03  | 24.3219-1728.3  | 020452   |   | Rz 19,05   |     |
|  | 1.4 16V (0W)  | 70   | 06.98  | 02.03  |   |  |   |  |     |
|  | 1.6 16V (04)  | 79   | 04.98  | 02.03  |   |  |   |  |     |
| 1.6 16V (0B)   | 79  | 10.00  | 02.03  |  |   |  |   |  |     |
| 1.9 dCi (1F)   | 75  | 10.00  | 02.03  |  |   |  |   |  |     |
| 1.9 dCi (05)   | 75  | 10.00  | 02.03  |  |   |  |   |  |     |
| 1.9 dTi  | 72  | 03.99  | 02.03  |  |   |  |   |  |     |
|  |   |  |  |  |   |  |   |  |     |
|  | 1.4 16V (0D)  | 70   | 10.00  | 02.03  | 24.3727-1054.2  | 581054   | 2   | L=1367   |     |
|  | 1.6 16V   | 79   | 04.98  | 02.03  |   |  |   |  |     |
|  | 1.9 dCi   | 72   | 10.00  | 02.03  |   |  |   |  |     |
|  | 1.9 dTi   |  | 05.97  | 02.03  |   |  |   |  |     |
|  | 2.0 i   |  | 09.95  | 02.03  |   |  |   |  |     |
|  | 1.4 16V   | 70   | 06.98  | 02.03  | 24.6582-1706.3  | 320191   |   | BRL (4)  |     |
|  | 1.6 16V   | 79   | 04.98  | 02.03  |   |  |   |  |     |
|  | 1.6 e   | 66   | 09.95  | 02.03  |   |  |   |  |     |
|  | 1.9 dCi   | 72   | 10.00  | 02.03  |   |  |   |  |     |
|  | 1.9 dTi   | 103  | 05.97  | 02.03  |   |  |   |  |     |
|  | 2.0 16V (03)  | 103  | 07.98  | 02.03  |   |  |   |  |     |
|  | 2.0 16V (OH)  | 108  | 09.98  | 02.03  |   |  |   |  |     |
|  | 2.0 16V (OP)  | 103  | 10.00  | 02.03  |   |  |   |  |     |
|  | 2.0 i   |  | 01.96  | 02.03  |   |  |   |  |     |
|  | 2.0 16V (OH)  | 108  | 09.95  | 02.03  | 24.6582-1701.3  | 320171   |   | BRL (4)  |     |
|  | 1.4 16V (0W)  | 70   | 06.98  | 02.03  | 24.3728-1018.2  | 591018   |   | L=972  |     |
|  | 1.6 16V (04)  | 79   | 04.98  | 02.03  |   |  |   |  |     |
|  | 1.6 e   | 66   | 09.95  | 02.03  |   |  |   |  |     |
|  | 2.0 16V (03)  | 103  | 07.98  | 02.03  |   |  |   |  |     |
|  | 2.0 i   |  | 09.95  | 02.03  |   |  |   |  |     |
|  | 1.9 dCi (05)  | 75   | 07.98  | 02.03  | 24.3728-1024.2  | 591024   |   | L=973  |     |
|  | 1.9 dTi   | 72   | 05.97  | 02.03  |   |  |   |  |     |
| <b>RENAULT MEGANE I Cabrio (EA_) (96-03)</b>                                       |   |  |  |  |   |  |   |  |     |
|  | 1.4 16V (W)   | 70   | 06.98  | 10.03  | 03.7760-5602.4  | 300121   |   | 10"  | ATE |
|  | 1.6 16V (B)   | 79   | 10.00  | 10.03  |   |  |   |  |     |
|  | 2.0 16V (P)   | 103  | 10.00  | 10.03  |   |  |   |  |     |
|  | 1.6 e   | 66   | 08.96  | 10.03  | 03.7750-4702.4  | 300153   |   | 9"   | ATE |
|  | 2.0 i   |  | 12.96  | 10.03  |   |  |   |  |     |
|  | 1.4 16V (W)   | 70   | 06.98  | 10.03  | 03.7760-5502.4  | 300151   |   | 10"  | ATE |
|  | 1.6 16V (4)   | 79   | 09.98  | 10.03  | 03.7760-5102.4  | 300140   |   | 10"  | ATE |
|  | 2.0 16V   | 102  | 01.02  | 10.03  |   |  |   |  |     |
|  | 2.0 16V (3)   | 103  | 09.98  | 10.03  |   |  |   |  |     |
|  | 1.4 16V (D)   | 70   | 10.00  | 10.03  | 03.7863-2002.4  | 300126   |   | 10"  | ATE |
| 1.6 16V (B)  | 79  | 10.00  | 10.03  |  |   |  |   |  |     |
| 2.0 16V (P)  | 103   | 10.00  | 10.03  |  |   |  |   |  |     |
|  | 1.4 16V   | 70   | 06.98  | 10.03  | 03.2122-1541.3  | 010511   |   | THz 22,20  | ATE |
|  | 1.6 16V (B)   | 79   | 10.00  | 10.03  |   |  |   |  |     |
|  | 2.0 16V (P)   | 103  | 10.00  | 10.03  |   |  |   |  |     |
|  | 1.6 e   | 66   | 08.96  | 10.03  | 03.2120-2031.3  | 010106   |   | THz 20,64  | ATE |
|  | 2.0 i   |  | 12.96  | 10.03  |   |  |   |  |     |
|  | 1.4 16V (W)   | 70   | 06.98  | 10.03  | 03.2122-1521.3  | 010494   |   | THz 22,20  | ATE |
|  | 1.6 e   | 66   | 08.96  | 10.03  | 03.2120-4441.3  | 010510   |   | THz 20,64  | ATE |
|  |  |  |  |  |   |  |   |  |     |

























| RENAULT MEGANE I Cabrio (EA_) (96-03)    |              |       |       |               |                |                |        |            |                                      |     |
|--|--------------|-------|-------|---------------|----------------|----------------|--------|------------|--------------------------------------|-----|
|  | 2.0 i        |       | 12.96 | 10.03         | + ABS          | 03.2120-4441.3 | 010510 |            | THz 20,64                            | ATE |
|  | 1.6 16V (4)  | 79    | 09.98 | 10.03         | + ABS          | 03.2123-2146.3 | 010572 |            | THz 23,81                            | ATE |
|  | 2.0 16V      | 102   | 01.02 | 10.03         |                |                |        |            |                                      |     |
|  | 2.0 16V (3)  | 103   | 09.98 | 10.03         |                |                |        |            |                                      |     |
|  | 1.4 16V (D)  | 70    | 10.00 | 10.03         | + ABS          | 03.2123-2146.3 | 010572 |            | THz 23,81                            | ATE |
|  | 1.6 16V (B)  | 79    | 10.00 | 10.03         | + ABS          |                |        |            |                                      |     |
|  | 2.0 16V (P)  | 103   | 10.00 | 10.03         | + ABS          |                |        |            |                                      |     |
|  | 1.6 e        | 66    | 08.96 | 10.03         | + ABS          | 24.2120-1723.3 | 010545 |            | THz 20,64                            | BDX |
|  | 2.0 i        |       | 12.96 | 10.03         | + ABS          |                |        |            |                                      |     |
|  | 1.6 e        | 66    | 08.96 | 10.03         | + ABS          | 24.2120-1725.3 | 010579 |            | THz 20,64                            | BDX |
| 2.0 i                                    |              | 12.96 | 10.03 | + ABS         |                |                |        |            |                                      |     |
|  | 1.4 16V (D)  | 70    | 10.00 | 10.03         | + ABS          | 03.2123-2181.3 | 010608 |            | THz 23,81                            | ATE |
|  | 1.6 16V (4)  | 79    | 09.98 | 10.03         | + ABS          |                |        |            |                                      |     |
|  | 1.6 16V (B)  | 79    | 10.00 | 10.03         | + ABS          |                |        |            |                                      |     |
|  | 2.0 16V      | 102   | 01.02 | 10.03         |                |                |        |            |                                      |     |
|  | 2.0 16V (3)  | 103   | 09.98 | 10.03         |                |                |        |            |                                      |     |
|  | 2.0 16V (H)  | 108   | 09.98 | 10.03         |                |                |        |            |                                      |     |
|  | 2.0 16V (P)  | 103   | 10.00 | 10.03         | + ABS          |                |        |            |                                      |     |
|  | 2.0 16V (H)  | 108   | 08.96 | 10.03         |                | 24.2123-1701.3 | 010424 |            | THz 23,81                            |     |
|  | 1.4 16V (W)  | 70    | 06.98 | 10.03         |                | 24.3481-1615.5 | 240031 | ☐          | D=48, - Halter                       | LUC |
|  | 1.6 e        | 66    | 08.96 | 10.03         |                | 24.3481-1616.5 | 240032 | ☐          | D=48, - Halter                       | LUC |
| 2.0 i                                    |              | 12.96 | 10.03 |               | 24.0101-4806.2 | 260052         |        | Einbausatz | LUC                                  |     |
|  | 1.4 16V (D)  | 70    | 10.00 | 10.03         |                | 24.3541-1749.5 | 240427 | ☐          | D=54, - Halter                       | LUC |
|  | 1.6 16V      | 79    | 09.98 | 10.03         |                | 24.3541-1750.5 | 240428 | ☐          | D=54, - Halter                       | LUC |
|  | 2.0 16V      | 102   | 01.02 | 10.03         |                |                |        |            |                                      |     |
|  | 2.0 16V (3)  | 103   | 09.98 | 10.03         |                |                |        |            |                                      |     |
|  | 2.0 16V (H)  | 108   | 09.98 | 10.03         |                |                |        |            |                                      |     |
|  | 2.0 16V (P)  | 103   | 10.00 | 10.03         |                |                |        |            |                                      |     |
|  | 2.0 16V (H)  | 108   | 08.96 | 08.98         |                | 24.3541-1741.5 | 240215 | ☐          | D=54, - Halter                       | LUC |
|  |              |       |       |               |                | 24.3541-1742.5 | 240216 | ☐          | D=54, - Halter                       | LUC |
|  |              |       |       |               |                | 24.3601-1707.5 | 240229 | ☐          | D=60, - Halter                       | LUC |
|  |              |       |       |               |                | 24.3601-1708.5 | 240230 | ☐          | D=60, - Halter                       | LUC |
|  | 1.4 16V      | 70    | 06.98 | 10.03         |                | 24.5111-0390.3 | 330566 | 2          | L=390                                |     |
|  | 1.6 16V      | 79    | 09.98 | 10.03         |                |                |        |            |                                      |     |
|  | 1.6 e        | 66    | 08.96 | 10.03         |                |                |        |            |                                      |     |
|  | 2.0 16V      | 102   | 01.02 | 10.03         |                |                |        |            |                                      |     |
|  | 2.0 16V (3)  | 103   | 09.98 | 10.03         |                |                |        |            |                                      |     |
|  | 2.0 16V (H)  | 108   | 08.96 | 10.03         |                |                |        |            |                                      |     |
|  | 2.0 16V (P)  | 103   | 10.00 | 10.03         |                |                |        |            |                                      |     |
|  | 2.0 i        |       | 12.96 | 10.03         |                |                |        |            |                                      |     |
|  | 1.4 16V      | 70    | 06.98 | 10.03         |                | 24.5229-0265.3 | 330540 | 2          | L=265                                |     |
|  | 1.6 16V      | 79    | 09.98 | 10.03         |                |                |        |            |                                      |     |
| 1.6 e                                    | 66           | 08.96 | 10.03 |               |                |                |        |            |                                      |     |
| 2.0 16V                                  | 102          | 01.02 | 10.03 |               |                |                |        |            |                                      |     |
| 2.0 16V (3)                              | 103          | 09.98 | 10.03 |               |                |                |        |            |                                      |     |
| 2.0 16V (H)                              | 108          | 08.96 | 10.03 |               |                |                |        |            |                                      |     |
| 2.0 16V (P)                              | 103          | 10.00 | 10.03 |               |                |                |        |            |                                      |     |
| 2.0 i                                    |              | 12.96 | 10.03 |               |                |                |        |            |                                      |     |
|  | 1.4 16V (W)  | 70    | 06.98 | 10.03         | - ABS          | 24.3217-1705.3 | 020020 |            | Rz 17,46                             |     |
|  | 1.6 16V (4)  | 79    | 09.98 | 10.03         | - ABS          |                |        |            |                                      |     |
|  | 1.6 e        | 66    | 08.96 | 10.03         |                |                |        |            |                                      |     |
|  | 2.0 i        |       | 12.96 | 10.03         |                |                |        |            |                                      |     |
|  | 1.4 16V (D)  | 70    | 10.00 | 10.03         | + ABS / - ASR  | 24.3219-1728.3 | 020452 |            | Rz 19,05                             |     |
| 1.4 16V (W)                              | 70           | 06.98 | 10.03 | + ABS         |                |                |        |            |                                      |     |
| 1.6 16V (4)                              | 79           | 09.98 | 10.03 | + ABS         |                |                |        |            |                                      |     |
| 1.6 16V (B)                              | 79           | 10.00 | 10.03 | + ABS / - ASR |                |                |        |            |                                      |     |
|  | 1.4 16V      | 70    | 06.98 | 10.03         |                | 24.3727-1054.2 | 581054 | 2 ↓        | L=1367                               |     |
|  | 1.6 16V      | 79    | 09.98 | 10.03         |                |                |        |            |                                      |     |
|  | 1.6 e        | 66    | 08.96 | 10.03         |                |                |        |            |                                      |     |
|  | 2.0 i        |       | 12.96 | 10.03         |                |                |        |            |                                      |     |
|  | 1.4 16V (D)  | 70    | 10.00 | 10.03         |                | 24.6582-1706.3 | 320191 |            | BRL (4)                              |     |
|  | 1.6 16V (B)  | 79    | 10.00 | 10.03         |                |                |        |            |                                      |     |
|  | 2.0 16V      | 102   | 01.02 | 10.03         |                |                |        |            |                                      |     |
|  | 2.0 16V (3)  | 103   | 09.98 | 10.03         |                |                |        |            |                                      |     |
|  | 2.0 16V (H)  | 108   | 09.98 | 10.03         |                |                |        |            |                                      |     |
|  | 2.0 16V (P)  | 103   | 10.00 | 10.03         |                |                |        |            |                                      |     |
|  | 1.6 e        | 66    | 08.96 | 10.03         |                | 24.6582-1701.3 | 320171 |            | BRL (4)                              |     |
|  | 2.0 16V (H)  | 108   | 08.96 | 10.03         |                |                |        |            |                                      |     |
|  | 2.0 i        |       | 12.96 | 10.03         |                |                |        |            |                                      |     |
|  | 1.4 16V (W)  | 70    | 06.98 | 10.03         |                | 24.3728-1018.2 | 591018 |            | L=972                                |     |
| 1.6 16V (4)                              | 79           | 09.98 | 10.03 |               |                |                |        |            |                                      |     |
| 1.6 e                                    | 66           | 08.96 | 10.03 |               |                |                |        |            |                                      |     |
| 2.0 16V                                  | 102          | 01.02 | 10.03 |               |                |                |        |            |                                      |     |
| 2.0 16V (3)                              | 103          | 09.98 | 10.03 |               |                |                |        |            |                                      |     |
| 2.0 i                                    |              | 12.96 | 10.03 |               |                |                |        |            |                                      |     |
| RENAULT MEGANE I Grandtour (KA_) (98-03) |              |       |       |               |                |                |        |            |                                      |     |
|  | 1.4 16V      | 70    | 09.98 | 12.03         | - ABS          | 03.7760-5602.4 | 300121 |            | 10"                                  | ATE |
|  | 1.4 e        | 55    | 09.98 | 12.03         | - ABS          |                |        |            |                                      |     |
|  | 1.6 16V      | 79    | 09.98 | 12.03         | - ABS          |                |        |            |                                      |     |
|  | 1.6 e        | 66    | 09.98 | 12.03         | - ABS          |                |        |            |                                      |     |
|  | 1.9 D        | 47    | 03.99 | 12.03         | - ABS          |                |        |            |                                      |     |
|  | 1.9 dTi (1U) | 59    | 02.01 | 12.03         | - ABS          |                |        |            |                                      |     |
|  | 1.9 dTi (ON) | 72    | 01.99 | 12.03         | - ABS          |                |        |            |                                      |     |
|  | 1.4 16V (OW) | 70    | 09.98 | 12.03         | + ABS          | 03.7760-5502.4 | 300151 |            | + verstärktes Fahrwerk <sup>1)</sup> | 10" |
|  |              |       |       |               |                |                |        |            |                                      | ATE |

<sup>1)</sup> + reinforced suspension / + sospensione rinforzata / + châssis renforcé / + suspensión reforzada

|     |  |  |  |  |  |  |  |  |                |        |
|--|--|--|--|--|---|--|--|--|----------------|--------|
| <b>RENAULT MEGANE I Grandtour (KA_) (98-03)</b>                                    |  |  |  |  |   |  |  |  |                |        |
|    | 1.4 e  | 55   | 09.98  | 12.03  | + ABS   | 03.7760-5502.4   | 300151   | + verstärktes Fahrwerk <sup>1)</sup>   | 10"            | ATE    |
|  | 1.6 e  | 66   | 03.99  | 12.03  | + ABS   |  |  |  |                |        |
|  | 1.9 D  | 47   | 03.99  | 12.03  | + ABS   |  |  |  |                |        |
|  | 1.6 16V (04)   | 79   | 09.98  | 12.03  | + ABS   | 03.7760-5102.4   | 300140   | - verstärktes Fahrwerk <sup>2)</sup>   | 10"            | ATE    |
|  | 1.9 dCi (05)   | 75   | 02.01  | 12.03  | + ABS   |  |  |  |                |        |
|  | 1.9 dTi (0N)   | 72   | 01.99  | 12.03  | + ABS   |  |  |  |                |        |
|  | 1.4 16V (0D)   | 70   | 03.99  | 12.03  | + ABS   | 03.7863-2002.4   | 300126   |  | 10"            | ATE    |
| 1.6 16V (0B)   | 79   | 03.99  | 12.03  | + ABS  |   |  |  |  |                |        |
| 1.8 16V  | 85   | 03.99  | 12.03  | + ABS  |   |  |  |  |                |        |
| 1.9 dCi (1F)   | 75   | 02.01  | 12.03  | + ABS  |   |  |  |  |                |        |
| 1.9 dTi (1U)   | 59   | 02.01  | 12.03  | + ABS  |   |  |  |  |                |        |
|    | 1.6 e  | 66   | 09.98  | 02.99  |   | 03.2120-2031.3   | 010106   | - ABS  | THz 20,64      | ATE    |
|  |  |  |  |  |   | 24.2120-1723.3   | 010545   | + ABS  | THz 20,64      | BDX    |
|  | 1.4 16V  | 70   | 09.98  | 12.03  |   | 03.2122-1541.3   | 010511   | - ABS  | THz 22,20      | ATE    |
|  | 1.4 e  | 55   | 09.98  | 12.03  |   | 03.2122-1521.3   | 010494   | + ABS  | THz 22,20      | ATE    |
|  | 1.6 e  | 66   | 03.99  | 12.03  |   |  |  |  |                |        |
|  | 1.9 D  | 47   | 03.99  | 12.03  |   |  |  |  |                |        |
|  | 1.6 16V  | 79   | 09.98  | 12.03  |   | 03.2123-1551.3   | 010512   | - ABS  | THz 23,81      | ATE    |
|  | 1.9 dCi  | 75   | 02.01  | 12.03  |   | 03.2123-2146.3   | 010572   | + ABS  | THz 23,81      | ATE    |
|  | 1.9 dTi (0N)   | 72   | 01.99  | 12.03  |   |  |  |  |                |        |
|  | 1.8 16V (1A)   | 85   | 01.01  | 12.03  | + ABS   | 03.2123-2146.3   | 010572   |  | THz 23,81      | ATE    |
|  | 1.8 16V (1M)   | 85   | 01.01  | 12.03  | + ABS   |  |  |  |                |        |
|  | 1.9 dTi (1U)   | 59   | 02.01  | 12.03  | - ABS   |  |  |  |                |        |
|  | 1.8 16V (12)   | 85   | 01.01  | 12.03  | + ABS   | 03.2123-2621.3   | 010701   |  | THz 23,81      | ATE    |
|  | 1.9 dTi (1U)   | 59   | 02.01  | 12.03  | + ABS   |  |  |  |                |        |
|    | 1.4 16V  | 70   | 09.98  | 12.03  |   | 24.3481-1615.5   | 240031   | <input type="checkbox"/>   | D=48, - Halter | LUC    |
|  | 1.4 e  | 55   | 09.98  | 12.03  |   | 24.3481-1616.5   | 240032   | <input type="checkbox"/>   | D=48, - Halter | LUC    |
|  | 1.6 e  | 66   | 09.98  | 12.03  |   | 24.0101-4806.2   | 260052   |  | Einbausatz     | LUC    |
|  | 1.9 D  | 47   | 03.99  | 12.03  |   |  |  |  |                |        |
|  | 1.6 16V  | 79   | 09.98  | 12.03  |   | 24.3541-1749.5   | 240427   | <input type="checkbox"/>   | D=54, - Halter | LUC    |
|  | 1.8 16V  | 85   | 01.01  | 12.03  |   | 24.3541-1750.5   | 240428   | <input type="checkbox"/>   | D=54, - Halter | LUC    |
|  | 1.9 dCi  | 75   | 02.01  | 12.03  |   |  |  |  |                |        |
| 1.9 dTi (1U)   | 59   | 02.01  | 12.03  |  |   |  |  |  |                |        |
| 1.9 dTi (0N)   | 72   | 01.99  | 12.03  |  |   |  |  |  |                |        |
|    | 1.4 16V  | 70   | 09.98  | 12.03  |   | 24.5111-0390.3   | 330566   | 2  |                | L=390  |
|  | 1.4 e  | 55   | 09.98  | 12.03  |   |  |  |  |                |        |
|  | 1.6 16V  | 79   | 09.98  | 12.03  |   |  |  |  |                |        |
|  | 1.6 e  | 66   | 09.98  | 12.03  |   |  |  |  |                |        |
|  | 1.8 16V  | 85   | 01.01  | 12.03  |   |  |  |  |                |        |
|  | 1.9 D  | 47   | 03.99  | 12.03  |   |  |  |  |                |        |
|  | 1.9 dCi  | 75   | 02.01  | 12.03  |   |  |  |  |                |        |
|  | 1.9 dTi (1U)   | 59   | 02.01  | 12.03  |   |  |  |  |                |        |
| 1.9 dTi (0N)   | 72   | 01.99  | 02.01  |  |   |  |  |  |                |        |
|  | 1.4 16V (0D)   | 70   | 03.99  | 12.03  |   | 24.3344-1707.7   | 220531   | <input type="checkbox"/>   | D=34, - Halter | LUC    |
|  | 1.6 16V (04)   | 79   | 07.99  | 12.03  |   | 24.3344-1708.7   | 220532   | <input type="checkbox"/>   | D=34, - Halter | LUC    |
|  | 1.8 16V  | 85   | 01.01  | 12.03  |   |  |  |  |                |        |
|  | 1.9 dCi  | 75   | 02.01  | 12.03  |   |  |  |  |                |        |
|  | 1.9 dTi (1U)   | 59   | 02.01  | 12.03  |   |  |  |  |                |        |
|  | 1.9 dTi (0N)   | 72   | 07.99  | 02.01  |   |  |  |  |                |        |
|  | 1.4 16V  | 70   | 09.98  | 12.03  |   | 24.5229-0265.3   | 330540   | 2  |                | L=265  |
|  | 1.4 e  | 55   | 09.98  | 12.03  |   |  |  |  |                |        |
|  | 1.6 16V  | 79   | 09.98  | 12.03  |   |  |  |  |                |        |
|  | 1.6 e  | 66   | 09.98  | 12.03  |   |  |  |  |                |        |
|  | 1.8 16V  | 85   | 01.01  | 12.03  |   |  |  |  |                |        |
|  | 1.9 D  | 47   | 03.99  | 12.03  |   |  |  |  |                |        |
|  | 1.9 dCi  | 75   | 02.01  | 12.03  |   |  |  |  |                |        |
|  | 1.9 dTi (1U)   | 59   | 02.01  | 12.03  |   |  |  |  |                |        |
| 1.9 dTi (0N)   | 72   | 01.99  | 02.01  |  |   |  |  |  |                |        |
|  | 1.4 16V (0W)   | 70   | 09.98  | 12.03  |   | 24.3220-1711.3   | 020409   |  | Rz 20,64       | LUC    |
|  | 1.4 e  | 55   | 09.98  | 12.03  |   |  |  |  |                |        |
|  | 1.6 16V (04)   | 79   | 09.98  | 06.99  |   |  |  |  |                |        |
|  | 1.6 e  | 66   | 09.98  | 12.03  |   |  |  |  |                |        |
|  | 1.9 D  | 47   | 03.99  | 12.03  |   |  |  |  |                |        |
| 1.9 dTi (0N)   | 72   | 01.99  | 06.99  |  |   |  |  |  |                |        |
|  | 1.4 16V  | 70   | 09.98  | 12.03  |   | 24.3727-1063.2   | 581063   | 2  |                | L=1456 |
|  | 1.4 e  | 55   | 09.98  | 12.03  |   |  |  |  |                |        |
|  | 1.6 e  | 66   | 09.98  | 12.03  |   |  |  |  |                |        |
|  | 1.9 D  | 47   | 03.99  | 12.03  |   |  |  |  |                |        |
|  | 1.6 16V  | 79   | 09.98  | 12.03  |   | 24.3727-1065.2   | 581065   | <input type="checkbox"/>   | L=1519         |        |
|  | 1.8 16V  | 85   | 01.01  | 12.03  |   | 24.3727-1064.2   | 581064   | <input type="checkbox"/>   | L=1480         |        |
|  | 1.9 dCi  | 75   | 02.01  | 12.03  |   |  |  |  |                |        |
| 1.9 dTi (1U)   | 59   | 02.01  | 12.03  |  |   |  |  |  |                |        |
| 1.9 dTi (0N)   | 72   | 01.99  | 02.01  |  |   |  |  |  |                |        |
|  | 1.4 16V  | 70   | 09.98  | 12.03  |   | 24.6582-1702.3   | 320172   |  | BRL (4)        |        |
|  | 1.4 e  | 55   | 09.98  | 12.03  |   |  |  |  |                |        |
|  | 1.6 16V (04)   | 79   | 09.98  | 12.03  |   |  |  |  |                |        |
|  | 1.6 e  | 66   | 09.98  | 12.03  |   |  |  |  |                |        |
|  | 1.9 D  | 47   | 03.99  | 12.03  |   |  |  |  |                |        |
|  | 1.9 dCi  | 75   | 02.01  | 12.03  |   |  |  |  |                |        |
| 1.9 dTi (0N)   | 72   | 01.99  | 12.03  |  |   |  |  |  |                |        |
|  | 1.4 16V  | 70   | 09.98  | 12.03  |   | 24.3728-1018.2   | 591018   |  |                | L=972  |
|  | 1.4 e  | 55   | 09.98  | 12.03  |   |  |  |  |                |        |
|  | 1.6 16V (04)   | 79   | 09.98  | 12.03  |   |  |  |  |                |        |
|  | 1.6 e  | 66   | 09.98  | 12.03  |   |  |  |  |                |        |
|  | 1.9 D  | 47   | 03.99  | 12.03  |   |  |  |  |                |        |

1) + reinforced suspension / + sospensione rinforzata / + châssis renforcé / + suspensión reforzada

2) - reinforced suspension / - sospensione rinforzata / - châssis renforcé / - suspensión reforzada

|     |   |  |  |  |  |  |             |  |
|--|---|--|--|--|---|--|---|--|
| <b>RENAULT MEGANE I Grandtour (KA_) (98-03)</b>                                    |   |  |  |  |   |  |   |  |
|    | 1.9 dTi (1U)  | 59   | 02.01  | 12.03  | 24.3728-1018.2  | 591018   |   | L=972  |
|  | 1.9 dCi   | 75   | 02.01  | 12.03  | 24.3728-1024.2  | 591024   |   | L=973  |
|  | 1.9 dTi (1U)  | 59   | 02.01  | 12.03  |   |  |   |  |
|  | 1.9 dTi (ON)  | 72   | 01.99  | 12.03  |   |  |   |  |
| <b>RENAULT MEGANE II Limousine 3/5-türig (BM/CM_) (02-08)</b>                      |   |  |  |  |   |  |   |  |
|    | 1.4 16V   | 72   | 11.02  | 11.08  | 24.2123-1760.3  | 010779   |   | Thz 23,81 LUC  |
|  | 1.5 dCi   | 60   | 11.02  | 11.08  |   |  |   |  |
|  | 1.5 dCi   | 63   | 05.05  | 11.08  |   |  |   |  |
|  | 1.5 dCi   | 76   | 01.07  | 11.08  |   |  |   |  |
|  | 1.5 dCi   | 78   | 05.05  | 11.08  |   |  |   |  |
|  | 1.6 16V   | 77   | 06.05  | 11.08  |   |  |   |  |
|  | 1.6 16V   | 83   | 11.02  | 11.08  |   |  |   |  |
|  | 1.6 FlexFuel  | 77   | 01.07  | 11.08  |   |  |   |  |
|  | 1.9 dCi   | 85   | 01.06  | 11.08  |   |  |   |  |
|  | 1.9 dCi   | 88   | 11.02  | 11.08  |   |  |   |  |
|  | 1.9 dCi   | 96   | 05.05  | 11.08  |   |  |   |  |
|  | 2.0 16V   | 99   | 11.02  | 11.08  |   |  |   |  |
|  | 2.0 16V   | 169  | 08.06  | 11.08  |   |  |   |  |
|  | 2.0 16V Sport   | 165  | 05.04  | 11.08  |   |  |   |  |
|  | 2.0 16V Turbo   | 120  | 05.04  | 11.08  |   |  |   |  |
|  | 2.0 dCi   | 110  | 09.05  | 11.08  |   |  |   |  |
| 2.0 dCi  | 127   | 01.07  | 11.08  |  |   |  |   |  |
|    | 1.4 16V   | 72   | 11.02  | 11.08  | 24.3541-1827.5  | 240407   |            | D=54, - Halter LUC   |
|  |   |  |  |  | 24.3541-1828.5  | 240408   |            | D=54, - Halter LUC   |
|  | 1.4 16V   | 72   | 10.05  | 11.08  | 11.9541-9545.2  | 220625   |            | D=54, - Halter ATE   |
|  | 1.5 dCi   | 60   | 10.05  | 11.08  | 11.9541-9546.2  | 220626   |            | D=54, - Halter ATE   |
|  | 1.5 dCi   | 63   | 10.05  | 11.08  | 11.0101-5407.2  | 260011   |   | Hülzensatz ATE   |
|  | 1.5 dCi   | 76   | 01.07  | 11.08  | 11.8171-0008.1  | 990049   |   | Führungsbolzen ATE   |
|  | 1.5 dCi   | 78   | 05.05  | 11.08  | 11.8116-0301.1  | 390610   | 2   | Haltefeder ATE   |
|  | 1.6 16V   | 77   | 06.05  | 11.08  |   |  |   |  |
|  | 1.6 16V   | 83   | 10.05  | 11.08  |   |  |   |  |
|  | 1.6 FlexFuel  | 77   | 01.07  | 11.08  |   |  |   |  |
|  | 1.9 dCi   | 85   | 01.06  | 11.08  |   |  |   |  |
|  | 1.9 dCi   | 88   | 10.05  | 11.08  |   |  |   |  |
|  | 1.9 dCi   | 96   | 05.05  | 11.08  |   |  |   |  |
|  | 2.0 16V   | 99   | 10.05  | 11.08  |   |  |   |  |
|  | 2.0 dCi   | 110  | 09.05  | 11.08  |   |  |   |  |
|  |  | 1.4 16V  | 72   | 11.02  | 09.05   | 24.5111-0429.3   | 331015  | 2  |
| 1.5 dCi  |   | 60   | 11.02  | 09.05  |   |  |   |  |
| 1.5 dCi  |   | 63   | 05.05  | 09.05  |   |  |   |  |
| 1.6 16V  |   | 83   | 11.02  | 09.05  |   |  |   |  |
| 1.9 dCi  |   | 88   | 11.02  | 09.05  |   |  |   |  |
| 2.0 16V  |   | 99   | 11.02  | 09.05  |   |  |   |  |
| 1.4 16V  |   | 72   | 10.05  | 11.08  | 24.5155-0445.3  | 331057   | 2   | L=445  |
| 1.5 dCi  |   | 60   | 10.05  | 11.08  |   |  |   |  |
| 1.5 dCi  |   | 63   | 10.05  | 11.08  |   |  |   |  |
| 1.5 dCi  |   | 76   | 01.07  | 11.08  |   |  |   |  |
| 1.5 dCi  |   | 78   | 05.05  | 11.08  |   |  |   |  |
| 1.6 16V  |   | 77   | 06.05  | 11.08  |   |  |   |  |
| 1.6 16V  |   | 83   | 10.05  | 11.08  |   |  |   |  |
| 1.6 FlexFuel   |   | 77   | 01.07  | 11.08  |   |  |   |  |
| 1.9 dCi  |   | 85   | 01.06  | 11.08  |   |  |   |  |
| 1.9 dCi  |   | 88   | 10.05  | 11.08  |   |  |   |  |
| 1.9 dCi  | 96  | 05.05  | 11.08  |  |   |  |   |  |
| 2.0 16V  | 99  | 10.05  | 11.08  |  |   |  |   |  |
| 2.0 dCi  | 110   | 09.05  | 11.08  |  |   |  |   |  |
| 2.0 dCi  | 127   | 01.07  | 11.08  |  |   |  |   |  |
|  | 1.4 16V   | 72   | 021015   | 11.08  | 24.3347-1705.7  | 220751   |          | D=34, - Halter LUC   |
|  | 1.5 dCi   | 60   | 021015   | 11.08  | 24.3347-1706.7  | 220752   |          | D=34, - Halter LUC   |
|  | 1.5 dCi   | 63   | 021015   | 11.08  | 24.0101-3803.2  | 260101   |   | Einbausatz LUC   |
|  | 1.5 dCi   | 76   | 021015   | 11.08  |   |  |   |  |
|  | 1.5 dCi   | 78   | 021015   | 11.08  |   |  |   |  |
|  | 1.6 16V   | 77   | 021015   | 11.08  |   |  |   |  |
|  | 1.6 16V   | 83   | 021015   | 11.08  |   |  |   |  |
|  | 1.6 FlexFuel  | 77   | 021015   | 11.08  |   |  |   |  |
|  | 1.9 dCi   | 85   | 021015   | 11.08  |   |  |   |  |
|  | 1.9 dCi   | 88   | 021015   | 11.08  |   |  |   |  |
|  | 1.9 dCi   | 96   | 021015   | 11.08  |   |  |   |  |
|  | 2.0 16V   | 99   | 021015   | 11.08  |   |  |   |  |
|  | 2.0 16V   | 169  | 021015   | 11.08  |   |  |   |  |
|  | 2.0 16V Sport   | 165  | 021015   | 11.08  |   |  |   |  |
|  | 2.0 16V Turbo   | 120  | 021015   | 11.08  |   |  |   |  |
|  | 2.0 dCi   | 110  | 021015   | 11.08  |   |  |   |  |
|  | 1.4 16V   | 72   | 11.02  | 11.08  | 11.9387-7001.2  | 220397   |  PR 1334 | D=38, - Halter ATE   |
|  | 1.5 dCi   | 60   | 11.02  | 11.08  | 11.9387-7002.2  | 220398   |  PR 1334 | D=38, - Halter ATE   |
|  | 1.5 dCi   | 63   | 05.05  | 11.08  | 11.8116-0340.1  | 390595   | 2   | Haltefeder ATE   |
|  | 1.5 dCi   | 76   | 01.07  | 11.08  | 11.8171-0008.1  | 990049   |   | Führungsbolzen ATE   |
|  | 1.5 dCi   | 78   | 05.05  | 11.08  | 11.0101-5407.2  | 260011   |   | Hülzensatz ATE   |
|  | 1.6 16V   | 77   | 06.05  | 11.08  |   |  |   |  |
|  | 1.6 16V   | 83   | 11.02  | 11.08  |   |  |   |  |
|  | 1.6 FlexFuel  | 77   | 01.07  | 11.08  |   |  |   |  |
|  | 1.9 dCi   | 85   | 01.06  | 11.08  |   |  |   |  |
|  | 1.9 dCi   | 88   | 11.02  | 11.08  |   |  |   |  |
|  | 1.9 dCi   | 96   | 05.05  | 11.08  |   |  |   |  |
|  | 2.0 16V   | 99   | 11.02  | 11.08  |   |  |   |  |

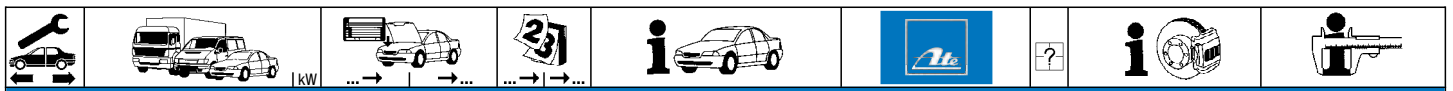

**RENAULT MEGANE II Limousine 3/5-türig (BM/CM\_) (02-08)**

|  |               |     |       |       |                |        |                    |  |     |
|--|---------------|-----|-------|-------|----------------|--------|--------------------|--|-----|
|  | 2.0 16V       | 169 | 08.06 | 11.08 | 11.9387-7001.2 | 220397 | PR 1334<br>PR 1334 | D=38, - Halter<br>D=38, - Halter<br>Haltefeder<br>Führungsbolzen<br>Hülzensatz | ATE |
|  | 2.0 16V Sport | 165 | 05.04 | 11.08 | 11.9387-7002.2 | 220398 |                    |  | ATE |
|  | 2.0 16V Turbo | 120 | 05.04 | 11.08 | 11.8116-0340.1 | 390595 |                    |  | ATE |
|  | 2.0 dCi       | 110 | 09.05 | 11.08 | 11.8171-0008.1 | 990049 |                    |  | ATE |
|  |               |     |       |       | 11.0101-5407.2 | 260011 |                    |  | ATE |
|  | 1.4 16V       | 72  | 11.02 | 08.05 | 24.5251-0185.3 | 330701 | 2                  | L=185  |     |
|  | 1.5 dCi       | 60  | 11.02 | 08.05 |                |        |                    |  |     |
|  | 1.5 dCi       | 63  | 05.05 | 08.05 |                |        |                    |  |     |
|  | 1.6 16V       | 83  | 11.02 | 08.05 |                |        |                    |  |     |
|  | 1.9 dCi       | 88  | 11.02 | 08.05 |                |        |                    |  |     |
|  | 1.9 dCi       | 96  | 05.05 | 08.05 |                |        |                    |  |     |
|  | 2.0 16V       | 99  | 11.02 | 08.05 |                |        |                    |  |     |
|  | 2.0 16V Sport | 165 | 05.04 | 08.05 |                |        |                    |  |     |
|  | 2.0 16V Turbo | 120 | 05.04 | 08.05 |                |        |                    |  |     |
|  |               |     |       |       |                |        |                    |  |     |
|  | 1.4 16V       | 72  | 09.05 | 11.08 | 24.5229-0185.3 | 330397 | 2                  | L=185  |     |
|  | 1.5 dCi       | 60  | 09.05 | 11.08 |                |        |                    |  |     |
|  | 1.5 dCi       | 63  | 09.05 | 11.08 |                |        |                    |  |     |
|  | 1.5 dCi       | 76  | 01.07 | 11.08 |                |        |                    |  |     |
|  | 1.5 dCi       | 78  | 05.05 | 11.08 |                |        |                    |  |     |
|  | 1.6 16V       | 77  | 06.05 | 11.08 |                |        |                    |  |     |
|  | 1.6 16V       | 83  | 09.05 | 11.08 |                |        |                    |  |     |
|  | 1.6 FlexFuel  | 77  | 01.07 | 11.08 |                |        |                    |  |     |
|  | 1.9 dCi       | 85  | 01.06 | 11.08 |                |        |                    |  |     |
|  | 1.9 dCi       | 88  | 09.05 | 11.08 |                |        |                    |  |     |
|  | 1.9 dCi       | 96  | 09.05 | 11.08 |                |        |                    |  |     |
|  | 2.0 16V       | 99  | 09.05 | 11.08 |                |        |                    |  |     |
|  | 2.0 16V       | 169 | 08.06 | 11.08 |                |        |                    |  |     |
|  | 2.0 16V Sport | 165 | 09.05 | 11.08 |                |        |                    |  |     |
|  | 2.0 16V Turbo | 120 | 09.05 | 11.08 |                |        |                    |  |     |
|  | 2.0 dCi       | 110 | 09.05 | 11.08 |                |        |                    |  |     |
|  | 2.0 dCi       | 127 | 01.07 | 11.08 |                |        |                    |  |     |
|  | 1.4 16V       | 72  | 11.02 | 11.08 | 24.3727-1070.2 | 581070 | 2                  | L=2023   |     |
|  | 1.5 dCi       | 60  | 11.02 | 11.08 |                |        |                    |  |     |
|  | 1.5 dCi       | 63  | 05.05 | 11.08 |                |        |                    |  |     |
|  | 1.5 dCi       | 76  | 01.07 | 11.08 |                |        |                    |  |     |
|  | 1.5 dCi       | 78  | 05.05 | 11.08 |                |        |                    |  |     |
|  | 1.6 16V       | 77  | 06.05 | 11.08 |                |        |                    |  |     |
|  | 1.6 16V       | 83  | 11.02 | 11.08 |                |        |                    |  |     |
|  | 1.6 FlexFuel  | 77  | 01.07 | 11.08 |                |        |                    |  |     |
|  | 1.9 dCi       | 85  | 01.06 | 11.08 |                |        |                    |  |     |
|  | 1.9 dCi       | 88  | 11.02 | 11.08 |                |        |                    |  |     |
|  | 1.9 dCi       | 96  | 05.05 | 11.08 |                |        |                    |  |     |
|  | 2.0 16V       | 99  | 11.02 | 11.08 |                |        |                    |  |     |
|  | 2.0 16V       | 169 | 08.06 | 11.08 |                |        |                    |  |     |
|  | 2.0 16V Sport | 165 | 05.04 | 11.08 |                |        |                    |  |     |
|  | 2.0 16V Turbo | 120 | 05.04 | 11.08 |                |        |                    |  |     |
|  | 2.0 dCi       | 110 | 09.05 | 11.08 |                |        |                    |  |     |
|  | 2.0 dCi       | 127 | 01.07 | 11.08 |                |        |                    |  |     |

**RENAULT MEGANE II Limousine 4-türig (LM\_) (03-08)**

|         |         |       |       |                               |                |        |                    |  |                               |
|---------|---------|-------|-------|-------------------------------|----------------|--------|--------------------|--|-------------------------------|
|         | 1.4 16V | 60    | 09.03 | 08.06                         | 24.2123-1760.3 | 010779 |                    | Thz 23,81  | LUC                           |
|         | 1.4 16V | 72    | 09.03 | 12.08                         |                |        |                    |  |                               |
|         | 1.5 dCi | 60    | 09.03 | 12.08                         |                |        |                    |  |                               |
|         | 1.5 dCi | 63    | 05.05 | 12.08                         |                |        |                    |  | - Sportfahrwerk <sup>1)</sup> |
|         | 1.5 dCi | 74    | 02.04 | 03.06                         |                |        |                    |  | - Sportfahrwerk <sup>1)</sup> |
|         | 1.5 dCi | 76    | 01.07 | 12.08                         |                |        |                    |  | - Sportfahrwerk <sup>1)</sup> |
|         | 1.5 dCi | 78    | 05.05 | 12.08                         |                |        |                    |  |                               |
|         | 1.6 16V | 75    | 09.03 | 12.08                         |                |        |                    |  |                               |
|         | 1.6 16V | 77    | 05.05 | 12.08                         |                |        |                    |  |                               |
|         | 1.6 16V | 82    | 01.07 | 12.08                         |                |        |                    |  |                               |
|         | 1.6 16V | 83    | 09.03 | 12.08                         |                |        |                    |  |                               |
|         | 1.9 dCi | 66    | 09.03 | 12.05                         |                |        |                    |  | - Sportfahrwerk <sup>1)</sup> |
|         | 1.9 dCi | 68    | 03.04 | 12.08                         |                |        |                    |  | - Sportfahrwerk <sup>1)</sup> |
|         | 1.9 dCi | 81    | 05.05 | 12.08                         |                |        |                    |  |                               |
| 1.9 dCi | 88      | 09.03 | 12.08 |                               |                |        |                    |  |                               |
| 1.9 dCi | 96      | 05.05 | 12.08 |                               |                |        |                    |  |                               |
| 2.0 16V | 99      | 09.03 | 12.08 | - Sportfahrwerk <sup>1)</sup> |                |        |                    |  |                               |
| 2.0 dCi | 110     | 09.05 | 12.08 |                               |                |        |                    |  |                               |
|         | 1.4 16V | 60    | 09.03 | 08.06                         | 24.3541-1827.5 | 240407 | PR 1334<br>PR 1334 | D=54, - Halter<br>D=54, - Halter   | LUC                           |
|         | 1.4 16V | 72    | 09.03 | 12.08                         |                |        |                    |  | 24.3541-1828.5                |
|         | 1.5 dCi | 60    | 10.05 | 12.08                         | 11.9541-9545.2 | 220625 | PR 1334<br>PR 1334 | D=54, - Halter<br>D=54, - Halter<br>Hülzensatz<br>Führungsbolzen<br>Haltefeder | ATE                           |
|         | 1.5 dCi | 63    | 10.05 | 12.08                         |                |        |                    |  |                               |
|         | 1.5 dCi | 74    | 10.05 | 03.06                         |                |        |                    |  |                               |
|         | 1.5 dCi | 76    | 01.07 | 12.08                         |                |        |                    |  |                               |
|         | 1.5 dCi | 78    | 10.05 | 12.08                         |                |        |                    |  |                               |
|         | 1.6 16V | 75    | 10.05 | 12.08                         |                |        |                    |  |                               |
|         | 1.6 16V | 77    | 10.05 | 12.08                         |                |        |                    |  |                               |
|         | 1.6 16V | 82    | 01.07 | 12.08                         |                |        |                    |  |                               |
|         | 1.6 16V | 83    | 10.05 | 12.08                         |                |        |                    |  |                               |
|         | 1.9 dCi | 66    | 10.05 | 12.05                         |                |        |                    |  |                               |
|         | 1.9 dCi | 68    | 10.05 | 12.08                         |                |        |                    |  |                               |
|         | 1.9 dCi | 81    | 10.05 | 12.08                         |                |        |                    |  |                               |
|         | 1.9 dCi | 88    | 10.05 | 12.08                         |                |        |                    |  |                               |
|         | 1.9 dCi | 96    | 10.05 | 12.08                         |                |        |                    |  |                               |
|         | 2.0 16V | 99    | 10.05 | 12.08                         |                |        |                    |  |                               |
| 2.0 dCi | 110     | 09.05 | 12.08 |                               |                |        |                    |  |                               |





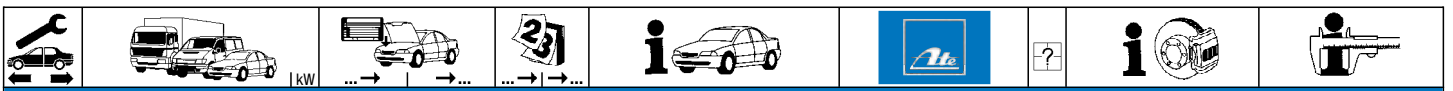









<sup>1)</sup> - sports suspension / - sospensione sportiva / - chássis de sport / - suspensión deportiva























**RENAULT MEGANE II Limousine 4-türig (LM\_) (03-08)**

|         |         |         |        |        |       |                |                |        |   |                |                |     |
|---------|---------|---------|--------|--------|-------|----------------|----------------|--------|---|----------------|----------------|-----|
|         | 1.4 16V | 60      |        | 09.03  | 09.05 | 24.5111-0429.3 | 331015         | 2      |   | L=429          |                |     |
|         | 1.4 16V | 72      |        | 09.03  | 09.05 |                |                |        |   |                |                |     |
|         | 1.5 dCi | 60      |        | 09.03  | 09.05 |                |                |        |   |                |                |     |
|         | 1.5 dCi | 63      |        | 05.05  | 09.05 |                |                |        |   |                |                |     |
|         | 1.5 dCi | 74      |        | 02.04  | 09.05 |                |                |        |   |                |                |     |
|         | 1.5 dCi | 78      |        | 05.05  | 09.05 |                |                |        |   |                |                |     |
|         | 1.6 16V | 75      |        | 09.03  | 09.05 |                |                |        |   |                |                |     |
|         | 1.6 16V | 77      |        | 05.05  | 09.05 |                |                |        |   |                |                |     |
|         | 1.6 16V | 83      |        | 09.03  | 09.05 |                |                |        |   |                |                |     |
|         | 1.9 dCi | 66      |        | 09.03  | 09.05 |                |                |        |   |                |                |     |
|         | 1.9 dCi | 68      |        | 03.04  | 09.05 |                |                |        |   |                |                |     |
|         | 1.9 dCi | 81      |        | 05.05  | 09.05 |                |                |        |   |                |                |     |
|         | 1.9 dCi | 88      |        | 09.03  | 09.05 |                |                |        |   |                |                |     |
|         | 1.9 dCi | 96      |        | 05.05  | 09.05 |                |                |        |   |                |                |     |
|         | 2.0 16V | 99      |        | 09.03  | 09.05 |                |                |        |   |                |                |     |
|         | 1.4 16V | 60      |        | 10.05  | 08.06 |                |                |        |   |                |                |     |
|         | 1.4 16V | 72      |        | 10.05  | 12.08 |                |                |        |   |                |                |     |
|         | 1.5 dCi | 60      |        | 10.05  | 12.08 |                |                |        |   |                |                |     |
|         | 1.5 dCi | 63      |        | 10.05  | 12.08 |                |                |        |   |                |                |     |
|         | 1.5 dCi | 74      |        | 10.05  | 03.06 |                |                |        |   |                |                |     |
|         | 1.5 dCi | 76      |        | 01.07  | 12.08 |                |                |        |   |                |                |     |
|         | 1.5 dCi | 78      |        | 10.05  | 12.08 |                |                |        |   |                |                |     |
|         | 1.6 16V | 75      |        | 10.05  | 12.08 |                |                |        |   |                |                |     |
|         | 1.6 16V | 77      |        | 10.05  | 12.08 |                |                |        |   |                |                |     |
|         | 1.6 16V | 82      |        | 01.07  | 12.08 |                |                |        |   |                |                |     |
|         | 1.6 16V | 83      |        | 10.05  | 12.08 |                |                |        |   |                |                |     |
|         | 1.9 dCi | 66      |        | 10.05  | 12.05 |                |                |        |   |                |                |     |
|         | 1.9 dCi | 68      |        | 10.05  | 12.08 |                |                |        |   |                |                |     |
|         | 1.9 dCi | 81      |        | 10.05  | 12.08 |                |                |        |   |                |                |     |
|         | 1.9 dCi | 88      |        | 10.05  | 12.08 |                |                |        |   |                |                |     |
|         | 1.9 dCi | 96      |        | 10.05  | 12.08 |                |                |        |   |                |                |     |
|         | 2.0 16V | 99      |        | 10.05  | 12.08 |                |                |        |   |                |                |     |
|         | 2.0 dCi | 110     |        | 09.05  | 12.08 |                |                |        |   |                |                |     |
|         |         | 1.4 16V | 60     | 021015 |       | 08.06          | 24.3347-1705.7 | 220751 |   | D=34, - Halter | LUC            |     |
|         |         | 1.4 16V | 72     | 021015 |       | 12.08          |                |        |   |                |                |     |
|         |         | 1.5 dCi | 60     | 021015 |       | 12.08          |                |        |   |                |                |     |
|         |         | 1.5 dCi | 63     | 021015 |       | 12.08          |                |        |   |                |                |     |
|         |         | 1.5 dCi | 74     | 021015 |       | 03.06          |                |        |   |                |                |     |
|         |         | 1.5 dCi | 76     |        | 01.07 | 12.08          |                |        |   |                |                |     |
|         |         | 1.5 dCi | 78     | 021015 |       | 12.08          |                |        |   |                |                |     |
|         |         | 1.6 16V | 75     | 021015 |       | 12.08          |                |        |   |                |                |     |
|         |         | 1.6 16V | 77     | 021015 |       | 12.08          |                |        |   |                |                |     |
| 1.6 16V |         | 82      |        | 01.07  | 12.08 |                |                |        |   |                |                |     |
| 1.6 16V |         | 83      | 021015 |        | 12.08 |                |                |        |   |                |                |     |
| 1.9 dCi |         | 66      | 021015 |        | 12.05 |                |                |        |   |                |                |     |
| 1.9 dCi |         | 68      | 021015 |        | 12.08 |                |                |        |   |                |                |     |
| 1.9 dCi |         | 81      | 021015 |        | 12.08 |                |                |        |   |                |                |     |
| 1.9 dCi | 88      | 021015  |        | 12.08  |       |                |                |        |   |                |                |     |
|         | 1.9 dCi | 96      | 021015 |        | 12.08 |                |                |        |   |                |                |     |
|         | 2.0 16V | 99      | 021015 |        | 12.08 |                |                |        |   |                |                |     |
|         | 2.0 dCi | 110     |        | 09.05  | 12.08 |                |                |        |   |                |                |     |
|         |         | 1.4 16V | 60     |        | 09.03 | 08.06          | 11.9387-7001.2 | 220397 | 2 | PR 1334        | D=38, - Halter | ATE |
|         |         | 1.4 16V | 72     |        | 09.03 | 12.08          |                |        |   |                |                |     |
|         |         | 1.5 dCi | 60     |        | 09.03 | 12.08          |                |        |   |                |                |     |
|         |         | 1.5 dCi | 63     |        | 05.05 | 12.08          |                |        |   |                |                |     |
|         |         | 1.5 dCi | 74     |        | 02.04 | 03.06          |                |        |   |                |                |     |
|         |         | 1.5 dCi | 76     |        | 01.07 | 12.08          |                |        |   |                |                |     |
|         |         | 1.5 dCi | 78     |        | 05.05 | 12.08          |                |        |   |                |                |     |
|         |         | 1.6 16V | 75     |        | 09.03 | 12.08          |                |        |   |                |                |     |
|         |         | 1.6 16V | 77     |        | 05.05 | 12.08          |                |        |   |                |                |     |
|         |         | 1.6 16V | 82     |        | 01.07 | 12.08          |                |        |   |                |                |     |
|         |         | 1.6 16V | 83     |        | 09.03 | 12.08          |                |        |   |                |                |     |
| 1.9 dCi |         | 66      |        | 09.03  | 12.05 |                |                |        |   |                |                |     |
| 1.9 dCi |         | 68      |        | 03.04  | 12.08 |                |                |        |   |                |                |     |
| 1.9 dCi |         | 81      |        | 05.05  | 12.08 |                |                |        |   |                |                |     |
| 1.9 dCi | 88      |         | 09.03  | 12.08  |       |                |                |        |   |                |                |     |
|         | 1.9 dCi | 96      |        | 05.05  | 12.08 |                |                |        |   |                |                |     |
|         | 2.0 16V | 99      |        | 09.03  | 12.08 |                |                |        |   |                |                |     |
|         | 2.0 dCi | 110     |        | 09.05  | 12.08 |                |                |        |   |                |                |     |
|         |         | 1.4 16V | 60     |        | 09.03 | 09.05          | 24.5251-0185.3 | 330701 | 2 |                | L=185          |     |
|         |         | 1.4 16V | 72     |        | 09.03 | 09.05          |                |        |   |                |                |     |
|         |         | 1.5 dCi | 60     |        | 09.03 | 09.05          |                |        |   |                |                |     |
|         |         | 1.5 dCi | 63     |        | 05.05 | 09.05          |                |        |   |                |                |     |
|         |         | 1.5 dCi | 74     |        | 02.04 | 09.05          |                |        |   |                |                |     |
|         |         | 1.5 dCi | 78     |        | 05.05 | 09.05          |                |        |   |                |                |     |
|         |         | 1.6 16V | 75     |        | 09.03 | 09.05          |                |        |   |                |                |     |
|         |         | 1.6 16V | 77     |        | 05.05 | 09.05          |                |        |   |                |                |     |
|         |         | 1.6 16V | 83     |        | 09.03 | 09.05          |                |        |   |                |                |     |
|         |         | 1.9 dCi | 66     |        | 09.03 | 09.05          |                |        |   |                |                |     |
|         |         | 1.9 dCi | 68     |        | 03.04 | 09.05          |                |        |   |                |                |     |
| 1.9 dCi |         | 81      |        | 05.05  | 09.05 |                |                |        |   |                |                |     |
| 1.9 dCi |         | 88      |        | 09.03  | 09.05 |                |                |        |   |                |                |     |
| 1.9 dCi |         | 96      |        | 05.05  | 09.05 |                |                |        |   |                |                |     |
| 2.0 16V | 99      |         | 09.03  | 09.05  |       |                |                |        |   |                |                |     |
|         | 1.4 16V | 60      |        | 10.05  | 08.06 | 24.5229-0185.3 | 330397         | 2      |   | L=185          |                |     |
|         | 1.4 16V | 72      |        | 10.05  | 12.08 |                |                |        |   |                |                |     |
|         | 1.5 dCi | 60      |        | 10.05  | 12.08 |                |                |        |   |                |                |     |

|     |  |  |  |  |  |  |  |  |                    |
|--|--|--|--|--|---|--|--|--|--------------------|
| <b>RENAULT MEGANE II Limousine 4-türig (LM_) (03-08)</b>                           |  |  |  |  |   |  |  |  |                    |
|    | 1.5 dCi  | 63   |  | 10.05  | 12.08   | 24.5229-0185.3   | 330397   | 2 ▣  | L=185              |
|  | 1.5 dCi  | 74   |  | 10.05  | 03.06   |  |  |  |                    |
|  | 1.5 dCi  | 76   |  | 01.07  | 12.08   |  |  |  |                    |
|  | 1.5 dCi  | 78   |  | 10.05  | 12.08   |  |  |  |                    |
|  | 1.6 16V  | 75   |  | 10.05  | 12.08   |  |  |  |                    |
|  | 1.6 16V  | 77   |  | 10.05  | 12.08   |  |  |  |                    |
|  | 1.6 16V  | 82   |  | 01.07  | 12.08   |  |  |  |                    |
|  | 1.6 16V  | 83   |  | 10.05  | 12.08   |  |  |  |                    |
|  | 1.9 dCi  | 66   |  | 10.05  | 12.05   |  |  |  |                    |
|  | 1.9 dCi  | 68   |  | 10.05  | 12.08   |  |  |  |                    |
|  | 1.9 dCi  | 81   |  | 10.05  | 12.08   |  |  |  |                    |
|  | 1.9 dCi  | 88   |  | 10.05  | 12.08   |  |  |  |                    |
|  | 1.9 dCi  | 96   |  | 10.05  | 12.08   |  |  |  |                    |
|  | 2.0 16V  | 99   |  | 10.05  | 12.08   |  |  |  |                    |
|  | 2.0 dCi  | 110  |  | 09.05  | 12.08   |  |  |  |                    |
|    | 1.4 16V  | 60   |  | 09.03  | 08.06   | 24.3727-1069.2   | 581069   | 2 ▾  | L=2080             |
|  | 1.4 16V  | 72   |  | 09.03  | 12.08   |  |  |  |                    |
|  | 1.5 dCi  | 60   |  | 09.03  | 12.08   |  |  |  |                    |
|  | 1.5 dCi  | 63   |  | 05.05  | 12.08   |  |  |  |                    |
|  | 1.5 dCi  | 74   |  | 02.04  | 03.06   |  |  |  |                    |
|  | 1.5 dCi  | 76   |  | 01.07  | 12.08   |  |  |  |                    |
|  | 1.5 dCi  | 78   |  | 05.05  | 12.08   |  |  |  |                    |
|  | 1.6 16V  | 75   |  | 09.03  | 12.08   |  |  |  |                    |
|  | 1.6 16V  | 77   |  | 05.05  | 12.08   |  |  |  |                    |
|  | 1.6 16V  | 82   |  | 01.07  | 12.08   |  |  |  |                    |
|  | 1.6 16V  | 83   |  | 09.03  | 12.08   |  |  |  |                    |
|  | 1.9 dCi  | 66   |  | 09.03  | 12.05   |  |  |  |                    |
|  | 1.9 dCi  | 68   |  | 03.04  | 12.08   |  |  |  |                    |
|  | 1.9 dCi  | 81   |  | 05.05  | 12.08   |  |  |  |                    |
|  | 1.9 dCi  | 88   |  | 09.03  | 12.08   |  |  |  |                    |
|  | 1.9 dCi  | 96   |  | 05.05  | 12.08   |  |  |  |                    |
|  | 2.0 16V  | 99   |  | 09.03  | 12.08   |  |  |  |                    |
|  | 2.0 dCi  | 110  |  | 09.05  | 12.08   |  |  |  |                    |
| <b>RENAULT MEGANE II Coupe/Cabrio (EM_) (03-10)</b>                                |  |  |  |  |   |  |  |  |                    |
|    | 1.5 dCi  | 63   |  | 05.05  | 04.10   | 24.2123-1760.3   | 010779   |  | Thz 23,81 LUC      |
|  | 1.5 dCi  | 76   |  | 01.07  | 06.09   |  |  |  |                    |
|  | 1.5 dCi  | 78   |  | 03.06  | 06.08   |  |  |  |                    |
|  | 1.6 16V  | 77   |  | 06.05  | 04.10   |  |  |  |                    |
|  | 1.6 16V  | 82   |  | 01.07  | 04.10   |  |  |  |                    |
|  | 1.6 16V  | 83   |  | 09.03  | 04.10   |  |  |  |                    |
|  | 1.9 dCi  | 81   |  | 05.05  | 04.10   |  |  |  |                    |
|  | 1.9 dCi  | 85   |  | 01.06  | 04.10   |  |  |  |                    |
|  | 1.9 dCi  | 88   |  | 09.03  | 04.10   |  |  |  |                    |
|  | 1.9 dCi  | 96   |  | 05.05  | 02.07   |  |  |  |                    |
|  | 2.0 16V  | 99   |  | 09.03  | 03.07   |  |  |  |                    |
|  | 2.0 16V Turbo  | 120  |  | 05.04  | 04.10   |  |  |  |                    |
|  | 2.0 dCi  | 110  |  | 09.05  | 04.10   |  |  |  |                    |
|  | 1.5 dCi  | 63   |  | 10.05  | 04.10   | 11.9541-9545.2   | 220625   | ▣  | D=54, - Halter ATE |
|  | 1.5 dCi  | 76   |  | 01.07  | 06.09   | 11.9541-9546.2   | 220626   | ▣  | D=54, - Halter ATE |
|  | 1.5 dCi  | 78   |  | 03.06  | 06.08   | 11.0101-5407.2   | 260011   |  | Hülzensatz ATE     |
|  | 1.6 16V  | 77   |  | 10.05  | 04.10   | 11.8171-0008.1   | 990049   |  | Führungsbolzen ATE |
|  | 1.6 16V  | 82   |  | 01.07  | 04.10   | 11.8116-0301.1   | 390610   | 2  | Haltefeder ATE     |
|  | 1.6 16V  | 83   |  | 10.05  | 04.10   |  |  |  |                    |
|  | 1.9 dCi  | 81   |  | 10.05  | 04.10   |  |  |  |                    |
|  | 1.9 dCi  | 85   |  | 01.06  | 04.10   |  |  |  |                    |
|  | 1.9 dCi  | 88   |  | 10.05  | 04.10   |  |  |  |                    |
|  | 1.9 dCi  | 96   |  | 10.05  | 02.07   |  |  |  |                    |
|  | 2.0 16V  | 99   |  | 10.05  | 03.07   |  |  |  |                    |
|  | 2.0 dCi  | 110  |  | 09.05  | 04.10   |  |  |  |                    |
|  | 1.5 dCi  | 63   |  | 05.05  | 09.05   | 24.5111-0429.3   | 331015   | 2  | L=429              |
|  | 1.6 16V  | 77   |  | 06.05  | 09.05   |  |  |  |                    |
|  | 1.6 16V  | 83   |  | 09.03  | 09.05   |  |  |  |                    |
|  | 1.9 dCi  | 81   |  | 05.05  | 09.05   |  |  |  |                    |
|  | 1.9 dCi  | 88   |  | 09.03  | 09.05   |  |  |  |                    |
|  | 1.9 dCi  | 96   |  | 05.05  | 09.05   |  |  |  |                    |
|  | 2.0 16V  | 99   |  | 09.03  | 09.05   |  |  |  |                    |
|  | 1.5 dCi  | 63   |  | 10.05  | 04.10   | 24.5155-0445.3   | 331057   | 2  | L=445              |
|  | 1.5 dCi  | 76   |  | 01.07  | 06.09   |  |  |  |                    |
|  | 1.5 dCi  | 78   |  | 03.06  | 06.08   |  |  |  |                    |
|  | 1.6 16V  | 77   |  | 10.05  | 04.10   |  |  |  |                    |
|  | 1.6 16V  | 82   |  | 01.07  | 04.10   |  |  |  |                    |
|  | 1.6 16V  | 83   |  | 10.05  | 04.10   |  |  |  |                    |
|  | 1.9 dCi  | 81   |  | 10.05  | 04.10   |  |  |  |                    |
|  | 1.9 dCi  | 85   |  | 01.06  | 04.10   |  |  |  |                    |
|  | 1.9 dCi  | 88   |  | 10.05  | 04.10   |  |  |  |                    |
|  | 1.9 dCi  | 96   |  | 10.05  | 02.07   |  |  |  |                    |
|  | 2.0 16V  | 99   |  | 10.05  | 03.07   |  |  |  |                    |
|  | 2.0 dCi  | 110  |  | 09.05  | 04.10   |  |  |  |                    |
|  | 1.5 dCi  | 63   |  | 05.05  | 04.07   | 24.3347-1705.7   | 220751   | ▣  | D=34, - Halter LUC |
|  | 1.5 dCi  | 76   |  | 01.07  | 04.07   | 24.3347-1706.7   | 220752   | ▣  | D=34, - Halter LUC |
|  | 1.5 dCi  | 78   |  | 03.06  | 04.07   | 24.0101-3803.2   | 260101   |  | Einbausatz LUC     |
|  | 1.6 16V  | 77   |  | 06.05  | 04.07   |  |  |  |                    |
|  | 1.6 16V  | 82   |  | 01.07  | 04.07   |  |  |  |                    |
|  | 1.6 16V  | 83   |  | 09.03  | 04.07   |  |  |  |                    |
|  | 1.9 dCi  | 81   |  | 05.05  | 04.07   |  |  |  |                    |
|  | 1.9 dCi  | 85   |  | 01.06  | 04.07   |  |  |  |                    |



|     |    |  |  |  |  |  |     |  |   |   |   |
|--|--|--|--|--|---|--|---|--|---|---|---|
| <b>RENAULT MEGANE II Coupe/Cabrio (EM_) (03-10)</b>                                |  |  |  |  |   |  |   |  |   |   |   |
|    | 1.9 dCi  | 88   | 09.03  | 04.07  | 24.3347-1705.7  | 220751   |    | D=34, - Halter<br>D=34, - Halter<br>Einbausatz                                     | LUC   |   |   |
|  | 1.9 dCi  | 96   | 05.05  | 02.07  | 24.3347-1706.7  | 220752   |   |  |   |   |   |
|  | 2.0 16V  | 99   | 09.03  | 03.07  | 24.0101-3803.2  | 260101   |   |  |   |   |   |
|  | 2.0 16V Turbo  | 120  | 05.04  | 04.07  |   |  |   |  |   |   |   |
|  | 2.0 dCi  | 110  | 09.05  | 04.07  |   |  |   |  |   |   |   |
|  | 1.5 dCi  | 63   | 05.07  | 04.10  | 24.3347-1705.7  | 220751   |   |  |   |   |   |
|  | 1.5 dCi  | 76   | 05.07  | 06.09  | 24.3347-1706.7  | 220752   |   |  |   |   |   |
|  | 1.5 dCi  | 78   | 05.07  | 06.08  | 24.0101-3803.2  | 260101   |   |  |   |   |   |
|  | 1.6 16V  | 77   | 05.07  | 04.10  |   |  |   |  |   |   |   |
|  | 1.6 16V  | 82   | 05.07  | 04.10  |   |  |   |  |   |   |   |
| 1.6 16V  | 83   | 05.07  | 04.10  |  |   |  |   |  |   |   |   |
| 1.9 dCi  | 81   | 05.07  | 04.10  |  |   |  |   |  |   |   |   |
| 1.9 dCi  | 85   | 05.07  | 04.10  |  |   |  |   |  |   |   |   |
| 1.9 dCi  | 88   | 05.07  | 04.10  |  |   |  |   |  |   |   |   |
| 2.0 16V Turbo  | 120  | 05.07  | 04.10  |  |   |  |   |  |   |   |   |
| 2.0 dCi  | 110  | 05.07  | 04.10  |  |   |  |   |  |   |   |   |
|    | 1.5 dCi  | 63   | 05.05  | 08.05  | 24.5251-0185.3  | 330701   | 2  | L=185  |   |   |   |
|  | 1.6 16V  | 77   | 06.05  | 08.05  |   |  |   |  |   |   |   |
|  | 1.6 16V  | 83   | 09.03  | 08.05  |   |  |   |  |   |   |   |
|  | 1.9 dCi  | 81   | 05.05  | 08.05  |   |  |   |  |   |   |   |
|  | 1.9 dCi  | 88   | 09.03  | 08.05  |   |  |   |  |   |   |   |
|  | 1.9 dCi  | 96   | 05.05  | 08.05  |   |  |   |  |   |   |   |
|  | 2.0 16V  | 99   | 09.03  | 08.05  |   |  |   |  |   |   |   |
|  | 2.0 16V Turbo  | 120  | 05.04  | 08.05  |   |  |   |  |   |   |   |
|  | 1.5 dCi  | 63   | 09.05  | 04.10  | 24.5229-0185.3  | 330397   |   |  | 2  | L=185   |   |
|  | 1.5 dCi  | 76   | 01.07  | 06.09  |   |  |   |  |   |   |   |
| 1.5 dCi  | 78   | 03.06  | 06.08  |  |   |  |   |  |   |   |   |
| 1.6 16V  | 77   | 09.05  | 04.10  |  |   |  |   |  |   |   |   |
| 1.6 16V  | 82   | 01.07  | 04.10  |  |   |  |   |  |   |   |   |
| 1.6 16V  | 83   | 09.05  | 04.10  |  |   |  |   |  |   |   |   |
| 1.9 dCi  | 81   | 09.05  | 04.10  |  |   |  |   |  |   |   |   |
| 1.9 dCi  | 85   | 01.06  | 04.10  |  |   |  |   |  |   |   |   |
| 1.9 dCi  | 88   | 09.05  | 04.10  |  |   |  |   |  |   |   |   |
| 1.9 dCi  | 96   | 09.05  | 02.07  |  |   |  |   |  |   |   |   |
| 2.0 16V  | 99   | 09.05  | 03.07  |  |   |  |   |  |   |   |   |
| 2.0 16V Turbo  | 120  | 09.05  | 04.10  |  |   |  |   |  |   |   |   |
| 2.0 dCi  | 110  | 09.05  | 04.10  |  |   |  |   |  |   |   |   |
| <b>RENAULT MEGANE II Grandtour (KM_) (03-08)</b>                                   |  |  |  |  |   |  |   |  |   |   |   |
|   | 1.4 16V  | 72   | 09.03  | 12.08  | 24.2123-1760.3  | 010779   |   | Thz 23,81  | LUC   |   |   |
|  | 1.5 dCi  | 60   | 09.03  | 05.06  |   |  |   |  |   |   |   |
|  | 1.5 dCi  | 63   | 05.05  | 12.08  |   |  |   |  |   |   |   |
|  | 1.5 dCi  | 74   | 02.04  | 03.06  |   |  |   |  |   |   |   |
|  | 1.5 dCi  | 76   | 01.07  | 12.08  |   |  |   |  |   |   |   |
|  | 1.5 dCi  | 78   | 05.05  | 06.08  |   |  |   |  |   |   |   |
|  | 1.6 16V  | 82   | 01.07  | 12.08  |   |  |   |  |   |   |   |
|  | 1.6 16V  | 83   | 09.03  | 12.08  |   |  |   |  |   |   |   |
|  | 1.6 FlexFuel   | 77   | 02.08  | 12.08  |   |  |   |  |   |   |   |
|  | 1.9 dCi  | 68   | 03.04  | 02.07  |   |  |   |  |   |   |   |
|  | 1.9 dCi  | 81   | 05.05  | 12.08  |   |  |   |  |   |   |   |
|  | 1.9 dCi  | 88   | 09.03  | 12.08  |   |  |   |  |   |   |   |
|  | 1.9 dCi  | 96   | 05.05  | 02.07  |   |  |   |  |   |   |   |
|  | 2.0 16V  | 99   | 09.03  | 12.08  |   |  |   |  |   |   |   |
|  | 2.0 dCi  | 110  | 09.05  | 12.08  |   |  |   |  |   |   |   |
|  |  | 1.4 16V  | 72   | 10.05  | 12.08   | 11.9541-9545.2   |   |  | 220625  |  | D=54, - Halter<br>D=54, - Halter<br>Hülensatz<br>Führungsbolzen<br>Haltefeder |
| 1.5 dCi  |  | 60   | 10.05  | 05.06  | 11.9541-9546.2  | 220626   |   |  |   |   |   |
| 1.5 dCi  |  | 63   | 10.05  | 12.08  | 11.0101-5407.2  | 260011   |   |  |   |   |   |
| 1.5 dCi  |  | 74   | 10.05  | 03.06  | 11.8171-0008.1  | 990049   |   |  |   |   |   |
| 1.5 dCi  |  | 76   | 01.07  | 12.08  | 11.8116-0301.1  | 390610   |   |  |   |   |   |
| 1.5 dCi  |  | 78   | 10.05  | 06.08  |   |  |   |  |   |   |   |
| 1.6 16V  |  | 82   | 01.07  | 12.08  |   |  |   |  |   |   |   |
| 1.6 16V  |  | 83   | 10.05  | 12.08  |   |  |   |  |   |   |   |
| 1.6 FlexFuel   |  | 77   | 02.08  | 12.08  |   |  |   |  |   |   |   |
| 1.9 dCi  |  | 68   | 10.05  | 02.07  |   |  |   |  |   |   |   |
| 1.9 dCi  |  | 81   | 10.05  | 12.08  |   |  |   |  |   |   |   |
| 1.9 dCi  |  | 88   | 10.05  | 12.08  |   |  |   |  |   |   |   |
| 1.9 dCi  |  | 96   | 10.05  | 02.07  |   |  |   |  |   |   |   |
| 2.0 16V  |  | 99   | 10.05  | 12.08  |   |  |   |  |   |   |   |
| 2.0 dCi  |  | 110  | 09.05  | 12.08  |   |  |   |  |   |   |   |
|  |  | 1.4 16V  | 72   | 09.03  | 09.05   | 24.5111-0429.3   | 331015  | 2  | L=429   |   |   |
|  | 1.5 dCi  | 60   | 09.03  | 09.05  |   |  |   |  |   |   |   |
|  | 1.5 dCi  | 63   | 05.05  | 09.05  |   |  |   |  |   |   |   |
|  | 1.5 dCi  | 74   | 02.04  | 09.05  |   |  |   |  |   |   |   |
|  | 1.5 dCi  | 78   | 05.05  | 09.05  |   |  |   |  |   |   |   |
|  | 1.6 16V  | 83   | 09.03  | 09.05  |   |  |   |  |   |   |   |
|  | 1.9 dCi  | 68   | 03.04  | 09.05  |   |  |   |  |   |   |   |
|  | 1.9 dCi  | 81   | 05.05  | 09.05  |   |  |   |  |   |   |   |
|  | 1.9 dCi  | 88   | 09.03  | 09.05  |   |  |   |  |   |   |   |
|  | 1.9 dCi  | 96   | 05.05  | 09.05  |   |  |   |  |   |   |   |
|  | 2.0 16V  | 99   | 09.03  | 09.05  |   |  |   |  |   |   |   |
|  | 1.4 16V  | 72   | 10.05  | 12.08  | 24.5155-0445.3  | 331057   | 2   |  |   | L=445   |   |
|  | 1.5 dCi  | 60   | 10.05  | 05.06  |   |  |   |  |   |   |   |
|  | 1.5 dCi  | 63   | 10.05  | 12.08  |   |  |   |  |   |   |   |
|  | 1.5 dCi  | 74   | 10.05  | 03.06  |   |  |   |  |   |   |   |
|  | 1.5 dCi  | 76   | 01.07  | 12.08  |   |  |   |  |   |   |   |
| 1.6 16V  | 82   | 01.07  | 12.08  |  |   |  |   |  |   |   |   |

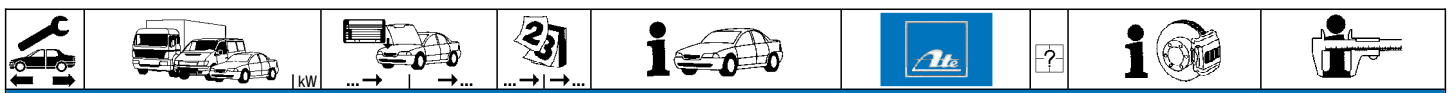

















**RENAULT MEGANE II Grandtour (KM\_) (03-08)**





















|  |   |   |  |  |  |  |                            |   |  |  |                   |
|--|---|---|--|--|--|--|----------------------------|---|--|--|-------------------|
|  | 1.6 16V<br>1.6 FlexFuel<br>1.9 dCi<br>1.9 dCi<br>1.9 dCi<br>1.9 dCi<br>2.0 16V<br>2.0 dCi   | 83<br>77<br>68<br>81<br>88<br>96<br>99<br>110   |  | 10.05<br>02.08<br>10.05<br>10.05<br>10.05<br>10.05<br>10.05<br>09.05   | 12.08<br>12.08<br>02.07<br>12.08<br>12.08<br>02.07<br>12.08  | 24.5155-0445.3                                     | 331057                     | 2 |  | L=445  |                   |
|  | 1.4 16V<br>1.5 dCi<br>1.5 dCi<br>1.5 dCi<br>1.5 dCi<br>1.5 dCi<br>1.6 16V<br>1.6 16V<br>1.9 dCi<br>1.9 dCi<br>1.9 dCi<br>1.9 dCi<br>2.0 16V<br>2.0 dCi      | 72<br>60<br>63<br>74<br>76<br>78<br>82<br>83<br>68<br>81<br>88<br>96<br>99<br>110       |  | 09.03<br>09.03<br>05.05<br>02.04<br>01.07<br>05.05<br>01.07<br>09.03<br>03.04<br>05.05<br>09.03<br>05.05<br>09.03<br>09.05 | 04.07<br>05.06<br>04.07<br>03.06<br>04.07<br>04.07<br>04.07<br>02.07<br>04.07<br>04.07<br>02.07<br>04.07<br>04.07          | 24.3347-1705.7<br>24.3347-1706.7<br>24.0101-3803.2 | 220751<br>220752<br>260101 |   |  | D=34, - Halter<br>D=34, - Halter<br>Einbausatz | LUC<br>LUC<br>LUC |
|  | 1.4 16V<br>1.5 dCi<br>1.5 dCi<br>1.5 dCi<br>1.5 dCi<br>1.6 16V<br>1.6 16V<br>1.6 FlexFuel<br>1.9 dCi<br>1.9 dCi<br>2.0 16V<br>2.0 dCi                       | 72<br>60<br>63<br>76<br>78<br>82<br>83<br>77<br>81<br>88<br>99<br>110                   |  | 05.07<br>05.07<br>05.07<br>05.07<br>05.07<br>05.07<br>02.08<br>05.07<br>05.07<br>05.07<br>05.07<br>05.07                   | 12.08<br>12.08<br>12.08<br>06.08<br>12.08<br>12.08<br>12.08<br>12.08<br>12.08<br>12.08<br>12.08<br>12.08                   | 24.3347-1705.7<br>24.3347-1706.7<br>24.0101-3803.2 | 220751<br>220752<br>260101 |   |  | D=34, - Halter<br>D=34, - Halter<br>Einbausatz | LUC<br>LUC<br>LUC |
|  | 1.4 16V<br>1.5 dCi<br>1.5 dCi<br>1.5 dCi<br>1.5 dCi<br>1.6 16V<br>1.9 dCi<br>1.9 dCi<br>1.9 dCi<br>1.9 dCi<br>2.0 16V                                       | 72<br>60<br>63<br>74<br>78<br>83<br>68<br>81<br>88<br>96<br>99                          |  | 09.03<br>09.03<br>05.05<br>02.04<br>05.05<br>09.03<br>03.04<br>05.05<br>09.03<br>05.05<br>09.03                            | 08.05<br>08.05<br>08.05<br>08.05<br>08.05<br>08.05<br>08.05<br>08.05<br>08.05<br>08.05<br>08.05                            | 24.5251-0185.3                                     | 330701                     | 2 |  | L=185  |                   |
|  | 1.4 16V<br>1.5 dCi<br>1.5 dCi<br>1.5 dCi<br>1.5 dCi<br>1.6 16V<br>1.6 16V<br>1.6 FlexFuel<br>1.9 dCi<br>1.9 dCi<br>1.9 dCi<br>1.9 dCi<br>2.0 16V<br>2.0 dCi | 72<br>60<br>63<br>74<br>76<br>78<br>82<br>83<br>77<br>68<br>81<br>88<br>96<br>99<br>110 |  | 09.05<br>09.05<br>09.05<br>09.05<br>09.05<br>01.07<br>09.05<br>02.08<br>09.05<br>09.05<br>09.05<br>09.05<br>09.05<br>09.05 | 12.08<br>05.06<br>12.08<br>03.06<br>12.08<br>12.08<br>12.08<br>12.08<br>02.07<br>12.08<br>12.08<br>02.07<br>12.08<br>12.08 | 24.5229-0185.3                                     | 330397                     | 2 |  | L=185  |                   |
|  | 1.4 16V<br>1.5 dCi<br>1.5 dCi<br>1.5 dCi<br>1.6 16V<br>1.6 16V<br>1.6 FlexFuel<br>1.9 dCi<br>1.9 dCi<br>1.9 dCi<br>1.9 dCi<br>2.0 16V<br>2.0 dCi            | 72<br>74<br>76<br>78<br>82<br>83<br>77<br>68<br>81<br>88<br>96<br>99<br>110             |  | 09.03<br>02.04<br>01.07<br>05.05<br>01.07<br>09.03<br>02.08<br>03.04<br>05.05<br>09.03<br>05.05<br>09.03<br>09.05          | 12.08<br>03.06<br>12.08<br>06.08<br>12.08<br>12.08<br>12.08<br>02.07<br>12.08<br>12.08<br>02.07<br>12.08<br>12.08          | 24.3727-1069.2                                     | 581069                     | 2 |  | L=2080   |                   |
|  | 1.5 dCi<br>1.5 dCi  | 60<br>63  |  | 09.03<br>05.05   | 05.06<br>12.08   | 24.3727-1070.2                                     | 581070                     | 2 |  | L=2023   |                   |

**RENAULT MEGANE III Schrägheck (BZ0\_) (08-)**

|  |  |  |  |   |  |  |                            |   |  |   |                   |
|--|--|--|--|---|--|--|----------------------------|---|--|---|-------------------|
|  | 1.2 TCe<br>1.2 TCe<br>1.4<br>1.5 dCi<br>1.5 dCi<br>1.5 dCi<br>1.5 dCi<br>1.5 dCi<br>1.6<br>1.6<br>1.6 16V Bifuel | 85<br>97<br>96<br>63<br>66<br>78<br>81<br>96<br>74<br>81<br>81 |  | 03.12<br>01.13<br>04.09<br>12.09<br>11.08<br>02.09<br>02.09<br>11.08<br>11.08<br>11.08<br>11.08 |  | 11.9541-9950.2<br>11.9541-9951.2<br>11.8116-0356.1 | 220843<br>220844<br>390586 | 2 |  | D=54, - Halter<br>D=54, - Halter<br>Halterfeder | ATE<br>ATE<br>ATE |
|--|--|--|--|---|--|--|----------------------------|---|--|---|-------------------|



|     |  |  |  |  |  |  |  |  |                   |     |
|--|--|--|--|--|---|--|--|--|-------------------|-----|
| <b>RENAULT MEGANE III Schrägheck (BZO_) (08-)</b>                                  |  |  |  |  |   |  |  |  |                   |     |
|    | 1.9 dCi  | 96   | 11.08  |  | 11.9541-9950.2 220843<br>11.9541-9951.2 220844<br>11.8116-0356.1 390586           | 2  |  | D=54, - Halter<br>D=54, - Halter<br>Haltefeder                                     | ATE<br>ATE<br>ATE |     |
|  | 2.0  | 103  | 02.09  |  | 11.9571-9775.2 220859   |  |  | D=57, - Halter   | ATE               |     |
|  | 2.0 dCi  | 110  | 10.10  |  | 11.9571-9776.2 220860   |  |  | D=57, - Halter   | ATE               |     |
|  | 2.0 dCi  | 118  | 04.09  |  | 11.0101-5704.2 260095   |  |  | Hülzensatz   | ATE               |     |
|  | 2.0 dCi  | 120  | 07.12  |  | 11.8116-0351.1 390538   | 2  |  | Haltefeder   | ATE               |     |
|  | 2.0 TCe  | 132  | 11.08  |  |   |  |  |  |                   |     |
|    | 1.2 TCe  | 85   | 03.12  |  | 24.3727-1080.2 581080   | 2  | ↓  | L=1883   |                   |     |
|  | 1.2 TCe  | 97   | 01.13  |  |   |  |  |  |                   |     |
|  | 1.4  | 96   | 04.09  |  |   |  |  |  |                   |     |
|  | 1.5 dCi  | 63   | 12.09  |  |   |  |  |  |                   |     |
|  | 1.5 dCi  | 66   | 11.08  |  |   |  |  |  |                   |     |
|  | 1.5 dCi  | 78   | 02.09  |  |   |  |  |  |                   |     |
|  | 1.5 dCi  | 81   | 02.09  |  |   |  |  |  |                   |     |
|  | 1.5 dCi  | 96   | 11.08  |  |   |  |  |  |                   |     |
|  | 1.6  | 74   | 11.08  |  |   |  |  |  |                   |     |
|  | 1.6  | 81   | 11.08  |  |   |  |  |  |                   |     |
|  | 1.6 16V Bifuel   | 81   | 11.08  |  |   |  |  |  |                   |     |
|  | 1.9 dCi  | 96   | 11.08  |  |   |  |  |  |                   |     |
|  | 2.0  | 103  | 02.09  |  |   |  |  |  |                   |     |
|  | 2.0 dCi  | 110  | 10.10  |  |   |  |  |  |                   |     |
|  | 2.0 dCi  | 118  | 04.09  |  |   |  |  |  |                   |     |
|  | 2.0 dCi  | 120  | 07.12  |  |   |  |  |  |                   |     |
|  | 2.0 TCe  | 132  | 11.08  |  |   |  |  |  |                   |     |
|  | 2.0 TCe  | 140  | 06.12  |  |   |  |  |  |                   |     |
|  | <b>RENAULT MEGANE III CC (EZO_) (10-)</b>  |  |  |  |   |  |  |  |                   |     |
|  |  | 1.2 TCe  | 97   | 04.13  |   | 11.9541-9950.2 220843  |  |  | D=54, - Halter    | ATE |
|  |  | 1.4 16V  | 96   | 06.10  |   | 11.9541-9951.2 220844  |  |  | D=54, - Halter    | ATE |
| 1.5 dCi  |  | 78   | 06.10  |  | 11.8116-0356.1 390586   | 2  |  | Haltefeder   | ATE               |     |
| 1.5 dCi  |  | 81   | 06.10  |  |   |  |  |  |                   |     |
| 1.6 16V  |  | 81   | 06.10  |  |   |  |  |  |                   |     |
| 1.6 16V Bio-Petrol   |  | 81   | 06.10  |  |   |  |  |  |                   |     |
| 1.6 dCi  |  | 96   | 04.11  |  |   |  |  |  |                   |     |
| 1.9 dCi  |  | 96   | 06.10  |  |   |  |  |  |                   |     |
| 2.0 16V  |  | 103  | 06.10  |  |   |  |  |  |                   |     |
| 2.0 dCi  |  | 118  | 06.10  |  | 11.9571-9775.2 220859   |  |  | D=57, - Halter   | ATE               |     |
|  | 2.0 TCe  | 132  | 06.10  |  | 11.9571-9776.2 220860   |  |  | D=57, - Halter   | ATE               |     |
|  |  |  |  |  | 11.0101-5704.2 260095   |  |  | Hülzensatz   | ATE               |     |
|  |  |  |  | 11.8116-0351.1 390538  | 2   |  | Haltefeder   | ATE  |                   |     |
|  | 1.4 16V  | 96   | 06.10  |  | 24.3727-1080.2 581080   | 1  | ↓  | L=1883   |                   |     |
|  | 1.5 dCi  | 78   | 06.10  |  |   |  |  |  |                   |     |
|  | 1.5 dCi  | 81   | 06.10  |  |   |  |  |  |                   |     |
|  | 1.6 16V  | 81   | 06.10  |  |   |  |  |  |                   |     |
|  | 1.6 16V Bio-Petrol   | 81   | 06.10  |  |   |  |  |  |                   |     |
|  | 1.9 dCi  | 96   | 06.10  |  |   |  |  |  |                   |     |
|  | 2.0 16V  | 103  | 06.10  |  |   |  |  |  |                   |     |
|  | 2.0 dCi  | 118  | 06.10  |  |   |  |  |  |                   |     |
|  | 2.0 TCe  | 132  | 06.10  |  |   |  |  |  |                   |     |
|  | <b>RENAULT MEGANE III Coupe (DZO_) (08-)</b>                                     |  |  |  |   |  |  |  |                   |     |
|  | 1.2 TCe  | 85   | 03.12  |  | 11.9541-9950.2 220843   |  |  | D=54, - Halter   | ATE               |     |
|  | 1.2 TCe  | 97   | 01.13  |  | 11.9541-9951.2 220844   |  |  | D=54, - Halter   | ATE               |     |
|  | 1.4 16V  | 96   | 04.09  |  | 11.8116-0356.1 390586   | 2  |  | Haltefeder   | ATE               |     |
|  | 1.5 dCi  | 63   | 11.08  |  |   |  |  |  |                   |     |
|  | 1.5 dCi  | 66   | 11.08  |  |   |  |  |  |                   |     |
|  | 1.5 dCi  | 78   | 11.08  |  |   |  |  |  |                   |     |
|  | 1.5 dCi  | 81   | 02.09  |  |   |  |  |  |                   |     |
|  | 1.6 16V  | 74   | 11.08  |  |   |  |  |  |                   |     |
|  | 1.6 16V  | 81   | 11.08  |  |   |  |  |  |                   |     |
|  | 1.6 16V Bifuel   | 81   | 11.08  |  |   |  |  |  |                   |     |
|  | 1.9 dCi  | 96   | 11.08  |  |   |  |  |  |                   |     |
|  | 2.0 16V  | 103  | 05.09  |  |   |  |  |  |                   |     |
|  | 2.0 dCi  | 110  | 04.09  |  | 11.9571-9775.2 220859   |  |  | D=57, - Halter   | ATE               |     |
|  | 2.0 dCi  | 118  | 04.09  |  | 11.9571-9776.2 220860   |  |  | D=57, - Halter   | ATE               |     |
|  | 2.0 dCi  | 120  | 07.12  |  | 11.0101-5704.2 260095   |  |  | Hülzensatz   | ATE               |     |
|  | 2.0 TCe  | 132  | 11.08  |  | 11.8116-0351.1 390538   | 2  |  | Haltefeder   | ATE               |     |
|  | 2.0 TCe  | 140  | 06.12  |  |   |  |  |  |                   |     |
|  |  |  |  |  |   |  |  |  |                   |     |
|  | 1.2 TCe  | 85   | 03.12  |  | 24.3727-1080.2 581080   | 2  | ↓  | L=1883   |                   |     |
|  | 1.2 TCe  | 97   | 01.13  |  |   |  |  |  |                   |     |
|  | 1.4 16V  | 96   | 04.09  |  |   |  |  |  |                   |     |
|  | 1.5 dCi  | 63   | 11.08  |  |   |  |  |  |                   |     |
|  | 1.5 dCi  | 66   | 11.08  |  |   |  |  |  |                   |     |
|  | 1.5 dCi  | 78   | 11.08  |  |   |  |  |  |                   |     |
|  | 1.5 dCi  | 81   | 02.09  |  |   |  |  |  |                   |     |
|  | 1.6 16V  | 74   | 11.08  |  |   |  |  |  |                   |     |
|  | 1.6 16V  | 81   | 11.08  |  |   |  |  |  |                   |     |
|  | 1.6 16V Bifuel   | 81   | 11.08  |  |   |  |  |  |                   |     |
|  | 1.9 dCi  | 96   | 11.08  |  |   |  |  |  |                   |     |
|  | 2.0 16V  | 103  | 05.09  |  |   |  |  |  |                   |     |
|  | 2.0 dCi  | 110  | 04.09  |  |   |  |  |  |                   |     |
|  | 2.0 dCi  | 118  | 04.09  |  |   |  |  |  |                   |     |
| 2.0 dCi  | 120  | 07.12  |  |  |   |  |  |  |                   |     |
| 2.0 R.S. TCe 265   | 195  | 08.11  |  |  |   |  |  |  |                   |     |
| 2.0 TCe  | 132  | 11.08  |  |  |   |  |  |  |                   |     |

| RENAULT MEGANE III Coupe (DZ0_) (08-)  |   |  |  |  |   |  |  |  |  |                          |  |
|--|---|--|--|--|---|--|--|--|--|--------------------------|--|
|     |   |  |                          |  |  |  |  |  |  |                          |  |
|    | 2.0 TCe<br>2.0 TCe 250  | 140<br>184   | 06.12<br>05.09   |  | 24.3727-1080.2  | 581080   | 2 ↓  |  | L=1883   |                          |  |
| RENAULT MEGANE III Grandtour (KZ_) (08-)   |   |  |  |  |   |  |  |  |  |                          |  |
|    | 1.2 TCe<br>1.2 TCe<br>1.4 16V<br>1.5 dCi<br>1.5 dCi<br>1.5 dCi<br>1.5 dCi<br>1.6 16V<br>1.6 16V<br>1.6 16V Bifuel<br>1.9 dCi<br>2.0 16V | 85<br>97<br>96<br>63<br>66<br>78<br>81<br>74<br>81<br>81<br>96<br>103            | 03.12<br>01.13<br>05.09<br>08.09<br>05.09<br>05.09<br>02.09<br>05.09<br>05.09<br>11.08<br>05.09          |  | 11.9541-9950.2<br>11.9541-9951.2<br>11.8116-0356.1                                | 220843<br>220844<br>390586   | 2  |  | D=54, - Halter<br>D=54, - Halter<br>Haltefeder               | ATE<br>ATE<br>ATE        |  |
|    | 2.0 dCi<br>2.0 dCi<br>2.0 dCi<br>2.0 TCe<br>2.0 TCe<br>2.0 TCe  | 110<br>118<br>120<br>132<br>140<br>162   | 08.09<br>04.09<br>07.12<br>05.09<br>09.12<br>09.12   |  | 11.9571-9775.2<br>11.9571-9776.2<br>11.0101-5704.2<br>11.8116-0351.1              | 220859<br>220860<br>260095<br>390538   | 2  |  | D=57, - Halter<br>D=57, - Halter<br>Hülzensatz<br>Haltefeder | ATE<br>ATE<br>ATE<br>ATE |  |
|    | 1.4 16V<br>1.5 dCi<br>1.5 dCi<br>1.5 dCi<br>1.6 16V Bifuel<br>2.0 dCi<br>2.0 dCi<br>2.0 dCi<br>2.0 TCe                                  | 96<br>66<br>78<br>81<br>81<br>110<br>118<br>120<br>132                           | 05.09<br>05.09<br>05.09<br>02.09<br>11.08<br>08.09<br>04.09<br>07.12<br>05.09                            |  | 24.3727-1080.2  | 581080   | 2 ↓  |  | L=1883   |                          |  |
|  | 1.2 TCe<br>1.2 TCe<br>1.5 dCi<br>1.6 16V<br>1.6 16V<br>1.9 dCi<br>2.0 16V   | 85<br>97<br>63<br>74<br>81<br>96<br>103  | 03.12<br>01.13<br>08.09<br>05.09<br>05.09<br>05.09<br>05.09  |  | 24.3727-1081.2  | 581081   | 2 ↓  |  | L=1940   |                          |  |
| RENAULT MEGANE SCENIC (JA_) (96-99)  |   |  |  |  |   |  |  |  |  |                          |  |
|  | 1.4 i<br>1.6 16V<br>1.6 e<br>1.6 i<br>1.9 D (JAOJ)<br>1.9 D (FAOJ/Y)<br>1.9 dTi (FAON)<br>1.9 dTi (JAON)<br>2.0 i                       | 51<br>79<br>66<br>55<br>47<br>47<br>72<br>72<br>84                               | 10.98<br>09.99<br>10.98<br>09.99<br>10.98<br>09.99<br>10.98<br>09.99<br>10.98<br>09.99                   |  | 03.7760-5102.4  | 300140   |  |  | 10"  | ATE                      |  |
|  | 1.4 i<br>1.6 e<br>1.6 i<br>1.6 16V<br>1.6 e<br>1.9 D<br>1.9 dT<br>1.9 dTi<br>2.0 i  | 51<br>66<br>55<br>79<br>66<br>47<br>66<br>72<br>84                               | 11.96<br>09.98<br>11.96<br>09.98<br>11.96<br>09.98<br>11.96<br>09.98<br>04.97<br>09.98<br>11.96<br>09.98 | - ABS<br>- ABS/ + Schaltgetriebe <sup>1)</sup><br>- ABS                          | 03.2120-2031.3  | 010106   |  |  | Thz 20,64  | ATE                      |  |
|  | 1.6 16V<br>1.6 e<br>1.9 D<br>1.9 dT<br>1.9 dTi<br>2.0 i   | 79<br>66<br>47<br>66<br>72<br>84   | 04.98<br>09.98<br>11.96<br>09.98<br>11.96<br>09.98   | + Automatikgetriebe <sup>2)</sup>  | 24.2122-1717.3  | 010501   |  |  | Thz 22,20  |                          |  |
|  | 1.4 i<br>1.6 16V<br>1.6 e<br>1.6 i<br>1.9 D (JAOJ)<br>1.9 D (FAOJ/Y)<br>1.9 dTi (FAON)<br>1.9 dTi (JAON)<br>2.0 i                       | 51<br>79<br>66<br>55<br>47<br>47<br>72<br>72<br>84                               | 10.98<br>09.99<br>10.98<br>09.99<br>10.98<br>09.99<br>10.98<br>09.99<br>10.98<br>09.99                   | - ABS<br>- ABS<br>- ABS<br>- ABS<br>- ABS<br>- ABS<br>- ABS<br>- ABS             | 03.2123-1551.3  | 010512   |  |  | Thz 23,81  | ATE                      |  |
|  | 1.4 i<br>1.6 e<br>1.6 i   | 51<br>66<br>55   | 11.96<br>09.98<br>11.96<br>09.98   | + ABS<br>+ ABS/ + Schaltgetriebe <sup>3)</sup><br>+ ABS                          | 24.2120-1723.3  | 010545   |  |  | Thz 20,64  | BDX                      |  |
|  | 1.6 e   | 66   | 11.96<br>09.98   | + ABS/ + Schaltgetriebe <sup>3)</sup>  | 24.2120-1725.3  | 010579   |  |  | Thz 20,64  | BDX                      |  |
|  | 1.4 i<br>1.6 16V<br>1.6 e<br>1.6 i<br>1.9 D (FAOJ)<br>1.9 D (JAOJ)<br>1.9 dTi (FAON)<br>1.9 dTi (JAON)<br>2.0 i                         | 51<br>79<br>66<br>55<br>47<br>47<br>72<br>72<br>84                               | 10.98<br>09.99<br>10.98<br>09.99<br>10.98<br>09.99<br>10.98<br>09.99<br>10.98<br>09.99                   | + ABS<br>+ ABS<br>+ ABS<br>+ ABS<br>+ ABS<br>+ ABS<br>+ ABS<br>+ ABS             | 03.2123-2146.3  | 010572   |  |  | Thz 23,81  | ATE                      |  |
|  | 1.6 16V<br>1.6 e<br>1.9 D (JAOJ)<br>1.9 dTi (JAON)<br>2.0 i   | 79<br>66<br>47<br>72<br>84   | 10.98<br>09.99<br>10.98<br>09.99<br>10.98<br>09.99   | + ABS<br>+ ABS<br>+ ABS<br>+ ABS   | 03.2123-2181.3  | 010608   |  |  | Thz 23,81  | ATE                      |  |

<sup>1)</sup> - ABS/ + manual transmission / - ABS/ + scatola camb.velocità / - ABS/ + transmission mécanique / - ABS/ + cambio de velocidad

<sup>2)</sup> + autom.transmission / + scatola cambio automatico / + transmission automatique / + cambio automático

<sup>3)</sup> + ABS/ + manual transm. / + ABS/+ scatola camb.velocità / + ABS/ + transmission mécanique / + ABS/ + cambio de velocidad

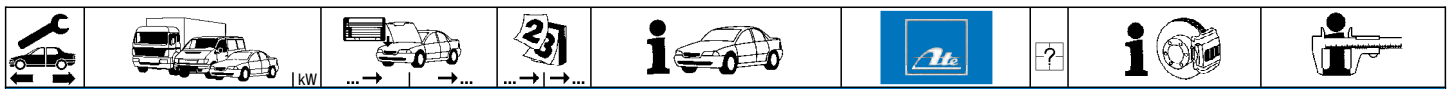

**RENAULT MEGANE SCENIC (JA\_) (96-99)**

|                |                  |         |       |       |       |                |                |  |  |  |                   |        |  |  |                                  |            |
|----------------|------------------|---------|-------|-------|-------|----------------|----------------|--|--|--|-------------------|--------|--|--|----------------------------------|------------|
|                | 1.4 i            | 51      |       | 11.96 | 09.98 | 24.3481-1615.5 | 240031         |  |  | D=48, - Halter<br>D=48, - Halter<br>Einbausatz | LUC<br>LUC<br>LUC |        |  |  |                                  |            |
|                | 1.6 e            | 66      |       | 11.96 | 09.98 | 24.3481-1616.5 | 240032         |  |  |  |                   |        |  |  |                                  |            |
|                | 1.6 i            | 55      |       | 11.96 | 09.98 | 24.0101-4806.2 | 260052         |  |  |  |                   |        |  |  |                                  |            |
|                | 1.6 16V          | 79      |       | 04.98 | 09.98 | 24.3541-1741.5 | 240215         |  |  |  |                   |        |  |  |                                  |            |
|                | 1.6 e            | 66      |       | 11.96 | 09.98 | 24.3541-1742.5 | 240216         |  |  |  |                   |        |  |  |                                  |            |
|                | 1.9 D (F/JA0J)   | 47      |       | 11.96 | 09.98 |                |                |  |  |  |                   |        |  |  |                                  |            |
|                | 1.9 D (FA0Y)     | 47      |       | 11.96 | 09.98 |                |                |  |  |  |                   |        |  |  |                                  |            |
|                | 1.9 D (JA0Y)     | 47      |       | 11.96 | 09.99 |                |                |  |  |  |                   |        |  |  |                                  |            |
|                | 1.9 dT           | 66      |       | 11.96 | 12.97 |                |                |  |  |  |                   |        |  |  |                                  |            |
|                | 1.9 dTi (FAON)   | 72      |       | 03.98 | 09.98 |                |                |  |  |  |                   |        |  |  |                                  |            |
|                | 1.4 i            | 51      |       | 10.98 | 09.99 | 24.3541-1749.5 | 240427         |  |  | D=54, - Halter<br>D=54, - Halter               | LUC<br>LUC        |        |  |  |                                  |            |
|                | 1.6 16V          | 79      |       | 10.98 | 09.99 | 24.3541-1750.5 | 240428         |  |  |  |                   |        |  |  |                                  |            |
|                | 1.6 e            | 66      |       | 10.98 | 09.99 |                |                |  |  |  |                   |        |  |  |                                  |            |
|                | 1.6 e            | 66      |       | 10.98 | 09.99 |                |                |  |  |  |                   |        |  |  |                                  |            |
|                | 1.6 i            | 55      |       | 10.98 | 09.99 |                |                |  |  |  |                   |        |  |  |                                  |            |
|                | 1.9 D (F/JA0J)   | 47      |       | 10.98 | 09.99 |                |                |  |  |  |                   |        |  |  |                                  |            |
|                | 1.9 D (FA0Y)     | 47      |       | 10.98 | 09.99 |                |                |  |  |  |                   |        |  |  |                                  |            |
|                | 1.9 dTi (FAON)   | 72      |       | 10.98 | 09.99 |                |                |  |  |  |                   |        |  |  |                                  |            |
|                | 1.9 dTi (JAON)   | 72      |       | 04.97 | 09.98 | 24.3541-1741.5 | 240215         |  |  |  |                   |        |  |  |                                  |            |
|                | 2.0 i            | 84      |       | 11.96 | 09.98 | 24.3541-1742.5 | 240216         |  |  |  |                   |        |  |  |                                  |            |
|                | 1.4 i            | 51      |       | 11.96 | 09.99 | 24.5111-0390.3 | 330566         |  |  | L=390  |                   |        |  |  |                                  |            |
|                | 1.6 16V          | 79      |       | 04.98 | 09.99 |                |                |  |  |  |                   |        |  |  |                                  |            |
|                | 1.6 e            | 66      |       | 11.96 | 09.99 |                |                |  |  |  |                   |        |  |  |                                  |            |
|                | 1.6 i            | 55      |       | 11.96 | 09.99 |                |                |  |  |  |                   |        |  |  |                                  |            |
|                | 1.9 D            | 47      |       | 11.96 | 09.99 |                |                |  |  |  |                   |        |  |  |                                  |            |
|                | 1.9 dT           | 66      |       | 11.96 | 12.97 |                |                |  |  |  |                   |        |  |  |                                  |            |
|                | 1.9 dTi (F/JAON) | 72      |       | 04.97 | 09.99 |                |                |  |  |  |                   |        |  |  |                                  |            |
|                | 2.0 i            | 84      |       | 11.96 | 09.99 |                |                |  |  |  |                   |        |  |  |                                  |            |
|                |                  | 1.6 16V | 79    |       | 04.98 | 09.99          | 24.3344-1707.7 |  |  |  |                   | 220531 |  |  | D=34, - Halter<br>D=34, - Halter | LUC<br>LUC |
|                |                  |         |       |       |       |                | 24.3344-1708.7 |  |  |  |                   | 220532 |  |  |                                  |            |
|                | 1.4 i            | 51      |       | 11.96 | 09.99 | 24.5229-0265.3 | 330540         |  |  | L=265  |                   |        |  |  |                                  |            |
|                | 1.6 16V          | 79      |       | 04.98 | 09.99 |                |                |  |  |  |                   |        |  |  |                                  |            |
|                | 1.6 e            | 66      |       | 11.96 | 09.99 |                |                |  |  |  |                   |        |  |  |                                  |            |
|                | 1.6 i            | 55      |       | 11.96 | 09.99 |                |                |  |  |  |                   |        |  |  |                                  |            |
|                | 1.9 D            | 47      |       | 11.96 | 09.99 |                |                |  |  |  |                   |        |  |  |                                  |            |
|                | 1.9 dT           | 66      |       | 11.96 | 12.97 |                |                |  |  |  |                   |        |  |  |                                  |            |
|                | 1.9 dTi (F/JAON) | 72      |       | 04.97 | 09.99 |                |                |  |  |  |                   |        |  |  |                                  |            |
|                | 2.0 i            | 84      |       | 11.96 | 09.99 |                |                |  |  |  |                   |        |  |  |                                  |            |
|                | 1.4 i            | 51      |       | 11.96 | 09.99 | 24.3220-1711.3 | 020409         |  |  | Rz 20,64                                       | LUC               |        |  |  |                                  |            |
|                | 1.6 16V          | 79      |       | 04.98 | 09.99 |                |                |  |  |  |                   |        |  |  |                                  |            |
|                | 1.6 e            | 66      |       | 11.96 | 09.99 |                |                |  |  |  |                   |        |  |  |                                  |            |
|                | 1.6 i            | 55      |       | 11.96 | 09.99 |                |                |  |  |  |                   |        |  |  |                                  |            |
|                | 1.9 D (F/JA0J)   | 47      |       | 11.96 | 09.99 |                |                |  |  |  |                   |        |  |  |                                  |            |
|                | 1.9 dT           | 66      |       | 11.96 | 09.99 |                |                |  |  |  |                   |        |  |  |                                  |            |
|                | 1.9 dTi (F/JAON) | 72      |       | 04.97 | 09.99 |                |                |  |  |  |                   |        |  |  |                                  |            |
|                | 2.0 i            | 84      |       | 11.96 | 09.99 |                |                |  |  |  |                   |        |  |  |                                  |            |
|                |                  | 1.4 i   | 51    |       | 11.96 | 09.99          | 24.3727-1045.2 |  |  |  |                   | 581045 |  |  | L=1476                           |            |
|                |                  | 1.6 16V | 79    |       | 04.98 | 09.99          |                |  |  |  |                   |        |  |  |                                  |            |
| 1.6 e          |                  | 66      |       | 11.96 | 09.99 |                |                |  |  |  |                   |        |  |  |                                  |            |
| 1.6 i          |                  | 55      |       | 11.96 | 09.99 |                |                |  |  |  |                   |        |  |  |                                  |            |
| 1.9 D (F/JA0J) |                  | 47      |       | 08.99 | 09.99 |                |                |  |  |  |                   |        |  |  |                                  |            |
| 1.9 D (F/JA0J) |                  | 47      |       | 11.96 | 07.99 |                |                |  |  |  |                   |        |  |  |                                  |            |
| 1.9 D (F/JA0Y) |                  | 47      |       | 11.96 | 09.99 |                |                |  |  |  |                   |        |  |  |                                  |            |
| 1.9 dT         |                  | 66      |       | 11.96 | 12.97 |                |                |  |  |  |                   |        |  |  |                                  |            |
| 1.9 dTi (FAON) |                  | 72      |       | 03.98 | 09.99 |                |                |  |  |  |                   |        |  |  |                                  |            |
| 1.9 dTi (JAON) |                  | 72      |       | 08.99 | 09.99 |                |                |  |  |  |                   |        |  |  |                                  |            |
| 1.9 dTi (JAON) | 72               |         | 04.97 | 07.99 |       |                |                |  |  |  |                   |        |  |  |                                  |            |
| 2.0 i          | 84               |         | 11.96 | 09.99 |       |                |                |  |  |  |                   |        |  |  |                                  |            |
|                | 1.9 D (F/JA0J)   | 47      |       | 08.99 | 09.99 | 24.3727-1056.2 | 581056         |  |  | L=1508<br>L=1479                               |                   |        |  |  |                                  |            |
|                | 1.9 dTi (JAON)   | 72      |       | 08.99 | 09.99 | 24.3727-1055.2 | 581055         |  |  |  |                   |        |  |  |                                  |            |
|                | 1.4 i            | 51      |       | 11.96 | 09.99 | 24.6582-1702.3 | 320172         |  |  | BRL (4)  |                   |        |  |  |                                  |            |
|                | 1.6 16V          | 79      |       | 04.98 | 09.99 |                |                |  |  |  |                   |        |  |  |                                  |            |
|                | 1.6 e            | 66      |       | 11.96 | 09.99 |                |                |  |  |  |                   |        |  |  |                                  |            |
|                | 1.6 i            | 55      |       | 11.96 | 09.99 |                |                |  |  |  |                   |        |  |  |                                  |            |
|                | 1.9 D            | 47      |       | 11.96 | 09.99 |                |                |  |  |  |                   |        |  |  |                                  |            |
|                | 1.9 dT           | 66      |       | 11.96 | 12.97 |                |                |  |  |  |                   |        |  |  |                                  |            |
|                | 1.9 dTi (F/JAON) | 72      |       | 04.97 | 09.99 |                |                |  |  |  |                   |        |  |  |                                  |            |
|                | 2.0 i            | 84      |       | 11.96 | 09.99 |                |                |  |  |  |                   |        |  |  |                                  |            |
|                | 1.4 i            | 51      |       | 11.96 | 09.99 | 24.3728-1018.2 | 591018         |  |  | L=972  |                   |        |  |  |                                  |            |
|                | 1.6 e            | 66      |       | 11.96 | 09.99 |                |                |  |  |  |                   |        |  |  |                                  |            |
|                | 1.6 i            | 55      |       | 11.96 | 09.99 |                |                |  |  |  |                   |        |  |  |                                  |            |
|                | 1.9 D (FA0J/Y)   | 47      |       | 11.96 | 09.99 |                |                |  |  |  |                   |        |  |  |                                  |            |
|                | 1.9 D (JA0J/Y)   | 47      |       | 11.96 | 09.99 |                |                |  |  |  |                   |        |  |  |                                  |            |
|                | 1.9 dT           | 66      |       | 11.96 | 12.97 |                |                |  |  |  |                   |        |  |  |                                  |            |
|                | 2.0 i            | 84      |       | 11.96 | 09.99 |                |                |  |  |  |                   |        |  |  |                                  |            |
|                | 1.6 16V          | 79      |       | 04.98 | 09.99 | 24.3728-1024.2 | 591024         |  |  | L=973  |                   |        |  |  |                                  |            |
|                | 1.9 dTi (FAON)   | 72      |       | 03.98 | 09.99 |                |                |  |  |  |                   |        |  |  |                                  |            |
|                | 1.9 dTi (JAON)   | 72      |       | 04.97 | 09.99 |                |                |  |  |  |                   |        |  |  |                                  |            |

1) + manual transmission / + scatola cambio velocità / + transmission mécanique / + cambio de velocidad  
2) + autom.transmission / + scatola cambio automatico / + transmission automatique / + cambio automático



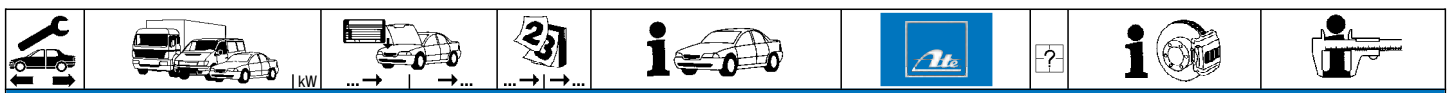















**RENAULT MODUS/GRAND MODUS (JPO\_) (04-13)**

|                 |                 |       |       |       |                |        |   |                |     |
|-----------------|-----------------|-------|-------|-------|----------------|--------|---|----------------|-----|
|                 | 1.2 16V         | 55    | 08.04 | 01.05 | 03.7863-6002.4 | 300249 |   | 10"            | ATE |
|                 | 1.4 16V         | 72    | 08.04 | 01.05 |                |        |   |                |     |
|                 | 1.5 dCi         | 50    | 08.04 | 01.05 |                |        |   |                |     |
|                 | 1.5 dCi         | 60    | 08.04 | 01.05 |                |        |   |                |     |
|                 | 1.5 dCi         | 63    | 08.04 | 01.05 |                |        |   |                |     |
|                 | 1.6 16V         | 65    | 08.04 | 01.05 |                |        |   |                |     |
|                 | 1.6 16V         | 82    | 08.04 | 01.05 |                |        |   |                |     |
|                 | 1.2 16V         | 55    | 12.04 | 06.13 |                |        |   |                |     |
|                 | 1.2 16V         | 74    | 05.07 | 06.13 |                |        |   |                |     |
|                 | 1.4 16V         | 72    | 02.05 | 10.07 |                |        |   |                |     |
|                 | 1.5 dCi         | 48    | 02.05 | 06.13 |                |        |   |                |     |
|                 | 1.5 dCi         | 50    | 02.05 | 06.13 |                |        |   |                |     |
|                 | 1.5 dCi         | 60    | 02.05 | 06.13 |                |        |   |                |     |
|                 | 1.5 dCi         | 63    | 02.05 | 06.13 |                |        |   |                |     |
|                 | 1.2 16V         | 55    | 08.04 | 01.05 | 03.2123-2863.3 | 010790 |   | THz 23,81      | ATE |
|                 | 1.4 16V         | 72    | 08.04 | 01.05 |                |        |   |                |     |
|                 | 1.5 dCi         | 50    | 08.04 | 01.05 |                |        |   |                |     |
|                 | 1.5 dCi         | 60    | 09.04 | 01.05 |                |        |   |                |     |
|                 | 1.5 dCi         | 63    | 08.04 | 01.05 |                |        |   |                |     |
|                 | 1.6 16V         | 65    | 08.04 | 01.05 |                |        |   |                |     |
|                 | 1.6 16V         | 82    | 08.04 | 01.05 |                |        |   |                |     |
|                 | 1.2 16V         | 55    | 08.04 | 01.05 |                |        |   |                |     |
|                 | 1.4 16V         | 72    | 08.04 | 01.05 |                |        |   |                |     |
|                 | 1.5 dCi         | 50    | 08.04 | 01.05 |                |        |   |                |     |
|                 | 1.5 dCi         | 60    | 09.04 | 01.05 |                |        |   |                |     |
|                 | 1.5 dCi         | 63    | 08.04 | 01.05 |                |        |   |                |     |
|                 | 1.6 16V         | 65    | 08.04 | 01.05 |                |        |   |                |     |
|                 | 1.6 16V         | 82    | 08.04 | 01.05 |                |        |   |                |     |
|                 | 1.2             | 58    | 12.04 | 06.13 | 03.2123-3241.3 | 010882 |   | THz 23,81      | ATE |
|                 | 1.2             | 76    | 04.11 | 06.13 |                |        |   |                |     |
|                 | 1.2 16V         | 48    | 05.05 | 06.13 |                |        |   |                |     |
|                 | 1.2 16V         | 55    | 02.05 | 06.13 |                |        |   |                |     |
|                 | 1.2 16V         | 74    | 05.07 | 06.13 |                |        |   |                |     |
|                 | 1.4 16V         | 72    | 02.05 | 06.13 |                |        |   |                |     |
|                 | 1.5 dCi         | 48    | 02.05 | 06.13 |                |        |   |                |     |
|                 | 1.5 dCi         | 50    | 02.05 | 06.13 |                |        |   |                |     |
|                 | 1.5 dCi         | 60    | 02.05 | 06.13 |                |        |   |                |     |
|                 | 1.5 dCi         | 63    | 02.05 | 06.13 |                |        |   |                |     |
|                 | 1.5 dCi         | 76    | 05.07 | 06.13 |                |        |   |                |     |
|                 | 1.5 dCi         | 78    | 05.07 | 06.13 |                |        |   |                |     |
|                 | 1.5 dCi 75      | 55    | 10.10 | 06.13 |                |        |   |                |     |
|                 | 1.5 dCi 90      | 65    | 10.10 | 06.13 |                |        |   |                |     |
|                 | 1.2 16V         | 55    | 08.04 | 06.13 | 03.2123-2821.3 | 010944 |   | THz 23,81      | ATE |
|                 | 1.2 16V         | 74    | 05.07 | 06.13 |                |        |   |                |     |
|                 | 1.2 16V Hi-Flex | 55    | 10.08 | 06.13 |                |        |   |                |     |
|                 | 1.4 16V         | 72    | 08.04 | 06.13 |                |        |   |                |     |
|                 | 1.5 dCi         | 50    | 08.04 | 06.13 |                |        |   |                |     |
|                 | 1.5 dCi         | 60    | 09.05 | 06.13 |                |        |   |                |     |
|                 | 1.5 dCi         | 63    | 08.04 | 06.13 |                |        |   |                |     |
|                 | 1.5 dCi         | 76    | 05.07 | 06.13 |                |        |   |                |     |
|                 | 1.6 16V         | 65    | 08.04 | 06.13 |                |        |   |                |     |
|                 | 1.6 16V         | 82    | 08.04 | 06.13 |                |        |   |                |     |
|                 | 1.2             | 58    | 12.04 | 06.13 |                |        |   |                |     |
|                 | 1.2             | 76    | 04.11 | 06.13 |                |        |   |                |     |
|                 | 1.2 16V         | 48    | 05.05 | 06.13 |                |        |   |                |     |
|                 | 1.2 16V         | 55    | 08.04 | 06.13 |                |        |   |                |     |
| 1.2 16V         | 74              | 05.07 | 06.13 |       |                |        |   |                |     |
| 1.2 16V Hi-Flex | 55              | 10.08 | 06.13 |       |                |        |   |                |     |
| 1.4 16V         | 72              | 08.04 | 06.13 |       |                |        |   |                |     |
| 1.5 dCi         | 48              | 12.04 | 06.13 |       |                |        |   |                |     |
| 1.5 dCi         | 50              | 08.04 | 06.13 |       |                |        |   |                |     |
| 1.5 dCi         | 60              | 09.04 | 06.13 |       |                |        |   |                |     |
| 1.5 dCi         | 63              | 08.04 | 06.13 |       |                |        |   |                |     |
| 1.5 dCi         | 76              | 05.07 | 06.13 |       |                |        |   |                |     |
| 1.5 dCi         | 78              | 05.05 | 06.13 |       |                |        |   |                |     |
| 1.5 dCi 75      | 55              | 10.10 | 06.13 |       |                |        |   |                |     |
| 1.5 dCi 90      | 65              | 10.10 | 06.13 |       |                |        |   |                |     |
| 1.6 16V         | 65              | 08.04 | 06.13 |       |                |        |   |                |     |
| 1.6 16V         | 82              | 08.04 | 06.13 |       |                |        |   |                |     |
|                 | 1.2             | 58    | 12.04 | 06.13 | 24.3541-1823.5 | 240417 |   | D=54, - Halter |     |
|                 | 1.2             | 76    | 04.11 | 06.13 |                |        |   |                |     |
|                 | 1.2 16V         | 48    | 05.05 | 06.13 |                |        |   |                |     |
|                 | 1.2 16V         | 55    | 08.04 | 06.13 |                |        |   |                |     |
|                 | 1.2 16V         | 74    | 05.07 | 06.13 |                |        |   |                |     |
|                 | 1.2 16V Hi-Flex | 55    | 10.08 | 06.13 |                |        |   |                |     |
|                 | 1.4 16V         | 72    | 08.04 | 06.13 |                |        |   |                |     |
|                 | 1.5 dCi         | 48    | 12.04 | 06.13 |                |        |   |                |     |
|                 | 1.5 dCi         | 50    | 08.04 | 06.13 |                |        |   |                |     |
|                 | 1.5 dCi         | 60    | 09.04 | 06.13 |                |        |   |                |     |
|                 | 1.5 dCi         | 63    | 08.04 | 06.13 |                |        |   |                |     |
|                 | 1.5 dCi         | 76    | 05.07 | 06.13 |                |        |   |                |     |
|                 | 1.5 dCi         | 78    | 05.05 | 06.13 |                |        |   |                |     |
|                 | 1.5 dCi 75      | 55    | 10.10 | 06.13 |                |        |   |                |     |
| 1.5 dCi 90      | 65              | 10.10 | 06.13 |       |                |        |   |                |     |
| 1.6 16V         | 65              | 08.04 | 06.13 |       |                |        |   |                |     |
| 1.6 16V         | 82              | 08.04 | 06.13 |       |                |        |   |                |     |
|                 | 1.2             | 58    | 12.04 | 06.13 | 24.5111-0455.3 | 330914 | 2 | L=455          |     |
|                 | 1.2             | 76    | 04.11 | 06.13 |                |        |   |                |     |
|                 | 1.2 16V         | 48    | 05.05 | 06.13 |                |        |   |                |     |
|                 | 1.2 16V         | 55    | 08.04 | 06.13 |                |        |   |                |     |
|                 | 1.2 16V         | 74    | 05.07 | 06.13 |                |        |   |                |     |
|                 | 1.2 16V Hi-Flex | 55    | 10.08 | 06.13 |                |        |   |                |     |
|                 | 1.4 16V         | 72    | 08.04 | 06.13 |                |        |   |                |     |
|                 | 1.5 dCi         | 48    | 12.04 | 06.13 |                |        |   |                |     |
|                 | 1.5 dCi         | 50    | 08.04 | 06.13 |                |        |   |                |     |
|                 | 1.5 dCi         | 60    | 09.04 | 06.13 |                |        |   |                |     |
|                 | 1.5 dCi         | 63    | 08.04 | 06.13 |                |        |   |                |     |
|                 | 1.5 dCi         | 76    | 05.07 | 06.13 |                |        |   |                |     |





|     |    |                                |   |  |  |  |  |  |
|--|--|--|---|--|---|--|--|--|
| <b>RENAULT MODUS/GRAND MODUS (JPO_) (04-13)</b>                                    |  |  |   |  |   |  |  |  |
|    | 1.5 dCi<br>1.5 dCi 75<br>1.5 dCi 90<br>1.6 16V<br>1.6 16V  | 78<br>55<br>65<br>65<br>82   | 05.05 06.13<br>10.10 06.13<br>10.10 06.13<br>08.04 06.13<br>08.04 06.13   |  | 24.5111-0455.3  | 330914   | 2  | L=455  |
|    | 1.2<br>1.2 16V<br>1.2 16V<br>1.2 16V<br>1.2 16V Hi-Flex<br>1.4 16V<br>1.5 dCi<br>1.5 dCi<br>1.5 dCi<br>1.5 dCi<br>1.5 dCi 75<br>1.5 dCi 90<br>1.6 16V<br>1.6 16V   | 76<br>48<br>55<br>74<br>55<br>72<br>50<br>60<br>63<br>76<br>78<br>55<br>65<br>65<br>82                         | 04.11 06.13<br>05.05 06.13 + ESP<br>08.04 06.13 + ESP<br>05.07 06.13 + ESP<br>10.08 06.13 + ESP<br>08.04 06.13<br>08.04 06.13 + ESP<br>09.04 06.13 + ESP<br>08.04 06.13<br>05.07 06.13<br>10.10 06.13<br>10.10 06.13<br>08.04 06.13<br>08.04 06.13  |  | 24.3347-1703.7<br>24.3347-1704.7<br>24.0101-3803.2                                | 220685<br>220686<br>260101   | <input type="checkbox"/><br><input type="checkbox"/>                               | D=34, - Halter<br>D=34, - Halter<br>Einbausatz<br><b>LUC</b><br><b>LUC</b>         |
|    | 1.2<br>1.2 16V<br>1.2 16V<br>1.2 16V<br>1.2 16V Hi-Flex<br>1.4 16V<br>1.5 dCi<br>1.5 dCi<br>1.5 dCi<br>1.5 dCi<br>1.5 dCi 75<br>1.5 dCi 90<br>1.6 16V<br>1.6 16V   | 76<br>48<br>55<br>74<br>55<br>72<br>50<br>60<br>63<br>76<br>78<br>55<br>65<br>65<br>82                         | 04.11 06.13<br>05.05 06.13<br>08.04 06.13<br>05.07 06.13<br>10.08 06.13<br>08.04 06.13<br>08.04 06.13<br>09.04 06.13<br>08.04 06.13<br>05.07 06.13<br>10.10 06.13<br>10.10 06.13<br>08.04 06.13<br>08.04 06.13  |  | 24.5229-0193.3  | 330571   | 2 <input type="checkbox"/>   | L=193  |
|    | 1.2 16V<br>1.2 16V<br>1.2 16V Hi-Flex<br>1.5 dCi<br>1.5 dCi<br>1.5 dCi   | 48<br>55<br>55<br>50<br>60<br>63   | 05.05 06.13 - ESP<br>08.04 06.13 - ESP<br>10.08 06.13 - ESP<br>08.04 06.13 - ESP<br>09.05 06.13 - ESP<br>12.04 06.13 - ESP  |  | 24.3219-1755.3  | 020508   |  | Rz 19,05   |
|  | 1.2 16V<br>1.2 16V<br>1.2 16V Hi-Flex<br>1.4 16V<br>1.5 dCi<br>1.5 dCi<br>1.5 dCi<br>1.6 16V<br>1.6 16V  | 55<br>74<br>55<br>72<br>50<br>60<br>63<br>65<br>82   | 08.04 06.13 - ABS<br>05.07 06.13 - ABS<br>10.08 06.13 - ABS<br>12.04 06.13 - ABS<br>08.04 06.13 - ABS<br>09.05 06.13 - ABS<br>12.04 06.13 - ABS<br>12.04 06.13 - ABS<br>12.04 06.13 - ABS   |  | 24.3727-1085.2<br>24.3727-1086.2  | 581085<br>581086   | <input type="checkbox"/><br><input type="checkbox"/>                               | L=1387<br>L=1497   |
|  | 1.2<br>1.2<br>1.2 16V<br>1.2 16V<br>1.2 16V Hi-Flex<br>1.4 16V<br>1.5 dCi<br>1.5 dCi<br>1.5 dCi<br>1.5 dCi<br>1.5 dCi<br>1.5 dCi 75<br>1.5 dCi 90<br>1.6 16V<br>1.6 16V  | 58<br>76<br>55<br>74<br>55<br>72<br>48<br>50<br>60<br>63<br>76<br>55<br>65<br>65<br>82                         | 12.04 06.13 + ABS<br>04.11 06.13 + ABS<br>08.04 06.13 + ABS<br>05.07 06.13 + ABS<br>10.08 06.13 + ABS<br>08.04 06.13 + ABS<br>12.04 06.13 + ABS<br>09.04 06.13 + ABS<br>08.04 06.13 + ABS<br>05.07 06.13 + ABS<br>05.05 06.13 + ABS<br>10.10 06.13 + ABS<br>10.10 06.13 + ABS<br>08.04 06.13 + ABS<br>08.04 06.13 + ABS   |  | 24.3727-1083.2<br>24.3727-1084.2  | 581083<br>581084   | <input type="checkbox"/><br><input type="checkbox"/>                               | L=1276<br>L=1375   |
| <b>RENAULT R19 (3/5-türig) (B53/C53/S53_) (88-95)</b>                              |  |  |   |  |   |  |  |  |
|  | 1.4 (B535)<br>1.4 (B537/G)<br>1.4 (C/S537)<br>1.4 (C535)<br>1.4 (C53A)<br>1.7 (B533/536)<br>1.7 (B53B)<br>1.7 (B53C)<br>1.7 (B53E/M)<br>1.7 (C533/53M)<br>1.7 (C53B)<br>1.7 (C53C)<br>1.7 (C53E)<br>1.8 (B538)<br>1.8 (B53V/553A-H)<br>1.8 (B53Y)<br>1.8 (C538)<br>1.8 (C53V/353A-F)<br>1.8 (C53Y) | 55<br>59<br>59<br>55<br>59<br>54<br>54<br>66<br>54<br>54<br>54<br>66<br>54<br>66<br>65<br>65<br>66<br>66<br>65 | 09.94 12.95 - ABS/ - Fahrschule 1)<br>09.88 12.95 - Fahrschule 2)<br>09.88 12.95<br>11.94 12.95 - ABS<br>09.90 12.95 - ABS<br>09.88 12.95 - ABS/ - Fahrschule 1)<br>09.88 12.95 - ABS/ - Fahrschule 1)<br>09.88 12.95 - ABS/ - Fahrschule 1)<br>09.88 12.95 - Fahrschule 2)<br>09.88 12.95 - ABS<br>09.88 12.95 - ABS<br>09.88 12.95 - ABS<br>10.91 12.95 - ABS/ - Fahrschule 1)<br>09.94 12.95 - ABS/ - Fahrschule 1)<br>05.92 12.95 - ABS/ - Fahrschule 1)<br>10.91 12.95 - ABS<br>09.94 12.95 - ABS<br>05.92 12.95 - ABS |  | 03.7740-3002.4  | 300068   |  | 8" <b>ATE</b>  |

1) - ABS/ - driving school / - ABS/ - scuola guida / - ABS/ - auto-école / - ABS/ - autoescuela  
2) - driving school / - scuola guida / - auto école / - autoescuela



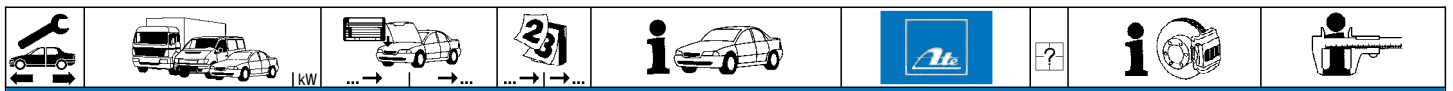

**RENAULT R19 (3/5-türig) (B53/C53/S53\_) (88-95)**

|                   |                  |              |       |  |                                       |                |        |                          |                |     |       |                |        |  |           |     |
|-------------------|------------------|--------------|-------|--|---------------------------------------|----------------|--------|--------------------------|----------------|-----|-------|----------------|--------|--|-----------|-----|
|                   | 1.9 D (B534/I/J) | 47           | 09.88 | 12.95                                    | - ABS/ - Fahrschule <sup>1)</sup>     | 03.7740-3002.4 | 300068 |                          | 8"             | ATE |       |                |        |  |           |     |
|                   | 1.9 D (B53Z)     | 47           | 05.92 | 12.95                                    | - Fahrschule <sup>2)</sup>            |                |        |                          |                |     |       |                |        |  |           |     |
|                   | 1.9 D (C534/I/J) | 47           | 09.88 | 12.95                                    | - ABS                                 |                |        |                          |                |     |       |                |        |  |           |     |
|                   | 1.9 D (C53Z)     | 47           | 05.92 | 12.95                                    |                                       |                |        |                          |                |     |       |                |        |  |           |     |
|                   | 1.9 D (S534)     | 47           | 09.88 | 12.95                                    |                                       |                |        |                          |                |     |       |                |        |  |           |     |
|                   | 1.9 dT (B53K)    | 66           | 09.90 | 12.95                                    | - ABS/ - Fahrschule <sup>1)</sup>     |                |        |                          |                |     |       |                |        |  |           |     |
|                   | 1.9 dT (C53K)    | 66           | 10.91 | 12.95                                    | - ABS                                 |                |        |                          |                |     |       |                |        |  |           |     |
|                   | 1.9 dT (S53K)    | 66           | 04.91 | 12.95                                    |                                       |                |        |                          |                |     |       |                |        |  |           |     |
|                   | 1.2              | 40           | 09.88 | 01.92                                    |                                       | 03.2119-3389.3 | 010057 |                          | Thz 19,05      | ATE |       |                |        |  |           |     |
|                   | 1.4              | 43           | 09.88 | 01.92                                    |                                       |                |        |                          |                |     |       |                |        |  |           |     |
|                   | 1.4 (B/C/S537)   | 59           | 09.88 | 01.92                                    |                                       |                |        |                          |                |     |       |                |        |  |           |     |
|                   | 1.4 (B/C53A)     | 59           | 09.90 | 01.92                                    | - ABS                                 |                |        |                          |                |     |       |                |        |  |           |     |
|                   | 1.4 (B537)       | 59           | 02.92 | 12.95                                    | + Fahrschule <sup>3)</sup>            |                |        |                          |                |     |       |                |        |  |           |     |
|                   | 1.4 (B53A)       | 59           | 02.92 | 12.95                                    | - ABS/ + Fahrschule <sup>4)</sup>     |                |        |                          |                |     |       |                |        |  |           |     |
|                   | 1.4 (B53H)       | 59           | 06.89 | 12.95                                    |                                       |                |        |                          |                |     |       |                |        |  |           |     |
|                   | 1.7              | 66           | 02.92 | 12.95                                    | - ABS/ + Fahrschule <sup>4)</sup>     |                |        |                          |                |     |       |                |        |  |           |     |
|                   | 1.7              | 66           | 09.88 | 01.92                                    | - ABS                                 |                |        |                          |                |     |       |                |        |  |           |     |
|                   | 1.7 (B/C533)     | 54           | 09.88 | 01.92                                    | - ABS                                 |                |        |                          |                |     |       |                |        |  |           |     |
|                   | 1.7 (B533)       | 54           | 02.92 | 12.95                                    | - ABS/ + Fahrschule <sup>4)</sup>     |                |        |                          |                |     |       |                |        |  |           |     |
|                   | 1.7 (B536/E)     | 54           | 09.88 | 12.95                                    |                                       |                |        |                          |                |     |       |                |        |  |           |     |
|                   | 1.7 (B53M)       | 54           | 09.88 | 12.95                                    | - ABS                                 |                |        |                          |                |     |       |                |        |  |           |     |
|                   | 1.9 D (B/C534/J) | 47           | 09.88 | 01.92                                    | - ABS                                 |                |        |                          |                |     |       |                |        |  |           |     |
|                   | 1.9 D (S534/J)   | 47           | 09.88 | 01.92                                    |                                       |                |        |                          |                |     |       |                |        |  |           |     |
|                   | 1.9 dT (B/C53K)  | 66           | 09.90 | 01.92                                    | - ABS                                 |                |        |                          |                |     |       |                |        |  |           |     |
|                   | 1.9 dT (B53K)    | 66           | 02.92 | 12.95                                    | - ABS/ + Fahrschule <sup>4)</sup>     |                |        |                          |                |     |       |                |        |  |           |     |
|                   | 1.9 dT (S53K)    | 66           | 04.91 | 01.92                                    |                                       |                |        |                          |                |     |       |                |        |  |           |     |
|                   |                  | 1.2          | 40    | 02.92                                    | 12.95                                 |                |        |                          |                |     |       | 03.2120-2031.3 | 010106 |  | Thz 20,64 | ATE |
|                   |                  | 1.4          | 43    | 02.92                                    | 12.95                                 |                |        |                          |                |     |       |                |        |  |           |     |
|                   |                  | 1.4 (B/C535) | 55    | 09.94                                    | 12.95                                 |                |        |                          |                |     | - ABS |                |        |  |           |     |
| 1.4 (B537)        |                  | 59           | 02.92 | 12.95                                    | - Fahrschule <sup>2)</sup>            |                |        |                          |                |     |       |                |        |  |           |     |
| 1.4 (B53A)        |                  | 59           | 02.92 | 12.95                                    | - ABS/ - Fahrschule <sup>1)</sup>     |                |        |                          |                |     |       |                |        |  |           |     |
| 1.4 (B53G)        |                  | 59           | 05.92 | 12.95                                    |                                       |                |        |                          |                |     |       |                |        |  |           |     |
| 1.4 (C/S537)      |                  | 59           | 02.92 | 12.95                                    |                                       |                |        |                          |                |     |       |                |        |  |           |     |
| 1.4 (C53A)        |                  | 59           | 02.92 | 12.95                                    | - ABS                                 |                |        |                          |                |     |       |                |        |  |           |     |
| 1.7 (B533)        |                  | 54           | 02.92 | 12.95                                    | - ABS/ - Fahrschule <sup>1)</sup>     |                |        |                          |                |     |       |                |        |  |           |     |
| 1.7 (B53B)        |                  | 54           | 02.92 | 12.95                                    | - ABS/ - Fahrschule <sup>1)</sup>     |                |        |                          |                |     |       |                |        |  |           |     |
| 1.7 (B53C/F)      |                  | 54           | 02.92 | 12.95                                    | - ABS/ - Fahrschule <sup>1)</sup>     |                |        |                          |                |     |       |                |        |  |           |     |
| 1.7 (C533)        |                  | 54           | 02.92 | 12.95                                    | - ABS                                 |                |        |                          |                |     |       |                |        |  |           |     |
| 1.7 (C53B)        |                  | 54           | 02.92 | 12.95                                    | - ABS                                 |                |        |                          |                |     |       |                |        |  |           |     |
| 1.7 (C53C/F)      |                  | 54           | 02.92 | 12.95                                    | - ABS                                 |                |        |                          |                |     |       |                |        |  |           |     |
| 1.8               |                  | 65           | 05.92 | 12.95                                    | - ABS                                 |                |        |                          |                |     |       |                |        |  |           |     |
| 1.8 (B/C53V/553H) |                  | 66           | 09.94 | 12.95                                    |                                       |                |        |                          |                |     |       |                |        |  |           |     |
| 1.8 (B553A/C/D/F) |                  | 66           | 09.94 | 12.95                                    | - ABS                                 |                |        |                          |                |     |       |                |        |  |           |     |
| 1.8 (C53A/C/D/F)  |                  | 66           | 09.94 | 12.95                                    | - ABS                                 |                |        |                          |                |     |       |                |        |  |           |     |
| 1.8 16V           |                  | 99           | 09.88 | 12.95                                    | - ABS                                 |                |        |                          |                |     |       |                |        |  |           |     |
| 1.9 D (B/C53I)    |                  | 47           | 05.92 | 12.95                                    | - ABS                                 |                |        |                          |                |     |       |                |        |  |           |     |
| 1.9 D (B534/J)    |                  | 47           | 02.92 | 12.95                                    | - ABS/ - Fahrschule <sup>1)</sup>     |                |        |                          |                |     |       |                |        |  |           |     |
| 1.9 D (C534/J)    | 47               | 02.92        | 12.95 |  |                                       |                |        |                          |                |     |       |                |        |  |           |     |
| 1.9 D (C534/J)    | 47               | 02.92        | 12.95 | - ABS                                    |                                       |                |        |                          |                |     |       |                |        |  |           |     |
| 1.9 D (S53I)      | 47               | 05.92        | 12.95 |  |                                       |                |        |                          |                |     |       |                |        |  |           |     |
| 1.9 dT (B/C53T)   | 66               | 05.92        | 12.95 |  |                                       |                |        |                          |                |     |       |                |        |  |           |     |
| 1.9 dT (B53K)     | 66               | 02.92        | 12.95 | - ABS/ - Fahrschule <sup>1)</sup>        |                                       |                |        |                          |                |     |       |                |        |  |           |     |
| 1.9 dT (C53K)     | 66               | 02.92        | 12.95 | - ABS                                    |                                       |                |        |                          |                |     |       |                |        |  |           |     |
| 1.9 dT (S53K)     | 66               | 02.92        | 12.95 |  |                                       |                |        |                          |                |     |       |                |        |  |           |     |
|                   | 1.4              | 55           | 09.94 | 12.95                                    | + ABS/ + Schaltgetriebe <sup>5)</sup> | 24.2120-1725.3 | 010579 |                          | Thz 20,64      | BDX |       |                |        |  |           |     |
|                   | 1.7              | 54           | 09.88 | 12.95                                    | + ABS/ + Schaltgetriebe <sup>5)</sup> |                |        |                          |                |     |       |                |        |  |           |     |
|                   | 1.7              | 66           | 09.88 | 12.95                                    | + ABS/ + Schaltgetriebe <sup>5)</sup> |                |        |                          |                |     |       |                |        |  |           |     |
|                   | 1.8              | 65           | 05.92 | 12.95                                    | + ABS/ + Schaltgetriebe <sup>5)</sup> |                |        |                          |                |     |       |                |        |  |           |     |
|                   | 1.8              | 66           | 09.94 | 12.95                                    | + ABS/ + Schaltgetriebe <sup>5)</sup> |                |        |                          |                |     |       |                |        |  |           |     |
|                   | 1.8              | 81           | 10.91 | 12.95                                    | + ABS/ + Schaltgetriebe <sup>5)</sup> |                |        |                          |                |     |       |                |        |  |           |     |
|                   | 1.8 16V (B/C539) | 99           | 09.88 | 12.95                                    | + ABS/ + Schaltgetriebe <sup>5)</sup> |                |        |                          |                |     |       |                |        |  |           |     |
|                   | 1.8 16V (B/C53D) | 99           | 06.89 | 12.95                                    | + ABS/ + Schaltgetriebe <sup>5)</sup> |                |        |                          |                |     |       |                |        |  |           |     |
|                   | 1.9 D (B/C534/J) | 47           | 09.88 | 12.95                                    | + ABS/ + Schaltgetriebe <sup>5)</sup> |                |        |                          |                |     |       |                |        |  |           |     |
|                   | 1.9 dT           | 66           | 10.95 | 12.95                                    | + ABS/ + Schaltgetriebe <sup>5)</sup> |                |        |                          |                |     |       |                |        |  |           |     |
|                   | 1.9 dT (B/C53T)  | 66           | 10.95 | 12.95                                    | + ABS/ + Schaltgetriebe <sup>5)</sup> |                |        |                          |                |     |       |                |        |  |           |     |
|                   | 1.2              | 40           | 09.88 | 12.95                                    |                                       | 24.3481-1505.5 | 240047 | <input type="checkbox"/> | D=48, - Halter | BDX |       |                |        |  |           |     |
|                   | 1.4              | 43           | 09.88 | 12.95                                    |                                       |                |        |                          |                |     |       |                |        |  |           |     |
|                   | 1.4 (B/C535)     | 55           | 09.94 | 12.95                                    |                                       |                |        |                          |                |     |       |                |        |  |           |     |
|                   | 1.7 (B/C536/E)   | 47           | 09.88 | 12.95                                    |                                       |                |        |                          |                |     |       |                |        |  |           |     |
|                   | 1.9 D (B/C/S53I) | 47           | 05.92 | 12.95                                    |                                       |                |        |                          |                |     |       |                |        |  |           |     |
|                   | 1.9 D (B/C534/J) | 47           | 10.91 | 12.95                                    | + ABS                                 |                |        |                          |                |     |       |                |        |  |           |     |
|                   | 1.9 D (B/C534/J) | 47           | 09.88 | 12.95                                    | - ABS                                 |                |        |                          |                |     |       |                |        |  |           |     |
|                   | 1.9 D (S534/J)   | 47           | 09.88 | 12.95                                    |                                       |                |        |                          |                |     |       |                |        |  |           |     |
|                   | 1.4 (B/C53A)     | 59           | 09.90 | 12.95                                    |                                       |                |        |                          |                |     |       |                |        |  |           |     |
|                   | 1.7 (B/C53B)     | 54           | 09.88 | 12.95                                    |                                       |                |        |                          |                |     |       |                |        |  |           |     |
|                   | 1.4 (B/C53A)     | 59           | 09.90 | 12.95                                    |                                       |                |        |                          |                |     |       |                |        |  |           |     |
| 1.4 (B/C53A)      | 59               | 09.90        | 12.94 | + ABS                                    |                                       |                |        |                          |                |     |       |                |        |  |           |     |
| 1.4 (B/C53A)      | 59               | 09.90        | 12.95 | - ABS                                    |                                       |                |        |                          |                |     |       |                |        |  |           |     |
| 1.7 (B/C53B)      | 54               | 09.88        | 12.95 | + Schaltgetriebe <sup>6)</sup>           |                                       |                |        |                          |                |     |       |                |        |  |           |     |
| 1.7 (B/C53B)      | 54               | 09.88        | 12.94 | + ABS/ + Automatikgetriebe <sup>7)</sup> |                                       |                |        |                          |                |     |       |                |        |  |           |     |
| 1.7 (B/C53B)      | 54               | 09.88        | 12.95 | - ABS                                    |                                       |                |        |                          |                |     |       |                |        |  |           |     |
| 1.7 (B/C53M)      | 54               | 09.88        | 12.95 |  |                                       |                |        |                          |                |     |       |                |        |  |           |     |
| 1.4 (B/C53A)      | 59               | 01.95        | 12.95 | + ABS/ + Automatikgetriebe <sup>7)</sup> |                                       |                |        |                          |                |     |       |                |        |  |           |     |
| 1.7 (B/C533)      | 54               | 09.88        | 12.95 |  |                                       |                |        |                          |                |     |       |                |        |  |           |     |
| 1.7 (B/C53B)      | 54               | 01.95        | 12.95 | + ABS/ + Automatikgetriebe <sup>7)</sup> |                                       |                |        |                          |                |     |       |                |        |  |           |     |

1) - ABS/ - driving school / - ABS/ - scuola guida / - ABS/ - auto-école / - ABS/ - autoescuela  
 2) - driving school / - scuola guida / - auto école / - autoescuela  
 3) + driving school / + scuola guida / + auto école / + autoescuela  
 4) - ABS/ + driving school / - ABS/ + scuola guida / - ABS/ + auto école / - ABS/ + autoescuela  
 5) + ABS/ + manual transm. / + ABS/ + scatola camb.velocità / + ABS/ + transmission mécanique / + ABS/ + cambio de velocidad  
 6) + manual transmission / + scatola cambio velocità / + transmission mécanique / + cambio de velocidad  
 7) + ABS/ + autom.transmission / + ABS/ + scatola cambio autom. / + ABS/ + transmission automatique / + ABS/ + cambio automático



| RENAULT R19 (3/5-türig) (B53/C53/S53_) (88-95) |                  | KW    |             | 23             |                | i              |       | Atc |           | ?   |           | i   |  | i |  |  |                   |
|--|------------------|-------|-------------|----------------|----------------|----------------|-------|-----|-----------|-----|-----------|-----|--|---|--|--|-------------------|
|  | 1.7 (B/C53C/F)   | 65    | 09.88       | 12.95          | 24.3481-1615.5 | 240031         | ☐     |     |           |     |           |     |  |   |  | D=48, - Halter<br>D=48, - Halter<br>Einbausatz | LUC<br>LUC<br>LUC |
|  | 1.8              | 66    | 05.92       | 12.95          | 24.3481-1616.5 | 240032         |       |     |           |     |           |     |  |   |  |  |                   |
|  | 1.8              | 66    | 09.94       | 12.95          | 24.0101-4806.2 | 260052         |       |     |           |     |           |     |  |   |  |  |                   |
|  | 1.8              | 81    | 10.91       | 12.95          |                |                |       |     |           |     |           |     |  |   |  |  |                   |
|  | 1.8 16V          | 99    | 09.88       | 12.95          |                |                |       |     |           |     |           |     |  |   |  |  |                   |
|  | 1.9 D (B/C534/J) | 47    | 09.88       | 09.91 + ABS    |                |                |       |     |           |     |           |     |  |   |  |  |                   |
|  | 1.9 dT           | 66    | 09.90       | 12.95          |                |                |       |     |           |     |           |     |  |   |  |  |                   |
|  | 1.9 dT (B/C53T)  | 66    | 05.92       | 12.95          |                |                |       |     |           |     |           |     |  |   |  |  |                   |
|  | 1.2              | 40    | 09.88       | 12.95          | 24.5111-0280.3 | 330389         | 2     |     |           |     |           |     |  |   |  | L=280  |                   |
|  | 1.4              | 43    | 09.88       | 12.95          |                |                |       |     |           |     |           |     |  |   |  |  |                   |
|  | 1.4 (B/C535)     | 55    | 09.90       | 12.95          |                |                |       |     |           |     |           |     |  |   |  |  |                   |
|  | 1.7              | 54    | 09.88       | 12.95          |                |                |       |     |           |     |           |     |  |   |  |  |                   |
|  | 1.7              | 66    | 09.88       | 12.95          |                |                |       |     |           |     |           |     |  |   |  |  |                   |
|  | 1.8              | 65    | 05.92       | 12.95          |                |                |       |     |           |     |           |     |  |   |  |  |                   |
|  | 1.8              | 66    | 09.94       | 12.95          |                |                |       |     |           |     |           |     |  |   |  |  |                   |
|  | 1.8              | 81    | 10.91       | 12.95          |                |                |       |     |           |     |           |     |  |   |  |  |                   |
|  | 1.8 16V          | 99    | 09.88       | 12.95          |                |                |       |     |           |     |           |     |  |   |  |  |                   |
|  | 1.9 D            | 47    | 09.88       | 12.95          |                |                |       |     |           |     |           |     |  |   |  |  |                   |
|  | 1.9 dT           | 66    | 09.90       | 12.95          |                |                |       |     |           |     |           |     |  |   |  |  |                   |
|  |                  | 1.2   | 40          | 09.88          | 12.95          | 24.5229-0240.3 |       |     |           |     |           |     |  |   |  |  | 330400            |
| 1.4  |                  | 43    | 09.88       | 12.95          | 24.5229-0255.3 | 330581         | L=255 |     |           |     |           |     |  |   |  |  |                   |
| 1.4  |                  | 55    | 09.90       | 12.95 - ABS    |                |                |       |     |           |     |           |     |  |   |  |  |                   |
| 1.7  |                  | 54    | 09.88       | 12.95 - ABS    |                |                |       |     |           |     |           |     |  |   |  |  |                   |
| 1.7  |                  | 66    | 09.88       | 12.95 - ABS    |                |                |       |     |           |     |           |     |  |   |  |  |                   |
| 1.8  |                  | 65    | 05.92       | 12.95 - ABS    |                |                |       |     |           |     |           |     |  |   |  |  |                   |
| 1.8  |                  | 66    | 09.94       | 12.95 - ABS    |                |                |       |     |           |     |           |     |  |   |  |  |                   |
| 1.8  |                  | 81    | 10.91       | 12.95 - ABS    |                |                |       |     |           |     |           |     |  |   |  |  |                   |
| 1.8 16V  |                  | 99    | 09.88       | 12.95 - ABS    |                |                |       |     |           |     |           |     |  |   |  |  |                   |
| 1.9 D  |                  | 47    | 09.88       | 12.95 - ABS    |                |                |       |     |           |     |           |     |  |   |  |  |                   |
| 1.9 dT   |                  | 66    | 09.90       | 12.95 - ABS    |                |                |       |     |           |     |           |     |  |   |  |  |                   |
| 1.4  |                  | 55    | 09.90       | 12.95 + ABS    | 24.5229-0220.3 | 330399         | L=220 |     |           |     |           |     |  |   |  |  |                   |
| 1.7  |                  | 54    | 09.88       | 12.95 + ABS    |                |                |       |     |           |     |           |     |  |   |  |  |                   |
| 1.7  |                  | 66    | 09.88       | 12.95 + ABS    |                |                |       |     |           |     |           |     |  |   |  |  |                   |
| 1.8  |                  | 65    | 05.92       | 12.95 + ABS    |                |                |       |     |           |     |           |     |  |   |  |  |                   |
| 1.8  |                  | 66    | 09.94       | 12.95 + ABS    |                |                |       |     |           |     |           |     |  |   |  |  |                   |
| 1.8  |                  | 81    | 10.91       | 12.95 + ABS    |                |                |       |     |           |     |           |     |  |   |  |  |                   |
| 1.8 16V  |                  | 99    | 09.88       | 12.95 + ABS    |                |                |       |     |           |     |           |     |  |   |  |  |                   |
| 1.9 D  | 47               | 09.88 | 12.95 + ABS |                |                |                |       |     |           |     |           |     |  |   |  |  |                   |
| 1.9 dT   | 66               | 04.91 | 12.95 + ABS |                |                |                |       |     |           |     |           |     |  |   |  |  |                   |
|  | 1.2              | 40    | 09.88       | 04.91          | 24.3220-1618.3 | 020245         | ☐     |     | RzR 20,64 | BDX |           |     |  |   |  |  |                   |
|  | 1.4              | 43    | 09.88       | 04.91          | 24.3220-1617.3 | 020244         |       |     |           |     | RzR 20,64 |     |  |   |  |  |                   |
|  | 1.4              | 59    | 09.90       | 04.91 - ABS    |                |                |       |     |           |     |           |     |  |   |  |  |                   |
|  | 1.7 (B/C533/536) | 54    | 09.88       | 04.91 - ABS    |                |                |       |     |           |     |           |     |  |   |  |  |                   |
|  | 1.7 (B/C53C/F)   | 54    | 09.88       | 04.91 - ABS    |                |                |       |     |           |     |           |     |  |   |  |  |                   |
|  | 1.7 (B/C53E/M)   | 54    | 09.88       | 12.95          |                |                |       |     |           |     |           |     |  |   |  |  |                   |
|  | 1.9 D (B/C534/J) | 47    | 09.88       | 04.91 - ABS    |                |                |       |     |           |     |           |     |  |   |  |  |                   |
|  | 1.9 D (S534)     | 47    | 09.88       | 04.91          |                |                |       |     |           |     |           |     |  |   |  |  |                   |
|  | 1.9 dT (B/-53K)  | 66    | 09.90       | 04.91 - ABS    |                |                |       |     |           |     |           |     |  |   |  |  |                   |
|  | 1.2              | 40    | 05.91       | 12.95          | 24.3220-1617.3 | 020244         |       |     |           |     | RzR 20,64 | BDX |  |   |  |  |                   |
|  | 1.4              | 43    | 05.91       | 12.95          | 24.3220-1618.3 | 020245         |       |     |           |     | RzR 20,64 | BDX |  |   |  |  |                   |
|  | 1.4              | 59    | 05.91       | 12.95 - ABS    |                |                |       |     |           |     |           |     |  |   |  |  |                   |
|  | 1.7 (B/C533/536) | 54    | 05.91       | 12.95 - ABS    |                |                |       |     |           |     |           |     |  |   |  |  |                   |
|  | 1.7 (B/C53C/F)   | 54    | 05.91       | 12.95 - ABS    |                |                |       |     |           |     |           |     |  |   |  |  |                   |
|  | 1.9 D (B/C534/J) | 47    | 05.91       | 12.95 - ABS    |                |                |       |     |           |     |           |     |  |   |  |  |                   |
|  | 1.9 D (S534/J)   | 47    | 05.91       | 12.95          |                |                |       |     |           |     |           |     |  |   |  |  |                   |
|  | 1.9 dT (B/-53K)  | 66    | 05.91       | 04.92 - ABS    |                |                |       |     |           |     |           |     |  |   |  |  |                   |
|  | 1.9 dT (S53K)    | 66    | 05.91       | 12.95          |                |                |       |     |           |     |           |     |  |   |  |  |                   |
| 1.2  | 40               | 05.92 | 12.95       | 24.3220-1617.3 | 020244         | RzR 20,64      | BDX   |     |           |     |           |     |  |   |  |  |                   |
| 1.4  | 59               | 09.94 | 12.95 - ABS | 24.3220-1618.3 | 020245         | RzR 20,64      | BDX   |     |           |     |           |     |  |   |  |  |                   |
| 1.4 (B/C535)                                   | 55               | 09.94 | 12.95 - ABS | 24.3220-1615.3 | 020242         | RzR 20,64      | LUC   |     |           |     |           |     |  |   |  |  |                   |
| 1.8 (353/535/A/F)                              | 66               | 09.94 | 12.95 - ABS | 24.3220-1616.3 | 020243         | RzR 20,64      | LUC   |     |           |     |           |     |  |   |  |  |                   |
| 1.8 (B/C53V)                                   | 66               | 09.94 | 12.95 - ABS |                |                |                |       |     |           |     |           |     |  |   |  |  |                   |
| 1.8 (B/C53Y)                                   | 65               | 05.92 | 12.95 - ABS |                |                |                |       |     |           |     |           |     |  |   |  |  |                   |
| 1.9 D (B/C53I)                                 | 47               | 05.92 | 12.95 - ABS |                |                |                |       |     |           |     |           |     |  |   |  |  |                   |
| 1.9 D (S53I)                                   | 47               | 05.92 | 12.95       |                |                |                |       |     |           |     |           |     |  |   |  |  |                   |
| 1.9 dT (-/C53K)                                | 66               | 10.91 | 04.92 - ABS |                |                |                |       |     |           |     |           |     |  |   |  |  |                   |
| 1.2  | 40               | 09.88 | 12.95       | 24.3220-1615.3 | 020242         | RzR 20,64      | LUC   |     |           |     |           |     |  |   |  |  |                   |
| 1.4 (B/C532)                                   | 43               | 09.88 | 12.95       | 24.3220-1616.3 | 020243         | RzR 20,64      | LUC   |     |           |     |           |     |  |   |  |  |                   |
| 1.7 (B/C533)                                   | 54               | 09.88 | 12.95 - ABS |                |                |                |       |     |           |     |           |     |  |   |  |  |                   |
| 1.7 (B/C53C/F)                                 | 54               | 09.88 | 12.95 - ABS |                |                |                |       |     |           |     |           |     |  |   |  |  |                   |
| 1.7 (B536)                                     | 54               | 09.88 | 12.95       |                |                |                |       |     |           |     |           |     |  |   |  |  |                   |
| 1.9 D (B/C534/J)                               | 47               | 09.88 | 12.95 - ABS |                |                |                |       |     |           |     |           |     |  |   |  |  |                   |
| 1.9 D (S534/J)                                 | 47               | 09.88 | 12.95       |                |                |                |       |     |           |     |           |     |  |   |  |  |                   |
| 1.9 dT (B/C53K)                                | 66               | 09.90 | 04.92 - ABS |                |                |                |       |     |           |     |           |     |  |   |  |  |                   |
| 1.7 (B/C53F)                                   | 66               | 09.90 | 12.95 - ABS | 24.3219-1116.3 | 020195         | Rz 19,05       | BDX   |     |           |     |           |     |  |   |  |  |                   |
| 1.8 (353C/D)                                   | 66               | 09.94 | 12.95 - ABS | 24.3219-1117.3 | 020196         | Rz 19,05       | BDX   |     |           |     |           |     |  |   |  |  |                   |
| 1.8 (553C/D/H)                                 | 66               | 09.94 | 12.95 - ABS |                |                |                |       |     |           |     |           |     |  |   |  |  |                   |
| 1.8 (B/C538)                                   | 66               | 10.91 | 12.95 - ABS |                |                |                |       |     |           |     |           |     |  |   |  |  |                   |
| 1.9 dT (B/C53K)                                | 66               | 05.92 | 12.95 - ABS |                |                |                |       |     |           |     |           |     |  |   |  |  |                   |
| 1.9 dT (B/C53T)                                | 66               | 05.92 | 12.95 - ABS |                |                |                |       |     |           |     |           |     |  |   |  |  |                   |
|  | 1.2              | 40    | 09.88       | 12.95          | 24.3727-1012.2 | 581012         | 2     | ↓   |           |     |           |     |  |   |  | L=1564   |                   |
|  | 1.4              | 43    | 09.88       | 12.95          |                |                |       |     |           |     |           |     |  |   |  |  |                   |
|  | 1.4              | 59    | 09.90       | 12.95 - ABS    |                |                |       |     |           |     |           |     |  |   |  |  |                   |
|  | 1.4 (B/C535)     | 55    | 09.90       | 12.95 - ABS    |                |                |       |     |           |     |           |     |  |   |  |  |                   |
|  | 1.7              | 54    | 09.88       | 12.95 - ABS    |                |                |       |     |           |     |           |     |  |   |  |  |                   |
|  | 1.7              | 66    | 09.88       | 12.95 - ABS    |                |                |       |     |           |     |           |     |  |   |  |  |                   |

<sup>1)</sup> notice length / attenzione lunghezza / faire attention longueur / atención largo

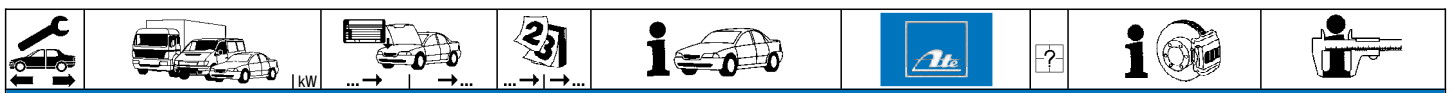

**RENAULT R19 (3/5-türig) (B53/C53/S53\_) (88-95)**

|                 |                 |       |       |       |       |                |        |     |                |         |        |  |              |
|-----------------|-----------------|-------|-------|-------|-------|----------------|--------|-----|----------------|---------|--------|--|--------------|
|                 | 1.8             | 65    | 05.92 | 12.95 | - ABS | 24.3727-1012.2 | 581012 | 2 ↓ | L=1564         |         |        |  |              |
|                 | 1.8             | 66    | 09.94 | 12.95 | - ABS |                |        |     |                |         |        |  |              |
|                 | 1.8             | 81    | 10.91 | 12.95 | - ABS |                |        |     |                |         |        |  |              |
|                 | 1.9 D           | 47    | 09.88 | 12.95 | - ABS |                |        |     |                |         |        |  |              |
|                 | 1.9 dT          | 66    | 09.90 | 12.95 | - ABS |                |        |     |                |         |        |  |              |
|                 | 1.4 (B/C535)    | 55    | 09.90 | 12.95 | + ABS | 24.3727-1011.2 | 581011 | 2 ↓ |                | L=1564  |        |  |              |
|                 | 1.7             | 54    | 09.88 | 12.95 | + ABS |                |        |     |                |         |        |  |              |
|                 | 1.7             | 66    | 09.88 | 12.95 | + ABS |                |        |     |                |         |        |  |              |
|                 | 1.8             | 65    | 05.92 | 12.95 | + ABS |                |        |     |                |         |        |  |              |
|                 | 1.8             | 66    | 09.94 | 12.95 | + ABS |                |        |     |                |         |        |  |              |
| 1.8             | 81              | 10.91 | 12.95 | + ABS |       |                |        |     |                |         |        |  |              |
| 1.8 16V         | 99              | 09.88 | 12.95 | + ABS |       |                |        |     |                |         |        |  |              |
| 1.9 D           | 47              | 09.88 | 12.95 | + ABS |       |                |        |     |                |         |        |  |              |
| 1.9 dT          | 66              | 09.90 | 12.95 | + ABS |       |                |        |     |                |         |        |  |              |
|                 | 1.7 (B/C53F)    |       | 06.89 | 11.94 | - ABS |                |        |     | 24.6583-1742.3 |         | 320183 |  | BRL (4) lila |
|                 | 1.8 (353C/D)    |       | 09.94 | 11.94 | - ABS |                |        |     |                |         |        |  |              |
|                 | 1.8 (553C/D/H)  |       | 09.94 | 11.94 | - ABS |                |        |     |                |         |        |  |              |
|                 | 1.8 (B/C538)    |       | 10.91 | 11.94 | - ABS |                |        |     |                |         |        |  |              |
|                 | 1.9 dT (B/C53K) | 66    | 09.90 | 11.94 | - ABS |                |        |     |                |         |        |  |              |
|                 | 1.9 dT (B/C53T) | 66    | 05.92 | 11.94 | - ABS |                |        |     |                |         |        |  |              |
|                 | 1.9 dT (S53K)   | 66    | 04.92 | 11.94 |       |                |        |     |                |         |        |  |              |
|                 | 1.7 (B/C53F)    |       | 12.94 | 12.95 | - ABS | 24.6583-1710.3 | 320166 |     |                | BRL (4) |        |  |              |
|                 | 1.8 (353C/D)    |       | 12.94 | 12.95 | - ABS |                |        |     |                |         |        |  |              |
|                 | 1.8 (553C/D/H)  |       | 12.94 | 12.95 | - ABS |                |        |     |                |         |        |  |              |
| 1.8 (B/C538)    |                 | 12.94 | 12.95 | - ABS |       |                |        |     |                |         |        |  |              |
| 1.9 D (B/C53Z)  | 47              | 09.94 | 12.95 | - ABS |       |                |        |     |                |         |        |  |              |
| 1.9 dT (B/C53K) | 66              | 12.94 | 12.95 | - ABS |       |                |        |     |                |         |        |  |              |
| 1.9 dT (B/C53T) | 66              | 12.94 | 12.95 | - ABS |       |                |        |     |                |         |        |  |              |
| 1.9 dT (S53K)   | 66              | 12.94 | 12.95 |       |       |                |        |     |                |         |        |  |              |
|                 | 1.2             | 40    | 09.88 | 12.95 |       |                |        |     | 24.3728-1005.2 |         | 591005 |  | L=1010       |
|                 | 1.4             | 43    | 09.88 | 12.95 |       |                |        |     |                |         |        |  |              |
|                 | 1.4             | 55    | 09.90 | 12.95 |       |                |        |     |                |         |        |  |              |
|                 | 1.4             | 59    | 09.90 | 12.95 |       |                |        |     |                |         |        |  |              |
|                 | 1.7             | 54    | 09.88 | 12.95 |       |                |        |     |                |         |        |  |              |
|                 | 1.7             | 66    | 09.88 | 12.95 |       |                |        |     |                |         |        |  |              |
|                 | 1.8             | 65    | 05.92 | 12.95 |       |                |        |     |                |         |        |  |              |
|                 | 1.8             | 66    | 09.94 | 12.95 |       |                |        |     |                |         |        |  |              |
|                 | 1.8             | 81    | 10.91 | 12.95 |       |                |        |     |                |         |        |  |              |
|                 | 1.8 16V         | 99    | 09.88 | 12.95 |       |                |        |     |                |         |        |  |              |
|                 | 1.9 D           | 47    | 09.88 | 12.95 |       |                |        |     |                |         |        |  |              |
|                 | 1.9 dT          | 66    | 09.90 | 12.95 |       |                |        |     |                |         |        |  |              |

**RENAULT R19 CHAMADE (L53\_) (89-95)**

|               |                    |       |       |                        |                        |                |        |  |           |     |
|---------------|--------------------|-------|-------|------------------------|------------------------|----------------|--------|--|-----------|-----|
|               | 1.4                | 40    | 05.89 | 12.95                  | - ABS/ - Fahrschule 1) | 03.7740-3002.4 | 300068 |  | 8"        | ATE |
|               | 1.4                | 43    | 05.89 | 12.95                  | - Fahrschule 2)        |                |        |  |           |     |
|               | 1.4                | 55    | 09.90 | 12.95                  | - ABS/ - Fahrschule 1) |                |        |  |           |     |
|               | 1.7                | 54    | 05.89 | 12.95                  | - ABS/ - Fahrschule 1) |                |        |  |           |     |
|               | 1.7                | 66    | 05.89 | 12.95                  | - ABS/ - Fahrschule 1) |                |        |  |           |     |
|               | 1.8                | 65    | 05.92 | 12.95                  | - ABS/ - Fahrschule 1) |                |        |  |           |     |
|               | 1.8                | 66    | 09.94 | 12.95                  | - ABS/ - Fahrschule 1) |                |        |  |           |     |
|               | 1.8                | 79    | 05.92 | 12.95                  | - ABS/ - Fahrschule 1) |                |        |  |           |     |
|               | 1.9 D              | 47    | 05.89 | 12.95                  | - ABS/ - Fahrschule 1) |                |        |  |           |     |
|               | 1.9 dT             | 66    | 04.91 | 12.95                  | - ABS/ - Fahrschule 1) |                |        |  |           |     |
| 1.9 TD (L53K) | 68                 | 09.90 | 04.92 | - ABS/ - Fahrschule 1) |                        |                |        |  |           |     |
|               | 1.2                | 40    | 06.89 | 01.92                  |                        | 03.2119-3389.3 | 010057 |  | Thz 19,05 | ATE |
|               | 1.4                | 43    | 05.89 | 01.92                  |                        |                |        |  |           |     |
|               | 1.4 (L537)         |       | 05.89 | 01.92                  | + Fahrschule 3)        |                |        |  |           |     |
|               | 1.4 (L53A)         |       | 02.92 | 12.95                  | - ABS/ + Fahrschule 4) |                |        |  |           |     |
|               | 1.4 (L53A)         |       | 09.90 | 01.92                  | - ABS                  |                |        |  |           |     |
|               | 1.4 (L53P)         | 43    | 05.89 | 12.95                  |                        |                |        |  |           |     |
|               | 1.7                | 66    | 02.92 | 12.95                  | - ABS/ + Fahrschule 4) |                |        |  |           |     |
|               | 1.7                | 66    | 05.89 | 01.92                  | - ABS                  |                |        |  |           |     |
|               | 1.7 (L533)         | 54    | 02.92 | 12.95                  | - ABS/ + Fahrschule 4) |                |        |  |           |     |
|               | 1.7 (L533)         | 54    | 05.89 | 01.92                  | - ABS                  |                |        |  |           |     |
|               | 1.7 (L536)         | 54    | 06.89 | 12.95                  |                        |                |        |  |           |     |
|               | 1.9 D (L534/J)     | 47    | 02.92 | 12.95                  | - ABS/ + Fahrschule 4) |                |        |  |           |     |
|               | 1.9 D (L534/J)     | 47    | 05.89 | 01.92                  | - ABS                  |                |        |  |           |     |
| 1.9 dT        | 66                 | 02.92 | 12.95 | - ABS/ + Fahrschule 4) |                        |                |        |  |           |     |
| 1.9 dT        | 66                 | 04.91 | 01.92 | - ABS                  |                        |                |        |  |           |     |
| 1.9 TD (L53K) | 68                 | 09.90 | 01.92 | - ABS                  |                        |                |        |  |           |     |
|               | 1.2                | 40    | 02.92 | 12.92                  |                        | 03.2120-2031.3 | 010106 |  | Thz 20,64 | ATE |
|               | 1.4                | 43    | 02.92 | 12.95                  |                        |                |        |  |           |     |
|               | 1.4 (L535)         | 55    | 09.94 | 12.95                  | - ABS                  |                |        |  |           |     |
|               | 1.4 (L537)         |       | 02.92 | 12.95                  | - Fahrschule 2)        |                |        |  |           |     |
|               | 1.4 (L53A)         |       | 02.92 | 12.95                  | - ABS/ - Fahrschule 1) |                |        |  |           |     |
|               | 1.4 (L53G)         |       | 05.92 | 12.95                  |                        |                |        |  |           |     |
|               | 1.7 (L533)         | 54    | 02.92 | 12.95                  | - ABS/ - Fahrschule 1) |                |        |  |           |     |
|               | 1.7 (L53C)         | 66    | 02.92 | 12.95                  | - ABS/ - Fahrschule 1) |                |        |  |           |     |
|               | 1.7 (L53F)         | 79    | 02.92 | 12.95                  | - ABS                  |                |        |  |           |     |
|               | 1.8                | 65    | 05.92 | 12.95                  | - ABS                  |                |        |  |           |     |
|               | 1.8                | 79    | 05.92 | 12.95                  | - ABS                  |                |        |  |           |     |
|               | 1.8 (L453A/C/D)    | 66    | 09.94 | 12.95                  | - ABS                  |                |        |  |           |     |
|               | 1.8 (L53V/453/F/H) | 66    | 09.94 | 12.95                  |                        |                |        |  |           |     |
|               | 1.8 16V            | 99    | 05.89 | 12.95                  | - ABS                  |                |        |  |           |     |
|               | 1.9 D (L534/J)     | 47    | 02.92 | 12.95                  | - ABS/ - Fahrschule 1) |                |        |  |           |     |
|               | 1.9 D (L53I)       | 47    | 05.92 | 12.95                  | - ABS                  |                |        |  |           |     |
|               | 1.9 dT             | 66    | 02.92 | 12.95                  | - ABS/ - Fahrschule 1) |                |        |  |           |     |

1) - ABS/ - driving school / - ABS/ - scuola guida / - ABS/ - auto-école / - ABS/ - autoescuela  
 2) - driving school / - scuola guida / - auto école / - autoescuela  
 3) + driving school / + scuola guida / + auto école / + autoescuela  
 4) - ABS/ + driving school / - ABS/ + scuola guida / - ABS/ + auto école / - ABS/ + autoescuela



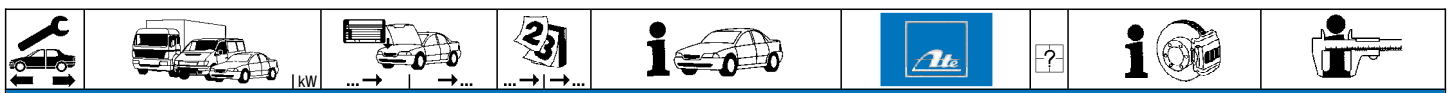

**RENAULT R19 CHAMADE (L53\_) (89-95)**





















|  |                     |    |       |       |  |                |        |   |                              |                |     |
|--|---------------------|----|-------|-------|--|----------------|--------|---|------------------------------|----------------|-----|
|  | 1.9 TD (L53K)       | 68 | 02.92 | 04.92 | - ABS                                    | 03.2120-2031.3 | 010106 |   |                              | THz 20,64      | ATE |
|  | 1.4                 | 55 | 09.94 | 12.95 | + ABS/ + Schaltgetriebe <sup>1)</sup>    | 24.2120-1725.3 | 010579 |   |                              | THz 20,64      | BDX |
|  | 1.7                 | 54 | 05.89 | 12.95 | + ABS/ + Schaltgetriebe <sup>1)</sup>    |                |        |   |                              |                |     |
|  | 1.7                 | 66 | 05.89 | 12.95 | + ABS/ + Schaltgetriebe <sup>1)</sup>    |                |        |   |                              |                |     |
|  | 1.8                 | 65 | 05.92 | 12.95 | + ABS/ + Schaltgetriebe <sup>1)</sup>    |                |        |   |                              |                |     |
|  | 1.8                 | 66 | 09.94 | 12.95 | + ABS/ + Schaltgetriebe <sup>1)</sup>    |                |        |   |                              |                |     |
|  | 1.8                 | 79 | 05.92 | 12.95 | + ABS/ + Schaltgetriebe <sup>1)</sup>    |                |        |   |                              |                |     |
|  | 1.8 16V             | 99 | 05.89 | 12.95 | + ABS/ + Schaltgetriebe <sup>1)</sup>    |                |        |   |                              |                |     |
|  | 1.9 D               | 47 | 05.89 | 12.95 | + ABS/ + Schaltgetriebe <sup>1)</sup>    |                |        |   |                              |                |     |
|  | 1.9 dT              | 66 | 10.95 | 12.95 | + ABS/ + Schaltgetriebe <sup>1)</sup>    |                |        |   |                              |                |     |
|  | 1.9 TD (L53K)       | 68 | 09.90 | 04.92 | + ABS/ + Schaltgetriebe <sup>1)</sup>    |                |        |   |                              |                |     |
|  | 1.2                 | 40 | 06.89 | 12.92 |  | 24.3481-1505.5 | 240047 |   |                              | D=48, - Halter | BDX |
|  | 1.4                 | 43 | 05.89 | 12.95 |  | 24.3481-1506.5 | 240048 |   |                              | D=48, - Halter | BDX |
|  | 1.4 (L535)          | 55 | 09.94 | 12.95 |  | 24.3481-1611.5 | 240029 |   |                              | D=48, - Halter | LUC |
|  | 1.7 (L536)          | 54 | 06.89 | 12.95 |  | 24.3481-1612.5 | 240030 |   |                              | D=48, - Halter | LUC |
|  | 1.9 D (L534/J)      | 47 | 10.91 | 12.95 | + ABS                                    | 24.0101-4803.2 | 260049 |   |                              | Einbausatz     | BDX |
|  | 1.9 D (L534/J)      | 47 | 05.89 | 12.95 | - ABS                                    | 24.0101-4807.2 | 260053 |   |                              | Einbausatz     | LUC |
|  | 1.9 D (L53I)        | 47 | 05.92 | 12.95 |  |                |        |   |                              |                |     |
|  | 1.4 (L53A)          |    | 09.90 | 12.95 |  | 24.3481-1505.5 | 240047 |   |                              | D=48, - Halter | BDX |
|  | 1.7 (L53B)          | 54 | 05.89 | 12.95 |  | 24.3481-1506.5 | 240048 |   |                              | D=48, - Halter | BDX |
|  |                     |    |       |       |  | 24.0101-4803.2 | 260049 |   |                              | Einbausatz     | BDX |
|  | 1.4 (L53A)          |    | 09.90 | 12.95 | + Schaltgetriebe <sup>2)</sup>           | 24.3481-1611.5 | 240029 |   |                              | D=48, - Halter | LUC |
|  | 1.4 (L53A)          |    | 09.90 | 12.94 | + ABS/ + Automatikgetriebe <sup>3)</sup> | 24.3481-1612.5 | 240030 |   |                              | D=48, - Halter | LUC |
|  | 1.4 (L53A)          |    | 09.90 | 12.95 | - ABS                                    | 24.0101-4807.2 | 260053 |   |                              | Einbausatz     | LUC |
|  | 1.7 (L53B)          | 54 | 05.89 | 12.95 | + Schaltgetriebe <sup>2)</sup>           |                |        |   |                              |                |     |
|  | 1.7 (L53B)          | 54 | 05.89 | 12.94 | + ABS/ + Automatikgetriebe <sup>3)</sup> |                |        |   |                              |                |     |
|  | 1.7 (L53B)          | 54 | 05.89 | 12.95 | - ABS                                    |                |        |   |                              |                |     |
|  | 1.4 (L53A)          |    | 01.95 | 12.95 | + ABS/ + Automatikgetriebe <sup>3)</sup> | 24.3481-1615.5 | 240031 |   |                              | D=48, - Halter | LUC |
|  | 1.7 (L533)          | 54 | 05.89 | 12.95 |  | 24.3481-1616.5 | 240032 |   |                              | D=48, - Halter | LUC |
|  | 1.7 (L53B)          | 54 | 01.95 | 12.95 | + ABS/ + Automatikgetriebe <sup>3)</sup> | 24.0101-4806.2 | 260052 |   |                              | Einbausatz     | LUC |
|  | 1.7 (L53C/F)        |    | 05.89 | 12.95 |  |                |        |   |                              |                |     |
|  | 1.8                 | 65 | 05.92 | 12.95 |  |                |        |   |                              |                |     |
|  | 1.8                 | 66 | 11.94 | 12.95 |  |                |        |   |                              |                |     |
|  | 1.8                 | 79 | 05.92 | 12.95 |  |                |        |   |                              |                |     |
|  | 1.8 16V             | 99 | 05.89 | 12.95 |  |                |        |   |                              |                |     |
|  | 1.9 D (L534/J)      | 47 | 05.89 | 09.91 | + ABS                                    |                |        |   |                              |                |     |
|  | 1.9 D (L53Z)        | 47 | 05.92 | 12.95 |  |                |        |   |                              |                |     |
|  | 1.9 dT              | 66 | 04.91 | 12.95 |  |                |        |   |                              |                |     |
|  | 1.2                 | 40 | 06.89 | 12.92 |  | 24.5111-0280.3 | 330389 | 2 |                              | L=280          |     |
|  | 1.4                 |    | 05.89 | 12.95 |  |                |        |   |                              |                |     |
|  | 1.4                 | 43 | 05.89 | 12.95 |  |                |        |   |                              |                |     |
|  | 1.4                 | 55 | 05.89 | 12.95 |  |                |        |   |                              |                |     |
|  | 1.7                 | 54 | 05.89 | 12.95 |  |                |        |   |                              |                |     |
|  | 1.7                 | 66 | 05.89 | 12.95 |  |                |        |   |                              |                |     |
|  | 1.8                 | 65 | 05.92 | 12.95 |  |                |        |   |                              |                |     |
|  | 1.8                 | 66 | 09.94 | 12.95 |  |                |        |   |                              |                |     |
|  | 1.8                 | 79 | 05.92 | 12.95 |  |                |        |   |                              |                |     |
|  | 1.8 16V             | 99 | 05.89 | 12.95 |  |                |        |   |                              |                |     |
|  | 1.9 D               | 47 | 05.89 | 12.95 |  |                |        |   |                              |                |     |
|  | 1.9 dT              | 66 | 04.91 | 12.95 |  |                |        |   |                              |                |     |
|  | 1.9 TD (L53K)       | 68 | 09.90 | 04.92 |  |                |        |   |                              |                |     |
|  | 1.2                 | 40 | 06.89 | 12.92 |  | 24.5229-0240.3 | 330400 | 2 | Länge beachten <sup>4)</sup> | L=242          |     |
|  | 1.4                 |    | 05.89 | 12.95 |  | 24.5229-0255.3 | 330581 | 2 | Länge beachten <sup>4)</sup> | L=255          |     |
|  | 1.4                 | 43 | 05.89 | 12.95 |  |                |        |   |                              |                |     |
|  | 1.4                 | 55 | 09.94 | 12.95 | - ABS                                    |                |        |   |                              |                |     |
|  | 1.7                 | 54 | 05.89 | 12.95 | - ABS                                    |                |        |   |                              |                |     |
|  | 1.7 (L53C)          | 66 | 05.89 | 12.95 | - ABS                                    |                |        |   |                              |                |     |
|  | 1.8                 | 65 | 05.92 | 12.95 | - ABS                                    |                |        |   |                              |                |     |
|  | 1.8 (L53V/453A/F/H) | 66 | 09.94 | 12.95 | - ABS                                    |                |        |   |                              |                |     |
|  | 1.8 16V             | 99 | 05.89 | 12.95 |  |                |        |   |                              |                |     |
|  | 1.9 D               | 47 | 05.89 | 12.95 | - ABS                                    |                |        |   |                              |                |     |
|  | 1.9 dT              | 66 | 04.91 | 12.95 | - ABS                                    |                |        |   |                              |                |     |
|  | 1.4                 | 55 | 09.90 | 12.95 | + ABS                                    | 24.5229-0220.3 | 330399 | 2 |                              | L=220          |     |
|  | 1.7                 | 54 | 05.89 | 12.95 | + ABS                                    |                |        |   |                              |                |     |
|  | 1.7 (L53C)          | 66 | 05.89 | 12.95 | + ABS                                    |                |        |   |                              |                |     |
|  | 1.7 (L53F)          | 79 | 09.90 | 12.95 |  |                |        |   |                              |                |     |
|  | 1.8                 | 65 | 05.92 | 12.95 | + ABS                                    |                |        |   |                              |                |     |
|  | 1.8                 | 66 | 09.94 | 12.95 | + ABS                                    |                |        |   |                              |                |     |
|  | 1.8                 | 79 | 05.92 | 12.95 | + ABS                                    |                |        |   |                              |                |     |
|  | 1.9 D               | 47 | 05.89 | 12.95 | + ABS                                    |                |        |   |                              |                |     |
|  | 1.9 dT              | 66 | 04.91 | 12.95 | + ABS                                    |                |        |   |                              |                |     |
|  | 1.9 TD (L53K)       | 68 | 09.90 | 04.92 |  |                |        |   |                              |                |     |
|  | 1.2                 | 40 | 06.89 | 04.91 |  | 24.3220-1618.3 | 020245 |   |                              | RzR 20,64      | BDX |
|  | 1.4                 | 43 | 05.89 | 04.91 |  | 24.3220-1617.3 | 020244 |   |                              | RzR 20,64      | BDX |
|  | 1.4 (L537/53H)      |    | 05.89 | 04.91 |  |                |        |   |                              |                |     |
|  | 1.4 (L53A)          |    | 09.90 | 04.91 | - ABS                                    |                |        |   |                              |                |     |
|  | 1.4 (L53P)          | 43 | 05.89 | 12.95 |  |                |        |   |                              |                |     |
|  | 1.7 (L533/536)      | 54 | 05.89 | 04.91 | - ABS                                    |                |        |   |                              |                |     |
|  | 1.7 (L53C)          | 66 | 05.89 | 04.91 | - ABS                                    |                |        |   |                              |                |     |
|  | 1.9 D (L534/J)      | 47 | 05.89 | 04.91 | - ABS                                    |                |        |   |                              |                |     |
|  | 1.2                 | 40 | 05.91 | 12.92 |  | 24.3220-1617.3 | 020244 |   |                              | RzR 20,64      | BDX |
|  | 1.4                 | 43 | 05.91 | 12.95 |  | 24.3220-1618.3 | 020245 |   |                              | RzR 20,64      | BDX |
|  | 1.4 (L537/53H)      |    | 05.91 | 12.95 |  |                |        |   |                              |                |     |
|  | 1.4 (L53A)          |    | 05.91 | 12.95 | - ABS                                    |                |        |   |                              |                |     |
|  | 1.7 (L533/536)      | 54 | 05.91 | 12.95 | - ABS                                    |                |        |   |                              |                |     |
|  | 1.7 (L53C)          | 66 | 05.91 | 12.95 | - ABS                                    |                |        |   |                              |                |     |

<sup>1)</sup> + ABS/ + manual transm. / + ABS/+ scatola camb.velocità / + ABS/ + transmission mécanique / + ABS/ + cambio de velocidad

<sup>2)</sup> + manual transmission / + scatola cambio velocità / + transmission mécanique / + cambio de velocidad

























<sup>3)</sup> + ABS/ + autom.transmission / + ABS/ + scatola cambio autom. / + ABS/ + transmission automatique / + ABS/ + cambio automatico













<sup>4)</sup> notice length / attenzione lunghezza / faire attention longueur / atención largo

| RENAULT R19 CHAMADE (L53_) (89-95)   |                     |    |  |       |       |                                       |                |        |   |                |              |
|--|---------------------|----|--|-------|-------|---------------------------------------|----------------|--------|---|----------------|--------------|
|    | 1.9 D (L534/J)      | 47 |  | 05.91 | 12.95 | - ABS                                 | 24.3220-1617.3 | 020244 |    | RzR 20,64      | <b>BDX</b>   |
|  | 1.4 (L535)          | 55 |  | 09.94 | 12.95 | - ABS                                 | 24.3220-1617.3 | 020244 |    | RzR 20,64      | <b>BDX</b>   |
|  | 1.4 (L53G)          |    |  | 05.92 | 12.95 |                                       | 24.3220-1618.3 | 020245 |    | RzR 20,64      | <b>BDX</b>   |
|  | 1.8                 | 65 |  | 05.92 | 12.95 | - ABS                                 | 24.3220-1615.3 | 020242 |    | RzR 20,64      | <b>LUC</b>   |
|  | 1.8 (L53V/453A/F)   | 66 |  | 09.94 | 12.95 | - ABS                                 | 24.3220-1616.3 | 020243 |    | RzR 20,64      | <b>LUC</b>   |
|  | 1.9 D (L53I)        | 47 |  | 05.92 | 12.95 | - ABS                                 |                |        |   |                |              |
|  | 1.9 dT              | 66 |  | 04.91 | 04.92 | - ABS                                 |                |        |   |                |              |
|  | 1.4                 | 43 |  | 05.89 | 12.95 |                                       | 24.3220-1615.3 | 020242 |    | RzR 20,64      | <b>LUC</b>   |
|  | 1.4 (L537/53H)      |    |  | 05.89 | 12.95 |                                       | 24.3220-1616.3 | 020243 |    | RzR 20,64      | <b>LUC</b>   |
|  | 1.4 (L53A)          |    |  | 09.90 | 12.95 | - ABS                                 |                |        |   |                |              |
|  | 1.7                 | 54 |  | 05.89 | 12.95 | - ABS                                 |                |        |   |                |              |
|  | 1.7 (L53C)          | 66 |  | 05.89 | 12.95 | - ABS                                 |                |        |   |                |              |
|  | 1.9 D (L534/J)      | 47 |  | 05.89 | 12.95 | - ABS                                 |                |        |   |                |              |
|  | 1.7 (L53F)          | 79 |  | 09.90 | 12.95 | - ABS                                 | 24.3219-1116.3 | 020195 |    | Rz 19,05       | <b>BDX</b>   |
|  | 1.8 (453C/D/H)      | 66 |  | 09.94 | 12.95 | - ABS                                 | 24.3219-1117.3 | 020196 |    | Rz 19,05       | <b>BDX</b>   |
|  | 1.8 (L538)          | 81 |  | 05.92 | 12.95 | - ABS                                 |                |        |   |                |              |
|  | 1.9 D (L53Z)        | 47 |  | 05.92 | 12.95 | - ABS                                 |                |        |   |                |              |
|  | 1.9 dT              | 66 |  | 05.92 | 12.95 | - ABS                                 |                |        |   |                |              |
|    | 1.2                 | 40 |  | 06.89 | 12.92 |                                       | 24.3727-1012.2 | 581012 | 2  |                | L=1564       |
|  | 1.4                 |    |  | 05.89 | 12.95 |                                       |                |        |   |                |              |
|  | 1.4                 | 43 |  | 05.89 | 12.95 |                                       |                |        |   |                |              |
|  | 1.4                 | 55 |  | 09.94 | 12.95 | - ABS                                 |                |        |   |                |              |
|  | 1.7                 | 54 |  | 05.89 | 12.95 | - ABS                                 |                |        |   |                |              |
|  | 1.7 (L53C)          | 66 |  | 05.89 | 12.95 | - ABS                                 |                |        |   |                |              |
|  | 1.8                 | 65 |  | 05.92 | 12.95 | - ABS                                 |                |        |   |                |              |
|  | 1.8 (L53V/453A/F)   | 66 |  | 09.94 | 12.95 | - ABS                                 |                |        |   |                |              |
|  | 1.9 D (L534/I/J)    | 47 |  | 05.89 | 12.95 | - ABS                                 |                |        |   |                |              |
|  | 1.9 dT              | 66 |  | 04.91 | 12.95 | - ABS                                 |                |        |   |                |              |
|  | 1.4                 | 55 |  | 09.90 | 12.95 | + ABS                                 | 24.3727-1011.2 | 581011 | 2  |                | L=1564       |
|  | 1.7                 | 54 |  | 05.89 | 12.95 | + ABS                                 |                |        |   |                |              |
|  | 1.7 (L53C/F)        |    |  | 05.89 | 12.95 | + ABS                                 |                |        |   |                |              |
|  | 1.8                 | 65 |  | 05.92 | 12.95 | + ABS                                 |                |        |   |                |              |
|  | 1.8                 | 79 |  | 05.92 | 12.95 | + ABS                                 |                |        |   |                |              |
|  | 1.8 (L53V/453A/C-F) | 66 |  | 09.94 | 12.95 | + ABS                                 |                |        |   |                |              |
|  | 1.8 16V             | 99 |  | 05.89 | 12.95 |                                       |                |        |   |                |              |
|  | 1.9 D               | 47 |  | 05.89 | 12.95 | + ABS                                 |                |        |   |                |              |
|  | 1.9 dT              | 66 |  | 04.91 | 12.95 | + ABS                                 |                |        |   |                |              |
|  | 1.9 TD (L53K)       | 68 |  | 09.90 | 04.92 |                                       |                |        |   |                |              |
|  | 1.7 (L53F)          | 79 |  | 09.90 | 11.94 | - ABS                                 | 24.6583-1742.3 | 320183 |   |                | BRL (4) lila |
|  | 1.8 (453C/D/H)      | 66 |  | 09.94 | 11.94 | - ABS                                 |                |        |   |                |              |
|  | 1.8 (L538)          | 81 |  | 05.92 | 11.94 | - ABS                                 |                |        |   |                |              |
|  | 1.9 dT              | 66 |  | 04.91 | 11.94 | - ABS                                 |                |        |   |                |              |
|  | 1.9 dT (L53T)       | 66 |  | 05.92 | 11.94 | - ABS                                 |                |        |   |                |              |
|  | 1.7 (L53F)          | 79 |  | 12.94 | 12.95 | - ABS                                 | 24.6583-1710.3 | 320166 |   |                | BRL (4)      |
|  | 1.8 (453C/D/H)      | 66 |  | 12.94 | 12.95 | - ABS                                 |                |        |   |                |              |
|  | 1.8 (L538)          | 81 |  | 12.94 | 12.95 | - ABS                                 |                |        |   |                |              |
|  | 1.9 D (L53Z)        | 47 |  | 09.94 | 12.95 | - ABS                                 |                |        |   |                |              |
|  | 1.9 dT              | 66 |  | 12.94 | 12.95 | - ABS                                 |                |        |   |                |              |
|  | 1.9 dT (L53T)       | 66 |  | 12.94 | 12.95 | - ABS                                 |                |        |   |                |              |
|  | 1.2                 | 40 |  | 06.89 | 12.92 |                                       | 24.3728-1005.2 | 591005 |   |                | L=1010       |
|  | 1.4                 |    |  | 05.89 | 12.95 |                                       |                |        |   |                |              |
|  | 1.4                 | 43 |  | 05.89 | 12.95 |                                       |                |        |   |                |              |
|  | 1.4                 | 55 |  | 05.89 | 12.95 |                                       |                |        |   |                |              |
|  | 1.7                 | 54 |  | 05.89 | 12.95 |                                       |                |        |   |                |              |
|  | 1.7                 | 66 |  | 05.89 | 12.95 |                                       |                |        |   |                |              |
|  | 1.8                 | 65 |  | 05.92 | 12.95 |                                       |                |        |   |                |              |
|  | 1.8                 | 66 |  | 09.94 | 12.95 |                                       |                |        |   |                |              |
|  | 1.8                 | 79 |  | 05.92 | 12.95 |                                       |                |        |   |                |              |
|  | 1.8 16V             | 99 |  | 05.89 | 12.95 |                                       |                |        |   |                |              |
|  | 1.9 D               | 47 |  | 05.89 | 12.95 |                                       |                |        |   |                |              |
|  | 1.9 dT              | 66 |  | 04.91 | 12.95 |                                       |                |        |   |                |              |
|  | 1.9 TD (L53K)       | 68 |  | 09.90 | 04.92 |                                       |                |        |   |                |              |
| RENAULT R19 Cabriolet (D53_) (91-96)   |                     |    |  |       |       |                                       |                |        |   |                |              |
|  | 1.7                 | 4  |  | 02.92 | 08.96 | - ABS                                 | 03.7740-3002.4 | 300068 |   | 8"             | <b>ATE</b>   |
|  | 1.8                 | 65 |  | 04.92 | 12.94 |                                       |                |        |   |                |              |
|  | 1.8                 | 66 |  | 01.93 | 08.96 | - ABS                                 |                |        |   |                |              |
|  | 1.7                 |    |  | 02.91 | 01.92 | - ABS                                 | 03.2119-3389.3 | 010057 |   | THz 19,05      | <b>ATE</b>   |
|  | 1.7                 |    |  | 02.92 | 08.96 | - ABS                                 | 03.2120-2031.3 | 010106 |   | THz 20,64      | <b>ATE</b>   |
|  | 1.8                 | 65 |  | 04.92 | 12.94 |                                       |                |        |   |                |              |
|  | 1.8                 | 66 |  | 01.93 | 12.94 |                                       |                |        |   |                |              |
|  | 1.8                 | 79 |  | 01.93 | 08.96 | - ABS                                 |                |        |   |                |              |
|  | 1.8 16V             |    |  | 02.91 | 03.95 | - ABS                                 |                |        |   |                |              |
|  | 1.7                 |    |  | 02.91 | 08.96 | + ABS/ + Schaltgetriebe <sup>1)</sup> | 24.2120-1725.3 | 010579 |   | THz 20,64      | <b>BDX</b>   |
|  | 1.8 (853A)          | 66 |  | 01.93 | 08.96 | + ABS/ + Schaltgetriebe <sup>1)</sup> |                |        |   |                |              |
|  | 1.8 16V             |    |  | 02.91 | 03.95 | + ABS                                 |                |        |   |                |              |
|  | 1.7                 |    |  | 02.91 | 08.96 |                                       | 24.3481-1615.5 | 240031 |  | D=48, - Halter | <b>LUC</b>   |
|  | 1.8                 | 65 |  | 04.92 | 12.94 |                                       | 24.3481-1616.5 | 240032 |  | D=48, - Halter | <b>LUC</b>   |
|  | 1.8                 | 66 |  | 01.93 | 12.94 |                                       | 24.0101-4806.2 | 260052 |   | Einbausatz     | <b>LUC</b>   |
|  | 1.8                 | 79 |  | 09.94 | 08.96 |                                       |                |        |   |                |              |
|  | 1.8 16V             |    |  | 02.91 | 03.95 |                                       |                |        |   |                |              |

<sup>1)</sup> + ABS/ + manual transm. / + ABS/+ scatola camb.velocità / + ABS/ + transmission mécanique / + ABS/ + cambio de velocidad



|     |   |              |    |   |  |  |   |  |  |
|--|---|--|--|---|---|--|---|--|--|
| <b>RENAULT R19 Cabriolet (D53_) (91-96)</b>  |   |  |  |   |   |  |   |  |  |
|    | 1.7<br>1.8<br>1.8<br>1.8<br>1.8 16V   | 65<br>66<br>79   | 02.91<br>04.92<br>01.93<br>09.94<br>02.91  | 08.96<br>12.94<br>08.96<br>08.96<br>03.95   | 24.5111-0280.3  | 330389   | 2   | L=280  |  |
|    | 1.7<br>1.8<br>1.8<br>1.8<br>1.8 16V   | 65<br>66<br>79   | 02.91<br>04.92<br>01.93<br>09.94<br>02.91  | 08.96 - ABS<br>12.94 - ABS<br>08.96 - ABS<br>08.96 - ABS<br>03.95 - ABS   | 24.5229-0255.3  | 330581   | 2   | L=255  |  |
|    | 1.7<br>1.8<br>1.8<br>1.8<br>1.8 16V   | 65<br>66<br>79   | 02.91<br>04.92<br>01.93<br>09.94<br>02.91  | 08.96 + ABS<br>12.94 + ABS<br>08.96 + ABS<br>08.96 + ABS<br>03.95 + ABS   | 24.5229-0220.3  | 330399   | 2   | L=220  |  |
|    | 1.7<br>1.8<br>1.8<br>1.8  | 65<br>66   | 02.91<br>04.92<br>01.93  | 08.96 - ABS<br>12.94 - ABS<br>08.96 - ABS   | 24.3220-1617.3<br>24.3220-1618.3<br>24.3220-1615.3<br>24.3220-1616.3              | 020244<br>020245<br>020242<br>020243   |  | RzR 20,64<br>RzR 20,64<br>RzR 20,64<br>RzR 20,64                                   | <b>BDX</b><br><b>LUC</b><br><b>LUC</b> |
|    | 1.8   | 79   | 09.94  | 08.96 - ABS   | 24.3219-1116.3<br>24.3219-1117.3  | 020195<br>020196   |  | Rz 19,05<br>Rz 19,05   | <b>BDX</b><br><b>BDX</b>               |
|    | 1.7<br>1.8<br>1.8<br>1.8<br>1.8 16V   | 65<br>66<br>79   | 02.91<br>04.92<br>01.93<br>09.94<br>02.91  | 08.96 - ABS<br>12.94 - ABS<br>08.96 - ABS<br>08.96 + ABS<br>03.95 + ABS   | 24.3727-1012.2  | 581012   | 2  | L=1564   |  |
|    | 1.7<br>1.8<br>1.8<br>1.8<br>1.8 16V   | 65<br>66<br>79   | 02.91<br>04.92<br>01.93<br>09.94<br>02.91  | 08.96 + ABS<br>12.94 + ABS<br>08.96 + ABS<br>08.96 + ABS<br>03.95 + ABS   | 24.3727-1011.2  | 581011   | 2  | L=1564   |  |
|    | 1.7<br>1.8<br>1.8<br>1.8<br>1.8 16V   | 65<br>66<br>79   | 02.91<br>04.92<br>01.93<br>09.94<br>02.91  | 08.96<br>12.94<br>08.96<br>08.96<br>03.95   | 24.3728-1005.2  | 591005   |   | L=1010   |  |
| <b>RENAULT R21 NEVADA (K48_) (86-95)</b>   |   |  |  |   |   |  |   |  |  |
|    | 1.7 (K 482)<br>1.7 (S 481)<br>1.7 i (K 48E)<br>2.0 i (K 483)<br>2.1 D (K 486)<br>2.1 D (S 486)<br>2.1 TD (K 488)<br>2.2 i (K 48K)<br>2.2 i (K 48S)  | 65<br>55<br>85<br>85<br>65<br>79<br>79   | 06.92<br>06.92<br>06.92<br>07.86<br>07.86<br>07.86<br>07.86<br>07.86<br>06.88  | 12.95 - (E) (MA)<br>12.95<br>12.95<br>04.89 - ABS<br>04.89<br>04.89<br>04.89<br>04.89 - ABS<br>04.89  | 03.6750-3502.4  | 300162   |   | 9"   | <b>ATE</b>                             |
|  | 1.6 (U)<br>1.7 (K 481)<br>1.7 (K 482)<br>1.7 (K 484)<br>1.7 (K 48J)<br>1.7 (K 48M)<br>1.7 (K 48N)<br>1.7 (S 482)<br>1.7 i (K 48E)<br>1.7 i (K 48F)<br>1.9 D (K 48I)<br>1.9 D (K/S 48H)  | 55<br>65<br>54<br>64<br>65<br>54<br>47<br>47   | 06.88<br>07.86<br>07.86<br>06.90<br>07.86<br>10.87<br>10.87<br>07.86<br>07.86<br>07.86<br>04.92<br>05.89                                     | 12.95<br>12.95<br>12.95 - (E) (MA)<br>12.95<br>12.95<br>12.95<br>12.95<br>12.95<br>12.95<br>12.95<br>12.95  | 03.2119-3389.3  | 010057   |   | Thz 19,05  | <b>ATE</b>                             |
|  | 1.7 (K 482)<br>1.7 (K 482)<br>1.7 (K 48E)<br>1.7 (S 481)<br>2.0 i (K 483)<br>2.0 i (K 48C)<br>2.1 D (K 486)<br>2.1 D (S 486)<br>2.1 D 4x4 (K 486)<br>2.1 TD (K 488)<br>2.2 i (K 48K)<br>2.2 i (K 48S)<br>2.2 i 4x4 (K 48K)  | 65<br>65<br>88<br>88<br>48<br>65<br>79<br>79<br>79   | 07.86<br>06.92<br>06.92<br>06.92<br>07.86<br>06.90<br>07.86<br>07.86<br>07.86<br>07.86<br>07.86<br>06.88<br>07.86                            | 12.95 + (E) (MA)<br>12.95 - (E) (MA)<br>12.95<br>12.95<br>04.89 - ABS<br>12.95 - ABS<br>04.89<br>12.95<br>12.95<br>04.89<br>04.89 - ABS<br>04.89<br>12.95 - ABS   | 03.2120-2682.3  | 010118   |   | Thz 20,64  | <b>ATE</b>                             |
|  | 1.7 (K 482)<br>2.0 i (K 483)<br>2.0 i (K 48C)<br>2.0 i (K 48R)<br>2.1 D (K 480)<br>2.1 D (K 486)<br>2.1 D (K 480)<br>2.1 D (K/S 48V)<br>2.1 D (S 480)<br>2.1 TD (K 487)<br>2.1 TD (K 488)<br>2.1 TD (K 48A)<br>2.1 TD (K 48P)<br>2.1 TD (K 48W)<br>2.2 i (K 48B)<br>2.2 i (K 48K) | 65<br>85<br>88<br>99<br>51<br>53<br>53<br>53<br>65<br>65<br>65<br>65<br>65<br>65<br>79<br>79 | 09.90<br>05.89<br>06.90<br>07.91<br>04.92<br>05.89<br>04.92<br>05.89<br>04.92<br>06.91<br>05.89<br>04.92<br>06.90<br>05.89<br>04.93<br>05.89 | 12.95 + (E) (MA)<br>12.95 - ABS<br>12.95 - ABS<br>12.95 - ABS<br>12.95 - ABS<br>12.95<br>12.95 - ABS<br>12.95<br>12.95<br>12.95 - ABS<br>12.95<br>12.95 - ABS<br>12.95<br>12.95<br>12.95 - ABS<br>12.95 - ABS | 03.2122-9631.3  | 010160   |   | Thz 22,20  | <b>ATE</b>                             |

|     |  |  |  |  |  |  |  |  |                |
|--|--|--|--|--|---|--|--|--|----------------|
| <b>RENAULT R21 NEVADA (K48_) (86-95)</b>   |  |  |  |  |   |  |  |  |                |
|    | 2.2 i (K 48S)  | 79   |  | 05.89  | 12.95   | 03.2122-9631.3   | 010160   | Thz 22,20  | ATE            |
|    | 1.7 (K/S 481)  | 55   |  | 07.86  | 12.95   | 24.3481-1615.5   | 240031   | D=48, - Halter<br>D=48, - Halter<br>Einbausatz                                     | LUC            |
|  | 1.7 i (K 48F)  | 54   |  | 07.86  | 12.95   | 24.3481-1616.5   | 240032   |  | LUC            |
|  | 1.9 D (K 48I)  | 47   |  | 04.92  | 12.95   | 24.0101-4806.2   | 260052   |  | LUC            |
|  | 1.9 D (K/S 48H)  | 47   |  | 05.89  | 12.95   |  |  |  |                |
|  | 1.6 (U)  |  |  | 06.88  | 12.95   | 24.3481-1615.5   | 240031   | D=48, - Halter<br>D=48, - Halter<br>Einbausatz                                     | LUC            |
|  | 1.7 (K 482)  | 65   |  | 07.86  | 12.95   | 24.3481-1616.5   | 240032   |  | LUC            |
|  | 1.7 (K 484)  |  |  | 06.90  | 12.95   | 24.0101-4806.2   | 260052   |  | LUC            |
|  | 1.7 (K 48J)  |  |  | 07.86  | 12.95   |  |  |  |                |
|  | 1.7 (K 48M)  | 54   |  | 10.87  | 12.95   |  |  |  |                |
|  | 1.7 (K 48N)  | 64   |  | 10.87  | 12.95   |  |  |  |                |
|  | 1.7 (S 482)  | 65   |  | 07.86  | 12.95   |  |  |  |                |
|  | 1.7 i (K 48E)  |  |  | 07.86  | 12.95   |  |  |  |                |
|  | 1.7 (K 482)  | 65   |  | 07.86  | 12.95   | 24.3541-1625.5   | 240045   |  | D=54, - Halter |
|  |  |  |  |  |   | 24.3541-1626.5   | 240046   | D=54, - Halter   | LUC            |
|    | 1.6 (U)  |  |  | 06.88  | 12.95   | 24.5111-0241.3   | 330680   | L=242  |                |
|  | 1.7 (K 482)  | 65   |  | 07.86  | 12.95   |  |  |  |                |
|  | 1.7 (K 484)  |  |  | 06.90  | 12.95   |  |  |  |                |
|  | 1.7 (K 48J)  |  |  | 07.86  | 12.95   |  |  |  |                |
|  | 1.7 (K 48M)  | 54   |  | 10.87  | 12.95   |  |  |  |                |
|  | 1.7 (K 48N)  | 64   |  | 10.87  | 12.95   |  |  |  |                |
|  | 1.7 (K/S 481)  | 55   |  | 07.86  | 12.95   |  |  |  |                |
|  | 1.7 (S 482)  | 65   |  | 07.86  | 12.95   |  |  |  |                |
|  | 1.7 i (K 48E)  |  |  | 07.86  | 12.95   |  |  |  |                |
|  | 1.7 i (K 48F)  | 54   |  | 07.86  | 12.95   |  |  |  |                |
|  | 1.9 D (K 48I)  | 47   |  | 04.92  | 12.95   |  |  |  |                |
|  | 1.9 D (K/S 48H)  | 47   |  | 05.89  | 12.95   |  |  |  |                |
|  | 1.7 (K 482)  | 65   |  | 07.86  | 12.95   | 24.5111-0300.3   | 330407   | L=300  |                |
|  | 2.0 i (K 483)  | 85   |  | 07.86  | 12.95   | 24.5111-0315.3   | 330390   | L=315  |                |
|  | 2.0 i (K 48C)  | 88   |  | 06.90  | 12.95   |  |  |  |                |
|  | 2.0 i (K 48R)  | 99   |  | 07.91  | 12.95   |  |  |  |                |
|  | 2.1 D (K 480)  | 51   |  | 04.92  | 12.95   |  |  |  |                |
|  | 2.1 D (K 480)  | 53   |  | 04.92  | 12.95   |  |  |  |                |
|  | 2.1 D (K/S 486)  |  |  | 07.86  | 12.95   |  |  |  |                |
|  | 2.1 D (K/S 48V)  | 53   |  | 05.89  | 12.95   |  |  |  |                |
|  | 2.1 D (S 480)  | 53   |  | 04.92  | 12.95   |  |  |  |                |
|  | 2.1 TD (K 487)   | 65   |  | 06.91  | 12.95   |  |  |  |                |
|  | 2.1 TD (K 488)   | 65   |  | 07.86  | 12.95   |  |  |  |                |
|  | 2.1 TD (K 48A)   | 65   |  | 04.92  | 12.95   |  |  |  |                |
|  | 2.1 TD (K 48P)   | 65   |  | 06.90  | 12.95   |  |  |  |                |
|  | 2.1 TD (K 48W)   | 65   |  | 05.89  | 12.95   |  |  |  |                |
|  | 2.2 i (K 48K)  | 79   |  | 07.86  | 12.95   |  |  |  |                |
|  | 2.2 i (K 48S)  | 79   |  | 06.88  | 12.95   |  |  |  |                |
|  | 2.0 i (K 483)  | 85   |  | 07.86  | 12.95   | 24.5111-0320.3   | 330487   | L=320  |                |
|  | 2.0 i (K 48C)  | 88   |  | 06.90  | 12.95   |  |  |  |                |
|  | 2.0 i (K 48R)  | 99   |  | 07.91  | 12.95   |  |  |  |                |
|  | 2.1 D (K 480)  | 51   |  | 04.92  | 12.95   |  |  |  |                |
|  | 2.1 D (K 480)  | 53   |  | 04.92  | 12.95   |  |  |  |                |
|  | 2.1 TD (K 487)   | 65   |  | 06.91  | 12.95   |  |  |  |                |
|  | 2.1 TD (K 48A)   | 65   |  | 04.92  | 12.95   |  |  |  |                |
|  | 2.2 i (K 48K)  | 79   |  | 07.86  | 12.95   |  |  |  |                |
|  | 1.6 (U)  |  |  | 06.88  | 12.95   | 24.5229-0220.3   | 330399   | L=220  |                |
|  | 1.7 (K 484)  |  |  | 06.90  | 12.95   |  |  |  |                |
|  | 1.7 (K 48J)  |  |  | 07.86  | 12.95   |  |  |  |                |
|  | 1.7 (K 48M)  | 54   |  | 10.87  | 12.95   |  |  |  |                |
|  | 1.7 (K 48N)  | 64   |  | 10.87  | 12.95   |  |  |  |                |
|  | 1.7 (K/S 481)  | 55   |  | 07.86  | 12.95   |  |  |  |                |
|  | 1.7 (K/S 482)  | 65   |  | 09.90  | 12.95   |  |  |  |                |
|  | 1.7 i (K 48E)  |  |  | 07.86  | 12.95   |  |  |  |                |
|  | 1.7 i (K 48F)  | 54   |  | 07.86  | 12.95   |  |  |  |                |
|  | 1.9 D (K 48I)  | 47   |  | 04.92  | 12.95   |  |  |  |                |
|  | 1.9 D (K/S 48H)  | 47   |  | 05.89  | 12.95   |  |  |  |                |
|  | 2.0 i (K 483)  | 85   |  | 05.89  | 12.95   |  |  |  |                |
|  | 2.0 i (K 48C)  | 88   |  | 06.90  | 12.95   |  |  |  |                |
|  | 2.0 i (K 48R)  | 99   |  | 07.91  | 12.95   |  |  |  |                |
|  | 2.1 D (K 480)  | 51   |  | 04.92  | 12.95   |  |  |  |                |
|  | 2.1 D (K 486)  |  |  | 05.89  | 12.95   |  |  |  |                |
|  | 2.1 D (K 480)  | 53   |  | 04.92  | 12.95   |  |  |  |                |
|  | 2.1 D (K/S 48V)  | 53   |  | 05.89  | 12.95   |  |  |  |                |
|  | 2.1 D (S 480)  | 53   |  | 04.92  | 12.95   |  |  |  |                |
|  | 2.1 TD (K 487)   | 65   |  | 06.91  | 12.95   |  |  |  |                |
|  | 2.1 TD (K 488)   | 65   |  | 05.89  | 12.95   |  |  |  |                |
|  | 2.1 TD (K 48A)   | 65   |  | 04.92  | 12.95   |  |  |  |                |
|  | 2.1 TD (K 48P)   | 65   |  | 06.90  | 12.95   |  |  |  |                |
|  | 2.1 TD (K 48W)   | 65   |  | 05.89  | 12.95   |  |  |  |                |
|  | 2.2 i (K 48B)  | 79   |  | 04.93  | 12.95   |  |  |  |                |
|  | 2.2 i (K 48K)  | 79   |  | 05.89  | 12.95   |  |  |  |                |
|  | 2.2 i (K 48S)  | 79   |  | 05.89  | 12.95   |  |  |  |                |
|  | 2.0 i (K 483)  | 85   |  | 07.86  | 12.95   | 24.5229-0220.3   | 330399   | Länge beachten <sup>1)</sup>   | L=220          |
|  | 2.0 i (K 48C)  | 88   |  | 06.90  | 12.95   | 24.5111-0260.3   | 330408   | Länge beachten <sup>1)</sup>   | L=260          |
|  | 2.0 i (K 48R)  | 99   |  | 07.91  | 12.95   | 24.5229-0285.3   | 330032   | Länge beachten <sup>1)</sup>   | L=285          |
|  | 2.1 D (K 480)  | 51   |  | 04.92  | 12.95   |  |  |  |                |
|  | 2.1 D (K 480)  | 53   |  | 04.92  | 12.95   |  |  |  |                |
|  | 2.1 TD (K 487)   | 65   |  | 06.91  | 12.95   |  |  |  |                |



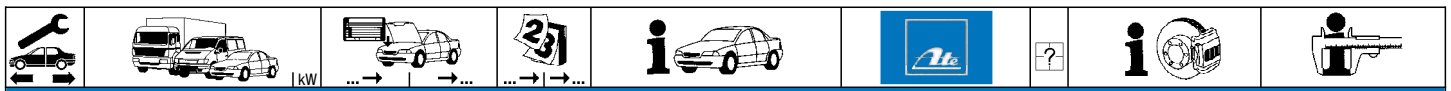















<sup>1)</sup> notice length / attenzione lunghezza / faire attention longueur / atención largo























**RENAULT R21 NEVADA (K48\_) (86-95)**

|  |                   |    |       |             |                |        |   |                              |             |
|--|-------------------|----|-------|-------------|----------------|--------|---|------------------------------|-------------|
|  | 2.1 TD (K 48A)    | 65 | 04.92 | 12.95 + ABS | 24.5229-0220.3 | 330399 | 2 | Länge beachten <sup>1)</sup> | L=220       |
|  | 2.2 i (K 48B)     | 79 | 04.93 | 12.95 + ABS | 24.5111-0260.3 | 330408 | 2 | Länge beachten <sup>1)</sup> | L=260       |
|  | 2.2 i (K 48K)     | 79 | 07.86 | 12.95 + ABS | 24.5229-0285.3 | 330032 | 2 | Länge beachten <sup>1)</sup> | L=285       |
|  | 1.6 (U)           |    | 06.88 | 12.95       | 24.3222-1122.3 | 020335 |   |                              | Rz 22,20    |
|  | 1.7 (K 484)       |    | 06.90 | 12.95       | 24.3222-1123.3 | 020336 |   |                              | Rz 22,20    |
|  | 1.7 (K 48J)       |    | 07.86 | 12.95       |                |        |   |                              |             |
|  | 1.7 (K 48M)       | 54 | 10.87 | 12.95       |                |        |   |                              |             |
|  | 1.7 (K 48N)       | 64 | 10.87 | 12.95       |                |        |   |                              |             |
|  | 1.7 (K/S 481)     | 55 | 07.86 | 12.95       |                |        |   |                              |             |
|  | 1.7 (K/S 482)     | 65 | 07.86 | 12.95       |                |        |   |                              |             |
|  | 1.7 i (K 48E)     |    | 07.86 | 12.95       |                |        |   |                              |             |
|  | 1.7 i (K 48F)     | 54 | 07.86 | 12.95       |                |        |   |                              |             |
|  | 1.9 D (K 48I)     | 47 | 04.92 | 12.95       |                |        |   |                              |             |
|  | 1.9 D (K/S 48H)   | 47 | 05.89 | 12.95       |                |        |   |                              |             |
|  | 2.0 i (K 483)     | 85 | 07.86 | 12.95 - ABS |                |        |   |                              |             |
|  | 2.0 i (K 48C)     | 88 | 06.90 | 12.95 - ABS |                |        |   |                              |             |
|  | 2.1 D (K 480)     | 51 | 04.92 | 12.95 - ABS |                |        |   |                              |             |
|  | 2.1 D (K 486)     |    | 07.86 | 12.95       |                |        |   |                              |             |
|  | 2.1 D (K/S 480)   | 53 | 04.92 | 12.95       |                |        |   |                              |             |
|  | 2.1 D (K/S 48V)   | 53 | 05.89 | 12.95       |                |        |   |                              |             |
|  | 2.1 D (S 486)     |    | 07.86 | 12.95       |                |        |   |                              |             |
|  | 2.1 TD (K 487)    | 65 | 06.91 | 12.95 - ABS |                |        |   |                              |             |
|  | 2.1 TD (K 488)    | 65 | 07.86 | 12.95       |                |        |   |                              |             |
|  | 2.1 TD (K 48A)    | 65 | 04.92 | 12.95       |                |        |   |                              |             |
|  | 2.1 TD (K 48P)    | 65 | 06.90 | 12.95       |                |        |   |                              |             |
|  | 2.1 TD (K 48W)    | 65 | 05.89 | 12.95       |                |        |   |                              |             |
|  | 2.2 i (K 48B)     | 79 | 04.93 | 12.95 - ABS |                |        |   |                              |             |
|  | 2.2 i (K 48K)     | 79 | 07.86 | 12.95 - ABS |                |        |   |                              |             |
|  | 2.2 i (K 48S)     | 79 | 06.88 | 12.95       |                |        |   |                              |             |
|  | 2.1 D 4x4 (K 486) | 48 | 07.86 | 12.95       | 24.3220-1115.3 | 020312 |   |                              | Rz 20,64    |
|  | 2.2 i 4x4 (K 48K) | 79 | 07.86 | 12.95 - ABS |                |        |   |                              | <b>BDX</b>  |
|  | 1.6 (U)           |    | 06.88 | 12.95       | 24.3727-1015.2 | 581015 | 2 |                              | L=1646      |
|  | 1.7 (K 484)       |    | 06.90 | 12.95       |                |        |   |                              |             |
|  | 1.7 (K 48J)       |    | 07.86 | 12.95       |                |        |   |                              |             |
|  | 1.7 (K 48M)       | 54 | 10.87 | 12.95       |                |        |   |                              |             |
|  | 1.7 (K 48N)       | 64 | 10.87 | 12.95       |                |        |   |                              |             |
|  | 1.7 (K/S 481)     | 55 | 07.86 | 12.95       |                |        |   |                              |             |
|  | 1.7 (K/S 482)     | 65 | 07.86 | 12.95       |                |        |   |                              |             |
|  | 1.7 i (K 48E)     |    | 07.86 | 12.95       |                |        |   |                              |             |
|  | 1.7 i (K 48F)     | 54 | 07.86 | 12.95       |                |        |   |                              |             |
|  | 1.9 D (K 48I)     | 47 | 04.92 | 12.95       |                |        |   |                              |             |
|  | 1.9 D (K/S 48H)   | 47 | 05.89 | 12.95       |                |        |   |                              |             |
|  | 2.0 i (K 483)     | 85 | 07.86 | 12.95 - ABS |                |        |   |                              |             |
|  | 2.0 i (K 48C)     | 88 | 06.90 | 12.95 - ABS |                |        |   |                              |             |
|  | 2.1 D (K 480)     | 51 | 04.92 | 12.95       |                |        |   |                              |             |
|  | 2.1 D (K 486)     |    | 07.86 | 12.95       |                |        |   |                              |             |
|  | 2.1 D (K 480)     | 53 | 04.92 | 12.95 - ABS |                |        |   |                              |             |
|  | 2.1 D (K/S 48V)   | 53 | 05.89 | 12.95       |                |        |   |                              |             |
|  | 2.1 D (S 486)     |    | 07.86 | 12.95       |                |        |   |                              |             |
|  | 2.1 D (S 480)     | 53 | 04.92 | 12.95       |                |        |   |                              |             |
|  | 2.1 TD (K 487)    | 65 | 06.91 | 12.95 - ABS |                |        |   |                              |             |
|  | 2.1 TD (K 488)    | 65 | 07.86 | 12.95 - ABS |                |        |   |                              |             |
|  | 2.1 TD (K 48A)    | 65 | 04.92 | 12.95 - ABS |                |        |   |                              |             |
|  | 2.1 TD (K 48P)    | 65 | 06.90 | 12.95       |                |        |   |                              |             |
|  | 2.1 TD (K 48W)    | 65 | 05.89 | 12.95       |                |        |   |                              |             |
|  | 2.2 i (K 48B)     | 79 | 04.93 | 12.95 - ABS |                |        |   |                              |             |
|  | 2.2 i (K 48K)     | 79 | 07.86 | 12.95 - ABS |                |        |   |                              |             |
|  | 2.2 i (K 48S)     | 79 | 06.88 | 12.95       |                |        |   |                              |             |
|  | 1.6 (U)           |    | 06.88 | 12.95       | 03.6583-0014.3 | 320104 |   |                              | BRL 8/3 (4) |
|  | 1.7 (K 484)       |    | 06.90 | 12.95       |                |        |   |                              |             |
|  | 1.7 (K 48J)       |    | 07.86 | 12.95       |                |        |   |                              |             |
|  | 1.7 (K 48M)       | 54 | 10.87 | 12.95       |                |        |   |                              |             |
|  | 1.7 (K 48N)       | 64 | 10.87 | 12.95       |                |        |   |                              |             |
|  | 1.7 (K/S 481)     | 55 | 07.86 | 12.95       |                |        |   |                              |             |
|  | 1.7 (K/S 482)     | 65 | 07.86 | 12.95       |                |        |   |                              |             |
|  | 1.7 i (K 48E)     |    | 07.86 | 12.95       |                |        |   |                              |             |
|  | 1.7 i (K 48F)     | 54 | 07.86 | 12.95       |                |        |   |                              |             |
|  | 1.9 D (K 48I)     | 47 | 04.92 | 12.95       |                |        |   |                              |             |
|  | 1.9 D (K/S 48H)   | 47 | 05.89 | 12.95       |                |        |   |                              |             |
|  | 2.0 i (K 483)     | 85 | 07.86 | 12.95 - ABS |                |        |   |                              |             |
|  | 2.0 i (K 48C)     | 88 | 06.90 | 12.95 - ABS |                |        |   |                              |             |
|  | 2.1 D (K 480)     | 51 | 04.92 | 12.95 - ABS |                |        |   |                              |             |
|  | 2.1 D (K 486)     |    | 07.86 | 12.95       |                |        |   |                              |             |
|  | 2.1 D (K 480)     | 53 | 04.92 | 12.95 - ABS |                |        |   |                              |             |
|  | 2.1 D (K/S 48V)   | 53 | 05.89 | 12.95       |                |        |   |                              |             |
|  | 2.1 D (S 486)     |    | 07.86 | 12.95       |                |        |   |                              |             |
|  | 2.1 D (S 480)     | 53 | 04.92 | 12.95       |                |        |   |                              |             |
|  | 2.1 TD (K 487)    | 65 | 06.91 | 12.95 - ABS |                |        |   |                              |             |
|  | 2.1 TD (K 488)    | 65 | 07.86 | 12.95       |                |        |   |                              |             |
|  | 2.1 TD (K 48A)    | 65 | 04.92 | 12.95 - ABS |                |        |   |                              |             |
|  | 2.1 TD (K 48P)    | 65 | 06.90 | 12.95       |                |        |   |                              |             |
|  | 2.1 TD (K 48W)    | 65 | 05.89 | 12.95       |                |        |   |                              |             |
|  | 2.2 i (K 48B)     | 79 | 04.93 | 12.95 - ABS |                |        |   |                              |             |
|  | 2.2 i (K 48K)     | 79 | 07.86 | 12.95 - ABS |                |        |   |                              |             |
|  | 2.2 i (K 48S)     | 79 | 06.88 | 12.95       |                |        |   |                              |             |

<sup>1)</sup> notice length / attenzione lunghezza / faire attention longueur / atención largo

|     |  |  |  |  |  |  |     |  |
|--|--|--|--|--|---|--|---|--|
| <b>RENAULT R21 NEVADA (K48_) (86-95)</b>   |  |  |  |  |   |  |   |  |
|    | 1.6 (U)  |  | 06.88  | 12.95  | 24.3728-1003.2  | 591003   |   | L=1138   |
|  | 1.7 (K 481)  | 55   | 07.86  | 12.95  |   |  |   |  |
|  | 1.7 (K 482)  | 65   | 07.86  | 12.95  |   |  |   |  |
|  | 1.7 (K 484)  |  | 06.90  | 12.95  |   |  |   |  |
|  | 1.7 (K 48J)  |  | 07.86  | 12.95  |   |  |   |  |
|  | 1.7 (K 48M)  | 54   | 10.87  | 12.95  |   |  |   |  |
|  | 1.7 (K 48N)  | 64   | 10.87  | 12.95  |   |  |   |  |
|  | 1.7 (S 481)  | 55   | 07.86  | 12.95  |   |  |   |  |
|  | 1.7 (S 482)  | 65   | 07.86  | 12.95  |   |  |   |  |
|  | 1.7 i (K 48E)  |  | 07.86  | 12.95  |   |  |   |  |
|  | 1.7 i (K 48F)  | 54   | 07.86  | 12.95  |   |  |   |  |
| <b>RENAULT SAFRANE (B54_) (92-00)</b>  |  |  |  |  |   |  |   |  |
|    | 2.0 i (B540)   | 77   | 09.92  | 01.95 - ABS  | 03.7750-5402.4  | 300080   |   | 9" ATE   |
|  | 2.1 dT   | 65   | 11.93  | 01.95 - ABS  |   |  |   |  |
|  | 2.2 i (B541)   | 79   | 04.92  | 01.95 - ABS  |   |  |   |  |
|    | 2.0 i (B540)   | 77   | 09.92  | 01.95 - ABS  | 03.2122-0621.3  | 010131   |   | THz 22,20 ATE  |
|  | 2.1 dT   | 65   | 11.93  | 01.95 - ABS  |   |  |   |  |
|  | 2.2 i (B541)   | 79   | 04.92  | 01.95 - ABS  |   |  |   |  |
|  | 2.0 i (B540)   | 77   | 02.95  | 07.96  | 24.2122-1707.3  | 010438   |   | THz 22,20  |
|  | 2.0 i (B540)   | 77   | 09.92  | 01.95 + ABS  |   |  |   |  |
|  | 2.0 i (B540)   | 77   | 09.92  | 01.95 - ABS  |   |  |   |  |
|  | 2.0 i (B542/E)   | 97   | 04.92  | 07.96  |   |  |   |  |
|  | 2.0 i (B54L)   | 100  | 08.96  | 12.00  |   |  |   |  |
|  | 2.1 dT   | 65   | 02.95  | 07.96  |   |  |   |  |
|  | 2.1 dT   | 65   | 11.93  | 01.95 + ABS  |   |  |   |  |
|  | 2.2 i (B541)   | 79   | 04.92  | 01.95 + ABS  |   |  |   |  |
|  | 2.2 i (B543)   | 101  | 04.92  | 07.96  |   |  |   |  |
|  | 2.5 dT   | 83   | 07.93  | 05.94 + Schaltgetriebe 1)  |   |  |   |  |
|  | 2.5 dT   | 83   | 12.92  | 06.93  |   |  |   |  |
|  | 2.0 i (B54L)   | 100  | 08.96  | 12.00  | 24.2123-1701.3  | 010424   |   | THz 23,81  |
|  | 2.2 dT   | 83   | 08.96  | 12.00  |   |  |   |  |
|  | 2.5 20V  | 121  | 08.96  | 12.00  |   |  |   |  |
|  | 2.5 dT   | 83   | 06.94  | 07.96  |   |  |   |  |
|  | 2.5 dT   | 83   | 07.93  | 05.94 + Automatikgetriebe 2)   |   |  |   |  |
|  | 3.0 V6   | 123  | 10.96  | 12.00  |   |  |   |  |
|  | 3.0 V6   | 140  | 03.99  | 12.00  |   |  |   |  |
|  | 3.0 V6 (B544/B/J)  | 123  | 12.92  | 07.96  |   |  |   |  |
|  | 3.0 V6 Biturbo   | 193  | 01.93  | 07.96  |   |  |   |  |
|   | 2.0 i (B540)   | 77   | 09.92  | 07.96  | 24.3541-1741.5  | 240215   |   | D=54, - Halter LUC   |
|  | 2.0 i (B542/E)   | 97   | 04.92  | 07.96  | 24.3541-1742.5  | 240216   |  | D=54, - Halter LUC   |
|  | 2.0 i (B54L)   | 100  | 08.96  | 12.00  |   |  |   |  |
|  | 2.1 dT   | 65   | 11.93  | 07.96  |   |  |   |  |
|  | 2.2 i (B541)   | 79   | 04.92  | 07.96  |   |  |   |  |
|  | 2.2 i (B543)   | 101  | 04.92  | 07.96  |   |  |   |  |
|  | 2.5 dT   | 83   | 09.92  | 05.94 + Schaltgetriebe 1)  |   |  |   |  |
|  | 2.5 dT   | 83   | 12.92  | 06.93 + Automatikgetriebe 2)   |   |  |   |  |
|  | 2.2 dT   | 83   | 08.96  | 12.00  | 24.3601-1707.5  | 240229   |  | D=60, - Halter LUC   |
|  | 2.5 20V  | 121  | 08.96  | 12.00  | 24.3601-1708.5  | 240230   |  | D=60, - Halter LUC   |
|  | 2.5 dT   | 83   | 06.94  | 07.96 + Schaltgetriebe 1)  |   |  |   |  |
|  | 2.5 dT   | 83   | 07.93  | 07.96 + Automatikgetriebe 2)   |   |  |   |  |
|  | 3.0 V6   | 123  | 08.96  | 12.00  |   |  |   |  |
|  | 3.0 V6   | 140  | 03.99  | 12.00  |   |  |   |  |
|  | 3.0 V6 (B544/B/J)  | 123  | 12.92  | 07.96  |   |  |   |  |
|  | 2.0 i (B540)   | 77   | 09.92  | 07.96  | 24.5111-0285.3  | 330608   | 2   | L=285  |
|  | 2.0 i (B542/E)   | 97   | 04.92  | 07.96  |   |  |   |  |
|  | 2.0 i (B54L)   | 100  | 08.96  | 12.00  |   |  |   |  |
|  | 2.1 dT   | 65   | 11.93  | 07.96  |   |  |   |  |
|  | 2.2 dT   | 83   | 08.96  | 12.00  |   |  |   |  |
|  | 2.2 i (B541)   | 79   | 04.92  | 07.96  |   |  |   |  |
|  | 2.2 i (B543)   | 101  | 04.92  | 07.96  |   |  |   |  |
|  | 2.5 20V  | 121  | 08.96  | 12.00  |   |  |   |  |
|  | 2.5 dT   | 83   | 12.92  | 07.96  |   |  |   |  |
|  | 3.0 V6   | 123  | 08.96  | 12.00  |   |  |   |  |
|  | 3.0 V6   | 140  | 03.99  | 12.00  |   |  |   |  |
|  | 3.0 V6 (B544/B/J)  | 123  | 12.92  | 07.96  |   |  |   |  |
|  | 2.0 i (B540)   | 77   | 09.92  | 07.96 + ABS  | 24.5111-0386.3  | 330503   | 2   | L=385  |
|  | 2.0 i (B540)   | 77   | 02.95  | 07.96 - ABS  |   |  |   |  |
|  | 2.0 i (B542/E)   | 97   | 04.92  | 07.96  |   |  |   |  |
|  | 2.0 i (B54L)   | 100  | 08.96  | 12.00  |   |  |   |  |
|  | 2.1 dT   | 65   | 11.93  | 07.96 + ABS  |   |  |   |  |
|  | 2.1 dT   | 65   | 02.95  | 07.96 - ABS  |   |  |   |  |
|  | 2.2 dT   | 83   | 08.96  | 12.00  |   |  |   |  |
|  | 2.2 i (B541)   | 79   | 04.92  | 07.96 + ABS  |   |  |   |  |
|  | 2.2 i (B541)   | 79   | 02.95  | 07.96 - ABS  |   |  |   |  |
|  | 2.2 i (B543)   | 101  | 04.92  | 07.96  |   |  |   |  |
|  | 2.5 20V  | 121  | 08.96  | 12.00  |   |  |   |  |
|  | 2.5 dT   | 83   | 12.92  | 07.96  |   |  |   |  |
|  | 3.0 V6   | 123  | 08.96  | 12.00  |   |  |   |  |
|  | 3.0 V6   | 140  | 03.99  | 12.00  |   |  |   |  |
|  | 3.0 V6 (B544)  | 123  | 12.92  | 07.96  |   |  |   |  |
|  | 3.0 V6 (B54B/J)  | 123  | 12.92  | 07.96  |   |  |   |  |
|  | 3.0 V6 4x4 (B544)  | 123  | 02.93  | 07.96  | 24.5111-0300.3  | 330407   | 2   | L=300  |
|  | 3.0 V6 Biturbo   | 193  | 01.93  | 07.96  |   |  |   |  |

1) + manual transmission / + scatola cambio velocità / + transmission mécanique / + cambio de velocidad  
2) + autom.transmission / + scatola cambio automatico / + transmission automatique / + cambio automático

|     |  |  |  |  |  |  |  |  |                |     |
|--|--|--|--|--|---|--|--|--|----------------|-----|
| <b>RENAULT SAFRANE (B54_) (92-00)</b>  |  |  |  |  |   |  |  |  |                |     |
|    | 2.0 i (B540)   | 77   | 09.92  | 01.95  | - ABS   | 24.3222-1615.3   | 020285   | Rz 22,20   | LUC            |     |
|  | 2.1 dT   | 65   | 11.93  | 01.95  | - ABS   |  |  |  |                |     |
|  | 2.2 i (B541)   | 79   | 04.92  | 01.95  | - ABS   |  |  |  |                |     |
|    | 2.0 i (B540)   | 77   | 09.92  | 01.95  | - ABS   | 24.3727-1030.2   | 581030   | L=700  |                |     |
|  | 2.1 dT   | 65   | 11.93  | 01.95  | - ABS   |  |  |  |                |     |
|  | 2.2 i (B541)   | 79   | 04.92  | 01.95  | - ABS   |  |  |  |                |     |
|  | 2.0 i (B540)   | 77   | 02.95  | 07.96  |   | 24.3727-1028.2   | 581028   | L=850  |                |     |
|  | 2.0 i (B540)   | 77   | 09.92  | 01.95  | + ABS   | 24.3727-1034.2   | 581034   | L=1091   |                |     |
|  | 2.0 i (B542/E)   | 97   | 04.92  | 07.96  |   |  |  |  |                |     |
|  | 2.0 i (B54L)   | 100  | 08.96  | 12.00  |   |  |  |  |                |     |
|  | 2.1 dT   | 65   | 02.95  | 07.96  |   |  |  |  |                |     |
|  | 2.1 dT   | 65   | 11.93  | 01.95  | + ABS   |  |  |  |                |     |
|  | 2.2 dT   | 83   | 08.96  | 12.00  |   |  |  |  |                |     |
|  | 2.2 i (B541)   | 79   | 02.95  | 07.96  |   |  |  |  |                |     |
|  | 2.2 i (B541)   | 79   | 04.92  | 01.95  | + ABS   |  |  |  |                |     |
|  | 2.2 i (B543)   | 101  | 04.92  | 07.96  |   |  |  |  |                |     |
|  | 2.5 20V  | 121  | 08.96  | 12.00  |   |  |  |  |                |     |
|  | 2.5 dT   | 83   | 12.92  | 07.96  |   |  |  |  |                |     |
|  | 3.0 V6   | 123  | 08.96  | 12.00  |   |  |  |  |                |     |
|  | 3.0 V6   | 140  | 03.99  | 12.00  |   |  |  |  |                |     |
|  | 3.0 V6 (B544)  | 123  | 12.92  | 09.96  |   |  |  |  |                |     |
|  | 3.0 V6 (B54B/J)  | 123  | 12.92  | 07.96  |   |  |  |  |                |     |
|    | 2.0 i (B540)   | 77   | 09.92  | 01.95  | - ABS   | 24.6583-1709.3   | 320165   | BRL (4)  |                |     |
|  | 2.1 dT   | 65   | 11.93  | 01.95  | - ABS   |  |  |  |                |     |
|  | 2.2 i (B541)   | 79   | 04.92  | 01.95  | - ABS   |  |  |  |                |     |
|  | 2.0 i (B540)   | 77   | 09.92  | 07.96  | + ABS   | 24.6583-1708.3   | 320164   | BRL (4)  |                |     |
|  | 2.0 i (B540)   | 77   | 02.95  | 07.96  | - ABS   |  |  |  |                |     |
|  | 2.0 i (B542)   | 97   | 04.92  | 07.96  | - Niveauregulierung <sup>1)</sup>   |  |  |  |                |     |
|  | 2.0 i (B54E)   | 97   | 01.93  | 07.96  |   |  |  |  |                |     |
|  | 2.0 i (B54L)   | 100  | 08.96  | 12.96  |   |  |  |  |                |     |
|  | 2.1 dT   | 65   | 11.93  | 07.96  | + ABS   |  |  |  |                |     |
|  | 2.1 dT   | 65   | 02.95  | 07.96  | - ABS   |  |  |  |                |     |
|  | 2.2 i (B541)   | 79   | 04.92  | 07.96  | + ABS   |  |  |  |                |     |
|  | 2.2 i (B541)   | 79   | 02.95  | 07.96  | - ABS   |  |  |  |                |     |
|  | 2.2 i (B543)   | 101  | 04.92  | 07.96  | - Niveauregulierung <sup>1)</sup>   |  |  |  |                |     |
|  | 2.5 dT   | 83   | 12.92  | 05.94  | - Niveaureg./ + Schaltgetriebe <sup>2)</sup>                                      |  |  |  |                |     |
|  | 2.5 dT   | 83   | 12.92  | 06.93  | - Niveaureg./ + Automatikgetr. <sup>3)</sup>                                      |  |  |  |                |     |
|   | 2.0 i (B540)   | 77   | 11.92  | 07.96  |   | 24.3728-1021.2   | 591021   | L=1293   |                |     |
|  | 2.1 dT   | 65   | 11.93  | 07.96  |   |  |  |  |                |     |
|  | 2.2 i (B541)   | 79   | 11.92  | 07.96  |   |  |  |  |                |     |
|  | 2.2 i (B543)   | 101  | 11.92  | 07.96  |   |  |  |  |                |     |
| <b>RENAULT SANDERO (BS0_) (09-)</b>  |  |  |  |  |   |  |  |  |                |     |
|  | 1.4  | 55   | 02.09  |  |   | 03.7853-4102.4   | 300271   | + ABS  | 9"             | ATE |
|  | 1.6  | 62   | 11.10  |  |   |  |  |  |                |     |
|  | 1.6  | 64   | 02.09  |  |   |  |  |  |                |     |
|  | 1.6  | 66   | 05.09  |  |   |  |  |  |                |     |
|  | 1.4  | 55   | 02.09  |  |   | 03.2120-4611.3   | 010937   | + ABS  | THz 20,64      | ATE |
|  | 1.6  | 62   | 11.10  |  |   |  |  |  |                |     |
|  | 1.6  | 64   | 02.09  |  |   |  |  |  |                |     |
|  | 1.6  | 66   | 05.09  |  |   |  |  |  |                |     |
|  | 1.4  | 55   | 02.09  |  |   | 24.3481-1611.5   | 240029   | <input type="checkbox"/> - belüftete Scheiben <sup>4)</sup>                        | D=48, - Halter | LUC |
|  | 1.6  | 62   | 11.10  |  |   | 24.3481-1612.5   | 240030   | <input type="checkbox"/> - belüftete Scheiben <sup>4)</sup>                        | D=48, - Halter | LUC |
|  | 1.6  | 64   | 02.09  |  |   |  |  |  |                |     |
|  | 1.6  | 66   | 05.09  |  |   |  |  |  |                |     |
|  | 1.4  | 55   | 02.09  |  |   | 24.3481-1615.5   | 240031   | <input type="checkbox"/> + belüftete Scheiben <sup>5)</sup>                        | D=48, - Halter | LUC |
|  | 1.6  | 62   | 11.10  |  |   | 24.3481-1616.5   | 240032   | <input type="checkbox"/> + belüftete Scheiben <sup>5)</sup>                        | D=48, - Halter | LUC |
|  | 1.6  | 64   | 02.09  |  |   |  |  |  |                |     |
|  | 1.6  | 66   | 05.09  |  |   |  |  |  |                |     |
|  | 1.4  | 55   | 02.09  |  |   | 24.5111-0300.3   | 330407   | 2  | L=300          |     |
|  | 1.6  | 62   | 11.10  |  |   |  |  |  |                |     |
|  | 1.6  | 64   | 02.09  |  |   |  |  |  |                |     |
|  | 1.6  | 66   | 05.09  |  |   |  |  |  |                |     |
|  | 1.4  | 55   | 02.09  |  |   | 24.5229-0285.3   | 330032   | 2  | L=285          |     |
|  | 1.6  | 62   | 11.10  |  |   |  |  |  |                |     |
|  | 1.6  | 64   | 02.09  |  |   |  |  |  |                |     |
|  | 1.6  | 66   | 05.09  |  |   |  |  |  |                |     |
|  | 1.4  | 55   | 02.09  |  |   | 24.3217-1710.3   | 020420   |  | Rz 17,78       | LUC |
|  | 1.6  | 62   | 11.10  |  |   |  |  |  |                |     |
|  | 1.6  | 64   | 02.09  |  |   |  |  |  |                |     |
|  | 1.6  | 66   | 05.09  |  |   |  |  |  |                |     |
|  | 1.4  | 55   | 02.09  |  |   | 24.3219-1722.3   | 020426   | - ABS  | Rz 19,05       | BDX |
|  | 1.6  | 62   | 11.10  |  |   |  |  |  |                |     |
|  | 1.6  | 64   | 02.09  |  |   |  |  |  |                |     |
|  | 1.6  | 66   | 05.09  |  |   |  |  |  |                |     |
|  | 1.4  | 55   | 02.09  |  |   | 24.3217-1711.3   | 020449   | + ABS  | Rz 17,78       | BOS |
|  | 1.6  | 64   | 02.09  |  |   |  |  |  |                |     |
|  | 1.6  | 64   | 11.10  |  |   |  |  |  |                |     |
|  | 1.6  | 66   | 05.09  |  |   |  |  |  |                |     |
|  | 1.4  | 55   | 02.09  |  |   | 24.3728-1031.2   | 591031   |  | L=1033         |     |
|  | 1.6  | 62   | 11.10  |  |   |  |  |  |                |     |
|  | 1.6  | 64   | 02.09  |  |   |  |  |  |                |     |
|  | 1.6  | 66   | 05.09  |  |   |  |  |  |                |     |

<sup>1)</sup> - suspension level control / - correttore assetto / - correcteur d'assiette / - regulación altura suspensión

<sup>2)</sup> - sus.level contr./+manual trans. / - corrett.assetto/+scatola camb.velocità / - correcteur d'assiette/+transm. mécan. / - regulac.altura suspens./ + camb.veloc.

<sup>3)</sup> - sus.level control/+autom.trans. / - corrett.assetto/+scatola camb.autom. / - correcteur d'assiette/+transm. autom. / - regulac.altura suspens./ + camb.autom.

<sup>4)</sup> - ventilated discs / - dischi ventilati / - disques ventilés / - disco ventilado

<sup>5)</sup> + ventilated discs / + dischi ventilati / + disques ventilés / + disco ventilado

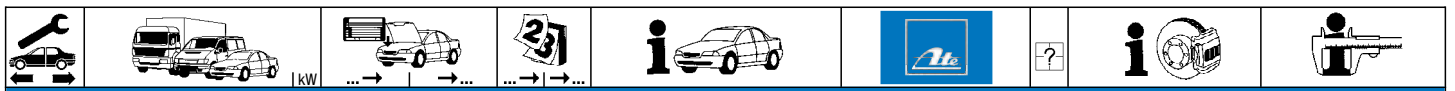

**RENAULT SCENIC I (JA\_) (99-03)**

|                       |                       |                       |       |              |              |                |        |   |                |     |
|-----------------------|-----------------------|-----------------------|-------|--------------|--------------|----------------|--------|---|----------------|-----|
|                       | 1.4 16V (OD,1H,OW,10) | 70                    | 09.99 | 06.03        | - ABS        | 03.7760-5102.4 | 300140 |   | 10"            | ATE |
|                       | 1.6 16V (JA0B,04,11)  | 79                    | 09.99 | 06.03        | - ABS        |                |        |   |                |     |
|                       | 1.8 16V (12,1R,1M,1A) | 85                    | 01.01 | 06.03        | - ABS        |                |        |   |                |     |
|                       | 1.8 16V 4x4           | 85                    | 07.00 | 06.03        | - ABS        |                |        |   |                |     |
|                       | 1.9 dCi (JA01,05,1F)  | 75                    | 09.99 | 06.03        | - ABS        |                |        |   |                |     |
|                       | 1.9 dCi RX4           | 75                    | 11.00 | 06.03        | - ABS        |                |        |   |                |     |
|                       | 1.9 dTi (JA0N)        | 72                    | 09.99 | 06.03        | - ABS        |                |        |   |                |     |
|                       | 2.0 16V (1B,1D,0C)    | 102                   | 06.00 | 06.03        | - ABS        |                |        |   |                |     |
|                       | 2.0 16V IDE           | 103                   | 09.99 | 06.03        | - ABS        |                |        |   |                |     |
|                       | 2.0 16V RX4           | 102                   | 06.00 | 06.03        | - ABS        |                |        |   |                |     |
|                       | 1.4 16V (OD,1H,OW,10) | 70                    | 09.99 | 06.03        | + ABS        | 03.7863-2002.4 | 300126 |   | 10"            | ATE |
|                       | 1.6 16V (JA0B,04,11)  | 79                    | 09.99 | 06.03        | + ABS        |                |        |   |                |     |
|                       | 1.8 16V (12,1R,1M,1A) | 85                    | 01.01 | 06.03        | + ABS        |                |        |   |                |     |
|                       | 1.8 16V 4x4           | 85                    | 07.00 | 04.01        | + ABS        |                |        |   |                |     |
|                       | 1.9 dCi (JA01,05,1F)  | 75                    | 09.99 | 06.03        | + ABS        |                |        |   |                |     |
|                       | 1.9 dCi RX4           | 75                    | 11.00 | 06.03        | + ABS        |                |        |   |                |     |
|                       | 1.9 dTi (JA1U)        | 59                    | 01.01 | 06.03        | + ABS        |                |        |   |                |     |
|                       | 2.0 16V IDE           | 103                   | 09.99 | 06.03        | + ABS        |                |        |   |                |     |
|                       | 2.0 16V RX4           | 102                   | 06.00 | 06.03        | + ABS        |                |        |   |                |     |
|                       |                       | 1.4 16V (OD,1H,OW,10) | 70    | 09.99        | 06.03        |                |        |   |                |     |
| 1.6 16V (JA0B,04,11)  |                       | 79                    | 09.99 | 06.03        | - ABS        |                |        |   |                |     |
| 1.8 16V (12,1R,1M,1A) |                       | 85                    | 01.01 | 06.03        | - ABS        |                |        |   |                |     |
| 1.8 16V 4x4           |                       | 85                    | 07.00 | 06.03        | - ABS        |                |        |   |                |     |
| 1.9 dCi (JA01,05,1F)  |                       | 75                    | 09.99 | 06.03        | - ABS        |                |        |   |                |     |
| 1.9 dCi RX4           |                       | 75                    | 11.00 | 06.03        | - ABS        |                |        |   |                |     |
| 1.9 dTi (JA0N)        |                       | 72                    | 09.99 | 06.03        | - ABS        |                |        |   |                |     |
| 2.0 16V (1B,1D,0C)    |                       | 102                   | 06.00 | 06.03        | - ABS        |                |        |   |                |     |
| 2.0 16V IDE           |                       | 103                   | 09.99 | 06.03        | - ABS        |                |        |   |                |     |
| 2.0 16V RX4           |                       | 102                   | 06.00 | 06.03        | - ABS        |                |        |   |                |     |
|                       | 1.4 16V (OD,1H,OW,10) | 70                    | 09.99 | 06.03        | + ABS/ - ESP | 03.2123-2146.3 | 010572 |   | Thz 23,81      | ATE |
|                       | 1.6 16V (JA0B,04,11)  | 79                    | 09.99 | 06.03        | + ABS/ - ESP |                |        |   |                |     |
|                       | 1.8 16V (12,1R,1M,1A) | 85                    | 01.01 | 06.03        | + ABS/ - ESP |                |        |   |                |     |
|                       | 1.8 16V 4x4           | 85                    | 07.00 | 04.01        | + ABS/ - ESP |                |        |   |                |     |
|                       | 1.9 dCi (JA01,05,1F)  | 75                    | 09.99 | 06.03        | + ABS/ - ESP |                |        |   |                |     |
|                       | 1.9 dCi RX4           | 75                    | 11.00 | 06.03        | + ABS/ - ESP |                |        |   |                |     |
|                       | 1.9 dTi (JA0N)        | 72                    | 09.99 | 06.03        | + ABS        |                |        |   |                |     |
|                       | 1.9 dTi (JA1U)        | 59                    | 01.01 | 06.03        | + ABS/ - ESP |                |        |   |                |     |
|                       | 2.0 16V (1B,1D,0C)    | 102                   | 06.00 | 06.03        | + ABS/ - ESP |                |        |   |                |     |
|                       | 2.0 16V IDE           | 103                   | 09.99 | 06.03        | + ABS/ - ESP |                |        |   |                |     |
| 2.0 16V RX4           | 102                   | 06.00                 | 06.03 | + ABS/ - ESP |              |                |        |   |                |     |
|                       | 1.4 16V (OD,1H,OW,10) | 70                    | 09.99 | 06.03        | + ABS/ + ESP | 03.2123-2621.3 | 010701 |   | Thz 23,81      | ATE |
|                       | 1.6 16V (JA0B,04,11)  | 79                    | 09.99 | 06.03        | + ABS/ + ESP |                |        |   |                |     |
|                       | 1.8 16V (12,1R,1M,1A) | 85                    | 01.01 | 06.03        | + ABS/ + ESP |                |        |   |                |     |
|                       | 1.8 16V 4x4           | 85                    | 07.00 | 04.01        | + ABS/ + ESP |                |        |   |                |     |
|                       | 1.9 dCi (JA01,05,1F)  | 75                    | 09.99 | 06.03        | + ABS/ + ESP |                |        |   |                |     |
|                       | 1.9 dCi RX4           | 75                    | 11.00 | 06.03        | + ABS/ + ESP |                |        |   |                |     |
|                       | 1.9 dTi (JA1U)        | 59                    | 01.01 | 06.03        | + ABS/ + ESP |                |        |   |                |     |
|                       | 2.0 16V (1B,1D,0C)    | 102                   | 06.00 | 06.03        | + ABS/ + ESP |                |        |   |                |     |
|                       | 2.0 16V IDE           | 103                   | 09.99 | 06.03        | + ABS/ + ESP |                |        |   |                |     |
|                       | 2.0 16V RX4           | 102                   | 06.00 | 06.03        | + ABS/ + ESP |                |        |   |                |     |
|                       | 1.4 16V (OD,1H,OW,10) | 70                    | 09.99 | 06.03        | + ABS/ - ESP | 03.2123-2181.3 | 010608 |   | Thz 23,81      | ATE |
|                       | 1.6 16V (JA0B,04,11)  | 79                    | 09.99 | 06.03        | + ABS/ - ESP |                |        |   |                |     |
|                       | 1.8 16V (12,1R,1M,1A) | 85                    | 01.01 | 06.03        | + ABS/ - ESP |                |        |   |                |     |
|                       | 1.8 16V 4x4           | 85                    | 07.00 | 06.03        | + ABS/ - ESP |                |        |   |                |     |
|                       | 1.9 dCi (JA01,05,1F)  | 75                    | 09.99 | 06.03        | + ABS/ - ESP |                |        |   |                |     |
|                       | 1.9 dCi RX4           | 75                    | 11.00 | 06.03        | + ABS/ - ESP |                |        |   |                |     |
|                       | 1.9 dTi (JA0N)        | 72                    | 09.99 | 06.03        |              |                |        |   |                |     |
|                       | 1.9 dTi (JA1U)        | 59                    | 01.01 | 06.03        |              |                |        |   |                |     |
|                       | 2.0 16V (1B,1D,0C)    | 102                   | 06.00 | 06.03        | + ABS/ - ESP |                |        |   |                |     |
|                       | 2.0 16V IDE           | 103                   | 09.99 | 06.03        | + ABS/ - ESP |                |        |   |                |     |
| 2.0 16V RX4           | 102                   | 06.00                 | 06.03 | + ABS/ - ESP |              |                |        |   |                |     |
|                       | 1.4 16V (OD,1H,OW,10) | 70                    | 09.99 | 06.03        |              | 24.3541-1749.5 | 240427 |   | D=54, - Halter | LUC |
|                       | 1.6 16V (JA0B,04,11)  | 79                    | 10.99 | 06.03        |              |                |        |   |                |     |
|                       | 1.8 16V (12,1R,1M,1A) | 85                    | 01.01 | 06.03        |              |                |        |   |                |     |
|                       | 1.8 16V 4x4           | 85                    | 07.00 | 06.03        |              |                |        |   |                |     |
|                       | 1.9 dCi (JA01,05,1F)  | 75                    | 09.99 | 06.03        |              |                |        |   |                |     |
|                       | 1.9 dCi RX4           | 75                    | 11.00 | 03.02        |              |                |        |   |                |     |
|                       | 1.9 dTi (JA0N)        | 72                    | 09.99 | 06.03        |              |                |        |   |                |     |
|                       | 1.9 dTi (JA1U)        | 59                    | 01.01 | 06.03        |              |                |        |   |                |     |
|                       | 2.0 16V (1B,1D,0C)    | 102                   | 06.00 | 06.03        |              |                |        |   |                |     |
|                       | 2.0 16V IDE           | 103                   | 09.99 | 06.03        |              |                |        |   |                |     |
| 2.0 16V RX4           | 102                   | 06.00                 | 03.02 |              |              |                |        |   |                |     |
|                       | 1.9 dCi RX4           | 75                    | 04.02 | 06.03        |              | 11.9571-9841.2 | 220401 |   | D=57, - Halter | ATE |
|                       | 2.0 16V RX4           | 102                   | 04.02 | 06.03        |              |                |        |   |                |     |
|                       | 1.4 16V (OD,1H,OW,10) | 70                    | 09.99 | 06.03        |              | 24.3541-1750.5 | 240428 |   | D=54, - Halter | LUC |
|                       | 1.6 16V (JA0B,04,11)  | 79                    | 10.99 | 06.03        |              |                |        |   |                |     |
|                       | 1.8 16V (12,1R,1M,1A) | 85                    | 01.01 | 06.03        |              |                |        |   |                |     |
|                       | 1.8 16V 4x4           | 85                    | 07.00 | 06.03        |              |                |        |   |                |     |
|                       | 1.9 dCi (JA01,05,1F)  | 75                    | 09.99 | 06.03        |              |                |        |   |                |     |
|                       | 1.9 dCi RX4           | 75                    | 11.00 | 03.02        |              |                |        |   |                |     |
|                       | 1.9 dTi (JA0N)        | 72                    | 09.99 | 06.03        |              |                |        |   |                |     |
|                       | 1.9 dTi (JA1U)        | 59                    | 01.01 | 06.03        |              |                |        |   |                |     |
|                       | 2.0 16V (1B,1D,0C)    | 102                   | 06.00 | 06.03        |              |                |        |   |                |     |
|                       | 2.0 16V IDE           | 103                   | 09.99 | 06.03        |              |                |        |   |                |     |
| 2.0 16V RX4           | 102                   | 06.00                 | 03.02 |              |              |                |        |   |                |     |
|                       | 1.4 16V (OD,1H,OW,10) | 70                    | 09.99 | 06.03        |              | 24.3571-9841.5 | 240501 |   | D=57, - Halter | ATE |
|                       | 1.6 16V (JA0B,04,11)  | 79                    | 09.99 | 06.03        |              |                |        |   |                |     |
|                       | 1.8 16V (12,1R,1M,1A) | 85                    | 01.01 | 06.03        |              |                |        |   |                |     |
|                       | 1.8 16V 4x4           | 85                    | 07.00 | 06.03        |              |                |        |   |                |     |
|                       | 1.9 dCi (JA01,05,1F)  | 75                    | 09.99 | 06.03        |              |                |        |   |                |     |
|                       | 1.9 dTi (JA0N)        | 72                    | 09.99 | 06.03        |              |                |        |   |                |     |
|                       | 1.9 dTi (JA1U)        | 59                    | 01.01 | 06.03        |              |                |        |   |                |     |
|                       | 2.0 16V (1B,1D,0C)    | 102                   | 06.00 | 06.03        |              |                |        |   |                |     |
|                       | 2.0 16V IDE           | 103                   | 09.99 | 06.03        |              |                |        |   |                |     |
|                       | 2.0 16V RX4           | 102                   | 06.00 | 03.02        |              |                |        |   |                |     |
|                       | 1.4 16V (OD,1H,OW,10) | 70                    | 09.99 | 06.03        |              | 24.3571-9842.2 | 220402 |   | D=57, - Halter | ATE |
|                       | 1.6 16V (JA0B,04,11)  | 79                    | 09.99 | 06.03        |              |                |        |   |                |     |
|                       | 1.8 16V (12,1R,1M,1A) | 85                    | 01.01 | 06.03        |              |                |        |   |                |     |
|                       | 1.8 16V 4x4           | 85                    | 07.00 | 06.03        |              |                |        |   |                |     |
|                       | 1.9 dCi (JA01,05,1F)  | 75                    | 09.99 | 06.03        |              |                |        |   |                |     |
|                       | 1.9 dTi (JA0N)        | 72                    | 09.99 | 06.03        |              |                |        |   |                |     |
|                       | 1.9 dTi (JA1U)        | 59                    | 01.01 | 06.03        |              |                |        |   |                |     |
|                       | 2.0 16V (1B,1D,0C)    | 102                   | 06.00 | 06.03        |              |                |        |   |                |     |
|                       | 2.0 16V IDE           | 103                   | 09.99 | 06.03        |              |                |        |   |                |     |
|                       | 2.0 16V RX4           | 102                   | 06.00 | 03.02        |              |                |        |   |                |     |
|                       | 1.4 16V (OD,1H,OW,10) | 70                    | 09.99 | 06.03        |              | 24.3571-9842.5 | 240502 |   | D=57, - Halter | ATE |
|                       | 1.6 16V (JA0B,04,11)  | 79                    | 09.99 | 06.03        |              |                |        |   |                |     |
|                       | 1.8 16V (12,1R,1M,1A) | 85                    | 01.01 | 06.03        |              |                |        |   |                |     |
|                       | 1.8 16V 4x4           | 85                    | 07.00 | 06.03        |              |                |        |   |                |     |
|                       | 1.9 dCi (JA01,05,1F)  | 75                    | 09.99 | 06.03        |              |                |        |   |                |     |
|                       | 1.9 dTi (JA0N)        | 72                    | 09.99 | 06.03        |              |                |        |   |                |     |
|                       | 1.9 dTi (JA1U)        | 59                    | 01.01 | 06.03        |              |                |        |   |                |     |
|                       | 2.0 16V (1B,1D,0C)    | 102                   | 06.00 | 06.03        |              |                |        |   |                |     |
|                       | 2.0 16V IDE           | 103                   | 09.99 | 06.03        |              |                |        |   |                |     |
|                       | 2.0 16V RX4           | 102                   | 06.00 | 03.02        |              |                |        |   |                |     |
|                       | 1.4 16V (OD,1H,OW,10) | 70                    | 09.99 | 06.03        |              | 24.5111-0390.3 | 330566 | 2 | L=390          |     |
|                       | 1.6 16V (JA0B,04,11)  | 79                    | 09.99 | 06.03        |              |                |        |   |                |     |
|                       | 1.8 16V (12,1R,1M,1A) | 85                    | 01.01 | 06.03        |              |                |        |   |                |     |
|                       | 1.8 16V 4x4           | 85                    | 07.00 | 06.03        |              |                |        |   |                |     |
|                       | 1.9 dCi (JA01,05,1F)  | 75                    | 09.99 | 06.03        |              |                |        |   |                |     |
|                       | 1.9 dTi (JA0N)        | 72                    | 09.99 | 06.03        |              |                |        |   |                |     |
|                       | 1.9 dTi (JA1U)        | 59                    | 01.01 | 06.03        |              |                |        |   |                |     |
|                       | 2.0 16V (1B,1D,0C)    | 102                   | 06.00 | 06.03        |              |                |        |   |                |     |
|                       | 2.0 16V IDE           | 103                   | 09.99 | 06.03        |              |                |        |   |                |     |
|                       | 2.0 16V RX4           | 102                   | 06.00 | 03.02        |              |                |        |   |                |     |





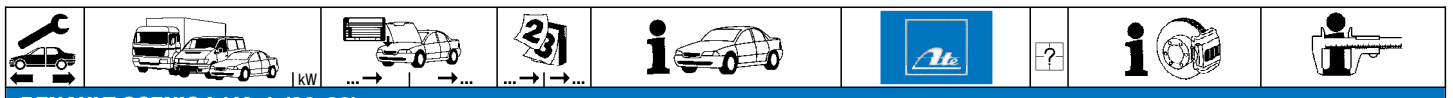







### RENAULT SCENIC I (JA\_) (99-03)

|                      |                       |     |       |       |       |       |                |        |   |  |                |     |
|----------------------|-----------------------|-----|-------|-------|-------|-------|----------------|--------|---|--|----------------|-----|
|                      | 1.4 16V (OD,1H,0W,10) | 70  |       | 09.99 | 06.03 | + ABS | 24.3344-1707.7 | 220531 |   |  | D=34, - Halter | LUC |
|                      | 1.6 16V (JA0B,04,11)  | 79  |       | 09.99 | 06.03 | + ABS | 24.3344-1708.7 | 220532 |   |  | D=34, - Halter | LUC |
|                      | 1.8 16V (12,1R,1M,1A) | 85  |       | 01.01 | 06.03 |       |                |        |   |  |                |     |
|                      | 1.8 16V 4x4           | 85  |       | 07.00 | 06.03 |       |                |        |   |  |                |     |
|                      | 1.9 dCi (JA01,05,1F)  | 75  |       | 09.99 | 06.03 |       |                |        |   |  |                |     |
|                      | 1.9 dTi (JA0N)        | 72  |       | 09.99 | 06.03 | + ABS |                |        |   |  |                |     |
|                      | 1.9 dTi (JA1U)        | 59  |       | 01.01 | 06.03 |       |                |        |   |  |                |     |
|                      | 2.0 16V (1B,1D,0C)    | 102 |       | 06.00 | 06.03 |       |                |        |   |  |                |     |
|                      | 2.0 16V IDE           | 103 |       | 09.99 | 06.03 |       |                |        |   |  |                |     |
|                      | 1.4 16V (OD,1H,0W,10) | 70  |       | 09.99 | 06.03 |       | 24.5229-0265.3 | 330540 | 2 |  | L=265          |     |
|                      | 1.6 16V (JA0B,04,11)  | 79  |       | 09.99 | 06.03 |       |                |        |   |  |                |     |
|                      | 1.8 16V (12,1R,1M,1A) | 85  |       | 01.01 | 06.03 |       |                |        |   |  |                |     |
|                      | 1.9 dCi (JA01,05,1F)  | 75  |       | 09.99 | 06.03 |       |                |        |   |  |                |     |
|                      | 2.0 16V (1B,1D,0C)    | 102 |       | 06.00 | 06.03 |       |                |        |   |  |                |     |
|                      | 2.0 16V IDE           | 103 |       | 09.99 | 06.03 |       |                |        |   |  |                |     |
|                      | 1.9 dCi RX4           | 75  |       | 11.00 | 06.03 |       | 24.5229-0325.3 | 330617 | 2 |  | L=325          |     |
|                      | 2.0 16V RX4           | 102 |       | 06.00 | 06.03 |       |                |        |   |  |                |     |
|                      |                       |     |       |       |       |       |                |        |   |  |                |     |
|                      | 1.4 16V (OD,1H,0W,10) | 70  |       | 09.99 | 06.03 | - ABS | 24.3220-1711.3 | 020409 |   |  | Rz 20,64       | LUC |
|                      | 1.6 16V (JA0B,04,11)  | 79  |       | 09.99 | 06.03 | - ABS |                |        |   |  |                |     |
|                      | 1.9 dTi (JA0N)        | 72  |       | 09.99 | 06.03 | - ABS |                |        |   |  |                |     |
|                      | 1.4 16V (OD,1H,0W,10) | 70  |       | 09.99 | 06.03 | + ABS | 24.3727-1056.2 | 581056 |   |  | L=1508         |     |
|                      | 1.6 16V (JA0B,04,11)  | 79  |       | 09.99 | 06.03 | + ABS | 24.3727-1055.2 | 581055 |   |  | L=1479         |     |
|                      | 1.8 16V 4x4           | 85  |       | 07.00 | 04.01 |       |                |        |   |  |                |     |
|                      | 1.9 dCi (JA01,05,1F)  | 75  |       | 09.99 | 06.03 | + ABS |                |        |   |  |                |     |
|                      | 1.9 dTi (JA0N)        | 72  |       | 09.99 | 06.03 | + ABS |                |        |   |  |                |     |
|                      | 2.0 16V (1B,1D,0C)    | 102 |       | 06.00 | 06.03 | + ABS |                |        |   |  |                |     |
|                      | 1.4 16V (OD,1H,0W,10) | 70  |       | 09.99 | 06.03 | - ABS | 24.3727-1045.2 | 581045 | 2 |  | L=1476         |     |
|                      | 1.6 16V (JA0B,04,11)  | 79  |       | 09.99 | 06.03 | - ABS |                |        |   |  |                |     |
|                      | 1.8 16V (12,1R,1M,1A) | 85  |       | 01.01 | 06.03 |       |                |        |   |  |                |     |
| 1.9 dCi (JA01,05,1F) | 75                    |     | 09.99 | 06.03 | - ABS |       |                |        |   |  |                |     |
| 1.9 dTi (JA0N)       | 72                    |     | 09.99 | 06.03 | - ABS |       |                |        |   |  |                |     |
| 1.9 dTi (JA1U)       | 59                    |     | 01.01 | 06.03 |       |       |                |        |   |  |                |     |
| 2.0 16V (1B,1D,0C)   | 102                   |     | 06.00 | 06.03 | - ABS |       |                |        |   |  |                |     |
| 2.0 16V IDE          | 103                   |     | 09.99 | 06.03 |       |       |                |        |   |  |                |     |
|                      | 1.4 16V (OD,1H,0W,10) | 70  |       | 09.99 | 06.03 |       | 24.6582-1702.3 | 320172 |   |  | BRL (4)        |     |
|                      | 1.6 16V (JA0B,04,11)  | 79  |       | 09.99 | 06.03 |       |                |        |   |  |                |     |
|                      | 1.9 dCi (JA01,05,1F)  | 75  |       | 09.99 | 06.03 |       |                |        |   |  |                |     |
|                      | 1.9 dCi RX4           | 75  |       | 11.00 | 06.03 |       |                |        |   |  |                |     |
|                      | 1.9 dTi (JA0N)        | 72  |       | 09.99 | 06.03 |       |                |        |   |  |                |     |
|                      | 2.0 16V (1B,1D,0C)    | 102 |       | 06.00 | 06.03 |       |                |        |   |  |                |     |
|                      | 2.0 16V IDE           | 103 |       | 09.99 | 06.03 |       |                |        |   |  |                |     |
| 2.0 16V RX4          | 102                   |     | 06.00 | 06.03 |       |       |                |        |   |  |                |     |
|                      | 1.4 16V (OD,1H,0W,10) | 70  |       | 09.99 | 06.03 |       | 24.3728-1024.2 | 591024 |   |  | L=973          |     |
|                      | 1.6 16V (JA0B,04,11)  | 79  |       | 09.99 | 06.03 |       |                |        |   |  |                |     |
|                      | 1.8 16V (12,1R,1M,1A) | 85  |       | 01.01 | 06.03 |       |                |        |   |  |                |     |
|                      | 1.8 16V 4x4           | 85  |       | 07.00 | 06.03 |       |                |        |   |  |                |     |
|                      | 1.9 dCi (JA01,05,1F)  | 75  |       | 09.99 | 06.03 |       |                |        |   |  |                |     |
|                      | 1.9 dTi (JA0N)        | 72  |       | 09.99 | 06.03 |       |                |        |   |  |                |     |
|                      | 1.9 dTi (JA1U)        | 59  |       | 01.01 | 06.03 |       |                |        |   |  |                |     |
|                      | 2.0 16V (1B,1D,0C)    | 102 |       | 06.00 | 06.03 |       |                |        |   |  |                |     |
|                      |                       |     |       |       |       |       |                |        |   |  |                |     |

### RENAULT SCENIC II (JM\_) (03-09)

|         |               |     |       |       |       |  |                |        |   |  |                |     |
|---------|---------------|-----|-------|-------|-------|--|----------------|--------|---|--|----------------|-----|
|         | 1.4 16V       | 72  |       | 06.03 | 03.09 |  | 24.2123-1760.3 | 010779 |   |  | THz 23,81      | LUC |
|         | 1.5 dCi       | 60  |       | 06.03 | 03.09 |  |                |        |   |  |                |     |
|         | 1.5 dCi       | 63  |       | 05.05 | 03.09 |  |                |        |   |  |                |     |
|         | 1.5 dCi       | 74  |       | 11.03 | 03.09 |  |                |        |   |  |                |     |
|         | 1.5 dCi       | 76  |       | 01.07 | 03.09 |  |                |        |   |  |                |     |
|         | 1.5 dCi       | 78  |       | 05.05 | 03.09 |  |                |        |   |  |                |     |
|         | 1.6 16V       | 82  |       | 01.07 | 03.09 |  |                |        |   |  |                |     |
|         | 1.6 16V       | 83  |       | 06.03 | 03.09 |  |                |        |   |  |                |     |
|         | 1.9 D         | 85  |       | 06.06 | 03.09 |  |                |        |   |  |                |     |
|         | 1.9 dCi       | 81  |       | 05.05 | 03.09 |  |                |        |   |  |                |     |
|         | 1.9 dCi       | 88  |       | 06.03 | 03.09 |  |                |        |   |  |                |     |
|         | 1.9 dCi       | 96  |       | 05.05 | 03.09 |  |                |        |   |  |                |     |
|         | 2.0 16V       | 99  |       | 06.03 | 03.09 |  |                |        |   |  |                |     |
|         | 2.0 16V Turbo | 120 |       | 05.04 | 03.09 |  |                |        |   |  |                |     |
| 2.0 dCi | 110           |     | 09.05 | 03.09 |       |  |                |        |   |  |                |     |
|         | 1.4 16V       | 72  |       | 10.05 | 03.09 |  | 11.9541-9545.2 | 220625 |   |  | D=54, - Halter | ATE |
|         | 1.5 dCi       | 78  |       | 10.05 | 03.09 |  | 11.9541-9546.2 | 220626 |   |  | D=54, - Halter | ATE |
|         | 2.0 16V       | 99  |       | 10.05 | 03.09 |  | 11.0101-5407.2 | 260011 |   |  | Hülsensatz     | ATE |
|         |               |     |       |       |       |  | 11.8171-0008.1 | 990049 |   |  | Führungsbolzen | ATE |
|         |               |     |       |       |       |  | 11.8116-0301.1 | 390610 | 2 |  | Haltefeder     | ATE |
|         | 1.5 dCi       | 60  |       | 10.05 | 03.09 |  | 11.9541-9543.2 | 220645 |   |  | D=54, - Halter | ATE |
|         | 1.5 dCi       | 63  |       | 10.05 | 03.09 |  | 11.9541-9544.2 | 220646 |   |  | D=54, - Halter | ATE |
|         | 1.5 dCi       | 74  |       | 10.05 | 03.09 |  | 11.0101-5407.2 | 260011 |   |  | Hülsensatz     | ATE |
|         | 1.5 dCi       | 76  |       | 01.07 | 03.09 |  | 11.8171-0008.1 | 990049 |   |  | Führungsbolzen | ATE |
|         | 1.6 16V       | 82  |       | 01.07 | 03.09 |  | 11.8116-0301.1 | 390610 | 2 |  | Haltefeder     | ATE |
|         | 1.6 16V       | 83  |       | 10.05 | 03.09 |  |                |        |   |  |                |     |
|         | 1.9 D         | 85  |       | 06.06 | 03.09 |  |                |        |   |  |                |     |
|         | 1.9 dCi       | 81  |       | 10.05 | 03.09 |  |                |        |   |  |                |     |
|         | 1.9 dCi       | 88  |       | 10.05 | 03.09 |  |                |        |   |  |                |     |
| 1.9 dCi | 96            |     | 10.05 | 03.09 |       |  |                |        |   |  |                |     |
| 2.0 dCi | 110           |     | 09.05 | 03.09 |       |  |                |        |   |  |                |     |

| RENAULT SCENIC II (JM_) (03-09)   |         |    |       |       |                             |                |        |   |            |                |     |                |        |   |  |                |     |
|---|---------|----|-------|-------|-----------------------------|----------------|--------|---|------------|----------------|-----|----------------|--------|---|--|----------------|-----|
|  | 1.4 16V | 72 |       | 06.03 | 09.05                       | 24.5111-0429.3 | 331015 | 2 |            | L=429          |     |                |        |   |  |                |     |
|   | 1.5 dCi | 60 |       | 06.03 | 09.05                       |                |        |   |            |                |     |                |        |   |  |                |     |
|   | 1.5 dCi | 63 |       | 05.05 | 09.05                       |                |        |   |            |                |     |                |        |   |  |                |     |
|   | 1.5 dCi | 74 |       | 11.03 | 09.05                       |                |        |   |            |                |     |                |        |   |  |                |     |
|   | 1.5 dCi | 78 |       | 05.05 | 09.05                       |                |        |   |            |                |     |                |        |   |  |                |     |
|   | 1.6 16V | 83 |       | 06.03 | 09.05                       |                |        |   |            |                |     |                |        |   |  |                |     |
|   | 1.9 dCi | 81 |       | 05.05 | 09.05                       |                |        |   |            |                |     |                |        |   |  |                |     |
|   | 1.9 dCi | 88 |       | 06.03 | 09.05                       |                |        |   |            |                |     |                |        |   |  |                |     |
|   | 1.9 dCi | 96 |       | 05.05 | 09.05                       |                |        |   |            |                |     |                |        |   |  |                |     |
|   | 2.0 16V | 99 |       | 06.03 | 09.05                       |                |        |   |            |                |     |                |        |   |  |                |     |
| 2.0 16V Turbo   | 120     |    | 05.04 | 09.05 |                             |                |        |   |            |                |     |                |        |   |  |                |     |
|  | 1.4 16V | 72 |       | 10.05 | 03.09                       | 24.5155-0445.3 | 331057 | 2 |            | L=445          |     |                |        |   |  |                |     |
|   | 1.5 dCi | 60 |       | 10.05 | 03.09                       |                |        |   |            |                |     |                |        |   |  |                |     |
|   | 1.5 dCi | 63 |       | 10.05 | 03.09                       |                |        |   |            |                |     |                |        |   |  |                |     |
|   | 1.5 dCi | 74 |       | 10.05 | 03.09                       |                |        |   |            |                |     |                |        |   |  |                |     |
|   | 1.5 dCi | 76 |       | 01.07 | 03.09                       |                |        |   |            |                |     |                |        |   |  |                |     |
|   | 1.5 dCi | 78 |       | 10.05 | 03.09                       |                |        |   |            |                |     |                |        |   |  |                |     |
|   | 1.6 16V | 82 |       | 01.07 | 03.09                       |                |        |   |            |                |     |                |        |   |  |                |     |
|   | 1.6 16V | 83 |       | 10.05 | 03.09                       |                |        |   |            |                |     |                |        |   |  |                |     |
|   | 1.9 D   | 85 |       | 06.06 | 03.09                       |                |        |   |            |                |     |                |        |   |  |                |     |
|   | 1.9 dCi | 81 |       | 10.05 | 03.09                       |                |        |   |            |                |     |                |        |   |  |                |     |
| 1.9 dCi   | 88      |    | 10.05 | 03.09 |                             |                |        |   |            |                |     |                |        |   |  |                |     |
| 1.9 dCi   | 96      |    | 10.05 | 03.09 |                             |                |        |   |            |                |     |                |        |   |  |                |     |
| 2.0 16V   | 99      |    | 10.05 | 03.09 |                             |                |        |   |            |                |     |                |        |   |  |                |     |
| 2.0 16V Turbo   | 120     |    | 10.05 | 03.09 |                             |                |        |   |            |                |     |                |        |   |  |                |     |
| 2.0 dCi   | 110     |    | 09.05 | 03.09 |                             |                |        |   |            |                |     |                |        |   |  |                |     |
|  | 1.6 16V | 83 |       | 06.03 | 03.09                       | 24.3347-1705.7 | 220751 | ☐ |            | D=34, - Halter | LUC |                |        |   |  |                |     |
|   | 1.9 dCi | 88 |       | 06.03 | 03.09                       |                |        |   |            |                |     |                |        |   |  |                |     |
|   | 1.4 16V | 72 |       | 06.03 | 04.07                       |                |        |   |            |                |     | 24.3387-1721.7 | 220781 | ☐ |  | D=38, - Halter | LUC |
|   | 1.5 dCi | 60 |       | 06.03 | 04.07                       |                |        |   |            |                |     |                |        |   |  |                |     |
|   | 1.5 dCi | 63 |       | 05.05 | 04.07                       |                |        |   |            |                |     |                |        |   |  |                |     |
|   | 1.5 dCi | 74 |       | 11.03 | 04.07                       |                |        |   |            |                |     |                |        |   |  |                |     |
|   | 1.5 dCi | 76 |       | 01.07 | 04.07                       |                |        |   |            |                |     |                |        |   |  |                |     |
|   | 1.5 dCi | 78 |       | 05.05 | 04.07                       |                |        |   |            |                |     |                |        |   |  |                |     |
|   | 1.6 16V | 82 |       | 01.07 | 04.07                       |                |        |   |            |                |     |                |        |   |  |                |     |
|   | 1.9 D   | 85 |       | 06.06 | 04.07                       |                |        |   |            |                |     |                |        |   |  |                |     |
| 1.9 dCi   | 96      |    | 05.05 | 04.07 |                             |                |        |   |            |                |     |                |        |   |  |                |     |
| 2.0 16V   | 99      |    | 06.03 | 04.07 |                             |                |        |   |            |                |     |                |        |   |  |                |     |
| 2.0 16V Turbo   | 120     |    | 05.04 | 04.07 |                             |                |        |   |            |                |     |                |        |   |  |                |     |
| 2.0 dCi   | 110     |    | 09.05 | 04.07 |                             |                |        |   |            |                |     |                |        |   |  |                |     |
|  | 1.4 16V | 72 |       | 06.03 | 09.05                       | 24.5251-0185.3 | 330701 | 2 |            | L=185          |     |                |        |   |  |                |     |
|   | 1.5 dCi | 60 |       | 06.03 | 09.05                       |                |        |   |            |                |     |                |        |   |  |                |     |
|   | 1.5 dCi | 63 |       | 05.05 | 09.05                       |                |        |   |            |                |     |                |        |   |  |                |     |
|   | 1.5 dCi | 74 |       | 11.03 | 09.05                       |                |        |   |            |                |     |                |        |   |  |                |     |
|   | 1.5 dCi | 78 |       | 05.05 | 09.05                       |                |        |   |            |                |     |                |        |   |  |                |     |
|   | 1.6 16V | 83 |       | 06.03 | 09.05                       |                |        |   |            |                |     |                |        |   |  |                |     |
|   | 1.9 dCi | 81 |       | 05.05 | 09.05                       |                |        |   |            |                |     |                |        |   |  |                |     |
|   | 1.9 dCi | 88 |       | 06.03 | 09.05                       |                |        |   |            |                |     |                |        |   |  |                |     |
|   | 1.9 dCi | 96 |       | 05.05 | 09.05                       |                |        |   |            |                |     |                |        |   |  |                |     |
|   | 2.0 16V | 99 |       | 06.03 | 09.05                       |                |        |   |            |                |     |                |        |   |  |                |     |
| 2.0 16V Turbo   | 120     |    | 05.04 | 09.05 |                             |                |        |   |            |                |     |                |        |   |  |                |     |
|  | 1.4 16V | 72 |       | 10.05 | 03.09                       | 24.5229-0185.3 | 330397 | 2 |            | L=185          |     |                |        |   |  |                |     |
|   | 1.5 dCi | 60 |       | 10.05 | 03.09                       |                |        |   |            |                |     |                |        |   |  |                |     |
|   | 1.5 dCi | 63 |       | 10.05 | 03.09                       |                |        |   |            |                |     |                |        |   |  |                |     |
|   | 1.5 dCi | 74 |       | 10.05 | 03.09                       |                |        |   |            |                |     |                |        |   |  |                |     |
|   | 1.5 dCi | 76 |       | 01.07 | 03.09                       |                |        |   |            |                |     |                |        |   |  |                |     |
|   | 1.5 dCi | 78 |       | 10.05 | 03.09                       |                |        |   |            |                |     |                |        |   |  |                |     |
|   | 1.6 16V | 82 |       | 01.07 | 03.09                       |                |        |   |            |                |     |                |        |   |  |                |     |
|   | 1.6 16V | 83 |       | 10.05 | 03.09                       |                |        |   |            |                |     |                |        |   |  |                |     |
|   | 1.9 D   | 85 |       | 06.06 | 03.09                       |                |        |   |            |                |     |                |        |   |  |                |     |
|   | 1.9 dCi | 81 |       | 10.05 | 03.09                       |                |        |   |            |                |     |                |        |   |  |                |     |
| 1.9 dCi   | 88      |    | 10.05 | 03.09 |                             |                |        |   |            |                |     |                |        |   |  |                |     |
| 1.9 dCi   | 96      |    | 10.05 | 03.09 |                             |                |        |   |            |                |     |                |        |   |  |                |     |
| 2.0 16V   | 99      |    | 10.05 | 03.09 |                             |                |        |   |            |                |     |                |        |   |  |                |     |
| 2.0 16V Turbo   | 120     |    | 10.05 | 03.09 |                             |                |        |   |            |                |     |                |        |   |  |                |     |
| 2.0 dCi   | 110     |    | 10.05 | 03.09 |                             |                |        |   |            |                |     |                |        |   |  |                |     |
|  | 1.4 16V | 72 |       | 06.03 | 03.09                       | 24.3727-1069.2 | 581069 | 2 | ☐          | L=2080         |     |                |        |   |  |                |     |
|   | 1.5 dCi | 60 |       | 06.03 | 03.09                       |                |        |   |            |                |     |                |        |   |  |                |     |
|   | 1.5 dCi | 63 |       | 05.05 | 03.09                       |                |        |   |            |                |     |                |        |   |  |                |     |
|   | 1.5 dCi | 74 |       | 11.03 | 03.09                       |                |        |   |            |                |     |                |        |   |  |                |     |
|   | 1.5 dCi | 78 |       | 05.05 | 03.09                       |                |        |   |            |                |     |                |        |   |  |                |     |
|   | 1.6 16V | 83 |       | 06.03 | 03.09                       |                |        |   |            |                |     |                |        |   |  |                |     |
|   | 1.9 D   | 85 |       | 06.06 | 03.09                       |                |        |   |            |                |     |                |        |   |  |                |     |
|   | 1.9 dCi | 81 |       | 05.05 | 03.09                       |                |        |   |            |                |     |                |        |   |  |                |     |
|   | 1.9 dCi | 88 |       | 06.03 | 03.09                       |                |        |   |            |                |     |                |        |   |  |                |     |
|   | 1.9 dCi | 96 |       | 05.05 | 03.09                       |                |        |   |            |                |     |                |        |   |  |                |     |
| 2.0 16V   | 99      |    | 06.03 | 03.09 |                             |                |        |   |            |                |     |                |        |   |  |                |     |
| 2.0 16V Turbo   | 120     |    | 05.04 | 03.09 |                             |                |        |   |            |                |     |                |        |   |  |                |     |
| 2.0 dCi   | 110     |    | 09.05 | 03.09 |                             |                |        |   |            |                |     |                |        |   |  |                |     |
| RENAULT SCENIC III (JZ_) (09-)  |         |    |       |       |                             |                |        |   |            |                |     |                |        |   |  |                |     |
|  | 1.2 TCe | 85 |       | 03.12 |                             | 11.9571-9775.2 | 220859 | ☐ |            | D=57, - Halter | ATE |                |        |   |  |                |     |
|   | 1.2 TCe | 97 |       | 03.13 |                             |                |        |   |            |                |     |                |        |   |  |                |     |
|   | 1.4 TCe | 96 |       | 04.09 |                             |                |        |   |            |                |     |                |        |   |  |                |     |
|   | 1.5 dCi | 70 |       | 11.10 | + 16"/17" Rad <sup>2)</sup> |                |        |   |            |                |     |                |        |   |  |                |     |
|   | 1.5 dCi | 78 |       | 04.09 | + 16"/17" Rad <sup>2)</sup> |                |        |   |            |                |     |                |        |   |  |                |     |
|   |         |    |       |       | 11.8116-0351.1              | 390538         | 2      |   | HülSENSatz | ATE            |     |                |        |   |  |                |     |
|   |         |    |       |       |                             |                |        |   | Haltefeder | ATE            |     |                |        |   |  |                |     |



















<sup>1)</sup> - electric parking brake / - freno a mano elettrico / - frein à main électrique / - freno de mano eléctrico

<sup>2)</sup> + 16"/17" wheel / + ruota 16"/17" / + roue 16"/17" / + ruedas 16"/17"

| RENAULT SCENIC III (JZ_) (09-)     |               |     |       |       |                             |                |        |   |  |  |                          |
|------------------------------------|---------------|-----|-------|-------|-----------------------------|----------------|--------|---|--|--|--------------------------|
|                                    | 1.5 dCi       | 81  |       | 04.09 | + 16"/17" Rad <sup>1)</sup> | 11.9571-9775.2 | 220859 | 2 |  | D=57, - Halter<br>D=57, - Halter<br>Hülsensatz<br>Haltefeder | ATE<br>ATE<br>ATE<br>ATE |
|                                    | 1.6 16V       | 81  |       | 04.09 | + 16"/17" Rad <sup>1)</sup> | 11.9571-9776.2 | 220860 |   |  |  |                          |
|                                    | 1.6 dCi       | 96  |       | 04.11 |                             | 11.0101-5704.2 | 260095 |   |  |  |                          |
|                                    | 1.6 E85       | 81  |       | 06.09 | + 16"/17" Rad <sup>1)</sup> | 11.8116-0351.1 | 390538 |   |  |  |                          |
|                                    | 1.9 dCi       | 96  |       | 04.09 |                             |                |        |   |  |  |                          |
|                                    | 2.0 16V       | 103 |       | 04.09 |                             |                |        |   |  |  |                          |
|                                    | 2.0 dCi       | 110 |       | 04.09 |                             |                |        |   |  |  |                          |
|                                    | 2.0 dCi       | 118 |       | 04.09 |                             |                |        |   |  |  |                          |
|                                    | 1.5 dCi       | 63  |       | 04.09 | + 15" Rad <sup>2)</sup>     | 11.9541-9950.2 | 220843 | 2 |  | D=54, - Halter<br>D=54, - Halter<br>Haltefeder               | ATE<br>ATE<br>ATE        |
|                                    | 1.5 dCi       | 70  |       | 11.10 | + 15" Rad <sup>2)</sup>     | 11.9541-9951.2 | 220844 |   |  |  |                          |
|                                    | 1.5 dCi       | 78  |       | 04.09 | + 15" Rad <sup>2)</sup>     | 11.8116-0356.1 | 390586 |   |  |  |                          |
|                                    | 1.5 dCi       | 81  |       | 04.09 | + 15" Rad <sup>2)</sup>     |                |        |   |  |  |                          |
|                                    | 1.6 16V       | 81  |       | 04.09 | + 15" Rad <sup>2)</sup>     |                |        |   |  |  |                          |
|                                    | 1.6 E85       | 81  |       | 06.09 | + 15" Rad <sup>2)</sup>     |                |        |   |  |  |                          |
| RENAULT GRAND SCENIC (JM_) (04-09) |               |     |       |       |                             |                |        |   |  |  |                          |
|                                    | 1.5 dCi       | 74  |       | 04.04 | 03.09                       | 24.2123-1760.3 | 010779 |   |  | THz 23,81  | LUC                      |
|                                    | 1.6           | 83  |       | 04.04 | 03.09                       |                |        |   |  |  |                          |
|                                    | 1.9 dCi       | 81  |       | 05.05 | 03.09                       |                |        |   |  |  |                          |
|                                    | 1.9 dCi       | 88  |       | 04.04 | 03.09                       |                |        |   |  |  |                          |
|                                    | 1.9 dCi       | 96  |       | 05.05 | 03.09                       |                |        |   |  |  |                          |
|                                    | 2.0 16V       | 99  |       | 04.04 | 03.09                       |                |        |   |  |  |                          |
|                                    | 2.0 16V Turbo | 120 |       | 04.04 | 03.09                       |                |        |   |  |  |                          |
|                                    | 1.5 dCi       | 74  |       | 04.04 | 09.05                       | 11.0101-5407.2 | 260011 | 2 |  | Hülsensatz<br>Führungsbolzen                                 | ATE<br>ATE               |
|                                    | 1.6           | 83  |       | 04.04 | 09.05                       | 11.8171-0008.1 | 990049 |   |  |  |                          |
|                                    | 1.9 dCi       | 81  |       | 05.05 | 09.05                       |                |        |   |  |  |                          |
|                                    | 1.9 dCi       | 88  |       | 04.04 | 09.05                       |                |        |   |  |  |                          |
|                                    | 1.9 dCi       | 96  |       | 05.05 | 09.05                       |                |        |   |  |  |                          |
|                                    | 2.0 16V       | 99  |       | 04.04 | 09.05                       |                |        |   |  |  |                          |
|                                    | 2.0 dCi       | 110 |       | 09.05 | 09.05                       |                |        |   |  |  |                          |
|                                    | 1.5 dCi       | 74  |       | 10.05 | 03.09                       | 11.9541-9543.2 | 220645 |   |  |  |                          |
|                                    | 1.6           | 83  |       | 10.05 | 03.09                       | 11.9541-9544.2 | 220646 |   |  |  |                          |
|                                    | 1.9 dCi       | 81  |       | 10.05 | 03.09                       | 11.0101-5407.2 | 260011 |   |  |  |                          |
| 1.9 dCi                            | 88            |     | 10.05 | 03.09 | 11.8171-0008.1              | 990049         |        |   |  |  |                          |
| 1.9 dCi                            | 96            |     | 10.05 | 03.09 | 11.8116-0301.1              | 390610         |        |   |  |  |                          |
| 2.0 16V                            | 99            |     | 10.05 | 03.09 |                             |                |        |   |  |  |                          |
| 2.0 dCi                            | 110           |     | 10.05 | 03.09 |                             |                |        |   |  |  |                          |
|                                    | 1.5 dCi       | 74  |       | 04.04 | 09.05                       | 24.5111-0429.3 | 331015 | 2 |  | L=429  |                          |
|                                    | 1.6           | 83  |       | 04.04 | 09.05                       |                |        |   |  |  |                          |
|                                    | 1.9 dCi       | 81  |       | 05.05 | 09.05                       |                |        |   |  |  |                          |
|                                    | 1.9 dCi       | 88  |       | 04.04 | 09.05                       |                |        |   |  |  |                          |
|                                    | 1.9 dCi       | 96  |       | 05.05 | 09.05                       |                |        |   |  |  |                          |
|                                    | 2.0 16V       | 99  |       | 04.04 | 09.05                       |                |        |   |  |  |                          |
|                                    | 2.0 16V Turbo | 120 |       | 04.04 | 09.05                       |                |        |   |  |  |                          |
|                                    | 2.0 dCi       | 110 |       | 09.05 | 09.05                       |                |        |   |  |  |                          |
|                                    | 1.5 dCi       | 74  |       | 10.05 | 03.09                       | 24.5155-0445.3 | 331057 |   |  |  |                          |
|                                    | 1.6           | 83  |       | 10.05 | 03.09                       |                |        |   |  |  |                          |
| 1.9 dCi                            | 81            |     | 10.05 | 03.09 |                             |                |        |   |  |  |                          |
| 1.9 dCi                            | 88            |     | 10.05 | 03.09 |                             |                |        |   |  |  |                          |
| 1.9 dCi                            | 96            |     | 10.05 | 03.09 |                             |                |        |   |  |  |                          |
| 2.0 16V                            | 99            |     | 10.05 | 03.09 |                             |                |        |   |  |  |                          |
| 2.0 16V Turbo                      | 120           |     | 10.05 | 03.09 |                             |                |        |   |  |  |                          |
| 2.0 dCi                            | 110           |     | 10.05 | 03.09 |                             |                |        |   |  |  |                          |
|                                    | 1.5 dCi       | 74  |       | 04.04 | 03.09                       | 24.3387-1721.7 | 220781 | 2 |  | D=38, - Halter<br>D=38, - Halter                             | LUC<br>LUC               |
|                                    | 1.6           | 83  |       | 04.04 | 03.09                       | 24.3387-1722.7 | 220782 |   |  |  |                          |
|                                    | 1.9 dCi       | 81  |       | 05.05 | 03.09                       |                |        |   |  |  |                          |
|                                    | 1.9 dCi       | 88  |       | 04.04 | 03.09                       |                |        |   |  |  |                          |
|                                    | 1.9 dCi       | 96  |       | 05.05 | 03.09                       |                |        |   |  |  |                          |
|                                    | 2.0 16V       | 99  |       | 04.04 | 03.09                       |                |        |   |  |  |                          |
|                                    | 2.0 16V Turbo | 120 |       | 04.04 | 03.09                       |                |        |   |  |  |                          |
|                                    | 1.5 dCi       | 74  |       | 04.04 | 08.05                       | 24.5251-0185.3 | 330701 | 2 |  | L=185  |                          |
|                                    | 1.6           | 83  |       | 04.04 | 08.05                       |                |        |   |  |  |                          |
|                                    | 1.9 dCi       | 81  |       | 05.05 | 08.05                       |                |        |   |  |  |                          |
|                                    | 1.9 dCi       | 88  |       | 04.04 | 08.05                       |                |        |   |  |  |                          |
|                                    | 1.9 dCi       | 96  |       | 05.05 | 08.05                       |                |        |   |  |  |                          |
|                                    | 2.0 16V       | 99  |       | 04.04 | 08.05                       |                |        |   |  |  |                          |
|                                    | 2.0 16V Turbo | 120 |       | 04.04 | 08.05                       |                |        |   |  |  |                          |
|                                    | 1.5 dCi       | 74  |       | 09.05 | 03.09                       | 24.5229-0185.3 | 330397 |   |  |  |                          |
|                                    | 1.6           | 83  |       | 09.05 | 03.09                       |                |        |   |  |  |                          |
|                                    | 1.9 dCi       | 81  |       | 09.05 | 03.09                       |                |        |   |  |  |                          |
| 1.9 dCi                            | 88            |     | 09.05 | 03.09 |                             |                |        |   |  |  |                          |
| 1.9 dCi                            | 96            |     | 09.05 | 03.09 |                             |                |        |   |  |  |                          |
| 2.0 16V                            | 99            |     | 09.05 | 03.09 |                             |                |        |   |  |  |                          |
| 2.0 16V Turbo                      | 120           |     | 09.05 | 03.09 |                             |                |        |   |  |  |                          |
|                                    | 1.5 dCi       | 74  |       | 04.04 | 03.09                       | 24.3727-1075.2 | 581075 | 2 |  | L=2100   |                          |
|                                    | 1.6           | 83  |       | 04.04 | 03.09                       |                |        |   |  |  |                          |
|                                    | 1.9 dCi       | 81  |       | 05.05 | 03.09                       |                |        |   |  |  |                          |
|                                    | 1.9 dCi       | 88  |       | 04.04 | 03.09                       |                |        |   |  |  |                          |
|                                    | 1.9 dCi       | 96  |       | 05.05 | 03.09                       |                |        |   |  |  |                          |
|                                    | 2.0 16V       | 99  |       | 04.04 | 03.09                       |                |        |   |  |  |                          |
|                                    | 2.0 16V Turbo | 120 |       | 04.04 | 03.09                       |                |        |   |  |  |                          |

<sup>1)</sup> + 16"/17" wheel / + ruota 16"/17" / + roue 16"/17" / + ruedas 16"/17"

<sup>2)</sup> + 15" wheel / + ruota 15" / + roue 15" / + ruedas 15"

|     |  |  |  |  |  |  |  |  |  |                                  |            |
|--|--|--|--|--|---|--|--|--|--|----------------------------------|------------|
| <b>RENAULT GRAND SCENIC (JZ_) (09-)</b>  |  |  |  |  |   |  |  |  |  |                                  |            |
|    | 1.2 TCe  | 85   |  | 03.12  |   | 11.9571-9775.2   | 220859   | 2  | D=57, - Halter<br>D=57, - Halter<br>Hülsensatz<br>Haltefeder | ATE<br>ATE<br>ATE<br>ATE         |            |
|  | 1.2 TCe  | 97   |  | 03.13  |   | 11.9571-9776.2   | 220860   |  |  |                                  |            |
|  | 1.4 16V  | 96   |  | 02.09  |   | 11.0101-5704.2   | 260095   |  |  |                                  |            |
|  | 1.5 dCi  | 70   |  | 11.10  |   | 11.8116-0351.1   | 390538   |  |  |                                  |            |
|  | 1.5 dCi  | 78   |  | 02.09  |   |  |  |  |  |                                  |            |
|  | 1.5 dCi  | 81   |  | 04.09  |   |  |  |  |  |                                  |            |
|  | 1.6 16V  | 81   |  | 02.09  |   |  |  |  |  |                                  |            |
|  | 1.6 dCi  | 96   |  | 04.11  |   |  |  |  |  |                                  |            |
|  | 1.9 dCi  | 96   |  | 02.09  |   |  |  |  |  |                                  |            |
|  | 2.0 16V  | 103  |  | 02.09  |   |  |  |  |  |                                  |            |
| 1.5 dCi  | 63   |  | 04.09  |  | 11.9541-9950.2  | 220843   | 2  | D=54, - Halter<br>D=54, - Halter<br>Haltefeder                                     | ATE<br>ATE<br>ATE  |                                  |            |
|  |  |  |  |  | 11.9541-9951.2  | 220844   |  |  |  |                                  |            |
|  |  |  |  |  | 11.8116-0356.1  | 390586   |  |  |  |                                  |            |
| 2.0 dCi  | 110  |  | 02.09  |  | 11.0101-5704.2  | 260095   | 2  | Hülsensatz<br>Dichtungssatz<br>Haltefeder  | ATE<br>ATE<br>ATE  |                                  |            |
| 2.0 dCi  | 118  |  | 04.09  |  | 11.0441-6008.2  | 250038   |  |  |  |                                  |            |
|  |  |  |  |  | 11.8116-0351.1  | 390538   |  |  |  |                                  |            |
| <b>RENAULT SPIDER (95-99)</b>  |  |  |  |  |   |  |  |  |  |                                  |            |
|    | 2.0 16V  | 110  |  | 03.95  | 10.99   | 24.2123-1702.3   | 010431   |  |  | THz 23,81                        |            |
|    | 2.0 16V  | 110  |  | 03.95  | 10.99   | 24.5111-0386.3   | 330503   | 2  |  | L=385<br>L=185                   |            |
|    | 2.0 16V  | 110  |  | 03.95  | 10.99   | 24.5229-0185.3   | 330397   | 2  |  | L=220                            |            |
| <b>RENAULT THALIA I (LB_) (98-)</b>  |  |  |  |  |   |  |  |  |  |                                  |            |
|    | 1.2 16V  | 55   |  | 04.02  |   | 03.7750-1332.4   | 300155   |  |  | 9"                               | ATE        |
|  | 1.4  | 55   |  | 08.00  |   |  |  |  |  |                                  |            |
|  | 1.4 16V  | 72   |  | 08.00  |   |  |  |  |  |                                  |            |
|  | 1.5 dCi  | 47   |  | 06.05  |   |  |  |  |  |                                  |            |
|  | 1.5 dCi  | 48   |  | 04.02  |   |  |  |  |  |                                  |            |
|  | 1.5 dCi  | 50   |  | 02.03  |   |  |  |  |  |                                  |            |
|  | 1.5 dCi  | 60   |  | 06.01  |   |  |  |  |  |                                  |            |
|  | 1.6 16V  | 79   |  | 04.02  |   |  |  |  |  |                                  |            |
|  | 1.9 D  | 48   |  | 02.98  | 05.01   |  |  |  |  |                                  |            |
|   | 1.2 16V  | 55   |  | 04.02  |   | 03.2120-2031.3   | 010106   |  | - ABS<br>+ ABS   | THz 20,64<br>THz 20,64           | ATE<br>ATE |
|  | 1.4  | 55   |  | 08.00  |   |  |  |  |  |                                  |            |
|  | 1.4 16V  | 72   |  | 08.00  |   |  |  |  |  |                                  |            |
|  | 1.5 dCi  | 47   |  | 06.05  |   |  |  |  |  |                                  |            |
|  | 1.5 dCi  | 48   |  | 04.02  |   |  |  |  |  |                                  |            |
|  | 1.5 dCi  | 50   |  | 02.03  |   |  |  |  |  |                                  |            |
|  | 1.2 16V  | 55   |  | 04.02  |   | 24.3481-1611.5   | 240029   | 2  |  | D=48, - Halter<br>D=48, - Halter | LUC<br>LUC |
|  | 1.4  | 55   |  | 08.00  |   |  |  |  |  |                                  |            |
|  | 1.4 16V  | 72   |  | 08.00  |   |  |  |  |  |                                  |            |
|  | 1.5 dCi  | 47   |  | 06.05  |   |  |  |  |  |                                  |            |
|  | 1.5 dCi  | 48   |  | 04.02  |   |  |  |  |  |                                  |            |
|  | 1.5 dCi  | 50   |  | 02.03  |   |  |  |  |  |                                  |            |
|  | 1.5 dCi  | 60   |  | 06.01  |   |  |  |  |  |                                  |            |
|  | 1.2 16V  | 55   |  | 04.02  |   | 24.5111-0321.3   | 330597   | 2  |  |                                  | L=320      |
|  | 1.4  | 55   |  | 08.00  |   |  |  |  |  |                                  |            |
|  | 1.4 16V  | 72   |  | 08.00  |   |  |  |  |  |                                  |            |
|  | 1.5 dCi  | 47   |  | 06.05  |   |  |  |  |  |                                  |            |
|  | 1.5 dCi  | 48   |  | 04.02  |   |  |  |  |  |                                  |            |
|  | 1.5 dCi  | 50   |  | 02.03  |   |  |  |  |  |                                  |            |
|  | 1.5 dCi  | 60   |  | 06.01  |   |  |  |  |  |                                  |            |
|  | 1.2 16V  | 55   |  | 04.02  |   | 24.5239-0165.3   | 330606   | 2  |  |                                  | L=165      |
|  | 1.4  | 55   |  | 08.00  |   |  |  |  |  |                                  |            |
|  | 1.4 16V  | 72   |  | 08.00  |   |  |  |  |  |                                  |            |
|  | 1.5 dCi  | 47   |  | 06.05  |   |  |  |  |  |                                  |            |
|  | 1.5 dCi  | 48   |  | 04.02  |   |  |  |  |  |                                  |            |
|  | 1.5 dCi  | 50   |  | 02.03  |   |  |  |  |  |                                  |            |
|  | 1.5 dCi  | 60   |  | 06.01  |   |  |  |  |  |                                  |            |
|  | 1.2 16V  | 55   |  | 04.02  |   | 24.3217-1116.3   | 020178   | 2  |  | Rz 17,46<br>Rz 17,46             | BDX<br>BDX |
|  | 1.4  | 55   |  | 08.00  |   |  |  |  |  |                                  |            |
|  | 1.2 16V  | 55   |  | 04.02  |   | 24.3217-1710.3   | 020420   |  |  | Rz 17,78                         | LUC        |
|  | 1.4 16V  | 72   |  | 08.00  |   |  |  |  |  |                                  |            |
|  | 1.5 dCi  | 47   |  | 06.05  |   | - ABS  |  |  |  |                                  |            |
|  | 1.5 dCi  | 48   |  | 04.02  |   |  |  |  |  |                                  |            |
|  | 1.5 dCi  | 50   |  | 02.03  |   |  |  |  |  |                                  |            |
|  | 1.5 dCi  | 60   |  | 06.01  |   |  |  |  |  |                                  |            |
|  | 1.6 16V  | 79   |  | 04.02  |   |  |  |  |  |                                  |            |
|  | 1.9 D  | 48   |  | 02.98  | 05.01   | 24.3217-1711.3   | 020449   |  |  | Rz 17,78                         | BOS        |
| 1.2 16V  | 55   |  | 04.02  |  |   |  |  |  |  |                                  |            |
| 1.4 16V  | 72   |  | 08.00  |  | + ABS   |  |  |  |  |                                  |            |

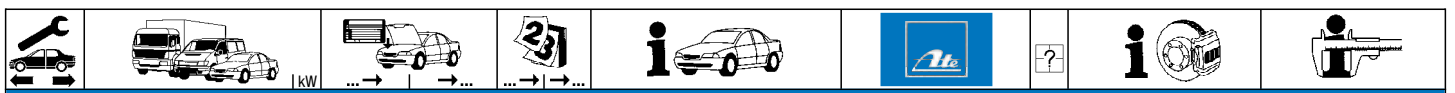

### RENAULT THALIA I (LB\_) (98-)

















|  |   |  |   |                |                                  |                  |  |                    |     |
|--|---|--|---|----------------|----------------------------------|------------------|--|--------------------|-----|
|  | 1.5 dCi<br>1.5 dCi<br>1.5 dCi<br>1.5 dCi<br>1.6 16V<br>1.9 D                              | 47<br>48<br>50<br>60<br>79<br>48                   | 06.05<br>04.02<br>02.03<br>06.01<br>04.02<br>02.98                            | 05.01          | 24.3217-1711.3<br>020449         |                  |  | Rz 17,78           | BOS |
|  | 1.4<br>1.2 16V<br>1.4   | 55<br>55<br>55                                     | 08.00<br>04.02<br>08.00   | - ABS<br>+ ABS | 24.3727-1049.2<br>24.3727-1048.2 | 581049<br>581048 | <input type="checkbox"/><br><input type="checkbox"/> | L=1263<br>L=1343   |     |
|  | 1.2 16V<br>1.4<br>1.4 16V<br>1.5 dCi<br>1.5 dCi<br>1.5 dCi<br>1.5 dCi<br>1.6 16V<br>1.9 D | 55<br>55<br>72<br>47<br>48<br>50<br>60<br>79<br>48 | 04.02<br>08.00<br>08.00<br>06.05<br>04.02<br>02.03<br>06.01<br>04.02<br>02.98 | 05.01          | 24.6582-1721.3                   | 320212           |  | BRL (4) weiss/lila |     |
|  | 1.2 16V<br>1.4<br>1.4 16V   | 55<br>55<br>72                                     | 04.02<br>08.00<br>08.00   |                | 24.3728-1023.2                   | 591023           |  | L=960              |     |

### RENAULT THALIA II / SYMBOL (LU\_) (08-)

|  |  |                      |                                  |                                  |                                  |                  |  |                                  |            |
|--|--|----------------------|----------------------------------|----------------------------------|----------------------------------|------------------|--|----------------------------------|------------|
|  | 1.2 16V<br>1.5 dCi<br>1.5 dCi<br>1.6 16V | 55<br>47<br>62<br>77 | 12.10<br>12.10<br>12.10<br>12.10 |                                  | 03.7853-1502.4                   | 300200           |  | 9"                               | ATE        |
|  | 1.2 16V<br>1.5 dCi<br>1.5 dCi<br>1.6 16V | 55<br>47<br>62<br>77 | 09.08<br>09.08<br>09.08<br>09.08 |                                  | 03.2120-2031.3                   | 010106           | - ABS  | THz 20,64                        | ATE        |
|  | 1.2 16V<br>1.5 dCi<br>1.5 dCi<br>1.6 16V | 55<br>47<br>62<br>77 | 09.08<br>09.08<br>09.08<br>09.08 |                                  | 03.2120-4461.3                   | 010571           | + ABS  | THz 20,64                        | ATE        |
|  | 1.2 16V<br>1.5 dCi<br>1.5 dCi<br>1.6 16V | 55<br>47<br>62<br>77 | 09.08<br>09.08<br>09.08<br>09.08 |                                  | 24.3481-1611.5<br>24.3481-1612.5 | 240029<br>240030 | <input type="checkbox"/><br><input type="checkbox"/> | D=48, - Halter<br>D=48, - Halter | LUC<br>LUC |
|  | 1.2 16V<br>1.5 dCi<br>1.5 dCi<br>1.6 16V | 55<br>47<br>62<br>77 | 09.08<br>09.08<br>09.08<br>09.08 |                                  | 24.3481-1615.5<br>24.3481-1616.5 | 240031<br>240032 | <input type="checkbox"/><br><input type="checkbox"/> | D=48, - Halter<br>D=48, - Halter | LUC<br>LUC |
|  | 1.2 16V<br>1.5 dCi<br>1.5 dCi<br>1.6 16V | 55<br>47<br>62<br>77 | 09.08<br>09.08<br>09.08<br>09.08 |                                  | 24.3481-1615.5<br>24.3481-1616.5 | 240031<br>240032 | <input type="checkbox"/><br><input type="checkbox"/> | D=48, - Halter<br>D=48, - Halter | LUC<br>LUC |
|  | 1.2 16V<br>1.5 dCi<br>1.5 dCi<br>1.6 16V | 55<br>47<br>62<br>77 | 09.08<br>09.08<br>09.08<br>09.08 |                                  | 24.5111-0321.3                   | 330597           | 2  | L=320                            |            |
|  | 1.2 16V<br>1.5 dCi<br>1.5 dCi<br>1.6 16V | 55<br>47<br>62<br>77 | 09.08<br>09.08<br>09.08<br>09.08 |                                  | 24.5239-0165.3                   | 330606           | 2  | L=165                            |            |
|  | 1.2 16V<br>1.5 dCi<br>1.5 dCi<br>1.6 16V | 55<br>47<br>62<br>77 | 09.08<br>09.08<br>09.08<br>09.08 | 05.09<br>05.09<br>05.09<br>05.09 | 24.3219-1722.3                   | 020426           |  | Rz 19,05                         | BDX        |
|  | 1.2 16V<br>1.5 dCi<br>1.5 dCi<br>1.6 16V | 55<br>47<br>62<br>77 | 06.09<br>06.09<br>06.09<br>06.09 |                                  | 24.3217-1711.3                   | 020449           |  | Rz 17,78                         | BOS        |
|  | 1.2 16V<br>1.5 dCi<br>1.5 dCi<br>1.6 16V | 55<br>47<br>62<br>77 | 09.08<br>09.08<br>09.08<br>09.08 |                                  | 24.3217-1710.3                   | 020420           |  | Rz 17,78                         | LUC        |
|  | 1.6 16V                                  | 77                   | 09.08                            |                                  | 24.6582-1721.3                   | 320212           |  | BRL (4) weiss/lila               |            |
|  | 1.2 16V<br>1.5 dCi<br>1.6 16V            | 55<br>62<br>77       | 09.08<br>09.08<br>09.08          |                                  | 24.3728-1023.2                   | 591023           |  | L=960                            |            |

### RENAULT TRAFIC I Propulsion (PXX) (89-97)



















|  |  |  |   |   |                                  |                  |  |                        |            |
|--|--|--|---|---|----------------------------------|------------------|--|------------------------|------------|
|  | 1.7<br>2.0<br>2.1 D<br>2.1 D   | 50<br>59<br>43<br>47                   | 05.89<br>05.89<br>05.89<br>06.94                            | 08.94<br>10.97<br>06.94<br>10.97                            | 03.2123-9207.3<br>03.2125-3801.3 | 010199<br>010215 |  | THz 23,81<br>THz 25,40 | ATE<br>ATE |
|  | 1.7 (P3-8)<br>2.0 (PC-2)<br>2.1 D (P3-3)<br>2.1 D (P3-3)<br>2.1 D (PC-3)<br>2.1 D (PC-3)<br>2.1 D (PC-F) | 50<br>59<br>43<br>47<br>43<br>47<br>47 | 05.89<br>05.89<br>05.89<br>06.94<br>05.89<br>06.94<br>09.94 | 08.94<br>10.97<br>06.94<br>10.97<br>06.94<br>10.97<br>10.97 | 24.5111-0317.3<br>24.5111-0315.3 | 330501<br>330390 | 2 <input type="checkbox"/><br>2 <input type="checkbox"/> | L=315<br>L=315         |            |
|  | 1.7<br>2.0<br>2.1 D<br>2.1 D   | 50<br>59<br>43<br>47                   | 05.89<br>05.89<br>05.89<br>06.94                            | 08.94<br>10.97<br>06.94<br>10.97                            | 24.3225-1601.3                   | 020359           |  | Rz 25,40               | LUC        |

|     |    |              |  |    |   |  |  |  |
|--|--|--|--|--|--|--|--|--|
| <b>RENAULT TRAFIC I Propulsion (PXX) (89-97)</b>                                   |  |  |  |  |  |  |  |  |
|    | 1.7<br>2.0<br>2.1 D<br>2.1 D   | 50<br>59<br>43<br>47   |  | 05.89<br>05.89<br>05.89<br>06.94   | 08.94<br>10.97<br>06.94<br>10.97   | 03.6512-0100.3   | 320077   | BRL 1/2 (2) ATE  |
| <b>RENAULT TRAFIC I Kasten (TXX) (89-01)</b>                                       |  |  |  |  |  |  |  |  |
|    | 2.2<br>2.2<br>2.2 4x4<br>2.2 4x4<br>2.5 D<br>2.5 D 4x4   | 70<br>74<br>70<br>74<br>55<br>55   |  | 05.89<br>06.94<br>05.89<br>06.94<br>05.89<br>05.89   | 06.94<br>10.97<br>06.94<br>10.97<br>03.01<br>03.01   | 03.6855-2402.4   | 300094   | 9" Tandem ATE  |
|    | 1.4<br>1.7<br>2.0<br>2.1 D<br>2.1 D<br>2.2<br>2.2<br>2.2 4x4<br>2.2 4x4<br>2.5 D<br>2.5 D 4x4  | 35<br>50<br>59<br>43<br>47<br>70<br>74<br>70<br>74<br>55<br>55                               |  | 05.89<br>05.89<br>05.89<br>05.89<br>06.94<br>05.89<br>06.94<br>05.89<br>06.94<br>05.89<br>05.89  | 06.91<br>08.94<br>08.90<br>06.94<br>10.97<br>06.94<br>10.97<br>06.94<br>10.97<br>10.97<br>10.97  | 03.2123-9207.3   | 010199   | THz 23,81 ATE  |
|  | 2.2<br>2.2<br>2.2 4x4<br>2.2 4x4   | 70<br>74<br>70<br>74   |  | 05.89<br>06.94<br>05.89<br>06.94   | 06.94<br>10.97<br>06.94<br>10.97   | 03.2125-3701.3   | 010627   | THz 25,40 ATE  |
|  | 2.2<br>2.2<br>2.5 D<br>2.5 D 4x4   | 70<br>74<br>55<br>55   |  | 05.89<br>06.94<br>05.89<br>05.89   | 06.94<br>10.97<br>10.97<br>10.97   | 03.2125-3801.3   | 010215   | THz 25,40 ATE  |
|  | 2.2<br>2.2<br>2.5 D<br>2.5 D 4x4   | 70<br>74<br>55<br>55   |  | 05.89<br>06.94<br>11.97<br>11.97   | 06.94<br>10.97<br>03.01<br>03.01   | 03.2125-3701.3   | 010627   | THz 25,40 ATE  |
|  | 2.2<br>2.2<br>2.5 D<br>2.5 D 4x4   | 70<br>74<br>55<br>55   |  | 05.89<br>06.94<br>11.97<br>11.97   | 06.94<br>10.97<br>03.01<br>03.01   | 24.2025-1708.3<br>24.2025-1706.3   | 010692<br>010676   | THz 25,40<br>THz 25,40   |
|    | 1.4<br>1.7<br>1.9 D<br>2.0<br>2.0 4x4<br>2.1 D<br>2.1 D<br>2.1 D<br>2.1 D 4x4<br>2.1 D 4x4<br>2.2<br>2.2<br>2.2 4x4<br>2.2 4x4<br>2.5 D<br>2.5 D 4x4 | 35<br>50<br>44<br>59<br>59<br>43<br>47<br>47<br>43<br>47<br>70<br>74<br>70<br>74<br>55<br>55 |  | 05.89<br>05.89<br>06.97<br>05.89<br>05.89<br>05.89<br>06.94<br>09.94<br>05.89<br>06.94<br>06.94<br>05.89<br>06.94<br>05.89<br>05.89<br>05.89 | 06.91<br>08.94<br>10.97<br>08.90<br>08.90<br>06.94<br>08.94<br>10.97<br>06.94<br>10.97<br>06.94<br>10.97<br>06.94<br>10.97<br>03.01<br>03.01 | 24.5111-0317.3<br>24.5111-0315.3   | 330501<br>330390   | L=315<br>L=315   |
|  | 2.1 D<br>2.1 D 4x4<br>2.1 D 4x4<br>2.2<br>2.2<br>2.2 4x4<br>2.2 4x4<br>2.5 D<br>2.5 D 4x4  | 47<br>43<br>47<br>70<br>74<br>70<br>74<br>55<br>55   |  | 09.94<br>05.89<br>06.94<br>05.89<br>06.94<br>05.89<br>06.94<br>05.89<br>05.89  | 10.97<br>06.94<br>10.97<br>06.94<br>10.97<br>06.94<br>10.97<br>03.01<br>03.01  | 24.5111-0317.3<br>24.5111-0315.3   | 330501<br>330390   | L=315<br>L=315   |
|  | 1.4<br>1.7<br>1.9 D<br>2.0<br>2.0 4x4<br>2.1 D<br>2.1 D<br>2.1 D 4x4<br>2.1 D 4x4<br>2.2<br>2.2<br>2.2 4x4<br>2.2 4x4<br>2.5 D<br>2.5 D 4x4          | 35<br>50<br>44<br>59<br>59<br>43<br>47<br>43<br>47<br>70<br>74<br>70<br>74<br>55<br>55       |  | 05.89<br>05.89<br>06.97<br>05.89<br>05.89<br>05.89<br>06.94<br>05.89<br>06.94<br>05.89<br>06.94<br>05.89<br>06.94<br>05.89<br>05.89          | 06.91<br>08.94<br>10.97<br>08.90<br>08.90<br>06.94<br>10.97<br>06.94<br>10.97<br>06.94<br>10.97<br>06.94<br>10.97<br>03.01<br>03.01          | 24.5111-0386.3   | 330503   | L=385  |
|  | 1.4 (T1-0)<br>1.7 (T1-8)<br>1.7 (T3-8)<br>1.7 (T4-8)<br>2.1 (T1-3)<br>2.1 (T1-3)<br>2.1 (T3-3)<br>2.1 (T3-3)<br>2.1 (T4-3)<br>2.1 (T4-3)             | 35<br>50<br>50<br>50<br>43<br>47<br>43<br>47<br>43<br>47                                     |  | 05.89<br>05.89<br>05.89<br>05.89<br>05.89<br>06.94<br>05.89<br>06.94<br>05.89<br>06.94   | 06.91<br>08.94<br>08.94<br>08.94<br>06.94<br>10.97<br>06.94<br>10.97<br>06.94<br>10.97   | 24.3222-1118.3   | 020315   | Rz 22,20 BDX   |
|  | 1.7 (T3-8)<br>1.7 (T4-8)<br>2.1 (T1-3)<br>2.1 (T1-3)<br>2.1 (T3-3)<br>2.1 (T3-3)<br>2.1 (T4-3)<br>2.1 (T4-3)   | 50<br>50<br>43<br>47<br>43<br>47<br>43<br>47   |  | 05.89<br>05.89<br>05.89<br>06.94<br>05.89<br>06.94<br>05.89<br>06.94   | 08.94<br>08.94<br>06.94<br>10.97<br>06.94<br>10.97<br>06.94<br>10.97   | 24.3223-1106.3   | 020317   | Rz 23,81 BDX   |
|  | 1.9 D<br>2.1 D   | 44<br>47   |  | 06.97<br>09.94   | 03.01<br>10.97   | 24.3225-1601.3   | 020359   | Rz 25,40 LUC   |

1) + single circuit brake / + impianto freni circuito singolo / + frein à 1 circuit / + freno de 1 circuito

2) + two circuit brake / + impianto frenante doppio circuito / + frein à deux circuits / + freno de 2 circuitos



|     |   |        |  |   |    |  |  |  |
|--|---|--|--|---|---|--|--|--|
| <b>RENAULT TRAFIC I Kasten (TXX) (89-01)</b>                                       |   |  |  |   |   |  |  |  |
|    | 2.1 D 4x4<br>2.2<br>2.2 4x4<br>2.5 D<br>2.5 D 4x4   | 47<br>74<br>74<br>55<br>55   |  | 09.94<br>09.94<br>09.94<br>09.94<br>09.94   | 10.97<br>10.97<br>10.97<br>03.01<br>03.01   | 24.3225-1601.3   | 020359   | Rz 25,40<br><b>LUC</b>   |
|    | 1.9 D<br>2.5 D<br>2.5 D 4x4   | 44<br>55<br>55   |  | 11.97<br>11.97<br>11.97   | 03.01<br>03.01<br>03.01   | 24.3727-1051.2<br>24.3727-1052.2   | 581051<br>581052   | <input type="checkbox"/><br><input type="checkbox"/><br><input type="checkbox"/>   |
|    | 1.4<br>1.7<br>1.9 D<br>2.0<br>2.0 4x4<br>2.1 D<br>2.1 D<br>2.1 D 4x4<br>2.1 D 4x4<br>2.2<br>2.2<br>2.2 4x4<br>2.2 4x4<br>2.5 D<br>2.5 D 4x4 | 35<br>50<br>44<br>59<br>59<br>43<br>47<br>43<br>47<br>70<br>74<br>70<br>74<br>55<br>55 |  | 05.89<br>05.89<br>06.97<br>05.89<br>05.89<br>06.94<br>06.94<br>05.89<br>06.94<br>05.89<br>06.94<br>06.94<br>06.94<br>05.89<br>03.01 | 06.91<br>08.94<br>10.97<br>08.90<br>08.90<br>06.94<br>10.97<br>06.94<br>10.97<br>06.94<br>06.94<br>10.97<br>10.97<br>03.01<br>03.01 | 03.6512-0100.3   | 320077   | BRL 1/2 (2)<br><b>ATE</b>  |
|    | 2.5 D   | 55   |  | 11.97   | 03.01   | 24.3728-1020.2   | 591020   | L=1271   |
| <b>RENAULT TRAFIC I Bus (TXW) (89-01)</b>  |   |  |  |   |   |  |  |  |
|    | 2.2<br>2.2<br>2.2 4x4<br>2.2 4x4<br>2.5 D<br>2.5 D 4x4  | 70<br>74<br>70<br>74<br>55<br>55   |  | 05.89<br>06.94<br>05.89<br>06.94<br>05.89<br>08.89  | 06.94<br>10.97<br>06.94<br>10.97<br>03.01<br>03.01  | 03.6855-2402.4   | 300094   | 9" Tandem<br><b>ATE</b>  |
|    | 1.7<br>2.0<br>2.1 D<br>2.1 D<br>2.2<br>2.2<br>2.2 4x4<br>2.2 4x4<br>2.5 D<br>2.5 D 4x4  | 50<br>59<br>43<br>47<br>70<br>74<br>70<br>74<br>55<br>55                               |  | 05.89<br>05.89<br>05.89<br>06.94<br>05.89<br>06.94<br>05.89<br>06.94<br>05.89<br>08.89  | 08.94<br>08.90<br>06.94<br>10.97<br>06.94<br>10.97<br>06.94<br>10.97<br>10.97<br>10.97  | 03.2123-9207.3   | 010199   | THz 23,81<br><b>ATE</b>  |
|  | 2.2<br>2.2<br>2.2 4x4<br>2.2 4x4  | 70<br>74<br>70<br>74   |  | 05.89<br>06.94<br>05.89<br>06.94  | 06.94<br>10.97<br>06.94<br>10.97  | 03.2125-3701.3   | 010627   | THz 25,40<br><b>ATE</b>  |
|  | 2.2<br>2.2<br>2.5 D<br>2.5 D 4x4  | 70<br>74<br>55<br>55   |  | 05.89<br>06.94<br>05.89<br>08.89  | 06.94<br>10.97<br>03.01<br>03.01  | 03.2125-3801.3   | 010215   | THz 25,40<br><b>ATE</b>  |
|  | 2.1 D<br>2.1 D<br>2.5 D   | 43<br>47<br>55   |  | 05.89<br>06.94<br>05.89   | 06.94<br>10.97<br>10.97   | 03.2125-7002.3   | 010628   | THz 25,40<br><b>ATE</b>  |
|  | 2.5 D<br>2.5 D 4x4  | 55<br>55   |  | 11.97<br>11.97  | 03.01<br>03.01  | 24.2025-1708.3<br>24.2025-1706.3   | 010692<br>010676   | - ABS<br>+ ABS<br>THz 25,40  |
|  | 1.7<br>1.9 D<br>2.0<br>2.1 D<br>2.1 D<br>2.2<br>2.2<br>2.2 4x4<br>2.2 4x4<br>2.5 D<br>2.5 D 4x4   | 50<br>44<br>59<br>43<br>47<br>70<br>74<br>70<br>74<br>55<br>55                         |  | 05.89<br>06.97<br>05.89<br>05.89<br>06.94<br>05.89<br>06.94<br>06.94<br>06.94<br>05.89<br>08.89                                     | 08.94<br>03.01<br>08.90<br>06.94<br>10.97<br>06.94<br>10.97<br>06.94<br>10.97<br>03.01<br>03.01                                     | 24.5111-0317.3<br>24.5111-0315.3   | 330501<br>330390   | <input type="checkbox"/><br><input type="checkbox"/><br>L=315<br>L=315             |
|  | 1.7<br>1.9 D<br>2.0<br>2.1 D<br>2.1 D<br>2.2<br>2.2<br>2.2 4x4<br>2.2 4x4<br>2.5 D<br>2.5 D 4x4   | 50<br>44<br>59<br>43<br>47<br>70<br>74<br>70<br>74<br>55<br>55                         |  | 05.89<br>06.97<br>05.89<br>05.89<br>06.94<br>05.89<br>06.94<br>06.94<br>06.94<br>05.89<br>08.89                                     | 08.94<br>03.01<br>08.90<br>06.94<br>10.97<br>06.94<br>10.97<br>06.94<br>10.97<br>03.01<br>10.97                                     | 24.5111-0386.3   | 330503   | 1 <input type="checkbox"/><br>L=385  |
|  | 1.7<br>1.9 D<br>2.0<br>2.1 D<br>2.1 D<br>2.2  | 50<br>44<br>59<br>43<br>47<br>70   |  | 05.89<br>06.97<br>05.89<br>05.89<br>06.94<br>05.89  | 08.94<br>03.01<br>08.90<br>06.94<br>10.97<br>06.94  | 24.3223-1106.3   | 020317   | Rz 23,81<br><b>BDX</b>   |

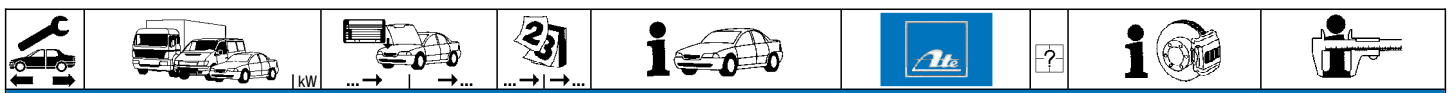













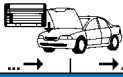























| RENAULT TRAFIC I Bus (TXW) (89-01) |   |  |  |   |   |                         |                                  |                  |  |                  |            |
|------------------------------------|---|--|--|---|---|-------------------------|----------------------------------|------------------|--|------------------|------------|
|                                    | 2.2<br>2.5 D<br>2.5 D 4x4   | 74<br>55<br>55   |  | 06.94<br>05.89<br>08.89   | 10.97<br>03.01<br>03.01   |                         | 24.3223-1106.3                   | 020317           |  | Rz 23,81         | <b>BDX</b> |
|                                    | 1.7<br>1.9 D<br>2.0<br>2.1 D<br>2.1 D<br>2.2<br>2.2<br>2.5 D<br>2.5 D 4x4                       | 50<br>44<br>59<br>43<br>47<br>70<br>74<br>55<br>55             |  | 05.89<br>06.97<br>05.89<br>05.89<br>06.94<br>05.89<br>06.94<br>06.94<br>03.01<br>08.89          | 08.94<br>03.01<br>08.90<br>08.90<br>10.97<br>06.94<br>10.97<br>03.01<br>03.01                   |                         | 24.3225-1601.3                   | 020359           |  | Rz 25,40         | <b>LUC</b> |
|                                    | 1.9 D<br>2.5 D<br>2.5 D 4x4   | 44<br>55<br>55   |  | 11.97<br>11.97<br>11.97   | 03.01<br>03.01<br>03.01   | + ABS<br>+ ABS<br>+ ABS | 24.3727-1051.2<br>24.3727-1052.2 | 581051<br>581052 | <input type="checkbox"/><br><input type="checkbox"/> | L=1295<br>L=1390 |            |
|                                    | 1.7<br>1.9 D<br>2.0<br>2.1 D<br>2.1 D<br>2.2<br>2.2<br>2.2 4x4<br>2.2 4x4<br>2.5 D<br>2.5 D 4x4 | 50<br>44<br>59<br>43<br>47<br>70<br>74<br>70<br>74<br>55<br>55 |  | 05.89<br>06.97<br>05.89<br>05.89<br>06.94<br>05.89<br>06.94<br>05.89<br>06.94<br>05.89<br>08.89 | 08.94<br>03.01<br>08.90<br>08.90<br>10.97<br>06.94<br>10.97<br>06.94<br>10.97<br>03.01<br>03.01 |                         | 03.6512-0100.3                   | 320077           |  | BRL 1/2 (2)      | <b>ATE</b> |
|                                    | 2.5 D   | 55   |  | 11.97   | 03.01   |                         | 24.3728-1020.2                   | 591020           |  | L=1271           |            |

| RENAULT TRAFIC II (JL/FL/EL) (01-) |  |   |  |  |  |  |                                  |                  |  |  |                          |
|------------------------------------|--|---|--|--|--|--|----------------------------------|------------------|--|--|--------------------------|
|                                    | 1.9 dCi<br>1.9 dCi 100<br>1.9 dCi 80   | 59<br>74<br>60  |  | 04.01<br>03.01<br>03.01  | 07.03<br>09.03<br>09.03                                |  | 24.2120-1738.3<br>24.2125-1734.3 | 010759<br>010878 | - ESP<br>+ ESP                                       | THz 20,64<br>THz 25,40                 | <b>LUC</b><br><b>LUC</b> |
|                                    | 1.9 dCi 100<br>1.9 dCi 80<br>2.0 16V   | 74<br>60<br>86  |  | 10.03<br>10.03<br>08.06  |  |  | 24.2120-1740.3<br>24.2125-1734.3 | 010764<br>010878 | - ESP<br>+ ESP                                       | THz 20,64<br>THz 25,40                 | <b>LUC</b><br><b>LUC</b> |
|                                    | 1.9 dCi<br>1.9 dCi 100<br>1.9 dCi 80<br>2.0 16V<br>2.0 16V<br>2.0 dCi 115<br>2.0 dCi 90<br>2.5 dCi<br>2.5 dCi 135<br>2.5 dCi 145<br>2.5 DTi<br>2.5 dCi 115 | 59<br>74<br>60<br>86<br>88<br>84<br>66<br>84<br>99<br>107<br>99<br>84 |  | 04.01<br>10.03<br>03.01<br>08.06<br>03.01<br>10.06<br>10.06<br>08.07<br>05.03<br>10.06<br>03.03<br>02.08 | 07.03<br><br><br><br><br><br><br><br><br><br><br>07.03 |  | 24.2125-1731.3<br>24.2125-1730.3 | 010826<br>010760 | - ESP<br>+ ESP                                       | THz 25,40<br>THz 25,40                 | <b>LUC</b><br><b>LUC</b> |
|                                    | 1.9 dCi<br>1.9 dCi 100<br>1.9 dCi 80<br>2.0 16V<br>2.0 16V<br>2.0 dCi 115<br>2.0 dCi 90<br>2.5 dCi<br>2.5 dCi 115<br>2.5 dCi 135<br>2.5 dCi 145<br>2.5 DTi | 59<br>74<br>60<br>86<br>88<br>84<br>66<br>84<br>84<br>99<br>107<br>99 |  | 04.01<br>03.01<br>03.01<br>08.06<br>03.01<br>10.06<br>10.06<br>08.07<br>02.08<br>05.03<br>10.06<br>03.03 | 07.03<br><br><br><br><br><br><br><br><br>07.03         |  | 24.3451-1713.7<br>24.3451-1714.7 | 220737<br>220738 | <input type="checkbox"/><br><input type="checkbox"/> | D=40/45, - Halter<br>D=40/45, - Halter | <b>LUC</b><br><b>LUC</b> |
|                                    | 1.9 dCi<br>1.9 dCi 100<br>1.9 dCi 80<br>2.0 16V<br>2.0 16V<br>2.0 dCi 115<br>2.0 dCi 90<br>2.5 dCi<br>2.5 dCi 115<br>2.5 dCi 135<br>2.5 dCi 145<br>2.5 DTi | 59<br>74<br>60<br>86<br>88<br>84<br>66<br>84<br>84<br>99<br>107<br>99 |  | 04.01<br>03.01<br>03.01<br>08.06<br>03.01<br>10.06<br>10.06<br>08.07<br>02.08<br>05.03<br>10.06<br>03.03 | 07.03<br><br><br><br><br><br><br><br><br>07.03         |  | 24.5111-0386.3                   | 330503           | 2  | L=385                                  |                          |
|                                    | 1.9 dCi<br>1.9 dCi 100<br>1.9 dCi 80<br>2.0 16V<br>2.0 16V<br>2.0 dCi 115<br>2.0 dCi 90<br>2.5 dCi<br>2.5 dCi 115<br>2.5 dCi 135<br>2.5 dCi 145<br>2.5 DTi | 59<br>74<br>60<br>86<br>88<br>84<br>66<br>84<br>84<br>99<br>107<br>99 |  | 11.01<br>11.01<br>11.01<br>08.06<br>11.01<br>10.06<br>10.06<br>08.07<br>02.08<br>05.03<br>10.06<br>03.03 | 07.03<br><br><br><br><br><br><br><br><br>07.03         |  | 24.3414-1707.5<br>24.3414-1708.5 | 240337<br>240338 | <input type="checkbox"/><br><input type="checkbox"/> | D=41, - Halter<br>D=41, - Halter       | <b>LUC</b><br><b>LUC</b> |





















| RENAULT TRAFIC II (JL/FL/EL) (01-)        |  |                 |       |       |                           |                |                           |                |                         |                      |            |                      |            |                 |    |  |       |       |                           |                |        |   |       |                      |            |                 |    |  |       |       |                           |                |        |   |   |                      |        |            |    |  |       |       |                           |                |        |   |                         |                      |            |                      |    |  |       |       |                           |                |        |   |                         |                |            |             |    |  |       |       |                           |                |        |  |   |            |            |                      |    |  |       |       |                           |  |  |  |  |  |  |                 |    |  |       |       |                           |                |        |   |                         |                |            |                      |    |  |       |       |                           |                |        |   |                         |                |            |             |    |  |       |  |                           |  |  |  |  |  |  |             |     |  |       |  |                           |  |  |  |  |  |  |         |    |  |       |       |                           |  |  |  |  |  |  |
|---|--|-----------------|-------|-------|---------------------------|----------------|---------------------------|----------------|-------------------------|----------------------|------------|----------------------|------------|-----------------|----|--|-------|-------|---------------------------|----------------|--------|---|-------|----------------------|------------|-----------------|----|--|-------|-------|---------------------------|----------------|--------|---|---|----------------------|--------|------------|----|--|-------|-------|---------------------------|----------------|--------|---|-------------------------|----------------------|------------|----------------------|----|--|-------|-------|---------------------------|----------------|--------|---|-------------------------|----------------|------------|-------------|----|--|-------|-------|---------------------------|----------------|--------|--|---|------------|------------|----------------------|----|--|-------|-------|---------------------------|--|--|--|--|--|--|-----------------|----|--|-------|-------|---------------------------|----------------|--------|---|-------------------------|----------------|------------|----------------------|----|--|-------|-------|---------------------------|----------------|--------|---|-------------------------|----------------|------------|-------------|----|--|-------|--|---------------------------|--|--|--|--|--|--|-------------|-----|--|-------|--|---------------------------|--|--|--|--|--|--|---------|----|--|-------|-------|---------------------------|--|--|--|--|--|--|
|   | <table border="1"> <tr><td>1.9 dCi</td><td>59</td><td></td><td>04.01</td><td>07.03</td><td></td><td>24.5229-0200.3</td><td>330572</td><td>2</td><td>□</td><td></td><td>L=200</td></tr> <tr><td>1.9 dCi 100</td><td>74</td><td></td><td>03.01</td><td></td><td></td><td>24.5111-0221.3</td><td>330818</td><td>2</td><td>▾</td><td></td><td>L=220</td></tr> <tr><td>1.9 dCi 80</td><td>60</td><td></td><td>03.01</td><td></td><td></td><td></td><td></td><td></td><td></td><td></td><td></td></tr> <tr><td>2.0 16V</td><td>86</td><td></td><td>08.06</td><td></td><td></td><td></td><td></td><td></td><td></td><td></td><td></td></tr> <tr><td>2.0 16V</td><td>88</td><td></td><td>03.01</td><td></td><td></td><td></td><td></td><td></td><td></td><td></td><td></td></tr> <tr><td>2.0 dCi 115</td><td>84</td><td></td><td>10.06</td><td></td><td></td><td></td><td></td><td></td><td></td><td></td><td></td></tr> <tr><td>2.0 dCi 90</td><td>66</td><td></td><td>10.06</td><td></td><td></td><td></td><td></td><td></td><td></td><td></td><td></td></tr> <tr><td>2.5 dCi</td><td>84</td><td></td><td>08.07</td><td></td><td></td><td></td><td></td><td></td><td></td><td></td><td></td></tr> <tr><td>2.5 dCi 115</td><td>84</td><td></td><td>02.08</td><td></td><td></td><td></td><td></td><td></td><td></td><td></td><td></td></tr> <tr><td>2.5 dCi 135</td><td>99</td><td></td><td>05.03</td><td></td><td></td><td></td><td></td><td></td><td></td><td></td><td></td></tr> <tr><td>2.5 dCi 145</td><td>107</td><td></td><td>10.06</td><td></td><td></td><td></td><td></td><td></td><td></td><td></td><td></td></tr> <tr><td>2.5 DTi</td><td>99</td><td></td><td>03.03</td><td>07.03</td><td></td><td></td><td></td><td></td><td></td><td></td><td></td></tr> </table>   | 1.9 dCi         | 59    |       | 04.01                     | 07.03          |                           | 24.5229-0200.3 | 330572                  | 2                    | □          |                      | L=200      | 1.9 dCi 100     | 74 |  | 03.01 |       |                           | 24.5111-0221.3 | 330818 | 2 | ▾     |                      | L=220      | 1.9 dCi 80      | 60 |  | 03.01 |       |                           |                |        |   |   |                      |        | 2.0 16V    | 86 |  | 08.06 |       |                           |                |        |   |                         |                      |            | 2.0 16V              | 88 |  | 03.01 |       |                           |                |        |   |                         |                |            | 2.0 dCi 115 | 84 |  | 10.06 |       |                           |                |        |  |   |            |            | 2.0 dCi 90           | 66 |  | 10.06 |       |                           |  |  |  |  |  |  | 2.5 dCi         | 84 |  | 08.07 |       |                           |                |        |   |                         |                |            | 2.5 dCi 115          | 84 |  | 02.08 |       |                           |                |        |   |                         |                |            | 2.5 dCi 135 | 99 |  | 05.03 |  |                           |  |  |  |  |  |  | 2.5 dCi 145 | 107 |  | 10.06 |  |                           |  |  |  |  |  |  | 2.5 DTi | 99 |  | 03.03 | 07.03 |                           |  |  |  |  |  |  |
| 1.9 dCi                                   | 59   |                 | 04.01 | 07.03 |                           | 24.5229-0200.3 | 330572                    | 2              | □                       |                      | L=200      |                      |            |                 |    |  |       |       |                           |                |        |   |       |                      |            |                 |    |  |       |       |                           |                |        |   |   |                      |        |            |    |  |       |       |                           |                |        |   |                         |                      |            |                      |    |  |       |       |                           |                |        |   |                         |                |            |             |    |  |       |       |                           |                |        |  |   |            |            |                      |    |  |       |       |                           |  |  |  |  |  |  |                 |    |  |       |       |                           |                |        |   |                         |                |            |                      |    |  |       |       |                           |                |        |   |                         |                |            |             |    |  |       |  |                           |  |  |  |  |  |  |             |     |  |       |  |                           |  |  |  |  |  |  |         |    |  |       |       |                           |  |  |  |  |  |  |
| 1.9 dCi 100                               | 74   |                 | 03.01 |       |                           | 24.5111-0221.3 | 330818                    | 2              | ▾                       |                      | L=220      |                      |            |                 |    |  |       |       |                           |                |        |   |       |                      |            |                 |    |  |       |       |                           |                |        |   |   |                      |        |            |    |  |       |       |                           |                |        |   |                         |                      |            |                      |    |  |       |       |                           |                |        |   |                         |                |            |             |    |  |       |       |                           |                |        |  |   |            |            |                      |    |  |       |       |                           |  |  |  |  |  |  |                 |    |  |       |       |                           |                |        |   |                         |                |            |                      |    |  |       |       |                           |                |        |   |                         |                |            |             |    |  |       |  |                           |  |  |  |  |  |  |             |     |  |       |  |                           |  |  |  |  |  |  |         |    |  |       |       |                           |  |  |  |  |  |  |
| 1.9 dCi 80                                | 60   |                 | 03.01 |       |                           |                |                           |                |                         |                      |            |                      |            |                 |    |  |       |       |                           |                |        |   |       |                      |            |                 |    |  |       |       |                           |                |        |   |   |                      |        |            |    |  |       |       |                           |                |        |   |                         |                      |            |                      |    |  |       |       |                           |                |        |   |                         |                |            |             |    |  |       |       |                           |                |        |  |   |            |            |                      |    |  |       |       |                           |  |  |  |  |  |  |                 |    |  |       |       |                           |                |        |   |                         |                |            |                      |    |  |       |       |                           |                |        |   |                         |                |            |             |    |  |       |  |                           |  |  |  |  |  |  |             |     |  |       |  |                           |  |  |  |  |  |  |         |    |  |       |       |                           |  |  |  |  |  |  |
| 2.0 16V                                   | 86   |                 | 08.06 |       |                           |                |                           |                |                         |                      |            |                      |            |                 |    |  |       |       |                           |                |        |   |       |                      |            |                 |    |  |       |       |                           |                |        |   |   |                      |        |            |    |  |       |       |                           |                |        |   |                         |                      |            |                      |    |  |       |       |                           |                |        |   |                         |                |            |             |    |  |       |       |                           |                |        |  |   |            |            |                      |    |  |       |       |                           |  |  |  |  |  |  |                 |    |  |       |       |                           |                |        |   |                         |                |            |                      |    |  |       |       |                           |                |        |   |                         |                |            |             |    |  |       |  |                           |  |  |  |  |  |  |             |     |  |       |  |                           |  |  |  |  |  |  |         |    |  |       |       |                           |  |  |  |  |  |  |
| 2.0 16V                                   | 88   |                 | 03.01 |       |                           |                |                           |                |                         |                      |            |                      |            |                 |    |  |       |       |                           |                |        |   |       |                      |            |                 |    |  |       |       |                           |                |        |   |   |                      |        |            |    |  |       |       |                           |                |        |   |                         |                      |            |                      |    |  |       |       |                           |                |        |   |                         |                |            |             |    |  |       |       |                           |                |        |  |   |            |            |                      |    |  |       |       |                           |  |  |  |  |  |  |                 |    |  |       |       |                           |                |        |   |                         |                |            |                      |    |  |       |       |                           |                |        |   |                         |                |            |             |    |  |       |  |                           |  |  |  |  |  |  |             |     |  |       |  |                           |  |  |  |  |  |  |         |    |  |       |       |                           |  |  |  |  |  |  |
| 2.0 dCi 115                               | 84   |                 | 10.06 |       |                           |                |                           |                |                         |                      |            |                      |            |                 |    |  |       |       |                           |                |        |   |       |                      |            |                 |    |  |       |       |                           |                |        |   |   |                      |        |            |    |  |       |       |                           |                |        |   |                         |                      |            |                      |    |  |       |       |                           |                |        |   |                         |                |            |             |    |  |       |       |                           |                |        |  |   |            |            |                      |    |  |       |       |                           |  |  |  |  |  |  |                 |    |  |       |       |                           |                |        |   |                         |                |            |                      |    |  |       |       |                           |                |        |   |                         |                |            |             |    |  |       |  |                           |  |  |  |  |  |  |             |     |  |       |  |                           |  |  |  |  |  |  |         |    |  |       |       |                           |  |  |  |  |  |  |
| 2.0 dCi 90                                | 66   |                 | 10.06 |       |                           |                |                           |                |                         |                      |            |                      |            |                 |    |  |       |       |                           |                |        |   |       |                      |            |                 |    |  |       |       |                           |                |        |   |   |                      |        |            |    |  |       |       |                           |                |        |   |                         |                      |            |                      |    |  |       |       |                           |                |        |   |                         |                |            |             |    |  |       |       |                           |                |        |  |   |            |            |                      |    |  |       |       |                           |  |  |  |  |  |  |                 |    |  |       |       |                           |                |        |   |                         |                |            |                      |    |  |       |       |                           |                |        |   |                         |                |            |             |    |  |       |  |                           |  |  |  |  |  |  |             |     |  |       |  |                           |  |  |  |  |  |  |         |    |  |       |       |                           |  |  |  |  |  |  |
| 2.5 dCi                                   | 84   |                 | 08.07 |       |                           |                |                           |                |                         |                      |            |                      |            |                 |    |  |       |       |                           |                |        |   |       |                      |            |                 |    |  |       |       |                           |                |        |   |   |                      |        |            |    |  |       |       |                           |                |        |   |                         |                      |            |                      |    |  |       |       |                           |                |        |   |                         |                |            |             |    |  |       |       |                           |                |        |  |   |            |            |                      |    |  |       |       |                           |  |  |  |  |  |  |                 |    |  |       |       |                           |                |        |   |                         |                |            |                      |    |  |       |       |                           |                |        |   |                         |                |            |             |    |  |       |  |                           |  |  |  |  |  |  |             |     |  |       |  |                           |  |  |  |  |  |  |         |    |  |       |       |                           |  |  |  |  |  |  |
| 2.5 dCi 115                               | 84   |                 | 02.08 |       |                           |                |                           |                |                         |                      |            |                      |            |                 |    |  |       |       |                           |                |        |   |       |                      |            |                 |    |  |       |       |                           |                |        |   |   |                      |        |            |    |  |       |       |                           |                |        |   |                         |                      |            |                      |    |  |       |       |                           |                |        |   |                         |                |            |             |    |  |       |       |                           |                |        |  |   |            |            |                      |    |  |       |       |                           |  |  |  |  |  |  |                 |    |  |       |       |                           |                |        |   |                         |                |            |                      |    |  |       |       |                           |                |        |   |                         |                |            |             |    |  |       |  |                           |  |  |  |  |  |  |             |     |  |       |  |                           |  |  |  |  |  |  |         |    |  |       |       |                           |  |  |  |  |  |  |
| 2.5 dCi 135                               | 99   |                 | 05.03 |       |                           |                |                           |                |                         |                      |            |                      |            |                 |    |  |       |       |                           |                |        |   |       |                      |            |                 |    |  |       |       |                           |                |        |   |   |                      |        |            |    |  |       |       |                           |                |        |   |                         |                      |            |                      |    |  |       |       |                           |                |        |   |                         |                |            |             |    |  |       |       |                           |                |        |  |   |            |            |                      |    |  |       |       |                           |  |  |  |  |  |  |                 |    |  |       |       |                           |                |        |   |                         |                |            |                      |    |  |       |       |                           |                |        |   |                         |                |            |             |    |  |       |  |                           |  |  |  |  |  |  |             |     |  |       |  |                           |  |  |  |  |  |  |         |    |  |       |       |                           |  |  |  |  |  |  |
| 2.5 dCi 145                               | 107  |                 | 10.06 |       |                           |                |                           |                |                         |                      |            |                      |            |                 |    |  |       |       |                           |                |        |   |       |                      |            |                 |    |  |       |       |                           |                |        |   |   |                      |        |            |    |  |       |       |                           |                |        |   |                         |                      |            |                      |    |  |       |       |                           |                |        |   |                         |                |            |             |    |  |       |       |                           |                |        |  |   |            |            |                      |    |  |       |       |                           |  |  |  |  |  |  |                 |    |  |       |       |                           |                |        |   |                         |                |            |                      |    |  |       |       |                           |                |        |   |                         |                |            |             |    |  |       |  |                           |  |  |  |  |  |  |             |     |  |       |  |                           |  |  |  |  |  |  |         |    |  |       |       |                           |  |  |  |  |  |  |
| 2.5 DTi                                   | 99   |                 | 03.03 | 07.03 |                           |                |                           |                |                         |                      |            |                      |            |                 |    |  |       |       |                           |                |        |   |       |                      |            |                 |    |  |       |       |                           |                |        |   |   |                      |        |            |    |  |       |       |                           |                |        |   |                         |                      |            |                      |    |  |       |       |                           |                |        |   |                         |                |            |             |    |  |       |       |                           |                |        |  |   |            |            |                      |    |  |       |       |                           |  |  |  |  |  |  |                 |    |  |       |       |                           |                |        |   |                         |                |            |                      |    |  |       |       |                           |                |        |   |                         |                |            |             |    |  |       |  |                           |  |  |  |  |  |  |             |     |  |       |  |                           |  |  |  |  |  |  |         |    |  |       |       |                           |  |  |  |  |  |  |
|   | <table border="1"> <tr><td>1.9 dCi</td><td>59</td><td></td><td>04.01</td><td>07.03</td><td>- Pritsche/Fahrgestell 1)</td><td>24.3727-0763.2</td><td>580763</td><td>1</td><td>□</td><td>+ kurzer Radstand 2)</td><td>L=1190</td></tr> <tr><td>1.9 dCi 100</td><td>74</td><td></td><td>03.01</td><td></td><td>- Pritsche/Fahrgestell 1)</td><td>24.3727-0796.2</td><td>580796</td><td></td><td>▴</td><td>+ kurzer Radstand 2)</td><td>L=1245/498</td></tr> <tr><td>1.9 dCi 80</td><td>60</td><td></td><td>03.01</td><td></td><td>- Pritsche/Fahrgestell 1)</td><td>24.3727-0764.2</td><td>580764</td><td>1</td><td>▣</td><td>+ langer Radstand 3)</td><td>L=1585</td></tr> <tr><td>2.0 16V</td><td>86</td><td></td><td>08.06</td><td></td><td>- Pritsche/Fahrgestell 1)</td><td>24.3727-0797.2</td><td>580797</td><td></td><td>▣</td><td>+ langer Radstand 3)</td><td>L=1643/498</td></tr> <tr><td>2.0 16V</td><td>88</td><td></td><td>03.01</td><td></td><td>- Pritsche/Fahrgestell 1)</td><td>24.3727-1068.2</td><td>581068</td><td></td><td>▣</td><td></td><td>L=1503</td></tr> <tr><td>2.0 dCi 115</td><td>84</td><td></td><td>10.06</td><td></td><td>- Pritsche/Fahrgestell 1)</td><td>24.3727-1071.2</td><td>581071</td><td></td><td>▣</td><td></td><td>L=1603</td></tr> <tr><td>2.0 dCi 90</td><td>66</td><td></td><td>10.06</td><td></td><td>- Pritsche/Fahrgestell 1)</td><td></td><td></td><td></td><td></td><td></td><td></td></tr> <tr><td>2.5 dCi</td><td>84</td><td></td><td>08.07</td><td></td><td>- Pritsche/Fahrgestell 1)</td><td></td><td></td><td></td><td></td><td></td><td></td></tr> <tr><td>2.5 dCi 115</td><td>84</td><td></td><td>02.08</td><td></td><td>- Pritsche/Fahrgestell 1)</td><td></td><td></td><td></td><td></td><td></td><td></td></tr> <tr><td>2.5 dCi 135</td><td>99</td><td></td><td>05.03</td><td></td><td>- Pritsche/Fahrgestell 1)</td><td></td><td></td><td></td><td></td><td></td><td></td></tr> <tr><td>2.5 dCi 145</td><td>107</td><td></td><td>10.06</td><td></td><td>- Pritsche/Fahrgestell 1)</td><td></td><td></td><td></td><td></td><td></td><td></td></tr> <tr><td>2.5 DTi</td><td>99</td><td></td><td>03.03</td><td>07.03</td><td>- Pritsche/Fahrgestell 1)</td><td></td><td></td><td></td><td></td><td></td><td></td></tr> </table> | 1.9 dCi         | 59    |       | 04.01                     | 07.03          | - Pritsche/Fahrgestell 1) | 24.3727-0763.2 | 580763                  | 1                    | □          | + kurzer Radstand 2) | L=1190     | 1.9 dCi 100     | 74 |  | 03.01 |       | - Pritsche/Fahrgestell 1) | 24.3727-0796.2 | 580796 |   | ▴     | + kurzer Radstand 2) | L=1245/498 | 1.9 dCi 80      | 60 |  | 03.01 |       | - Pritsche/Fahrgestell 1) | 24.3727-0764.2 | 580764 | 1 | ▣ | + langer Radstand 3) | L=1585 | 2.0 16V    | 86 |  | 08.06 |       | - Pritsche/Fahrgestell 1) | 24.3727-0797.2 | 580797 |   | ▣                       | + langer Radstand 3) | L=1643/498 | 2.0 16V              | 88 |  | 03.01 |       | - Pritsche/Fahrgestell 1) | 24.3727-1068.2 | 581068 |   | ▣                       |                | L=1503     | 2.0 dCi 115 | 84 |  | 10.06 |       | - Pritsche/Fahrgestell 1) | 24.3727-1071.2 | 581071 |  | ▣ |            | L=1603     | 2.0 dCi 90           | 66 |  | 10.06 |       | - Pritsche/Fahrgestell 1) |  |  |  |  |  |  | 2.5 dCi         | 84 |  | 08.07 |       | - Pritsche/Fahrgestell 1) |                |        |   |                         |                |            | 2.5 dCi 115          | 84 |  | 02.08 |       | - Pritsche/Fahrgestell 1) |                |        |   |                         |                |            | 2.5 dCi 135 | 99 |  | 05.03 |  | - Pritsche/Fahrgestell 1) |  |  |  |  |  |  | 2.5 dCi 145 | 107 |  | 10.06 |  | - Pritsche/Fahrgestell 1) |  |  |  |  |  |  | 2.5 DTi | 99 |  | 03.03 | 07.03 | - Pritsche/Fahrgestell 1) |  |  |  |  |  |  |
| 1.9 dCi                                   | 59   |                 | 04.01 | 07.03 | - Pritsche/Fahrgestell 1) | 24.3727-0763.2 | 580763                    | 1              | □                       | + kurzer Radstand 2) | L=1190     |                      |            |                 |    |  |       |       |                           |                |        |   |       |                      |            |                 |    |  |       |       |                           |                |        |   |   |                      |        |            |    |  |       |       |                           |                |        |   |                         |                      |            |                      |    |  |       |       |                           |                |        |   |                         |                |            |             |    |  |       |       |                           |                |        |  |   |            |            |                      |    |  |       |       |                           |  |  |  |  |  |  |                 |    |  |       |       |                           |                |        |   |                         |                |            |                      |    |  |       |       |                           |                |        |   |                         |                |            |             |    |  |       |  |                           |  |  |  |  |  |  |             |     |  |       |  |                           |  |  |  |  |  |  |         |    |  |       |       |                           |  |  |  |  |  |  |
| 1.9 dCi 100                               | 74   |                 | 03.01 |       | - Pritsche/Fahrgestell 1) | 24.3727-0796.2 | 580796                    |                | ▴                       | + kurzer Radstand 2) | L=1245/498 |                      |            |                 |    |  |       |       |                           |                |        |   |       |                      |            |                 |    |  |       |       |                           |                |        |   |   |                      |        |            |    |  |       |       |                           |                |        |   |                         |                      |            |                      |    |  |       |       |                           |                |        |   |                         |                |            |             |    |  |       |       |                           |                |        |  |   |            |            |                      |    |  |       |       |                           |  |  |  |  |  |  |                 |    |  |       |       |                           |                |        |   |                         |                |            |                      |    |  |       |       |                           |                |        |   |                         |                |            |             |    |  |       |  |                           |  |  |  |  |  |  |             |     |  |       |  |                           |  |  |  |  |  |  |         |    |  |       |       |                           |  |  |  |  |  |  |
| 1.9 dCi 80                                | 60   |                 | 03.01 |       | - Pritsche/Fahrgestell 1) | 24.3727-0764.2 | 580764                    | 1              | ▣                       | + langer Radstand 3) | L=1585     |                      |            |                 |    |  |       |       |                           |                |        |   |       |                      |            |                 |    |  |       |       |                           |                |        |   |   |                      |        |            |    |  |       |       |                           |                |        |   |                         |                      |            |                      |    |  |       |       |                           |                |        |   |                         |                |            |             |    |  |       |       |                           |                |        |  |   |            |            |                      |    |  |       |       |                           |  |  |  |  |  |  |                 |    |  |       |       |                           |                |        |   |                         |                |            |                      |    |  |       |       |                           |                |        |   |                         |                |            |             |    |  |       |  |                           |  |  |  |  |  |  |             |     |  |       |  |                           |  |  |  |  |  |  |         |    |  |       |       |                           |  |  |  |  |  |  |
| 2.0 16V                                   | 86   |                 | 08.06 |       | - Pritsche/Fahrgestell 1) | 24.3727-0797.2 | 580797                    |                | ▣                       | + langer Radstand 3) | L=1643/498 |                      |            |                 |    |  |       |       |                           |                |        |   |       |                      |            |                 |    |  |       |       |                           |                |        |   |   |                      |        |            |    |  |       |       |                           |                |        |   |                         |                      |            |                      |    |  |       |       |                           |                |        |   |                         |                |            |             |    |  |       |       |                           |                |        |  |   |            |            |                      |    |  |       |       |                           |  |  |  |  |  |  |                 |    |  |       |       |                           |                |        |   |                         |                |            |                      |    |  |       |       |                           |                |        |   |                         |                |            |             |    |  |       |  |                           |  |  |  |  |  |  |             |     |  |       |  |                           |  |  |  |  |  |  |         |    |  |       |       |                           |  |  |  |  |  |  |
| 2.0 16V                                   | 88   |                 | 03.01 |       | - Pritsche/Fahrgestell 1) | 24.3727-1068.2 | 581068                    |                | ▣                       |                      | L=1503     |                      |            |                 |    |  |       |       |                           |                |        |   |       |                      |            |                 |    |  |       |       |                           |                |        |   |   |                      |        |            |    |  |       |       |                           |                |        |   |                         |                      |            |                      |    |  |       |       |                           |                |        |   |                         |                |            |             |    |  |       |       |                           |                |        |  |   |            |            |                      |    |  |       |       |                           |  |  |  |  |  |  |                 |    |  |       |       |                           |                |        |   |                         |                |            |                      |    |  |       |       |                           |                |        |   |                         |                |            |             |    |  |       |  |                           |  |  |  |  |  |  |             |     |  |       |  |                           |  |  |  |  |  |  |         |    |  |       |       |                           |  |  |  |  |  |  |
| 2.0 dCi 115                               | 84   |                 | 10.06 |       | - Pritsche/Fahrgestell 1) | 24.3727-1071.2 | 581071                    |                | ▣                       |                      | L=1603     |                      |            |                 |    |  |       |       |                           |                |        |   |       |                      |            |                 |    |  |       |       |                           |                |        |   |   |                      |        |            |    |  |       |       |                           |                |        |   |                         |                      |            |                      |    |  |       |       |                           |                |        |   |                         |                |            |             |    |  |       |       |                           |                |        |  |   |            |            |                      |    |  |       |       |                           |  |  |  |  |  |  |                 |    |  |       |       |                           |                |        |   |                         |                |            |                      |    |  |       |       |                           |                |        |   |                         |                |            |             |    |  |       |  |                           |  |  |  |  |  |  |             |     |  |       |  |                           |  |  |  |  |  |  |         |    |  |       |       |                           |  |  |  |  |  |  |
| 2.0 dCi 90                                | 66   |                 | 10.06 |       | - Pritsche/Fahrgestell 1) |                |                           |                |                         |                      |            |                      |            |                 |    |  |       |       |                           |                |        |   |       |                      |            |                 |    |  |       |       |                           |                |        |   |   |                      |        |            |    |  |       |       |                           |                |        |   |                         |                      |            |                      |    |  |       |       |                           |                |        |   |                         |                |            |             |    |  |       |       |                           |                |        |  |   |            |            |                      |    |  |       |       |                           |  |  |  |  |  |  |                 |    |  |       |       |                           |                |        |   |                         |                |            |                      |    |  |       |       |                           |                |        |   |                         |                |            |             |    |  |       |  |                           |  |  |  |  |  |  |             |     |  |       |  |                           |  |  |  |  |  |  |         |    |  |       |       |                           |  |  |  |  |  |  |
| 2.5 dCi                                   | 84   |                 | 08.07 |       | - Pritsche/Fahrgestell 1) |                |                           |                |                         |                      |            |                      |            |                 |    |  |       |       |                           |                |        |   |       |                      |            |                 |    |  |       |       |                           |                |        |   |   |                      |        |            |    |  |       |       |                           |                |        |   |                         |                      |            |                      |    |  |       |       |                           |                |        |   |                         |                |            |             |    |  |       |       |                           |                |        |  |   |            |            |                      |    |  |       |       |                           |  |  |  |  |  |  |                 |    |  |       |       |                           |                |        |   |                         |                |            |                      |    |  |       |       |                           |                |        |   |                         |                |            |             |    |  |       |  |                           |  |  |  |  |  |  |             |     |  |       |  |                           |  |  |  |  |  |  |         |    |  |       |       |                           |  |  |  |  |  |  |
| 2.5 dCi 115                               | 84   |                 | 02.08 |       | - Pritsche/Fahrgestell 1) |                |                           |                |                         |                      |            |                      |            |                 |    |  |       |       |                           |                |        |   |       |                      |            |                 |    |  |       |       |                           |                |        |   |   |                      |        |            |    |  |       |       |                           |                |        |   |                         |                      |            |                      |    |  |       |       |                           |                |        |   |                         |                |            |             |    |  |       |       |                           |                |        |  |   |            |            |                      |    |  |       |       |                           |  |  |  |  |  |  |                 |    |  |       |       |                           |                |        |   |                         |                |            |                      |    |  |       |       |                           |                |        |   |                         |                |            |             |    |  |       |  |                           |  |  |  |  |  |  |             |     |  |       |  |                           |  |  |  |  |  |  |         |    |  |       |       |                           |  |  |  |  |  |  |
| 2.5 dCi 135                               | 99   |                 | 05.03 |       | - Pritsche/Fahrgestell 1) |                |                           |                |                         |                      |            |                      |            |                 |    |  |       |       |                           |                |        |   |       |                      |            |                 |    |  |       |       |                           |                |        |   |   |                      |        |            |    |  |       |       |                           |                |        |   |                         |                      |            |                      |    |  |       |       |                           |                |        |   |                         |                |            |             |    |  |       |       |                           |                |        |  |   |            |            |                      |    |  |       |       |                           |  |  |  |  |  |  |                 |    |  |       |       |                           |                |        |   |                         |                |            |                      |    |  |       |       |                           |                |        |   |                         |                |            |             |    |  |       |  |                           |  |  |  |  |  |  |             |     |  |       |  |                           |  |  |  |  |  |  |         |    |  |       |       |                           |  |  |  |  |  |  |
| 2.5 dCi 145                               | 107  |                 | 10.06 |       | - Pritsche/Fahrgestell 1) |                |                           |                |                         |                      |            |                      |            |                 |    |  |       |       |                           |                |        |   |       |                      |            |                 |    |  |       |       |                           |                |        |   |   |                      |        |            |    |  |       |       |                           |                |        |   |                         |                      |            |                      |    |  |       |       |                           |                |        |   |                         |                |            |             |    |  |       |       |                           |                |        |  |   |            |            |                      |    |  |       |       |                           |  |  |  |  |  |  |                 |    |  |       |       |                           |                |        |   |                         |                |            |                      |    |  |       |       |                           |                |        |   |                         |                |            |             |    |  |       |  |                           |  |  |  |  |  |  |             |     |  |       |  |                           |  |  |  |  |  |  |         |    |  |       |       |                           |  |  |  |  |  |  |
| 2.5 DTi                                   | 99   |                 | 03.03 | 07.03 | - Pritsche/Fahrgestell 1) |                |                           |                |                         |                      |            |                      |            |                 |    |  |       |       |                           |                |        |   |       |                      |            |                 |    |  |       |       |                           |                |        |   |   |                      |        |            |    |  |       |       |                           |                |        |   |                         |                      |            |                      |    |  |       |       |                           |                |        |   |                         |                |            |             |    |  |       |       |                           |                |        |  |   |            |            |                      |    |  |       |       |                           |  |  |  |  |  |  |                 |    |  |       |       |                           |                |        |   |                         |                |            |                      |    |  |       |       |                           |                |        |   |                         |                |            |             |    |  |       |  |                           |  |  |  |  |  |  |             |     |  |       |  |                           |  |  |  |  |  |  |         |    |  |       |       |                           |  |  |  |  |  |  |
|   | <table border="1"> <tr><td>1.9 dCi</td><td>59</td><td></td><td>04.01</td><td>07.03</td><td>+ Pritsche/Fahrgestell 4)</td><td>24.3727-1068.2</td><td>581068</td><td></td><td>▣</td><td></td><td>L=1503</td></tr> <tr><td>1.9 dCi 100</td><td>74</td><td></td><td>03.01</td><td></td><td>+ Pritsche/Fahrgestell 4)</td><td>24.3727-1071.2</td><td>581071</td><td></td><td>▣</td><td></td><td>L=1603</td></tr> <tr><td>1.9 dCi 80</td><td>60</td><td></td><td>03.01</td><td></td><td>+ Pritsche/Fahrgestell 4)</td><td></td><td></td><td></td><td></td><td></td><td></td></tr> <tr><td>2.0 16V</td><td>86</td><td></td><td>08.06</td><td></td><td>+ Pritsche/Fahrgestell 4)</td><td></td><td></td><td></td><td></td><td></td><td></td></tr> <tr><td>2.0 16V</td><td>88</td><td></td><td>03.01</td><td></td><td>+ Pritsche/Fahrgestell 4)</td><td></td><td></td><td></td><td></td><td></td><td></td></tr> <tr><td>2.0 dCi 115</td><td>84</td><td></td><td>10.06</td><td></td><td>+ Pritsche/Fahrgestell 4)</td><td></td><td></td><td></td><td></td><td></td><td></td></tr> <tr><td>2.0 dCi 90</td><td>66</td><td></td><td>10.06</td><td></td><td>+ Pritsche/Fahrgestell 4)</td><td></td><td></td><td></td><td></td><td></td><td></td></tr> <tr><td>2.5 dCi</td><td>84</td><td></td><td>08.07</td><td></td><td>+ Pritsche/Fahrgestell 4)</td><td></td><td></td><td></td><td></td><td></td><td></td></tr> <tr><td>2.5 dCi 115</td><td>84</td><td></td><td>02.08</td><td></td><td>+ Pritsche/Fahrgestell 4)</td><td></td><td></td><td></td><td></td><td></td><td></td></tr> <tr><td>2.5 dCi 135</td><td>99</td><td></td><td>05.03</td><td></td><td>+ Pritsche/Fahrgestell 4)</td><td></td><td></td><td></td><td></td><td></td><td></td></tr> <tr><td>2.5 dCi 145</td><td>107</td><td></td><td>10.06</td><td></td><td>+ Pritsche/Fahrgestell 4)</td><td></td><td></td><td></td><td></td><td></td><td></td></tr> <tr><td>2.5 DTi</td><td>99</td><td></td><td>03.03</td><td>07.03</td><td>+ Pritsche/Fahrgestell 4)</td><td></td><td></td><td></td><td></td><td></td><td></td></tr> </table>   | 1.9 dCi         | 59    |       | 04.01                     | 07.03          | + Pritsche/Fahrgestell 4) | 24.3727-1068.2 | 581068                  |                      | ▣          |                      | L=1503     | 1.9 dCi 100     | 74 |  | 03.01 |       | + Pritsche/Fahrgestell 4) | 24.3727-1071.2 | 581071 |   | ▣     |                      | L=1603     | 1.9 dCi 80      | 60 |  | 03.01 |       | + Pritsche/Fahrgestell 4) |                |        |   |   |                      |        | 2.0 16V    | 86 |  | 08.06 |       | + Pritsche/Fahrgestell 4) |                |        |   |                         |                      |            | 2.0 16V              | 88 |  | 03.01 |       | + Pritsche/Fahrgestell 4) |                |        |   |                         |                |            | 2.0 dCi 115 | 84 |  | 10.06 |       | + Pritsche/Fahrgestell 4) |                |        |  |   |            |            | 2.0 dCi 90           | 66 |  | 10.06 |       | + Pritsche/Fahrgestell 4) |  |  |  |  |  |  | 2.5 dCi         | 84 |  | 08.07 |       | + Pritsche/Fahrgestell 4) |                |        |   |                         |                |            | 2.5 dCi 115          | 84 |  | 02.08 |       | + Pritsche/Fahrgestell 4) |                |        |   |                         |                |            | 2.5 dCi 135 | 99 |  | 05.03 |  | + Pritsche/Fahrgestell 4) |  |  |  |  |  |  | 2.5 dCi 145 | 107 |  | 10.06 |  | + Pritsche/Fahrgestell 4) |  |  |  |  |  |  | 2.5 DTi | 99 |  | 03.03 | 07.03 | + Pritsche/Fahrgestell 4) |  |  |  |  |  |  |
| 1.9 dCi                                   | 59   |                 | 04.01 | 07.03 | + Pritsche/Fahrgestell 4) | 24.3727-1068.2 | 581068                    |                | ▣                       |                      | L=1503     |                      |            |                 |    |  |       |       |                           |                |        |   |       |                      |            |                 |    |  |       |       |                           |                |        |   |   |                      |        |            |    |  |       |       |                           |                |        |   |                         |                      |            |                      |    |  |       |       |                           |                |        |   |                         |                |            |             |    |  |       |       |                           |                |        |  |   |            |            |                      |    |  |       |       |                           |  |  |  |  |  |  |                 |    |  |       |       |                           |                |        |   |                         |                |            |                      |    |  |       |       |                           |                |        |   |                         |                |            |             |    |  |       |  |                           |  |  |  |  |  |  |             |     |  |       |  |                           |  |  |  |  |  |  |         |    |  |       |       |                           |  |  |  |  |  |  |
| 1.9 dCi 100                               | 74   |                 | 03.01 |       | + Pritsche/Fahrgestell 4) | 24.3727-1071.2 | 581071                    |                | ▣                       |                      | L=1603     |                      |            |                 |    |  |       |       |                           |                |        |   |       |                      |            |                 |    |  |       |       |                           |                |        |   |   |                      |        |            |    |  |       |       |                           |                |        |   |                         |                      |            |                      |    |  |       |       |                           |                |        |   |                         |                |            |             |    |  |       |       |                           |                |        |  |   |            |            |                      |    |  |       |       |                           |  |  |  |  |  |  |                 |    |  |       |       |                           |                |        |   |                         |                |            |                      |    |  |       |       |                           |                |        |   |                         |                |            |             |    |  |       |  |                           |  |  |  |  |  |  |             |     |  |       |  |                           |  |  |  |  |  |  |         |    |  |       |       |                           |  |  |  |  |  |  |
| 1.9 dCi 80                                | 60   |                 | 03.01 |       | + Pritsche/Fahrgestell 4) |                |                           |                |                         |                      |            |                      |            |                 |    |  |       |       |                           |                |        |   |       |                      |            |                 |    |  |       |       |                           |                |        |   |   |                      |        |            |    |  |       |       |                           |                |        |   |                         |                      |            |                      |    |  |       |       |                           |                |        |   |                         |                |            |             |    |  |       |       |                           |                |        |  |   |            |            |                      |    |  |       |       |                           |  |  |  |  |  |  |                 |    |  |       |       |                           |                |        |   |                         |                |            |                      |    |  |       |       |                           |                |        |   |                         |                |            |             |    |  |       |  |                           |  |  |  |  |  |  |             |     |  |       |  |                           |  |  |  |  |  |  |         |    |  |       |       |                           |  |  |  |  |  |  |
| 2.0 16V                                   | 86   |                 | 08.06 |       | + Pritsche/Fahrgestell 4) |                |                           |                |                         |                      |            |                      |            |                 |    |  |       |       |                           |                |        |   |       |                      |            |                 |    |  |       |       |                           |                |        |   |   |                      |        |            |    |  |       |       |                           |                |        |   |                         |                      |            |                      |    |  |       |       |                           |                |        |   |                         |                |            |             |    |  |       |       |                           |                |        |  |   |            |            |                      |    |  |       |       |                           |  |  |  |  |  |  |                 |    |  |       |       |                           |                |        |   |                         |                |            |                      |    |  |       |       |                           |                |        |   |                         |                |            |             |    |  |       |  |                           |  |  |  |  |  |  |             |     |  |       |  |                           |  |  |  |  |  |  |         |    |  |       |       |                           |  |  |  |  |  |  |
| 2.0 16V                                   | 88   |                 | 03.01 |       | + Pritsche/Fahrgestell 4) |                |                           |                |                         |                      |            |                      |            |                 |    |  |       |       |                           |                |        |   |       |                      |            |                 |    |  |       |       |                           |                |        |   |   |                      |        |            |    |  |       |       |                           |                |        |   |                         |                      |            |                      |    |  |       |       |                           |                |        |   |                         |                |            |             |    |  |       |       |                           |                |        |  |   |            |            |                      |    |  |       |       |                           |  |  |  |  |  |  |                 |    |  |       |       |                           |                |        |   |                         |                |            |                      |    |  |       |       |                           |                |        |   |                         |                |            |             |    |  |       |  |                           |  |  |  |  |  |  |             |     |  |       |  |                           |  |  |  |  |  |  |         |    |  |       |       |                           |  |  |  |  |  |  |
| 2.0 dCi 115                               | 84   |                 | 10.06 |       | + Pritsche/Fahrgestell 4) |                |                           |                |                         |                      |            |                      |            |                 |    |  |       |       |                           |                |        |   |       |                      |            |                 |    |  |       |       |                           |                |        |   |   |                      |        |            |    |  |       |       |                           |                |        |   |                         |                      |            |                      |    |  |       |       |                           |                |        |   |                         |                |            |             |    |  |       |       |                           |                |        |  |   |            |            |                      |    |  |       |       |                           |  |  |  |  |  |  |                 |    |  |       |       |                           |                |        |   |                         |                |            |                      |    |  |       |       |                           |                |        |   |                         |                |            |             |    |  |       |  |                           |  |  |  |  |  |  |             |     |  |       |  |                           |  |  |  |  |  |  |         |    |  |       |       |                           |  |  |  |  |  |  |
| 2.0 dCi 90                                | 66   |                 | 10.06 |       | + Pritsche/Fahrgestell 4) |                |                           |                |                         |                      |            |                      |            |                 |    |  |       |       |                           |                |        |   |       |                      |            |                 |    |  |       |       |                           |                |        |   |   |                      |        |            |    |  |       |       |                           |                |        |   |                         |                      |            |                      |    |  |       |       |                           |                |        |   |                         |                |            |             |    |  |       |       |                           |                |        |  |   |            |            |                      |    |  |       |       |                           |  |  |  |  |  |  |                 |    |  |       |       |                           |                |        |   |                         |                |            |                      |    |  |       |       |                           |                |        |   |                         |                |            |             |    |  |       |  |                           |  |  |  |  |  |  |             |     |  |       |  |                           |  |  |  |  |  |  |         |    |  |       |       |                           |  |  |  |  |  |  |
| 2.5 dCi                                   | 84   |                 | 08.07 |       | + Pritsche/Fahrgestell 4) |                |                           |                |                         |                      |            |                      |            |                 |    |  |       |       |                           |                |        |   |       |                      |            |                 |    |  |       |       |                           |                |        |   |   |                      |        |            |    |  |       |       |                           |                |        |   |                         |                      |            |                      |    |  |       |       |                           |                |        |   |                         |                |            |             |    |  |       |       |                           |                |        |  |   |            |            |                      |    |  |       |       |                           |  |  |  |  |  |  |                 |    |  |       |       |                           |                |        |   |                         |                |            |                      |    |  |       |       |                           |                |        |   |                         |                |            |             |    |  |       |  |                           |  |  |  |  |  |  |             |     |  |       |  |                           |  |  |  |  |  |  |         |    |  |       |       |                           |  |  |  |  |  |  |
| 2.5 dCi 115                               | 84   |                 | 02.08 |       | + Pritsche/Fahrgestell 4) |                |                           |                |                         |                      |            |                      |            |                 |    |  |       |       |                           |                |        |   |       |                      |            |                 |    |  |       |       |                           |                |        |   |   |                      |        |            |    |  |       |       |                           |                |        |   |                         |                      |            |                      |    |  |       |       |                           |                |        |   |                         |                |            |             |    |  |       |       |                           |                |        |  |   |            |            |                      |    |  |       |       |                           |  |  |  |  |  |  |                 |    |  |       |       |                           |                |        |   |                         |                |            |                      |    |  |       |       |                           |                |        |   |                         |                |            |             |    |  |       |  |                           |  |  |  |  |  |  |             |     |  |       |  |                           |  |  |  |  |  |  |         |    |  |       |       |                           |  |  |  |  |  |  |
| 2.5 dCi 135                               | 99   |                 | 05.03 |       | + Pritsche/Fahrgestell 4) |                |                           |                |                         |                      |            |                      |            |                 |    |  |       |       |                           |                |        |   |       |                      |            |                 |    |  |       |       |                           |                |        |   |   |                      |        |            |    |  |       |       |                           |                |        |   |                         |                      |            |                      |    |  |       |       |                           |                |        |   |                         |                |            |             |    |  |       |       |                           |                |        |  |   |            |            |                      |    |  |       |       |                           |  |  |  |  |  |  |                 |    |  |       |       |                           |                |        |   |                         |                |            |                      |    |  |       |       |                           |                |        |   |                         |                |            |             |    |  |       |  |                           |  |  |  |  |  |  |             |     |  |       |  |                           |  |  |  |  |  |  |         |    |  |       |       |                           |  |  |  |  |  |  |
| 2.5 dCi 145                               | 107  |                 | 10.06 |       | + Pritsche/Fahrgestell 4) |                |                           |                |                         |                      |            |                      |            |                 |    |  |       |       |                           |                |        |   |       |                      |            |                 |    |  |       |       |                           |                |        |   |   |                      |        |            |    |  |       |       |                           |                |        |   |                         |                      |            |                      |    |  |       |       |                           |                |        |   |                         |                |            |             |    |  |       |       |                           |                |        |  |   |            |            |                      |    |  |       |       |                           |  |  |  |  |  |  |                 |    |  |       |       |                           |                |        |   |                         |                |            |                      |    |  |       |       |                           |                |        |   |                         |                |            |             |    |  |       |  |                           |  |  |  |  |  |  |             |     |  |       |  |                           |  |  |  |  |  |  |         |    |  |       |       |                           |  |  |  |  |  |  |
| 2.5 DTi                                   | 99   |                 | 03.03 | 07.03 | + Pritsche/Fahrgestell 4) |                |                           |                |                         |                      |            |                      |            |                 |    |  |       |       |                           |                |        |   |       |                      |            |                 |    |  |       |       |                           |                |        |   |   |                      |        |            |    |  |       |       |                           |                |        |   |                         |                      |            |                      |    |  |       |       |                           |                |        |   |                         |                |            |             |    |  |       |       |                           |                |        |  |   |            |            |                      |    |  |       |       |                           |  |  |  |  |  |  |                 |    |  |       |       |                           |                |        |   |                         |                |            |                      |    |  |       |       |                           |                |        |   |                         |                |            |             |    |  |       |  |                           |  |  |  |  |  |  |             |     |  |       |  |                           |  |  |  |  |  |  |         |    |  |       |       |                           |  |  |  |  |  |  |
|   | <table border="1"> <tr><td>1.9 dCi</td><td>59</td><td></td><td>04.01</td><td>07.03</td><td></td><td>24.3727-1068.2</td><td>581068</td><td></td><td>▣</td><td></td><td>L=1503</td></tr> <tr><td>1.9 dCi 100</td><td>74</td><td></td><td>03.01</td><td></td><td></td><td>24.3727-1071.2</td><td>581071</td><td></td><td>▣</td><td></td><td>L=1603</td></tr> <tr><td>1.9 dCi 80</td><td>60</td><td></td><td>03.01</td><td></td><td></td><td></td><td></td><td></td><td></td><td></td><td></td></tr> <tr><td>2.0 16V</td><td>86</td><td></td><td>08.06</td><td></td><td></td><td></td><td></td><td></td><td></td><td></td><td></td></tr> <tr><td>2.0 16V</td><td>88</td><td></td><td>03.01</td><td></td><td></td><td></td><td></td><td></td><td></td><td></td><td></td></tr> <tr><td>2.0 dCi 115</td><td>84</td><td></td><td>10.06</td><td></td><td></td><td></td><td></td><td></td><td></td><td></td><td></td></tr> <tr><td>2.0 dCi 90</td><td>66</td><td></td><td>10.06</td><td></td><td></td><td></td><td></td><td></td><td></td><td></td><td></td></tr> <tr><td>2.5 dCi</td><td>84</td><td></td><td>08.07</td><td></td><td></td><td></td><td></td><td></td><td></td><td></td><td></td></tr> <tr><td>2.5 dCi 115</td><td>84</td><td></td><td>02.08</td><td></td><td></td><td></td><td></td><td></td><td></td><td></td><td></td></tr> <tr><td>2.5 dCi 135</td><td>99</td><td></td><td>05.03</td><td></td><td></td><td></td><td></td><td></td><td></td><td></td><td></td></tr> <tr><td>2.5 dCi 145</td><td>107</td><td></td><td>10.06</td><td></td><td></td><td></td><td></td><td></td><td></td><td></td><td></td></tr> <tr><td>2.5 DTi</td><td>99</td><td></td><td>03.03</td><td>07.03</td><td></td><td></td><td></td><td></td><td></td><td></td><td></td></tr> </table>   | 1.9 dCi         | 59    |       | 04.01                     | 07.03          |                           | 24.3727-1068.2 | 581068                  |                      | ▣          |                      | L=1503     | 1.9 dCi 100     | 74 |  | 03.01 |       |                           | 24.3727-1071.2 | 581071 |   | ▣     |                      | L=1603     | 1.9 dCi 80      | 60 |  | 03.01 |       |                           |                |        |   |   |                      |        | 2.0 16V    | 86 |  | 08.06 |       |                           |                |        |   |                         |                      |            | 2.0 16V              | 88 |  | 03.01 |       |                           |                |        |   |                         |                |            | 2.0 dCi 115 | 84 |  | 10.06 |       |                           |                |        |  |   |            |            | 2.0 dCi 90           | 66 |  | 10.06 |       |                           |  |  |  |  |  |  | 2.5 dCi         | 84 |  | 08.07 |       |                           |                |        |   |                         |                |            | 2.5 dCi 115          | 84 |  | 02.08 |       |                           |                |        |   |                         |                |            | 2.5 dCi 135 | 99 |  | 05.03 |  |                           |  |  |  |  |  |  | 2.5 dCi 145 | 107 |  | 10.06 |  |                           |  |  |  |  |  |  | 2.5 DTi | 99 |  | 03.03 | 07.03 |                           |  |  |  |  |  |  |
| 1.9 dCi                                   | 59   |                 | 04.01 | 07.03 |                           | 24.3727-1068.2 | 581068                    |                | ▣                       |                      | L=1503     |                      |            |                 |    |  |       |       |                           |                |        |   |       |                      |            |                 |    |  |       |       |                           |                |        |   |   |                      |        |            |    |  |       |       |                           |                |        |   |                         |                      |            |                      |    |  |       |       |                           |                |        |   |                         |                |            |             |    |  |       |       |                           |                |        |  |   |            |            |                      |    |  |       |       |                           |  |  |  |  |  |  |                 |    |  |       |       |                           |                |        |   |                         |                |            |                      |    |  |       |       |                           |                |        |   |                         |                |            |             |    |  |       |  |                           |  |  |  |  |  |  |             |     |  |       |  |                           |  |  |  |  |  |  |         |    |  |       |       |                           |  |  |  |  |  |  |
| 1.9 dCi 100                               | 74   |                 | 03.01 |       |                           | 24.3727-1071.2 | 581071                    |                | ▣                       |                      | L=1603     |                      |            |                 |    |  |       |       |                           |                |        |   |       |                      |            |                 |    |  |       |       |                           |                |        |   |   |                      |        |            |    |  |       |       |                           |                |        |   |                         |                      |            |                      |    |  |       |       |                           |                |        |   |                         |                |            |             |    |  |       |       |                           |                |        |  |   |            |            |                      |    |  |       |       |                           |  |  |  |  |  |  |                 |    |  |       |       |                           |                |        |   |                         |                |            |                      |    |  |       |       |                           |                |        |   |                         |                |            |             |    |  |       |  |                           |  |  |  |  |  |  |             |     |  |       |  |                           |  |  |  |  |  |  |         |    |  |       |       |                           |  |  |  |  |  |  |
| 1.9 dCi 80                                | 60   |                 | 03.01 |       |                           |                |                           |                |                         |                      |            |                      |            |                 |    |  |       |       |                           |                |        |   |       |                      |            |                 |    |  |       |       |                           |                |        |   |   |                      |        |            |    |  |       |       |                           |                |        |   |                         |                      |            |                      |    |  |       |       |                           |                |        |   |                         |                |            |             |    |  |       |       |                           |                |        |  |   |            |            |                      |    |  |       |       |                           |  |  |  |  |  |  |                 |    |  |       |       |                           |                |        |   |                         |                |            |                      |    |  |       |       |                           |                |        |   |                         |                |            |             |    |  |       |  |                           |  |  |  |  |  |  |             |     |  |       |  |                           |  |  |  |  |  |  |         |    |  |       |       |                           |  |  |  |  |  |  |
| 2.0 16V                                   | 86   |                 | 08.06 |       |                           |                |                           |                |                         |                      |            |                      |            |                 |    |  |       |       |                           |                |        |   |       |                      |            |                 |    |  |       |       |                           |                |        |   |   |                      |        |            |    |  |       |       |                           |                |        |   |                         |                      |            |                      |    |  |       |       |                           |                |        |   |                         |                |            |             |    |  |       |       |                           |                |        |  |   |            |            |                      |    |  |       |       |                           |  |  |  |  |  |  |                 |    |  |       |       |                           |                |        |   |                         |                |            |                      |    |  |       |       |                           |                |        |   |                         |                |            |             |    |  |       |  |                           |  |  |  |  |  |  |             |     |  |       |  |                           |  |  |  |  |  |  |         |    |  |       |       |                           |  |  |  |  |  |  |
| 2.0 16V                                   | 88   |                 | 03.01 |       |                           |                |                           |                |                         |                      |            |                      |            |                 |    |  |       |       |                           |                |        |   |       |                      |            |                 |    |  |       |       |                           |                |        |   |   |                      |        |            |    |  |       |       |                           |                |        |   |                         |                      |            |                      |    |  |       |       |                           |                |        |   |                         |                |            |             |    |  |       |       |                           |                |        |  |   |            |            |                      |    |  |       |       |                           |  |  |  |  |  |  |                 |    |  |       |       |                           |                |        |   |                         |                |            |                      |    |  |       |       |                           |                |        |   |                         |                |            |             |    |  |       |  |                           |  |  |  |  |  |  |             |     |  |       |  |                           |  |  |  |  |  |  |         |    |  |       |       |                           |  |  |  |  |  |  |
| 2.0 dCi 115                               | 84   |                 | 10.06 |       |                           |                |                           |                |                         |                      |            |                      |            |                 |    |  |       |       |                           |                |        |   |       |                      |            |                 |    |  |       |       |                           |                |        |   |   |                      |        |            |    |  |       |       |                           |                |        |   |                         |                      |            |                      |    |  |       |       |                           |                |        |   |                         |                |            |             |    |  |       |       |                           |                |        |  |   |            |            |                      |    |  |       |       |                           |  |  |  |  |  |  |                 |    |  |       |       |                           |                |        |   |                         |                |            |                      |    |  |       |       |                           |                |        |   |                         |                |            |             |    |  |       |  |                           |  |  |  |  |  |  |             |     |  |       |  |                           |  |  |  |  |  |  |         |    |  |       |       |                           |  |  |  |  |  |  |
| 2.0 dCi 90                                | 66   |                 | 10.06 |       |                           |                |                           |                |                         |                      |            |                      |            |                 |    |  |       |       |                           |                |        |   |       |                      |            |                 |    |  |       |       |                           |                |        |   |   |                      |        |            |    |  |       |       |                           |                |        |   |                         |                      |            |                      |    |  |       |       |                           |                |        |   |                         |                |            |             |    |  |       |       |                           |                |        |  |   |            |            |                      |    |  |       |       |                           |  |  |  |  |  |  |                 |    |  |       |       |                           |                |        |   |                         |                |            |                      |    |  |       |       |                           |                |        |   |                         |                |            |             |    |  |       |  |                           |  |  |  |  |  |  |             |     |  |       |  |                           |  |  |  |  |  |  |         |    |  |       |       |                           |  |  |  |  |  |  |
| 2.5 dCi                                   | 84   |                 | 08.07 |       |                           |                |                           |                |                         |                      |            |                      |            |                 |    |  |       |       |                           |                |        |   |       |                      |            |                 |    |  |       |       |                           |                |        |   |   |                      |        |            |    |  |       |       |                           |                |        |   |                         |                      |            |                      |    |  |       |       |                           |                |        |   |                         |                |            |             |    |  |       |       |                           |                |        |  |   |            |            |                      |    |  |       |       |                           |  |  |  |  |  |  |                 |    |  |       |       |                           |                |        |   |                         |                |            |                      |    |  |       |       |                           |                |        |   |                         |                |            |             |    |  |       |  |                           |  |  |  |  |  |  |             |     |  |       |  |                           |  |  |  |  |  |  |         |    |  |       |       |                           |  |  |  |  |  |  |
| 2.5 dCi 115                               | 84   |                 | 02.08 |       |                           |                |                           |                |                         |                      |            |                      |            |                 |    |  |       |       |                           |                |        |   |       |                      |            |                 |    |  |       |       |                           |                |        |   |   |                      |        |            |    |  |       |       |                           |                |        |   |                         |                      |            |                      |    |  |       |       |                           |                |        |   |                         |                |            |             |    |  |       |       |                           |                |        |  |   |            |            |                      |    |  |       |       |                           |  |  |  |  |  |  |                 |    |  |       |       |                           |                |        |   |                         |                |            |                      |    |  |       |       |                           |                |        |   |                         |                |            |             |    |  |       |  |                           |  |  |  |  |  |  |             |     |  |       |  |                           |  |  |  |  |  |  |         |    |  |       |       |                           |  |  |  |  |  |  |
| 2.5 dCi 135                               | 99   |                 | 05.03 |       |                           |                |                           |                |                         |                      |            |                      |            |                 |    |  |       |       |                           |                |        |   |       |                      |            |                 |    |  |       |       |                           |                |        |   |   |                      |        |            |    |  |       |       |                           |                |        |   |                         |                      |            |                      |    |  |       |       |                           |                |        |   |                         |                |            |             |    |  |       |       |                           |                |        |  |   |            |            |                      |    |  |       |       |                           |  |  |  |  |  |  |                 |    |  |       |       |                           |                |        |   |                         |                |            |                      |    |  |       |       |                           |                |        |   |                         |                |            |             |    |  |       |  |                           |  |  |  |  |  |  |             |     |  |       |  |                           |  |  |  |  |  |  |         |    |  |       |       |                           |  |  |  |  |  |  |
| 2.5 dCi 145                               | 107  |                 | 10.06 |       |                           |                |                           |                |                         |                      |            |                      |            |                 |    |  |       |       |                           |                |        |   |       |                      |            |                 |    |  |       |       |                           |                |        |   |   |                      |        |            |    |  |       |       |                           |                |        |   |                         |                      |            |                      |    |  |       |       |                           |                |        |   |                         |                |            |             |    |  |       |       |                           |                |        |  |   |            |            |                      |    |  |       |       |                           |  |  |  |  |  |  |                 |    |  |       |       |                           |                |        |   |                         |                |            |                      |    |  |       |       |                           |                |        |   |                         |                |            |             |    |  |       |  |                           |  |  |  |  |  |  |             |     |  |       |  |                           |  |  |  |  |  |  |         |    |  |       |       |                           |  |  |  |  |  |  |
| 2.5 DTi                                   | 99   |                 | 03.03 | 07.03 |                           |                |                           |                |                         |                      |            |                      |            |                 |    |  |       |       |                           |                |        |   |       |                      |            |                 |    |  |       |       |                           |                |        |   |   |                      |        |            |    |  |       |       |                           |                |        |   |                         |                      |            |                      |    |  |       |       |                           |                |        |   |                         |                |            |             |    |  |       |       |                           |                |        |  |   |            |            |                      |    |  |       |       |                           |  |  |  |  |  |  |                 |    |  |       |       |                           |                |        |   |                         |                |            |                      |    |  |       |       |                           |                |        |   |                         |                |            |             |    |  |       |  |                           |  |  |  |  |  |  |             |     |  |       |  |                           |  |  |  |  |  |  |         |    |  |       |       |                           |  |  |  |  |  |  |
|   | <table border="1"> <tr><td>1.9 dCi</td><td>59</td><td></td><td>04.01</td><td>07.03</td><td>- ABS</td><td>24.6582-1711.3</td><td>320267</td><td></td><td></td><td></td><td>BRL (4)</td></tr> <tr><td>1.9 dCi 100</td><td>74</td><td></td><td>03.01</td><td></td><td>- ABS</td><td></td><td></td><td></td><td></td><td></td><td></td></tr> <tr><td>1.9 dCi 80</td><td>60</td><td></td><td>03.01</td><td></td><td>- ABS</td><td></td><td></td><td></td><td></td><td></td><td></td></tr> <tr><td>2.0 16V</td><td>86</td><td></td><td>08.06</td><td></td><td>- ABS</td><td></td><td></td><td></td><td></td><td></td><td></td></tr> <tr><td>2.0 16V</td><td>88</td><td></td><td>03.01</td><td></td><td>- ABS</td><td></td><td></td><td></td><td></td><td></td><td></td></tr> <tr><td>2.0 dCi 115</td><td>84</td><td></td><td>10.06</td><td></td><td>- ABS</td><td></td><td></td><td></td><td></td><td></td><td></td></tr> <tr><td>2.0 dCi 90</td><td>66</td><td></td><td>10.06</td><td></td><td>- ABS</td><td></td><td></td><td></td><td></td><td></td><td></td></tr> <tr><td>2.5 dCi</td><td>84</td><td></td><td>08.07</td><td></td><td>- ABS</td><td></td><td></td><td></td><td></td><td></td><td></td></tr> <tr><td>2.5 dCi 115</td><td>84</td><td></td><td>02.08</td><td></td><td>- ABS</td><td></td><td></td><td></td><td></td><td></td><td></td></tr> <tr><td>2.5 dCi 135</td><td>99</td><td></td><td>05.03</td><td></td><td>- ABS</td><td></td><td></td><td></td><td></td><td></td><td></td></tr> <tr><td>2.5 dCi 145</td><td>107</td><td></td><td>10.06</td><td></td><td>- ABS</td><td></td><td></td><td></td><td></td><td></td><td></td></tr> <tr><td>2.5 DTi</td><td>99</td><td></td><td>03.03</td><td>07.03</td><td>- ABS</td><td></td><td></td><td></td><td></td><td></td><td></td></tr> </table>  | 1.9 dCi         | 59    |       | 04.01                     | 07.03          | - ABS                     | 24.6582-1711.3 | 320267                  |                      |            |                      | BRL (4)    | 1.9 dCi 100     | 74 |  | 03.01 |       | - ABS                     |                |        |   |       |                      |            | 1.9 dCi 80      | 60 |  | 03.01 |       | - ABS                     |                |        |   |   |                      |        | 2.0 16V    | 86 |  | 08.06 |       | - ABS                     |                |        |   |                         |                      |            | 2.0 16V              | 88 |  | 03.01 |       | - ABS                     |                |        |   |                         |                |            | 2.0 dCi 115 | 84 |  | 10.06 |       | - ABS                     |                |        |  |   |            |            | 2.0 dCi 90           | 66 |  | 10.06 |       | - ABS                     |  |  |  |  |  |  | 2.5 dCi         | 84 |  | 08.07 |       | - ABS                     |                |        |   |                         |                |            | 2.5 dCi 115          | 84 |  | 02.08 |       | - ABS                     |                |        |   |                         |                |            | 2.5 dCi 135 | 99 |  | 05.03 |  | - ABS                     |  |  |  |  |  |  | 2.5 dCi 145 | 107 |  | 10.06 |  | - ABS                     |  |  |  |  |  |  | 2.5 DTi | 99 |  | 03.03 | 07.03 | - ABS                     |  |  |  |  |  |  |
| 1.9 dCi                                   | 59   |                 | 04.01 | 07.03 | - ABS                     | 24.6582-1711.3 | 320267                    |                |                         |                      | BRL (4)    |                      |            |                 |    |  |       |       |                           |                |        |   |       |                      |            |                 |    |  |       |       |                           |                |        |   |   |                      |        |            |    |  |       |       |                           |                |        |   |                         |                      |            |                      |    |  |       |       |                           |                |        |   |                         |                |            |             |    |  |       |       |                           |                |        |  |   |            |            |                      |    |  |       |       |                           |  |  |  |  |  |  |                 |    |  |       |       |                           |                |        |   |                         |                |            |                      |    |  |       |       |                           |                |        |   |                         |                |            |             |    |  |       |  |                           |  |  |  |  |  |  |             |     |  |       |  |                           |  |  |  |  |  |  |         |    |  |       |       |                           |  |  |  |  |  |  |
| 1.9 dCi 100                               | 74   |                 | 03.01 |       | - ABS                     |                |                           |                |                         |                      |            |                      |            |                 |    |  |       |       |                           |                |        |   |       |                      |            |                 |    |  |       |       |                           |                |        |   |   |                      |        |            |    |  |       |       |                           |                |        |   |                         |                      |            |                      |    |  |       |       |                           |                |        |   |                         |                |            |             |    |  |       |       |                           |                |        |  |   |            |            |                      |    |  |       |       |                           |  |  |  |  |  |  |                 |    |  |       |       |                           |                |        |   |                         |                |            |                      |    |  |       |       |                           |                |        |   |                         |                |            |             |    |  |       |  |                           |  |  |  |  |  |  |             |     |  |       |  |                           |  |  |  |  |  |  |         |    |  |       |       |                           |  |  |  |  |  |  |
| 1.9 dCi 80                                | 60   |                 | 03.01 |       | - ABS                     |                |                           |                |                         |                      |            |                      |            |                 |    |  |       |       |                           |                |        |   |       |                      |            |                 |    |  |       |       |                           |                |        |   |   |                      |        |            |    |  |       |       |                           |                |        |   |                         |                      |            |                      |    |  |       |       |                           |                |        |   |                         |                |            |             |    |  |       |       |                           |                |        |  |   |            |            |                      |    |  |       |       |                           |  |  |  |  |  |  |                 |    |  |       |       |                           |                |        |   |                         |                |            |                      |    |  |       |       |                           |                |        |   |                         |                |            |             |    |  |       |  |                           |  |  |  |  |  |  |             |     |  |       |  |                           |  |  |  |  |  |  |         |    |  |       |       |                           |  |  |  |  |  |  |
| 2.0 16V                                   | 86   |                 | 08.06 |       | - ABS                     |                |                           |                |                         |                      |            |                      |            |                 |    |  |       |       |                           |                |        |   |       |                      |            |                 |    |  |       |       |                           |                |        |   |   |                      |        |            |    |  |       |       |                           |                |        |   |                         |                      |            |                      |    |  |       |       |                           |                |        |   |                         |                |            |             |    |  |       |       |                           |                |        |  |   |            |            |                      |    |  |       |       |                           |  |  |  |  |  |  |                 |    |  |       |       |                           |                |        |   |                         |                |            |                      |    |  |       |       |                           |                |        |   |                         |                |            |             |    |  |       |  |                           |  |  |  |  |  |  |             |     |  |       |  |                           |  |  |  |  |  |  |         |    |  |       |       |                           |  |  |  |  |  |  |
| 2.0 16V                                   | 88   |                 | 03.01 |       | - ABS                     |                |                           |                |                         |                      |            |                      |            |                 |    |  |       |       |                           |                |        |   |       |                      |            |                 |    |  |       |       |                           |                |        |   |   |                      |        |            |    |  |       |       |                           |                |        |   |                         |                      |            |                      |    |  |       |       |                           |                |        |   |                         |                |            |             |    |  |       |       |                           |                |        |  |   |            |            |                      |    |  |       |       |                           |  |  |  |  |  |  |                 |    |  |       |       |                           |                |        |   |                         |                |            |                      |    |  |       |       |                           |                |        |   |                         |                |            |             |    |  |       |  |                           |  |  |  |  |  |  |             |     |  |       |  |                           |  |  |  |  |  |  |         |    |  |       |       |                           |  |  |  |  |  |  |
| 2.0 dCi 115                               | 84   |                 | 10.06 |       | - ABS                     |                |                           |                |                         |                      |            |                      |            |                 |    |  |       |       |                           |                |        |   |       |                      |            |                 |    |  |       |       |                           |                |        |   |   |                      |        |            |    |  |       |       |                           |                |        |   |                         |                      |            |                      |    |  |       |       |                           |                |        |   |                         |                |            |             |    |  |       |       |                           |                |        |  |   |            |            |                      |    |  |       |       |                           |  |  |  |  |  |  |                 |    |  |       |       |                           |                |        |   |                         |                |            |                      |    |  |       |       |                           |                |        |   |                         |                |            |             |    |  |       |  |                           |  |  |  |  |  |  |             |     |  |       |  |                           |  |  |  |  |  |  |         |    |  |       |       |                           |  |  |  |  |  |  |
| 2.0 dCi 90                                | 66   |                 | 10.06 |       | - ABS                     |                |                           |                |                         |                      |            |                      |            |                 |    |  |       |       |                           |                |        |   |       |                      |            |                 |    |  |       |       |                           |                |        |   |   |                      |        |            |    |  |       |       |                           |                |        |   |                         |                      |            |                      |    |  |       |       |                           |                |        |   |                         |                |            |             |    |  |       |       |                           |                |        |  |   |            |            |                      |    |  |       |       |                           |  |  |  |  |  |  |                 |    |  |       |       |                           |                |        |   |                         |                |            |                      |    |  |       |       |                           |                |        |   |                         |                |            |             |    |  |       |  |                           |  |  |  |  |  |  |             |     |  |       |  |                           |  |  |  |  |  |  |         |    |  |       |       |                           |  |  |  |  |  |  |
| 2.5 dCi                                   | 84   |                 | 08.07 |       | - ABS                     |                |                           |                |                         |                      |            |                      |            |                 |    |  |       |       |                           |                |        |   |       |                      |            |                 |    |  |       |       |                           |                |        |   |   |                      |        |            |    |  |       |       |                           |                |        |   |                         |                      |            |                      |    |  |       |       |                           |                |        |   |                         |                |            |             |    |  |       |       |                           |                |        |  |   |            |            |                      |    |  |       |       |                           |  |  |  |  |  |  |                 |    |  |       |       |                           |                |        |   |                         |                |            |                      |    |  |       |       |                           |                |        |   |                         |                |            |             |    |  |       |  |                           |  |  |  |  |  |  |             |     |  |       |  |                           |  |  |  |  |  |  |         |    |  |       |       |                           |  |  |  |  |  |  |
| 2.5 dCi 115                               | 84   |                 | 02.08 |       | - ABS                     |                |                           |                |                         |                      |            |                      |            |                 |    |  |       |       |                           |                |        |   |       |                      |            |                 |    |  |       |       |                           |                |        |   |   |                      |        |            |    |  |       |       |                           |                |        |   |                         |                      |            |                      |    |  |       |       |                           |                |        |   |                         |                |            |             |    |  |       |       |                           |                |        |  |   |            |            |                      |    |  |       |       |                           |  |  |  |  |  |  |                 |    |  |       |       |                           |                |        |   |                         |                |            |                      |    |  |       |       |                           |                |        |   |                         |                |            |             |    |  |       |  |                           |  |  |  |  |  |  |             |     |  |       |  |                           |  |  |  |  |  |  |         |    |  |       |       |                           |  |  |  |  |  |  |
| 2.5 dCi 135                               | 99   |                 | 05.03 |       | - ABS                     |                |                           |                |                         |                      |            |                      |            |                 |    |  |       |       |                           |                |        |   |       |                      |            |                 |    |  |       |       |                           |                |        |   |   |                      |        |            |    |  |       |       |                           |                |        |   |                         |                      |            |                      |    |  |       |       |                           |                |        |   |                         |                |            |             |    |  |       |       |                           |                |        |  |   |            |            |                      |    |  |       |       |                           |  |  |  |  |  |  |                 |    |  |       |       |                           |                |        |   |                         |                |            |                      |    |  |       |       |                           |                |        |   |                         |                |            |             |    |  |       |  |                           |  |  |  |  |  |  |             |     |  |       |  |                           |  |  |  |  |  |  |         |    |  |       |       |                           |  |  |  |  |  |  |
| 2.5 dCi 145                               | 107  |                 | 10.06 |       | - ABS                     |                |                           |                |                         |                      |            |                      |            |                 |    |  |       |       |                           |                |        |   |       |                      |            |                 |    |  |       |       |                           |                |        |   |   |                      |        |            |    |  |       |       |                           |                |        |   |                         |                      |            |                      |    |  |       |       |                           |                |        |   |                         |                |            |             |    |  |       |       |                           |                |        |  |   |            |            |                      |    |  |       |       |                           |  |  |  |  |  |  |                 |    |  |       |       |                           |                |        |   |                         |                |            |                      |    |  |       |       |                           |                |        |   |                         |                |            |             |    |  |       |  |                           |  |  |  |  |  |  |             |     |  |       |  |                           |  |  |  |  |  |  |         |    |  |       |       |                           |  |  |  |  |  |  |
| 2.5 DTi                                   | 99   |                 | 03.03 | 07.03 | - ABS                     |                |                           |                |                         |                      |            |                      |            |                 |    |  |       |       |                           |                |        |   |       |                      |            |                 |    |  |       |       |                           |                |        |   |   |                      |        |            |    |  |       |       |                           |                |        |   |                         |                      |            |                      |    |  |       |       |                           |                |        |   |                         |                |            |             |    |  |       |       |                           |                |        |  |   |            |            |                      |    |  |       |       |                           |  |  |  |  |  |  |                 |    |  |       |       |                           |                |        |   |                         |                |            |                      |    |  |       |       |                           |                |        |   |                         |                |            |             |    |  |       |  |                           |  |  |  |  |  |  |             |     |  |       |  |                           |  |  |  |  |  |  |         |    |  |       |       |                           |  |  |  |  |  |  |
| RENAULT TWINGO I Limousine (C06_) (93-07) |  |                 |       |       |                           |                |                           |                |                         |                      |            |                      |            |                 |    |  |       |       |                           |                |        |   |       |                      |            |                 |    |  |       |       |                           |                |        |   |   |                      |        |            |    |  |       |       |                           |                |        |   |                         |                      |            |                      |    |  |       |       |                           |                |        |   |                         |                |            |             |    |  |       |       |                           |                |        |  |   |            |            |                      |    |  |       |       |                           |  |  |  |  |  |  |                 |    |  |       |       |                           |                |        |   |                         |                |            |                      |    |  |       |       |                           |                |        |   |                         |                |            |             |    |  |       |  |                           |  |  |  |  |  |  |             |     |  |       |  |                           |  |  |  |  |  |  |         |    |  |       |       |                           |  |  |  |  |  |  |
|   | <table border="1"> <tr><td>1.2 (C060)</td><td>44</td><td></td><td>08.04</td><td>07.07</td><td></td><td>24.2120-1706.3</td><td>010262</td><td></td><td>- ABS</td><td>ThZ 20,64</td><td></td></tr> <tr><td>1.2 (C063,C064)</td><td>40</td><td></td><td>03.93</td><td>10.96</td><td></td><td>24.2120-1723.3</td><td>010545</td><td></td><td>+ ABS</td><td>ThZ 20,64</td><td><b>BDX</b></td></tr> <tr><td>1.2 (C066,C068)</td><td>43</td><td></td><td>05.96</td><td>07.07</td><td></td><td></td><td></td><td></td><td></td><td></td><td></td></tr> <tr><td>1.2 (C067)</td><td>40</td><td></td><td>05.96</td><td>07.07</td><td></td><td></td><td></td><td></td><td></td><td></td><td></td></tr> <tr><td>1.2 (C06C,C06D,C06K)</td><td>55</td><td></td><td>01.01</td><td>07.07</td><td></td><td></td><td></td><td></td><td></td><td></td><td></td></tr> </table>  | 1.2 (C060)      | 44    |       | 08.04                     | 07.07          |                           | 24.2120-1706.3 | 010262                  |                      | - ABS      | ThZ 20,64            |            | 1.2 (C063,C064) | 40 |  | 03.93 | 10.96 |                           | 24.2120-1723.3 | 010545 |   | + ABS | ThZ 20,64            | <b>BDX</b> | 1.2 (C066,C068) | 43 |  | 05.96 | 07.07 |                           |                |        |   |   |                      |        | 1.2 (C067) | 40 |  | 05.96 | 07.07 |                           |                |        |   |                         |                      |            | 1.2 (C06C,C06D,C06K) | 55 |  | 01.01 | 07.07 |                           |                |        |   |                         |                |            |             |    |  |       |       |                           |                |        |  |   |            |            |                      |    |  |       |       |                           |  |  |  |  |  |  |                 |    |  |       |       |                           |                |        |   |                         |                |            |                      |    |  |       |       |                           |                |        |   |                         |                |            |             |    |  |       |  |                           |  |  |  |  |  |  |             |     |  |       |  |                           |  |  |  |  |  |  |         |    |  |       |       |                           |  |  |  |  |  |  |
| 1.2 (C060)                                | 44   |                 | 08.04 | 07.07 |                           | 24.2120-1706.3 | 010262                    |                | - ABS                   | ThZ 20,64            |            |                      |            |                 |    |  |       |       |                           |                |        |   |       |                      |            |                 |    |  |       |       |                           |                |        |   |   |                      |        |            |    |  |       |       |                           |                |        |   |                         |                      |            |                      |    |  |       |       |                           |                |        |   |                         |                |            |             |    |  |       |       |                           |                |        |  |   |            |            |                      |    |  |       |       |                           |  |  |  |  |  |  |                 |    |  |       |       |                           |                |        |   |                         |                |            |                      |    |  |       |       |                           |                |        |   |                         |                |            |             |    |  |       |  |                           |  |  |  |  |  |  |             |     |  |       |  |                           |  |  |  |  |  |  |         |    |  |       |       |                           |  |  |  |  |  |  |
| 1.2 (C063,C064)                           | 40   |                 | 03.93 | 10.96 |                           | 24.2120-1723.3 | 010545                    |                | + ABS                   | ThZ 20,64            | <b>BDX</b> |                      |            |                 |    |  |       |       |                           |                |        |   |       |                      |            |                 |    |  |       |       |                           |                |        |   |   |                      |        |            |    |  |       |       |                           |                |        |   |                         |                      |            |                      |    |  |       |       |                           |                |        |   |                         |                |            |             |    |  |       |       |                           |                |        |  |   |            |            |                      |    |  |       |       |                           |  |  |  |  |  |  |                 |    |  |       |       |                           |                |        |   |                         |                |            |                      |    |  |       |       |                           |                |        |   |                         |                |            |             |    |  |       |  |                           |  |  |  |  |  |  |             |     |  |       |  |                           |  |  |  |  |  |  |         |    |  |       |       |                           |  |  |  |  |  |  |
| 1.2 (C066,C068)                           | 43   |                 | 05.96 | 07.07 |                           |                |                           |                |                         |                      |            |                      |            |                 |    |  |       |       |                           |                |        |   |       |                      |            |                 |    |  |       |       |                           |                |        |   |   |                      |        |            |    |  |       |       |                           |                |        |   |                         |                      |            |                      |    |  |       |       |                           |                |        |   |                         |                |            |             |    |  |       |       |                           |                |        |  |   |            |            |                      |    |  |       |       |                           |  |  |  |  |  |  |                 |    |  |       |       |                           |                |        |   |                         |                |            |                      |    |  |       |       |                           |                |        |   |                         |                |            |             |    |  |       |  |                           |  |  |  |  |  |  |             |     |  |       |  |                           |  |  |  |  |  |  |         |    |  |       |       |                           |  |  |  |  |  |  |
| 1.2 (C067)                                | 40   |                 | 05.96 | 07.07 |                           |                |                           |                |                         |                      |            |                      |            |                 |    |  |       |       |                           |                |        |   |       |                      |            |                 |    |  |       |       |                           |                |        |   |   |                      |        |            |    |  |       |       |                           |                |        |   |                         |                      |            |                      |    |  |       |       |                           |                |        |   |                         |                |            |             |    |  |       |       |                           |                |        |  |   |            |            |                      |    |  |       |       |                           |  |  |  |  |  |  |                 |    |  |       |       |                           |                |        |   |                         |                |            |                      |    |  |       |       |                           |                |        |   |                         |                |            |             |    |  |       |  |                           |  |  |  |  |  |  |             |     |  |       |  |                           |  |  |  |  |  |  |         |    |  |       |       |                           |  |  |  |  |  |  |
| 1.2 (C06C,C06D,C06K)                      | 55   |                 | 01.01 | 07.07 |                           |                |                           |                |                         |                      |            |                      |            |                 |    |  |       |       |                           |                |        |   |       |                      |            |                 |    |  |       |       |                           |                |        |   |   |                      |        |            |    |  |       |       |                           |                |        |   |                         |                      |            |                      |    |  |       |       |                           |                |        |   |                         |                |            |             |    |  |       |       |                           |                |        |  |   |            |            |                      |    |  |       |       |                           |  |  |  |  |  |  |                 |    |  |       |       |                           |                |        |   |                         |                |            |                      |    |  |       |       |                           |                |        |   |                         |                |            |             |    |  |       |  |                           |  |  |  |  |  |  |             |     |  |       |  |                           |  |  |  |  |  |  |         |    |  |       |       |                           |  |  |  |  |  |  |
|   | <table border="1"> <tr><td>1.2 (C063,C064)</td><td>40</td><td></td><td>03.93</td><td>10.96</td><td></td><td>24.3451-1711.5</td><td>240251</td><td>▣</td><td></td><td>D=45, - Halter</td><td><b>BDX</b></td></tr> <tr><td>1.2 (C066,C068)</td><td>43</td><td></td><td>05.96</td><td>09.98</td><td>+ Schaltgetriebe 5)</td><td>24.3451-1712.5</td><td>240252</td><td>▣</td><td></td><td>D=45, - Halter</td><td><b>BDX</b></td></tr> <tr><td>1.2 (C067)</td><td>40</td><td></td><td>05.96</td><td>09.98</td><td>+ Schaltgetriebe 5)</td><td></td><td></td><td></td><td></td><td></td><td></td></tr> <tr><td>1.2 (C060)</td><td>44</td><td></td><td>08.04</td><td>07.07</td><td></td><td>24.3481-1611.5</td><td>240029</td><td>▣</td><td>- belüftete Scheiben 6)</td><td>D=48, - Halter</td><td><b>LUC</b></td></tr> <tr><td>1.2 (C066,C068)</td><td>43</td><td></td><td>10.98</td><td>08.00</td><td></td><td>24.3481-1612.5</td><td>240030</td><td>▣</td><td>- belüftete Scheiben 6)</td><td>D=48, - Halter</td><td><b>LUC</b></td></tr> <tr><td>1.2 (C067)</td><td>40</td><td></td><td>10.98</td><td>07.07</td><td></td><td>24.0101-4807.2</td><td>260053</td><td></td><td></td><td>Einbausatz</td><td><b>LUC</b></td></tr> <tr><td>1.2 (C06C,C06D,C06K)</td><td>55</td><td></td><td>01.01</td><td>07.07</td><td>+ verstärktes Fahrwerk 7)</td><td></td><td></td><td></td><td></td><td></td><td></td></tr> <tr><td>1.2 (C066,C068)</td><td>43</td><td></td><td>09.00</td><td>07.07</td><td></td><td>24.3481-1615.5</td><td>240031</td><td>▣</td><td>+ belüftete Scheiben 8)</td><td>D=48, - Halter</td><td><b>LUC</b></td></tr> <tr><td>1.2 (C06C,C06D,C06K)</td><td>55</td><td></td><td>01.01</td><td>07.07</td><td>+ verstärktes Fahrwerk 9)</td><td>24.3481-1616.5</td><td>240032</td><td>▣</td><td>+ belüftete Scheiben 8)</td><td>D=48, - Halter</td><td><b>LUC</b></td></tr> </table>  | 1.2 (C063,C064) | 40    |       | 03.93                     | 10.96          |                           | 24.3451-1711.5 | 240251                  | ▣                    |            | D=45, - Halter       | <b>BDX</b> | 1.2 (C066,C068) | 43 |  | 05.96 | 09.98 | + Schaltgetriebe 5)       | 24.3451-1712.5 | 240252 | ▣ |       | D=45, - Halter       | <b>BDX</b> | 1.2 (C067)      | 40 |  | 05.96 | 09.98 | + Schaltgetriebe 5)       |                |        |   |   |                      |        | 1.2 (C060) | 44 |  | 08.04 | 07.07 |                           | 24.3481-1611.5 | 240029 | ▣ | - belüftete Scheiben 6) | D=48, - Halter       | <b>LUC</b> | 1.2 (C066,C068)      | 43 |  | 10.98 | 08.00 |                           | 24.3481-1612.5 | 240030 | ▣ | - belüftete Scheiben 6) | D=48, - Halter | <b>LUC</b> | 1.2 (C067)  | 40 |  | 10.98 | 07.07 |                           | 24.0101-4807.2 | 260053 |  |   | Einbausatz | <b>LUC</b> | 1.2 (C06C,C06D,C06K) | 55 |  | 01.01 | 07.07 | + verstärktes Fahrwerk 7) |  |  |  |  |  |  | 1.2 (C066,C068) | 43 |  | 09.00 | 07.07 |                           | 24.3481-1615.5 | 240031 | ▣ | + belüftete Scheiben 8) | D=48, - Halter | <b>LUC</b> | 1.2 (C06C,C06D,C06K) | 55 |  | 01.01 | 07.07 | + verstärktes Fahrwerk 9) | 24.3481-1616.5 | 240032 | ▣ | + belüftete Scheiben 8) | D=48, - Halter | <b>LUC</b> |             |    |  |       |  |                           |  |  |  |  |  |  |             |     |  |       |  |                           |  |  |  |  |  |  |         |    |  |       |       |                           |  |  |  |  |  |  |
| 1.2 (C063,C064)                           | 40   |                 | 03.93 | 10.96 |                           | 24.3451-1711.5 | 240251                    | ▣              |                         | D=45, - Halter       | <b>BDX</b> |                      |            |                 |    |  |       |       |                           |                |        |   |       |                      |            |                 |    |  |       |       |                           |                |        |   |   |                      |        |            |    |  |       |       |                           |                |        |   |                         |                      |            |                      |    |  |       |       |                           |                |        |   |                         |                |            |             |    |  |       |       |                           |                |        |  |   |            |            |                      |    |  |       |       |                           |  |  |  |  |  |  |                 |    |  |       |       |                           |                |        |   |                         |                |            |                      |    |  |       |       |                           |                |        |   |                         |                |            |             |    |  |       |  |                           |  |  |  |  |  |  |             |     |  |       |  |                           |  |  |  |  |  |  |         |    |  |       |       |                           |  |  |  |  |  |  |
| 1.2 (C066,C068)                           | 43   |                 | 05.96 | 09.98 | + Schaltgetriebe 5)       | 24.3451-1712.5 | 240252                    | ▣              |                         | D=45, - Halter       | <b>BDX</b> |                      |            |                 |    |  |       |       |                           |                |        |   |       |                      |            |                 |    |  |       |       |                           |                |        |   |   |                      |        |            |    |  |       |       |                           |                |        |   |                         |                      |            |                      |    |  |       |       |                           |                |        |   |                         |                |            |             |    |  |       |       |                           |                |        |  |   |            |            |                      |    |  |       |       |                           |  |  |  |  |  |  |                 |    |  |       |       |                           |                |        |   |                         |                |            |                      |    |  |       |       |                           |                |        |   |                         |                |            |             |    |  |       |  |                           |  |  |  |  |  |  |             |     |  |       |  |                           |  |  |  |  |  |  |         |    |  |       |       |                           |  |  |  |  |  |  |
| 1.2 (C067)                                | 40   |                 | 05.96 | 09.98 | + Schaltgetriebe 5)       |                |                           |                |                         |                      |            |                      |            |                 |    |  |       |       |                           |                |        |   |       |                      |            |                 |    |  |       |       |                           |                |        |   |   |                      |        |            |    |  |       |       |                           |                |        |   |                         |                      |            |                      |    |  |       |       |                           |                |        |   |                         |                |            |             |    |  |       |       |                           |                |        |  |   |            |            |                      |    |  |       |       |                           |  |  |  |  |  |  |                 |    |  |       |       |                           |                |        |   |                         |                |            |                      |    |  |       |       |                           |                |        |   |                         |                |            |             |    |  |       |  |                           |  |  |  |  |  |  |             |     |  |       |  |                           |  |  |  |  |  |  |         |    |  |       |       |                           |  |  |  |  |  |  |
| 1.2 (C060)                                | 44   |                 | 08.04 | 07.07 |                           | 24.3481-1611.5 | 240029                    | ▣              | - belüftete Scheiben 6) | D=48, - Halter       | <b>LUC</b> |                      |            |                 |    |  |       |       |                           |                |        |   |       |                      |            |                 |    |  |       |       |                           |                |        |   |   |                      |        |            |    |  |       |       |                           |                |        |   |                         |                      |            |                      |    |  |       |       |                           |                |        |   |                         |                |            |             |    |  |       |       |                           |                |        |  |   |            |            |                      |    |  |       |       |                           |  |  |  |  |  |  |                 |    |  |       |       |                           |                |        |   |                         |                |            |                      |    |  |       |       |                           |                |        |   |                         |                |            |             |    |  |       |  |                           |  |  |  |  |  |  |             |     |  |       |  |                           |  |  |  |  |  |  |         |    |  |       |       |                           |  |  |  |  |  |  |
| 1.2 (C066,C068)                           | 43   |                 | 10.98 | 08.00 |                           | 24.3481-1612.5 | 240030                    | ▣              | - belüftete Scheiben 6) | D=48, - Halter       | <b>LUC</b> |                      |            |                 |    |  |       |       |                           |                |        |   |       |                      |            |                 |    |  |       |       |                           |                |        |   |   |                      |        |            |    |  |       |       |                           |                |        |   |                         |                      |            |                      |    |  |       |       |                           |                |        |   |                         |                |            |             |    |  |       |       |                           |                |        |  |   |            |            |                      |    |  |       |       |                           |  |  |  |  |  |  |                 |    |  |       |       |                           |                |        |   |                         |                |            |                      |    |  |       |       |                           |                |        |   |                         |                |            |             |    |  |       |  |                           |  |  |  |  |  |  |             |     |  |       |  |                           |  |  |  |  |  |  |         |    |  |       |       |                           |  |  |  |  |  |  |
| 1.2 (C067)                                | 40   |                 | 10.98 | 07.07 |                           | 24.0101-4807.2 | 260053                    |                |                         | Einbausatz           | <b>LUC</b> |                      |            |                 |    |  |       |       |                           |                |        |   |       |                      |            |                 |    |  |       |       |                           |                |        |   |   |                      |        |            |    |  |       |       |                           |                |        |   |                         |                      |            |                      |    |  |       |       |                           |                |        |   |                         |                |            |             |    |  |       |       |                           |                |        |  |   |            |            |                      |    |  |       |       |                           |  |  |  |  |  |  |                 |    |  |       |       |                           |                |        |   |                         |                |            |                      |    |  |       |       |                           |                |        |   |                         |                |            |             |    |  |       |  |                           |  |  |  |  |  |  |             |     |  |       |  |                           |  |  |  |  |  |  |         |    |  |       |       |                           |  |  |  |  |  |  |
| 1.2 (C06C,C06D,C06K)                      | 55   |                 | 01.01 | 07.07 | + verstärktes Fahrwerk 7) |                |                           |                |                         |                      |            |                      |            |                 |    |  |       |       |                           |                |        |   |       |                      |            |                 |    |  |       |       |                           |                |        |   |   |                      |        |            |    |  |       |       |                           |                |        |   |                         |                      |            |                      |    |  |       |       |                           |                |        |   |                         |                |            |             |    |  |       |       |                           |                |        |  |   |            |            |                      |    |  |       |       |                           |  |  |  |  |  |  |                 |    |  |       |       |                           |                |        |   |                         |                |            |                      |    |  |       |       |                           |                |        |   |                         |                |            |             |    |  |       |  |                           |  |  |  |  |  |  |             |     |  |       |  |                           |  |  |  |  |  |  |         |    |  |       |       |                           |  |  |  |  |  |  |
| 1.2 (C066,C068)                           | 43   |                 | 09.00 | 07.07 |                           | 24.3481-1615.5 | 240031                    | ▣              | + belüftete Scheiben 8) | D=48, - Halter       | <b>LUC</b> |                      |            |                 |    |  |       |       |                           |                |        |   |       |                      |            |                 |    |  |       |       |                           |                |        |   |   |                      |        |            |    |  |       |       |                           |                |        |   |                         |                      |            |                      |    |  |       |       |                           |                |        |   |                         |                |            |             |    |  |       |       |                           |                |        |  |   |            |            |                      |    |  |       |       |                           |  |  |  |  |  |  |                 |    |  |       |       |                           |                |        |   |                         |                |            |                      |    |  |       |       |                           |                |        |   |                         |                |            |             |    |  |       |  |                           |  |  |  |  |  |  |             |     |  |       |  |                           |  |  |  |  |  |  |         |    |  |       |       |                           |  |  |  |  |  |  |
| 1.2 (C06C,C06D,C06K)                      | 55   |                 | 01.01 | 07.07 | + verstärktes Fahrwerk 9) | 24.3481-1616.5 | 240032                    | ▣              | + belüftete Scheiben 8) | D=48, - Halter       | <b>LUC</b> |                      |            |                 |    |  |       |       |                           |                |        |   |       |                      |            |                 |    |  |       |       |                           |                |        |   |   |                      |        |            |    |  |       |       |                           |                |        |   |                         |                      |            |                      |    |  |       |       |                           |                |        |   |                         |                |            |             |    |  |       |       |                           |                |        |  |   |            |            |                      |    |  |       |       |                           |  |  |  |  |  |  |                 |    |  |       |       |                           |                |        |   |                         |                |            |                      |    |  |       |       |                           |                |        |   |                         |                |            |             |    |  |       |  |                           |  |  |  |  |  |  |             |     |  |       |  |                           |  |  |  |  |  |  |         |    |  |       |       |                           |  |  |  |  |  |  |
|   | <table border="1"> <tr><td>1.2 (C060)</td><td>44</td><td></td><td>08.04</td><td>07.07</td><td></td><td>24.5111-0241.3</td><td>330680</td><td>2</td><td></td><td></td><td>L=242</td></tr> <tr><td>1.2 (C063,C064)</td><td>40</td><td></td><td>03.93</td><td>10.96</td><td></td><td></td><td></td><td></td><td></td><td></td><td></td></tr> <tr><td>1.2 (C066,C068)</td><td>43</td><td></td><td>05.96</td><td>07.07</td><td></td><td></td><td></td><td></td><td></td><td></td><td></td></tr> <tr><td>1.2 (C067)</td><td>40</td><td></td><td>05.96</td><td>07.07</td><td></td><td></td><td></td><td></td><td></td><td></td><td></td></tr> <tr><td>1.2 (C06C,C06D,C06K)</td><td>55</td><td></td><td>01.01</td><td>07.07</td><td></td><td></td><td></td><td></td><td></td><td></td><td></td></tr> </table>  | 1.2 (C060)      | 44    |       | 08.04                     | 07.07          |                           | 24.5111-0241.3 | 330680                  | 2                    |            |                      | L=242      | 1.2 (C063,C064) | 40 |  | 03.93 | 10.96 |                           |                |        |   |       |                      |            | 1.2 (C066,C068) | 43 |  | 05.96 | 07.07 |                           |                |        |   |   |                      |        | 1.2 (C067) | 40 |  | 05.96 | 07.07 |                           |                |        |   |                         |                      |            | 1.2 (C06C,C06D,C06K) | 55 |  | 01.01 | 07.07 |                           |                |        |   |                         |                |            |             |    |  |       |       |                           |                |        |  |   |            |            |                      |    |  |       |       |                           |  |  |  |  |  |  |                 |    |  |       |       |                           |                |        |   |                         |                |            |                      |    |  |       |       |                           |                |        |   |                         |                |            |             |    |  |       |  |                           |  |  |  |  |  |  |             |     |  |       |  |                           |  |  |  |  |  |  |         |    |  |       |       |                           |  |  |  |  |  |  |
| 1.2 (C060)                                | 44   |                 | 08.04 | 07.07 |                           | 24.5111-0241.3 | 330680                    | 2              |                         |                      | L=242      |                      |            |                 |    |  |       |       |                           |                |        |   |       |                      |            |                 |    |  |       |       |                           |                |        |   |   |                      |        |            |    |  |       |       |                           |                |        |   |                         |                      |            |                      |    |  |       |       |                           |                |        |   |                         |                |            |             |    |  |       |       |                           |                |        |  |   |            |            |                      |    |  |       |       |                           |  |  |  |  |  |  |                 |    |  |       |       |                           |                |        |   |                         |                |            |                      |    |  |       |       |                           |                |        |   |                         |                |            |             |    |  |       |  |                           |  |  |  |  |  |  |             |     |  |       |  |                           |  |  |  |  |  |  |         |    |  |       |       |                           |  |  |  |  |  |  |
| 1.2 (C063,C064)                           | 40   |                 | 03.93 | 10.96 |                           |                |                           |                |                         |                      |            |                      |            |                 |    |  |       |       |                           |                |        |   |       |                      |            |                 |    |  |       |       |                           |                |        |   |   |                      |        |            |    |  |       |       |                           |                |        |   |                         |                      |            |                      |    |  |       |       |                           |                |        |   |                         |                |            |             |    |  |       |       |                           |                |        |  |   |            |            |                      |    |  |       |       |                           |  |  |  |  |  |  |                 |    |  |       |       |                           |                |        |   |                         |                |            |                      |    |  |       |       |                           |                |        |   |                         |                |            |             |    |  |       |  |                           |  |  |  |  |  |  |             |     |  |       |  |                           |  |  |  |  |  |  |         |    |  |       |       |                           |  |  |  |  |  |  |
| 1.2 (C066,C068)                           | 43   |                 | 05.96 | 07.07 |                           |                |                           |                |                         |                      |            |                      |            |                 |    |  |       |       |                           |                |        |   |       |                      |            |                 |    |  |       |       |                           |                |        |   |   |                      |        |            |    |  |       |       |                           |                |        |   |                         |                      |            |                      |    |  |       |       |                           |                |        |   |                         |                |            |             |    |  |       |       |                           |                |        |  |   |            |            |                      |    |  |       |       |                           |  |  |  |  |  |  |                 |    |  |       |       |                           |                |        |   |                         |                |            |                      |    |  |       |       |                           |                |        |   |                         |                |            |             |    |  |       |  |                           |  |  |  |  |  |  |             |     |  |       |  |                           |  |  |  |  |  |  |         |    |  |       |       |                           |  |  |  |  |  |  |
| 1.2 (C067)                                | 40   |                 | 05.96 | 07.07 |                           |                |                           |                |                         |                      |            |                      |            |                 |    |  |       |       |                           |                |        |   |       |                      |            |                 |    |  |       |       |                           |                |        |   |   |                      |        |            |    |  |       |       |                           |                |        |   |                         |                      |            |                      |    |  |       |       |                           |                |        |   |                         |                |            |             |    |  |       |       |                           |                |        |  |   |            |            |                      |    |  |       |       |                           |  |  |  |  |  |  |                 |    |  |       |       |                           |                |        |   |                         |                |            |                      |    |  |       |       |                           |                |        |   |                         |                |            |             |    |  |       |  |                           |  |  |  |  |  |  |             |     |  |       |  |                           |  |  |  |  |  |  |         |    |  |       |       |                           |  |  |  |  |  |  |
| 1.2 (C06C,C06D,C06K)                      | 55   |                 | 01.01 | 07.07 |                           |                |                           |                |                         |                      |            |                      |            |                 |    |  |       |       |                           |                |        |   |       |                      |            |                 |    |  |       |       |                           |                |        |   |   |                      |        |            |    |  |       |       |                           |                |        |   |                         |                      |            |                      |    |  |       |       |                           |                |        |   |                         |                |            |             |    |  |       |       |                           |                |        |  |   |            |            |                      |    |  |       |       |                           |  |  |  |  |  |  |                 |    |  |       |       |                           |                |        |   |                         |                |            |                      |    |  |       |       |                           |                |        |   |                         |                |            |             |    |  |       |  |                           |  |  |  |  |  |  |             |     |  |       |  |                           |  |  |  |  |  |  |         |    |  |       |       |                           |  |  |  |  |  |  |
|   | <table border="1"> <tr><td>1.2 (C063,C064)</td><td>40</td><td></td><td>03.93</td><td>10.96</td><td>- ABS</td><td>24.5229-0185.3</td><td>330397</td><td>2</td><td></td><td></td><td>L=185</td></tr> <tr><td>1.2 (C066,C068)</td><td>43</td><td></td><td>05.96</td><td>07.07</td><td>- ABS</td><td></td><td></td><td></td><td></td><td></td><td></td></tr> <tr><td>1.2 (C067)</td><td>40</td><td></td><td>05.96</td><td>07.07</td><td>- ABS</td><td></td><td></td><td></td><td></td><td></td><td></td></tr> </table>   | 1.2 (C063,C064) | 40    |       | 03.93                     | 10.96          | - ABS                     | 24.5229-0185.3 | 330397                  | 2                    |            |                      | L=185      | 1.2 (C066,C068) | 43 |  | 05.96 | 07.07 | - ABS                     |                |        |   |       |                      |            | 1.2 (C067)      | 40 |  | 05.96 | 07.07 | - ABS                     |                |        |   |   |                      |        |            |    |  |       |       |                           |                |        |   |                         |                      |            |                      |    |  |       |       |                           |                |        |   |                         |                |            |             |    |  |       |       |                           |                |        |  |   |            |            |                      |    |  |       |       |                           |  |  |  |  |  |  |                 |    |  |       |       |                           |                |        |   |                         |                |            |                      |    |  |       |       |                           |                |        |   |                         |                |            |             |    |  |       |  |                           |  |  |  |  |  |  |             |     |  |       |  |                           |  |  |  |  |  |  |         |    |  |       |       |                           |  |  |  |  |  |  |
| 1.2 (C063,C064)                           | 40   |                 | 03.93 | 10.96 | - ABS                     | 24.5229-0185.3 | 330397                    | 2              |                         |                      | L=185      |                      |            |                 |    |  |       |       |                           |                |        |   |       |                      |            |                 |    |  |       |       |                           |                |        |   |   |                      |        |            |    |  |       |       |                           |                |        |   |                         |                      |            |                      |    |  |       |       |                           |                |        |   |                         |                |            |             |    |  |       |       |                           |                |        |  |   |            |            |                      |    |  |       |       |                           |  |  |  |  |  |  |                 |    |  |       |       |                           |                |        |   |                         |                |            |                      |    |  |       |       |                           |                |        |   |                         |                |            |             |    |  |       |  |                           |  |  |  |  |  |  |             |     |  |       |  |                           |  |  |  |  |  |  |         |    |  |       |       |                           |  |  |  |  |  |  |
| 1.2 (C066,C068)                           | 43   |                 | 05.96 | 07.07 | - ABS                     |                |                           |                |                         |                      |            |                      |            |                 |    |  |       |       |                           |                |        |   |       |                      |            |                 |    |  |       |       |                           |                |        |   |   |                      |        |            |    |  |       |       |                           |                |        |   |                         |                      |            |                      |    |  |       |       |                           |                |        |   |                         |                |            |             |    |  |       |       |                           |                |        |  |   |            |            |                      |    |  |       |       |                           |  |  |  |  |  |  |                 |    |  |       |       |                           |                |        |   |                         |                |            |                      |    |  |       |       |                           |                |        |   |                         |                |            |             |    |  |       |  |                           |  |  |  |  |  |  |             |     |  |       |  |                           |  |  |  |  |  |  |         |    |  |       |       |                           |  |  |  |  |  |  |
| 1.2 (C067)                                | 40   |                 | 05.96 | 07.07 | - ABS                     |                |                           |                |                         |                      |            |                      |            |                 |    |  |       |       |                           |                |        |   |       |                      |            |                 |    |  |       |       |                           |                |        |   |   |                      |        |            |    |  |       |       |                           |                |        |   |                         |                      |            |                      |    |  |       |       |                           |                |        |   |                         |                |            |             |    |  |       |       |                           |                |        |  |   |            |            |                      |    |  |       |       |                           |  |  |  |  |  |  |                 |    |  |       |       |                           |                |        |   |                         |                |            |                      |    |  |       |       |                           |                |        |   |                         |                |            |             |    |  |       |  |                           |  |  |  |  |  |  |             |     |  |       |  |                           |  |  |  |  |  |  |         |    |  |       |       |                           |  |  |  |  |  |  |
|   | <table border="1"> <tr><td>1.2 (C063,C064)</td><td>40</td><td></td><td>03.93</td><td>10.96</td><td>+ ABS</td><td>24.5229-0209.3</td><td>330670</td><td>2</td><td></td><td></td><td>L=210</td></tr> <tr><td>1.2 (C066,C068)</td><td>43</td><td></td><td>05.96</td><td>04.98</td><td>+ ABS</td><td></td><td></td><td></td><td></td><td></td><td></td></tr> </table>  | 1.2 (C063,C064) | 40    |       | 03.93                     | 10.96          | + ABS                     | 24.5229-0209.3 | 330670                  | 2                    |            |                      | L=210      | 1.2 (C066,C068) | 43 |  | 05.96 | 04.98 | + ABS                     |                |        |   |       |                      |            |                 |    |  |       |       |                           |                |        |   |   |                      |        |            |    |  |       |       |                           |                |        |   |                         |                      |            |                      |    |  |       |       |                           |                |        |   |                         |                |            |             |    |  |       |       |                           |                |        |  |   |            |            |                      |    |  |       |       |                           |  |  |  |  |  |  |                 |    |  |       |       |                           |                |        |   |                         |                |            |                      |    |  |       |       |                           |                |        |   |                         |                |            |             |    |  |       |  |                           |  |  |  |  |  |  |             |     |  |       |  |                           |  |  |  |  |  |  |         |    |  |       |       |                           |  |  |  |  |  |  |
| 1.2 (C063,C064)                           | 40   |                 | 03.93 | 10.96 | + ABS                     | 24.5229-0209.3 | 330670                    | 2              |                         |                      | L=210      |                      |            |                 |    |  |       |       |                           |                |        |   |       |                      |            |                 |    |  |       |       |                           |                |        |   |   |                      |        |            |    |  |       |       |                           |                |        |   |                         |                      |            |                      |    |  |       |       |                           |                |        |   |                         |                |            |             |    |  |       |       |                           |                |        |  |   |            |            |                      |    |  |       |       |                           |  |  |  |  |  |  |                 |    |  |       |       |                           |                |        |   |                         |                |            |                      |    |  |       |       |                           |                |        |   |                         |                |            |             |    |  |       |  |                           |  |  |  |  |  |  |             |     |  |       |  |                           |  |  |  |  |  |  |         |    |  |       |       |                           |  |  |  |  |  |  |
| 1.2 (C066,C068)                           | 43   |                 | 05.96 | 04.98 | + ABS                     |                |                           |                |                         |                      |            |                      |            |                 |    |  |       |       |                           |                |        |   |       |                      |            |                 |    |  |       |       |                           |                |        |   |   |                      |        |            |    |  |       |       |                           |                |        |   |                         |                      |            |                      |    |  |       |       |                           |                |        |   |                         |                |            |             |    |  |       |       |                           |                |        |  |   |            |            |                      |    |  |       |       |                           |  |  |  |  |  |  |                 |    |  |       |       |                           |                |        |   |                         |                |            |                      |    |  |       |       |                           |                |        |   |                         |                |            |             |    |  |       |  |                           |  |  |  |  |  |  |             |     |  |       |  |                           |  |  |  |  |  |  |         |    |  |       |       |                           |  |  |  |  |  |  |

1) - Pickup/Chassis / - Autocarro a cassone/Telaio / - Camion plateau/Châssis / - Camión plataforma/Chasis  
2) + short wheel base / + passo lungo / + empattement court / + distancia corta entre ejes  
3) + long wheel base / + passo lungo / + empattement long / + distancia larga entre ejes  
4) + Pickup/Chassis / + Autocarro a cassone/Telaio / + Camion plateau/Châssis / + Camión plataforma/Chasis  
5) + manual transmission / + scatola cambio velocità / + transmission mécanique / + cambio de velocidad  
6) - ventilated discs / - dischi ventilati / - disques ventilés / - disco ventilado  
7) + reinforced suspension / + sospensione rinforzata / + châssis renforcé / + suspensión reforzada  
8) + ventilated discs / + dischi ventilati / + disques ventilés / + disco ventilado  
9) - reinforced suspension / - sospensione rinforzata / - châssis renforcé / - suspensión reforzada

|     |  |  |  |  |  |  |       |     |
|--|--|--|--|--|---|--|---|---|
| <b>RENAULT TWINGO I Limousine (C06_) (93-07)</b>                                   |  |  |  |  |   |  |   |   |
|    | 1.2 (C067)   | 40   | 05.96  | 04.98 + ABS  | 24.5229-0209.3  | 330670   | 2   | L=210   |
|  | 1.2 (C06C,C06D,C06K)   | 55   | 01.01  | 07.07 - ABS  |   |  |   |   |
|    | 1.2 (C060)   | 44   | 08.04  | 07.07 + ABS  | 24.5229-0185.3  | 330397   | 2   | L=185   |
|  | 1.2 (C066,C068)  | 43   | 05.98  | 07.07 + ABS  |   |  |   |   |
|  | 1.2 (C067)   | 40   | 05.98  | 07.07 + ABS  |   |  |   |   |
|  | 1.2 (C06C,C06D,C06K)   | 55   | 01.01  | 07.07 + ABS  |   |  |   |   |
|  | 1.2 (C063,C064)  | 40   | 03.93  | 10.96 - ABS  | 24.3220-1623.3  | 020353   |      | RzR 20,64 <b>BDX</b>  |
|    | 1.2 (C066,C068)  | 43   | 05.96  | 07.07 - ABS  | 24.3220-1624.3  | 020354   |      | RzR 20,64 <b>BDX</b>  |
|  | 1.2 (C067)   | 40   | 05.96  | 07.07 - ABS  |   |  |   |   |
|  | 1.2 (C063,C064)  | 40   | 03.93  | 10.96 + ABS  | 24.3220-1117.3  | 020314   |   | Rz 20,64  |
|  | 1.2 (C066,C068)  | 43   | 05.96  | 06.98 + ABS  |   |  |   |   |
|  | 1.2 (C067)   | 40   | 05.96  | 06.98 + ABS  |   |  |   |   |
|  | 1.2 (C060)   | 44   | 08.04  | 07.07 + ABS  | 24.3217-1710.3  | 020420   |   | Rz 17,78 <b>LUC</b>   |
|  | 1.2 (C066,C068)  | 43   | 07.98  | 07.07 + ABS  |   |  |   |   |
|  | 1.2 (C067)   | 40   | 07.98  | 07.07 + ABS  |   |  |   |   |
|  | 1.2 (C06C,C06D,C06K)   | 55   | 01.01  | 07.07  |   |  |   |   |
|  |  | 1.2 (C063,C064)  | 40   | 03.93  | 10.96   | 24.3727-1038.2   | 581038  | 2  |
| 1.2 (C066,C068)  |  | 43   | 05.96  | 07.07  | 24.3727-1039.2  | 581039   | 2    | L=1460  |
| 1.2 (C067)   |  | 40   | 05.96  | 07.07  |   |  |   |   |
| 1.2 (C06C,C06D,C06K)   |  | 55   | 01.01  | 07.07  |   |  |   |   |
| 1.2 (C060)   |  | 44   | 08.04  | 07.07  | 24.3727-1039.2  | 581039   | 2    | L=1460  |
|    | 1.2 (C063,C064)  | 40   | 03.93  | 10.96  | 24.3728-1014.2  | 591014   |   | L=938   |
|  | 1.2 (C066,C068)  | 43   | 05.96  | 01.98  |   |  |   |   |
|  | 1.2 (C067)   | 40   | 05.96  | 01.98  |   |  |   |   |
|  | 1.2 (C060)   | 44   | 08.04  | 07.07  | 24.3728-1019.2  | 591019   |   | L=930   |
|  | 1.2 (C066,C068)  | 43   | 02.98  | 07.07  |   |  |   |   |
| 1.2 (C067)   | 40   | 02.98  | 07.07  |  |   |  |   |   |
| 1.2 (C06C,C06D,C06K)   | 55   | 01.01  | 07.07  |  |   |  |   |   |
| <b>RENAULT TWINGO I Kasten (S06_) (93-07)</b>                                      |  |  |  |  |   |  |   |   |
|    | 1.2 (S063,S064)  | 40   | 03.93  | 04.96  | 24.2120-1706.3  | 010262   | - ABS   | THz 20,64   |
|  | 1.2 (S066,S068)  | 43   | 05.96  | 07.07  | 24.2120-1723.3  | 010545   | + ABS   | THz 20,64 <b>BDX</b>  |
|    | 1.2 (S063,S064)  | 40   | 03.93  | 04.96  | 24.3451-1711.5  | 240251   |      | D=45, - Halter <b>BDX</b>   |
|  | 1.2 (S066,S068)  | 43   | 05.96  | 09.98 + Schaltgetriebe 1)  | 24.3451-1712.5  | 240252   |      | D=45, - Halter <b>BDX</b>   |
|  | 1.2 (S066,S068)  | 43   | 10.98  | 07.07 + Schaltgetriebe 1)  | 24.3481-1611.5  | 240029   |     | D=48, - Halter <b>LUC</b>   |
|  | 1.2 (S066,S068)  | 43   | 10.98  | 07.07 + Automatikgetriebe 2)   | 24.3481-1612.5  | 240030   |    | D=48, - Halter <b>LUC</b>   |
|   | 1.2 (S063,S064)  | 40   | 03.93  | 04.96  | 24.5111-0241.3  | 330680   | 2   | L=242   |
|  | 1.2 (S066,S068)  | 43   | 05.96  | 07.07  |   |  |   |   |
|  | 1.2 (S063,S064)  | 40   | 03.93  | 04.96 - ABS  | 24.5229-0185.3  | 330397   | 2   | L=185   |
|  | 1.2 (S066,S068)  | 43   | 05.96  | 07.07 - ABS  |   |  |   |   |
|  | 1.2 (S063,S064)  | 40   | 03.93  | 04.96 + ABS  | 24.5229-0209.3  | 330670   | 2   | L=210   |
|  | 1.2 (S066,S068)  | 43   | 05.96  | 04.98 + ABS  |   |  |   |   |
|  | 1.2 (S066,S068)  | 43   | 05.98  | 07.07 + ABS  | 24.5229-0185.3  | 330397   | 2   | L=185   |
|  | 1.2 (S063,S064)  | 40   | 03.93  | 04.96 - ABS  | 24.3220-1623.3  | 020353   |    | RzR 20,64 <b>BDX</b>  |
|  | 1.2 (S066,S068)  | 43   | 05.96  | 07.07 - ABS  | 24.3220-1624.3  | 020354   |    | RzR 20,64 <b>BDX</b>  |
|  | 1.2 (S063,S064)  | 40   | 03.93  | 04.96 + ABS  | 24.3220-1117.3  | 020314   |   | Rz 20,64  |
|  | 1.2 (S066,S068)  | 43   | 05.96  | 06.98 + ABS  |   |  |   |   |
|  | 1.2 (S066,S068)  | 43   | 07.98  | 07.07 + ABS  | 24.3217-1710.3  | 020420   |   | Rz 17,78 <b>LUC</b>   |
|  | 1.2 (S063,S064)  | 40   | 03.93  | 04.96  | 24.3727-1038.2  | 581038   | 2  | L=1442  |
|  | 1.2 (S066,S068)  | 43   | 05.96  | 07.07  | 24.3727-1039.2  | 581039   | 2  | L=1460  |
|  | 1.2 (S063,S064)  | 40   | 03.93  | 04.96  | 24.3728-1014.2  | 591014   |   | L=938   |
|  | 1.2 (S066,S068)  | 43   | 05.96  | 01.98  |   |  |   |   |
|  | 1.2 (S066,S068)  | 43   | 02.98  | 07.07  | 24.3728-1019.2  | 591019   |   | L=930   |
| <b>RENAULT TWINGO II (CNO_) (07-)</b>  |  |  |  |  |   |  |   |   |
|  | 1.2  | 43   | 03.07  |  | 03.7853-3902.4  | 300270   | - ESP   | 9" <b>ATE</b>   |
|  | 1.2 16V  | 55   | 03.07  |  |   |  |   |   |
|  | 1.2 16V  | 56   | 03.07  |  |   |  |   |   |
|  | 1.2 TCe 100  | 75   | 02.11  |  |   |  |   |   |
|  | 1.2 Turbo  | 74   | 03.07  |  |   |  |   |   |
|  | 1.5 dCi  | 47   | 03.07  |  |   |  |   |   |
|  | 1.5 dCi  | 62   | 04.08  |  |   |  |   |   |
|  | 1.5 dCi 75   | 55   | 10.10  |  |   |  |   |   |
|  | 1.5 dCi 90   | 63   | 10.10  |  |   |  |   |   |
|  | 1.2  | 43   | 03.07  |  | 03.2120-4581.3  | 010915   | - ESP   | THz 20,64 <b>ATE</b>  |
|  | 1.2 16V  | 55   | 03.07  |  |   |  |   |   |
|  | 1.2 16V  | 56   | 03.07  |  |   |  |   |   |
|  | 1.2 TCe 100  | 75   | 02.11  |  |   |  |   |   |
|  | 1.2 Turbo  | 74   | 03.07  |  |   |  |   |   |
|  | 1.5 dCi  | 47   | 03.07  |  |   |  |   |   |
|  | 1.5 dCi  | 62   | 04.08  |  |   |  |   |   |
|  | 1.5 dCi 75   | 55   | 10.10  |  |   |  |   |   |
|  | 1.5 dCi 90   | 63   | 10.10  |  |   |  |   |   |
|  | 1.2  | 43   | 03.07  |  | 03.2120-4641.3  | 010932   | + ESP   | THz 20,64 <b>ATE</b>  |
|  | 1.2 16V  | 55   | 03.07  |  |   |  |   |   |
|  | 1.2 16V  | 56   | 03.07  |  |   |  |   |   |
|  | 1.2 TCe 100  | 75   | 02.11  |  |   |  |   |   |
|  | 1.2 Turbo  | 74   | 03.07  |  |   |  |   |   |
|  | 1.5 dCi  | 47   | 03.07  |  |   |  |   |   |
|  | 1.5 dCi  | 62   | 04.08  |  |   |  |   |   |
|  | 1.5 dCi 75   | 55   | 10.10  |  |   |  |   |   |
|  | 1.5 dCi 90   | 63   | 10.10  |  |   |  |   |   |





















1) + manual transmission / + scatola cambio velocità / + transmission mécanique / + cambio de velocidad  
2) + autom.transmission / + scatola cambio automatico / + transmission automatique / + cambio automático























|     |    |  |                 |                 |   |  |   |   |
|--|--|--|---|---|--|--|---|---|
| <b>RENAULT TWINGO II (CNO_) (07-)</b>  |  |  |   |   |  |  |   |   |
|    | 1.5 dCi 75<br>1.5 dCi 90   | 55<br>63   | 10.10<br>10.10  |   | 03.2120-4641.3   | 010932   | + ESP   | Thz 20,64<br>ATE  |
|    | 1.2<br>1.5 dCi   | 43<br>47   | 03.07<br>03.07  |   | 24.3481-1611.5<br>24.3481-1612.5   | 240029<br>240030   | <input type="checkbox"/> - belüftete Scheiben <sup>1)</sup><br><input type="checkbox"/> - belüftete Scheiben <sup>1)</sup>  | D=48, - Halter<br>D=48, - Halter<br>LUC<br>LUC  |
|  | 1.2<br>1.2 16V<br>1.2 16V<br>1.2 TCe 100<br>1.2 Turbo<br>1.5 dCi<br>1.5 dCi<br>1.5 dCi 75<br>1.5 dCi 90                  | 43<br>55<br>56<br>75<br>74<br>47<br>62<br>55<br>63                               | 03.07<br>03.07<br>03.07<br>02.11<br>03.07<br>03.07<br>04.08<br>10.10<br>10.10                   |   | 24.3481-1615.5<br>24.3481-1616.5   | 240031<br>240032   | <input type="checkbox"/> + belüftete Scheiben <sup>2)</sup><br><input type="checkbox"/> + belüftete Scheiben <sup>2)</sup>  | D=48, - Halter<br>D=48, - Halter<br>LUC<br>LUC  |
|  | 1.6 RS   | 98   | 05.08   |   | 11.9571-9757.2<br>11.9571-9758.2<br>11.8116-0301.1   | 220857<br>220858<br>390610   | <input type="checkbox"/><br><input type="checkbox"/><br>2   | D=57, - Halter<br>D=57, - Halter<br>Halterfeder<br>ATE<br>ATE<br>ATE  |
|    | 1.2<br>1.2 16V<br>1.2 16V<br>1.2 TCe 100<br>1.2 Turbo<br>1.5 dCi<br>1.5 dCi<br>1.5 dCi 75<br>1.5 dCi 90                  | 43<br>55<br>56<br>75<br>74<br>47<br>62<br>55<br>63                               | 03.07<br>03.07<br>03.07<br>02.11<br>03.07<br>03.07<br>04.08<br>10.10<br>10.10                   |   | 24.5111-0321.3   | 330597   | 2   | L=320   |
|    | 1.6 RS   | 98   | 05.08   |   | 24.3347-1705.7<br>24.3347-1706.7<br>24.0101-3803.2   | 220751<br>220752<br>260101   | <input type="checkbox"/><br><input type="checkbox"/>  | D=34, - Halter<br>D=34, - Halter<br>Einbausatz<br>LUC<br>LUC<br>LUC   |
|    | 1.2<br>1.2 16V<br>1.2 16V<br>1.2 TCe 100<br>1.2 Turbo<br>1.5 dCi<br>1.5 dCi<br>1.5 dCi 75<br>1.5 dCi 90                  | 43<br>55<br>56<br>75<br>74<br>47<br>62<br>55<br>63                               | 03.07<br>03.07<br>03.07<br>02.11<br>03.07<br>03.07<br>04.08<br>10.10<br>10.10                   |   | 24.5239-0165.3   | 330606   | 2   | L=165   |
|   | 1.2<br>1.2 16V<br>1.2 16V<br>1.2 TCe 100<br>1.2 Turbo<br>1.5 dCi<br>1.5 dCi<br>1.5 dCi 75<br>1.5 dCi 90                  | 43<br>55<br>56<br>75<br>74<br>47<br>62<br>55<br>63                               | 03.07<br>03.07<br>03.07<br>02.11<br>03.07<br>03.07<br>04.08<br>10.10<br>10.10                   | 09.12<br>09.12<br>09.12<br>09.12<br>09.12<br>09.12<br>09.12<br>09.12                            | 24.3217-1727.3   | 020524   |   | Rz 17,46  |
|  | 1.2<br>1.2 16V<br>1.2 16V<br>1.2 TCe 100<br>1.2 Turbo<br>1.5 dCi<br>1.5 dCi<br>1.5 dCi 75<br>1.5 dCi 90                  | 43<br>55<br>56<br>75<br>74<br>47<br>62<br>55<br>63                               | 03.07<br>03.07<br>03.07<br>02.11<br>03.07<br>03.07<br>04.08<br>10.10<br>10.10                   |   | 24.3727-1077.2<br>24.3727-1076.2   | 581077<br>581076   | <input type="checkbox"/><br><input type="checkbox"/>  | L=1273<br>L=1355  |
| <b>RENAULT VEL SATIS (BJO_) (02-09)</b>  |  |  |   |   |  |  |   |   |
|  | 2.0 16V Turbo<br>2.0 16V Turbo<br>2.2 dCi<br>2.2 dCi<br>3.0 dCi<br>3.5<br>3.5 V6   | 120<br>125<br>85<br>110<br>130<br>170<br>177                                     | 06.02<br>04.04<br>04.04<br>06.02<br>06.02<br>10.04<br>06.02                                     | 03.05<br>03.05<br>03.05<br>03.05<br>03.05<br>03.05<br>03.05                                     | 03.4125-0014.3   | 010794   |   | Thz 25,40<br>ATE  |
|  | 2.0<br>2.0 16V Turbo<br>2.0 16V Turbo<br>2.0 dCi<br>2.0 dCi<br>2.2 dCi<br>2.2 dCi<br>3.0 dCi<br>3.0 dCi<br>3.5<br>3.5 V6 | 108<br>120<br>125<br>110<br>127<br>85<br>110<br>130<br>133<br>170<br>177         | 04.05<br>04.05<br>04.05<br>08.05<br>01.06<br>04.05<br>04.05<br>04.05<br>06.06<br>10.04<br>04.05 | 12.09<br>12.09<br>12.09<br>12.09<br>12.09<br>12.09<br>12.09<br>12.09<br>12.09<br>12.09<br>12.09 | 03.4155-0043.3   | 010795   |   | Thz 25,40<br>ATE  |
|  | 2.0<br>2.0 16V Turbo<br>2.0 16V Turbo<br>2.0 dCi<br>2.0 dCi<br>2.2 dCi<br>2.2 dCi<br>3.0 dCi<br>3.0 dCi<br>3.0 dCi       | 108<br>120<br>125<br>110<br>127<br>85<br>110<br>130<br>133<br>133                | 04.05<br>06.02<br>04.04<br>08.05<br>01.06<br>04.04<br>06.02<br>06.02<br>06.06                   | 12.09<br>12.09<br>12.09<br>12.09<br>12.09<br>12.09<br>12.09<br>12.09<br>12.09                   | 11.9601-9787.2<br>11.9601-9788.2<br>24.3601-9787.5<br>24.3601-9788.5<br>11.0101-5407.2<br>11.8171-0008.1<br>11.8116-0301.1 | 220585<br>220586<br>240505<br>240506<br>260011<br>990049<br>390610                 | <input type="checkbox"/><br><input type="checkbox"/><br><input type="checkbox"/><br><input type="checkbox"/><br><input type="checkbox"/><br><input type="checkbox"/><br>2 | D=60, - Halter<br>D=60, - Halter<br>D=60, - Halter<br>D=60, - Halter<br>Hülzensatz<br>Führungsbolzen<br>Halterfeder<br>ATE<br>ATE<br>ATE<br>ATE<br>ATE<br>ATE |

1) - ventilated discs / - dischi ventilati / - disques ventilés / - disco ventilado  
2) + ventilated discs / + dischi ventilati / + disques ventilés / + disco ventilado



|     |    |  |  |                 |                |  |   |  |  |   |
|--|--|--|--|---|---|--|---|--|--|---|
| <b>RENAULT VEL SATIS (BJO_) (02-09)</b>  |  |  |  |   |   |  |   |  |  |   |
|    | 3.5<br>3.5 V6  | 170<br>177   |  | 10.04<br>06.02  | 12.09<br>12.09  |  | 11.9601-9787.2 220585<br>11.9601-9788.2 220586<br>24.3601-9787.5 240505<br>24.3601-9788.5 240506<br>11.0101-5407.2 260011<br>11.8171-0008.1 990049<br>11.8116-0301.1 390610 | 2  | D=60, - Halter<br>D=60, - Halter<br>D=60, - Halter<br>D=60, - Halter<br>Hülsensatz<br>Führungsbolzen<br>Haltefeder | ATE<br>ATE<br>ATE<br>ATE<br>ATE<br>ATE<br>ATE |
|    | 2.0<br>2.0 16V Turbo<br>2.0 16V Turbo<br>2.0 dCi<br>2.0 dCi<br>2.2 dCi<br>2.2 dCi<br>3.0 dCi<br>3.0 dCi<br>3.5<br>3.5 V6 | 108<br>120<br>125<br>110<br>127<br>85<br>110<br>130<br>133<br>170<br>177         |  | 04.05<br>06.02<br>04.04<br>08.05<br>01.06<br>04.04<br>06.02<br>06.06<br>10.04<br>06.02          | 12.09<br>12.09<br>12.09<br>12.09<br>12.09<br>12.09<br>12.09<br>12.09<br>12.09<br>12.09<br>12.09 |  | 24.5252-0390.3 330702   | 2  | L=390  |   |
|    | 2.0<br>2.0 16V Turbo<br>2.0 16V Turbo<br>2.0 dCi<br>2.0 dCi<br>2.2 dCi<br>2.2 dCi<br>3.0 dCi<br>3.0 dCi<br>3.5<br>3.5 V6 | 108<br>120<br>125<br>110<br>127<br>85<br>110<br>130<br>133<br>170<br>177         |  | 04.05<br>06.02<br>04.04<br>08.05<br>01.06<br>04.04<br>06.02<br>06.06<br>10.04<br>06.02          | 12.09<br>12.09<br>12.09<br>12.09<br>12.09<br>12.09<br>12.09<br>12.09<br>12.09<br>12.09<br>12.09 |  | 11.9387-7001.2 220397<br>11.9387-7002.2 220398<br>11.8116-0340.1 390595<br>11.8171-0008.1 990049<br>11.0101-5407.2 260011   | 2  | D=38, - Halter<br>D=38, - Halter<br>Haltefeder<br>Führungsbolzen<br>Hülsensatz                                     | ATE<br>ATE<br>ATE<br>ATE<br>ATE               |
|    | 2.0 16V Turbo<br>2.2 dCi<br>3.0 dCi<br>3.5 V6  | 120<br>110<br>130<br>177   |  | 06.02<br>06.02<br>06.02<br>06.02  | 08.02<br>08.02<br>08.02<br>08.02  |  | 24.5111-0335.3 330778   | 2  | L=335  |   |
|    | 2.0<br>2.0 16V Turbo<br>2.0 16V Turbo<br>2.0 dCi<br>2.0 dCi<br>2.2 dCi<br>2.2 dCi<br>3.0 dCi<br>3.0 dCi<br>3.5<br>3.5 V6 | 108<br>120<br>125<br>110<br>127<br>85<br>110<br>130<br>133<br>170<br>177         |  | 04.05<br>09.02<br>04.04<br>08.05<br>01.06<br>04.04<br>09.02<br>09.02<br>06.06<br>10.04<br>09.02 | 12.09<br>12.09<br>12.09<br>12.09<br>12.09<br>12.09<br>12.09<br>12.09<br>12.09<br>12.09<br>12.09 |  | 24.5111-0317.3 330501   | 2  | L=315  |   |
| <b>RENAULT WIND (E4M_) (10-13)</b>   |  |  |  |   |   |  |   |  |  |   |
|  | 1.2 16V Turbo<br>1.2 TCe 100<br>1.6 16V  | 74<br>75<br>98   |  | 07.10<br>02.11<br>07.10   | 09.13<br>09.13<br>09.13   |  | 11.9571-9757.2 220857<br>11.9571-9758.2 220858<br>11.8116-0301.1 390610   | 2  | D=57, - Halter<br>D=57, - Halter<br>Haltefeder   | ATE<br>ATE<br>ATE                             |
|  | 1.2 16V Turbo<br>1.2 TCe 100<br>1.6 16V  | 74<br>75<br>98   |  | 07.10<br>02.11<br>07.10   | 09.13<br>09.13<br>09.13   |  | 24.3347-1705.7 220751<br>24.3347-1706.7 220752<br>24.0101-3803.2 260101   | 2  | D=34, - Halter<br>D=34, - Halter<br>Einbausatz   | LUC<br>LUC<br>LUC                             |
|  | 1.2 16V Turbo<br>1.2 TCe 100<br>1.6 16V  | 74<br>75<br>98   |  | 07.10<br>02.11<br>07.10   | 09.13<br>09.13<br>09.13   |  | 24.5239-0165.3 330606   | 2  | L=165  |   |
| <b>RENAULT ZOE (12-)</b>   |  |  |  |   |   |  |   |  |  |   |
|  | Z.E.   | 65   |  | 06.12   |   |  | 24.3541-1823.5 240417<br>24.3541-1824.5 240418  | 2  | D=54, - Halter<br>D=54, - Halter   |   |
| <b>ROVER 25-Serie (RF) (99-)</b>   |  |  |  |   |   |  |   |  |  |   |
|  | 1.1 16V<br>1.4 16V<br>1.4 16V<br>1.6 16V<br>1.8 16V<br>1.8 16V<br>2.0 IDT  | 55<br>62<br>76<br>80<br>85<br>107<br>74  |  | 01.04<br>10.99<br>10.99<br>10.99<br>10.99<br>02.00<br>10.99                                     |   |  | 24.3219-1743.3 020485   |  | Rz 19,05   |   |
| <b>ROVER 45-Serie (RT) (00-)</b>   |  |  |  |   |   |  |   |  |  |   |
|  | 1.4<br>1.6<br>1.8<br>2.0 IDT<br>2.0 V6   | 76<br>80<br>86<br>74<br>110  | 74464<br>74464<br>74464<br>74464<br>74464  | 02.00<br>02.00<br>02.00<br>02.00<br>02.00   |   |  | 24.3219-1710.3 020386   | 2  | Rz 19,05   |   |
|  | 1.4<br>1.6<br>1.8<br>2.0 IDT<br>2.0 V6   | 76 74465<br>80 74465<br>86 74465<br>74 74465<br>110 74465                        |  |   |   |  | 24.3219-1743.3 020485   |  | Rz 19,05   |   |



|     |               |  |   |                       |  |                |    |  |                          |
|--|---|--|---|---|---|--|--|--|--------------------------|
| <b>ROVER 75-Serie (RJ) (99-04)</b>   |   |  |   |   |   |  |  |  |                          |
|    | 1.8<br>1.8 Turbo<br>2.0 CDT<br>2.0 CDTi<br>2.0 V6<br>2.5 V6<br>2.5 V6                         | 88<br>110<br>85<br>96<br>110<br>129<br>130                                       |   | 02.99 05.04<br>05.03 05.04<br>02.99 05.04<br>02.03 05.04<br>02.99 05.04<br>02.99 10.01<br>08.01 05.04 |   | 11.9571-9871.2 220425<br>11.9571-9872.2 220426<br>11.0101-5407.2 260011<br>11.8171-0008.1 990049 | 2  | D=57, - Halter<br>D=57, - Halter<br>Hülsensatz<br>Führungsbolzen                   | ATE<br>ATE<br>ATE<br>ATE |
|    | 1.8<br>1.8 Turbo<br>2.0 CDT<br>2.0 CDTi<br>2.0 V6<br>2.5 V6<br>2.5 V6                         | 88<br>110<br>85<br>96<br>110<br>129<br>130                                       |   | 02.99 05.04<br>05.03 05.04<br>02.99 05.04<br>02.03 05.04<br>02.99 05.04<br>02.99 10.01<br>08.01 05.04 |   | 11.9361-9961.2 220855<br>11.9361-9962.2 220856   |  | D=36, - Halter<br>D=36, - Halter   | ATE<br>ATE               |
| <b>ROVER 75 Serie (RX) (04-)</b>   |   |  |   |   |   |  |  |  |                          |
|    | 1.8<br>1.8 Turbo<br>2.0 CDTi<br>2.5 V6<br>4.6 V8  | 88<br>110<br>96<br>130   | 04.04   |   |   | 11.9571-9871.2 220425<br>11.9571-9872.2 220426<br>24.3571-1733.5 240349<br>24.3571-1734.5 240350 | + Scheibe 284X22 <sup>1)</sup><br>+ Scheibe 284X22 <sup>1)</sup><br>+ Scheibe 325X25 <sup>2)</sup><br>+ Scheibe 325X25 <sup>2)</sup> | D=57, - Halter<br>D=57, - Halter<br>D=57, - Halter<br>D=57, - Halter               | ATE<br>ATE<br>ATE<br>ATE |
|    | 1.8<br>1.8 Turbo<br>2.0 CDTi<br>2.5 V6  | 88<br>110<br>96<br>130   | 04.04   |   |   | 11.9361-9961.2 220855<br>11.9361-9962.2 220856<br>24.3401-1703.5 240351<br>24.3401-1704.5 240352 | + Scheibe 280X10 <sup>3)</sup><br>+ Scheibe 280X10 <sup>3)</sup><br>+ Scheibe 276X19 <sup>4)</sup><br>+ Scheibe 276X19 <sup>4)</sup> | D=36, - Halter<br>D=36, - Halter<br>D=40, - Halter<br>D=40, - Halter               | ATE<br>ATE<br>ATE<br>ATE |
| <b>ROVER 200-Serie (XW) (90-95)</b>  |   |  |   |   |   |  |  |  |                          |
|    | 214<br>216<br>218 D<br>220 Turbo  |  | 10.89 10.95<br>10.89 10.95<br>09.91 10.95<br>01.93 10.95  |   |   | 24.3219-1710.3 020386  |  | Rz 19,05   |                          |
| <b>ROVER 200 II-Serie (RF) (95-00)</b>   |   |  |   |   |   |  |  |  |                          |
|    | 211<br>214 i<br>214 Si<br>216 Si<br>218 i 16V Vitesse<br>220 D<br>220 SDi                     | 44   | 01.98 03.00<br>11.95 03.00<br>11.95 03.00<br>11.95 03.00<br>11.95 03.00<br>11.95 03.00<br>11.95 03.00   |   |   | 24.2122-1722.3 010554  |  | THz 22,20  |                          |
|  | 211<br>214 i<br>214 Si<br>216 Si<br>218 i 16V Vitesse<br>220 D<br>220 SDi                     | 44   | 01.98 03.00<br>01.96 03.00<br>11.95 03.00<br>11.95 03.00<br>01.96 03.00<br>01.96 03.00<br>01.96 03.00 + ABS                                     |   |   | 24.3541-1813.5 240381<br>24.3541-1814.5 240382   |  | D=54, - Halter<br>D=54, - Halter   |                          |
|  | 211<br>214 i<br>214 Si<br>216 Si<br>218 i 16V Vitesse<br>220 D<br>220 SDi                     | 44   | 01.98 03.00 + ABS<br>01.96 03.00 + ABS<br>11.95 03.00 + ABS<br>01.96 03.00 + ABS<br>01.97 03.00 + ABS<br>01.96 03.00 + ABS<br>01.96 03.00 + ABS |   |   | 24.3304-1701.5 240113<br>24.3304-1702.5 240114   |  | D=30, - Halter<br>D=30, - Halter   | LUC<br>LUC               |
|  | 211<br>214 i<br>214 Si<br>216 Si<br>218 i 16V Vitesse<br>220 D<br>220 SDi                     | 44   | 01.98 03.00 - ABS<br>01.96 03.00 - ABS<br>11.95 03.00 - ABS<br>01.96 03.00 - ABS<br>01.97 03.00 - ABS<br>01.96 03.00 - ABS<br>01.96 03.00 - ABS |   |   | 24.3219-1743.3 020485  |  | Rz 19,05   |                          |
| <b>ROVER 400-Serie (RT) (95-00)</b>  |   |  |   |   |   |  |  |  |                          |
|  | 414 Si<br>416 Si<br>420 D<br>420 Di<br>420 Si   | 76<br>63<br>77<br>100  | 05.95 03.00 - ABS<br>06.95 03.00 - ABS<br>11.95 03.00 - ABS<br>05.95 03.00 - ABS<br>12.95 03.00 - ABS   |   |   | 24.3219-1743.3 020485  |  | Rz 19,05   |                          |
| <b>ROVER MINI (91-95)</b>  |   |  |   |   |   |  |  |  |                          |
|  | 1.3 MK I  |  | 01.91 04.95   |   |   | 24.3219-1401.3 020351  |  | Rz 19,05   | AP                       |
| <b>SAAB 9-3 (YS3D) (98-02)</b>   |   |  |   |   |   |  |  |  |                          |
|  | 2.0 i<br>2.0 SE Turbo<br>2.0 Turbo<br>2.0 Turbo<br>2.0 Turbo<br>2.0 Turbo<br>2.2 TiD<br>2.3 i | 96<br>147<br>110<br>113<br>136<br>151<br>92<br>110                               | 01.01 09.02<br>01.01 09.02<br>01.01 09.02<br>01.01 09.02<br>01.01 09.02<br>01.01 09.02<br>01.01 09.02<br>01.01 09.02                            |   |   | 03.7750-2932.4 300175  |  | 9"   | ATE                      |

1) + disc 284X22 / + disco 284X22 / + disque 284X22 / + disco 284X22  
2) + disc 325X25 / + disco 325X25 / + disque 325X25 / + disco 325X25  
3) + disc 280X10 / + disco 280X10 / + disque 280X10 / + disco 280X10  
4) + disc 276X19 / + disco 276X19 / + disque 276X19 / + disco 276X19



| SAAB 9-3 (YS3D) (98-02) |              | kW       |          | ...     |                | ...    |   | ... |  | ... |  | ... |  | ... |  | ... |  | ... |           |                |       |         |                |        |   |  |  |  |  |  |  |  |  |  |  |  |                |     |
|-------------------------|--------------|----------|----------|---------|----------------|--------|---|-----|--|-----|--|-----|--|-----|--|-----|--|-----|-----------|----------------|-------|---------|----------------|--------|---|--|--|--|--|--|--|--|--|--|--|--|----------------|-----|
|                         | 2.0 i        | 96       | 02.98    | 12.00   | 03.2123-1121.3 | 010176 |   |     |  |     |  |     |  |     |  |     |  |     | Thz 23,81 | ATE            |       |         |                |        |   |  |  |  |  |  |  |  |  |  |  |  |                |     |
|                         | 2.0 SE Turbo | 147      | 02.98    | 12.00   |                |        |   |     |  |     |  |     |  |     |  |     |  |     |           |                |       |         |                |        |   |  |  |  |  |  |  |  |  |  |  |  |                |     |
|                         | 2.0 Turbo    | 113      | 10.98    | 12.00   |                |        |   |     |  |     |  |     |  |     |  |     |  |     |           |                |       |         |                |        |   |  |  |  |  |  |  |  |  |  |  |  |                |     |
|                         | 2.0 Turbo    | 136      | 02.98    | 12.00   |                |        |   |     |  |     |  |     |  |     |  |     |  |     |           |                |       |         |                |        |   |  |  |  |  |  |  |  |  |  |  |  |                |     |
|                         | 2.0 Turbo    | 151      | 10.99    | 12.00   |                |        |   |     |  |     |  |     |  |     |  |     |  |     |           |                |       |         |                |        |   |  |  |  |  |  |  |  |  |  |  |  |                |     |
|                         | 2.2 TiD      | 85       | 02.98    | 11.00   |                |        |   |     |  |     |  |     |  |     |  |     |  |     |           |                |       |         |                |        |   |  |  |  |  |  |  |  |  |  |  |  |                |     |
|                         | 2.2 TiD      | 92       | 11.00    | 12.00   |                |        |   |     |  |     |  |     |  |     |  |     |  |     |           |                |       |         |                |        |   |  |  |  |  |  |  |  |  |  |  |  |                |     |
|                         | 2.3 i        | 110      | 02.98    | 12.00   |                |        |   |     |  |     |  |     |  |     |  |     |  |     |           |                |       |         |                |        |   |  |  |  |  |  |  |  |  |  |  |  |                |     |
|                         | 2.0 i        | 96       | 01.01    | 09.02   |                |        |   |     |  |     |  |     |  |     |  |     |  |     |           |                |       |         |                |        |   |  |  |  |  |  |  |  |  |  |  |  |                |     |
|                         | 2.0 SE Turbo | 147      | 01.01    | 09.02   |                |        |   |     |  |     |  |     |  |     |  |     |  |     |           |                |       |         |                |        |   |  |  |  |  |  |  |  |  |  |  |  |                |     |
| 2.0 Turbo               | 110          | 01.01    | 09.02    |         |                |        |   |     |  |     |  |     |  |     |  |     |  |     |           |                |       |         |                |        |   |  |  |  |  |  |  |  |  |  |  |  |                |     |
| 2.0 Turbo               | 113          | 01.01    | 09.02    |         |                |        |   |     |  |     |  |     |  |     |  |     |  |     |           |                |       |         |                |        |   |  |  |  |  |  |  |  |  |  |  |  |                |     |
| 2.0 Turbo               | 136          | 01.01    | 09.02    |         |                |        |   |     |  |     |  |     |  |     |  |     |  |     |           |                |       |         |                |        |   |  |  |  |  |  |  |  |  |  |  |  |                |     |
| 2.0 Turbo               | 151          | 01.01    | 09.02    |         |                |        |   |     |  |     |  |     |  |     |  |     |  |     |           |                |       |         |                |        |   |  |  |  |  |  |  |  |  |  |  |  |                |     |
| 2.2 TiD                 | 92           | 01.01    | 09.02    |         |                |        |   |     |  |     |  |     |  |     |  |     |  |     |           |                |       |         |                |        |   |  |  |  |  |  |  |  |  |  |  |  |                |     |
| 2.3 i                   | 110          | 01.01    | 09.02    |         |                |        |   |     |  |     |  |     |  |     |  |     |  |     |           |                |       |         |                |        |   |  |  |  |  |  |  |  |  |  |  |  |                |     |
| 2.3 Turbo               | 165          | 10.98    | 09.02    |         |                |        |   |     |  |     |  |     |  |     |  |     |  |     |           |                |       |         |                |        |   |  |  |  |  |  |  |  |  |  |  |  |                |     |
|                         | 2.0 i        | 96       | X7020000 | 02.98   | 11.3571-8525.2 | 220363 | 2 |     |  |     |  |     |  |     |  |     |  |     |           | D=57, - Halter | ATE   |         |                |        |   |  |  |  |  |  |  |  |  |  |  |  |                |     |
|                         | 2.0 i        | 96       | X2020000 | 02.98   |                |        |   |     |  |     |  |     |  |     |  |     |  |     |           |                |       | + (USA) |                |        |   |  |  |  |  |  |  |  |  |  |  |  |                |     |
|                         | 2.0 i        | 96       |          | 02.98   |                |        |   |     |  |     |  |     |  |     |  |     |  |     |           |                |       | 12.98   | - (USA)        |        |   |  |  |  |  |  |  |  |  |  |  |  |                |     |
|                         | 2.0 SE Turbo | 147      | X7020000 | 02.98   |                |        |   |     |  |     |  |     |  |     |  |     |  |     |           |                |       | + (USA) |                |        |   |  |  |  |  |  |  |  |  |  |  |  |                |     |
|                         | 2.0 SE Turbo | 147      | X2020000 | 02.98   |                |        |   |     |  |     |  |     |  |     |  |     |  |     |           |                |       | + (USA) |                |        |   |  |  |  |  |  |  |  |  |  |  |  |                |     |
|                         | 2.0 SE Turbo | 147      |          | 02.98   |                |        |   |     |  |     |  |     |  |     |  |     |  |     |           |                |       | 12.98   | - (USA)        |        |   |  |  |  |  |  |  |  |  |  |  |  |                |     |
|                         | 2.0 Turbo    | 113      | X7020000 | 10.98   |                |        |   |     |  |     |  |     |  |     |  |     |  |     |           |                |       | + (USA) |                |        |   |  |  |  |  |  |  |  |  |  |  |  |                |     |
|                         | 2.0 Turbo    | 113      | X2020000 | 10.98   |                |        |   |     |  |     |  |     |  |     |  |     |  |     |           |                |       | + (USA) |                |        |   |  |  |  |  |  |  |  |  |  |  |  |                |     |
|                         | 2.0 Turbo    | 113      |          | 10.98   |                |        |   |     |  |     |  |     |  |     |  |     |  |     |           |                |       | 12.98   | - (USA)        |        |   |  |  |  |  |  |  |  |  |  |  |  |                |     |
|                         | 2.0 Turbo    | 136      | X7020000 | 02.98   |                |        |   |     |  |     |  |     |  |     |  |     |  |     |           |                |       | + (USA) |                |        |   |  |  |  |  |  |  |  |  |  |  |  |                |     |
|                         | 2.0 Turbo    | 136      | X2020000 | 02.98   |                |        |   |     |  |     |  |     |  |     |  |     |  |     |           |                |       | + (USA) |                |        |   |  |  |  |  |  |  |  |  |  |  |  |                |     |
|                         | 2.0 Turbo    | 136      |          | 02.98   |                |        |   |     |  |     |  |     |  |     |  |     |  |     |           |                |       | 12.98   | - (USA)        |        |   |  |  |  |  |  |  |  |  |  |  |  |                |     |
|                         | 2.2 TiD      | 85       | X7020000 | 02.98   |                |        |   |     |  |     |  |     |  |     |  |     |  |     |           |                |       | + (USA) |                |        |   |  |  |  |  |  |  |  |  |  |  |  |                |     |
|                         | 2.2 TiD      | 85       | X2020000 | 02.98   |                |        |   |     |  |     |  |     |  |     |  |     |  |     |           |                |       | + (USA) |                |        |   |  |  |  |  |  |  |  |  |  |  |  |                |     |
|                         | 2.2 TiD      | 85       |          | 02.98   |                |        |   |     |  |     |  |     |  |     |  |     |  |     |           |                |       | 12.98   | - (USA)        |        |   |  |  |  |  |  |  |  |  |  |  |  |                |     |
|                         | 2.3 i        | 110      | X7020000 | 02.98   |                |        |   |     |  |     |  |     |  |     |  |     |  |     |           |                |       | + (USA) |                |        |   |  |  |  |  |  |  |  |  |  |  |  |                |     |
|                         | 2.3 i        | 110      | X2020000 | 02.98   |                |        |   |     |  |     |  |     |  |     |  |     |  |     |           |                |       | + (USA) |                |        |   |  |  |  |  |  |  |  |  |  |  |  |                |     |
|                         | 2.3 i        | 110      |          | 02.98   |                |        |   |     |  |     |  |     |  |     |  |     |  |     |           |                |       | 12.98   | - (USA)        |        |   |  |  |  |  |  |  |  |  |  |  |  |                |     |
|                         | 2.0 i        | 96       | X7020001 | 09.02   |                |        |   |     |  |     |  |     |  |     |  |     |  |     |           |                |       | + (USA) | 24.3571-1725.5 | 240313 | 2 |  |  |  |  |  |  |  |  |  |  |  | D=57, - Halter | ATE |
|                         | 2.0 i        | 96       | X2020001 | 09.02   |                |        |   |     |  |     |  |     |  |     |  |     |  |     |           |                |       | + (USA) |                |        |   |  |  |  |  |  |  |  |  |  |  |  |                |     |
| 2.0 i                   | 96           |          | 01.99    | 09.02   | - (USA)        |        |   |     |  |     |  |     |  |     |  |     |  |     |           |                |       |         |                |        |   |  |  |  |  |  |  |  |  |  |  |  |                |     |
| 2.0 SE Turbo            | 147          | X7020001 | 09.02    | + (USA) |                |        |   |     |  |     |  |     |  |     |  |     |  |     |           |                |       |         |                |        |   |  |  |  |  |  |  |  |  |  |  |  |                |     |
| 2.0 SE Turbo            | 147          | X2020001 | 09.02    | + (USA) |                |        |   |     |  |     |  |     |  |     |  |     |  |     |           |                |       |         |                |        |   |  |  |  |  |  |  |  |  |  |  |  |                |     |
| 2.0 SE Turbo            | 147          |          | 01.99    | 09.02   | - (USA)        |        |   |     |  |     |  |     |  |     |  |     |  |     |           |                |       |         |                |        |   |  |  |  |  |  |  |  |  |  |  |  |                |     |
| 2.0 Turbo               | 110          | X7020001 | 09.02    | + (USA) |                |        |   |     |  |     |  |     |  |     |  |     |  |     |           |                |       |         |                |        |   |  |  |  |  |  |  |  |  |  |  |  |                |     |
| 2.0 Turbo               | 110          | X2020001 | 09.02    | + (USA) |                |        |   |     |  |     |  |     |  |     |  |     |  |     |           |                |       |         |                |        |   |  |  |  |  |  |  |  |  |  |  |  |                |     |
| 2.0 Turbo               | 110          |          | 01.01    | 09.02   | - (USA)        |        |   |     |  |     |  |     |  |     |  |     |  |     |           |                |       |         |                |        |   |  |  |  |  |  |  |  |  |  |  |  |                |     |
| 2.0 Turbo               | 113          | X7020001 | 09.02    | + (USA) |                |        |   |     |  |     |  |     |  |     |  |     |  |     |           |                |       |         |                |        |   |  |  |  |  |  |  |  |  |  |  |  |                |     |
| 2.0 Turbo               | 113          | X2020001 | 09.02    | + (USA) |                |        |   |     |  |     |  |     |  |     |  |     |  |     |           |                |       |         |                |        |   |  |  |  |  |  |  |  |  |  |  |  |                |     |
| 2.0 Turbo               | 113          |          | 01.99    | 09.02   | - (USA)        |        |   |     |  |     |  |     |  |     |  |     |  |     |           |                |       |         |                |        |   |  |  |  |  |  |  |  |  |  |  |  |                |     |
| 2.0 Turbo               | 136          | X7020001 | 09.02    | + (USA) |                |        |   |     |  |     |  |     |  |     |  |     |  |     |           |                |       |         |                |        |   |  |  |  |  |  |  |  |  |  |  |  |                |     |
| 2.0 Turbo               | 136          | X2020001 | 09.02    | + (USA) |                |        |   |     |  |     |  |     |  |     |  |     |  |     |           |                |       |         |                |        |   |  |  |  |  |  |  |  |  |  |  |  |                |     |
| 2.0 Turbo               | 136          |          | 01.99    | 09.02   | - (USA)        |        |   |     |  |     |  |     |  |     |  |     |  |     |           |                |       |         |                |        |   |  |  |  |  |  |  |  |  |  |  |  |                |     |
| 2.0 Turbo               | 151          |          | 10.99    | 09.02   |                |        |   |     |  |     |  |     |  |     |  |     |  |     |           |                |       |         |                |        |   |  |  |  |  |  |  |  |  |  |  |  |                |     |
| 2.2 TiD                 | 85           | X7020001 | 09.02    | + (USA) |                |        |   |     |  |     |  |     |  |     |  |     |  |     |           |                |       |         |                |        |   |  |  |  |  |  |  |  |  |  |  |  |                |     |
| 2.2 TiD                 | 85           | X2020001 | 11.00    | + (USA) |                |        |   |     |  |     |  |     |  |     |  |     |  |     |           |                |       |         |                |        |   |  |  |  |  |  |  |  |  |  |  |  |                |     |
| 2.2 TiD                 | 85           |          | 01.99    | 11.00   | - (USA)        |        |   |     |  |     |  |     |  |     |  |     |  |     |           |                |       |         |                |        |   |  |  |  |  |  |  |  |  |  |  |  |                |     |
| 2.2 TiD                 | 92           |          | 11.00    | 09.02   |                |        |   |     |  |     |  |     |  |     |  |     |  |     |           |                |       |         |                |        |   |  |  |  |  |  |  |  |  |  |  |  |                |     |
| 2.3 i                   | 110          | X7020001 | 09.02    | + (USA) |                |        |   |     |  |     |  |     |  |     |  |     |  |     |           |                |       |         |                |        |   |  |  |  |  |  |  |  |  |  |  |  |                |     |
| 2.3 i                   | 110          | X2020001 | 09.02    | + (USA) |                |        |   |     |  |     |  |     |  |     |  |     |  |     |           |                |       |         |                |        |   |  |  |  |  |  |  |  |  |  |  |  |                |     |
| 2.3 i                   | 110          |          | 01.99    | 09.02   | - (USA)        |        |   |     |  |     |  |     |  |     |  |     |  |     |           |                |       |         |                |        |   |  |  |  |  |  |  |  |  |  |  |  |                |     |
| 2.3 Turbo               | 165          |          | 10.98    | 09.02   |                |        |   |     |  |     |  |     |  |     |  |     |  |     |           |                |       |         |                |        |   |  |  |  |  |  |  |  |  |  |  |  |                |     |
|                         | 2.0 i        | 96       | 02.98    | 09.02   | 83.7288-0318.3 | 330375 | 2 |     |  |     |  |     |  |     |  |     |  |     |           |                | L=315 |         |                |        |   |  |  |  |  |  |  |  |  |  |  |  |                |     |
|                         | 2.0 SE Turbo | 147      | 02.98    | 09.02   |                |        |   |     |  |     |  |     |  |     |  |     |  |     |           |                |       |         |                |        |   |  |  |  |  |  |  |  |  |  |  |  |                |     |
|                         | 2.0 Turbo    | 110      | 01.01    | 09.02   |                |        |   |     |  |     |  |     |  |     |  |     |  |     |           |                |       |         |                |        |   |  |  |  |  |  |  |  |  |  |  |  |                |     |
|                         | 2.0 Turbo    | 113      | 10.98    | 09.02   |                |        |   |     |  |     |  |     |  |     |  |     |  |     |           |                |       |         |                |        |   |  |  |  |  |  |  |  |  |  |  |  |                |     |
|                         | 2.0 Turbo    | 136      | 02.98    | 09.02   |                |        |   |     |  |     |  |     |  |     |  |     |  |     |           |                |       |         |                |        |   |  |  |  |  |  |  |  |  |  |  |  |                |     |
|                         | 2.0 Turbo    | 151      | 10.99    | 09.02   |                |        |   |     |  |     |  |     |  |     |  |     |  |     |           |                |       |         |                |        |   |  |  |  |  |  |  |  |  |  |  |  |                |     |
|                         | 2.2 TiD      | 85       | 02.98    | 11.00   |                |        |   |     |  |     |  |     |  |     |  |     |  |     |           |                |       |         |                |        |   |  |  |  |  |  |  |  |  |  |  |  |                |     |
|                         | 2.2 TiD      | 92       | 11.00    | 09.02   |                |        |   |     |  |     |  |     |  |     |  |     |  |     |           |                |       |         |                |        |   |  |  |  |  |  |  |  |  |  |  |  |                |     |
|                         | 2.3 i        | 110      | 02.98    | 09.02   |                |        |   |     |  |     |  |     |  |     |  |     |  |     |           |                |       |         |                |        |   |  |  |  |  |  |  |  |  |  |  |  |                |     |
|                         | 2.3 Turbo    | 165      | 10.98    | 09.02   |                |        |   |     |  |     |  |     |  |     |  |     |  |     |           |                |       |         |                |        |   |  |  |  |  |  |  |  |  |  |  |  |                |     |
|                         | 2.0 i        | 96       | 02.98    | 09.02   | 13.2351-0025.2 | 210210 |   |     |  |     |  |     |  |     |  |     |  |     |           |                | D=35  | ATE     |                |        |   |  |  |  |  |  |  |  |  |  |  |  |                |     |
|                         | 2.0 SE Turbo | 147      | 02.98    | 09.02   |                |        |   |     |  |     |  |     |  |     |  |     |  |     |           |                |       |         |                |        |   |  |  |  |  |  |  |  |  |  |  |  |                |     |
|                         | 2.0 Turbo    | 110      | 01.01    | 09.02   |                |        |   |     |  |     |  |     |  |     |  |     |  |     |           |                |       |         |                |        |   |  |  |  |  |  |  |  |  |  |  |  |                |     |
|                         | 2.0 Turbo    | 113      | 10.98    | 09.02   |                |        |   |     |  |     |  |     |  |     |  |     |  |     |           |                |       |         |                |        |   |  |  |  |  |  |  |  |  |  |  |  |                |     |
|                         | 2.0 Turbo    | 136      | 02.98    | 09.02   |                |        |   |     |  |     |  |     |  |     |  |     |  |     |           |                |       |         |                |        |   |  |  |  |  |  |  |  |  |  |  |  |                |     |
|                         | 2.0 Turbo    | 151      | 10.99    | 09.02   |                |        |   |     |  |     |  |     |  |     |  |     |  |     |           |                |       |         |                |        |   |  |  |  |  |  |  |  |  |  |  |  |                |     |
|                         | 2.2 TiD      | 85       | 02.98    | 11.00   |                |        |   |     |  |     |  |     |  |     |  |     |  |     |           |                |       |         |                |        |   |  |  |  |  |  |  |  |  |  |  |  |                |     |
|                         | 2.2 TiD      | 92       | 11.00    | 09.02   |                |        |   |     |  |     |  |     |  |     |  |     |  |     |           |                |       |         |                |        |   |  |  |  |  |  |  |  |  |  |  |  |                |     |
|                         | 2.3 i        | 110      | 02.98    | 09.02   |                |        |   |     |  |     |  |     |  |     |  |     |  |     |           |                |       |         |                |        |   |  |  |  |  |  |  |  |  |  |  |  |                |     |
|                         | 2.3 Turbo    | 165      | 10.98    | 09.02   |                |        |   |     |  |     |  |     |  |     |  |     |  |     |           |                |       |         |                |        |   |  |  |  |  |  |  |  |  |  |  |  |                |     |
|                         | 2.0 i        | 96       | 02.98    | 09.02   | 24.5117-0205.3 | 330669 |   |     |  |     |  |     |  |     |  |     |  |     |           |                | L=205 |         |                |        |   |  |  |  |  |  |  |  |  |  |  |  |                |     |
|                         | 2.0 SE Turbo | 147      | 02.98    | 09.02   |                |        |   |     |  |     |  |     |  |     |  |     |  |     |           |                |       |         |                |        |   |  |  |  |  |  |  |  |  |  |  |  |                |     |
|                         | 2.0 Turbo    | 110      | 01.01    | 09.02   |                |        |   |     |  |     |  |     |  |     |  |     |  |     |           |                |       |         |                |        |   |  |  |  |  |  |  |  |  |  |  |  |                |     |
|                         | 2.0 Turbo    | 113      | 10.98    | 09.02   |                |        |   |     |  |     |  |     |  |     |  |     |  |     |           |                |       |         |                |        |   |  |  |  |  |  |  |  |  |  |  |  |                |     |
|                         | 2.0 Turbo    | 136      | 02.98    | 09.02   |                |        |   |     |  |     |  |     |  |     |  |     |  |     |           |                |       |         |                |        |   |  |  |  |  |  |  |  |  |  |  |  |                |     |
|                         | 2.0 Turbo    | 151      | 10.99    | 09.02   |                |        |   |     |  |     |  |     |  |     |  |     |  |     |           |                |       |         |                |        |   |  |  |  |  |  |  |  |  |  |  |  |                |     |
|                         | 2.2 TiD      | 85       | 02.98    | 11.00   |                |        |   |     |  |     |  |     |  |     |  |     |  |     |           |                |       |         |                |        |   |  |  |  |  |  |  |  |  |  |  |  |                |     |
|                         | 2.2 TiD      | 92       | 11.00    | 09.02   |                |        |   |     |  |     |  |     |  |     |  |     |  |     |           |                |       |         |                |        |   |  |  |  |  |  |  |  |  |  |  |  |                |     |
|                         | 2.3 i        | 110      | 02.98    | 09.02   |                |        |   |     |  |     |  |     |  |     |  |     |  |     |           |                |       |         |                |        |   |  |  |  |  |  |  |  |  |  |  |  |                |     |
|                         | 2.3 Turbo    | 165      | 10.98    | 09.02   |                |        |   |     |  |     |  |     |  |     |  |     |  |     |           |                |       |         |                |        |   |  |  |  |  |  |  |  |  |  |  |  |                |     |



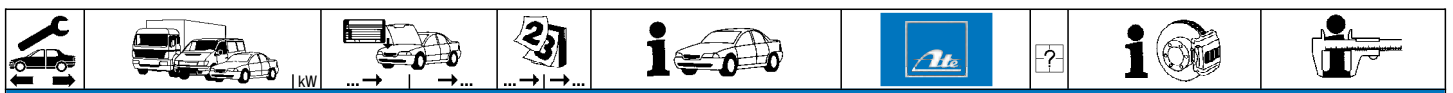

| SAAB 9-3 (YS3D) (98-02) |              |     |       |       |       |                |        |   |  |          |
|-------------------------|--------------|-----|-------|-------|-------|----------------|--------|---|--|----------|
|                         | 2.3 i        | 110 |       | 02.98 | 09.02 | 24.5117-0205.3 | 330669 |   |  | L=205    |
|                         | 2.3 Turbo    | 165 |       | 10.98 | 09.02 | 24.5117-0195.3 | 330565 |   |  | L=198    |
|                         | 2.0 i        | 96  |       | 02.98 | 09.02 | 24.3727-1106.2 | 581106 | 1 |  | L=2180   |
|                         | 2.0 SE Turbo | 147 |       | 02.98 | 09.02 |                |        |   |  |          |
|                         | 2.0 Turbo    | 110 |       | 01.01 | 09.02 |                |        |   |  |          |
|                         | 2.0 Turbo    | 113 |       | 10.98 | 09.02 |                |        |   |  |          |
|                         | 2.0 Turbo    | 136 |       | 02.98 | 09.02 |                |        |   |  |          |
|                         | 2.0 Turbo    | 151 |       | 10.99 | 09.02 |                |        |   |  |          |
|                         | 2.2 TiD      | 85  |       | 02.98 | 11.00 |                |        |   |  |          |
|                         | 2.2 TiD      | 92  |       | 11.00 | 09.02 |                |        |   |  |          |
|                         | 2.3 i        | 110 |       | 02.98 | 09.02 |                |        |   |  |          |
| 2.3 Turbo               | 165          |     | 10.98 | 09.02 |       |                |        |   |  |          |
|                         | 2.0 i        | 96  |       | 02.98 | 09.02 | 24.2419-1727.3 | 030116 |   |  | Gz 19,05 |
|                         | 2.0 SE Turbo | 147 |       | 02.98 | 09.02 |                |        |   |  |          |
|                         | 2.0 Turbo    | 110 |       | 01.01 | 09.02 |                |        |   |  |          |
|                         | 2.0 Turbo    | 113 |       | 10.98 | 09.02 |                |        |   |  |          |
|                         | 2.0 Turbo    | 136 |       | 02.98 | 09.02 |                |        |   |  |          |
|                         | 2.0 Turbo    | 151 |       | 10.99 | 09.02 |                |        |   |  |          |
|                         | 2.2 TiD      | 85  |       | 02.98 | 11.00 |                |        |   |  |          |
|                         | 2.2 TiD      | 92  |       | 11.00 | 09.02 |                |        |   |  |          |
|                         | 2.3 i        | 110 |       | 02.98 | 09.02 |                |        |   |  |          |
| 2.3 Turbo               | 165          |     | 10.98 | 09.02 |       |                |        |   |  |          |

| SAAB 9-3 Limousine (YS3F) (03-12) |                       |          |          |          |                |                |        |   |  |  |                |                |                |        |   |  |  |                |                |                |        |   |                         |                            |             |                |                |        |   |                         |                           |            |                |                |        |   |  |               |                |                |                |        |   |  |             |     |                |                |        |   |  |            |     |                |                |        |   |  |                |     |                |                |        |   |  |  |     |                |                |        |   |  |  |     |                |                |        |   |  |  |     |                |                |        |   |  |  |     |                |                |        |   |  |                         |                |                |                |        |   |  |                         |                |                |
|-----------------------------------|-----------------------|----------|----------|----------|----------------|----------------|--------|---|--|--|----------------|----------------|----------------|--------|---|--|--|----------------|----------------|----------------|--------|---|-------------------------|----------------------------|-------------|----------------|----------------|--------|---|-------------------------|---------------------------|------------|----------------|----------------|--------|---|--|---------------|----------------|----------------|----------------|--------|---|--|-------------|-----|----------------|----------------|--------|---|--|------------|-----|----------------|----------------|--------|---|--|----------------|-----|----------------|----------------|--------|---|--|--|-----|----------------|----------------|--------|---|--|--|-----|----------------|----------------|--------|---|--|--|-----|----------------|----------------|--------|---|--|--|-----|----------------|----------------|--------|---|--|-------------------------|----------------|----------------|----------------|--------|---|--|-------------------------|----------------|----------------|
|                                   | 1.8 i                 | 90       |          | 03.04    | 06.12          | 24.2125-1732.3 | 010827 |   |  | Thz 25,40                                    | LUC            |                |                |        |   |  |  |                |                |                |        |   |                         |                            |             |                |                |        |   |                         |                           |            |                |                |        |   |  |               |                |                |                |        |   |  |             |     |                |                |        |   |  |            |     |                |                |        |   |  |                |     |                |                |        |   |  |  |     |                |                |        |   |  |  |     |                |                |        |   |  |  |     |                |                |        |   |  |  |     |                |                |        |   |  |                         |                |                |                |        |   |  |                         |                |                |
|                                   | 1.8 t                 | 110      |          | 09.02    | 06.12          |                |        |   |  |  |                |                |                |        |   |  |  |                |                |                |        |   |                         |                            |             |                |                |        |   |                         |                           |            |                |                |        |   |  |               |                |                |                |        |   |  |             |     |                |                |        |   |  |            |     |                |                |        |   |  |                |     |                |                |        |   |  |  |     |                |                |        |   |  |  |     |                |                |        |   |  |  |     |                |                |        |   |  |  |     |                |                |        |   |  |                         |                |                |                |        |   |  |                         |                |                |
|                                   | 1.8 t BioPower        | 110      |          | 01.07    | 06.12          |                |        |   |  |  |                |                |                |        |   |  |  |                |                |                |        |   |                         |                            |             |                |                |        |   |                         |                           |            |                |                |        |   |  |               |                |                |                |        |   |  |             |     |                |                |        |   |  |            |     |                |                |        |   |  |                |     |                |                |        |   |  |  |     |                |                |        |   |  |  |     |                |                |        |   |  |  |     |                |                |        |   |  |  |     |                |                |        |   |  |                         |                |                |                |        |   |  |                         |                |                |
|                                   | 1.9 TiD               | 88       |          | 07.04    | 06.12          |                |        |   |  |  |                |                |                |        |   |  |  |                |                |                |        |   |                         |                            |             |                |                |        |   |                         |                           |            |                |                |        |   |  |               |                |                |                |        |   |  |             |     |                |                |        |   |  |            |     |                |                |        |   |  |                |     |                |                |        |   |  |  |     |                |                |        |   |  |  |     |                |                |        |   |  |  |     |                |                |        |   |  |  |     |                |                |        |   |  |                         |                |                |                |        |   |  |                         |                |                |
|                                   | 1.9 TiD               | 110      |          | 07.04    | 06.12          |                |        |   |  |  |                |                |                |        |   |  |  |                |                |                |        |   |                         |                            |             |                |                |        |   |                         |                           |            |                |                |        |   |  |               |                |                |                |        |   |  |             |     |                |                |        |   |  |            |     |                |                |        |   |  |                |     |                |                |        |   |  |  |     |                |                |        |   |  |  |     |                |                |        |   |  |  |     |                |                |        |   |  |  |     |                |                |        |   |  |                         |                |                |                |        |   |  |                         |                |                |
|                                   | 1.9 TTiD              | 110      |          | 07.07    | 06.12          |                |        |   |  |  |                |                |                |        |   |  |  |                |                |                |        |   |                         |                            |             |                |                |        |   |                         |                           |            |                |                |        |   |  |               |                |                |                |        |   |  |             |     |                |                |        |   |  |            |     |                |                |        |   |  |                |     |                |                |        |   |  |  |     |                |                |        |   |  |  |     |                |                |        |   |  |  |     |                |                |        |   |  |  |     |                |                |        |   |  |                         |                |                |                |        |   |  |                         |                |                |
|                                   | 2.0 t                 | 110      |          | 09.02    | 06.12          |                |        |   |  |  |                |                |                |        |   |  |  |                |                |                |        |   |                         |                            |             |                |                |        |   |                         |                           |            |                |                |        |   |  |               |                |                |                |        |   |  |             |     |                |                |        |   |  |            |     |                |                |        |   |  |                |     |                |                |        |   |  |  |     |                |                |        |   |  |  |     |                |                |        |   |  |  |     |                |                |        |   |  |  |     |                |                |        |   |  |                         |                |                |                |        |   |  |                         |                |                |
|                                   | 2.0 T Aero            | 154      |          | 09.02    | 06.12          |                |        |   |  |  |                |                |                |        |   |  |  |                |                |                |        |   |                         |                            |             |                |                |        |   |                         |                           |            |                |                |        |   |  |               |                |                |                |        |   |  |             |     |                |                |        |   |  |            |     |                |                |        |   |  |                |     |                |                |        |   |  |  |     |                |                |        |   |  |  |     |                |                |        |   |  |  |     |                |                |        |   |  |  |     |                |                |        |   |  |                         |                |                |                |        |   |  |                         |                |                |
|                                   | 2.0 t BioPower        | 110      |          | 01.07    | 06.12          |                |        |   |  |  |                |                |                |        |   |  |  |                |                |                |        |   |                         |                            |             |                |                |        |   |                         |                           |            |                |                |        |   |  |               |                |                |                |        |   |  |             |     |                |                |        |   |  |            |     |                |                |        |   |  |                |     |                |                |        |   |  |  |     |                |                |        |   |  |  |     |                |                |        |   |  |  |     |                |                |        |   |  |  |     |                |                |        |   |  |                         |                |                |                |        |   |  |                         |                |                |
|                                   | 2.0 t BioPower        | 145      |          | 06.07    | 06.12          |                |        |   |  |  |                |                |                |        |   |  |  |                |                |                |        |   |                         |                            |             |                |                |        |   |                         |                           |            |                |                |        |   |  |               |                |                |                |        |   |  |             |     |                |                |        |   |  |            |     |                |                |        |   |  |                |     |                |                |        |   |  |  |     |                |                |        |   |  |  |     |                |                |        |   |  |  |     |                |                |        |   |  |  |     |                |                |        |   |  |                         |                |                |                |        |   |  |                         |                |                |
|                                   | 2.0 t BioPower XWD    | 110      |          | 09.02    | 06.12          |                |        |   |  |  |                |                |                |        |   |  |  |                |                |                |        |   |                         |                            |             |                |                |        |   |                         |                           |            |                |                |        |   |  |               |                |                |                |        |   |  |             |     |                |                |        |   |  |            |     |                |                |        |   |  |                |     |                |                |        |   |  |  |     |                |                |        |   |  |  |     |                |                |        |   |  |  |     |                |                |        |   |  |  |     |                |                |        |   |  |                         |                |                |                |        |   |  |                         |                |                |
|                                   | 2.0 t XWD             | 110      |          | 01.07    | 06.12          |                |        |   |  |  |                |                |                |        |   |  |  |                |                |                |        |   |                         |                            |             |                |                |        |   |                         |                           |            |                |                |        |   |  |               |                |                |                |        |   |  |             |     |                |                |        |   |  |            |     |                |                |        |   |  |                |     |                |                |        |   |  |  |     |                |                |        |   |  |  |     |                |                |        |   |  |  |     |                |                |        |   |  |  |     |                |                |        |   |  |                         |                |                |                |        |   |  |                         |                |                |
|                                   | 2.0 Turbo Performance | 110      |          | 04.04    | 06.12          |                |        |   |  |  |                |                |                |        |   |  |  |                |                |                |        |   |                         |                            |             |                |                |        |   |                         |                           |            |                |                |        |   |  |               |                |                |                |        |   |  |             |     |                |                |        |   |  |            |     |                |                |        |   |  |                |     |                |                |        |   |  |  |     |                |                |        |   |  |  |     |                |                |        |   |  |  |     |                |                |        |   |  |  |     |                |                |        |   |  |                         |                |                |                |        |   |  |                         |                |                |
|                                   | 2.2 TiD               | 92       |          | 09.02    | 06.12          |                |        |   |  |  |                |                |                |        |   |  |  |                |                |                |        |   |                         |                            |             |                |                |        |   |                         |                           |            |                |                |        |   |  |               |                |                |                |        |   |  |             |     |                |                |        |   |  |            |     |                |                |        |   |  |                |     |                |                |        |   |  |  |     |                |                |        |   |  |  |     |                |                |        |   |  |  |     |                |                |        |   |  |  |     |                |                |        |   |  |                         |                |                |                |        |   |  |                         |                |                |
|                                   | 2.8 T Aero            | 184      |          | 03.05    | 12.05          |                |        |   |  |  |                |                |                |        |   |  |  |                |                |                |        |   |                         |                            |             |                |                |        |   |                         |                           |            |                |                |        |   |  |               |                |                |                |        |   |  |             |     |                |                |        |   |  |            |     |                |                |        |   |  |                |     |                |                |        |   |  |  |     |                |                |        |   |  |  |     |                |                |        |   |  |  |     |                |                |        |   |  |  |     |                |                |        |   |  |                         |                |                |                |        |   |  |                         |                |                |
|                                   | 1.8 i                 | 90       |          | 03.04    | 06.12          | 11.9571-9781.2 | 220659 | 2 |  | GG / nur paarweise austauschen <sup>2)</sup> | D=57, - Halter | ATE            |                |        |   |  |  |                |                |                |        |   |                         |                            |             |                |                |        |   |                         |                           |            |                |                |        |   |  |               |                |                |                |        |   |  |             |     |                |                |        |   |  |            |     |                |                |        |   |  |                |     |                |                |        |   |  |  |     |                |                |        |   |  |  |     |                |                |        |   |  |  |     |                |                |        |   |  |  |     |                |                |        |   |  |                         |                |                |                |        |   |  |                         |                |                |
|                                   | 1.8 t                 | 110      |          | 09.02    | 06.12          |                |        |   |  |  |                |                | 11.9571-9782.2 | 220660 | 2 |  | GG / nur paarweise austauschen <sup>2)</sup> | D=57, - Halter | ATE            |                |        |   |                         |                            |             |                |                |        |   |                         |                           |            |                |                |        |   |  |               |                |                |                |        |   |  |             |     |                |                |        |   |  |            |     |                |                |        |   |  |                |     |                |                |        |   |  |  |     |                |                |        |   |  |  |     |                |                |        |   |  |  |     |                |                |        |   |  |  |     |                |                |        |   |  |                         |                |                |                |        |   |  |                         |                |                |
|                                   | 1.8 t BioPower        | 110      |          | 01.07    | 06.12          |                |        |   |  |  |                |                |                |        |   |  |  |                |                | 11.8116-0295.2 | 390524 | 2 |                         | + ALU-Sättel <sup>3)</sup> | Halterfeder | ATE            |                |        |   |                         |                           |            |                |                |        |   |  |               |                |                |                |        |   |  |             |     |                |                |        |   |  |            |     |                |                |        |   |  |                |     |                |                |        |   |  |  |     |                |                |        |   |  |  |     |                |                |        |   |  |  |     |                |                |        |   |  |  |     |                |                |        |   |  |                         |                |                |                |        |   |  |                         |                |                |
|                                   | 1.9 TiD               | 88       |          | 07.04    | 06.12          |                |        |   |  |  |                |                |                |        |   |  |  |                |                |                |        |   |                         |                            |             |                | 11.8116-0356.1 | 390586 | 2 |                         | + GG-Sättel <sup>4)</sup> | Hülsensatz | ATE            |                |        |   |  |               |                |                |                |        |   |  |             |     |                |                |        |   |  |            |     |                |                |        |   |  |                |     |                |                |        |   |  |  |     |                |                |        |   |  |  |     |                |                |        |   |  |  |     |                |                |        |   |  |  |     |                |                |        |   |  |                         |                |                |                |        |   |  |                         |                |                |
|                                   | 1.9 TiD               | 110      |          | 07.04    | 06.12          |                |        |   |  |  |                |                |                |        |   |  |  |                |                |                |        |   |                         |                            |             |                |                |        |   |                         |                           |            |                | 11.0101-5407.2 | 260011 | 2 |  |               | Führungsbolzen | ATE            |                |        |   |  |             |     |                |                |        |   |  |            |     |                |                |        |   |  |                |     |                |                |        |   |  |  |     |                |                |        |   |  |  |     |                |                |        |   |  |  |     |                |                |        |   |  |  |     |                |                |        |   |  |                         |                |                |                |        |   |  |                         |                |                |
|                                   | 1.9 TTiD              | 110      |          | 07.07    | 06.12          |                |        |   |  |  |                |                |                |        |   |  |  |                |                |                |        |   |                         |                            |             |                |                |        |   |                         |                           |            |                |                |        |   |  |               |                |                | 11.8171-0008.1 | 990049 | 2 |  |             |     | ATE            |                |        |   |  |            |     |                |                |        |   |  |                |     |                |                |        |   |  |  |     |                |                |        |   |  |  |     |                |                |        |   |  |  |     |                |                |        |   |  |  |     |                |                |        |   |  |                         |                |                |                |        |   |  |                         |                |                |
|                                   | 2.0 t                 | 110      |          | 09.02    | 06.12          |                |        |   |  |  |                |                |                |        |   |  |  |                |                |                |        |   |                         |                            |             |                |                |        |   |                         |                           |            |                |                |        |   |  |               |                |                |                |        |   |  |             |     |                | 11.0101-5407.2 | 260011 | 2 |  |            |     | ATE            |                |        |   |  |                |     |                |                |        |   |  |  |     |                |                |        |   |  |  |     |                |                |        |   |  |  |     |                |                |        |   |  |  |     |                |                |        |   |  |                         |                |                |                |        |   |  |                         |                |                |
|                                   | 2.0 Turbo Performance | 110      |          | 04.04    | 06.12          |                |        |   |  |  |                |                |                |        |   |  |  |                |                |                |        |   |                         |                            |             |                |                |        |   |                         |                           |            |                |                |        |   |  |               |                |                |                |        |   |  |             |     |                |                |        |   |  |            |     |                | 11.8171-0008.1 | 990049 | 2 |  |                |     | ATE            |                |        |   |  |  |     |                |                |        |   |  |  |     |                |                |        |   |  |  |     |                |                |        |   |  |  |     |                |                |        |   |  |                         |                |                |                |        |   |  |                         |                |                |
|                                   | 2.2 TiD               | 92       |          | 09.02    | 06.12          |                |        |   |  |  |                |                |                |        |   |  |  |                |                |                |        |   |                         |                            |             |                |                |        |   |                         |                           |            |                |                |        |   |  |               |                |                |                |        |   |  |             |     |                |                |        |   |  |            |     |                |                |        |   |  |                |     |                | 11.8116-0325.2 | 390461 | 2 |  |  |     | ATE            |                |        |   |  |  |     |                |                |        |   |  |  |     |                |                |        |   |  |  |     |                |                |        |   |  |                         |                |                |                |        |   |  |                         |                |                |
|                                   | 2.0 T Aero            | 154      | 41039808 | 51046733 |                |                |        |   |  |  |                |                |                |        |   |  |  |                |                |                |        |   |                         |                            |             |                |                |        |   |                         |                           |            |                |                |        |   |  |               |                |                |                |        |   |  |             |     |                |                |        |   |  |            |     |                |                |        |   |  |                |     |                |                |        |   |  |  |     |                | 11.0101-5407.2 | 260011 | 2 |  |  |     | ATE            |                |        |   |  |  |     |                |                |        |   |  |  |     |                |                |        |   |  |                         |                |                |                |        |   |  |                         |                |                |
|                                   | 2.0 T Aero            | 154      | 41022028 | 51046733 |                |                |        |   |  |  |                |                |                |        |   |  |  |                |                |                |        |   |                         |                            |             |                |                |        |   |                         |                           |            |                |                |        |   |  |               |                |                |                |        |   |  |             |     |                |                |        |   |  |            |     |                |                |        |   |  |                |     |                |                |        |   |  |  |     |                |                |        |   |  |  |     |                | 11.8171-0008.1 | 990049 | 2 |  |  |     | ATE            |                |        |   |  |  |     |                |                |        |   |  |                         |                |                |                |        |   |  |                         |                |                |
|                                   | 2.0 Turbo Performance | 154      |          | 51046733 | 04.04          |                |        |   |  |  |                |                |                |        |   |  |  |                |                |                |        |   |                         |                            |             |                |                |        |   |                         |                           |            |                |                |        |   |  |               |                |                |                |        |   |  |             |     |                |                |        |   |  |            |     |                |                |        |   |  |                |     |                |                |        |   |  |  |     |                |                |        |   |  |  |     |                |                |        |   |  |  |     |                | 11.8116-0325.2 | 390461 | 2 |  |  |     | ATE            |                |        |   |  |                         |                |                |                |        |   |  |                         |                |                |
|                                   | 1.8 i                 | 90       | 51046734 |          | 12.05          |                |        |   |  |  |                |                |                |        |   |  |  |                |                |                |        |   |                         |                            |             |                |                |        |   |                         |                           |            |                |                |        |   |  |               |                |                |                |        |   |  |             |     |                |                |        |   |  |            |     |                |                |        |   |  |                |     |                |                |        |   |  |  |     |                |                |        |   |  |  |     |                |                |        |   |  |  |     |                |                |        |   |  |  |     |                | 11.9571-9779.2 | 220657 | 2 |  | + 16" Rad <sup>5)</sup> | D=57, - Halter | ATE            |                |        |   |  |                         |                |                |
|                                   | 1.8 t                 | 110      | 51046734 |          | 12.05          |                |        |   |  |  |                |                |                |        |   |  |  |                |                |                |        |   |                         |                            |             |                |                |        |   |                         |                           |            |                |                |        |   |  |               |                |                |                |        |   |  |             |     |                |                |        |   |  |            |     |                |                |        |   |  |                |     |                |                |        |   |  |  |     |                |                |        |   |  |  |     |                |                |        |   |  |  |     |                |                |        |   |  |  |     |                |                |        |   |  |                         |                |                | 11.9571-9780.2 | 220658 | 2 |  | + 16" Rad <sup>5)</sup> | D=57, - Halter | ATE            |
|                                   | 1.9 TiD               | 88       | 51046734 |          | 12.05          |                |        |   |  |  |                |                |                |        |   |  |  |                |                |                |        |   |                         |                            |             |                |                |        |   |                         |                           |            |                |                |        |   |  |               |                |                |                |        |   |  |             |     |                |                |        |   |  |            |     |                |                |        |   |  |                |     |                |                |        |   |  |  |     |                |                |        |   |  |  |     |                |                |        |   |  |  |     |                |                |        |   |  |  |     |                |                |        |   |  |                         |                |                |                |        |   |  |                         |                |                |
| 1.9 TiD                           | 110                   | 51046734 |          | 12.05    | 11.8116-0356.1 | 390586         | 2      |   |  | Halterfeder                                  | ATE            |                |                |        |   |  |  |                |                |                |        |   |                         |                            |             |                |                |        |   |                         |                           |            |                |                |        |   |  |               |                |                |                |        |   |  |             |     |                |                |        |   |  |            |     |                |                |        |   |  |                |     |                |                |        |   |  |  |     |                |                |        |   |  |  |     |                |                |        |   |  |  |     |                |                |        |   |  |  |     |                |                |        |   |  |                         |                |                |                |        |   |  |                         |                |                |
| 2.0 t                             | 110                   | 51046734 |          | 12.05    |                |                |        |   |  |  |                | 11.8171-0008.1 | 990049         | 2      |   |  | Führungsbolzen                               | ATE            |                |                |        |   |                         |                            |             |                |                |        |   |                         |                           |            |                |                |        |   |  |               |                |                |                |        |   |  |             |     |                |                |        |   |  |            |     |                |                |        |   |  |                |     |                |                |        |   |  |  |     |                |                |        |   |  |  |     |                |                |        |   |  |  |     |                |                |        |   |  |  |     |                |                |        |   |  |                         |                |                |                |        |   |  |                         |                |                |
| 2.0 T Aero                        | 154                   | 51046734 |          | 12.05    |                |                |        |   |  |  |                |                |                |        |   |  |  |                | 11.9606-9971.2 | 220589         | 2      |   | + 16" Rad <sup>5)</sup> | D=60, - Halter             | ATE         |                |                |        |   |                         |                           |            |                |                |        |   |  |               |                |                |                |        |   |  |             |     |                |                |        |   |  |            |     |                |                |        |   |  |                |     |                |                |        |   |  |  |     |                |                |        |   |  |  |     |                |                |        |   |  |  |     |                |                |        |   |  |  |     |                |                |        |   |  |                         |                |                |                |        |   |  |                         |                |                |
| 2.2 TiD                           | 92                    | 51046734 |          | 12.05    |                |                |        |   |  |  |                |                |                |        |   |  |  |                |                |                |        |   |                         |                            |             | 11.9606-9972.2 | 220590         | 2      |   | + 16" Rad <sup>5)</sup> | D=60, - Halter            | ATE        |                |                |        |   |  |               |                |                |                |        |   |  |             |     |                |                |        |   |  |            |     |                |                |        |   |  |                |     |                |                |        |   |  |  |     |                |                |        |   |  |  |     |                |                |        |   |  |  |     |                |                |        |   |  |  |     |                |                |        |   |  |                         |                |                |                |        |   |  |                         |                |                |
| 2.8 T Aero                        | 184                   |          | 03.05    | 12.05    |                |                |        |   |  |  |                |                |                |        |   |  |  |                |                |                |        |   |                         |                            |             |                |                |        |   |                         |                           |            | 11.0441-6008.2 | 250038         | 2      |   |  | Dichtungssatz | ATE            |                |                |        |   |  |             |     |                |                |        |   |  |            |     |                |                |        |   |  |                |     |                |                |        |   |  |  |     |                |                |        |   |  |  |     |                |                |        |   |  |  |     |                |                |        |   |  |  |     |                |                |        |   |  |                         |                |                |                |        |   |  |                         |                |                |
| 1.8 i Vector                      | 90                    |          | 01.06    | 06.12    |                |                |        |   |  |  |                |                |                |        |   |  |  |                |                |                |        |   |                         |                            |             |                |                |        |   |                         |                           |            |                |                |        |   |  |               |                | 11.8116-0345.2 | 390596         | 2      |   |  | Halterfeder | ATE |                |                |        |   |  |            |     |                |                |        |   |  |                |     |                |                |        |   |  |  |     |                |                |        |   |  |  |     |                |                |        |   |  |  |     |                |                |        |   |  |  |     |                |                |        |   |  |                         |                |                |                |        |   |  |                         |                |                |
| 1.8 t                             | 110                   |          | 01.06    | 06.12    |                |                |        |   |  |  |                |                |                |        |   |  |  |                |                |                |        |   |                         |                            |             |                |                |        |   |                         |                           |            |                |                |        |   |  |               |                |                |                |        |   |  |             |     | 11.0101-5407.2 | 260011         | 2      |   |  | Hülsensatz | ATE |                |                |        |   |  |                |     |                |                |        |   |  |  |     |                |                |        |   |  |  |     |                |                |        |   |  |  |     |                |                |        |   |  |  |     |                |                |        |   |  |                         |                |                |                |        |   |  |                         |                |                |
| 1.8 t BioPower                    | 110                   |          | 01.07    | 06.12    |                |                |        |   |  |  |                |                |                |        |   |  |  |                |                |                |        |   |                         |                            |             |                |                |        |   |                         |                           |            |                |                |        |   |  |               |                |                |                |        |   |  |             |     |                |                |        |   |  |            |     | 11.8171-0008.1 | 990049         | 2      |   |  | Führungsbolzen | ATE |                |                |        |   |  |  |     |                |                |        |   |  |  |     |                |                |        |   |  |  |     |                |                |        |   |  |  |     |                |                |        |   |  |                         |                |                |                |        |   |  |                         |                |                |
| 1.8 t Vector                      | 110                   |          | 09.02    | 06.12    |                |                |        |   |  |  |                |                |                |        |   |  |  |                |                |                |        |   |                         |                            |             |                |                |        |   |                         |                           |            |                |                |        |   |  |               |                |                |                |        |   |  |             |     |                |                |        |   |  |            |     |                |                |        |   |  |                |     | 11.8171-0008.1 | 990049         | 2      |   |  |  | ATE |                |                |        |   |  |  |     |                |                |        |   |  |  |     |                |                |        |   |  |  |     |                |                |        |   |  |                         |                |                |                |        |   |  |                         |                |                |
| 1.9 TiD                           | 88                    |          | 01.06    | 06.12    |                |                |        |   |  |  |                |                |                |        |   |  |  |                |                |                |        |   |                         |                            |             |                |                |        |   |                         |                           |            |                |                |        |   |  |               |                |                |                |        |   |  |             |     |                |                |        |   |  |            |     |                |                |        |   |  |                |     |                |                |        |   |  |  |     | 11.8171-0008.1 | 990049         | 2      |   |  |  | ATE |                |                |        |   |  |  |     |                |                |        |   |  |  |     |                |                |        |   |  |                         |                |                |                |        |   |  |                         |                |                |
| 1.9 TiD                           | 110                   |          | 01.06    | 06.12    |                |                |        |   |  |  |                |                |                |        |   |  |  |                |                |                |        |   |                         |                            |             |                |                |        |   |                         |                           |            |                |                |        |   |  |               |                |                |                |        |   |  |             |     |                |                |        |   |  |            |     |                |                |        |   |  |                |     |                |                |        |   |  |  |     |                |                |        |   |  |  |     | 11.8171-0008.1 | 990049         | 2      |   |  |  | ATE |                |                |        |   |  |  |     |                |                |        |   |  |                         |                |                |                |        |   |  |                         |                |                |
| 1.9 TiD Vector                    | 88                    |          | 07.04    | 06.12    |                |                |        |   |  |  |                |                |                |        |   |  |  |                |                |                |        |   |                         |                            |             |                |                |        |   |                         |                           |            |                |                |        |   |  |               |                |                |                |        |   |  |             |     |                |                |        |   |  |            |     |                |                |        |   |  |                |     |                |                |        |   |  |  |     |                |                |        |   |  |  |     |                |                |        |   |  |  |     | 11.8171-0008.1 | 990049         | 2      |   |  |  | ATE |                |                |        |   |  |                         |                |                |                |        |   |  |                         |                |                |
| 1.9 TiD Vector                    | 110                   |          | 07.04    | 06.12    |                |                |        |   |  |  |                |                |                |        |   |  |  |                |                |                |        |   |                         |                            |             |                |                |        |   |                         |                           |            |                |                |        |   |  |               |                |                |                |        |   |  |             |     |                |                |        |   |  |            |     |                |                |        |   |  |                |     |                |                |        |   |  |  |     |                |                |        |   |  |  |     |                |                |        |   |  |  |     |                |                |        |   |  |  |     | 11.8171-0008.1 | 990049         | 2      |   |  |                         | ATE            |                |                |        |   |  |                         |                |                |
| 1.9 TTiD                          | 110                   |          | 07.07    | 06.12    |                |                |        |   |  |  |                |                |                |        |   |  |  |                |                |                |        |   |                         |                            |             |                |                |        |   |                         |                           |            |                |                |        |   |  |               |                |                |                |        |   |  |             |     |                |                |        |   |  |            |     |                |                |        |   |  |                |     |                |                |        |   |  |  |     |                |                |        |   |  |  |     |                |                |        |   |  |  |     |                |                |        |   |  |  |     |                |                |        |   |  |                         |                | 11.8171-0008.1 | 990049         | 2      |   |  |                         | ATE            |                |
| 1.9 TTiD                          | 110                   |          | 07.07    | 06.12    |                |                |        |   |  |  |                |                |                |        |   |  |  |                |                |                |        |   |                         |                            |             |                |                |        |   |                         |                           |            |                |                |        |   |  |               |                |                |                |        |   |  |             |     |                |                |        |   |  |            |     |                |                |        |   |  |                |     |                |                |        |   |  |  |     |                |                |        |   |  |  |     |                |                |        |   |  |  |     |                |                |        |   |  |  |     |                |                |        |   |  |                         |                |                |                |        |   |  |                         |                | 11.8171-0008.1 |
| 2.0 t                             | 110                   |          | 01.06    | 06.12    | 11.8171-0008.1 | 990049         | 2      |   |  |  | ATE            |                |                |        |   |  |  |                |                |                |        |   |                         |                            |             |                |                |        |   |                         |                           |            |                |                |        |   |  |               |                |                |                |        |   |  |             |     |                |                |        |   |  |            |     |                |                |        |   |  |                |     |                |                |        |   |  |  |     |                |                |        |   |  |  |     |                |                |        |   |  |  |     |                |                |        |   |  |  |     |                |                |        |   |  |                         |                |                |                |        |   |  |                         |                |                |
| 2.0 T Aero                        | 154                   | 41039807 | 09.02    | 06.12    |                |                |        |   |  |  |                | 11.8171-0008.1 | 990049         | 2      |   |  |  | ATE            |                |                |        |   |                         |                            |             |                |                |        |   |                         |                           |            |                |                |        |   |  |               |                |                |                |        |   |  |             |     |                |                |        |   |  |            |     |                |                |        |   |  |                |     |                |                |        |   |  |  |     |                |                |        |   |  |  |     |                |                |        |   |  |  |     |                |                |        |   |  |  |     |                |                |        |   |  |                         |                |                |                |        |   |  |                         |                |                |
| 2.0 T Aero                        | 154                   |          | 01.06    | 06.12    |                |                |        |   |  |  |                |                |                |        |   |  |  |                | 11.8171-0008.1 | 990049         | 2      |   |                         |                            | ATE         |                |                |        |   |                         |                           |            |                |                |        |   |  |               |                |                |                |        |   |  |             |     |                |                |        |   |  |            |     |                |                |        |   |  |                |     |                |                |        |   |  |  |     |                |                |        |   |  |  |     |                |                |        |   |  |  |     |                |                |        |   |  |  |     |                |                |        |   |  |                         |                |                |                |        |   |  |                         |                |                |
| 2.0 t BioPower                    | 110                   |          | 01.07    | 06.12    |                |                |        |   |  |  |                |                |                |        |   |  |  |                |                |                |        |   |                         |                            |             | 11.8171-0008.1 | 990049         | 2      |   |                         |                           | ATE        |                |                |        |   |  |               |                |                |                |        |   |  |             |     |                |                |        |   |  |            |     |                |                |        |   |  |                |     |                |                |        |   |  |  |     |                |                |        |   |  |  |     |                |                |        |   |  |  |     |                |                |        |   |  |  |     |                |                |        |   |  |                         |                |                |                |        |   |  |                         |                |                |
| 2.0 t BioPower                    | 145                   |          | 06.07    | 06.12    |                |                |        |   |  |  |                |                |                |        |   |  |  |                |                |                |        |   |                         |                            |             |                |                |        |   |                         |                           |            | 11.8171-0008.1 | 990049         | 2      |   |  |               | ATE            |                |                |        |   |  |             |     |                |                |        |   |  |            |     |                |                |        |   |  |                |     |                |                |        |   |  |  |     |                |                |        |   |  |  |     |                |                |        |   |  |  |     |                |                |        |   |  |  |     |                |                |        |   |  |                         |                |                |                |        |   |  |                         |                |                |
| 2.0 t BioPower XWD                | 110                   |          | 09.02    | 06.12    |                |                |        |   |  |  |                |                |                |        |   |  |  |                |                |                |        |   |                         |                            |             |                |                |        |   |                         |                           |            |                |                |        |   |  |               |                | 11.8171-0008.1 | 990049         | 2      |   |  |             | ATE |                |                |        |   |  |            |     |                |                |        |   |  |                |     |                |                |        |   |  |  |     |                |                |        |   |  |  |     |                |                |        |   |  |  |     |                |                |        |   |  |  |     |                |                |        |   |  |                         |                |                |                |        |   |  |                         |                |                |
| 2.0 t Vector                      | 129                   |          | 09.02    | 06.12    |                |                |        |   |  |  |                |                |                |        |   |  |  |                |                |                |        |   |                         |                            |             |                |                |        |   |                         |                           |            |                |                |        |   |  |               |                |                |                |        |   |  |             |     | 11.8171-0008.1 | 990049         | 2      |   |  |            | ATE |                |                |        |   |  |                |     |                |                |        |   |  |  |     |                |                |        |   |  |  |     |                |                |        |   |  |  |     |                |                |        |   |  |  |     |                |                |        |   |  |                         |                |                |                |        |   |  |                         |                |                |
| 2.0 t XWD                         | 110                   |          | 01.07    | 06.12    |                |                |        |   |  |  |                |                |                |        |   |  |  |                |                |                |        |   |                         |                            |             |                |                |        |   |                         |                           |            |                |                |        |   |  |               |                |                |                |        |   |  |             |     |                |                |        |   |  |            |     | 11.8171-0008.1 | 990049         | 2      |   |  |                | ATE |                |                |        |   |  |  |     |                |                |        |   |  |  |     |                |                |        |   |  |  |     |                |                |        |   |  |  |     |                |                |        |   |  |                         |                |                |                |        |   |  |                         |                |                |
| 2.0 Turbo Performance             | 110                   |          | 04.04    | 06.12    |                |                |        |   |  |  |                |                |                |        |   |  |  |                |                |                |        |   |                         |                            |             |                |                |        |   |                         |                           |            |                |                |        |   |  |               |                |                |                |        |   |  |             |     |                |                |        |   |  |            |     |                |                |        |   |  |                |     | 11.8171-0008.1 | 990049         | 2      |   |  |  | ATE |                |                |        |   |  |  |     |                |                |        |   |  |  |     |                |                |        |   |  |  |     |                |                |        |   |  |                         |                |                |                |        |   |  |                         |                |                |
| 2.2 TiD                           | 92                    |          | 01.06    | 06.12    |                |                |        |   |  |  |                |                |                |        |   |  |  |                |                |                |        |   |                         |                            |             |                |                |        |   |                         |                           |            |                |                |        |   |  |               |                |                |                |        |   |  |             |     |                |                |        |   |  |            |     |                |                |        |   |  |                |     |                |                |        |   |  |  |     | 11.8171-0008.1 | 990049         | 2      |   |  |  | ATE |                |                |        |   |  |  |     |                |                |        |   |  |  |     |                |                |        |   |  |                         |                |                |                |        |   |  |                         |                |                |
| 2.2 TiD Vector                    | 92                    |          | 09.02    | 06.12    |                |                |        |   |  |  |                |                |                |        |   |  |  |                |                |                |        |   |                         |                            |             |                |                |        |   |                         |                           |            |                |                |        |   |  |               |                |                |                |        |   |  |             |     |                |                |        |   |  |            |     |                |                |        |   |  |                |     |                |                |        |   |  |  |     |                |                |        |   |  |  |     | 11.8171-0008.1 | 990049         | 2      |   |  |  | ATE |                |                |        |   |  |  |     |                |                |        |   |  |                         |                |                |                |        |   |  |                         |                |                |
| 2.8 T Aero                        | 184                   |          | 01.06    | 06.12    |                |                |        |   |  |  |                |                |                |        |   |  |  |                |                |                |        |   |                         |                            |             |                |                |        |   |                         |                           |            |                |                |        |   |  |               |                |                |                |        |   |  |             |     |                |                |        |   |  |            |     |                |                |        |   |  |                |     |                |                |        |   |  |  |     |                |                |        |   |  |  |     |                |                |        |   |  |  |     | 11.8171-0008.1 | 990049         | 2      |   |  |  | ATE |                |                |        |   |  |                         |                |                |                |        |   |  |                         |                |                |
| 2.8 T Aero                        | 188                   |          | 07.07    | 06.12    |                |                |        |   |  |  |                |                |                |        |   |  |  |                |                |                |        |   |                         |                            |             |                |                |        |   |                         |                           |            |                |                |        |   |  |               |                |                |                |        |   |  |             |     |                |                |        |   |  |            |     |                |                |        |   |  |                |     |                |                |        |   |  |  |     |                |                |        |   |  |  |     |                |                |        |   |  |  |     |                |                |        |   |  |  |     | 11.8171-0008.1 | 990049         | 2      |   |  |                         | ATE            |                |                |        |   |  |                         |                |                |
| 2.8 T Aero                        | 206                   |          | 07.07    | 06.12    |                |                |        |   |  |  |                |                |                |        |   |  |  |                |                |                |        |   |                         |                            |             |                |                |        |   |                         |                           |            |                |                |        |   |  |               |                |                |                |        |   |  |             |     |                |                |        |   |  |            |     |                |                |        |   |  |                |     |                |                |        |   |  |  |     |                |                |        |   |  |  |     |                |                |        |   |  |  |     |                |                |        |   |  |  |     |                |                |        |   |  |                         |                | 11.8171-0008.1 | 990049         | 2      |   |  |                         | ATE            |                |
| 2.8 T Aero V6 XWD                 | 206                   |          | 04.08    | 06.12    |                |                |        |   |  |  |                |                |                |        |   |  |  |                |                |                |        |   |                         |                            |             |                |                |        |   |                         |                           |            |                |                |        |   |  |               |                |                |                |        |   |  |             |     |                |                |        |   |  |            |     |                |                |        |   |  |                |     |                |                |        |   |  |  |     |                |                |        |   |  |  |     |                |                |        |   |  |  |     |                |                |        |   |  |  |     |                |                |        |   |  |                         |                |                |                |        |   |  |                         |                | 11.8171-0008.1 |
| 2.8 Turbo V6                      | 206                   |          | 04.08    | 06.12    | 11.8171-0008.1 | 990049         | 2      |   |  |  | ATE            |                |                |        |   |  |  |                |                |                |        |   |                         |                            |             |                |                |        |   |                         |                           |            |                |                |        |   |  |               |                |                |                |        |   |  |             |     |                |                |        |   |  |            |     |                |                |        |   |  |                |     |                |                |        |   |  |  |     |                |                |        |   |  |  |     |                |                |        |   |  |  |     |                |                |        |   |  |  |     |                |                |        |   |  |                         |                |                |                |        |   |  |                         |                |                |

1) + 15" wheel / + ruota 15" / + roue 15" / + rueda 15"  
 2) GG/ replace only in pairs / GG/ sostituire solo a coppie / GG/ ne remplacer que par paires / GG/ reemplazar sólo por pares  
 3) + aluminium calipers / + pinze in alluminio / + étriers en aluminium / + pinzas de aluminio  
 4) + cast iron caliper / + pinza in ghisa / + étriers en fonte grise / + fundición gris-pinza  
 5) + 16" wheel / + ruota 16" / + roue 16" / + rueda 16"



| SAAB 9-3 Limousine (YS3F) (03-12) |                       |          |          |       |       |                |                |        |                              |  |  |     |                              |  |     |     |
|-----------------------------------|-----------------------|----------|----------|-------|-------|----------------|----------------|--------|------------------------------|--|--|-----|------------------------------|--|-----|-----|
|                                   | 1.8 i                 | 90       |          | 03.04 | 06.12 |                | 11.8116-0410.2 | 390589 | 2                            | Haltefeder<br>Hülsensatz<br>Führungsbolzen                                     | ATE  |     |                              |  |     |     |
|                                   | 1.8 t                 | 110      |          | 09.02 | 06.12 |                | 11.0101-5407.2 | 260011 |                              |  | ATE  |     |                              |  |     |     |
|                                   | 1.8 t BioPower        | 110      |          | 01.07 | 06.12 |                | 11.8171-0008.1 | 990049 |                              |  | ATE  |     |                              |  |     |     |
|                                   | 1.9 TiD               | 88       |          | 07.04 | 06.12 |                |                |        |                              |  |  |     |                              |  |     |     |
|                                   | 1.9 TiD               | 110      |          | 07.04 | 06.12 |                |                |        |                              |  |  |     |                              |  |     |     |
|                                   | 1.9 TTiD              |          |          | 07.07 | 06.12 |                |                |        |                              |  |  |     |                              |  |     |     |
|                                   | 2.0 t                 |          |          | 09.02 | 06.12 |                |                |        |                              |  |  |     |                              |  |     |     |
|                                   | 2.0 t BioPower        |          |          | 01.07 | 06.12 |                |                |        |                              |  |  |     |                              |  |     |     |
|                                   | 2.0 t BioPower        | 145      |          | 06.07 | 06.12 |                |                |        |                              |  |  |     |                              |  |     |     |
|                                   | 2.0 t BioPower XWD    |          |          | 09.02 | 06.12 |                |                |        |                              |  |  |     |                              |  |     |     |
|                                   | 2.0 t XWD             |          |          | 01.07 | 06.12 |                |                |        |                              |  |  |     |                              |  |     |     |
|                                   | 2.0 Turbo Performance |          |          | 04.04 | 06.12 |                |                |        |                              |  |  |     |                              |  |     |     |
|                                   | 2.2 TiD               | 92       |          | 09.02 | 06.12 |                |                |        |                              |  |  |     |                              |  |     |     |
|                                   | 2.8 T Aero            | 184      |          | 03.05 | 06.12 |                |                |        |                              |  |  |     |                              |  |     |     |
|                                   | 2.8 T Aero            | 188      |          | 07.07 | 06.12 |                |                |        |                              |  |  |     |                              |  |     |     |
| 2.8 T Aero                        | 206                   |          | 07.07    | 06.12 |       |                |                |        |                              |  |  |     |                              |  |     |     |
| 2.8 T Aero V6 XWD                 | 206                   |          | 05.08    | 06.12 |       |                |                |        |                              |  |  |     |                              |  |     |     |
| 2.8 Turbo V6                      |                       |          | 04.08    | 06.12 |       |                |                |        |                              |  |  |     |                              |  |     |     |
|                                   | 1.8 i                 | 90       |          | 03.04 | 06.12 |                | 83.7807-0412.3 | 331098 | 2                            | L=412  |  |     |                              |  |     |     |
|                                   | 1.8 t                 | 110      |          | 09.02 | 06.12 |                |                |        |                              |  |  |     |                              |  |     |     |
|                                   | 1.8 t BioPower        | 110      |          | 01.07 | 06.12 |                |                |        |                              |  |  |     |                              |  |     |     |
|                                   | 1.9 TiD               | 88       |          | 07.04 | 06.12 |                |                |        |                              |  |  |     |                              |  |     |     |
|                                   | 1.9 TiD               | 110      |          | 07.04 | 06.12 |                |                |        |                              |  |  |     |                              |  |     |     |
|                                   | 1.9 TTiD              |          |          | 07.07 | 06.12 |                |                |        |                              |  |  |     |                              |  |     |     |
|                                   | 2.0 t                 |          |          | 09.02 | 06.12 |                |                |        |                              |  |  |     |                              |  |     |     |
|                                   | 2.0 T Aero            | 154      |          | 09.02 | 06.12 |                |                |        |                              |  |  |     |                              |  |     |     |
|                                   | 2.0 t BioPower        |          |          | 01.07 | 06.12 |                |                |        |                              |  |  |     |                              |  |     |     |
|                                   | 2.0 t BioPower        | 145      |          | 06.07 | 06.12 |                |                |        |                              |  |  |     |                              |  |     |     |
|                                   | 2.0 t BioPower XWD    |          |          | 09.02 | 06.12 |                |                |        |                              |  |  |     |                              |  |     |     |
|                                   | 2.0 t XWD             |          |          | 01.07 | 06.12 |                |                |        |                              |  |  |     |                              |  |     |     |
|                                   | 2.0 Turbo Performance |          |          | 04.04 | 06.12 |                |                |        |                              |  |  |     |                              |  |     |     |
|                                   | 2.2 TiD               | 92       |          | 09.02 | 06.12 |                |                |        |                              |  |  |     |                              |  |     |     |
|                                   | 2.8 T Aero            | 184      |          | 03.05 | 06.12 |                |                |        |                              |  |  |     |                              |  |     |     |
| 2.8 T Aero                        | 188                   |          | 07.07    | 06.12 |       |                |                |        |                              |  |  |     |                              |  |     |     |
| 2.8 T Aero                        | 206                   |          | 07.07    | 06.12 |       |                |                |        |                              |  |  |     |                              |  |     |     |
| 2.8 T Aero V6 XWD                 | 206                   |          | 04.08    | 06.12 |       |                |                |        |                              |  |  |     |                              |  |     |     |
| 2.8 Turbo V6                      |                       |          | 04.08    | 06.12 |       |                |                |        |                              |  |  |     |                              |  |     |     |
|                                   | 1.8 i                 | 90       |          | 03.04 | 06.12 |                | 11.9387-7003.2 | 220567 | 2                            | + 15" Rad 1)   | D=38, - Halter<br>D=38, - Halter<br>Hülsensatz<br>Führungsbolzen<br>Haltefeder | ATE |                              |  |     |     |
|                                   | 1.8 t                 | 110      |          | 09.02 | 06.12 |                | 11.9387-7004.2 | 220568 |                              |  |  |     | ATE                          |  |     |     |
|                                   | 1.8 t BioPower        | 110      |          | 01.07 | 06.12 |                | 11.0101-5407.2 | 260011 |                              |  |  |     | ATE                          |  |     |     |
|                                   | 1.9 TiD               | 88       |          | 07.04 | 06.12 |                | 11.8171-0008.1 | 990049 |                              |  |  |     | ATE                          |  |     |     |
|                                   | 1.9 TiD               | 110      |          | 07.04 | 06.12 |                | 11.8116-0340.1 | 390595 |                              |  |  |     | ATE                          |  |     |     |
|                                   | 1.9 TTiD              |          |          | 07.07 | 06.12 |                |                |        |                              |  |  |     |                              |  |     |     |
|                                   | 2.0 t                 |          |          | 09.02 | 06.12 |                |                |        |                              |  |  |     |                              |  |     |     |
|                                   | 2.0 T Aero            | 154      |          | 09.02 | 06.12 |                |                |        |                              |  |  |     |                              |  |     |     |
|                                   | 2.0 t BioPower        |          |          | 01.07 | 06.12 |                |                |        |                              |  |  |     |                              |  |     |     |
|                                   | 2.0 t BioPower        | 145      |          | 06.07 | 06.12 |                |                |        |                              |  |  |     |                              |  |     |     |
|                                   | 2.0 Turbo Performance |          |          | 04.04 | 06.12 |                |                |        |                              |  |  |     |                              |  |     |     |
|                                   | 2.2 TiD               | 92       |          | 09.02 | 06.12 |                |                |        |                              |  |  |     |                              |  |     |     |
|                                   | 1.8 t                 | 110      | 51049406 | 09.02 |       |                | 11.9407-7003.2 | 220835 |                              |  |  | 2   | + 16" Rad 2)<br>+ 16" Rad 2) | D=40, - Halter<br>D=40, - Halter<br>Hülsensatz<br>Führungsbolzen<br>Haltefeder | ATE |     |
|                                   | 1.8 t BioPower        | 110      | 51049406 | 01.07 |       |                | 11.9407-7004.2 | 220836 |                              |  |  |     |                              |  |     | ATE |
|                                   | 2.0 t                 |          | 51049406 | 09.02 |       |                | 11.0101-5407.2 | 260011 |                              |  |  |     |                              |  |     | ATE |
| 2.0 T Aero                        | 154                   | 51049406 | 09.02    |       |       | 11.8171-0008.1 | 990049         |        | ATE                          |  |  |     |                              |  |     |     |
| 2.0 t BioPower                    |                       | 51049406 | 01.07    |       |       | 11.8116-0340.1 | 390595         |        | ATE                          |  |  |     |                              |  |     |     |
| 2.0 t BioPower                    | 145                   | 51049406 | 06.07    |       |       |                |                |        |                              |  |  |     |                              |  |     |     |
| 2.0 t BioPower XWD                |                       | 51049406 | 09.02    |       |       |                |                |        |                              |  |  |     |                              |  |     |     |
| 2.0 t Vector                      | 129                   | 51049406 | 09.03    |       |       |                |                |        |                              |  |  |     |                              |  |     |     |
| 2.0 t XWD                         |                       | 51049406 | 01.07    |       |       |                |                |        |                              |  |  |     |                              |  |     |     |
| 2.0 Turbo Performance             |                       | 51049406 | 04.04    |       |       |                |                |        |                              |  |  |     |                              |  |     |     |
| 2.2 TiD                           | 92                    | 51049406 | 09.02    |       |       |                |                |        |                              |  |  |     |                              |  |     |     |
| 1.8 t                             | 110                   | 51049407 |          | 06.12 |       | 11.9387-7005.2 | 220569         | 2      | + 16" Rad 2)<br>+ 16" Rad 2) | D=38, - Halter<br>D=38, - Halter<br>Hülsensatz<br>Führungsbolzen<br>Haltefeder | ATE  |     |                              |  |     |     |
| 1.8 t BioPower                    | 110                   | 51049407 |          | 06.12 |       | 11.9387-7006.2 | 220570         |        |                              |  |  |     |                              |  | ATE |     |
| 2.0 t                             |                       | 51049407 |          | 06.12 |       | 11.0101-5407.2 | 260011         |        |                              |  |  |     |                              |  | ATE |     |
| 2.0 T Aero                        | 154                   | 51049407 |          | 06.12 |       | 11.8171-0008.1 | 990049         |        |                              |  |  |     |                              |  | ATE |     |
| 2.0 t BioPower                    |                       | 51049407 |          | 06.12 |       | 11.8116-0340.1 | 390595         |        |                              |  |  | ATE |                              |  |     |     |
| 2.0 t BioPower                    | 145                   | 51049407 |          | 06.12 |       |                |                |        |                              |  |  |     |                              |  |     |     |
| 2.0 t BioPower XWD                |                       | 51049407 |          | 06.12 |       |                |                |        |                              |  |  |     |                              |  |     |     |
| 2.0 t Vector                      | 129                   | 51049407 |          | 06.12 |       |                |                |        |                              |  |  |     |                              |  |     |     |
| 2.0 t XWD                         |                       | 51049407 |          | 06.12 |       |                |                |        |                              |  |  |     |                              |  |     |     |
| 2.0 Turbo Performance             |                       | 51049407 |          | 06.12 |       |                |                |        |                              |  |  |     |                              |  |     |     |
| 2.2 TiD                           | 92                    | 51049407 |          | 06.12 |       |                |                |        |                              |  |  |     |                              |  |     |     |
| 2.8 T Aero                        | 184                   |          | 03.05    | 06.12 |       |                |                |        |                              |  |  |     |                              |  |     |     |
| 2.8 T Aero                        | 188                   |          | 07.07    | 06.12 |       |                |                |        |                              |  |  |     |                              |  |     |     |
| 2.8 T Aero                        | 206                   |          | 07.07    | 06.12 |       |                |                |        |                              |  |  |     |                              |  |     |     |
| 2.8 T Aero V6 XWD                 | 206                   |          | 04.08    | 06.12 |       |                |                |        |                              |  |  |     |                              |  |     |     |
| 2.8 Turbo V6                      |                       |          | 04.08    | 06.12 |       |                |                |        |                              |  |  |     |                              |  |     |     |
|                                   | 1.8 i                 | 90       |          | 03.04 | 06.12 |                | 24.5259-0315.3 | 330882 | 2                            | L=315  |  |     |                              |  |     |     |
|                                   | 1.8 t                 | 110      |          | 09.02 | 06.12 |                |                |        |                              |  |  |     |                              |  |     |     |
|                                   | 1.8 t BioPower        | 110      |          | 01.07 | 06.12 |                |                |        |                              |  |  |     |                              |  |     |     |
|                                   | 1.9 TiD               | 88       |          | 07.04 | 06.12 |                |                |        |                              |  |  |     |                              |  |     |     |
|                                   | 1.9 TiD               | 110      |          | 07.04 | 06.12 |                |                |        |                              |  |  |     |                              |  |     |     |
|                                   | 1.9 TTiD              |          |          | 07.07 | 06.12 |                |                |        |                              |  |  |     |                              |  |     |     |
|                                   | 2.0 t                 |          |          | 09.02 | 06.12 |                |                |        |                              |  |  |     |                              |  |     |     |
|                                   | 2.0 T Aero            | 154      |          | 09.02 | 06.12 |                |                |        |                              |  |  |     |                              |  |     |     |
|                                   | 2.0 t BioPower        |          |          | 01.07 | 06.12 |                |                |        |                              |  |  |     |                              |  |     |     |
|                                   | 2.0 t BioPower XWD    | 145      |          | 06.07 | 06.12 |                |                |        |                              |  |  |     |                              |  |     |     |

1) + 15" wheel / + ruota 15" / + roue 15" / + rueda 15"

2) + 16" wheel / + ruota 16" / + roue 16" / + rueda 16"

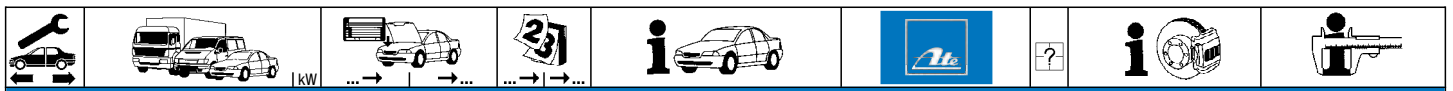

**SAAB 9-3 Limousine (YS3F) (03-12)**

|  |                       |     |       |       |                |        |   |  |       |
|--|-----------------------|-----|-------|-------|----------------|--------|---|--|-------|
|  | 2.0 t XWD             |     | 01.07 | 06.12 | 24.5259-0315.3 | 330882 | 2 |  | L=315 |
|  | 2.0 Turbo Performance |     | 04.04 | 06.12 |                |        |   |  |       |
|  | 2.2 TiD               | 92  | 09.02 | 06.12 |                |        |   |  |       |
|  | 2.8 T Aero            | 184 | 03.05 | 06.12 |                |        |   |  |       |
|  | 2.8 T Aero            | 188 | 07.07 | 06.12 |                |        |   |  |       |
|  | 2.8 T Aero            | 206 | 07.07 | 06.12 |                |        |   |  |       |
|  | 2.8 T Aero V6 XWD     | 206 | 04.08 | 06.12 |                |        |   |  |       |
|  | 2.8 Turbo V6          |     | 04.08 | 06.12 |                |        |   |  |       |

**SAAB 9-3 SportCombi (05-12)**

|  |                    |     |       |                               |                |        |   |  |   |                                 |
|--|--------------------|-----|-------|-------------------------------|----------------|--------|---|--|---|---------------------------------|
|  | 1.8 i              | 90  | 03.05 | 06.12                         | 24.2125-1732.3 | 010827 |   |  | Thz 25,40   | LUC                             |
|  | 1.8 t              | 110 | 03.05 | 06.12                         |                |        |   |  |   |                                 |
|  | 1.8 t BioPower     | 110 | 01.07 | 06.12                         |                |        |   |  |   |                                 |
|  | 1.8 t BioPower     | 129 | 07.07 | 06.12                         |                |        |   |  |   |                                 |
|  | 1.9 TiD            | 88  | 03.05 | 06.12                         |                |        |   |  |   |                                 |
|  | 1.9 TiD            | 110 | 03.05 | 06.12                         |                |        |   |  |   |                                 |
|  | 1.9 TTiD           |     | 07.07 | 06.12                         |                |        |   |  |   |                                 |
|  | 2.0                | 143 | 04.06 | 09.07                         |                |        |   |  |   |                                 |
|  | 2.0 t              |     | 03.05 | 06.12                         |                |        |   |  |   |                                 |
|  | 2.0 T              |     | 03.05 | 06.12                         |                |        |   |  |   |                                 |
|  | 2.0 t BioPower     |     | 01.07 | 06.12                         |                |        |   |  |   |                                 |
|  | 2.0 t BioPower     | 145 | 06.07 | 06.12                         |                |        |   |  |   |                                 |
|  | 2.0 t BioPower     | 147 | 07.07 | 06.12                         |                |        |   |  |   |                                 |
|  | 2.0 t BioPower     | 162 | 01.11 | 06.12                         |                |        |   |  |   |                                 |
|  | 2.0 t BioPower XWD |     | 01.07 | 06.12                         |                |        |   |  |   |                                 |
|  | 2.0 t BioPower XWD | 162 | 01.11 | 06.12                         |                |        |   |  |   |                                 |
|  | 2.0 t XWD          |     | 01.07 | 06.12                         |                |        |   |  |   |                                 |
|  | 2.0 T XWD          | 154 | 07.08 | 06.12                         |                |        |   |  |   |                                 |
|  | 2.0 T XWD          | 177 | 03.09 | 06.12                         |                |        |   |  |   |                                 |
|  | 1.8 i              | 90  | 03.05 | 06.12 + 15" Rad <sup>1)</sup> | 11.9571-9781.2 | 220659 | 2 | GG / nur paarweise austauschen <sup>2)</sup><br>GG / nur paarweise austauschen <sup>2)</sup> | D=57, - Halter<br>D=57, - Halter<br>Hülsensatz<br>Führungsbolzen<br>Haltefeder                  | ATE<br>ATE<br>ATE<br>ATE        |
|  | 1.8 t              | 110 | 03.05 | 06.12 + 15" Rad <sup>1)</sup> | 11.9571-9782.2 | 220660 |   |  |   |                                 |
|  | 1.8 t BioPower     | 110 | 01.07 | 06.12 + 15" Rad <sup>1)</sup> | 11.0101-5407.2 | 260011 |   |  |   |                                 |
|  | 1.8 t BioPower     | 129 | 07.07 | 06.12 + 15" Rad <sup>1)</sup> | 11.8171-0008.1 | 990049 |   |  |   |                                 |
|  | 1.9 TiD            | 88  | 03.05 | 06.12 + 15" Rad <sup>1)</sup> | 11.8116-0356.1 | 390586 |   |  |   |                                 |
|  | 1.9 TiD            | 110 | 03.05 | 06.12 + 15" Rad <sup>1)</sup> |                |        |   |  |   |                                 |
|  | 1.9 TTiD           |     | 07.07 | 06.12 + 15" Rad <sup>1)</sup> |                |        |   |  |   |                                 |
|  | 2.0                | 143 | 04.06 | 09.07 + 15" Rad <sup>1)</sup> |                |        |   |  |   |                                 |
|  | 2.0 t              |     | 03.05 | 06.12 + 15" Rad <sup>1)</sup> |                |        |   |  |   |                                 |
|  | 2.0 t BioPower     |     | 01.07 | 06.12 + 15" Rad <sup>1)</sup> |                |        |   |  |   |                                 |
|  | 2.0 t BioPower     | 145 | 06.07 | 06.12 + 15" Rad <sup>1)</sup> |                |        |   |  |   |                                 |
|  | 2.0 t BioPower     | 147 | 07.07 | 06.12 + 15" Rad <sup>1)</sup> |                |        |   |  |   |                                 |
|  | 2.0 t BioPower     | 162 | 01.11 | 06.12 + 15" Rad <sup>1)</sup> |                |        |   |  |   |                                 |
|  | 2.0 t BioPower XWD |     | 01.07 | 06.12 + 15" Rad <sup>1)</sup> |                |        |   |  |   |                                 |
|  | 2.0 t BioPower XWD | 162 | 01.11 | 06.12 + 15" Rad <sup>1)</sup> |                |        |   |  |   |                                 |
|  | 2.0 t XWD          |     | 01.07 | 06.12 + 15" Rad <sup>1)</sup> |                |        |   |  |   |                                 |
|  | 2.0 T              |     | 03.05 | 12.05                         | 11.9571-9779.2 | 220657 | 2 | + 16" Rad <sup>3)</sup><br>+ 16" Rad <sup>3)</sup>   | D=57, - Halter<br>D=57, - Halter<br>Hülsensatz<br>Führungsbolzen<br>Haltefeder                  | ATE<br>ATE<br>ATE<br>ATE        |
|  | 2.8 T              | 184 | 03.05 | 12.05                         | 11.9571-9780.2 | 220658 |   |  |   |                                 |
|  | 2.8 Turbo V6       | 169 | 03.05 | 12.05                         | 11.0101-5407.2 | 260011 |   |  |   |                                 |
|  |                    |     |       |                               | 11.8171-0008.1 | 990049 |   |  |   |                                 |
|  |                    |     |       |                               | 11.8116-0356.1 | 390586 |   |  |   |                                 |
|  | 2.0 T              |     | 01.06 | 06.12                         | 11.9606-9971.2 | 220589 | 2 | + 16" plus Rad <sup>4)</sup><br>+ 16" plus Rad <sup>4)</sup>                                 | D=60, - Halter<br>D=60, - Halter<br>Dichtungssatz<br>Haltefeder<br>Hülsensatz<br>Führungsbolzen | ATE<br>ATE<br>ATE<br>ATE<br>ATE |
|  | 2.0 T XWD          | 154 | 07.08 | 06.12                         | 11.9606-9972.2 | 220590 |   |  |   |                                 |
|  | 2.0 T XWD          | 177 | 03.09 | 06.12                         | 11.0441-6008.2 | 250038 |   |  |   |                                 |
|  | 2.8 T              | 184 | 01.06 | 06.12                         | 11.8116-0345.2 | 390596 |   |  |   |                                 |
|  | 2.8 T              | 188 | 07.07 | 06.12                         | 11.0101-5407.2 | 260011 |   |  |   |                                 |
|  | 2.8 T Aero         | 206 | 07.07 | 06.12                         | 11.8171-0008.1 | 990049 |   |  |   |                                 |
|  | 2.8 T Aero V6 XWD  | 206 | 04.08 | 06.12                         |                |        |   |  |   |                                 |
|  | 2.8 Turbo V6       | 169 | 01.06 | 06.12                         |                |        |   |  |   |                                 |
|  | 2.8 Turbo V6       | 203 | 05.08 | 06.12                         |                |        |   |  |   |                                 |
|  | 1.8 i              | 90  | 03.05 | 06.12                         | 11.8116-0410.2 | 390589 |   |  |   |                                 |
|  | 1.8 t              | 110 | 03.05 | 06.12                         | 11.0101-5407.2 | 260011 |   |  |   |                                 |
|  | 1.8 t BioPower     | 110 | 01.07 | 06.12                         | 11.8171-0008.1 | 990049 |   |  |   |                                 |
|  | 1.8 t BioPower     | 129 | 07.07 | 06.12                         |                |        |   |  |   |                                 |
|  | 1.9 TiD            | 88  | 03.05 | 06.12                         |                |        |   |  |   |                                 |
|  | 1.9 TiD            | 110 | 03.05 | 06.12                         |                |        |   |  |   |                                 |
|  | 1.9 TTiD           |     | 07.07 | 06.12                         |                |        |   |  |   |                                 |
|  | 2.0                | 143 | 04.06 | 09.07                         |                |        |   |  |   |                                 |
|  | 2.0 t              |     | 03.05 | 06.12                         |                |        |   |  |   |                                 |
|  | 2.0 t BioPower     |     | 01.07 | 06.12                         |                |        |   |  |   |                                 |
|  | 2.0 t BioPower     | 145 | 06.07 | 06.12                         |                |        |   |  |   |                                 |
|  | 2.0 t BioPower     | 147 | 07.07 | 06.12                         |                |        |   |  |   |                                 |
|  | 2.0 t BioPower XWD |     | 01.07 | 06.12                         |                |        |   |  |   |                                 |
|  | 2.0 t BioPower XWD | 162 | 01.11 | 06.12                         |                |        |   |  |   |                                 |
|  | 2.0 t BioPower XWD | 162 | 01.11 | 06.12                         |                |        |   |  |   |                                 |
|  | 2.0 t XWD          |     | 01.07 | 06.12                         |                |        |   |  |   |                                 |
|  | 1.8 i              | 90  | 03.05 | 06.12                         | 83.7807-0412.3 | 331098 | 2 |  | L=412   |                                 |
|  | 1.8 t              | 110 | 03.05 | 06.12                         |                |        |   |  |   |                                 |
|  | 1.8 t BioPower     | 110 | 01.07 | 06.12                         |                |        |   |  |   |                                 |
|  | 1.8 t BioPower     | 129 | 07.07 | 06.12                         |                |        |   |  |   |                                 |
|  | 1.9 TiD            | 88  | 03.05 | 06.12                         |                |        |   |  |   |                                 |
|  | 1.9 TiD            | 110 | 03.05 | 06.12                         |                |        |   |  |   |                                 |
|  | 1.9 TTiD           |     | 07.07 | 06.12                         |                |        |   |  |   |                                 |
|  | 2.0                | 143 | 04.06 | 09.07                         |                |        |   |  |   |                                 |
|  | 2.0 t              |     | 03.05 | 06.12                         |                |        |   |  |   |                                 |
|  | 2.0 T              |     | 03.05 | 06.12                         |                |        |   |  |   |                                 |
|  | 2.0 t BioPower     |     | 01.07 | 06.12                         |                |        |   |  |   |                                 |
|  | 2.0 t BioPower     | 145 | 06.07 | 06.12                         |                |        |   |  |   |                                 |

1) + 15" wheel / + ruota 15" / + roue 15" / + rueda 15"  
 2) GG/ replace only in pairs / GG/ sostituire solo a coppie / GG/ ne remplacer que par paires / GG/ reemplazar sólo por pares  
 3) + 16" wheel / + ruota 16" / + roue 16" / + rueda 16"  
 4) + 16" plus wheel / + ruota 16" plus / + roue 16" plus / + rueda 16" plus



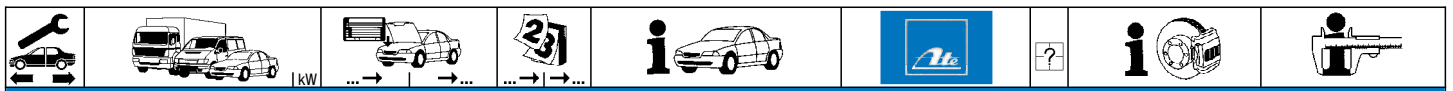

**SAAB 9-3 SportCombi (05-12)**

















|  |                        |          |       |       |                |        |   |  |                |     |
|--|------------------------|----------|-------|-------|----------------|--------|---|--|----------------|-----|
|  | 2.0 t BioPower 147     |          | 07.07 | 06.12 | 83.7807-0412.3 | 331098 | 2 |  | L=412          |     |
|  | 2.0 t BioPower 162     |          | 01.11 | 06.12 |                |        |   |  |                |     |
|  | 2.0 t BioPower XWD     |          | 01.07 | 06.12 |                |        |   |  |                |     |
|  | 2.0 t BioPower XWD 162 |          | 01.11 | 06.12 |                |        |   |  |                |     |
|  | 2.0 t XWD              |          | 01.07 | 06.12 |                |        |   |  |                |     |
|  | 2.0 T XWD 154          |          | 07.08 | 06.12 |                |        |   |  |                |     |
|  | 2.0 T XWD 177          |          | 03.09 | 06.12 |                |        |   |  |                |     |
|  | 2.8 T 184              |          | 03.05 | 06.12 |                |        |   |  |                |     |
|  | 2.8 T 188              |          | 07.07 | 06.12 |                |        |   |  |                |     |
|  | 2.8 T Aero 206         |          | 07.07 | 06.12 |                |        |   |  |                |     |
|  | 2.8 T Aero V6 XWD 206  |          | 04.08 | 06.12 |                |        |   |  |                |     |
|  | 2.8 Turbo V6 169       |          | 03.05 | 06.12 |                |        |   |  |                |     |
|  | 2.8 Turbo V6 203       |          | 05.08 | 06.12 |                |        |   |  |                |     |
|  | 1.8 i 90               |          | 03.05 | 06.12 | 11.9387-7003.2 | 220567 | 2 |  | D=38, - Halter | ATE |
|  | 1.8 t 110              |          | 03.05 | 06.12 | 11.9387-7004.2 | 220568 |   |  | D=38, - Halter | ATE |
|  | 1.8 t BioPower 110     |          | 01.07 | 06.12 | 11.0101-5407.2 | 260011 |   |  | Hülzensatz     | ATE |
|  | 1.8 t BioPower 129     |          | 07.07 | 06.12 | 11.8171-0008.1 | 990049 |   |  | Führungsbolzen | ATE |
|  | 1.9 TiD 88             |          | 03.05 | 06.12 | 11.8116-0340.1 | 390595 | 2 |  | Haltefeder     | ATE |
|  | 1.9 TiD 110            |          | 03.05 | 06.12 |                |        |   |  |                |     |
|  | 1.9 TTiD               |          | 07.07 | 06.12 |                |        |   |  |                |     |
|  | 2.0 143                |          | 04.06 | 09.07 |                |        |   |  |                |     |
|  | 2.0 t                  |          | 03.05 | 06.12 |                |        |   |  |                |     |
|  | 2.0 t BioPower         |          | 01.07 | 06.12 |                |        |   |  |                |     |
|  | 2.0 t BioPower 145     |          | 06.07 | 06.12 |                |        |   |  |                |     |
|  | 2.0 t BioPower 147     |          | 07.07 | 06.12 |                |        |   |  |                |     |
|  | 2.0 t BioPower 162     |          | 01.11 | 06.12 |                |        |   |  |                |     |
|  | 2.0 t BioPower XWD     |          | 01.07 | 06.12 |                |        |   |  |                |     |
|  | 2.0 t BioPower XWD 162 |          | 01.11 | 06.12 |                |        |   |  |                |     |
|  | 2.0 t XWD              |          | 01.07 | 06.12 |                |        |   |  |                |     |
|  | 2.0 T                  | 93171500 | 03.05 |       | 11.9407-7003.2 | 220835 | 2 |  | D=40, - Halter | ATE |
|  | 2.0 T XWD 154          | 93171500 | 07.08 |       | 11.9407-7004.2 | 220836 |   |  | D=40, - Halter | ATE |
|  | 2.0 T XWD 177          | 93171500 | 03.09 |       | 11.0101-5407.2 | 260011 |   |  | Hülzensatz     | ATE |
|  | 2.8 T 184              | 93171500 | 03.05 |       | 11.8171-0008.1 | 990049 |   |  | Führungsbolzen | ATE |
|  | 2.8 T 188              | 93171500 | 07.07 |       | 11.8116-0340.1 | 390595 | 2 |  | Haltefeder     | ATE |
|  | 2.8 T Aero 206         | 93171500 | 07.07 |       |                |        |   |  |                |     |
|  | 2.8 T Aero V6 XWD 206  | 93171500 | 04.08 |       |                |        |   |  |                |     |
|  | 2.8 Turbo V6 169       | 93171500 | 03.05 |       |                |        |   |  |                |     |
|  | 2.8 Turbo V6 203       | 93171500 | 05.08 |       |                |        |   |  |                |     |
|  | 2.0 T                  | 93171501 |       | 06.12 | 11.9387-7005.2 | 220569 | 2 |  | D=38, - Halter | ATE |
|  | 2.0 T XWD 154          | 93171501 |       | 06.12 | 11.9387-7006.2 | 220570 |   |  | D=38, - Halter | ATE |
|  | 2.0 T XWD 177          | 93171501 |       | 06.12 | 11.0101-5407.2 | 260011 |   |  | Hülzensatz     | ATE |
|  | 2.8 T 184              | 93171501 |       | 06.12 | 11.8171-0008.1 | 990049 |   |  | Führungsbolzen | ATE |
|  | 2.8 T 188              | 93171501 |       | 06.12 | 11.8116-0340.1 | 390595 | 2 |  | Haltefeder     | ATE |
|  | 2.8 T Aero 206         | 93171501 |       | 06.12 |                |        |   |  |                |     |
|  | 2.8 T Aero V6 XWD 206  | 93171501 |       | 06.12 |                |        |   |  |                |     |
|  | 2.8 Turbo V6 169       | 93171501 |       | 06.12 |                |        |   |  |                |     |
|  | 2.8 Turbo V6 203       | 93171501 |       | 06.12 |                |        |   |  |                |     |
|  | 1.8 i 90               |          | 03.05 | 06.12 | 24.5259-0315.3 | 330882 | 2 |  | L=315          |     |
|  | 1.8 t 110              |          | 03.05 | 06.12 |                |        |   |  |                |     |
|  | 1.8 t BioPower 110     |          | 01.07 | 06.12 |                |        |   |  |                |     |
|  | 1.8 t BioPower 129     |          | 07.07 | 06.12 |                |        |   |  |                |     |
|  | 1.9 TiD 88             |          | 03.05 | 06.12 |                |        |   |  |                |     |
|  | 1.9 TiD 110            |          | 03.05 | 06.12 |                |        |   |  |                |     |
|  | 1.9 TTiD               |          | 07.07 | 06.12 |                |        |   |  |                |     |
|  | 2.0 143                |          | 04.06 | 09.07 |                |        |   |  |                |     |
|  | 2.0 t                  |          | 03.05 | 06.12 |                |        |   |  |                |     |
|  | 2.0 T                  |          | 03.05 | 06.12 |                |        |   |  |                |     |
|  | 2.0 t BioPower         |          | 01.07 | 06.12 |                |        |   |  |                |     |
|  | 2.0 t BioPower 145     |          | 06.07 | 06.12 |                |        |   |  |                |     |
|  | 2.0 t BioPower 147     |          | 07.07 | 06.12 |                |        |   |  |                |     |
|  | 2.0 t BioPower 162     |          | 01.11 | 06.12 |                |        |   |  |                |     |
|  | 2.0 t BioPower XWD     |          | 01.07 | 06.12 |                |        |   |  |                |     |
|  | 2.0 t BioPower XWD 162 |          | 01.11 | 06.12 |                |        |   |  |                |     |
|  | 2.0 t XWD              |          | 01.07 | 06.12 |                |        |   |  |                |     |
|  | 2.0 T XWD 154          |          | 07.08 | 06.12 |                |        |   |  |                |     |
|  | 2.0 T XWD 177          |          | 03.09 | 06.12 |                |        |   |  |                |     |
|  | 2.8 T 184              |          | 03.05 | 06.12 |                |        |   |  |                |     |
|  | 2.8 T 188              |          | 07.07 | 06.12 |                |        |   |  |                |     |
|  | 2.8 T Aero 206         |          | 07.07 | 06.12 |                |        |   |  |                |     |
|  | 2.8 T Aero V6 XWD 206  |          | 04.08 | 06.12 |                |        |   |  |                |     |
|  | 2.8 Turbo V6 169       |          | 03.05 | 06.12 |                |        |   |  |                |     |
|  | 2.8 Turbo V6 203       |          | 05.08 | 06.12 |                |        |   |  |                |     |

**SAAB 9-3 Cabriolet (YS3D) (98-03)**

|  |                   |  |       |       |                |        |  |  |           |     |
|--|-------------------|--|-------|-------|----------------|--------|--|--|-----------|-----|
|  | 2.0 i # 96        |  | 09.00 | 07.03 | 03.7750-2932.4 | 300175 |  |  | 9"        | ATE |
|  | 2.0 SE Turbo #147 |  | 01.01 | 07.03 |                |        |  |  |           |     |
|  | 2.0 T #113        |  | 09.00 | 07.03 |                |        |  |  |           |     |
|  | 2.0 T #136        |  | 09.00 | 07.03 |                |        |  |  |           |     |
|  | 2.0 T #151        |  | 09.00 | 07.03 |                |        |  |  |           |     |
|  | 2.0 Turbo #110    |  | 09.00 | 07.03 |                |        |  |  |           |     |
|  | 2.3 i #110        |  | 09.00 | 07.03 |                |        |  |  |           |     |
|  | 2.3 i #165        |  | 09.00 | 07.03 |                |        |  |  |           |     |
|  | 2.0 i # 96        |  | 02.98 | 08.00 | 03.2123-1121.3 | 010176 |  |  | THz 23,81 | ATE |
|  | 2.0 SE Turbo #147 |  | 02.98 | 08.00 |                |        |  |  |           |     |
|  | 2.0 T #113        |  | 10.98 | 08.00 |                |        |  |  |           |     |
|  | 2.0 T #136        |  | 02.98 | 08.00 |                |        |  |  |           |     |
|  | 2.0 T #151        |  | 10.99 | 08.00 |                |        |  |  |           |     |





|     |  |  |  |  |  |  |  |  |     |
|--|--|--|--|--|---|--|--|--|-----|
| <b>SAAB 9-3 Cabriolet (YS3D) (98-03)</b>   |  |  |  |  |   |  |  |  |     |
|    | 2.3 i  | 110  |  | 02.98  | 08.00   | 03.2123-1121.3   | 010176   | Thz 23,81  | ATE |
|  | 2.3 i  | 165  |  | 10.99  | 08.00   |  |  |  |     |
|  | 2.0 i  | 96   |  | 09.00  | 07.03   | 03.2123-1626.3   | 010727   | Thz 23,81  | ATE |
|  | 2.0 SE Turbo   | 147  |  | 01.01  | 07.03   |  |  |  |     |
|  | 2.0 T  | 113  |  | 09.00  | 07.03   |  |  |  |     |
|  | 2.0 T  | 136  |  | 09.00  | 07.03   |  |  |  |     |
|  | 2.0 T  | 151  |  | 09.00  | 07.03   |  |  |  |     |
|  | 2.0 Turbo  | 110  |  | 09.00  | 07.03   |  |  |  |     |
|  | 2.3 i  | 110  |  | 09.00  | 07.03   |  |  |  |     |
|  | 2.3 i  | 165  |  | 09.00  | 07.03   |  |  |  |     |
|    | 2.0 i  | 96   | X7020000   | 02.98  | + (USA)   | 11.3571-8525.2   | 220363   | D=57, - Halter   | ATE |
|  | 2.0 i  | 96   | X2020000   | 02.98  | + (USA)   | 11.3571-8526.2   | 220364   | D=57, - Halter   | ATE |
|  | 2.0 i  | 96   |  | 02.98  | 12.98 - (USA)   | 11.8171-0008.1   | 990049   | Führungsbolzen   | ATE |
|  | 2.0 SE Turbo   | 147  | X7020000   | 02.98  | + (USA)   | 11.0101-5407.2   | 260011   | Hülzensatz   | ATE |
|  | 2.0 SE Turbo   | 147  | X2020000   | 02.98  | + (USA)   | 11.8116-0292.1   | 390521   | Haltefeder   | ATE |
|  | 2.0 SE Turbo   | 147  |  | 02.98  | 12.98 - (USA)   |  |  |  |     |
|  | 2.0 T  | 113  | X7020000   | 10.98  | + (USA)   |  |  |  |     |
|  | 2.0 T  | 113  | X2020000   | 10.98  | + (USA)   |  |  |  |     |
|  | 2.0 T  | 113  |  | 10.98  | 12.98 - (USA)   |  |  |  |     |
|  | 2.0 T  | 136  | X7020000   | 02.98  | + (USA)   |  |  |  |     |
|  | 2.0 T  | 136  | X2020000   | 02.98  | + (USA)   |  |  |  |     |
|  | 2.0 T  | 136  |  | 02.98  | 12.98 - (USA)   |  |  |  |     |
|  | 2.3 i  | 110  | X7020000   | 02.98  | + (USA)   |  |  |  |     |
|  | 2.3 i  | 110  | X2020000   | 02.98  | + (USA)   |  |  |  |     |
|  | 2.3 i  | 110  |  | 02.98  | 12.98 - (USA)   |  |  |  |     |
|  | 2.0 i  | 96   | X7020001   | 07.03  | + (USA)   | 24.3571-1725.5   | 240313   | D=57, - Halter   | ATE |
|  | 2.0 i  | 96   | X2020001   | 07.03  | + (USA)   | 24.3571-1726.5   | 240314   | D=57, - Halter   | ATE |
|  | 2.0 i  | 96   |  | 01.99  | 07.03 - (USA)   | 11.0101-5407.2   | 260011   | Hülzensatz   | ATE |
|  | 2.0 SE Turbo   | 147  | X7020001   | 07.03  | + (USA)   | 11.0441-5704.2   | 250034   | Dichtungssatz  | ATE |
|  | 2.0 SE Turbo   | 147  | X2020001   | 07.03  | + (USA)   | 11.8171-0008.1   | 990049   | Führungsbolzen   | ATE |
|  | 2.0 SE Turbo   | 147  |  | 01.99  | 07.03 - (USA)   | 11.8116-0292.1   | 390521   | Haltefeder   | ATE |
|  | 2.0 T  | 113  | X7020001   | 07.03  | + (USA)   |  |  |  |     |
|  | 2.0 T  | 113  | X2020001   | 07.03  | + (USA)   |  |  |  |     |
|  | 2.0 T  | 113  |  | 01.99  | 07.03 - (USA)   |  |  |  |     |
|  | 2.0 T  | 136  | X7020001   | 07.03  | + (USA)   |  |  |  |     |
|  | 2.0 T  | 136  | X2020001   | 07.03  | + (USA)   |  |  |  |     |
|  | 2.0 T  | 136  |  | 01.99  | 07.03 - (USA)   |  |  |  |     |
|  | 2.0 T  | 151  |  | 10.99  | 07.03   |  |  |  |     |
|  | 2.0 Turbo  | 110  |  | 01.01  | 07.03   |  |  |  |     |
|  | 2.3 i  | 110  | X7020001   | 07.03  | + (USA)   |  |  |  |     |
|  | 2.3 i  | 110  | X2020001   | 07.03  | + (USA)   |  |  |  |     |
|  | 2.3 i  | 110  |  | 01.99  | 07.03 - (USA)   |  |  |  |     |
|  | 2.3 i  | 165  |  | 10.99  | 07.03   |  |  |  |     |
|  | 2.0 i  | 96   |  | 02.98  | 07.03   | 83.7288-0318.3   | 330375   | L=315  |     |
|  | 2.0 SE Turbo   | 147  |  | 02.98  | 07.03   | 24.5298-0322.3   | 331314   | L=322  |     |
|  | 2.0 T  | 113  |  | 10.98  | 07.03   |  |  |  |     |
|  | 2.0 T  | 136  |  | 02.98  | 07.03   |  |  |  |     |
|  | 2.0 T  | 151  |  | 10.99  | 07.03   |  |  |  |     |
|  | 2.0 Turbo  | 110  |  | 01.01  | 07.03   |  |  |  |     |
|  | 2.3 i  | 110  |  | 02.98  | 07.03   |  |  |  |     |
|  | 2.3 i  | 165  |  | 10.99  | 07.03   |  |  |  |     |
|  | 2.0 i  | 96   |  | 02.98  | 07.03   | 13.2351-0025.2   | 210210   | D=35   | ATE |
|  | 2.0 SE Turbo   | 147  |  | 02.98  | 07.03   | 13.2351-0026.2   | 210211   | D=35   | ATE |
|  | 2.0 T  | 113  |  | 10.98  | 07.03   | 13.0441-3506.2   | 250052   | Dichtungssatz  | ATE |
|  | 2.0 T  | 136  |  | 02.98  | 07.03   |  |  |  |     |
|  | 2.0 T  | 151  |  | 10.99  | 07.03   |  |  |  |     |
|  | 2.0 Turbo  | 110  |  | 01.01  | 07.03   |  |  |  |     |
|  | 2.3 i  | 110  |  | 02.98  | 07.03   |  |  |  |     |
|  | 2.3 i  | 165  |  | 02.98  | 07.03   |  |  |  |     |
|  | 2.0 i  | 96   |  | 02.98  | 07.03   | 24.5117-0205.3   | 330669   | L=205  |     |
|  | 2.0 SE Turbo   | 147  |  | 02.98  | 07.03   | 24.5117-0195.3   | 330565   | L=198  |     |
|  | 2.0 T  | 113  |  | 10.98  | 07.03   |  |  |  |     |
|  | 2.0 T  | 136  |  | 02.98  | 07.03   |  |  |  |     |
|  | 2.0 T  | 151  |  | 10.99  | 07.03   |  |  |  |     |
|  | 2.0 Turbo  | 110  |  | 01.01  | 07.03   |  |  |  |     |
|  | 2.3 i  | 110  |  | 02.98  | 07.03   |  |  |  |     |
|  | 2.3 i  | 165  |  | 10.99  | 07.03   |  |  |  |     |
|  | 2.0 i  | 96   |  | 02.98  | 07.03   | 24.3727-1106.2   | 581106   | L=2180   |     |
|  | 2.0 SE Turbo   | 147  |  | 02.98  | 07.03   |  |  |  |     |
|  | 2.0 T  | 113  |  | 10.98  | 07.03   |  |  |  |     |
|  | 2.0 T  | 136  |  | 02.98  | 07.03   |  |  |  |     |
|  | 2.0 T  | 151  |  | 10.99  | 07.03   |  |  |  |     |
|  | 2.0 Turbo  | 110  |  | 01.01  | 07.03   |  |  |  |     |
|  | 2.3 i  | 110  |  | 02.98  | 07.03   |  |  |  |     |
|  | 2.3 i  | 165  |  | 10.99  | 07.03   |  |  |  |     |
|  | 2.0 i  | 96   |  | 02.98  | 07.03   | 24.2419-1727.3   | 030116   | Gz 19,05   |     |
|  | 2.0 SE Turbo   | 147  |  | 02.98  | 07.03   |  |  |  |     |
|  | 2.0 T  | 113  |  | 10.98  | 07.03   |  |  |  |     |
|  | 2.0 T  | 136  |  | 02.98  | 07.03   |  |  |  |     |
|  | 2.0 T  | 151  |  | 10.99  | 07.03   |  |  |  |     |
|  | 2.0 Turbo  | 110  |  | 01.01  | 07.03   |  |  |  |     |
|  | 2.3 i  | 110  |  | 02.98  | 07.03   |  |  |  |     |
|  | 2.3 i  | 165  |  | 10.99  | 07.03   |  |  |  |     |

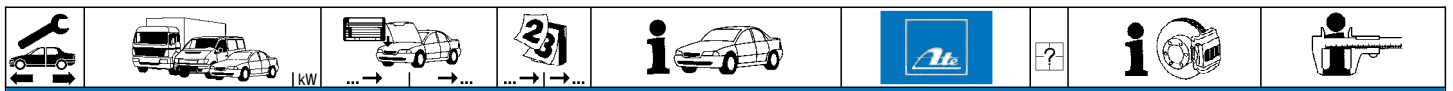









**SAAB 9-3 Cabriolet (YS3F) (03-12)**

|  |   |   |  |  |  |  |  |  |  |  |   |  |
|--|---|---|--|--|--|--|--|--|--|--|---|--|
|  | 1.8 t<br>1.8 t BioPower<br>1.8 t BioPower<br>1.9 TiD<br>1.9 TTiD<br>2.0<br>2.0 t<br>2.0 T<br>2.0 t BioPower<br>2.0 t BioPower<br>2.0 t BioPower<br>2.0 Turbo Performance  | #110<br>#110<br>#129<br>#110<br>#<br>#143<br>#<br>#<br>#<br>#<br>#147<br>#185 |  | 08.03<br>01.07<br>07.07<br>01.06<br>07.07<br>04.06<br>08.03<br>08.03<br>06.07<br>01.07<br>07.07<br>04.04                                     | 06.12<br>06.12<br>06.12<br>06.12<br>06.12<br>09.07<br>06.12<br>06.12<br>06.12<br>06.12<br>06.12<br>06.12   |  | 24.2125-1732.3   | 010827   |  |  | Thz 25,40   | LUC                                    |
|  | 1.8 t<br>1.8 t BioPower<br>1.8 t BioPower<br>1.9 TiD<br>1.9 TTiD<br>2.0<br>2.0 t<br>2.0 T<br>2.0 t BioPower<br>2.0 t BioPower<br>2.0 t BioPower<br>2.0 Turbo Performance  | 110<br>110<br>129<br>110<br>110<br>143<br>143<br>147<br>185                   |  | 08.03<br>01.07<br>07.07<br>01.06<br>07.07<br>04.06<br>08.03<br>08.03<br>06.07<br>01.07<br>07.07<br>04.04                                     | 06.12 + 15" Rad <sup>1)</sup><br>06.12 + 15" Rad <sup>1)</sup><br>06.12 + 15" Rad <sup>1)</sup><br>06.12 + 15" Rad <sup>1)</sup><br>06.12 + 15" Rad <sup>1)</sup><br>06.12 + 15" Rad <sup>1)</sup><br>06.12 + 15" Rad / + <sup>USA</sup> <sup>5)</sup><br>06.12 + 15" Rad <sup>1)</sup><br>06.12 + 15" Rad <sup>1)</sup><br>06.12 + 15" Rad <sup>1)</sup><br>06.12 + 15" Rad <sup>1)</sup> |  | 11.9571-9781.2<br>11.9571-9782.2<br>11.0101-5407.2<br>11.8171-0008.1<br>11.8116-0295.2<br>11.8116-0356.1 | 220659<br>220660<br>260011<br>990049<br>390524<br>390586   | <input type="checkbox"/> GG / nur paarweise austauschen <sup>2)</sup><br><input type="checkbox"/> GG / nur paarweise austauschen <sup>2)</sup> | + ALU-Sättel <sup>3)</sup><br>+ GG-Sättel <sup>4)</sup>  | D=57, - Halter<br>D=57, - Halter<br>Hülzensatz<br>Führungsbolzen<br>Haltefeder<br>Haltefeder    | ATE<br>ATE<br>ATE<br>ATE<br>ATE<br>ATE |
|  | 1.8 t<br>1.8 t BioPower<br>1.8 t BioPower<br>2.0<br>2.0 t<br>2.0 T<br>2.0 T<br>2.0 t BioPower<br>2.0 t BioPower<br>2.0 t BioPower<br>2.0 Turbo Performance  | 110<br>110<br>129<br>143<br>143<br>147<br>185                                 | 51046733<br>51046733<br>51046733<br>51046733<br>51046733<br>51046733<br>51046733<br>51046733<br>51046733<br>51046733 | 08.03<br>01.07<br>07.07<br>04.06<br>08.03<br>08.03<br>06.07<br>01.07<br>07.07<br>04.04   |  | + <sup>USA</sup><br>- <sup>USA</sup>   | 11.0101-5407.2<br>11.8171-0008.1<br>11.8116-0325.2   | 260011<br>990049<br>390461   | 2  |  | Hülzensatz<br>Führungsbolzen<br>Haltefeder  | ATE<br>ATE<br>ATE                      |
|  | 1.8 t<br>1.8 t BioPower<br>1.8 t BioPower<br>1.9 TiD<br>1.9 TTiD<br>2.0<br>2.0 t<br>2.0 T<br>2.0 t BioPower<br>2.0 t BioPower<br>2.0 t BioPower<br>2.0 Turbo Performance  | 110<br>110<br>129<br>110<br>110<br>143<br>143<br>147<br>185                   | 51046734<br>51046734<br>51046734<br>51046734<br>51046734<br>51046734<br>51046734<br>51046734                         | 08.03<br>06.12<br>06.12<br>01.06<br>07.07<br>06.12<br>06.12<br>06.12<br>06.12<br>06.12<br>06.12  |  | - <sup>USA</sup>   | 11.9571-9779.2<br>11.9571-9780.2<br>11.0101-5407.2<br>11.8171-0008.1<br>11.8116-0356.1                   | 220657<br>220658<br>260011<br>990049<br>390586   | 2  | <input type="checkbox"/> + 16" Rad <sup>6)</sup><br><input type="checkbox"/> + 16" Rad <sup>6)</sup> | D=57, - Halter<br>D=57, - Halter<br>Hülzensatz<br>Führungsbolzen<br>Haltefeder                  | ATE<br>ATE<br>ATE<br>ATE<br>ATE        |
|  | 2.0 T<br>2.0 Turbo Performance<br>2.8 T<br>2.8 T<br>2.8 T Aero<br>2.8 T V6 Aero   | 185<br>184<br>221<br>188  | 41022027   | 08.03<br>04.04<br>02.06<br>10.08<br>07.07<br>06.08   | - <sup>USA</sup>   | 11.9606-9971.2<br>11.9606-9972.2<br>11.0441-6008.2<br>11.0101-5407.2<br>11.8171-0008.1<br>11.8116-0345.2 | 220589<br>220590<br>250038<br>260011<br>990049<br>390596   | <input type="checkbox"/> + 16" plus Rad <sup>7)</sup><br><input type="checkbox"/> + 16" plus Rad <sup>7)</sup> | 2  |  | D=60, - Halter<br>D=60, - Halter<br>Dichtungssatz<br>Hülzensatz<br>Führungsbolzen<br>Haltefeder | ATE<br>ATE<br>ATE<br>ATE<br>ATE<br>ATE |
|  | 1.8 t<br>1.8 t BioPower<br>1.8 t BioPower<br>1.9 TiD<br>1.9 TTiD<br>2.0<br>2.0 t<br>2.0 T<br>2.0 t BioPower<br>2.0 t BioPower<br>2.0 t BioPower<br>2.0 Turbo Performance<br>2.8 T<br>2.8 T<br>2.8 T Aero<br>2.8 T V6 Aero | 110<br>110<br>129<br>110<br>110<br>143<br>143<br>184<br>221<br>188            |  | 08.03<br>01.07<br>07.07<br>01.06<br>07.07<br>04.06<br>08.03<br>08.03<br>06.07<br>01.07<br>07.07<br>04.04<br>02.06<br>10.08<br>07.07<br>06.08 | 06.12<br>06.12<br>06.12<br>06.12<br>06.12<br>09.07<br>06.12<br>06.12<br>06.12<br>06.12<br>06.12<br>06.12<br>06.12<br>06.12<br>06.12<br>06.12   |  | 11.8116-0410.2<br>11.0101-5407.2<br>11.8171-0008.1   | 390589<br>260011<br>990049   | 2  |  | Haltefeder<br>Hülzensatz<br>Führungsbolzen  | ATE<br>ATE<br>ATE                      |
|  | 1.8 t<br>1.8 t BioPower<br>1.8 t BioPower<br>1.9 TiD<br>1.9 TTiD<br>2.0<br>2.0 t<br>2.0 T<br>2.0 t BioPower<br>2.0 t BioPower<br>2.0 t BioPower<br>2.0 Turbo Performance<br>2.8 T<br>2.8 T<br>2.8 T Aero<br>2.8 T V6 Aero | 110<br>110<br>129<br>110<br>110<br>143<br>143<br>184<br>221<br>188            |  | 08.03<br>01.07<br>07.07<br>01.06<br>07.07<br>04.06<br>08.03<br>08.03<br>06.07<br>01.07<br>07.07<br>04.04<br>02.06<br>10.08<br>07.07<br>06.08 | 06.12<br>06.12<br>06.12<br>06.12<br>06.12<br>09.07<br>06.12<br>06.12<br>06.12<br>06.12<br>06.12<br>06.12<br>06.12<br>06.12<br>06.12<br>06.12   |  | 83.7807-0412.3   | 331098   | 2  |  | L=412   |  |

1) + 15" wheel / + ruota 15" / + roue 15" / + rueda 15"  
2) GG/ replace only in pairs / GG/ sostituire solo a coppie / GG/ ne remplacer que par paires / GG/ reemplazar sólo por pares  
3) + aluminium calipers / + pinze in alluminio / + étriers en aluminium / + pinzas de aluminio  
4) + cast iron caliper / + pinza in ghisa / + étriers en fonte grise / + fundición gris-pinza  
5) + 15" wheel / + <sup>USA</sup> / + ruota 15" / + <sup>USA</sup> / + roue 15" / + <sup>USA</sup> / + rueda 15" / + <sup>USA</sup>  
6) + 16" wheel / + ruota 16" / + roue 16" / + rueda 16"  
7) + 16" plus wheel / + ruota 16" plus / + roue 16" plus / + rueda 16" plus



| SAAB 9-3 Cabriolet (YS3F) (03-12)  |   |                                  |  |  |  |             |   |   |  |
|--|---|----------------------------------|--|--|--|-------------|---|---|--|
|     | 1.8 t 110<br>1.8 t BioPower 110<br>1.8 t BioPower 129<br>1.9 TiD 110<br>1.9 TTiD 110<br>2.0 143<br>2.0 t BioPower<br>2.0 t BioPower<br>2.0 t BioPower 147<br>2.0 t Linear 129   |                                  | 08.03 06.12<br>01.07 06.12<br>07.07 06.12<br>01.06 06.12<br>07.07 06.12<br>04.06 09.07<br>06.07 06.12<br>01.07 06.12<br>07.07 06.12<br>08.03 06.12   |  | 11.9387-7003.2 220567<br>11.9387-7004.2 220568<br>11.0101-5407.2 260011<br>11.8171-0008.1 990049<br>11.8116-0340.1 390595                          | 2           |   | D=38, - Halter<br>D=38, - Halter<br>Hülsensatz<br>Führungsbolzen<br>Haltefeder                  | ATE<br>ATE<br>ATE<br>ATE<br>ATE        |
|  | 2.0 T<br>2.0 t Vector 129<br>2.0 Turbo Performance 185  | 51049406<br>51049406<br>51049406 | 08.03<br>08.03<br>04.04  |  | 11.9407-7003.2 220835<br>11.9407-7004.2 220836<br>11.0101-5407.2 260011<br>11.8171-0008.1 990049<br>11.8116-0340.1 390595                          | 2           |   | D=40, - Halter<br>D=40, - Halter<br>Hülsensatz<br>Führungsbolzen<br>Haltefeder                  | ATE<br>ATE<br>ATE<br>ATE<br>ATE        |
|  | 2.0 T<br>2.0 t Vector 129<br>2.0 Turbo Performance 185<br>2.8 T 184<br>2.8 T 221<br>2.8 T Aero 188<br>2.8 T V6 Aero   | 51049407<br>51049407<br>51049407 | 06.12<br>06.12<br>06.12<br>02.06 06.12<br>10.08 06.12<br>07.07 06.12<br>06.08 06.12  |  | 11.9387-7005.2 220569<br>11.9387-7006.2 220570<br>11.0101-5407.2 260011<br>11.8171-0008.1 990049<br>11.8116-0340.1 390595                          | 2           |   | D=38, - Halter<br>D=38, - Halter<br>Hülsensatz<br>Führungsbolzen<br>Haltefeder                  | ATE<br>ATE<br>ATE<br>ATE<br>ATE        |
|    | 1.8 t 110<br>1.8 t BioPower 110<br>1.8 t BioPower 129<br>1.9 TiD 110<br>1.9 TTiD 110<br>2.0 143<br>2.0 t<br>2.0 T<br>2.0 t BioPower<br>2.0 t BioPower<br>2.0 t BioPower 147<br>2.0 Turbo Performance 185<br>2.8 T 184<br>2.8 T 221<br>2.8 T Aero 188<br>2.8 T V6 Aero |                                  | 08.03 06.12<br>01.07 06.12<br>07.07 06.12<br>01.06 06.12<br>07.07 06.12<br>04.06 09.07<br>08.03 06.12<br>08.03 06.12<br>06.07 06.12<br>01.07 06.12<br>07.07 06.12<br>04.04 06.12<br>02.06 06.12<br>10.08 06.12<br>07.07 06.12<br>06.08 06.12 |  | 24.5259-0315.3 330882  | 2           |   | L=315   |  |
| SAAB 9-3 X (09-12)   |   |                                  |  |  |  |             |   |   |  |
|  | 1.9 TTiD 96<br>1.9 TTiD 132<br>2.0 T BioPower XWD 120<br>2.0 T BioPower XWD 154<br>2.0 T BioPower XWD 162<br>2.0 T XWD 154  |                                  | 01.10 06.12<br>03.09 06.12<br>01.11 06.12<br>03.09 06.12<br>01.11 06.12<br>03.09 06.12   |  | 24.2125-1732.3 010827  |             |   | Thz 25,40   | LUC                                    |
|  | 1.9 TTiD 96<br>1.9 TTiD 132<br>2.0 T BioPower XWD 120<br>2.0 T BioPower XWD 154<br>2.0 T BioPower XWD 162<br>2.0 T XWD 154  |                                  | 01.10 06.12 + 15" Rad <sup>1)</sup><br>03.09 06.12 + 15" Rad <sup>1)</sup><br>01.11 06.12 + 15" Rad <sup>1)</sup><br>03.09 06.12 + 15" Rad <sup>1)</sup><br>01.11 06.12 + 15" Rad <sup>1)</sup><br>03.09 06.12 + 15" Rad <sup>1)</sup>       |  | 11.9571-9781.2 220659<br>11.9571-9782.2 220660<br>11.8116-0295.2 390524<br>11.8116-0356.1 390586<br>11.0101-5407.2 260011<br>11.8171-0008.1 990049 | 2<br>2<br>2 | GG / nur paarweise austauschen <sup>2)</sup><br>GG / nur paarweise austauschen <sup>2)</sup><br>+ ALU-Sättel <sup>3)</sup><br>+ GG-Sättel <sup>4)</sup> | D=57, - Halter<br>D=57, - Halter<br>Haltefeder<br>Haltefeder<br>Hülsensatz<br>Führungsbolzen    | ATE<br>ATE<br>ATE<br>ATE<br>ATE<br>ATE |
|  | 1.9 TTiD 96<br>1.9 TTiD 132<br>2.0 T BioPower XWD 120<br>2.0 T BioPower XWD 154<br>2.0 T BioPower XWD 162<br>2.0 T XWD 154  |                                  | 01.10 06.12<br>03.09 06.12<br>01.11 06.12<br>03.09 06.12<br>01.11 06.12<br>03.09 06.12   |  | 11.9571-9779.2 220657<br>11.9571-9780.2 220658<br>11.8116-0356.1 390586<br>11.0101-5407.2 260011<br>11.8171-0008.1 990049                          | 2           | + 16" Rad <sup>5)</sup><br>+ 16" Rad <sup>5)</sup>  | D=57, - Halter<br>D=57, - Halter<br>Haltefeder<br>Hülsensatz<br>Führungsbolzen                  | ATE<br>ATE<br>ATE<br>ATE<br>ATE        |
|  | 1.9 TTiD 96<br>1.9 TTiD 132<br>2.0 T BioPower XWD 120<br>2.0 T BioPower XWD 154<br>2.0 T BioPower XWD 162<br>2.0 T XWD 154  |                                  | 01.10 06.12<br>03.09 06.12<br>01.11 06.12<br>03.09 06.12<br>01.11 06.12<br>03.09 06.12   |  | 11.9606-9971.2 220589<br>11.9606-9972.2 220590<br>11.0441-6008.2 250038<br>11.8116-0345.2 390596<br>11.0101-5407.2 260011<br>11.8171-0008.1 990049 | 2           | + 16" plus Rad <sup>6)</sup><br>+ 16" plus Rad <sup>6)</sup>  | D=60, - Halter<br>D=60, - Halter<br>Dichtungssatz<br>Haltefeder<br>Hülsensatz<br>Führungsbolzen | ATE<br>ATE<br>ATE<br>ATE<br>ATE<br>ATE |
|  | 1.9 TTiD 96<br>1.9 TTiD 132<br>2.0 T BioPower XWD 120<br>2.0 T BioPower XWD 154<br>2.0 T BioPower XWD 162<br>2.0 T XWD 154  |                                  | 01.10 06.12<br>03.09 06.12<br>01.11 06.12<br>03.09 06.12<br>01.11 06.12<br>03.09 06.12   |  | 11.8116-0410.2 390589<br>11.0101-5407.2 260011<br>11.8171-0008.1 990049  | 2           |   | Haltefeder<br>Hülsensatz<br>Führungsbolzen  | ATE<br>ATE<br>ATE                      |
|  | 1.9 TTiD 96<br>1.9 TTiD 132<br>2.0 T BioPower XWD 120<br>2.0 T BioPower XWD 154<br>2.0 T BioPower XWD 162<br>2.0 T XWD 154  |                                  | 01.10 06.12<br>03.09 06.12<br>01.11 06.12<br>03.09 06.12<br>01.11 06.12<br>03.09 06.12   |  | 83.7807-0412.3 331098  | 2           |   | L=412   |  |
|  | 1.9 TTiD 96<br>1.9 TTiD 132<br>2.0 T BioPower XWD 120<br>2.0 T BioPower XWD 154<br>2.0 T BioPower XWD 162<br>2.0 T XWD 154  |                                  | 01.10 06.12<br>03.09 06.12<br>01.11 06.12<br>03.09 06.12<br>01.11 06.12<br>03.09 06.12   |  | 11.9387-7003.2 220567<br>11.9387-7004.2 220568<br>11.8171-0008.1 990049<br>11.0101-5407.2 260011<br>11.8116-0340.1 390595                          | 2           | + 15" Rad <sup>1)</sup><br>+ 15" Rad <sup>1)</sup>  | D=38, - Halter<br>D=38, - Halter<br>Führungsbolzen<br>Hülsensatz<br>Haltefeder                  | ATE<br>ATE<br>ATE<br>ATE<br>ATE        |

<sup>1)</sup> + 15" wheel / + ruota 15" / + roue 15" / + rueda 15"

<sup>2)</sup> GG/ replace only in pairs / GG/ sostituire solo a coppie / GG/ ne remplacer que par paires / GG/ reemplazar sólo por pares

<sup>3)</sup> + aluminium calipers / + pinze in alluminio / + étriers en aluminium / + pinzas de aluminio

<sup>4)</sup> + cast iron caliper / + pinza in ghisa / + étriers en fonte grise / + fundición gris-pinza

<sup>5)</sup> + 16" wheel / + ruota 16" / + roue 16" / + rueda 16"

<sup>6)</sup> + 16" plus wheel / + ruota 16" plus / + roue 16" plus / + rueda 16" plus

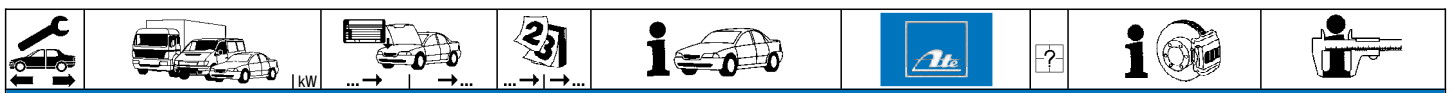

**SAAB 9-3 X (09-12)**

|  |                    |     |       |       |                |        |  |  |     |
|--|--------------------|-----|-------|-------|----------------|--------|--|--|-----|
|  | 1.9 TTiD           | 96  | 01.10 | 06.12 | 11.9387-7005.2 | 220569 | <input type="checkbox"/> - 15" Rad <sup>1)</sup><br><input type="checkbox"/> - 15" Rad <sup>1)</sup> | D=38, - Halter<br>D=38, - Halter<br>Führungsbolzen<br>Hülsensatz<br>Haltefeder | ATE |
|  | 1.9 TTiD           | 132 | 03.09 | 06.12 | 11.9387-7006.2 | 220570 |  |  | ATE |
|  | 2.0 T BioPower XWD | 120 | 01.11 | 06.12 | 11.8171-0008.1 | 990049 |  |  | ATE |
|  | 2.0 T BioPower XWD | 154 | 03.09 | 06.12 | 11.0101-5407.2 | 260011 |  |  | ATE |
|  | 2.0 T BioPower XWD | 162 | 01.11 | 06.12 | 11.8116-0340.1 | 390595 |  |  | ATE |
|  | 2.0 T XWD          | 154 | 03.09 | 06.12 |                |        |  |  | ATE |

**SAAB 9-5 Limousine (YS3E) (97-10)**

|                |                |       |       |                |                |        |           |           |                |        |  |           |     |
|----------------|----------------|-------|-------|----------------|----------------|--------|-----------|-----------|----------------|--------|--|-----------|-----|
|                | 2.0            | 1136  | 07.00 | 12.01          | 03.7745-3003.4 | 300157 |           | 8" Tandem | ATE            |        |  |           |     |
|                | 2.0 t          | 1110  | 09.97 | 12.01          |                |        |           |           |                |        |  |           |     |
|                | 2.0 T          | 1129  | 10.98 | 12.01          |                |        |           |           |                |        |  |           |     |
|                | 2.0 Turbo SE   | 1141  | 10.98 | 07.00          |                |        |           |           |                |        |  |           |     |
|                | 2.3 t          | 1125  | 09.97 | 12.01          |                |        |           |           |                |        |  |           |     |
|                | 2.3 t          | 1136  | 01.01 | 12.01          |                |        |           |           |                |        |  |           |     |
|                | 2.3 T Aero     | 1169  | 10.99 | 09.01          |                |        |           |           |                |        |  |           |     |
|                | 2.3 T Aero     | 1184  | 09.01 | 12.01          |                |        |           |           |                |        |  |           |     |
|                | 3.0 t          | 1147  | 01.98 | 12.01          |                |        |           |           |                |        |  |           |     |
|                | 3.0 TiD        | 1130  | 07.01 | 12.01          |                |        |           |           |                |        |  |           |     |
|                | 1.9 TiD        | 1110  | 01.06 | 02.10          |                |        |           |           | 03.7745-3902.4 | 300129 |  | 8" Tandem | ATE |
|                | 2.0            | 1136  | 01.02 | 02.10          |                |        |           |           |                |        |  |           |     |
|                | 2.0 t          | 1110  | 01.02 | 02.10          |                |        |           |           |                |        |  |           |     |
|                | 2.0 T          | 1129  | 01.02 | 02.10          |                |        |           |           |                |        |  |           |     |
| 2.0 t BioPower | 1110           | 01.05 | 02.10 |                |                |        |           |           |                |        |  |           |     |
| 2.0 t BioPower | 1132           | 06.06 | 02.10 |                |                |        |           |           |                |        |  |           |     |
| 2.2 TiD        | 88             | 03.02 | 02.10 |                |                |        |           |           |                |        |  |           |     |
| 2.3 t          | 1125           | 01.02 | 02.10 |                |                |        |           |           |                |        |  |           |     |
| 2.3 T          | 1134           | 04.08 | 02.10 |                |                |        |           |           |                |        |  |           |     |
| 2.3 t          | 1136           | 01.02 | 02.10 |                |                |        |           |           |                |        |  |           |     |
| 2.3 T          | 1162           | 07.03 | 02.10 |                |                |        |           |           |                |        |  |           |     |
| 2.3 T          | 1188           | 04.08 | 02.10 |                |                |        |           |           |                |        |  |           |     |
| 2.3 T          | 1191           | 11.05 | 02.10 |                |                |        |           |           |                |        |  |           |     |
| 2.3 T Aero     | 1184           | 01.02 | 02.10 |                |                |        |           |           |                |        |  |           |     |
| 2.3 T Aero     | 1225           | 04.03 | 03.04 |                |                |        |           |           |                |        |  |           |     |
| 2.3 t BioPower | 1136           | 01.07 | 02.10 |                |                |        |           |           |                |        |  |           |     |
| 2.3 t BioPower | 1152           | 11.06 | 02.10 |                |                |        |           |           |                |        |  |           |     |
| 2.3 t BioPower | 1154           | 01.07 | 02.10 |                |                |        |           |           |                |        |  |           |     |
| 3.0 t          | 1147           | 01.02 | 02.10 |                |                |        |           |           |                |        |  |           |     |
| 3.0 TiD        | 1130           | 01.02 | 02.10 |                |                |        |           |           |                |        |  |           |     |
|                | 2.0            | 1136  | 07.00 | 12.01          | 03.2125-7402.3 | 010541 |           | Thz 25,40 | ATE            |        |  |           |     |
|                | 2.0 t          | 1110  | 09.97 | 12.01          |                |        |           |           |                |        |  |           |     |
|                | 2.0 T          | 1129  | 10.98 | 12.01          |                |        |           |           |                |        |  |           |     |
|                | 2.0 Turbo SE   | 1141  | 10.98 | 07.00          |                |        |           |           |                |        |  |           |     |
|                | 2.3 t          | 1125  | 09.97 | 12.01          |                |        |           |           |                |        |  |           |     |
|                | 2.3 t          | 1136  | 01.01 | 12.01          |                |        |           |           |                |        |  |           |     |
|                | 2.3 T Aero     | 1169  | 10.99 | 09.01          |                |        |           |           |                |        |  |           |     |
|                | 2.3 T Aero     | 1184  | 09.01 | 12.01          |                |        |           |           |                |        |  |           |     |
|                | 3.0 t          | 1147  | 01.98 | 12.01          |                |        |           |           |                |        |  |           |     |
|                | 3.0 TiD        | 1130  | 07.01 | 12.01          |                |        |           |           |                |        |  |           |     |
|                | 2.0            | 1136  | 01.02 | 12.05          |                |        |           |           | 03.2125-9901.3 | 010634 |  | Thz 25,40 | ATE |
|                | 2.0 t          | 1110  | 01.02 | 12.05          |                |        |           |           |                |        |  |           |     |
|                | 2.0 T          | 1129  | 01.02 | 12.05          |                |        |           |           |                |        |  |           |     |
|                | 2.0 t BioPower | 1110  | 01.05 | 12.05          |                |        |           |           |                |        |  |           |     |
| 2.2 TiD        | 88             | 03.02 | 12.05 |                |                |        |           |           |                |        |  |           |     |
| 2.3 t          | 1125           | 01.02 | 12.05 |                |                |        |           |           |                |        |  |           |     |
| 2.3 t          | 1136           | 01.02 | 12.05 |                |                |        |           |           |                |        |  |           |     |
| 2.3 T          | 1162           | 07.03 | 12.05 |                |                |        |           |           |                |        |  |           |     |
| 2.3 T          | 1191           | 11.05 | 12.05 |                |                |        |           |           |                |        |  |           |     |
| 2.3 T Aero     | 1184           | 01.02 | 12.05 |                |                |        |           |           |                |        |  |           |     |
| 2.3 T Aero     | 1225           | 04.03 | 03.04 |                |                |        |           |           |                |        |  |           |     |
| 3.0 t          | 1147           | 01.02 | 12.05 |                |                |        |           |           |                |        |  |           |     |
| 3.0 TiD        | 1130           | 01.02 | 12.05 |                |                |        |           |           |                |        |  |           |     |
| 1.9 TiD        | 1110           | 01.06 | 02.10 | 03.2125-9911.3 | 010883         |        | Thz 25,40 | ATE       |                |        |  |           |     |
| 2.0            | 1136           | 01.06 | 02.10 |                |                |        |           |           |                |        |  |           |     |
| 2.0 t          | 1110           | 01.06 | 02.10 |                |                |        |           |           |                |        |  |           |     |
| 2.0 T          | 1129           | 01.06 | 02.10 |                |                |        |           |           |                |        |  |           |     |
| 2.0 t BioPower | 1110           | 01.06 | 02.10 |                |                |        |           |           |                |        |  |           |     |
| 2.0 t BioPower | 1132           | 06.06 | 02.10 |                |                |        |           |           |                |        |  |           |     |
| 2.2 TiD        | 88             | 01.06 | 02.10 |                |                |        |           |           |                |        |  |           |     |
| 2.3 t          | 1125           | 01.06 | 02.10 |                |                |        |           |           |                |        |  |           |     |
| 2.3 T          | 1134           | 04.08 | 02.10 |                |                |        |           |           |                |        |  |           |     |
| 2.3 t          | 1136           | 01.06 | 02.10 |                |                |        |           |           |                |        |  |           |     |
| 2.3 T          | 1162           | 01.06 | 02.10 |                |                |        |           |           |                |        |  |           |     |
| 2.3 T          | 1188           | 04.08 | 02.10 |                |                |        |           |           |                |        |  |           |     |
| 2.3 T          | 1191           | 01.06 | 02.10 |                |                |        |           |           |                |        |  |           |     |
| 2.3 T Aero     | 1184           | 01.06 | 02.10 |                |                |        |           |           |                |        |  |           |     |
| 2.3 t BioPower | 1136           | 01.07 | 02.10 |                |                |        |           |           |                |        |  |           |     |
| 2.3 t BioPower | 1152           | 11.06 | 02.10 |                |                |        |           |           |                |        |  |           |     |
| 2.3 t BioPower | 1154           | 01.07 | 02.10 |                |                |        |           |           |                |        |  |           |     |
| 3.0 t          | 1147           | 01.06 | 02.10 |                |                |        |           |           |                |        |  |           |     |
| 3.0 TiD        | 1130           | 01.06 | 02.10 |                |                |        |           |           |                |        |  |           |     |
|                | 2.0            | 1136  | 07.00 | 12.01          | 03.2125-7502.3 | 010616 |           | Thz 25,40 | ATE            |        |  |           |     |
|                | 2.0 t          | 1110  | 09.97 | 12.01          |                |        |           |           |                |        |  |           |     |
|                | 2.0 T          | 1129  | 10.98 | 12.01          |                |        |           |           |                |        |  |           |     |
|                | 2.0 Turbo SE   | 1141  | 10.98 | 07.00          |                |        |           |           |                |        |  |           |     |
|                | 2.3 t          | 1125  | 09.97 | 12.01          |                |        |           |           |                |        |  |           |     |
|                | 2.3 t          | 1136  | 01.01 | 12.01          |                |        |           |           |                |        |  |           |     |
|                | 2.3 T Aero     | 1169  | 10.99 | 09.01          |                |        |           |           |                |        |  |           |     |

<sup>1)</sup> - 15" wheel / - ruota 15" / - roue 15" / - rueda 15"



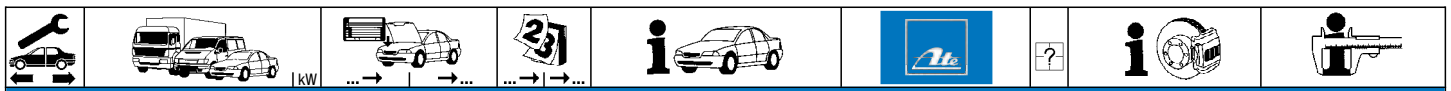













**SAAB 9-5 Limousine (YS3E) (97-10)**

|  |   |   |  |  |   |  |  |  |   |                              |   |  |
|--|---|---|--|--|---|--|--|--|---|------------------------------|---|--|
|  | 2.3 T Aero<br>3.0 t<br>3.0 TiD  | 184<br>147<br>130   |  | 09.01<br>01.98<br>07.01  | 12.01<br>12.01<br>12.01   |  | 03.2125-7502.3   | 010616   |   |                              | Thz 25,40   | ATE                                    |
|  | 1.9 TiD<br>2.0<br>2.0 t<br>2.0 T<br>2.0 t BioPower<br>2.0 t BioPower<br>2.0 Turbo SE<br>2.2 TiD<br>2.3 t<br>2.3 T<br>2.3 t<br>2.3 T<br>2.3 T<br>2.3 T<br>2.3 T Aero<br>2.3 T Aero<br>2.3 T Aero<br>2.3 t BioPower<br>2.3 t BioPower<br>2.3 t BioPower<br>3.0 t<br>3.0 TiD | 110<br>136<br>110<br>129<br>110<br>132<br>141<br>88<br>125<br>134<br>136<br>162<br>188<br>191<br>169<br>184<br>225<br>136<br>152<br>154<br>147<br>130 |  | 01.06<br>07.00<br>09.97<br>10.98<br>01.05<br>06.06<br>10.98<br>03.02<br>09.97<br>04.08<br>01.01<br>07.03<br>04.08<br>11.05<br>10.99<br>09.01<br>04.03<br>01.07<br>11.06<br>01.07<br>01.98<br>07.01 | 02.10<br>02.10<br>02.10<br>02.10<br>02.10<br>02.10<br>07.00<br>02.10<br>02.10<br>02.10<br>02.10<br>02.10<br>02.10<br>02.10<br>09.01<br>02.10<br>03.04<br>02.10<br>02.10<br>02.10<br>02.10<br>02.10<br>02.10 |  | 43.4006-0001.2   | 310028   |   |                              | Behälter  |  |
|  | 2.0 t<br>2.0 t<br>2.0 T<br>2.0 Turbo SE<br>2.0 Turbo SE<br>2.3 t<br>2.3 t   | 110<br>110<br>129<br>141<br>141<br>125<br>125   | X3020000<br><br>X3020000<br><br>X3020000                                 | 09.97<br>09.97<br>10.98<br>10.98<br>09.97<br>09.97   | + (USA)<br>- (USA)<br>12.98<br>12.98<br>+ (USA)<br>- (USA)<br>+ (USA)<br>- (USA)  |  | 11.3571-8525.2<br>11.3571-8526.2<br>11.8171-0008.1<br>11.0101-5407.2<br>11.8116-0292.1<br>11.0441-5704.2 | 220363<br>220364<br>990049<br>260011<br>390521<br>250034 | 2 | + 15" Rad 1)<br>+ 15" Rad 1) | D=57, - Halter<br>D=57, - Halter<br>Führungsbolzen<br>Hülzensatz<br>Haltefeder<br>Dichtungssatz | ATE<br>ATE<br>ATE<br>ATE<br>ATE<br>ATE |
|  | 2.0<br>2.0<br>2.0 t<br>2.0 t<br>2.0 T<br>2.0 Turbo SE<br>2.0 Turbo SE<br>2.3 t<br>2.3 t<br>2.3 t<br>2.3 t   | 136<br>136<br>110<br>110<br>129<br>141<br>141<br>125<br>125<br>136<br>136   | X3020001<br><br>X3020001<br><br>X3020001<br><br>X3020001<br><br>X3020001 | 07.00<br>12.01<br>01.99<br>01.99<br>01.99<br>01.99<br>01.01  | + (USA)<br>- (USA)<br>+ (USA)<br>- (USA)<br>+ (USA)<br>- (USA)<br>+ (USA)<br>- (USA)  |  | 24.3571-1725.5<br>24.3571-1726.5<br>11.0101-5407.2<br>11.0441-5704.2<br>11.8171-0008.1<br>11.8116-0292.1 | 240313<br>240314<br>260011<br>250034<br>990049<br>390521 | 2 | + 15" Rad 1)<br>+ 15" Rad 1) | D=57, - Halter<br>D=57, - Halter<br>Hülzensatz<br>Dichtungssatz<br>Führungsbolzen<br>Haltefeder | ATE<br>ATE<br>ATE<br>ATE<br>ATE<br>ATE |
|  | 2.0<br>2.0 t<br>2.0 T<br>2.0 t BioPower<br>2.0 t BioPower<br>2.2 TiD<br>2.3 t<br>2.3 T<br>2.3 t<br>2.3 T<br>2.3 T<br>2.3 t BioPower<br>2.3 t BioPower<br>2.3 t BioPower   | 136<br>110<br>129<br>110<br>132<br>88<br>125<br>134<br>136<br>162<br>162<br>136<br>152<br>154   | 43510123   | 07.00<br>01.02<br>01.02<br>01.05<br>06.06<br>03.02<br>01.02<br>04.08<br>01.02<br>07.03<br>01.07<br>11.06<br>01.07  | + (USA)<br>- (USA)  |  | 24.3571-1725.5<br>24.3571-1726.5<br>11.0101-5407.2<br>11.0441-5704.2<br>11.8171-0008.1<br>11.8116-0292.1 | 240313<br>240314<br>260011<br>250034<br>990049<br>390521 | 2 | + 15" Rad 1)<br>+ 15" Rad 1) | D=57, - Halter<br>D=57, - Halter<br>Hülzensatz<br>Dichtungssatz<br>Führungsbolzen<br>Haltefeder | ATE<br>ATE<br>ATE<br>ATE<br>ATE<br>ATE |
|  | 2.0 Turbo SE<br>2.3 T Aero<br>2.3 T Aero<br>3.0 t<br>3.0 TiD  | 141<br>169<br>184<br>147<br>130   |  | 01.00<br>10.99<br>09.01<br>01.98<br>07.01  | 07.00<br>09.01<br>12.01<br>12.01<br>12.01   |  | 24.3571-1725.5<br>24.3571-1726.5<br>11.0101-5407.2<br>11.0441-5704.2<br>11.8171-0008.1<br>11.8116-0292.1 | 240313<br>240314<br>260011<br>250034<br>990049<br>390521 | 2 | + 16" Rad 2)<br>+ 16" Rad 2) | D=57, - Halter<br>D=57, - Halter<br>Hülzensatz<br>Dichtungssatz<br>Führungsbolzen<br>Haltefeder | ATE<br>ATE<br>ATE<br>ATE<br>ATE        |
|  | 2.3 T<br>2.3 T<br>2.3 T<br>2.3 T Aero<br>2.3 T Aero<br>3.0 t<br>3.0 TiD   | 162<br>188<br>191<br>184<br>225<br>147<br>130   |  | 07.03<br>04.08<br>11.05<br>01.02<br>04.03<br>01.02<br>01.02  | + (USA)   |  | 24.3571-1725.5<br>24.3571-1726.5<br>11.0101-5407.2<br>11.0441-5704.2<br>11.8171-0008.1<br>11.8116-0292.1 | 240313<br>240314<br>260011<br>250034<br>990049<br>390521 | 2 | + 16" Rad 2)<br>+ 16" Rad 2) | D=57, - Halter<br>D=57, - Halter<br>Hülzensatz<br>Dichtungssatz<br>Führungsbolzen<br>Haltefeder | ATE<br>ATE<br>ATE<br>ATE<br>ATE<br>ATE |
|  | 1.9 TiD<br>2.0<br>2.0 t<br>2.0 T<br>2.0 t BioPower<br>2.0 t BioPower<br>2.0 Turbo SE<br>2.2 TiD<br>2.3 t<br>2.3 T<br>2.3 t<br>2.3 T<br>2.3 T<br>2.3 T<br>2.3 T Aero<br>2.3 T Aero<br>2.3 T Aero   | 110<br>136<br>110<br>129<br>110<br>132<br>141<br>88<br>125<br>134<br>136<br>162<br>188<br>191<br>169<br>184<br>225                                    |  | 01.06<br>07.00<br>09.97<br>10.98<br>01.05<br>06.06<br>10.98<br>03.02<br>09.97<br>04.08<br>01.01<br>07.03<br>04.08<br>11.05<br>10.99<br>09.01<br>04.03  | 02.10<br>02.10<br>02.10<br>02.10<br>02.10<br>02.10<br>07.00<br>02.10<br>02.10<br>02.10<br>02.10<br>02.10<br>02.10<br>02.10<br>09.01<br>02.10<br>03.04   |  | 83.7257-0424.3   | 330985   | 2 |                              | L=423   |  |

1) + 15" wheel / + ruota 15" / + roue 15" / + rueda 15"  
2) + 16" wheel / + ruota 16" / + roue 16" / + rueda 16"



|     |   |   |    |    |    |                        |  |  |  |
|--|---|---|--|--|---|--|--|--|--|
| <b>SAAB 9-5 Limousine (YS3E) (97-10)</b>   |   |   |  |  |   |  |  |  |  |
|    | 2.3 t BioPower<br>2.3 t BioPower<br>2.3 t BioPower<br>3.0 t<br>3.0 TiD  | 136<br>152<br>154<br>147<br>130   |  | 01.07<br>11.06<br>01.07<br>01.98<br>07.01  | 02.10<br>02.10<br>02.10<br>02.10<br>02.10   | 83.7257-0424.3   | 330985   | 2  | L=423  |
|    | 2.0<br>2.0 t<br>2.0 T<br>2.0 t BioPower<br>2.0 t BioPower<br>2.0 Turbo SE<br>2.3 t<br>2.3 T<br>2.3 t BioPower<br>2.3 t BioPower<br>2.3 t BioPower<br>3.0 t  | 136<br>110<br>129<br>110<br>132<br>141<br>125<br>134<br>136<br>152<br>154<br>147  | X3025751<br>X3025751<br>X3025751<br>X3025751<br>X3025751<br>X3025751<br>X3025751<br>X3025751<br>X3025751<br>X3025751<br>X3025751<br>X3025751   | 07.00<br>09.97<br>10.98<br>01.05<br>06.06<br>10.98<br>09.97<br>04.08<br>01.07<br>11.06<br>01.07<br>01.98   |   | 13.0441-3820.2   | 250142   |  | Dichtungssatz<br>ATE   |
|  | 1.9 TiD<br>2.0<br>2.0 t<br>2.0 T<br>2.0 t BioPower<br>2.0 t BioPower<br>2.0 Turbo SE<br>2.2 TiD<br>2.3 t<br>2.3 T<br>2.3 t<br>2.3 T<br>2.3 T<br>2.3 T Aero<br>2.3 T Aero<br>2.3 T Aero<br>2.3 t BioPower<br>2.3 t BioPower<br>2.3 t BioPower<br>3.0 t<br>3.0 TiD          | 110<br>136<br>110<br>129<br>110<br>132<br>141<br>88<br>125<br>134<br>162<br>188<br>169<br>184<br>184<br>136<br>152<br>154<br>147<br>130               | X3025752<br>X3025752<br>X3025752<br>X3025752<br>X3025752<br>X3025752<br>X3025752<br>53500057<br>X3025752<br>X3025752<br>X3025752<br>X3025752   | 01.06<br>02.10<br>02.10<br>02.10<br>02.10<br>02.10<br>07.00<br>03.02<br>02.10<br>02.10<br>01.01<br>07.03<br>04.08<br>10.99<br>09.01<br>09.01<br>02.10<br>02.10<br>02.10<br>12.01<br>12.01<br>07.01 | 02.10<br>02.10<br>02.10<br>02.10<br>02.10<br>02.10<br>02.10<br>02.10<br>02.10<br>02.10<br>02.10<br>02.10<br>02.10<br>02.10<br>02.10<br>02.10<br>02.10<br>02.10<br>02.10<br>02.10<br>02.10<br>02.10          | 11.9381-9957.2<br>11.9381-9958.2<br>11.0101-5407.2<br>11.8171-0008.1<br>11.8116-0143.1<br>11.0441-3803.2 | 220661<br>220662<br>260011<br>990049<br>390513<br>250010                           | 2  | + 15" Rad 1)<br>+ 15" Rad 1)<br>D=38, - Halter<br>D=38, - Halter<br>Hülensatz<br>Führungsbolzen<br>Haltefeder<br>Dichtungssatz<br>ATE<br>ATE<br>ATE<br>ATE<br>ATE<br>ATE |
|  | 2.3 T<br>2.3 T<br>2.3 T Aero<br>2.3 T Aero<br>2.3 T Aero<br>3.0 t<br>3.0 TiD  | 188<br>191<br>184<br>184<br>225<br>147<br>130   | 53500056   | 04.08<br>11.05<br>01.02<br>01.02<br>04.03<br>01.02<br>01.02  | 02.10<br>02.10<br>02.10<br>02.10<br>03.04<br>02.10<br>02.10   | 11.3401-0055.2<br>11.3401-0056.2<br>11.8171-0008.1<br>11.0101-5407.2<br>11.8116-0143.1<br>11.0441-4002.2 | 220519<br>220520<br>990049<br>260011<br>390513<br>250011                           | 2  | + 16" Rad 2)<br>+ 16" Rad 2)<br>D=40, + Halter<br>D=40, + Halter<br>Führungsbolzen<br>Hülensatz<br>Haltefeder<br>Dichtungssatz<br>ATE<br>ATE<br>ATE<br>ATE<br>ATE        |
|  | 1.9 TiD<br>2.0<br>2.0 t<br>2.0 T<br>2.0 t BioPower<br>2.0 t BioPower<br>2.0 Turbo SE<br>2.2 TiD<br>2.3 t<br>2.3 T<br>2.3 t<br>2.3 T<br>2.3 T<br>2.3 T<br>2.3 T Aero<br>2.3 T Aero<br>2.3 T Aero<br>2.3 t BioPower<br>2.3 t BioPower<br>2.3 t BioPower<br>3.0 t<br>3.0 TiD | 110<br>136<br>110<br>129<br>110<br>132<br>141<br>88<br>125<br>134<br>136<br>162<br>188<br>191<br>169<br>184<br>225<br>136<br>152<br>154<br>147<br>130 |  | 01.06<br>07.00<br>09.97<br>10.98<br>01.05<br>06.06<br>10.98<br>03.02<br>09.97<br>04.08<br>01.01<br>07.03<br>04.08<br>11.05<br>10.99<br>09.01<br>04.03<br>01.07<br>11.06<br>01.07<br>01.98<br>07.01 | 02.10<br>02.10<br>02.10<br>02.10<br>02.10<br>02.10<br>07.00<br>02.10<br>02.10<br>02.10<br>02.10<br>02.10<br>02.10<br>02.10<br>02.10<br>02.10<br>02.10<br>02.10<br>02.10<br>02.10<br>02.10<br>02.10<br>02.10 | 24.5233-0200.3<br>83.7119-0180.3   | 330425<br>330634   | 2<br>2   | am Bremssattel 3)<br>L=198<br>L=180  |
|  | 1.9 TiD<br>2.0<br>2.0<br>2.0 t<br>2.0 t<br>2.0 T<br>2.0 t BioPower<br>2.0 t BioPower<br>2.0 t BioPower<br>2.0 Turbo SE<br>2.0 Turbo SE<br>2.2 TiD<br>2.3 t<br>2.3 t<br>2.3 T<br>2.3 T<br>2.3 T<br>2.3 T<br>2.3 T<br>2.3 T   | 110<br>136<br>136<br>110<br>110<br>129<br>110<br>110<br>132<br>132<br>141<br>88<br>125<br>125<br>134<br>134<br>162<br>188<br>191                      | X3001207<br>W3075143<br>X3001207<br>W3075143<br>W3075143<br>X3001207<br>W3075143<br>X3001207<br>W3075143<br>X3001207<br>W3075143<br>X3001207<br>X3001207<br>W3075143<br>W3075143<br>W3075143<br>X3001207<br>W3075143<br>X3001207<br>W3075143<br>W3075143 | 01.06<br>02.10<br>02.10<br>02.10<br>02.10<br>02.10<br>02.10<br>02.10<br>02.10<br>02.10<br>02.10<br>03.02<br>02.10<br>02.10<br>02.10<br>02.10<br>07.03<br>04.08<br>11.05                            | 02.10<br>+ (USA)<br>- (USA)<br>+ (USA)<br>- (USA)<br>02.10<br>02.10<br>+ (USA)<br>- (USA)<br>+ (USA)<br>- (USA)<br>02.10<br>02.10<br>+ (USA)<br>- (USA)<br>02.10<br>02.10<br>02.10                          | 24.3727-1108.2   | 581108   | 2<br>2   | L=1410/1410  |

1) + 15" wheel / + ruota 15" / + roue 15" / + rueda 15"

2) + 16" wheel / + ruota 16" / + roue 16" / + rueda 16"

3) on the brake caliper / sulla pinza freno / sur l'étrier de frein / a la pinza de freno



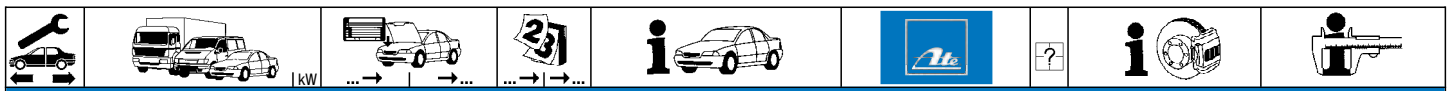

| SAAB 9-5 Limousine (YS3E) (97-10) |                |              |          |               |               |                |        |     |             |
|-----------------------------------|----------------|--------------|----------|---------------|---------------|----------------|--------|-----|-------------|
|                                   | 2.3 T Aero     | 169          |          | 10.99         | 09.01         | 24.3727-1108.2 | 581108 | 2 ↓ | L=1410/1410 |
|                                   | 2.3 T Aero     | 184          |          | 09.01         | 02.10         |                |        |     |             |
|                                   | 2.3 T Aero     | 225          |          | 04.03         | 03.04         |                |        |     |             |
|                                   | 2.3 t BioPower | 136 X3001207 |          |               | 02.10 + (USA) |                |        |     |             |
|                                   | 2.3 t BioPower | 136 W3075143 |          |               | 02.10 - (USA) |                |        |     |             |
|                                   | 2.3 t BioPower | 152 X3001207 |          |               | 02.10 + (USA) |                |        |     |             |
|                                   | 2.3 t BioPower | 152 W3075143 |          |               | 02.10 - (USA) |                |        |     |             |
|                                   | 2.3 t BioPower | 154 X3001207 |          |               | 02.10 + (USA) |                |        |     |             |
|                                   | 2.3 t BioPower | 154 W3075143 |          |               | 02.10 - (USA) |                |        |     |             |
|                                   | 3.0 t          | 147 X3001207 |          |               | 02.10 + (USA) |                |        |     |             |
| 3.0 t                             | 147 W3075143   |              |          | 02.10 - (USA) |               |                |        |     |             |
| 3.0 TiD                           | 130            |              | 07.01    | 02.10         |               |                |        |     |             |
|                                   | 2.0 t          | 110          | X3039386 | 09.97         |               | 24.2415-1703.3 | 030102 |     | Gz 15,87    |
|                                   | 2.0 T          | 129          | X3039386 | 10.98         |               |                |        |     |             |
|                                   | 2.3 t          | 125          | X3039386 | 09.97         |               |                |        |     |             |
|                                   | 3.0 t          | 147          | X3039386 | 01.98         |               |                |        |     |             |



















| SAAB 9-5 Kombi (YS3E) (98-10) |                |         |       |       |       |                |        |  |               |       |                |        |  |               |
|-------------------------------|----------------|---------|-------|-------|-------|----------------|--------|--|---------------|-------|----------------|--------|--|---------------|
|                               | 2.0            | 136     |       | 07.00 | 07.01 | 03.7745-3003.4 | 300157 |  | 8" Tandem ATE |       |                |        |  |               |
|                               | 2.0 t          | 136     |       | 10.98 | 12.01 |                |        |  |               |       |                |        |  |               |
|                               | 2.0 t          | 110     |       | 10.98 | 12.01 |                |        |  |               |       |                |        |  |               |
|                               | 2.3 t          | 125     |       | 10.98 | 12.01 |                |        |  |               |       |                |        |  |               |
|                               | 2.3 t          | 136     |       | 01.01 | 12.01 |                |        |  |               |       |                |        |  |               |
|                               | 2.3 T Aero     | 169     |       | 10.99 | 09.01 |                |        |  |               |       |                |        |  |               |
|                               | 3.0 t          | 147     |       | 10.98 | 12.01 |                |        |  |               |       |                |        |  |               |
|                               | 3.0 TiD        | 130     |       | 07.01 | 12.01 |                |        |  |               |       |                |        |  |               |
|                               |                | 1.9 TiD | 110   |       | 01.06 |                |        |  |               | 02.10 | 03.7745-3902.4 | 300129 |  | 8" Tandem ATE |
|                               |                | 1.9 TiD | 129   |       | 01.07 |                |        |  |               | 02.10 |                |        |  |               |
| 2.0 t                         |                | 136     |       | 01.02 | 02.10 |                |        |  |               |       |                |        |  |               |
| 2.0 t                         |                | 110     |       | 01.02 | 02.10 |                |        |  |               |       |                |        |  |               |
| 2.0 t BioPower                |                | 136     |       | 06.06 | 02.10 |                |        |  |               |       |                |        |  |               |
| 2.0 t BioPower                |                | 110     |       | 01.06 | 02.10 |                |        |  |               |       |                |        |  |               |
| 2.2 TiD                       |                | 88      |       | 03.02 | 02.10 |                |        |  |               |       |                |        |  |               |
| 2.3                           |                | 224     |       | 06.03 | 08.05 |                |        |  |               |       |                |        |  |               |
| 2.3 t                         |                | 125     |       | 01.02 | 02.10 |                |        |  |               |       |                |        |  |               |
| 2.3 t                         |                | 136     |       | 01.02 | 02.10 |                |        |  |               |       |                |        |  |               |
| 2.3 T                         |                | 162     |       | 07.03 | 02.10 |                |        |  |               |       |                |        |  |               |
| 2.3 T                         |                | 188     |       | 04.08 | 02.10 |                |        |  |               |       |                |        |  |               |
| 2.3 T                         |                | 191     |       | 01.06 | 02.10 |                |        |  |               |       |                |        |  |               |
| 2.3 T Aero                    |                | 184     |       | 01.02 | 02.10 |                |        |  |               |       |                |        |  |               |
| 2.3 T Aero                    |                | 225     |       | 04.03 | 03.04 |                |        |  |               |       |                |        |  |               |
| 2.3 t BioPower                |                | 136     |       | 01.07 | 02.10 |                |        |  |               |       |                |        |  |               |
| 2.3 t BioPower                |                | 152     |       | 11.06 | 02.10 |                |        |  |               |       |                |        |  |               |
| 2.3 t BioPower                |                | 154     |       | 01.07 | 02.10 |                |        |  |               |       |                |        |  |               |
| 3.0 t                         |                | 147     |       | 01.02 | 02.10 |                |        |  |               |       |                |        |  |               |
| 3.0 TiD                       |                | 130     |       | 01.02 | 02.10 |                |        |  |               |       |                |        |  |               |
|                               | 2.0            | 136     |       | 07.00 | 07.01 | 03.2125-7402.3 | 010541 |  | Thz 25,40 ATE |       |                |        |  |               |
|                               | 2.0 t          | 136     |       | 10.98 | 12.01 |                |        |  |               |       |                |        |  |               |
|                               | 2.0 t          | 110     |       | 10.98 | 12.01 |                |        |  |               |       |                |        |  |               |
|                               | 2.3 t          | 125     |       | 10.98 | 12.01 |                |        |  |               |       |                |        |  |               |
|                               | 2.3 t          | 136     |       | 01.01 | 12.01 |                |        |  |               |       |                |        |  |               |
|                               | 2.3 T Aero     | 169     |       | 10.99 | 09.01 |                |        |  |               |       |                |        |  |               |
|                               | 3.0 t          | 147     |       | 10.98 | 12.01 |                |        |  |               |       |                |        |  |               |
|                               | 3.0 TiD        | 130     |       | 07.01 | 12.01 |                |        |  |               |       |                |        |  |               |
|                               |                | 2.0 t   | 136   |       | 01.02 |                |        |  |               | 12.05 | 03.2125-9901.3 | 010634 |  | Thz 25,40 ATE |
|                               |                | 2.0 t   | 110   |       | 01.02 |                |        |  |               | 12.05 |                |        |  |               |
| 2.2 TiD                       |                | 88      |       | 03.02 | 12.05 |                |        |  |               |       |                |        |  |               |
| 2.3                           |                | 224     |       | 06.03 | 08.05 |                |        |  |               |       |                |        |  |               |
| 2.3 t                         |                | 125     |       | 01.02 | 12.05 |                |        |  |               |       |                |        |  |               |
| 2.3 t                         |                | 136     |       | 01.02 | 12.05 |                |        |  |               |       |                |        |  |               |
| 2.3 T                         |                | 162     |       | 07.03 | 12.05 |                |        |  |               |       |                |        |  |               |
| 2.3 T                         |                | 191     |       | 11.05 | 12.05 |                |        |  |               |       |                |        |  |               |
| 2.3 T Aero                    |                | 184     |       | 01.02 | 12.05 |                |        |  |               |       |                |        |  |               |
| 2.3 T Aero                    |                | 225     |       | 04.03 | 03.04 |                |        |  |               |       |                |        |  |               |
| 3.0 t                         | 147            |         | 01.02 | 12.05 |       |                |        |  |               |       |                |        |  |               |
| 3.0 TiD                       | 130            |         | 01.02 | 12.05 |       |                |        |  |               |       |                |        |  |               |
|                               | 1.9 TiD        | 110     |       | 01.06 | 02.10 | 03.2125-9911.3 | 010883 |  | Thz 25,40 ATE |       |                |        |  |               |
|                               | 1.9 TiD        | 129     |       | 01.07 | 02.10 |                |        |  |               |       |                |        |  |               |
|                               | 2.0 t          | 136     |       | 01.06 | 02.10 |                |        |  |               |       |                |        |  |               |
|                               | 2.0 t          | 110     |       | 01.06 | 02.10 |                |        |  |               |       |                |        |  |               |
|                               | 2.0 t BioPower | 136     |       | 06.06 | 02.10 |                |        |  |               |       |                |        |  |               |
|                               | 2.0 t BioPower | 110     |       | 01.06 | 02.10 |                |        |  |               |       |                |        |  |               |
|                               | 2.2 TiD        | 88      |       | 01.06 | 02.10 |                |        |  |               |       |                |        |  |               |
|                               | 2.3 t          | 125     |       | 01.06 | 02.10 |                |        |  |               |       |                |        |  |               |
|                               | 2.3 t          | 136     |       | 01.06 | 02.10 |                |        |  |               |       |                |        |  |               |
|                               | 2.3 T          | 162     |       | 01.06 | 02.10 |                |        |  |               |       |                |        |  |               |
| 2.3 T                         | 188            |         | 04.08 | 02.10 |       |                |        |  |               |       |                |        |  |               |
| 2.3 T                         | 191            |         | 01.06 | 02.10 |       |                |        |  |               |       |                |        |  |               |
| 2.3 T Aero                    | 184            |         | 01.06 | 02.10 |       |                |        |  |               |       |                |        |  |               |
| 2.3 t BioPower                | 136            |         | 01.07 | 02.10 |       |                |        |  |               |       |                |        |  |               |
| 2.3 t BioPower                | 152            |         | 11.06 | 02.10 |       |                |        |  |               |       |                |        |  |               |
| 2.3 t BioPower                | 154            |         | 01.07 | 02.10 |       |                |        |  |               |       |                |        |  |               |
| 3.0 t                         | 147            |         | 01.06 | 02.10 |       |                |        |  |               |       |                |        |  |               |
| 3.0 TiD                       | 130            |         | 01.06 | 02.10 |       |                |        |  |               |       |                |        |  |               |
|                               | 2.0            | 136     |       | 07.00 | 07.01 | 03.2125-7502.3 | 010616 |  | Thz 25,40 ATE |       |                |        |  |               |
|                               | 2.0 t          | 136     |       | 10.98 | 12.01 |                |        |  |               |       |                |        |  |               |
|                               | 2.0 t          | 110     |       | 10.98 | 12.01 |                |        |  |               |       |                |        |  |               |



| SAAB 9-5 Kombi (YS3E) (98-10) |  | 03.2125-7502.3  |  | 010616   |  | THz 25,40  |  | ATE    |                              |   |  |
|-------------------------------|--|---|--|--|--|--|--|--------|------------------------------|---|--|
|                               | 2.3 t<br>2.3 t<br>2.3 T Aero<br>3.0 t<br>3.0 TiD   | 125<br>136<br>169<br>147<br>130   |  | 10.98<br>01.01<br>10.99<br>10.98<br>07.01  | 12.01<br>12.01<br>09.01<br>12.01<br>12.01  |  |  |        |                              |   |  |
|                               | 1.9 TiD<br>1.9 TiD<br>2.0<br>2.0 t<br>2.0 t<br>2.0 t BioPower<br>2.0 t BioPower<br>2.2 TiD<br>2.3<br>2.3 t<br>2.3 t<br>2.3 T<br>2.3 T<br>2.3 T<br>2.3 T Aero<br>2.3 T Aero<br>2.3 T Aero<br>2.3 t BioPower<br>2.3 t BioPower<br>2.3 t BioPower<br>3.0 t<br>3.0 TiD | 110<br>129<br>136<br>110<br>110<br>88<br>224<br>125<br>136<br>162<br>188<br>191<br>169<br>184<br>225<br>136<br>152<br>154<br>147<br>130 |  | 01.06<br>01.07<br>07.00<br>10.98<br>10.98<br>06.06<br>01.06<br>03.02<br>06.03<br>10.98<br>01.02<br>07.03<br>04.08<br>01.06<br>10.99<br>09.01<br>04.03<br>01.07<br>11.06<br>01.07<br>10.98<br>07.01 | 02.10<br>02.10<br>07.01<br>02.10<br>02.10<br>02.10<br>02.10<br>02.10<br>08.05<br>02.10<br>02.10<br>02.10<br>02.10<br>02.10<br>09.01<br>02.10<br>03.04<br>02.10<br>02.10<br>02.10<br>02.10<br>02.10 | 43.4006-0001.2   | 310028   |        | Behälter                     |   |  |
|                               | 2.0<br>2.0<br>2.0 t<br>2.0 t<br>2.0 t<br>2.0 t<br>2.3 t<br>2.3 t   | 136<br>136<br>110<br>110<br>125<br>125  | X3020000<br>X3020000<br>X3020000<br>X3020000 | 07.00<br>07.00<br>10.98<br>10.98<br>10.98<br>10.98   | 07.01<br>07.01<br>- (USA)<br>- (USA)<br>- (USA)<br>- (USA)   | 11.3571-8525.2<br>11.3571-8526.2<br>11.8171-0008.1<br>11.0101-5407.2<br>11.8116-0292.1<br>11.0441-5704.2 | 220363<br>220364<br>990049<br>260011<br>390521<br>250034 | 2<br>2 | + 15" Rad 1)<br>+ 15" Rad 1) | D=57, - Halter<br>D=57, - Halter<br>Führungsbolzen<br>Hülzensatz<br>Haltefeder<br>Dichtungssatz | ATE<br>ATE<br>ATE<br>ATE<br>ATE<br>ATE |
|                               | 2.0<br>2.0<br>2.0 t<br>2.0 t<br>2.0 t<br>2.0 t<br>2.3 t<br>2.3 t   | 136<br>136<br>110<br>110<br>125<br>136  | X3020001<br>X3020001<br>X3020001<br>X3020001 | 07.00<br>07.00<br>01.99<br>01.99<br>01.99<br>01.01   | + (USA)<br>- (USA)<br>+ (USA)<br>+ (USA)<br>- (USA)<br>- (USA)   | 24.3571-1725.5<br>24.3571-1726.5<br>11.0101-5407.2<br>11.0441-5704.2<br>11.8171-0008.1<br>11.8116-0292.1 | 240313<br>240314<br>260011<br>250034<br>990049<br>390521 | 2<br>2 | + 15" Rad 1)<br>+ 15" Rad 1) | D=57, - Halter<br>D=57, - Halter<br>Hülzensatz<br>Dichtungssatz<br>Führungsbolzen<br>Haltefeder | ATE<br>ATE<br>ATE<br>ATE<br>ATE<br>ATE |
|                               | 1.9 TiD<br>1.9 TiD<br>2.0 t<br>2.0 t BioPower<br>2.0 t BioPower<br>2.2 TiD<br>2.3 t<br>2.3 t<br>2.3 T<br>2.3 T<br>2.3 T BioPower<br>2.3 t BioPower<br>2.3 t BioPower   | 110<br>129<br>110<br>110<br>88<br>125<br>136<br>162<br>162<br>136<br>152<br>154   | 43510123                                     | 01.06<br>01.07<br>01.02<br>06.06<br>01.06<br>03.02<br>01.02<br>01.02<br>07.03<br>01.07<br>11.06<br>01.07   | 02.10<br>02.10<br>02.10<br>02.10<br>02.10<br>02.10<br>02.10<br>02.10<br>02.10<br>02.10<br>02.10<br>02.10   | 24.3571-1725.5<br>24.3571-1726.5<br>11.0101-5407.2<br>11.0441-5704.2<br>11.8171-0008.1<br>11.8116-0292.1 | 240313<br>240314<br>260011<br>250034<br>990049<br>390521 | 2      | + 15" Rad 1)<br>+ 15" Rad 1) | D=57, - Halter<br>D=57, - Halter<br>Hülzensatz<br>Dichtungssatz<br>Führungsbolzen<br>Haltefeder | ATE<br>ATE<br>ATE<br>ATE<br>ATE<br>ATE |
|                               | 2.0<br>2.3 T Aero<br>2.3 T Aero<br>3.0 t<br>3.0 TiD  | 136<br>169<br>184<br>147<br>130   |  | 07.00<br>10.99<br>09.01<br>10.98<br>07.01  | 07.01<br>09.01<br>12.01<br>12.01<br>12.01  | 24.3571-1725.5<br>24.3571-1726.5<br>11.0101-5407.2<br>11.0441-5704.2<br>11.8171-0008.1<br>11.8116-0292.1 | 240313<br>240314<br>260011<br>250034<br>990049<br>390521 | 2      | + 16" Rad 2)<br>+ 16" Rad 2) | D=57, - Halter<br>D=57, - Halter<br>Hülzensatz<br>Dichtungssatz<br>Führungsbolzen<br>Haltefeder | ATE<br>ATE<br>ATE<br>ATE<br>ATE        |
|                               | 2.3<br>2.3 T<br>2.3 T<br>2.3 T<br>2.3 T Aero<br>2.3 T Aero<br>2.3 t BioPower<br>2.3 t BioPower<br>3.0 t<br>3.0 TiD   | 224<br>162<br>188<br>191<br>184<br>225<br>136<br>152<br>147<br>130  |  | 06.03<br>07.03<br>04.08<br>01.06<br>01.02<br>04.03<br>01.07<br>11.06<br>01.02<br>01.02   | 02.10<br>02.10<br>02.10<br>02.10<br>02.10<br>02.10<br>02.10<br>02.10<br>02.10<br>02.10   | 24.3571-1725.5<br>24.3571-1726.5<br>11.0101-5407.2<br>11.0441-5704.2<br>11.8171-0008.1<br>11.8116-0292.1 | 240313<br>240314<br>260011<br>250034<br>990049<br>390521 | 2      | + 16" Rad 2)<br>+ 16" Rad 2) | D=57, - Halter<br>D=57, - Halter<br>Hülzensatz<br>Dichtungssatz<br>Führungsbolzen<br>Haltefeder | ATE<br>ATE<br>ATE<br>ATE<br>ATE<br>ATE |
|                               | 1.9 TiD<br>1.9 TiD<br>2.0<br>2.0 t<br>2.0 t<br>2.0 t BioPower<br>2.0 t BioPower<br>2.2 TiD<br>2.3<br>2.3 t<br>2.3 t<br>2.3 T<br>2.3 T  | 110<br>129<br>136<br>110<br>110<br>88<br>224<br>125<br>136<br>162<br>188  |  | 01.06<br>01.07<br>07.00<br>10.98<br>10.98<br>06.06<br>01.06<br>03.02<br>06.03<br>10.98<br>01.02<br>07.03<br>04.08  | 02.10<br>02.10<br>07.01<br>02.10<br>02.10<br>02.10<br>02.10<br>02.10<br>08.05<br>02.10<br>02.10<br>02.10<br>02.10  | 83.7257-0424.3   | 330985   | 2      |                              | L=423   |  |

1) + 15" wheel / + ruota 15" / + roue 15" / + rueda 15"























2) + 16" wheel / + ruota 16" / + roue 16" / + rueda 16"



























| SAAB 9-5 Kombi (YS3E) (98-10)  |  |  |  |  |   |  |  |  |  |                |  |   |  |     |
|--|--|--|--|--|---|--|--|--|--|----------------|--|---|--|-----|
|     |    |    |    |    |    |                        |  |  |  |                |  |   |  |     |
|    | 2.3 T<br>2.3 T Aero<br>2.3 T Aero<br>2.3 T Aero<br>2.3 t BioPower<br>2.3 t BioPower<br>2.3 t BioPower<br>3.0 t<br>3.0 TiD  | 191<br>169<br>184<br>225<br>136<br>152<br>154<br>147<br>130  |  | 01.06<br>10.99<br>09.01<br>04.03<br>01.07<br>11.06<br>01.07<br>10.98<br>07.01  | 02.10<br>09.01<br>02.10<br>03.04<br>02.10<br>02.10<br>02.10<br>02.10  | 83.7257-0424.3   | 330985   | 2  |  |                |  |   | L=423                                  |     |
|    | 2.0 t<br>2.0 t<br>2.0 t BioPower<br>2.0 t BioPower<br>2.3 t<br>2.3 t BioPower<br>2.3 t BioPower<br>2.3 t BioPower<br>3.0 t   | 110<br>110<br>110<br>125<br>136<br>152<br>154<br>147   | X3025751<br>X3025751<br>X3025751<br>X3025751<br>X3025751<br>X3025751<br>X3025751<br>X3025751   | 10.98<br>10.98<br>06.06<br>01.06<br>10.98<br>01.07<br>11.06<br>01.07<br>10.98  |   | 13.0441-3820.2   | 250142   |  |  |                |  |   | Dichtungssatz                          | ATE |
|    | 1.9 TiD<br>1.9 TiD<br>2.0<br>2.0 t<br>2.0 t<br>2.0 t BioPower<br>2.0 t BioPower<br>2.2 TiD<br>2.3 t<br>2.3 t<br>2.3 T<br>2.3 T Aero<br>2.3 T Aero<br>2.3 T Aero<br>2.3 t BioPower<br>2.3 t BioPower<br>2.3 t BioPower<br>3.0 t<br>3.0 TiD                          | 110<br>129<br>136<br>110<br>110<br>110<br>88<br>125<br>136<br>162<br>169<br>184<br>184<br>136<br>152<br>154<br>147<br>130                      | X3025752<br>X3025752<br>X3025752<br>X3025752<br>X3025752<br>X3025752<br>X3025752<br>X3025752   | 01.06<br>01.07<br>07.00<br>02.10<br>02.10<br>02.10<br>02.10<br>03.02<br>01.01<br>07.03<br>10.99<br>09.01<br>09.01<br>02.10<br>02.10<br>02.10<br>12.01<br>07.01                                     | 02.10<br>02.10<br>07.01<br>02.10<br>02.10<br>02.10<br>02.10<br>02.10<br>02.10<br>02.10<br>09.01<br>12.01<br>02.10<br>02.10<br>02.10<br>12.01<br>12.01   | 11.9381-9957.2<br>11.9381-9958.2<br>11.0101-5407.2<br>11.8171-0008.1<br>11.8116-0143.1<br>11.0441-3803.2 | 220661<br>220662<br>260011<br>990049<br>390513<br>250010                           | 2  |  + 15" Rad <sup>1)</sup><br> + 15" Rad <sup>1)</sup> |                |  | D=38, - Halter<br>D=38, - Halter<br>Hülzensatz<br>Führungsbolzen<br>Haltefeder<br>Dichtungssatz | ATE<br>ATE<br>ATE<br>ATE<br>ATE<br>ATE |     |
|   | 2.3<br>2.3 T<br>2.3 T<br>2.3 T Aero<br>2.3 T Aero<br>2.3 T Aero<br>3.0 t<br>3.0 TiD  | 224<br>188<br>191<br>184<br>184<br>225<br>147<br>130   | 53500056   | 06.03<br>04.08<br>01.06<br>01.02<br>01.02<br>04.03<br>01.02<br>01.02   | 08.05<br>02.10<br>02.10<br>02.10<br>02.10<br>03.04<br>02.10<br>02.10  | 11.3401-0055.2<br>11.3401-0056.2<br>11.8171-0008.1<br>11.0101-5407.2<br>11.8116-0143.1<br>11.0441-4002.2 | 220519<br>220520<br>990049<br>260011<br>390513<br>250011                           | 2  |  + 16" Rad <sup>2)</sup><br> + 16" Rad <sup>2)</sup> | + USA<br>- USA |  | D=40, + Halter<br>D=40, + Halter<br>Führungsbolzen<br>Hülzensatz<br>Haltefeder<br>Dichtungssatz | ATE<br>ATE<br>ATE<br>ATE<br>ATE<br>ATE |     |
|  | 1.9 TiD<br>1.9 TiD<br>2.0<br>2.0 t<br>2.0 t<br>2.0 t BioPower<br>2.0 t BioPower<br>2.2 TiD<br>2.3<br>2.3 t<br>2.3 t<br>2.3 T<br>2.3 T<br>2.3 T<br>2.3 T Aero<br>2.3 T Aero<br>2.3 T Aero<br>2.3 t BioPower<br>2.3 t BioPower<br>2.3 t BioPower<br>3.0 t<br>3.0 TiD | 110<br>129<br>136<br>110<br>110<br>110<br>88<br>224<br>125<br>136<br>162<br>188<br>191<br>169<br>184<br>225<br>136<br>152<br>154<br>147<br>130 |  | 01.06<br>01.07<br>07.00<br>10.98<br>10.98<br>06.06<br>01.06<br>03.02<br>06.03<br>10.98<br>01.02<br>07.03<br>04.08<br>01.06<br>09.01<br>09.01<br>04.03<br>01.07<br>11.06<br>01.07<br>10.98<br>07.01 | 02.10<br>02.10<br>07.01<br>02.10<br>02.10<br>02.10<br>02.10<br>02.10<br>08.05<br>02.10<br>02.10<br>02.10<br>02.10<br>09.01<br>02.10<br>02.10<br>03.04<br>02.10<br>02.10<br>02.10<br>02.10<br>02.10<br>02.10 | 24.5233-0200.3<br>83.7119-0180.3   | 330425<br>330634   | 2<br>2   |  |                |  | am Bremssattel <sup>3)</sup>  | L=198<br>L=180                         |     |
|  | 1.9 TiD<br>1.9 TiD<br>2.0<br>2.0<br>2.0 t<br>2.0 t<br>2.0 t<br>2.0 t<br>2.0 t BioPower<br>2.0 t BioPower<br>2.0 t BioPower<br>2.2 TiD<br>2.3<br>2.3 t<br>2.3 t<br>2.3 T<br>2.3 T<br>2.3 T  | 110<br>129<br>136<br>136<br>110<br>110<br>110<br>88<br>110<br>110<br>110<br>88<br>224<br>125<br>125<br>136<br>162<br>188<br>191                | X3001207<br>W3075143<br>X3001207<br>W3075143<br>X3001207<br>W3075143<br>X3001207<br>W3075143<br>X3001207<br>W3075143<br>X3001207<br>W3075143<br>X3001207<br>X3001207<br>X3001207<br>W3075143 | 01.06<br>01.07<br>07.01<br>07.01<br>02.10<br>02.10<br>02.10<br>02.10<br>02.10<br>02.10<br>02.10<br>02.10<br>03.02<br>06.03<br>02.10<br>02.10<br>07.03<br>04.08<br>01.06                            | 02.10<br>02.10<br>+ USA<br>- USA<br>+ USA<br>- USA<br>+ USA<br>- USA<br>+ USA<br>- USA<br>+ USA<br>- USA<br>02.10<br>08.05<br>+ USA<br>- USA<br>02.10<br>02.10<br>02.10                                     | 24.3727-1108.2   | 581108   | 2<br>2   |  |                |  |   | L=1410/1410                            |     |

<sup>1)</sup> + 15" wheel / + ruota 15" / + roue 15" / + rueda 15"

<sup>2)</sup> + 16" wheel / + ruota 16" / + roue 16" / + rueda 16"

<sup>3)</sup> on the brake caliper / sulla pinza freno / sur l'étrier de frein / a la pinza de freno

|     |   |    |  |  |    |    |  |  |   |
|--|---|--|--|--|---|--|--|--|---|
| <b>SAAB 9-5 Kombi (YS3E) (98-10)</b>   |   |  |  |  |   |  |  |  |   |
|    | 2.3 T Aero<br>2.3 T Aero<br>2.3 T Aero<br>2.3 t BioPower<br>2.3 t BioPower<br>2.3 t BioPower<br>2.3 t BioPower<br>2.3 t BioPower<br>2.3 t BioPower<br>3.0 t<br>3.0 t<br>3.0 TiD | 169<br>184<br>225<br>136 X3001207<br>136 W3075143<br>152 W3075143<br>152 X3001207<br>154 X3001207<br>154 W3075143<br>147 X3001206<br>147 W3075143<br>130 |  | 10.99<br>09.01<br>04.03  | 09.01<br>02.10<br>03.04<br>02.10 + (USA)<br>02.10 - (USA)<br>02.10 - (USA)<br>02.10 + (USA)<br>02.10 + (USA)<br>02.10 - (USA)<br>02.10 + (USA)<br>02.10 - (USA)<br>07.01<br>02.10 | 24.3727-1108.2   | 581108   | 2 ↓  | L=1410/1410   |
|    | 2.0 t<br>2.0 t<br>2.3 t<br>3.0 t  | 110<br>125<br>147  | X3039386<br>X3039386<br>X3039386<br>X3039386                                     | 10.98<br>10.98<br>10.98<br>10.98   |   | 24.2415-1703.3   | 030102   |  | Gz 15,87  |
| <b>SAAB 9-5 II (10-12)</b>   |   |  |  |  |   |  |  |  |   |
|    | 1.6 T<br>2.0 T<br>2.0 T BioPower<br>2.0 T BioPower XWD<br>2.0 T XWD<br>2.0 TiD<br>2.0 TTiD<br>2.0 TTiD XWD<br>2.8 T V6 XWD  | 1132<br>1162<br>1162<br>1162<br>1162<br>1118<br>1140<br>1140<br>1221   |  | 03.10<br>03.10<br>03.10<br>03.10<br>03.10<br>03.10<br>03.10<br>03.10<br>03.10    | 06.12<br>06.12<br>06.12<br>06.12<br>06.12<br>06.12<br>06.12<br>06.12<br>06.12   | 03.7858-0732.4   | 300272   |  | 9/8" Tandem<br>ATE  |
|    | 1.6 T<br>2.0 T<br>2.0 T BioPower<br>2.0 T BioPower XWD<br>2.0 T XWD<br>2.0 TiD<br>2.0 TTiD<br>2.0 TTiD XWD<br>2.8 T V6 XWD  | 1132<br>1162<br>1162<br>1162<br>1162<br>1118<br>1140<br>1140<br>1221   |  | 03.10<br>03.10<br>03.10<br>03.10<br>03.10<br>03.10<br>03.10<br>03.10<br>03.10    | 06.12<br>06.12<br>06.12<br>06.12<br>06.12<br>06.12<br>06.12<br>06.12<br>06.12   | 03.2125-0421.3   | 010934   |  | Thz 25,40<br>ATE  |
| <b>SAAB 900 (94-98)</b>  |   |  |  |  |   |  |  |  |   |
|   | 2.0 16V Turbo<br>2.0 i<br>2.3 16V<br>2.5 V6   | 1132<br>1162<br>1162<br>1162   |  | 09.93<br>09.93<br>09.93<br>09.93   | 03.98<br>03.98<br>03.98<br>03.98  | 03.2123-1121.3   | 010176   |  | Thz 23,81<br>ATE  |
|  | 2.0 16V Turbo<br>2.0 16V Turbo<br>2.0 i<br>2.0 i<br>2.3 16V<br>2.3 16V  | 1132<br>1162<br>1162<br>1162<br>1162<br>1162   | T7003723<br>T2024503<br>T7003723<br>T2024503<br>T7003723<br>T2024503             | 09.93<br>09.93<br>09.93<br>09.93<br>09.93<br>09.93                               |   | 03.2123-1121.3   | 010176   |  | Thz 23,81<br>ATE  |
|  | 2.0 16V Turbo<br>2.0 i<br>2.3 16V<br>2.5 V6   | 1132<br>1162<br>1162<br>1162   |  | 09.93<br>09.93<br>09.93<br>09.93   | 08.96<br>08.96<br>08.96<br>08.96  | 11.3541-8085.2<br>24.3541-8086.5<br>24.3541-8085.5<br>11.8171-0008.1<br>11.0101-5407.2<br>11.8116-0292.1<br>11.0441-5704.2 | 220287<br>240526<br>240525<br>990049<br>260011<br>390521<br>250034                 | 2<br>2   | D=54, + Halter<br>D=54, - Halter<br>D=54, - Halter<br>Führungsbolzen<br>Hülzensatz<br>Haltefeder<br>Dichtungssatz<br>ATE<br>ATE<br>ATE<br>ATE<br>ATE<br>ATE |
|  | 2.0 16V Turbo<br>2.0 i<br>2.3 16V<br>2.5 V6   | 1132<br>1162<br>1162<br>1162   |  | 09.96<br>09.96<br>09.96<br>09.96   | 03.98<br>03.98<br>03.98<br>03.98  | 11.3571-8525.2<br>11.3571-8526.2<br>11.0101-5407.2<br>11.8171-0008.1<br>11.8116-0292.1                                     | 220363<br>220364<br>260011<br>990049<br>390521                                     | 2<br>2   | D=57, - Halter<br>D=57, - Halter<br>Hülzensatz<br>Führungsbolzen<br>Haltefeder<br>ATE<br>ATE<br>ATE<br>ATE<br>ATE   |
|  | 2.0 16V Turbo<br>2.0 i<br>2.3 16V<br>2.5 V6   | 1132<br>1162<br>1162<br>1162   |  | 09.93<br>09.93<br>09.93<br>09.93   | 03.98<br>03.98<br>03.98<br>03.98  | 83.7288-0318.3<br>24.5298-0322.3   | 330375<br>331314   | 2<br>2   | L=315<br>L=322  |
|  | 2.0 16V Turbo<br>2.0 i<br>2.3 16V<br>2.5 V6   | 1132<br>1162<br>1162<br>1162   |  | 09.93<br>09.93<br>09.93<br>09.93   | 08.96<br>08.96<br>08.96<br>08.96  | 13.2351-0013.2<br>13.2351-0014.2<br>24.9235-0013.5<br>24.9235-0014.5<br>13.0441-3506.2                                     | 210010<br>210011<br>230001<br>230002<br>250052                                     | 2<br>2   | D=35<br>D=35<br>D=35<br>D=35<br>Dichtungssatz<br>ATE<br>ATE<br>ATE<br>ATE<br>ATE  |
|  | 2.0 16V Turbo<br>2.0 i<br>2.3 16V<br>2.5 V6   | 1132<br>1162<br>1162<br>1162   |  | 09.96<br>09.96<br>09.96<br>09.96   | 03.98<br>03.98<br>03.98<br>03.98  | 13.2351-0025.2<br>13.2351-0026.2<br>13.0441-3506.2   | 210210<br>210211<br>250052   | 2<br>2   | D=35<br>D=35<br>Dichtungssatz<br>ATE<br>ATE<br>ATE  |
|  | 2.0 16V Turbo<br>2.0 i<br>2.3 16V<br>2.5 V6   | 1132<br>1162<br>1162<br>1162   | R2017931<br>R2017931<br>R2017931<br>R2017931                                     | 03.98<br>03.98<br>03.98<br>03.98   |   | 24.5117-0205.3   | 330669   | 2<br>2   | L=205   |
|  | 2.0 16V Turbo<br>2.0 i<br>2.3 16V<br>2.5 V6   | 1132<br>1162<br>1162<br>1162   | R2024559<br>R2024559<br>R2024559<br>R2024559                                     | 03.98<br>03.98<br>03.98<br>03.98   |   | 24.5117-0195.3   | 330565   | 2<br>2   | L=198   |
|  | 2.0 16V Turbo<br>2.0 16V Turbo<br>2.0 i<br>2.0 i<br>2.3 16V<br>2.3 16V  | 1132<br>1162<br>1162<br>1162<br>1162<br>1162   | V7002550<br>V2011537<br>V7002550<br>V2011537<br>V7002550<br>V2011537             | 03.98<br>03.98<br>03.98<br>03.98<br>03.98<br>03.98                               |   | 24.3727-1106.2   | 581106   | 2 ↓  | L=2180  |

|     |  |  |  |  |                                 |                        |  |   |
|--|--|--|--|--|--|--|--|---|
| <b>SAAB 900 (94-98)</b>  |  |  |  |  |  |  |  |   |
|    | 2.5 V6<br>2.5 V6   | V7002550<br>V2011537   |  | 03.98<br>03.98   | 24.3727-1106.2   | 581106   | 2 ↓  | L=2180  |
|    | 2.0 16V Turbo<br>2.0 i<br>2.3 16V<br>2.5 V6                                      |  |  | 09.93<br>09.93<br>09.93<br>09.93   | 03.98<br>03.98<br>03.98<br>03.98   | 24.2419-1727.3   | 030116   | Gz 19,05  |
| <b>SAAB 9000 (85-93)</b>   |  |  |  |  |  |  |  |   |
|    | 2.0 16V<br>2.0 16V Turbo<br>2.3 16V<br>2.3 16V Turbo                             |  |  | 08.92<br>08.92<br>08.92<br>08.92   | 08.93 + ABS/ - ASR/ - TCS<br>08.93 + ABS/ - ASR/ - TCS<br>08.93 + ABS/ - ASR/ - TCS<br>08.93 + ABS/ - ASR/ - TCS | 10.6123-0522.3   | 010633   | Thz 23,81<br><b>ATE</b>   |
|    | 2.0 16V<br>2.0 16V Turbo   |  |  | 09.86<br>09.86   | 08.89<br>08.87   | 24.0101-3601.2   | 260044   | Einbausatz<br><b>LUC</b>  |
|    | 2.0 16V<br>2.0 16V Turbo<br>2.3 16V<br>2.3 16V Turbo                             |  |  | 09.89<br>09.87<br>09.89<br>09.89   | 08.93<br>08.93<br>08.93<br>08.93   | 11.3571-8008.2<br>11.0441-5702.2<br>11.0101-5407.2<br>11.8171-0008.1<br>11.8116-0073.1                   | 220118<br>250033<br>260011<br>990049<br>390498                                     | D=57<br>Dichtungssatz<br>Hülzensatz<br>Führungsbolzen<br>Haltefeder<br><b>ATE</b><br><b>ATE</b><br><b>ATE</b><br><b>ATE</b>                       |
|    | 2.0 16V<br>2.0 16V Turbo<br>2.3 16V<br>2.3 16V Turbo                             |  |  | 09.84<br>09.84<br>09.89<br>09.89   | 08.93<br>08.93<br>08.93<br>08.93   | 83.6169-0505.3   | 330288   | L=505   |
|    | 2.0 16V<br>2.0 16V Turbo<br>2.3 16V<br>2.3 16V Turbo                             |  |  | 09.84<br>09.84<br>09.89<br>09.89   | 08.93<br>08.93<br>08.93<br>08.93   | 11.3334-8001.2<br>11.3334-8002.2<br>11.0441-3302.2<br>11.0101-5407.2<br>11.8171-0008.1<br>11.8116-0047.1 | 220006<br>220007<br>250004<br>260011<br>990049<br>390494                           | D=33<br>D=33<br>Dichtungssatz<br>Hülzensatz<br>Führungsbolzen<br>Haltefeder<br><b>ATE</b><br><b>ATE</b><br><b>ATE</b><br><b>ATE</b><br><b>ATE</b> |
|    | 2.0 16V<br>2.0 16V Turbo<br>2.3 16V<br>2.3 16V Turbo                             |  |  | 09.84<br>09.84<br>09.89<br>09.89   | 08.93<br>08.93<br>08.93<br>08.93   | 83.6155-0327.3   | 330287   | L=325   |
|    | 2.0 16V<br>2.0 16V Turbo   |  |  | 09.86<br>09.86   | 08.89<br>08.89   | 24.3727-1105.2<br>24.3727-1107.2   | 581105<br>581107   | L=2024<br>L=1892  |
|   | 2.0 16V<br>2.0 16V Turbo<br>2.3 16V<br>2.3 16V Turbo                             |  |  | 09.89<br>09.89<br>09.89<br>09.89   | 08.93<br>08.93<br>08.93<br>08.93   | 24.3727-1105.2<br>24.3727-1107.2   | 581105<br>581107   | L=2024<br>L=1892  |
| <b>SAAB 9000 (94-98)</b>   |  |  |  |  |  |  |  |   |
|  | 2.0 16V<br>2.0 16V Turbo<br>2.3 16V<br>2.3 16V Turbo<br>3.0 V6                   |  |  | 09.93<br>09.93<br>09.93<br>09.93<br>09.94  | 05.98 - ASR/ - TCS<br>05.98 - ASR/ - TCS<br>05.98 - ASR/ - TCS<br>05.98 - ASR/ - TCS<br>05.98 - ASR/ - TCS       | 10.6123-0522.3   | 010633   | Thz 23,81<br><b>ATE</b>   |
|  | 2.0 16V<br>2.0 16V Turbo<br>2.3 16V<br>2.3 16V Turbo<br>3.0 V6                   |  |  | 09.93<br>09.93<br>09.93<br>09.93<br>09.94  | 05.98<br>05.98<br>05.98<br>05.98<br>05.98  | 11.3571-8008.2<br>11.0441-5702.2<br>11.0101-5407.2<br>11.8171-0008.1<br>11.8116-0073.1                   | 220118<br>250033<br>260011<br>990049<br>390498                                     | D=57<br>Dichtungssatz<br>Hülzensatz<br>Führungsbolzen<br>Haltefeder<br><b>ATE</b><br><b>ATE</b><br><b>ATE</b><br><b>ATE</b><br><b>ATE</b>         |
|  | 2.0 16V<br>2.0 16V Turbo<br>2.3 16V<br>2.3 16V Turbo<br>3.0 V6                   |  |  | 09.93<br>09.93<br>09.93<br>09.93<br>09.94  | 05.98<br>05.98<br>05.98<br>05.98<br>05.98  | 83.6169-0505.3   | 330288   | L=505   |
|  | 2.0 16V<br>2.0 16V Turbo<br>2.3 16V<br>2.3 16V Turbo<br>3.0 V6                   |  |  | 09.93<br>09.93<br>09.93<br>09.93<br>09.94  | 05.98<br>05.98<br>05.98<br>05.98<br>05.98  | 11.3334-8001.2<br>11.3334-8002.2<br>11.0441-3302.2<br>11.0101-5407.2<br>11.8171-0008.1<br>11.8116-0047.1 | 220006<br>220007<br>250004<br>260011<br>990049<br>390494                           | D=33<br>D=33<br>Dichtungssatz<br>Hülzensatz<br>Führungsbolzen<br>Haltefeder<br><b>ATE</b><br><b>ATE</b><br><b>ATE</b><br><b>ATE</b><br><b>ATE</b> |
|  | 2.0 16V<br>2.0 16V Turbo<br>2.3 16V<br>2.3 16V Turbo<br>3.0 V6                   |  |  | 09.93<br>09.93<br>09.93<br>09.93<br>09.94  | 09.96<br>08.96<br>08.96<br>08.96<br>08.96  | 83.6155-0327.3   | 330287   | L=325   |
|  | 2.0 16V<br>2.0 16V Turbo<br>2.3 16V<br>2.3 16V Turbo<br>3.0 V6                   |  |  | 09.96<br>09.96<br>09.96<br>09.96<br>09.96  | 05.98<br>05.98<br>05.98<br>05.98<br>05.98  | 83.6169-0325.3   | 330546   | L=325   |
|  | 2.0 16V<br>2.0 16V Turbo<br>2.3 16V<br>2.3 16V Turbo<br>3.0 V6                   |  |  | 09.93<br>09.93<br>09.93<br>09.93<br>09.94  | 08.96<br>08.96<br>08.96<br>08.96<br>08.96  | 24.3727-1105.2<br>24.3727-1107.2   | 581105<br>581107   | L=2024<br>L=1892  |
|  | 2.0 16V<br>2.0 16V Turbo<br>2.3 16V<br>2.3 16V Turbo<br>3.0 V6                   |  |  | 09.96<br>09.96<br>09.96<br>09.96<br>09.96  | 05.98<br>05.98<br>05.98<br>05.98<br>05.98  | 24.3727-1105.2<br>24.3727-1107.2   | 581105<br>581107   | L=2024<br>L=1892  |

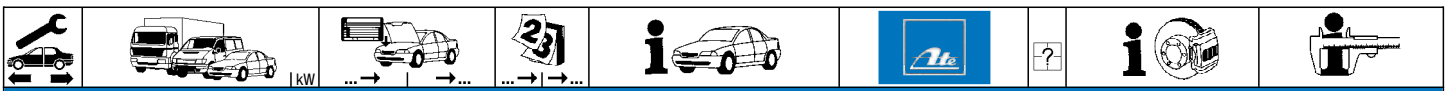

**SEAT ALHAMBRA I (96-10)**

|         |                  |           |             |             |       |                |                |        |                   |               |
|---------|------------------|-----------|-------------|-------------|-------|----------------|----------------|--------|-------------------|---------------|
|         | 1.8 T 20V        | 110       | 7M-W-507041 | 05.98       |       | 03.7760-3002.4 | 300120         |        | 10"               | ATE           |
|         | 1.9 TDI          | 66        | 7M-W-507041 | 03.96       |       |                |                |        |                   |               |
|         | 1.9 TDI          | 81        | 7M-W-507041 | 10.97       |       |                |                |        |                   |               |
|         | 2.0 i            | 85        | 7M-W-507041 | 03.96       |       |                |                |        |                   |               |
|         | 1.8 T 20V        | 110       | 7M-W-507042 |             | 05.00 | 03.7755-1902.4 | 300138         |        | 9" Tandem         | ATE           |
|         | 1.9 TDI          | 66        | 7M-W-507042 |             | 05.00 |                |                |        |                   |               |
|         | 1.9 TDI          | 81        | 7M-W-507042 |             | 05.00 |                |                |        |                   |               |
|         | 2.0 i            | 85        | 7M-W-507042 |             | 05.00 |                |                |        |                   |               |
|         | 1.8 T 20V        | 110       | 7M-3-515799 | 06.00       |       | 03.7755-6302.4 | 300221         | - ESP  | 9/8" Tandem       | ATE           |
|         | 1.9 TDI          | 66        | 7M-3-515799 | 06.00       |       | 03.7858-3302.4 | 300122         | + ESP  | 9/8" Tandem       | ATE           |
|         | 1.9 TDI          | 85        | 7M-3-515799 | 06.00       |       |                |                |        |                   |               |
|         | 1.9 TDI          | 96        | 7M-3-515799 | 11.02       |       |                |                |        |                   |               |
|         | 1.9 TDI 4motion  | 85        | 7M-3-515799 | 02.01       |       |                |                |        |                   |               |
|         | 2.0 i            | 85        | 7M-3-515799 | 06.00       |       |                |                |        |                   |               |
|         | 2.8 i V6         | 150       | 7M-3-515799 | 06.00       |       |                |                |        |                   |               |
|         | 2.8 i V6 4motion | 150       | 7M-3-515799 | 02.01       |       |                |                |        |                   |               |
|         | 1.8 T 20V        | 110       | 7M-3-515800 |             | 08.10 | 03.7755-6302.4 | 300221         | - ESP  | 9/8" Tandem       | ATE           |
|         | 1.9 TDI          | 66        | 7M-3-515800 |             | 08.10 | 03.7858-9502.4 | 300205         | + ESP  | 9/8" Tandem       | ATE           |
|         | 1.9 TDI          | 85        | 7M-3-515800 |             | 08.10 |                |                |        |                   |               |
|         | 1.9 TDI          | 96        | 7M-3-515800 |             | 08.10 |                |                |        |                   |               |
|         | 1.9 TDI          | 110       |             | 05.05       | 08.10 |                |                |        |                   |               |
|         | 1.9 TDI 4motion  | 85        | 7M-3-515800 |             | 08.10 |                |                |        |                   |               |
|         | 1.9 TDI 4motion  | 96        |             | 06.05       | 08.10 |                |                |        |                   |               |
|         | 2.0 i            | 85        | 7M-3-515800 |             | 08.10 |                |                |        |                   |               |
|         | 2.0 TDI          | 103       |             | 11.05       | 08.10 |                |                |        |                   |               |
|         | 2.8 i V6         | 150       | 7M-3-515800 |             | 08.10 |                |                |        |                   |               |
|         | 2.8 i V6 4motion | 150       | 7M-3-515800 |             | 08.10 |                |                |        |                   |               |
|         |                  | 1.8 T 20V | 110         |             | 05.98 | 05.00          | 03.7760-3002.4 | 300120 | + ABS             | 10"           |
| 1.9 TDI |                  | 66        |             | 03.96       | 05.00 |                |                |        |                   |               |
| 1.9 TDI |                  | 81        |             | 10.97       | 05.00 |                |                |        |                   |               |
| 2.0 i   |                  | 85        |             | 03.96       | 05.00 |                |                |        |                   |               |
|         | 1.8 T 20V        | 110       |             | 06.00       | 08.10 | 03.7755-6302.4 | 300221         | - ESP  | 9/8" Tandem       | ATE           |
|         | 1.9 TDI          | 66        |             | 06.00       | 08.10 |                |                |        |                   |               |
|         | 1.9 TDI          | 85        |             | 06.00       | 08.10 |                |                |        |                   |               |
|         | 1.9 TDI          | 96        |             | 11.02       | 08.10 |                |                |        |                   |               |
|         | 1.9 TDI          | 110       |             | 05.05       | 08.10 |                |                |        |                   |               |
|         | 1.9 TDI 4motion  | 85        |             | 02.01       | 08.10 |                |                |        |                   |               |
|         | 1.9 TDI 4motion  | 96        |             | 06.05       | 08.10 |                |                |        |                   |               |
|         | 2.0 i            | 85        |             | 06.00       | 08.10 |                |                |        |                   |               |
|         | 2.0 TDI          | 103       |             | 11.05       | 08.10 |                |                |        |                   |               |
|         | 2.8 i V6         | 150       |             | 06.00       | 08.10 |                |                |        |                   |               |
|         | 2.8 i V6 4motion | 150       |             | 02.01       | 08.10 |                |                |        |                   |               |
|         |                  | 1.8 T 20V | 110         | 7M-W-507041 | 05.98 |                | 03.2123-1548.3 | 010478 | - ABS             | THz 23,81     |
| 1.9 TDI |                  | 66        | 7M-W-507041 | 03.96       |       | 03.2123-1526.3 | 010477         | + ABS  | THz 23,81         | ATE           |
| 1.9 TDI |                  | 81        | 7M-W-507041 | 10.97       |       | 03.3517-5100.1 | 390326         | - ABS  | Verschlußschraube | ATE           |
| 2.0 i   |                  | 85        | 7M-W-507041 | 03.96       |       |                |                |        |                   |               |
|         | 1.8 T 20V        | 110       | 7M-W-507042 |             | 05.00 | 03.2125-8404.3 | 010583         | - ABS  | THz 25,40         | ATE           |
|         | 1.9 TDI          | 66        | 7M-W-507042 |             | 05.00 | 03.2125-0343.3 | 010896         | + ABS  | THz 25,40         | ATE           |
|         | 1.9 TDI          | 81        | 7M-W-507042 |             | 05.00 |                |                |        |                   |               |
|         | 2.0 i            | 85        | 7M-W-507042 |             | 05.00 |                |                |        |                   |               |
|         | 1.8 T 20V        | 110       | 7M-3-515799 | 06.00       |       | 03.2125-0343.3 | 010896         | - ESP  | THz 25,40         | ATE           |
|         | 1.9 TDI          | 66        | 7M-3-515799 | 06.00       |       | 03.2125-9604.3 | 010581         | + ESP  | THz 25,40         | ATE           |
|         | 1.9 TDI          | 85        | 7M-3-515799 | 06.00       |       |                |                |        |                   |               |
|         | 1.9 TDI          | 96        | 7M-3-515799 | 11.02       |       |                |                |        |                   |               |
|         | 1.9 TDI 4motion  | 85        | 7M-3-515799 | 02.01       |       |                |                |        |                   |               |
|         | 2.0 i            | 85        | 7M-3-515799 | 06.00       |       |                |                |        |                   |               |
|         | 2.8 i V6         | 150       | 7M-3-515799 | 06.00       |       |                |                |        |                   |               |
|         | 2.8 i V6 4motion | 150       | 7M-3-515799 | 02.01       |       |                |                |        |                   |               |
|         | 1.8 T 20V        | 110       | 7M-3-515800 |             | 08.10 | 03.2125-0343.3 | 010896         | - ESP  | THz 25,40         | ATE           |
|         | 1.9 TDI          | 66        | 7M-3-515800 |             | 08.10 |                |                |        |                   |               |
|         | 1.9 TDI          | 85        | 7M-3-515800 |             | 08.10 |                |                |        |                   |               |
|         | 1.9 TDI          | 96        | 7M-3-515800 |             | 08.10 |                |                |        |                   |               |
|         | 1.9 TDI          | 110       |             | 05.05       | 08.10 |                |                |        |                   |               |
|         | 1.9 TDI 4motion  | 85        | 7M-3-515800 |             | 08.10 |                |                |        |                   |               |
|         | 1.9 TDI 4motion  | 96        |             | 06.05       | 08.10 |                |                |        |                   |               |
|         | 2.0 i            | 85        | 7M-3-515800 |             | 08.10 |                |                |        |                   |               |
|         | 2.0 TDI          | 103       |             | 11.05       | 08.10 |                |                |        |                   |               |
|         | 2.8 i V6         | 150       | 7M-3-515800 |             | 08.10 |                |                |        |                   |               |
|         | 2.8 i V6 4motion | 150       | 7M-3-515800 |             | 08.10 |                |                |        |                   |               |
|         |                  | 1.8 T 20V | 110         |             | 05.98 | 05.00          | 11.0441-5704.2 | 250034 |                   | Dichtungssatz |
| 1.9 TDI |                  | 66        |             | 03.96       | 05.00 | 11.0101-5409.2 | 260035         |        | Hülsensatz        | ATE           |
| 1.9 TDI |                  | 81        |             | 10.97       | 05.00 | 11.8171-0008.1 | 990049         |        | Führungsbolzen    | ATE           |
| 2.0 i   |                  | 85        |             | 03.96       | 05.00 | 11.8116-0143.1 | 390513         | 2      | Haltefeder        | ATE           |
|         | 1.8 T 20V        | 110       | 7M-1-530756 | 06.00       |       | 11.0441-5704.2 | 250034         |        | Dichtungssatz     | ATE           |
|         | 1.9 TDI          | 66        | 7M-1-530756 | 06.00       |       | 11.0101-5409.2 | 260035         |        | Hülsensatz        | ATE           |
|         | 1.9 TDI          | 85        | 7M-1-530756 | 06.00       |       | 11.8171-0008.1 | 990049         |        | Führungsbolzen    | ATE           |
|         | 2.0 i            | 85        | 7M-1-530756 | 06.00       |       | 11.8116-0143.1 | 390513         | 2      | Haltefeder        | ATE           |
|         | 1.9 TDI          | 66        | 7M-2-500001 |             | 08.10 | 11.9571-9811.2 | 220485         |        | D=57, - Halter    | ATE           |
|         | 1.9 TDI          | 85        | 7M-2-500001 |             | 08.10 | 11.9571-9812.2 | 220486         |        | D=57, - Halter    | ATE           |
|         | 1.9 TDI          | 96        |             | 11.02       | 08.10 | 11.0441-5704.2 | 250034         |        | Dichtungssatz     | ATE           |
|         | 2.0 i            | 85        | 7M-2-500001 |             | 08.10 | 11.0101-5706.2 | 260097         |        | Hülsensatz        | ATE           |
|         | 2.0 TDI          | 103       |             | 11.05       | 08.10 | 11.8171-0067.1 | 250153         |        | Führungsbolzen    | ATE           |
|         |                  |           |             |             |       | 11.8116-0326.1 | 390471         | 2      | Haltefeder        | ATE           |

























### SEAT ALHAMBRA I (96-10)

|                  |                  |     |             |       |       |       |                |        |   |     |   |
|------------------|------------------|-----|-------------|-------|-------|-------|----------------|--------|---|-----|---|
|                  | 1.8 T 20V        | 110 | 7M-2-500001 |       | 05.98 | 08.10 | 11.9571-9819.2 | 220469 | 2 | ATE | D=57, - Halter<br>ATE<br>D=57, - Halter<br>ATE<br>Hülzensatz<br>ATE<br>Führungsbolzen<br>ATE<br>Haltefeder<br>ATE |
|                  | 1.9 TDI          | 110 |             |       | 05.05 | 08.10 | 11.9571-9820.2 | 220470 |   |     |   |
|                  | 1.9 TDI 4motion  | 85  |             |       | 02.01 | 08.10 | 11.0101-5705.2 | 260096 |   |     |   |
|                  | 1.9 TDI 4motion  | 96  |             |       | 06.05 | 08.10 | 11.8171-0067.1 | 250153 |   |     |   |
|                  | 2.8 i V6         | 150 |             |       | 06.00 | 08.10 | 11.8116-0326.1 | 390471 |   |     |   |
|                  | 2.8 i V6 4motion | 150 |             |       | 02.01 | 08.10 |                |        |   |     |   |
|                  | 1.8 T 20V        | 110 | 7M-1-530756 | 05.98 |       |       | 83.7717-0450.3 | 330807 | 2 | ATE | L=450<br>L=454  |
|                  | 1.9 TDI          | 66  | 7M-1-530756 | 03.96 |       |       | 24.5166-0454.3 | 331306 |   |     |   |
|                  | 1.9 TDI          | 81  |             |       | 10.97 | 05.00 |                |        |   |     |   |
|                  | 1.9 TDI          | 85  |             |       | 06.00 |       |                |        |   |     |   |
|                  | 1.9 TDI          | 96  | 7M-1-530756 | 11.02 |       |       |                |        |   |     |   |
|                  | 1.9 TDI 4motion  | 96  | 7M-1-530756 | 06.05 |       |       |                |        |   |     |   |
|                  | 2.0 i            | 85  | 7M-1-530756 | 03.96 |       |       |                |        | 2 | ATE | L=455   |
|                  | 1.8 T 20V        | 110 | 7M-2-500001 |       |       | 08.10 | 83.6219-0455.3 | 330592 |   |     |   |
|                  | 1.9 TDI          | 66  | 7M-2-500001 |       |       | 08.10 |                |        |   |     |   |
|                  | 1.9 TDI          | 85  | 7M-2-500001 |       |       | 08.10 |                |        |   |     |   |
|                  | 1.9 TDI          | 96  | 7M-2-500001 |       |       | 08.10 |                |        |   |     |   |
|                  | 1.9 TDI          | 110 |             |       | 05.05 | 08.10 |                |        |   |     |   |
|                  | 1.9 TDI 4motion  | 85  |             |       | 02.01 | 08.10 |                |        |   |     |   |
|                  | 1.9 TDI 4motion  | 96  | 7M-2-500001 |       |       | 08.10 |                |        |   |     |   |
|                  | 2.0 i            | 85  | 7M-2-500001 |       |       | 08.10 |                |        |   |     |   |
|                  | 2.0 TDI          | 103 |             |       | 11.05 | 08.10 |                |        |   |     |   |
|                  | 2.8 i V6         | 150 |             |       | 06.00 | 08.10 |                |        |   |     |   |
| 2.8 i V6 4motion | 150              |     |             | 02.01 | 08.10 |       |                |        |   |     |   |
|                  | 1.8 T 20V        | 110 | 7M-1-530756 | 05.98 |       |       | 24.3384-1707.5 | 240171 | 2 | LUC | D=38, - Halter<br>LUC<br>D=38, - Halter<br>LUC<br>Faltenbalsatz<br>LUC  |
|                  | 1.9 TDI          | 66  |             |       | 03.96 | 08.10 | 24.3384-1708.5 | 240172 |   |     |   |
|                  | 1.9 TDI          | 81  |             |       | 10.97 | 05.00 | 11.0101-5403.2 | 260010 |   |     |   |
|                  | 1.9 TDI          | 85  |             |       | 06.00 | 08.10 |                |        |   |     |   |
|                  | 1.9 TDI          | 96  |             |       | 11.02 | 08.10 |                |        |   |     |   |
|                  | 2.0 i            | 85  |             |       | 03.96 | 08.10 |                |        |   |     |   |
|                  | 2.0 TDI          | 103 |             |       | 11.05 | 08.10 |                |        | 2 | LUC | D=38, - Halter<br>LUC<br>D=38, - Halter<br>LUC  |
|                  | 1.8 T 20V        | 110 | 7M-2-500001 |       |       | 08.10 | 24.3384-1715.5 | 240265 |   |     |   |
|                  | 1.9 TDI          | 110 |             |       | 05.05 | 08.10 | 24.3384-1716.5 | 240266 |   |     |   |
|                  | 1.9 TDI 4motion  | 85  |             |       | 02.01 | 08.10 |                |        |   |     |   |
|                  | 1.9 TDI 4motion  | 96  |             |       | 06.05 | 08.10 |                |        |   |     |   |
|                  | 2.8 i V6         | 150 |             |       | 06.00 | 08.10 |                |        |   |     |   |
|                  | 2.8 i V6 4motion | 150 |             |       | 02.01 | 08.10 |                |        | 2 | LUC | L=370<br>L=140  |
|                  | 1.8 T 20V        | 110 |             |       | 05.98 | 08.10 | 83.6225-0370.3 | 330768 |   |     |   |
|                  | 1.9 TDI          | 66  |             |       | 03.96 | 08.10 | 83.6113-0140.3 | 330482 |   |     |   |
|                  | 1.9 TDI          | 81  |             |       | 10.97 | 05.00 |                |        |   |     |   |
|                  | 1.9 TDI          | 85  |             |       | 06.00 | 08.10 |                |        |   |     |   |
|                  | 1.9 TDI          | 96  |             |       | 11.02 | 08.10 |                |        |   |     |   |
|                  | 1.9 TDI          | 110 |             |       | 05.05 | 08.10 |                |        |   |     |   |
|                  | 1.9 TDI 4motion  | 85  |             |       | 02.01 | 08.10 |                |        |   |     |   |
|                  | 1.9 TDI 4motion  | 96  |             |       | 06.05 | 08.10 |                |        |   |     |   |
|                  | 2.0 i            | 85  |             |       | 03.96 | 08.10 |                |        |   |     |   |
|                  | 2.0 TDI          | 103 |             |       | 11.05 | 08.10 |                |        |   |     |   |
|                  | 2.8 i V6         | 150 |             |       | 06.00 | 08.10 |                |        | 2 | ATE | L=1293  |
|                  | 2.8 i V6 4motion | 150 |             |       | 02.01 | 08.10 |                |        |   |     |   |
|                  | 1.8 T 20V        | 110 |             |       | 05.98 | 04.00 | 24.3727-0163.2 | 580163 |   |     |   |
|                  | 1.9 TDI          | 66  |             |       | 03.96 | 08.10 |                |        |   |     |   |
|                  | 1.9 TDI          | 81  |             |       | 10.97 | 05.00 |                |        |   |     |   |
|                  | 1.9 TDI          | 85  |             |       | 06.00 | 08.10 |                |        |   |     |   |
|                  | 1.9 TDI          | 96  |             |       | 11.02 | 08.10 |                |        | 2 | ATE | Gz 19,05  |
|                  | 1.9 TDI          | 110 |             |       | 05.05 | 08.10 |                |        |   |     |   |
|                  | 2.0 i            | 85  |             |       | 03.96 | 08.10 |                |        |   |     |   |
|                  | 2.0 TDI          | 103 |             |       | 11.05 | 08.10 |                |        |   |     |   |
|                  | 1.8 T 20V        | 110 |             |       | 05.98 | 08.10 | 24.2419-1722.3 | 030111 |   |     |   |
|                  | 1.9 TDI          | 66  |             |       | 03.96 | 08.10 |                |        |   |     |   |
|                  | 1.9 TDI          | 81  |             |       | 10.97 | 05.00 |                |        |   |     |   |
|                  | 1.9 TDI          | 85  |             |       | 06.00 | 08.10 |                |        |   |     |   |
|                  | 1.9 TDI          | 96  |             |       | 11.02 | 08.10 |                |        |   |     |   |
|                  | 1.9 TDI          | 110 |             |       | 05.05 | 08.10 |                |        |   |     |   |
|                  | 1.9 TDI 4motion  | 85  |             |       | 02.01 | 08.10 |                |        |   |     |   |
| 1.9 TDI 4motion  | 96               |     |             | 06.05 | 08.10 |       |                |        |   |     |   |
| 2.0 i            | 85               |     |             | 03.96 | 08.10 |       |                |        |   |     |   |
| 2.0 TDI          | 103              |     |             | 11.05 | 08.10 |       |                |        |   |     |   |
| 2.8 i V6         | 150              |     |             | 06.00 | 08.10 |       |                |        |   |     |   |
| 2.8 i V6 4motion | 150              |     |             | 02.01 | 08.10 |       |                |        |   |     |   |















### SEAT ALHAMBRA II (10-)

|  |                 |     |  |  |       |  |                |        |   |     |           |
|--|-----------------|-----|--|--|-------|--|----------------|--------|---|-----|-----------|
|  | 1.4 TSI         | 110 |  |  | 09.10 |  | 03.7873-4502.4 | 300284 | 2 | ATE | 11"       |
|  | 1.8 TFSI        | 118 |  |  | 11.12 |  |                |        |   |     |           |
|  | 2.0 TDI         | 85  |  |  | 04.11 |  |                |        |   |     |           |
|  | 2.0 TDI         | 100 |  |  | 09.10 |  |                |        |   |     |           |
|  | 2.0 TDI         | 103 |  |  | 06.10 |  |                |        |   |     |           |
|  | 2.0 TDI         | 125 |  |  | 09.10 |  |                |        |   |     |           |
|  | 2.0 TDI         | 130 |  |  | 11.12 |  |                |        |   |     |           |
|  | 2.0 TDI 4motion | 103 |  |  | 04.11 |  |                |        |   |     |           |
|  | 2.0 TSI         | 147 |  |  | 09.10 |  |                |        |   |     |           |
|  | 1.4 TSI         | 110 |  |  | 09.10 |  | 03.4153-0186.3 | 010816 | 2 | ATE | 1Hz 23,81 |
|  | 1.8 TFSI        | 118 |  |  | 11.12 |  |                |        |   |     |           |
|  | 2.0 TDI         | 85  |  |  | 04.11 |  |                |        |   |     |           |
|  | 2.0 TDI         | 100 |  |  | 09.10 |  |                |        |   |     |           |
|  | 2.0 TDI         | 103 |  |  | 06.10 |  |                |        |   |     |           |
|  | 2.0 TDI         | 125 |  |  | 09.10 |  |                |        |   |     |           |

1) on the brake caliper / sulla pinza freno / sur l'étrier de frein / a la pinza de freno

|     |   |  |    |   |  |  |    |  |
|--|---|--|--|---|---|--|--|--|
| <b>SEAT ALHAMBRA II (10-)</b>  |   |  |  |   |   |  |  |  |
|    | 2.0 TDI #130<br>2.0 TDI 4motion #103<br>2.0 TSI #147  |  | 11.12<br>04.11<br>09.10  |   | 03.4153-0186.3  | 010816   |  | Thz 23,81 ATE  |
|    | 1.4 TSI 110<br>1.8 TFSI 118<br>2.0 TDI 85<br>2.0 TDI 100<br>2.0 TDI 103<br>2.0 TDI 125<br>2.0 TDI 130<br>2.0 TDI 4motion 103<br>2.0 TSI 147   |  | 09.10<br>11.12<br>04.11<br>09.10<br>06.10<br>09.10<br>11.12<br>04.11<br>09.10  | PR: 1LJ<br>PR: 1LJ<br>PR: 1LJ<br>PR: 1LJ<br>PR: 1LJ<br>PR: 1LJ<br>PR: 1LJ<br>PR: 1LJ<br>PR: 1LJ   | 11.9571-9759.2<br>11.9571-9760.2<br>11.8171-0008.1<br>11.0101-5409.2              | 220847<br>220848<br>990049<br>260035   | <br> | D=57, - Halter<br>D=57, - Halter<br>Führungsbolzen<br>Hülzensatz ATE<br>ATE<br>ATE |
|    | 1.4 TSI 110<br>1.8 TFSI 118<br>2.0 TDI 85<br>2.0 TDI 100<br>2.0 TDI 103<br>2.0 TDI 125<br>2.0 TDI 130<br>2.0 TDI 4motion 103<br>2.0 TSI 147   |  | 09.10<br>11.12<br>04.11<br>09.10<br>06.10<br>09.10<br>11.12<br>04.11<br>09.10  |   | 24.5143-0257.3  | 331167   | 2  | L=257  |
| <b>SEAT ALTEA (5P1) (04-)</b>  |   |  |  |   |   |  |  |  |
|    | 1.2 TSI #77<br>1.4 i 16V #63<br>1.4 TSI #92<br>1.6 i 16V #75<br>1.6 LPG #75<br>1.6 TDI #<br>1.8 TFSI #118<br>1.9 TDI #<br>2.0 FSI #110<br>2.0 i 16V #100<br>2.0 TDI #100<br>2.0 TDI #103<br>2.0 TDI #125<br>2.0 TFSI #147 |  | 04.10<br>05.06<br>11.07<br>03.04<br>09.09<br>10.09<br>01.07<br>03.04<br>03.04<br>03.04<br>03.04<br>03.04<br>03.06<br>03.06 | 04.10 PR: 1AC,1AT<br>04.10 PR: 1AC,1AT<br>04.10 PR: 1AC,1AT<br>04.10 PR: 1AC,1AT<br>04.10 PR: 1AC,1AT<br>04.10 PR: 1AC,1AT<br>04.10 PR: 1AC,1AT<br>04.10 PR: 1AC,1AT<br>04.10 PR: 1AC,1AT<br>04.10 PR: 1AC,1AT<br>04.10 PR: 1AC,1AT<br>04.10 PR: 1AC,1AT<br>04.10 PR: 1AC,1AT<br>04.10 PR: 1AC,1AT                                | 03.7863-9502.4  | 300204   | Kolbendurchmesser Ø 22,20mm <sup>1)</sup>  | 10" ATE  |
|    | 1.2 TSI #77<br>1.4 i 16V #63<br>1.4 TSI #92<br>1.6 i 16V #75<br>1.6 LPG #75<br>1.6 TDI #<br>1.8 TFSI #118<br>1.9 TDI #<br>2.0 FSI #110<br>2.0 i 16V #100<br>2.0 TDI #100<br>2.0 TDI #103<br>2.0 TDI #125<br>2.0 TFSI #147 |  | 04.10<br>05.06<br>11.07<br>03.04<br>09.09<br>10.09<br>01.07<br>03.04<br>03.04<br>03.04<br>03.04<br>03.06<br>03.06          | 04.10 PR: 1AS<br>04.10 PR: 1AS<br>04.10 PR: 1AS<br>04.10 PR: 1AS<br>04.10 PR: 1AS<br>04.10 PR: 1AS<br>04.10 PR: 1AS<br>04.10 PR: 1AS<br>04.10 PR: 1AS<br>04.10 PR: 1AS<br>04.10 PR: 1AS<br>04.10 PR: 1AS<br>04.10 PR: 1AS   | 03.7863-9602.4  | 300206   | Kolbendurchmesser Ø 22,20mm <sup>1)</sup>  | 10" ATE  |
|  | 1.2 TSI #77<br>1.4 i 16V #63<br>1.4 TSI #92<br>1.6 i 16V #75<br>1.6 LPG #75<br>1.6 TDI #<br>1.8 TFSI #118<br>1.9 TDI #<br>2.0 FSI #110<br>2.0 i 16V #100<br>2.0 TDI #100<br>2.0 TDI #103<br>2.0 TDI #125<br>2.0 TFSI #147 |  | 04.10<br>05.06<br>11.07<br>03.04<br>09.09<br>10.09<br>01.07<br>03.04<br>03.04<br>03.04<br>03.04<br>03.06<br>03.06          | 04.10 PR: 1AC,1AT,1AS<br>04.10 PR: 1AC,1AT,1AS<br>04.10 PR: 1AC,1AT,1AS<br>04.10 PR: 1AC,1AT,1AS<br>04.10 PR: 1AC,1AT,1AS<br>04.10 PR: 1AC,1AT,1AS<br>04.10 PR: 1AC,1AT,1AS<br>04.10 PR: 1AC,1AT,1AS<br>04.10 PR: 1AC,1AT,1AS<br>04.10 PR: 1AC,1AT,1AS<br>04.10 PR: 1AC,1AT,1AS<br>04.10 PR: 1AC,1AT,1AS<br>04.10 PR: 1AC,1AT,1AS | 03.2122-2129.3  | 010799   |  | Thz 22,20 ATE  |
|  | 1.2 TSI #77<br>1.4 i 16V #63<br>1.4 TSI #92<br>1.6 i 16V #75<br>1.6 LPG #75<br>1.6 TDI #<br>1.8 TFSI #118<br>1.9 TDI #<br>2.0 FSI #110<br>2.0 i 16V #100<br>2.0 TDI #100<br>2.0 TDI #103<br>2.0 TDI #125<br>2.0 TFSI #147 |  | 05.10<br>05.10<br>05.10<br>05.10<br>05.10<br>05.10<br>05.10<br>05.10<br>05.10<br>05.10<br>05.10<br>05.10<br>05.10          | PR: 1AC,1AT,1AS<br>PR: 1AC,1AT,1AS<br>PR: 1AC,1AT,1AS<br>PR: 1AC,1AT,1AS<br>PR: 1AC,1AT,1AS<br>PR: 1AC,1AT,1AS<br>PR: 1AC,1AT,1AS<br>PR: 1AC,1AT,1AS<br>PR: 1AC,1AT,1AS<br>PR: 1AC,1AT,1AS<br>PR: 1AC,1AT,1AS<br>PR: 1AC,1AT,1AS  | 03.2122-2129.3  | 010799   |  | Thz 22,20 ATE  |
|  | 1.2 TSI #77<br>1.4 i 16V #63<br>1.4 TSI #92<br>1.6 i 16V #75<br>1.6 LPG #75<br>1.6 TDI #<br>1.8 TFSI #118<br>1.9 TDI #  |  | 05.10<br>05.10<br>05.10<br>05.10<br>05.10<br>05.10<br>05.10  | PR: 1AC,1AT,1LJ<br>PR: 1AC,1AT,1LJ<br>PR: 1AC,1AT,1LJ<br>PR: 1AC,1AT,1LJ<br>PR: 1AC,1AT,1LJ<br>PR: 1AC,1AT,1LJ<br>PR: 1AC,1AT,1LJ   | 03.2123-3449.3  | 010808   |  | Thz 23,81 ATE  |

<sup>1)</sup> piston diameter Ø 22,20mm / diametro del pistone Ø 22,20mm / diamètre de piston Ø 22,20mm / diámetro del pistón Ø 22,20mm

|     |    |  |                                   |    |   |  |  |   |
|--|--|--|---|--|--|--|--|---|
| <b>SEAT ALTEA (5P1) (04-)</b>  |  |  |   |  |  |  |  |   |
|    | 2.0 FSI<br>2.0 i 16V<br>2.0 TDI<br>2.0 TDI<br>2.0 TDI<br>2.0 TFSI  | #110<br>#100<br>#100<br>#103<br>#125<br>#147                                     | 05.10<br>05.10<br>05.10<br>05.10<br>05.10<br>05.10  | PR: 1AC,1AT,1LJ<br>PR: 1AC,1AT,1LJ<br>PR: 1AC,1AT,1LJ<br>PR: 1AC,1AT,1LJ<br>PR: 1AC,1AT,1LJ<br>PR: 1AC,1AT,1LJ   | 03.2123-3449.3<br>010808   |  |  | Thz 23,81<br><b>ATE</b>   |
|    | 1.2 TSI<br>1.4 i 16V<br>1.4 TSI<br>1.6 i 16V<br>1.6 LPG<br>1.6 TDI<br>1.8 TFSI<br>1.9 TDI<br>2.0 FSI<br>2.0 i 16V<br>2.0 TDI<br>2.0 TDI<br>2.0 TDI<br>2.0 TFSI | 77<br>63<br>92<br>75<br>75<br>118<br>110<br>100<br>100<br>103<br>125<br>147      | 04.10<br>05.06<br>11.07<br>03.04<br>09.09<br>10.09<br>01.07<br>03.04<br>03.04<br>03.04<br>03.04<br>03.06<br>03.06 | PR: 1ZF<br>PR: 1ZF<br>PR: 1ZF<br>PR: 1ZF<br>PR: 1ZF<br>PR: 1ZF<br>PR: 1ZF<br>PR: 1ZF<br>PR: 1ZF<br>PR: 1ZF<br>PR: 1ZF<br>PR: 1ZF   | 11.9541-9549.2<br>11.9541-9550.2<br>11.0101-5409.2<br>220575<br>220576<br>260035   |  |  | D=54, - Halter<br>D=54, - Halter<br>Hülensatz<br><b>ATE</b><br><b>ATE</b><br><b>ATE</b>   |
|  | 1.2 TSI<br>1.4 i 16V<br>1.4 TSI<br>1.6 i 16V<br>1.6 LPG<br>1.6 TDI<br>1.8 TFSI<br>1.9 TDI<br>2.0 FSI<br>2.0 i 16V<br>2.0 TDI<br>2.0 TDI<br>2.0 TDI<br>2.0 TFSI | 77<br>63<br>92<br>75<br>75<br>118<br>110<br>100<br>100<br>103<br>125<br>147      | 04.10<br>05.06<br>11.07<br>03.04<br>09.09<br>10.09<br>01.07<br>03.04<br>03.04<br>03.04<br>03.06<br>03.06          | PR: 1ZE<br>PR: 1ZE<br>PR: 1ZE<br>PR: 1ZE<br>PR: 1ZE<br>PR: 1ZE<br>PR: 1ZE<br>PR: 1ZE<br>PR: 1ZE<br>PR: 1ZE<br>PR: 1ZE<br>PR: 1ZE   | 11.9541-9553.2<br>11.9541-9554.2<br>11.0101-5409.2<br>11.8171-0008.1<br>11.8116-0351.1<br>220563<br>220564<br>260035<br>990049<br>390538 | 2  |  | D=54, - Halter<br>D=54, - Halter<br>Hülensatz<br>Führungsbolzen<br>Haltefeder<br><b>ATE</b><br><b>ATE</b><br><b>ATE</b><br><b>ATE</b><br><b>ATE</b> |
|  | 1.2 TSI<br>1.4 i 16V<br>1.4 TSI<br>1.6 i 16V<br>1.6 LPG<br>1.6 TDI<br>1.8 TFSI<br>1.9 TDI<br>2.0 FSI<br>2.0 i 16V<br>2.0 TDI<br>2.0 TDI<br>2.0 TDI<br>2.0 TFSI | 77<br>63<br>92<br>75<br>75<br>118<br>110<br>100<br>100<br>103<br>125<br>147      | 04.10<br>05.06<br>11.07<br>03.04<br>09.09<br>10.09<br>01.07<br>03.04<br>03.04<br>03.04<br>03.06<br>03.06          | PR: 1ZA,1LJ<br>PR: 1ZA,1LJ<br>PR: 1ZA,1LJ<br>PR: 1ZA,1LJ<br>PR: 1ZA,1LJ<br>PR: 1ZA,1LJ<br>PR: 1ZA,1LJ<br>PR: 1ZA,1LJ<br>PR: 1ZA,1LJ<br>PR: 1ZA,1LJ<br>PR: 1ZA,1LJ<br>PR: 1ZA,1LJ   | 11.9541-9553.2<br>11.9541-9554.2<br>11.0101-5409.2<br>11.8171-0008.1<br>11.8116-0351.1<br>220563<br>220564<br>260035<br>990049<br>390538 | 2  |  | D=54, - Halter<br>D=54, - Halter<br>Hülensatz<br>Führungsbolzen<br>Haltefeder<br><b>ATE</b><br><b>ATE</b><br><b>ATE</b><br><b>ATE</b><br><b>ATE</b> |
|  | 1.2 TSI<br>1.4 i 16V<br>1.4 TSI<br>1.6 i 16V<br>1.6 LPG<br>1.6 TDI<br>1.8 TFSI<br>1.9 TDI<br>2.0 FSI<br>2.0 i 16V<br>2.0 TDI<br>2.0 TDI<br>2.0 TDI<br>2.0 TFSI | 77<br>63<br>92<br>75<br>75<br>118<br>110<br>100<br>100<br>103<br>125<br>147      | 04.10<br>05.06<br>11.07<br>03.04<br>09.09<br>10.09<br>01.07<br>03.04<br>03.04<br>03.04<br>03.06<br>03.06          |  | 83.7847-0563.3<br>331124   | 2  |  | L=562   |
|  | 1.2 TSI<br>1.4 i 16V<br>1.4 TSI<br>1.6 i 16V<br>1.6 LPG<br>1.6 TDI<br>1.8 TFSI<br>1.9 TDI<br>2.0 FSI<br>2.0 i 16V<br>2.0 TDI<br>2.0 TDI<br>2.0 TDI<br>2.0 TFSI | 77<br>63<br>92<br>75<br>75<br>118<br>110<br>100<br>100<br>103<br>125<br>147      | 04.10<br>05.06<br>11.07<br>03.04<br>09.09<br>10.09<br>01.07<br>03.04<br>03.04<br>03.04<br>03.06<br>03.06          | PR: 1KD,1KQ,1KZ<br>PR: 1KD,1KQ,1KZ<br>PR: 1KD,1KQ,1KZ<br>PR: 1KD,1KQ,1KZ<br>PR: 1KD,1KQ,1KZ<br>PR: 1KD,1KQ,1KZ<br>PR: 1KD,1KQ,1KZ<br>PR: 1KD,1KQ,1KZ<br>PR: 1KD,1KQ,1KZ<br>PR: 1KD,1KQ,1KZ<br>PR: 1KD,1KQ,1KZ<br>PR: 1KD,1KQ,1KZ | 24.3384-1755.7<br>24.3384-1756.7<br>220635<br>220636   |  |  | D=38, - Halter<br>D=38, - Halter<br><b>LUC</b><br><b>LUC</b>  |
|  | 1.2 TSI<br>1.4 i 16V<br>1.4 TSI<br>1.6 i 16V<br>1.6 LPG<br>1.6 TDI<br>1.8 TFSI<br>1.9 TDI<br>2.0 FSI<br>2.0 i 16V<br>2.0 TDI                                   | 77<br>63<br>92<br>75<br>75<br>118<br>110<br>100<br>100                           | 04.10<br>05.06<br>11.07<br>03.04<br>09.09<br>10.09<br>01.07<br>03.04<br>03.04<br>03.04<br>03.04                   |  | 83.7849-0231.3<br>330872   | 2  |  | L=233   |

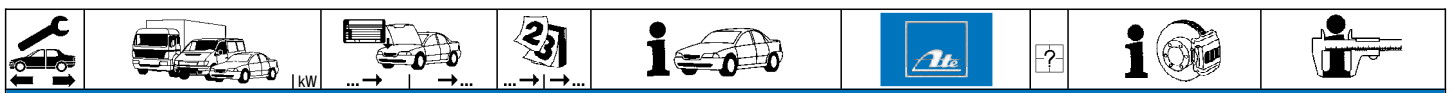

### SEAT ALTEA (5P1) (04-)

|  |  |  |  |  |                                  |                  |        |  |                                |
|--|--|--|--|--|----------------------------------|------------------|--------|--|--------------------------------|
|  | 2.0 TDI 103<br>2.0 TDI 125<br>2.0 TFSI 147   |  | 03.04<br>03.06<br>03.06  |  | 83.7849-0231.3                   | 330872           | 2      |  | L=233                          |
|  | 1.2 TSI 77<br>1.4 i 16V 63<br>1.4 TSI 92<br>1.6 i 16V 75<br>1.6 LPG 75<br>1.6 TDI 75<br>1.8 TFSI 118<br>1.9 TDI 110<br>2.0 FSI 100<br>2.0 i 16V 100<br>2.0 TDI 100<br>2.0 TDI 103<br>2.0 TDI 125<br>2.0 TFSI 147 |  | 04.10<br>05.06<br>11.07<br>03.04<br>09.09<br>10.09<br>01.07<br>03.04<br>03.04<br>03.04<br>03.04<br>03.04<br>03.06<br>03.06 |  | 24.3727-2708.2<br>24.3727-0195.2 | 582708<br>580195 | 2<br>2 |  | L=1447<br>L=1447               |
|  | 1.2 TSI 77<br>1.4 i 16V 63<br>1.4 TSI 92<br>1.6 i 16V 75<br>1.6 LPG 75<br>1.6 TDI 75<br>1.8 TFSI 118<br>1.9 TDI 110<br>2.0 FSI 100<br>2.0 i 16V 100<br>2.0 TDI 100<br>2.0 TDI 103<br>2.0 TDI 125<br>2.0 TFSI 147 |  | 04.10<br>05.06<br>11.07<br>03.04<br>09.09<br>10.09<br>01.07<br>03.04<br>03.04<br>03.04<br>03.04<br>03.04<br>03.06<br>03.06 |  | 24.2415-1711.3<br>24.2415-1713.3 | 030130<br>030132 |        |  | Gz 15,87<br>Gz 15,87, + Sensor |
|  | 1.2 TSI 77<br>1.4 i 16V 63<br>1.4 TSI 92<br>1.6 i 16V 75<br>1.6 TDI 75<br>1.8 TFSI 118<br>1.9 TDI 110<br>2.0 FSI 100<br>2.0 i 16V 100<br>2.0 TDI 100<br>2.0 TDI 103<br>2.0 TDI 125<br>2.0 TFSI 147               |  | 04.10<br>05.06<br>11.07<br>03.04<br>10.09<br>01.07<br>03.04<br>03.04<br>03.04<br>03.04<br>03.04<br>03.04<br>03.06<br>03.06 | 06.11<br>06.11<br>06.11<br>12.06<br>06.11<br>06.11<br>06.11<br>06.11<br>06.11<br>06.11<br>06.11<br>06.11<br>06.11<br>06.11 |                                  | 24.2519-1705.3   | 040095 |  | Nz 19,05                       |

### SEAT ALTEA XL (5P5) (06-)

|  |   |  |   |   |                |        |  |   |           |     |
|--|---|--|---|---|----------------|--------|--|---|-----------|-----|
|  | 1.2 TSI 77<br>1.4 i 16V 63<br>1.4 TSI 92<br>1.6 i 16V 75<br>1.6 LPG 75<br>1.6 TDI 75<br>1.8 TFSI 118<br>1.9 TDI 110<br>2.0 FSI 110<br>2.0 TDI 125<br>2.0 TDI 125<br>2.0 TDI 4x4 125<br>2.0 TFSI 4x4 125 |  | 04.10<br>05.08<br>11.07<br>10.06<br>09.09<br>10.09<br>10.06<br>10.06<br>10.06<br>10.06<br>10.06<br>06.07<br>06.07 | 04.10 PR: 1AC,1AT<br>04.10 PR: 1AC,1AT<br>04.10 PR: 1AC,1AT<br>04.10 PR: 1AC,1AT<br>04.10 PR: 1AC,1AT<br>04.10 PR: 1AC,1AT<br>04.10 PR: 1AC,1AT<br>04.10 PR: 1AC,1AT<br>04.10 PR: 1AC,1AT<br>04.10 PR: 1AC,1AT<br>04.10 PR: 1AC,1AT<br>04.10 PR: 1AC,1AT<br>04.10 PR: 1AC,1AT | 03.7863-9502.4 | 300204 |  | Kolbendurchmesser Ø 22,20mm <sup>1)</sup> | 10"       | ATE |
|  | 1.2 TSI 77<br>1.4 i 16V 63<br>1.4 TSI 92<br>1.6 i 16V 75<br>1.6 LPG 75<br>1.6 TDI 75<br>1.8 TFSI 118<br>1.9 TDI 110<br>2.0 FSI 110<br>2.0 TDI 125<br>2.0 TDI 125<br>2.0 TDI 4x4 125<br>2.0 TFSI 4x4 125 |  | 04.10<br>05.08<br>11.07<br>10.06<br>09.09<br>10.09<br>10.06<br>10.06<br>10.06<br>10.06<br>10.06<br>06.07<br>06.07 | 04.10 PR: 1AS<br>04.10 PR: 1AS<br>04.10 PR: 1AS<br>04.10 PR: 1AS<br>04.10 PR: 1AS<br>04.10 PR: 1AS<br>04.10 PR: 1AS<br>04.10 PR: 1AS<br>04.10 PR: 1AS<br>04.10 PR: 1AS<br>04.10 PR: 1AS<br>04.10 PR: 1AS<br>04.10 PR: 1AS   | 03.7863-9602.4 | 300206 |  | Kolbendurchmesser Ø 22,20mm <sup>1)</sup> | 10"       | ATE |
|  | 1.2 TSI 77<br>1.4 i 16V 63<br>1.4 TSI 92<br>1.6 i 16V 75<br>1.6 LPG 75<br>1.6 TDI 75<br>1.8 TFSI 118<br>1.9 TDI 110<br>2.0 FSI 110<br>2.0 TDI 125<br>2.0 TDI 125<br>2.0 TDI 4x4 125<br>2.0 TFSI 4x4 125 |  | 04.10<br>05.08<br>11.07<br>10.06<br>09.09<br>10.09<br>10.06<br>10.06<br>10.06<br>10.06<br>10.06<br>06.07<br>06.07 | 04.10<br>04.10<br>04.10<br>04.10<br>04.10<br>04.10<br>04.10<br>04.10<br>04.10<br>04.10<br>04.10<br>04.10<br>04.10   | 03.2122-2129.3 | 010799 |  |   | Thz 22,20 | ATE |
|  | 1.2 TSI 77<br>1.4 i 16V 63  |  | 05.10<br>05.10  | PR: 1AC,1AT,1AS<br>PR: 1AC,1AT,1AS  | 03.2122-2129.3 | 010799 |  |   | Thz 22,20 | ATE |

<sup>1)</sup> piston diameter Ø 22,20mm / diametro del pistone Ø 22,20mm / diamètre de piston Ø 22,20mm / diámetro del pistón Ø 22,20mm

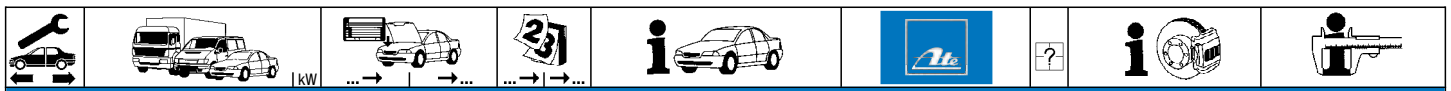

**SEAT ALTEA XL (5P5) (06-)**

|              |             |       |                 |                 |                |        |   |  |                |     |
|--------------|-------------|-------|-----------------|-----------------|----------------|--------|---|--|----------------|-----|
|              | 1.4 TSI     | 92    | 05.10           | PR: 1AC,1AT,1AS | 03.2122-2129.3 | 010799 |   |  | Thz 22,20      | ATE |
|              | 1.6 i 16V   | 75    | 05.10           | PR: 1AC,1AT,1AS |                |        |   |  |                |     |
|              | 1.6 LPG     | 75    | 05.10           | PR: 1AC,1AT,1AS |                |        |   |  |                |     |
|              | 1.6 TDI     |       | 05.10           | PR: 1AC,1AT,1AS |                |        |   |  |                |     |
|              | 1.8 TFSI    | 118   | 05.10           | PR: 1AC,1AT,1AS |                |        |   |  |                |     |
|              | 1.9 TDI     |       | 05.10           | PR: 1AC,1AT,1AS |                |        |   |  |                |     |
|              | 2.0 FSI     | 110   | 05.10           | PR: 1AC,1AT,1AS |                |        |   |  |                |     |
|              | 2.0 TDI     |       | 05.10           | PR: 1AC,1AT,1AS |                |        |   |  |                |     |
|              | 2.0 TDI     | 125   | 05.10           | PR: 1AC,1AT,1AS |                |        |   |  |                |     |
|              | 2.0 TDI 4x4 |       | 05.10           | PR: 1AC,1AT,1AS |                |        |   |  |                |     |
| 2.0 TFSI 4x4 |             | 05.10 | PR: 1AC,1AT,1AS |                 |                |        |   |  |                |     |
|              | 1.2 TSI     | 77    | 05.10           | PR: 1AC,1AT,1LJ | 03.2123-3449.3 | 010808 |   |  | Thz 23,81      | ATE |
|              | 1.4 i 16V   | 63    | 05.10           | PR: 1AC,1AT,1LJ |                |        |   |  |                |     |
|              | 1.4 TSI     | 92    | 05.10           | PR: 1AC,1AT,1LJ |                |        |   |  |                |     |
|              | 1.6 i 16V   | 75    | 05.10           | PR: 1AC,1AT,1LJ |                |        |   |  |                |     |
|              | 1.6 LPG     | 75    | 05.10           | PR: 1AC,1AT,1LJ |                |        |   |  |                |     |
|              | 1.6 TDI     |       | 05.10           | PR: 1AC,1AT,1LJ |                |        |   |  |                |     |
|              | 1.8 TFSI    | 118   | 05.10           | PR: 1AC,1AT,1LJ |                |        |   |  |                |     |
|              | 1.9 TDI     |       | 05.10           | PR: 1AC,1AT,1LJ |                |        |   |  |                |     |
|              | 2.0 FSI     | 110   | 05.10           | PR: 1AC,1AT,1LJ |                |        |   |  |                |     |
|              | 2.0 TDI     |       | 05.10           | PR: 1AC,1AT,1LJ |                |        |   |  |                |     |
| 2.0 TDI      | 125         | 05.10 | PR: 1AC,1AT,1LJ |                 |                |        |   |  |                |     |
| 2.0 TDI 4x4  |             | 05.10 | PR: 1AC,1AT,1LJ |                 |                |        |   |  |                |     |
| 2.0 TFSI 4x4 |             | 05.10 | PR: 1AC,1AT,1LJ |                 |                |        |   |  |                |     |
|              | 1.2 TSI     | 77    | 04.10           | PR: 1ZF         | 11.9541-9549.2 | 220575 |   |  | D=54, - Halter | ATE |
|              | 1.4 i 16V   | 63    | 05.08           | PR: 1ZF         |                |        |   |  |                |     |
|              | 1.4 TSI     | 92    | 11.07           | PR: 1ZF         |                |        |   |  |                |     |
|              | 1.6 i 16V   | 75    | 10.06           | PR: 1ZF         |                |        |   |  |                |     |
|              | 1.6 LPG     | 75    | 09.09           | PR: 1ZF         |                |        |   |  |                |     |
|              | 1.6 TDI     |       | 10.09           | PR: 1ZF         |                |        |   |  |                |     |
|              | 1.8 TFSI    | 118   | 10.06           | PR: 1ZF         |                |        |   |  |                |     |
|              | 1.9 TDI     |       | 10.06           | PR: 1ZF         |                |        |   |  |                |     |
|              | 2.0 FSI     | 110   | 10.06           | PR: 1ZF         |                |        |   |  |                |     |
|              | 2.0 TDI     |       | 10.06           | PR: 1ZF         |                |        |   |  |                |     |
| 2.0 TDI      | 125         | 10.06 | PR: 1ZF         |                 |                |        |   |  |                |     |
| 2.0 TDI 4x4  |             | 06.07 | PR: 1ZF         |                 |                |        |   |  |                |     |
| 2.0 TFSI 4x4 |             | 06.07 | PR: 1ZF         |                 |                |        |   |  |                |     |
|              | 1.2 TSI     | 77    | 04.10           | PR: 1ZE         | 11.9541-9553.2 | 220563 |   |  | D=54, - Halter | ATE |
|              | 1.4 i 16V   | 63    | 05.08           | PR: 1ZE         |                |        |   |  |                |     |
|              | 1.4 TSI     | 92    | 11.07           | PR: 1ZE         |                |        |   |  |                |     |
|              | 1.6 i 16V   | 75    | 10.06           | PR: 1ZE         |                |        |   |  |                |     |
|              | 1.6 LPG     | 75    | 09.09           | PR: 1ZE         |                |        |   |  |                |     |
|              | 1.6 TDI     |       | 10.09           | PR: 1ZE         |                |        |   |  |                |     |
|              | 1.8 TFSI    | 118   | 10.06           | PR: 1ZE         |                |        |   |  |                |     |
|              | 1.9 TDI     |       | 10.06           | PR: 1ZE         |                |        |   |  |                |     |
|              | 2.0 FSI     | 110   | 10.06           | PR: 1ZE         |                |        |   |  |                |     |
|              | 2.0 TDI     |       | 10.06           | PR: 1ZE         |                |        |   |  |                |     |
| 2.0 TDI      | 125         | 10.06 | PR: 1ZE         |                 |                |        |   |  |                |     |
| 2.0 TDI 4x4  |             | 06.07 | PR: 1ZE         |                 |                |        |   |  |                |     |
| 2.0 TFSI 4x4 |             | 06.07 | PR: 1ZE         |                 |                |        |   |  |                |     |
|              | 1.2 TSI     | 77    | 04.10           | PR: 1ZA,1LJ     | 11.9541-9553.2 | 220563 |   |  | D=54, - Halter | ATE |
|              | 1.4 i 16V   | 63    | 05.08           | PR: 1ZA,1LJ     |                |        |   |  |                |     |
|              | 1.4 TSI     | 92    | 11.07           | PR: 1ZA,1LJ     |                |        |   |  |                |     |
|              | 1.6 i 16V   | 75    | 10.06           | PR: 1ZA,1LJ     |                |        |   |  |                |     |
|              | 1.6 LPG     | 75    | 09.09           | PR: 1ZA,1LJ     |                |        |   |  |                |     |
|              | 1.6 TDI     |       | 10.09           | PR: 1ZA,1LJ     |                |        |   |  |                |     |
|              | 1.8 TFSI    | 118   | 10.06           | PR: 1ZA,1LJ     |                |        |   |  |                |     |
|              | 1.9 TDI     |       | 10.06           | PR: 1ZA,1LJ     |                |        |   |  |                |     |
|              | 2.0 FSI     | 110   | 10.06           | PR: 1ZA,1LJ     |                |        |   |  |                |     |
|              | 2.0 TDI     |       | 10.06           | PR: 1ZA,1LJ     |                |        |   |  |                |     |
| 2.0 TDI      | 125         | 10.06 | PR: 1ZA,1LJ     |                 |                |        |   |  |                |     |
| 2.0 TDI 4x4  |             | 06.07 | PR: 1ZA,1LJ     |                 |                |        |   |  |                |     |
| 2.0 TFSI 4x4 |             | 06.07 | PR: 1ZA,1LJ     |                 |                |        |   |  |                |     |
|              | 1.2 TSI     | 77    | 04.10           |                 | 83.7847-0563.3 | 331124 | 2 |  | L=562          |     |
|              | 1.4 i 16V   | 63    | 05.08           |                 |                |        |   |  |                |     |
|              | 1.4 TSI     | 92    | 11.07           |                 |                |        |   |  |                |     |
|              | 1.6 i 16V   | 75    | 10.06           |                 |                |        |   |  |                |     |
|              | 1.6 LPG     | 75    | 09.09           |                 |                |        |   |  |                |     |
|              | 1.6 TDI     |       | 10.09           |                 |                |        |   |  |                |     |
|              | 1.8 TFSI    | 118   | 10.06           |                 |                |        |   |  |                |     |
|              | 1.9 TDI     |       | 10.06           |                 |                |        |   |  |                |     |
|              | 2.0 FSI     | 110   | 10.06           |                 |                |        |   |  |                |     |
|              | 2.0 TDI     |       | 10.06           |                 |                |        |   |  |                |     |
| 2.0 TDI      | 125         | 10.06 |                 |                 |                |        |   |  |                |     |
| 2.0 TDI 4x4  |             | 06.07 |                 |                 |                |        |   |  |                |     |
| 2.0 TFSI 4x4 |             | 06.07 |                 |                 |                |        |   |  |                |     |
|              | 1.2 TSI     | 77    | 04.10           | PR: 1KD,1KQ,1KZ | 24.3384-1755.7 | 220635 |   |  | D=38, - Halter | LUC |
|              | 1.4 i 16V   | 63    | 05.08           | PR: 1KD,1KQ,1KZ |                |        |   |  |                |     |
|              | 1.4 TSI     | 92    | 11.07           | PR: 1KD,1KQ,1KZ |                |        |   |  |                |     |
|              | 1.6 i 16V   | 75    | 10.06           | PR: 1KD,1KQ,1KZ |                |        |   |  |                |     |
|              | 1.6 LPG     | 75    | 09.09           | PR: 1KD,1KQ,1KZ |                |        |   |  |                |     |
|              | 1.6 TDI     |       | 10.09           | PR: 1KD,1KQ,1KZ |                |        |   |  |                |     |
|              | 1.8 TFSI    | 118   | 10.06           | PR: 1KD,1KQ,1KZ |                |        |   |  |                |     |
|              | 1.9 TDI     |       | 10.06           | PR: 1KD,1KQ,1KZ |                |        |   |  |                |     |
|              | 2.0 FSI     | 110   | 10.06           | PR: 1KD,1KQ,1KZ |                |        |   |  |                |     |
|              | 2.0 TDI     |       | 10.06           | PR: 1KD,1KQ,1KZ |                |        |   |  |                |     |
| 2.0 TDI      | 125         | 10.06 | PR: 1KD,1KQ,1KZ |                 |                |        |   |  |                |     |



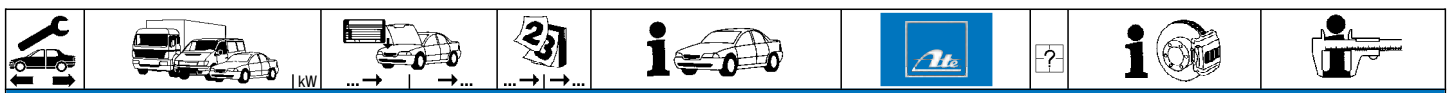

**SEAT ALTEA XL (5P5) (06-)**

|  |  |   |  |  |                                  |                  |        |                                  |            |
|--|--|---|--|--|----------------------------------|------------------|--------|----------------------------------|------------|
|  | 2.0 TDI 4x4<br>2.0 TFSI 4x4  |   | 06.07<br>06.07   | PR: 1KD,1KQ,1KZ<br>PR: 1KD,1KQ,1KZ   | 24.3384-1755.7<br>24.3384-1756.7 | 220635<br>220636 |        | D=38, - Halter<br>D=38, - Halter | LUC<br>LUC |
|  | 1.2 TSI<br>1.4 i 16V<br>1.4 TSI<br>1.6 i 16V<br>1.6 LPG<br>1.6 TDI<br>1.8 TFSI<br>1.9 TDI<br>2.0 FSI<br>2.0 TDI<br>2.0 TDI 4x4<br>2.0 TFSI 4x4 | 77<br>63<br>92<br>75<br>75<br>118<br>110<br>125 | 04.10<br>05.08<br>11.07<br>10.06<br>09.09<br>10.09<br>10.06<br>10.06<br>10.06<br>10.06<br>06.07<br>06.07 |  | 83.7849-0231.3                   | 330872           | 2<br>2 | L=233                            |            |
|  | 1.2 TSI<br>1.4 i 16V<br>1.4 TSI<br>1.6 i 16V<br>1.6 LPG<br>1.6 TDI<br>1.8 TFSI<br>1.9 TDI<br>2.0 FSI<br>2.0 TDI<br>2.0 TDI 4x4<br>2.0 TFSI 4x4 | 77<br>63<br>92<br>75<br>75<br>118<br>110<br>125 | 04.10<br>05.08<br>11.07<br>10.06<br>09.09<br>10.09<br>10.06<br>10.06<br>10.06<br>10.06<br>06.07<br>06.07 |  | 24.3727-2708.2<br>24.3727-0195.2 | 582708<br>580195 | 2<br>2 | L=1447<br>L=1447                 |            |
|  | 1.2 TSI<br>1.4 i 16V<br>1.4 TSI<br>1.6 i 16V<br>1.6 LPG<br>1.6 TDI<br>1.8 TFSI<br>1.9 TDI<br>2.0 FSI<br>2.0 TDI<br>2.0 TDI 4x4<br>2.0 TFSI 4x4 | 77<br>63<br>92<br>75<br>75<br>118<br>110<br>125 | 04.10<br>05.08<br>11.07<br>10.06<br>09.09<br>10.09<br>10.06<br>10.06<br>10.06<br>10.06<br>06.07<br>06.07 |  | 24.2415-1711.3<br>24.2415-1713.3 | 030130<br>030132 |        | Gz 15,87<br>Gz 15,87, + Sensor   |            |
|  | 1.2 TSI<br>1.4 i 16V<br>1.4 TSI<br>1.6 i 16V<br>1.6 TDI<br>1.8 TFSI<br>1.9 TDI<br>2.0 FSI<br>2.0 TDI<br>2.0 TDI 4x4<br>2.0 TFSI 4x4            | 77<br>63<br>92<br>75<br>118<br>110<br>125       | 04.10<br>05.08<br>11.07<br>10.06<br>10.09<br>10.06<br>10.06<br>10.06<br>10.06<br>10.06<br>06.07<br>06.07 | 06.11<br>06.11<br>06.11<br>12.06<br>06.11<br>06.11<br>06.11<br>06.11<br>06.11<br>06.11<br>06.11<br>06.11 | 24.2519-1705.3                   | 040095           |        | Nz 19,05                         |            |

**SEAT AROSA (6H) (97-05)**

|  |   |                            |   |   |  |  |                |   |                          |
|--|---|----------------------------|---|---|--|--|----------------|---|--------------------------|
|  | 1.0 i<br>1.4 i<br>1.4 i 16V<br>1.4 TDI<br>1.7 SDI | 37<br>44<br>74<br>55<br>44 | 05.97<br>05.97<br>10.99<br>10.99<br>11.97 | 04.05<br>04.05<br>04.05<br>04.05<br>04.05 | 03.2120-3943.3<br>03.2122-1344.3   | 010532<br>010593                               | - ABS<br>+ ABS | ThZ 20,64<br>ThZ 22,20  | ATE<br>ATE               |
|  | 1.0 i<br>1.4 i<br>1.4 i 16V<br>1.4 TDI<br>1.7 SDI | 37<br>44<br>74<br>55<br>44 | 05.97<br>05.97<br>10.99<br>10.99<br>11.97 | 04.05<br>04.05<br>04.05<br>04.05<br>04.05 | 03.2122-1184.3   | 010592   | + ABS          | ThZ 22,20   | ATE                      |
|  | 1.0 i<br>1.4 i<br>1.7 SDI                         | 37<br>44<br>44             | 05.97<br>05.97<br>11.97                   | 04.05<br>04.05<br>04.05                   | 11.0441-4808.2<br>11.0101-4803.2<br>24.0102-4803.2                                     | 250022<br>260008<br>260086                     |                | Dichtungssatz<br>Hülssensatz<br>Hülssensatz+Schrauben                                     |                          |
|  | 1.4 i<br>1.7 SDI                                  | 44<br>44                   | 05.97<br>11.97                            | 04.05<br>04.05                            | 24.3481-1735.5<br>24.3481-1736.5<br>11.0101-4801.2<br>24.0102-4801.2<br>11.0441-4808.2 | 240283<br>240284<br>260006<br>260085<br>250022 |                | D=48, - Halter<br>D=48, - Halter<br>Hülssensatz<br>Hülssensatz+Schrauben<br>Dichtungssatz | ATE<br>ATE<br>ATE<br>ATE |
|  | 1.4 i 16V<br>1.4 TDI                              | 74<br>55                   | 10.99<br>10.99                            | 04.05<br>04.05                            | 24.3541-1779.5<br>24.3541-1780.5<br>11.0101-5403.2                                     | 240249<br>240250<br>260010                     |                | D=54, - Halter<br>D=54, - Halter<br>Faltenbalgsatz  | LUC<br>LUC<br>LUC        |
|  | 1.0 i<br>1.4 i<br>1.4 i 16V<br>1.4 TDI<br>1.7 SDI | 37<br>44<br>74<br>55<br>44 | 05.97<br>05.97<br>10.99<br>10.99<br>11.97 | 04.05<br>04.05<br>04.05<br>04.05<br>04.05 | 83.7852-0377.3   | 330835   | 2              | L=375   |                          |
|  | 1.4 i 16V   | 74                         | 10.99                                     | 04.05                                     | 24.3344-1711.7<br>24.3344-1712.7   | 220539<br>220540                               |                | D=34, - Halter<br>D=34, - Halter  | LUC<br>LUC               |



















| <b>SEAT AROSA (6H) (97-05)</b> |           |    |       |       |                |        |     |                 |
|--------------------------------|-----------|----|-------|-------|----------------|--------|-----|-----------------|
|                                | 1.0 i     | 37 | 05.97 | 04.05 | 83.7858-0140.3 | 330837 | 2   | L=140           |
|                                | 1.4 i     | 44 | 05.97 | 04.05 |                |        |     |                 |
|                                | 1.4 i 16V | 74 | 10.99 | 04.05 |                |        |     |                 |
|                                | 1.4 TDI   | 55 | 10.99 | 04.05 |                |        |     |                 |
|                                | 1.7 SDI   | 44 | 11.97 | 04.05 |                |        |     |                 |
|                                | 1.0 i     | 37 | 05.97 | 04.05 | 24.3215-0903.3 | 020154 |     | Rz 15,87        |
|                                | 1.4 i     | 44 | 05.97 | 04.05 |                |        |     |                 |
|                                | 1.4 TDI   | 55 | 10.99 | 04.05 |                |        |     |                 |
|                                | 1.7 SDI   | 44 | 11.97 | 04.05 |                |        |     |                 |
|                                | 1.0 i     | 37 | 05.97 | 04.05 | 24.3217-0908.3 | 020167 |     | Rz 17,46        |
|                                | 1.4 i     | 44 | 05.97 | 04.05 |                |        |     |                 |
|                                | 1.4 TDI   | 55 | 10.99 | 04.05 |                |        |     |                 |
|                                | 1.7 SDI   | 44 | 11.97 | 04.05 |                |        |     |                 |
|                                | 1.0 i     | 37 | 05.97 | 04.05 | 24.3727-2702.2 | 582702 | 2 ↓ | L=1395          |
|                                | 1.4 i     | 44 | 05.97 | 04.05 |                |        |     |                 |
|                                | 1.7 SDI   | 44 | 11.97 | 04.05 |                |        |     |                 |
|                                | 1.0 i     | 37 | 05.97 | 04.05 | 24.3727-2707.2 | 582707 | 2 ↓ | L=1496          |
|                                | 1.4 i     | 44 | 05.97 | 04.05 |                |        |     |                 |
|                                | 1.7 SDI   | 44 | 11.97 | 04.05 |                |        |     |                 |
|                                | 1.0 i     | 37 | 04.05 | 04.05 | 24.3727-0159.2 | 580159 | 2 ↓ | L=1392          |
|                                | 1.4 i     | 44 | 04.05 | 04.05 |                |        |     |                 |
|                                | 1.4 i 16V | 74 | 10.99 | 04.05 |                |        |     |                 |
|                                | 1.4 TDI   | 55 | 10.99 | 04.05 |                |        |     |                 |
|                                | 1.7 SDI   | 44 | 04.05 | 04.05 |                |        |     |                 |
|                                | 1.0 i     | 37 | 05.97 | 04.05 | 03.6583-0184.3 | 320229 |     | BRL 8/3 (4) ATE |
|                                | 1.4 i     | 44 | 05.97 | 04.05 |                |        |     |                 |
|                                | 1.4 i 16V | 74 | 10.99 | 04.05 |                |        |     |                 |
|                                | 1.4 TDI   | 55 | 10.99 | 04.05 |                |        |     |                 |
|                                | 1.7 SDI   | 44 | 11.97 | 04.05 |                |        |     |                 |
|                                | 1.4 TDI   | 55 | 10.99 | 04.05 | 24.2519-1701.3 | 040075 |     | Nz 19,05        |
|                                | 1.0 i     | 37 | 05.97 | 04.05 | 24.3728-2707.2 | 592707 |     | L=1047, + AUT   |
|                                | 1.4 i     | 44 | 05.97 | 04.05 |                |        |     |                 |
|                                | 1.4 i 16V | 74 | 10.99 | 04.05 |                |        |     |                 |
|                                | 1.7 SDI   | 44 | 11.97 | 04.05 |                |        |     |                 |

















| <b>SEAT CORDOBA I (93-99)</b> |           |    |       |       |                |        |  |                           |
|-------------------------------|-----------|----|-------|-------|----------------|--------|--|---------------------------|
|                               | 1.8 i 16V | 95 | 02.94 | 05.99 | 03.7740-1402.4 | 300133 |  | - ABS 8" ATE              |
|                               | 2.0 i     | 85 | 11.93 | 05.99 |                |        |  |                           |
|                               | 1.4 i     |    | 11.93 | 05.99 | 03.2120-3943.3 | 010532 |  | - ABS THz 20,64 ATE       |
|                               | 1.6 i     |    | 11.93 | 05.99 | 03.3517-0101.2 | 390322 |  | - ABS Verschlusschraube   |
|                               | 1.6 i     | 55 | 05.97 | 05.99 |                |        |  |                           |
|                               | 1.7 SDI   | 44 | 07.97 | 05.99 |                |        |  |                           |
|                               | 1.8 i     | 66 | 11.93 | 05.99 |                |        |  |                           |
|                               | 1.9 D     |    | 11.93 | 05.99 |                |        |  |                           |
|                               | 1.9 SDI   | 47 | 09.95 | 05.99 |                |        |  |                           |
|                               | 1.9 TD    | 55 | 11.93 | 05.99 |                |        |  |                           |
|                               | 1.8 i 16V | 95 | 02.94 | 05.99 | 03.2122-1042.3 | 010137 |  | - ABS THz 22,20 ATE       |
|                               | 1.9 TDI   | 66 | 07.96 | 05.99 | 03.3517-0101.2 | 390322 |  | - ABS Verschlusschraube   |
|                               | 1.9 TDI   | 81 | 03.97 | 05.99 |                |        |  |                           |
|                               | 2.0 i     | 85 | 11.93 | 05.99 |                |        |  |                           |
|                               | 1.8 i 16V | 95 | 02.94 | 05.99 | 10.6123-0674.3 | 010639 |  | + ABS THz 23,81 ATE       |
|                               | 2.0 i     | 85 | 11.93 | 05.99 |                |        |  |                           |
|                               | 1.4 i     |    | 11.93 | 12.96 | 24.3481-1745.5 | 240277 |  | D=48, - Halter ATE        |
|                               |           |    |       |       | 24.3481-1746.5 | 240278 |  | D=48, - Halter ATE        |
|                               |           |    |       |       | 11.0441-4808.2 | 250022 |  | Dichtungssatz ATE         |
|                               |           |    |       |       | 11.0101-4803.2 | 260008 |  | Hülssensatz ATE           |
|                               |           |    |       |       | 24.0102-4803.2 | 260086 |  | Hülssensatz+Schrauben ATE |
|                               | 1.4 i     |    | 11.93 | 12.96 | 11.0441-4808.2 | 250022 |  | Dichtungssatz ATE         |
|                               | 1.6 i     |    | 11.93 | 12.96 | 11.0101-4801.2 | 260006 |  | Hülssensatz ATE           |
|                               | 1.8 i     | 66 | 11.93 | 12.96 | 24.0102-4801.2 | 260085 |  | Hülssensatz+Schrauben ATE |
|                               | 1.9 D     |    | 11.93 | 12.96 |                |        |  |                           |
|                               | 1.9 SDI   | 47 | 09.95 | 12.96 |                |        |  |                           |
|                               | 1.9 TD    | 55 | 11.93 | 12.96 |                |        |  |                           |
|                               | 1.8 i 16V | 95 | 02.94 | 12.96 | 24.3541-1609.5 | 240039 |  | D=54, - Halter LUC        |
|                               | 2.0 i     | 85 | 11.93 | 12.96 | 24.3541-1610.5 | 240040 |  | D=54, - Halter LUC        |
|                               |           |    |       |       | 11.0101-5403.2 | 260010 |  | Faltenbalgsatz LUC        |
|                               | 1.4 i     |    | 01.97 | 05.99 | 24.3481-1745.5 | 240277 |  | D=48, - Halter ATE        |
|                               | 1.6 i     |    | 01.97 | 05.99 | 24.3481-1746.5 | 240278 |  | D=48, - Halter ATE        |
|                               | 1.6 i     | 55 | 05.97 | 05.99 | 11.0441-4808.2 | 250022 |  | Dichtungssatz ATE         |
|                               | 1.7 SDI   | 44 | 07.97 | 05.99 | 11.0101-4803.2 | 260008 |  | Hülssensatz ATE           |
|                               | 1.8 i     | 66 | 01.97 | 05.99 | 24.0102-4803.2 | 260086 |  | Hülssensatz+Schrauben ATE |
|                               | 1.8 i 16V | 95 | 01.97 | 05.99 |                |        |  |                           |
|                               | 1.9 D     |    | 01.97 | 05.99 |                |        |  |                           |
|                               | 1.9 SDI   | 47 | 01.97 | 05.99 |                |        |  |                           |
|                               | 1.9 TD    | 55 | 01.97 | 05.99 |                |        |  |                           |
|                               | 1.9 TDI   | 66 | 01.97 | 05.99 |                |        |  |                           |
|                               | 1.9 TDI   | 81 | 03.97 | 05.99 |                |        |  |                           |
|                               | 2.0 i     | 85 | 01.97 | 05.99 |                |        |  |                           |
|                               | 1.4 i     |    | 01.97 | 05.99 | 11.0101-4801.2 | 260006 |  | Hülssensatz ATE           |
|                               | 1.6 i     |    | 01.97 | 05.99 | 11.0441-4808.2 | 250022 |  | Dichtungssatz ATE         |
|                               | 1.6 i     | 55 | 05.97 | 05.99 |                |        |  |                           |
|                               | 1.7 SDI   | 44 | 07.97 | 05.99 |                |        |  |                           |



|     |    |  |                                |   |  |                |    |                                        |
|--|--|--|--|---|---|--|--|--|
| <b>SEAT CORDOBA I (93-99)</b>  |  |  |  |   |   |  |  |  |
|    | 1.8 i<br>1.8 i 16V<br>1.9 D<br>1.9 SDI<br>1.9 TD<br>1.9 TDI<br>1.9 TDI<br>2.0 i  | 66<br>95<br>47<br>55<br>66<br>81<br>85   |  | 01.97 05.99 PR: 1LG,1LM<br>01.97 05.99 PR: 1LG,1LM<br>01.97 05.99 PR: 1LG,1LM<br>01.97 05.99 PR: 1LG,1LM<br>01.97 05.99 PR: 1LG,1LM<br>03.97 05.99 PR: 1LG,1LM<br>01.97 05.99 PR: 1LG,1LM   |   | 11.0101-4801.2 260006<br>11.0441-4808.2 250022   |  | Hülsensatz<br>Dichtungssatz<br><b>ATE</b><br><b>ATE</b>  |
|  | 1.4 i<br>1.6 i<br>1.6 i<br>1.7 SDI<br>1.8 i<br>1.8 i 16V<br>1.9 D<br>1.9 SDI<br>1.9 TD<br>1.9 TDI<br>1.9 TDI<br>2.0 i              | 55<br>44<br>66<br>95<br>47<br>55<br>66<br>81<br>85                               |  | 01.97 05.99 PR: 1LY,1ZK<br>01.97 05.99 PR: 1LY,1ZK<br>05.97 05.99 PR: 1LY,1ZK<br>07.97 05.99 PR: 1LY,1ZK<br>01.97 05.99 PR: 1LY,1ZK<br>01.97 05.99 PR: 1LY,1ZK<br>01.97 05.99 PR: 1LY,1ZK<br>01.97 05.99 PR: 1LY,1ZK<br>01.97 05.99 PR: 1LY,1ZK<br>03.97 05.99 PR: 1LY,1ZK<br>01.97 05.99 PR: 1LY,1ZK   |   | 24.3541-1609.5 240039<br>24.3541-1610.5 240040<br>11.0101-5403.2 260010                          | <input type="checkbox"/><br><input type="checkbox"/>   | D=54, - Halter<br>D=54, - Halter<br>Faltenbalgsatz<br><b>LUC</b><br><b>LUC</b><br><b>LUC</b>                             |
|  | 1.4 i<br>1.6 i<br>1.6 i<br>1.7 SDI<br>1.8 i<br>1.8 i 16V<br>1.9 D<br>1.9 SDI<br>1.9 TD<br>1.9 TDI<br>1.9 TDI<br>2.0 i<br>2.0 i 16V | 55<br>44<br>66<br>95<br>47<br>55<br>66<br>81<br>85<br>110                        |  | 01.97 05.99 PR: 1LV,1LW,1LD<br>01.97 05.99 PR: 1LV,1LW,1LD<br>05.97 05.99 PR: 1LV,1LW,1LD<br>07.97 05.99 PR: 1LV,1LW,1LD<br>01.97 05.99 PR: 1LV,1LW,1LD<br>01.97 05.99 PR: 1LV,1LW,1LD<br>01.97 05.99 PR: 1LV,1LW,1LD<br>01.97 05.99 PR: 1LV,1LW,1LD<br>01.97 05.99 PR: 1LV,1LW,1LD<br>01.97 05.99 PR: 1LV,1LW,1LD<br>03.97 05.99 PR: 1LV,1LW,1LD<br>01.97 05.99 PR: 1LV,1LW,1LD<br>07.96 05.99 |   | 24.3541-1731.5 240061<br>24.3541-1732.5 240062   | <input type="checkbox"/><br><input type="checkbox"/>   | D=54, - Halter<br>D=54, - Halter<br><b>LUC</b><br><b>LUC</b>   |
|    | 1.4 i<br>1.6 i<br>1.6 i<br>1.7 SDI<br>1.8 i<br>1.8 i 16V<br>1.9 D<br>1.9 SDI<br>1.9 TD<br>1.9 TDI<br>1.9 TDI<br>2.0 i<br>2.0 i 16V | 55<br>44<br>66<br>95<br>47<br>55<br>66<br>81<br>85<br>110                        |  | 11.93 05.99<br>11.93 05.99<br>05.97 05.99<br>07.97 05.99<br>11.93 05.99<br>02.94 05.99<br>11.93 05.99<br>09.95 05.99<br>11.93 05.99<br>07.96 05.99<br>03.97 05.99<br>11.93 05.99<br>07.96 05.99   |   | 83.7713-0435.3 330792 2  |  | L=435  |
|  | 1.8 i 16V<br>1.8 i 16V<br>2.0 i<br>2.0 i   | 95<br>95<br>85<br>85   | 6K-ZR516424 02.94<br>6K-ZR014473 02.94<br>6K-ZR516424 11.93<br>6K-ZR014473 11.93                               |   |   | 24.3384-1603.5 240015<br>24.3384-1604.5 240016<br>24.0101-3601.2 260044                          | <input type="checkbox"/><br><input type="checkbox"/><br><input type="checkbox"/><br><input type="checkbox"/>   | D=38, - Halter<br>D=38, - Halter<br>Einbausatz<br><b>LUC</b><br><b>LUC</b><br><b>LUC</b>                                 |
|  | 1.8 i 16V<br>1.8 i 16V<br>2.0 i<br>2.0 i   | 95<br>95<br>85<br>85   | 6K-ZR516425 6K-ZR610014<br>6K-ZR014474 6K-ZR085725<br>85 6K-ZR516425 6K-ZR610014<br>85 6K-ZR014474 6K-ZR085725 |   |   | 24.3384-1707.5 240171<br>24.3384-1708.5 240172<br>24.0101-3601.2 260044<br>11.0101-5403.2 260010 | <input type="checkbox"/><br><input type="checkbox"/><br><input type="checkbox"/><br><input type="checkbox"/>   | D=38, - Halter<br>D=38, - Halter<br>Einbausatz<br>Faltenbalgsatz<br><b>LUC</b><br><b>LUC</b><br><b>LUC</b><br><b>LUC</b> |
|  | 1.8 i 16V<br>1.8 i 16V<br>1.9 TDI<br>2.0 i<br>2.0 i<br>2.0 i 16V   | 95<br>95<br>81<br>85<br>85<br>110  | 6K-ZR610015<br>6K-ZR085726<br>6K-X-399999 03.97<br>6K-ZR610015<br>85 6K-ZR085726<br>6K-X-399999 07.96          | 12.96<br>12.96<br>03.97<br>12.96<br>12.96   |   | 24.3384-1737.5 240301<br>24.3384-1738.5 240302<br>11.0101-5403.2 260010                          | <input type="checkbox"/><br><input type="checkbox"/><br><input type="checkbox"/><br><input type="checkbox"/><br><input type="checkbox"/><br><input type="checkbox"/> | D=38, - Halter<br>D=38, - Halter<br>Faltenbalgsatz<br><b>LUC</b><br><b>LUC</b><br><b>LUC</b>                             |
|  | 1.8 i 16V<br>1.9 TDI<br>2.0 i<br>2.0 i 16V   | 95<br>81<br>85<br>110  | 6K-X-400000<br>6K-X-400000   | 01.97 05.99 PR: 1KK<br>05.99 PR: 1KK<br>01.97 05.99 PR: 1KK<br>05.99 PR: 1KK  |   | 24.3384-1723.7 220523<br>24.3384-1724.7 220524   | <input type="checkbox"/><br><input type="checkbox"/><br><input type="checkbox"/><br><input type="checkbox"/>   | D=38(M12x1), - Halter<br>D=38(M12x1), - Halter<br><b>LUC</b><br><b>LUC</b>   |
|  | 1.8 i 16V<br>1.9 TDI<br>2.0 i<br>2.0 i 16V   | 95<br>81<br>85<br>110  | 6K-X-400000<br>6K-X-400000   | 01.97 05.99 PR: 1KE,1KQ<br>05.99 PR: 1KE,1KQ<br>01.97 05.99 PR: 1KE,1KQ<br>05.99 PR: 1KE,1KQ  |   | 24.3344-1711.7 220539<br>24.3344-1712.7 220540   | <input type="checkbox"/><br><input type="checkbox"/><br><input type="checkbox"/><br><input type="checkbox"/>   | D=34, - Halter<br>D=34, - Halter<br><b>LUC</b><br><b>LUC</b>   |
|  | 1.4 i<br>1.6 i<br>1.6 i<br>1.7 SDI<br>1.8 i<br>1.9 D<br>1.9 SDI<br>1.9 TD<br>1.9 TDI   | 55<br>44<br>66<br>47<br>55<br>66   |  | 11.93 05.99<br>11.93 05.99<br>05.97 05.99<br>07.97 05.99<br>11.93 05.99<br>11.93 05.99<br>09.95 05.99<br>11.93 05.99<br>07.96 05.99   |   | 83.7836-0135.3 330816 2  |  | L=135  |
|  | 1.8 i 16V<br>1.9 TDI<br>2.0 i<br>2.0 i 16V   | 95<br>81<br>85<br>110  |  | 02.94 05.99<br>03.97 05.99<br>11.93 05.99<br>07.96 05.99  |   | 83.7704-0160.3 330805 2  |  | L=160  |
|  | 1.4 i<br>1.6 i<br>1.8 i<br>1.9 D<br>1.9 SDI  | 66<br>47   |  | 11.93 12.96<br>11.93 12.96<br>11.93 12.96<br>11.93 12.96<br>09.95 12.96   |   | 03.3217-2112.3 020027<br>24.3217-0908.3 020167   | + GG <sup>1)</sup><br>+ ALU <sup>2)</sup>  | Rz 17,46<br>Rz 17,46   |

1) + cast iron / + ghisa / + fonte grise / + fundición de gris

2) + aluminium / + alluminio / + aluminium / + aluminio

























| SEAT CORDOBA I (93-99)   |   |  |  |  |  |   |  |  |                          |            |
|--|---|--|--|--|--|---|--|--|--------------------------|------------|
|     |                                       |  |                                      |                                      |                         |                       |  |  |                          |            |
|    | 1.9 TD<br>1.9 TDI   | 55<br>66   |  | 11.93<br>07.96   | 12.96<br>12.96   | 03.3217-2112.3<br>24.3217-0908.3  | 020027<br>020167   | + GG <sup>1)</sup><br>+ ALU <sup>2)</sup>  | Rz 17,46<br>Rz 17,46     |            |
|  | 1.4 i<br>1.6 i<br>1.6 i<br>1.7 SDI<br>1.8 i<br>1.9 D<br>1.9 SDI<br>1.9 TD<br>1.9 TDI                                  |  |  | 01.97<br>01.97<br>05.97<br>07.97<br>01.97<br>01.97<br>01.97<br>01.97<br>01.97  | 05.99<br>05.99<br>05.99<br>05.99<br>05.99<br>05.99<br>05.99<br>05.99<br>05.99                            | PR: 1KA,1KB<br>PR: 1KA,1KB<br>PR: 1KB<br>PR: 1KB<br>PR: 1KB<br>PR: 1KB<br>PR: 1KB<br>PR: 1KB<br>PR: 1KB | 24.3217-0908.3<br>020167   |  | Rz 17,46                 |            |
|  | 1.4 i<br>1.6 i<br>1.6 i<br>1.7 SDI<br>1.8 i<br>1.9 D<br>1.9 SDI<br>1.9 TD<br>1.9 TDI                                  |  |  | 01.97<br>01.97<br>05.97<br>07.97<br>01.97<br>01.97<br>01.97<br>01.97<br>01.97  | 05.99<br>05.99<br>05.99<br>05.99<br>05.99<br>05.99<br>05.99<br>05.99<br>05.99                            | PR: 1KM<br>PR: 1KM<br>PR: 1KM<br>PR: 1KM<br>PR: 1KM<br>PR: 1KM<br>PR: 1KM<br>PR: 1KM<br>PR: 1KM         | 24.3219-0909.3<br>020188   |  | Rz 19,05                 |            |
|    | 1.4 i<br>1.4 i<br>1.6 i<br>1.6 i<br>1.9 D<br>1.9 D<br>1.9 TD<br>1.9 TD  |  | 6K-ZR549075<br>6K-ZR037976<br>6K-ZR549075<br>6K-ZR037976<br>6K-ZR549075<br>6K-ZR037976<br>6K-ZR549075<br>6K-ZR037976 | 11.93<br>11.93<br>11.93<br>11.93<br>11.93<br>11.93<br>11.93<br>11.93   |  |   |  | 2 ↓  | L=1503                   |            |
|  | 1.4 i<br>1.4 i<br>1.6 i<br>1.6 i<br>1.9 D<br>1.9 D<br>1.9 TD<br>1.9 TD  |  | 6K-ZR549076<br>6K-ZR037977<br>6K-ZR549076<br>6K-ZR037977<br>6K-ZR549076<br>6K-ZR037977<br>6K-ZR549076<br>6K-ZR037977 | 6K-ZR663842<br>6K-ZR126718<br>6K-ZR663842<br>6K-ZR126718<br>6K-ZR663842<br>6K-ZR126718<br>6K-ZR663842<br>6K-ZR126718 |  |   |  | 2 ↓  | L=1532                   |            |
|  | 1.4 i<br>1.4 i<br>1.6 i<br>1.6 i  |  | 6K-ZR663843<br>6K-ZR126719<br>6K-ZR663843<br>6K-ZR126719   | 6K-W-169289<br>6K-W-169289<br>6K-W-169289<br>6K-W-169289   |  |   |  | 2 ↓  | L=1512                   |            |
|  | 1.4 i<br>1.6 i  |  | 6K-W-169290<br>6K-W-169290   | 05.99<br>05.99   |  |   |  | 2 ↓ + ABS<br>2 ↓ - ABS   | L=1514<br>L=1512         |            |
|  | 1.9 D<br>1.9 D<br>1.9 TD<br>1.9 TD  |  | 6K-ZR663843<br>6K-ZR126719<br>6K-ZR663843<br>6K-ZR126719   | 05.99<br>05.99<br>05.99<br>05.99   |  |   |  | 2 ↓  | L=1512                   |            |
|  | 1.8 i 16V<br>1.8 i 16V<br>2.0 i<br>2.0 i<br>2.0 i 16V<br>2.0 i 16V  |  | 95 6K-ZR610015<br>95 6K-ZR085726<br>85 6K-ZR610015<br>85 6K-ZR085726<br>110 6K-ZR610015<br>110 6K-ZR085726           | 6K-V-013236<br>6K-V-000537<br>6K-V-013236<br>6K-V-000537<br>6K-V-013236<br>6K-V-000537                               |  |   |  | 2 ↓  | L=1632                   |            |
|  | 1.8 i 16V<br>2.0 i<br>2.0 i 16V   |  | 95 6K-W-169290<br>85 6K-W-169290<br>110 6K-W-169290  | 05.99<br>05.99<br>05.99  |  |   |  | 2 ↓  | L=1641                   |            |
|  | 1.4 i<br>1.6 i<br>1.6 i<br>1.7 SDI<br>1.8 i<br>1.8 i 16V<br>1.9 D<br>1.9 SDI<br>1.9 TD<br>1.9 TDI<br>1.9 TDI<br>2.0 i |  |  | 11.93<br>11.93<br>05.97<br>07.97<br>11.93<br>02.94<br>11.93<br>09.95<br>11.93<br>03.97<br>03.97<br>11.93             | 05.99<br>05.99<br>05.99<br>05.99<br>05.99<br>05.99<br>05.99<br>05.99<br>05.99<br>05.99<br>05.99<br>05.99 | 03.0101-0025.2<br>03.6584-0113.3  | 320014<br>320111   | + Druckabhängig <sup>3)</sup><br>+ Lastabhängig <sup>4)</sup>                      | BRES 3/35<br>BRL 8/4 (4) | ATE<br>ATE |
|  | 1.9 TDI<br>1.9 TDI  | 66<br>81   |  | 07.96<br>03.97   | 05.99<br>05.99   | 03.2419-9510.3  | 030028   |  | Gz 19,05                 |            |
|  | 1.9 TDI<br>1.9 TDI  | 66<br>81   |  | 07.96<br>03.97   | 05.99<br>05.99   | 24.2523-0908.3  | 040049   |  | Nz 23,81                 |            |
|  | 1.4 i<br>1.6 i<br>1.6 i   |  |  | 11.93<br>11.93<br>05.97  | 05.99<br>05.99<br>05.99  | 24.3728-2704.2  | 592704   |  | L=1065, - AUT            |            |
|  | 1.8 i<br>1.8 i<br>1.8 i 16V<br>1.8 i 16V<br>2.0 i<br>2.0 i  |  | 6K-ZR530332<br>6K-ZR025747<br>6K-ZR530332<br>6K-ZR025747<br>6K-ZR530332<br>6K-ZR025747                               | 11.93<br>11.93<br>02.94<br>02.94<br>11.93<br>11.93   |  |   |  |  | L=854, + AUT             |            |
|  | 1.8 i<br>1.8 i<br>1.8 i 16V   |  | 6K-ZR530333<br>6K-ZR025748<br>6K-ZR530333  | 05.99<br>05.99<br>05.99  |  |   |  |  | L=854, + AUT             |            |





















1) + cast iron / + ghisa / + fonte grise / + fundición de gris

2) + aluminium / + alluminio / + aluminium / + aluminio

















3) + pressure sensitive / + in funzione della pressione / + asservi à la pression / + dependiente de la presión

4) + load sensitive / + dependente dal carico / + asservi à la charge / + dependiente de carga

|     |  |  |  |  |  |  |     |  |
|--|--|--|--|--|---|--|---|--|
| <b>SEAT CORDOBA I (93-99)</b>  |  |  |  |  |   |  |   |  |
|    | 1.8 i 16V  | 95 6K-ZR025748   |  | 05.99  | 24.3728-0128.2  | 590128   |   | L=854, + AUT   |
|  | 1.9 D  |  | 11.93  | 05.99  |   |  |   |  |
|  | 1.9 TD   | 55   | 11.93  | 05.99  |   |  |   |  |
|  | 2.0 i  | 85 6K-ZR530333   |  | 05.99  |   |  |   |  |
|  | 2.0 i  | 85 6K-ZR025748   |  | 05.99  |   |  |   |  |
| <b>SEAT CORDOBA II (6K2) (99-02)</b>   |  |  |  |  |   |  |   |  |
|    | 1.0  | 37   | 06.99  | 09.02  | 03.7750-6302.4  | 300161   | - ABS   | 9" ATE   |
|  | 1.4 i  | 44   | 06.99  | 09.02  |   |  |   |  |
|  | 1.4 i 16V  |  | 06.99  | 09.02  |   |  |   |  |
|  | 1.6 i  |  | 06.99  | 09.02  |   |  |   |  |
|  | 1.8 T 20V  | 115  | 07.00  | 09.02  |   |  |   |  |
|  | 1.9 SDI  |  | 06.99  | 09.02  |   |  |   |  |
|  | 1.9 TDI  | 66   | 06.99  | 09.02  |   |  |   |  |
|  | 1.9 TDI  | 81   | 06.99  | 09.02  |   |  |   |  |
|  | 1.0  | 37   | 06.99  | 09.02 + ABS  | 10.6350-3902.4  | 300213   | PR: 1KB   | 9" ATE   |
|  | 1.4 i  | 44   | 06.99  | 09.02 + ABS  | 10.6350-4002.4  | 300285   | PR: 1KK,1KM,1KQ   | 9" ATE   |
|  | 1.4 i 16V  |  | 06.99  | 09.02 + ABS  |   |  |   |  |
|  | 1.6 i  |  | 06.99  | 09.02 + ABS  |   |  |   |  |
|  | 1.8 T 20V  | 115  | 07.00  | 09.02 + ABS  |   |  |   |  |
|  | 1.9 SDI  |  | 06.99  | 09.02 + ABS  |   |  |   |  |
|  | 1.9 TDI  | 66   | 06.99  | 09.02 + ABS  |   |  |   |  |
|  | 1.9 TDI  | 81   | 06.99  | 09.02 + ABS  |   |  |   |  |
|    | 1.0  | 37   | 06.99  | 09.02  | 03.2122-1042.3  | 010137   | - ABS   | THz 22,20 ATE  |
|  | 1.4 i  | 44   | 06.99  | 09.02  | 03.2123-1424.3  | 010637   | + ABS   | THz 23,81 ATE  |
|  | 1.4 i 16V  |  | 06.99  | 09.02  |   |  |   |  |
|  | 1.6 i  |  | 06.99  | 09.02  |   |  |   |  |
|  | 1.8 T 20V  | 115  | 07.00  | 09.02  |   |  |   |  |
|  | 1.9 SDI  |  | 06.99  | 09.02  |   |  |   |  |
|  | 1.9 TDI  | 66   | 06.99  | 09.02  |   |  |   |  |
|  | 1.9 TDI  | 81   | 06.99  | 09.02  |   |  |   |  |
|    | 1.0  | 37   | 06.99  | 09.02  | 11.0441-4808.2  | 250022   |   | Dichtungssatz ATE  |
|  | 1.4 i  | 44   | 06.99  | 09.02  | 11.0101-4801.2  | 260006   |   | Hülsensatz ATE   |
|  | 1.4 i 16V  |  | 06.99  | 09.02  | 24.0102-4801.2  | 260085   |   | Hülsensatz+Schrauben ATE   |
|  | 1.6 i  | 55   | 06.99  | 09.02  |   |  |   |  |
|  | 1.9 SDI  |  | 06.99  | 09.02  |   |  |   |  |
|  | 1.6 i  | 74   | 06.99  | 09.02  | 24.3541-1609.5  | 240039   |    | D=54, - Halter LUC   |
|  | 1.9 TDI  | 66   | 06.99  | 09.02  | 24.3541-1610.5  | 240040   |    | D=54, - Halter LUC   |
|  | 1.8 T 20V  | 115  | 07.00  | 09.02  | 11.0101-5403.2  | 260010   |   | Faltenbalgsatz LUC   |
|  | 1.9 TDI  | 81   | 06.99  | 09.02  | 24.3541-1731.5  | 240061   |   | D=54, - Halter LUC   |
|  | 1.9 TDI  | 81   | 06.99  | 09.02  | 24.3541-1732.5  | 240062   |  | D=54, - Halter LUC   |
|  | 1.0  | 37   | 06.99  | 09.02  | 83.7713-0435.3  | 330792   | 2   | L=435  |
|  | 1.4 i  | 44   | 06.99  | 09.02  |   |  |   |  |
|  | 1.4 i 16V  |  | 06.99  | 09.02  |   |  |   |  |
|  | 1.6 i  |  | 06.99  | 09.02  |   |  |   |  |
|  | 1.8 T 20V  | 115  | 07.00  | 09.02  |   |  |   |  |
|  | 1.9 SDI  |  | 06.99  | 09.02  |   |  |   |  |
|  | 1.9 TDI  | 66   | 06.99  | 09.02  |   |  |   |  |
|  | 1.9 TDI  | 81   | 06.99  | 09.02  |   |  |   |  |
|  | 1.8 T 20V  | 115  | 07.00  | 09.02  | 24.3384-1723.7  | 220523   |  | D=38(M12x1), - Halter LUC  |
|  | 1.9 TDI  | 81   | 06.99  | 09.02  | 24.3384-1724.7  | 220524   |  | D=38(M12x1), - Halter LUC  |
|  | 1.0  | 37   | 06.99  | 09.02  | 83.7858-0140.3  | 330837   | 2   | L=140  |
|  | 1.4 i  | 44   | 06.99  | 09.02  |   |  |   |  |
|  | 1.4 i 16V  |  | 06.99  | 09.02  |   |  |   |  |
|  | 1.6 i  |  | 06.99  | 09.02  |   |  |   |  |
|  | 1.8 T 20V  | 115  | 07.00  | 09.02  |   |  |   |  |
|  | 1.9 SDI  |  | 06.99  | 09.02  |   |  |   |  |
|  | 1.9 TDI  | 66   | 06.99  | 09.02  |   |  |   |  |
|  | 1.9 TDI  | 81   | 06.99  | 09.02  |   |  |   |  |
|  | 1.0  | 37   | 06.99  | 09.02  | 24.3217-0908.3  | 020167   |   | Rz 17,46   |
|  | 1.4 i  | 44   | 06.99  | 09.02  |   |  |   |  |
|  | 1.4 i 16V  |  | 06.99  | 09.02  |   |  |   |  |
|  | 1.6 i  | 55   | 06.99  | 09.02  |   |  |   |  |
|  | 1.9 SDI  |  | 06.99  | 09.02  |   |  |   |  |
|  | 1.9 TDI  | 66   | 06.99  | 09.02  |   |  |   |  |
|  | 1.6 i  | 74   | 06.99  | 09.02  | 24.3219-0909.3  | 020188   |   | Rz 19,05   |
|  | 1.0  | 37   | 06.99  | 09.02  | 24.3727-0162.2  | 580162   | 2 ↓   | L=1514   |
|  | 1.4 i  | 44   | 06.99  | 09.02  |   |  |   |  |
|  | 1.4 i 16V  |  | 06.99  | 09.02  |   |  |   |  |
|  | 1.6 i  |  | 06.99  | 09.02  |   |  |   |  |
|  | 1.9 SDI  |  | 06.99  | 09.02  |   |  |   |  |
|  | 1.9 TDI  | 66   | 06.99  | 09.02  |   |  |   |  |
|  | 1.8 T 20V  | 115  | 07.00  | 09.02  | 24.3727-0165.2  | 580165   | 2 ↓   | L=1641   |
|  | 1.9 TDI  | 81   | 06.99  | 09.02  |   |  |   |  |
|  | 1.0  | 37   | 06.99  | 09.02  | 24.2415-1712.3  | 030131   |   | Gz 15,87   |
|  | 1.4 i  | 44   | 06.99  | 09.02  |   |  |   |  |
|  | 1.4 i 16V  |  | 06.99  | 09.02  |   |  |   |  |
|  | 1.6 i  |  | 06.99  | 09.02  |   |  |   |  |
|  | 1.8 T 20V  | 115  | 07.00  | 09.02  |   |  |   |  |
|  | 1.9 SDI  |  | 06.99  | 09.02  |   |  |   |  |
|  | 1.9 TDI  | 66   | 06.99  | 09.02  |   |  |   |  |
|  | 1.9 TDI  | 81   | 06.99  | 09.02  |   |  |   |  |

|     |                       |  |  |   |  |  |  |    |  |                          |
|--|---|--|--|---|---|--|--|--|--|--------------------------|
| <b>SEAT CORDOBA II (6K2) (99-02)</b>   |   |  |  |   |   |  |  |  |  |                          |
|    | 1.0<br>1.4 i<br>1.4 i 16V<br>1.6 i<br>1.8 T 20V<br>1.9 SDI<br>1.9 TDI<br>1.9 TDI                      | 37<br>44<br><br>115<br>66<br>81  |  | 06.99 09.02<br>06.99 09.02<br>06.99 09.02<br>06.99 09.02<br>07.00 09.02<br>06.99 09.02<br>06.99 09.02<br>06.99 09.02  |   | 24.2519-1701.3<br>24.2523-1701.3   | 040075<br>040080   | + Schaltseilzug <sup>1)</sup><br>+ Schaltgestänge <sup>2)</sup>  | Nz 19,05<br>Nz 23,81   |                          |
| <b>SEAT CORDOBA III (6L2) (02-09)</b>  |   |  |  |   |   |  |  |  |  |                          |
|    | 1.2 i<br>1.4 i 16V<br>1.4 i 16V<br>1.4 TDI<br>1.6 i 16V<br>1.9 SDI<br>1.9 TDI<br>1.9 TDI<br>2.0 i 16V | 47<br>74<br>74<br>47<br>74<br>96<br>85   |  | 10.02 06.09<br>10.02 06.09<br>10.02 06.09<br>10.02 06.09<br>02.03 06.09<br>10.02 06.09<br>10.02 06.09<br>10.02 06.09<br>10.02 06.09   |   | 03.7750-6302.4   | 300161   |  | 9" ATE   |                          |
|    | 1.2 i<br>1.4 i 16V<br>1.4 i 16V<br>1.4 TDI<br>1.6 i 16V<br>1.9 SDI<br>1.9 TDI<br>1.9 TDI<br>2.0 i 16V | 47<br>74<br>74<br>47<br>74<br>96<br>85   |  | 10.02 06.09<br>10.02 06.09<br>10.02 06.09<br>10.02 06.09<br>02.03 06.09<br>10.02 06.09<br>10.02 06.09<br>10.02 06.09<br>10.02 06.09   |   | 24.2120-1736.3<br>24.2120-1734.3   | 010732<br>010702   | - ABS<br>+ ABS   | THz 20,64<br>THz 20,64   |                          |
|    | 1.2 i<br>1.4 i 16V<br>1.4 i 16V<br>1.4 TDI<br>1.6 i 16V<br>1.9 SDI<br>1.9 TDI<br>1.9 TDI<br>2.0 i 16V | 47<br>74<br>74<br>47<br>74<br>96<br>85   |  | 10.02 06.09 PR: 1LQ,1ZF<br>10.02 06.09 PR: 1LQ,1ZF<br>10.02 06.09 PR: 1LQ,1ZF<br>10.02 06.09 PR: 1LQ,1ZF<br>02.03 06.09 PR: 1LQ,1ZF<br>10.02 06.09 PR: 1LQ,1ZF<br>10.02 06.09 PR: 1LQ,1ZF<br>10.02 06.09 PR: 1LQ,1ZF<br>10.02 06.09 PR: 1LQ,1ZF |   | 11.9541-9549.2<br>11.9541-9550.2<br>11.0101-5409.2                                 | 220575<br>220576<br>260035   | <input type="checkbox"/><br><input type="checkbox"/>   | D=54, - Halter<br>D=54, - Halter<br>Hülzensatz                                     | ATE<br>ATE<br>ATE        |
|    | 1.2 i<br>1.4 i 16V<br>1.4 i 16V<br>1.4 TDI<br>1.6 i 16V<br>1.9 SDI<br>1.9 TDI<br>1.9 TDI<br>2.0 i 16V | 47<br>74<br>74<br>47<br>74<br>96<br>85   |  | 10.02 06.09 PR: 1LN,1ZH<br>10.02 06.09 PR: 1LN,1ZH<br>10.02 06.09 PR: 1LN,1ZH<br>10.02 06.09 PR: 1LN,1ZH<br>02.03 06.09 PR: 1LN,1ZH<br>10.02 06.09 PR: 1LN,1ZH<br>10.02 06.09 PR: 1LN,1ZH<br>10.02 06.09 PR: 1LN,1ZH<br>10.02 06.09 PR: 1LN,1ZH |   | 24.3541-1797.7<br>24.3541-1798.7   | 220553<br>220554   | <input type="checkbox"/><br><input type="checkbox"/>   | D=54, - Halter<br>D=54, - Halter   | LUC<br>LUC               |
|  | 1.2 i<br>1.4 i 16V<br>1.4 i 16V<br>1.4 TDI<br>1.6 i 16V<br>1.9 SDI<br>1.9 TDI<br>1.9 TDI<br>2.0 i 16V | 47<br>74<br>74<br>47<br>74<br>96<br>85   |  | 10.02 06.09<br>10.02 06.09<br>10.02 06.09<br>10.02 06.09<br>02.03 06.09<br>10.02 06.09<br>10.02 06.09<br>10.02 06.09<br>10.02 06.09   |   | 83.6247-0522.3   | 330595   | 2  | L=522  |                          |
|  | 1.2 i<br>1.4 i 16V<br>1.4 i 16V<br>1.4 TDI<br>1.6 i 16V<br>1.9 SDI<br>1.9 TDI<br>1.9 TDI<br>2.0 i 16V | 47<br>74<br>74<br>47<br>74<br>96<br>85   |  | 10.02 06.09<br>10.02 06.09<br>10.02 06.09<br>10.02 06.09<br>02.03 06.09<br>10.02 06.09<br>10.02 06.09<br>10.02 06.09<br>10.02 06.09   |   | 24.3344-1709.7<br>24.3344-1710.7<br>24.3384-1729.7<br>24.3384-1730.7               | 220537<br>220538<br>220541<br>220542   | <input type="checkbox"/><br><input type="checkbox"/><br><input type="checkbox"/><br><input type="checkbox"/>                 | D=34, - Halter<br>D=34, - Halter<br>D=38(M12x1), - Halter<br>D=38(M12x1), - Halter | LUC<br>LUC<br>LUC<br>LUC |
|  | 1.2 i<br>1.4 i 16V<br>1.4 i 16V<br>1.4 TDI<br>1.6 i 16V<br>1.9 SDI<br>1.9 TDI<br>1.9 TDI<br>2.0 i 16V | 47<br>74<br>74<br>47<br>74<br>96<br>85   |  | 10.02 06.09<br>10.02 06.09<br>10.02 06.09<br>10.02 06.09<br>02.03 06.09<br>10.02 06.09<br>10.02 06.09<br>10.02 06.09<br>10.02 06.09   |   | 83.7858-0140.3   | 330837   | 2  | L=140  |                          |
|  | 1.2 i<br>1.4 i 16V<br>1.4 i 16V<br>1.4 TDI<br>1.6 i 16V<br>1.9 SDI<br>1.9 TDI<br>1.9 TDI<br>2.0 i 16V | 47<br>74<br>74<br>47<br>74<br>96<br>85   |  | 10.02 06.09<br>10.02 06.09<br>10.02 06.09<br>10.02 06.09<br>02.03 06.09<br>10.02 06.09<br>10.02 06.09<br>10.02 06.09<br>10.02 06.09   |   | 24.3219-0909.3   | 020188   |  | Rz 19,05   |                          |
|  | 1.2 i<br>1.4 i 16V<br>1.4 i 16V<br>1.4 TDI  | 47<br>74<br>74   |  | 10.02 06.09<br>10.02 06.09<br>10.02 06.09<br>10.02 06.09  |   | 24.3727-0199.2   | 580199   | 2  - Schlechtwegeausführung <sup>3)</sup> | L=1580   |                          |













































1) + gearshift cable / + leva cambio con cavo / + câble de changem.de vitesse / + cable de acc. del cambio  
2) + gearshift linkage / + leva cambio con tiranteria / + tige de changem.de vitesse / + varillaje del cambio  
3) - rough road construction / - versione per percorsi accidentati / - version pour mauvaise route / - versión 4x4











|     |  |  |  |  |  |  |  |  |  |                |     |
|--|--|--|--|--|---|--|--|--|--|----------------|-----|
| <b>SEAT CORDOBA III (6L2) (02-09)</b>  |  |  |  |  |   |  |  |  |  |                |     |
|    | 1.6 i 16V  | 47   |  | 02.03  | 06.09   | 24.3727-0199.2   | 580199   | 2 ↓ - Schlechtwegeausführung <sup>1)</sup>   | L=1580                                     |                |     |
|  | 1.9 SDI  | 74   |  | 10.02  | 06.09   |  |  |  |  |                |     |
|  | 1.9 TDI  | 74   |  | 10.02  | 06.09   |  |  |  |  |                |     |
|  | 1.9 TDI  | 96   |  | 10.02  | 06.09   |  |  |  |  |                |     |
|  | 2.0 i 16V  | 85   |  | 10.02  | 06.09   |  |  |  |  |                |     |
|  | 1.2 i  | 47   |  | 10.02  | 06.09   | PR: 1JB,1KD,1KK,1KP,1KS,1KT  | 24.3727-0176.2   | 580176   | 2 ↓ + Schlechtwegeausführung <sup>2)</sup> | L=1640         |     |
|  | 1.4 i 16V  | 74   |  | 10.02  | 06.09   | PR: 1JB,1KD,1KK,1KP,1KS,1KT  | 24.3727-0198.2   | 580198   | 2 ↓ + Schlechtwegeausführung <sup>2)</sup> | L=1645         |     |
|  | 1.4 TDI  | 74   |  | 10.02  | 06.09   | PR: 1JB,1KD,1KK,1KP,1KS,1KT  |  |  |  |                |     |
|  | 1.6 i 16V  | 47   |  | 02.03  | 06.09   | PR: 1JB,1KD,1KK,1KP,1KS,1KT  |  |  |  |                |     |
|  | 1.9 SDI  | 74   |  | 10.02  | 06.09   | PR: 1JB,1KD,1KK,1KP,1KS,1KT  |  |  |  |                |     |
|  | 1.9 TDI  | 74   |  | 10.02  | 06.09   | PR: 1JB,1KD,1KK,1KP,1KS,1KT  |  |  |  |                |     |
|  | 1.9 TDI  | 96   |  | 10.02  | 06.09   | PR: 1JB,1KD,1KK,1KP,1KS,1KT  |  |  |  |                |     |
| 2.0 i 16V  | 85   |  | 10.02  | 06.09  | PR: 1JB,1KD,1KK,1KP,1KS,1KT   |  |  |  |  |                |     |
|    | 1.2 i  | 47   |  | 10.02  | 06.09   | PR: 1JB,1KM  | 24.3727-2504.2   | 582504   | 2 ↓ + Schlechtwegeausführung <sup>2)</sup> | L=1580         |     |
|  | 1.4 i 16V  | 74   |  | 10.02  | 06.09   | PR: 1JB,1KM  |  |  |  |                |     |
|  | 1.4 TDI  | 74   |  | 10.02  | 06.09   | PR: 1JB,1KM  |  |  |  |                |     |
|  | 1.6 i 16V  | 47   |  | 02.03  | 06.09   | PR: 1JB,1KM  |  |  |  |                |     |
|  | 1.9 SDI  | 74   |  | 10.02  | 06.09   | PR: 1JB,1KM  |  |  |  |                |     |
|  | 1.9 TDI  | 74   |  | 10.02  | 06.09   | PR: 1JB,1KM  |  |  |  |                |     |
|  | 1.9 TDI  | 96   |  | 10.02  | 06.09   | PR: 1JB,1KM  |  |  |  |                |     |
|  | 2.0 i 16V  | 85   |  | 10.02  | 06.09   | PR: 1JB,1KM  |  |  |  |                |     |
|  | 1.2 i  | 47   |  | 10.02  | 06.09   |  | 03.6583-0216.3   | 320247   | - ABS                                      | BRL 8/3 (4)    |     |
|  | 1.4 i 16V  | 74   |  | 10.02  | 06.09   |  | 03.6584-0120.3   | 320279   | - ABS                                      | BRL 8/4 (4)    |     |
|  | 1.4 TDI  | 74   |  | 10.02  | 06.09   |  |  |  |  |                |     |
|  | 1.6 i 16V  | 47   |  | 02.03  | 06.09   |  |  |  |  |                |     |
| 1.9 SDI  | 74   |  | 10.02  | 06.09  |   |  |  |  |  |                |     |
| 1.9 TDI  | 74   |  | 10.02  | 06.09  |   |  |  |  |  |                |     |
| 1.9 TDI  | 96   |  | 10.02  | 06.09  |   |  |  |  |  |                |     |
| 2.0 i 16V  | 85   |  | 10.02  | 06.09  |   |  |  |  |  |                |     |
| <b>SEAT EXEO / ST (09-13)</b>  |  |  |  |  |   |  |  |  |  |                |     |
|    | 1.6  | 75   |  | 04.09  | 06.13   |  | 03.7858-4502.4   | 300202   |  | 9/8" Tandem    | ATE |
|  | 1.8 T  | 110  |  | 04.09  | 06.13   |  |  |  |  |                |     |
|  | 1.8 TSI  | 88   |  | 09.10  | 06.13   |  |  |  |  |                |     |
|  | 1.8 TSI  | 118  |  | 05.10  | 06.13   |  |  |  |  |                |     |
|  | 2.0 TDI  | 88   |  | 04.09  | 06.13   |  |  |  |  |                |     |
|  | 2.0 TDI  | 105  |  | 04.09  | 06.13   |  |  |  |  |                |     |
|  | 2.0 TDI  | 125  |  | 04.09  | 06.13   |  |  |  |  |                |     |
|  | 2.0 TFSI   | 125  |  | 04.09  | 06.13   |  |  |  |  |                |     |
|  | 1.6  | 75   |  | 04.09  | 06.13   |  | 03.2125-0373.3   | 010810   |  | THz 25,40      | ATE |
|  | 1.8 T  | 110  |  | 04.09  | 06.13   |  | 24.2125-1720.3   | 010688   |  | THz 25,40      | LUC |
|  | 1.8 TSI  | 88   |  | 09.10  | 06.13   |  |  |  |  |                |     |
|  | 1.8 TSI  | 118  |  | 05.10  | 06.13   |  |  |  |  |                |     |
|  | 2.0 TDI  | 88   |  | 04.09  | 06.13   |  |  |  |  |                |     |
|  | 2.0 TDI  | 105  |  | 04.09  | 06.13   |  |  |  |  |                |     |
|  | 2.0 TDI  | 125  |  | 04.09  | 06.13   |  |  |  |  |                |     |
|  | 2.0 TFSI   | 125  |  | 04.09  | 06.13   |  |  |  |  |                |     |
|  | 1.6  | 75   |  | 04.09  | 06.13   | PR: 1LA  | 11.9606-9953.2   | 220587   | ☐  | D=60, - Halter | ATE |
|  | 1.8 T  | 110  |  | 04.09  | 06.13   | PR: 1LA  | 11.9606-9954.2   | 220588   | ☐  | D=60, - Halter | ATE |
|  | 1.8 TSI  | 88   |  | 09.10  | 06.13   | PR: 1LA  |  |  |  |                |     |
|  | 1.8 TSI  | 118  |  | 05.10  | 06.13   | PR: 1LA  |  |  |  |                |     |
|  | 2.0 TDI  | 88   |  | 04.09  | 06.13   | PR: 1LA  |  |  |  |                |     |
|  | 2.0 TDI  | 105  |  | 04.09  | 06.13   | PR: 1LA  |  |  |  |                |     |
|  | 2.0 TDI  | 125  |  | 04.09  | 06.13   | PR: 1LA  |  |  |  |                |     |
|  | 2.0 TFSI   | 125  |  | 04.09  | 06.13   | PR: 1LA  |  |  |  |                |     |
|  | 1.6  | 75   |  | 04.09  | 06.13   | PR: 1LB  | 11.3571-8522.2   | 220320   | ☐  | D=57, - Halter | ATE |
|  | 1.8 T  | 110  |  | 04.09  | 06.13   | PR: 1LB  | 11.3571-8521.2   | 220319   | ☐  | D=57, - Halter | ATE |
|  | 1.8 TSI  | 88   |  | 09.10  | 06.13   | PR: 1LB  | 24.3571-8522.5   | 240496   | ☐  | D=57, - Halter | ATE |
|  | 1.8 TSI  | 118  |  | 05.10  | 06.13   | PR: 1LB  | 24.3571-8521.5   | 240495   | ☐  | D=57, - Halter | ATE |
|  | 2.0 TDI  | 88   |  | 04.09  | 06.13   | PR: 1LB  |  |  |  |                |     |
|  | 2.0 TDI  | 105  |  | 04.09  | 06.13   | PR: 1LB  |  |  |  |                |     |
|  | 2.0 TDI  | 125  |  | 04.09  | 06.13   | PR: 1LB  |  |  |  |                |     |
|  | 2.0 TFSI   | 125  |  | 04.09  | 06.13   | PR: 1LB  |  |  |  |                |     |
|  | 1.6  | 75   |  | 04.09  | 06.13   | PR: 1LT  | 11.9571-9836.2   | 220428   | ☐  | D=57, - Halter | ATE |
|  | 1.8 T  | 110  |  | 04.09  | 06.13   | PR: 1LT  | 11.9571-9835.2   | 220427   | ☐  | D=57, - Halter | ATE |
|  | 1.8 TSI  | 88   |  | 09.10  | 06.13   | PR: 1LT  |  |  |  |                |     |
|  | 1.8 TSI  | 118  |  | 05.10  | 06.13   | PR: 1LT  |  |  |  |                |     |
|  | 2.0 TDI  | 88   |  | 04.09  | 06.13   | PR: 1LT  |  |  |  |                |     |
|  | 2.0 TDI  | 105  |  | 04.09  | 06.13   | PR: 1LT  |  |  |  |                |     |
|  | 2.0 TDI  | 125  |  | 04.09  | 06.13   | PR: 1LT  |  |  |  |                |     |
|  | 2.0 TFSI   | 125  |  | 04.09  | 06.13   | PR: 1LT  |  |  |  |                |     |
|  | 1.6  | 75   |  | 04.09  | 06.13   | PR: 1LZ  | 24.3541-1763.5   | 240231   | ☐  | D=54, - Halter | LUC |
|  | 1.8 T  | 110  |  | 04.09  | 06.13   | PR: 1LZ  | 24.3541-1764.5   | 240232   | ☐  | D=54, - Halter | LUC |
|  | 1.8 TSI  | 88   |  | 09.10  | 06.13   | PR: 1LZ  |  |  |  |                |     |
|  | 1.8 TSI  | 118  |  | 05.10  | 06.13   | PR: 1LZ  |  |  |  |                |     |
|  | 2.0 TDI  | 88   |  | 04.09  | 06.13   | PR: 1LZ  |  |  |  |                |     |
|  | 2.0 TDI  | 105  |  | 04.09  | 06.13   | PR: 1LZ  |  |  |  |                |     |
|  | 2.0 TDI  | 125  |  | 04.09  | 06.13   | PR: 1LZ  |  |  |  |                |     |
|  | 2.0 TFSI   | 125  |  | 04.09  | 06.13   | PR: 1LZ  |  |  |  |                |     |

<sup>1)</sup> - rough road construction / - versione per percorsi accidentati / - version pour mauvaise route / - versión 4x4

<sup>2)</sup> + rough road construction / + versione per percorsi accidentati / + version pour mauvaise route / + versión 4x4



| SEAT EXEO / ST (09-13)   |  |   |  |  |   |  |  |   |   |                |
|--|--|---|--|--|---|--|--|---|---|----------------|
|     |  |     |  |  |  |  |  |   |   |                |
|    | 1.6  | 75  |  | 04.09  | 06.13   | 83.7213-0307.3   | 330791   | 2   |   | L=305          |
|  | 1.8 T  | 110   |  | 04.09  | 06.13   |  |  |   |   |                |
|  | 1.8 TSI  | 88  |  | 09.10  | 06.13   |  |  |   |   |                |
|  | 1.8 TSI  | 118   |  | 05.10  | 06.13   |  |  |   |   |                |
|  | 2.0 TDI  | 88  |  | 04.09  | 06.13   |  |  |   |   |                |
|  | 2.0 TDI  | 105   |  | 04.09  | 06.13   |  |  |   |   |                |
|  | 2.0 TDI  | 125   |  | 04.09  | 06.13   |  |  |   |   |                |
|  | 2.0 TFSI   |   |  | 04.09  | 06.13   |  |  |   |   |                |
|    | 1.6  | 75  |  | 04.09  | 06.13   | 24.3384-1735.7   | 220547   |  |   | D=38, - Halter |
|  | 1.8 T  | 110   |  | 04.09  | 06.13   | 24.3384-1736.7   | 220548   |  |   | D=38, - Halter |
|  | 1.8 TSI  | 88  |  | 09.10  | 06.13   |  |  |   |   |                |
|  | 1.8 TSI  | 118   |  | 05.10  | 06.13   |  |  |   |   |                |
|  | 2.0 TDI  | 88  |  | 04.09  | 06.13   |  |  |   |   |                |
|  | 2.0 TDI  | 105   |  | 04.09  | 06.13   |  |  |   |   |                |
|  | 2.0 TDI  | 125   |  | 04.09  | 06.13   |  |  |   |   |                |
|  | 2.0 TFSI   |   |  | 04.09  | 06.13   |  |  |   |   |                |
|  |  |   |  |  |   |  |  |   |   |                |
|  | 1.6  | 75  |  | 04.09  | 06.13   | 24.3414-1713.7   | 220793   |  |   | D=41, - Halter |
|  | 1.8 T  | 110   |  | 04.09  | 06.13   | 24.3414-1714.7   | 220794   |  |   | D=41, - Halter |
|  | 1.8 TSI  | 88  |  | 09.10  | 06.13   |  |  |   |   |                |
|  | 1.8 TSI  | 118   |  | 05.10  | 06.13   |  |  |   |   |                |
|  | 2.0 TDI  | 88  |  | 04.09  | 06.13   |  |  |   |   |                |
|  | 2.0 TDI  | 105   |  | 04.09  | 06.13   |  |  |   |   |                |
|  | 2.0 TDI  | 125   |  | 04.09  | 06.13   |  |  |   |   |                |
|  | 2.0 TFSI   |   |  | 04.09  | 06.13   |  |  |   |   |                |
|  |  |   |  |  |   |  |  |   |   |                |
|    | 1.6  | 75  |  | 04.09  | 06.13   | 24.5138-0263.3   | 330885   | 2   |   | L=263          |
|  | 1.8 T  | 110   |  | 04.09  | 06.13   |  |  |   |   |                |
|  | 1.8 TSI  | 88  |  | 09.10  | 06.13   |  |  |   |   |                |
|  | 1.8 TSI  | 118   |  | 05.10  | 06.13   |  |  |   |   |                |
|  | 2.0 TDI  | 88  |  | 04.09  | 06.13   |  |  |   |   |                |
|  | 2.0 TDI  | 105   |  | 04.09  | 06.13   |  |  |   |   |                |
|  | 2.0 TDI  | 125   |  | 04.09  | 06.13   |  |  |   |   |                |
|  | 2.0 TFSI   |   |  | 04.09  | 06.13   |  |  |   |   |                |
| SEAT IBIZA I (85-92)   |  |   |  |  |   |  |  |   |   |                |
|    | 0.9  |   |  | 11.86  | 01.93   | 03.2120-2031.3   | 010106   |   |   | Thz 20,64      |
|  | 1.2  |   |  | 05.85  | 01.93   |  |  |   |   |                |
|  | 1.5  |   |  | 05.85  | 01.93   |  |  |   |   |                |
|  | 1.5 i  |   |  | 04.88  | 01.93   |  |  |   |   |                |
|  | 1.7 D  |   |  | 05.85  | 01.93   |  |  |   |   |                |
|   | 0.9  |   |  | 11.86  | 01.93   | 24.5112-0412.3   | 330569   | 2   |   | L=410          |
|  | 1.2  |   |  | 05.85  | 01.93   |  |  |   |   |                |
|  | 1.5  |   |  | 05.85  | 01.93   |  |  |   |   |                |
|  | 1.5 i  |   |  | 04.88  | 01.93   |  |  |   |   |                |
|  | 1.7 D  |   |  | 05.85  | 01.93   |  |  |   |   |                |
|  | 1.7 i  |   |  | 01.92  | 01.93   |  |  |   |   |                |
|  | 0.9  |   |  | 11.86  | 01.93   | 24.5223-0294.3   | 330576   | 2   |   | L=294          |
|  | 1.2  |   |  | 05.85  | 01.93   |  |  |   |   |                |
|  | 1.5  |   |  | 05.85  | 01.93   |  |  |   |   |                |
|  | 1.5 i  |   |  | 04.88  | 01.93   |  |  |   |   |                |
|  | 1.7 D  |   |  | 05.85  | 01.93   |  |  |   |   |                |
|  | 1.7 i  |   |  | 01.92  | 01.93   |  |  |   |   |                |
|  | 0.9  |   |  | 11.86  | 01.93   | 24.3217-1115.3   | 020310   |   |   | Rz 17,46       |
|  | 1.2  |   |  | 05.85  | 01.93   |  |  |   |   |                |
|  | 1.5  |   |  | 05.85  | 01.93   |  |  |   |   |                |
|  | 1.5 i  |   |  | 04.88  | 01.93   |  |  |   |   |                |
|  | 1.7 D  |   |  | 05.85  | 01.93   |  |  |   |   |                |
|  | 1.7 i  |   |  | 01.92  | 01.93   |  |  |   |   |                |
|  | 0.9  |   |  | 11.86  | 01.93   | 24.3727-2701.2   | 582701   | 1   |  | L=2275         |
|  | 1.2  |   |  | 05.85  | 01.93   |  |  |   |   |                |
|  | 1.5  |   |  | 05.85  | 01.93   |  |  |   |   |                |
|  | 1.5 i  |   |  | 04.88  | 01.93   |  |  |   |   |                |
|  | 1.7 D  |   |  | 05.85  | 01.93   |  |  |   |   |                |
|  | 1.7 i  |   |  | 05.85  | 01.93   |  |  |   |   |                |
| SEAT IBIZA II (93-99)  |  |   |  |  |   |  |  |   |   |                |
|  | 1.6 i  |  |  | 02.93  | 07.99   | 03.7750-6302.4   | 300161   |   | - ABS   | 9"             |
|  | 1.8 i  |  |  | 02.93  | 07.99   |  |  |   |   |                |
|  | 1.8 i 16V  |  |  | 02.94  | 07.99   |  |  |   |   |                |
|  | 1.9 D  |  |  | 02.93  | 07.99   |  |  |   |   |                |
|  | 1.9 SDI  |  |  | 09.95  | 07.99   |  |  |   |   |                |
|  | 1.9 TD   |  |  | 02.93  | 07.99   |  |  |   |   |                |
|  | 2.0 i  |  |  | 02.93  | 07.99   |  |  |   |   |                |
|  | 1.0 i  |  |  | 02.93  | 07.99   | 03.7740-1402.4   | 300133   |   | - ABS   | 8"             |
|  | 1.3 i  |  |  | 02.93  | 07.99   |  |  |   |   |                |
|  | 1.4 i  |  |  | 09.93  | 07.99   |  |  |   |   |                |
|  | 1.6 i  |  |  | 02.93  | 07.99   |  |  |   |   |                |
|  | 1.0 i  |  | 6K-TR069 487   |  | 07.99   | 10.6350-3902.4   | 300213   |   | + ABS   | 9"             |
|  | 1.3 i  |  | 6K-TR069 487   |  | 07.99   | 10.6350-4002.4   | 300285   |   | + ABS   | 9"             |
|  | 1.4 i  |  | 6K-TR069 487   |  | 07.99   |  |  |   |   |                |
|  | 1.4 i 16V  |  | 74 6K-TR069 487  |  | 07.99   |  |  |   |   |                |
|  | 1.6 i  |  | 6K-TR069 487   |  | 07.99   |  |  |   |   |                |
|  | 1.7 SDI  |  | 6K-TR069 487   |  | 07.99   |  |  |   |   |                |
|  | 1.8 i  |  | 6K-TR069 487   |  | 07.99   |  |  |   |   |                |
|  | 1.8 i 16V  |  | 6K-TR069 487   |  | 07.99   |  |  |   |   |                |
|  | 1.9 D  |  | 6K-TR069 487   |  | 07.99   |  |  |   |   |                |
|  | 1.9 SDI  |  | 6K-TR069 487   |  | 07.99   |  |  |   |   |                |
|  | 1.9 TD   |  | 6K-TR069 487   |  | 07.99   |  |  |   |   |                |

| SEAT IBIZA II (93-99)  |                   |    |              |             |                |        |   |                      |     |
|--|-------------------|----|--------------|-------------|----------------|--------|---|----------------------|-----|
|    | 1.9 TDI           | 66 | 6K-TR069 487 | 07.99       | 10.6350-3902.4 | 300213 | + ABS   | 9"                   | ATE |
|  | 1.9 TDI           | 81 | 6K-TR069 487 | 07.99       | 10.6350-4002.4 | 300285 | + ABS   | 9"                   | ATE |
|  | 2.0 i             |    | 6K-TR069 487 | 07.99       |                |        |   |                      |     |
|  | 2.0 i 16V Cupra 2 |    | 6K-TR069 487 | 07.99       |                |        |   |                      |     |
|    | 1.0 i             |    |              | 02.93 07.99 | 03.2120-3943.3 | 010532 | - ABS   | THz 20,64            | ATE |
|  | 1.3 i             |    |              | 02.93 07.99 | 03.3517-0101.2 | 390322 | - ABS   | Verschlußschraube    |     |
|  | 1.4 i             |    |              | 09.93 07.99 |                |        |   |                      |     |
|  | 1.6 i             |    |              | 02.93 07.99 |                |        |   |                      |     |
|  | 1.7 SDI           |    |              | 07.97 07.99 |                |        |   |                      |     |
|  | 1.8 i             |    |              | 02.93 07.99 |                |        |   |                      |     |
|  | 1.9 D             |    |              | 02.93 07.99 |                |        |   |                      |     |
|  | 1.9 SDI           |    |              | 09.95 07.99 |                |        |   |                      |     |
|  | 1.9 TD            |    |              | 02.93 07.99 |                |        |   |                      |     |
|  | 1.8 i 16V         |    |              | 02.94 07.99 | 03.2122-1042.3 | 010137 | - ABS   | THz 22,20            | ATE |
|  | 1.9 TDI           | 66 |              | 07.96 07.99 | 03.3517-0101.2 | 390322 | - ABS   | Verschlußschraube    |     |
|  | 1.9 TDI           | 81 |              | 03.97 07.99 |                |        |   |                      |     |
|  | 2.0 i             |    |              | 02.93 07.99 |                |        |   |                      |     |
|  | 1.8 i 16V         |    |              | 02.94 07.99 | 10.6123-0674.3 | 010639 | + ABS   | THz 23,81            | ATE |
|  | 2.0 i             |    |              | 02.93 07.99 |                |        |   |                      |     |
|    | 1.0 i             |    |              | 02.93 07.99 | 24.3481-1745.5 | 240277 |    | D=48, - Halter       | ATE |
|  | 1.3 i             |    |              | 02.93 07.99 | 24.3481-1746.5 | 240278 |    | D=48, - Halter       | ATE |
|  | 1.4 i             |    |              | 09.93 07.99 | 11.0441-4808.2 | 250022 |   | Dichtungssatz        | ATE |
|  | 1.4 i 16V         | 74 |              | 09.96 07.99 | 11.0101-4803.2 | 260008 |   | Hülsensatz           | ATE |
|  | 1.6 i             |    |              | 02.93 07.99 | 24.0102-4803.2 | 260086 |   | Hülsensatz+Schrauben | ATE |
|  | 1.7 SDI           |    |              | 07.97 07.99 |                |        |   |                      |     |
|  | 1.8 i             |    |              | 02.93 07.99 |                |        |   |                      |     |
|  | 1.8 i 16V         |    |              | 02.94 07.99 |                |        |   |                      |     |
|  | 1.9 D             |    |              | 02.93 07.99 |                |        |   |                      |     |
|  | 1.9 SDI           |    |              | 09.95 07.99 |                |        |   |                      |     |
|  | 1.9 TD            |    |              | 02.93 07.99 |                |        |   |                      |     |
|  | 1.9 TDI           | 66 |              | 07.96 07.99 |                |        |   |                      |     |
|  | 1.9 TDI           | 81 |              | 03.97 07.99 |                |        |   |                      |     |
|  | 2.0 i             |    |              | 02.93 07.99 |                |        |   |                      |     |
|  | 2.0 i 16V Cupra 2 |    |              | 07.96 07.99 |                |        |   |                      |     |
|  | 1.0 i             |    |              | 02.93 07.99 | 11.0441-4808.2 | 250022 |   | Dichtungssatz        | ATE |
|  | 1.3 i             |    |              | 02.93 07.99 | 11.0101-4801.2 | 260006 |   | Hülsensatz           | ATE |
|  | 1.4 i             |    |              | 09.93 07.99 | 24.0102-4801.2 | 260085 |   | Hülsensatz+Schrauben | ATE |
|  | 1.4 i 16V         | 74 |              | 09.96 07.99 |                |        |   |                      |     |
|  | 1.6 i             |    |              | 02.93 07.99 |                |        |   |                      |     |
|  | 1.7 SDI           |    |              | 07.97 07.99 |                |        |   |                      |     |
|  | 1.8 i             |    |              | 02.93 07.99 |                |        |   |                      |     |
|  | 1.8 i 16V         |    |              | 02.94 07.99 |                |        |   |                      |     |
|  | 1.9 D             |    |              | 02.93 07.99 |                |        |   |                      |     |
|  | 1.9 SDI           |    |              | 09.95 07.99 |                |        |   |                      |     |
|  | 1.9 TD            |    |              | 02.93 07.99 |                |        |   |                      |     |
|  | 1.9 TDI           | 66 |              | 07.96 07.99 |                |        |   |                      |     |
|  | 1.9 TDI           | 81 |              | 03.97 07.99 |                |        |   |                      |     |
|  | 2.0 i             |    |              | 02.93 07.99 |                |        |   |                      |     |
|  | 2.0 i 16V Cupra 2 |    |              | 07.96 07.99 |                |        |   |                      |     |
|  | 1.0 i             |    |              | 02.93 07.99 | 24.3541-1609.5 | 240039 |  | D=54, - Halter       | LUC |
|  | 1.3 i             |    |              | 02.93 07.99 | 24.3541-1610.5 | 240040 |  | D=54, - Halter       | LUC |
|  | 1.4 i             |    |              | 09.93 07.99 | 11.0101-5403.2 | 260010 |   | Faltenbalsatz        | LUC |
|  | 1.4 i 16V         | 74 |              | 09.96 07.99 |                |        |   |                      |     |
|  | 1.6 i             |    |              | 02.93 07.99 |                |        |   |                      |     |
|  | 1.7 SDI           |    |              | 07.97 07.99 |                |        |   |                      |     |
|  | 1.8 i             |    |              | 02.93 07.99 |                |        |   |                      |     |
|  | 1.8 i 16V         |    |              | 02.94 07.99 |                |        |   |                      |     |
|  | 1.9 D             |    |              | 02.93 07.99 |                |        |   |                      |     |
|  | 1.9 SDI           |    |              | 09.95 07.99 |                |        |   |                      |     |
|  | 1.9 TD            |    |              | 02.93 07.99 |                |        |   |                      |     |
|  | 1.9 TDI           | 66 |              | 07.96 07.99 |                |        |   |                      |     |
|  | 1.9 TDI           | 81 |              | 03.97 07.99 |                |        |   |                      |     |
|  | 2.0 i             |    |              | 02.93 07.99 |                |        |   |                      |     |
|  | 2.0 i 16V Cupra 2 |    |              | 07.96 07.99 |                |        |   |                      |     |
|  | 1.0 i             |    |              | 02.93 07.99 | 24.3541-1731.5 | 240061 |  | D=54, - Halter       | LUC |
|  | 1.3 i             |    |              | 02.93 07.99 | 24.3541-1732.5 | 240062 |  | D=54, - Halter       | LUC |
|  | 1.4 i             |    |              | 09.93 07.99 |                |        |   |                      |     |
|  | 1.4 i 16V         | 74 |              | 09.96 07.99 |                |        |   |                      |     |
|  | 1.6 i             |    |              | 02.93 07.99 |                |        |   |                      |     |
|  | 1.7 SDI           |    |              | 07.97 07.99 |                |        |   |                      |     |
|  | 1.8 i             |    |              | 02.93 07.99 |                |        |   |                      |     |
|  | 1.8 i 16V         |    |              | 02.94 07.99 |                |        |   |                      |     |
|  | 1.9 D             |    |              | 02.93 07.99 |                |        |   |                      |     |
|  | 1.9 SDI           |    |              | 09.95 07.99 |                |        |   |                      |     |
|  | 1.9 TD            |    |              | 02.93 07.99 |                |        |   |                      |     |
|  | 1.9 TDI           | 66 |              | 07.96 07.99 |                |        |   |                      |     |
|  | 1.9 TDI           | 81 |              | 03.97 07.99 |                |        |   |                      |     |
|  | 2.0 i             |    |              | 02.93 07.99 |                |        |   |                      |     |
|  | 2.0 i 16V Cupra 2 |    |              | 07.96 07.99 |                |        |   |                      |     |
|  | 1.0 i             |    |              | 02.93 07.99 | 83.7713-0435.3 | 330792 | 2   | L=435                |     |
|  | 1.3 i             |    |              | 02.93 07.99 |                |        |   |                      |     |
|  | 1.4 i             |    |              | 09.93 07.99 |                |        |   |                      |     |
|  | 1.4 i 16V         | 74 |              | 09.96 07.99 |                |        |   |                      |     |
|  | 1.6 i             |    |              | 02.93 07.99 |                |        |   |                      |     |
|  | 1.7 SDI           |    |              | 07.97 07.99 |                |        |   |                      |     |
|  | 1.8 i             |    |              | 02.93 07.99 |                |        |   |                      |     |

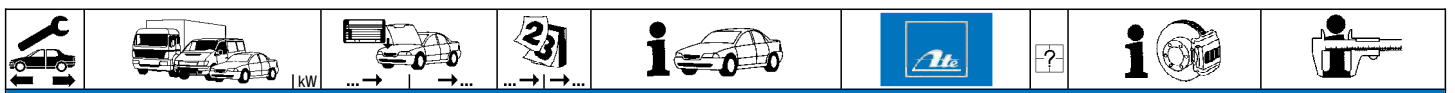

**SEAT IBIZA II (93-99)**

|                   |                   |             |             |       |                |                |                          |                          |                       |       |
|-------------------|-------------------|-------------|-------------|-------|----------------|----------------|--------------------------|--------------------------|-----------------------|-------|
|                   | 1.8 i 16V         |             | 02.94       | 07.99 | 83.7713-0435.3 | 330792         | 2                        | L=435                    |                       |       |
|                   | 1.9 D             |             | 02.93       | 07.99 |                |                |                          |                          |                       |       |
|                   | 1.9 SDI           |             | 09.95       | 07.99 |                |                |                          |                          |                       |       |
|                   | 1.9 TD            |             | 02.93       | 07.99 |                |                |                          |                          |                       |       |
|                   | 1.9 TDI           | 66          | 07.96       | 07.99 |                |                |                          |                          |                       |       |
|                   | 1.9 TDI           | 81          | 03.97       | 07.99 |                |                |                          |                          |                       |       |
|                   | 2.0 i             |             | 02.93       | 07.99 |                |                |                          |                          |                       |       |
|                   | 2.0 i 16V Cupra 2 |             | 07.96       | 07.99 |                |                |                          |                          |                       |       |
|                   | 1.8 i 16V         |             | 02.94       |       | 24.3384-1603.5 | 240015         | <input type="checkbox"/> | D=38, - Halter           | LUC                   |       |
|                   | 1.8 i 16V         |             | 02.94       |       | 24.3384-1604.5 | 240016         | <input type="checkbox"/> | D=38, - Halter           | LUC                   |       |
|                   | 2.0 i             |             | 02.93       |       | 24.0101-3601.2 | 260044         | <input type="checkbox"/> | Einbausatz               | LUC                   |       |
|                   | 2.0 i             |             | 02.93       |       |                |                | <input type="checkbox"/> |                          | LUC                   |       |
|                   | 1.8 i 16V         | 6K-ZR516425 | 07.99       |       | 24.3384-1707.5 | 240171         | <input type="checkbox"/> | D=38, - Halter           | LUC                   |       |
|                   | 1.8 i 16V         | 6K-ZR014474 | 07.99       |       | 24.3384-1708.5 | 240172         | <input type="checkbox"/> | D=38, - Halter           | LUC                   |       |
|                   | 2.0 i             | 6K-ZR516425 | 07.99       |       | 24.0101-3601.2 | 260044         | <input type="checkbox"/> | Einbausatz               | LUC                   |       |
|                   | 2.0 i             | 6K-ZR014474 | 07.99       |       | 11.0101-5403.2 | 260010         | <input type="checkbox"/> | Faltenbalgsatz           | LUC                   |       |
|                   | 1.9 TDI           | 81          | 03.97       | 07.99 | 24.3384-1737.5 | 240301         | <input type="checkbox"/> | D=38, - Halter           | LUC                   |       |
|                   |                   |             |             |       | 24.3384-1738.5 | 240302         | <input type="checkbox"/> | D=38, - Halter           | LUC                   |       |
|                   |                   |             |             |       |                |                | <input type="checkbox"/> |                          | LUC                   |       |
|                   |                   |             |             |       |                |                | <input type="checkbox"/> |                          | LUC                   |       |
|                   | 1.0 i             |             | 02.93       | 07.99 | PR: 1KK        | 24.3384-1723.7 | 220523                   | <input type="checkbox"/> | D=38(M12x1), - Halter | LUC   |
|                   | 1.3 i             |             | 02.93       | 07.99 | PR: 1KK        | 24.3384-1724.7 | 220524                   | <input type="checkbox"/> | D=38(M12x1), - Halter | LUC   |
|                   | 1.4 i             |             | 09.93       | 07.99 | PR: 1KK        |                |                          | <input type="checkbox"/> |                       | LUC   |
|                   | 1.4 i 16V         | 74          | 09.96       | 07.99 | PR: 1KK        |                |                          | <input type="checkbox"/> |                       | LUC   |
|                   | 1.6 i             |             | 02.93       | 07.99 | PR: 1KK        |                |                          | <input type="checkbox"/> |                       | LUC   |
|                   | 1.7 SDI           |             | 07.97       | 07.99 | PR: 1KK        |                |                          | <input type="checkbox"/> |                       | LUC   |
|                   | 1.8 i             |             | 02.93       | 07.99 | PR: 1KK        |                |                          | <input type="checkbox"/> |                       | LUC   |
|                   | 1.8 i 16V         |             | 02.94       | 07.99 | PR: 1KK        |                |                          | <input type="checkbox"/> |                       | LUC   |
|                   | 1.9 D             |             | 02.93       | 07.99 | PR: 1KK        |                |                          | <input type="checkbox"/> |                       | LUC   |
|                   | 1.9 SDI           |             | 09.95       | 07.99 | PR: 1KK        |                |                          | <input type="checkbox"/> |                       | LUC   |
|                   | 1.9 TD            |             | 02.93       | 07.99 | PR: 1KK        |                |                          | <input type="checkbox"/> |                       | LUC   |
|                   | 1.9 TDI           | 66          | 07.96       | 07.99 | PR: 1KK        |                |                          | <input type="checkbox"/> |                       | LUC   |
|                   | 1.9 TDI           | 81          | 03.97       | 07.99 | PR: 1KK        |                |                          | <input type="checkbox"/> |                       | LUC   |
|                   | 2.0 i             |             | 02.93       | 07.99 | PR: 1KK        |                |                          | <input type="checkbox"/> |                       | LUC   |
|                   | 2.0 i 16V Cupra 2 |             | 07.96       | 07.99 | PR: 1KK        |                |                          | <input type="checkbox"/> |                       | LUC   |
|                   |                   | 1.0 i       |             | 02.93 | 07.99          |                | 83.7836-0135.3           | 330816                   | 2                     | L=135 |
|                   |                   | 1.3 i       |             | 02.93 | 07.99          |                | 24.5230-0143.3           | 330402                   | 2                     | L=143 |
|                   |                   | 1.4 i       |             | 09.93 | 07.99          |                |                          |                          |                       |       |
| 1.4 i 16V         |                   | 74          | 09.96       | 07.99 |                |                |                          |                          |                       |       |
| 1.6 i             |                   |             | 02.93       | 07.99 |                |                |                          |                          |                       |       |
| 1.7 SDI           |                   |             | 07.97       | 07.99 |                |                |                          |                          |                       |       |
| 1.8 i             |                   |             | 02.93       | 07.99 |                |                |                          |                          |                       |       |
| 1.9 D             |                   |             | 02.93       | 07.99 |                |                |                          |                          |                       |       |
| 1.9 SDI           |                   |             | 09.95       | 07.99 |                |                |                          |                          |                       |       |
| 1.9 TD            |                   |             | 02.93       | 07.99 |                |                |                          |                          |                       |       |
| 1.9 TDI           |                   | 66          | 07.96       | 07.99 |                |                |                          |                          |                       |       |
| 1.8 i 16V         |                   |             | 02.94       | 07.99 |                | 83.7704-0160.3 | 330805                   | 2                        | L=160                 |       |
| 1.9 TDI           | 81                | 03.97       | 07.99       |       |                |                |                          |                          |                       |       |
| 2.0 i             |                   | 02.93       | 07.99       |       |                |                |                          |                          |                       |       |
| 2.0 i 16V Cupra 2 |                   | 07.96       | 07.99       |       |                |                |                          |                          |                       |       |
|                   | 1.0 i             |             | 02.93       | 07.99 |                | 03.3217-2112.3 | 020027                   | - ABS                    | Rz 17,46              |       |
|                   | 1.3 i             |             | 02.93       | 07.99 |                | 24.3217-0908.3 | 020167                   | - ABS                    | Rz 17,46              |       |
|                   | 1.4 i             |             | 09.93       | 07.99 |                | 24.3219-0909.3 | 020188                   | + ABS                    | Rz 19,05              |       |
|                   | 1.4 i 16V         | 74          | 09.96       | 07.99 |                |                |                          |                          |                       |       |
|                   | 1.6 i             |             | 02.93       | 07.99 |                |                |                          |                          |                       |       |
|                   | 1.7 SDI           |             | 07.97       | 07.99 |                |                |                          |                          |                       |       |
|                   | 1.8 i             |             | 02.93       | 07.99 |                |                |                          |                          |                       |       |
|                   | 1.8 i 16V         |             | 02.94       | 07.99 |                |                |                          |                          |                       |       |
|                   | 1.9 D             |             | 02.93       | 07.99 |                |                |                          |                          |                       |       |
|                   | 1.9 SDI           |             | 09.95       | 07.99 |                |                |                          |                          |                       |       |
|                   | 1.9 TD            |             | 02.93       | 07.99 |                |                |                          |                          |                       |       |
|                   | 1.9 TDI           | 66          | 07.96       | 07.99 |                |                |                          |                          |                       |       |
|                   | 1.0 i             |             | 02.93       | 07.99 |                | 24.3727-2703.2 | 582703                   | 2 ↓                      | L=1503                |       |
|                   | 1.0 i             |             | 02.93       | 07.99 |                |                |                          |                          |                       |       |
|                   | 1.3 i             |             | 02.93       | 07.99 |                |                |                          |                          |                       |       |
|                   | 1.3 i             |             | 02.93       | 07.99 |                |                |                          |                          |                       |       |
|                   | 1.4 i             |             | 09.93       | 07.99 |                |                |                          |                          |                       |       |
|                   | 1.4 i             |             | 09.93       | 07.99 |                |                |                          |                          |                       |       |
|                   | 1.4 i 16V         | 74          | 09.96       | 07.99 |                |                |                          |                          |                       |       |
|                   | 1.4 i 16V         | 74          | 09.96       | 07.99 |                |                |                          |                          |                       |       |
|                   | 1.6 i             |             | 02.93       | 07.99 |                |                |                          |                          |                       |       |
|                   | 1.6 i             |             | 02.93       | 07.99 |                |                |                          |                          |                       |       |
|                   | 1.9 D             |             | 02.93       | 07.99 |                |                |                          |                          |                       |       |
|                   | 1.9 D             |             | 02.93       | 07.99 |                |                |                          |                          |                       |       |
|                   | 1.9 TD            |             | 02.93       | 07.99 |                |                |                          |                          |                       |       |
|                   | 1.9 TD            |             | 02.93       | 07.99 |                |                |                          |                          |                       |       |
|                   | 1.0 i             | 6K-ZR549076 | 6K-ZR663842 |       |                | 24.3727-2706.2 | 582706                   | 2 ↓                      | L=1532                |       |
|                   | 1.0 i             | 6K-ZR037977 | 6K-ZR126718 |       |                |                |                          |                          |                       |       |
|                   | 1.3 i             | 6K-ZR549076 | 6K-ZR663842 |       |                |                |                          |                          |                       |       |
|                   | 1.3 i             | 6K-ZR037977 | 6K-ZR126718 |       |                |                |                          |                          |                       |       |
| 1.4 i             | 6K-ZR549076       | 6K-ZR663842 |             |       |                |                |                          |                          |                       |       |
| 1.4 i             | 6K-ZR037977       | 6K-ZR126718 |             |       |                |                |                          |                          |                       |       |
| 1.4 i 16V         | 74 6K-ZR549076    | 6K-ZR663842 |             |       |                |                |                          |                          |                       |       |
| 1.4 i 16V         | 74 6K-ZR037977    | 6K-ZR126718 |             |       |                |                |                          |                          |                       |       |
| 1.6 i             | 6K-ZR549076       | 6K-ZR663842 |             |       |                |                |                          |                          |                       |       |
| 1.6 i             | 6K-ZR037977       | 6K-ZR126718 |             |       |                |                |                          |                          |                       |       |
| 1.9 D             | 6K-ZR549076       | 6K-ZR663842 |             |       |                |                |                          |                          |                       |       |
| 1.9 D             | 6K-ZR037977       | 6K-ZR126718 |             |       |                |                |                          |                          |                       |       |













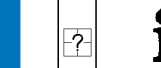

| SEAT IBIZA II (93-99)        |               |             |             |             |                   |                   |                |        |                               |                                |              |     |
|------------------------------|---------------|-------------|-------------|-------------|-------------------|-------------------|----------------|--------|-------------------------------|--------------------------------|--------------|-----|
|                              | 1.9 TD        | 6K-ZR549076 | 6K-ZR663842 |             |                   | 24.3727-2706.2    | 582706         | 2 ↓    |                               | L=1532                         |              |     |
|                              | 1.9 TD        | 6K-ZR037977 | 6K-ZR126718 |             |                   |                   |                |        |                               |                                |              |     |
|                              | 1.0 i         | 6K-ZR663843 | 6K-W-169289 |             |                   | 24.3727-0161.2    | 580161         | 2 ↓    |                               | L=1512                         |              |     |
|                              | 1.0 i         | 6K-ZR126719 | 6K-W-169289 |             |                   |                   |                |        |                               |                                |              |     |
|                              | 1.3 i         | 6K-ZR663843 | 6K-W-169289 |             |                   |                   |                |        |                               |                                |              |     |
|                              | 1.3 i         | 6K-ZR126719 | 6K-W-169289 |             |                   |                   |                |        |                               |                                |              |     |
|                              | 1.4 i         | 6K-ZR663843 | 6K-W-169289 |             |                   |                   |                |        |                               |                                |              |     |
|                              | 1.4 i         | 6K-ZR126719 | 6K-W-169289 |             |                   |                   |                |        |                               |                                |              |     |
|                              | 1.4 i 16V     | 74          | 6K-ZR663843 | 6K-W-169289 |                   |                   |                |        |                               |                                |              |     |
|                              | 1.4 i 16V     | 74          | 6K-ZR126719 | 6K-W-169289 |                   |                   |                |        |                               |                                |              |     |
|                              | 1.6 i         |             | 6K-ZR663843 | 6K-W-169289 |                   |                   |                |        |                               |                                |              |     |
|                              | 1.6 i         |             | 6K-ZR126719 | 6K-W-169289 |                   |                   |                |        |                               |                                |              |     |
|                              | 1.0 i         |             | 6K-W-169290 |             | 07.99             |                   | 24.3727-0162.2 | 580162 | 2 ↓ + ABS                     |                                | L=1514       |     |
|                              | 1.3 i         |             | 6K-W-169290 |             | 07.99             |                   | 24.3727-0161.2 | 580161 | 2 ↓ - ABS                     |                                | L=1512       |     |
| 1.4 i                        |               | 6K-W-169290 |             | 07.99       |                   |                   |                |        |                               |                                |              |     |
| 1.4 i 16V                    | 74            | 6K-W-169290 |             | 07.99       |                   |                   |                |        |                               |                                |              |     |
| 1.6 i                        |               | 6K-W-169290 |             | 07.99       |                   |                   |                |        |                               |                                |              |     |
| 1.9 D                        |               | 6K-ZR663843 |             | 07.99       |                   | 24.3727-0161.2    | 580161         | 2 ↓    |                               | L=1512                         |              |     |
| 1.9 D                        |               | 6K-ZR126719 |             | 07.99       |                   |                   |                |        |                               |                                |              |     |
| 1.9 TD                       |               | 6K-ZR663843 |             | 07.99       |                   |                   |                |        |                               |                                |              |     |
| 1.9 TD                       |               | 6K-ZR126719 |             | 07.99       |                   |                   |                |        |                               |                                |              |     |
| 1.8 i 16V                    |               | 6K-ZR610015 | 6K-V-013236 |             |                   | 24.3727-2704.2    | 582704         | 2 ↓    |                               | L=1632                         |              |     |
| 1.8 i 16V                    |               | 6K-ZR085726 | 6K-V-000537 |             |                   |                   |                |        |                               |                                |              |     |
| 1.9 TDI                      | 81            | 6K-ZR610015 | 6K-V-013236 |             |                   |                   |                |        |                               |                                |              |     |
| 1.9 TDI                      | 81            | 6K-ZR085726 | 6K-V-000537 |             |                   |                   |                |        |                               |                                |              |     |
| 2.0 i                        |               | 6K-ZR610015 | 6K-V-013236 |             |                   |                   |                |        |                               |                                |              |     |
| 2.0 i                        |               | 6K-ZR085726 | 6K-V-000537 |             |                   |                   |                |        |                               |                                |              |     |
| 2.0 i 16V Cupra 2            |               | 6K-ZR610015 | 6K-V-013236 |             |                   |                   |                |        |                               |                                |              |     |
| 2.0 i 16V Cupra 2            |               | 6K-ZR085726 | 6K-V-000537 |             |                   |                   |                |        |                               |                                |              |     |
| 1.8 i 16V                    |               | 6K-W-169290 |             | 07.99       |                   | 24.3727-0165.2    | 580165         | 2 ↓    |                               | L=1641                         |              |     |
| 1.9 TDI                      | 81            | 6K-W-169290 |             | 07.99       |                   |                   |                |        |                               |                                |              |     |
| 2.0 i                        |               | 6K-W-169290 |             | 07.99       |                   |                   |                |        |                               |                                |              |     |
| 2.0 i 16V Cupra 2            |               | 6K-W-169290 |             | 07.99       |                   |                   |                |        |                               |                                |              |     |
|                              | 1.0 i         |             |             | 02.93       | 07.99             | 03.0101-0025.2    | 320014         |        | + Druckabhängig <sup>1)</sup> | BRES 3/35                      | ATE          |     |
|                              | 1.3 i         |             |             | 02.93       | 07.99             | 03.6584-0113.3    | 320111         |        | + Lastabhängig <sup>2)</sup>  | BRL 8/4 (4)                    | ATE          |     |
|                              | 1.4 i         |             |             | 09.93       | 07.99             |                   |                |        |                               |                                |              |     |
|                              | 1.6 i         |             |             | 02.93       | 07.99             |                   |                |        |                               |                                |              |     |
|                              | 1.7 SDI       |             |             | 07.97       | 07.99             |                   |                |        |                               |                                |              |     |
|                              | 1.8 i         |             |             | 02.93       | 07.99             |                   |                |        |                               |                                |              |     |
|                              | 1.8 i 16V     |             |             | 02.94       | 07.99             |                   |                |        |                               |                                |              |     |
|                              | 1.9 D         |             |             | 02.93       | 07.99             |                   |                |        |                               |                                |              |     |
|                              | 1.9 SDI       |             |             | 09.95       | 07.99             |                   |                |        |                               |                                |              |     |
|                              | 1.9 TD        |             |             | 02.93       | 07.99             |                   |                |        |                               |                                |              |     |
|                              | 1.9 TDI       | 66          |             | 07.96       | 07.99             |                   |                |        |                               |                                |              |     |
| 1.9 TDI                      | 81            |             | 03.97       | 07.99       |                   |                   |                |        |                               |                                |              |     |
| 2.0 i                        |               |             | 02.93       | 07.99       |                   |                   |                |        |                               |                                |              |     |
|                              | 1.9 TDI       | 66          |             | 07.96       | 07.99             | 03.2419-9510.3    | 030028         |        |                               | Gz 19,05                       |              |     |
|                              | 1.9 TDI       | 81          |             | 03.97       | 07.99             |                   |                |        |                               |                                |              |     |
|                              | 1.9 TDI       | 66          |             | 07.96       | 07.99             | 24.2523-0908.3    | 040049         |        |                               | Nz 23,81                       |              |     |
|                              | 1.9 TDI       | 81          |             | 03.97       | 07.99             |                   |                |        |                               |                                |              |     |
|                              | 1.4 i         | ↓           |             | 09.93       | 07.99             | 24.3728-2704.2    | 592704         |        |                               | L=1065, - AUT                  |              |     |
|                              | 1.6 i         | ↓           |             | 02.93       | 07.99             |                   |                |        |                               |                                |              |     |
|                              | 1.8 i         | ↓           |             | 02.93       |                   | 24.3728-0128.2    | 590128         |        |                               | L=854, + AUT                   |              |     |
|                              | 1.8 i         | ↓           |             | 02.93       |                   |                   |                |        |                               |                                |              |     |
|                              | 1.8 i 16V     | ↓           |             | 02.94       |                   |                   |                |        |                               |                                |              |     |
|                              | 1.8 i 16V     | ↓           |             | 02.94       |                   |                   |                |        |                               |                                |              |     |
|                              | 2.0 i         | ↓           |             | 02.93       |                   |                   |                |        |                               |                                |              |     |
|                              | 2.0 i         | ↓           |             | 02.93       |                   |                   |                |        |                               |                                |              |     |
|                              | 1.8 i         | ↓           | 6K-ZR530333 |             | 07.99             |                   | 24.3728-0128.2 | 590128 |                               |                                | L=854, + AUT |     |
|                              | 1.8 i         | ↓           | 6K-ZR025748 |             | 07.99             |                   |                |        |                               |                                |              |     |
| 1.8 i 16V                    | ↓             | 6K-ZR530333 |             | 07.99       |                   |                   |                |        |                               |                                |              |     |
| 1.8 i 16V                    | ↓             | 6K-ZR025748 |             | 07.99       |                   |                   |                |        |                               |                                |              |     |
| 1.9 D                        | ↓             |             | 02.93       | 07.99       |                   |                   |                |        |                               |                                |              |     |
| 1.9 TD                       | ↓             |             | 02.93       | 07.99       |                   |                   |                |        |                               |                                |              |     |
| 2.0 i                        | ↓             | 6K-ZR530333 |             | 07.99       |                   |                   |                |        |                               |                                |              |     |
| 2.0 i                        | ↓             | 6K-ZR025748 |             | 07.99       |                   |                   |                |        |                               |                                |              |     |
| SEAT IBIZA III (6K1) (99-02) |               |             |             |             |                   |                   |                |        |                               |                                |              |     |
|                              | 1.0 i         | ↓           |             | 08.99       | 01.02             | 03.7750-6302.4    | 300161         |        | - ABS                         | 9"                             | ATE          |     |
|                              | 1.4 i         | ↓ 44        |             | 08.99       | 01.02             |                   |                |        |                               |                                |              |     |
|                              | 1.4 i 16V     | ↓           |             | 08.99       | 01.02             |                   |                |        |                               |                                |              |     |
|                              | 1.6 i         | ↓           |             | 08.99       | 01.02             |                   |                |        |                               |                                |              |     |
|                              | 1.8 i Cupra R | ↓132        |             | 04.01       | 01.02             |                   |                |        |                               |                                |              |     |
|                              | 1.8 T 20V     | ↓115        |             | 07.00       | 01.02             |                   |                |        |                               |                                |              |     |
|                              | 1.9 SDI       | ↓           |             | 08.99       | 01.02             |                   |                |        |                               |                                |              |     |
|                              | 1.9 TDI       | ↓ 66        |             | 08.99       | 01.02             |                   |                |        |                               |                                |              |     |
|                              | 1.9 TDI       | ↓ 81        |             | 08.99       | 01.02             |                   |                |        |                               |                                |              |     |
|                              | 1.0 i         | ↓           |             | 08.99       | 01.02             | PR: 0G1, 0G3, 1KB | 10.6350-3902.4 | 300213 |                               | + Schaltgetriebe <sup>3)</sup> | 9"           | ATE |
|                              | 1.4 i         | ↓ 44        |             | 08.99       | 01.02             | PR: 0G1, 0G3, 1KB |                |        |                               |                                |              |     |
|                              | 1.4 i 16V     | ↓           |             | 08.99       | 01.02             | PR: 0G1, 0G3, 1KB |                |        |                               |                                |              |     |
|                              | 1.6 i         | ↓           |             | 08.99       | 01.02             | PR: 0G1, 0G3, 1KB |                |        |                               |                                |              |     |
|                              | 1.8 i Cupra R | ↓132        |             | 04.01       | 01.02             | PR: 0G1, 0G3, 1KB |                |        |                               |                                |              |     |
| 1.8 T 20V                    | ↓115          |             | 07.00       | 01.02       | PR: 0G1, 0G3, 1KB |                   |                |        |                               |                                |              |     |

























<sup>1)</sup> + pressure sensitive / + in funzione della pressione / + asservi à la pression / + dependiente de la presión

<sup>2)</sup> + load sensitive / + dependente dal carico / + asservi à la charge / + dependiente de carga

<sup>3)</sup> + manual transmission / + scatola cambio velocità / + transmission mécanique / + cambio de velocidad

|     |    |  |  |  |  |  |  |  |       |                |               |                                |                          |                          |                |                       |                |
|--|--|--|--|--|--|--|--|--|-------|----------------|---------------|--------------------------------|--------------------------|--------------------------|----------------|-----------------------|----------------|
| <b>SEAT IBIZA III (6K1) (99-02)</b>  |  |  |  |  |  |  |  |  |       |                |               |                                |                          |                          |                |                       |                |
|    | 1.9 SDI  |  | 08.99  | 01.02  | PR: 0G1, 0G3, 1KB  | 10.6350-3902.4   | 300213   | + Schaltgetriebe <sup>1)</sup>   | 9"    | ATE            |               |                                |                          |                          |                |                       |                |
|  | 1.9 TDI  | 66   | 08.99  | 01.02  | PR: 0G1, 0G3, 1KB  |  |  |  |       |                |               |                                |                          |                          |                |                       |                |
|  | 1.9 TDI  | 81   | 08.99  | 01.02  | PR: 0G1, 0G3, 1KB  |  |  |  |       |                |               |                                |                          |                          |                |                       |                |
|  | 1.0 i  |  | 08.99  | 01.02  | PR: 1KB,1KK,1KM,1KQ,1ZK  | 10.6350-4002.4   | 300285   | + Automatikgetriebe <sup>2)</sup>  | 9"    | ATE            |               |                                |                          |                          |                |                       |                |
|  | 1.4 i  | 44   | 08.99  | 01.02  | PR: 1KB,1KK,1KM,1KQ,1ZK  |  |  |  |       |                |               |                                |                          |                          |                |                       |                |
|  | 1.4 i 16V  |  | 08.99  | 01.02  | PR: 1KB,1KK,1KM,1KQ,1ZK  |  |  |  |       |                |               |                                |                          |                          |                |                       |                |
|  | 1.6 i  |  | 08.99  | 01.02  | PR: 1KB,1KK,1KM,1KQ,1ZK  |  |  |  |       |                |               |                                |                          |                          |                |                       |                |
|  | 1.8 i Cupra R  | 132  | 04.01  | 01.02  | PR: 1KB,1KK,1KM,1KQ,1ZK  |  |  |  |       |                |               |                                |                          |                          |                |                       |                |
|  | 1.8 T 20V  | 115  | 07.00  | 01.02  | PR: 1KB,1KK,1KM,1KQ,1ZK  |  |  |  |       |                |               |                                |                          |                          |                |                       |                |
|  | 1.9 SDI  |  | 08.99  | 01.02  | PR: 1KB,1KK,1KM,1KQ,1ZK  |  |  |  |       |                |               |                                |                          |                          |                |                       |                |
| 1.9 TDI  | 66   | 08.99  | 01.02  | PR: 1KB,1KK,1KM,1KQ,1ZK  |  |  |  |  |       |                |               |                                |                          |                          |                |                       |                |
| 1.9 TDI  | 81   | 08.99  | 01.02  | PR: 1KB,1KK,1KM,1KQ,1ZK  |  |  |  |  |       |                |               |                                |                          |                          |                |                       |                |
| 1.0 i  |  | 08.99  | 01.02  | PR: 0G4  | 10.6350-4002.4   |  |  |  |       |                | 300285        | + Schaltgetriebe <sup>1)</sup> | 9"                       | ATE                      |                |                       |                |
| 1.4 i  | 44   | 08.99  | 01.02  | PR: 0G4  |  |  |  |  |       |                |               |                                |                          |                          |                |                       |                |
| 1.4 i 16V  |  | 08.99  | 01.02  | PR: 0G4  |  |  |  |  |       |                |               |                                |                          |                          |                |                       |                |
| 1.6 i  |  | 08.99  | 01.02  | PR: 0G4  |  |  |  |  |       |                |               |                                |                          |                          |                |                       |                |
| 1.8 i Cupra R  | 132  | 04.01  | 01.02  | PR: 0G4  |  |  |  |  |       |                |               |                                |                          |                          |                |                       |                |
| 1.8 T 20V  | 115  | 07.00  | 01.02  | PR: 0G4  |  |  |  |  |       |                |               |                                |                          |                          |                |                       |                |
| 1.9 SDI  |  | 08.99  | 01.02  | PR: 0G4  |  |  |  |  |       |                |               |                                |                          |                          |                |                       |                |
| 1.9 TDI  | 66   | 08.99  | 01.02  | PR: 0G4  |  |  |  |  |       |                |               |                                |                          |                          |                |                       |                |
| 1.9 TDI  | 81   | 08.99  | 01.02  | PR: 0G4  |  |  |  |  |       |                |               |                                |                          |                          |                |                       |                |
|    | 1.0 i  |  | 08.99  | 01.02  |  |  | 03.2122-1042.3   | 010137   | - ABS | THz 22,20      |               |                                |                          |                          | ATE            |                       |                |
|  | 1.4 i  | 44   | 08.99  | 01.02  |  | 03.2123-1424.3   |  |  |       |                | 010637        | + ABS                          | THz 23,81                |                          |                |                       |                |
|  | 1.4 i 16V  |  | 08.99  | 01.02  |  |  |  |  |       |                |               |                                |                          |                          |                |                       |                |
|  | 1.6 i  |  | 08.99  | 01.02  |  |  |  |  |       |                |               |                                |                          |                          |                |                       |                |
|  | 1.8 i Cupra R  | 132  | 04.01  | 01.02  |  |  |  |  |       |                |               |                                |                          |                          |                |                       |                |
|  | 1.8 T 20V  | 115  | 07.00  | 01.02  |  |  |  |  |       |                |               |                                |                          |                          |                |                       |                |
|  | 1.9 SDI  |  | 08.99  | 01.02  |  |  |  |  |       |                |               |                                |                          |                          |                |                       |                |
|  | 1.9 TDI  | 66   | 08.99  | 01.02  |  |  |  |  |       |                |               |                                |                          |                          |                |                       |                |
|  | 1.9 TDI  | 81   | 08.99  | 01.02  |  |  |  |  |       |                |               |                                |                          |                          |                |                       |                |
|  |    | 1.0 i  |  | 08.99  | 01.02  | PR: 1LG  | 11.0441-4808.2   | 250022   |       |                | Dichtungssatz | ATE                            |                          |                          |                |                       |                |
| 1.4 i  |  | 44   | 08.99  | 01.02  | PR: 1LG,1LM  | 11.0101-4801.2   |  |  |       |                |               |                                | 260006                   |                          |                |                       |                |
| 1.4 i 16V  |  |  | 08.99  | 01.02  | PR: 1LG  | 24.0102-4801.2   |  |  |       |                |               |                                | 260085                   |                          |                |                       |                |
| 1.6 i  |  |  | 08.99  | 01.02  | PR: 1LG  |  |  |  |       |                |               |                                |                          |                          |                |                       |                |
| 1.8 T 20V  |  | 115  | 07.00  | 01.02  | PR: 1LG  |  |  |  |       |                |               |                                |                          |                          |                |                       |                |
| 1.9 SDI  |  |  | 08.99  | 01.02  | PR: 1LG,1LM  |  |  |  |       |                |               |                                |                          |                          |                |                       |                |
| 1.9 TDI  |  | 66   | 08.99  | 01.02  | PR: 1LG  |  |  |  |       |                |               |                                |                          |                          |                |                       |                |
| 1.9 TDI  |  | 81   | 08.99  | 01.02  | PR: 1LG  |  |  |  |       |                |               |                                |                          |                          |                |                       |                |
| 1.0 i  |  |  | 08.99  | 01.02  | PR: 1ZK  | 24.3541-1609.5   | 240039   | <input type="checkbox"/>   |       | D=54, - Halter | LUC           |                                |                          |                          |                |                       |                |
| 1.4 i  |  | 44   | 08.99  | 01.02  | PR: 1ZK  |  |  |  |       |                |               | 24.3541-1610.5                 | 240040                   |                          |                |                       |                |
| 1.4 i 16V  |  | 08.99  | 01.02  | PR: 1ZK  | 11.0101-5403.2   |  |  |  |       |                |               | 260010                         |                          |                          |                |                       |                |
| 1.6 i  |  | 08.99  | 01.02  | PR: 1ZK  |  |  |  |  |       |                |               |                                |                          |                          |                |                       |                |
| 1.8 T 20V  | 115  | 07.00  | 01.02  | PR: 1ZK  |  |  |  |  |       |                |               |                                |                          |                          |                |                       |                |
| 1.9 SDI  |  | 08.99  | 01.02  | PR: 1ZK  |  |  |  |  |       |                |               |                                |                          |                          |                |                       |                |
| 1.9 TDI  | 66   | 08.99  | 01.02  | PR: 1ZK  |  |  |  |  |       |                |               |                                |                          |                          |                |                       |                |
| 1.9 TDI  | 81   | 08.99  | 01.02  | PR: 1ZK  |  |  |  |  |       |                |               |                                |                          |                          |                |                       |                |
| 1.0 i  |  | 08.99  | 01.02  | PR: 1LV  | 24.3541-1731.5   |  |  |  |       |                |               | 240061                         | <input type="checkbox"/> |                          | D=54, - Halter | LUC                   |                |
| 1.4 i  | 44   | 08.99  | 01.02  | PR: 1LV  |  |  |  |  |       |                |               |                                |                          |                          |                |                       | 24.3541-1732.5 |
| 1.4 i 16V  |  | 08.99  | 01.02  | PR: 1LV  |  |  |  |  |       |                |               |                                |                          |                          |                |                       |                |
| 1.6 i  |  | 08.99  | 01.02  | PR: 1LV  |  |  |  |  |       |                |               |                                |                          |                          |                |                       |                |
| 1.8 T 20V  | 115  | 07.00  | 01.02  | PR: 1LV  |  |  |  |  |       |                |               |                                |                          |                          |                |                       |                |
| 1.9 SDI  |  | 08.99  | 01.02  | PR: 1LV  |  |  |  |  |       |                |               |                                |                          |                          |                |                       |                |
| 1.9 TDI  | 66   | 08.99  | 01.02  | PR: 1LV  |  |  |  |  |       |                |               |                                |                          |                          |                |                       |                |
| 1.9 TDI  | 81   | 08.99  | 01.02  | PR: 1LV  |  |  |  |  |       |                |               |                                |                          |                          |                |                       |                |
| 1.0 i  |  | 08.99  | 01.02  | PR: 1LW  |  | 24.3541-1731.5   | 240061   | <input type="checkbox"/>   |       | D=54, - Halter | LUC           |                                |                          |                          |                |                       |                |
| 1.4 i  | 44   | 08.99  | 01.02  | PR: 1LW  |  |  |  |  |       |                |               |                                |                          |                          |                |                       | 24.3541-1732.5 |
| 1.4 i 16V  |  | 08.99  | 01.02  | PR: 1LW  |  |  |  |  |       |                |               |                                |                          |                          |                |                       |                |
| 1.6 i  |  | 08.99  | 01.02  | PR: 1LW  |  |  |  |  |       |                |               |                                |                          |                          |                |                       |                |
| 1.8 T 20V  | 115  | 07.00  | 01.02  | PR: 1LW  |  |  |  |  |       |                |               |                                |                          |                          |                |                       |                |
| 1.9 SDI  |  | 08.99  | 01.02  | PR: 1LW  |  |  |  |  |       |                |               |                                |                          |                          |                |                       |                |
| 1.9 TDI  | 66   | 08.99  | 01.02  | PR: 1LW  |  |  |  |  |       |                |               |                                |                          |                          |                |                       |                |
| 1.9 TDI  | 81   | 08.99  | 01.02  | PR: 1LW  |  |  |  |  |       |                |               |                                |                          |                          |                |                       |                |
| 1.0 i  |  | 08.99  | 01.02  | PR: 1LA  | 24.3481-1745.5   |  |  |  |       |                |               | 240277                         | <input type="checkbox"/> |                          | D=48, - Halter | ATE                   |                |
| 1.4 i  | 44   | 08.99  | 01.02  | PR: 1LA  |  |  |  |  |       |                |               |                                |                          |                          |                |                       | 24.3481-1746.5 |
| 1.4 i 16V  |  | 08.99  | 01.02  | PR: 1LA  |  |  |  |  |       |                |               |                                |                          |                          |                |                       |                |
| 1.6 i  |  | 08.99  | 01.02  | PR: 1LA  |  |  |  |  |       |                |               |                                |                          |                          |                |                       |                |
| 1.8 T 20V  | 115  | 07.00  | 01.02  | PR: 1LA  |  |  |  |  |       |                |               |                                |                          |                          |                |                       |                |
| 1.9 SDI  |  | 08.99  | 01.02  | PR: 1LA  |  |  |  |  |       |                |               |                                |                          |                          |                |                       |                |
| 1.9 TDI  | 66   | 08.99  | 01.02  | PR: 1LA  |  |  |  |  |       |                |               |                                |                          |                          |                |                       |                |
| 1.9 TDI  | 81   | 08.99  | 01.02  | PR: 1LA  |  |  |  |  |       |                |               |                                |                          |                          |                |                       |                |
|  | 1.0 i  |  | 08.99  | 01.02  |  |  | 83.7713-0435.3   | 330792   | 2     |                | L=435         |                                |                          |                          |                |                       |                |
|  | 1.4 i  | 44   | 08.99  | 01.02  |  |  |  |  |       |                |               |                                |                          |                          |                |                       |                |
|  | 1.4 i 16V  |  | 08.99  | 01.02  |  |  |  |  |       |                |               |                                |                          |                          |                |                       |                |
|  | 1.6 i  |  | 08.99  | 01.02  |  |  |  |  |       |                |               |                                |                          |                          |                |                       |                |
|  | 1.8 T 20V  | 115  | 07.00  | 01.02  |  |  |  |  |       |                |               |                                |                          |                          |                |                       |                |
|  | 1.9 SDI  |  | 08.99  | 01.02  |  |  |  |  |       |                |               |                                |                          |                          |                |                       |                |
|  | 1.9 TDI  | 66   | 08.99  | 01.02  |  |  |  |  |       |                |               |                                |                          |                          |                |                       |                |
|  | 1.9 TDI  | 81   | 08.99  | 01.02  |  |  |  |  |       |                |               |                                |                          |                          |                |                       |                |
|  |  | 1.0 i  |  | 08.99  | 01.02  | PR: 1KK  |  |  |       |                |               | 24.3384-1723.7                 | 220523                   | <input type="checkbox"/> |                | D=38(M12x1), - Halter | LUC            |
|  |  | 1.4 i  | 44   | 08.99  | 01.02  | PR: 1KK  |  |  |       |                |               |                                |                          |                          |                |                       |                |
| 1.4 i 16V  |  |  | 08.99  | 01.02  | PR: 1KK  |  |  |  |       |                |               |                                |                          |                          |                |                       |                |
| 1.6 i  |  |  | 08.99  | 01.02  | PR: 1KK  |  |  |  |       |                |               |                                |                          |                          |                |                       |                |
| 1.8 i Cupra R  |  | 132  | 04.01  | 01.02  | PR: 1KK  |  |  |  |       |                |               |                                |                          |                          |                |                       |                |
| 1.8 T 20V  |  | 115  | 07.00  | 01.02  | PR: 1KK  |  |  |  |       |                |               |                                |                          |                          |                |                       |                |
| 1.9 SDI  |  |  | 08.99  | 01.02  | PR: 1KK  |  |  |  |       |                |               |                                |                          |                          |                |                       |                |
| 1.9 TDI  |  | 66   | 08.99  | 01.02  | PR: 1KK  |  |  |  |       |                |               |                                |                          |                          |                |                       |                |















1) + manual transmission / + scatola cambio velocità / + transmission mécanique / + cambio de velocidad  
2) + autom.transmission / + scatola cambio automatico / + transmission automatique / + cambio automático

|     |  |  |  |  |  |  |  |  |  |  |            |
|--|--|--|--|--|---|--|--|--|--|--|------------|
| <b>SEAT IBIZA III (6K1) (99-02)</b>  |  |  |  |  |   |  |  |  |  |  |            |
|    | 1.9 TDI  | 81   |  | 08.99  | 01.02   | PR: 1KK  | 24.3384-1723.7<br>24.3384-1724.7   | 220523<br>220524   | <br>     | D=38(M12x1), - Halter<br>D=38(M12x1), - Halter | LUC<br>LUC |
|  | 1.0 i  |  |  | 08.99  | 01.02   | PR: 1KE,1KQ  | 24.3344-1711.7   | 220539   | <br>     | D=34, - Halter                                 | LUC        |
|  | 1.4 i  | 44   |  | 08.99  | 01.02   | PR: 1KE,1KQ  | 24.3344-1712.7   | 220540   |   | D=34, - Halter                                 | LUC        |
|  | 1.4 i 16V  |  |  | 08.99  | 01.02   | PR: 1KE,1KQ  |  |  |  |  |            |
|  | 1.6 i  |  |  | 08.99  | 01.02   | PR: 1KE,1KQ  |  |  |  |  |            |
|  | 1.8 i Cupra R  | 132  |  | 04.01  | 01.02   | PR: 1KE,1KQ  |  |  |  |  |            |
|  | 1.8 T 20V  | 115  |  | 07.00  | 01.02   | PR: 1KE,1KQ  |  |  |  |  |            |
|  | 1.9 SDI  |  |  | 08.99  | 01.02   | PR: 1KE,1KQ  |  |  |  |  |            |
|  | 1.9 TDI  | 66   |  | 08.99  | 01.02   | PR: 1KE,1KQ  |  |  |  |  |            |
|  | 1.9 TDI  | 81   |  | 08.99  | 01.02   | PR: 1KE,1KQ  |  |  |  |  |            |
|    | 1.0 i  |  |  | 08.99  | 01.02   |  | 83.7858-0140.3   | 330837   | 2  |  | L=140      |
|  | 1.4 i  | 44   |  | 08.99  | 01.02   |  |  |  |  |  |            |
|  | 1.4 i 16V  |  |  | 08.99  | 01.02   |  |  |  |  |  |            |
|  | 1.6 i  |  |  | 08.99  | 01.02   |  |  |  |  |  |            |
|  | 1.8 i Cupra R  | 132  |  | 04.01  | 01.02   |  |  |  |  |  |            |
|  | 1.8 T 20V  | 115  |  | 07.00  | 01.02   |  |  |  |  |  |            |
|  | 1.9 SDI  |  |  | 08.99  | 01.02   |  |  |  |  |  |            |
|  | 1.9 TDI  | 66   |  | 08.99  | 01.02   |  |  |  |  |  |            |
|  | 1.9 TDI  | 81   |  | 08.99  | 01.02   |  |  |  |  |  |            |
|    | 1.0 i  |  |  | 08.99  | 01.02   |  | 24.3217-0908.3   | 020167   |  |  | Rz 17,46   |
|  | 1.4 i  | 44   |  | 08.99  | 01.02   |  |  |  |  |  |            |
|  | 1.4 i 16V  | 55   |  | 08.99  | 01.02   |  |  |  |  |  |            |
|  | 1.6 i  | 55   |  | 08.99  | 01.02   |  |  |  |  |  |            |
|  | 1.9 SDI  |  |  | 08.99  | 01.02   |  |  |  |  |  |            |
|  | 1.9 TDI  | 66   |  | 08.99  | 01.02   |  |  |  |  |  |            |
|  | 1.4 i 16V  | 74   |  | 08.99  | 01.02   |  | 24.3219-0909.3   | 020188   |  |  | Rz 19,05   |
|  | 1.6 i  | 74   |  | 08.99  | 01.02   |  |  |  |  |  |            |
|    | 1.0 i  |  |  | 08.99  | 01.02   |  | 24.3727-0162.2   | 580162   | 2 ↓  |  | L=1514     |
|  | 1.4 i  | 44   |  | 08.99  | 01.02   |  |  |  |  |  |            |
|  | 1.4 i 16V  |  |  | 08.99  | 01.02   |  |  |  |  |  |            |
|  | 1.6 i  |  |  | 08.99  | 01.02   |  |  |  |  |  |            |
|  | 1.9 SDI  |  |  | 08.99  | 01.02   |  |  |  |  |  |            |
|  | 1.9 TDI  | 66   |  | 08.99  | 01.02   |  |  |  |  |  |            |
|  | 1.8 i Cupra R  | 132  |  | 04.01  | 01.02   |  | 24.3727-0165.2   | 580165   | 2 ↓  |  | L=1641     |
|  | 1.8 T 20V  | 115  |  | 07.00  | 01.02   |  |  |  |  |  |            |
|  | 1.9 TDI  | 81   |  | 08.99  | 01.02   |  |  |  |  |  |            |
|   | 1.0 i  | 44   |  | 08.99  | 01.02   |  | 24.2415-1712.3   | 030131   |  |  | Gz 15,87   |
|  | 1.4 i  | 44   |  | 08.99  | 01.02   |  |  |  |  |  |            |
|  | 1.4 i 16V  |  |  | 08.99  | 01.02   |  |  |  |  |  |            |
|  | 1.6 i  |  |  | 08.99  | 01.02   |  |  |  |  |  |            |
|  | 1.8 i Cupra R  | 132  |  | 04.01  | 01.02   |  |  |  |  |  |            |
|  | 1.8 T 20V  | 115  |  | 07.00  | 01.02   |  |  |  |  |  |            |
|  | 1.9 SDI  |  |  | 08.99  | 01.02   |  |  |  |  |  |            |
|  | 1.9 TDI  | 66   |  | 08.99  | 01.02   |  |  |  |  |  |            |
|  | 1.9 TDI  | 81   |  | 08.99  | 01.02   |  |  |  |  |  |            |
|  | 1.0 i  |  |  | 08.99  | 01.02   |  | 24.2519-1701.3   | 040075   |  | + Schaltseilzug <sup>1)</sup>                  | Nz 19,05   |
|  | 1.4 i  | 44   |  | 08.99  | 01.02   |  | 24.2523-1701.3   | 040080   |  | + Schaltgestänge <sup>2)</sup>                 | Nz 23,81   |
|  | 1.4 i 16V  |  |  | 08.99  | 01.02   |  |  |  |  |  |            |
|  | 1.6 i  |  |  | 08.99  | 01.02   |  |  |  |  |  |            |
|  | 1.8 i Cupra R  | 132  |  | 04.01  | 01.02   |  |  |  |  |  |            |
|  | 1.8 T 20V  | 115  |  | 07.00  | 01.02   |  |  |  |  |  |            |
|  | 1.9 SDI  |  |  | 08.99  | 01.02   |  |  |  |  |  |            |
|  | 1.9 TDI  | 66   |  | 08.99  | 01.02   |  |  |  |  |  |            |
|  | 1.9 TDI  | 81   |  | 08.99  | 01.02   |  |  |  |  |  |            |
| <b>SEAT IBIZA IV (6L1) (02-10)</b>   |  |  |  |  |   |  |  |  |  |  |            |
|  | 1.2  | 44   |  | 06.07  | 05.08   |  | 24.2120-1736.3   | 010732   |  | - ABS  | Thz 20,64  |
|  | 1.2 i  | 47   |  | 02.02  | 02.10   |  | 24.2120-1734.3   | 010702   |  | + ABS  | Thz 20,64  |
|  | 1.2 i 12V  | 51   |  | 05.06  | 02.10   |  |  |  |  |  |            |
|  | 1.4 i 16V  | 55   |  | 02.02  | 02.10   |  |  |  |  |  |            |
|  | 1.4 i 16V  | 63   |  | 05.06  | 02.10   |  |  |  |  |  |            |
|  | 1.4 i 16V  | 74   |  | 02.02  | 02.10   |  |  |  |  |  |            |
|  | 1.4 TDI  | 51   |  | 05.05  | 02.10   |  |  |  |  |  |            |
|  | 1.4 TDI  | 55   |  | 02.02  | 02.10   |  |  |  |  |  |            |
|  | 1.4 TDI  | 59   |  | 05.05  | 02.10   |  |  |  |  |  |            |
|  | 1.6 i 16V  |  |  | 02.03  | 02.10   |  |  |  |  |  |            |
|  | 1.8 T Cupra R  | 132  |  | 01.04  | 02.10   |  |  |  |  |  |            |
|  | 1.8 T FR   | 110  |  | 12.03  | 02.10   |  |  |  |  |  |            |
|  | 1.9 SDI  | 47   |  | 02.02  | 02.10   |  |  |  |  |  |            |
|  | 1.9 TDI  | 74   |  | 02.02  | 02.10   |  |  |  |  |  |            |
|  | 1.9 TDI  | 96   |  | 02.02  | 02.10   |  |  |  |  |  |            |
|  | 1.9 TDI Cupra R  | 110  |  | 01.04  | 02.10   |  |  |  |  |  |            |
|  | 1.9 TDI Cupra R  | 118  |  | 03.04  | 02.10   |  |  |  |  |  |            |
|  | 2.0  | 85   |  | 04.02  | 02.10   |  |  |  |  |  |            |
|  | 1.2  | 44   |  | 06.07  | 05.08   | PR: 1LQ,1ZF  | 11.9541-9549.2   | 220575   | <br> | D=54, - Halter                                 | ATE        |
|  | 1.2 i  | 47   |  | 02.02  | 02.10   | PR: 1LQ,1ZF  | 11.9541-9550.2   | 220576   |   | D=54, - Halter                                 | ATE        |
|  | 1.2 i 12V  | 51   |  | 05.06  | 02.10   | PR: 1LQ,1ZF  | 11.0101-5409.2   | 260035   |  | Hülensatz                                      | ATE        |
|  | 1.4 i 16V  | 55   |  | 02.02  | 02.10   | PR: 1LQ,1ZF  |  |  |  |  |            |
|  | 1.4 i 16V  | 63   |  | 05.06  | 02.10   | PR: 1LQ,1ZF  |  |  |  |  |            |
|  | 1.4 i 16V  | 74   |  | 02.02  | 02.10   | PR: 1LQ,1ZF  |  |  |  |  |            |
|  | 1.4 TDI  | 51   |  | 05.05  | 02.10   | PR: 1LQ,1ZF  |  |  |  |  |            |
|  | 1.4 TDI  | 55   |  | 02.02  | 02.10   | PR: 1LQ,1ZF  |  |  |  |  |            |
|  | 1.4 TDI  | 59   |  | 05.05  | 02.10   | PR: 1LQ,1ZF  |  |  |  |  |            |
|  | 1.6 i 16V  |  |  | 02.03  | 02.10   | PR: 1LQ,1ZF  |  |  |  |  |            |
|  | 1.8 T FR   | 110  |  | 12.03  | 02.10   | PR: 1LQ,1ZF  |  |  |  |  |            |

<sup>1)</sup> + gearshift cable / + leva cambio con cavo / + câble de changem.de vitesse / + cable de acc. del cambio

<sup>2)</sup> + gearshift linkage / + leva cambio con tiranteria / + tige de changem.de vitesse / + varillaje del cambio











































|     |   |                        |    |    |    |                        |  |               |  |
|--|---|--|--|--|---|--|--|---|--|
| <b>SEAT IBIZA IV (6L1) (02-10)</b>   |   |  |  |  |   |  |  |   |  |
|    | 1.9 SDI<br>1.9 TDI<br>1.9 TDI<br>1.9 TDI Cupra R<br>1.9 TDI Cupra R<br>2.0  | 47<br>74<br>96<br>110<br>118<br>85   | 02.02<br>02.02<br>02.02<br>01.04<br>03.04<br>04.02   | 02.10<br>02.10<br>02.10<br>02.10<br>02.08<br>02.10   | PR: 1LQ,1ZF<br>PR: 1LQ,1ZF<br>PR: 1LQ,1ZF<br>PR: 1LQ,1ZF<br>PR: 1LQ,1ZF<br>PR: 1LQ,1ZF  | 11.9541-9549.2<br>11.9541-9550.2<br>11.0101-5409.2   | 220575<br>220576<br>260035   | D=54, - Halter<br>D=54, - Halter<br>Hülsensatz  | ATE<br>ATE<br>ATE                      |
|  | 1.2<br>1.2 i<br>1.2 i 12V<br>1.4 i 16V<br>1.4 i 16V<br>1.4 i 16V<br>1.4 TDI<br>1.4 TDI<br>1.4 TDI<br>1.6 i 16V<br>1.8 T FR<br>1.9 SDI<br>1.9 TDI<br>1.9 TDI<br>1.9 TDI Cupra R<br>1.9 TDI Cupra R<br>2.0                  | 44<br>47<br>51<br>55<br>63<br>74<br>51<br>55<br>59<br>110<br>47<br>74<br>96<br>110<br>118<br>85        | 06.07<br>02.02<br>05.06<br>02.02<br>05.06<br>02.02<br>05.05<br>02.02<br>05.05<br>02.03<br>12.03<br>02.02<br>02.02<br>02.02<br>01.04<br>03.04<br>04.02          | 05.08<br>02.10<br>02.10<br>02.10<br>02.10<br>02.10<br>02.10<br>02.10<br>02.10<br>02.10<br>02.10<br>02.10<br>02.10<br>02.10<br>02.10<br>02.10<br>02.10          | PR: 1LN,1ZH<br>PR: 1LN,1ZH<br>PR: 1LN,1ZH<br>PR: 1LN,1ZH<br>PR: 1LN,1ZH<br>PR: 1LN,1ZH<br>PR: 1LN,1ZH<br>PR: 1LN,1ZH<br>PR: 1LN,1ZH<br>PR: 1LN,1ZH<br>PR: 1LN,1ZH<br>PR: 1LN,1ZH<br>PR: 1LN,1ZH<br>PR: 1LN,1ZH<br>PR: 1LN,1ZH<br>PR: 1LN,1ZH  | 24.3541-1797.7<br>24.3541-1798.7   | 220553<br>220554   | D=54, - Halter<br>D=54, - Halter  | LUC<br>LUC                             |
|  | 1.8 T Cupra R   | 132  | 01.04  | 02.10  |   | 11.9541-9595.2<br>11.9541-9596.2<br>11.0441-5409.2<br>11.0101-5409.2<br>11.8171-0008.1<br>11.8116-0143.1 | 220501<br>220502<br>250031<br>260035<br>990049<br>390513                           | D=54, - Halter<br>D=54, - Halter<br>Dichtungssatz<br>Hülsensatz<br>Führungsbolzen<br>Haltefeder | ATE<br>ATE<br>ATE<br>ATE<br>ATE<br>ATE |
|    | 1.2<br>1.2 i<br>1.2 i 12V<br>1.4 i 16V<br>1.4 i 16V<br>1.4 i 16V<br>1.4 TDI<br>1.4 TDI<br>1.4 TDI<br>1.6 i 16V<br>1.8 T FR<br>1.9 SDI<br>1.9 TDI<br>1.9 TDI<br>2.0  | 44<br>47<br>51<br>55<br>63<br>74<br>51<br>55<br>59<br>110<br>47<br>74<br>96<br>85                      | 06.07<br>02.02<br>05.06<br>02.02<br>05.06<br>02.02<br>05.05<br>02.02<br>05.05<br>02.03<br>12.03<br>02.02<br>02.02<br>02.02<br>04.02                            | 05.08<br>02.10<br>02.10<br>02.10<br>02.10<br>02.10<br>02.10<br>02.10<br>02.10<br>02.10<br>02.10<br>02.10<br>02.10<br>02.10<br>02.10                            |   | 83.6247-0522.3   | 330595   | L=522   |  |
|  | 1.2<br>1.2 i<br>1.2 i 12V<br>1.4 i 16V<br>1.4 i 16V<br>1.4 i 16V<br>1.4 TDI<br>1.4 TDI<br>1.4 TDI<br>1.6 i 16V<br>1.8 T Cupra R<br>1.8 T FR<br>1.9 SDI<br>1.9 TDI<br>1.9 TDI<br>1.9 TDI Cupra R<br>1.9 TDI Cupra R<br>2.0 | 44<br>47<br>51<br>55<br>63<br>74<br>51<br>55<br>59<br>132<br>110<br>47<br>74<br>96<br>110<br>118<br>85 | 06.07<br>02.02<br>05.06<br>02.02<br>05.06<br>02.02<br>05.05<br>02.02<br>05.05<br>02.03<br>01.04<br>12.03<br>02.02<br>02.02<br>02.02<br>01.04<br>03.04<br>04.02 | 05.08<br>02.10<br>02.10<br>02.10<br>02.10<br>02.10<br>02.10<br>02.10<br>02.10<br>02.10<br>02.10<br>02.10<br>02.10<br>02.10<br>02.10<br>02.10<br>02.08<br>02.10 |   | 24.3344-1709.7<br>24.3344-1710.7<br>24.3384-1729.7<br>24.3384-1730.7                                     | 220537<br>220538<br>220541<br>220542   | D=34, - Halter<br>D=34, - Halter<br>D=38(M12x1), - Halter<br>D=38(M12x1), - Halter              | LUC<br>LUC<br>LUC<br>LUC               |
|  | 1.2<br>1.2 i<br>1.2 i 12V<br>1.4 i 16V<br>1.4 i 16V<br>1.4 i 16V<br>1.4 TDI<br>1.4 TDI<br>1.4 TDI<br>1.6 i 16V<br>1.8 T Cupra R<br>1.8 T FR<br>1.9 SDI<br>1.9 TDI<br>1.9 TDI<br>1.9 TDI Cupra R<br>1.9 TDI Cupra R<br>2.0 | 44<br>47<br>51<br>55<br>63<br>74<br>51<br>55<br>59<br>132<br>110<br>47<br>74<br>96<br>110<br>118<br>85 | 06.07<br>02.02<br>05.06<br>02.02<br>05.06<br>02.02<br>05.05<br>02.02<br>05.05<br>02.03<br>01.04<br>12.03<br>02.02<br>02.02<br>02.02<br>01.04<br>03.04<br>04.02 | 05.08<br>02.10<br>02.10<br>02.10<br>02.10<br>02.10<br>02.10<br>02.10<br>02.10<br>02.10<br>02.10<br>02.10<br>02.10<br>02.10<br>02.10<br>02.10<br>02.10<br>02.10 | PR: 1KD,1KK,1KS,1KT,1KP<br>PR: 1KD,1KK,1KS,1KT,1KP<br>PR: 1KD,1KK,1KS,1KT,1KP<br>PR: 1KD,1KK,1KS,1KT,1KP<br>PR: 1KD,1KK,1KS,1KT,1KP<br>PR: 1KD,1KK,1KS,1KT,1KP<br>PR: 1KD,1KK,1KS,1KT,1KP<br>PR: 1KD,1KK,1KS,1KT,1KP<br>PR: 1KD,1KK,1KS,1KT,1KP<br>PR: 1KD,1KK,1KS,1KT,1KP<br>PR: 1KD,1KK,1KS,1KT,1KP<br>PR: 1KD,1KK,1KS,1KT,1KP<br>PR: 1KD,1KK,1KS,1KT,1KP<br>PR: 1KD,1KK,1KS,1KT,1KP<br>PR: 1KD,1KK,1KS,1KT,1KP<br>PR: 1KD,1KK,1KS,1KT,1KP<br>PR: 1KD,1KK,1KS,1KT,1KP | 83.7858-0140.3   | 330837   | L=140   |  |
|  | 1.2<br>1.2 i<br>1.2 i 12V<br>1.4 i 16V<br>1.4 i 16V<br>1.4 i 16V<br>1.4 TDI   | 44<br>47<br>51<br>55<br>63<br>74<br>51   | 06.07<br>02.02<br>05.06<br>02.02<br>05.06<br>02.02   | 05.08<br>02.10<br>02.10<br>02.10<br>02.10<br>02.10   |   | 24.3219-0909.3   | 020188   | Rz 19,05  |  |

| SEAT IBIZA IV (6L1) (02-10) |                 |     |  |       |       |                             |        |     |  |             |     |
|-----------------------------|-----------------|-----|--|-------|-------|-----------------------------|--------|-----|--|-------------|-----|
|                             | 1.4 TDI         | 55  |  | 02.02 | 02.10 | 24.3219-0909.3              | 020188 |     |  | Rz 19,05    |     |
|                             | 1.4 TDI         | 59  |  | 05.05 | 02.10 |                             |        |     |  |             |     |
|                             | 1.6 i 16V       |     |  | 02.03 | 02.10 |                             |        |     |  |             |     |
|                             | 1.9 SDI         | 47  |  | 02.02 | 02.10 |                             |        |     |  |             |     |
|                             | 1.9 TDI         | 74  |  | 02.02 | 02.10 |                             |        |     |  |             |     |
|                             | 1.9 TDI         | 96  |  | 02.02 | 02.10 |                             |        |     |  |             |     |
|                             | 1.9 TDI Cupra R | 110 |  | 01.04 | 02.10 |                             |        |     |  |             |     |
|                             | 1.9 TDI Cupra R | 118 |  | 03.04 | 02.08 |                             |        |     |  |             |     |
|                             | 2.0             | 85  |  | 04.02 | 02.10 |                             |        |     |  |             |     |
|                             | 1.2             | 44  |  | 06.07 | 05.08 | 24.3727-0199.2              | 580199 | 2 ↓ | - Schlechtwegeausführung <sup>1)</sup> | L=1580      |     |
|                             | 1.2 i           | 47  |  | 02.02 | 02.10 |                             |        |     |  |             |     |
|                             | 1.2 i 12V       | 51  |  | 05.06 | 02.10 |                             |        |     |  |             |     |
|                             | 1.4 i 16V       | 55  |  | 02.02 | 02.10 |                             |        |     |  |             |     |
|                             | 1.4 i 16V       | 63  |  | 05.06 | 02.10 |                             |        |     |  |             |     |
|                             | 1.4 i 16V       | 74  |  | 02.02 | 02.10 |                             |        |     |  |             |     |
|                             | 1.4 TDI         | 51  |  | 05.05 | 02.10 |                             |        |     |  |             |     |
|                             | 1.4 TDI         | 55  |  | 02.02 | 02.10 |                             |        |     |  |             |     |
|                             | 1.4 TDI         | 59  |  | 05.05 | 02.10 |                             |        |     |  |             |     |
|                             | 1.6 i 16V       |     |  | 02.03 | 02.10 |                             |        |     |  |             |     |
|                             | 1.8 T Cupra R   | 132 |  | 01.04 | 02.10 |                             |        |     |  |             |     |
|                             | 1.8 T FR        | 110 |  | 12.03 | 02.10 |                             |        |     |  |             |     |
|                             | 1.9 SDI         | 47  |  | 02.02 | 02.10 |                             |        |     |  |             |     |
|                             | 1.9 TDI         | 74  |  | 02.02 | 02.10 |                             |        |     |  |             |     |
|                             | 1.9 TDI         | 96  |  | 02.02 | 02.10 |                             |        |     |  |             |     |
|                             | 1.9 TDI Cupra R | 110 |  | 01.04 | 02.10 |                             |        |     |  |             |     |
|                             | 1.9 TDI Cupra R | 118 |  | 03.04 | 02.08 |                             |        |     |  |             |     |
|                             | 2.0             | 85  |  | 04.02 | 02.10 |                             |        |     |  |             |     |
|                             | 1.2             | 44  |  | 06.07 | 05.08 | 24.3727-0176.2              | 580176 | 2 ↓ | + Schlechtwegeausführung <sup>2)</sup> | L=1640      |     |
|                             | 1.2 i           | 47  |  | 02.02 | 02.10 | 24.3727-0198.2              | 580198 | 2 ↓ | + Schlechtwegeausführung <sup>2)</sup> | L=1645      |     |
|                             | 1.2 i 12V       | 51  |  | 05.06 | 02.10 | PR: 1KD,1KK,1KS,1KT,1SE,1SJ |        |     |  |             |     |
|                             | 1.4 i 16V       | 55  |  | 02.02 | 02.10 | PR: 1KD,1KK,1KS,1KT,1SE,1SJ |        |     |  |             |     |
|                             | 1.4 i 16V       | 63  |  | 05.06 | 02.10 | PR: 1KD,1KK,1KS,1KT,1SE,1SJ |        |     |  |             |     |
|                             | 1.4 i 16V       | 74  |  | 02.02 | 02.10 | PR: 1KD,1KK,1KS,1KT,1SE,1SJ |        |     |  |             |     |
|                             | 1.4 TDI         | 51  |  | 05.05 | 02.10 | PR: 1KD,1KK,1KS,1KT,1SE,1SJ |        |     |  |             |     |
|                             | 1.4 TDI         | 55  |  | 02.02 | 02.10 | PR: 1KD,1KK,1KS,1KT,1SE,1SJ |        |     |  |             |     |
|                             | 1.4 TDI         | 59  |  | 05.05 | 02.10 | PR: 1KD,1KK,1KS,1KT,1SE,1SJ |        |     |  |             |     |
|                             | 1.6 i 16V       |     |  | 02.03 | 02.10 | PR: 1KD,1KK,1KS,1KT,1SE,1SJ |        |     |  |             |     |
|                             | 1.8 T Cupra R   | 132 |  | 01.04 | 02.10 | PR: 1KD,1KK,1KS,1KT,1SE,1SJ |        |     |  |             |     |
|                             | 1.8 T FR        | 110 |  | 12.03 | 02.10 | PR: 1KD,1KK,1KS,1KT,1SE,1SJ |        |     |  |             |     |
|                             | 1.9 SDI         | 47  |  | 02.02 | 02.10 | PR: 1KD,1KK,1KS,1KT,1SE,1SJ |        |     |  |             |     |
|                             | 1.9 TDI         | 74  |  | 02.02 | 02.10 | PR: 1KD,1KK,1KS,1KT,1SE,1SJ |        |     |  |             |     |
|                             | 1.9 TDI         | 96  |  | 02.02 | 02.10 | PR: 1KD,1KK,1KS,1KT,1SE,1SJ |        |     |  |             |     |
|                             | 1.9 TDI Cupra R | 110 |  | 01.04 | 02.10 | PR: 1KD,1KK,1KS,1KT,1SE,1SJ |        |     |  |             |     |
|                             | 1.9 TDI Cupra R | 118 |  | 03.04 | 02.08 | PR: 1KD,1KK,1KS,1KT,1SE,1SJ |        |     |  |             |     |
|                             | 2.0             | 85  |  | 04.02 | 02.10 | PR: 1KD,1KK,1KS,1KT,1SE,1SJ |        |     |  |             |     |
|                             | 1.2             | 44  |  | 06.07 | 05.08 | 24.3727-2504.2              | 582504 | 2 ↓ | + Schlechtwegeausführung <sup>2)</sup> | L=1580      |     |
|                             | 1.2 i           | 47  |  | 02.02 | 02.10 | PR: 1JB,1KM                 |        |     |  |             |     |
|                             | 1.2 i 12V       | 51  |  | 05.06 | 02.10 | PR: 1JB,1KM                 |        |     |  |             |     |
|                             | 1.4 i 16V       | 55  |  | 02.02 | 02.10 | PR: 1JB,1KM                 |        |     |  |             |     |
|                             | 1.4 i 16V       | 63  |  | 05.06 | 02.10 | PR: 1JB,1KM                 |        |     |  |             |     |
|                             | 1.4 i 16V       | 74  |  | 02.02 | 02.10 | PR: 1JB,1KM                 |        |     |  |             |     |
|                             | 1.4 TDI         | 51  |  | 05.05 | 02.10 | PR: 1JB,1KM                 |        |     |  |             |     |
|                             | 1.4 TDI         | 55  |  | 02.02 | 02.10 | PR: 1JB,1KM                 |        |     |  |             |     |
|                             | 1.4 TDI         | 59  |  | 05.05 | 02.10 | PR: 1JB,1KM                 |        |     |  |             |     |
|                             | 1.6 i 16V       |     |  | 02.03 | 02.10 | PR: 1JB,1KM                 |        |     |  |             |     |
|                             | 1.8 T Cupra R   | 132 |  | 01.04 | 02.10 | PR: 1JB,1KM                 |        |     |  |             |     |
|                             | 1.8 T FR        | 110 |  | 12.03 | 02.10 | PR: 1JB,1KM                 |        |     |  |             |     |
|                             | 1.9 SDI         | 47  |  | 02.02 | 02.10 | PR: 1JB,1KM                 |        |     |  |             |     |
|                             | 1.9 TDI         | 74  |  | 02.02 | 02.10 | PR: 1JB,1KM                 |        |     |  |             |     |
|                             | 1.9 TDI         | 96  |  | 02.02 | 02.10 | PR: 1JB,1KM                 |        |     |  |             |     |
|                             | 1.9 TDI Cupra R | 110 |  | 01.04 | 02.10 | PR: 1JB,1KM                 |        |     |  |             |     |
|                             | 1.9 TDI Cupra R | 118 |  | 03.04 | 02.08 | PR: 1JB,1KM                 |        |     |  |             |     |
|                             | 2.0             | 85  |  | 04.02 | 02.10 | PR: 1JB,1KM                 |        |     |  |             |     |
|                             | 1.2             | 44  |  | 06.07 | 05.08 | 03.6583-0216.3              | 320247 |     | - ABS                                  | BRL 8/3 (4) | ATE |
|                             | 1.2 i           | 47  |  | 02.02 | 02.10 | 03.6584-0120.3              | 320279 |     | - ABS                                  | BRL 8/4 (4) | ATE |
|                             | 1.2 i 12V       | 51  |  | 05.06 | 02.10 |                             |        |     |  |             |     |
|                             | 1.4 i 16V       | 55  |  | 02.02 | 02.10 |                             |        |     |  |             |     |
|                             | 1.4 i 16V       | 63  |  | 05.06 | 02.10 |                             |        |     |  |             |     |
|                             | 1.4 i 16V       | 74  |  | 02.02 | 02.10 |                             |        |     |  |             |     |
|                             | 1.4 TDI         | 51  |  | 05.05 | 02.10 |                             |        |     |  |             |     |
|                             | 1.4 TDI         | 55  |  | 02.02 | 02.10 |                             |        |     |  |             |     |
|                             | 1.4 TDI         | 59  |  | 05.05 | 02.10 |                             |        |     |  |             |     |
|                             | 1.6 i 16V       |     |  | 02.03 | 02.10 |                             |        |     |  |             |     |
|                             | 1.8 T Cupra R   | 132 |  | 01.04 | 02.10 |                             |        |     |  |             |     |
|                             | 1.8 T FR        | 110 |  | 12.03 | 02.10 |                             |        |     |  |             |     |
|                             | 1.9 SDI         | 47  |  | 02.02 | 02.10 |                             |        |     |  |             |     |
|                             | 1.9 TDI         | 74  |  | 02.02 | 02.10 |                             |        |     |  |             |     |
|                             | 1.9 TDI         | 96  |  | 02.02 | 02.10 |                             |        |     |  |             |     |
|                             | 1.9 TDI Cupra R | 110 |  | 01.04 | 02.10 |                             |        |     |  |             |     |
|                             | 1.9 TDI Cupra R | 118 |  | 03.04 | 02.08 |                             |        |     |  |             |     |
|                             | 2.0             | 85  |  | 04.02 | 02.10 |                             |        |     |  |             |     |

<sup>1)</sup> - rough road construction / - versione per percorsi accidentati / - version pour mauvaise route / - versión 4x4

<sup>2)</sup> + rough road construction / + versione per percorsi accidentati / + version pour mauvaise route / + versión 4x4





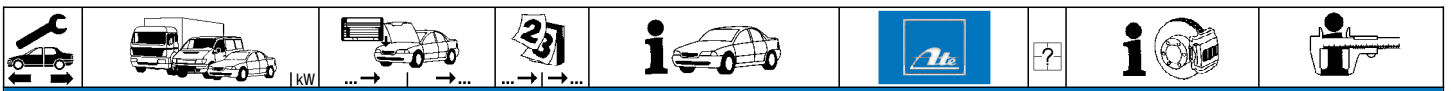







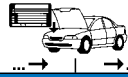

|     |    |  |  |  |  |  |    |  |   |  |                |        |  |          |
|--|--|--|--|--|---|--|--|--|---|--|----------------|--------|--|----------|
| <b>SEAT IBIZA V / ST / SPORTCOUPE (08-)</b>  |  |  |  |  |   |  |  |  |   |  |                |        |  |          |
|    | 1.2  | 44   | 07.09  | PR: 1LQ,1LR,1ZG  | 11.9541-9549.2  | 220575   |   | D=54, - Halter<br>ATE<br>D=54, - Halter<br>ATE<br>Hülsensatz<br>ATE                |   |  |                |        |  |          |
|  | 1.2  | 51   | 07.08  | PR: 1LQ,1LR,1ZG  | 11.9541-9550.2  | 220576   |  |  |   |  |                |        |  |          |
|  | 1.2 TDI  | 55   | 04.10  | PR: 1LQ,1LR,1ZG  | 11.0101-5409.2  | 260035   |  |  |   |  |                |        |  |          |
|  | 1.2 TSI  | 63   | 08.12  | PR: 1LQ,1LR,1ZG  |   |  |  |  |   |  |                |        |  |          |
|  | 1.2 TSI  | 77   | 09.10  | PR: 1LQ,1LR,1ZG  |   |  |  |  |   |  |                |        |  |          |
|  | 1.4 i 16V  | 63   | 07.08  | PR: 1LQ,1LR,1ZG  |   |  |  |  |   |  |                |        |  |          |
|  | 1.4 TDI  | 59   | 07.08  | PR: 1LQ,1LR,1ZG  |   |  |  |  |   |  |                |        |  |          |
|  | 1.6 i 16V  | 77   | 07.08  | PR: 1LQ,1LR,1ZG  |   |  |  |  |   |  |                |        |  |          |
|  | 1.6 LPG  | 60   | 05.11  | PR: 1LQ,1LR,1ZG  |   |  |  |  |   |  |                |        |  |          |
|  | 1.9 TDI  | 66   | 07.08  | PR: 1LQ,1LR,1ZG  |   |  |  |  |   |  |                |        |  |          |
|  | 1.9 TDI  | 77   | 07.08  | PR: 1LQ,1LR,1ZG  |   |  |  |  |   |  |                |        |  |          |
|  | 2.0  | 85   | 10.08  | PR: 1LQ,1LR,1ZG  |   |  |  |  |   |  |                |        |  |          |
|  | 1.2  | 44   | 07.09  | PR: 1LN,1ZH  | 24.3541-1797.7  | 220553   |  |  |  | D=54, - Halter<br>LUC<br>D=54, - Halter<br>LUC |                |        |  |          |
|  | 1.2  | 51   | 07.08  | PR: 1LN,1ZH  | 24.3541-1798.7  | 220554   |  |  |   |  |                |        |  |          |
|  | 1.2 TDI  | 55   | 04.10  | PR: 1LN,1ZH  |   |  |  |  |   |  |                |        |  |          |
|  | 1.2 TSI  | 63   | 08.12  | PR: 1LN,1ZH  |   |  |  |  |   |  |                |        |  |          |
|  | 1.2 TSI  | 77   | 09.10  | PR: 1LN,1ZH  |   |  |  |  |   |  |                |        |  |          |
|  | 1.4 i 16V  | 63   | 07.08  | PR: 1LN,1ZH  |   |  |  |  |   |  |                |        |  |          |
|  | 1.4 TDI  | 59   | 07.08  | PR: 1LN,1ZH  |   |  |  |  |   |  |                |        |  |          |
| 1.4 TSI FR   | 110  | 06.09  | PR: 1LN,1ZH  |  |   |  |  |  |   |  |                |        |  |          |
| 1.6 i 16V  | 77   | 07.08  | PR: 1LN,1ZH  |  |   |  |  |  |   |  |                |        |  |          |
| 1.6 LPG  | 60   | 05.11  | PR: 1LN,1ZH  |  |   |  |  |  |   |  |                |        |  |          |
| 1.9 TDI  | 66   | 07.08  | PR: 1LN,1ZH  |  |   |  |  |  |   |  |                |        |  |          |
| 1.9 TDI  | 77   | 07.08  | PR: 1LN,1ZH  |  |   |  |  |  |   |  |                |        |  |          |
| 2.0  | 85   | 10.08  | PR: 1LN,1ZH  |  |   |  |  |  |   |  |                |        |  |          |
| 2.0 TDI  | 105  | 01.10  | PR: 1LN,1ZH  |  |   |  |  |  |   |  |                |        |  |          |
|    | 1.2  | 44   | 07.09  | 06.10  | 83.6247-0522.3  | 330595   | 2  | L=522  |   |  |                |        |  |          |
|  | 1.2  | 51   | 07.08  | 06.10  |   |  |  |  |   |  |                |        |  |          |
|  | 1.2 TDI  | 55   | 04.10  | 06.10  |   |  |  |  |   |  |                |        |  |          |
|  | 1.4 i 16V  | 63   | 07.08  | 06.10  |   |  |  |  |   |  |                |        |  |          |
|  | 1.4 TDI  | 59   | 07.08  | 06.10  |   |  |  |  |   |  |                |        |  |          |
|  | 1.4 TSI Cupra  | 132  | 06.09  | 06.10  |   |  |  |  |   |  |                |        |  |          |
|  | 1.4 TSI FR   | 110  | 06.09  | 06.10  |   |  |  |  |   |  |                |        |  |          |
|  | 1.6 i 16V  | 77   | 07.08  | 06.10  |   |  |  |  |   |  |                |        |  |          |
|  | 1.6 TDI  | 66   | 06.09  | 06.10  |   |  |  |  |   |  |                |        |  |          |
|  | 1.6 TDI  | 77   | 06.09  | 06.10  |   |  |  |  |   |  |                |        |  |          |
|  | 1.9 TDI  | 66   | 07.08  | 06.10  |   |  |  |  |   |  |                |        |  |          |
|  | 1.9 TDI  | 77   | 07.08  | 06.10  |   |  |  |  |   |  |                |        |  |          |
|  | 2.0  | 85   | 10.08  | 06.10  |   |  |  |  |   |  |                |        |  |          |
|  | 2.0 TDI  | 105  | 01.10  | 06.10  |   |  |  |  |   |  |                |        |  |          |
|  | 1.4 TSI FR   | 110  | 06.09  | PR: 1KD,1KS  | 24.3344-1709.7  | 220537   |  | D=34, - Halter<br>LUC<br>D=34, - Halter<br>LUC                                     |   |  |                |        |  |          |
|  |  |  |  |  | 24.3344-1710.7  | 220538   |  |  |   |  |                |        |  |          |
|  | 1.2  | 44   | 07.09  |  | 83.7858-0140.3  | 330837   | 2  | L=140  |   |  |                |        |  |          |
|  | 1.2  | 51   | 07.08  |  |   |  |  |  |   |  |                |        |  |          |
|  | 1.2 TDI  | 55   | 04.10  |  |   |  |  |  |   |  |                |        |  |          |
|  | 1.2 TSI  | 63   | 08.12  |  |   |  |  |  |   |  |                |        |  |          |
|  | 1.2 TSI  | 77   | 09.10  |  |   |  |  |  |   |  |                |        |  |          |
|  | 1.4 i 16V  | 63   | 07.08  |  |   |  |  |  |   |  |                |        |  |          |
|  | 1.4 TDI  | 59   | 07.08  |  |   |  |  |  |   |  |                |        |  |          |
|  | 1.4 TSI Cupra  | 132  | 06.09  |  |   |  |  |  |   |  |                |        |  |          |
|  | 1.4 TSI FR   | 110  | 06.09  |  |   |  |  |  |   |  |                |        |  |          |
|  | 1.6 i 16V  | 77   | 07.08  |  |   |  |  |  |   |  |                |        |  |          |
|  | 1.6 LPG  | 60   | 05.11  |  |   |  |  |  |   |  |                |        |  |          |
|  | 1.6 TDI  | 66   | 06.09  |  |   |  |  |  |   |  |                |        |  |          |
|  | 1.6 TDI  | 77   | 06.09  |  |   |  |  |  |   |  |                |        |  |          |
|  | 1.9 TDI  | 66   | 07.08  |  |   |  |  |  |   |  |                |        |  |          |
|  | 1.9 TDI  | 77   | 07.08  |  |   |  |  |  |   |  |                |        |  |          |
|  | 2.0  | 85   | 10.08  |  |   |  |  |  |   |  |                |        |  |          |
|  | 2.0 TDI  | 105  | 01.10  |  |   |  |  |  |   |  |                |        |  |          |
|  |  | 1.2  | 44   |  |   |  |  |  | 07.09   | PR: 1KM  | 24.3219-0909.3 | 020188 |  | Rz 19,05 |
|  |  | 1.2  | 51   |  |   |  |  |  | 07.08   | PR: 1KM  |                |        |  |          |
| 1.2 TDI  |  | 55   | 04.10  | PR: 1KM  |   |  |  |  |   |  |                |        |  |          |
| 1.2 TSI  |  | 63   | 08.12  | PR: 1KM  |   |  |  |  |   |  |                |        |  |          |
| 1.2 TSI  |  | 77   | 09.10  | PR: 1KM  |   |  |  |  |   |  |                |        |  |          |
| 1.4 i 16V  |  | 63   | 07.08  | PR: 1KM  |   |  |  |  |   |  |                |        |  |          |
| 1.4 TDI  |  | 59   | 07.08  | PR: 1KM  |   |  |  |  |   |  |                |        |  |          |
| 1.6 i 16V  |  | 77   | 07.08  | PR: 1KM  |   |  |  |  |   |  |                |        |  |          |
| 1.6 LPG  |  | 60   | 05.11  | PR: 1KM  |   |  |  |  |   |  |                |        |  |          |
| 1.9 TDI  |  | 66   | 07.08  | PR: 1KM  |   |  |  |  |   |  |                |        |  |          |
| 1.9 TDI  | 77   | 07.08  | PR: 1KM  |  |   |  |  |  |   |  |                |        |  |          |
|  | 1.2  | 44   | 07.09  |  | 03.6583-0216.3  | 320247   | - ABS  | BRL 8/3 (4)<br>ATE   |   |  |                |        |  |          |
|  | 1.2  | 51   | 07.08  |  |   |  |  |  |   |  |                |        |  |          |
|  | 1.2 TDI  | 55   | 04.10  |  |   |  |  |  |   |  |                |        |  |          |
|  | 1.2 TSI  | 63   | 08.12  |  |   |  |  |  |   |  |                |        |  |          |
|  | 1.2 TSI  | 77   | 09.10  |  |   |  |  |  |   |  |                |        |  |          |
|  | 1.4 i 16V  | 63   | 07.08  |  |   |  |  |  |   |  |                |        |  |          |
|  | 1.4 TDI  | 59   | 07.08  |  |   |  |  |  |   |  |                |        |  |          |
|  | 1.6 i 16V  | 77   | 07.08  |  |   |  |  |  |   |  |                |        |  |          |
|  | 1.6 LPG  | 60   | 05.11  |  |   |  |  |  |   |  |                |        |  |          |
|  | 1.9 TDI  | 66   | 07.08  |  |   |  |  |  |   |  |                |        |  |          |
| 1.9 TDI  | 77   | 07.08  |  |  |   |  |  |  |   |  |                |        |  |          |
|  |  |  |  | 03.6584-0120.3   | 320279  | - ABS  | BRL 8/4 (4)<br>ATE   |  |   |  |                |        |  |          |

|     |   |                              |   |   |    |  |  |    |  |                   |
|--|---|--|---|---|---|--|--|--|--|-------------------|
| <b>SEAT INCA (6K9) (96-03)</b>   |   |  |   |   |   |  |  |  |  |                   |
|    | 1.4 i<br>1.4 i 16V<br>1.6 i<br>1.7 SDI<br>1.9 D<br>1.9 SDI / TDI  | 44<br>55<br>55<br>42<br>47<br>44   |   | 11.95 08.03<br>04.00 08.03<br>11.95 08.03<br>09.96 08.03<br>11.95 08.03<br>11.95 08.03  |   | 03.7750-6302.4<br>10.6350-4002.4   | 300161<br>300285   | - ABS<br>+ ABS   | 9"<br>9"   | ATE<br>ATE        |
|    | 1.4 i<br>1.4 i<br>1.4 i 16V<br>1.6 i<br>1.6 i<br>1.7 SDI<br>1.7 SDI<br>1.9 D<br>1.9 D<br>1.9 SDI / TDI<br>1.9 SDI / TDI   | 44<br>44<br>55<br>55<br>55<br>42<br>42<br>47<br>47<br>44<br>44   | 9K-X-006000<br>9K-X-006000<br>9K-X-006000<br>9K-X-006000<br>9K-X-006000   | 11.95 08.03<br>11.95 08.03<br>04.00 08.03<br>11.95 08.03<br>11.95 08.03<br>09.96 08.03<br>09.96 08.03<br>11.95 08.03<br>11.95 08.03<br>11.95 08.03<br>11.95 08.03 |   | 03.2122-1042.3<br>03.3517-0101.2   | 010137<br>390322   | - ABS<br>- ABS   | THz 22,20<br>Verschlusschraube                     | ATE               |
|    | 1.4 i<br>1.4 i 16V<br>1.6 i<br>1.7 SDI<br>1.9 D<br>1.9 SDI / TDI  | 44<br>55<br>55<br>42<br>47<br>44   |   | 11.95 08.03<br>04.00 08.03<br>11.95 08.03<br>09.96 08.03<br>11.95 08.03<br>11.95 08.03  |   | 03.2123-1484.3   | 010595   | + ABS  | THz 23,81  | ATE               |
|    | 1.4 i<br>1.4 i 16V<br>1.6 i<br>1.7 SDI<br>1.9 D<br>1.9 SDI / TDI  | 44<br>55<br>55<br>42<br>47<br>44   |   | 11.95 08.03<br>04.00 08.03<br>11.95 08.03<br>09.96 08.03<br>11.95 08.03<br>11.95 08.03  |   | 24.3541-1609.5<br>24.3541-1610.5<br>11.0101-5403.2                                 | 240039<br>240040<br>260010   | <br> | D=54, - Halter<br>D=54, - Halter<br>Faltenbalgsatz | LUC<br>LUC<br>LUC |
|    | 1.4 i<br>1.4 i 16V<br>1.6 i<br>1.7 SDI<br>1.9 D<br>1.9 SDI / TDI  | 44<br>55<br>55<br>42<br>47<br>44   |   | 11.95 08.03<br>04.00 08.03<br>11.95 08.03<br>09.96 08.03<br>11.95 08.03<br>11.95 08.03  |   | 83.7713-0435.3   | 330792   | 2  | L=435  |                   |
|    | 1.4 i<br>1.4 i 16V<br>1.6 i<br>1.7 SDI<br>1.9 D<br>1.9 SDI / TDI  | 44<br>55<br>55<br>42<br>47<br>44   |   | 11.95 08.03<br>04.00 08.03<br>11.95 08.03<br>09.96 08.03<br>11.95 08.03<br>11.95 08.03  |   | 83.6236-0402.3   | 330464   | 2  | L=400  |                   |
|  | 1.4 i<br>1.4 i 16V<br>1.6 i<br>1.7 SDI<br>1.9 D<br>1.9 SDI / TDI  | 44<br>55<br>55<br>42<br>47<br>44   |   | 11.95 08.03<br>04.00 08.03<br>11.95 08.03<br>09.96 08.03<br>11.95 08.03<br>11.95 08.03  |   | 24.3220-0909.3   | 020210   |  | Rz 20,64   |                   |
|  | 1.4 i<br>1.4 i 16V<br>1.6 i<br>1.7 SDI<br>1.9 D<br>1.9 SDI / TDI  | 44<br>55<br>55<br>42<br>47<br>44   |   | 11.95 08.03<br>04.00 08.03<br>11.95 08.03<br>09.96 08.03<br>11.95 08.03<br>11.95 08.03  |   | 24.3727-2700.2   | 582700   | 2   | L=1671   |                   |
|  | 1.4 i<br>1.6 i<br>1.7 SDI<br>1.9 D<br>1.9 SDI / TDI   | 44<br>55<br>42<br>47<br>44   |   | 11.95 08.03<br>11.95 08.03<br>09.96 08.03<br>11.95 08.03<br>11.95 08.03   |   | 24.3728-2704.2<br>24.3728-0128.2   | 592704<br>590128   |  | L=1065, - AUT<br>L=854, + AUT                      |                   |
| <b>SEAT LEON I (1M1) (99-05)</b>   |   |  |   |   |   |  |  |  |  |                   |
|  | 1.4 i 16V<br>1.6 i 16V<br>1.8 20V T<br>1.8 20V T 4x4<br>1.8 i 20V<br>1.8 T 4x4<br>1.8 T Cupra R<br>1.8 T Cupra R<br>1.9 SDI<br>1.9 TDI<br>1.9 TDI<br>1.9 TDI<br>1.9 TDI<br>1.9 TDI<br>1.9 TDI Syncro<br>2.3 VR5<br>2.8<br>2.8 i Cupra 4x4 | 44<br>44<br>132<br>132<br>92<br>154<br>154<br>165<br>50<br>44<br>44<br>96<br>110<br>110<br>110<br>150<br>150 | 1M-1B018341<br>1M-1B018341<br>1M-1B018341<br>1M-1B018341<br>1M-1B018341<br>1M-1B018341<br>1M-1B018341<br>1M-1B018341<br>1M-1B018341<br>1M-1B018341<br>1M-1B018341<br>1M-1B018341<br>1M-1B018341<br>1M-1B018341<br>1M-1B018341<br>1M-1B018341<br>1M-1B018341 | 11.99<br>11.99<br>11.99<br>11.99<br>11.99<br>05.02<br>05.02<br>07.03<br>11.99<br>11.99<br>11.99<br>05.03<br>02.01<br>05.02<br>09.00<br>05.02<br>02.01             | + ESP<br>+ ESP<br>+ ESP<br>+ ESP<br>+ ESP<br>+ ESP<br>+ ESP<br>+ ESP<br>+ ESP<br>+ ESP<br>+ ESP<br>+ ESP<br>+ ESP<br>+ ESP<br>+ ESP<br>+ ESP<br>+ ESP | 03.7863-0402.4   | 300124   |  | 10"  | ATE               |
|  | 1.4 i 16V<br>1.6 i 16V<br>1.8 20V T<br>1.8 20V T 4x4<br>1.8 i 20V<br>1.8 T 4x4<br>1.8 T Cupra R<br>1.8 T Cupra R<br>1.9 SDI   | 44<br>44<br>132<br>132<br>92<br>154<br>154<br>165<br>50  | 1M-1B018342<br>1M-1B018342<br>1M-1B018342<br>1M-1B018342<br>1M-1B018342<br>1M-1B018342<br>1M-1B018342<br>1M-1B018342<br>1M-1B018342   | 07.05<br>07.05<br>07.05<br>07.05<br>07.05<br>07.05<br>07.05<br>07.05<br>07.05   | + ESP<br>+ ESP<br>+ ESP<br>+ ESP<br>+ ESP<br>+ ESP<br>+ ESP<br>+ ESP<br>+ ESP   | 03.7860-0602.4   | 300141   |  | 10"  | ATE               |













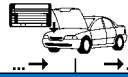



**SEAT LEON I (1M1) (99-05)**

|  |  |   |  |   |  |  |      |           |  |                                 |
|--|--|---|--|---|--|--|------|-----------|--|---------------------------------|
|  | 1.9 TDI<br>1.9 TDI<br>1.9 TDI<br>1.9 TDI<br>1.9 TDI Syncro<br>2.3 VR5<br>2.8<br>2.8 i Cupra 4x4  | 1M-1B018342<br>1M-1B018342<br>96 1M-1B018342<br>110 1M-1B018342<br>110 1M-1B018342<br>110 1M-1B018342<br>150 1M-1B018342<br>150 1M-1B018342 |  | 07.05 + ESP<br>07.05 + ESP<br>07.05 + ESP<br>07.05 + ESP<br>07.05 + ESP<br>07.05 + ESP<br>07.05 + ESP<br>07.05 + ESP  | 03.7860-0602.4   | 300141   |      | 10"       | ATE  |                                 |
|  | 1.4 i 16V<br>1.6 i 16V<br>1.8 20V T<br>1.8 20V T 4x4<br>1.8 i 20V<br>1.8 T 4x4<br>1.8 T Cupra R<br>1.8 T Cupra R<br>1.9 SDI<br>1.9 TDI<br>1.9 TDI<br>1.9 TDI<br>1.9 TDI<br>1.9 TDI Syncro<br>2.3 VR5<br>2.8<br>2.8 i Cupra 4x4 | <br><br>132<br>132<br>92<br>154<br>154<br>165<br>50<br><br>96<br>96<br>110<br>110<br>110<br>110<br>150<br>150                               |  | 11.99 07.05 - ESP<br>11.99 07.05 - ESP<br>11.99 07.05 - ESP<br>11.99 07.05 - ESP<br>11.99 07.05 - ESP<br>05.02 07.05 - ESP<br>05.02 07.05 - ESP<br>07.03 07.05 - ESP<br>11.99 07.05 - ESP<br>11.99 07.05 - ESP<br>11.99 07.05 - ESP<br>05.03 07.05 - ESP<br>02.01 07.05 - ESP<br>05.02 07.05 - ESP<br>09.00 07.05 - ESP<br>05.02 07.05 - ESP<br>02.01 07.05 - ESP | 24.2123-1709.3   | 010503   |      | THz 23,81 |  |                                 |
|  | 1.4 i 16V<br>1.6 i 16V<br>1.8 20V T<br>1.8 20V T 4x4<br>1.8 i 20V<br>1.9 SDI<br>1.9 TDI<br>1.9 TDI   | <br><br>132<br>132<br>92<br>50<br><br><br>  |  | 11.99 08.00 + ESP<br>11.99 08.00 + ESP<br>11.99 08.00 + ESP<br>11.99 08.00 + ESP<br>11.99 08.00 + ESP<br>11.99 08.00 + ESP<br>11.99 08.00 + ESP<br>11.99 08.00 + ESP  | 03.2123-2024.3   | 010597   |      | THz 23,81 | ATE  |                                 |
|  | 1.4 i 16V<br>1.6 i 16V<br>1.8 20V T<br>1.8 20V T 4x4<br>1.8 i 20V<br>1.8 T 4x4<br>1.8 T Cupra R<br>1.8 T Cupra R<br>1.9 SDI<br>1.9 TDI<br>1.9 TDI<br>1.9 TDI<br>1.9 TDI<br>1.9 TDI Syncro<br>2.3 VR5<br>2.8<br>2.8 i Cupra 4x4 | <br><br>132<br>132<br>92<br>154<br>154<br>165<br>50<br><br>96<br>96<br>110<br>110<br>110<br>110<br>150<br>150                               |  | 09.00 07.05 + ESP<br>09.00 07.05 + ESP<br>09.00 07.05 + ESP<br>11.99 07.05 + ESP<br>09.00 07.05 + ESP<br>05.02 07.05 + ESP<br>07.03 07.05 + ESP<br>07.03 07.05 + ESP<br>09.00 07.05 + ESP<br>09.00 07.05 + ESP<br>11.99 07.05 + ESP<br>09.00 07.05 + ESP<br>02.01 07.05 + ESP<br>05.02 07.05 + ESP<br>09.00 07.05 + ESP<br>05.02 07.05 + ESP<br>02.01 07.05 + ESP | 03.2123-2715.3   | 010802   |      | THz 23,81 | ATE  |                                 |
|  | 1.4 i 16V<br>1.6 i 16V<br>1.8 20V T<br>1.8 20V T 4x4<br>1.8 i 20V<br>1.9 SDI<br>1.9 TDI<br>1.9 TDI   | <br><br>132<br>132<br>92<br>50<br><br><br>  |  | 11.99 08.00 + ESP<br>11.99 08.00 + ESP<br>11.99 08.00 + ESP<br>11.99 08.00 + ESP<br>11.99 08.00 + ESP<br>11.99 08.00 + ESP<br>11.99 08.00 + ESP<br>11.99 08.00 + ESP  | 03.2123-2064.3   | 010598   |      | THz 23,81 | ATE  |                                 |
|  | 1.4 i 16V<br>1.6 i 16V<br>1.8 20V T<br>1.8 20V T 4x4<br>1.8 i 20V<br>1.8 T 4x4<br>1.8 T Cupra R<br>1.8 T Cupra R<br>1.9 SDI<br>1.9 TDI<br>1.9 TDI<br>1.9 TDI<br>1.9 TDI<br>1.9 TDI Syncro<br>2.3 VR5<br>2.8<br>2.8 i Cupra 4x4 | <br><br>132<br>132<br>92<br>154<br>154<br>165<br>50<br><br>96<br>96<br>110<br>110<br>110<br>110<br>150<br>150                               |  | 09.00 07.05 + ESP<br>09.00 07.05 + ESP<br>09.00 07.05 + ESP<br>11.99 07.05 + ESP<br>09.00 07.05 + ESP<br>05.02 07.05 + ESP<br>05.02 07.05 + ESP<br>07.03 07.05 + ESP<br>09.00 07.05 + ESP<br>09.00 07.05 + ESP<br>09.00 07.05 + ESP<br>05.03 07.05 + ESP<br>02.01 07.05 + ESP<br>05.02 07.05 + ESP<br>09.00 07.05 + ESP<br>05.02 07.05 + ESP<br>02.01 07.05 + ESP | 03.2123-2774.3   | 010803   |      | THz 23,81 | ATE  |                                 |
|  | 1.4 i 16V<br>1.6 i 16V<br>1.8 20V T<br>1.8 20V T 4x4<br>1.8 i 20V<br>1.8 T 4x4<br>1.8 T Cupra R<br>1.8 T Cupra R<br>1.9 SDI<br>1.9 TDI<br>1.9 TDI<br>1.9 TDI<br>1.9 TDI<br>1.9 TDI Syncro<br>2.3 VR5<br>2.8<br>2.8 i Cupra 4x4 | <br><br>132<br>132<br>92<br>154<br>154<br>165<br>50<br><br>96<br>96<br>110<br>110<br>110<br>110<br>150<br>150                               |  | 11.99 07.05 PR: 1LQ,1LS<br>11.99 07.05 PR: 1LQ,1LS<br>11.99 07.05 PR: 1LQ,1LS<br>11.99 07.05 PR: 1LQ,1LS<br>11.99 07.05 PR: 1LQ,1LS<br>05.02 07.05 PR: 1LQ,1LS<br>05.02 07.05 PR: 1LT<br>07.03 07.05 PR: 1LT<br>11.99 07.05 PR: 1LQ,1LS<br>11.99 07.05 PR: 1LQ,1LS<br>11.99 07.05 PR: 1LQ,1LS<br>05.03 07.05 PR: 1LQ,1LS  | 11.9541-9549.2<br>11.9541-9550.2<br>11.0101-5409.2<br>11.8171-0008.1<br>11.8116-0143.1 | 220575<br>220576<br>260035<br>990049<br>390513 | <br> | 2         | D=54, - Halter<br>D=54, - Halter<br>Hülsensatz<br>Führungsbolzen<br>Haltefeder | ATE<br>ATE<br>ATE<br>ATE<br>ATE |











|     |  |  |  |  |  |  |  |  |   |     |   |  |     |
|--|--|--|--|--|---|--|--|--|---|-----|---|--|-----|
| <b>SEAT LEON I (1M1) (99-05)</b>   |  |  |  |  |   |  |  |  |   |     |   |  |     |
|    | 1.9 TDI  | 110  | 02.01  | 07.05  | PR: 1LQ,1LS   | 11.9541-9549.2   | 220575   | 2  | D=54, - Halter<br>ATE<br>D=54, - Halter<br>ATE<br>Hülzensatz<br>ATE<br>Führungsbolzen<br>ATE<br>Haltefeder<br>ATE | ATE |   |  |     |
|  | 1.9 TDI Syncro   | 110  | 05.02  | 07.05  | PR: 1LQ,1LS   | 11.9541-9550.2   | 220576   |  |   |     |   |  |     |
|  | 2.3 VR5  | 110  | 09.00  | 07.05  | PR: 1LQ,1LS   | 11.0101-5409.2   | 260035   |  |   |     |   |  |     |
|  | 2.8  | 150  | 05.02  | 07.05  | PR: 1LQ,1LS   | 11.8171-0008.1   | 990049   |  |   |     |   |  |     |
|  | 2.8 i Cupra 4x4  | 150  | 02.01  | 07.05  | PR: 1LT   | 11.8116-0143.1   | 390513   |  |   |     |   |  |     |
|  | 1.4 i 16V  |  | 11.99  | 07.05  | PR: 1LE   | 11.3541-8523.2   | 220115   |  |   |     | 2 | D=54, - Halter<br>ATE<br>D=54, - Halter<br>ATE<br>D=54, - Halter<br>ATE<br>D=54, - Halter<br>ATE<br>Haltefeder<br>ATE<br>Dichtungssatz<br>ATE<br>Hülzensatz<br>ATE<br>Führungsbolzen<br>ATE<br>Haltefeder<br>ATE | ATE |
|  | 1.6 i 16V  |  | 11.99  | 07.05  | PR: 1LE   | 11.3541-8524.2   | 220116   |  |   |     |   |  |     |
|  | 1.8 20V T  | 132  | 11.99  | 07.05  | PR: 1LE   | 24.3541-8523.5   | 240551   |  |   |     |   |  |     |
|  | 1.8 20V T 4x4  | 132  | 11.99  | 07.05  | PR: 1LE   | 24.3541-8524.5   | 240552   |  |   |     |   |  |     |
|  | 1.8 i 20V  | 92   | 11.99  | 07.05  | PR: 1LE   | 11.8170-0306.1   | 260102   |  |   |     |   |  |     |
|  | 1.8 T 4x4  | 154  | 05.02  | 07.05  | PR: 1LE   | 11.0441-5409.2   | 250031   |  |   |     |   |  |     |
|  | 1.9 SDI  | 50   | 11.99  | 07.05  | PR: 1LE   | 11.0101-5409.2   | 260035   |  |   |     |   |  |     |
|  | 1.9 TDI  |  | 11.99  | 07.05  | PR: 1LE   | 11.8171-0008.1   | 990049   |  |   |     |   |  |     |
|  | 1.9 TDI  |  | 11.99  | 07.05  | PR: 1LE   | 11.8116-0143.1   | 390513   |  |   |     |   |  |     |
|  | 1.9 TDI  | 96   | 05.03  | 07.05  | PR: 1LE   |  |  |  |   |     |   |  |     |
|  | 1.9 TDI  | 110  | 02.01  | 07.05  | PR: 1LE   |  |  |  |   |     |   |  |     |
|  | 1.9 TDI Syncro   | 110  | 05.02  | 07.05  | PR: 1LE   |  |  |  |   |     |   |  |     |
|  | 2.3 VR5  | 110  | 09.00  | 07.05  | PR: 1LE   |  |  |  |   |     |   |  |     |
|  | 2.8  | 150  | 05.02  | 07.05  | PR: 1LE   |  |  |  |   |     |   |  |     |
|  | 1.4 i 16V  |  | 11.99  | 07.05  | PR: 1LJ,1ZQ   | 11.9541-9595.2   | 220501   |  |   |     |   |  |     |
| 1.6 i 16V  |  | 11.99  | 07.05  | PR: 1LJ,1ZQ  | 11.9541-9596.2  | 220502   |  |  |   |     |   |  |     |
| 1.8 20V T  | 132  | 11.99  | 07.05  | PR: 1LJ,1ZQ  | 11.0441-5409.2  | 250031   |  |  |   |     |   |  |     |
| 1.8 20V T 4x4  | 132  | 11.99  | 07.05  | PR: 1LJ,1ZQ  | 11.0101-5409.2  | 260035   |  |  |   |     |   |  |     |
| 1.8 i 20V  | 92   | 11.99  | 07.05  | PR: 1LJ,1ZQ  | 11.8171-0008.1  | 990049   |  |  |   |     |   |  |     |
| 1.8 T 4x4  | 154  | 05.02  | 07.05  | PR: 1LJ,1ZQ  | 11.8116-0143.1  | 390513   |  |  |   |     |   |  |     |
| 1.9 SDI  | 50   | 11.99  | 07.05  | PR: 1LJ,1ZQ  |   |  |  |  |   |     |   |  |     |
| 1.9 TDI  |  | 11.99  | 07.05  | PR: 1LJ,1ZQ  |   |  |  |  |   |     |   |  |     |
| 1.9 TDI  |  | 11.99  | 07.05  | PR: 1LJ,1ZQ  |   |  |  |  |   |     |   |  |     |
| 1.9 TDI  | 96   | 05.03  | 07.05  | PR: 1LJ,1ZQ  |   |  |  |  |   |     |   |  |     |
| 1.9 TDI  | 110  | 02.01  | 07.05  | PR: 1LJ,1ZQ  |   |  |  |  |   |     |   |  |     |
| 1.9 TDI Syncro   | 110  | 05.02  | 07.05  | PR: 1LJ,1ZQ  |   |  |  |  |   |     |   |  |     |
| 2.3 VR5  | 110  | 09.00  | 07.05  | PR: 1LJ,1ZQ  |   |  |  |  |   |     |   |  |     |
| 2.8  | 150  | 05.02  | 07.05  | PR: 1LJ,1ZQ  |   |  |  |  |   |     |   |  |     |
|    | 1.4 i 16V  |  | 11.99  | 07.05  |   | 83.7838-0435.3   | 330834   | 2  | L=435   |     |   |  |     |
|  | 1.6 i 16V  |  | 11.99  | 07.05  |   |  |  |  |   |     |   |  |     |
|  | 1.8 20V T  | 132  | 11.99  | 07.05  |   |  |  |  |   |     |   |  |     |
|  | 1.8 20V T 4x4  | 132  | 11.99  | 07.05  |   |  |  |  |   |     |   |  |     |
|  | 1.8 i 20V  | 92   | 11.99  | 07.05  |   |  |  |  |   |     |   |  |     |
|  | 1.8 T 4x4  | 154  | 05.02  | 07.05  |   |  |  |  |   |     |   |  |     |
|  | 1.9 SDI  | 50   | 11.99  | 07.05  |   |  |  |  |   |     |   |  |     |
|  | 1.9 TDI  |  | 11.99  | 07.05  |   |  |  |  |   |     |   |  |     |
|  | 1.9 TDI  | 96   | 05.03  | 07.05  |   |  |  |  |   |     |   |  |     |
|  | 1.9 TDI  | 110  | 02.01  | 07.05  |   |  |  |  |   |     |   |  |     |
| 1.9 TDI Syncro   | 110  | 05.02  | 07.05  |  |   |  |  |  |   |     |   |  |     |
| 2.3 VR5  | 110  | 09.00  | 07.05  |  |   |  |  |  |   |     |   |  |     |
| 2.8  | 150  | 05.02  | 07.05  |  |   |  |  |  |   |     |   |  |     |
|  | 1.8 T Cupra R  | 154  | 05.02  | 07.05  |   | 83.6247-0562.3   | 330594   | 2  | L=560   |     |   |  |     |
|  | 1.8 T Cupra R  | 165  | 07.03  | 07.05  |   |  |  |  |   |     |   |  |     |
|  | 2.8 i Cupra 4x4  | 150  | 02.01  | 07.05  |   |  |  |  |   |     |   |  |     |
|  | 1.4 i 16V  |  | 11.99  | 07.05  |   | 24.3384-1729.7   | 220541   | 2  | D=38(M12x1), - Halter<br>LUC<br>D=38(M12x1), - Halter<br>LUC  | LUC |   |  |     |
|  |  |  |  |  |   | 24.3384-1730.7   | 220542   |  |   |     |   |  |     |
|  | 1.6 i 16V  |  | 11.99  | 07.05  | PR: 1KK,1KP,1KQ   | 24.3414-1705.7   | 220549   |  |   |     |   |  |     |
|  | 1.8 20V T  | 132  | 11.99  | 07.05  | PR: 1KK,1KP,1KQ   | 24.3414-1706.7   | 220550   |  |   |     |   |  |     |
|  | 1.8 20V T 4x4  | 132  | 11.99  | 07.05  | PR: 1KK,1KP,1KQ   |  |  |  |   |     |   |  |     |
|  | 1.8 i 20V  | 92   | 11.99  | 07.05  | PR: 1KK,1KP,1KQ   |  |  |  |   |     |   |  |     |
|  | 1.8 T 4x4  | 154  | 05.02  | 07.05  | PR: 1KK,1KP,1KQ   |  |  |  |   |     |   |  |     |
|  | 1.9 SDI  | 50   | 11.99  | 07.05  | PR: 1KK,1KP,1KQ   |  |  |  |   |     |   |  |     |
|  | 1.9 TDI  |  | 11.99  | 07.05  | PR: 1KK,1KP,1KQ   |  |  |  |   |     |   |  |     |
|  | 1.9 TDI  |  | 11.99  | 07.05  | PR: 1KK,1KP,1KQ   |  |  |  |   |     |   |  |     |
|  | 1.9 TDI  | 96   | 05.03  | 07.05  | PR: 1KK,1KP,1KQ   |  |  |  |   |     |   |  |     |
|  | 1.9 TDI  | 110  | 02.01  | 07.05  | PR: 1KK,1KP,1KQ   |  |  |  |   |     |   |  |     |
|  | 1.9 TDI Syncro   | 110  | 05.02  | 07.05  | PR: 1KK,1KP,1KQ   |  |  |  |   |     |   |  |     |
|  | 2.3 VR5  | 110  | 09.00  | 07.05  | PR: 1KK,1KP,1KQ   |  |  |  |   |     |   |  |     |
|  | 2.8  | 150  | 05.02  | 07.05  | PR: 1KK,1KP,1KQ   |  |  |  |   |     |   |  |     |
|  | 1.6 i 16V  |  | 11.99  | 07.05  | PR: 1KY,2EE   | 24.3384-1745.7   | 220609   |  |   |     | 2 | D=38, - Halter<br>LUC<br>D=38, - Halter<br>LUC   | LUC |
|  | 1.8 20V T  | 132  | 11.99  | 07.05  | PR: 1KY,2EE   | 24.3384-1746.7   | 220610   |  |   |     |   |  |     |
|  | 1.8 20V T 4x4  | 132  | 11.99  | 07.05  | PR: 1KY,2EE   |  |  |  |   |     |   |  |     |
|  | 1.8 i 20V  | 92   | 11.99  | 07.05  | PR: 1KY,2EE   |  |  |  |   |     |   |  |     |
|  | 1.8 T 4x4  | 154  | 05.02  | 07.05  | PR: 1KY,2EE   |  |  |  |   |     |   |  |     |
| 1.8 T Cupra R  | 154  | 05.02  | 07.05  | PR: 1KY  |   |  |  |  |   |     |   |  |     |
| 1.8 T Cupra R  | 165  | 07.03  | 07.05  | PR: 1KY  |   |  |  |  |   |     |   |  |     |
| 1.9 SDI  | 50   | 11.99  | 07.05  | PR: 1KY,2EE  |   |  |  |  |   |     |   |  |     |
| 1.9 TDI  |  | 11.99  | 07.05  | PR: 1KY,2EE  |   |  |  |  |   |     |   |  |     |
| 1.9 TDI  |  | 11.99  | 07.05  | PR: 1KY,2EE  |   |  |  |  |   |     |   |  |     |
| 1.9 TDI  | 96   | 05.03  | 07.05  | PR: 1KY,2EE  |   |  |  |  |   |     |   |  |     |
| 1.9 TDI  | 110  | 02.01  | 07.05  | PR: 1KY,2EE  |   |  |  |  |   |     |   |  |     |
| 1.9 TDI Syncro   | 110  | 05.02  | 07.05  | PR: 1KY,2EE  |   |  |  |  |   |     |   |  |     |
| 2.3 VR5  | 110  | 09.00  | 07.05  | PR: 1KY,2EE  |   |  |  |  |   |     |   |  |     |
| 2.8  | 150  | 05.02  | 07.05  | PR: 1KY,2EE  |   |  |  |  |   |     |   |  |     |
| 2.8 i Cupra 4x4  | 150  | 02.01  | 07.05  | PR: 1KY  |   |  |  |  |   |     |   |  |     |
|  | 1.4 i 16V  |  | 11.99  | 07.05  |   | 83.7858-0140.3   | 330837   | 2  | L=140   |     |   |  |     |
|  | 1.6 i 16V  |  | 11.99  | 07.05  |   |  |  |  |   |     |   |  |     |
|  | 1.8 20V T  | 132  | 11.99  | 07.05  |   |  |  |  |   |     |   |  |     |
|  | 1.8 i 20V  | 92   | 11.99  | 07.05  |   |  |  |  |   |     |   |  |     |
|  | 1.8 T Cupra R  | 154  | 05.02  | 07.05  |   |  |  |  |   |     |   |  |     |



|     |    kW |  |  |  |  |  |  |  |                 |
|--|---|--|--|--|---|--|--|--|-----------------|
| <b>SEAT LEON I (1M1) (99-05)</b>   |   |  |  |  |   |  |  |  |                 |
|    | 1.8 T Cupra R   | 165  |  | 07.03  | 07.05   | 83.7858-0140.3   | 330837   | 2  | L=140           |
|  | 1.9 SDI   | 50   |  | 11.99  | 07.05   |  |  |  |                 |
|  | 1.9 TDI   |  |  | 11.99  | 07.05   |  |  |  |                 |
|  | 1.9 TDI   |  |  | 11.99  | 07.05   |  |  |  |                 |
|  | 1.9 TDI   | 96   |  | 05.03  | 07.05   |  |  |  |                 |
|  | 1.9 TDI   | 110  |  | 02.01  | 07.05   |  |  |  |                 |
|  | 2.8   | 150  |  | 02.01  | 07.05   |  |  |  |                 |
|  | 1.8 20V T 4x4   | 132  |  | 11.99  | 07.05   | 83.7858-0140.3   | 330837   | 2  | L=140           |
|  | 1.8 T 4x4   | 154  |  | 05.02  | 07.05   |  |  |  |                 |
|  | 1.9 TDI Syncro  | 110  |  | 05.02  | 07.05   |  |  |  |                 |
| 2.8 i Cupra 4x4  | 150   |  | 02.01  | 07.05  |   |  |  |  |                 |
|    | 1.4 i 16V   |  |  | 11.99  | 07.05   | 24.3727-0173.2   | 580173   | 2 ↓  | L=1693          |
|  | 1.6 i 16V   |  |  | 11.99  | 07.05   |  |  |  |                 |
|  | 1.8 20V T   | 132  |  | 11.99  | 07.05   |  |  |  |                 |
|  | 1.8 20V T 4x4   | 132  |  | 11.99  | 07.05   |  |  |  |                 |
|  | 1.8 i 20V   | 92   |  | 11.99  | 07.05   |  |  |  |                 |
|  | 1.8 T 4x4   | 154  |  | 05.02  | 07.05   |  |  |  |                 |
|  | 1.8 T Cupra R   | 154  |  | 05.02  | 07.05   |  |  |  |                 |
|  | 1.8 T Cupra R   | 165  |  | 07.03  | 07.05   |  |  |  |                 |
|  | 1.9 SDI   | 50   |  | 11.99  | 07.05   |  |  |  |                 |
|  | 1.9 TDI   |  |  | 11.99  | 07.05   |  |  |  |                 |
|  | 1.9 TDI   |  |  | 11.99  | 07.05   |  |  |  |                 |
|  | 1.9 TDI   | 96   |  | 05.03  | 07.05   |  |  |  |                 |
|  | 1.9 TDI   | 110  |  | 02.01  | 07.05   |  |  |  |                 |
|  | 1.9 TDI Syncro  | 110  |  | 05.02  | 07.05   |  |  |  |                 |
|  | 2.3 VR5   | 110  |  | 09.00  | 07.05   |  |  |  |                 |
|  | 2.8   | 150  |  | 05.02  | 07.05   |  |  |  |                 |
| 2.8 i Cupra 4x4  | 150   |  | 02.01  | 07.05  |   |  |  |  |                 |
|    | 1.4 i 16V   |  |  | 11.99  | 07.05   | 03.6583-0179.3   | 320228   |  | BRL 8/3 (4) ATE |
|  | 1.6 i 16V   |  |  | 11.99  | 07.05   |  |  |  |                 |
|  | 1.8 20V T   | 132  |  | 11.99  | 07.05   |  |  |  |                 |
|  | 1.8 20V T 4x4   | 132  |  | 11.99  | 07.05   |  |  |  |                 |
|  | 1.8 i 20V   | 92   |  | 11.99  | 07.05   |  |  |  |                 |
|  | 1.8 T 4x4   | 154  |  | 05.02  | 07.05   |  |  |  |                 |
|  | 1.8 T Cupra R   | 154  |  | 05.02  | 07.05   |  |  |  |                 |
|  | 1.8 T Cupra R   | 165  |  | 07.03  | 07.05   |  |  |  |                 |
|  | 1.9 SDI   | 50   |  | 11.99  | 07.05   |  |  |  |                 |
|  | 1.9 TDI   |  |  | 11.99  | 07.05   |  |  |  |                 |
|  | 1.9 TDI   |  |  | 11.99  | 07.05   |  |  |  |                 |
|  | 1.9 TDI   | 96   |  | 05.03  | 07.05   |  |  |  |                 |
|  | 1.9 TDI   | 110  |  | 02.01  | 07.05   |  |  |  |                 |
|  | 1.9 TDI Syncro  | 110  |  | 05.02  | 07.05   |  |  |  |                 |
|  | 2.3 VR5   | 110  |  | 09.00  | 07.05   |  |  |  |                 |
|  | 2.8   | 150  |  | 05.02  | 07.05   |  |  |  |                 |
| 2.8 i Cupra 4x4  | 150   |  | 02.01  | 07.05  |   |  |  |  |                 |
|  | 1.4 i 16V   | ‡  |  | 11.99  | 07.05   | 24.2415-1701.3   | 030095   |  | Gz 15,87        |
|  | 1.6 i 16V   | ‡  |  | 11.99  | 07.05   |  |  |  |                 |
|  | 1.8 20V T   | ‡132   |  | 11.99  | 07.05   |  |  |  |                 |
|  | 1.8 20V T 4x4   | ‡132   |  | 11.99  | 07.05   |  |  |  |                 |
|  | 1.8 i 20V   | ‡ 92   |  | 11.99  | 07.05   |  |  |  |                 |
|  | 1.8 T 4x4   | ‡154   |  | 05.02  | 07.05   |  |  |  |                 |
|  | 1.8 T Cupra R   | ‡154   |  | 05.02  | 07.05   |  |  |  |                 |
|  | 1.8 T Cupra R   | ‡165   |  | 07.03  | 07.05   |  |  |  |                 |
|  | 1.9 SDI   | ‡ 50   |  | 11.99  | 07.05   |  |  |  |                 |
|  | 1.9 TDI   | ‡  |  | 11.99  | 07.05   |  |  |  |                 |
|  | 1.9 TDI   | ‡  |  | 11.99  | 07.05   |  |  |  |                 |
|  | 1.9 TDI   | ‡ 96   |  | 05.03  | 07.05   |  |  |  |                 |
|  | 1.9 TDI   | ‡110   |  | 02.01  | 07.05   |  |  |  |                 |
|  | 1.9 TDI Syncro  | ‡110   |  | 05.02  | 07.05   |  |  |  |                 |
|  | 2.3 VR5   | ‡110   |  | 09.00  | 07.05   |  |  |  |                 |
|  | 2.8   | ‡150   |  | 05.02  | 07.05   |  |  |  |                 |
| 2.8 i Cupra 4x4  | ‡150  |  | 02.01  | 07.05  |   |  |  |  |                 |
|  | 1.4 i 16V   | ‡  |  | 11.99  | 07.05   | 24.2415-1702.3   | 030096   |  | Gz 15,87        |
|  | 1.6 i 16V   | ‡  |  | 11.99  | 07.05   |  |  |  |                 |
|  | 1.8 20V T   | ‡132   |  | 11.99  | 07.05   |  |  |  |                 |
|  | 1.8 20V T 4x4   | ‡132   |  | 11.99  | 07.05   |  |  |  |                 |
|  | 1.8 i 20V   | ‡ 92   |  | 11.99  | 07.05   |  |  |  |                 |
|  | 1.8 T 4x4   | ‡154   |  | 05.02  | 07.05   |  |  |  |                 |
|  | 1.8 T Cupra R   | ‡154   |  | 05.02  | 07.05   |  |  |  |                 |
|  | 1.8 T Cupra R   | ‡165   |  | 07.03  | 07.05   |  |  |  |                 |
|  | 1.9 SDI   | ‡ 50   |  | 11.99  | 07.05   |  |  |  |                 |
|  | 1.9 TDI   | ‡  |  | 11.99  | 07.05   |  |  |  |                 |
|  | 1.9 TDI   | ‡  |  | 11.99  | 07.05   |  |  |  |                 |
|  | 1.9 TDI   | ‡ 96   |  | 05.03  | 07.05   |  |  |  |                 |
|  | 1.9 TDI   | ‡110   |  | 02.01  | 07.05   |  |  |  |                 |
|  | 1.9 TDI Syncro  | ‡110   |  | 05.02  | 07.05   |  |  |  |                 |
|  | 2.3 VR5   | ‡110   |  | 09.00  | 07.05   |  |  |  |                 |
|  | 2.8   | ‡150   |  | 05.02  | 07.05   |  |  |  |                 |
| 2.8 i Cupra 4x4  | ‡150  |  | 02.01  | 07.05  |   |  |  |  |                 |
|  | 1.4 i 16V   |  |  | 11.99  | 07.05   | 24.2519-1701.3   | 040075   |  | Nz 19,05        |
|  | 1.6 i 16V   |  |  | 11.99  | 07.05   | 24.2523-1701.3   | 040080   |  | Nz 23,81        |
|  | 1.8 20V T   | 132  |  | 11.99  | 07.05   |  |  |  |                 |
|  | 1.8 20V T 4x4   | 132  |  | 11.99  | 07.05   |  |  |  |                 |
|  | 1.8 i 20V   | 92   |  | 11.99  | 07.05   |  |  |  |                 |
|  | 1.8 T 4x4   | 154  |  | 05.02  | 07.05   |  |  |  |                 |
|  | 1.8 T Cupra R   | 154  |  | 05.02  | 07.05   |  |  |  |                 |
|  | 1.8 T Cupra R   | 165  |  | 07.03  | 07.05   |  |  |  |                 |

1) + gearshift cable / + leva cambio con cavo / + câble de changem.de vitesse / + cable de acc. del cambio

2) + gearshift linkage / + leva cambio con tiranteria / + tige de changem.de vitesse / + varillaje del cambio





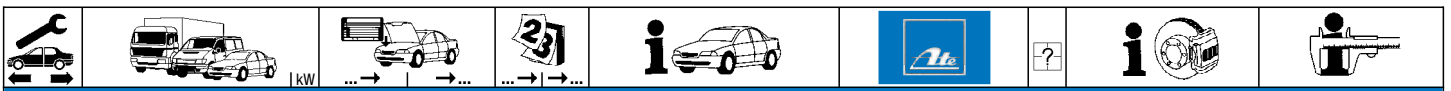





| SEAT LEON I (1M1) (99-05)  |  | SEAT LEON II (1P1) (05-12)   |  |   |  |  |  |
|--|--|--|--|---|--|--|--|
|     |  |  |  |  |  |  |  |
| <b>SEAT LEON I (1M1) (99-05)</b>   |  | <b>SEAT LEON II (1P1) (05-12)</b>  |  |   |  |  |  |
|    | 1.9 SDI 50   |  | 11.99 07.05  | 24.2519-1701.3  | 040075   | + Schaltseilzug <sup>1)</sup>  | Nz 19,05   |
|  | 1.9 TDI  |  | 11.99 07.05  | 24.2523-1701.3  | 040080   | + Schaltgestänge <sup>2)</sup>   | Nz 23,81   |
|  | 1.9 TDI  |  | 11.99 07.05  |   |  |  |  |
|  | 1.9 TDI  | 96   | 05.03 07.05  |   |  |  |  |
|  | 1.9 TDI  | 110  | 02.01 07.05  |   |  |  |  |
|  | 1.9 TDI Syncro   | 110  | 05.02 07.05  |   |  |  |  |
|  | 2.3 VR5  | 110  | 09.00 07.05  |   |  |  |  |
|  | 2.8  | 150  | 05.02 07.05  |   |  |  |  |
|  | 2.8 i Cupra 4x4  | 150  | 02.01 07.05  |   |  |  |  |
|    | 1.2 TSI 77   |  | 02.10 05.10 PR: 1AC,1AT  | 03.7863-9502.4  | 300204   | Kolbendurchmesser Ø 22,20mm <sup>3)</sup>  | 10" ATE  |
|  | 1.4 i 16V  | 55   | 08.05 05.10 PR: 1AC,1AT  | 03.7863-9702.4  | 300207   | Kolbendurchmesser Ø 23,81mm <sup>4)</sup>  | 10" ATE  |
|  | 1.4 i 16V  | 63   | 06.06 05.10 PR: 1AC,1AT  |   |  |  |  |
|  | 1.4 TSI  | 92   | 11.07 05.10 PR: 1AC,1AT  |   |  |  |  |
|  | 1.6 i  | 75   | 08.05 05.10 PR: 1AC,1AT  |   |  |  |  |
|  | 1.6 i 16V  | 77   | 08.05 05.10 PR: 1AC,1AT  |   |  |  |  |
|  | 1.6 LPG  | 75   | 12.09 05.10 PR: 1AC,1AT  |   |  |  |  |
|  | 1.6 TDI Ecomotive  | 77   | 02.10 05.10 PR: 1AC,1AT  |   |  |  |  |
|  | 1.8 T 20V  | 132  | 08.05 05.10 PR: 1AC,1AT  |   |  |  |  |
|  | 1.8 T 20V  | 165  | 08.05 05.10 PR: 1AC,1AT  |   |  |  |  |
|  | 1.8 TSI  | 118  | 06.07 05.10 PR: 1AC,1AT  |   |  |  |  |
|  | 1.9 TDI  |  | 08.05 05.10 PR: 1AC,1AT  |   |  |  |  |
|  | 1.9 TDI  | 81   | 08.05 05.10 PR: 1AC,1AT  |   |  |  |  |
|  | 1.9 TDI  | 110  | 08.05 05.10 PR: 1AC,1AT  |   |  |  |  |
|  | 2.0 FSI  | 110  | 08.05 05.10 PR: 1AC,1AT  |   |  |  |  |
|  | 2.0 i 16V  | 100  | 08.05 05.10 PR: 1AC,1AT  |   |  |  |  |
|  | 2.0 TDI  |  | 08.05 05.10 PR: 1AC,1AT  |   |  |  |  |
|  | 2.0 TDI  | 125  | 02.06 05.10 PR: 1AC,1AT  |   |  |  |  |
|  | 2.0 TFSI   |  | 11.06 05.10 PR: 1AC,1AT  |   |  |  |  |
|  | 2.0 TFSI   | 136  | 08.05 05.10 PR: 1AC,1AT  |   |  |  |  |
|  | 2.0 TFSI   | 155  | 09.05 05.10 PR: 1AC,1AT  |   |  |  |  |
|  | 1.2 TSI  | 77   | 02.10 10.12 PR: 1AS  | 03.7863-9602.4  | 300206   | Kolbendurchmesser Ø 22,20mm <sup>3)</sup>  | 10" ATE  |
|  | 1.4 i 16V  | 55   | 08.05 10.12 PR: 1AS  |   |  |  |  |
|  | 1.4 i 16V  | 63   | 06.06 10.12 PR: 1AS  |   |  |  |  |
|  | 1.4 TSI  | 92   | 11.07 10.12 PR: 1AS  |   |  |  |  |
|  | 1.6 i  | 75   | 08.05 10.12 PR: 1AS  |   |  |  |  |
|  | 1.6 i 16V  | 77   | 08.05 10.12 PR: 1AS  |   |  |  |  |
|  | 1.6 LPG  | 75   | 12.09 10.12 PR: 1AS  |   |  |  |  |
|  | 1.6 TDI  | 66   | 11.10 10.12 PR: 1AS  |   |  |  |  |
|  | 1.6 TDI Ecomotive  | 77   | 02.10 10.12 PR: 1AS  |   |  |  |  |
|  | 1.8 T 20V  | 132  | 08.05 10.12 PR: 1AS  |   |  |  |  |
|  | 1.8 T 20V  | 165  | 08.05 10.12 PR: 1AS  |   |  |  |  |
|  | 1.8 TSI  | 118  | 06.07 10.12 PR: 1AS  |   |  |  |  |
|  | 1.9 TDI  |  | 08.05 10.12 PR: 1AS  |   |  |  |  |
|  | 1.9 TDI  | 81   | 08.05 10.12 PR: 1AS  |   |  |  |  |
|  | 1.9 TDI  | 110  | 08.05 10.12 PR: 1AS  |   |  |  |  |
|  | 2.0 FSI  | 110  | 08.05 10.12 PR: 1AS  |   |  |  |  |
|  | 2.0 i 16V  | 100  | 08.05 10.12 PR: 1AS  |   |  |  |  |
|  | 2.0 TDI  |  | 08.05 10.12 PR: 1AS  |   |  |  |  |
|  | 2.0 TDI  | 125  | 02.06 10.12 PR: 1AS  |   |  |  |  |
|  | 2.0 TFSI   |  | 11.06 10.12 PR: 1AS  |   |  |  |  |
|  | 2.0 TFSI   | 136  | 08.05 10.12 PR: 1AS  |   |  |  |  |
|  | 2.0 TFSI   | 155  | 09.05 10.12 PR: 1AS  |   |  |  |  |
|  | 1.2 TSI 77 FIP-6-027 023   |  | 05.10  | 03.2122-2129.3  | 010799   | PR: 1AC,1AT,1AS  | Thz 22,20 ATE  |
|  | 1.4 i 16V 55 FIP-6-027 023   |  | 05.10  | 03.2123-3449.3  | 010808   | PR: 1AC,1AT,1LJ,1ZA  | Thz 23,81 ATE  |
|  | 1.4 i 16V 63 FIP-6-027 023   |  | 05.10  |   |  |  |  |
|  | 1.4 TSI 92 FIP-6-027 023   |  | 05.10  |   |  |  |  |
|  | 1.6 i 75 FIP-6-027 023   |  | 05.10  |   |  |  |  |
|  | 1.6 i 16V 77 FIP-6-027 023   |  | 05.10  |   |  |  |  |
|  | 1.6 LPG 75 FIP-6-027 023   |  | 05.10  |   |  |  |  |
|  | 1.6 TDI Ecomotive 77 FIP-6-027 023   |  | 05.10  |   |  |  |  |
|  | 1.8 T 20V 132 FIP-6-027 023  |  | 05.10  |   |  |  |  |
|  | 1.8 T 20V 165 FIP-6-027 023  |  | 05.10  |   |  |  |  |
|  | 1.8 TSI 118 FIP-6-027 023  |  | 05.10  |   |  |  |  |
|  | 1.9 TDI FIP-6-027 023  |  | 05.10  |   |  |  |  |
|  | 1.9 TDI 81 FIP-6-027 023   |  | 05.10  |   |  |  |  |
|  | 1.9 TDI 110 FIP-6-027 023  |  | 05.10  |   |  |  |  |
|  | 2.0 FSI 110 FIP-6-027 023  |  | 05.10  |   |  |  |  |
|  | 2.0 i 16V 100 FIP-6-027 023  |  | 05.10  |   |  |  |  |
|  | 2.0 TDI FIP-6-027 023  |  | 05.10  |   |  |  |  |
|  | 2.0 TDI 125 FIP-6-027 023  |  | 05.10  |   |  |  |  |
|  | 2.0 TFSI FIP-6-027 023   |  | 05.10  |   |  |  |  |
|  | 2.0 TFSI 136 FIP-6-027 023   |  | 05.10  |   |  |  |  |
|  | 2.0 TFSI 155 FIP-6-027 023   |  | 05.10  |   |  |  |  |
|  | 1.2 TSI 77   |  | 06.10 10.12 PR: 1LB,1ZA,1ZB  | 03.2123-3449.3  | 010808   |  | Thz 23,81 ATE  |
|  | 1.4 i 16V 55   |  | 06.10 10.12 PR: 1LB,1ZA,1ZB  |   |  |  |  |
|  | 1.4 i 16V 63   |  | 06.10 10.12 PR: 1LB,1ZA,1ZB  |   |  |  |  |
|  | 1.4 TSI 92   |  | 06.10 10.12 PR: 1LB,1ZA,1ZB  |   |  |  |  |
|  | 1.6 i 75   |  | 06.10 10.12 PR: 1LB,1ZA,1ZB  |   |  |  |  |
|  | 1.6 i 16V 77   |  | 06.10 10.12 PR: 1LB,1ZA,1ZB  |   |  |  |  |
|  | 1.6 LPG 75   |  | 06.10 10.12 PR: 1LB,1ZA,1ZB  |   |  |  |  |
|  | 1.6 TDI 66   |  | 11.10 10.12 PR: 1LB,1ZA,1ZB  |   |  |  |  |
|  | 1.6 TDI Ecomotive 77   |  | 06.10 10.12 PR: 1LB,1ZA,1ZB  |   |  |  |  |
|  | 1.8 T 20V 132  |  | 06.10 10.12 PR: 1LB,1ZA,1ZB  |   |  |  |  |
|  | 1.8 T 20V 165  |  | 06.10 10.12 PR: 1LB,1ZA,1ZB  |   |  |  |  |
|  | 1.8 TSI 118  |  | 06.10 10.12 PR: 1LB,1ZA,1ZB  |   |  |  |  |

<sup>1)</sup> + gearshift cable / + leva cambio con cavo / + câble de changem.de vitesse / + cable de acc. del cambio  
<sup>2)</sup> + gearshift linkage / + leva cambio con tiranteria / + tige de changem.de vitesse / + varillaje del cambio  
<sup>3)</sup> piston diameter Ø 22,20mm / diametro del pistone Ø 22,20mm / diamètre de piston Ø 22,20mm / diametro del pistón Ø 22,20mm  
<sup>4)</sup> piston diameter Ø 23,81mm / diametro del pistone Ø 23,81mm / diamètre de piston Ø 23,81mm / diametro del pistón Ø 23,81mm



**SEAT LEON II (1P1) (05-12)**

|           |                   |       |       |             |                 |                |        |  |                |     |
|-----------|-------------------|-------|-------|-------------|-----------------|----------------|--------|--|----------------|-----|
|           | 1.9 TDI           | 81    | 06.10 | 10.12       | PR: 1LB,1ZA,1ZB | 03.2123-3449.3 | 010808 |  | Thz 23,81      | ATE |
|           | 1.9 TDI           | 110   | 06.10 | 10.12       | PR: 1LB,1ZA,1ZB |                |        |  |                |     |
|           | 2.0 FSI           | 110   | 06.10 | 10.12       | PR: 1LB,1ZA,1ZB |                |        |  |                |     |
|           | 2.0 i 16V         | 100   | 06.10 | 10.12       | PR: 1LB,1ZA,1ZB |                |        |  |                |     |
|           | 2.0 TDI           | 125   | 06.10 | 10.12       | PR: 1LB,1ZA,1ZB |                |        |  |                |     |
|           | 2.0 TDI           | 125   | 06.10 | 10.12       | PR: 1LB,1ZA,1ZB |                |        |  |                |     |
|           | 2.0 TFSI          | 136   | 06.10 | 10.12       | PR: 1LB,1ZA,1ZB |                |        |  |                |     |
|           | 2.0 TFSI          | 136   | 06.10 | 10.12       | PR: 1LB,1ZA,1ZB |                |        |  |                |     |
|           | 2.0 TFSI          | 155   | 06.10 | 10.12       | PR: 1LB,1ZA,1ZB |                |        |  |                |     |
|           | 2.0 TFSI          | 155   | 06.10 | 10.12       | PR: 1LB,1ZA,1ZB |                |        |  |                |     |
|           | 1.2 TSI           | 77    | 06.10 | 10.12       | PR: 1ZE,1ZF     | 03.2122-2129.3 | 010799 |  | Thz 22,20      | ATE |
|           | 1.4 i 16V         | 55    | 06.10 | 10.12       | PR: 1ZE,1ZF     |                |        |  |                |     |
|           | 1.4 i 16V         | 63    | 06.10 | 10.12       | PR: 1ZE,1ZF     |                |        |  |                |     |
|           | 1.4 TSI           | 92    | 06.10 | 10.12       | PR: 1ZE,1ZF     |                |        |  |                |     |
|           | 1.6 i             | 75    | 06.10 | 10.12       | PR: 1ZE,1ZF     |                |        |  |                |     |
|           | 1.6 i 16V         | 77    | 06.10 | 10.12       | PR: 1ZE,1ZF     |                |        |  |                |     |
|           | 1.6 LPG           | 75    | 06.10 | 10.12       | PR: 1ZE,1ZF     |                |        |  |                |     |
|           | 1.6 TDI           | 66    | 11.10 | 10.12       | PR: 1ZE,1ZF     |                |        |  |                |     |
|           | 1.6 TDI Ecomotive | 77    | 06.10 | 10.12       | PR: 1ZE,1ZF     |                |        |  |                |     |
|           | 1.8 T 20V         | 132   | 06.10 | 10.12       | PR: 1ZE,1ZF     |                |        |  |                |     |
|           | 1.8 T 20V         | 165   | 06.10 | 10.12       | PR: 1ZE,1ZF     |                |        |  |                |     |
|           | 1.8 TSI           | 118   | 06.10 | 10.12       | PR: 1ZE,1ZF     |                |        |  |                |     |
|           | 1.9 TDI           | 81    | 06.10 | 10.12       | PR: 1ZE,1ZF     |                |        |  |                |     |
|           | 1.9 TDI           | 110   | 06.10 | 10.12       | PR: 1ZE,1ZF     |                |        |  |                |     |
|           | 2.0 FSI           | 110   | 06.10 | 10.12       | PR: 1ZE,1ZF     |                |        |  |                |     |
|           | 2.0 i 16V         | 100   | 06.10 | 10.12       | PR: 1ZE,1ZF     |                |        |  |                |     |
|           | 2.0 TDI           | 125   | 06.10 | 10.12       | PR: 1ZE,1ZF     |                |        |  |                |     |
|           | 2.0 TDI           | 125   | 06.10 | 10.12       | PR: 1ZE,1ZF     |                |        |  |                |     |
|           | 2.0 TFSI          | 136   | 06.10 | 10.12       | PR: 1ZE,1ZF     |                |        |  |                |     |
|           | 2.0 TFSI          | 155   | 06.10 | 10.12       | PR: 1ZE,1ZF     |                |        |  |                |     |
|           | 1.2 TSI           | 77    | 02.10 | 10.12       | PR: 1ZF,1ZM     | 11.9541-9549.2 | 220575 |  | D=54, - Halter | ATE |
|           | 1.4 i 16V         | 55    | 08.05 | 10.12       | PR: 1ZF,1ZM     |                |        |  |                |     |
|           | 1.4 i 16V         | 63    | 06.06 | 10.12       | PR: 1ZF,1ZM     |                |        |  |                |     |
|           | 1.4 TSI           | 92    | 11.07 | 10.12       | PR: 1ZF,1ZM     |                |        |  |                |     |
|           | 1.6 i             | 75    | 08.05 | 10.12       | PR: 1ZF,1ZM     |                |        |  |                |     |
|           | 1.6 i 16V         | 77    | 08.05 | 10.12       | PR: 1ZF,1ZM     |                |        |  |                |     |
|           | 1.6 LPG           | 75    | 12.09 | 10.12       | PR: 1ZF,1ZM     |                |        |  |                |     |
|           | 1.6 TDI           | 66    | 11.10 | 10.12       | PR: 1ZF,1ZM     |                |        |  |                |     |
|           | 1.6 TDI Ecomotive | 77    | 02.10 | 10.12       | PR: 1ZF,1ZM     |                |        |  |                |     |
|           | 1.8 T 20V         | 132   | 08.05 | 10.12       | PR: 1ZF,1ZM     |                |        |  |                |     |
|           | 1.8 T 20V         | 165   | 08.05 | 10.12       | PR: 1ZF,1ZM     |                |        |  |                |     |
|           | 1.8 TSI           | 118   | 06.07 | 10.12       | PR: 1ZF,1ZM     |                |        |  |                |     |
|           | 1.9 TDI           | 81    | 08.05 | 10.12       | PR: 1ZF,1ZM     |                |        |  |                |     |
|           | 1.9 TDI           | 110   | 08.05 | 10.12       | PR: 1ZF,1ZM     |                |        |  |                |     |
|           | 2.0 FSI           | 110   | 08.05 | 10.12       | PR: 1ZF,1ZM     |                |        |  |                |     |
|           | 2.0 i 16V         | 100   | 08.05 | 10.12       | PR: 1ZF,1ZM     |                |        |  |                |     |
|           | 2.0 TDI           | 125   | 08.05 | 10.12       | PR: 1ZF,1ZM     |                |        |  |                |     |
|           | 2.0 TDI           | 125   | 02.06 | 10.12       | PR: 1ZF,1ZM     |                |        |  |                |     |
|           | 2.0 TFSI          | 136   | 11.06 | 10.12       | PR: 1ZF,1ZM     |                |        |  |                |     |
|           | 2.0 TFSI          | 136   | 08.05 | 10.12       | PR: 1ZF,1ZM     |                |        |  |                |     |
| 2.0 TFSI  | 155               | 09.05 | 10.12 | PR: 1ZF,1ZM |                 |                |        |  |                |     |
|           | 1.2 TSI           | 77    | 02.10 | 10.12       | PR: 1ZE         | 11.9541-9553.2 | 220563 |  | D=54, - Halter | ATE |
|           | 1.4 i 16V         | 55    | 08.05 | 10.12       | PR: 1ZE         |                |        |  |                |     |
|           | 1.4 i 16V         | 63    | 06.06 | 10.12       | PR: 1ZE         |                |        |  |                |     |
|           | 1.4 TSI           | 92    | 11.07 | 10.12       | PR: 1ZE         |                |        |  |                |     |
|           | 1.6 i             | 75    | 08.05 | 10.12       | PR: 1ZE         |                |        |  |                |     |
|           | 1.6 i 16V         | 77    | 08.05 | 10.12       | PR: 1ZE         |                |        |  |                |     |
|           | 1.6 LPG           | 75    | 12.09 | 10.12       | PR: 1ZE         |                |        |  |                |     |
|           | 1.6 TDI           | 66    | 11.10 | 10.12       | PR: 1ZE         |                |        |  |                |     |
|           | 1.6 TDI Ecomotive | 77    | 02.10 | 10.12       | PR: 1ZE         |                |        |  |                |     |
|           | 1.8 T 20V         | 132   | 08.05 | 10.12       | PR: 1ZE         |                |        |  |                |     |
|           | 1.8 T 20V         | 165   | 08.05 | 10.12       | PR: 1ZE         |                |        |  |                |     |
|           | 1.8 TSI           | 118   | 06.07 | 10.12       | PR: 1ZE         |                |        |  |                |     |
|           | 1.9 TDI           | 81    | 08.05 | 10.12       | PR: 1ZE         |                |        |  |                |     |
|           | 1.9 TDI           | 110   | 08.05 | 10.12       | PR: 1ZE         |                |        |  |                |     |
|           | 2.0 FSI           | 110   | 08.05 | 10.12       | PR: 1ZE         |                |        |  |                |     |
|           | 2.0 i 16V         | 100   | 08.05 | 10.12       | PR: 1ZE         |                |        |  |                |     |
|           | 2.0 TDI           | 125   | 08.05 | 10.12       | PR: 1ZE         |                |        |  |                |     |
|           | 2.0 TDI           | 125   | 02.06 | 10.12       | PR: 1ZE         |                |        |  |                |     |
|           | 2.0 TFSI          | 136   | 11.06 | 10.12       | PR: 1ZE         |                |        |  |                |     |
|           | 2.0 TFSI          | 136   | 08.05 | 10.12       | PR: 1ZE         |                |        |  |                |     |
| 2.0 TFSI  | 155               | 09.05 | 10.12 | PR: 1ZE     |                 |                |        |  |                |     |
|           | 1.2 TSI           | 77    | 02.10 | 10.12       | PR: 1LJ         | 11.9541-9553.2 | 220563 |  | D=54, - Halter | ATE |
|           | 1.4 i 16V         | 55    | 08.05 | 10.12       | PR: 1LJ         |                |        |  |                |     |
|           | 1.4 i 16V         | 63    | 06.06 | 10.12       | PR: 1LJ         |                |        |  |                |     |
|           | 1.4 TSI           | 92    | 11.07 | 10.12       | PR: 1LJ         |                |        |  |                |     |
|           | 1.6 i             | 75    | 08.05 | 10.12       | PR: 1LJ         |                |        |  |                |     |
|           | 1.6 i 16V         | 77    | 08.05 | 10.12       | PR: 1LJ         |                |        |  |                |     |
|           | 1.6 LPG           | 75    | 12.09 | 10.12       | PR: 1LJ         |                |        |  |                |     |
|           | 1.6 TDI           | 66    | 11.10 | 10.12       | PR: 1LJ         |                |        |  |                |     |
|           | 1.6 TDI Ecomotive | 77    | 02.10 | 10.12       | PR: 1LJ         |                |        |  |                |     |
|           | 1.8 T 20V         | 132   | 08.05 | 10.12       | PR: 1LJ         |                |        |  |                |     |
| 1.8 T 20V | 165               | 08.05 | 10.12 | PR: 1LJ     |                 |                |        |  |                |     |



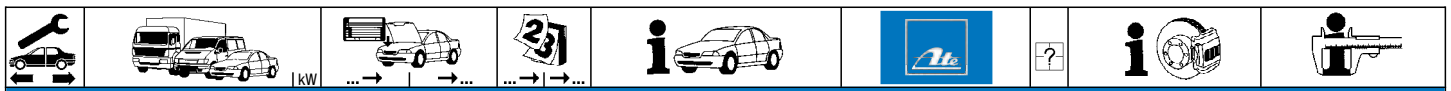















|     |    kW |  |  |  |  |  |  |  |  |     |
|--|---|--|--|--|---|--|--|--|--|-----|
| <b>SEAT LEON II (1P1) (05-12)</b>  |   |  |  |  |   |  |  |  |  |     |
|    | 1.8 TSI   | 118  |  | 06.07  | 10.12   | PR: 1LJ  | 11.9541-9553.2   | 220563   | D=54, - Halter<br>D=54, - Halter<br>Hülzensatz<br>Führungsbolzen<br>Haltefeder | ATE |
|  | 1.9 TDI   |  |  | 08.05  | 10.12   | PR: 1LJ  | 11.9541-9554.2   | 220564   |  | ATE |
|  | 1.9 TDI   | 81   |  | 08.05  | 10.12   | PR: 1LJ  | 11.0101-5409.2   | 260035   |  | ATE |
|  | 1.9 TDI   | 110  |  | 08.05  | 10.12   | PR: 1LJ  | 11.8171-0008.1   | 990049   |  | ATE |
|  | 2.0 FSI   | 110  |  | 08.05  | 10.12   | PR: 1LJ  | 11.8116-0351.1   | 390538   |  | ATE |
|  | 2.0 i 16V   | 100  |  | 08.05  | 10.12   | PR: 1LJ  |  |  |  |     |
|  | 2.0 TDI   |  |  | 08.05  | 10.12   | PR: 1LJ  |  |  |  |     |
|  | 2.0 TDI   | 125  |  | 02.06  | 10.12   | PR: 1LJ  |  |  |  |     |
|  | 2.0 TFSI  |  |  | 11.06  | 10.12   | PR: 1LJ  |  |  |  |     |
|  | 2.0 TFSI  | 136  |  | 08.05  | 10.12   | PR: 1LJ  |  |  |  |     |
| 2.0 TFSI   | 155   |  | 09.05  | 10.12  | PR: 1LJ   |  |  |  |  |     |
|  | 1.4 i 16V   | 55   |  | 08.05  | 09.09   | PR: 1LU  | 11.9576-9995.2   | 220651   | D=57, - Halter<br>D=57, - Halter<br>Hülzensatz<br>Führungsbolzen<br>Haltefeder | ATE |
|  | 1.4 i 16V   | 63   |  | 06.06  | 09.09   | PR: 1LU  | 11.9576-9996.2   | 220652   |  | ATE |
|  | 1.4 TSI   | 92   |  | 11.07  | 09.09   | PR: 1LU  | 11.0101-5409.2   | 260035   |  | ATE |
|  | 1.6 i   | 75   |  | 08.05  | 09.09   | PR: 1LU  | 11.8171-0008.1   | 990049   |  | ATE |
|  | 1.6 i 16V   | 77   |  | 08.05  | 09.09   | PR: 1LU  | 11.8116-0410.2   | 390589   |  | ATE |
|  | 1.8 T 20V   | 132  |  | 08.05  | 09.09   | PR: 1LU  |  |  |  |     |
|  | 1.8 T 20V   | 165  |  | 08.05  | 09.09   | PR: 1LU  |  |  |  |     |
|  | 1.8 TSI   | 118  |  | 06.07  | 09.09   | PR: 1LU  |  |  |  |     |
|  | 1.9 TDI   |  |  | 08.05  | 09.09   | PR: 1LU  |  |  |  |     |
|  | 1.9 TDI   | 81   |  | 08.05  | 09.09   | PR: 1LU  |  |  |  |     |
|  | 1.9 TDI   | 110  |  | 08.05  | 09.09   | PR: 1LU  |  |  |  |     |
|  | 2.0 FSI   | 110  |  | 08.05  | 09.09   | PR: 1LU  |  |  |  |     |
|  | 2.0 i 16V   | 100  |  | 08.05  | 09.09   | PR: 1LU  |  |  |  |     |
|  | 2.0 TDI   |  |  | 08.05  | 09.09   | PR: 1LU  |  |  |  |     |
|  | 2.0 TDI   | 125  |  | 02.06  | 09.09   | PR: 1LU  |  |  |  |     |
|  | 2.0 TFSI  |  |  | 11.06  | 09.09   | PR: 1LU  |  |  |  |     |
| 2.0 TFSI   | 136   |  | 08.05  | 09.09  | PR: 1LU   |  |  |  |  |     |
| 2.0 TFSI   | 155   |  | 09.05  | 09.09  | PR: 1LU   |  |  |  |  |     |
|  | 1.2 TSI   | 77   |  | 02.10  | 10.12   | PR: 1LB  | 11.9576-9947.2   | 220809   | D=57, - Halter<br>D=57, - Halter<br>Hülzensatz<br>Führungsbolzen               | ATE |
|  | 1.4 i 16V   | 55   |  | 10.09  | 10.12   | PR: 1LB  | 11.9576-9948.2   | 220810   |  | ATE |
|  | 1.4 i 16V   | 63   |  | 10.09  | 10.12   | PR: 1LB  | 11.0101-5409.2   | 260035   |  | ATE |
|  | 1.4 TSI   | 92   |  | 10.09  | 10.12   | PR: 1LB  | 11.8171-0008.1   | 990049   |  | ATE |
|  | 1.6 i   | 75   |  | 10.09  | 10.12   | PR: 1LB  |  |  |  |     |
|  | 1.6 i 16V   | 77   |  | 10.09  | 10.12   | PR: 1LB  |  |  |  |     |
|  | 1.6 LPG   | 75   |  | 12.09  | 10.12   | PR: 1LB  |  |  |  |     |
|  | 1.6 TDI   | 66   |  | 11.10  | 10.12   | PR: 1LB  |  |  |  |     |
|  | 1.6 TDI Ecomotive   | 77   |  | 02.10  | 10.12   | PR: 1LB  |  |  |  |     |
|  | 1.8 T 20V   | 132  |  | 10.09  | 10.12   | PR: 1LB  |  |  |  |     |
|  | 1.8 T 20V   | 165  |  | 10.09  | 10.12   | PR: 1LB  |  |  |  |     |
|  | 1.8 TSI   | 118  |  | 10.09  | 10.12   | PR: 1LB  |  |  |  |     |
|  | 1.9 TDI   |  |  | 10.09  | 10.12   | PR: 1LB  |  |  |  |     |
|  | 1.9 TDI   | 81   |  | 10.09  | 10.12   | PR: 1LB  |  |  |  |     |
|  | 1.9 TDI   | 110  |  | 10.09  | 10.12   | PR: 1LB  |  |  |  |     |
|  | 2.0 FSI   | 110  |  | 10.09  | 10.12   | PR: 1LB  |  |  |  |     |
|  | 2.0 i 16V   | 100  |  | 10.09  | 10.12   | PR: 1LB  |  |  |  |     |
|  | 2.0 TDI   |  |  | 10.09  | 10.12   | PR: 1LB  |  |  |  |     |
| 2.0 TDI  | 125   |  | 10.09  | 10.12  | PR: 1LB   |  |  |  |  |     |
| 2.0 TFSI   |   |  | 10.09  | 10.12  | PR: 1LB   |  |  |  |  |     |
| 2.0 TFSI   | 136   |  | 10.09  | 10.12  | PR: 1LB   |  |  |  |  |     |
| 2.0 TFSI   | 155   |  | 10.09  | 10.12  | PR: 1LB   |  |  |  |  |     |
|  | 1.2 TSI   | 77   |  | 02.10  | 10.12   | PR: 1ZA,1ZB,1ZE,1ZF  | 83.7847-0563.3   | 331124   | L=562  |     |
|  | 1.4 i 16V   | 55   |  | 08.05  | 10.12   | PR: 1ZA,1ZB,1ZE,1ZF  |  |  |  |     |
|  | 1.4 i 16V   | 63   |  | 06.06  | 10.12   | PR: 1ZA,1ZB,1ZE,1ZF  |  |  |  |     |
|  | 1.4 TSI   | 92   |  | 11.07  | 10.12   | PR: 1ZA,1ZB,1ZE,1ZF  |  |  |  |     |
|  | 1.6 i   | 75   |  | 08.05  | 10.12   | PR: 1ZA,1ZB,1ZE,1ZF  |  |  |  |     |
|  | 1.6 i 16V   | 77   |  | 08.05  | 10.12   | PR: 1ZA,1ZB,1ZE,1ZF  |  |  |  |     |
|  | 1.6 LPG   | 75   |  | 12.09  | 10.12   | PR: 1ZA,1ZB,1ZE,1ZF  |  |  |  |     |
|  | 1.6 TDI   | 66   |  | 11.10  | 10.12   | PR: 1ZA,1ZB,1ZE,1ZF  |  |  |  |     |
|  | 1.6 TDI Ecomotive   | 77   |  | 02.10  | 10.12   | PR: 1ZA,1ZB,1ZE,1ZF  |  |  |  |     |
|  | 1.8 T 20V   | 132  |  | 08.05  | 10.12   | PR: 1ZA,1ZB,1ZE,1ZF  |  |  |  |     |
|  | 1.8 T 20V   | 165  |  | 08.05  | 10.12   | PR: 1ZA,1ZB,1ZE,1ZF  |  |  |  |     |
|  | 1.8 TSI   | 118  |  | 06.07  | 10.12   | PR: 1ZA,1ZB,1ZE,1ZF  |  |  |  |     |
|  | 1.9 TDI   |  |  | 08.05  | 10.12   | PR: 1ZA,1ZB,1ZE,1ZF  |  |  |  |     |
|  | 1.9 TDI   | 81   |  | 08.05  | 10.12   | PR: 1ZA,1ZB,1ZE,1ZF  |  |  |  |     |
|  | 1.9 TDI   | 110  |  | 08.05  | 10.12   | PR: 1ZA,1ZB,1ZE,1ZF  |  |  |  |     |
|  | 2.0 FSI   | 110  |  | 08.05  | 10.12   | PR: 1ZA,1ZB,1ZE,1ZF  |  |  |  |     |
|  | 2.0 i 16V   | 100  |  | 08.05  | 10.12   | PR: 1ZA,1ZB,1ZE,1ZF  |  |  |  |     |
|  | 2.0 TDI   |  |  | 08.05  | 10.12   | PR: 1ZA,1ZB,1ZE,1ZF  |  |  |  |     |
| 2.0 TDI  | 125   |  | 02.06  | 10.12  | PR: 1ZA,1ZB,1ZE,1ZF   |  |  |  |  |     |
| 2.0 TFSI   |   |  | 11.06  | 10.12  | PR: 1ZA,1ZB,1ZE,1ZF   |  |  |  |  |     |
| 2.0 TFSI   | 136   |  | 08.05  | 10.12  | PR: 1ZA,1ZB,1ZE,1ZF   |  |  |  |  |     |
| 2.0 TFSI   | 155   |  | 09.05  | 10.12  | PR: 1ZA,1ZB,1ZE,1ZF   |  |  |  |  |     |
|  | 1.2 TSI   | 77   |  | 02.10  | 10.12   | PR: 1LB  | 83.7849-0502.3   | 331125   | L=504  |     |
|  | 1.4 i 16V   | 55   |  | 08.05  | 10.12   | PR: 1LB  |  |  |  |     |
|  | 1.4 i 16V   | 63   |  | 06.06  | 10.12   | PR: 1LB  |  |  |  |     |
|  | 1.4 TSI   | 92   |  | 11.07  | 10.12   | PR: 1LB  |  |  |  |     |
|  | 1.6 i   | 75   |  | 08.05  | 10.12   | PR: 1LB  |  |  |  |     |
|  | 1.6 i 16V   | 77   |  | 08.05  | 10.12   | PR: 1LB  |  |  |  |     |
|  | 1.6 LPG   | 75   |  | 12.09  | 10.12   | PR: 1LB  |  |  |  |     |
|  | 1.6 TDI   | 66   |  | 11.10  | 10.12   | PR: 1LB  |  |  |  |     |
|  | 1.6 TDI Ecomotive   | 77   |  | 02.10  | 10.12   | PR: 1LB  |  |  |  |     |
|  | 1.8 T 20V   | 132  |  | 08.05  | 10.12   | PR: 1LB  |  |  |  |     |
|  | 1.8 T 20V   | 165  |  | 08.05  | 10.12   | PR: 1LB  |  |  |  |     |
|  | 1.8 TSI   | 118  |  | 06.07  | 10.12   | PR: 1LB  |  |  |  |     |
| 1.9 TDI  |   |  | 08.05  | 10.12  | PR: 1LB   |  |  |  |  |     |
| 1.9 TDI  | 81  |  | 08.05  | 10.12  | PR: 1LB   |  |  |  |  |     |
| 1.9 TDI  |   |  | 08.05  | 10.12  | PR: 1LB   |  |  |  |  |     |































**SEAT LEON II (1P1) (05-12)**

|  |   |   |  |  |  |
|--|---|---|--|--|--|
|  | 1.9 TDI 110<br>2.0 FSI 110<br>2.0 i 16V 100<br>2.0 TDI 125<br>2.0 TFSI 136<br>2.0 TFSI 155  | 08.05 10.12 PR: 1LB<br>08.05 10.12 PR: 1LB<br>08.05 10.12 PR: 1LB<br>02.06 10.12 PR: 1LB<br>11.06 10.12 PR: 1LB<br>08.05 10.12 PR: 1LB<br>09.05 10.12 PR: 1LB   | 83.7849-0502.3 331125 2                        |  | L=504                                    |
|  | 1.2 TSI 77<br>1.4 i 16V 55<br>1.4 i 16V 63<br>1.4 TSI 92<br>1.6 i 75<br>1.6 i 16V 77<br>1.6 LPG 75<br>1.6 TDI 66<br>1.6 TDI Ecomotive 77<br>1.8 T 20V 132<br>1.8 T 20V 165<br>1.8 TSI 118<br>1.9 TDI 81<br>1.9 TDI 110<br>2.0 FSI 110<br>2.0 i 16V 100<br>2.0 TDI 125<br>2.0 TFSI 136<br>2.0 TFSI 155 | 02.10 10.12 PR: 1KD<br>08.05 10.12 PR: 1KD<br>06.06 10.12 PR: 1KD<br>11.07 10.12 PR: 1KD<br>08.05 10.12 PR: 1KD<br>08.05 10.12 PR: 1KD<br>12.09 10.12 PR: 1KD<br>11.10 10.12 PR: 1KD<br>02.10 10.12 PR: 1KD<br>08.05 10.12 PR: 1KD<br>08.05 10.12 PR: 1KD<br>06.07 10.12 PR: 1KD<br>08.05 10.12 PR: 1KD<br>08.05 10.12 PR: 1KD<br>08.05 10.12 PR: 1KD<br>08.05 10.12 PR: 1KD<br>08.05 10.12 PR: 1KD<br>02.06 10.12 PR: 1KD<br>11.06 10.12 PR: 1KD<br>08.05 10.12 PR: 1KD<br>09.05 10.12 PR: 1KD | 24.3384-1755.7 220635<br>24.3384-1756.7 220636 | <input type="checkbox"/><br><input type="checkbox"/> | D=38, - Halter LUC<br>D=38, - Halter LUC |
|  | 1.2 TSI 77<br>1.4 i 16V 55<br>1.4 i 16V 63<br>1.4 TSI 92<br>1.6 i 75<br>1.6 i 16V 77<br>1.6 LPG 75<br>1.6 TDI 66<br>1.6 TDI Ecomotive 77<br>1.8 T 20V 132<br>1.8 T 20V 165<br>1.8 TSI 118<br>1.9 TDI 81<br>1.9 TDI 110<br>2.0 FSI 110<br>2.0 i 16V 100<br>2.0 TDI 125<br>2.0 TFSI 136<br>2.0 TFSI 155 | 02.10 10.12 PR: 1KY<br>08.05 10.12 PR: 1KY<br>06.06 10.12 PR: 1KY<br>11.07 10.12 PR: 1KY<br>08.05 10.12 PR: 1KY<br>08.05 10.12 PR: 1KY<br>12.09 10.12 PR: 1KY<br>11.10 10.12 PR: 1KY<br>02.10 10.12 PR: 1KY<br>08.05 10.12 PR: 1KY<br>08.05 10.12 PR: 1KY<br>06.07 10.12 PR: 1KY<br>08.05 10.12 PR: 1KY<br>08.05 10.12 PR: 1KY<br>08.05 10.12 PR: 1KY<br>08.05 10.12 PR: 1KY<br>08.05 10.12 PR: 1KY<br>02.06 10.12 PR: 1KY<br>11.06 10.12 PR: 1KY<br>08.05 10.12 PR: 1KY<br>09.05 10.12 PR: 1KY | 24.3414-1709.7 220631<br>24.3414-1710.7 220632 | <input type="checkbox"/><br><input type="checkbox"/> | D=41, - Halter LUC<br>D=41, - Halter LUC |
|  | 1.2 TSI 77<br>1.4 i 16V 55<br>1.4 i 16V 63<br>1.4 TSI 92<br>1.6 i 75<br>1.6 i 16V 77<br>1.6 LPG 75<br>1.6 TDI 66<br>1.6 TDI Ecomotive 77<br>1.8 T 20V 132<br>1.8 T 20V 165<br>1.8 TSI 118<br>1.9 TDI 81<br>1.9 TDI 110<br>2.0 FSI 110<br>2.0 i 16V 100<br>2.0 TDI 125<br>2.0 TFSI 136<br>2.0 TFSI 155 | 02.10 10.12 PR: 1KZ<br>08.05 10.12 PR: 1KZ<br>06.06 10.12 PR: 1KZ<br>11.07 10.12 PR: 1KZ<br>08.05 10.12 PR: 1KZ<br>08.05 10.12 PR: 1KZ<br>12.09 10.12 PR: 1KZ<br>11.10 10.12 PR: 1KZ<br>02.10 10.12 PR: 1KZ<br>08.05 10.12 PR: 1KZ<br>08.05 10.12 PR: 1KZ<br>06.07 10.12 PR: 1KZ<br>08.05 10.12 PR: 1KZ<br>08.05 10.12 PR: 1KZ<br>08.05 10.12 PR: 1KZ<br>08.05 10.12 PR: 1KZ<br>08.05 10.12 PR: 1KZ<br>02.06 10.12 PR: 1KZ<br>11.06 10.12 PR: 1KZ<br>08.05 10.12 PR: 1KZ<br>09.05 10.12 PR: 1KZ | 24.3387-1717.7 220757<br>24.3387-1718.7 220758 | <input type="checkbox"/><br><input type="checkbox"/> | D=38, - Halter LUC<br>D=38, - Halter LUC |
|  | 1.4 i 16V 55<br>1.4 i 16V 63<br>1.4 TSI 92<br>1.6 i 75<br>1.6 i 16V 77<br>1.8 T 20V 132<br>1.8 T 20V 165<br>1.8 TSI 118<br>1.9 TDI 81<br>1.9 TDI 110<br>2.0 FSI 110<br>2.0 i 16V 100  | 08.05 10.09<br>06.06 10.09<br>11.07 10.09<br>08.05 10.09<br>08.05 10.09<br>08.05 10.09<br>08.05 10.09<br>06.07 10.09<br>08.05 10.09<br>08.05 10.09<br>08.05 10.09<br>08.05 10.09  | 83.7849-0231.3 330872 2                        |  | L=233                                    |



| SEAT LEON II (1P1) (05-12)   |  |  |  |  |   |  |  |  |   |  |               |
|--|--|--|--|--|---|--|--|--|---|--|---------------|
|     |  |  |  |  |  |  |  |  |   |  |               |
|    | 2.0 TDI  | 125  |  | 08.05  | 10.09   | 83.7849-0231.3   | 330872   | 2  |   |  | L=233         |
|  | 2.0 TDI  |  |  | 02.06  | 10.09   |  |  |  |   |  |               |
|  | 2.0 TFSI   |  |  | 11.06  | 10.09   |  |  |  |   |  |               |
|  | 2.0 TFSI   | 136  |  | 08.05  | 10.09   |  |  |  |   |  |               |
|  | 2.0 TFSI   | 155  |  | 09.05  | 10.09   |  |  |  |   |  |               |
|    | 1.2 TSI  | 77   |  | 02.10  | 10.12   | 24.3727-2708.2   | 582708   | 2  | ↓ |  | L=1447        |
|  | 1.4 i 16V  | 55   |  | 08.05  | 10.12   | 24.3727-0195.2   | 580195   | 2  | ↓ |  | L=1447        |
|  | 1.4 i 16V  | 63   |  | 06.06  | 10.12   |  |  |  |   |  |               |
|  | 1.4 TSI  | 92   |  | 11.07  | 10.12   |  |  |  |   |  |               |
|  | 1.6 i  | 75   |  | 08.05  | 10.12   |  |  |  |   |  |               |
|  | 1.6 i 16V  | 77   |  | 08.05  | 10.12   |  |  |  |   |  |               |
|  | 1.6 LPG  | 75   |  | 12.09  | 10.12   |  |  |  |   |  |               |
|  | 1.6 TDI  | 66   |  | 11.10  | 10.12   |  |  |  |   |  |               |
|  | 1.6 TDI Ecomotive  | 77   |  | 02.10  | 10.12   |  |  |  |   |  |               |
|  | 1.8 T 20V  | 132  |  | 08.05  | 10.12   |  |  |  |   |  |               |
|  | 1.8 T 20V  | 165  |  | 08.05  | 10.12   |  |  |  |   |  |               |
|  | 1.8 TSI  | 118  |  | 06.07  | 10.12   |  |  |  |   |  |               |
|  | 1.9 TDI  |  |  | 08.05  | 10.12   |  |  |  |   |  |               |
|  | 1.9 TDI  | 81   |  | 08.05  | 10.12   |  |  |  |   |  |               |
|  | 1.9 TDI  | 110  |  | 08.05  | 10.12   |  |  |  |   |  |               |
|  | 1.9 TDI  | 110  |  | 08.05  | 10.12   |  |  |  |   |  |               |
|  | 2.0 FSI  | 110  |  | 08.05  | 10.12   |  |  |  |   |  |               |
|  | 2.0 i 16V  | 100  |  | 08.05  | 10.12   |  |  |  |   |  |               |
|  | 2.0 TDI  |  |  | 08.05  | 10.12   |  |  |  |   |  |               |
|  | 2.0 TDI  | 125  |  | 02.06  | 10.12   |  |  |  |   |  |               |
|  | 2.0 TFSI   |  |  | 11.06  | 10.12   |  |  |  |   |  |               |
|  | 2.0 TFSI   | 136  |  | 08.05  | 10.12   |  |  |  |   |  |               |
|  | 2.0 TFSI   | 155  |  | 09.05  | 10.12   |  |  |  |   |  |               |
|    | 1.2 TSI  | 77   |  | 02.10  | 10.12   | 24.2415-1711.3   | 030130   |  |   |  | Gz 15,87      |
|  | 1.4 i 16V  | 55   |  | 08.05  | 10.12   |  |  |  |   |  |               |
|  | 1.4 i 16V  | 63   |  | 06.06  | 10.12   |  |  |  |   |  |               |
|  | 1.4 TSI  | 92   |  | 11.07  | 10.12   |  |  |  |   |  |               |
|  | 1.6 i  | 75   |  | 08.05  | 10.12   |  |  |  |   |  |               |
|  | 1.6 i 16V  | 77   |  | 08.05  | 10.12   |  |  |  |   |  |               |
|  | 1.6 LPG  | 75   |  | 12.09  | 10.12   |  |  |  |   |  |               |
|  | 1.6 TDI  | 66   |  | 11.10  | 10.12   |  |  |  |   |  |               |
|  | 1.6 TDI Ecomotive  | 77   |  | 02.10  | 10.12   |  |  |  |   |  |               |
|  | 1.8 T 20V  | 132  |  | 08.05  | 10.12   |  |  |  |   |  |               |
|  | 1.8 T 20V  | 165  |  | 08.05  | 10.12   |  |  |  |   |  |               |
|  | 1.8 TSI  | 118  |  | 06.07  | 10.12   |  |  |  |   |  |               |
|  | 1.9 TDI  |  |  | 08.05  | 10.12   |  |  |  |   |  |               |
|  | 1.9 TDI  | 81   |  | 08.05  | 10.12   |  |  |  |   |  |               |
|  | 1.9 TDI  | 110  |  | 08.05  | 10.12   |  |  |  |   |  |               |
|  | 1.9 TDI  | 110  |  | 08.05  | 10.12   |  |  |  |   |  |               |
|  | 2.0 FSI  | 110  |  | 08.05  | 10.12   |  |  |  |   |  |               |
|  | 2.0 i 16V  | 100  |  | 08.05  | 10.12   |  |  |  |   |  |               |
|  | 2.0 TDI  |  |  | 08.05  | 10.12   |  |  |  |   |  |               |
|  | 2.0 TDI  | 125  |  | 02.06  | 10.12   |  |  |  |   |  |               |
|  | 2.0 TFSI   |  |  | 11.06  | 10.12   |  |  |  |   |  |               |
|  | 2.0 TFSI   | 136  |  | 08.05  | 10.12   |  |  |  |   |  |               |
|  | 2.0 TFSI   | 155  |  | 09.05  | 10.12   |  |  |  |   |  |               |
|  | 1.4 TSI  | 92   |  | 11.07  | 06.11   | 24.2519-1705.3   | 040095   |  |   |  | Nz 19,05      |
|  | 1.6 i  | 75   |  | 08.05  | 10.12   |  |  |  |   |  |               |
|  | 1.6 LPG  | 75   |  | 12.09  | 10.12   |  |  |  |   |  |               |
|  | 1.6 TDI  | 66   |  | 11.10  | 10.12   |  |  |  |   |  |               |
|  | 1.6 TDI Ecomotive  | 77   |  | 02.10  | 10.12   |  |  |  |   |  |               |
|  | 1.8 TSI  | 118  |  | 06.07  | 10.12   |  |  |  |   |  |               |
|  | 1.9 TDI  |  |  | 08.05  | 10.12   |  |  |  |   |  |               |
|  | 1.9 TDI  | 110  |  | 08.05  | 10.12   |  |  |  |   |  |               |
|  | 1.9 TDI  | 110  |  | 08.05  | 10.12   |  |  |  |   |  |               |
|  | 2.0 FSI  | 110  |  | 08.05  | 10.12   |  |  |  |   |  |               |
|  | 2.0 TDI  |  |  | 08.05  | 10.12   |  |  |  |   |  |               |
|  | 2.0 TDI  | 125  |  | 02.06  | 10.12   |  |  |  |   |  |               |
|  | 2.0 TFSI   |  |  | 11.06  | 10.12   |  |  |  |   |  |               |
|  | 2.0 TFSI   | 136  |  | 08.05  | 10.12   |  |  |  |   |  |               |
|  | 2.0 TFSI   | 155  |  | 09.05  | 10.12   |  |  |  |   |  |               |
| SEAT MALAGA (85-92)  |  |  |  |  |   |  |  |  |   |  |               |
|  | 1.2  |  |  | 09.85  | 12.92   | 03.2120-2031.3   | 010106   |  |   |  | Thz 20,64 ATE |
|  | 1.5  |  |  | 09.85  | 12.92   |  |  |  |   |  |               |
|  | 1.5 i  |  |  | 09.87  | 12.92   |  |  |  |   |  |               |
|  | 1.7 D  |  |  | 09.85  | 12.92   |  |  |  |   |  |               |
|  | 1.2  |  |  | 09.85  | 12.92   | 24.5112-0412.3   | 330569   | 2  |   |  | L=410         |
|  | 1.5  |  |  | 09.85  | 12.92   |  |  |  |   |  |               |
|  | 1.5 i  |  |  | 09.87  | 12.92   |  |  |  |   |  |               |
|  | 1.7 D  |  |  | 09.85  | 12.92   |  |  |  |   |  |               |
|  | 1.2  |  |  | 09.85  | 12.92   | 24.5223-0294.3   | 330576   | 2  |   |  | L=294         |
|  | 1.5  |  |  | 09.85  | 12.92   |  |  |  |   |  |               |
|  | 1.5 i  |  |  | 09.87  | 12.92   |  |  |  |   |  |               |
|  | 1.7 D  |  |  | 09.85  | 12.92   |  |  |  |   |  |               |
|  | 1.2  |  |  | 09.85  | 12.92   | 24.3217-1115.3   | 020310   |  |   |  | Rz 17,46 FI   |
|  | 1.5  |  |  | 09.85  | 12.92   |  |  |  |   |  |               |
|  | 1.5 i  |  |  | 09.87  | 12.92   |  |  |  |   |  |               |
|  | 1.7 D  |  |  | 09.85  | 12.92   |  |  |  |   |  |               |
|  | 1.2  |  |  | 09.85  | 12.92   | 24.3727-2701.2   | 582701   | 1  | ↓ |  | L=2275        |
|  | 1.5  |  |  | 09.85  | 12.92   |  |  |  |   |  |               |
|  | 1.5 i  |  |  | 09.87  | 12.92   |  |  |  |   |  |               |
|  | 1.7 D  |  |  | 09.85  | 12.92   |  |  |  |   |  |               |



|     |  |  |  |  |   |  |  |             |
|--|--|--|--|--|--|--|--|---|
| <b>SEAT MARBELLA (87-98)</b>   |  |  |  |  |  |  |  |   |
|    | 0.8<br>0.9   |  |  | 01.87<br>01.87   | 12.92<br>10.98   | 24.3219-0803.3   | 020183   | Rz 19,05  |
|    | 0.8<br>0.9   |  |  | 01.87<br>01.87   | 12.92<br>10.98   | 24.3727-0503.2   | 580503   | 1 ↓<br>L=2670   |
|    | 0.8<br>0.9   |  |  | 01.87<br>01.87   | 12.92<br>10.98   | 24.3728-2703.2   | 592703   | L=561   |
| <b>SEAT Mii (12-)</b>  |  |  |  |  |  |  |  |   |
|    | 1.0<br>1.0<br>1.0 EcoFuel  | 44<br>55<br>50   |  | 05.12<br>05.12<br>11.12  |  | 11.9541-9549.2<br>11.9541-9550.2   | 220575<br>220576   | ☐<br>☐<br>D=54, - Halter<br>D=54, - Halter<br><b>ATE</b><br><b>ATE</b>                        |
|    | 1.0<br>1.0<br>1.0 EcoFuel  | 44<br>55<br>50   |  | 05.12<br>05.12<br>11.12  |  | 24.3217-0908.3   | 020167   | Rz 17,46  |
| <b>SEAT TERRA (87-96)</b>  |  |  |  |  |  |  |  |   |
|    | 0.9<br>1.3 D<br>1.4 D  |  |  | 09.87<br>03.90<br>09.87  | 08.90<br>08.90<br>08.90  | 24.3222-1718.3   | 020440   | Rz 22,00<br><b>BDX</b>  |
|    | 0.9<br>1.3 D<br>1.4 D  |  |  | 09.90<br>09.90<br>09.90  | 12.96<br>12.96<br>12.96  | 24.3219-0803.3   | 020183   | Rz 19,05  |
|    | 0.9<br>1.3 D<br>1.4 D  |  |  | 03.87<br>03.90<br>01.90  | 12.96<br>12.96<br>12.96  | 24.3727-2705.2   | 582705   | 1 ↓<br>L=3170   |
| <b>SEAT TOLEDO I (1L) (91-98)</b>  |  |  |  |  |  |  |  |   |
|    | 1.6 i  |  | 1L-ZD101450  | 09.91  |  | 03.2120-2031.3<br>03.3517-0101.2   | 010106<br>390322   | THz 20,64<br>Verschlusschraube<br><b>ATE</b>  |
|    | 1.6 i<br>1.8 i<br>1.9 D<br>1.9 TD  |  | 1L-ZD101451<br>1L-ZD315000<br>1L-ZD315000<br>1L-ZD315000                         | 09.91<br>09.91<br>09.91  | - ABS<br>- ABS   | 03.2120-3943.3<br>03.3517-0101.2   | 010532<br>390322   | THz 20,64<br>Verschlusschraube<br><b>ATE</b>  |
|   | 1.6 i<br>1.8 i<br>1.9 D<br>1.9 TD<br>1.9 TDI                                     | 55   | 1L-ZD315001<br>1L-ZD315001<br>1L-ZD315001<br>1L-ZD315001                         | 09.98<br>09.98<br>09.98<br>04.95   | - ABS<br>- ABS<br>- ABS  | 03.2122-1042.3<br>03.3517-0101.2   | 010137<br>390322   | THz 22,20<br>Verschlusschraube<br><b>ATE</b>  |
|  | 1.8 i<br>1.9 TD  | 55   |  | 09.91<br>09.91   | + ABS<br>+ ABS   | 10.6122-0144.3   | 010638   | THz 22,20<br><b>ATE</b>   |
|  | 1.8 i 16V<br>1.9 TDI<br>2.0 i<br>2.0 i 16V                                       | 85<br>110  |  | 09.91<br>04.95<br>09.91<br>03.94   | 03.94<br>+ ABS<br>09.98<br>09.98   | 10.6123-0674.3   | 010639   | THz 23,81<br><b>ATE</b>   |
|  | 1.6 i<br>1.8 i<br>1.9 D<br>1.9 TD  | 55   |  | 09.91<br>09.91<br>09.91<br>09.91   | 08.96<br>08.96<br>08.96<br>08.96   | 11.0441-4808.2<br>11.0101-4801.2<br>24.0102-4801.2                                 | 250022<br>260006<br>260085   | Dichtungssatz<br>Hülsensatz<br>Hülsensatz+Schrauben<br><b>ATE</b><br><b>ATE</b><br><b>ATE</b> |
|  | 1.8 i 16V<br>1.9 TDI<br>2.0 i<br>2.0 i 16V                                       | 85<br>110  |  | 09.91<br>04.95<br>09.91  | 03.94<br>08.96<br>08.96  | 24.3541-1609.5<br>24.3541-1610.5<br>11.0101-5403.2                                 | 240039<br>240040<br>260010   | D=54, - Halter<br>D=54, - Halter<br>Faltenbalgsatz<br><b>LUC</b><br><b>LUC</b><br><b>LUC</b>  |
|  | 1.6 i<br>1.8 i<br>1.9 D<br>1.9 TD<br>1.9 TDI<br>2.0 i<br>2.0 i 16V               | 55<br>85<br>110  |  | 09.96<br>09.96<br>09.96<br>09.96<br>09.96<br>09.96                               | 09.98 PR: 1LG,1LK,1LM<br>09.98 PR: 1LG,1LK,1LM<br>09.98 PR: 1LG,1LK,1LM<br>09.98 PR: 1LG,1LK,1LM<br>09.98 PR: 1LG,1LK,1LM<br>09.98 PR: 1LG,1LK,1LM | 11.0441-4808.2<br>11.0101-4801.2<br>24.0102-4801.2                                 | 250022<br>260006<br>260085   | Dichtungssatz<br>Hülsensatz<br>Hülsensatz+Schrauben<br><b>ATE</b><br><b>ATE</b><br><b>ATE</b> |
|  | 1.6 i<br>1.8 i<br>1.9 D<br>1.9 TD<br>1.9 TDI<br>2.0 i<br>2.0 i 16V               | 55<br>85<br>110  |  | 09.96<br>09.96<br>09.96<br>09.96<br>09.96  | 09.98 PR: 1LD,1LV<br>09.98 PR: 1LD,1LV<br>09.98 PR: 1LD,1LV<br>09.98 PR: 1LD,1LV<br>09.98 PR: 1LD,1LV  | 24.3541-1731.5<br>24.3541-1732.5<br>11.0101-5403.2                                 | 240061<br>240062<br>260010   | D=54, - Halter<br>D=54, - Halter<br>Faltenbalgsatz<br><b>LUC</b><br><b>LUC</b><br><b>LUC</b>  |
|  | 1.6 i<br>1.8 i<br>1.9 D<br>1.9 TD<br>1.9 TDI<br>2.0 i<br>2.0 i 16V               | 55<br>85<br>110  |  | 09.96<br>09.96<br>09.96<br>09.96<br>09.96  | 09.98 PR: 1LY,1ZK<br>09.98 PR: 1LY,1ZK<br>09.98 PR: 1LY,1ZK<br>09.98 PR: 1LY,1ZK<br>09.98 PR: 1LY,1ZK  | 24.3541-1609.5<br>24.3541-1610.5<br>11.0101-5403.2                                 | 240039<br>240040<br>260010   | D=54, - Halter<br>D=54, - Halter<br>Faltenbalgsatz<br><b>LUC</b><br><b>LUC</b><br><b>LUC</b>  |
|  | 1.6 i<br>1.8 i<br>1.9 D<br>1.9 TD<br>1.9 TDI                                     | 55   | 1L-ZD342000<br>1L-ZD342000<br>1L-ZD342000<br>1L-ZD342000<br>1L-ZD342000          | 09.91<br>09.91<br>09.91<br>09.91<br>04.95  |  | 83.7775-0312.3   | 330795   | 2<br>L=310  |
|  | 1.8 i 16V  |  | 1L-ZD342000  | 09.91  |  | 83.6225-0287.3   | 330735   | 2<br>L=285  |

| SEAT TOLEDO I (1L) (91-98)   |             |           |             |             |       |                |                |        |  |                |                |
|------------------------------|-------------|-----------|-------------|-------------|-------|----------------|----------------|--------|--|----------------|----------------|
|                              | 2.0 i       | 85        | 1L-ZD342000 | 09.91       |       | 83.6225-0287.3 | 330735         | 2      |  | L=285          |                |
|                              | 2.0 i 16V   | 110       | 1L-ZD342000 | 03.94       |       |                |                |        |  |                |                |
|                              | 1.6 i       |           | 1L-ZD342001 | 09.98       |       | 83.6113-0321.3 | 330621         | 2      |  | L=320          |                |
|                              | 1.8 i       |           | 1L-ZD342001 | 09.98       |       |                |                |        |  |                |                |
|                              | 1.8 i 16V   |           | 1L-ZD342001 | 03.94       |       |                |                |        |  |                |                |
|                              | 1.9 D       |           | 1L-ZD342001 | 09.98       |       |                |                |        |  |                |                |
|                              | 1.9 TD      | 55        | 1L-ZD342001 | 09.98       |       |                |                |        |  |                |                |
|                              | 1.9 TDI     |           | 1L-ZD342001 | 09.98       |       |                |                |        |  |                |                |
|                              | 2.0 i       | 85        | 1L-ZD342001 | 09.98       |       |                |                |        |  |                |                |
|                              | 2.0 i 16V   | 110       | 1L-ZD342001 | 09.98       |       |                |                |        |  |                |                |
|                              |             | 1.8 i 16V |             |             | 09.91 | 03.94          | 24.3384-1603.5 | 240015 |  |                | D=38, - Halter |
|                              |             | 2.0 i     | 85          | 1L-ZD328000 | 09.91 |                | 24.3384-1604.5 | 240016 |  |                | D=38, - Halter |
|                              |             |           |             |             |       | 24.0101-3601.2 | 260044         |        |  | Einbausatz     |                |
| 1.9 TDI                      |             |           |             | 04.95       | 08.96 | 24.3384-1707.5 | 240171         |        |  | D=38, - Halter |                |
| 2.0 i                        |             | 85        | 1L-ZD328001 | 08.96       |       | 24.3384-1708.5 | 240172         |        |  | D=38, - Halter |                |
| 2.0 i 16V                    |             | 110       |             | 03.94       | 08.96 | 24.0101-3601.2 | 260044         |        |  | Einbausatz     |                |
|                              |             |           |             |             |       | 11.0101-5403.2 | 260010         |        |  | Faltenbalgsatz |                |
| 1.6 i                        |             |           |             | 09.96       | 09.98 | 24.3384-1707.5 | 240171         |        |  | D=38, - Halter |                |
| 1.8 i                        |             |           |             | 09.96       | 09.98 | 24.3384-1708.5 | 240172         |        |  | D=38, - Halter |                |
| 1.9 D                        |             |           |             | 09.96       | 09.98 | 24.0101-3601.2 | 260044         |        |  | Einbausatz     |                |
| 1.9 TD                       | 55          |           | 09.96       | 09.98       |       |                |                |        |  |                |                |
| 1.9 TDI                      |             |           | 09.96       | 09.98       |       |                |                |        |  |                |                |
| 2.0 i                        | 85          |           | 09.96       | 09.98       |       |                |                |        |  |                |                |
| 2.0 i 16V                    | 110         |           | 09.96       | 09.98       |       |                |                |        |  |                |                |
|                              | 1.6 i       |           |             | 09.91       | 09.98 | 83.7804-0160.3 | 330811         | 2      |  | L=160          |                |
|                              | 1.8 i       |           |             | 09.91       | 09.98 |                |                |        |  |                |                |
|                              | 1.9 D       |           |             | 09.91       | 09.98 |                |                |        |  |                |                |
|                              | 1.9 TD      | 55        |             | 09.91       | 09.98 |                |                |        |  |                |                |
|                              | 1.9 TDI     |           |             | 04.95       | 09.98 |                |                |        |  |                |                |
|                              | 1.8 i 16V   |           |             | 09.91       | 03.94 | 83.7704-0160.3 | 330805         | 2      |  | L=160          |                |
|                              | 2.0 i       | 85        |             | 09.91       | 09.98 |                |                |        |  |                |                |
|                              | 2.0 i 16V   | 110       |             | 03.94       | 09.98 |                |                |        |  |                |                |
|                              |             | 1.6 i     |             |             | 09.91 | 09.98          | 03.3217-2112.3 | 020027 |  |                | + GG 1)        |
|                              |             | 1.8 i     |             |             | 09.91 | 09.98          | 24.3217-0908.3 | 020167 |  |                | + ALU 2)       |
| 1.9 D                        |             |           |             | 09.91       | 09.98 |                |                |        |  |                |                |
| 1.9 TD                       |             | 55        |             | 09.91       | 09.98 |                |                |        |  |                |                |
| 1.9 TDI                      |             |           |             | 04.95       | 09.98 |                |                |        |  |                |                |
|                              | 1.6 i       |           |             | 09.91       | 09.98 | 24.3727-0132.2 | 580132         | 2      |  | L=1527         |                |
|                              | 1.8 i       |           |             | 09.91       | 09.98 |                |                |        |  |                |                |
|                              | 1.9 D       |           |             | 09.91       | 09.98 |                |                |        |  |                |                |
|                              | 1.9 TD      | 55        |             | 09.91       | 09.98 |                |                |        |  |                |                |
|                              | 1.9 TDI     |           |             | 04.95       | 09.98 |                |                |        |  |                |                |
|                              | 1.8 i 16V   |           |             | 09.91       | 03.94 | 24.3727-0133.2 | 580133         | 2      |  | L=1622         |                |
|                              | 2.0 i       | 85        |             | 09.91       | 09.98 |                |                |        |  |                |                |
|                              | 2.0 i 16V   | 110       |             | 03.94       | 09.98 |                |                |        |  |                |                |
|                              |             | 1.6 i     |             |             | 09.91 | 09.98          | 03.6584-0015.3 | 320109 |  |                | BRL 8/4 (4)    |
| 1.8 i                        |             |           |             | 09.91       | 09.98 |                |                |        |  |                |                |
| 1.8 i 16V                    |             |           |             | 09.91       | 03.94 |                |                |        |  |                |                |
| 1.9 D                        |             |           |             | 09.91       | 09.98 |                |                |        |  |                |                |
| 1.9 TD                       |             | 55        |             | 09.91       | 09.98 |                |                |        |  |                |                |
| 1.9 TDI                      |             |           |             | 04.95       | 09.98 |                |                |        |  |                |                |
| 2.0 i                        | 85          |           | 09.91       | 09.98       |       |                |                |        |  |                |                |
|                              | 2.0 i 16V   | 110       |             | 03.94       | 09.98 | 03.6584-0113.3 | 320111         |        |  | BRL 8/4 (4)    |                |
|                              |             | 1.9 TDI   |             |             | 04.95 | 09.98          | 03.2419-1206.3 | 030074 |  |                | Gz 19,05       |
| 2.0 i 16V                    |             | 110       |             | 03.94       | 09.98 |                |                |        |  |                |                |
|                              | 1.9 TDI     |           |             | 04.95       | 09.98 | 24.2523-0908.3 | 040049         |        |  | Nz 23,81       |                |
|                              | 2.0 i 16V   | 110       |             | 03.94       | 09.98 |                |                |        |  |                |                |
|                              | 1.6 i       | ‡         |             | 09.91       | 09.98 | 24.3728-0121.2 | 590121         |        |  | L=800, + AUT   |                |
|                              | 1.8 i       | ‡         |             | 09.91       | 09.98 |                |                |        |  |                |                |
|                              | 1.8 i 16V   | ‡         |             | 09.91       | 03.94 |                |                |        |  |                |                |
|                              | 1.9 D       | ‡         |             | 09.91       | 09.98 |                |                |        |  |                |                |
|                              | 1.9 TD      | ‡ 55      |             | 09.91       | 09.98 |                |                |        |  |                |                |
|                              | 1.9 TDI     | ‡         |             | 04.95       | 09.98 |                |                |        |  |                |                |
|                              | 2.0 i       | ‡ 85      |             | 09.91       | 09.98 |                |                |        |  |                |                |
|                              | 2.0 i 16V   | ‡ 110     |             | 03.94       | 09.98 |                |                |        |  |                |                |
| SEAT TOLEDO II (1M2) (98-04) |             |           |             |             |       |                |                |        |  |                |                |
|                              | 1.4 i 16V   | ‡ 55      | 1M-1B018341 | 07.99       | + ESP | 03.7863-0402.4 | 300124         |        |  | 10"            |                |
|                              | 1.6 i       | ‡         | 1M-1B018341 | 10.98       | + ESP |                |                |        |  |                |                |
|                              | 1.8 4x4     | ‡         | 1M-1B018341 | 05.01       | + ESP |                |                |        |  |                |                |
|                              | 1.8 i 20V   | ‡         | 1M-1B018341 | 10.98       | + ESP |                |                |        |  |                |                |
|                              | 1.8 i 20V T | ‡ 132     | 1M-1B018341 | 05.01       | + ESP |                |                |        |  |                |                |
|                              | 1.9 SDI     | ‡ 50      | 1M-1B018341 | 11.99       | + ESP |                |                |        |  |                |                |
|                              | 1.9 TDI     | ‡ 66      | 1M-1B018341 | 10.98       | + ESP |                |                |        |  |                |                |
|                              | 1.9 TDI     | ‡ 81      | 1M-1B018341 | 10.98       | + ESP |                |                |        |  |                |                |
|                              | 1.9 TDI     | ‡ 96      | 1M-1B018341 | 05.03       | + ESP |                |                |        |  |                |                |
|                              | 1.9 TDI     | ‡ 110     | 1M-1B018341 | 10.00       | + ESP |                |                |        |  |                |                |
|                              | 2.3 i V5    | ‡         | 1M-1B018341 | 10.98       | + ESP |                |                |        |  |                |                |
|                              | 2.8         | ‡ 150     | 1M-1B018341 | 10.00       | + ESP |                |                |        |  |                |                |
|                              | 2.8 4x4     | ‡ 150     | 1M-1B018341 | 05.02       | + ESP |                |                |        |  |                |                |
|                              | 1.4 i 16V   | ‡ 55      | 1M-1B018342 |             | 09.04 | + ESP          | 03.7860-0602.4 | 300141 |  |                | 10"            |
|                              | 1.6 i       | ‡         | 1M-1B018342 |             | 09.04 | + ESP          |                |        |  |                |                |
|                              | 1.8 4x4     | ‡         | 1M-1B018342 |             | 09.04 | + ESP          |                |        |  |                |                |

1) + cast iron / + ghisa / + fonte grise / + fundición de gris



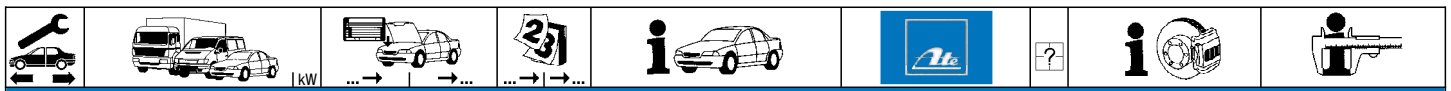









2) + aluminium / + alluminio / + aluminium / + aluminio













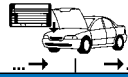







**SEAT TOLEDO II (1M2) (98-04)**

|  |  |  |  |   |  |  |  |  |   |
|--|--|--|--|---|--|--|--|--|---|
|  | 1.8 i 20V<br>1.8 i 20VT<br>1.9 SDI<br>1.9 TDI<br>1.9 TDI<br>1.9 TDI<br>1.9 TDI<br>2.3 i V5<br>2.8<br>2.8 4x4                       | 1M-1B018342<br>132 1M-1B018342<br>50 1M-1B018342<br>66 1M-1B018342<br>81 1M-1B018342<br>96 1M-1B018342<br>110 1M-1B018342<br>1M-1B018342<br>150 1M-1B018342<br>150 1M-1B018342 |  | 09.04 + ESP<br>09.04 + ESP<br>09.04 + ESP<br>09.04 + ESP<br>09.04 + ESP<br>09.04 + ESP<br>09.04 + ESP<br>09.04 + ESP<br>09.04 + ESP   | 03.7860-0602.4   | 300141   |  | 10"  | ATE   |
|  | 1.4 i 16V<br>1.6 i<br>1.8 i 20V<br>1.9 SDI<br>1.9 TDI<br>1.9 TDI<br>1.9 TDI<br>1.9 TDI<br>2.3 i V5                                 | 55<br><br>50<br>66<br>81<br>96<br>110  |  | 07.99 09.04 - ESP<br>10.98 09.04 - ESP<br>10.98 09.04 - ESP<br>11.99 09.04 - ESP<br>10.98 09.04 - ESP<br>10.98 09.04 - ESP<br>05.03 09.04 - ESP<br>10.00 09.04 - ESP<br>10.98 09.04 - ESP   | 24.2123-1709.3   | 010503   |  | Thz 23,81  |   |
|  | 1.4 i 16V<br>1.6 i<br>1.8 i 20V<br>1.9 SDI<br>1.9 TDI<br>1.9 TDI<br>1.9 TDI<br>2.3 i V5  | 55<br><br>50<br>66<br>81   |  | 07.99 08.00 + ESP<br>10.98 08.00 + ESP<br>10.98 08.00 + ESP<br>11.99 08.00 + ESP<br>10.98 08.00 + ESP<br>10.98 08.00 + ESP<br>10.98 08.00 + ESP   | 03.2123-2024.3   | 010597   |  | Thz 23,81  | ATE   |
|  | 1.4 i 16V<br>1.6 i<br>1.8 4x4<br>1.8 i 20V<br>1.8 i 20VT<br>1.9 SDI<br>1.9 TDI<br>1.9 TDI<br>1.9 TDI<br>2.3 i V5<br>2.8<br>2.8 4x4 | 55<br><br>50<br>66<br>81<br>96<br>110<br>132<br>50<br>66<br>81<br>96<br>110<br>150<br>150  |  | 09.00 09.04 + ESP<br>09.00 09.04 + ESP<br>05.01 09.04 + ESP<br>09.00 09.04 + ESP<br>05.01 09.04 + ESP<br>09.00 09.04 + ESP<br>09.00 09.04 + ESP<br>09.00 09.04 + ESP<br>05.03 09.04 + ESP<br>10.00 09.04 + ESP<br>09.00 09.04 + ESP<br>10.00 09.04 + ESP<br>05.02 09.04 + ESP   | 03.2123-2715.3   | 010802   |  | Thz 23,81  | ATE   |
|  | 1.4 i 16V<br>1.6 i<br>1.8 i 20V<br>1.9 SDI<br>1.9 TDI<br>1.9 TDI<br>2.3 i V5   | 55<br><br>50<br>66<br>81   |  | 07.99 08.00 + ESP<br>10.98 08.00 + ESP<br>10.98 08.00 + ESP<br>11.99 08.00 + ESP<br>10.98 08.00 + ESP<br>10.98 08.00 + ESP  | 03.2123-2064.3   | 010598   |  | Thz 23,81  | ATE   |
|  | 1.4 i 16V<br>1.6 i<br>1.8 4x4<br>1.8 i 20V<br>1.8 i 20VT<br>1.9 SDI<br>1.9 TDI<br>1.9 TDI<br>1.9 TDI<br>2.3 i V5<br>2.8<br>2.8 4x4 | 55<br><br>50<br>66<br>81<br>96<br>110<br>132<br>50<br>66<br>81<br>96<br>110<br>150<br>150  |  | 09.00 09.04 + ESP<br>09.00 09.04 + ESP<br>05.01 09.04 + ESP<br>09.00 09.04 + ESP<br>05.01 09.04 + ESP<br>11.99 09.04 + ESP<br>09.00 09.04 + ESP<br>09.00 09.04 + ESP<br>09.00 09.04 + ESP<br>05.03 09.04 + ESP<br>10.00 09.04 + ESP<br>09.00 09.04 + ESP<br>10.00 09.04 + ESP<br>05.02 09.04 + ESP  | 03.2123-2774.3   | 010803   |  | Thz 23,81  | ATE   |
|  | 1.4 i 16V<br>1.6 i<br>1.8 4x4<br>1.8 i 20V<br>1.8 i 20VT<br>1.9 SDI<br>1.9 TDI<br>1.9 TDI<br>1.9 TDI<br>2.3 i V5<br>2.8<br>2.8 4x4 | 55<br><br>132<br>50<br>66<br>81<br>96<br>110<br>150<br>150   |  | 07.99 09.04 PR: 1LQ,1LR,1LS<br>10.98 09.04 PR: 1LQ,1LR,1LS<br>05.01 09.04 PR: 1LQ,1LR,1LS<br>10.98 09.04 PR: 1LQ,1LR,1LS<br>05.01 09.04 PR: 1LQ,1LR,1LS<br>11.99 09.04 PR: 1LQ,1LR,1LS<br>10.98 09.04 PR: 1LQ,1LR,1LS<br>10.98 09.04 PR: 1LQ,1LR,1LS<br>05.03 09.04 PR: 1LQ,1LR,1LS<br>10.00 09.04 PR: 1LQ,1LR,1LS<br>10.98 09.04 PR: 1LQ,1LR,1LS<br>10.00 09.04 PR: 1LQ,1LR,1LS<br>05.02 09.04 PR: 1LQ,1LR,1LS   | 11.9541-9549.2<br>11.9541-9550.2<br>11.0101-5409.2   | 220575<br>220576<br>260035   | <input type="checkbox"/><br><input type="checkbox"/>   | D=54, - Halter<br>D=54, - Halter<br>Hülsensatz   | ATE<br>ATE<br>ATE   |
|  | 1.4 i 16V<br>1.6 i<br>1.8 4x4<br>1.8 i 20V<br>1.8 i 20VT<br>1.9 SDI<br>1.9 TDI<br>1.9 TDI<br>1.9 TDI<br>2.3 i V5<br>2.8<br>2.8 4x4 | 55<br><br>132<br>50<br>66<br>81<br>96<br>110<br>150<br>150   |  | 07.99 09.04 PR: 1LN,1LE,1ZE,1ZH<br>10.98 09.04 PR: 1LN,1LE,1ZE,1ZH<br>05.01 09.04 PR: 1LN,1LE,1ZE,1ZH<br>10.98 09.04 PR: 1LN,1LE,1ZE,1ZH<br>05.01 09.04 PR: 1LN,1LE,1ZE,1ZH<br>11.99 09.04 PR: 1LN,1LE,1ZE,1ZH<br>04.99 09.04 PR: 1LN,1LE,1ZE,1ZH<br>10.98 09.04 PR: 1LN,1LE,1ZE,1ZH<br>05.03 09.04 PR: 1LN,1LE,1ZE,1ZH<br>10.00 09.04 PR: 1LN,1LE,1ZE,1ZH<br>10.98 09.04 PR: 1LN,1LE,1ZE,1ZH<br>10.00 09.04 PR: 1LN,1LE,1ZE,1ZH<br>05.02 09.04 PR: 1LN,1LE,1ZE,1ZH | 11.3541-8523.2<br>11.3541-8524.2<br>24.3541-8523.5<br>24.3541-8524.5<br>11.8170-0306.1<br>11.0441-5409.2<br>11.0101-5409.2<br>11.8171-0008.1<br>11.8116-0143.1 | 220115<br>220116<br>240551<br>240552<br>260102<br>250031<br>260035<br>990049<br>390513 | <input type="checkbox"/><br><input type="checkbox"/><br><input type="checkbox"/><br><input type="checkbox"/><br>2<br>2 | D=54, - Halter<br>D=54, - Halter<br>D=54, - Halter<br>D=54, - Halter<br>Halter<br>Dichtungssatz<br>Hülsensatz<br>Führungsbolzen<br>Halterfeder | ATE<br>ATE<br>ATE<br>ATE<br>ATE<br>ATE<br>ATE<br>ATE<br>ATE |



|     |   |  |    |    |   |    |  |                                       |
|--|---|--|--|--|--|--|--|---|
| <b>SEAT TOLEDO II (1M2) (98-04)</b>  |   |  |  |  |  |  |  |   |
|    | 1.6 i<br>1.8 4x4<br>1.8 i 20V<br>1.8 i 20VT<br>1.9 SDI<br>1.9 TDI<br>1.9 TDI<br>1.9 TDI<br>1.9 TDI<br>2.3 i V5<br>2.8<br>2.8 4x4              | 132<br>50<br>66<br>81<br>96<br>110<br>150<br>150                                 |  | 10.98 09.04 PR: 1LJ,1ZQ<br>05.01 09.04 PR: 1LJ,1ZQ<br>10.98 09.04 PR: 1LJ,1ZQ<br>05.01 09.04 PR: 1LJ,1ZQ<br>11.99 09.04 PR: 1LJ,1ZQ<br>04.99 09.04 PR: 1LJ,1ZQ<br>10.98 09.04 PR: 1LJ,1ZQ<br>05.03 09.04 PR: 1LJ,1ZQ<br>10.00 09.04 PR: 1LJ,1ZQ<br>10.98 09.04 PR: 1LJ,1ZQ<br>10.00 09.04 PR: 1LJ,1ZQ<br>05.02 09.04 PR: 1LJ,1ZQ |  | 11.9541-9595.2 220501<br>11.9541-9596.2 220502<br>11.0441-5409.2 250031<br>11.0101-5409.2 260035<br>11.8171-0008.1 990049<br>11.8116-0143.1 390513 | 2  | D=54, - Halter ATE<br>D=54, - Halter ATE<br>Dichtungssatz ATE<br>Hülzensatz ATE<br>Führungsbolzen ATE<br>Haltefeder ATE |
|    | 1.4 i 16V<br>1.6 i<br>1.8 4x4<br>1.8 i 20V<br>1.8 i 20VT<br>1.9 SDI<br>1.9 TDI<br>1.9 TDI<br>1.9 TDI<br>1.9 TDI<br>2.3 i V5<br>2.8<br>2.8 4x4 | 55<br>132<br>50<br>66<br>81<br>96<br>110<br>150<br>150                           |  | 07.99 09.04<br>10.98 09.04<br>05.01 09.04<br>10.98 09.04<br>05.01 09.04<br>11.99 09.04<br>10.98 09.04<br>10.98 09.04<br>05.03 09.04<br>10.00 09.04<br>10.98 09.04<br>10.00 09.04<br>05.02 09.04  |  | 83.7838-0435.3 330834  | 2  | L=435   |
|    | 1.4 i 16V<br>1.6 i<br>1.8 4x4<br>1.8 i 20V<br>1.8 i 20VT<br>1.9 SDI<br>1.9 TDI<br>1.9 TDI<br>1.9 TDI<br>1.9 TDI<br>2.3 i V5<br>2.8<br>2.8 4x4 | 55<br>132<br>50<br>66<br>81<br>96<br>110<br>150<br>150                           | 1M-Y-006 500<br>1M-Y-006 500<br>1M-Y-006 500<br>1M-Y-006 500<br>1M-Y-006 500<br>1M-Y-006 500<br>1M-Y-006 500<br>1M-Y-006 500<br>1M-Y-006 500<br>1M-Y-006 500<br>1M-Y-006 500<br>1M-Y-006 500<br>1M-Y-006 500 | 07.99<br>10.98<br>05.01<br>10.98<br>11.99<br>10.98<br>10.98<br>05.03<br>10.00<br>10.98<br>10.00<br>05.02   | PR: 1KP<br>PR: 1KP<br>PR: 1KP<br>PR: 1KP<br>PR: 1KP<br>PR: 1KP<br>PR: 1KP<br>PR: 1KP<br>PR: 1KP<br>PR: 1KP<br>PR: 1KP<br>PR: 1KP   | 24.3384-1723.7 220523<br>24.3384-1724.7 220524<br>24.3414-1703.7 220535<br>24.3414-1704.7 220536   | 2  | D=38(M12x1), - Halter LUC<br>D=38(M12x1), - Halter LUC<br>D=41, - Halter LUC<br>D=41, - Halter LUC                      |
|  | 1.4 i 16V<br>1.6 i<br>1.8 4x4<br>1.8 i 20V<br>1.8 i 20VT<br>1.9 SDI<br>1.9 TDI<br>1.9 TDI<br>1.9 TDI<br>1.9 TDI<br>2.3 i V5<br>2.8<br>2.8 4x4 | 55<br>132<br>50<br>66<br>81<br>96<br>110<br>150<br>150                           | 1M-Y-006 501<br>1M-Y-006 501<br>1M-Y-006 501<br>1M-Y-006 501<br>1M-Y-006 501<br>1M-Y-006 501<br>1M-Y-006 501<br>1M-Y-006 501<br>1M-Y-006 501<br>1M-Y-006 501<br>1M-Y-006 501<br>1M-Y-006 501<br>1M-Y-006 501 | 09.04<br>09.04<br>09.04<br>09.04<br>09.04<br>09.04<br>09.04<br>09.04<br>09.04<br>09.04<br>09.04<br>09.04<br>09.04  | PR: 1KP<br>PR: 1KP<br>PR: 1KP<br>PR: 1KP<br>PR: 1KP<br>PR: 1KP<br>PR: 1KP<br>PR: 1KP<br>PR: 1KP<br>PR: 1KP<br>PR: 1KP<br>PR: 1KP   | 24.3414-1705.7 220549<br>24.3414-1706.7 220550   | 2  | D=41, - Halter LUC<br>D=41, - Halter LUC  |
|  | 1.4 i 16V<br>1.6 i<br>1.8 4x4<br>1.8 i 20V<br>1.8 i 20VT<br>1.9 SDI<br>1.9 TDI<br>1.9 TDI<br>1.9 TDI<br>1.9 TDI<br>2.3 i V5<br>2.8<br>2.8 4x4 | 55<br>132<br>50<br>66<br>81<br>96<br>110<br>150<br>150                           | 1M-Y-006 501<br>1M-Y-006 501<br>1M-Y-006 501<br>1M-Y-006 501<br>1M-Y-006 501<br>1M-Y-006 501<br>1M-Y-006 501<br>1M-Y-006 501<br>1M-Y-006 501<br>1M-Y-006 501<br>1M-Y-006 501<br>1M-Y-006 501<br>1M-Y-006 501 | 09.04<br>09.04<br>09.04<br>09.04<br>09.04<br>09.04<br>09.04<br>09.04<br>09.04<br>09.04<br>09.04<br>09.04<br>09.04  | PR: 1KK,1KQ<br>PR: 1KK,1KQ<br>PR: 1KK,1KQ<br>PR: 1KK,1KQ<br>PR: 1KK,1KQ<br>PR: 1KK,1KQ<br>PR: 1KK,1KQ<br>PR: 1KK,1KQ<br>PR: 1KK,1KQ<br>PR: 1KK,1KQ<br>PR: 1KK,1KQ<br>PR: 1KK,1KQ | 24.3384-1729.7 220541<br>24.3384-1730.7 220542   | 2  | D=38(M12x1), - Halter LUC<br>D=38(M12x1), - Halter LUC  |
|  | 1.4 i 16V<br>1.6 i<br>1.8 4x4<br>1.8 i 20V<br>1.8 i 20VT<br>1.9 SDI<br>1.9 TDI<br>1.9 TDI<br>1.9 TDI<br>1.9 TDI<br>2.3 i V5<br>2.8<br>2.8 4x4 | 55<br>132<br>50<br>66<br>81<br>96<br>110<br>150<br>150                           |  | 07.99 09.04<br>10.98 09.04<br>05.01 09.04<br>10.98 09.04<br>05.01 09.04<br>11.99 09.04<br>04.99 09.04<br>10.98 09.04<br>05.03 09.04<br>10.00 09.04<br>10.98 09.04<br>10.00 09.04<br>05.02 09.04  | PR: 1KY,2EE<br>PR: 1KY,2EE<br>PR: 1KY,2EE<br>PR: 1KY,2EE<br>PR: 1KY,2EE<br>PR: 1KY,2EE<br>PR: 1KY,2EE<br>PR: 1KY,2EE<br>PR: 1KY,2EE<br>PR: 1KY,2EE<br>PR: 1KY,2EE<br>PR: 1KY,2EE | 24.3384-1745.7 220609<br>24.3384-1746.7 220610   | 2  | D=38, - Halter LUC<br>D=38, - Halter LUC  |
|  | 1.4 i 16V<br>1.6 i<br>1.8 i 20V<br>1.8 i 20VT<br>1.9 SDI<br>1.9 TDI<br>1.9 TDI<br>1.9 TDI   | 55<br>132<br>50<br>66<br>81<br>96  |  | 07.99 09.04<br>10.98 09.04<br>10.98 09.04<br>05.01 09.04<br>11.99 09.04<br>10.98 09.04<br>10.98 09.04<br>05.03 09.04   |  | 83.7858-0140.3 330837  | 2  | L=140   |

|     |    |  |  |  |  |  |  |  |                        |
|--|--|--|--|--|---|--|--|--|------------------------|
| <b>SEAT TOLEDO II (1M2) (98-04)</b>  |  |  |  |  |   |  |  |  |                        |
|    | 1.9 TDI  | 110  |  | 10.00  | 09.04   | 83.7858-0140.3   | 330837   | 2  | L=140                  |
|  | 2.3 i V5   |  |  | 10.98  | 09.04   |  |  |  |                        |
|    | 2.8  | 150  |  | 10.00  | 09.04   | 83.7858-0140.3   | 330837   | 2  | L=140                  |
|  | 1.8 4x4  |  |  | 05.01  | 09.04   |  |  |  |                        |
|    | 2.8 4x4  | 150  |  | 05.02  | 09.04   | 24.3727-0149.2   | 580149   | 2 ↓  | L=1688                 |
|  | 1.4 i 16V  | 55   |  | 07.99  | 09.04   |  |  |  |                        |
|    | 1.6 i  |  |  | 10.98  | 09.04   | 03.6583-0179.3   | 320228   |  | BRL 8/3 (4) <b>ATE</b> |
|  | 1.8 4x4  |  |  | 05.01  | 09.04   |  |  |  |                        |
|  | 1.8 i 20V  |  |  | 10.98  | 09.04   |  |  |  |                        |
|  | 1.8 i 20VT   |  |  | 05.01  | 09.04   |  |  |  |                        |
|  | 1.8 i 20VT   | 132  |  | 05.01  | 09.04   |  |  |  |                        |
|  | 1.9 SDI  | 50   |  | 11.99  | 09.04   |  |  |  |                        |
|  | 1.9 TDI  | 66   |  | 10.98  | 09.04   |  |  |  |                        |
|  | 1.9 TDI  | 81   |  | 10.98  | 09.04   |  |  |  |                        |
|  | 1.9 TDI  | 96   |  | 05.03  | 09.04   |  |  |  |                        |
|  | 1.9 TDI  | 110  |  | 10.00  | 09.04   |  |  |  |                        |
|  | 2.3 i V5   |  |  | 10.98  | 09.04   |  |  |  |                        |
|  | 2.8  | 150  |  | 10.00  | 09.04   |  |  |  |                        |
|  | 2.8 4x4  | 150  |  | 05.02  | 09.04   |  |  |  |                        |
|  |    | 1.4 i 16V  | 55   |  | 07.99   |  |  |  |                        |
| 1.6 i  |  |  |  | 10.98  | 09.04   |  |  |  |                        |
| 1.8 4x4  |  |  |  | 05.01  | 09.04   |  |  |  |                        |
| 1.8 i 20V  |  |  |  | 10.98  | 09.04   |  |  |  |                        |
| 1.8 i 20VT   |  |  |  | 05.01  | 09.04   |  |  |  |                        |
| 1.9 SDI  |  | 50   |  | 11.99  | 09.04   |  |  |  |                        |
| 1.9 TDI  |  | 66   |  | 10.98  | 09.04   |  |  |  |                        |
| 1.9 TDI  |  | 81   |  | 10.98  | 09.04   |  |  |  |                        |
| 1.9 TDI  |  | 96   |  | 05.03  | 09.04   |  |  |  |                        |
| 1.9 TDI  |  | 110  |  | 10.00  | 09.04   |  |  |  |                        |
| 2.3 i V5   |  |  |  | 10.98  | 09.04   |  |  |  |                        |
| 2.8  |  | 150  |  | 10.00  | 09.04   |  |  |  |                        |
| 2.8 4x4  |  | 150  |  | 05.02  | 09.04   |  |  |  |                        |
|    |  | 1.4 i 16V  | 55   |  | 07.99   | 09.04  | 24.2415-1702.3   | 030096   |                        |
|  | 1.6 i  |  |  | 10.98  | 09.04   |  |  |  |                        |
|  | 1.8 4x4  |  |  | 05.01  | 09.04   |  |  |  |                        |
|  | 1.8 i 20V  |  |  | 10.98  | 09.04   |  |  |  |                        |
|  | 1.8 i 20VT   |  |  | 05.01  | 09.04   |  |  |  |                        |
|  | 1.9 SDI  | 50   |  | 11.99  | 09.04   |  |  |  |                        |
|  | 1.9 TDI  | 66   |  | 10.98  | 09.04   |  |  |  |                        |
|  | 1.9 TDI  | 81   |  | 10.98  | 09.04   |  |  |  |                        |
|  | 1.9 TDI  | 96   |  | 05.03  | 09.04   |  |  |  |                        |
|  | 1.9 TDI  | 110  |  | 10.00  | 09.04   |  |  |  |                        |
|  | 2.3 i V5   |  |  | 10.98  | 09.04   |  |  |  |                        |
|  | 2.8  | 150  |  | 10.00  | 09.04   |  |  |  |                        |
|  | 2.8 4x4  | 150  |  | 05.02  | 09.04   |  |  |  |                        |
|  |  | 1.4 i 16V  | 55   |  | 07.99   | 09.04  |  |  |                        |
| 1.6 i  |  |  |  | 10.98  | 09.04   |  |  |  |                        |
|  | 1.8 4x4  |  |  | 05.01  | 09.04   | 24.2519-1701.3   | 040075   |  | Nz 19,05               |
|  | 1.8 i 20V  |  |  | 10.98  | 09.04   |  |  |  |                        |
|  | 1.8 i 20VT   |  |  | 05.01  | 09.04   |  |  |  |                        |
|  | 1.9 SDI  | 50   |  | 11.99  | 09.04   |  |  |  |                        |
|  | 1.9 TDI  | 66   |  | 10.98  | 09.04   |  |  |  |                        |
|  | 1.9 TDI  | 81   |  | 10.98  | 09.04   |  |  |  |                        |
|  | 1.9 TDI  | 96   |  | 05.03  | 09.04   |  |  |  |                        |
|  | 1.9 TDI  | 110  |  | 10.00  | 09.04   |  |  |  |                        |
|  | 2.3 i V5   |  |  | 10.98  | 09.04   |  |  |  |                        |
|  | 2.8  | 150  |  | 10.00  | 09.04   |  |  |  |                        |
| 2.8 4x4  | 150  |  | 05.02  | 09.04  |   |  |  |  |                        |
| <b>SEAT TOLEDO III (5P2) (05-09)</b>   |  |  |  |  |   |  |  |  |                        |
|  | 1.6 i 16V  | 75   |  | 10.04  | 03.09   | 03.7863-9502.4   | 300204   | PR: 1AC,1AT<br>PR: 1AS   | 10" <b>ATE</b>         |
|  | 1.8 TFSI   | 118  |  | 01.07  | 03.09   |  |  |  |                        |
|  | 1.9 TDI  | 77   |  | 10.04  | 03.09   |  |  |  |                        |
|  | 2.0 FSI  | 110  |  | 10.04  | 03.09   |  |  |  |                        |
|  | 2.0 i 16V  | 100  |  | 10.04  | 03.09   |  |  |  |                        |
|  | 2.0 TDI  |  |  | 10.04  | 03.09   |  |  |  |                        |
|  | 2.0 TDI  | 125  |  | 01.06  | 03.09   |  |  |  |                        |
|  | 2.0 TFSI   | 147  |  | 11.05  | 03.09   |  |  |  |                        |
|  | 1.6 i 16V  | 75   |  | 10.04  | 03.09   | 03.2122-2129.3   | 010799   |  | Thz 22,20 <b>ATE</b>   |
|  | 1.8 TFSI   | 118  |  | 01.07  | 03.09   |  |  |  |                        |
|  | 1.9 TDI  | 77   |  | 10.04  | 03.09   |  |  |  |                        |
|  | 2.0 FSI  | 110  |  | 10.04  | 03.09   |  |  |  |                        |
|  | 2.0 i 16V  | 100  |  | 10.04  | 03.09   |  |  |  |                        |
|  | 2.0 TDI  |  |  | 10.04  | 03.09   |  |  |  |                        |
|  | 2.0 TDI  | 125  |  | 01.06  | 03.09   |  |  |  |                        |
|  | 2.0 TFSI   | 147  |  | 11.05  | 03.09   |  |  |  |                        |

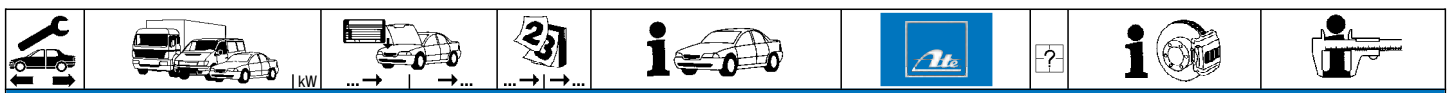

**SEAT TOLEDO III (5P2) (05-09)**





















|  |           |     |  |       |       |             |                |        |   |  |                |     |
|--|-----------|-----|--|-------|-------|-------------|----------------|--------|---|--|----------------|-----|
|  | 1.6 i 16V | 75  |  | 10.04 | 03.09 | PR: 1ZF     | 11.9541-9549.2 | 220575 |   |  | D=54, - Halter | ATE |
|  | 1.8 TFSI  | 118 |  | 01.07 | 03.09 | PR: 1ZF     | 11.9541-9550.2 | 220576 |   |  | D=54, - Halter | ATE |
|  | 1.9 TDI   | 77  |  | 10.04 | 03.09 | PR: 1ZF     |                |        |   |  |                |     |
|  | 2.0 FSI   | 110 |  | 10.04 | 03.09 | PR: 1ZF     |                |        |   |  |                |     |
|  | 2.0 i 16V | 100 |  | 10.04 | 03.09 | PR: 1ZF     |                |        |   |  |                |     |
|  | 2.0 TDI   | 125 |  | 10.04 | 03.09 | PR: 1ZF     |                |        |   |  |                |     |
|  | 2.0 TDI   | 125 |  | 01.06 | 03.09 | PR: 1ZF     |                |        |   |  |                |     |
|  | 2.0 TFSI  | 147 |  | 11.05 | 03.09 | PR: 1ZF     |                |        |   |  |                |     |
|  | 1.6 i 16V | 75  |  | 10.04 | 03.09 | PR: 1ZE     | 11.9541-9553.2 | 220563 |   |  | D=54, - Halter | ATE |
|  | 1.8 TFSI  | 118 |  | 01.07 | 03.09 | PR: 1ZE     | 11.9541-9554.2 | 220564 |   |  | D=54, - Halter | ATE |
|  | 1.9 TDI   | 77  |  | 10.04 | 03.09 | PR: 1ZE     | 11.0101-5409.2 | 260035 |   |  | Hülzensatz     | ATE |
|  | 2.0 FSI   | 110 |  | 10.04 | 03.09 | PR: 1ZE     | 11.8171-0008.1 | 990049 |   |  | Führungsbolzen | ATE |
|  | 2.0 i 16V | 100 |  | 10.04 | 03.09 | PR: 1ZE     | 11.8116-0351.1 | 390538 | 2 |  | Haltefeder     | ATE |
|  | 2.0 TDI   | 125 |  | 10.04 | 03.09 | PR: 1ZE     |                |        |   |  |                |     |
|  | 2.0 TDI   | 125 |  | 01.06 | 03.09 | PR: 1ZE     |                |        |   |  |                |     |
|  | 2.0 TFSI  | 147 |  | 11.05 | 03.09 | PR: 1ZE     |                |        |   |  |                |     |
|  | 1.6 i 16V | 75  |  | 10.04 | 03.09 |             | 83.7847-0563.3 | 331124 | 2 |  | L=562          |     |
|  | 1.8 TFSI  | 118 |  | 01.07 | 03.09 |             |                |        |   |  |                |     |
|  | 1.9 TDI   | 77  |  | 10.04 | 03.09 |             |                |        |   |  |                |     |
|  | 2.0 FSI   | 110 |  | 10.04 | 03.09 |             |                |        |   |  |                |     |
|  | 2.0 i 16V | 100 |  | 10.04 | 03.09 |             |                |        |   |  |                |     |
|  | 2.0 TDI   | 125 |  | 10.04 | 03.09 |             |                |        |   |  |                |     |
|  | 2.0 TDI   | 125 |  | 01.06 | 03.09 |             |                |        |   |  |                |     |
|  | 2.0 TFSI  | 147 |  | 11.05 | 03.09 |             |                |        |   |  |                |     |
|  | 1.6 i 16V | 75  |  | 10.04 | 03.09 | PR: 1KD     | 24.3384-1755.7 | 220635 |   |  | D=38, - Halter | LUC |
|  | 1.8 TFSI  | 118 |  | 01.07 | 03.09 | PR: 1KD     | 24.3384-1756.7 | 220636 |   |  | D=38, - Halter | LUC |
|  | 1.9 TDI   | 77  |  | 10.04 | 03.09 | PR: 1KD     |                |        |   |  |                |     |
|  | 2.0 FSI   | 110 |  | 10.04 | 03.09 | PR: 1KD     |                |        |   |  |                |     |
|  | 2.0 i 16V | 100 |  | 10.04 | 03.09 | PR: 1KD     |                |        |   |  |                |     |
|  | 2.0 TDI   | 125 |  | 10.04 | 03.09 | PR: 1KD     |                |        |   |  |                |     |
|  | 2.0 TDI   | 125 |  | 01.06 | 03.09 | PR: 1KD     |                |        |   |  |                |     |
|  | 2.0 TFSI  | 147 |  | 11.05 | 03.09 | PR: 1KD     |                |        |   |  |                |     |
|  | 1.6 i 16V | 75  |  | 10.04 | 03.09 | PR: 1KJ     | 24.3387-1717.7 | 220757 |   |  | D=38, - Halter | LUC |
|  | 1.8 TFSI  | 118 |  | 01.07 | 03.09 | PR: 1KJ     | 24.3387-1718.7 | 220758 |   |  | D=38, - Halter | LUC |
|  | 1.9 TDI   | 77  |  | 10.04 | 03.09 | PR: 1KJ     |                |        |   |  |                |     |
|  | 2.0 FSI   | 110 |  | 10.04 | 03.09 | PR: 1KJ     |                |        |   |  |                |     |
|  | 2.0 i 16V | 100 |  | 10.04 | 03.09 | PR: 1KJ     |                |        |   |  |                |     |
|  | 2.0 TDI   | 125 |  | 10.04 | 03.09 | PR: 1KJ     |                |        |   |  |                |     |
|  | 2.0 TDI   | 125 |  | 01.06 | 03.09 | PR: 1KJ     |                |        |   |  |                |     |
|  | 2.0 TFSI  | 147 |  | 11.05 | 03.09 | PR: 1KJ     |                |        |   |  |                |     |
|  | 1.6 i 16V | 75  |  | 10.04 | 03.09 | PR: 1KF,1KZ | 24.3414-1709.7 | 220631 |   |  | D=41, - Halter | LUC |
|  | 1.8 TFSI  | 118 |  | 01.07 | 03.09 | PR: 1KF,1KZ | 24.3414-1710.7 | 220632 |   |  | D=41, - Halter | LUC |
|  | 1.9 TDI   | 77  |  | 10.04 | 03.09 | PR: 1KF,1KZ |                |        |   |  |                |     |
|  | 2.0 FSI   | 110 |  | 10.04 | 03.09 | PR: 1KF,1KZ |                |        |   |  |                |     |
|  | 2.0 i 16V | 100 |  | 10.04 | 03.09 | PR: 1KF,1KZ |                |        |   |  |                |     |
|  | 2.0 TDI   | 125 |  | 10.04 | 03.09 | PR: 1KF,1KZ |                |        |   |  |                |     |
|  | 2.0 TDI   | 125 |  | 01.06 | 03.09 | PR: 1KF,1KZ |                |        |   |  |                |     |
|  | 2.0 TFSI  | 147 |  | 11.05 | 03.09 | PR: 1KF,1KZ |                |        |   |  |                |     |
|  | 1.6 i 16V | 75  |  | 10.04 | 03.09 |             | 83.7849-0231.3 | 330872 | 2 |  | L=233          |     |
|  | 1.8 TFSI  | 118 |  | 01.07 | 03.09 |             |                |        |   |  |                |     |
|  | 1.9 TDI   | 77  |  | 10.04 | 03.09 |             |                |        |   |  |                |     |
|  | 2.0 FSI   | 110 |  | 10.04 | 03.09 |             |                |        |   |  |                |     |
|  | 2.0 i 16V | 100 |  | 10.04 | 03.09 |             |                |        |   |  |                |     |
|  | 2.0 TDI   | 125 |  | 10.04 | 03.09 |             |                |        |   |  |                |     |
|  | 2.0 TDI   | 125 |  | 01.06 | 03.09 |             |                |        |   |  |                |     |
|  | 2.0 TFSI  | 147 |  | 11.05 | 03.09 |             |                |        |   |  |                |     |
|  | 1.6 i 16V | 75  |  | 10.04 | 03.09 |             | 24.3727-2708.2 | 582708 | 2 |  | L=1447         |     |
|  | 1.8 TFSI  | 118 |  | 01.07 | 03.09 |             |                |        |   |  |                |     |
|  | 1.9 TDI   | 77  |  | 10.04 | 03.09 |             |                |        |   |  |                |     |
|  | 2.0 FSI   | 110 |  | 10.04 | 03.09 |             |                |        |   |  |                |     |
|  | 2.0 i 16V | 100 |  | 10.04 | 03.09 |             |                |        |   |  |                |     |
|  | 2.0 TDI   | 125 |  | 10.04 | 03.09 |             |                |        |   |  |                |     |
|  | 2.0 TDI   | 125 |  | 01.06 | 03.09 |             |                |        |   |  |                |     |
|  | 2.0 TFSI  | 147 |  | 11.05 | 03.09 |             |                |        |   |  |                |     |
|  | 1.6 i 16V | 75  |  | 10.04 | 03.09 |             | 24.2415-1711.3 | 030130 |   |  | Gz 15,87       |     |
|  | 1.8 TFSI  | 118 |  | 01.07 | 03.09 |             |                |        |   |  |                |     |
|  | 1.9 TDI   | 77  |  | 10.04 | 03.09 |             |                |        |   |  |                |     |
|  | 2.0 FSI   | 110 |  | 10.04 | 03.09 |             |                |        |   |  |                |     |
|  | 2.0 i 16V | 100 |  | 10.04 | 03.09 |             |                |        |   |  |                |     |
|  | 2.0 TDI   | 125 |  | 10.04 | 03.09 |             |                |        |   |  |                |     |
|  | 2.0 TDI   | 125 |  | 01.06 | 03.09 |             |                |        |   |  |                |     |
|  | 2.0 TFSI  | 147 |  | 11.05 | 03.09 |             |                |        |   |  |                |     |
|  | 1.9 TDI   | 77  |  | 10.04 | 03.09 |             | 24.2519-1705.3 | 040095 |   |  | Nz 19,05       |     |
|  | 2.0 FSI   | 110 |  | 10.04 | 03.09 |             |                |        |   |  |                |     |

**SEAT TOLEDO IV (KG3) (12-)**

|  |         |    |  |       |  |         |                |        |  |  |                |     |
|--|---------|----|--|-------|--|---------|----------------|--------|--|--|----------------|-----|
|  | 1.2     | 55 |  | 07.12 |  | PR: 1ZG | 11.9541-9549.2 | 220575 |  |  | D=54, - Halter | ATE |
|  | 1.2 TSI | 63 |  | 07.12 |  | PR: 1ZG | 11.9541-9550.2 | 220576 |  |  | D=54, - Halter | ATE |
|  | 1.2 TSI | 77 |  | 07.12 |  | PR: 1ZG | 11.8171-0008.1 | 990049 |  |  | Führungsbolzen | ATE |
|  | 1.4 TSI | 90 |  | 07.12 |  | PR: 1ZG | 11.0101-5409.2 | 260035 |  |  | Hülzensatz     | ATE |
|  | 1.6     | 77 |  | 07.13 |  | PR: 1ZG |                |        |  |  |                |     |
|  | 1.6 TDI | 77 |  | 07.12 |  | PR: 1ZG |                |        |  |  |                |     |





|     |              |  |   |    |       |  |  |                                 |
|--|--|--|---|--|--|--|--|---|
| <b>SEAT TOLEDO IV (KG3) (12-)</b>  |  |  |   |  |  |  |  |   |
|    | 1.2<br>1.2 TSI<br>1.2 TSI<br>1.4 TSI<br>1.6<br>1.6 TDI                                       | 55<br>63<br>77<br>90<br>77<br>77   | 07.12<br>07.12<br>07.12<br>07.12<br>07.13<br>07.12  | + 15" Rad <sup>1)</sup><br>+ 15" Rad <sup>1)</sup><br>+ 15" Rad <sup>1)</sup><br>+ 15" Rad <sup>1)</sup><br>+ 15" Rad <sup>1)</sup><br>+ 15" Rad <sup>1)</sup> | 11.9541-9553.2<br>11.9541-9554.2<br>11.8171-0008.1<br>11.0101-5409.2<br>11.8116-0351.1 | 220563<br>220564<br>990049<br>260035<br>390538                                     | 2  | D=54, - Halter<br>D=54, - Halter<br>Führungsbolzen<br>Hülzensatz<br>Haltefeder<br>ATE<br>ATE<br>ATE<br>ATE<br>ATE |
|    | 1.2<br>1.2 TSI<br>1.2 TSI<br>1.4 TSI<br>1.6<br>1.6 TDI                                       | 55<br>63<br>77<br>90<br>77<br>77   | 07.12<br>07.12<br>07.12<br>07.12<br>07.13<br>07.12  |  | 83.7858-0140.3   | 330837   | 2  | L=140   |
|    | 1.2<br>1.2 TSI<br>1.2 TSI<br>1.4 TSI<br>1.6 TDI  | 55<br>63<br>77<br>90<br>77   | 07.12<br>07.12<br>07.12<br>07.12<br>07.12   |  | 83.7858-0140.3   | 330837   | 2  | L=140   |
| <b>SKODA CITIGO (12-)</b>  |  |  |   |  |  |  |  |   |
|    | 1.0<br>1.0<br>1.0 CNG  | 44<br>55<br>50   | 05.12<br>05.12<br>11.12   |  | 11.9541-9549.2<br>11.9541-9550.2   | 220575<br>220576   | 2  | D=54, - Halter<br>D=54, - Halter<br>ATE<br>ATE  |
|    | 1.0<br>1.0<br>1.0 CNG  | 44<br>55<br>50   | 05.12<br>05.12<br>11.12   |  | 24.3217-0908.3   | 020167   |  | Rz 17,46  |
| <b>SKODA FABIA I (6Y) (99-07)</b>  |  |  |   |  |  |  |  |   |
|    | 1.0 i<br>1.2 i<br>1.4 i<br>1.4 i 16V<br>1.4 TDI<br>1.9 SDI<br>1.9 TDI<br>2.0 i<br>RS 1.9 TDI | <br><br><br><br><br>47<br>74<br>85<br>96   | 02.00<br>08.02<br>12.07<br>02.00<br>12.07<br>10.99<br>12.07<br>04.03<br>12.07<br>12.99<br>12.07<br>02.00<br>12.07<br>12.99<br>12.07<br>09.03<br>12.07 | 08.02<br>12.07<br>12.07<br>12.07<br>12.07<br>12.07<br>12.07<br>12.07<br>12.07<br>12.07<br>12.07<br>12.07<br>12.07<br>12.07<br>12.07<br>12.07                   | 24.2120-1736.3<br>24.2120-1734.3   | 010732<br>010702   | - ABS<br>+ ABS   | Thz 20,64<br>Thz 20,64  |
|    | 1.0 i<br>1.2 i<br>1.4 i<br>1.4 i 16V<br>1.4 TDI<br>1.9 SDI<br>1.9 TDI<br>2.0 i<br>RS 1.9 TDI | <br><br><br><br><br>47<br>74<br>85<br>96   | 02.00<br>08.02<br>12.07<br>02.00<br>12.07<br>10.99<br>12.07<br>04.03<br>12.07<br>12.99<br>12.07<br>02.00<br>12.07<br>12.99<br>12.07<br>09.03<br>12.07 | PR: 1LB,1LM<br>PR: 1LB,1LM<br>PR: 1LB,1LM<br>PR: 1LB,1LM<br>PR: 1LB,1LM<br>PR: 1LB,1LM<br>PR: 1LB,1LM<br>PR: 1LB,1LM<br>PR: 1LB,1LM                            | 24.3481-1735.5<br>24.3481-1736.5   | 240283<br>240284   |  | D=48, - Halter<br>D=48, - Halter<br>ATE<br>ATE  |
|  | 1.0 i<br>1.2 i<br>1.4 i<br>1.4 i 16V<br>1.4 TDI<br>1.9 SDI<br>1.9 TDI<br>2.0 i<br>RS 1.9 TDI | <br><br><br><br><br>47<br>74<br>85<br>96   | 02.00<br>08.02<br>12.07<br>02.00<br>12.07<br>10.99<br>12.07<br>04.03<br>12.07<br>12.99<br>12.07<br>02.00<br>12.07<br>12.99<br>12.07<br>09.03<br>12.07 | PR: 1LQ,1LR<br>PR: 1LQ,1LR<br>PR: 1LQ,1LR<br>PR: 1LQ,1LR<br>PR: 1LQ,1LR<br>PR: 1LQ,1LR<br>PR: 1LQ,1LR<br>PR: 1LQ,1LR<br>PR: 1LQ,1LR                            | 11.9541-9549.2<br>11.9541-9550.2<br>11.0101-5409.2                                     | 220575<br>220576<br>260035   |  | D=54, - Halter<br>D=54, - Halter<br>Hülzensatz<br>ATE<br>ATE<br>ATE   |
|  | 1.0 i<br>1.2 i<br>1.4 i<br>1.4 i 16V<br>1.4 TDI<br>1.9 SDI<br>1.9 TDI<br>2.0 i<br>RS 1.9 TDI | <br><br><br><br><br>47<br>74<br>85<br>96   | 02.00<br>08.02<br>12.07<br>02.00<br>12.07<br>10.99<br>12.07<br>04.03<br>12.07<br>12.99<br>12.07<br>02.00<br>12.07<br>12.99<br>12.07<br>09.03<br>12.07 | PR: 1LN,1LP<br>PR: 1LN,1LP<br>PR: 1LN,1LP<br>PR: 1LN,1LP<br>PR: 1LN,1LP<br>PR: 1LN,1LP<br>PR: 1LN,1LP<br>PR: 1LN,1LP<br>PR: 1LN,1LP                            | 24.3541-1797.7<br>24.3541-1798.7   | 220553<br>220554   |  | D=54, - Halter<br>D=54, - Halter<br>LUC<br>LUC  |
|  | 1.0 i<br>1.2 i<br>1.4 i<br>1.4 i 16V<br>1.4 TDI<br>1.9 SDI<br>1.9 TDI<br>2.0 i<br>RS 1.9 TDI | <br><br><br><br><br>47<br>74<br>85<br>96   | 02.00<br>08.02<br>12.07<br>02.00<br>12.07<br>10.99<br>12.07<br>04.03<br>12.07<br>12.99<br>12.07<br>02.00<br>12.07<br>12.99<br>12.07<br>09.03<br>12.07 |  | 83.6247-0522.3   | 330595   | 2  | L=522   |
|  | 1.4 i 16V<br>1.4 TDI<br>1.9 TDI<br>2.0 i   | <br>74<br>85   | 10.99<br>04.03<br>02.00<br>12.99  | PR: 1KK<br>PR: 1KK<br>PR: 1KK<br>PR: 1KK   | 24.3384-1729.7<br>24.3384-1730.7   | 220541<br>220542   | 2  | D=38(M12x1), - Halter<br>D=38(M12x1), - Halter<br>LUC<br>LUC  |
|  | 1.0 i<br>1.2 i<br>1.4 i<br>1.4 i 16V<br>1.4 TDI<br>1.9 SDI<br>1.9 TDI<br>2.0 i<br>RS 1.9 TDI | <br><br><br><br><br>47<br>74<br>85<br>96   | 02.00<br>08.02<br>12.07<br>02.00<br>12.07<br>10.99<br>12.07<br>04.03<br>12.07<br>12.99<br>12.07<br>02.00<br>12.07<br>12.99<br>12.07<br>09.03<br>12.07 | PR: 1KK,1KP<br>PR: 1KK,1KP<br>PR: 1KK,1KP<br>PR: 1KK,1KP<br>PR: 1KK,1KP<br>PR: 1KK,1KP<br>PR: 1KK,1KP<br>PR: 1KK,1KP<br>PR: 1KK,1KP                            | 83.7858-0140.3   | 330837   | 2  | L=140   |

<sup>1)</sup> + 15" wheel / + ruota 15" / + roue 15" / + rueda 15"

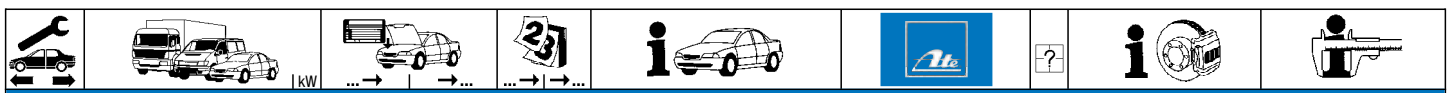

**SKODA FABIA I (6Y) (99-07)**

|  |  |                      |   |   |   |                                  |                  |  |                  |
|--|--|----------------------|---|---|---|----------------------------------|------------------|--|------------------|
|  | 1.0 i<br>1.2 i<br>1.4 i<br>1.4 i 16V<br>1.4 TDI<br>1.9 SDI                                   | 47                   | 02.00<br>08.02<br>02.00<br>10.99<br>04.03<br>12.99                            | 08.02<br>12.07<br>12.07<br>12.07<br>12.07<br>12.07                            |   | 24.3219-0909.3                   | 020188           |  | Rz 19,05         |
|  | 1.0 i<br>1.2 i<br>1.4 i<br>1.4 i 16V<br>1.4 TDI<br>1.9 SDI<br>1.9 TDI<br>2.0 i<br>RS 1.9 TDI | 47<br>74<br>85<br>96 | 02.00<br>08.02<br>02.00<br>10.99<br>04.03<br>12.99<br>02.00<br>12.99<br>09.03 | 08.02<br>12.07<br>12.07<br>12.07<br>12.07<br>12.07<br>12.07<br>12.07<br>12.07 | PR: 1JA,1JC,1JD,1KM<br>PR: 1JA,1JC,1JD,1KM<br>PR: 1JA,1JC,1JD,1KM<br>PR: 1JA,1JC,1JD,1KM<br>PR: 1JA,1JC,1JD,1KM<br>PR: 1JA,1JC,1JD,1KM<br>PR: 1JA,1JC,1JD,1KM<br>PR: 1JA,1JC,1JD,1KM<br>PR: 1JA,1JC,1JD,1KM                                     | 24.3727-0199.2                   | 580199           | 2 ⚡ - Schlechtwegeausführung <sup>1)</sup>   | L=1580           |
|  | 1.0 i<br>1.2 i<br>1.4 i<br>1.4 i 16V<br>1.4 TDI<br>1.9 SDI<br>1.9 TDI<br>2.0 i<br>RS 1.9 TDI | 47<br>74<br>85<br>96 | 02.00<br>08.02<br>02.00<br>10.99<br>04.03<br>12.99<br>02.00<br>12.99<br>09.03 | 08.02<br>12.07<br>12.07<br>12.07<br>12.07<br>12.07<br>12.07<br>12.07<br>12.07 | PR: 1JB,1KK,1KT<br>PR: 1JB,1KK,1KT<br>PR: 1JB,1KK,1KT<br>PR: 1JB,1KK,1KT<br>PR: 1JB,1KK,1KT<br>PR: 1JB,1KK,1KT<br>PR: 1JB,1KK,1KT<br>PR: 1JB,1KK,1KT<br>PR: 1JB,1KK,1KT   | 24.3727-0176.2<br>24.3727-0198.2 | 580176<br>580198 | 2 ⚡ + Schlechtwegeausführung <sup>2)</sup><br>2 ⚡ + Schlechtwegeausführung <sup>2)</sup> | L=1640<br>L=1645 |
|  | 1.0 i<br>1.2 i<br>1.4 i<br>1.4 i 16V<br>1.4 TDI<br>1.9 SDI<br>1.9 TDI<br>2.0 i<br>RS 1.9 TDI | 47<br>74<br>85<br>96 | 02.00<br>08.02<br>02.00<br>10.99<br>04.03<br>12.99<br>02.00<br>12.99<br>09.03 | 08.02<br>12.07<br>12.07<br>12.07<br>12.07<br>12.07<br>12.07<br>12.07<br>12.07 | PR: 1JB,1KM<br>PR: 1JB,1KM<br>PR: 1JB,1KM<br>PR: 1JB,1KM<br>PR: 1JB,1KM<br>PR: 1JB,1KM<br>PR: 1JB,1KM<br>PR: 1JB,1KM<br>PR: 1JB,1KM   | 24.3727-2504.2                   | 582504           | 2 ⚡ + Schlechtwegeausführung <sup>2)</sup>   | L=1580           |
|  | 1.0 i<br>1.2 i<br>1.4 i<br>1.4 i 16V<br>1.4 TDI<br>1.9 SDI<br>1.9 TDI<br>2.0 i<br>RS 1.9 TDI | 47<br>74<br>85<br>96 | 02.00<br>08.02<br>02.00<br>10.99<br>04.03<br>12.99<br>02.00<br>12.99<br>09.03 | 08.02<br>12.07<br>12.07<br>12.07<br>12.07<br>12.07<br>12.07<br>12.07<br>12.07 | PR: 1JA,1JD,1KK,1KP,1KQ<br>PR: 1JA,1JD,1KK,1KP,1KQ<br>PR: 1JA,1JD,1KK,1KP,1KQ<br>PR: 1JA,1JD,1KK,1KP,1KQ<br>PR: 1JA,1JD,1KK,1KP,1KQ<br>PR: 1JA,1JD,1KK,1KP,1KQ<br>PR: 1JA,1JD,1KK,1KP,1KQ<br>PR: 1JA,1JD,1KK,1KP,1KQ<br>PR: 1JA,1JD,1KK,1KP,1KQ | 24.3727-0197.2                   | 580197           | 2 ⚡ + HA-Scheibenbremse <sup>3)</sup>  | L=1645           |
|  | 1.4 i<br>1.4 i 16V<br>1.4 TDI<br>1.9 SDI<br>1.9 TDI<br>2.0 i<br>RS 1.9 TDI                   | 47<br>74<br>85<br>96 | 02.00<br>10.99<br>04.03<br>12.99<br>02.00<br>12.99<br>09.03                   | 12.07<br>12.07<br>12.07<br>12.07<br>12.07<br>12.07<br>12.07                   | PR: 1AL<br>PR: 1AL<br>PR: 1AL<br>PR: 1AL<br>PR: 1AL<br>PR: 1AL<br>PR: 1AL   | 03.6583-0216.3                   | 320247           | - ABS / + Schrägheck <sup>4)</sup>   | BRL 8/3 (4) ATE  |
|  | 1.4 i<br>1.4 i 16V<br>1.4 TDI<br>1.9 SDI<br>1.9 TDI<br>2.0 i<br>RS 1.9 TDI                   | 47<br>74<br>85<br>96 | 02.00<br>10.99<br>04.03<br>12.99<br>02.00<br>12.99<br>09.03                   | 12.07<br>12.07<br>12.07<br>12.07<br>12.07<br>12.07<br>12.07                   | PR: 1AL<br>PR: 1AL<br>PR: 1AL<br>PR: 1AL<br>PR: 1AL<br>PR: 1AL<br>PR: 1AL   | 03.6584-0120.3                   | 320279           | - ABS / - Schrägheck <sup>5)</sup>   | BRL 8/4 (4) ATE  |
|  | 1.4 i<br>1.4 i 16V<br>1.4 TDI<br>1.9 SDI<br>1.9 TDI<br>2.0 i<br>RS 1.9 TDI                   | 47<br>74<br>85<br>96 | 02.00<br>10.99<br>04.03<br>12.99<br>02.00<br>12.99<br>09.03                   | 12.07<br>12.07<br>12.07<br>12.07<br>12.07<br>12.07<br>12.07                   | PR: 1AB,1LM<br>PR: 1AB,1LM<br>PR: 1AB,1LM<br>PR: 1AB,1LM<br>PR: 1AB,1LM<br>PR: 1AB,1LM<br>PR: 1AB,1LM   | 03.6043-1733.3                   | 320284           | - ABS  | BRE 3/25 ATE     |
|  | 1.0 i<br>1.2 i<br>1.4 i<br>1.4 i 16V<br>1.4 TDI<br>1.9 SDI<br>1.9 TDI<br>2.0 i<br>RS 1.9 TDI | 47<br>74<br>85<br>96 | 02.00<br>08.02<br>02.00<br>10.99<br>04.03<br>12.99<br>02.00<br>12.99<br>09.03 | 08.02<br>12.07<br>12.07<br>12.07<br>12.07<br>12.07<br>12.07<br>12.07<br>12.07 |   | 24.2415-1702.3                   | 030096           |  | Gz 15,87         |

**SKODA FABIA II (5J) (07-)**

|  |   |   |  |   |                |        |       |           |
|--|---|---|--|---|----------------|--------|-------|-----------|
|  | 1.2<br>1.2<br>1.2 TDI<br>1.2 TSI<br>1.2 TSI<br>1.4 i 16V<br>1.4 TDI<br>1.4 TDI<br>1.4 TSI RS<br>1.6 i 16V<br>1.6 TDI<br>1.6 TDI | 44<br>51<br>55<br>63<br>77<br>63<br>51<br>59<br>132<br>77<br>55<br>66 | 03.07<br>03.07<br>05.10<br>03.10<br>03.10<br>03.07<br>03.07<br>03.07<br>05.10<br>03.07<br>04.10<br>03.10 | PR: 1AL,1LQ,1LN,1LR<br>PR: 1AL,1LQ,1LN,1LR<br>PR: 1AL,1LQ,1LN,1LR<br>PR: 1AL,1LQ,1LN,1LR<br>PR: 1AL,1LQ,1LN,1LR<br>PR: 1AL,1LQ,1LN,1LR<br>PR: 1AL,1LQ,1LN,1LR<br>PR: 1AL,1LQ,1LN,1LR<br>PR: 1AL,1LQ,1LN,1LR<br>PR: 1AL,1LQ,1LN,1LR<br>PR: 1AL,1LQ,1LN,1LR | 24.2120-1736.3 | 010732 | - ABS | Thz 20,64 |
|--|---|---|--|---|----------------|--------|-------|-----------|





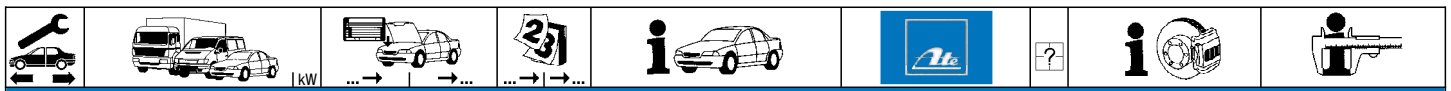









<sup>1)</sup> - rough road construction / - versione per percorsi accidentati / - version pour mauvaise route / - versión 4x4  
<sup>2)</sup> + rough road construction / + versione per percorsi accidentati / + version pour mauvaise route / + versión 4x4  
<sup>3)</sup> + RA disc brake / + P disco freno / + frein à disque essieu AR / + ET-disco de freno  
<sup>4)</sup> - ABS / + hatchback / - ABS / + coda spiovente / - ABS / + arrière profilé / - ABS / + portón tras.alargado  
<sup>5)</sup> - ABS / - hatchback / - ABS / - coda spiovente / - ABS / - arrière profilé / - ABS / - portón tras.alargado



























**SKODA FABIA II (5J) (07-)**

















|            |            |           |                     |                             |                |                |        |                       |       |
|------------|------------|-----------|---------------------|-----------------------------|----------------|----------------|--------|-----------------------|-------|
|            | 1.6 TDI    | 77        | 03.10               | PR: 1AL,1LQ,1LN,1LR         | 24.2120-1736.3 | 010732         | - ABS  | THz 20,64             |       |
|            | 1.9 TDI    | 77        | 03.07               | PR: 1AL,1LQ,1LN,1LR         |                |                |        |                       |       |
|            | 1.2        | 44        | 03.07               | PR: 1AC,1AR,1AT,1LN,1LQ,1LR | 24.2120-1734.3 | 010702         | + ABS  | THz 20,64             |       |
|            | 1.2        | 51        | 03.07               | PR: 1AC,1AR,1AT,1LN,1LQ,1LR |                |                |        |                       |       |
|            | 1.2 TDI    | 55        | 05.10               | PR: 1AC,1AR,1AT,1LN,1LQ,1LR |                |                |        |                       |       |
|            | 1.2 TSI    | 63        | 03.10               | PR: 1AC,1AR,1AT,1LN,1LQ,1LR |                |                |        |                       |       |
|            | 1.2 TSI    | 77        | 03.10               | PR: 1AC,1AR,1AT,1LN,1LQ,1LR |                |                |        |                       |       |
|            | 1.4 i 16V  | 63        | 03.07               | PR: 1AC,1AR,1AT,1LN,1LQ,1LR |                |                |        |                       |       |
|            | 1.4 TDI    | 51        | 03.07               | PR: 1AC,1AR,1AT,1LN,1LQ,1LR |                |                |        |                       |       |
|            | 1.4 TDI    | 59        | 03.07               | PR: 1AC,1AR,1AT,1LN,1LQ,1LR |                |                |        |                       |       |
|            | 1.4 TSI RS | 132       | 05.10               | PR: 1AC,1AR,1AT,1LN,1LQ,1LR |                |                |        |                       |       |
|            | 1.6 i 16V  | 77        | 03.07               | PR: 1AC,1AR,1AT,1LN,1LQ,1LR |                |                |        |                       |       |
|            | 1.6 TDI    | 55        | 04.10               | PR: 1AC,1AR,1AT,1LN,1LQ,1LR |                |                |        |                       |       |
|            | 1.6 TDI    | 66        | 03.10               | PR: 1AC,1AR,1AT,1LN,1LQ,1LR |                |                |        |                       |       |
|            | 1.6 TDI    | 77        | 03.10               | PR: 1AC,1AR,1AT,1LN,1LQ,1LR |                |                |        |                       |       |
|            | 1.9 TDI    | 77        | 03.07               | PR: 1AC,1AR,1AT,1LN,1LQ,1LR |                |                |        |                       |       |
|            | 1.2        | 44        | 03.07               | PR: 1AC,1AR,1LB,1LM         | 24.2119-1712.3 | 010912         | + ABS  | THz 19,05 - Behälter  |       |
|            | 1.2        | 51        | 03.07               | PR: 1AC,1AR,1LB,1LM         |                |                |        |                       |       |
|            | 1.2 TDI    | 55        | 05.10               | PR: 1AC,1AR,1LB,1LM         |                |                |        |                       |       |
|            | 1.2 TSI    | 63        | 03.10               | PR: 1AC,1AR,1LB,1LM         |                |                |        |                       |       |
| 1.2 TSI    | 77         | 03.10     | PR: 1AC,1AR,1LB,1LM |                             |                |                |        |                       |       |
| 1.4 i 16V  | 63         | 03.07     | PR: 1AC,1AR,1LB,1LM |                             |                |                |        |                       |       |
| 1.4 TDI    | 51         | 03.07     | PR: 1AC,1AR,1LB,1LM |                             |                |                |        |                       |       |
| 1.4 TDI    | 59         | 03.07     | PR: 1AC,1AR,1LB,1LM |                             |                |                |        |                       |       |
| 1.4 TSI RS | 132        | 05.10     | PR: 1AC,1AR,1LB,1LM |                             |                |                |        |                       |       |
| 1.6 i 16V  | 77         | 03.07     | PR: 1AC,1AR,1LB,1LM |                             |                |                |        |                       |       |
| 1.6 TDI    | 55         | 04.10     | PR: 1AC,1AR,1LB,1LM |                             |                |                |        |                       |       |
| 1.6 TDI    | 66         | 03.10     | PR: 1AC,1AR,1LB,1LM |                             |                |                |        |                       |       |
| 1.6 TDI    | 77         | 03.10     | PR: 1AC,1AR,1LB,1LM |                             |                |                |        |                       |       |
| 1.9 TDI    | 77         | 03.07     | PR: 1AC,1AR,1LB,1LM |                             |                |                |        |                       |       |
|            | 1.2        | 44        | 03.07               | PR: 1LB,1LM                 | 24.3481-1735.5 | 240283         |        | D=48, - Halter<br>ATE |       |
|            | 1.2        | 51        | 03.07               | PR: 1LB,1LM                 | 24.3481-1736.5 | 240284         |        | D=48, - Halter<br>ATE |       |
|            | 1.2 TDI    | 55        | 05.10               | PR: 1LB,1LM                 |                |                |        |                       |       |
|            | 1.2 TSI    | 63        | 03.10               | PR: 1LB,1LM                 |                |                |        |                       |       |
|            | 1.2 TSI    | 77        | 03.10               | PR: 1LB,1LM                 |                |                |        |                       |       |
|            | 1.4 i 16V  | 63        | 03.07               | PR: 1LB,1LM                 |                |                |        |                       |       |
|            | 1.4 TDI    | 51        | 03.07               | PR: 1LB,1LM                 |                |                |        |                       |       |
|            | 1.4 TDI    | 59        | 03.07               | PR: 1LB,1LM                 |                |                |        |                       |       |
|            | 1.4 TSI RS | 132       | 05.10               | PR: 1LB,1LM                 |                |                |        |                       |       |
|            | 1.6 i 16V  | 77        | 03.07               | PR: 1LB,1LM                 |                |                |        |                       |       |
|            | 1.6 TDI    | 55        | 04.10               | PR: 1LB,1LM                 |                |                |        |                       |       |
|            | 1.6 TDI    | 66        | 03.10               | PR: 1LB,1LM                 |                |                |        |                       |       |
|            | 1.6 TDI    | 77        | 03.10               | PR: 1LB,1LM                 |                |                |        |                       |       |
|            | 1.9 TDI    | 77        | 03.07               | PR: 1LB,1LM                 |                |                |        |                       |       |
|            | 1.2        | 44        | 03.07               | PR: 1LQ,1LR,1ZG             | 11.9541-9549.2 | 220575         |        | D=54, - Halter<br>ATE |       |
|            | 1.2        | 51        | 03.07               | PR: 1LQ,1LR,1ZG             | 11.9541-9550.2 | 220576         |        | D=54, - Halter<br>ATE |       |
|            | 1.2 TDI    | 55        | 05.10               | PR: 1LQ,1LR,1ZG             | 11.0101-5409.2 | 260035         |        | Hülsensatz<br>ATE     |       |
|            | 1.2 TSI    | 63        | 03.10               | PR: 1LQ,1LR,1ZG             |                |                |        |                       |       |
|            | 1.2 TSI    | 77        | 03.10               | PR: 1LQ,1LR,1ZG             |                |                |        |                       |       |
|            | 1.4 i 16V  | 63        | 03.07               | PR: 1LQ,1LR,1ZG             |                |                |        |                       |       |
| 1.4 TDI    | 51         | 03.07     | PR: 1LQ,1LR,1ZG     |                             |                |                |        |                       |       |
| 1.4 TDI    | 59         | 03.07     | PR: 1LQ,1LR,1ZG     |                             |                |                |        |                       |       |
| 1.4 TSI RS | 132        | 05.10     | PR: 1LQ,1LR,1ZG     |                             |                |                |        |                       |       |
| 1.6 i 16V  | 77         | 03.07     | PR: 1LQ,1LR,1ZG     |                             |                |                |        |                       |       |
| 1.6 TDI    | 55         | 04.10     | PR: 1LQ,1LR,1ZG     |                             |                |                |        |                       |       |
| 1.6 TDI    | 66         | 03.10     | PR: 1LQ,1LR,1ZG     |                             |                |                |        |                       |       |
| 1.6 TDI    | 77         | 03.10     | PR: 1LQ,1LR,1ZG     |                             |                |                |        |                       |       |
| 1.9 TDI    | 77         | 03.07     | PR: 1LQ,1LR,1ZG     |                             |                |                |        |                       |       |
|            | 1.2        | 44        | 03.07               | PR: 1LN,1ZH                 | 24.3541-1797.7 | 220553         |        | D=54, - Halter<br>LUC |       |
|            | 1.2        | 51        | 03.07               | PR: 1LN,1ZH                 | 24.3541-1798.7 | 220554         |        | D=54, - Halter<br>LUC |       |
|            | 1.2 TDI    | 55        | 05.10               | PR: 1LN,1ZH                 |                |                |        |                       |       |
|            | 1.2 TSI    | 63        | 03.10               | PR: 1LN,1ZH                 |                |                |        |                       |       |
|            | 1.2 TSI    | 77        | 03.10               | PR: 1LN,1ZH                 |                |                |        |                       |       |
|            | 1.4 i 16V  | 63        | 03.07               | PR: 1LN,1ZH                 |                |                |        |                       |       |
|            | 1.4 TDI    | 51        | 03.07               | PR: 1LN,1ZH                 |                |                |        |                       |       |
|            | 1.4 TDI    | 59        | 03.07               | PR: 1LN,1ZH                 |                |                |        |                       |       |
|            | 1.4 TSI RS | 132       | 05.10               | PR: 1LN,1ZH                 |                |                |        |                       |       |
|            | 1.6 i 16V  | 77        | 03.07               | PR: 1LN,1ZH                 |                |                |        |                       |       |
|            | 1.6 TDI    | 55        | 04.10               | PR: 1LN,1ZH                 |                |                |        |                       |       |
|            | 1.6 TDI    | 66        | 03.10               | PR: 1LN,1ZH                 |                |                |        |                       |       |
|            | 1.6 TDI    | 77        | 03.10               | PR: 1LN,1ZH                 |                |                |        |                       |       |
|            | 1.9 TDI    | 77        | 03.07               | PR: 1LN,1ZH                 |                |                |        |                       |       |
|            |            | 1.2       | 44                  | 03.07                       |                | 83.6247-0522.3 | 330595 | 2                     | L=522 |
|            |            | 1.2       | 51                  | 03.07                       |                |                |        |                       |       |
|            |            | 1.2 TDI   | 55                  | 05.10                       |                |                |        |                       |       |
|            |            | 1.2 TSI   | 63                  | 03.10                       |                |                |        |                       |       |
|            |            | 1.2 TSI   | 77                  | 03.10                       |                |                |        |                       |       |
|            |            | 1.4 i 16V | 63                  | 03.07                       |                |                |        |                       |       |
| 1.4 TDI    |            | 51        | 03.07               |                             |                |                |        |                       |       |
| 1.4 TDI    |            | 59        | 03.07               |                             |                |                |        |                       |       |
| 1.4 TSI RS |            | 132       | 05.10               |                             |                |                |        |                       |       |
| 1.6 i 16V  |            | 77        | 03.07               |                             |                |                |        |                       |       |
| 1.6 TDI    |            | 55        | 04.10               |                             |                |                |        |                       |       |
| 1.6 TDI    |            | 66        | 03.10               |                             |                |                |        |                       |       |

| SKODA FABIA II (5J) (07-)  |   | KW  |  | PR   |   | ATE                              |   | LUC   |  |            |
|--|---|---|--|--|---|----------------------------------|---|---|--|------------|
|    | 1.2<br>1.2<br>1.4 i 16V<br>1.4 TDI<br>1.4 TDI<br>1.6 i 16V<br>1.9 TDI   | 44<br>51<br>63<br>51<br>59<br>77<br>77  | 03.07<br>03.07<br>03.07<br>03.07<br>03.07<br>03.07<br>03.07  | 05.09<br>05.09<br>05.09<br>05.09<br>05.09<br>05.09<br>05.09  | PR: 1KK<br>PR: 1KK<br>PR: 1KK<br>PR: 1KK<br>PR: 1KK<br>PR: 1KK<br>PR: 1KK | 24.3384-1729.7<br>24.3384-1730.7 | 220541<br>220542  |    | D=38(M12x1), - Halter<br>D=38(M12x1), - Halter | LUC<br>LUC |
|    | 1.2<br>1.2<br>1.2 TDI<br>1.2 TSI<br>1.2 TSI<br>1.4 i 16V<br>1.4 TDI<br>1.4 TDI<br>1.4 TSI RS<br>1.6 i 16V<br>1.6 TDI<br>1.6 TDI<br>1.6 TDI<br>1.9 TDI | 44<br>51<br>55<br>63<br>77<br>63<br>51<br>59<br>132<br>77<br>55<br>66<br>77<br>77 | 03.07<br>03.07<br>05.10<br>03.10<br>03.10<br>03.07<br>03.07<br>03.07<br>05.10<br>03.07<br>04.10<br>03.10<br>03.10<br>03.07 |  |   | 83.7858-0140.3                   | 330837  | 2   | L=140  |            |
|    | 1.2<br>1.2<br>1.2 TDI<br>1.2 TSI<br>1.2 TSI<br>1.4 i 16V<br>1.4 TDI<br>1.4 TDI<br>1.6 i 16V<br>1.6 TDI<br>1.6 TDI<br>1.6 TDI<br>1.9 TDI               | 44<br>51<br>55<br>63<br>77<br>63<br>51<br>59<br>77<br>55<br>66<br>77<br>77        | 03.07<br>03.07<br>05.10<br>03.10<br>03.10<br>03.07<br>03.07<br>03.07<br>03.07<br>04.10<br>03.10<br>03.10<br>03.07          |  |   | 24.3219-0909.3                   | 020188  |   | Rz 19,05                                       |            |
|    | 1.2<br>1.2<br>1.2 TDI<br>1.2 TSI<br>1.2 TSI<br>1.4 i 16V<br>1.4 TDI<br>1.4 TDI<br>1.4 TSI RS<br>1.6 i 16V<br>1.6 TDI<br>1.6 TDI<br>1.6 TDI<br>1.9 TDI | 44<br>51<br>55<br>63<br>77<br>63<br>51<br>59<br>132<br>77<br>55<br>66<br>77<br>77 | 03.07<br>03.07<br>05.10<br>03.10<br>03.10<br>03.07<br>03.07<br>03.07<br>05.10<br>03.07<br>04.10<br>03.10<br>03.10<br>03.07 | PR: 1JA,1JD,1JE,1KK,1KP,1KQ,1KT<br>PR: 1JA,1JD,1JE,1KK,1KP,1KQ,1KT<br>PR: 1JA,1JD,1JE,1KK,1KP,1KQ,1KT<br>PR: 1JA,1JD,1JE,1KK,1KP,1KQ,1KT<br>PR: 1JA,1JD,1JE,1KK,1KP,1KQ,1KT<br>PR: 1JA,1JD,1JE,1KK,1KP,1KQ,1KT<br>PR: 1JA,1JD,1JE,1KK,1KP,1KQ,1KT<br>PR: 1JA,1JD,1JE,1KK,1KP,1KQ,1KT<br>PR: 1JA,1JD,1JE,1KK,1KP,1KQ,1KT<br>PR: 1JA,1JD,1JE,1KK,1KP,1KQ,1KT<br>PR: 1JA,1JD,1JE,1KK,1KP,1KQ,1KT<br>PR: 1JA,1JD,1JE,1KK,1KP,1KQ,1KT<br>PR: 1JA,1JD,1JE,1KK,1KP,1KQ,1KT<br>PR: 1JA,1JD,1JE,1KK,1KP,1KQ,1KT | 24.3727-0199.2<br>24.3727-0197.2  | 580199<br>580197                 | 2  + HA-Trommelbremse 1)<br>2  + HA-Scheibenbremse 2) | L=1580<br>L=1645  |  |            |
|  | 1.2<br>1.2<br>1.2 TDI<br>1.2 TSI<br>1.2 TSI<br>1.4 i 16V<br>1.4 TDI<br>1.4 TDI<br>1.6 i 16V<br>1.6 TDI<br>1.6 TDI<br>1.6 TDI<br>1.9 TDI               | 44<br>51<br>55<br>63<br>77<br>63<br>51<br>59<br>77<br>55<br>66<br>77<br>77        | 03.07<br>03.07<br>05.10<br>03.10<br>03.10<br>03.07<br>03.07<br>03.07<br>03.07<br>04.10<br>03.10<br>03.10<br>03.07          |  |   | 03.6583-0216.3<br>03.6584-0120.3 | 320247<br>320279  | - ABS<br>- ABS  | BRL 8/3 (4)<br>BRL 8/4 (4)                     | ATE<br>ATE |
| SKODA FAVORIT (781) (87-95)  |   |   |  |  |   |                                  |   |   |  |            |
|  | 135<br>136  |   | 08.87<br>08.87   | 12.95<br>12.95   |   | 24.5166-0325.3                   | 331293  | 2   | L=325  |            |
|  | 135<br>136  |   | 08.87<br>08.87   | 12.95<br>12.95   |   | 24.5228-0235.3                   | 330395  | 2   | L=235  |            |
|  | 135<br>136  |   | 01.93<br>01.93   | 12.95<br>12.95   |   | 24.3219-1721.3                   | 020422  |   | Rz 19,05                                       |            |
| SKODA FELICIA I (791/795) (95-97)  |   |   |  |  |   |                                  |   |   |  |            |
|  | 1.3 (135)<br>1.3 i (136)<br>1.6 i<br>1.9 D  | 50  | 10.94<br>10.94<br>08.95<br>10.96   | 02.98<br>02.98<br>02.98<br>02.98   |   | 24.2122-1731.3<br>03.2123-1428.3 | 010656<br>010476  | - ABS<br>+ ABS  | THz 22,20<br>THz 23,81                         | ATE        |
|  | 1.3 (135)<br>1.3 i (136)<br>1.6 i<br>1.9 D  | 50  | 10.94<br>10.94<br>08.95<br>10.96   | 02.98<br>02.98<br>02.98<br>02.98   |   | 24.3541-1737.5<br>24.3541-1738.5 | 240197<br>240198  |  | D=54, - Halter<br>D=54, - Halter               | LUC<br>LUC |

1) + RA drum brake / + P freno a tamburo / + frein à tambour essieu AR / + ET-tambores de freno

2) + RA disc brake / + P disco freno / + frein à disque essieu AR / + ET-disco de freno

|     |  |  |  |  |  |  |  |  |       |                |     |
|--|--|--|--|--|---|--|--|--|-------|----------------|-----|
| <b>SKODA FELICIA I (791/795) (95-97)</b>   |  |  |  |  |   |  |  |  |       |                |     |
|    | 1.3 (135)  | 50   |  | 10.94  | 06.96   | 24.5112-0339.3   | 330771   | 2  | - ABS | L=340          |     |
|  | 1.3 i (136)  |  | 10.94  | 06.96  |   |  |  |  |       |                |     |
|  | 1.6 i  |  | 08.95  | 06.96  |   |  |  |  |       |                |     |
|    | 1.3 (135)  | 50   |  | 07.96  | 02.98   | 24.5166-0325.3   | 331293   | 2  | - ABS | L=325          |     |
|  | 1.3 i (136)  |  | 07.96  | 02.98  |   |  |  |  |       |                |     |
|  | 1.6 i  |  | 07.96  | 02.98  |   |  |  |  |       |                |     |
|  | 1.9 D  |  | 10.96  | 02.98  |   |  |  |  |       |                |     |
|    | 1.3 (135)  | 50   |  | 10.94  | 03.95   | 24.5228-0235.3   | 330395   | 2  |       | L=235          |     |
|  | 1.3 i (136)  |  | 10.94  | 03.95  |   |  |  |  |       |                |     |
|  | 1.3 (135)  |  | 04.95  | 02.98  |   |  |  |  |       |                |     |
|  | 1.3 i (136)  |  | 04.95  | 02.98  |   |  |  |  |       |                |     |
|    | 1.6 i  | 50   |  | 08.95  | 02.98   | 24.5228-0180.3   | 330761   | 2  |       | L=180          |     |
|  | 1.9 D  |  | 10.96  | 02.98  |   |  |  |  |       |                |     |
|  | 1.3 (135) Lim.   |  | 10.94  | 02.98  |   |  |  |  |       |                |     |
|  | 1.3 i (136) Lim.   |  | 10.94  | 02.98  |   |  |  |  |       |                |     |
|    | 1.6 i Lim.   | 50   |  | 08.95  | 02.98   | 24.3219-1721.3   | 020422   |  |       | Rz 19,05       |     |
|  | 1.9 D Lim.   |  | 10.96  | 02.98  |   |  |  |  |       |                |     |
|  | 1.3 (135) Kombi  |  | 10.94  | 02.98  |   |  |  |  |       |                |     |
|  | 1.3 i (136) Kombi  |  | 10.94  | 02.98  |   |  |  |  |       |                |     |
|    | 1.6 i Kombi  | 50   |  | 08.95  | 02.98   | 24.3222-1712.3   | 020424   |  |       | Rz 22,20       |     |
|  | 1.9 D Kombi  |  | 10.96  | 02.98  |   |  |  |  |       |                |     |
|  | 1.3 (135)  |  | 10.94  | 02.98  |   |  |  |  |       |                |     |
|  | 1.3 i (136)  |  | 10.94  | 02.98  |   |  |  |  |       |                |     |
|  | 1.6 i  | 50   |  | 08.95  | 02.98   | 24.3727-2500.2   | 582500   | 2  |       | L=1752         |     |
|  | 1.9 D  |  | 10.96  | 02.98  |   |  |  |  |       |                |     |
|  | 1.3 (135)  |  | 10.94  | 02.98  |   |  |  |  |       |                |     |
|  | 1.3 i (136)  |  | 10.94  | 02.98  |   |  |  |  |       |                |     |
|  | 1.6 i  | 50   |  | 08.95  | 02.98   | 24.3728-2500.2   | 592500   |  |       | L=742          |     |
|  | 1.9 D  |  | 10.96  | 02.98  |   |  |  |  |       |                |     |
|  | 1.3 (135)  |  | 10.94  | 02.98  |   |  |  |  |       |                |     |
| <b>SKODA FELICIA II (6U) (98-01)</b>   |  |  |  |  |   |  |  |  |       |                |     |
|  | 1.3 i  |  |  | 03.98  | 08.01   | 03.2123-1428.3   | 010476   |  |       | THz 23,81      | ATE |
|  | 1.6 i  |  | 03.98  | 08.01  |   |  |  |  |       |                |     |
|  | 1.9 D  |  | 03.98  | 08.01  |   |  |  |  |       |                |     |
|  | 1.3 i  |  |  | 03.98  | 08.01   | 24.3541-1737.5   | 240197   |  |       | D=54, - Halter | LUC |
|  | 1.6 i  |  | 03.98  | 08.01  |   |  |  |  |       |                |     |
|  | 1.9 D  |  | 03.98  | 08.01  |   |  |  |  |       |                |     |
|  | 1.3 i  |  |  | 03.98  | 08.01   | 24.5166-0325.3   | 331293   | 2  |       | L=325          |     |
|  | 1.6 i  |  | 03.98  | 08.01  |   |  |  |  |       |                |     |
|  | 1.9 D  |  | 03.98  | 08.01  |   |  |  |  |       |                |     |
|  | 1.3 i  |  |  | 03.98  | 08.98   | 24.5228-0180.3   | 330761   | 2  |       | L=180          |     |
|  | 1.6 i  |  | 03.98  | 08.98  |   |  |  |  |       |                |     |
|  | 1.9 D  |  | 03.98  | 08.98  |   |  |  |  |       |                |     |
|  | 1.3 i  |  |  | 09.98  | 08.01   | 83.6236-0175.3   | 330710   | 2  |       | L=175          |     |
|  | 1.6 i  |  | 09.98  | 08.01  |   |  |  |  |       |                |     |
|  | 1.9 D  |  | 09.98  | 08.01  |   |  |  |  |       |                |     |
|  | 1.3 i  |  |  | 03.98  | 08.01   | 24.3222-1712.3   | 020424   |  | - ABS | Rz 22,20       |     |
|  | 1.6 i  |  | 03.98  | 08.01  |   |  |  |  |       |                |     |
|  | 1.9 D  |  | 03.98  | 08.01  |   |  |  |  |       |                |     |
|  | 1.3 i  |  |  | 03.98  | 08.01   | 24.3219-1721.3   | 020422   |  | + ABS | Rz 19,05       |     |
|  | 1.6 i  |  | 03.98  | 08.01  |   |  |  |  |       |                |     |
|  | 1.9 D  |  | 03.98  | 08.01  |   |  |  |  |       |                |     |
|  | 1.3 i  |  |  | 03.98  | 08.01   | 24.3727-2500.2   | 582500   | 2  |       | L=1752         |     |
|  | 1.6 i  |  | 03.98  | 08.01  |   |  |  |  |       |                |     |
|  | 1.9 D  |  | 03.98  | 08.01  |   |  |  |  |       |                |     |
| <b>SKODA FELICIA PICK-UP (797) (97-00)</b>   |  |  |  |  |   |  |  |  |       |                |     |
|  | 1.3  | 40   |  | 06.97  | 12.00   | 24.2122-1731.3   | 010656   |  | - ABS | THz 22,20      | ATE |
|  | 1.3  | 50   |  | 06.97  | 12.00   |  |  |  |       |                |     |
|  | 1.6  | 55   |  | 06.97  | 12.99   |  |  |  |       |                |     |
|  | 1.9 D  | 47   |  | 06.97  | 12.00   |  |  |  |       |                |     |
|  | 1.3  | 40   |  | 06.97  | 12.00   | 24.3541-1737.5   | 240197   |  |       | D=54, - Halter | LUC |
|  | 1.3  | 50   |  | 06.97  | 12.00   |  |  |  |       |                |     |
|  | 1.6  | 55   |  | 06.97  | 12.99   |  |  |  |       |                |     |
|  | 1.9 D  | 47   |  | 06.97  | 12.00   |  |  |  |       |                |     |
|  | 1.3  | 40   |  | 06.97  | 12.00   | 24.5166-0325.3   | 331293   | 2  |       | L=325          |     |
|  | 1.3  | 50   |  | 06.97  | 12.00   |  |  |  |       |                |     |
|  | 1.6  | 55   |  | 06.97  | 12.99   |  |  |  |       |                |     |
|  | 1.9 D  | 47   |  | 06.97  | 12.00   |  |  |  |       |                |     |
|  | 1.3  | 40   |  | 06.97  | 12.00   | 83.6236-0175.3   | 330710   | 2  |       | L=175          |     |
|  | 1.3  | 50   |  | 06.97  | 12.00   |  |  |  |       |                |     |
|  | 1.6  | 55   |  | 06.97  | 12.99   |  |  |  |       |                |     |
|  | 1.9 D  | 47   |  | 06.97  | 12.00   |  |  |  |       |                |     |
|  | 1.3  | 40   |  | 06.97  | 12.00   | 24.3222-1712.3   | 020424   |  |       | Rz 22,20       |     |
|  | 1.3  | 50   |  | 06.97  | 12.00   |  |  |  |       |                |     |
|  | 1.6  | 55   |  | 06.97  | 12.99   |  |  |  |       |                |     |
|  | 1.9 D  | 47   |  | 06.97  | 12.00   |  |  |  |       |                |     |
|  | 1.3  | 40   |  | 06.97  | 12.00   | 24.3219-1721.3   | 020422   |  |       | Rz 19,05       |     |
|  | 1.3  | 50   |  | 06.97  | 12.00   |  |  |  |       |                |     |
|  | 1.6  | 55   |  | 06.97  | 12.99   |  |  |  |       |                |     |
|  | 1.9 D  | 47   |  | 06.97  | 12.00   |  |  |  |       |                |     |

|     |  |  |  |  |  |  |  |  |
|--|--|--|--|--|---|--|--|--|
| <b>SKODA FELICIA PICK-UP (797) (97-00)</b>   |  |  |  |  |   |  |  |  |
|    | 1.3  | 40   | 06.97  | 12.00  | 24.3727-2508.2  | 582508   | 2 ↓  | L=1782   |
|  | 1.3  | 50   | 06.97  | 12.00  |   |  |  |  |
|  | 1.6  | 55   | 06.97  | 12.99  |   |  |  |  |
|  | 1.9 D  | 47   | 06.97  | 12.00  |   |  |  |  |
|    | 1.3  | 40   | 06.97  | 12.00  | 03.6584-0107.3  | 320110   |  | BRL 8/4 (4) ATE  |
|  | 1.3  | 50   | 06.97  | 12.00  |   |  |  |  |
|  | 1.6  | 55   | 06.97  | 12.99  |   |  |  |  |
|  | 1.9 D  | 47   | 06.97  | 12.00  | 03.6583-0167.3  | 320140   |  | BRL 8/3 (4) ATE  |
|    | 1.3  | 40   | 06.96  | 12.00  | 24.3728-2500.2  | 592500   |  | L=742  |
|  | 1.6  | 55   | 06.96  | 12.99  |   |  |  |  |
| <b>SKODA FORMAN (785) (91-95)</b>  |  |  |  |  |   |  |  |  |
|    | 1.3  |  | 01.93  | 12.95  | 24.3219-1721.3  | 020422   |  | Rz 19,05   |
|  | 1.3 i  |  | 02.94  | 12.95  |   |  |  |  |
| <b>SKODA OCTAVIA I (1U) (97-10)</b>  |  |  |  |  |   |  |  |  |
|    | 1.4 i  | ↓  | 04.99  | 07.00  | 03.7863-0402.4  | 300124   | + ESP  | 10" ATE  |
|  | 1.6 i  | ↓  | 10.96  | 07.00  |   |  |  |  |
|  | 1.8 i 20V  | ↓ 92   | 10.96  | 07.00  |   |  |  |  |
|  | 1.8 i 20V Turbo  | ↓ 110  | 03.98  | 07.00  |   |  |  |  |
|  | 1.9 SDI  | ↓  | 05.97  | 07.00  |   |  |  |  |
|  | 1.9 TDI  | ↓ 66   | 10.96  | 07.00  |   |  |  |  |
|  | 1.9 TDI  | ↓ 81   | 08.97  | 07.00  |   |  |  |  |
|  | 1.9 TDI 4x4  | ↓  | 11.99  | 07.00  |   |  |  |  |
|  | 2.0 i  | ↓  | 04.99  | 07.00  |   |  |  |  |
|  | 2.0 i 4x4  | ↓ 88   | 01.00  | 07.00  |   |  |  |  |
|  | 1.4 i  | ↓  | 05.01  | 06.10  | PR: 1AC,1AH,1AJ,1AT   | 03.7863-3502.4   | 300128   | 10" ATE  |
|  | 1.6 i  | ↓  | 05.01  | 06.10  | PR: 1AC,1AH,1AJ,1AT   |  |  |  |
|  | 1.8 i 20V  | ↓ 92   | 05.01  | 06.10  | PR: 1AC,1AH,1AJ,1AT   |  |  |  |
|  | 1.8 i 20V Turbo  | ↓ 110  | 05.01  | 06.10  | PR: 1AC,1AH,1AJ,1AT   |  |  |  |
|  | 1.8 i 20V Turbo 4x4  | ↓ 110  | 05.01  | 06.10  | PR: 1AC,1AH,1AJ,1AT   |  |  |  |
|  | 1.9 SDI  | ↓  | 05.01  | 06.10  | PR: 1AC,1AH,1AJ,1AT   |  |  |  |
|  | 1.9 TDI  | ↓ 66   | 05.01  | 06.10  | PR: 1AC,1AH,1AJ,1AT   |  |  |  |
|  | 1.9 TDI  | ↓ 74   | 05.01  | 06.10  | PR: 1AC,1AH,1AJ,1AT   |  |  |  |
|  | 1.9 TDI  | ↓ 81   | 05.01  | 06.10  | PR: 1AC,1AH,1AJ,1AT   |  |  |  |
|  | 1.9 TDI  | ↓ 96   | 01.03  | 06.10  | PR: 1AC,1AH,1AJ,1AT   |  |  |  |
|  | 1.9 TDI 4x4  | ↓  | 05.01  | 06.10  | PR: 1AC,1AH,1AJ,1AT   |  |  |  |
|  | 2.0 i  | ↓  | 05.01  | 06.10  | PR: 1AC,1AH,1AJ,1AT   |  |  |  |
|  | 2.0 i 4x4  | ↓ 85   | 05.01  | 06.10  | PR: 1AC,1AH,1AJ,1AT   |  |  |  |
|  | 2.0 i 4x4  | ↓ 88   | 05.01  | 06.10  | PR: 1AC,1AH,1AJ,1AT   |  |  |  |
|  | RS 1.8 T 20V   | ↓ 132  | 05.01  | 06.10  | PR: 1AC,1AH,1AJ,1AT   |  |  |  |
|  | 1.4 i  | ↓  | 04.99  | 07.00  | 24.2123-1709.3  | 010503   | - ESP  | THz 23,81  |
|  | 1.6 i  | ↓  | 10.96  | 07.00  | 03.2123-2024.3  | 010597   | + ESP  | THz 23,81  |
|  | 1.8 i 20V  | ↓ 92   | 10.96  | 07.00  |   |  |  |  |
|  | 1.8 i 20V Turbo  | ↓ 110  | 03.98  | 07.00  |   |  |  |  |
|  | 1.9 SDI  | ↓  | 05.97  | 07.00  |   |  |  |  |
|  | 1.9 TDI  | ↓ 66   | 10.96  | 07.00  |   |  |  |  |
|  | 1.9 TDI  | ↓ 81   | 08.97  | 07.00  |   |  |  |  |
|  | 1.9 TDI 4x4  | ↓  | 11.99  | 07.00  |   |  |  |  |
|  | 2.0 i  | ↓  | 04.99  | 07.00  |   |  |  |  |
|  | 2.0 i 4x4  | ↓ 88   | 01.00  | 07.00  |   |  |  |  |
|  | 1.4 i  | ↓  | 08.00  | 06.10  | PR: 1AM   | 24.2123-1709.3   | 010503   | THz 23,81  |
|  | 1.6 i  | ↓  | 08.00  | 06.10  | PR: 1AM   |  |  |  |
|  | 1.8 i 20V  | ↓ 92   | 08.00  | 06.10  | PR: 1AM   |  |  |  |
|  | 1.8 i 20V Turbo  | ↓ 110  | 08.00  | 06.10  | PR: 1AM   |  |  |  |
|  | 1.8 i 20V Turbo 4x4  | ↓ 110  | 05.01  | 06.10  | PR: 1AM   |  |  |  |
|  | 1.9 SDI  | ↓  | 08.00  | 06.10  | PR: 1AM   |  |  |  |
|  | 1.9 TDI  | ↓ 66   | 08.00  | 06.10  | PR: 1AM   |  |  |  |
|  | 1.9 TDI  | ↓ 74   | 08.00  | 06.10  | PR: 1AM   |  |  |  |
|  | 1.9 TDI  | ↓ 81   | 08.00  | 06.10  | PR: 1AM   |  |  |  |
|  | 1.9 TDI  | ↓ 96   | 01.03  | 06.10  | PR: 1AM   |  |  |  |
|  | 1.9 TDI 4x4  | ↓  | 08.00  | 06.10  | PR: 1AM   |  |  |  |
|  | 2.0 i  | ↓  | 08.00  | 06.10  | PR: 1AM   |  |  |  |
|  | 2.0 i 4x4  | ↓ 85   | 05.01  | 06.10  | PR: 1AM   |  |  |  |
|  | 2.0 i 4x4  | ↓ 88   | 08.00  | 06.10  | PR: 1AM   |  |  |  |
|  | RS 1.8 T 20V   | ↓ 132  | 05.01  | 06.10  | PR: 1AM   |  |  |  |
|  | 1.4 i  | ↓  | 08.00  | 06.10  | PR: 1AC,1AH,1AJ   | 03.2123-2963.3   | 010804   | THz 23,81  |
|  | 1.6 i  | ↓  | 08.00  | 06.10  | PR: 1AC,1AH,1AJ   |  |  |  |
|  | 1.8 i 20V  | ↓ 92   | 08.00  | 06.10  | PR: 1AC,1AH,1AJ   |  |  |  |
|  | 1.8 i 20V Turbo  | ↓ 110  | 08.00  | 06.10  | PR: 1AC,1AH,1AJ   |  |  |  |
|  | 1.8 i 20V Turbo 4x4  | ↓ 110  | 05.01  | 06.10  | PR: 1AC,1AH,1AJ   |  |  |  |
|  | 1.9 SDI  | ↓  | 08.00  | 06.10  | PR: 1AC,1AH,1AJ   |  |  |  |
|  | 1.9 TDI  | ↓ 66   | 08.00  | 06.10  | PR: 1AC,1AH,1AJ   |  |  |  |
|  | 1.9 TDI  | ↓ 74   | 08.00  | 06.10  | PR: 1AC,1AH,1AJ   |  |  |  |
|  | 1.9 TDI  | ↓ 81   | 08.00  | 06.10  | PR: 1AC,1AH,1AJ   |  |  |  |
|  | 1.9 TDI  | ↓ 96   | 01.03  | 06.10  | PR: 1AC,1AH,1AJ   |  |  |  |
|  | 1.9 TDI 4x4  | ↓  | 08.00  | 06.10  | PR: 1AC,1AH,1AJ   |  |  |  |
|  | 2.0 i  | ↓  | 08.00  | 06.10  | PR: 1AC,1AH,1AJ   |  |  |  |
|  | 2.0 i 4x4  | ↓ 85   | 05.01  | 06.10  | PR: 1AC,1AH,1AJ   |  |  |  |
|  | 2.0 i 4x4  | ↓ 88   | 08.00  | 06.10  | PR: 1AC,1AH,1AJ   |  |  |  |
|  | RS 1.8 T 20V   | ↓ 132  | 05.01  | 06.10  | PR: 1AC,1AH,1AJ   |  |  |  |
|  | 1.4 i  | ↓  | 08.00  | 06.10  | PR: 1AT   | 03.2123-2715.3   | 010802   | THz 23,81  |
|  | 1.6 i  | ↓  | 08.00  | 06.10  | PR: 1AT   |  |  |  |
|  | 1.8 i 20V  | ↓ 92   | 08.00  | 06.10  | PR: 1AT   |  |  |  |



| SKODA OCTAVIA I (1U) (97-10) |                     |                 |                     |                         |                         |                |                |                |                |                |                |                |                |                |        |               |     |                |        |            |     |                |        |                |     |
|------------------------------|---------------------|-----------------|---------------------|-------------------------|-------------------------|----------------|----------------|----------------|----------------|----------------|----------------|----------------|----------------|----------------|--------|---------------|-----|----------------|--------|------------|-----|----------------|--------|----------------|-----|
|                              | 1.8 i 20V Turbo     | 110             | 08.00               | 06.10                   | PR: 1AT                 | 03.2123-2715.3 | 010802         |                |                | Thz 23,81      | ATE            |                |                |                |        |               |     |                |        |            |     |                |        |                |     |
|                              | 1.8 i 20V Turbo 4x4 | 110             | 05.01               | 06.10                   | PR: 1AT                 |                |                |                |                |                |                |                |                |                |        |               |     |                |        |            |     |                |        |                |     |
|                              | 1.9 SDI             |                 | 08.00               | 06.10                   | PR: 1AT                 |                |                |                |                |                |                |                |                |                |        |               |     |                |        |            |     |                |        |                |     |
|                              | 1.9 TDI             | 66              | 08.00               | 06.10                   | PR: 1AT                 |                |                |                |                |                |                |                |                |                |        |               |     |                |        |            |     |                |        |                |     |
|                              | 1.9 TDI             | 74              | 08.00               | 06.10                   | PR: 1AT                 |                |                |                |                |                |                |                |                |                |        |               |     |                |        |            |     |                |        |                |     |
|                              | 1.9 TDI             | 81              | 08.00               | 06.10                   | PR: 1AT                 |                |                |                |                |                |                |                |                |                |        |               |     |                |        |            |     |                |        |                |     |
|                              | 1.9 TDI             | 96              | 01.03               | 06.10                   | PR: 1AT                 |                |                |                |                |                |                |                |                |                |        |               |     |                |        |            |     |                |        |                |     |
|                              | 1.9 TDI 4x4         |                 | 08.00               | 06.10                   | PR: 1AT                 |                |                |                |                |                |                |                |                |                |        |               |     |                |        |            |     |                |        |                |     |
|                              | 2.0 i               |                 | 08.00               | 06.10                   | PR: 1AT                 |                |                |                |                |                |                |                |                |                |        |               |     |                |        |            |     |                |        |                |     |
|                              | 2.0 i 4x4           | 85              | 05.01               | 06.10                   | PR: 1AT                 |                |                |                |                |                |                |                |                |                |        |               |     |                |        |            |     |                |        |                |     |
|                              | 2.0 i 4x4           | 88              | 08.00               | 06.10                   | PR: 1AT                 |                |                |                |                |                |                |                |                |                |        |               |     |                |        |            |     |                |        |                |     |
|                              | RS 1.8 T 20V        | 132             | 05.01               | 06.10                   | PR: 1AT                 |                |                |                |                |                |                |                |                |                |        |               |     |                |        |            |     |                |        |                |     |
|                              |                     | 1.4 i           |                     | 04.99                   | 07.00                   |                |                |                |                |                |                |                | 03.2123-2064.3 | 010598         | + ESP  | Thz 23,81     | ATE |                |        |            |     |                |        |                |     |
| 1.6 i                        |                     |                 | 10.96               | 07.00                   |                         |                |                |                |                |                |                |                |                |                |        |               |     |                |        |            |     |                |        |                |     |
| 1.8 i 20V                    |                     | 92              | 10.96               | 07.00                   |                         |                |                |                |                |                |                |                |                |                |        |               |     |                |        |            |     |                |        |                |     |
| 1.8 i 20V Turbo              |                     | 110             | 03.98               | 07.00                   |                         |                |                |                |                |                |                |                |                |                |        |               |     |                |        |            |     |                |        |                |     |
| 1.9 SDI                      |                     |                 | 05.97               | 07.00                   |                         |                |                |                |                |                |                |                |                |                |        |               |     |                |        |            |     |                |        |                |     |
| 1.9 TDI                      |                     | 66              | 10.96               | 07.00                   |                         |                |                |                |                |                |                |                |                |                |        |               |     |                |        |            |     |                |        |                |     |
| 1.9 TDI                      |                     | 81              | 08.97               | 07.00                   |                         |                |                |                |                |                |                |                |                |                |        |               |     |                |        |            |     |                |        |                |     |
| 1.9 TDI 4x4                  |                     |                 | 11.99               | 07.00                   |                         |                |                |                |                |                |                |                |                |                |        |               |     |                |        |            |     |                |        |                |     |
| 2.0 i                        |                     |                 | 04.99               | 07.00                   |                         |                |                |                |                |                |                |                |                |                |        |               |     |                |        |            |     |                |        |                |     |
| 2.0 i 4x4                    |                     | 88              | 01.00               | 07.00                   |                         |                |                |                |                |                |                |                |                |                |        |               |     |                |        |            |     |                |        |                |     |
|                              |                     | 1.4 i           |                     | 08.00                   | 06.10                   | PR: 1AT        | 03.2123-2774.3 | 010803         |                | Thz 23,81      | ATE            |                |                |                |        |               |     |                |        |            |     |                |        |                |     |
|                              |                     | 1.6 i           |                     | 08.00                   | 06.10                   | PR: 1AT        |                |                |                |                |                |                |                |                |        |               |     |                |        |            |     |                |        |                |     |
|                              |                     | 1.8 i 20V       | 92                  | 08.00                   | 06.10                   | PR: 1AT        |                |                |                |                |                |                |                |                |        |               |     |                |        |            |     |                |        |                |     |
|                              | 1.8 i 20V Turbo     | 110             | 08.00               | 06.10                   | PR: 1AT                 |                |                |                |                |                |                |                |                |                |        |               |     |                |        |            |     |                |        |                |     |
|                              | 1.8 i 20V Turbo 4x4 | 110             | 05.01               | 06.10                   | PR: 1AT                 |                |                |                |                |                |                |                |                |                |        |               |     |                |        |            |     |                |        |                |     |
|                              | 1.9 SDI             |                 | 08.00               | 06.10                   | PR: 1AT                 |                |                |                |                |                |                |                |                |                |        |               |     |                |        |            |     |                |        |                |     |
|                              | 1.9 TDI             | 66              | 08.00               | 06.10                   | PR: 1AT                 |                |                |                |                |                |                |                |                |                |        |               |     |                |        |            |     |                |        |                |     |
|                              | 1.9 TDI             | 74              | 08.00               | 06.10                   | PR: 1AT                 |                |                |                |                |                |                |                |                |                |        |               |     |                |        |            |     |                |        |                |     |
|                              | 1.9 TDI             | 81              | 08.00               | 06.10                   | PR: 1AT                 |                |                |                |                |                |                |                |                |                |        |               |     |                |        |            |     |                |        |                |     |
|                              | 1.9 TDI             | 96              | 01.03               | 06.10                   | PR: 1AT                 |                |                |                |                |                |                |                |                |                |        |               |     |                |        |            |     |                |        |                |     |
|                              | 1.9 TDI 4x4         |                 | 08.00               | 06.10                   | PR: 1AT                 |                |                |                |                |                |                |                |                |                |        |               |     |                |        |            |     |                |        |                |     |
|                              | 2.0 i               |                 | 08.00               | 06.10                   | PR: 1AT                 |                |                |                |                |                |                |                |                |                |        |               |     |                |        |            |     |                |        |                |     |
|                              | 2.0 i 4x4           | 85              | 05.01               | 06.10                   | PR: 1AT                 |                |                |                |                |                |                |                |                |                |        |               |     |                |        |            |     |                |        |                |     |
| 2.0 i 4x4                    | 88                  | 08.00           | 06.10               | PR: 1AT                 |                         |                |                |                |                |                |                |                |                |                |        |               |     |                |        |            |     |                |        |                |     |
| RS 1.8 T 20V                 | 132                 | 05.01           | 06.10               | PR: 1AT                 |                         |                |                |                |                |                |                |                |                |                |        |               |     |                |        |            |     |                |        |                |     |
|                              | 1.6 i               |                 | 1U-W-104149         | 10.96                   | PR: 1LQ,1LR,1LS,1ZM     | 11.9541-9549.2 | 220575         |                | D=54, - Halter | ATE            |                |                |                |                |        |               |     |                |        |            |     |                |        |                |     |
|                              | 1.8 i 20V           | 92              | 1U-W-104149         | 10.96                   | PR: 1LQ,1LR,1LS,1ZM     |                |                |                |                |                |                |                |                |                |        |               |     |                |        |            |     |                |        |                |     |
|                              | 1.8 i 20V Turbo     | 110             | 1U-W-104149         | 03.98                   | PR: 1LQ,1LR,1LS,1ZM     |                |                |                |                |                |                |                |                |                |        |               |     |                |        |            |     |                |        |                |     |
|                              | 1.9 SDI             |                 | 1U-W-104149         | 05.97                   | PR: 1LQ,1LR,1LS,1ZM     |                |                |                |                |                |                |                |                |                |        |               |     |                |        |            |     |                |        |                |     |
|                              | 1.9 TDI             | 66              | 1U-W-104149         | 10.96                   | PR: 1LQ,1LR,1LS,1ZM     |                |                |                |                |                |                |                |                |                |        |               |     |                |        |            |     |                |        |                |     |
|                              | 1.9 TDI             | 81              | 1U-W-104149         | 08.97                   | PR: 1LQ,1LR,1LS,1ZM     |                |                |                |                |                |                |                |                |                |        |               |     |                |        |            |     |                |        |                |     |
|                              | 1.4 i               |                 | 04.99               | 06.10                   | PR: 1LQ,1LR,1LS,1ZM     |                |                |                |                |                | 11.9541-9549.2 | 220575         | D=54, - Halter | ATE            |        |               |     |                |        |            |     |                |        |                |     |
|                              | 1.6 i               | 1U-W-104150     | 06.10               | PR: 1LQ,1LR,1LS,1ZM     |                         |                |                |                |                |                |                |                |                |                |        |               |     |                |        |            |     |                |        |                |     |
|                              | 1.8 i 20V           | 92 1U-W-104150  | 06.10               | PR: 1LQ,1LR,1LS,1ZM     |                         |                |                |                |                |                |                |                |                |                |        |               |     |                |        |            |     |                |        |                |     |
|                              | 1.8 i 20V Turbo     | 110 1U-W-104150 | 06.10               | PR: 1LQ,1LR,1LS,1ZM     |                         |                |                |                |                |                |                |                |                |                |        |               |     |                |        |            |     |                |        |                |     |
|                              | 1.8 i 20V Turbo 4x4 | 110             | 05.01               | 06.10                   | PR: 1LQ,1LR,1LS,1ZM     |                |                |                |                |                |                |                |                |                |        |               |     |                |        |            |     |                |        |                |     |
|                              | 1.9 SDI             | 1U-W-104150     | 06.10               | PR: 1LQ,1LR,1LS,1ZM     |                         |                |                |                |                |                |                |                |                |                |        |               |     |                |        |            |     |                |        |                |     |
|                              | 1.9 TDI             | 66 1U-W-104150  | 06.10               | PR: 1LQ,1LR,1LS,1ZM     |                         |                |                |                |                |                |                |                |                |                |        |               |     |                |        |            |     |                |        |                |     |
| 1.9 TDI                      | 74 1U-W-104150      | 08.00           | 06.10               | PR: 1LQ,1LR,1LS,1ZM     |                         |                |                |                |                |                |                |                |                |                |        |               |     |                |        |            |     |                |        |                |     |
| 1.9 TDI                      | 81 1U-W-104150      | 06.10           | PR: 1LQ,1LR,1LS,1ZM |                         |                         |                |                |                |                |                |                |                |                |                |        |               |     |                |        |            |     |                |        |                |     |
| 1.9 TDI                      | 96                  | 01.03           | 06.10               | PR: 1LQ,1LR,1LS,1ZM     |                         |                |                |                |                |                |                |                |                |                |        |               |     |                |        |            |     |                |        |                |     |
| 1.9 TDI 4x4                  |                     | 11.99           | 06.10               | PR: 1LQ,1LR,1LS,1ZM     |                         |                |                |                |                |                |                |                |                |                |        |               |     |                |        |            |     |                |        |                |     |
| 2.0 i                        |                     | 04.99           | 06.10               | PR: 1LQ,1LR,1LS,1ZM     |                         |                |                |                |                |                |                |                |                |                |        |               |     |                |        |            |     |                |        |                |     |
| 2.0 i 4x4                    | 85                  | 05.01           | 06.10               | PR: 1LQ,1LR,1LS,1ZM     |                         |                |                |                |                |                |                |                |                |                |        |               |     |                |        |            |     |                |        |                |     |
| 2.0 i 4x4                    | 88                  | 01.00           | 06.10               | PR: 1LQ,1LR,1LS,1ZM     |                         |                |                |                |                |                |                |                |                |                |        |               |     |                |        |            |     |                |        |                |     |
|                              | 1.4 i               |                 | 04.99               | 06.10                   | PR: 1LN,1LE,1ZD,1ZE,1ZH | 11.3541-8523.2 | 220115         | D=54, - Halter | ATE            |                |                |                |                |                |        |               |     |                |        |            |     |                |        |                |     |
|                              | 1.6 i               |                 | 10.96               | 06.10                   | PR: 1LN,1LE,1ZD,1ZE,1ZH |                |                |                |                |                |                |                |                |                |        |               |     |                |        |            |     |                |        |                |     |
|                              | 1.8 i 20V           | 92              | 10.96               | 06.10                   | PR: 1LN,1LE,1ZD,1ZE,1ZH |                |                |                |                |                |                |                |                |                |        |               |     |                |        |            |     |                |        |                |     |
|                              | 1.8 i 20V Turbo     | 110             | 03.98               | 06.10                   | PR: 1LN,1LE,1ZD,1ZE,1ZH |                |                |                |                |                |                |                |                |                |        |               |     |                |        |            |     |                |        |                |     |
|                              | 1.8 i 20V Turbo 4x4 | 110             | 05.01               | 06.10                   | PR: 1LN,1LE,1ZD,1ZE,1ZH |                |                |                |                |                |                |                |                |                |        |               |     |                |        |            |     |                |        |                |     |
|                              | 1.9 SDI             |                 | 05.97               | 06.10                   | PR: 1LN,1LE,1ZD,1ZE,1ZH |                |                |                |                |                |                |                |                |                |        |               |     |                |        |            |     |                |        |                |     |
|                              | 1.9 TDI             | 66              | 10.96               | 06.10                   | PR: 1LN,1LE,1ZD,1ZE,1ZH |                |                |                |                |                |                |                |                |                |        |               |     |                |        |            |     |                |        |                |     |
|                              | 1.9 TDI             | 74              | 08.00               | 06.10                   | PR: 1LN,1LE,1ZD,1ZE,1ZH |                |                |                |                |                |                |                |                |                |        |               |     |                |        |            |     |                |        |                |     |
|                              | 1.9 TDI             | 81              | 08.97               | 06.10                   | PR: 1LN,1LE,1ZD,1ZE,1ZH |                |                |                |                |                |                |                |                |                |        |               |     |                |        |            |     |                |        |                |     |
|                              | 1.9 TDI             | 96              | 01.03               | 06.10                   | PR: 1LN,1LE,1ZD,1ZE,1ZH |                |                |                |                |                |                |                |                |                |        |               |     |                |        |            |     |                |        |                |     |
|                              | 1.9 TDI 4x4         |                 | 11.99               | 06.10                   | PR: 1LN,1LE,1ZD,1ZE,1ZH |                |                |                |                |                |                |                |                |                |        |               |     |                |        |            |     |                |        |                |     |
|                              | 2.0 i               |                 | 04.99               | 06.10                   | PR: 1LN,1LE,1ZD,1ZE,1ZH |                |                |                |                |                |                |                |                |                |        |               |     |                |        |            |     |                |        |                |     |
|                              | 2.0 i 4x4           | 85              | 05.01               | 06.10                   | PR: 1LN,1LE,1ZD,1ZE,1ZH |                |                |                |                |                |                |                |                |                |        |               |     |                |        |            |     |                |        |                |     |
| 2.0 i 4x4                    | 88                  | 01.00           | 06.10               | PR: 1LN,1LE,1ZD,1ZE,1ZH |                         |                |                |                |                |                |                |                |                |                |        |               |     |                |        |            |     |                |        |                |     |
|                              | RS 1.8 T 20V        | 132             | 05.01               | 06.10                   | PR: 1ZN                 | 11.9541-9595.2 | 220501         | D=54, - Halter | ATE            |                |                |                |                |                |        |               |     |                |        |            |     |                |        |                |     |
|                              |                     |                 |                     |                         |                         |                |                |                |                | 11.9541-9596.2 | 220502         | D=54, - Halter | ATE            |                |        |               |     |                |        |            |     |                |        |                |     |
|                              |                     |                 |                     |                         |                         |                |                |                |                |                |                |                |                | 11.0441-5409.2 | 250031 | Dichtungssatz | ATE |                |        |            |     |                |        |                |     |
|                              |                     |                 |                     |                         |                         |                |                |                |                |                |                |                |                |                |        |               |     | 11.0101-5409.2 | 260035 | Hülsensatz | ATE |                |        |                |     |
|                              |                     |                 |                     |                         |                         |                |                |                |                |                |                |                |                |                |        |               |     |                |        |            |     | 11.8171-0008.1 | 990049 | Führungsbolzen | ATE |
|                              |                     |                 |                     |                         |                         |                |                |                |                |                |                |                |                |                |        |               |     |                |        |            |     |                |        |                |     |
|                              |                     |                 |                     |                         |                         |                |                |                |                |                |                |                |                |                |        |               |     |                |        |            |     |                |        |                |     |
|                              | 1.4 i               |                 | 04.99               | 06.10                   |                         | 83.7838-0435.3 | 330834         | 2              | L=435          |                |                |                |                |                |        |               |     |                |        |            |     |                |        |                |     |
|                              | 1.6 i               |                 | 10.96               | 06.10                   |                         |                |                |                |                |                |                |                |                |                |        |               |     |                |        |            |     |                |        |                |     |
|                              | 1.8 i 20V           | 92              | 10.96               | 06.10                   |                         |                |                |                |                |                |                |                |                |                |        |               |     |                |        |            |     |                |        |                |     |
|                              | 1.8 i 20V Turbo     | 110             | 03.98               | 06.10                   |                         |                |                |                |                |                |                |                |                |                |        |               |     |                |        |            |     |                |        |                |     |
|                              | 1.9 SDI             |                 | 05.97               | 06.10                   |                         |                |                |                |                |                |                |                |                |                |        |               |     |                |        |            |     |                |        |                |     |
|                              | 1.9 TDI             | 66              | 10.96               | 06.10                   |                         |                |                |                |                |                |                |                |                |                |        |               |     |                |        |            |     |                |        |                |     |
|                              | 1.9 TDI             | 74              | 08.00               | 06.10                   |                         |                |                |                |                |                |                |                |                |                |        |               |     |                |        |            |     |                |        |                |     |
|                              | 1.9 TDI             | 81              | 08.97               | 06.10                   |                         |                |                |                |                |                |                |                |                |                |        |               |     |                |        |            |     |                |        |                |     |
|                              | 1.9 TDI             | 96              | 01.03               | 06.10                   |                         |                |                |                |                |                |                |                |                |                |        |               |     |                |        |            |     |                |        |                |     |
| 2.0 i                        |                     | 04.99           | 06.10               |                         |                         |                |                |                |                |                |                |                |                |                |        |               |     |                |        |            |     |                |        |                |     |

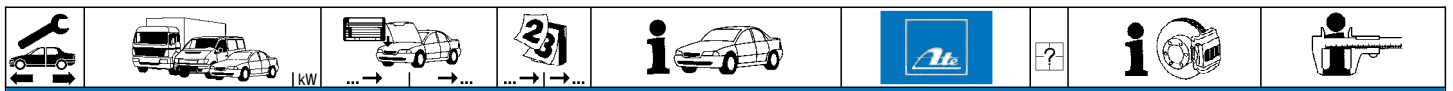

**SKODA OCTAVIA I (1U) (97-10)**

|  |  |  |  |   |  |                                  |                  |  |  |                  |
|--|--|--|--|---|--|----------------------------------|------------------|--|--|------------------|
|  | 1.8 i 20V Turbo 4x4<br>1.9 TDI 4x4<br>2.0 i 4x4<br>2.0 i 4x4<br>RS 1.8 T 20V   | 110<br>85<br>88<br>132                               |  | 05.01<br>11.99<br>05.01<br>01.00<br>05.01   | 06.10<br>06.10<br>06.10<br>06.10<br>06.10  | 83.6247-0562.3                   | 330594           | 2  |  | L=560            |
|  | 1.8 i 20V<br>1.8 i 20V Turbo<br>1.9 SDI<br>1.9 TDI   | 92<br>110<br>81                                      | 1U-W-129 999<br>1U-W-129 999<br>1U-W-129 999<br>1U-W-129 999   | 10.96<br>03.98<br>05.97<br>08.97  | PR: 1KK,1KS<br>PR: 1KK,1KS<br>PR: 1KK,1KS<br>PR: 1KK,1KS   | 24.3384-1723.7<br>24.3384-1724.7 | 220523<br>220524 | <input type="checkbox"/><br><input type="checkbox"/> | D=38(M12x1), - Halter<br>D=38(M12x1), - Halter                                   | LUC<br>LUC       |
|  | 1.6 i<br>1.8 i 20V<br>1.8 i 20V Turbo<br>1.9 SDI<br>1.9 TDI<br>1.9 TDI<br>2.0 i  | 92<br>110<br>110<br>66<br>81<br>96                   | 1U-Y-294 000<br>1U-W-130 000<br>1U-W-130 000<br>1U-W-130 000<br>1U-Y-294 000<br>1U-Y-294 000   | 10.96<br>10.96<br>10.96<br>10.96<br>04.99   | PR: 1KP<br>PR: 1KP<br>PR: 1KP<br>PR: 1KP<br>PR: 1KP<br>PR: 1KP   | 24.3414-1703.7<br>24.3414-1704.7 | 220535<br>220536 | <input type="checkbox"/><br><input type="checkbox"/> | D=41, - Halter<br>D=41, - Halter   | LUC<br>LUC       |
|  | 1.6 i<br>1.8 i 20V<br>1.8 i 20V Turbo<br>1.8 i 20V Turbo 4x4<br>1.9 SDI<br>1.9 TDI<br>1.9 TDI<br>1.9 TDI<br>1.9 TDI<br>1.9 TDI<br>1.9 TDI 4x4<br>2.0 i<br>2.0 i 4x4<br>2.0 i 4x4 | 92<br>110<br>110<br>66<br>74<br>81<br>96<br>85<br>88 | 1U-Y-294 001<br>1U-Y-294 001<br>1U-Y-294 001<br>1U-Y-294 001<br>1U-Y-294 001<br>1U-Y-294 001<br>1U-Y-294 001<br>1U-Y-294 001<br>1U-Y-294 001<br>1U-Y-294 001<br>1U-Y-294 001 | 06.10<br>06.10<br>06.10<br>05.01<br>08.00<br>08.00<br>01.03<br>11.99<br>05.01<br>01.00          | PR: 1KP<br>PR: 1KP<br>PR: 1KP<br>PR: 1KE<br>PR: 1KP<br>PR: 1KP<br>PR: 1KP<br>PR: 1KP<br>PR: 1KE<br>PR: 1KE   | 24.3414-1705.7<br>24.3414-1706.7 | 220549<br>220550 | <input type="checkbox"/><br><input type="checkbox"/> | D=41, - Halter<br>D=41, - Halter   | LUC<br>LUC       |
|  | 1.4 i<br>1.6 i<br>1.8 i 20V<br>1.8 i 20V Turbo<br>1.9 SDI<br>1.9 TDI<br>1.9 TDI<br>1.9 TDI<br>1.9 TDI<br>2.0 i<br>RS 1.8 T 20V   | 92<br>110<br>66<br>74<br>81<br>96<br>132             |  | 04.99<br>10.96<br>10.96<br>03.98<br>05.97<br>10.96<br>08.00<br>08.97<br>01.03<br>04.99<br>05.01 | 06.10<br>06.10<br>06.10<br>06.10<br>06.10<br>06.10<br>06.10<br>06.10<br>06.10<br>06.10<br>06.10  | 83.7858-0140.3                   | 330837           | 2  | L=140  |                  |
|  | 1.8 i 20V Turbo 4x4<br>1.9 TDI 4x4<br>2.0 i 4x4<br>2.0 i 4x4   | 110<br>85<br>88                                      |  | 05.01<br>11.99<br>05.01<br>01.00  | 06.10<br>06.10<br>06.10<br>06.10   | 83.7858-0140.3                   | 330837           | 2  | L=140  |                  |
|  | 1.4 i<br>1.6 i<br>1.9 SDI<br>1.9 TDI   | 66   |  | 04.99<br>10.96<br>05.97<br>10.96  | 06.10<br>06.10<br>06.10<br>06.10   | 24.3220-0909.3                   | 020210           |  | Rz 20,64   |                  |
|  | 1.4 i<br>1.6 i<br>1.9 SDI<br>1.9 TDI   | 66   |  | 04.99<br>10.96<br>05.97<br>10.96  | 06.10<br>06.10<br>06.10<br>06.10   | 24.3219-0909.3                   | 020188           |  | Rz 19,05   |                  |
|  | 1.4 i<br>1.6 i<br>1.9 SDI<br>1.9 TDI   | 66   | 1U-Y-294000<br>1U-Y-294000<br>1U-Y-294000<br>1U-Y-294000   | 04.99<br>10.96<br>05.97<br>10.96  | + Trommelbremse <sup>1)</sup><br>+ Trommelbremse <sup>1)</sup><br>+ Trommelbremse <sup>1)</sup><br>+ Trommelbremse <sup>1)</sup>   | 24.3727-2503.2<br>24.3727-2505.2 | 582503<br>582505 | 2<br>2   | - Schlechtwegeausführung <sup>2)</sup><br>+ Schlechtwegeausführung <sup>3)</sup> | L=1620<br>L=1620 |
|  | 1.4 i<br>1.6 i<br>1.9 SDI<br>1.9 TDI   | 66   | 1U-Y-294001<br>1U-Y-294001<br>1U-Y-294001<br>1U-Y-294001   |   | 06.10<br>06.10<br>06.10<br>06.10   | 24.3727-2509.2<br>24.3727-2511.2 | 582509<br>582511 | 2<br>2   |  | L=1620<br>L=1620 |
|  | 1.6 i<br>1.8 i 20V<br>1.8 i 20V Turbo<br>1.9 SDI<br>1.9 TDI<br>1.9 TDI<br>2.0 i  | 92<br>110<br>66<br>81                                | 1U-Y-294000<br>1U-Y-294000<br>1U-Y-294000<br>1U-Y-294000<br>1U-Y-294000<br>1U-Y-294000   | 10.96<br>10.96<br>03.98<br>05.97<br>10.96<br>08.97<br>04.99                                     | + Scheibenbremse <sup>4)</sup><br>+ Scheibenbremse <sup>4)</sup><br>+ Scheibenbremse <sup>4)</sup><br>+ Scheibenbremse <sup>4)</sup><br>+ Scheibenbremse <sup>4)</sup><br>+ Scheibenbremse <sup>4)</sup><br>+ Scheibenbremse <sup>4)</sup> | 24.3727-0149.2                   | 580149           | 2  | L=1688   |                  |
|  | 1.6 i<br>1.8 i 20V<br>1.8 i 20V Turbo<br>1.9 SDI<br>1.9 TDI<br>1.9 TDI<br>2.0 i  | 92<br>110<br>66<br>81                                | 1U-Y-294001<br>1U-Y-294001<br>1U-Y-294001<br>1U-Y-294001<br>1U-Y-294001<br>1U-Y-294001   | 07.00<br>07.00<br>07.00<br>07.00<br>07.00<br>07.00  | + Scheibenbremse <sup>4)</sup><br>+ Scheibenbremse <sup>4)</sup><br>+ Scheibenbremse <sup>4)</sup><br>+ Scheibenbremse <sup>4)</sup><br>+ Scheibenbremse <sup>4)</sup><br>+ Scheibenbremse <sup>4)</sup>                                   | 24.3727-0173.2                   | 580173           | 2  | L=1693   |                  |
|  | 1.8 i 20V Turbo 4x4<br>1.9 TDI 4x4<br>2.0 i 4x4<br>2.0 i 4x4   | 110<br>85<br>88                                      |  | 05.01<br>11.99<br>05.01<br>01.00  | 06.10<br>06.10<br>06.10<br>06.10   | 24.3727-0175.2                   | 580175           | 2  | L=1723   |                  |
|  | 1.4 i<br>1.6 i<br>1.9 SDI<br>1.9 TDI   | 66   |  | 04.99<br>10.96<br>05.97<br>10.96  | 06.10<br>06.10<br>06.10<br>06.10   | 03.6584-0107.3                   | 320110           |  | BRL 8/4 (4)  | ATE              |
|  | 1.4 i<br>1.6 i<br>1.8 i 20V  | 92   |  | 04.99<br>10.96<br>10.96   | 06.10<br>06.10<br>06.10  | 03.6583-0179.3                   | 320228           |  | BRL 8/3 (4)  | ATE              |

1) + drum brake / + freno a tamburo / + freins à tambour / + tambores de freno  
 2) - rough road construction / - versione per percorsi accidentati / - version pour mauvaise route / - versión 4x4  
 3) + rough road construction / + versione per percorsi accidentati / + version pour mauvaise route / + versión 4x4  
 4) + disc brake / + disco freno / + disques de frein / + disco de freno





### SKODA OCTAVIA I (1U) (97-10)

|              |                     |       |       |                                |                                |                |        |  |             |     |
|--------------|---------------------|-------|-------|--------------------------------|--------------------------------|----------------|--------|--|-------------|-----|
|              | 1.8 i 20V Turbo     | 110   | 03.98 | 06.10                          | + Scheibenbremse <sup>1)</sup> | 03.6583-0179.3 | 320228 |  | BRL 8/3 (4) | ATE |
|              | 1.8 i 20V Turbo 4x4 | 110   | 05.01 | 06.10                          | + Scheibenbremse <sup>1)</sup> |                |        |  |             |     |
|              | 1.9 SDI             |       | 05.97 | 06.10                          | + Scheibenbremse <sup>1)</sup> |                |        |  |             |     |
|              | 1.9 TDI             | 66    | 10.96 | 06.10                          | + Scheibenbremse <sup>1)</sup> |                |        |  |             |     |
|              | 1.9 TDI             | 74    | 08.00 | 06.10                          | + Scheibenbremse <sup>1)</sup> |                |        |  |             |     |
|              | 1.9 TDI             | 81    | 08.97 | 06.10                          | + Scheibenbremse <sup>1)</sup> |                |        |  |             |     |
|              | 1.9 TDI             | 96    | 01.03 | 06.10                          | + Scheibenbremse <sup>1)</sup> |                |        |  |             |     |
|              | 1.9 TDI 4x4         |       | 11.99 | 06.10                          | + Scheibenbremse <sup>1)</sup> |                |        |  |             |     |
|              | 2.0 i               |       | 04.99 | 06.10                          | + Scheibenbremse <sup>1)</sup> |                |        |  |             |     |
|              | 2.0 i 4x4           | 85    | 05.01 | 06.10                          | + Scheibenbremse <sup>1)</sup> |                |        |  |             |     |
|              | 2.0 i 4x4           | 88    | 01.00 | 06.10                          | + Scheibenbremse <sup>1)</sup> |                |        |  |             |     |
| RS 1.8 T 20V | 132                 | 05.01 | 06.10 | + Scheibenbremse <sup>1)</sup> |                                |                |        |  |             |     |
|              | 1.4 i               | ↔     | 04.99 | 06.10                          |                                | 24.2415-1701.3 | 030095 |  | Gz 15,87    |     |
|              | 1.6 i               | ↔     | 10.96 | 06.10                          |                                |                |        |  |             |     |
|              | 1.8 i 20V           | ↔ 92  | 10.96 | 06.10                          |                                |                |        |  |             |     |
|              | 1.8 i 20V Turbo     | ↔ 110 | 03.98 | 06.10                          |                                |                |        |  |             |     |
|              | 1.8 i 20V Turbo 4x4 | ↔ 110 | 05.01 | 06.10                          |                                |                |        |  |             |     |
|              | 1.9 SDI             | ↔     | 05.97 | 06.10                          |                                |                |        |  |             |     |
|              | 1.9 TDI             | ↔ 66  | 10.96 | 06.10                          |                                |                |        |  |             |     |
|              | 1.9 TDI             | ↔ 74  | 08.00 | 06.10                          |                                |                |        |  |             |     |
|              | 1.9 TDI             | ↔ 81  | 08.97 | 06.10                          |                                |                |        |  |             |     |
|              | 1.9 TDI             | ↔ 96  | 01.03 | 06.10                          |                                |                |        |  |             |     |
|              | 1.9 TDI 4x4         | ↔     | 11.99 | 06.10                          |                                |                |        |  |             |     |
| 2.0 i        | ↔                   | 04.99 | 06.10 |                                |                                |                |        |  |             |     |
| 2.0 i 4x4    | ↔ 85                | 05.01 | 06.10 |                                |                                |                |        |  |             |     |
| 2.0 i 4x4    | ↔ 88                | 01.00 | 06.10 |                                |                                |                |        |  |             |     |
| RS 1.8 T 20V | ↔ 132               | 05.01 | 06.10 |                                |                                |                |        |  |             |     |
|              | 1.4 i               | ↔     | 04.99 | 06.10                          |                                | 24.2415-1702.3 | 030096 |  | Gz 15,87    |     |
|              | 1.6 i               | ↔     | 10.96 | 06.10                          |                                |                |        |  |             |     |
|              | 1.8 i 20V           | ↔ 92  | 10.96 | 06.10                          |                                |                |        |  |             |     |
|              | 1.8 i 20V Turbo     | ↔ 110 | 03.98 | 06.10                          |                                |                |        |  |             |     |
|              | 1.8 i 20V Turbo 4x4 | ↔ 110 | 05.01 | 06.10                          |                                |                |        |  |             |     |
|              | 1.9 SDI             | ↔     | 05.97 | 06.10                          |                                |                |        |  |             |     |
|              | 1.9 TDI             | ↔ 66  | 10.96 | 06.10                          |                                |                |        |  |             |     |
|              | 1.9 TDI             | ↔ 74  | 08.00 | 06.10                          |                                |                |        |  |             |     |
|              | 1.9 TDI             | ↔ 81  | 08.97 | 06.10                          |                                |                |        |  |             |     |
|              | 1.9 TDI             | ↔ 96  | 01.03 | 06.10                          |                                |                |        |  |             |     |
|              | 1.9 TDI 4x4         | ↔     | 11.99 | 06.10                          |                                |                |        |  |             |     |
| 2.0 i        | ↔                   | 04.99 | 06.10 |                                |                                |                |        |  |             |     |
| 2.0 i 4x4    | ↔ 85                | 05.01 | 06.10 |                                |                                |                |        |  |             |     |
| 2.0 i 4x4    | ↔ 88                | 01.00 | 06.10 |                                |                                |                |        |  |             |     |
| RS 1.8 T 20V | ↔ 132               | 05.01 | 06.10 |                                |                                |                |        |  |             |     |
|              | 1.6 i               |       | 10.96 | 06.10                          |                                | 24.2523-1701.3 | 040080 |  | Nz 23,81    |     |
|              | 1.9 SDI             |       | 05.97 | 06.10                          |                                |                |        |  |             |     |
|              | 1.8 i 20V           | 92    | 10.96 | 06.10                          |                                |                |        |  |             |     |
|              | 1.8 i 20V Turbo     | 110   | 03.98 | 06.10                          |                                |                |        |  |             |     |
|              | 1.8 i 20V Turbo 4x4 | 110   | 05.01 | 06.10                          |                                |                |        |  |             |     |
|              | 1.9 TDI             | 66    | 10.96 | 06.10                          |                                |                |        |  |             |     |
|              | 1.9 TDI             | 74    | 08.00 | 06.10                          |                                |                |        |  |             |     |
|              | 1.9 TDI             | 81    | 08.97 | 06.10                          |                                |                |        |  |             |     |
|              | 1.9 TDI             | 96    | 01.03 | 06.10                          |                                |                |        |  |             |     |
|              | 1.9 TDI 4x4         |       | 11.99 | 06.10                          |                                |                |        |  |             |     |
|              | 2.0 i               |       | 04.99 | 06.10                          |                                |                |        |  |             |     |
| 2.0 i 4x4    | 85                  | 05.01 | 06.10 |                                |                                |                |        |  |             |     |
| 2.0 i 4x4    | 88                  | 01.00 | 06.10 |                                |                                |                |        |  |             |     |
| RS 1.8 T 20V | 132                 | 05.01 | 06.10 |                                |                                |                |        |  |             |     |

### SKODA OCTAVIA II (1Z) (04-13)

|             |             |       |       |       |  |                |        |             |           |     |
|-------------|-------------|-------|-------|-------|--|----------------|--------|-------------|-----------|-----|
|             | 1.2 TSI     | ↔ 77  | 02.10 | 01.13 |  | 03.7863-9502.4 | 300204 | PR: 1AC,1AT | 10"       | ATE |
|             | 1.4 i 16V   | ↔     | 06.04 | 01.13 |  |                |        |             |           |     |
|             | 1.4 TSI     | ↔ 90  | 11.08 | 01.13 |  |                |        |             |           |     |
|             | 1.6         | ↔ 75  | 09.09 | 01.13 |  |                |        |             |           |     |
|             | 1.6 FSI     | ↔ 85  | 06.04 | 01.13 |  |                |        |             |           |     |
|             | 1.6 i 16V   | ↔ 75  | 06.04 | 01.13 |  |                |        |             |           |     |
|             | 1.6 TDI     | ↔ 77  | 06.09 | 01.13 |  |                |        |             |           |     |
|             | 1.6 TDI 4x4 | ↔ 77  | 06.09 | 01.13 |  |                |        |             |           |     |
|             | 1.8 TSI     | ↔     | 06.07 | 01.13 |  |                |        |             |           |     |
|             | 1.8 TSI 4x4 | ↔     | 11.08 | 01.13 |  |                |        |             |           |     |
|             | 1.9 TDI     | ↔ 77  | 06.04 | 01.13 |  |                |        |             |           |     |
|             | 1.9 TDI 4x4 | ↔ 77  | 11.04 | 01.13 |  |                |        |             |           |     |
|             | 2.0 FSI     | ↔ 110 | 11.04 | 01.13 |  |                |        |             |           |     |
|             | 2.0 FSI 4x4 | ↔ 110 | 11.04 | 01.13 |  |                |        |             |           |     |
|             | 2.0 RS      | ↔ 147 | 10.05 | 01.13 |  |                |        |             |           |     |
|             | 2.0 TDI     | ↔ 81  | 03.10 | 01.13 |  |                |        |             |           |     |
|             | 2.0 TDI     | ↔ 100 | 06.04 | 01.13 |  |                |        |             |           |     |
| 2.0 TDI     | ↔ 103       | 06.04 | 01.13 |       |  |                |        |             |           |     |
| 2.0 TDI 4x4 | ↔ 81        | 05.11 | 01.13 |       |  |                |        |             |           |     |
| 2.0 TDI 4x4 | ↔ 103       | 07.06 | 01.13 |       |  |                |        |             |           |     |
| 2.0 TDI RS  | ↔ 125       | 04.06 | 01.13 |       |  |                |        |             |           |     |
|             | 1.2 TSI     | ↔ 77  | 02.10 | 01.13 |  | 03.2122-2129.3 | 010799 |             | THz 22,20 | ATE |
|             | 1.4 i 16V   | ↔     | 06.04 | 01.13 |  |                |        |             |           |     |
|             | 1.4 TSI     | ↔ 90  | 11.08 | 01.13 |  |                |        |             |           |     |
|             | 1.6         | ↔ 75  | 09.09 | 01.13 |  |                |        |             |           |     |
|             | 1.6 FSI     | ↔ 85  | 06.04 | 01.13 |  |                |        |             |           |     |
|             | 1.6 i 16V   | ↔ 75  | 06.04 | 01.13 |  |                |        |             |           |     |
|             | 1.6 TDI     | ↔ 77  | 06.09 | 01.13 |  |                |        |             |           |     |
| 1.6 TDI 4x4 | ↔ 77        | 06.09 | 01.13 |       |  |                |        |             |           |     |















<sup>1)</sup> + disc brake / + disco freno / + disques de frein / + disco de freno

























**SKODA OCTAVIA II (1Z) (04-13)**

|  |   |   |  |   |   |  |  |           |  |                                 |
|--|---|---|--|---|---|--|--|-----------|--|---------------------------------|
|  | 1.8 TSI<br>1.8 TSI 4x4<br>1.9 TDI<br>1.9 TDI 4x4<br>2.0 FSI<br>2.0 FSI 4x4<br>2.0 RS<br>2.0 TDI<br>2.0 TDI<br>2.0 TDI<br>2.0 TDi 4x4<br>2.0 TDi 4x4<br>2.0 TDI RS   | 77<br>77<br>77<br>110<br>110<br>147<br>81<br>100<br>103<br>81<br>103<br>125   | 06.07<br>11.08<br>06.04<br>11.04<br>11.04<br>11.04<br>10.05<br>03.10<br>06.04<br>06.04<br>05.11<br>07.06<br>04.06  | 01.13<br>01.13<br>01.13<br>01.13<br>01.13<br>01.13<br>01.13<br>01.13<br>01.13<br>01.13<br>01.13<br>01.13<br>01.13   | 03.2122-2129.3<br>010799  |  |  | Thz 22,20 | ATE  |                                 |
|  | 1.2 TSI<br>1.4 i 16V<br>1.4 TSI<br>1.6<br>1.6 FSI<br>1.6 i 16V<br>1.6 TDI<br>1.6 TDI 4x4<br>1.8 TSI<br>1.8 TSI 4x4<br>1.9 TDI<br>1.9 TDI 4x4<br>2.0 FSI<br>2.0 FSI 4x4<br>2.0 TDI<br>2.0 TDI<br>2.0 TDI<br>2.0 TDi 4x4<br>2.0 TDi 4x4                         | 77<br>90<br>75<br>85<br>75<br>77<br>77<br>77<br>81<br>100<br>103<br>110<br>110<br>110<br>81<br>100<br>103<br>81<br>103        | 02.10<br>06.04<br>11.08<br>09.09<br>06.04<br>06.04<br>06.09<br>06.09<br>06.07<br>11.08<br>06.04<br>11.04<br>11.04<br>11.04<br>03.10<br>06.04<br>06.04<br>05.11<br>07.06          | 01.13<br>01.13<br>01.13<br>01.13<br>01.13<br>01.13<br>01.13<br>01.13<br>01.13<br>01.13<br>01.13<br>01.13<br>01.13<br>01.13<br>01.13<br>01.13<br>01.13<br>01.13<br>01.13<br>01.13          | PR: 1ZC, 1ZF, 1ZM<br>PR: 1ZC, 1ZF, 1ZM<br>PR: 1ZC, 1ZF, 1ZM<br>PR: 1ZC, 1ZF, 1ZM<br>PR: 1ZC, 1ZF, 1ZM<br>PR: 1ZC, 1ZF, 1ZM<br>PR: 1ZC, 1ZF, 1ZM<br>PR: 1ZC, 1ZF, 1ZM<br>PR: 1ZC, 1ZF, 1ZM<br>PR: 1ZC, 1ZF, 1ZM<br>PR: 1ZC, 1ZF, 1ZM<br>PR: 1ZC, 1ZF, 1ZM<br>PR: 1ZC, 1ZF, 1ZM<br>PR: 1ZC, 1ZF, 1ZM<br>PR: 1ZC, 1ZF, 1ZM<br>PR: 1ZC, 1ZF, 1ZM<br>PR: 1ZC, 1ZF, 1ZM<br>PR: 1ZC, 1ZF, 1ZM<br>PR: 1ZC, 1ZF, 1ZM | 11.9541-9549.2<br>11.9541-9550.2   | 220575<br>220576                               |           | D=54, - Halter<br>D=54, - Halter   | ATE<br>ATE                      |
|  | 1.2 TSI<br>1.4 i 16V<br>1.4 TSI<br>1.6<br>1.6 FSI<br>1.6 i 16V<br>1.6 TDI<br>1.6 TDI 4x4<br>1.8 TSI<br>1.8 TSI 4x4<br>1.9 TDI<br>1.9 TDI 4x4<br>2.0 FSI<br>2.0 FSI 4x4<br>2.0 TDI<br>2.0 TDI<br>2.0 TDI<br>2.0 TDi 4x4<br>2.0 TDi 4x4                         | 77<br>90<br>75<br>85<br>75<br>77<br>77<br>77<br>81<br>100<br>103<br>110<br>110<br>110<br>81<br>100<br>103<br>81<br>103        | 02.10<br>06.04<br>11.08<br>09.09<br>06.04<br>06.04<br>06.09<br>06.09<br>06.07<br>11.08<br>06.04<br>11.04<br>11.04<br>11.04<br>03.10<br>06.04<br>06.04<br>05.11<br>07.06          | 01.13<br>01.13<br>01.13<br>01.13<br>01.13<br>01.13<br>01.13<br>01.13<br>01.13<br>01.13<br>01.13<br>01.13<br>01.13<br>01.13<br>01.13<br>01.13<br>01.13<br>01.13<br>01.13<br>01.13          | PR: 1ZE<br>PR: 1ZE<br>PR: 1ZE<br>PR: 1ZE<br>PR: 1ZE<br>PR: 1ZE<br>PR: 1ZE<br>PR: 1ZE<br>PR: 1ZE<br>PR: 1ZE<br>PR: 1ZE<br>PR: 1ZE<br>PR: 1ZE<br>PR: 1ZE<br>PR: 1ZE<br>PR: 1ZE<br>PR: 1ZE<br>PR: 1ZE<br>PR: 1ZE   | 11.9541-9553.2<br>11.9541-9554.2<br>11.0101-5409.2<br>11.8171-0008.1<br>11.8116-0351.1 | 220563<br>220564<br>260035<br>990049<br>390538 | 2         | D=54, - Halter<br>D=54, - Halter<br>Hülzensatz<br>Führungsbolzen<br>Haltefeder | ATE<br>ATE<br>ATE<br>ATE<br>ATE |
|  | 2.0 RS<br>2.0 TDI RS  | 147<br>125  | 10.05<br>04.06   | 01.13<br>01.13  | PR: 1LL, 1LP, 1ZB<br>PR: 1LL, 1LP, 1ZB  | 11.0101-5409.2<br>11.8171-0008.1<br>11.8116-0351.1                                     | 260035<br>990049<br>390538                     | 2         | Hülzensatz<br>Führungsbolzen<br>Haltefeder                                     | ATE<br>ATE<br>ATE               |
|  | 1.2 TSI<br>1.4 i 16V<br>1.4 TSI<br>1.6<br>1.6 FSI<br>1.6 i 16V<br>1.6 TDI<br>1.6 TDI 4x4<br>1.8 TSI<br>1.8 TSI 4x4<br>1.9 TDI<br>1.9 TDI 4x4<br>2.0 FSI<br>2.0 FSI 4x4<br>2.0 RS<br>2.0 TDI<br>2.0 TDI<br>2.0 TDI<br>2.0 TDi 4x4<br>2.0 TDi 4x4<br>2.0 TDI RS | 77<br>90<br>75<br>85<br>75<br>77<br>77<br>77<br>81<br>100<br>103<br>110<br>110<br>147<br>81<br>100<br>103<br>81<br>103<br>125 | 02.10<br>06.04<br>11.08<br>09.09<br>06.04<br>06.04<br>06.09<br>06.09<br>06.07<br>11.08<br>06.04<br>11.04<br>11.04<br>10.05<br>03.10<br>06.04<br>06.04<br>05.11<br>07.06<br>04.06 | 01.13<br>01.13<br>01.13<br>01.13<br>01.13<br>01.13<br>01.13<br>01.13<br>01.13<br>01.13<br>01.13<br>01.13<br>01.13<br>01.13<br>01.13<br>01.13<br>01.13<br>01.13<br>01.13<br>01.13<br>01.13 |   | 83.7847-0563.3   | 331124   | 2         | L=562  |                                 |
|  | 1.2 TSI<br>1.4 i 16V<br>1.4 TSI<br>1.6<br>1.6 FSI<br>1.6 i 16V<br>1.6 TDI<br>1.6 TDI<br>1.8 TSI<br>1.9 TDI<br>1.9 TDI 4x4<br>2.0 FSI<br>2.0 FSI 4x4<br>2.0 RS<br>2.0 TDI<br>2.0 TDI<br>2.0 TDI<br>2.0 TDi 4x4<br>2.0 TDi 4x4<br>2.0 TDI RS                    | 77<br>90<br>75<br>85<br>75<br>77<br>77<br>77<br>81<br>100<br>103<br>110<br>110<br>147<br>81<br>100<br>103<br>81<br>103<br>125 | 02.10<br>06.04<br>11.08<br>09.09<br>06.04<br>06.04<br>06.09<br>06.09<br>06.07<br>06.04<br>11.04<br>11.04<br>10.05<br>03.10<br>06.04<br>06.04<br>05.11<br>07.06<br>04.06          | 01.13<br>01.13<br>01.13<br>01.13<br>01.13<br>01.13<br>01.13<br>01.13<br>01.13<br>01.13<br>01.13<br>01.13<br>01.13<br>01.13<br>01.13<br>01.13<br>01.13<br>01.13<br>01.13<br>01.13<br>01.13 | PR: 1KD<br>PR: 1KD<br>PR: 1KD<br>PR: 1KD<br>PR: 1KD<br>PR: 1KD<br>PR: 1KD<br>PR: 1KD<br>PR: 1KD<br>PR: 1KD<br>PR: 1KD<br>PR: 1KD<br>PR: 1KD<br>PR: 1KD<br>PR: 1KD<br>PR: 1KD<br>PR: 1KD<br>PR: 1KD<br>PR: 1KD<br>PR: 1KD  | 24.3384-1755.7<br>24.3384-1756.7   | 220635<br>220636                               |           | D=38, - Halter<br>D=38, - Halter   | LUC<br>LUC                      |





















|     |   |  |  |  |  |  |  |  |  |            |        |        |
|--|---|--|--|--|---|--|--|--|--|------------|--------|--------|
| SKODA OCTAVIA II (1Z) (04-13)  |   |  |  |  |   |  |  |  |  |            |        |        |
|    | 2.0 TDI   | 103  |  | 06.04  | 01.13   | PR: 1KD  | 24.3384-1755.7   | 220635   | D=38, - Halter<br>D=38, - Halter<br>D=41, - Halter<br>D=41, - Halter | LUC<br>LUC |        |        |
|  | 2.0 TDI 4x4   | 81   |  | 05.11  | 01.13   | PR: 1KD  | 24.3384-1756.7   | 220636   |  |            |        |        |
|  | 1.2 TSI   | 77   |  | 02.10  | 01.13   | PR: 1KF  | 24.3414-1709.7   | 220631   |  |            |        |        |
|  | 1.4 i 16V   |  |  | 06.04  | 01.13   | PR: 1KF  | 24.3414-1710.7   | 220632   |  |            |        |        |
|  | 1.4 TSI   | 90   |  | 11.08  | 01.13   | PR: 1KF  |  |  |  |            |        |        |
|  | 1.6   | 75   |  | 09.09  | 01.13   | PR: 1KF  |  |  |  |            |        |        |
|  | 1.6 FSI   | 85   |  | 06.04  | 01.13   | PR: 1KF  |  |  |  |            |        |        |
|  | 1.6 i 16V   | 75   |  | 06.04  | 01.13   | PR: 1KF  |  |  |  |            |        |        |
|  | 1.6 TDI   | 77   |  | 06.09  | 01.13   | PR: 1KF  |  |  |  |            |        |        |
|  | 1.6 TDI 4x4   | 77   |  | 06.09  | 01.13   | PR: 1KF  |  |  |  |            |        |        |
|  | 1.8 TSI   |  |  | 06.07  | 01.13   | PR: 1KF  |  |  |  |            |        |        |
|  | 1.8 TSI 4x4   |  |  | 11.08  | 01.13   | PR: 1KF  |  |  |  |            |        |        |
|  | 1.9 TDI   | 77   |  | 06.04  | 01.13   | PR: 1KF  |  |  |  |            |        |        |
|  | 1.9 TDI 4x4   | 77   |  | 11.04  | 01.13   | PR: 1KF  |  |  |  |            |        |        |
|  | 2.0 FSI   | 110  |  | 11.04  | 01.13   | PR: 1KF  |  |  |  |            |        |        |
|  | 2.0 FSI 4x4   | 110  |  | 11.04  | 01.13   | PR: 1KF  |  |  |  |            |        |        |
|  | 2.0 TDI   | 81   |  | 03.10  | 01.13   | PR: 1KF  |  |  |  |            |        |        |
|  | 2.0 TDI   | 100  |  | 06.04  | 01.13   | PR: 1KF  |  |  |  |            |        |        |
|  | 2.0 TDI   | 103  |  | 06.04  | 01.13   | PR: 1KF  |  |  |  |            |        |        |
|  | 2.0 TDi 4x4   | 81   |  | 05.11  | 01.13   | PR: 1KF  |  |  |  |            |        |        |
| 2.0 TDI 4x4  | 103   |  | 07.06  | 01.13  | PR: 1KF   |  |  |  |  |            |        |        |
|    | 1.4 i 16V   |  |  | 06.04  | 10.09   |  | 83.7849-0231.3   | 330872   | 2  | L=233      |        |        |
|  | 1.4 TSI   | 90   |  | 11.08  | 10.09   |  |  |  |  |            |        |        |
|  | 1.6   | 75   |  | 09.09  | 10.09   |  |  |  |  |            |        |        |
|  | 1.6 FSI   | 85   |  | 06.04  | 10.09   |  |  |  |  |            |        |        |
|  | 1.6 i 16V   | 75   |  | 06.04  | 10.09   |  |  |  |  |            |        |        |
|  | 1.6 TDI   | 77   |  | 06.09  | 10.09   |  |  |  |  |            |        |        |
|  | 1.6 TDI 4x4   | 77   |  | 06.09  | 10.09   |  |  |  |  |            |        |        |
|  | 1.8 TSI   |  |  | 06.07  | 10.09   |  |  |  |  |            |        |        |
|  | 1.8 TSI 4x4   |  |  | 11.08  | 10.09   |  |  |  |  |            |        |        |
|  | 1.9 TDI   | 77   |  | 06.04  | 10.09   |  |  |  |  |            |        |        |
|  | 1.9 TDI 4x4   | 77   |  | 11.04  | 10.09   |  |  |  |  |            |        |        |
|  | 2.0 FSI   | 110  |  | 11.04  | 10.09   |  |  |  |  |            |        |        |
|  | 2.0 FSI 4x4   | 110  |  | 11.04  | 10.09   |  |  |  |  |            |        |        |
|  | 2.0 RS  | 147  |  | 10.05  | 10.09   |  |  |  |  |            |        |        |
|  | 2.0 TDI   | 100  |  | 06.04  | 10.09   |  |  |  |  |            |        |        |
|  | 2.0 TDI   | 103  |  | 06.04  | 10.09   |  |  |  |  |            |        |        |
|  | 2.0 TDI 4x4   | 103  |  | 07.06  | 10.09   |  |  |  |  |            |        |        |
|  | 2.0 TDI RS  | 125  |  | 04.06  | 10.09   |  |  |  |  |            |        |        |
|  |  | 1.4 i 16V  |  |  | 06.04   | 11.05  |  | 24.3727-2708.2   | 582708   |            | 2 ↓    | L=1447 |
|  |   | 1.6 FSI  | 85   |  | 06.04   | 11.05  |  |  |  |            |        |        |
| 1.6 i 16V  |   | 75   |  | 06.04  | 11.05   |  |  |  |  |            |        |        |
| 1.9 TDI  |   | 77   |  | 06.04  | 11.05   |  |  |  |  |            |        |        |
| 1.9 TDI 4x4  |   | 77   |  | 06.04  | 11.05   |  |  |  |  |            |        |        |
| 2.0 FSI  |   | 110  |  | 11.04  | 11.05   |  |  |  |  |            |        |        |
| 2.0 FSI 4x4  |   | 110  |  | 11.04  | 11.05   |  |  |  |  |            |        |        |
| 2.0 RS   |   | 147  |  | 10.05  | 11.05   |  |  |  |  |            |        |        |
| 2.0 TDI  |   | 100  |  | 06.04  | 11.05   |  |  |  |  |            |        |        |
| 2.0 TDI  |   | 103  |  | 06.04  | 11.05   |  |  |  |  |            |        |        |
|  |   | 1.2 TSI  | 77   |  | 02.10   | 01.13  |  | 24.3727-0195.2   | 580195   | 2 ↓        | L=1447 |        |
|  |   | 1.4 i 16V  |  |  | 12.05   | 01.13  |  |  |  |            |        |        |
|  |   | 1.4 TSI  | 90   |  | 11.08   | 01.13  |  |  |  |            |        |        |
|  |   | 1.6  | 75   |  | 09.09   | 01.13  |  |  |  |            |        |        |
|  | 1.6 FSI   | 85   |  | 12.05  | 01.13   |  |  |  |  |            |        |        |
|  | 1.6 i 16V   | 75   |  | 12.05  | 01.13   |  |  |  |  |            |        |        |
|  | 1.6 TDI   | 77   |  | 06.09  | 01.13   |  |  |  |  |            |        |        |
|  | 1.6 TDI 4x4   | 77   |  | 06.09  | 01.13   |  |  |  |  |            |        |        |
|  | 1.8 TSI   |  |  | 06.07  | 01.13   |  |  |  |  |            |        |        |
|  | 1.8 TSI 4x4   |  |  | 11.08  | 01.13   |  |  |  |  |            |        |        |
|  | 1.9 TDI   | 77   |  | 12.05  | 01.13   |  |  |  |  |            |        |        |
|  | 1.9 TDI 4x4   | 77   |  | 12.05  | 01.13   |  |  |  |  |            |        |        |
|  | 2.0 FSI   | 110  |  | 12.05  | 01.13   |  |  |  |  |            |        |        |
|  | 2.0 FSI 4x4   | 110  |  | 12.05  | 01.13   |  |  |  |  |            |        |        |
|  | 2.0 RS  | 147  |  | 12.05  | 01.13   |  |  |  |  |            |        |        |
|  | 2.0 TDI   | 81   |  | 03.10  | 01.13   |  |  |  |  |            |        |        |
| 2.0 TDI  | 100   |  | 12.05  | 01.13  |   |  |  |  |  |            |        |        |
| 2.0 TDI  | 103   |  | 12.05  | 01.13  |   |  |  |  |  |            |        |        |
| 2.0 TDi 4x4  | 81  |  | 05.11  | 01.13  |   |  |  |  |  |            |        |        |
| 2.0 TDI 4x4  | 103   |  | 07.06  | 01.13  |   |  |  |  |  |            |        |        |
| 2.0 TDI RS   | 125   |  | 04.06  | 01.13  |   |  |  |  |  |            |        |        |
|  | 1.2 TSI   | 77   |  | 02.10  | 01.13   |  | 24.2415-1711.3   | 030130   | Gz 15,87<br>Gz 15,87, + Sensor                                       |            |        |        |
|  | 1.4 i 16V   |  |  | 06.04  | 01.13   |  | 24.2415-1713.3   | 030132   |  |            |        |        |
|  | 1.4 TSI   | 90   |  | 11.08  | 01.13   |  |  |  |  |            |        |        |
|  | 1.6   | 75   |  | 09.09  | 01.13   |  |  |  |  |            |        |        |
|  | 1.6 FSI   | 85   |  | 06.04  | 01.13   |  |  |  |  |            |        |        |
|  | 1.6 i 16V   | 75   |  | 06.04  | 01.13   |  |  |  |  |            |        |        |
|  | 1.6 TDI   | 77   |  | 06.09  | 01.13   |  |  |  |  |            |        |        |
|  | 1.6 TDI 4x4   | 77   |  | 06.09  | 01.13   |  |  |  |  |            |        |        |
|  | 1.8 TSI   |  |  | 06.07  | 01.13   |  |  |  |  |            |        |        |
|  | 1.8 TSI 4x4   |  |  | 11.08  | 01.13   |  |  |  |  |            |        |        |
|  | 1.9 TDI   | 77   |  | 06.04  | 01.13   |  |  |  |  |            |        |        |
|  | 1.9 TDI 4x4   | 77   |  | 11.04  | 01.13   |  |  |  |  |            |        |        |
|  | 2.0 FSI   | 110  |  | 11.04  | 01.13   |  |  |  |  |            |        |        |
|  | 2.0 FSI 4x4   | 110  |  | 11.04  | 01.13   |  |  |  |  |            |        |        |
|  | 2.0 RS  | 147  |  | 10.05  | 01.13   |  |  |  |  |            |        |        |
|  | 2.0 TDI   | 81   |  | 03.10  | 01.13   |  |  |  |  |            |        |        |
| 2.0 TDI  | 100   |  | 06.04  | 01.13  |   |  |  |  |  |            |        |        |

|     |  |  |  |  |  |  |     |  |     |
|--|--|--|--|--|---|--|---|--|-----|
| <b>SKODA OCTAVIA II (1Z) (04-13)</b>   |  |  |  |  |   |  |   |  |     |
|    | 2.0 TDI  | 103  | 06.04  | 01.13  | 24.2415-1711.3  | 030130   |   | Gz 15,87   |     |
|  | 2.0 TDi 4x4  | 81   | 05.11  | 01.13  | 24.2415-1713.3  | 030132   |   | Gz 15,87, + Sensor   |     |
|  | 2.0 TDI 4x4  | 103  | 07.06  | 01.13  |   |  |   |  |     |
|  | 2.0 TDI RS   | 125  | 04.06  | 01.13  |   |  |   |  |     |
|    | 1.2 TSI  | 77   | 02.10  | 01.13  | 24.2519-1705.3  | 040095   |   | Nz 19,05   |     |
|  | 1.4 i 16V  |  | 06.04  | 01.13  |   |  |   |  |     |
|  | 1.4 TSI  | 90   | 11.08  | 01.13  |   |  |   |  |     |
|  | 1.6  | 75   | 09.09  | 01.13  |   |  |   |  |     |
|  | 1.6 FSI  | 85   | 06.04  | 01.13  |   |  |   |  |     |
|  | 1.6 i 16V  | 75   | 06.04  | 01.13  |   |  |   |  |     |
|  | 1.6 TDI  | 77   | 06.09  | 01.13  |   |  |   |  |     |
|  | 1.6 TDI 4x4  | 77   | 06.09  | 01.13  |   |  |   |  |     |
|  | 1.8 TSI  |  | 06.07  | 01.13  |   |  |   |  |     |
|  | 1.8 TSI 4x4  |  | 11.08  | 01.13  |   |  |   |  |     |
|  | 1.9 TDI  | 77   | 06.04  | 01.13  |   |  |   |  |     |
|  | 1.9 TDI 4x4  | 77   | 11.04  | 01.13  |   |  |   |  |     |
|  | 2.0 FSI  | 110  | 11.04  | 01.13  |   |  |   |  |     |
|  | 2.0 FSI 4x4  | 110  | 11.04  | 01.13  |   |  |   |  |     |
|  | 2.0 RS   | 147  | 10.05  | 01.13  |   |  |   |  |     |
|  | 2.0 TDI  | 81   | 03.10  | 01.13  |   |  |   |  |     |
|  | 2.0 TDI  | 100  | 06.04  | 01.13  |   |  |   |  |     |
|  | 2.0 TDI  | 103  | 06.04  | 01.13  |   |  |   |  |     |
|  | 2.0 TDi 4x4  | 81   | 05.11  | 01.13  |   |  |   |  |     |
|  | 2.0 TDI 4x4  | 103  | 07.06  | 01.13  |   |  |   |  |     |
|  | 2.0 TDI RS   | 125  | 04.06  | 01.13  |   |  |   |  |     |
| <b>SKODA PICK-UP (93-95)</b>   |  |  |  |  |   |  |   |  |     |
|    | 1.3  |  | 12.92  | 12.95  | 24.3222-1712.3  | 020424   |   | Rz 22,20   |     |
| <b>SKODA RAPID / RAPID Spaceback (12-)</b>   |  |  |  |  |   |  |   |  |     |
|    | 1.2  | 55   | 10.12  | PR: 1ZG  | 11.9541-9549.2  | 220575   |    | D=54, - Halter   | ATE |
|  | 1.2 TSI  | 63   | 10.12  | PR: 1ZG  | 11.9541-9550.2  | 220576   |    | D=54, - Halter   | ATE |
|  | 1.2 TSI  | 77   | 10.12  | PR: 1ZG  | 11.8171-0008.1  | 990049   |   | Führungsbolzen   | ATE |
|  | 1.4 TSI  | 90   | 10.12  | PR: 1ZG  | 11.0101-5407.2  | 260011   |   | Hülsensatz   | ATE |
|  | 1.6  | 77   | 07.13  | PR: 1ZG  |   |  |   |  |     |
|  | 1.6 TDI  | 66   | 08.13  | PR: 1ZG  |   |  |   |  |     |
|  | 1.6 TDI  | 77   | 10.12  | PR: 1ZG  |   |  |   |  |     |
|  | 1.2  | 55   | 10.12  | PR: 1ZC  | 11.9541-9553.2  | 220563   |   | D=54, - Halter   | ATE |
|  | 1.2 TSI  | 63   | 10.12  | PR: 1ZC  | 11.9541-9554.2  | 220564   |  | D=54, - Halter   | ATE |
|  | 1.2 TSI  | 77   | 10.12  | PR: 1ZC  | 11.8171-0008.1  | 990049   |   | Führungsbolzen   | ATE |
|  | 1.4 TSI  | 90   | 10.12  | PR: 1ZC  | 11.8116-0351.1  | 390538   | 2   | Haltefeder   | ATE |
|  | 1.6  | 77   | 07.13  | PR: 1ZC  | 11.0101-5409.2  | 260035   |   | Hülsensatz   | ATE |
|  | 1.6 TDI  | 66   | 08.13  | PR: 1ZC  |   |  |   |  |     |
|  | 1.6 TDI  | 77   | 10.12  | PR: 1ZC  |   |  |   |  |     |
|  | 1.2  | 55   | 10.12  |  | 83.7858-0140.3  | 330837   | 2   | L=140  |     |
|  | 1.2 TSI  | 63   | 10.12  |  |   |  |   |  |     |
|  | 1.2 TSI  | 77   | 10.12  |  |   |  |   |  |     |
|  | 1.4 TSI  | 90   | 10.12  |  |   |  |   |  |     |
|  | 1.6  | 77   | 07.13  |  |   |  |   |  |     |
|  | 1.6 TDI  | 66   | 08.13  |  |   |  |   |  |     |
|  | 1.6 TDI  | 77   | 10.12  |  |   |  |   |  |     |
| <b>SKODA ROOMSTER (5J) (06-)</b>   |  |  |  |  |   |  |   |  |     |
|  | 1.0 i  | 53   | 07.06  | 12.10  | 24.2120-1736.3  | 010732   | - ABS   | THz 20,64  |     |
|  | 1.2  |  | 07.06  | 12.10  | 24.2120-1734.3  | 010702   | + ABS   | THz 20,64  |     |
|  | 1.2 TDI  | 55   | 03.10  | 12.10  |   |  |   |  |     |
|  | 1.2 TSI  | 63   | 03.10  | 12.10  |   |  |   |  |     |
|  | 1.2 TSI  | 77   | 03.10  | 12.10  |   |  |   |  |     |
|  | 1.4  | 63   | 07.06  | 12.10  |   |  |   |  |     |
|  | 1.4 TDI  | 51   | 07.06  | 12.10  |   |  |   |  |     |
|  | 1.4 TDI  | 59   | 07.06  | 12.10  |   |  |   |  |     |
|  | 1.6  | 77   | 07.06  | 12.10  |   |  |   |  |     |
|  | 1.6 TDI  | 66   | 03.10  | 12.10  |   |  |   |  |     |
|  | 1.6 TDI  | 77   | 03.10  | 12.10  |   |  |   |  |     |
|  | 1.9 TDI  |  | 07.06  | 12.10  |   |  |   |  |     |
|  | 1.0 i  | 53   | 07.06  | PR: 1LQ,1LR,1ZG  | 11.9541-9549.2  | 220575   |  | D=54, - Halter   | ATE |
|  | 1.2  |  | 07.06  | PR: 1LQ,1LR,1ZG  | 11.9541-9550.2  | 220576   |  | D=54, - Halter   | ATE |
|  | 1.2 TDI  | 55   | 03.10  | PR: 1LQ,1LR,1ZG  | 11.0101-5409.2  | 260035   |   | Hülsensatz   | ATE |
|  | 1.2 TSI  | 63   | 03.10  | PR: 1LQ,1LR,1ZG  | 11.8171-0008.1  | 990049   |   | Führungsbolzen   | ATE |
|  | 1.2 TSI  | 77   | 03.10  | PR: 1LQ,1LR,1ZG  |   |  |   |  |     |
|  | 1.4  | 63   | 07.06  | PR: 1LQ,1LR,1ZG  |   |  |   |  |     |
|  | 1.4 TDI  | 51   | 07.06  | PR: 1LQ,1LR,1ZG  |   |  |   |  |     |
|  | 1.4 TDI  | 59   | 07.06  | PR: 1LQ,1LR,1ZG  |   |  |   |  |     |
|  | 1.6  | 77   | 07.06  | PR: 1LQ,1LR,1ZG  |   |  |   |  |     |
|  | 1.6 TDI  | 66   | 03.10  | PR: 1LQ,1LR,1ZG  |   |  |   |  |     |
|  | 1.6 TDI  | 77   | 03.10  | PR: 1LQ,1LR,1ZG  |   |  |   |  |     |
|  | 1.9 TDI  |  | 07.06  | PR: 1LQ,1LR,1ZG  |   |  |   |  |     |
|  | 1.0 i  | 53   | 07.06  | PR: 1LN  | 24.3541-1797.7  | 220553   |  | D=54, - Halter   | LUC |
|  | 1.2  |  | 07.06  | PR: 1LN  | 24.3541-1798.7  | 220554   |  | D=54, - Halter   | LUC |
|  | 1.2 TDI  | 55   | 03.10  | PR: 1LN  |   |  |   |  |     |
|  | 1.2 TSI  | 63   | 03.10  | PR: 1LN  |   |  |   |  |     |
|  | 1.2 TSI  | 77   | 03.10  | PR: 1LN  |   |  |   |  |     |
|  | 1.4  | 63   | 07.06  | PR: 1LN  |   |  |   |  |     |
|  | 1.4 TDI  | 51   | 07.06  | PR: 1LN  |   |  |   |  |     |
|  | 1.4 TDI  | 59   | 07.06  | PR: 1LN  |   |  |   |  |     |



| SKODA ROOMSTER (5J) (06-) |                        |       |         |         |                |                |             |  |                                 |
|---------------------------|------------------------|-------|---------|---------|----------------|----------------|-------------|--|---------------------------------|
|                           | 1.6                    | 77    | 07.06   | PR: 1LN | 24.3541-1797.7 | 220553         | ☐<br>☐      | D=54, - Halter<br>D=54, - Halter   | LUC<br>LUC                      |
|                           | 1.6 TDI                | 66    | 03.10   | PR: 1LN | 24.3541-1798.7 | 220554         |             |  |                                 |
|                           | 1.6 TDI                | 77    | 03.10   | PR: 1LN |                |                |             |  |                                 |
|                           | 1.9 TDI                |       | 07.06   | PR: 1LN |                |                |             |  |                                 |
|                           | 1.0 i                  | 53    | 07.06   | PR: 1ZC | 11.9541-9553.2 | 220563         | ☐<br>☐<br>2 | D=54, - Halter<br>D=54, - Halter<br>Hülsensatz<br>Führungsbolzen<br>Haltefeder | ATE<br>ATE<br>ATE<br>ATE<br>ATE |
|                           | 1.2                    |       | 07.06   | PR: 1ZC | 11.9541-9554.2 | 220564         |             |  |                                 |
|                           | 1.2 TDI                | 55    | 03.10   | PR: 1ZC | 11.0101-5409.2 | 260035         |             |  |                                 |
|                           | 1.2 TSI                | 63    | 03.10   | PR: 1ZC | 11.8171-0008.1 | 990049         |             |  |                                 |
|                           | 1.2 TSI                | 77    | 03.10   | PR: 1ZC | 11.8116-0351.1 | 390538         |             |  |                                 |
|                           | 1.4                    | 63    | 07.06   | PR: 1ZC |                |                |             |  |                                 |
|                           | 1.4 TDI                | 51    | 07.06   | PR: 1ZC |                |                |             |  |                                 |
|                           | 1.4 TDI                | 59    | 07.06   | PR: 1ZC |                |                |             |  |                                 |
|                           | 1.6                    | 77    | 07.06   | PR: 1ZC |                |                |             |  |                                 |
| 1.6 TDI                   | 66                     | 03.10 | PR: 1ZC |         |                |                |             |  |                                 |
| 1.6 TDI                   | 77                     | 03.10 | PR: 1ZC |         |                |                |             |  |                                 |
| 1.9 TDI                   |                        | 07.06 | PR: 1ZC |         |                |                |             |  |                                 |
|                           | 1.0 i                  | 53    | 07.06   |         | 83.6247-0522.3 | 330595         | 2           | L=522  |                                 |
|                           | 1.2                    |       | 07.06   |         |                |                |             |  |                                 |
|                           | 1.2 TDI                | 55    | 03.10   |         |                |                |             |  |                                 |
|                           | 1.2 TSI                | 63    | 03.10   |         |                |                |             |  |                                 |
|                           | 1.2 TSI                | 77    | 03.10   |         |                |                |             |  |                                 |
|                           | 1.4                    | 63    | 07.06   |         |                |                |             |  |                                 |
|                           | 1.4 TDI                | 51    | 07.06   |         |                |                |             |  |                                 |
|                           | 1.4 TDI                | 59    | 07.06   |         |                |                |             |  |                                 |
|                           | 1.6                    | 77    | 07.06   |         |                |                |             |  |                                 |
|                           | 1.6 TDI                | 66    | 03.10   |         |                |                |             |  |                                 |
|                           | 1.6 TDI                | 77    | 03.10   |         |                |                |             |  |                                 |
|                           | 1.9 TDI                |       | 07.06   |         |                |                |             |  |                                 |
|                           |                        | 1.0 i | 53      | 07.06   | PR: 1KK        | 24.3384-1729.7 |             |  |                                 |
| 1.2                       |                        |       | 07.06   | PR: 1KK | 24.3384-1730.7 | 220542         |             |  |                                 |
| 1.2 TDI                   |                        | 55    | 03.10   | PR: 1KK |                |                |             |  |                                 |
| 1.2 TSI                   |                        | 63    | 03.10   | PR: 1KK |                |                |             |  |                                 |
| 1.2 TSI                   |                        | 77    | 03.10   | PR: 1KK |                |                |             |  |                                 |
| 1.4                       |                        | 63    | 07.06   | PR: 1KK |                |                |             |  |                                 |
| 1.4 TDI                   |                        | 51    | 07.06   | PR: 1KK |                |                |             |  |                                 |
| 1.4 TDI                   |                        | 59    | 07.06   | PR: 1KK |                |                |             |  |                                 |
| 1.6                       |                        | 77    | 07.06   | PR: 1KK |                |                |             |  |                                 |
| 1.6 TDI                   |                        | 66    | 03.10   | PR: 1KK |                |                |             |  |                                 |
| 1.6 TDI                   |                        | 77    | 03.10   | PR: 1KK |                |                |             |  |                                 |
| 1.9 TDI                   |                        |       | 07.06   | PR: 1KK |                |                |             |  |                                 |
|                           |                        | 1.0 i | 53      | 07.06   |                | 83.7858-0140.3 | 330837      | 2  | L=140                           |
|                           | 1.2                    |       | 07.06   |         |                |                |             |  |                                 |
|                           | 1.2 TDI                | 55    | 03.10   |         |                |                |             |  |                                 |
|                           | 1.2 TSI                | 63    | 03.10   |         |                |                |             |  |                                 |
|                           | 1.2 TSI                | 77    | 03.10   |         |                |                |             |  |                                 |
|                           | 1.4                    | 63    | 07.06   |         |                |                |             |  |                                 |
|                           | 1.4 TDI                | 51    | 07.06   |         |                |                |             |  |                                 |
|                           | 1.4 TDI                | 59    | 07.06   |         |                |                |             |  |                                 |
|                           | 1.6                    | 77    | 07.06   |         |                |                |             |  |                                 |
|                           | 1.6 TDI                | 66    | 03.10   |         |                |                |             |  |                                 |
|                           | 1.6 TDI                | 77    | 03.10   |         |                |                |             |  |                                 |
|                           | 1.9 TDI                |       | 07.06   |         |                |                |             |  |                                 |
|                           |                        | 1.0 i | 53      | 07.06   | PR: 1KC        | 24.3219-0909.3 | 020188      |  |                                 |
| 1.2                       |                        |       | 07.06   | PR: 1KC |                |                |             |  |                                 |
| 1.2 TDI                   |                        | 55    | 03.10   | PR: 1KC |                |                |             |  |                                 |
| 1.2 TSI                   |                        | 63    | 03.10   | PR: 1KC |                |                |             |  |                                 |
| 1.2 TSI                   |                        | 77    | 03.10   | PR: 1KC |                |                |             |  |                                 |
| 1.4                       |                        | 63    | 07.06   | PR: 1KC |                |                |             |  |                                 |
| 1.4 TDI                   |                        | 51    | 07.06   | PR: 1KC |                |                |             |  |                                 |
| 1.4 TDI                   |                        | 59    | 07.06   | PR: 1KC |                |                |             |  |                                 |
| 1.6                       |                        | 77    | 07.06   | PR: 1KC |                |                |             |  |                                 |
| 1.6 TDI                   |                        | 66    | 03.10   | PR: 1KC |                |                |             |  |                                 |
| 1.6 TDI                   |                        | 77    | 03.10   | PR: 1KC |                |                |             |  |                                 |
| 1.9 TDI                   |                        |       | 07.06   | PR: 1KC |                |                |             |  |                                 |
|                           |                        | 1.0 i | 53      | 07.06   |                | 03.6584-0107.3 | 320110      | - ABS  | BRL 8/4 (4)                     |
|                           | 1.2                    |       | 07.06   |         |                |                |             |  |                                 |
|                           | 1.2 TDI                | 55    | 03.10   |         |                |                |             |  |                                 |
|                           | 1.2 TSI                | 63    | 03.10   |         |                |                |             |  |                                 |
|                           | 1.2 TSI                | 77    | 03.10   |         |                |                |             |  |                                 |
|                           | 1.4                    | 63    | 07.06   |         |                |                |             |  |                                 |
|                           | 1.4 TDI                | 51    | 07.06   |         |                |                |             |  |                                 |
|                           | 1.4 TDI                | 59    | 07.06   |         |                |                |             |  |                                 |
|                           | 1.6                    | 77    | 07.06   |         |                |                |             |  |                                 |
|                           | 1.6 TDI                | 66    | 03.10   |         |                |                |             |  |                                 |
|                           | 1.6 TDI                | 77    | 03.10   |         |                |                |             |  |                                 |
|                           | 1.9 TDI                |       | 07.06   |         |                |                |             |  |                                 |
|                           | SKODA SUPERB I (02-08) |       |         |         |                |                |             |  |                                 |
|                           | 1.8 i 20V Turbo        | 110   | 12.01   | 02.08   | 03.2125-0373.3 | 010810         |             | Thz 25,40<br>Thz 25,40   | ATE<br>LUC                      |
|                           | 1.9 TDI                | 74    | 08.02   | 12.07   | 24.2125-1720.3 | 010688         |             |  |                                 |
|                           | 1.9 TDI                | 77    | 10.05   | 12.07   |                |                |             |  |                                 |
|                           | 1.9 TDI                | 85    | 01.07   | 12.07   |                |                |             |  |                                 |
|                           | 1.9 TDI                | 96    | 12.01   | 12.07   |                |                |             |  |                                 |
|                           | 2.0 i                  | 85    | 12.01   | 02.08   |                |                |             |  |                                 |
|                           | 2.0 TDI                | 103   | 10.05   | 12.07   |                |                |             |  |                                 |
|                           | 2.5 TDI                | 114   | 12.01   | 12.07   |                |                |             |  |                                 |
|                           | 2.5 TDI                | 120   | 06.03   | 12.07   |                |                |             |  |                                 |
|                           | ↓                      |       |         |         |                |                |             |  |                                 |

|     |  |  |  |  |  |  |  |   |            |
|--|--|--|--|--|---|--|--|---|------------|
| <b>SKODA SUPERB I (02-08)</b>  |  |  |  |  |   |  |  |   |            |
|    | 2.8 i V6   | 142  |  | 12.01  | 12.07   | 03.2125-0373.3<br>24.2125-1720.3   | 010810<br>010688   | THz 25,40<br>THz 25,40  | ATE<br>LUC |
|    | 1.8 i 20V Turbo  | 110  |  | 12.01  | 02.08   | 11.3571-8522.2   | 220320   | <input type="checkbox"/> D=57, - Halter<br><input type="checkbox"/> D=57, - Halter<br><input type="checkbox"/> D=57, - Halter<br><input type="checkbox"/> Halter<br><input type="checkbox"/> Dichtungssatz<br><input type="checkbox"/> Hülsensatz<br><input type="checkbox"/> Führungsbolzen<br><input type="checkbox"/> Haltefeder | ATE        |
|  | 1.9 TDI  | 74   |  | 08.02  | 12.07   | 11.3571-8521.2   | 220319   |   | ATE        |
|  | 1.9 TDI  | 77   |  | 10.05  | 12.07   | 24.3571-8522.5   | 240496   |   | ATE        |
|  | 1.9 TDI  | 85   |  | 01.07  | 12.07   | 24.3571-8521.5   | 240495   |   | ATE        |
|  | 1.9 TDI  | 96   |  | 12.01  | 12.07   | 11.8170-0306.1   | 260102   |   | ATE        |
|  | 2.0 i  | 85   |  | 12.01  | 02.08   | 11.0441-5704.2   | 250034   |   | ATE        |
|  |  |  |  |  |   | 11.0101-5409.2   | 260035   |   | ATE        |
|  |  |  |  |  |   | 11.8171-0008.1   | 990049   |   | ATE        |
|  |  |  |  |  |   | 11.8116-0143.1   | 390513   |   | ATE        |
|  | 2.0 TDI  | 103  |  | 10.05  | 12.07   | 11.9571-9836.2   | 220428   |   | ATE        |
|  | 2.5 TDI  | 114  |  | 12.01  | 12.07   | 11.9571-9835.2   | 220427   | ATE   |            |
|  | 2.5 TDI  | 120  |  | 06.03  | 12.07   | 11.0441-5704.2   | 250034   | ATE   |            |
|  | 2.8 i V6   | 142  |  | 12.01  | 12.07   | 11.0101-5409.2   | 260035   | ATE   |            |
|  |  |  |  |  |   | 11.8171-0008.1   | 990049   | ATE   |            |
|  |  |  |  |  |   | 11.8116-0143.1   | 390513   | ATE   |            |
|    | 1.8 i 20V Turbo  | 110  |  | 12.01  | 02.08   | 83.7813-0295.3   | 330799   | L=295   |            |
|  | 1.9 TDI  | 74   |  | 08.02  | 12.07   |  |  |   |            |
|  | 1.9 TDI  | 77   |  | 10.05  | 12.07   |  |  |   |            |
|  | 1.9 TDI  | 85   |  | 01.07  | 12.07   |  |  |   |            |
|  | 1.9 TDI  | 96   |  | 12.01  | 12.07   |  |  |   |            |
|  | 2.0 i  | 85   |  | 12.01  | 02.08   |  |  |   |            |
|  | 2.0 TDI  | 103  |  | 10.05  | 12.07   |  |  |   |            |
|  | 2.5 TDI  | 114  |  | 12.01  | 12.07   |  |  |   |            |
|  | 2.5 TDI  | 120  |  | 06.03  | 12.07   |  |  |   |            |
|  | 2.8 i V6   | 142  |  | 12.01  | 12.07   |  |  |   |            |
|    | 1.8 i 20V Turbo  | 110  |  | 12.01  | 02.08   | 24.3384-1731.7   | 220543   | D=38, - Halter  | LUC        |
|  | 1.9 TDI  | 74   |  | 08.02  | 12.07   | 24.3384-1732.7   | 220544   | D=38, - Halter  | LUC        |
|  | 1.9 TDI  | 77   |  | 10.05  | 12.07   |  |  |   |            |
|  | 1.9 TDI  | 85   |  | 01.07  | 12.07   |  |  |   |            |
|  | 1.9 TDI  | 96   |  | 12.01  | 12.07   |  |  |   |            |
|  | 2.0 i  | 85   |  | 12.01  | 02.08   |  |  |   |            |
|  | 2.0 TDI  | 103  |  | 10.05  | 12.07   |  |  |   |            |
|  | 2.5 TDI  | 114  |  | 12.01  | 12.07   |  |  |   |            |
|  | 2.5 TDI  | 120  |  | 06.03  | 12.07   |  |  |   |            |
|  | 2.8 i V6   | 142  |  | 12.01  | 12.07   |  |  |   |            |
|    | 1.8 i 20V Turbo  | 110  |  | 12.01  | 02.08   | 83.7812-0180.3   | 330854   | L=180   |            |
|  | 1.9 TDI  | 74   |  | 08.02  | 12.07   |  |  |   |            |
|  | 1.9 TDI  | 77   |  | 10.05  | 12.07   |  |  |   |            |
|  | 1.9 TDI  | 85   |  | 01.07  | 12.07   |  |  |   |            |
|  | 1.9 TDI  | 96   |  | 12.01  | 12.07   |  |  |   |            |
|  | 2.0 i  | 85   |  | 12.01  | 02.08   |  |  |   |            |
|  | 2.0 TDI  | 103  |  | 10.05  | 12.07   |  |  |   |            |
|  | 2.5 TDI  | 114  |  | 12.01  | 12.07   |  |  |   |            |
|  | 2.5 TDI  | 120  |  | 06.03  | 12.07   |  |  |   |            |
|  | 2.8 i V6   | 142  |  | 12.01  | 12.07   |  |  |   |            |
|  | 1.8 i 20V Turbo  | 110  |  | 12.01  | 02.08   | 24.3727-2506.2   | 582506   | L=1992  |            |
|  | 1.9 TDI  | 74   |  | 08.02  | 12.07   | 24.3727-2507.2   | 582507   | L=1992  |            |
|  | 1.9 TDI  | 77   |  | 10.05  | 12.07   |  |  |   |            |
|  | 1.9 TDI  | 85   |  | 01.07  | 12.07   |  |  |   |            |
|  | 1.9 TDI  | 96   |  | 12.01  | 12.07   |  |  |   |            |
|  | 2.0 i  | 85   |  | 12.01  | 02.08   |  |  |   |            |
|  | 2.0 TDI  | 103  |  | 10.05  | 12.07   |  |  |   |            |
|  | 2.5 TDI  | 114  |  | 12.01  | 12.07   |  |  |   |            |
|  | 2.5 TDI  | 120  |  | 06.03  | 12.07   |  |  |   |            |
|  | 2.8 i V6   | 142  |  | 12.01  | 12.07   |  |  |   |            |
|  | 1.8 i 20V Turbo  | 110  |  | 12.01  | 02.08   | 24.2419-1707.3   | 030092   | Gz 19,05  |            |
|  | 2.0 i  | 85   |  | 12.01  | 02.08   |  |  |   |            |
|  | 2.8 i V6   | 142  |  | 12.01  | 12.07   |  |  |   |            |
|  | 1.8 i 20V Turbo  | 110  |  | 12.01  | 02.08   | 24.2522-1706.3   | 040090   | Nz 22,20  |            |
|  | 1.9 TDI  | 74   |  | 08.02  | 12.07   |  |  |   |            |
|  | 1.9 TDI  | 77   |  | 10.05  | 12.07   |  |  |   |            |
|  | 1.9 TDI  | 85   |  | 01.07  | 12.07   |  |  |   |            |
|  | 1.9 TDI  | 96   |  | 12.01  | 12.07   |  |  |   |            |
|  | 2.0 i  | 85   |  | 12.01  | 02.08   |  |  |   |            |
|  | 2.0 TDI  | 103  |  | 10.05  | 12.07   |  |  |   |            |
|  | 2.5 TDI  | 114  |  | 12.01  | 12.07   |  |  |   |            |
|  | 2.5 TDI  | 120  |  | 06.03  | 12.07   |  |  |   |            |
|  | 2.8 i V6   | 142  |  | 12.01  | 12.07   |  |  |   |            |
| <b>SKODA SUPERB II (08-)</b>   |  |  |  |  |   |  |  |   |            |
|  | 1.4 TSI  | 92   |  | 08.08  |   | 03.7863-9702.4   | 300207   | 10"   | ATE        |
|  | 1.4 TSI  | 103  |  | 08.08  |   |  |  |   |            |
|  | 1.6 i 16V  | 77   |  | 08.08  |   |  |  |   |            |
|  | 1.6 TDI  | 77   |  | 09.10  |   |  |  |   |            |
|  | 1.8 TFSI   |  |  | 08.08  |   |  |  |   |            |
|  | 1.8 TFSI 4x4   |  |  | 10.08  |   |  |  |   |            |
|  | 1.9 TDI  | 77   |  | 08.08  |   |  |  |   |            |
|  | 2.0 TDI  | 103  |  | 08.08  |   |  |  |   |            |
|  | 2.0 TDI  | 125  |  | 08.08  |   |  |  |   |            |
|  | 2.0 TDI 4x4  |  |  | 10.08  |   |  |  |   |            |
|  | 2.0 TSI  | 147  |  | 05.10  |   |  |  |   |            |
|  | 3.6 FSI V6 4x4   | 191  |  | 11.08  |   |  |  |   |            |

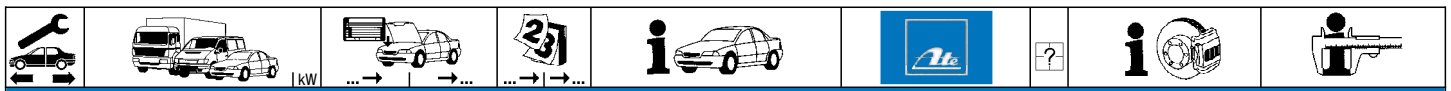

**SKODA SUPERB II (08-)**

|  |   |  |  |   |  |  |  |   |  |                                 |
|--|---|--|--|---|--|--|--|---|--|---------------------------------|
|  | 1.4 TSI<br>1.4 TSI<br>1.6 i 16V<br>1.6 TDI<br>1.8 TFSI<br>1.8 TFSI 4x4<br>1.9 TDI<br>2.0 TDI<br>2.0 TDI<br>2.0 TDI 4x4<br>2.0 TSI<br>3.6 FSI V6 4x4 | 92<br>103<br>77<br>77<br>77<br>77<br>103<br>125<br>103<br>147<br>191 | 08.08<br>08.08<br>08.08<br>09.10<br>08.08<br>10.08<br>08.08<br>08.08<br>08.08<br>10.08<br>05.10<br>11.08 |   |  | 03.2123-3449.3<br>010808   |  |   | THz 23,81  | ATE                             |
|  | 1.4 TSI<br>1.4 TSI<br>1.6 i 16V<br>1.6 TDI<br>1.8 TFSI<br>1.8 TFSI 4x4<br>1.9 TDI<br>2.0 TDI<br>2.0 TDI<br>2.0 TDI 4x4<br>2.0 TSI<br>3.6 FSI V6 4x4 | 92<br>103<br>77<br>77<br>77<br>77<br>103<br>125<br>103<br>147<br>191 | 08.08<br>08.08<br>08.08<br>09.10<br>08.08<br>10.08<br>08.08<br>08.08<br>08.08<br>10.08<br>05.10<br>11.08 | PR: 1ZE<br>PR: 1ZE<br>PR: 1ZE<br>PR: 1ZE<br>PR: 1ZE<br>PR: 1ZE<br>PR: 1ZE<br>PR: 1ZE<br>PR: 1ZE<br>PR: 1ZE<br>PR: 1ZE   |  | 11.9541-9553.2<br>11.9541-9554.2<br>11.0101-5409.2<br>11.8171-0008.1<br>11.8116-0351.1 | 220563<br>220564<br>260035<br>990049<br>390538 | 2 | D=54, - Halter<br>D=54, - Halter<br>Hülzensatz<br>Führungsbolzen<br>Haltefeder | ATE<br>ATE<br>ATE<br>ATE<br>ATE |
|  | 1.4 TSI<br>1.4 TSI<br>1.6 i 16V<br>1.6 TDI<br>1.8 TFSI<br>1.8 TFSI 4x4<br>1.9 TDI<br>2.0 TDI<br>2.0 TDI<br>2.0 TDI 4x4<br>2.0 TSI<br>3.6 FSI V6 4x4 | 92<br>103<br>77<br>77<br>77<br>77<br>103<br>125<br>103<br>147<br>191 | 08.08<br>08.08<br>08.08<br>09.10<br>08.08<br>10.08<br>08.08<br>08.08<br>08.08<br>10.08<br>05.10<br>11.08 | PR: 1LJ,1ZA<br>PR: 1LJ,1ZA<br>PR: 1LJ,1ZA<br>PR: 1LJ,1ZA<br>PR: 1LJ,1ZA<br>PR: 1LJ,1ZA<br>PR: 1LJ,1ZA<br>PR: 1LJ,1ZA<br>PR: 1LJ,1ZA<br>PR: 1LJ,1ZA<br>PR: 1LJ,1ZA |  | 11.9541-9553.2<br>11.9541-9554.2<br>11.0101-5409.2<br>11.8171-0008.1<br>11.8116-0351.1 | 220563<br>220564<br>260035<br>990049<br>390538 | 2 | D=54, - Halter<br>D=54, - Halter<br>Hülzensatz<br>Führungsbolzen<br>Haltefeder | ATE<br>ATE<br>ATE<br>ATE<br>ATE |
|  | 1.4 TSI<br>1.4 TSI<br>1.6 i 16V<br>1.6 TDI<br>1.8 TFSI<br>1.8 TFSI 4x4<br>1.9 TDI<br>2.0 TDI<br>2.0 TDI<br>2.0 TDI 4x4<br>2.0 TSI<br>3.6 FSI V6 4x4 | 92<br>103<br>77<br>77<br>77<br>77<br>103<br>125<br>103<br>147<br>191 | 08.08<br>08.08<br>08.08<br>09.10<br>08.08<br>10.08<br>08.08<br>08.08<br>08.08<br>10.08<br>05.10<br>11.08 | PR: 1LK<br>PR: 1LK<br>PR: 1LK<br>PR: 1LK<br>PR: 1LK<br>PR: 1LK<br>PR: 1LK<br>PR: 1LK<br>PR: 1LK<br>PR: 1LK<br>PR: 1LK   |  | 11.9576-9995.2<br>11.9576-9996.2<br>11.0101-5409.2<br>11.8171-0008.1<br>11.8116-0410.2 | 220651<br>220652<br>260035<br>990049<br>390589 | 2 | D=57, - Halter<br>D=57, - Halter<br>Hülzensatz<br>Führungsbolzen<br>Haltefeder | ATE<br>ATE<br>ATE<br>ATE<br>ATE |
|  | 1.4 TSI<br>1.4 TSI<br>1.6 i 16V<br>1.6 TDI<br>1.8 TFSI<br>1.8 TFSI 4x4<br>1.9 TDI<br>2.0 TDI<br>2.0 TDI<br>2.0 TDI 4x4<br>2.0 TSI<br>3.6 FSI V6 4x4 | 92<br>103<br>77<br>77<br>77<br>77<br>103<br>125<br>103<br>147<br>191 | 08.08<br>08.08<br>08.08<br>09.10<br>08.08<br>10.08<br>08.08<br>08.08<br>08.08<br>10.08<br>05.10<br>11.08 | PR: 1ZE,1LJ<br>PR: 1ZE,1LJ<br>PR: 1ZE,1LJ<br>PR: 1ZE,1LJ<br>PR: 1ZE,1LJ<br>PR: 1ZE,1LJ<br>PR: 1ZE,1LJ<br>PR: 1ZE,1LJ<br>PR: 1ZE,1LJ<br>PR: 1ZE,1LJ<br>PR: 1ZE,1LJ |  | 83.7847-0563.3   | 331124   | 2 | L=562  |                                 |
|  | 1.4 TSI<br>1.4 TSI<br>1.6 i 16V<br>1.6 TDI<br>1.8 TFSI<br>1.8 TFSI 4x4<br>1.9 TDI<br>2.0 TDI<br>2.0 TDI<br>2.0 TDI 4x4<br>2.0 TSI<br>3.6 FSI V6 4x4 | 92<br>103<br>77<br>77<br>77<br>77<br>103<br>125<br>103<br>147<br>191 | 08.08<br>08.08<br>08.08<br>09.10<br>08.08<br>10.08<br>08.08<br>08.08<br>08.08<br>10.08<br>05.10<br>11.08 | PR: 1LK<br>PR: 1LK<br>PR: 1LK<br>PR: 1LK<br>PR: 1LK<br>PR: 1LK<br>PR: 1LK<br>PR: 1LK<br>PR: 1LK<br>PR: 1LK<br>PR: 1LK   |  | 83.7849-0502.3   | 331125   | 2 | L=504  |                                 |
|  | 1.4 TSI<br>1.4 TSI<br>1.6 i 16V<br>1.6 TDI<br>1.8 TFSI<br>1.8 TFSI 4x4<br>1.9 TDI<br>2.0 TDI<br>2.0 TDI<br>2.0 TDI 4x4<br>2.0 TSI                   | 92<br>103<br>77<br>77<br>77<br>77<br>103<br>125<br>103<br>147        | 08.08<br>08.08<br>08.08<br>09.10<br>08.08<br>08.08<br>08.08<br>08.08<br>08.08<br>10.08<br>05.10          | PR: 1KF,1KJ<br>PR: 1KF,1KJ<br>PR: 1KF,1KJ<br>PR: 1KF,1KJ<br>PR: 1KF,1KJ<br>PR: 1KF,1KJ<br>PR: 1KF,1KJ<br>PR: 1KF,1KJ<br>PR: 1KF,1KJ<br>PR: 1KF,1KJ                |  | 24.3414-1709.7<br>24.3414-1710.7   | 220631<br>220632                               | 2 | D=41, - Halter<br>D=41, - Halter   | LUC<br>LUC                      |
|  | 1.8 TFSI 4x4<br>2.0 TDI 4x4<br>3.6 FSI V6 4x4   | 191  | 10.08<br>10.08<br>11.08  | PR: 2EA<br>PR: 2EA<br>PR: 2EA   |  | 24.3417-1711.7<br>24.3417-1712.7   | 220883<br>220884                               | 2 | D=41, - Halter<br>D=41, - Halter   | LUC<br>LUC                      |

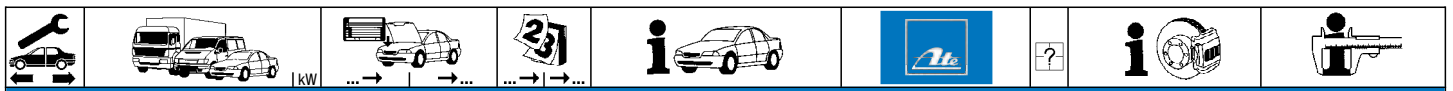

**SKODA SUPERB II (08-)**

|  |   |  |  |                                  |                  |   |   |                                |
|--|---|--|--|----------------------------------|------------------|---|---|--------------------------------|
|  | 1.4 TSI 92<br>1.4 TSI 103<br>1.6 i 16V 77<br>1.8 TFSI 103<br>1.8 TFSI 4x4 103<br>1.9 TDI 77<br>2.0 TDI 103<br>2.0 TDI 125<br>2.0 TDI 4x4 103<br>3.6 FSI V6 4x4 191                              | 08.08<br>08.08<br>08.08<br>08.08<br>10.08<br>08.08<br>08.08<br>08.08<br>10.08<br>11.08                   | 10.09<br>10.09<br>10.09<br>10.09<br>10.09<br>10.09<br>10.09<br>10.09<br>10.09<br>10.09   | 83.7849-0231.3                   | 330872           | 2 |   | L=233                          |
|  | 1.4 TSI 92<br>1.4 TSI 103<br>1.6 i 16V 77<br>1.8 TFSI 103<br>1.8 TFSI 4x4 103<br>1.9 TDI 77<br>2.0 TDI 103<br>2.0 TDI 125<br>2.0 TDI 4x4 103<br>3.6 FSI V6 4x4 191                              | 08.08<br>08.08<br>08.08<br>08.08<br>10.08<br>08.08<br>08.08<br>08.08<br>10.08<br>11.08                   | 11.08 PR: 1SA,1SK<br>11.08 PR: 1SA,1SK<br>11.08 PR: 1SA,1SK<br>11.08 PR: 1SA,1SK<br>11.08 PR: 1SA,1SK<br>11.08 PR: 1SA,1SK<br>11.08 PR: 1SA,1SK<br>11.08 PR: 1SA,1SK<br>11.08 PR: 1SA,1SK<br>11.08 PR: 1SA,1SK | 24.3727-2510.2                   | 582510           | 2 | ↓ | L=1590                         |
|  | 1.4 TSI 92<br>1.4 TSI 103<br>1.6 i 16V 77<br>1.6 TDI 77<br>1.8 TFSI 103<br>1.8 TFSI 4x4 103<br>1.9 TDI 77<br>2.0 TDI 103<br>2.0 TDI 125<br>2.0 TDI 4x4 147<br>2.0 TSI 191<br>3.6 FSI V6 4x4 191 | 08.08<br>08.08<br>08.08<br>09.10<br>08.08<br>10.08<br>08.08<br>08.08<br>08.08<br>10.08<br>05.10<br>11.08 |  | 24.2415-1711.3<br>24.2415-1713.3 | 030130<br>030132 |   |   | Gz 15,87<br>Gz 15,87, + Sensor |
|  | 1.4 TSI 92<br>1.4 TSI 103<br>1.6 i 16V 77<br>1.6 TDI 77<br>1.8 TFSI 103<br>1.8 TFSI 4x4 103<br>1.9 TDI 77<br>2.0 TDI 103<br>2.0 TDI 125<br>2.0 TDI 4x4 147<br>2.0 TSI 191<br>3.6 FSI V6 4x4 191 | 08.08<br>08.08<br>08.08<br>09.10<br>08.08<br>10.08<br>08.08<br>08.08<br>08.08<br>10.08<br>05.10<br>11.08 | 07.11 PR: OEJ<br>07.11 PR: OEJ<br>07.11 PR: OEJ<br>07.11 PR: OEJ<br>07.11 PR: OEJ<br>07.11 PR: OEJ<br>07.11 PR: OEJ<br>07.11 PR: OEJ<br>07.11 PR: OEJ<br>07.11 PR: OEJ<br>07.11 PR: OEJ                        | 24.2519-1705.3                   | 040095           |   |   | Nz 19,05                       |

**SKODA SUPERB Kombi (09-)**

|  |  |  |  |  |  |   |  |  |
|--|--|--|--|--|--|---|--|--|
|  | 1.4 TSI 92<br>1.6 TDI 77<br>1.8 TSI 103<br>1.8 TSI 4x4 103<br>1.9 TDI 77<br>2.0 TDI 103<br>2.0 TDI 125<br>2.0 TDI 4x4 125<br>2.0 TSI 147<br>3.6 V6 4x4 191 | 11.09<br>09.10<br>11.09<br>11.09<br>10.09<br>11.09<br>11.09<br>11.09<br>05.10<br>11.09 |  | 03.7863-9702.4   | 300207   |   |  | 10" ATE  |
|  | 1.4 TSI 92<br>1.6 TDI 77<br>1.8 TSI 103<br>1.8 TSI 4x4 103<br>1.9 TDI 77<br>2.0 TDI 103<br>2.0 TDI 125<br>2.0 TDI 4x4 125<br>2.0 TSI 147<br>3.6 V6 4x4 191 | 11.09<br>09.10<br>11.09<br>11.09<br>10.09<br>11.09<br>11.09<br>11.09<br>05.10<br>11.09 |  | 03.2123-3449.3   | 010808   |   |  | Thz 23,81 ATE  |
|  | 1.4 TSI 92<br>1.6 TDI 77<br>1.8 TSI 103<br>1.8 TSI 4x4 103<br>1.9 TDI 77<br>2.0 TDI 103<br>2.0 TDI 125<br>2.0 TDI 4x4 125<br>2.0 TSI 147<br>3.6 V6 4x4 191 | 11.09<br>09.10<br>11.09<br>11.09<br>10.09<br>11.09<br>11.09<br>11.09<br>05.10<br>11.09 | PR: 1ZE<br>PR: 1ZE<br>PR: 1ZE<br>PR: 1ZE<br>PR: 1ZE<br>PR: 1ZE<br>PR: 1ZE<br>PR: 1ZE<br>PR: 1ZE<br>PR: 1ZE   | 11.9541-9553.2<br>11.9541-9554.2<br>11.8171-0008.1<br>11.8116-0351.1<br>11.0101-5409.2 | 220563<br>220564<br>990049<br>390538<br>260035 | 2 |  | D=54, - Halter ATE<br>D=54, - Halter ATE<br>Führungsbolzen ATE<br>Haltefeder ATE<br>Hülsensatz ATE |
|  | 1.4 TSI 92<br>1.6 TDI 77<br>1.8 TSI 103<br>1.8 TSI 4x4 103<br>1.9 TDI 77<br>2.0 TDI 103<br>2.0 TDI 125<br>2.0 TDI 4x4 125<br>2.0 TSI 147<br>3.6 V6 4x4 191 | 11.09<br>09.10<br>11.09<br>11.09<br>10.09<br>11.09<br>11.09<br>11.09<br>05.10<br>11.09 | PR: 1LJ,1ZA<br>PR: 1LJ,1ZA<br>PR: 1LJ,1ZA<br>PR: 1LJ,1ZA<br>PR: 1LJ,1ZA<br>PR: 1LJ,1ZA<br>PR: 1LJ,1ZA<br>PR: 1LJ,1ZA<br>PR: 1LJ,1ZA<br>PR: 1LJ,1ZA | 11.9541-9553.2<br>11.9541-9554.2<br>11.8171-0008.1<br>11.8116-0351.1<br>11.0101-5409.2 | 220563<br>220564<br>990049<br>390538<br>260035 | 2 |  | D=54, - Halter ATE<br>D=54, - Halter ATE<br>Führungsbolzen ATE<br>Haltefeder ATE<br>Hülsensatz ATE |



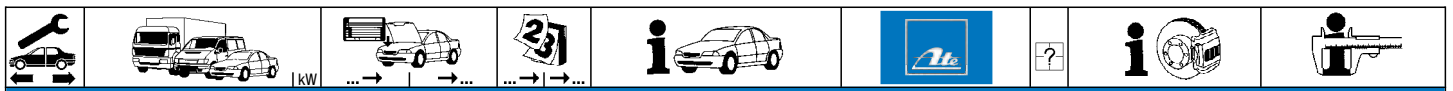



### SKODA SUPERB Kombi (09-)

|            |             |     |       |             |             |                |        |   |  |                                 |
|------------|-------------|-----|-------|-------------|-------------|----------------|--------|---|--|---------------------------------|
|            | 1.4 TSI     | 92  |       | 11.09       | PR: 1LK     | 11.9576-9995.2 | 220651 | 2 | D=57, - Halter<br>D=57, - Halter<br>Führungsbolzen<br>Haltefeder<br>Hülzensatz | ATE<br>ATE<br>ATE<br>ATE<br>ATE |
|            | 1.6 TDI     | 77  |       | 09.10       | PR: 1LK     | 11.9576-9996.2 | 220652 |   |  |                                 |
|            | 1.8 TSI     |     |       | 11.09       | PR: 1LK     | 11.8171-0008.1 | 990049 |   |  |                                 |
|            | 1.8 TSI 4x4 |     |       | 11.09       | PR: 1LK     | 11.8116-0410.2 | 390589 |   |  |                                 |
|            | 1.9 TDI     | 77  |       | 10.09       | PR: 1LK     | 11.0101-5409.2 | 260035 |   |  |                                 |
|            | 2.0 TDI     | 103 |       | 11.09       | PR: 1LK     |                |        |   |  |                                 |
|            | 2.0 TDI     | 125 |       | 11.09       | PR: 1LK     |                |        |   |  |                                 |
|            | 2.0 TDI 4x4 | 125 |       | 11.09       | PR: 1LK     |                |        |   |  |                                 |
|            | 2.0 TSI     | 147 |       | 05.10       | PR: 1LK     |                |        |   |  |                                 |
| 3.6 V6 4x4 | 191         |     | 11.09 | PR: 1LK     |             |                |        |   |  |                                 |
|            | 1.4 TSI     | 92  |       | 11.09       | PR: 1LJ,1ZE | 83.7847-0563.3 | 331124 | 2 | L=562  |                                 |
|            | 1.6 TDI     | 77  |       | 09.10       | PR: 1LJ,1ZE |                |        |   |  |                                 |
|            | 1.8 TSI     |     |       | 11.09       | PR: 1LJ,1ZE |                |        |   |  |                                 |
|            | 1.8 TSI 4x4 |     |       | 11.09       | PR: 1LJ,1ZE |                |        |   |  |                                 |
|            | 1.9 TDI     | 77  |       | 10.09       | PR: 1LJ,1ZE |                |        |   |  |                                 |
|            | 2.0 TDI     | 103 |       | 11.09       | PR: 1LJ,1ZE |                |        |   |  |                                 |
|            | 2.0 TDI     | 125 |       | 11.09       | PR: 1LJ,1ZE |                |        |   |  |                                 |
|            | 2.0 TDI 4x4 | 125 |       | 11.09       | PR: 1LJ,1ZE |                |        |   |  |                                 |
|            | 2.0 TSI     | 147 |       | 05.10       | PR: 1LJ,1ZE |                |        |   |  |                                 |
| 3.6 V6 4x4 | 191         |     | 11.09 | PR: 1LJ,1ZE |             |                |        |   |  |                                 |
|            | 1.4 TSI     | 92  |       | 11.09       | PR: 1LK     | 83.7849-0502.3 | 331125 | 2 | L=504  |                                 |
|            | 1.6 TDI     | 77  |       | 09.10       | PR: 1LK     |                |        |   |  |                                 |
|            | 1.8 TSI     |     |       | 11.09       | PR: 1LK     |                |        |   |  |                                 |
|            | 1.8 TSI 4x4 |     |       | 11.09       | PR: 1LK     |                |        |   |  |                                 |
|            | 1.9 TDI     | 77  |       | 10.09       | PR: 1LK     |                |        |   |  |                                 |
|            | 2.0 TDI     | 103 |       | 11.09       | PR: 1LK     |                |        |   |  |                                 |
|            | 2.0 TDI     | 125 |       | 11.09       | PR: 1LK     |                |        |   |  |                                 |
|            | 2.0 TDI 4x4 | 125 |       | 11.09       | PR: 1LK     |                |        |   |  |                                 |
|            | 2.0 TSI     | 147 |       | 05.10       | PR: 1LK     |                |        |   |  |                                 |
| 3.6 V6 4x4 | 191         |     | 11.09 | PR: 1LK     |             |                |        |   |  |                                 |
|            | 1.4 TSI     | 92  |       | 11.09       | PR: 1KF,1KJ | 24.3414-1709.7 | 220631 | 2 | D=41, - Halter<br>D=41, - Halter   | LUC<br>LUC                      |
|            | 1.6 TDI     | 77  |       | 09.10       | PR: 1KF,1KJ |                |        |   |  |                                 |
|            | 1.8 TSI     |     |       | 11.09       | PR: 1KF,1KJ |                |        |   |  |                                 |
|            | 1.8 TSI 4x4 |     |       | 11.09       | PR: 1KF,1KJ |                |        |   |  |                                 |
|            | 1.9 TDI     | 77  |       | 10.09       | PR: 1KF,1KJ |                |        |   |  |                                 |
|            | 2.0 TDI     | 103 |       | 11.09       | PR: 1KF,1KJ |                |        |   |  |                                 |
|            | 2.0 TDI     | 125 |       | 11.09       | PR: 1KF,1KJ |                |        |   |  |                                 |
|            | 2.0 TDI 4x4 | 125 |       | 11.09       | PR: 1KF,1KJ |                |        |   |  |                                 |
|            | 2.0 TSI     | 147 |       | 05.10       | PR: 1KF,1KJ |                |        |   |  |                                 |
| 3.6 V6 4x4 | 191         |     | 11.09 | PR: 1KF,1KJ |             |                |        |   |  |                                 |
|            | 1.8 TSI 4x4 | 92  |       | 11.09       | PR: 2EA     | 24.3417-1711.7 | 220883 | 2 | D=41, - Halter   | LUC                             |
|            | 2.0 TDI 4x4 | 125 |       | 11.09       | PR: 2EA     |                |        |   |  |                                 |
|            | 3.6 V6 4x4  | 191 |       | 11.09       | PR: 2EA     |                |        |   |  |                                 |
|            | 1.4 TSI     | 92  |       | 11.09       |             | 24.2415-1711.3 | 030130 |   | Gz 15,87<br>Gz 15,87, + Sensor   |                                 |
|            | 1.6 TDI     | 77  |       | 09.10       |             |                |        |   |  |                                 |
|            | 1.8 TSI     |     |       | 11.09       |             |                |        |   |  |                                 |
|            | 1.8 TSI 4x4 |     |       | 11.09       |             |                |        |   |  |                                 |
|            | 1.9 TDI     | 77  |       | 10.09       |             |                |        |   |  |                                 |
|            | 2.0 TDI     | 103 |       | 11.09       |             |                |        |   |  |                                 |
|            | 2.0 TDI     | 125 |       | 11.09       |             |                |        |   |  |                                 |
|            | 2.0 TDI 4x4 | 125 |       | 11.09       |             |                |        |   |  |                                 |
|            | 2.0 TSI     | 147 |       | 05.10       |             |                |        |   |  |                                 |
| 3.6 V6 4x4 | 191         |     | 11.09 |             |             |                |        |   |  |                                 |
|            | 1.4 TSI     | 92  |       | 11.09       | PR: 0EJ     | 24.2519-1705.3 | 040095 |   | Nz 19,05   |                                 |
|            | 1.6 TDI     | 77  |       | 09.10       | PR: 0EJ     |                |        |   |  |                                 |
|            | 1.8 TSI     |     |       | 11.09       | PR: 0EJ     |                |        |   |  |                                 |
|            | 1.8 TSI 4x4 |     |       | 11.09       | PR: 0EJ     |                |        |   |  |                                 |
|            | 1.9 TDI     | 77  |       | 10.09       | PR: 0EJ     |                |        |   |  |                                 |
|            | 2.0 TDI     | 103 |       | 11.09       | PR: 0EJ     |                |        |   |  |                                 |
|            | 2.0 TDI     | 125 |       | 11.09       | PR: 0EJ     |                |        |   |  |                                 |
|            | 2.0 TDI 4x4 | 125 |       | 11.09       | PR: 0EJ     |                |        |   |  |                                 |
|            | 2.0 TSI     | 147 |       | 05.10       | PR: 0EJ     |                |        |   |  |                                 |
| 3.6 V6 4x4 | 191         |     | 11.09 | PR: 0EJ     |             |                |        |   |  |                                 |





















### SKODA YETI (09-)

|  |             |     |  |       |                 |                |        |  |           |     |
|--|-------------|-----|--|-------|-----------------|----------------|--------|--|-----------|-----|
|  | 1.2 TSI     | 77  |  | 09.09 | PR: 1AC,1ZE,1ZF | 03.7863-9502.4 | 300204 |  | 10"       | ATE |
|  | 1.4 TSI     | 90  |  | 06.10 | PR: 1AC,1ZE,1ZF |                |        |  |           |     |
|  | 1.6 TDI     | 77  |  | 11.10 | PR: 1AC,1ZE,1ZF |                |        |  |           |     |
|  | 1.8 TSI 4x4 | 118 |  | 05.09 | PR: 1AC,1ZE,1ZF |                |        |  |           |     |
|  | 2.0 TDI     | 81  |  | 11.09 | PR: 1AC,1ZE,1ZF |                |        |  |           |     |
|  | 2.0 TDI 4x4 | 81  |  | 11.09 | PR: 1AC,1ZE,1ZF |                |        |  |           |     |
|  | 2.0 TDI 4x4 | 103 |  | 05.09 | PR: 1AC,1ZE,1ZF |                |        |  |           |     |
|  | 2.0 TDI 4x4 | 125 |  | 11.09 | PR: 1AC,1ZE,1ZF |                |        |  |           |     |
|  | 1.2 TSI     | 77  |  | 09.09 | PR: 1ZA,1LK     | 03.7863-9702.4 | 300207 |  | 10"       | ATE |
|  | 1.4 TSI     | 90  |  | 06.10 | PR: 1ZA,1LK     |                |        |  |           |     |
|  | 1.6 TDI     | 77  |  | 11.10 | PR: 1ZA,1LK     |                |        |  |           |     |
|  | 1.8 TSI 4x4 | 118 |  | 05.09 | PR: 1ZA,1LK     |                |        |  |           |     |
|  | 2.0 TDI     | 81  |  | 11.09 | PR: 1ZA,1LK     |                |        |  |           |     |
|  | 2.0 TDI 4x4 | 81  |  | 11.09 | PR: 1ZA,1LK     |                |        |  |           |     |
|  | 2.0 TDI 4x4 | 103 |  | 05.09 | PR: 1ZA,1LK     |                |        |  |           |     |
|  | 2.0 TDI 4x4 | 125 |  | 11.09 | PR: 1ZA,1LK     |                |        |  |           |     |
|  | 1.2 TSI     | 77  |  | 09.09 | PR: 1ZE,1ZF     | 03.2122-2129.3 | 010799 |  | Thz 22,20 | ATE |
|  | 1.4 TSI     | 90  |  | 06.10 | PR: 1ZE,1ZF     |                |        |  |           |     |
|  | 1.6 TDI     | 77  |  | 11.10 | PR: 1ZE,1ZF     |                |        |  |           |     |
|  | 1.8 TSI 4x4 | 118 |  | 05.09 | PR: 1ZE,1ZF     |                |        |  |           |     |
|  | 2.0 TDI     | 81  |  | 11.09 | PR: 1ZE,1ZF     |                |        |  |           |     |
|  | 2.0 TDI 4x4 | 81  |  | 11.09 | PR: 1ZE,1ZF     |                |        |  |           |     |
|  | 2.0 TDI 4x4 | 103 |  | 05.09 | PR: 1ZE,1ZF     |                |        |  |           |     |
|  | 2.0 TDI 4x4 | 125 |  | 11.09 | PR: 1ZE,1ZF     |                |        |  |           |     |































































| SKODA YETI (09-)   |             |       |             |                |                |        |  |                    |                      |                |                |        |         |                |                |                |
|--|-------------|-------|-------------|----------------|----------------|--------|--|--------------------|----------------------|----------------|----------------|--------|---------|----------------|----------------|----------------|
|    | 1.2 TSI     | 77    | 09.09       | PR: 1ZA        | 03.2123-3449.3 | 010808 |  |                    | Thz 23,81            | ATE            |                |        |         |                |                |                |
|  | 1.4 TSI     | 90    | 06.10       | PR: 1ZA        |                |        |  |                    |                      |                |                |        |         |                |                |                |
|  | 1.6 TDI     | 77    | 11.10       | PR: 1ZA        |                |        |  |                    |                      |                |                |        |         |                |                |                |
|  | 1.8 TSI 4x4 | 118   | 05.09       | PR: 1ZA        |                |        |  |                    |                      |                |                |        |         |                |                |                |
|  | 2.0 TDI     | 81    | 11.09       | PR: 1ZA        |                |        |  |                    |                      |                |                |        |         |                |                |                |
|  | 2.0 TDI 4x4 | 81    | 11.09       | PR: 1ZA        |                |        |  |                    |                      |                |                |        |         |                |                |                |
|  | 2.0 TDI 4x4 | 103   | 05.09       | PR: 1ZA        |                |        |  |                    |                      |                |                |        |         |                |                |                |
|  | 2.0 TDI 4x4 | 125   | 11.09       | PR: 1ZA        |                |        |  |                    |                      |                |                |        |         |                |                |                |
|    | 1.2 TSI     | 77    | 09.09       | PR: 1ZF        | 11.9541-9549.2 | 220575 |  |                    | D=54, - Halter       | ATE            |                |        |         |                |                |                |
|  | 1.4 TSI     | 90    | 06.10       | PR: 1ZF        |                |        |  |                    |                      |                |                |        |         |                |                |                |
|  | 1.6 TDI     | 77    | 11.10       | PR: 1ZF        |                |        |  |                    |                      |                |                |        |         |                |                |                |
|  | 1.8 TSI 4x4 | 118   | 05.09       | PR: 1ZF        |                |        |  |                    |                      |                |                |        |         |                |                |                |
|  | 2.0 TDI     | 81    | 11.09       | PR: 1ZF        |                |        |  |                    |                      |                |                |        |         |                |                |                |
|  | 2.0 TDI 4x4 | 81    | 11.09       | PR: 1ZF        |                |        |  |                    |                      |                |                |        |         |                |                |                |
|  | 2.0 TDI 4x4 | 103   | 05.09       | PR: 1ZF        |                |        |  |                    |                      |                |                |        |         |                |                |                |
|  | 2.0 TDI 4x4 | 125   | 11.09       | PR: 1ZF        |                |        |  |                    |                      |                |                |        |         |                |                |                |
|  | 1.2 TSI     | 77    | 09.09       | PR: 1ZA,1ZE    |                |        |  |                    |                      |                | 11.9541-9553.2 | 220563 |         |                | D=54, - Halter | ATE            |
|  | 1.4 TSI     | 90    | 06.10       | PR: 1ZA,1ZE    |                |        |  |                    |                      |                |                |        |         |                |                |                |
|  | 1.6 TDI     | 77    | 11.10       | PR: 1ZA,1ZE    |                |        |  |                    |                      |                |                |        |         |                |                |                |
|  | 1.8 TSI 4x4 | 118   | 05.09       | PR: 1ZA,1ZE    |                |        |  |                    |                      |                |                |        |         |                |                |                |
| 2.0 TDI  | 81          | 11.09 | PR: 1ZA,1ZE |                |                |        |  |                    |                      |                |                |        |         |                |                |                |
| 2.0 TDI 4x4  | 81          | 11.09 | PR: 1ZA,1ZE |                |                |        |  |                    |                      |                |                |        |         |                |                |                |
| 2.0 TDI 4x4  | 103         | 05.09 | PR: 1ZA,1ZE |                |                |        |  |                    |                      |                |                |        |         |                |                |                |
| 2.0 TDI 4x4  | 125         | 11.09 | PR: 1ZA,1ZE |                |                |        |  |                    |                      |                |                |        |         |                |                |                |
| 1.2 TSI  | 77          | 09.09 | PR: 1KJ     | 24.3384-1755.7 | 220635         |        |  | D=38, - Halter     | LUC                  |                |                |        |         |                |                |                |
| 1.4 TSI  | 90          | 06.10 | PR: 1KD     |                |                |        |  |                    |                      |                |                |        |         |                |                |                |
| 1.6 TDI  | 77          | 11.10 | PR: 1KD     |                |                |        |  |                    |                      |                |                |        |         |                |                |                |
| 2.0 TDI  | 81          | 11.09 | PR: 1KD     |                |                |        |  |                    |                      |                |                |        |         |                |                |                |
| 1.2 TSI  | 77          | 09.09 | PR: 1KJ     |                |                |        |  |                    |                      | 24.3414-1709.7 | 220631         |        |         | D=41, - Halter | LUC            |                |
| 1.4 TSI  | 90          | 06.10 | PR: 1KJ     |                |                |        |  |                    |                      |                |                |        |         |                |                |                |
| 1.6 TDI  | 77          | 11.10 | PR: 1KJ     |                |                |        |  |                    |                      |                |                |        |         |                |                |                |
| 1.8 TSI 4x4  | 118         | 05.09 | PR: 1KJ     |                |                |        |  |                    |                      |                |                |        |         |                |                |                |
| 2.0 TDI  | 81          | 11.09 | PR: 1KJ     |                |                |        |  |                    |                      |                |                |        |         |                |                |                |
| 2.0 TDI 4x4  | 81          | 11.09 | PR: 1KJ     |                |                |        |  |                    |                      |                |                |        |         |                |                |                |
| 2.0 TDI 4x4  | 103         | 05.09 | PR: 1KJ     |                |                |        |  |                    |                      |                |                |        |         |                |                |                |
| 2.0 TDI 4x4  | 125         | 11.09 | PR: 1KJ     |                |                |        |  |                    |                      |                |                |        |         |                |                |                |
| 1.2 TSI  | 77          | 09.09 | 10.09       | 83.7849-0243.3 | 331099         | 2      |  | L=243              |                      |                |                |        |         |                |                |                |
| 1.8 TSI 4x4  | 118         | 05.09 | 10.09       |                |                |        |  |                    |                      |                |                |        |         |                |                |                |
| 2.0 TDI 4x4  | 103         | 05.09 | 10.09       |                |                |        |  |                    |                      |                |                |        |         |                |                |                |
| 1.2 TSI  | 77          | 09.09 | PR: 1SA,1SK |                |                |        |  |                    |                      |                |                |        |         |                |                | 24.3727-0195.2 |
| 1.4 TSI  | 90          | 06.10 | PR: 1SA,1SK |                |                |        |  |                    |                      |                |                |        |         |                |                |                |
| 1.6 TDI  | 77          | 11.10 | PR: 1SA,1SK |                |                |        |  |                    |                      |                |                |        |         |                |                |                |
| 1.8 TSI 4x4  | 118         | 05.09 | PR: 1SA,1SK |                |                |        |  |                    |                      |                |                |        |         |                |                |                |
| 2.0 TDI  | 81          | 11.09 | PR: 1SA,1SK |                |                |        |  |                    |                      |                |                |        |         |                |                |                |
| 2.0 TDI 4x4  | 81          | 11.09 | PR: 1SA,1SK |                |                |        |  |                    |                      |                |                |        |         |                |                |                |
| 2.0 TDI 4x4  | 103         | 05.09 | PR: 1SA,1SK |                |                |        |  |                    |                      |                |                |        |         |                |                |                |
| 2.0 TDI 4x4  | 125         | 11.09 | PR: 1SA,1SK |                |                |        |  |                    |                      |                |                |        |         |                |                |                |
| 1.2 TSI  | 77          | 09.09 | PR: OEM     |                |                |        |  |                    |                      | 24.2415-1711.3 | 030130         |        |         | Gz 15,87       |                |                |
| 1.4 TSI  | 90          | 06.10 | PR: OEM     |                |                |        |  |                    |                      |                |                |        |         |                |                |                |
| 1.6 TDI  | 77          | 11.10 | PR: OEM     |                |                |        |  |                    |                      |                |                |        |         |                |                |                |
| 1.8 TSI 4x4  | 118         | 05.09 | PR: OEM     |                |                |        |  |                    |                      |                |                |        |         |                |                |                |
| 2.0 TDI  | 81          | 11.09 | PR: OEM     |                |                |        |  |                    |                      |                |                |        |         |                |                |                |
| 2.0 TDI 4x4  | 81          | 11.09 | PR: OEM     |                |                |        |  |                    |                      |                |                |        |         |                |                |                |
| 2.0 TDI 4x4  | 103         | 05.09 | PR: OEM     |                |                |        |  |                    |                      |                |                |        |         |                |                |                |
| 2.0 TDI 4x4  | 125         | 11.09 | PR: OEM     |                |                |        |  |                    |                      |                |                |        |         |                |                |                |
| 1.2 TSI  | 77          | 09.09 | PR: OEJ     | 24.2415-1713.3 | 030132         |        |  | Gz 15,87, + Sensor |                      |                |                |        |         |                |                |                |
| 1.4 TSI  | 90          | 06.10 | PR: OEJ     |                |                |        |  |                    |                      |                |                |        |         |                |                |                |
| 1.6 TDI  | 77          | 11.10 | PR: OEJ     |                |                |        |  |                    |                      |                |                |        |         |                |                |                |
| 1.8 TSI 4x4  | 118         | 05.09 | PR: OEJ     |                |                |        |  |                    |                      |                |                |        |         |                |                |                |
| 2.0 TDI  | 81          | 11.09 | PR: OEJ     |                |                |        |  |                    |                      |                |                |        |         |                |                |                |
| 2.0 TDI 4x4  | 81          | 11.09 | PR: OEJ     |                |                |        |  |                    |                      |                |                |        |         |                |                |                |
| 2.0 TDI 4x4  | 103         | 05.09 | PR: OEJ     |                |                |        |  |                    |                      |                |                |        |         |                |                |                |
| 2.0 TDI 4x4  | 125         | 11.09 | PR: OEJ     |                |                |        |  |                    |                      |                |                |        |         |                |                |                |
| 1.2 TSI  | 77          | 09.09 | PR: OEJ     |                |                |        |  |                    |                      | 24.2519-1705.3 | 040095         |        | PR: OEJ | Nz 19,05       |                |                |
| 1.4 TSI  | 90          | 06.10 | PR: OEJ     |                |                |        |  |                    |                      |                |                |        |         |                |                |                |
| 1.6 TDI  | 77          | 11.10 | PR: OEJ     |                |                |        |  |                    |                      |                |                |        |         |                |                |                |
| 1.8 TSI 4x4  | 118         | 05.09 | PR: OEJ     |                |                |        |  |                    |                      |                |                |        |         |                |                |                |
| 2.0 TDI  | 81          | 11.09 | PR: OEJ     |                |                |        |  |                    |                      |                |                |        |         |                |                |                |
| 2.0 TDI 4x4  | 81          | 11.09 | PR: OEJ     |                |                |        |  |                    |                      |                |                |        |         |                |                |                |
| 2.0 TDI 4x4  | 103         | 05.09 | PR: OEJ     |                |                |        |  |                    |                      |                |                |        |         |                |                |                |
| 2.0 TDI 4x4  | 125         | 11.09 | PR: OEJ     |                |                |        |  |                    |                      |                |                |        |         |                |                |                |
| SMART CABRIO (BM450) (00-03)   |             |       |             |                |                |        |  |                    |                      |                |                |        |         |                |                |                |
|  | 0.6         | 40    | 01.03       | 01.04          | 24.2119-1711.3 | 010911 |  |                    | Thz 19,05 - Behälter |                |                |        |         |                |                |                |
|  | 0.6         | 45    | 01.03       | 01.04          |                |        |  |                    |                      |                |                |        |         |                |                |                |
|  | 0.6         | 52    | 01.03       | 01.04          |                |        |  |                    |                      |                |                |        |         |                |                |                |
|  | 0.7         | 45    | 01.03       | 01.04          |                |        |  |                    |                      |                |                |        |         |                |                |                |
|  | 0.7         | 55    | 01.03       | 01.04          |                |        |  |                    |                      |                |                |        |         |                |                |                |

1) pedal assembly / pedaliera completa / pédalier complet / pedalería completa























|     |  |  |  |  |  |  |  |  |                      |
|--|--|--|--|--|---|--|--|--|----------------------|
| <b>SMART CABRIO (BM450) (00-03)</b>  |  |  |  |  |   |  |  |  |                      |
|    | 0.8 CDI  | 30   |  | 01.03  | 01.04   | 24.2119-1711.3   | 010911   | Pedalwerk komplett <sup>1)</sup>   | Thz 19,05 - Behälter |
|    | 0.6  | 40   |  | 03.00  | 01.04   | 24.3421-1707.5   | 240445   | <input type="checkbox"/>   | D=42, - Halter       |
|  | 0.6  | 45   |  | 01.01  | 01.04   | 24.3421-1708.5   | 240446   | <input type="checkbox"/>   | D=42, - Halter       |
|  | 0.6  | 52   |  | 06.02  | 01.04   |  |  |  |                      |
|  | 0.7  | 45   |  | 01.03  | 01.04   |  |  |  |                      |
|  | 0.7  | 55   |  | 01.03  | 01.04   |  |  |  |                      |
|  | 0.8 CDI  | 30   |  | 03.01  | 01.04   |  |  |  |                      |
|    | 0.6  | 40   |  | 03.00  | 01.04   | 24.5112-0315.3   | 330509   | 2  | L=315                |
|  | 0.6  | 45   |  | 01.01  | 01.04   |  |  |  |                      |
|  | 0.6  | 52   |  | 06.02  | 01.04   |  |  |  |                      |
|  | 0.7  | 45   |  | 01.03  | 01.04   |  |  |  |                      |
|  | 0.7  | 55   |  | 01.03  | 01.04   |  |  |  |                      |
|  | 0.8 CDI  | 30   |  | 03.01  | 01.04   |  |  |  |                      |
|    | 0.6  | 40   |  | 03.00  | 01.04   | 24.5146-0330.3   | 330973   | 2  | L=330                |
|  | 0.6  | 45   |  | 01.01  | 01.04   |  |  |  |                      |
|  | 0.6  | 52   |  | 06.02  | 01.04   |  |  |  |                      |
|  | 0.7  | 45   |  | 01.03  | 01.04   |  |  |  |                      |
|  | 0.7  | 55   |  | 01.03  | 01.04   |  |  |  |                      |
|  | 0.8 CDI  | 30   |  | 03.01  | 01.04   |  |  |  |                      |
|    | 0.6  | 40   |  | 03.00  | 01.04   | 24.3222-1721.3   | 020456   | <input type="checkbox"/>   | Rz 22,00             |
|  | 0.6  | 45   |  | 01.01  | 01.04   | 24.3222-1722.3   | 020457   | <input type="checkbox"/>   | Rz 22,00             |
|  | 0.6  | 52   |  | 06.02  | 01.04   |  |  |  |                      |
|  | 0.7  | 45   |  | 01.03  | 01.04   |  |  |  |                      |
|  | 0.7  | 55   |  | 01.03  | 01.04   |  |  |  |                      |
|  | 0.8 CDI  | 30   |  | 03.01  | 01.04   |  |  |  |                      |
|    | 0.6  | 40   |  | 03.00  | 01.04   | 24.3727-2802.2   | 582802   | 1  | L=990/990, + Zub     |
|  | 0.6  | 45   |  | 01.01  | 01.04   |  |  |  |                      |
|  | 0.6  | 52   |  | 06.02  | 01.04   |  |  |  |                      |
|  | 0.7  | 45   |  | 01.03  | 01.04   |  |  |  |                      |
|  | 0.7  | 55   |  | 01.03  | 01.04   |  |  |  |                      |
|  | 0.8 CDI  | 30   |  | 03.01  | 01.04   |  |  |  |                      |
| <b>SMART CITY COUPE (BM450) (98-04)</b>  |  |  |  |  |   |  |  |  |                      |
|    | 0.6  | 33   |  | 01.03  | 01.04   | 24.2119-1711.3   | 010911   | Pedalwerk komplett <sup>1)</sup>   | Thz 19,05 - Behälter |
|  | 0.6  | 40   |  | 01.03  | 01.04   |  |  |  |                      |
|  | 0.6  | 45   |  | 01.03  | 01.04   |  |  |  |                      |
|  | 0.6  | 52   |  | 01.03  | 01.04   |  |  |  |                      |
|  | 0.7  | 37   |  | 01.03  | 01.04   |  |  |  |                      |
|  | 0.7  | 45   |  | 01.03  | 01.04   |  |  |  |                      |
|  | 0.7  | 55   |  | 01.03  | 01.04   |  |  |  |                      |
|  | 0.8 CDI  | 30   |  | 01.03  | 01.04   |  |  |  |                      |
|  | 0.6  | 33   |  | 07.98  | 01.04   | 24.3421-1707.5   | 240445   | <input type="checkbox"/>   | D=42, - Halter       |
|  | 0.6  | 40   |  | 07.98  | 01.04   | 24.3421-1708.5   | 240446   | <input type="checkbox"/>   | D=42, - Halter       |
|  | 0.6  | 45   |  | 01.01  | 01.04   |  |  |  |                      |
|  | 0.6  | 52   |  | 06.02  | 01.04   |  |  |  |                      |
|  | 0.7  | 37   |  | 01.03  | 01.04   |  |  |  |                      |
|  | 0.7  | 45   |  | 01.03  | 01.04   |  |  |  |                      |
|  | 0.7  | 55   |  | 01.03  | 01.04   |  |  |  |                      |
|  | 0.8 CDI  | 30   |  | 11.99  | 01.04   |  |  |  |                      |
|  | 0.6  | 33   |  | 07.98  | 01.04   | 24.5112-0315.3   | 330509   | 2  | L=315                |
|  | 0.6  | 40   |  | 07.98  | 01.04   |  |  |  |                      |
|  | 0.6  | 45   |  | 01.01  | 01.04   |  |  |  |                      |
|  | 0.6  | 52   |  | 06.02  | 01.04   |  |  |  |                      |
|  | 0.7  | 37   |  | 01.03  | 01.04   |  |  |  |                      |
|  | 0.7  | 45   |  | 01.03  | 01.04   |  |  |  |                      |
|  | 0.7  | 55   |  | 01.03  | 01.04   |  |  |  |                      |
|  | 0.8 CDI  | 30   |  | 11.99  | 01.04   |  |  |  |                      |
|  | 0.6  | 33   |  | 07.98  | 01.04   | 24.5146-0330.3   | 330973   | 2  | L=330                |
|  | 0.6  | 40   |  | 07.98  | 01.04   |  |  |  |                      |
|  | 0.6  | 45   |  | 01.01  | 01.04   |  |  |  |                      |
|  | 0.6  | 52   |  | 06.02  | 01.04   |  |  |  |                      |
|  | 0.7  | 37   |  | 01.03  | 01.04   |  |  |  |                      |
|  | 0.7  | 45   |  | 01.03  | 01.04   |  |  |  |                      |
|  | 0.7  | 55   |  | 01.03  | 01.04   |  |  |  |                      |
|  | 0.8 CDI  | 30   |  | 11.99  | 01.04   |  |  |  |                      |
|  | 0.6  | 33   |  | 07.98  | 10.99   | 24.3217-1713.3   | 020450   | <input type="checkbox"/>   | Rz 17,46             |
|  | 0.6  | 40   |  | 07.98  | 10.99   | 24.3217-1714.3   | 020451   | <input type="checkbox"/>   | Rz 17,46             |
|  | 0.6  | 33   |  | 11.99  | 01.04   | 24.3222-1721.3   | 020456   | <input type="checkbox"/>   | Rz 22,00             |
|  | 0.6  | 40   |  | 11.99  | 01.04   | 24.3222-1722.3   | 020457   | <input type="checkbox"/>   | Rz 22,00             |
|  | 0.6  | 45   |  | 01.01  | 01.04   |  |  |  |                      |
|  | 0.6  | 52   |  | 06.02  | 01.04   |  |  |  |                      |
|  | 0.7  | 37   |  | 01.03  | 01.04   |  |  |  |                      |
|  | 0.7  | 45   |  | 01.03  | 01.04   |  |  |  |                      |
|  | 0.7  | 55   |  | 01.03  | 01.04   |  |  |  |                      |
|  | 0.8 CDI  | 30   |  | 11.99  | 01.04   |  |  |  |                      |
|  | 0.6  | 33   |  | 07.98  | 01.04   | 24.3727-2802.2   | 582802   | 1  | L=990/990, + Zub     |
|  | 0.6  | 40   |  | 07.98  | 01.04   |  |  |  |                      |
|  | 0.6  | 45   |  | 01.01  | 01.04   |  |  |  |                      |
|  | 0.6  | 52   |  | 06.02  | 01.04   |  |  |  |                      |
|  | 0.7  | 37   |  | 01.03  | 01.04   |  |  |  |                      |
|  | 0.7  | 45   |  | 01.03  | 01.04   |  |  |  |                      |
|  | 0.7  | 55   |  | 01.03  | 01.04   |  |  |  |                      |
|  | 0.8 CDI  | 30   |  | 11.99  | 01.04   |  |  |  |                      |



































<sup>1)</sup> pedal assembly / pedaliera completa / pédalier complet / pedalería completa

|     |  |  |  |  |  |  |  |       |                                   |
|--|--|--|--|--|---|--|--|---|-----------------------------------|
| <b>SMART CROSSBLADE (BM450) (02-04)</b>  |  |  |  |  |   |  |  |   |                                   |
|    | 0.6  | 52   |  | 01.03  | 01.04   | 24.2119-1711.3   | 010911   | Pedalwerk komplett <sup>1)</sup>  | THz 19,05 - Behälter              |
|    | 0.6  | 52   |  | 06.02  | 01.04   | 24.3421-1707.5   | 240445   |      | D=42, - Halter                    |
|    | 0.6  | 52   |  | 06.02  | 01.04   | 24.3421-1708.5   | 240446   |      | D=42, - Halter                    |
|    | 0.6  | 52   |  | 06.02  | 01.04   | 24.5112-0315.3   | 330509   | 2   | L=315                             |
|    | 0.6  | 52   |  | 06.02  | 01.04   | 24.5146-0330.3   | 330973   | 2   | L=330                             |
|    | 0.6  | 52   |  | 06.02  | 01.04   | 24.3222-1721.3   | 020456   |      | Rz 22,00                          |
|    | 0.6  | 52   |  | 06.02  | 01.04   | 24.3222-1722.3   | 020457   |      | Rz 22,00                          |
|    | 0.6  | 52   |  | 06.02  | 01.04   | 24.3727-2802.2   | 582802   | 1    | L=990/990, + Zub                  |
| <b>SMART FORFOUR (BM454) (04-06)</b>   |  |  |  |  |   |  |  |   |                                   |
|    | 1.1  | 70   |  | 03.04  | 12.06   | 24.2122-1770.3   | 010898   |   | THz 22,20                         |
|    | 1.3  | 70   |  | 03.04  | 12.06   |  |  |   | LUC                               |
|    | 1.5  | 80   |  | 03.04  | 12.06   |  |  |   | LUC                               |
|    | 1.5  | 90   |  | 11.04  | 12.06   |  |  |   | LUC                               |
|  | 1.5 BRABUS   | 130  |  | 02.05  | 12.06   |  |  |   | LUC                               |
|  | 1.5 CDI  | 50   |  | 08.04  | 12.06   |  |  |   | LUC                               |
|  | 1.5 CDI  | 70   |  | 08.04  | 12.06   |  |  |   | LUC                               |
|  | 1.1  | 70   |  | 03.04  | 12.06   | 24.3541-1819.7   | 220767   |    | D=54, - Halter                    |
|  | 1.3  | 70   |  | 03.04  | 12.06   | 24.3541-1820.7   | 220768   |    | D=54, - Halter                    |
|  | 1.5  | 80   |  | 03.04  | 12.06   |  |  |   | LUC                               |
|  | 1.5  | 90   |  | 11.04  | 12.06   |  |  |   | LUC                               |
|  | 1.5 CDI  | 50   |  | 08.04  | 12.06   |  |  |   | LUC                               |
|  | 1.5 CDI  | 70   |  | 08.04  | 12.06   |  |  |   | LUC                               |
|  | 1.1  | 70   |  | 03.04  | 12.06   | 24.5298-0474.3   | 331038   | 2   | L=474                             |
|  | 1.3  | 70   |  | 03.04  | 12.06   |  |  |   | LUC                               |
|  | 1.5  | 80   |  | 03.04  | 12.06   |  |  |   | LUC                               |
|  | 1.5  | 90   |  | 11.04  | 12.06   |  |  |   | LUC                               |
|  | 1.5 BRABUS   | 130  |  | 02.05  | 12.06   |  |  |   | LUC                               |
|  | 1.5 CDI  | 50   |  | 08.04  | 12.06   |  |  |   | LUC                               |
|  | 1.5 CDI  | 70   |  | 08.04  | 12.06   |  |  |   | LUC                               |
|  | 1.1  | 70   |  | 03.04  | 12.06   | 24.3344-1725.7   | 220771   |    | D=34, - Halter                    |
|  | 1.3  | 70   |  | 03.04  | 12.06   | 24.3344-1726.7   | 220772   |    | D=34, - Halter                    |
|  | 1.5  | 80   |  | 03.04  | 12.06   |  |  |   | LUC                               |
|  | 1.5  | 90   |  | 11.04  | 12.06   |  |  |   | LUC                               |
|  | 1.5 BRABUS   | 130  |  | 02.05  | 12.06   |  |  |   | LUC                               |
|  | 1.5 CDI  | 50   |  | 08.04  | 12.06   |  |  |   | LUC                               |
|  | 1.5 CDI  | 70   |  | 08.04  | 12.06   |  |  |   | LUC                               |
|  | 1.1  | 70   |  | 03.04  | 12.06   | 24.5150-0459.3   | 331018   | 2   | + HA-Scheibenbremse <sup>2)</sup> |
|  | 1.3  | 70   |  | 03.04  | 12.06   |  |  |   | L=459                             |
|  | 1.5  | 80   |  | 03.04  | 12.06   |  |  |   | LUC                               |
|  | 1.5  | 90   |  | 11.04  | 12.06   |  |  |   | LUC                               |
|  | 1.5 BRABUS   | 130  |  | 02.05  | 12.06   |  |  |   | LUC                               |
|  | 1.5 CDI  | 50   |  | 08.04  | 12.06   |  |  |   | LUC                               |
|  | 1.5 CDI  | 70   |  | 08.04  | 12.06   |  |  |   | LUC                               |
|  | 1.1  | 70   |  | 03.04  | 12.06   | 24.3219-1757.3   | 020517   |   | Rz 19,05                          |
|  | 1.3  | 70   |  | 03.04  | 12.06   |  |  |   | LUC                               |
|  | 1.5  | 90   |  | 11.04  | 12.06   |  |  |   | LUC                               |
|  | 1.5 CDI  | 50   |  | 08.04  | 12.06   |  |  |   | LUC                               |
| <b>SMART FORTWO CABRIO (BM450) (04-07)</b>   |  |  |  |  |   |  |  |   |                                   |
|  | 0.7  | 45   |  | 01.04  | 04.07   | 24.2119-1711.3   | 010911   | Pedalwerk komplett <sup>1)</sup>  | THz 19,05 - Behälter              |
|  | 0.7 BRABUS   | 55   |  | 01.04  | 04.07   |  |  |   | LUC                               |
|  | 0.8 CDI  | 30   |  | 01.04  | 04.07   |  |  |   | LUC                               |
|  | 0.7  | 45   |  | 01.04  | 04.07   | 24.3421-1707.5   | 240445   |    | D=42, - Halter                    |
|  | 0.7 BRABUS   | 55   |  | 01.04  | 04.07   | 24.3421-1708.5   | 240446   |    | D=42, - Halter                    |
|  | 0.8 CDI  | 30   |  | 01.04  | 04.07   |  |  |   | LUC                               |
|  | 0.7  | 45   |  | 01.04  | 04.07   | 24.5112-0315.3   | 330509   | 2   | L=315                             |
|  | 0.7 BRABUS   | 55   |  | 01.04  | 04.07   |  |  |   | LUC                               |
|  | 0.8 CDI  | 30   |  | 01.04  | 04.07   |  |  |   | LUC                               |
|  | 0.7  | 45   |  | 01.04  | 04.07   | 24.5146-0330.3   | 330973   | 2   | L=330                             |
|  | 0.7 BRABUS   | 55   |  | 01.04  | 04.07   |  |  |   | LUC                               |
|  | 0.8 CDI  | 30   |  | 01.04  | 04.07   |  |  |   | LUC                               |
|  | 0.7  | 45   |  | 01.04  | 04.07   | 24.3222-1721.3   | 020456   |    | Rz 22,00                          |
|  | 0.7 BRABUS   | 55   |  | 01.04  | 04.07   | 24.3222-1722.3   | 020457   |    | Rz 22,00                          |
|  | 0.8 CDI  | 30   |  | 01.04  | 04.07   |  |  |   | BOS                               |
|  | 0.7  | 45   |  | 01.04  | 04.07   | 24.3727-2802.2   | 582802   | 1  | L=990/990, + Zub                  |
|  | 0.7 BRABUS   | 55   |  | 01.04  | 04.07   |  |  |   | LUC                               |
|  | 0.8 CDI  | 30   |  | 01.04  | 04.07   |  |  |   | LUC                               |

<sup>1)</sup> pedal assembly / pedaliera completa / pédalier complet / pedaliera completa

<sup>2)</sup> + RA disc brake / + P disco freno / + frein à disque essieu AR / + ET-disco de freno

|     |   |  |  |                                   |  |  |  |  |                          |
|--|---|--|--|---|---|--|--|--|--------------------------|
| <b>SMART FORTWO COUPE (BM450) (04-07)</b>  |   |  |  |   |   |  |  |  |                          |
|    | 0.7<br>0.7<br>0.7 BRABUS<br>0.8 CDI   | 37<br>45<br>55<br>30   | J182805<br>J182805   | 01.04<br>01.04<br>01.04<br>01.04  | 04.07<br>01.04<br>04.07<br>04.07  | 24.2119-1711.3<br>010911   |  | Thz 19,05 - Behälter   |                          |
|    | 0.7<br>0.7<br>0.7 BRABUS<br>0.8 CDI   | 37<br>45<br>55<br>30   |  | 01.04<br>01.04<br>01.04<br>01.04  | 04.07<br>04.07<br>04.07<br>04.07  | 24.3421-1707.5<br>24.3421-1708.5   | 240445<br>240446   | D=42, - Halter<br>D=42, - Halter   |                          |
|    | 0.7<br>0.7<br>0.7 BRABUS<br>0.8 CDI   | 37<br>45<br>55<br>30   |  | 01.04<br>01.04<br>01.04<br>01.04  | 04.07<br>04.07<br>04.07<br>04.07  | 24.5112-0315.3   | 330509   | L=315  |                          |
|    | 0.7<br>0.7<br>0.7 BRABUS<br>0.8 CDI   | 37<br>45<br>55<br>30   |  | 01.04<br>01.04<br>01.04<br>01.04  | 04.07<br>04.07<br>04.07<br>04.07  | 24.5146-0330.3   | 330973   | L=330  |                          |
|    | 0.7<br>0.7<br>0.7 BRABUS<br>0.8 CDI   | 37<br>45<br>55<br>30   |  | 01.04<br>01.04<br>01.04<br>01.04  | 04.07<br>04.07<br>04.07<br>04.07  | 24.3222-1721.3<br>24.3222-1722.3   | 020456<br>020457   | Rz 22,00<br>Rz 22,00   | <b>BOS</b><br><b>BOS</b> |
|    | 0.7<br>0.7<br>0.7 BRABUS<br>0.8 CDI   | 37<br>45<br>55<br>30   |  | 01.04<br>01.04<br>01.04<br>01.04  | 04.07<br>04.07<br>04.07<br>04.07  | 24.3727-2802.2   | 582802   | L=990/990, + Zub   |                          |
| <b>SMART FORTWO CABRIO (BM451) (07-)</b>   |   |  |  |   |   |  |  |  |                          |
|    | 0.8 CDI<br>0.8 CDi<br>1.0<br>1.0 BRABUS<br>1.0 BRABUS<br>1.0 MHD Hybrid<br>1.0 Turbo<br>Electric Drive<br>Electric Drive<br>Electric Drive<br>Electric Drive<br>Electric Drive BRABUS | 33<br>40<br>52<br>88<br>71<br>62<br>20<br>30<br>35<br>55<br>60                   |  | 04.07<br>08.09<br>04.07<br>07.07<br>04.12<br>10.07<br>04.07<br>12.10<br>11.09<br>12.11<br>04.12<br>01.13          |   | 24.5112-0285.3   | 330604   | L=285  |                          |
|   | 0.8 CDI<br>0.8 CDi<br>1.0<br>1.0 BRABUS<br>1.0 BRABUS<br>1.0 MHD Hybrid<br>1.0 Turbo<br>Electric Drive<br>Electric Drive<br>Electric Drive<br>Electric Drive<br>Electric Drive BRABUS | 33<br>40<br>52<br>88<br>71<br>62<br>20<br>30<br>35<br>55<br>60                   |  | 04.07<br>08.09<br>04.07<br>07.07<br>04.12<br>10.07<br>04.07<br>12.10<br>11.09<br>12.11<br>04.12<br>01.13          |   | 24.3220-1735.3<br>24.3220-1736.3   | 020521<br>020522   | Rz 20,64<br>Rz 20,64   |                          |
| <b>SMART FORTWO COUPE (BM451) (07-)</b>  |   |  |  |   |   |  |  |  |                          |
|  | 0.8 CDI<br>0.8 CDi<br>1.0<br>1.0<br>1.0<br>1.0 BRABUS<br>1.0 MHD Hybrid<br>1.0 Turbo<br>Electric Drive<br>Electric Drive<br>Electric Drive<br>Electric Drive<br>Electric Drive BRABUS | 33<br>40<br>45<br>52<br>88<br>72<br>71<br>62<br>20<br>30<br>35<br>55<br>60       |  | 04.07<br>08.09<br>04.07<br>04.07<br>01.10<br>07.07<br>10.07<br>04.07<br>12.10<br>11.09<br>12.11<br>04.12<br>01.13 |   | 24.5112-0285.3   | 330604   | L=285  |                          |
|  | 0.8 CDI<br>0.8 CDi<br>1.0<br>1.0<br>1.0<br>1.0 BRABUS<br>1.0 MHD Hybrid<br>1.0 Turbo<br>Electric Drive<br>Electric Drive<br>Electric Drive<br>Electric Drive<br>Electric Drive BRABUS | 33<br>40<br>45<br>52<br>88<br>72<br>71<br>62<br>20<br>30<br>35<br>55<br>60       |  | 04.07<br>08.09<br>04.07<br>04.07<br>01.10<br>07.07<br>10.07<br>04.07<br>12.10<br>11.09<br>12.11<br>04.12<br>01.13 |   | 24.3220-1735.3<br>24.3220-1736.3   | 020521<br>020522   | Rz 20,64<br>Rz 20,64   |                          |
| <b>SMART ROADSTER (BM452) (03-05)</b>  |   |  |  |   |   |  |  |  |                          |
|  | 0.7<br>0.7<br>0.7 BRABUS  | 45<br>60<br>74   |  | 04.03<br>04.03<br>03.04   | 12.05<br>12.05<br>12.05   | 24.3421-1707.5<br>24.3421-1708.5   | 240445<br>240446   | D=42, - Halter<br>D=42, - Halter   |                          |

| SMART ROADSTER COUPE (BM452) (03-05)   |  |  |  |  |  |                                  |                  |  |  |  |                                  |
|--|--|--|--|--|--|----------------------------------|------------------|--|--|--|----------------------------------|
|     | 0.7<br>0.7<br>0.7 BRABUS   | 45<br>60<br>74                               |  | 04.05<br>04.03<br>03.04  | 12.05<br>12.05<br>12.05  | 24.3421-1707.5<br>24.3421-1708.5 | 240445<br>240446 |   |  |  | D=42, - Halter<br>D=42, - Halter |
| SUBARU FORESTER (97-02)  |  |  |  |  |  |                                  |                  |  |  |  |                                  |
|    | 2.0<br>2.0   | 90<br>92                                     |  | 08.97<br>07.98   | 09.02<br>09.02   | 24.3219-1759.3                   | 020528           |  |  |  | Rz 19,05                         |
| SUBARU FORESTER (02-08)  |  |  |  |  |  |                                  |                  |  |  |  |                                  |
|    | 2.0<br>2.0 X   | 92<br>116                                    |  | 09.02<br>09.05   | 05.08<br>05.08   | 24.3219-1759.3                   | 020528           |  |  |  | Rz 19,05                         |
| SUBARU JUSTY (95-03)   |  |  |  |  |  |                                  |                  |  |  |  |                                  |
|    | 1.3 4x4  | 50   |  | 10.95  | 09.00  | 24.3217-1725.3<br>24.3217-1726.3 | 020512<br>020513 | <br>     |  |  | Rz 17,46<br>Rz 17,46             |
| SUBARU JUSTY (G3X) (03-07)   |  |  |  |  |  |                                  |                  |  |  |  |                                  |
|    | 1.3 i 16V<br>1.3 i 16V 4WD<br>1.5 i 16V 4WD  | 66<br>69<br>73                               |  | 09.03<br>09.03<br>09.03  | 08.07<br>08.07<br>08.07  | 24.5291-0430.3                   | 331084           | 2  |  |  | L=430                            |
|    | 1.3 i 16V<br>1.3 i 16V 4WD<br>1.5 i 16V 4WD  | 66<br>69<br>73                               |  | 09.03<br>09.03<br>09.03  | 08.07<br>08.07<br>08.07  | 24.5284-0283.3                   | 331080           | 2  |  |  | L=283                            |
|    | 1.3 i 16V<br>1.3 i 16V 4WD<br>1.5 i 16V 4WD  | 66<br>69<br>73                               |  | 09.03<br>09.03<br>09.03  | 08.07<br>08.07<br>08.07  | 24.3215-1701.3                   | 020493           |  |  |  | Rz 15,87                         |
|    | 1.3 i 16V<br>1.3 i 16V 4WD   | 66<br>69                                     |  | 09.03<br>09.03   | 08.07<br>08.07   | 24.3728-2200.2                   | 592200           |  |  |  | L=660                            |
| SUBARU JUSTY (07-)   |  |  |  |  |  |                                  |                  |  |  |  |                                  |
|    | 1.0 i 12V (AL276)  | 51   |  | 09.07  |  | 24.3217-1721.3<br>24.3217-1722.3 | 020489<br>020490 | <br>     |  |  | Rz 17,46<br>Rz 17,46             |
| SUBARU TREZIA (11-)  |  |  |  |  |  |                                  |                  |  |  |  |                                  |
|  | 1.3 16V<br>1.4 D   | 73<br>66                                     |  | 03.11<br>03.11   |  | 24.5235-0200.3                   | 331280           |   |  |  | L=198                            |
| SUZUKI ALTO (93-02)  |  |  |  |  |  |                                  |                  |  |  |  |                                  |
|  | 1.3 16V<br>1.6 16V   | 63<br>71                                     |  | 10.98<br>10.98   | 09.00<br>09.00   | 24.3217-1725.3<br>24.3217-1726.3 | 020512<br>020513 | <br> |  |  | Rz 17,46<br>Rz 17,46             |
|  | 1.3 16V<br>1.6 16V   | 63<br>71                                     |  | 10.98<br>10.98   | 09.00<br>09.00   | 24.3727-2003.2<br>24.3727-2000.2 | 582003<br>582000 | <br> |  |  | L=1656<br>L=1572                 |
|  | 1.3 16V<br>1.6 16V   | 63<br>71                                     |  | 10.98<br>10.98   | 09.00<br>09.00   | 24.3728-2000.2                   | 592000           |  |  |  | L=603                            |
| SUZUKI ALTO (02-08)  |  |  |  |  |  |                                  |                  |  |  |  |                                  |
|  | 1.1 i 16V (RF410)  | 46   |  | 06.02  | 12.08  | 24.3511-1713.5<br>24.3511-1714.5 | 240453<br>240454 | <br> |  |  | D=51, - Halter<br>D=51, - Halter |
|  | 1.1 i 16V (RF410)  | 46   |  | 06.02  | 12.08  | 24.3215-1702.3                   | 020494           |  |  |  | Rz 15,87                         |
| SUZUKI BALENO (95-02)  |  |  |  |  |  |                                  |                  |  |  |  |                                  |
|  | 1.3<br>1.3 i 16V<br>1.6 i 16V<br>1.6 i 16V 4x4   | 52<br>63<br>72<br>72                         |  | 09.96<br>07.95<br>07.95<br>07.95                                     | 05.02<br>05.02<br>05.02<br>05.02                                     | 24.3217-1725.3<br>24.3217-1726.3 | 020512<br>020513 | <br> |  |  | Rz 17,46<br>Rz 17,46             |
|  | 1.3<br>1.3<br>1.3 i 16V<br>1.3 i 16V<br>1.6 i 16V<br>1.6 i 16V<br>1.6 i 16V 4x4<br>1.6 i 16V 4x4 | 52<br>52<br>63<br>63<br>72<br>72<br>72<br>72 |  | 09.96<br>09.96<br>07.95<br>07.95<br>07.95<br>07.95<br>07.95<br>07.95 | 05.02<br>05.02<br>05.02<br>05.02<br>05.02<br>05.02<br>05.02<br>05.02 | 24.3727-2003.2<br>24.3727-2000.2 | 582003<br>582000 | <br> |  |  | L=1656<br>L=1572                 |
|  | 1.3<br>1.3 i 16V<br>1.6 i 16V<br>1.6 i 16V 4x4<br>1.8 i 16V GT<br>1.9 TD                         | 52<br>63<br>72<br>72<br>89<br>55             |  | 09.96<br>07.95<br>07.95<br>07.95<br>03.96<br>04.98                   | 05.02<br>05.02<br>05.02<br>05.02<br>05.02<br>05.02                   | 24.3728-2000.2                   | 592000           |  |  |  | L=603                            |

1) + 5 door / + 5 porte / + 5 portes / + 5 puertas





































2) + 4 door / + 4 porte / + 4 portes / + 4 puertas

| SUZUKI CARRY (99-04)        |               |     |  |       |       |                |        |   |  |  |  |          |  |
|-----------------------------|---------------|-----|--|-------|-------|----------------|--------|---|--|--|--|----------|--|
|                             | 1.3           | 58  |  | 03.99 | 09.04 | 24.3219-1723.3 | 020427 |   |  |  |  | Rz 19,05 |  |
|                             | 1.3 4x4       | 56  |  | 02.99 | 09.04 | 24.3219-1758.3 | 020527 |   |  |  |  | Rz 19,05 |  |
|                             | 1.3 i 16V     | 58  |  | 03.00 | 09.04 |                |        |   |  |  |  |          |  |
| SUZUKI GRAND VITARA (98-05) |               |     |  |       |       |                |        |   |  |  |  |          |  |
|                             | 1.6 i 16V     | 69  |  | 03.98 | 11.04 | 24.5291-0756.3 | 331196 |   |  |  |  | L=755    |  |
|                             | 1.6 i 16V 4x4 | 73  |  | 02.00 | 09.02 | 24.5291-0755.3 | 331195 |   |  |  |  | L=755    |  |
|                             | 2.0 i 16V     | 94  |  | 03.98 | 11.04 |                |        |   |  |  |  |          |  |
|                             | 2.0 i 16V     | 94  |  | 03.98 | 11.04 |                |        |   |  |  |  |          |  |
|                             | 2.0 i 16V     | 97  |  | 08.98 | 12.00 |                |        |   |  |  |  |          |  |
|                             | 2.0 i 16V 4x4 | 103 |  | 04.98 | 08.05 |                |        |   |  |  |  |          |  |
|                             | 2.0 TD        | 64  |  | 03.98 | 09.05 |                |        |   |  |  |  |          |  |
|                             | 2.0 TDi       | 80  |  | 07.01 | 09.05 |                |        |   |  |  |  |          |  |
|                             | 2.5 i V6      | 106 |  | 04.98 | 09.00 |                |        |   |  |  |  |          |  |
|                             | 2.5 i V6      | 116 |  | 04.01 | 09.05 |                |        |   |  |  |  |          |  |
|                             | 2.7 i V6      | 127 |  | 09.01 | 09.05 |                |        |   |  |  |  |          |  |
|                             | 2.7 i V6      | 135 |  | 04.03 | 09.05 |                |        |   |  |  |  |          |  |
|                             | 1.6 i 16V     | 69  |  | 03.98 | 11.04 | 24.3222-1727.3 | 020519 |   |  |  |  | Rz 22,20 |  |
|                             | 1.6 i 16V 4x4 | 73  |  | 02.00 | 09.02 | 24.3222-1728.3 | 020520 |   |  |  |  | Rz 22,20 |  |
|                             | 2.0 i 16V     | 94  |  | 03.98 | 11.04 |                |        |   |  |  |  |          |  |
|                             | 2.0 i 16V     | 94  |  | 03.98 | 11.04 |                |        |   |  |  |  |          |  |
|                             | 2.0 i 16V     | 97  |  | 08.98 | 12.00 |                |        |   |  |  |  |          |  |
|                             | 2.0 i 16V 4x4 | 103 |  | 04.98 | 08.05 |                |        |   |  |  |  |          |  |
|                             | 2.0 TD        | 64  |  | 03.98 | 09.05 |                |        |   |  |  |  |          |  |
|                             | 2.0 TDi       | 80  |  | 07.01 | 09.05 |                |        |   |  |  |  |          |  |
|                             | 2.5 i V6      | 106 |  | 04.98 | 09.00 |                |        |   |  |  |  |          |  |
|                             | 2.5 i V6      | 116 |  | 04.01 | 09.05 |                |        |   |  |  |  |          |  |
|                             | 2.7 i V6      | 127 |  | 09.01 | 09.05 |                |        |   |  |  |  |          |  |
|                             | 2.7 i V6      | 135 |  | 04.03 | 09.05 |                |        |   |  |  |  |          |  |
| SUZUKI GRAND VITARA (05-)   |               |     |  |       |       |                |        |   |  |  |  |          |  |
|                             | 1.6 i 16V     | 78  |  | 04.05 |       | 24.5291-0756.3 | 331196 |   |  |  |  | L=755    |  |
|                             | 1.6 i 16V 4x4 | 73  |  | 09.05 |       | 24.5291-0755.3 | 331195 |   |  |  |  | L=755    |  |
|                             | 1.6 i 16V 4x4 | 78  |  | 04.05 |       |                |        |   |  |  |  |          |  |
|                             | 1.9 DDiS      | 95  |  | 10.05 | 08.08 |                |        |   |  |  |  |          |  |
|                             | 1.9 DDiS 4x4  | 95  |  | 10.05 |       |                |        |   |  |  |  |          |  |
|                             | 2.0 VVTi 4x4  | 103 |  | 10.05 |       |                |        |   |  |  |  |          |  |
|                             | 2.7 VVTi 4x4  | 135 |  | 01.07 |       |                |        |   |  |  |  |          |  |
|                             | 2.7 VVTi 4x4  | 136 |  | 10.05 | 08.08 |                |        |   |  |  |  |          |  |
|                             | 1.6 i 16V     | 78  |  | 04.05 |       | 24.3222-1727.3 | 020519 |   |  |  |  | Rz 22,20 |  |
|                             | 1.6 i 16V 4x4 | 73  |  | 09.05 |       | 24.3222-1728.3 | 020520 |   |  |  |  | Rz 22,20 |  |
|                             | 1.6 i 16V 4x4 | 78  |  | 04.05 |       |                |        |   |  |  |  |          |  |
|                             | 1.9 DDiS      | 95  |  | 10.05 | 08.08 |                |        |   |  |  |  |          |  |
|                             | 1.9 DDiS 4x4  | 95  |  | 10.05 |       |                |        |   |  |  |  |          |  |
|                             | 2.0 VVTi 4x4  | 103 |  | 10.05 |       |                |        |   |  |  |  |          |  |
|                             | 2.7 VVTi 4x4  | 135 |  | 01.07 |       |                |        |   |  |  |  |          |  |
|                             | 2.7 VVTi 4x4  | 136 |  | 10.05 | 08.08 |                |        |   |  |  |  |          |  |
| SUZUKI IGNIS I (00-03)      |               |     |  |       |       |                |        |   |  |  |  |          |  |
|                             | 1.3 i 16V     | 61  |  | 10.00 | 08.03 | 24.3215-1702.3 | 020494 |   |  |  |  | Rz 15,87 |  |
|                             | 1.3 i 16V 4x4 | 61  |  | 10.00 | 08.03 |                |        |   |  |  |  |          |  |
|                             | 1.3 i 16V     | 61  |  | 10.00 | 08.03 | 24.3728-2200.2 | 592200 |   |  |  |  | L=660    |  |
|                             | 1.3 i 16V 4x4 | 61  |  | 10.00 | 08.03 |                |        |   |  |  |  |          |  |
|                             | 1.3 Sport     | 61  |  | 10.00 | 08.03 |                |        |   |  |  |  |          |  |
| SUZUKI IGNIS II (03-)       |               |     |  |       |       |                |        |   |  |  |  |          |  |
|                             | 1.3 DDiS      | 51  |  | 09.03 |       | 24.5291-0430.3 | 331084 | 2 |  |  |  | L=430    |  |
|                             | 1.3 i 16V     | 69  |  | 09.03 |       |                |        |   |  |  |  |          |  |
|                             | 1.3 i 16V 4x4 | 69  |  | 09.03 |       |                |        |   |  |  |  |          |  |
|                             | 1.5 i 16V     | 73  |  | 09.03 |       |                |        |   |  |  |  |          |  |
|                             | 1.5 i 16V 4x4 | 73  |  | 09.03 |       |                |        |   |  |  |  |          |  |
|                             | 1.3 DDiS      | 51  |  | 09.03 |       | 24.5284-0283.3 | 331080 | 2 |  |  |  | L=283    |  |
|                             | 1.3 i 16V     | 69  |  | 09.03 |       |                |        |   |  |  |  |          |  |
|                             | 1.3 i 16V 4x4 | 69  |  | 09.03 |       |                |        |   |  |  |  |          |  |
|                             | 1.5 i 16V     | 73  |  | 09.03 |       |                |        |   |  |  |  |          |  |
|                             | 1.5 i 16V 4x4 | 73  |  | 09.03 |       |                |        |   |  |  |  |          |  |
|                             | 1.3 i 16V     | 69  |  | 09.03 |       | 24.3215-1702.3 | 020494 |   |  |  |  | Rz 15,87 |  |
|                             | 1.3 i 16V 4x4 | 69  |  | 09.03 |       |                |        |   |  |  |  |          |  |
|                             | 1.5 i 16V     | 73  |  | 09.03 |       |                |        |   |  |  |  |          |  |
|                             | 1.5 i 16V 4x4 | 73  |  | 09.03 |       |                |        |   |  |  |  |          |  |
|                             | 1.5 Sport     | 80  |  | 12.03 |       |                |        |   |  |  |  |          |  |
|                             | 1.3 DDiS      | 51  |  | 09.03 |       | 24.3215-1701.3 | 020493 |   |  |  |  | Rz 15,87 |  |
|                             | 1.3 DDiS      | 51  |  | 09.03 |       | 24.3728-2200.2 | 592200 |   |  |  |  | L=660    |  |
|                             | 1.3 i 16V     | 69  |  | 09.03 |       |                |        |   |  |  |  |          |  |
|                             | 1.3 i 16V 4x4 | 69  |  | 09.03 |       |                |        |   |  |  |  |          |  |
| SUZUKI JIMNY (98-)          |               |     |  |       |       |                |        |   |  |  |  |          |  |
|                             | 1.3 4x4       | 63  |  | 09.98 | 08.00 | 24.5291-0508.3 | 331085 |   |  |  |  | L=508    |  |
|                             | 1.3 4x4       | 65  |  | 09.00 | 08.02 | 24.5291-0345.3 | 331165 |   |  |  |  | L=345    |  |
|                             | 1.3 i 16V     | 59  |  | 09.98 |       |                |        |   |  |  |  |          |  |
|                             | 1.3 i 16V     | 60  |  | 02.01 |       |                |        |   |  |  |  |          |  |
|                             | 1.3 i 16V 4x4 | 59  |  | 09.98 |       |                |        |   |  |  |  |          |  |
|                             | 1.3 i 16V 4x4 | 60  |  | 02.01 |       |                |        |   |  |  |  |          |  |
|                             | 1.3 i 16V 4x4 | 63  |  | 08.05 |       |                |        |   |  |  |  |          |  |
|                             | 1.5 DDiS 4x4  | 48  |  | 12.03 |       |                |        |   |  |  |  |          |  |

1) + Van / + Furgone / + Fourgonnette / + Furgón

2) + Convertible / + Cabriolet / + Décapotable / + Cabriolé

3) - sports suspension / - sospensione sportiva / - châssis de sport / - suspensión deportiva



































|     |   |  |  |  |   |  |    |  |
|--|---|--|--|--|--|--|--|--|
| <b>SUZUKI JIMNY (98-)</b>  |   |  |  |  |  |  |  |  |
|    | 1.5 DDiS 4x4  | 63   |  | 08.05  |  | 24.5291-0508.3 331085<br>24.5291-0345.3 331165                                     | <br>     | L=508<br>L=345   |
|    | 1.3 4x4<br>1.3 4x4<br>1.3 i 16V<br>1.3 i 16V<br>1.3 i 16V 4x4<br>1.3 i 16V 4x4<br>1.3 i 16V 4x4<br>1.5 DDiS 4x4<br>1.5 DDiS 4x4 | 63<br>65<br>59<br>60<br>59<br>60<br>63<br>48<br>63                               |  | 09.98<br>09.00<br>09.98<br>02.01<br>09.98<br>02.01<br>08.05<br>12.03<br>08.05    | 08.00<br>08.02   | 24.5279-0360.3 331045  | 2  | L=360  |
|    | 1.3 4x4<br>1.3 4x4<br>1.3 i 16V<br>1.3 i 16V<br>1.3 i 16V 4x4<br>1.3 i 16V 4x4<br>1.3 i 16V 4x4<br>1.5 DDiS 4x4<br>1.5 DDiS 4x4 | 63<br>65<br>59<br>60<br>59<br>60<br>63<br>48<br>63                               |  | 09.98<br>09.00<br>09.98<br>02.01<br>09.98<br>02.01<br>08.05<br>12.03<br>08.05    | 08.00<br>08.02   | 24.3219-1723.3 020427<br>24.3219-1758.3 020527                                     | <br>     | Rz 19,05<br>Rz 19,05   |
|    | 1.3 4x4<br>1.3 4x4<br>1.3 i 16V<br>1.3 i 16V<br>1.3 i 16V 4x4<br>1.3 i 16V 4x4<br>1.3 i 16V 4x4<br>1.5 DDiS 4x4<br>1.5 DDiS 4x4 | 63<br>65<br>59<br>60<br>59<br>60<br>63<br>48<br>63                               |  | 09.98<br>09.00<br>09.98<br>02.01<br>09.98<br>02.01<br>08.05<br>12.03<br>08.05    | 08.00<br>08.02   | 24.3728-2001.2 592001  |  | L=1977   |
| <b>SUZUKI LIANA (01-07)</b>  |   |  |  |  |  |  |  |  |
|    | 1.3 i 16V<br>1.4 DDiS<br>1.6 i 16V<br>1.6 i 16V<br>1.6 i 16V<br>1.6 i 16V 4WD<br>1.6 i 16V 4WD<br>1.6 i 16V 4WD                 | 66<br>66<br>76<br>78<br>79<br>76<br>78<br>79                                     |  | 07.01<br>04.04<br>07.01<br>04.02<br>01.05<br>07.01<br>04.02<br>01.05             | 12.07<br>12.07<br>12.07<br>12.07<br>12.07<br>12.07<br>12.07  | 24.3217-1725.3 020512<br>24.3217-1726.3 020513                                     | <br>     | Rz 17,46<br>Rz 17,46   |
| <b>SUZUKI SPLASH (08-)</b>   |   |  |  |  |  |  |  |  |
|  | 1.0 i 12V<br>1.0 i 12V<br>1.2 16V<br>1.2 VVT<br>1.2 VVT<br>1.3 CDTi   | 48<br>50<br>63<br>66<br>69<br>55   |  | 01.08<br>06.11<br>01.08<br>06.11<br>09.10<br>01.08                               |  | 24.3541-1821.7 220695<br>24.3541-1822.7 220696<br>24.0101-3802.2 260100            | <br> | D=54, - Halter<br>D=54, - Halter<br>Einbausatz<br><b>LUC</b><br><b>LUC</b>         |
|  | 1.0 i 12V<br>1.0 i 12V<br>1.2 16V<br>1.2 VVT<br>1.2 VVT<br>1.3 CDTi   | 48<br>50<br>63<br>66<br>69<br>55   |  | 01.08<br>06.11<br>01.08<br>06.11<br>09.10<br>01.08                               |  | 24.5273-0490.3 330940  | 2  | L=490  |
|  | 1.0 i 12V<br>1.0 i 12V<br>1.2 16V<br>1.2 VVT<br>1.2 VVT<br>1.3 CDTi   | 48<br>50<br>63<br>66<br>69<br>55   |  | 01.08<br>06.11<br>01.08<br>06.11<br>09.10<br>01.08                               |  | 24.5279-0305.3 330946<br>24.5279-0300.3 331135                                     | <br> | L=305<br>L=300   |
|  | 1.0 i 12V<br>1.0 i 12V<br>1.2 16V<br>1.2 VVT<br>1.2 VVT<br>1.3 CDTi   | 48<br>50<br>63<br>66<br>69<br>55   |  | 01.08<br>06.11<br>01.08<br>06.11<br>09.10<br>01.08                               |  | 24.3219-1756.3 020511  |  | Rz 19,05 <b>BOS</b>  |
|  | 1.0 i 12V<br>1.0 i 12V<br>1.2 16V<br>1.2 VVT<br>1.2 VVT<br>1.3 CDTi   | 48<br>50<br>63<br>66<br>69<br>55   |  | 01.08<br>06.11<br>01.08<br>06.11<br>09.10<br>01.08                               |  | 24.3727-0793.2 580793<br>24.3727-0792.2 580792                                     | <br> | L=1600<br>L=1600   |
| <b>SUZUKI SWIFT II (89-96)</b>   |   |  |  |  |  |  |  |  |
|  | 1.3 (SF413)<br>1.3 (SF413)  |  |  | 04.89<br>04.89   | 10.96 + 5 türig <sup>1)</sup><br>10.96 + 3 türig <sup>2)</sup>   | 24.3215-1704.3 020532  |  | Rz 15,87   |
|  | 1.0 i (SF310)<br>1.3 (SF413)<br>1.3 (SF413)<br>1.3 i 16V GTi (SF413)  |  | 320339<br>320339<br>320339<br>320339   | 08.92<br>04.89<br>04.89<br>08.92   | + ABS/ + 4 türig <sup>3)</sup><br>+ ABS/ + 4 türig <sup>3)</sup><br>+ ABS/ + 4 türig <sup>3)</sup><br>+ ABS/ + 4 türig <sup>3)</sup> | 24.3217-1725.3 020512<br>24.3217-1726.3 020513                                     | <br> | Rz 17,46<br>Rz 17,46   |
|  | 1.0 i (SF310)   |  |  | 08.92  | 10.96  | 24.3728-2003.2 592003  |  | L=607  |

<sup>1)</sup> + 5 door / + 5 porte / + 5 portes / + 5 puertas

<sup>2)</sup> + 3 door / + 3 porte / + 3 portes / + 3 puertas

<sup>3)</sup> + ABS/ + 4 door / + ABS/ + 4 porte / + ABS/ + 4 portes / + ABS/ + 4 puertas



|     |  |  |  |  |  |  |  |     |   |        |
|--|--|--|--|--|---|--|--|---|---|--------|
| <b>SUZUKI SWIFT II (96-04)</b>   |  |  |  |  |   |  |  |   |   |        |
|    | 1.0 i (SF310)  | 39   |  | 11.96  | 12.04   | 24.3215-1704.3   | 020532   |   | Rz 15,87  |        |
|  | 1.3 i (SF413)  | 50   |  | 11.96  | 05.01 + 5 türg 1)   |  |  |   |   |        |
|  | 1.3 i (SF413)  | 50   |  | 11.96  | 05.01 + 3 türg 2)   |  |  |   |   |        |
|  | 1.3 i (SF413)  | 50   |  | 11.96  | 05.01 + 2 türg 3)   |  |  |   |   |        |
|  | 1.3 i (SF413)  | 63   |  | 06.01  | 12.04 + 5 türg 1)   |  |  |   |   |        |
|  | 1.3 i (SF413)  | 63   |  | 06.01  | 12.04 + 3 türg 2)   |  |  |   |   |        |
|  | 1.3 i (SF413)  | 63   |  | 06.01  | 12.04 + 2 türg 3)   |  |  |   |   |        |
|    | 1.3 i (SF413)  | 50   |  | 11.96  | 05.01 + 4 türg 4)   | 24.3217-1725.3   | 020512   |    | Rz 17,46  |        |
|  | 1.3 i (SF413)  | 63   |  | 06.01  | 12.04 + 4 türg 4)   | 24.3217-1726.3   | 020513   |    | Rz 17,46  |        |
|  | 1.3 i 4WD (SF413)  | 50   |  | 11.96  | 05.01   |  |  |   |   |        |
|  | 1.3 i 4WD (SF413)  | 63   |  | 06.01  | 12.04   |  |  |   |   |        |
|    | 1.0 i (SF310)  | 39   |  | 11.96  | 12.04   | 24.3728-2003.2   | 592003   |   | L=607   |        |
| <b>SUZUKI SWIFT III (05-10)</b>  |  |  |  |  |   |  |  |   |   |        |
|    | 1.3 16V  | 68   |  | 02.05  | 09.10   | 24.3541-1821.7   | 220695   |    | D=54, - Halter  | LUC    |
|  | 1.3 16V 4x4  | 66   |  | 01.06  | 09.10   | 24.3541-1822.7   | 220696   |    | D=54, - Halter  | LUC    |
|  | 1.3 16V 4x4  | 68   |  | 02.05  | 09.10   | 24.0101-3802.2   | 260100   |   | Einbausatz  | LUC    |
|  | 1.3 DDiS   | 51   |  | 08.05  | 09.07   |  |  |   |   |        |
|  | 1.3 DDiS   | 55   |  | 08.05  | 09.10   |  |  |   |   |        |
|  | 1.5 16V 4x4  | 74   |  | 02.05  | 09.10   |  |  |   |   |        |
|  | 1.5 VVTi   | 75   |  | 02.05  | 09.10   |  |  |   |   |        |
|  | 1.6 VVTi   | 92   |  | 05.06  | 09.10   |  |  |   |   |        |
|    | 1.3 16V  | 68   |  | 02.05  | 09.10   | 24.5273-0490.3   | 330940   | 2   | Herst.Land  5)   | L=490  |
|  | 1.3 16V 4x4  | 66   |  | 01.06  | 09.10   |  |  |   |   |        |
|  | 1.3 16V 4x4  | 68   |  | 02.05  | 09.10   |  |  |   |   |        |
|  | 1.3 DDiS   | 51   |  | 08.05  | 09.07   |  |  |   |   |        |
|  | 1.3 DDiS   | 55   |  | 08.05  | 09.10   |  |  |   |   |        |
|  | 1.5 16V 4x4  | 74   |  | 02.05  | 09.10   |  |  |   |   |        |
|    | 1.3 16V  | 68   |  | 02.05  | 09.10   | 24.5279-0305.3   | 330946   |    | Herst.Land  5)   | L=305  |
|  | 1.3 16V 4x4  | 66   |  | 01.06  | 09.10   | 24.5279-0300.3   | 331135   |    | Herst.Land  5)   | L=300  |
|  | 1.3 16V 4x4  | 68   |  | 02.05  | 09.10   |  |  |   |   |        |
|  | 1.3 DDiS   | 51   |  | 08.05  | 09.07   |  |  |   |   |        |
|  | 1.3 DDiS   | 55   |  | 08.05  | 09.10   |  |  |   |   |        |
|  | 1.5 16V 4x4  | 74   |  | 02.05  | 09.10   |  |  |   |   |        |
|   | 1.3 16V  | 68   |  | 02.05  | 09.10   | 24.3219-1756.3   | 020511   |   | Rz 19,05  | BOS    |
|  | 1.3 16V 4x4  | 66   |  | 01.06  | 09.10   |  |  |   |   |        |
|  | 1.3 16V 4x4  | 68   |  | 02.05  | 09.10   |  |  |   |   |        |
|  | 1.3 DDiS   | 51   |  | 08.05  | 09.07   |  |  |   |   |        |
|  | 1.3 DDiS   | 55   |  | 08.05  | 09.10   |  |  |   |   |        |
|  | 1.5 16V 4x4  | 74   |  | 02.05  | 09.10   |  |  |   |   |        |
|  | 1.3 16V  | 68   |  | 02.05  | 09.10   | 24.3727-2005.2   | 582005   |  | Herst.Land  5) | L=1625 |
|  | 1.3 16V 4x4  | 66   |  | 01.06  | 09.10   | 24.3727-2004.2   | 582004   |  | Herst.Land  5) | L=2625 |
|  | 1.3 16V 4x4  | 68   |  | 02.05  | 09.10   |  |  |   |   |        |
|  | 1.3 DDiS   | 51   |  | 08.05  | 09.07   |  |  |   |   |        |
|  | 1.3 DDiS   | 55   |  | 08.05  | 09.10   |  |  |   |   |        |
|  | 1.5 16V 4x4  | 74   |  | 02.05  | 09.10   |  |  |   |   |        |
| <b>SUZUKI SX4 (06-)</b>  |  |  |  |  |   |  |  |   |   |        |
|  | 1.5 i 16V  | 73   |  | 06.06  |   | 24.5273-0375.3   | 331147   | 2   |   | L=375  |
|  | 1.5 VVT  | 82   |  | 07.10  |   |  |  |   |   |        |
|  | 1.6 DDiS   | 66   |  | 04.07  |   |  |  |   |   |        |
|  | 1.6 i 16V  | 88   |  | 10.07  |   |  |  |   |   |        |
|  | 1.6 i 16V 4x4  | 88   |  | 07.09  |   |  |  |   |   |        |
|  | 1.6 VVT  | 79   |  | 06.06  |   |  |  |   |   |        |
|  | 1.6 VVT 4x4  | 79   |  | 06.06  |   |  |  |   |   |        |
|  | 1.9 DDiS   | 88   |  | 06.06  |   |  |  |   |   |        |
|  | 1.9 DDiS 4x4   | 88   |  | 06.06  |   |  |  |   |   |        |
|  | 2.0 DDiS   | 99   |  | 07.09  |   |  |  |   |   |        |
|  | 1.5 i 16V  | 73   |  | 06.06  |   | 24.5279-0300.3   | 331135   | 2   |   | L=300  |
|  | 1.5 VVT  | 82   |  | 07.10  |   |  |  |   |   |        |
|  | 1.6 DDiS   | 66   |  | 04.07  |   |  |  |   |   |        |
|  | 1.6 i 16V  | 88   |  | 10.07  |   |  |  |   |   |        |
|  | 1.6 i 16V 4x4  | 88   |  | 07.09  |   |  |  |   |   |        |
|  | 1.6 VVT  | 79   |  | 06.06  |   |  |  |   |   |        |
|  | 1.6 VVT 4x4  | 79   |  | 06.06  |   |  |  |   |   |        |
|  | 1.9 DDiS   | 88   |  | 06.06  |   |  |  |   |   |        |
|  | 1.9 DDiS 4x4   | 88   |  | 06.06  |   |  |  |   |   |        |
|  | 2.0 DDiS   | 99   |  | 07.09  |   |  |  |   |   |        |
|  | 2.0 i 16V  | 107  |  | 06.06  |   |  |  |   |   |        |
|  | 2.0 i 16V 4x4  | 107  |  | 06.06  |   |  |  |   |   |        |
|  | 1.5 i 16V  | 73   |  | 06.06  |   | 24.3219-1756.3   | 020511   |   | Rz 19,05  | BOS    |
|  | 1.5 VVT  | 82   |  | 07.10  |   |  |  |   |   |        |
|  | 1.6 DDiS   | 66   |  | 04.07  |   |  |  |   |   |        |
|  | 1.6 i 16V  | 88   |  | 10.07  |   |  |  |   |   |        |
|  | 1.6 i 16V 4x4  | 88   |  | 07.09  |   |  |  |   |   |        |
|  | 1.6 VVT  | 79   |  | 06.06  |   |  |  |   |   |        |
|  | 1.6 VVT 4x4  | 79   |  | 06.06  |   |  |  |   |   |        |
|  | 1.6 VVT 4x4  | 79   |  | 06.06  |   |  |  |   |   |        |

1) + 5 door / + 5 porte / + 5 portes / + 5 puertas

2) + 3 door / + 3 porte / + 3 portes / + 3 puertas













3) + 2 door / + 2 porte / + 2 portes / + 2 puertas

4) + 4 door / + 4 porte / + 4 portes / + 4 puertas

5) country of manufacture  / paese del costruttore  / pays du constructeur  / pais del fabricante 

6) country of manufacture  / paese del costruttore  / pays du constructeur  / pais del fabricante 



| SUZUKI SX4 (06-)   |   | SUZUKI VITARA (89-98)                                    |  | SUZUKI WAGON R+ (00-)   |  | TOYOTA AURIS (06-12)   |  |
|--|---|--|--|---|--|--|--|
|    | 1.9 DDiS<br>1.9 DDiS 4x4<br>2.0 DDiS<br>2.0 DDiS 4x4  | 88<br>88<br>99<br>99                                     | 06.06<br>06.06<br>07.09<br>07.09   |   | 24.3219-1756.3<br>020511   | - ABS  | Rz 19,05<br><b>BOS</b>                                       |
|    | 1.6<br>1.6 Cabrio<br>2.0 i V6<br>1.6 i 16V  | 100  | 01.89<br>01.89<br>12.94<br>02.91   | 01.95<br>01.95<br>03.98<br>12.94  | 24.3728-2004.2<br>592004   |  | L=1850<br>L=1843   |
|    | 1.3 DDiS<br>1.3 i 16V<br>1.3 i 16V<br>1.3 i 16V<br>1.3 i 16V 4WD<br>1.3 i 16V 4WD   | 51<br>56<br>65<br>69<br>56<br>69                         | 09.03<br>05.00<br>08.01<br>09.03<br>10.01<br>09.03                                     | 04.08<br>08.03<br>- ABS<br>- ABS<br>- ABS<br>- ABS  | 24.2120-1731.3<br>010667   |  | THz 20,64  |
|    | 1.0 i 12V<br>1.0 i 12V<br>1.0 XT Plus<br>1.2 i 16V<br>1.3 DDiS<br>1.3 i 16V<br>1.3 i 16V<br>1.3 i 16V<br>1.3 i 16V 4WD<br>1.3 i 16V 4WD | 39<br>44<br>74<br>59<br>51<br>56<br>65<br>69<br>56<br>69 | 07.03<br>06.04<br>08.00<br>06.04<br>09.03<br>05.00<br>08.01<br>09.03<br>10.01<br>09.03 | 08.05<br>- ABS<br>08.03<br>+ ABS<br>+ ABS<br>+ ABS<br>+ ABS<br>+ ABS  | 24.2120-1730.3<br>010678   |  | THz 20,64  |
|    | 1.3 i 16V<br>1.3 i 16V 4WD  | 56<br>56   | 05.00<br>10.01   | 08.03<br>08.03  | 24.3481-1757.5<br>240325<br>24.3481-1758.5<br>240326                             | <input type="checkbox"/><br><input type="checkbox"/>                             | D=48, - Halter<br>D=48, - Halter<br><b>BOS</b><br><b>BOS</b> |
|    | 1.0 i 12V<br>1.0 i 12V<br>1.0 XT Plus<br>1.2 i 16V<br>1.3 DDiS<br>1.3 i 16V<br>1.3 i 16V<br>1.3 i 16V<br>1.3 i 16V 4WD<br>1.3 i 16V 4WD | 39<br>44<br>74<br>59<br>51<br>56<br>65<br>69<br>56<br>69 | 07.03<br>06.04<br>08.00<br>06.04<br>09.03<br>05.00<br>08.01<br>09.03<br>10.01<br>09.03 | 08.05<br>- ABS<br>08.03<br>04.08<br>08.03   | 24.5291-0430.3<br>331084   | 2  | L=430  |
|  | 1.0 i 12V<br>1.0 i 12V<br>1.0 XT Plus<br>1.2 i 16V<br>1.3 DDiS<br>1.3 i 16V<br>1.3 i 16V<br>1.3 i 16V<br>1.3 i 16V 4WD<br>1.3 i 16V 4WD | 39<br>44<br>74<br>59<br>51<br>56<br>65<br>69<br>56<br>69 | 07.03<br>06.04<br>08.00<br>06.04<br>09.03<br>05.00<br>08.01<br>09.03<br>10.01<br>09.03 | 08.05<br>- ABS<br>08.03<br>04.08<br>08.03   | 24.5284-0283.3<br>331080   | 2  | L=283  |
|  | 1.0 i 12V<br>1.0 i 12V<br>1.0 XT Plus<br>1.2 i 16V<br>1.3 DDiS<br>1.3 i 16V   | 39<br>44<br>74<br>59<br>51<br>65                         | 07.03<br>06.04<br>08.00<br>06.04<br>09.03<br>08.01                                     | 08.05<br>- ABS<br>07.01<br>04.08<br>08.03   | 24.3215-1701.3<br>020493   |  | Rz 15,87   |
|  | 1.3 i 16V<br>1.3 i 16V<br>1.3 i 16V 4WD<br>1.3 i 16V 4WD  | 56<br>69<br>56<br>69                                     | 05.00<br>09.03<br>10.01<br>09.03   | 08.03<br>08.03  | 24.3215-1702.3<br>020494   |  | Rz 15,87   |
|  | 1.3 i 16V<br>1.3 i 16V 4WD  | 56<br>56   | 05.00<br>10.01   | 08.03<br>08.03  | 24.3727-0771.2<br>580771<br>24.3727-0774.2<br>580774                             | <input type="checkbox"/><br><input type="checkbox"/>                             | L=1516, + Zub<br>L=1507, + Zub                               |
|  | 1.4 D-4D<br>1.4 VVTi<br>1.6 16V<br>1.6 VVTi<br>2.0 D-4D<br>2.2 D-4D   | 66<br>71<br>97<br>91<br>93<br>130                        | 03.07<br>03.07<br>05.09<br>03.07<br>03.07<br>03.07                                     | 09.12<br>09.12<br>Herst.Land (1)<br>Herst.Land (1)<br>Herst.Land (1)<br>Herst.Land (1)                            | 24.5274-0180.3<br>330941   | 2  | L=180  |
|  | 1.33 Dual-VVTi<br>1.4 D-4D<br>1.4 VVTi<br>1.6 16V<br>1.6 VVTi<br>1.8 16V<br>1.8 VVTi<br>2.0 D-4D  | 74<br>66<br>71<br>97<br>91<br>108<br>100<br>93           | 05.09<br>03.07<br>03.07<br>05.09<br>03.07<br>02.09<br>10.06<br>03.07                   | 09.12<br>Herst.Land (2)<br>Herst.Land (2)<br>Herst.Land (2)<br>Herst.Land (2)<br>09.12<br>09.12<br>Herst.Land (2) | 24.5262-0180.3<br>331180   | 2  | L=180  |
|  | 1.4 D-4D<br>1.4 VVTi<br>1.6 16V<br>1.6 VVTi<br>2.0 D-4D<br>2.2 D-4D   | 66<br>71<br>97<br>91<br>93<br>130                        | 03.07<br>03.07<br>05.09<br>03.07<br>03.07<br>03.07                                     | 09.12<br>Herst.Land (1)<br>Herst.Land (1)<br>Herst.Land (1)<br>Herst.Land (1)<br>Herst.Land (1)                   | 24.3727-1934.2<br>581934<br>24.3727-1936.2<br>581936<br>24.3727-1935.2<br>581935 | <input type="checkbox"/><br><input type="checkbox"/><br><input type="checkbox"/> | L=336<br>L=1576<br>L=1585                                    |

1) country of manufacture (1) / paese del costruttore (1) / pays du constructeur (1) / país del fabricante (1)  
2) country of manufacture (2) / paese del costruttore (2) / pays du constructeur (2) / país del fabricante (2)



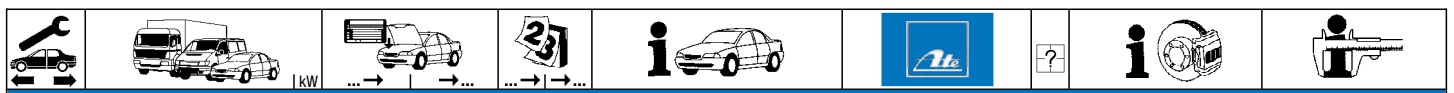

**TOYOTA AVENSIS (97-03)**



















































|  |   |  |  |  |  |  |  |  |   |  |   |
|--|---|--|--|--|--|--|--|--|---|--|---|
|  | 1.6 i 16V (AT220)<br>1.6 VVTi (ZZT220)<br>2.0 D4-D (CDT221)<br>2.0 i 16V (ST220)<br>2.0 TD (CT220)  |  | 09.97<br>10.00<br>10.99<br>09.97<br>09.97                            | 09.00<br>02.03<br>02.03<br>09.00<br>02.03                            |  | 03.7750-2532.4   | 300225   |  |   | 9"   | ATE   |
|  | 1.6 i 16V (AT220)<br>1.6 VVTi (ZZT220)<br>1.8 i 16V (AT221)<br>1.8 VVTi (ZZT221)<br>2.0 D4-D (CDT221)<br>2.0 i 16V (ST220)<br>2.0 TD (CT220)<br>2.0 VVTi (AZT220) |  | 09.97<br>10.00<br>09.97<br>10.00<br>10.99<br>09.97<br>09.97<br>10.00 | 09.00<br>02.03<br>09.00<br>02.03<br>02.03<br>09.00<br>02.03<br>02.03 |  | 03.2123-2221.3   | 010861   |  |   | Thz 23,81  | ATE   |
|  | 1.6 i 16V (AT220)<br>1.8 i 16V (AT221)<br>2.0 D4-D (CDT221)<br>2.0 i 16V (ST220)<br>2.0 TD (CT220)  |  | 09.97<br>09.97<br>10.99<br>09.97<br>09.97                            | 09.00<br>09.00<br>02.03<br>09.00<br>02.03                            | + HA-Trommelbremse <sup>1)</sup><br>+ HA-Trommelbremse <sup>1)</sup><br>+ HA-Trommelbremse <sup>1)</sup><br>+ HA-Trommelbremse <sup>1)</sup><br>+ HA-Trommelbremse <sup>1)</sup>   | 11.9571-9801.2<br>11.9571-9802.2<br>24.3571-9801.5<br>24.3571-9802.5<br>11.0101-5407.2<br>11.8171-0008.1<br>11.8116-0279.1 | 220577<br>220578<br>240497<br>240498<br>260011<br>990049<br>390519 | <input type="checkbox"/><br><input type="checkbox"/><br><input type="checkbox"/><br><input type="checkbox"/><br><input type="checkbox"/>                             |   | D=57, - Halter<br>D=57, - Halter<br>D=57, - Halter<br>D=57, - Halter<br>Hülzensatz<br>Führungsbolzen<br>Haltefeder | ATE<br>ATE<br>ATE<br>ATE<br>ATE<br>ATE<br>ATE |
|  | 1.6 VVTi (ZZT220)<br>1.8 VVTi (ZZT221)<br>2.0 D4-D (CDT221)<br>2.0 i 16V (ST220)<br>2.0 TD (CT220)<br>2.0 VVTi (AZT220)   |  | 07.01<br>07.01<br>07.01<br>07.01<br>07.01<br>07.01                   | 02.03<br>02.03<br>02.03<br>02.03<br>02.03<br>02.03                   | + HA-Scheibenbremse <sup>2)</sup><br>+ HA-Scheibenbremse <sup>2)</sup><br>+ HA-Scheibenbremse <sup>2)</sup><br>+ HA-Scheibenbremse <sup>2)</sup><br>+ HA-Scheibenbremse <sup>2)</sup><br>+ HA-Scheibenbremse <sup>2)</sup> | 11.9571-9821.2<br>11.9571-9822.2<br>11.0101-5407.2<br>11.8171-0008.1<br>11.8116-0279.1                                     | 220579<br>220580<br>260011<br>990049<br>390519                     | <input type="checkbox"/><br><input type="checkbox"/><br><input type="checkbox"/><br><input type="checkbox"/><br><input type="checkbox"/>                             | 2 | D=57, - Halter<br>D=57, - Halter<br>Hülzensatz<br>Führungsbolzen<br>Haltefeder                                     | ATE<br>ATE<br>ATE<br>ATE<br>ATE               |
|  | 1.6 VVTi (ZZT220)<br>1.8 VVTi (ZZT221)<br>2.0 D4-D (CDT221)<br>2.0 i 16V (ST220)<br>2.0 TD (CT220)<br>2.0 VVTi (AZT220)   |  | 10.00<br>10.00<br>10.99<br>10.00<br>09.97<br>10.00                   | 06.01<br>06.01<br>06.01<br>06.01<br>06.01<br>06.01                   |  | 24.3381-1705.5<br>24.3381-1706.5   | 240415<br>240416   | <input type="checkbox"/><br><input type="checkbox"/><br><input type="checkbox"/><br><input type="checkbox"/><br><input type="checkbox"/><br><input type="checkbox"/> |   | D=38, - Halter<br>D=38, - Halter   |   |
|  | 1.6 i 16V (AT220)<br>1.8 i 16V (AT221)<br>2.0 D4-D (CDT221)<br>2.0 i 16V (ST220)<br>2.0 TD (CT220)  |  | 09.97<br>09.97<br>10.99<br>09.97<br>09.97                            | 09.00<br>02.03<br>02.03<br>09.00<br>02.03                            |  | 24.3220-1725.3<br>24.3220-1726.3   | 020483<br>020484   | <input type="checkbox"/><br><input type="checkbox"/><br><input type="checkbox"/><br><input type="checkbox"/><br><input type="checkbox"/>                             |   | Rz 20,64<br>Rz 20,64   |   |
|  | 1.6 i 16V (AT220)<br>1.8 i 16V (AT221)<br>2.0 D4-D (CDT221)<br>2.0 i 16V (ST220)<br>2.0 TD (CT220)  |  | 09.97<br>09.97<br>10.99<br>09.97<br>09.97                            | 09.00<br>09.00<br>02.03<br>09.00<br>02.03                            | + HA-Trommelbremse <sup>1)</sup><br>+ HA-Trommelbremse <sup>1)</sup><br>+ HA-Trommelbremse <sup>1)</sup><br>+ HA-Trommelbremse <sup>1)</sup><br>+ HA-Trommelbremse <sup>1)</sup>   | 24.3727-1904.2<br>24.3727-1905.2   | 581904<br>581905   | <input type="checkbox"/><br><input type="checkbox"/><br><input type="checkbox"/><br><input type="checkbox"/><br><input type="checkbox"/>                             |   | L=1829<br>L=1789   |   |
|  | 1.6 VVTi (ZZT220)<br>1.8 VVTi (ZZT221)<br>2.0 D4-D (CDT221)<br>2.0 i 16V (ST220)<br>2.0 TD (CT220)<br>2.0 VVTi (AZT220)   |  | 10.00<br>10.00<br>10.99<br>10.00<br>09.97<br>10.00                   | 06.01<br>06.01<br>06.01<br>06.01<br>06.01<br>06.01                   | + HA-Scheibenbremse <sup>2)</sup><br>+ HA-Scheibenbremse <sup>2)</sup><br>+ HA-Scheibenbremse <sup>2)</sup><br>+ HA-Scheibenbremse <sup>2)</sup><br>+ HA-Scheibenbremse <sup>2)</sup><br>+ HA-Scheibenbremse <sup>2)</sup> | 24.3727-1900.2<br>24.3727-1910.2   | 581900<br>581910   | <input type="checkbox"/><br><input type="checkbox"/><br><input type="checkbox"/><br><input type="checkbox"/><br><input type="checkbox"/><br><input type="checkbox"/> |   | L=1805<br>L=1760   |   |
|  | 1.6 VVTi (ZZT220)<br>1.8 VVTi (ZZT221)<br>2.0 D4-D (CDT221)<br>2.0 i 16V (ST220)<br>2.0 TD (CT220)<br>2.0 VVTi (AZT220)   |  | 07.01<br>07.01<br>07.01<br>07.01<br>07.01<br>07.01                   | 02.03<br>02.03<br>02.03<br>02.03<br>02.03<br>02.03                   | + HA-Scheibenbremse <sup>2)</sup><br>+ HA-Scheibenbremse <sup>2)</sup><br>+ HA-Scheibenbremse <sup>2)</sup><br>+ HA-Scheibenbremse <sup>2)</sup><br>+ HA-Scheibenbremse <sup>2)</sup><br>+ HA-Scheibenbremse <sup>2)</sup> | 24.3727-1916.2<br>24.3727-1915.2   | 581916<br>581915   | <input type="checkbox"/><br><input type="checkbox"/><br><input type="checkbox"/><br><input type="checkbox"/><br><input type="checkbox"/><br><input type="checkbox"/> |   | L=1868<br>L=1824   |   |

**TOYOTA AVENSIS (03-09)**

|  |  |   |   |   |  |  |                            |  |  |                           |  |
|--|--|---|---|---|--|--|----------------------------|--|--|---------------------------|--|
|  | 1.6 i 16V<br>1.8 i 16V<br>2.0 D-4D<br>2.0 D-4D<br>2.0 i 16V<br>2.2 D-4D<br>2.2 D-CAT<br>2.4 i 16V<br>2.4 i 16V | 81<br>95<br>85<br>93<br>108<br>110<br>130<br>120<br>125 | 04.03<br>04.03<br>04.03<br>03.06<br>04.03<br>10.05<br>07.05<br>10.03<br>09.03 | 01.09<br>01.09<br>04.06<br>01.09<br>01.09<br>01.09<br>01.09<br>01.09<br>01.09 |  | 24.5262-0576.3<br>24.5262-0575.3                   | 330923<br>330922           | <input type="checkbox"/><br><input type="checkbox"/><br><input type="checkbox"/><br><input type="checkbox"/><br><input type="checkbox"/><br><input type="checkbox"/><br><input type="checkbox"/><br><input type="checkbox"/><br><input type="checkbox"/> |  | L=575<br>L=575            |  |
|  | 1.6 i 16V<br>1.8 i 16V<br>2.0 D-4D<br>2.0 D-4D<br>2.0 i 16V<br>2.2 D-4D<br>2.2 D-CAT<br>2.4 i 16V<br>2.4 i 16V | 81<br>95<br>85<br>93<br>108<br>110<br>130<br>120<br>125 | 04.03<br>04.03<br>04.03<br>03.06<br>04.03<br>10.05<br>07.05<br>10.03<br>09.03 | 01.09<br>01.09<br>04.06<br>01.09<br>01.09<br>01.09<br>01.09<br>01.09<br>01.09 |  | 24.5276-0240.3                                     | 330943                     | <input type="checkbox"/><br><input type="checkbox"/><br><input type="checkbox"/><br><input type="checkbox"/><br><input type="checkbox"/><br><input type="checkbox"/><br><input type="checkbox"/><br><input type="checkbox"/><br><input type="checkbox"/> | 2  | L=240                     |  |
|  | 1.6 i 16V<br>1.8 i 16V<br>2.0 D-4D<br>2.0 D-4D<br>2.0 i 16V<br>2.2 D-4D<br>2.2 D-CAT<br>2.4 i 16V<br>2.4 i 16V | 81<br>95<br>85<br>93<br>108<br>110<br>130<br>120<br>125 | 04.03<br>04.03<br>04.03<br>03.06<br>04.03<br>10.05<br>07.05<br>10.03<br>09.03 | 01.09<br>01.09<br>04.06<br>01.09<br>01.09<br>01.09<br>01.09<br>01.09<br>01.09 |  | 24.3727-1919.2<br>24.3727-1930.2<br>24.3727-1931.2 | 581919<br>581930<br>581931 | <input type="checkbox"/><br><input type="checkbox"/><br><input type="checkbox"/><br><input type="checkbox"/><br><input type="checkbox"/><br><input type="checkbox"/><br><input type="checkbox"/><br><input type="checkbox"/><br><input type="checkbox"/> | <input type="checkbox"/><br><input type="checkbox"/><br><input type="checkbox"/> | L=398<br>L=1770<br>L=1823 |  |

<sup>1)</sup> + RA drum brake / + P freno a tamburo / + frein à tambour essieu AR / + ET-tambores de freno

<sup>2)</sup> + RA disc brake / + P disco freno / + frein à disque essieu AR / + ET-disco de freno

|     |  |  |  |  |  |  |  |     |                |            |
|--|--|--|--|--|---|--|--|---|----------------|------------|
| <b>TOYOTA AVENSIS VERSO (01-05)</b>  |  |  |  |  |   |  |  |   |                |            |
|    | 2.0 D4-D (CLM20)   | 85   |  | 08.01  | 07.05   | 24.5263-0575.3   | 330924   |    | L=575          |            |
|  | 2.0 VVTi (ACM20)   | 110  |  | 08.01  | 07.05   | 24.5263-0576.3   | 330925   |    | L=575          |            |
|    | 2.0 D4-D (CLM20)   | 85   |  | 08.01  | 07.05   | 24.3431-1708.7   | 220936   |    | D=43, - Halter | <b>LUC</b> |
|  | 2.0 VVTi (ACM20)   | 110  |  | 08.01  | 07.05   |  |  |   |                |            |
|    | 2.0 D4-D (CLM20)   | 85   |  | 08.01  | 07.05   | 24.5145-0176.3   | 330965   |    | L=175          |            |
|  | 2.0 VVTi (ACM20)   | 110  |  | 08.01  | 07.05   | 24.5235-0250.3   | 330917   |    | L=250          |            |
|    | 2.0 D4-D (CLM20)   | 85   |  | 08.01  | 07.05   | 24.3727-1914.2   | 581914   |    | L=319          |            |
|  | 2.0 VVTi (ACM20)   | 110  |  | 08.01  | 07.05   |  |  |   |                |            |
|  | 2.0 D4-D (CLM20)   | 85   |  | 08.01  | 07.05   | 24.3727-1914.2   | 581914   |    | L=319          |            |
|  | 2.0 VVTi (ACM20)   | 110  |  | 08.01  | 07.05   |  |  |   |                |            |
| <b>TOYOTA AYGO (05-)</b>   |  |  |  |  |   |  |  |   |                |            |
|    | 1.0 i 12V  | 50   |  | 07.05  |   | 24.4120-1701.3   | 010846   |   | Thz 20,64      | <b>BOS</b> |
|  | 1.0 i 12V GPL  | 50   |  | 07.05  |   |  |  |   |                |            |
|  | 1.4 HDi  | 40   |  | 07.05  | 08.10   |  |  |   |                |            |
|    | 1.0 i 12V  | 50   |  | 07.05  |   | 24.5295-0496.3   | 331033   |    | L=496          |            |
|  | 1.0 i 12V GPL  | 50   |  | 07.05  |   | 24.5262-0501.3   | 331025   |    | L=501          |            |
|  | 1.4 HDi  | 40   |  | 07.05  | 08.10   |  |  |   |                |            |
|    | 1.0 i 12V  | 50   |  | 07.05  |   | 24.5261-0225.3   | 330909   | 2   | L=225          |            |
|  | 1.0 i 12V GPL  | 50   |  | 07.05  |   |  |  |   |                |            |
|  | 1.4 HDi  | 40   |  | 07.05  | 08.10   |  |  |   |                |            |
|    | 1.0 i 12V  | 50   |  | 07.05  |   | 24.3217-1719.3   | 020482   |   | Rz 17,46       | <b>BOS</b> |
|  | 1.0 i 12V GPL  | 50   |  | 07.05  |   |  |  |   |                |            |
|  | 1.4 HDi  | 40   |  | 07.05  | 08.10   |  |  |   |                |            |
|    | 1.0 i 12V  | 50   |  | 07.05  |   | 24.3728-0851.2   | 590851   |   | L=1596         |            |
|  | 1.0 i 12V GPL  | 50   |  | 07.05  |   |  |  |   |                |            |
| <b>TOYOTA CARINA II (87-92)</b>  |  |  |  |  |   |  |  |   |                |            |
|    | 1.6 (AT171)  |  |  | 12.87  | 01.92   | 24.3219-1712.3   | 020388   |    | Rz 19,05       |            |
|  | 2.0 (ST171)  |  |  | 12.87  | 01.92   |  |  |   |                |            |
|  | 2.0 D (CT170)  |  |  | 12.87  | 01.92   |  |  |   |                |            |
| <b>TOYOTA CARINA E (92-97)</b>   |  |  |  |  |   |  |  |   |                |            |
|   | 1.6 i (AT190)  |  |  | 10.94  | 09.97   | 03.2123-1181.3   | 010522   |   | Thz 23,81      | <b>ATE</b> |
|  | 1.8 i (AT191)  |  |  | 10.94  | 09.97   |  |  |   |                |            |
|  | 2.0 D (CT190)  |  |  | 10.94  | 09.97   |  |  |   |                |            |
|  | 2.0 i (ST191)  |  |  | 10.94  | 09.97   |  |  |   |                |            |
|  | 1.6 i (AT190)  |  |  | 02.92  | 09.97   | 24.3571-1713.5   | 240201   |  | D=57, - Halter | <b>SUM</b> |
|  | 1.8 i (AT191)  |  |  | 02.92  | 09.97   | 24.3571-1714.5   | 240202   |  | D=57, - Halter | <b>SUM</b> |
|  | 2.0 D (CT190)  |  |  | 02.92  | 09.97   |  |  |   |                |            |
|  | 1.6 i (AT190)  |  |  | 02.92  | 12.95   | 24.3219-1729.3   | 020446   |  | Rz 19,05       |            |
|  | 1.8 i (AT191)  |  |  | 02.92  | 12.95   | 24.3219-1730.3   | 020447   |  | Rz 19,05       |            |
|  | 2.0 D (CT190)  |  |  | 02.92  | 12.95   |  |  |   |                |            |
|  | 2.0 i (ST191)  |  |  | 02.92  | 12.95   |  |  |   |                |            |
|  | 1.6 i (AT190)  |  |  | 02.92  | 09.97   | 24.3727-1932.2   | 581932   |  | L=1780         |            |
|  | 1.8 i (AT191)  |  |  | 02.92  | 09.97   | 24.3727-1933.2   | 581933   |  | L=1727         |            |
|  | 2.0 D (CT190)  |  |  | 02.92  | 09.97   |  |  |   |                |            |
|  | 2.0 i (ST191)  |  |  | 02.92  | 09.97   |  |  |   |                |            |
| <b>TOYOTA CELICA (89-93)</b>   |  |  |  |  |   |  |  |   |                |            |
|  | 1.6 i (AT180)  | 77   |  | 10.89  | 11.93   | 24.3219-1712.3   | 020388   |  | Rz 19,05       |            |
| <b>TOYOTA CELICA (93-99)</b>   |  |  |  |  |   |  |  |   |                |            |
|  | 1.8 i (AT200)  |  |  | 11.93  | 11.99   | 24.3571-1713.5   | 240201   |  | D=57, - Halter | <b>SUM</b> |
|  |  |  |  |  |   | 24.3571-1714.5   | 240202   |  | D=57, - Halter | <b>SUM</b> |
| <b>TOYOTA CELICA (99-05)</b>   |  |  |  |  |   |  |  |   |                |            |
|  | 1.8 VVTi (ZZT230)  | 105  |  | 11.99  | 09.05   | 24.5264-0245.3   | 331133   | 2   | L=245          |            |
|  | 1.8 VVTi TS (ZZT231)   | 141  |  | 11.99  | 09.05   |  |  |   |                |            |
| <b>TOYOTA COROLLA (87-92)</b>  |  |  |  |  |   |  |  |   |                |            |
|  | 1.6 4WD (AE95)   |  |  | 05.87  | 05.92   | 24.3219-1714.3   | 020390   |   | Rz 19,05       |            |
|  | 1.3 (EE90)   |  |  | 09.89  | 05.92   | 24.3727-1902.2   | 581902   |  | L=1560         |            |
|  | 1.6 (AE92)   |  |  | 05.87  | 05.92   |  |  |   |                |            |
|  | 1.8 D (CE90)   |  |  | 05.87  | 05.92   |  |  |   |                |            |
| <b>TOYOTA COROLLA (92-97)</b>  |  |  |  |  |   |  |  |   |                |            |
|  | 1.3 16V (EE101)  |  |  | 05.92  | 04.97   | 24.3541-1705.5   | 240111   |  | D=54, - Halter | <b>SUM</b> |
|  | 1.6 (AE101)  |  |  | 05.92  | 04.97   | 24.3541-1706.5   | 240112   |  | D=54, - Halter | <b>SUM</b> |
|  | 1.8 (AE102)  |  |  | 05.92  | 05.95   | 24.0101-5405.2   | 260063   |   | Einbausatz     | <b>SUM</b> |
|  | 1.8 (AE103)  |  |  | 05.95  | 04.97   |  |  |   |                |            |
|  | 2.0 D (CE100)  |  |  | 05.92  | 04.97   |  |  |   |                |            |

1) + Hosei brake / + freno Hosei / + freins Hosei / + freno de Hosei

2) + Europe / + Europa / + Europe / + Europa

3) + Europe/ + Estate / + Europa/ + Station Wagon / + Europe/ + Break / + Europa/ + Break

4) + Europe/ - GUS States / + Europa/ - Stati del GUS / + Europe/ - Etats de la CEI / + Europa/ - estados del GUS

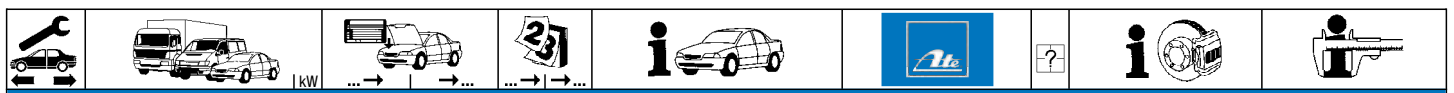

**TOYOTA COROLLA (92-97)**

|               |                     |       |       |       |                                       |                                 |        |                          |          |  |
|---------------|---------------------|-------|-------|-------|---------------------------------------|---------------------------------|--------|--------------------------|----------|--|
|               | 1.3 (EE100)         |       | 05.92 | 05.95 | 24.5235-0275.3                        | 331179                          | 2      |                          | L=275    |  |
|               | 1.3 (EE105)         |       | 05.92 | 04.97 |                                       |                                 |        |                          |          |  |
|               | 1.3 16V (EE101)     |       | 05.92 | 04.97 |                                       |                                 |        |                          |          |  |
|               | 1.5 (EE104)         |       | 05.92 | 04.97 |                                       |                                 |        |                          |          |  |
|               | 1.5 (EE108)         |       | 05.92 | 04.97 |                                       |                                 |        |                          |          |  |
|               | 1.6 (AE101)         |       | 05.92 | 04.95 |                                       |                                 |        |                          |          |  |
|               | 1.6 GT APEX (AE101) |       | 05.92 | 05.95 |                                       |                                 |        |                          |          |  |
| 2.0 D (CE100) |                     | 05.92 | 04.95 |       |                                       |                                 |        |                          |          |  |
|               | 1.3 16V (EE101)     |       | 05.92 | 04.97 | + Europa <sup>1)</sup>                | 24.3219-1729.3                  | 020446 | <input type="checkbox"/> | Rz 19,05 |  |
|               | 1.6 (AE101)         |       | 05.92 | 04.97 | + Europa <sup>1)</sup>                | 24.3219-1730.3                  | 020447 | <input type="checkbox"/> | Rz 19,05 |  |
|               | 2.0 D (CE100)       |       | 05.92 | 04.97 | + Europa/ - GUS-Staaten <sup>2)</sup> |                                 |        |                          |          |  |
|               | 1.6 GT APEX (AE101) |       | 05.92 | 05.95 | - Europa/ + Coupe <sup>3)</sup>       | 24.3727-1922.2                  | 581922 | <input type="checkbox"/> | L=1448   |  |
|               | 1.8 (AE102)         |       | 05.92 | 05.95 | + Europa <sup>1)</sup>                | 24.3727-1923.2                  | 581923 | <input type="checkbox"/> | L=1457   |  |
|               | 1.3 (EE100)         |       | 05.92 | 05.93 | + Europa <sup>1)</sup>                | 24.3727-1907.2                  | 581907 | <input type="checkbox"/> | L=1585   |  |
|               | 1.3 (EE105)         |       | 05.92 | 05.93 |                                       | 24.3727-1908.2                  | 581908 | <input type="checkbox"/> | L=1603   |  |
|               | 1.3 16V (EE101)     |       | 05.92 | 05.93 |                                       |                                 |        |                          |          |  |
|               | 1.5 (AE100)         |       | 05.92 | 05.93 |                                       |                                 |        |                          |          |  |
|               | 1.5 (EE104)         |       | 05.92 | 05.93 |                                       | + Europa <sup>1)</sup>          |        |                          |          |  |
|               | 1.5 (EE108)         |       | 05.92 | 05.93 |                                       | + Europa <sup>1)</sup>          |        |                          |          |  |
|               | 1.6 (AE101)         |       | 05.92 | 05.93 |                                       |                                 |        |                          |          |  |
|               | 1.6 GT APEX (AE101) |       | 05.92 | 05.93 |                                       | + Europa/ + Coupe <sup>4)</sup> |        |                          |          |  |
|               | 1.8 (AE102)         |       | 08.91 | 05.95 |                                       | - Europa <sup>5)</sup>          |        |                          |          |  |
|               | 2.0 D (CE100)       |       | 05.92 | 05.93 |                                       |                                 |        |                          |          |  |

**TOYOTA COROLLA (97-02)**



























|                       |                       |       |       |                                   |                |        |                          |       |           |                                   |                |        |  |       |
|-----------------------|-----------------------|-------|-------|-----------------------------------|----------------|--------|--------------------------|-------|-----------|-----------------------------------|----------------|--------|--|-------|
|                       | 1.4 i 16V (ZZE111)    | 71    | 02.00 | 01.02                             | 03.2122-1691.3 | 010918 |                          |       | Thz 22,20 | ATE                               |                |        |  |       |
|                       | 1.6 i 16V (ZZE112)    | 81    | 02.00 | 01.02                             |                |        |                          |       |           |                                   |                |        |  |       |
|                       | 1.8 i 16V AWD (AE115) | 81    | 05.97 | 01.02                             |                |        |                          |       |           |                                   |                |        |  |       |
|                       | 1.9 D (WZE110)        | 51    | 02.00 | 01.02                             |                |        |                          |       |           |                                   |                |        |  |       |
|                       | 2.0 D-4D (CDE110)     | 66    | 09.00 | 01.02                             |                |        |                          |       |           |                                   |                |        |  |       |
|                       | 1.4 i (EE111)         | 63    | 05.97 | 01.00                             | 24.5260-0280.3 | 330883 | 2                        |       | L=280     |                                   |                |        |  |       |
|                       | 1.6 i (AE111)         | 81    | 05.97 | 01.00                             |                |        |                          |       |           |                                   |                |        |  |       |
|                       | 2.0 D (CE110)         | 53    | 05.97 | 01.00                             |                |        |                          |       |           |                                   |                |        |  |       |
|                       | 1.4 i (EE111)         | 63    | 05.97 | 01.00                             | 24.3219-1729.3 | 020446 |                          |       | Rz 19,05  |                                   |                |        |  |       |
|                       | 1.4 i 16V (ZZE111)    | 71    | 02.00 | 12.01                             |                |        |                          |       |           |                                   |                |        |  |       |
|                       | 1.6 i (AE111)         | 81    | 05.97 | 01.00                             |                |        |                          |       |           |                                   |                |        |  |       |
|                       | 1.6 i 16V (ZZE112)    | 81    | 02.00 | 12.01                             |                |        |                          |       |           |                                   |                |        |  |       |
|                       | 1.8 i 16V AWD (AE115) | 81    | 05.97 | 12.01                             |                |        |                          |       |           | + Kombiwagen <sup>6)</sup>        |                |        |  |       |
|                       | 1.9 D (WZE110)        | 51    | 02.00 | 12.01                             |                |        |                          |       |           |                                   |                |        |  |       |
|                       | 2.0 D (CE110)         | 53    | 05.97 | 01.00                             |                |        |                          |       |           |                                   |                |        |  |       |
|                       | 1.4 i (EE111)         | 63    | 05.97 | 07.98                             | 24.3727-1918.2 | 581918 |                          |       | L=292     |                                   |                |        |  |       |
|                       | 1.4 i 16V (ZZE111)    | 71    | 02.00 | 12.01                             |                |        |                          |       |           | + HA-Trommelbremse <sup>7)</sup>  |                |        |  |       |
|                       | 1.6 i (AE111)         | 81    | 05.97 | 07.98                             |                |        |                          |       |           | + HA-Trommelbremse <sup>7)</sup>  |                |        |  |       |
|                       | 1.6 i 16V (ZZE112)    | 81    | 02.00 | 12.01                             |                |        |                          |       |           | + HA-Trommelbremse <sup>7)</sup>  |                |        |  |       |
|                       | 1.9 D (WZE110)        | 51    | 02.00 | 12.01                             |                |        |                          |       |           | + HA-Trommelbremse <sup>7)</sup>  |                |        |  |       |
|                       | 2.0 D (CE110)         | 53    | 05.97 | 07.98                             |                |        |                          |       |           | + HA-Trommelbremse <sup>7)</sup>  |                |        |  |       |
|                       | 1.4 i (EE111)         | 63    | 08.98 | 01.00                             |                |        |                          |       |           | + HA-Scheibenbremse <sup>8)</sup> | 24.3727-1918.2 | 581918 |  | L=292 |
|                       | 1.4 i 16V (ZZE111)    | 71    | 02.00 | 12.01                             |                |        |                          |       |           | + HA-Scheibenbremse <sup>8)</sup> |                |        |  |       |
|                       | 1.6 i (AE111)         | 81    | 08.98 | 01.00                             |                |        |                          |       |           | + HA-Scheibenbremse <sup>8)</sup> |                |        |  |       |
|                       | 1.6 i 16V (ZZE112)    | 81    | 02.00 | 12.01                             |                |        |                          |       |           | + HA-Scheibenbremse <sup>8)</sup> |                |        |  |       |
| 1.9 D (WZE110)        | 51                    | 02.00 | 12.01 | + HA-Scheibenbremse <sup>8)</sup> |                |        |                          |       |           |                                   |                |        |  |       |
| 2.0 D (CE110)         | 53                    | 08.98 | 01.00 | + HA-Scheibenbremse <sup>8)</sup> |                |        |                          |       |           |                                   |                |        |  |       |
| 2.0 D-4D (CDE110)     | 66                    | 09.00 | 12.01 | + HA-Scheibenbremse <sup>8)</sup> |                |        |                          |       |           |                                   |                |        |  |       |
| 1.8 i 16V AWD (AE115) | 81                    | 05.97 | 12.01 | + Kombiwagen <sup>6)</sup>        | 24.3727-1918.2 | 581918 | <input type="checkbox"/> | L=292 |           |                                   |                |        |  |       |

**TOYOTA COROLLA (02-04)**

























|                   |                       |       |       |       |                |        |   |  |                |                |        |  |  |                |
|-------------------|-----------------------|-------|-------|-------|----------------|--------|---|--|----------------|----------------|--------|--|--|----------------|
|                   | 1.8 VVTLi TS (ZZE123) | 141   | 01.02 | 05.04 | 24.5262-0576.3 | 330923 |   |  | L=575          |                |        |  |  |                |
|                   | 2.0 D-4D (CDE120)     | 66    | 08.02 | 05.04 |                |        |   |  |                |                |        |  |  |                |
|                   | 2.0 D-4D (CDE120)     | 81    | 01.02 | 05.04 |                |        |   |  |                |                |        |  |  |                |
|                   | 2.0 D-4D (CDE120)     | 85    | 05.03 | 05.04 |                |        |   |  |                |                |        |  |  |                |
|                   | 1.4 VVTi (ZZE120)     | 71    | 01.02 | 05.04 | 24.3361-1701.7 | 220717 |   |  | D=36, - Halter |                |        |  |  |                |
|                   | 1.6 VVTi (ZZE121)     | 81    | 01.02 | 05.04 |                |        |   |  |                |                |        |  |  |                |
|                   | 2.0 D-4D (CDE120)     | 66    | 01.02 | 05.04 |                |        |   |  |                |                |        |  |  |                |
|                   | 1.4 VVTi (ZZE120)     | 71    | 02.02 | 05.04 |                |        |   |  |                | 24.3341-1703.5 | 240443 |  |  | D=34, - Halter |
|                   | 1.6 VVTi (ZZE121)     | 81    | 08.02 | 05.04 |                |        |   |  |                |                |        |  |  |                |
|                   | 1.8 VVTLi TS (ZZE123) | 141   | 01.02 | 05.04 |                |        |   |  |                |                |        |  |  |                |
|                   | 2.0 D-4D (CDE120)     | 66    | 08.02 | 05.04 |                |        |   |  |                |                |        |  |  |                |
| 2.0 D-4D (CDE120) | 81                    | 01.02 | 05.04 |       |                |        |   |  |                |                |        |  |  |                |
| 2.0 D-4D (CDE120) | 85                    | 05.03 | 05.04 |       |                |        |   |  |                |                |        |  |  |                |
|                   | 1.4 VVTi (ZZE120)     | 71    | 01.02 | 05.04 | 24.5264-0221.3 | 330995 | 2 |  | L=221          |                |        |  |  |                |
|                   | 1.6 VVTi (ZZE121)     | 81    | 01.02 | 05.04 |                |        |   |  |                |                |        |  |  |                |
|                   | 1.8 VVTLi TS (ZZE123) | 141   | 01.02 | 05.04 |                |        |   |  |                |                |        |  |  |                |
|                   | 2.0 D-4D (CDE120)     | 66    | 08.02 | 05.04 |                |        |   |  |                |                |        |  |  |                |
|                   | 2.0 D-4D (CDE120)     | 81    | 01.02 | 05.04 |                |        |   |  |                |                |        |  |  |                |
|                   | 2.0 D-4D (CDE120)     | 85    | 05.03 | 05.04 |                |        |   |  |                |                |        |  |  |                |
|                   | 1.4 VVTi (ZZE120)     | 71    | 01.02 | 05.04 | 24.3727-1919.2 | 581919 |   |  | L=398          |                |        |  |  |                |
|                   | 1.6 VVTi (ZZE121)     | 81    | 01.02 | 05.04 |                |        |   |  |                |                |        |  |  |                |
|                   | 2.0 D-4D (CDE120)     | 66    | 01.02 | 05.04 |                |        |   |  |                |                |        |  |  |                |
|                   | 1.4 VVTi (ZZE120)     | 71    | 02.02 | 05.04 |                |        |   |  |                | 24.3727-1919.2 | 581919 |  |  | L=398          |
|                   | 1.6 VVTi (ZZE121)     | 81    | 08.02 | 05.04 |                |        |   |  |                |                |        |  |  |                |
|                   | 1.8 VVTLi TS (ZZE123) | 141   | 01.02 | 05.04 |                |        |   |  |                |                |        |  |  |                |
|                   | 2.0 D-4D (CDE120)     | 66    | 08.02 | 05.04 |                |        |   |  |                |                |        |  |  |                |
|                   | 2.0 D-4D (CDE120)     | 81    | 01.02 | 05.04 |                |        |   |  |                |                |        |  |  |                |
|                   | 2.0 D-4D (CDE120)     | 85    | 05.03 | 05.04 |                |        |   |  |                |                |        |  |  |                |





































<sup>1)</sup> + Europa / + Europa / + Europe / + Europa  
<sup>2)</sup> + Europe/ - GUS States / + Europa/ - Stati del GUS / + Europe/ - Etats de la CEI / + Europa/ - estados del GUS  
<sup>3)</sup> - Europe/ + Coupe / - Europa/ + Coupé / - Europe/ + Coupé / - Europa/ + Coupé  
<sup>4)</sup> + Europe/ + Coupe / + Europa/ + Coupé / + Europe/ + Coupé / + Europa/ + Coupé  
<sup>5)</sup> - Europe / - Europa / - Europe / - Europa  
<sup>6)</sup> + Estate / + Station Wagon / + Break / + Break  
<sup>7)</sup> + RA drum brake / + P freno a tamburo / + frein à tambour essieu AR / + ET-tambores de freno  
<sup>8)</sup> + RA disc brake / + P disco freno / + frein à disque essieu AR / + ET-disco de freno  
<sup>9)</sup> country of manufacture (C) / paese del costruttore (C) / pays du constructeur (C) / país del fabricante (C)  
<sup>10)</sup> country of manufacture (C) / paese del costruttore (C) / pays du constructeur (C) / país del fabricante (C)



|     |    |  |  |  |  |  |  |  |
|--|--|--|--|--|---|--|--|--|
| <b>TOYOTA COROLLA (04-06)</b>  |  |  |  |  |   |  |  |  |
|    | 1.4 D-4D (NDE120)<br>1.4 VVTi (ZZE120)<br>1.6 VVTi (ZZE121)<br>2.0 D-4D (CDE120)   | 66<br>71<br>81<br>85   | 06.04<br>06.04<br>06.04<br>06.04   | 10.06<br>10.06<br>- ESP<br>- ESP   | 24.2120-1749.3  | 010903   |  | Thz 20,64<br><b>LUC</b>  |
|    | 1.4 D-4D (NDE120)<br>1.4 VVTi (ZZE120)<br>1.6 VVTi (ZZE121)<br>1.8 VVTi (ZZE123)<br>2.0 D-4D (CDE120)                      | 66<br>71<br>81<br>141<br>85  | 06.04<br>06.04<br>06.04<br>06.04<br>06.04  | 10.06<br>10.06<br>10.06<br>10.06<br>10.06  | 24.5262-0576.3<br>24.5262-0575.3  | 330923<br>330922   | <input type="checkbox"/><br><input type="checkbox"/>                               | L=575<br>L=575   |
|    | 1.4 D-4D (NDE120)<br>1.4 VVTi (ZZE120)<br>1.6 VVTi (ZZE121)<br>1.8 VVTi (ZZE123)<br>2.0 D-4D (CDE120)                      | 66<br>71<br>81<br>141<br>85  | 06.04<br>06.04<br>06.04<br>06.04<br>06.04  | 10.06<br>10.06<br>10.06<br>10.06<br>10.06  | 24.3341-1703.5<br>24.3341-1704.5  | 240443<br>240444   | <input type="checkbox"/><br><input type="checkbox"/>                               | D=34, - Halter<br>D=34, - Halter   |
|    | 1.4 D-4D (NDE120)<br>1.4 VVTi (ZZE120)<br>1.6 VVTi (ZZE121)<br>1.8 VVTi (ZZE123)<br>2.0 D-4D (CDE120)                      | 66<br>71<br>81<br>141<br>85  | 06.04<br>06.04<br>06.04<br>06.04<br>06.04  | 10.06<br>10.06<br>10.06<br>10.06<br>10.06  | 24.5264-0221.3  | 330995   | 2  | L=221  |
|    | 1.4 D-4D (NDE120)<br>1.4 VVTi (ZZE120)<br>1.6 VVTi (ZZE121)<br>2.0 D-4D (CDE120)<br>1.8 VVTi (ZZE123)                      | 66<br>71<br>81<br>85<br>141  | 06.04<br>06.04<br>06.04<br>06.04<br>06.04  | 10.06<br>10.06<br>10.06<br>10.06<br>10.06  | 24.3727-1919.2<br>24.3727-1928.2<br>24.3727-1929.2                                | 581919<br>581928<br>581929   | <input type="checkbox"/><br><input type="checkbox"/><br><input type="checkbox"/>   | L=398<br>L=1637<br>L=1698  |
|  | 1.8 VVTi (ZZE123)  | 141  | 06.04  | 10.06  | 24.3727-1919.2  | 581919   | <input type="checkbox"/>   | L=398  |
| <b>TOYOTA COROLLA (06-)</b>  |  |  |  |  |   |  |  |  |
|    | 1.33 16V (NRE150)<br>1.4 D-4D (NDE150)<br>1.4 VVTi (ZZE150)<br>1.6 VVTi (ZRE151)<br>1.6 VVTi (ZRE151)<br>2.0 D-4D (ADE150) | 74<br>66<br>71<br>91<br>97<br>93   | 10.08<br>01.09<br>11.06<br>11.06<br>01.09<br>01.07                               | 12.08<br>12.08   | 24.5274-0180.3  | 330941   | 2  | L=180  |
|    | 1.33 16V (NRE150)<br>1.4 VVTi (ZZE150)<br>1.6 VVTi (ZRE151)<br>1.6 VVTi (ZRE151)   | 74<br>71<br>91<br>97   | 10.08<br>11.06<br>11.06<br>01.09   | 12.08<br>12.08   | 24.3727-1936.2<br>24.3727-1935.2  | 581936<br>581935   | <input type="checkbox"/><br><input type="checkbox"/>                               | L=1576<br>L=1585   |
| <b>TOYOTA COROLLA VERSO (02-04)</b>  |  |  |  |  |   |  |  |  |
|   | 1.4 VVTi (ZZE120)<br>1.6 VVTi (ZZE121)<br>2.0 D-4D (CDE120)  | 71<br>81<br>66   | 01.02<br>01.02<br>01.02  | 05.04<br>05.04<br>05.04  | 24.2120-1749.3  | 010903   |  | Thz 20,64<br><b>LUC</b>  |
|  | 1.4 VVTi (ZZE120)<br>1.6 VVTi (ZZE121)<br>2.0 D-4D (CDE120)  | 71<br>81<br>66   | 06.02<br>06.02<br>06.02  | 05.04<br>05.04<br>05.04  | 24.5262-0576.3<br>24.5262-0575.3  | 330923<br>330922   | <input type="checkbox"/><br><input type="checkbox"/>                               | L=575<br>L=575   |
|  | 1.4 VVTi (ZZE120)<br>1.6 VVTi (ZZE121)<br>1.8 VVTi (ZZE122)<br>2.0 D-4D (CDE120)   | 71<br>81<br>99<br>66   | 01.02<br>01.02<br>01.02<br>01.02   | 05.04<br>05.04<br>05.04<br>05.04   | 24.3361-1701.7<br>24.3361-1702.7  | 220717<br>220718   | <input type="checkbox"/><br><input type="checkbox"/>                               | D=36, - Halter<br>D=36, - Halter   |
|  | 1.4 VVTi (ZZE120)<br>1.6 VVTi (ZZE121)<br>1.8 VVTi (ZZE122)<br>2.0 D-4D (CDE120)   | 71<br>81<br>99<br>66   | 01.02<br>01.02<br>01.02<br>01.02   | 05.04<br>05.04<br>05.04<br>05.04   | 24.5264-0221.3  | 330995   | 2  | L=221  |
|  | 1.4 VVTi (ZZE120)<br>1.6 VVTi (ZZE121)<br>1.8 VVTi (ZZE122)<br>2.0 D-4D (CDE120)   | 71<br>81<br>99<br>66   | 01.02<br>01.02<br>01.02<br>01.02   | 05.04<br>05.04<br>05.04<br>05.04   | 24.3727-1917.2<br>24.3727-1926.2<br>24.3727-1927.2                                | 581917<br>581926<br>581927   | <input type="checkbox"/><br><input type="checkbox"/><br><input type="checkbox"/>   | L=408<br>L=1616<br>L=1688  |
| <b>TOYOTA COROLLA VERSO (04-09)</b>  |  |  |  |  |   |  |  |  |
|  | 1.6 VVTi (ZNR10)<br>1.8 VVTi (ZNR11)<br>2.0 D-4D (CUR10)<br>2.2 D-4D (AUR10)<br>2.2 D-4D (AUR10)                           | 81<br>95<br>85<br>100<br>130   | 09.04<br>09.04<br>09.04<br>09.05<br>09.05  | 03.09<br>03.09<br>03.09<br>03.09<br>03.09  | 24.3571-1759.5<br>24.3571-1760.5  | 240459<br>240460   | <input type="checkbox"/><br><input type="checkbox"/>                               | D=57, - Halter<br>D=57, - Halter   |
|  | 1.6 VVTi (ZNR10)<br>1.8 VVTi (ZNR11)<br>2.0 D-4D (CUR10)<br>2.2 D-4D (AUR10)<br>2.2 D-4D (AUR10)                           | 81<br>95<br>85<br>100<br>130   | 05.04<br>05.04<br>05.04<br>09.05<br>09.05  | 03.09<br>03.09<br>03.09<br>03.09<br>03.09  | 24.5262-0576.3<br>24.5262-0575.3  | 330923<br>330922   | <input type="checkbox"/><br><input type="checkbox"/>                               | L=575<br>L=575   |
|  | 1.6 VVTi (ZNR10)<br>1.8 VVTi (ZNR11)<br>2.0 D-4D (CUR10)<br>2.2 D-4D (AUR10)<br>2.2 D-4D (AUR10)                           | 81<br>95<br>85<br>100<br>130   | 05.04<br>05.04<br>05.04<br>09.05<br>09.05  | 03.09<br>03.09<br>03.09<br>03.09<br>03.09  | 24.5275-0200.3  | 330942   | 2  | L=200  |
|  | 1.6 VVTi (ZNR10)<br>1.8 VVTi (ZNR11)<br>2.0 D-4D (CUR10)<br>2.2 D-4D (AUR10)<br>2.2 D-4D (AUR10)                           | 81<br>95<br>85<br>100<br>130   | 05.04<br>05.04<br>05.04<br>09.05<br>09.05  | 03.09<br>03.09<br>03.09<br>03.09<br>03.09  | 24.3727-1939.2<br>24.3727-1940.2  | 581939<br>581940   | <input type="checkbox"/><br><input type="checkbox"/>                               | L=1927<br>L=1984   |
| <b>TOYOTA HIACE (06-)</b>  |  |  |  |  |   |  |  |  |
|  | 2.5 D-4D<br>2.5 D-4D   | 70<br>86   | 09.06<br>09.06   |  | 24.5265-0263.3<br>24.5265-0264.3  | 331157<br>331158   | <input type="checkbox"/><br><input type="checkbox"/>                               | L=263<br>L=263   |



|     |              |  |  |  |  |  |  |    |
|--|--|--|--|--|---|--|--|--|
| <b>TOYOTA HILUX (97-05)</b>  |  |  |  |  |   |  |  |  |
|    | 2.4 i 4WD<br>2.4 i 4WD<br>2.4 TD 4WD<br>2.5 D-4D 4WD   | 88<br>103<br>66<br>75  |  | 08.97<br>08.97<br>08.97<br>11.01   | 07.01<br>07.01<br>01.02<br>07.05  | 24.3222-1730.3   | 020533   | Rz 22,20   |
| <b>TOYOTA HILUX (05-)</b>  |  |  |  |  |   |  |  |  |
|    | 2.5 D-4D 4x4 (KUN25)<br>2.5 D-4D 4x4 (KUN25)<br>2.5 D-4D 4x4 (KUN25)<br>3.0 D-4D 4x4 (KUN26) | 75<br>88<br>106<br>126   |  | 08.05<br>12.07<br>12.07<br>12.07   |   | 24.5235-0275.3   | 331179   | 2<br>L=275   |
| <b>TOYOTA IQ (09-)</b>   |  |  |  |  |   |  |  |  |
|    | 1.0 i 12V<br>1.33<br>1.33<br>1.4 D-4D  | 50<br>69<br>72<br>66   |  | 01.09<br>01.09<br>01.09<br>01.09   | - ABS<br>- ABS<br>- ABS<br>- ABS  | 24.3217-1721.3<br>24.3217-1722.3   | 020489<br>020490   | <input type="checkbox"/><br><input type="checkbox"/><br><input type="checkbox"/><br><input type="checkbox"/><br>Rz 17,46<br>Rz 17,46 |
| <b>TOYOTA LAND CRUISER 100 (98-08)</b>   |  |  |  |  |   |  |  |  |
|    | 4.2 TDi (HDJ100)<br>4.7 V8 (UZJ100)<br>4.7 V8 (UZJ100)                                       | 150<br>173<br>175  |  | 01.98<br>01.98<br>05.02  | 07.08<br>04.02<br>07.08   | 24.5235-0360.3   | 331058   | 1 <input type="checkbox"/> + ABS<br>L=360  |
| <b>TOYOTA PASEO (95-99)</b>  |  |  |  |  |   |  |  |  |
|    | 1.5 i 16V (EL54)<br>1.5 i 16V (EL54)   | 66<br>66   |  | 08.95<br>01.98   | 12.97<br>12.99  | 24.3727-1913.2   | 581913   | <input type="checkbox"/><br><input type="checkbox"/><br>L=258<br>L=258   |
| <b>TOYOTA PICNIC (96-01)</b>   |  |  |  |  |   |  |  |  |
|    | 2.0 i 16V (SXM10)<br>2.2 TD (CXM10)  | 66   |  | 09.96<br>09.97   | 12.01<br>04.01  | 24.5264-0526.3<br>24.5264-0525.3   | 330927<br>330926   | <input type="checkbox"/><br><input type="checkbox"/><br>L=525<br>L=525   |
|    | 2.0 i 16V (SXM10)<br>2.2 TD (CXM10)  | 66   |  | 09.96<br>09.97   | 12.01<br>04.01  | 24.5235-0190.3   | 330916   | 2<br>L=190   |
| <b>TOYOTA PREVIA (00-05)</b>   |  |  |  |  |   |  |  |  |
|    | 2.0 D-4D (CLR30)<br>2.4 VVTi (ACR30)   | 85<br>115  |  | 03.01<br>08.00   | 12.05<br>12.05  | 24.3431-1708.7   | 220936   | <input type="checkbox"/><br>D=43, - Halter <b>LUC</b>  |
| <b>TOYOTA PRIUS (03-09)</b>  |  |  |  |  |   |  |  |  |
|  | 1.5 VVTi (NHW20)   | 57   |  | 08.03  | 03.09   | 24.3361-1701.7<br>24.3361-1702.7   | 220717<br>220718   | <input type="checkbox"/><br><input type="checkbox"/><br>D=36, - Halter<br>D=36, - Halter   |
|  | 1.5 VVTi (NHW20)   | 57   |  | 08.03  | 03.09   | 24.5264-0205.3   | 331059   | 2<br>L=205   |
| <b>TOYOTA RAV4 I (94-00)</b>   |  |  |  |  |   |  |  |  |
|  | 2.0 i 16V (SXA10)<br>2.0 i 16V (SXA10/11)  | 94<br>95   |  | 12.97<br>04.94   | 06.00<br>06.00  | 24.3727-1913.2   | 581913   | <input type="checkbox"/><br>L=258  |
| <b>TOYOTA RAV4 II (00-05)</b>  |  |  |  |  |   |  |  |  |
|  | 1.8 VVTi<br>2.0 D-4D 4WD<br>2.0 VVTi 4WD<br>2.4 VVTi 4x4                                     | 92<br>85<br>110<br>112   |  | 02.01<br>09.01<br>06.00<br>08.03   | 10.05<br>10.05<br>10.05<br>10.05  | 24.5265-0558.3<br>24.5265-0557.3   | 330929<br>330928   | <input type="checkbox"/><br><input type="checkbox"/><br>L=558<br>L=557   |
|  | 1.8 VVTi<br>2.0 D-4D 4WD<br>2.0 VVTi 4WD<br>2.4 VVTi 4x4                                     | 92<br>85<br>110<br>112   |  | 02.01<br>09.01<br>06.00<br>08.03   | 10.05<br>10.05<br>10.05<br>10.05  | 24.5296-0280.3<br>24.5296-0281.3   | 331034<br>331035   | <input type="checkbox"/><br><input type="checkbox"/><br>L=280<br>L=280   |
|  | 1.8 VVTi<br>2.0 D-4D 4WD<br>2.0 VVTi 4WD<br>2.4 VVTi 4x4                                     | 92<br>85<br>110<br>112   |  | 02.01<br>09.01<br>06.00<br>08.03   | 10.05<br>10.05<br>10.05<br>10.05  | 24.3219-1754.3   | 020507   | - ABS<br>- ABS<br>- ABS<br>- ABS<br>Rz 19,05   |
|  | 1.8 VVTi<br>2.0 D-4D 4WD<br>2.0 VVTi 4WD<br>2.4 VVTi 4x4                                     | 92<br>85<br>110<br>112   |  | 02.01<br>09.01<br>06.00<br>08.03   | 10.05<br>10.05<br>10.05<br>10.05  | 24.3727-1917.2<br>24.3727-1924.2<br>24.3727-1925.2                                 | 581917<br>581924<br>581925   | <input type="checkbox"/><br><input type="checkbox"/><br><input type="checkbox"/><br>L=408<br>L=1307<br>L=1307                        |
|  | 1.8 VVTi<br>2.0 D-4D 4WD<br>2.0 VVTi 4WD<br>2.4 VVTi 4x4                                     | 92<br>85<br>110<br>112   |  | 02.01<br>09.01<br>06.00<br>08.03   | 10.05<br>10.05<br>10.05<br>10.05  | 24.3727-1917.2   | 581917   | + ABS<br>+ ABS<br>+ ABS<br>+ ABS<br>L=408  |
| <b>TOYOTA STARLET (96-99)</b>  |  |  |  |  |   |  |  |  |
|  | 1.3 i 16V (EP91)   | 55   |  | 01.96  | 07.99   | 24.3727-1913.2   | 581913   | <input type="checkbox"/><br>L=258  |

| TOYOTA VERSO (09-)   |  | TOYOTA VERSO S (10-)   |  | TOYOTA YARIS (99-05)   |   | TOYOTA YARIS (06-)   |   |  |                      |     |
|--|--|--|--|--|---|--|---|--|----------------------|-----|
|     |  |  |  |  |  |  |     |  |                      |     |
| <b>TOYOTA VERSO (09-)</b>  |  | <b>TOYOTA VERSO S (10-)</b>  |  | <b>TOYOTA YARIS (99-05)</b>  |   | <b>TOYOTA YARIS (06-)</b>  |   |  |                      |     |
|    | 1.6 16V  | 81   | 02.09  |  | 24.5262-0180.3  | 331180   | 2   |  | L=180                |     |
|  | 1.6 16V  | 97   | 02.09  |  |   |  |   |  |                      |     |
|  | 1.8 16V  | 95   | 02.09  |  |   |  |   |  |                      |     |
|  | 1.8 16V  | 108  | 02.09  |  |   |  |   |  |                      |     |
|  | 2.0 D-4D   | 93   | 02.09  |  |   |  |   |  |                      |     |
|  | 2.2 D-4D   | 100  | 02.09  |  |   |  |   |  |                      |     |
|  | 2.2 D-4D   | 110  | 02.09  |  |   |  |   |  |                      |     |
|  | 2.2 D-CAT  | 130  | 02.09  |  |   |  |   |  |                      |     |
| <b>TOYOTA VERSO S (10-)</b>  |  | <b>TOYOTA YARIS (99-05)</b>  |  | <b>TOYOTA YARIS (06-)</b>  |   | <b>TOYOTA YARIS (06-)</b>  |   | <b>TOYOTA YARIS (06-)</b>  |                      |     |
|    | 1.33   | 70   | 11.10  |  | 24.5235-0200.3  | 331280   |   |  | L=198                |     |
|  | 1.33   | 73   | 11.10  |  |   |  |   |  |                      |     |
|  | 1.4 D4-D   | 66   | 11.10  |  |   |  |   |  |                      |     |
|    | 1.0 i 16V  | 48   | 04.03  | 08.05 + HA-Scheibenbremse 1)   | 24.3511-1711.5  | 240379   |    |  | D=51, - Halter       |     |
|  | 1.0 i 16V  | 50   | 08.99  | 03.03 + HA-Scheibenbremse 1)   | 24.3511-1712.5  | 240380   |    |  | D=51, - Halter       |     |
|  | 1.3 i 16V  | 63   | 09.99  | 10.04 + HA-Scheibenbremse 1)   |   |  |   |  |                      |     |
|  | 1.3 i 16V  | 64   | 04.02  | 03.03 + HA-Scheibenbremse 1)   |   |  |   |  |                      |     |
|  | 1.4 D-4D   | 55   | 12.01  | 08.05 + HA-Scheibenbremse 1)   |   |  |   |  |                      |     |
|  | 1.5 VVTi Sport   | 77   | 01.03  | 08.05 + HA-Scheibenbremse 1)   |   |  |   |  |                      |     |
|  | 1.5 VVTi Sport   | 78   | 04.01  | 03.03 + HA-Scheibenbremse 1)   |   |  |   |  |                      |     |
|  | 1.5 VVTi Turbo Sport   | 110  | 04.03  | 10.04 + HA-Scheibenbremse 1)   |   |  |   |  |                      |     |
|    | 1.0 i 16V  | 48   | 04.03  | 08.05  | 24.5277-0531.3  | 331003   |    | Herst.Land (C) 2)  | L=530                |     |
|  | 1.0 i 16V  | 50   | 03.99  | 03.03  | 24.5277-0530.3  | 331002   |    | Herst.Land (C) 2)  | L=530                |     |
|  | 1.3 i 16V  | 63   | 09.99  | 10.04  |   |  |   |  |                      |     |
|  | 1.3 i 16V  | 64   | 04.02  | 08.05  |   |  |   |  |                      |     |
|  | 1.4 D-4D   | 55   | 12.01  | 08.05  |   |  |   |  |                      |     |
|  | 1.5 VVTi Sport   | 77   | 01.03  | 08.05  |   |  |   |  |                      |     |
|  | 1.5 VVTi Sport   | 78   | 04.01  | 03.03  |   |  |   |  |                      |     |
|  | 1.5 VVTi Turbo Sport   | 110  | 04.03  | 10.04  |   |  |   |  |                      |     |
|    | 1.0 i 16V  | 48   | 04.03  | 08.05  | 24.5261-0291.3  | 330994   | 2   | Herst.Land (C) 2)  | L=291                |     |
|  | 1.0 i 16V  | 50   | 03.99  | 03.03  |   |  |   |  |                      |     |
|  | 1.3 i 16V  | 63   | 05.00  | 10.04  | 24.5263-0440.3  | 331282   |    |  | L=440                |     |
|  |  |  |  |  | 24.5263-0441.3  | 331283   |    |  | L=440                |     |
|  | 1.0 i 16V  | 48   | 04.03  | 08.05 + ABS  | 24.5263-0592.3  | 331284   |    | Herst.Land (C) 3)  | L=325/290            |     |
|  | 1.0 i 16V  | 50   | 03.99  | 03.03 + ABS  | 24.5263-0593.3  | 331285   |    | Herst.Land (C) 3)  | L=325/290            |     |
|  | 1.3 i 16V  | 64   | 04.02  | 08.05 + ABS  |   |  |   |  |                      |     |
|  | 1.4 D-4D   | 55   | 12.01  | 08.05 + ABS  |   |  |   |  |                      |     |
|  | 1.4 D-4D   | 55   | 12.01  | 08.05 Herst.Land (C) 2)  | 24.5263-0594.3  | 331286   |    |  | L=325/290            |     |
|  | 1.5 VVTi Sport   | 77   | 01.03  | 08.05  | 24.5263-0595.3  | 331287   |    |  | L=325/290            |     |
|  | 1.5 VVTi Sport   | 78   | 04.01  | 03.03  |   |  |   |  |                      |     |
|  | 1.5 VVTi Turbo Sport   | 110  | 04.03  | 10.04  |   |  |   |  |                      |     |
|  | 1.0 i 16V  | 50   | 08.99  | 03.03 - ABS  | 24.3217-1721.3  | 020489   |  | Herst.Land (C) 2)  | Rz 17,46             |     |
|  | 1.3 i 16V  | 63   | 09.99  | 10.04 - ABS  | 24.3217-1722.3  | 020490   |  | Herst.Land (C) 2)  | Rz 17,46             |     |
|  | 1.4 D-4D   | 55   | 12.01  | 08.05 - ABS  |   |  |   |  |                      |     |
|  | 1.0 i 16V  | 48   | 04.03  | 08.05 - ABS  | 24.3219-1744.3  | 020488   |   | Herst.Land (C) 3)  | Rz 19,05             |     |
|  | 1.0 i 16V  | 50   | 03.99  | 03.03 - ABS  |   |  |   |  |                      |     |
|  | 1.3 i 16V  | 64   | 04.02  | 08.05 - ABS  |   |  |   |  |                      |     |
|  | 1.4 D-4D   | 55   | 12.01  | 08.05 - ABS  |   |  |   |  |                      |     |
|  | 1.0 i 16V  | 50   | 03.99  | 07.99 + HA-Trommelbremse 4)  | 24.3727-1909.2  | 581909   |  |  | L=1543               |     |
|  | 1.3 i 16V  | 63   | 09.99  | 10.04 + HA-Trommelbremse 4)  | 24.3727-1903.2  | 581903   |  |  | L=1503               |     |
|  | 1.4 D-4D   | 55   | 12.01  | 03.03 + HA-Trommelbremse 4)  |   |  |   |  |                      |     |
|  | 1.0 i 16V  | 48   | 04.03  | 08.05 + HA-Trommelbremse 4)  | 24.3727-1921.2  | 581921   |  |  | L=1580               |     |
|  | 1.0 i 16V  | 50   | 08.99  | 03.03 + HA-Trommelbremse 4)  | 24.3727-1920.2  | 581920   |  |  | L=1553               |     |
|  | 1.3 i 16V  | 64   | 04.02  | 08.05 + HA-Trommelbremse 4)  |   |  |   |  |                      |     |
|  | 1.4 D-4D   | 55   | 04.03  | 08.05 + HA-Trommelbremse 4)  |   |  |   |  |                      |     |
|  | 1.0 i 16V  | 48   | 04.03  | 08.05 + HA-Scheibenbremse 1)   | 24.3727-1911.2  | 581911   |  |  | L=1520               |     |
|  | 1.0 i 16V  | 50   | 08.99  | 03.03 + HA-Scheibenbremse 1)   | 24.3727-1912.2  | 581912   |  |  | L=1475               |     |
|  | 1.3 i 16V  | 63   | 09.99  | 10.04 + HA-Scheibenbremse 1)   |   |  |   |  |                      |     |
|  | 1.3 i 16V  | 64   | 04.02  | 08.05 + HA-Scheibenbremse 1)   |   |  |   |  |                      |     |
|  | 1.4 D-4D   | 55   | 12.01  | 08.05 + HA-Scheibenbremse 1)   |   |  |   |  |                      |     |
|  | 1.5 VVTi Sport   | 77   | 01.03  | 08.05 + HA-Scheibenbremse 1)   |   |  |   |  |                      |     |
|  | 1.5 VVTi Sport   | 78   | 04.01  | 03.03 + HA-Scheibenbremse 1)   |   |  |   |  |                      |     |
|  | 1.5 VVTi Turbo Sport   | 110  | 04.03  | 10.04 + HA-Scheibenbremse 1)   |   |  |   |  |                      |     |
| <b>TOYOTA YARIS (06-)</b>  |  | <b>TOYOTA YARIS (06-)</b>  |  | <b>TOYOTA YARIS (06-)</b>  |   | <b>TOYOTA YARIS (06-)</b>  |   | <b>TOYOTA YARIS (06-)</b>  |                      |     |
|  | 1.0 GPL  | 51   | 01.06  | Herst.Land (C) 3)  | 03.7853-3203.4  | 300241   |   | - ESP  | 9"                   | ATE |
|  | 1.0 VVT-i  | 51   | 01.06  | Herst.Land (C) 3)  |   |  |   |  |                      |     |
|  | 1.3 VVT-i  | 63   | 01.06  |  |   |  |   |  |                      |     |
|  | 1.3 VVT-i  | 64   | 01.06  |  |   |  |   |  |                      |     |
|  | 1.33 VVT-i   | 74   | 03.09  |  |   |  |   |  |                      |     |
|  | 1.4 D-4D   | 66   | 01.06  |  | 03.7853-3402.4  | 300256   |   | - ESP  | 9"                   | ATE |
|  | 1.0 GPL  | 51   | 01.06  | Herst.Land (C) 3)  | 03.7750-7132.4  | 300255   |   | + ESP  | 9"                   | ATE |
|  | 1.0 VVT-i  | 51   | 01.06  | Herst.Land (C) 3)  |   |  |   |  |                      |     |
|  | 1.3 VVT-i  | 63   | 01.06  |  |   |  |   |  |                      |     |
|  | 1.3 VVT-i  | 64   | 01.06  |  |   |  |   |  |                      |     |
|  | 1.33 VVT-i   | 74   | 03.09  |  |   |  |   |  |                      |     |
|  | 1.4 D-4D   | 66   | 01.06  |  |   |  |   |  |                      |     |
|  | 1.0 GPL  | 51   | 01.06  | Herst.Land (C) 3)  | 03.4152-0053.3  | 010884   |   | - ESP  | THz 22,20 - Behälter | ATE |
|  | 1.0 VVT-i  | 51   | 01.06  | Herst.Land (C) 3)  | 03.4152-0058.3  | 010885   |   | + ESP  | THz 22,20 - Behälter | ATE |
|  | 1.3 VVT-i  | 63   | 01.06  |  |   |  |   |  |                      |     |
|  | 1.3 VVT-i  | 64   | 01.06  |  |   |  |   |  |                      |     |
|  | 1.33 VVT-i   | 74   | 03.09  |  |   |  |   |  |                      |     |
|  | 1.4 D-4D   | 66   | 01.06  |  |   |  |   |  |                      |     |

1) + RA disc brake / + P disco freno / + frein à disque essieu AR / + ET-disco de freno  
2) country of manufacture (C) / paese del costruttore (C) / pays du constructeur (C) / país del fabricante (C)  
3) country of manufacture (C) / paese del costruttore (C) / pays du constructeur (C) / país del fabricante (C)  
4) + RA drum brake / + P freno a tamburo / + frein à tambour essieu AR / + ET-tambores de freno



| <b>TOYOTA YARIS (06-)</b>         |                |    |  |       |                   |                |        |  |  |                                 |
|-----------------------------------|----------------|----|--|-------|-------------------|----------------|--------|--|--|---------------------------------|
|                                   | 1.0 GPL        | 51 |  | 01.06 |                   | 11.9541-9569.2 | 220725 | <input type="checkbox"/> Herst.Land (F) 1)<br><input type="checkbox"/> Herst.Land (F) 1) | D=54, - Halter<br>D=54, - Halter<br>Hülsensatz<br>Führungsbolzen<br>Haltefeder | ATE<br>ATE<br>ATE<br>ATE<br>ATE |
|                                   | 1.0 VVT-i      | 51 |  | 01.06 |                   | 11.9541-9570.2 | 220726 |  |  |                                 |
|                                   | 1.3 VVT-i      | 63 |  | 01.06 |                   | 11.0101-5407.2 | 260011 |  |  |                                 |
|                                   | 1.3 VVT-i      | 64 |  | 01.06 |                   | 11.8171-0008.1 | 990049 |  |  |                                 |
|                                   | 1.33 VVT-i     | 74 |  | 03.09 |                   | 11.8116-0264.1 | 390594 |  |  |                                 |
|                                   | 1.4 D-4D       | 66 |  | 01.06 |                   |                |        |  |  |                                 |
|                                   | 1.0 GPL        | 51 |  | 01.06 |                   | 24.5286-0488.3 | 331221 | <input type="checkbox"/> Herst.Land (F) 1)<br><input type="checkbox"/> Herst.Land (F) 1) | L=488<br>L=488   |                                 |
|                                   | 1.0 VVT-i      | 51 |  | 01.06 |                   | 24.5286-0489.3 | 331222 |  |  |                                 |
|                                   | 1.3 VVT-i      | 63 |  | 01.06 |                   |                |        |  |  |                                 |
|                                   | 1.3 VVT-i      | 64 |  | 01.06 |                   |                |        |  |  |                                 |
|                                   | 1.33 VVT-i     | 74 |  | 03.09 |                   |                |        |  |  |                                 |
|                                   | 1.4 D-4D       | 66 |  | 01.06 |                   |                |        |  |  |                                 |
|                                   | 1.0 GPL        | 51 |  | 01.06 | + ABS             | 11.9347-7005.2 | 220643 | <input type="checkbox"/> Herst.Land (F) 1)<br><input type="checkbox"/> Herst.Land (F) 1) | D=34, - Halter<br>D=34, - Halter<br>Hülsensatz<br>Führungsbolzen<br>Haltefeder | ATE<br>ATE<br>ATE<br>ATE<br>ATE |
|                                   | 1.0 VVT-i      | 51 |  | 01.06 | + ABS             | 11.9347-7006.2 | 220644 |  |  |                                 |
|                                   | 1.3 VVT-i      | 63 |  | 01.06 | + ABS             | 11.0101-5407.2 | 260011 |  |  |                                 |
|                                   | 1.3 VVT-i      | 64 |  | 01.06 | + ABS             | 11.8171-0008.1 | 990049 |  |  |                                 |
|                                   | 1.33 VVT-i     | 74 |  | 03.09 | + ABS             | 11.8116-0340.1 | 390595 |  |  |                                 |
|                                   | 1.4 D-4D       | 66 |  | 01.06 | + ABS             |                |        |  |  |                                 |
|                                   | 1.0 GPL        | 51 |  | 01.06 |                   | 24.5235-0200.3 | 331280 | <input type="checkbox"/> Herst.Land (D) 2)   | L=198  |                                 |
|                                   | 1.0 VVT-i      | 51 |  | 01.06 |                   |                |        |  |  |                                 |
|                                   | 1.8 VVT-i      | 98 |  | 01.07 |                   |                |        |  |  |                                 |
|                                   | 1.0 GPL        | 51 |  | 01.06 |                   | 24.5261-0195.3 | 331077 | <input type="checkbox"/> Herst.Land (F) 1)<br><input type="checkbox"/> Herst.Land (F) 1) | L=195<br>L=255   |                                 |
|                                   | 1.0 VVT-i      | 51 |  | 01.06 |                   | 24.5261-0255.3 | 331078 |  |  |                                 |
|                                   | 1.3 VVT-i      | 63 |  | 01.06 |                   |                |        |  |  |                                 |
|                                   | 1.3 VVT-i      | 64 |  | 01.06 |                   |                |        |  |  |                                 |
|                                   | 1.33 VVT-i     | 74 |  | 03.09 |                   |                |        |  |  |                                 |
|                                   | 1.4 D-4D       | 66 |  | 01.06 |                   |                |        |  |  |                                 |
|                                   | 1.0 GPL        | 51 |  | 01.06 | - ABS             | 24.3220-1728.3 | 020509 | <input type="checkbox"/> Herst.Land (F) 1)   | Rz 20,64   |                                 |
|                                   | 1.0 VVT-i      | 51 |  | 01.06 | - ABS             |                |        |  |  |                                 |
|                                   | 1.3 VVT-i      | 63 |  | 01.06 | - ABS             |                |        |  |  |                                 |
|                                   | 1.3 VVT-i      | 64 |  | 01.06 | - ABS             |                |        |  |  |                                 |
|                                   | 1.33 VVT-i     | 74 |  | 03.09 | - ABS             |                |        |  |  |                                 |
|                                   | 1.4 D-4D       | 66 |  | 01.06 | - ABS             |                |        |  |  |                                 |
|                                   | 1.0 GPL        | 51 |  | 01.06 | - ABS             | 24.3727-1937.2 | 581937 | <input type="checkbox"/> Herst.Land (F) 1)<br><input type="checkbox"/> Herst.Land (F) 1) | L=1555<br>L=1600   |                                 |
|                                   | 1.0 VVT-i      | 51 |  | 01.06 | - ABS             | 24.3727-1938.2 | 581938 |  |  |                                 |
|                                   | 1.3 VVT-i      | 63 |  | 01.06 | - ABS             |                |        |  |  |                                 |
|                                   | 1.3 VVT-i      | 64 |  | 01.06 | - ABS             |                |        |  |  |                                 |
|                                   | 1.33 VVT-i     | 74 |  | 03.09 | - ABS             |                |        |  |  |                                 |
|                                   | 1.4 D-4D       | 66 |  | 01.06 | - ABS             |                |        |  |  |                                 |
| <b>TOYOTA YARIS (11-)</b>         |                |    |  |       |                   |                |        |  |  |                                 |
|                                   | 1.0 VVTi       | 51 |  | 09.11 | Herst.Land (F) 1) | 11.9541-9569.2 | 220725 | <input type="checkbox"/>   | D=54, - Halter<br>D=54, - Halter   | ATE<br>ATE                      |
|                                   | 1.3 VVTi       | 63 |  | 01.11 | Herst.Land (F) 1) | 11.9541-9570.2 | 220726 |  |  |                                 |
|                                   | 1.3 VVTi       | 70 |  | 09.11 | Herst.Land (F) 1) |                |        |  |  |                                 |
|                                   | 1.3 VVTi       | 73 |  | 09.11 | Herst.Land (F) 1) |                |        |  |  |                                 |
|                                   | 1.3 VVTi 4WD   | 70 |  | 09.11 | Herst.Land (F) 1) |                |        |  |  |                                 |
|                                   | 1.4 D-4D       | 66 |  | 09.11 | Herst.Land (F) 1) |                |        |  |  |                                 |
|                                   | 1.0 VVTi       | 51 |  | 09.11 | Herst.Land (F) 1) | 11.9347-7005.2 | 220643 | <input type="checkbox"/> + ESP<br><input type="checkbox"/> + ESP                         | D=34, - Halter<br>D=34, - Halter   | ATE<br>ATE                      |
|                                   | 1.3 VVTi       | 63 |  | 01.11 | Herst.Land (F) 1) | 11.9347-7006.2 | 220644 |  |  |                                 |
|                                   | 1.3 VVTi       | 70 |  | 09.11 | Herst.Land (F) 1) |                |        |  |  |                                 |
|                                   | 1.3 VVTi       | 73 |  | 09.11 | Herst.Land (F) 1) |                |        |  |  |                                 |
|                                   | 1.3 VVTi 4WD   | 70 |  | 09.11 | Herst.Land (F) 1) |                |        |  |  |                                 |
|                                   | 1.4 D-4D       | 66 |  | 09.11 | Herst.Land (F) 1) |                |        |  |  |                                 |
|                                   | 1.0 VVTi       | 51 |  | 09.11 | Herst.Land (D) 2) | 24.5235-0200.3 | 331280 | <input type="checkbox"/>   | L=198  |                                 |
|                                   | 1.3 VVTi       | 63 |  | 01.11 | Herst.Land (D) 2) |                |        |  |  |                                 |
|                                   | 1.3 VVTi       | 70 |  | 09.11 | Herst.Land (D) 2) |                |        |  |  |                                 |
|                                   | 1.3 VVTi       | 73 |  | 09.11 | Herst.Land (D) 2) |                |        |  |  |                                 |
|                                   | 1.3 VVTi 4WD   | 70 |  | 09.11 | Herst.Land (D) 2) |                |        |  |  |                                 |
|                                   |                |    |  | 09.11 | Herst.Land (D) 2) |                |        |  |  |                                 |
| <b>TOYOTA YARIS VERSO (99-05)</b> |                |    |  |       |                   |                |        |  |  |                                 |
|                                   | 1.3 i 16V      | 62 |  | 01.03 | 09.05             | 24.3511-1711.5 | 240379 | <input type="checkbox"/>   | D=51, - Halter<br>D=51, - Halter   |                                 |
|                                   | 1.3 i 16V      | 63 |  | 11.99 | 03.03             | 24.3511-1712.5 | 240380 |  |  |                                 |
|                                   | 1.4 D-4D       | 55 |  | 12.01 | 09.05             |                |        |  |  |                                 |
|                                   | 1.5 VVTi       | 77 |  | 05.03 | 09.05             |                |        |  |  |                                 |
|                                   | 1.5 VVTi Sport | 78 |  | 03.00 | 03.03             |                |        |  |  |                                 |
|                                   |                |    |  | 03.00 | 03.03             |                |        |  |  |                                 |
|                                   | 1.3 i 16V      | 62 |  | 01.03 | 09.05             | 24.5277-0531.3 | 331003 | <input type="checkbox"/>   | L=530<br>L=530   |                                 |
|                                   | 1.3 i 16V      | 63 |  | 11.99 | 03.03             | 24.5277-0530.3 | 331002 |  |  |                                 |
|                                   | 1.4 D-4D       | 55 |  | 12.01 | 09.05             |                |        |  |  |                                 |
|                                   | 1.5 VVTi       | 77 |  | 05.03 | 09.05             |                |        |  |  |                                 |
|                                   | 1.5 VVTi Sport | 78 |  | 03.00 | 03.03             |                |        |  |  |                                 |
|                                   |                |    |  | 03.00 | 03.03             |                |        |  |  |                                 |
|                                   | 1.3 i 16V      | 63 |  | 11.99 | 02.01             | 24.3321-1701.7 | 220715 | <input type="checkbox"/> + ABS<br><input type="checkbox"/> + ABS                         | D=32, - Halter<br>D=32, - Halter   |                                 |
|                                   | 1.5 VVTi Sport | 78 |  | 03.00 | 02.01             | 24.3321-1702.7 | 220716 |  |  |                                 |
|                                   | 1.3 i 16V      | 62 |  | 01.03 | 09.05             | 24.5261-0291.3 | 330994 | <input type="checkbox"/>   | L=291  |                                 |
|                                   | 1.3 i 16V      | 63 |  | 11.99 | 03.03             |                |        |  |  |                                 |
|                                   | 1.4 D-4D       | 55 |  | 12.01 | 09.05             |                |        |  |  |                                 |
|                                   | 1.5 VVTi       | 77 |  | 05.03 | 09.05             |                |        |  |  |                                 |
|                                   | 1.5 VVTi Sport | 78 |  | 03.00 | 03.03             |                |        |  |  |                                 |
|                                   |                |    |  | 03.00 | 03.03             |                |        |  |  |                                 |
|                                   | 1.3 i 16V      | 62 |  | 01.03 | 09.05             | 24.3217-1721.3 | 020489 | <input type="checkbox"/>   | Rz 17,46<br>Rz 17,46   |                                 |
|                                   | 1.3 i 16V      | 63 |  | 11.99 | 03.03             | 24.3217-1722.3 | 020490 |  |  |                                 |
|                                   | 1.3 i 16V      | 62 |  | 01.03 | 09.05             | 24.3219-1749.3 | 020500 |  |  |                                 |
|                                   | 1.3 i 16V      | 63 |  | 11.99 | 03.03             | 24.3219-1750.3 | 020501 |  |  |                                 |
|                                   | 1.3 i 16V      | 62 |  | 12.01 | 09.05             |                |        | <input type="checkbox"/>   | Rz 19,05<br>Rz 19,05   |                                 |
|                                   | 1.4 D-4D       | 55 |  | 12.01 | 09.05             |                |        |  |  |                                 |

1) country of manufacture (P) / paese del costruttore (P) / pays du constructeur (P) / país del fabricante (P)  
 2) country of manufacture (D) / paese del costruttore (D) / pays du constructeur (D) / país del fabricante (D)  
 3) - ABS/ + autom.transmission / - ABS/ + scatola cambio autom. / - ABS/ + transmission automatique / - ABS/ + cambio automático  
 4) - ABS/ + manual transmission / - ABS/ + scatola camb.velocità / - ABS/ + transmission mécanique / - ABS/ + cambio de velocidad

| TOYOTA YARIS VERSO (99-05) |                 | 05.03 |             | 09.05       |                                       | 24.3219-1749.3 |        | 020500                   |  | Rz 19,05 |           |
|----------------------------|-----------------|-------|-------------|-------------|---------------------------------------|----------------|--------|--------------------------|--|----------|-----------|
|                            | 1.5 VVTi        | 77    | 05.03       | 09.05       | - ABS                                 | 24.3219-1749.3 | 020500 | <input type="checkbox"/> |  |          | Rz 19,05  |
|                            | 1.5 VVTi Sport  | 78    | 03.00       | 03.03       | - ABS                                 | 24.3219-1750.3 | 020501 | <input type="checkbox"/> |  |          | Rz 19,05  |
|                            | 1.3 i 16V       | 62    | 01.03       | 09.05       | - ABS/ + Schaltgetriebe <sup>1)</sup> | 24.3727-1909.2 | 581909 | <input type="checkbox"/> |  |          | L=1543    |
|                            | 1.3 i 16V       | 63    | 11.99       | 03.03       | - ABS/ + Schaltgetriebe <sup>1)</sup> | 24.3727-1903.2 | 581903 | <input type="checkbox"/> |  |          | L=1503    |
|                            | 1.4 D-4D        | 55    | 12.01       | 09.05       | - ABS                                 |                |        |                          |  |          |           |
|                            | 1.5 VVTi        | 77    | 05.03       | 09.05       | - ABS                                 |                |        |                          |  |          |           |
|                            | 1.5 VVTi Sport  | 78    | 03.00       | 03.03       | - ABS                                 |                |        |                          |  |          |           |
| VOLKSWAGEN BORA (98-04)    |                 | 09.98 |             | 08.00       |                                       | 03.7863-0402.4 |        | 300124                   |  | 10" ATE  |           |
|                            | 1.4 16V         | 92    | 09.98       | 08.00       | + ESP                                 | 03.7863-0402.4 | 300124 |                          |  |          | 10" ATE   |
|                            | 1.6             | 92    | 09.98       | 08.00       | + ESP                                 |                |        |                          |  |          |           |
|                            | 1.6 16V         | 92    | 02.00       | 08.00       | + ESP                                 |                |        |                          |  |          |           |
|                            | 1.8             | 92    | 09.98       | 08.00       | + ESP                                 |                |        |                          |  |          |           |
|                            | 1.8 4motion     | 92    | 02.99       | 08.00       | + ESP                                 |                |        |                          |  |          |           |
|                            | 1.9 SDI         | 66    | 09.98       | 08.00       | + ESP                                 |                |        |                          |  |          |           |
|                            | 1.9 TDI         | 66    | 09.98       | 08.00       | + ESP                                 |                |        |                          |  |          |           |
|                            | 1.9 TDI         | 81    | 09.98       | 08.00       | + ESP                                 |                |        |                          |  |          |           |
|                            | 1.9 TDI         | 85    | 02.99       | 08.00       | + ESP                                 |                |        |                          |  |          |           |
|                            | 1.9 TDI 4motion | 66    | 02.99       | 08.00       | + ESP                                 |                |        |                          |  |          |           |
|                            | 1.9 TDI 4motion | 85    | 02.99       | 08.00       | + ESP                                 |                |        |                          |  |          |           |
|                            | 2.0             | 85    | 09.98       | 08.00       | + ESP                                 |                |        |                          |  |          |           |
|                            | 2.3 V5          | 92    | 09.98       | 08.00       | + ESP                                 |                |        |                          |  |          |           |
|                            | 2.3 V5 4motion  | 92    | 02.99       | 08.00       | + ESP                                 |                |        |                          |  |          |           |
|                            | 2.8 V6 4motion  | 150   | 05.99       | 08.00       | + ESP                                 |                |        |                          |  |          |           |
|                            | 1.4 16V         | 92    | 1J-2-373846 | 09.00       | + ESP                                 | 03.7860-0602.4 | 300141 |                          |  |          | 10" ATE   |
|                            | 1.6             | 92    | 1J-2-373846 | 09.00       | + ESP                                 |                |        |                          |  |          |           |
|                            | 1.6 16V         | 92    | 1J-2-373846 | 09.00       | + ESP                                 |                |        |                          |  |          |           |
|                            | 1.6 FSI         | 92    | 1J-2-373846 | 01.02       | + ESP                                 |                |        |                          |  |          |           |
|                            | 1.8             | 92    | 1J-2-373846 | 09.00       | + ESP                                 |                |        |                          |  |          |           |
|                            | 1.8 4motion     | 92    | 1J-2-373846 | 09.00       | + ESP                                 |                |        |                          |  |          |           |
|                            | 1.8 T           | 110   | 1J-2-373846 | 09.00       | + ESP                                 |                |        |                          |  |          |           |
|                            | 1.9 SDI         | 66    | 1J-2-373846 | 09.00       | + ESP                                 |                |        |                          |  |          |           |
|                            | 1.9 TDI         | 74    | 1J-2-373846 | 09.00       | 06.01 + ESP                           |                |        |                          |  |          |           |
|                            | 1.9 TDI         | 81    | 09.00       | 06.01 + ESP |                                       |                |        |                          |  |          |           |
|                            | 1.9 TDI         | 85    | 09.00       | 06.01 + ESP |                                       |                |        |                          |  |          |           |
|                            | 1.9 TDI         | 96    | 1J-2-373846 | 04.01 + ESP |                                       |                |        |                          |  |          |           |
|                            | 1.9 TDI         | 110   | 1J-2-373846 | 10.00 + ESP |                                       |                |        |                          |  |          |           |
|                            | 1.9 TDI 4motion | 66    | 1J-2-373846 | 09.00       | 06.01 + ESP                           |                |        |                          |  |          |           |
|                            | 1.9 TDI 4motion | 74    | 1J-2-373846 | 09.00       | + ESP                                 |                |        |                          |  |          |           |
|                            | 1.9 TDI 4motion | 85    | 09.00       | 06.01 + ESP |                                       |                |        |                          |  |          |           |
|                            | 1.9 TDI 4motion | 96    | 1J-2-373846 | 04.01 + ESP |                                       |                |        |                          |  |          |           |
|                            | 1.9 TDI 4motion | 110   | 1J-2-373846 | 10.00 + ESP |                                       |                |        |                          |  |          |           |
|                            | 2.0             | 85    | 1J-2-373846 | 09.00       | + ESP                                 |                |        |                          |  |          |           |
|                            | 2.0 4motion     | 85    | 1J-2-373846 | 04.00       | + ESP                                 |                |        |                          |  |          |           |
|                            | 2.3 V5          | 92    | 1J-2-373846 | 09.00       | + ESP                                 |                |        |                          |  |          |           |
|                            | 2.3 V5 4motion  | 92    | 1J-2-373846 | 09.00       | + ESP                                 |                |        |                          |  |          |           |
|                            | 2.8 V6 4motion  | 150   | 1J-2-373846 | 09.00       | + ESP                                 |                |        |                          |  |          |           |
|                            | 1.4 16V         | 92    | 1J-2-373847 | 12.04       | + ESP                                 | 03.7863-3502.4 | 300128 |                          |  |          | 10" ATE   |
|                            | 1.6             | 92    | 1J-2-373847 | 12.04       | + ESP                                 |                |        |                          |  |          |           |
|                            | 1.6 16V         | 92    | 1J-2-373847 | 12.04       | + ESP                                 |                |        |                          |  |          |           |
|                            | 1.6 FSI         | 92    | 1J-2-373847 | 12.04       | + ESP                                 |                |        |                          |  |          |           |
|                            | 1.8             | 92    | 1J-2-373847 | 12.04       | + ESP                                 |                |        |                          |  |          |           |
|                            | 1.8 4motion     | 92    | 1J-2-373847 | 12.04       | + ESP                                 |                |        |                          |  |          |           |
|                            | 1.8 T           | 110   | 1J-2-373847 | 12.04       | + ESP                                 |                |        |                          |  |          |           |
|                            | 1.8 T           | 132   | 05.02       | 12.04       | + ESP                                 |                |        |                          |  |          |           |
|                            | 1.9 SDI         | 66    | 1J-2-373847 | 12.04       | + ESP                                 |                |        |                          |  |          |           |
|                            | 1.9 TDI         | 74    | 1J-2-373847 | 12.04       | + ESP                                 |                |        |                          |  |          |           |
|                            | 1.9 TDI         | 96    | 1J-2-373847 | 12.04       | + ESP                                 |                |        |                          |  |          |           |
|                            | 1.9 TDI         | 110   | 1J-2-373847 | 12.04       | + ESP                                 |                |        |                          |  |          |           |
|                            | 1.9 TDI 4motion | 74    | 1J-2-373847 | 12.04       | + ESP                                 |                |        |                          |  |          |           |
|                            | 1.9 TDI 4motion | 96    | 1J-2-373847 | 12.04       | + ESP                                 |                |        |                          |  |          |           |
|                            | 1.9 TDI 4motion | 110   | 1J-2-373847 | 12.04       | + ESP                                 |                |        |                          |  |          |           |
|                            | 2.0             | 85    | 1J-2-373847 | 12.04       | + ESP                                 |                |        |                          |  |          |           |
|                            | 2.0 4motion     | 85    | 1J-2-373847 | 12.04       | + ESP                                 |                |        |                          |  |          |           |
|                            | 2.3 V5          | 92    | 1J-2-373847 | 12.04       | + ESP                                 |                |        |                          |  |          |           |
|                            | 2.3 V5 4motion  | 92    | 1J-2-373847 | 12.04       | + ESP                                 |                |        |                          |  |          |           |
|                            | 2.8 V6 4motion  | 150   | 1J-2-373847 | 12.04       | + ESP                                 |                |        |                          |  |          |           |
|                            | 1.4 16V         | 92    | 09.98       | 12.04       | - ESP                                 | 24.2123-1709.3 | 010503 |                          |  |          | Thz 23,81 |
|                            | 1.6             | 92    | 09.98       | 12.04       | - ESP                                 |                |        |                          |  |          |           |
|                            | 1.6 16V         | 92    | 02.00       | 12.04       | - ESP                                 |                |        |                          |  |          |           |
|                            | 1.6 FSI         | 92    | 01.02       | 12.04       | - ESP                                 |                |        |                          |  |          |           |
|                            | 1.8             | 92    | 09.98       | 12.04       | - ESP                                 |                |        |                          |  |          |           |
|                            | 1.8 4motion     | 92    | 02.99       | 12.04       | - ESP                                 |                |        |                          |  |          |           |
|                            | 1.8 T           | 110   | 09.00       | 12.04       | - ESP                                 |                |        |                          |  |          |           |
|                            | 1.8 T           | 132   | 05.02       | 12.04       | - ESP                                 |                |        |                          |  |          |           |
|                            | 1.9 SDI         | 66    | 09.98       | 12.04       | - ESP                                 |                |        |                          |  |          |           |
|                            | 1.9 TDI         | 74    | 09.98       | 06.01       | - ESP                                 |                |        |                          |  |          |           |
|                            | 1.9 TDI         | 81    | 09.00       | 12.04       | - ESP                                 |                |        |                          |  |          |           |
|                            | 1.9 TDI         | 85    | 09.98       | 06.01       | - ESP                                 |                |        |                          |  |          |           |
|                            | 1.9 TDI         | 96    | 02.99       | 06.01       | - ESP                                 |                |        |                          |  |          |           |
|                            | 1.9 TDI         | 110   | 04.01       | 12.04       | - ESP                                 |                |        |                          |  |          |           |
|                            | 1.9 TDI         | 110   | 10.00       | 12.04       | - ESP                                 |                |        |                          |  |          |           |
|                            | 1.9 TDI 4motion | 66    | 02.99       | 06.01       | - ESP                                 |                |        |                          |  |          |           |
|                            | 1.9 TDI 4motion | 74    | 09.00       | 12.04       | - ESP                                 |                |        |                          |  |          |           |
|                            | 1.9 TDI 4motion | 85    | 02.99       | 06.01       | - ESP                                 |                |        |                          |  |          |           |





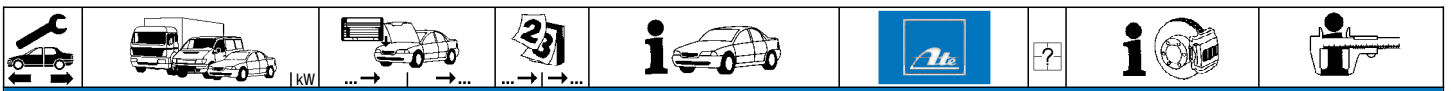





1) - ABS/ + manual transmission / - ABS/ + scatola camb.velocità / - ABS/ + transmission mécanique / - ABS/ + cambio de velocidad





**VOLKSWAGEN BORA (98-04)**

|  |  |  |  |   |  |                |        |  |           |     |
|--|--|--|--|---|--|----------------|--------|--|-----------|-----|
|  | 1.9 TDI 4motion<br>1.9 TDI 4motion<br>2.0<br>2.0 4motion<br>2.3 V5<br>2.3 V5 4motion<br>2.8 V6 4motion   | 96<br>110<br>85<br>85<br>96<br>96<br>150   | 04.01<br>10.00<br>09.98<br>04.00<br>09.98<br>02.99<br>05.99  | 12.04<br>12.04<br>12.04<br>12.04<br>12.04<br>12.04<br>12.04   | - ESP<br>- ESP<br>- ESP<br>- ESP<br>- ESP<br>- ESP<br>- ESP  | 24.2123-1709.3 | 010503 |  | THz 23,81 |     |
|  | 1.4 16V<br>1.6<br>1.6 16V<br>1.8<br>1.8 4motion<br>1.9 SDI<br>1.9 TDI<br>1.9 TDI<br>1.9 TDI<br>1.9 TDI 4motion<br>1.9 TDI 4motion<br>2.0<br>2.3 V5<br>2.3 V5 4motion<br>2.8 V6 4motion   | 96<br>96<br>96<br>92<br>92<br>66<br>81<br>85<br>66<br>85<br>85<br>85<br>85<br>66<br>66<br>150  | 09.98<br>09.98<br>02.00<br>09.98<br>02.99<br>09.98<br>09.98<br>02.99<br>02.99<br>09.98<br>02.99<br>09.98<br>02.99<br>09.98<br>02.99<br>05.99   | 08.00<br>08.00<br>08.00<br>08.00<br>08.00<br>08.00<br>08.00<br>08.00<br>08.00<br>08.00<br>08.00<br>08.00<br>08.00<br>08.00<br>08.00<br>08.00  | + ESP<br>+ ESP<br>+ ESP<br>+ ESP<br>+ ESP<br>+ ESP<br>+ ESP<br>+ ESP<br>+ ESP<br>+ ESP<br>+ ESP<br>+ ESP<br>+ ESP<br>+ ESP<br>+ ESP<br>+ ESP   | 03.2123-2024.3 | 010597 |  | THz 23,81 | ATE |
|  | 1.4 16V<br>1.6<br>1.6 16V<br>1.6 FSI<br>1.8<br>1.8 4motion<br>1.8 T<br>1.8 T<br>1.9 SDI<br>1.9 TDI<br>1.9 TDI<br>1.9 TDI<br>1.9 TDI<br>1.9 TDI<br>1.9 TDI<br>1.9 TDI<br>1.9 TDI<br>1.9 TDI 4motion<br>1.9 TDI 4motion<br>1.9 TDI 4motion<br>1.9 TDI 4motion<br>1.9 TDI 4motion<br>1.9 TDI 4motion<br>2.0<br>2.0 4motion<br>2.3 V5<br>2.3 V5 4motion<br>2.8 V6 4motion    | 96<br>96<br>96<br>96<br>92<br>92<br>110<br>132<br>66<br>66<br>74<br>81<br>85<br>96<br>110<br>66<br>74<br>85<br>96<br>110<br>66<br>74<br>85<br>96<br>110<br>85<br>85<br>66<br>66<br>150 | 09.00<br>09.00<br>09.00<br>01.02<br>09.00<br>09.00<br>09.00<br>05.02<br>09.00<br>09.00<br>09.00<br>09.00<br>09.00<br>09.00<br>09.00<br>09.00<br>09.00<br>09.00<br>09.00<br>09.00<br>09.00<br>09.00<br>09.00<br>09.00<br>09.00<br>09.00<br>09.00<br>09.00<br>09.00<br>09.00 | 12.04<br>12.04<br>12.04<br>12.04<br>12.04<br>12.04<br>12.04<br>12.04<br>12.04<br>06.01<br>12.04<br>06.01<br>06.01<br>06.01<br>06.01<br>12.04<br>12.04<br>06.01<br>12.04<br>06.01<br>06.01<br>06.01<br>12.04<br>12.04<br>12.04<br>12.04<br>12.04<br>12.04<br>12.04<br>12.04<br>12.04 | + ESP<br>+ ESP<br>+ ESP<br>+ ESP<br>+ ESP<br>+ ESP<br>+ ESP<br>+ ESP<br>+ ESP<br>+ ESP<br>+ ESP<br>+ ESP<br>+ ESP<br>+ ESP<br>+ ESP<br>+ ESP<br>+ ESP<br>+ ESP<br>+ ESP<br>+ ESP<br>+ ESP<br>+ ESP<br>+ ESP<br>+ ESP<br>+ ESP<br>+ ESP<br>+ ESP<br>+ ESP<br>+ ESP<br>+ ESP | 03.2123-2715.3 | 010802 |  | THz 23,81 | ATE |
|  | 1.4 16V<br>1.6<br>1.6 16V<br>1.8<br>1.8 4motion<br>1.9 SDI<br>1.9 TDI<br>1.9 TDI<br>1.9 TDI<br>1.9 TDI<br>1.9 TDI<br>1.9 TDI<br>1.9 TDI<br>1.9 TDI<br>1.9 TDI<br>1.9 TDI<br>1.9 TDI<br>1.9 TDI<br>1.9 TDI 4motion<br>1.9 TDI 4motion<br>1.9 TDI 4motion<br>1.9 TDI 4motion<br>1.9 TDI 4motion<br>2.0<br>2.0 4motion<br>2.3 V5<br>2.3 V5 4motion<br>2.8 V6 4motion        | 96<br>96<br>96<br>92<br>92<br>66<br>81<br>85<br>66<br>85<br>85<br>96<br>110<br>66<br>74<br>85<br>96<br>110<br>66<br>74<br>85<br>96<br>110<br>85<br>85<br>66<br>66<br>150               | 09.98<br>09.98<br>02.00<br>09.98<br>02.99<br>09.98<br>09.98<br>02.99<br>02.99<br>09.98<br>02.99<br>09.98<br>02.99<br>09.98<br>02.99<br>05.99   | 08.00<br>08.00<br>08.00<br>08.00<br>08.00<br>08.00<br>08.00<br>08.00<br>08.00<br>06.01<br>12.04<br>06.01<br>06.01<br>06.01<br>06.01<br>12.04<br>12.04<br>06.01<br>12.04<br>06.01<br>06.01<br>06.01<br>12.04<br>12.04<br>12.04<br>12.04<br>12.04                                     | + ESP<br>+ ESP<br>+ ESP<br>+ ESP<br>+ ESP<br>+ ESP<br>+ ESP<br>+ ESP<br>+ ESP<br>+ ESP<br>+ ESP<br>+ ESP<br>+ ESP<br>+ ESP<br>+ ESP<br>+ ESP<br>+ ESP<br>+ ESP<br>+ ESP<br>+ ESP<br>+ ESP<br>+ ESP<br>+ ESP<br>+ ESP<br>+ ESP<br>+ ESP<br>+ ESP<br>+ ESP                   | 03.2123-2064.3 | 010598 |  | THz 23,81 | ATE |
|  | 1.4 16V<br>1.6<br>1.6 16V<br>1.6 FSI<br>1.8<br>1.8 4motion<br>1.8 T<br>1.8 T<br>1.9 SDI<br>1.9 TDI<br>1.9 TDI<br>1.9 TDI<br>1.9 TDI<br>1.9 TDI<br>1.9 TDI<br>1.9 TDI<br>1.9 TDI<br>1.9 TDI<br>1.9 TDI<br>1.9 TDI 4motion<br>1.9 TDI 4motion<br>1.9 TDI 4motion<br>1.9 TDI 4motion<br>1.9 TDI 4motion<br>2.0<br>2.0 4motion<br>2.3 V5<br>2.3 V5 4motion<br>2.8 V6 4motion | 96<br>96<br>96<br>96<br>92<br>92<br>110<br>132<br>66<br>66<br>74<br>81<br>85<br>96<br>110<br>66<br>74<br>85<br>96<br>110<br>66<br>74<br>85<br>96<br>110<br>85<br>85<br>66<br>66<br>150 | 09.00<br>09.00<br>09.00<br>01.02<br>09.00<br>09.00<br>09.00<br>05.02<br>09.00<br>09.00<br>09.00<br>09.00<br>09.00<br>09.00<br>09.00<br>09.00<br>09.00<br>09.00<br>09.00<br>09.00<br>09.00<br>09.00<br>09.00<br>09.00<br>09.00<br>09.00<br>09.00<br>09.00<br>09.00          | 12.04<br>12.04<br>12.04<br>12.04<br>12.04<br>12.04<br>12.04<br>12.04<br>12.04<br>06.01<br>12.04<br>06.01<br>06.01<br>06.01<br>06.01<br>12.04<br>12.04<br>06.01<br>12.04<br>06.01<br>06.01<br>06.01<br>12.04<br>12.04<br>12.04<br>12.04<br>12.04                                     | + ESP<br>+ ESP<br>+ ESP<br>+ ESP<br>+ ESP<br>+ ESP<br>+ ESP<br>+ ESP<br>+ ESP<br>+ ESP<br>+ ESP<br>+ ESP<br>+ ESP<br>+ ESP<br>+ ESP<br>+ ESP<br>+ ESP<br>+ ESP<br>+ ESP<br>+ ESP<br>+ ESP<br>+ ESP<br>+ ESP<br>+ ESP<br>+ ESP<br>+ ESP<br>+ ESP<br>+ ESP<br>+ ESP          | 03.2123-2774.3 | 010803 |  | THz 23,81 | ATE |

| VOLKSWAGEN BORA (98-04)  |       |                         |       |         |                         |                |  |  |                |                |                |        |     |
|--|-------|-------------------------|-------|---------|-------------------------|----------------|--|--|----------------|----------------|----------------|--------|-----|
| <br>1.4 16V<br>1.6<br>1.6 16V<br>1.6 FSI<br>1.8<br>1.8 4motion<br>1.8 T<br>1.8 T<br>1.9 SDI<br>1.9 TDI<br>1.9 TDI<br>1.9 TDI<br>1.9 TDI<br>1.9 TDI<br>1.9 TDI 4motion<br>1.9 TDI 4motion<br>1.9 TDI 4motion<br>1.9 TDI 4motion<br>1.9 TDI 4motion<br>2.0<br>2.0 4motion<br>2.3 V5<br>2.3 V5 4motion<br>2.8 V6 4motion |       |                         | 09.98 | 12.04   | PR: 1LR,1LS,1LQ,1ZP,1ZM | 11.9541-9549.2 | 220575   | <br>   |                | D=54, - Halter | ATE            |        |     |
|  |       |                         | 09.98 | 12.04   | PR: 1LR,1LS,1LQ,1ZP,1ZM |                |  |  |                |                | 11.9541-9550.2 | 220576 | ATE |
|  |       |                         | 02.00 | 12.04   | PR: 1LR,1LS,1LQ,1ZP,1ZM |                |  |  |                |                | 11.0441-5409.2 | 250031 | ATE |
|  |       |                         | 01.02 | 12.04   | PR: 1LR,1LS,1LQ,1ZP,1ZM |                |  |  |                |                | 11.0101-5409.2 | 260035 | ATE |
|  |       |                         | 09.98 | 12.04   | PR: 1LR,1LS,1LQ,1ZP,1ZM |                |  |  |                |                | 11.8171-0008.1 | 990049 | ATE |
|  |       |                         | 02.99 | 12.04   | PR: 1LR,1LS,1LQ,1ZP,1ZM |                |  |  |                |                |                |        |     |
|  |       |                         | 09.00 | 12.04   | PR: 1LR,1LS,1LQ,1ZP,1ZM |                |  |  |                |                |                |        |     |
|  |       |                         | 05.02 | 12.04   | PR: 1LR,1LS,1LQ,1ZP,1ZM |                |  |  |                |                |                |        |     |
|  |       |                         | 09.98 | 12.04   | PR: 1LR,1LS,1LQ,1ZP,1ZM |                |  |  |                |                |                |        |     |
|  |       |                         | 09.98 | 06.01   | PR: 1LR,1LS,1LQ,1ZP,1ZM |                |  |  |                |                |                |        |     |
|  |       |                         | 09.00 | 12.04   | PR: 1LR,1LS,1LQ,1ZP,1ZM |                |  |  |                |                |                |        |     |
|  |       |                         | 09.98 | 06.01   | PR: 1LR,1LS,1LQ,1ZP,1ZM |                |  |  |                |                |                |        |     |
|  |       |                         | 02.99 | 06.01   | PR: 1LR,1LS,1LQ,1ZP,1ZM |                |  |  |                |                |                |        |     |
|  |       |                         | 04.01 | 12.04   | PR: 1LR,1LS,1LQ,1ZP,1ZM |                |  |  |                |                |                |        |     |
|  |       |                         | 10.00 | 12.04   | PR: 1LR,1LS,1LQ,1ZP,1ZM |                |  |  |                |                |                |        |     |
|  |       |                         | 02.99 | 06.01   | PR: 1LR,1LS,1LQ,1ZP,1ZM |                |  |  |                |                |                |        |     |
|  |       |                         | 09.00 | 12.04   | PR: 1LR,1LS,1LQ,1ZP,1ZM |                |  |  |                |                |                |        |     |
|  |       |                         | 02.99 | 06.01   | PR: 1LR,1LS,1LQ,1ZP,1ZM |                |  |  |                |                |                |        |     |
|  |       |                         | 04.01 | 12.04   | PR: 1LR,1LS,1LQ,1ZP,1ZM |                |  |  |                |                |                |        |     |
|  |       |                         | 10.00 | 12.04   | PR: 1LR,1LS,1LQ,1ZP,1ZM |                |  |  |                |                |                |        |     |
| 09.98  | 12.04 | PR: 1LR,1LS,1LQ,1ZP,1ZM |       |         |                         |                |  |  |                |                |                |        |     |
| 04.00  | 12.04 | PR: 1LR,1LS,1LQ,1ZP,1ZM |       |         |                         |                |  |  |                |                |                |        |     |
| 09.98  | 12.04 | PR: 1LR,1LS,1LQ,1ZP,1ZM |       |         |                         |                |  |  |                |                |                |        |     |
| 02.99  | 12.04 | PR: 1LR,1LS,1LQ,1ZP,1ZM |       |         |                         |                |  |  |                |                |                |        |     |
| 05.99  | 12.04 | PR: 1LR,1LS,1LQ,1ZP,1ZM |       |         |                         |                |  |  |                |                |                |        |     |
| 1.4 16V<br>1.6<br>1.6 16V<br>1.6 FSI<br>1.8<br>1.8 4motion<br>1.8 T<br>1.8 T<br>1.9 SDI<br>1.9 TDI<br>1.9 TDI<br>1.9 TDI<br>1.9 TDI<br>1.9 TDI<br>1.9 TDI 4motion<br>1.9 TDI 4motion<br>1.9 TDI 4motion<br>1.9 TDI 4motion<br>1.9 TDI 4motion<br>2.0<br>2.0 4motion<br>2.3 V5<br>2.3 V5 4motion<br>2.8 V6 4motion  |       |                         | 09.98 | 12.04   | PR: 1LN,1ZD,1ZE,1ZH     | 11.3541-8523.2 | 220115   | <br><br><br> | 2              | D=54, - Halter | ATE            |        |     |
|  |       |                         | 09.98 | 12.04   | PR: 1LN,1ZD,1ZE,1ZH     |                |  |  |                |                | 11.3541-8524.2 | 220116 | ATE |
|  |       |                         | 02.00 | 12.04   | PR: 1LN,1ZD,1ZE,1ZH     |                |  |  |                |                | 24.3541-8523.5 | 240551 | ATE |
|  |       |                         | 01.02 | 12.04   | PR: 1LN,1ZD,1ZE,1ZH     |                |  |  |                |                | 24.3541-8524.5 | 240552 | ATE |
|  |       |                         | 09.98 | 12.04   | PR: 1LN,1ZD,1ZE,1ZH     |                |  |  |                |                | 11.8170-0306.1 | 260102 | ATE |
|  |       |                         | 02.99 | 12.04   | PR: 1LN,1ZD,1ZE,1ZH     |                |  |  |                |                | 11.0441-5409.2 | 250031 | ATE |
|  |       |                         | 09.00 | 12.04   | PR: 1LN,1ZD,1ZE,1ZH     |                |  |  |                |                | 11.0101-5409.2 | 260035 | ATE |
|  |       |                         | 09.00 | 12.04   | PR: 1LN,1ZD,1ZE,1ZH     |                |  |  |                |                | 11.8171-0008.1 | 990049 | ATE |
|  |       |                         | 05.02 | 12.04   | PR: 1LN,1ZD,1ZE,1ZH     |                |  |  |                |                | 11.8116-0143.1 | 390513 | ATE |
|  |       |                         | 09.98 | 12.04   | PR: 1LN,1ZD,1ZE,1ZH     |                |  |  |                |                |                |        |     |
|  |       |                         | 09.98 | 06.01   | PR: 1LN,1ZD,1ZE,1ZH     |                |  |  |                |                |                |        |     |
|  |       |                         | 09.00 | 12.04   | PR: 1LN,1ZD,1ZE,1ZH     |                |  |  |                |                |                |        |     |
|  |       |                         | 09.98 | 06.01   | PR: 1LN,1ZD,1ZE,1ZH     |                |  |  |                |                |                |        |     |
|  |       |                         | 02.99 | 06.01   | PR: 1LN,1ZD,1ZE,1ZH     |                |  |  |                |                |                |        |     |
|  |       |                         | 04.01 | 12.04   | PR: 1LN,1ZD,1ZE,1ZH     |                |  |  |                |                |                |        |     |
|  |       |                         | 10.00 | 12.04   | PR: 1LN,1ZD,1ZE,1ZH     |                |  |  |                |                |                |        |     |
|  |       |                         | 02.99 | 06.01   | PR: 1LN,1ZD,1ZE,1ZH     |                |  |  |                |                |                |        |     |
|  |       |                         | 09.00 | 12.04   | PR: 1LN,1ZD,1ZE,1ZH     |                |  |  |                |                |                |        |     |
|  |       |                         | 02.99 | 06.01   | PR: 1LN,1ZD,1ZE,1ZH     |                |  |  |                |                |                |        |     |
|  |       |                         | 04.01 | 12.04   | PR: 1LN,1ZD,1ZE,1ZH     |                |  |  |                |                |                |        |     |
| 10.00  | 12.04 | PR: 1LN,1ZD,1ZE,1ZH     |       |         |                         |                |  |  |                |                |                |        |     |
| 09.98  | 12.04 | PR: 1LN,1ZD,1ZE,1ZH     |       |         |                         |                |  |  |                |                |                |        |     |
| 04.00  | 12.04 | PR: 1LN,1ZD,1ZE,1ZH     |       |         |                         |                |  |  |                |                |                |        |     |
| 09.98  | 12.04 | PR: 1LN,1ZD,1ZE,1ZH     |       |         |                         |                |  |  |                |                |                |        |     |
| 02.99  | 12.04 | PR: 1LN,1ZD,1ZE,1ZH     |       |         |                         |                |  |  |                |                |                |        |     |
| 05.99  | 12.04 | PR: 1LN,1ZD,1ZE,1ZH     |       |         |                         |                |  |  |                |                |                |        |     |
| 1.4 16V<br>1.6<br>1.6 16V<br>1.6 FSI<br>1.8<br>1.8 4motion<br>1.8 T<br>1.8 T<br>1.9 SDI<br>1.9 TDI<br>1.9 TDI<br>1.9 TDI<br>1.9 TDI<br>1.9 TDI<br>1.9 TDI 4motion<br>1.9 TDI 4motion<br>1.9 TDI 4motion<br>1.9 TDI 4motion<br>1.9 TDI 4motion<br>2.0<br>2.0 4motion<br>2.3 V5<br>2.3 V5 4motion<br>2.8 V6 4motion  |       |                         | 09.98 | 12.04   | PR: 1ZQ                 | 11.9541-9595.2 | 220501   | <br>   | 2              | D=54, - Halter | ATE            |        |     |
|  |       |                         | 09.98 | 12.04   | PR: 1ZQ                 |                |  |  |                |                | 11.9541-9596.2 | 220502 | ATE |
|  |       |                         | 02.00 | 12.04   | PR: 1ZQ                 |                |  |  |                |                | 11.0441-5409.2 | 250031 | ATE |
|  |       |                         | 01.02 | 12.04   | PR: 1ZQ                 |                |  |  |                |                | 11.0101-5409.2 | 260035 | ATE |
|  |       |                         | 09.98 | 12.04   | PR: 1ZQ                 |                |  |  |                |                | 11.8171-0008.1 | 990049 | ATE |
|  |       |                         | 02.99 | 12.04   | PR: 1ZQ                 |                |  |  |                |                | 11.8116-0143.1 | 390513 | ATE |
|  |       |                         | 09.00 | 12.04   | PR: 1ZQ                 |                |  |  |                |                |                |        |     |
|  |       |                         | 05.02 | 12.04   | PR: 1ZQ                 |                |  |  |                |                |                |        |     |
|  |       |                         | 09.98 | 12.04   | PR: 1ZQ                 |                |  |  |                |                |                |        |     |
|  |       |                         | 09.98 | 06.01   | PR: 1ZQ                 |                |  |  |                |                |                |        |     |
|  |       |                         | 09.00 | 12.04   | PR: 1ZQ                 |                |  |  |                |                |                |        |     |
|  |       |                         | 09.98 | 06.01   | PR: 1ZQ                 |                |  |  |                |                |                |        |     |
|  |       |                         | 02.99 | 06.01   | PR: 1ZQ                 |                |  |  |                |                |                |        |     |
|  |       |                         | 04.01 | 12.04   | PR: 1ZQ                 |                |  |  |                |                |                |        |     |
|  |       |                         | 10.00 | 12.04   | PR: 1ZQ                 |                |  |  |                |                |                |        |     |
|  |       |                         | 02.99 | 06.01   | PR: 1ZQ                 |                |  |  |                |                |                |        |     |
|  |       |                         | 09.00 | 12.04   | PR: 1ZQ                 |                |  |  |                |                |                |        |     |
|  |       |                         | 02.99 | 06.01   | PR: 1ZQ                 |                |  |  |                |                |                |        |     |
|  |       |                         | 04.01 | 12.04   | PR: 1ZQ                 |                |  |  |                |                |                |        |     |
|  |       |                         | 10.00 | 12.04   | PR: 1ZQ                 |                |  |  |                |                |                |        |     |
| 09.98  | 12.04 | PR: 1ZQ                 |       |         |                         |                |  |  |                |                |                |        |     |
| 04.00  | 12.04 | PR: 1ZQ                 |       |         |                         |                |  |  |                |                |                |        |     |
| 09.98  | 12.04 | PR: 1ZQ                 |       |         |                         |                |  |  |                |                |                |        |     |
| 02.99  | 12.04 | PR: 1ZQ                 |       |         |                         |                |  |  |                |                |                |        |     |
| 05.99  | 12.04 | PR: 1ZQ                 |       |         |                         |                |  |  |                |                |                |        |     |
| 1.4 16V<br>1.6<br>1.6 16V<br>1.6 FSI<br>1.8<br>1.8 4motion<br>1.8 T<br>1.8 T<br>1.9 SDI<br>1.9 TDI<br>1.9 TDI  |       | 1J-2W315 308            | 09.98 | PR: 1LJ | 11.9541-9595.2          | 220501         | <br> | 2  | D=54, - Halter | ATE            |                |        |     |
|  |       | 1J-2W315 308            | 09.98 | PR: 1LJ |                         |                |  |  |                | 11.9541-9596.2 | 220502         | ATE    |     |
|  |       | 1J-2W315 308            | 02.00 | PR: 1LJ |                         |                |  |  |                | 11.0441-5409.2 | 250031         | ATE    |     |
|  |       | 1J-2W315 308            | 01.02 | PR: 1LJ |                         |                |  |  |                | 11.0101-5409.2 | 260035         | ATE    |     |
|  |       | 1J-2W315 308            | 09.98 | PR: 1LJ |                         |                |  |  |                | 11.8171-0008.1 | 990049         | ATE    |     |
|  |       | 1J-2W315 308            | 02.99 | PR: 1LJ |                         |                |  |  |                | 11.8116-0143.1 | 390513         | ATE    |     |
|  |       | 1J-2W315 308            | 09.00 | PR: 1LJ |                         |                |  |  |                |                |                |        |     |
|  |       | 1J-2W315 308            | 05.02 | PR: 1LJ |                         |                |  |  |                |                |                |        |     |
|  |       | 1J-2W315 308            | 09.98 | PR: 1LJ |                         |                |  |  |                |                |                |        |     |
|  |       | 1J-2W315 308            | 09.98 | PR: 1LJ |                         |                |  |  |                |                |                |        |     |
|  |       | 1J-2W315 308            | 09.00 | PR: 1LJ |                         |                |  |  |                |                |                |        |     |
|  |       | 1J-2W315 308            | 09.98 | PR: 1LJ |                         |                |  |  |                |                |                |        |     |



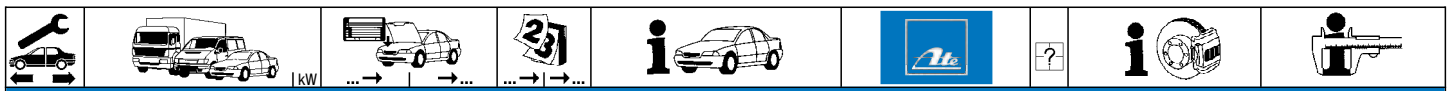

**VOLKSWAGEN BORA (98-04)**

|  |                 |     |              |              |                       |                       |        |   |   |     |
|--|-----------------|-----|--------------|--------------|-----------------------|-----------------------|--------|---|---|-----|
|  | 1.9 TDI         | 85  | 1J-2W315 308 | <b>02.99</b> | PR: 1LJ               | <b>11.9541-9595.2</b> | 220501 | 2 | D=54, - Halter<br>ATE<br>D=54, - Halter<br>ATE<br>Dichtungssatz<br>ATE<br>Hülzensatz<br>ATE<br>Führungsbolzen<br>ATE<br>Haltefeder<br>ATE | ATE |
|  | 1.9 TDI         | 96  | 1J-2W315 308 | <b>04.01</b> | PR: 1LJ               | <b>11.9541-9596.2</b> | 220502 |   |   |     |
|  | 1.9 TDI         | 110 | 1J-2W315 308 | <b>10.00</b> | PR: 1LJ               | <b>11.0441-5409.2</b> | 250031 |   |   |     |
|  | 1.9 TDI 4motion | 66  | 1J-2W315 308 | <b>02.99</b> | PR: 1LJ               | <b>11.0101-5409.2</b> | 260035 |   |   |     |
|  | 1.9 TDI 4motion | 74  | 1J-2W315 308 | <b>09.00</b> | PR: 1LJ               | <b>11.8171-0008.1</b> | 990049 |   |   |     |
|  | 1.9 TDI 4motion | 85  | 1J-2W315 308 | <b>02.99</b> | PR: 1LJ               | <b>11.8116-0143.1</b> | 390513 |   |   |     |
|  | 1.9 TDI 4motion | 96  | 1J-2W315 308 | <b>04.01</b> | PR: 1LJ               |                       |        |   |   |     |
|  | 1.9 TDI 4motion | 110 | 1J-2W315 308 | <b>10.00</b> | PR: 1LJ               |                       |        |   |   |     |
|  | 2.0             | 85  | 1J-2W315 308 | <b>09.98</b> | PR: 1LJ               |                       |        |   |   |     |
|  | 2.0 4motion     | 85  | 1J-2W315 308 | <b>04.00</b> | PR: 1LJ               |                       |        |   |   |     |
|  | 2.3 V5          |     | 1J-2W315 308 | <b>09.98</b> | PR: 1LJ               |                       |        |   |   |     |
|  | 2.3 V5 4motion  |     | 1J-2W315 308 | <b>02.99</b> | PR: 1LJ               |                       |        |   |   |     |
|  | 2.8 V6 4motion  | 150 | 1J-2W315 308 | <b>05.99</b> | PR: 1LJ               |                       |        |   |   |     |
|  | 1.4 16V         |     | 1J-2W315 309 |              | 12.04 PR: 1LJ         | <b>11.9541-9595.2</b> | 220501 |   |   |     |
|  | 1.6             |     | 1J-2W315 309 |              | 12.04 PR: 1LJ         | <b>11.9541-9596.2</b> | 220502 |   |   |     |
|  | 1.6 16V         |     | 1J-2W315 309 |              | 12.04 PR: 1LJ         | <b>11.0441-5409.2</b> | 250031 |   |   |     |
|  | 1.6 FSI         |     | 1J-2W315 309 |              | 12.04 PR: 1LJ         | <b>11.0101-5409.2</b> | 260035 |   |   |     |
|  | 1.8             | 92  | 1J-2W315 309 |              | 12.04 PR: 1LJ         | <b>11.8171-0008.1</b> | 990049 |   |   |     |
|  | 1.8 4motion     | 92  | 1J-2W315 309 |              | 12.04 PR: 1LJ         | <b>11.8116-0143.1</b> | 390513 |   |   |     |
|  | 1.8 T           | 110 | 1J-2W315 309 |              | 12.04 PR: 1LJ         |                       |        |   |   |     |
|  | 1.8 T           | 132 | 1J-2W315 309 |              | 12.04 PR: 1LJ         |                       |        |   |   |     |
|  | 1.9 SDI         |     | 1J-2W315 309 |              | 12.04 PR: 1LJ         |                       |        |   |   |     |
|  | 1.9 TDI         | 66  | 1J-2W315 309 |              | 06.01 PR: 1LJ         |                       |        |   |   |     |
|  | 1.9 TDI         | 74  | 1J-2W315 309 |              | 12.04 PR: 1LJ         |                       |        |   |   |     |
|  | 1.9 TDI         | 81  | 1J-2W315 309 |              | 06.01 PR: 1LJ         |                       |        |   |   |     |
|  | 1.9 TDI         | 85  | 1J-2W315 309 |              | 06.01 PR: 1LJ         |                       |        |   |   |     |
|  | 1.9 TDI         | 96  | 1J-2W315 309 |              | 12.04 PR: 1LJ         |                       |        |   |   |     |
|  | 1.9 TDI         | 110 | 1J-2W315 309 |              | 12.04 PR: 1LJ         |                       |        |   |   |     |
|  | 1.9 TDI 4motion | 66  | 1J-2W315 309 |              | 06.01 PR: 1LJ         |                       |        |   |   |     |
|  | 1.9 TDI 4motion | 74  | 1J-2W315 309 |              | 12.04 PR: 1LJ         |                       |        |   |   |     |
|  | 1.9 TDI 4motion | 85  | 1J-2W315 309 |              | 06.01 PR: 1LJ         |                       |        |   |   |     |
|  | 1.9 TDI 4motion | 96  | 1J-2W315 309 |              | 12.04 PR: 1LJ         |                       |        |   |   |     |
|  | 1.9 TDI 4motion | 110 | 1J-2W315 309 |              | 12.04 PR: 1LJ         |                       |        |   |   |     |
|  | 2.0             | 85  | 1J-2W315 309 |              | 12.04 PR: 1LJ         |                       |        |   |   |     |
|  | 2.0 4motion     | 85  | 1J-2W315 309 |              | 12.04 PR: 1LJ         |                       |        |   |   |     |
|  | 2.3 V5          |     | 1J-2W315 309 |              | 12.04 PR: 1LJ         |                       |        |   |   |     |
|  | 2.3 V5 4motion  |     | 1J-2W315 309 |              | 12.04 PR: 1LJ         |                       |        |   |   |     |
|  | 2.8 V6 4motion  | 150 | 1J-2W315 309 |              | 12.04 PR: 1LJ         |                       |        |   |   |     |
|  | 1.4 16V         |     |              | <b>09.98</b> | 12.04                 | <b>83.7838-0435.3</b> | 330834 | 2 | L=435   |     |
|  | 1.6             |     |              | <b>09.98</b> | 12.04                 |                       |        |   |   |     |
|  | 1.6 16V         |     |              | <b>02.00</b> | 12.04                 |                       |        |   |   |     |
|  | 1.6 FSI         |     |              | <b>01.02</b> | 12.04                 |                       |        |   |   |     |
|  | 1.8             | 92  |              | <b>09.98</b> | 12.04                 |                       |        |   |   |     |
|  | 1.8 4motion     | 92  |              | <b>02.99</b> | 08.00                 |                       |        |   |   |     |
|  | 1.8 T           | 110 |              | <b>09.00</b> | 12.04                 |                       |        |   |   |     |
|  | 1.8 T           | 132 |              | <b>05.02</b> | 12.04                 |                       |        |   |   |     |
|  | 1.9 SDI         |     |              | <b>09.98</b> | 12.04                 |                       |        |   |   |     |
|  | 1.9 TDI         | 66  |              | <b>09.98</b> | 06.01                 |                       |        |   |   |     |
|  | 1.9 TDI         | 74  |              | <b>09.00</b> | 12.04                 |                       |        |   |   |     |
|  | 1.9 TDI         | 81  |              | <b>09.98</b> | 06.01                 |                       |        |   |   |     |
|  | 1.9 TDI         | 85  |              | <b>02.99</b> | 06.01                 |                       |        |   |   |     |
|  | 1.9 TDI         | 96  |              | <b>04.01</b> | 12.04                 |                       |        |   |   |     |
|  | 1.9 TDI         | 110 |              | <b>10.00</b> | 12.04                 |                       |        |   |   |     |
|  | 1.9 TDI 4motion | 66  |              | <b>02.99</b> | 08.00                 |                       |        |   |   |     |
|  | 1.9 TDI 4motion | 85  |              | <b>02.99</b> | 08.00                 |                       |        |   |   |     |
|  | 2.0             | 85  |              | <b>09.98</b> | 12.04                 |                       |        |   |   |     |
|  | 2.0 4motion     | 85  |              | <b>04.00</b> | 08.00                 |                       |        |   |   |     |
|  | 2.3 V5          |     |              | <b>09.98</b> | 12.04                 |                       |        |   |   |     |
|  | 2.3 V5 4motion  |     |              | <b>02.99</b> | 08.00                 |                       |        |   |   |     |
|  | 2.8 V6 4motion  | 150 |              | <b>05.99</b> | 08.00                 |                       |        |   |   |     |
|  | 1.8 4motion     | 92  |              | <b>09.00</b> | 12.04                 | <b>83.6247-0562.3</b> | 330594 | 2 | L=560   |     |
|  | 1.9 TDI 4motion | 66  |              | <b>09.00</b> | 06.01                 |                       |        |   |   |     |
|  | 1.9 TDI 4motion | 74  |              | <b>09.00</b> | 12.04                 |                       |        |   |   |     |
|  | 1.9 TDI 4motion | 85  |              | <b>09.00</b> | 06.01                 |                       |        |   |   |     |
|  | 1.9 TDI 4motion | 96  |              | <b>04.01</b> | 12.04                 |                       |        |   |   |     |
|  | 1.9 TDI 4motion | 110 |              | <b>10.00</b> | 12.04                 |                       |        |   |   |     |
|  | 2.0 4motion     | 85  |              | <b>09.00</b> | 12.04                 |                       |        |   |   |     |
|  | 2.3 V5 4motion  |     |              | <b>09.00</b> | 12.04                 |                       |        |   |   |     |
|  | 2.8 V6 4motion  | 150 |              | <b>09.00</b> | 12.04                 |                       |        |   |   |     |
|  | 1.4 16V         |     | 1J-YW238580  | <b>09.98</b> | PR: 1KP,1KT           | <b>24.3414-1703.7</b> | 220535 |   |   |     |
|  | 1.6             |     | 1J-YW238580  | <b>09.98</b> | PR: 1KP,1KT           | <b>24.3414-1704.7</b> | 220536 |   |   |     |
|  | 1.8             | 92  | 1J-YW238580  | <b>09.98</b> | PR: 1KP,1KT           |                       |        |   |   |     |
|  | 1.9 SDI         |     | 1J-YW238580  | <b>09.98</b> | PR: 1KP,1KT           |                       |        |   |   |     |
|  | 1.9 TDI         | 66  | 1J-YW238580  | <b>09.98</b> | PR: 1KP,1KT           |                       |        |   |   |     |
|  | 1.9 TDI         | 81  | 1J-YW238580  | <b>09.98</b> | PR: 1KP,1KT           |                       |        |   |   |     |
|  | 1.9 TDI         | 85  | 1J-YW238580  | <b>02.99</b> | PR: 1KP,1KT           |                       |        |   |   |     |
|  | 2.0             | 85  | 1J-YW238580  | <b>09.98</b> | PR: 1KP,1KT           |                       |        |   |   |     |
|  | 2.3 V5          |     | 1J-YW238580  | <b>09.98</b> | PR: 1KP,1KT           |                       |        |   |   |     |
|  | 1.4 16V         |     | 1J-YW238581  |              | 12.04 PR: 1KE,1KP,1KT | <b>24.3414-1705.7</b> | 220549 | 2 | D=41, - Halter<br>LUC<br>D=41, - Halter<br>LUC  | LUC |
|  | 1.6             |     | 1J-YW238581  |              | 12.04 PR: 1KE,1KP,1KT | <b>24.3414-1706.7</b> | 220550 |   |   |     |
|  | 1.6 16V         |     |              | <b>02.00</b> | 12.04 PR: 1KE,1KP,1KT |                       |        |   |   |     |
|  | 1.6 FSI         |     |              | <b>01.02</b> | 12.04 PR: 1KE,1KP,1KT |                       |        |   |   |     |
|  | 1.8             | 92  | 1J-YW238581  |              | 12.04 PR: 1KE,1KP,1KT |                       |        |   |   |     |
|  | 1.8 4motion     | 92  |              | <b>02.99</b> | 12.04 PR: 1KE,1KP,1KT |                       |        |   |   |     |
|  | 1.8 T           | 110 |              | <b>09.00</b> | 12.04 PR: 1KE,1KP,1KT |                       |        |   |   |     |
|  | 1.8 T           | 132 |              | <b>05.02</b> | 12.04 PR: 1KE,1KP,1KT |                       |        |   |   |     |
|  | 1.9 SDI         |     | 1J-YW238581  |              | 12.04 PR: 1KE,1KP,1KT |                       |        |   |   |     |
|  |                 |     |              |              |                       |                       |        |   |   |     |



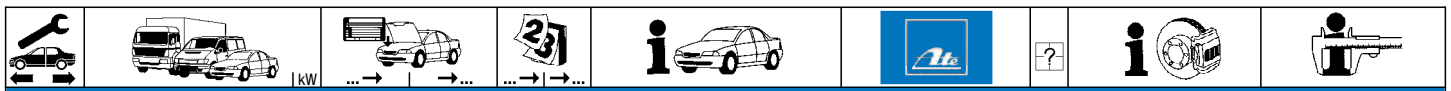

**VOLKSWAGEN BORA (98-04)**

|                |                 |         |             |             |                 |                 |                |                |  |   |                                  |            |        |  |   |        |  |
|----------------|-----------------|---------|-------------|-------------|-----------------|-----------------|----------------|----------------|--|---|----------------------------------|------------|--------|--|---|--------|--|
|                | 1.9 TDI         | 66      | 1J-YW238581 |             | 06.01           | PR: 1KE,1KP,1KT | 24.3414-1705.7 | 220549         |  |   | D=41, - Halter<br>D=41, - Halter | LUC<br>LUC |        |  |   |        |  |
|                | 1.9 TDI         | 74      |             | 09.00       | 12.04           | PR: 1KE,1KP,1KT | 24.3414-1706.7 | 220550         |  |   |                                  |            |        |  |   |        |  |
|                | 1.9 TDI         | 81      | 1J-YW238581 |             | 06.01           | PR: 1KE,1KP,1KT |                |                |  |   |                                  |            |        |  |   |        |  |
|                | 1.9 TDI         | 85      | 1J-YW238581 |             | 06.01           | PR: 1KE,1KP,1KT |                |                |  |   |                                  |            |        |  |   |        |  |
|                | 1.9 TDI         | 96      |             | 04.01       | 12.04           | PR: 1KE,1KP,1KT |                |                |  |   |                                  |            |        |  |   |        |  |
|                | 1.9 TDI         | 110     |             | 10.00       | 12.04           | PR: 1KE,1KP,1KT |                |                |  |   |                                  |            |        |  |   |        |  |
|                | 1.9 TDI 4motion | 66      |             | 02.99       | 06.01           | PR: 1KE,1KP,1KT |                |                |  |   |                                  |            |        |  |   |        |  |
|                | 1.9 TDI 4motion | 74      |             | 09.00       | 12.04           | PR: 1KE,1KP,1KT |                |                |  |   |                                  |            |        |  |   |        |  |
|                | 1.9 TDI 4motion | 85      |             | 02.99       | 06.01           | PR: 1KE,1KP,1KT |                |                |  |   |                                  |            |        |  |   |        |  |
|                | 1.9 TDI 4motion | 96      |             | 04.01       | 12.04           | PR: 1KE,1KP,1KT |                |                |  |   |                                  |            |        |  |   |        |  |
|                | 1.9 TDI 4motion | 110     |             | 10.00       | 12.04           | PR: 1KE,1KP,1KT |                |                |  |   |                                  |            |        |  |   |        |  |
|                | 2.0             | 85      | 1J-YW238581 |             | 12.04           | PR: 1KE,1KP,1KT |                |                |  |   |                                  |            |        |  |   |        |  |
|                | 2.0 4motion     | 85      |             | 04.00       | 12.04           | PR: 1KE,1KP,1KT |                |                |  |   |                                  |            |        |  |   |        |  |
|                | 2.3 V5          |         | 1J-YW238581 |             | 12.04           | PR: 1KE,1KP,1KT |                |                |  |   |                                  |            |        |  |   |        |  |
| 2.3 V5 4motion |                 |         | 02.99       | 12.04       | PR: 1KE,1KP,1KT |                 |                |                |  |   |                                  |            |        |  |   |        |  |
| 2.8 V6 4motion | 150             |         | 05.99       | 12.04       | PR: 1KE,1KP,1KT |                 |                |                |  |   |                                  |            |        |  |   |        |  |
|                | 1.4 16V         |         |             | 09.98       | 12.04           | PR: 1KU,1KY,2EE | 24.3384-1745.7 | 220609         |  |   | D=38, - Halter<br>D=38, - Halter | LUC<br>LUC |        |  |   |        |  |
|                | 1.6             |         |             | 09.98       | 12.04           | PR: 1KU,1KY,2EE | 24.3384-1746.7 | 220610         |  |   |                                  |            |        |  |   |        |  |
|                | 1.6 16V         |         |             | 02.00       | 12.04           | PR: 1KU,1KY,2EE |                |                |  |   |                                  |            |        |  |   |        |  |
|                | 1.6 FSI         |         |             | 01.02       | 12.04           | PR: 1KU,1KY,2EE |                |                |  |   |                                  |            |        |  |   |        |  |
|                | 1.8             | 92      |             | 09.98       | 12.04           | PR: 1KU,1KY,2EE |                |                |  |   |                                  |            |        |  |   |        |  |
|                | 1.8 4motion     | 92      |             | 02.99       | 12.04           | PR: 1KU,1KY,2EE |                |                |  |   |                                  |            |        |  |   |        |  |
|                | 1.8 T           | 110     |             | 09.00       | 12.04           | PR: 1KU,1KY,2EE |                |                |  |   |                                  |            |        |  |   |        |  |
|                | 1.8 T           | 132     |             | 05.02       | 12.04           | PR: 1KU,1KY,2EE |                |                |  |   |                                  |            |        |  |   |        |  |
|                | 1.9 SDI         |         |             | 09.98       | 12.04           | PR: 1KU,1KY,2EE |                |                |  |   |                                  |            |        |  |   |        |  |
|                | 1.9 TDI         | 66      |             | 09.98       | 06.01           | PR: 1KU,1KY,2EE |                |                |  |   |                                  |            |        |  |   |        |  |
|                | 1.9 TDI         | 74      |             | 09.00       | 12.04           | PR: 1KU,1KY,2EE |                |                |  |   |                                  |            |        |  |   |        |  |
|                | 1.9 TDI         | 81      |             | 09.98       | 06.01           | PR: 1KU,1KY,2EE |                |                |  |   |                                  |            |        |  |   |        |  |
|                | 1.9 TDI         | 85      |             | 02.99       | 06.01           | PR: 1KU,1KY,2EE |                |                |  |   |                                  |            |        |  |   |        |  |
|                | 1.9 TDI         | 96      |             | 04.01       | 12.04           | PR: 1KU,1KY,2EE |                |                |  |   |                                  |            |        |  |   |        |  |
|                | 1.9 TDI         | 110     |             | 10.00       | 12.04           | PR: 1KU,1KY,2EE |                |                |  |   |                                  |            |        |  |   |        |  |
|                | 1.9 TDI 4motion | 66      |             | 02.99       | 06.01           | PR: 1KU,1KY,2EE |                |                |  |   |                                  |            |        |  |   |        |  |
|                | 1.9 TDI 4motion | 74      |             | 09.00       | 12.04           | PR: 1KU,1KY,2EE |                |                |  |   |                                  |            |        |  |   |        |  |
|                | 1.9 TDI 4motion | 85      |             | 02.99       | 06.01           | PR: 1KU,1KY,2EE |                |                |  |   |                                  |            |        |  |   |        |  |
|                | 1.9 TDI 4motion | 96      |             | 04.01       | 12.04           | PR: 1KU,1KY,2EE |                |                |  |   |                                  |            |        |  |   |        |  |
|                | 1.9 TDI 4motion | 110     |             | 10.00       | 12.04           | PR: 1KU,1KY,2EE |                |                |  |   |                                  |            |        |  |   |        |  |
|                | 2.0             | 85      |             | 09.98       | 12.04           | PR: 1KU,1KY,2EE |                |                |  |   |                                  |            |        |  |   |        |  |
|                | 2.0 4motion     | 85      |             | 04.00       | 12.04           | PR: 1KU,1KY,2EE |                |                |  |   |                                  |            |        |  |   |        |  |
|                | 2.3 V5          |         |             | 09.98       | 12.04           | PR: 1KU,1KY,2EE |                |                |  |   |                                  |            |        |  |   |        |  |
|                | 2.3 V5 4motion  |         |             | 02.99       | 12.04           | PR: 1KU,1KY,2EE |                |                |  |   |                                  |            |        |  |   |        |  |
|                | 2.8 V6 4motion  | 150     |             | 05.99       | 12.04           | PR: 1KU,1KY,2EE |                |                |  |   |                                  |            |        |  |   |        |  |
|                |                 | 1.4 16V |             |             | 09.98           | 12.04           |                | 83.7858-0140.3 |  |   |                                  |            | 330837 |  | 2 | L=140  |  |
|                |                 | 1.6     |             |             | 09.98           | 12.04           |                |                |  |   |                                  |            |        |  |   |        |  |
|                |                 | 1.6 16V |             |             | 02.00           | 12.04           |                |                |  |   |                                  |            |        |  |   |        |  |
| 1.6 FSI        |                 |         |             | 01.02       | 12.04           |                 |                |                |  |   |                                  |            |        |  |   |        |  |
| 1.8            |                 | 92      |             | 09.98       | 12.04           |                 |                |                |  |   |                                  |            |        |  |   |        |  |
| 1.8 T          |                 | 110     |             | 09.00       | 12.04           |                 |                |                |  |   |                                  |            |        |  |   |        |  |
| 1.8 T          |                 | 132     |             | 05.02       | 12.04           |                 |                |                |  |   |                                  |            |        |  |   |        |  |
| 1.9 SDI        |                 |         |             | 09.98       | 12.04           |                 |                |                |  |   |                                  |            |        |  |   |        |  |
| 1.9 TDI        |                 | 66      |             | 09.98       | 06.01           |                 |                |                |  |   |                                  |            |        |  |   |        |  |
| 1.9 TDI        |                 | 74      |             | 09.00       | 12.04           |                 |                |                |  |   |                                  |            |        |  |   |        |  |
| 1.9 TDI        |                 | 81      |             | 09.98       | 06.01           |                 |                |                |  |   |                                  |            |        |  |   |        |  |
| 1.9 TDI        |                 | 85      |             | 02.99       | 06.01           |                 |                |                |  |   |                                  |            |        |  |   |        |  |
| 1.9 TDI        |                 | 96      |             | 04.01       | 12.04           |                 |                |                |  |   |                                  |            |        |  |   |        |  |
| 1.9 TDI        |                 | 110     |             | 10.00       | 12.04           |                 |                |                |  |   |                                  |            |        |  |   |        |  |
| 2.0            | 85              |         | 09.98       | 12.04       |                 |                 |                |                |  |   |                                  |            |        |  |   |        |  |
| 2.3 V5         |                 |         | 09.98       | 12.04       |                 |                 |                |                |  |   |                                  |            |        |  |   |        |  |
|                | 1.8 4motion     | 92      |             | 02.99       | 12.04           |                 | 83.7858-0140.3 | 330837         |  | 2 | L=140                            |            |        |  |   |        |  |
|                | 1.9 TDI 4motion | 66      |             | 02.99       | 06.01           |                 |                |                |  |   |                                  |            |        |  |   |        |  |
|                | 1.9 TDI 4motion | 74      |             | 09.00       | 12.04           |                 |                |                |  |   |                                  |            |        |  |   |        |  |
|                | 1.9 TDI 4motion | 85      |             | 02.99       | 06.01           |                 |                |                |  |   |                                  |            |        |  |   |        |  |
|                | 1.9 TDI 4motion | 96      |             | 04.01       | 12.04           |                 |                |                |  |   |                                  |            |        |  |   |        |  |
|                | 1.9 TDI 4motion | 110     |             | 10.00       | 12.04           |                 |                |                |  |   |                                  |            |        |  |   |        |  |
|                | 2.0 4motion     | 85      |             | 04.00       | 12.04           |                 |                |                |  |   |                                  |            |        |  |   |        |  |
|                | 2.3 V5 4motion  |         |             | 02.99       | 12.04           |                 |                |                |  |   |                                  |            |        |  |   |        |  |
|                | 2.8 V6 4motion  | 150     |             | 05.99       | 12.04           |                 |                |                |  |   |                                  |            |        |  |   |        |  |
|                |                 | 1.4 16V |             | 1J-YW238580 | 09.98           |                 |                | 24.3727-0149.2 |  |   |                                  |            | 580149 |  | 2 | L=1688 |  |
|                |                 | 1.6     |             | 1J-YW238580 | 09.98           |                 |                |                |  |   |                                  |            |        |  |   |        |  |
|                |                 | 1.8     | 92          | 1J-YW238580 | 09.98           |                 |                |                |  |   |                                  |            |        |  |   |        |  |
|                |                 | 1.9 SDI |             | 1J-YW238580 | 09.98           |                 |                |                |  |   |                                  |            |        |  |   |        |  |
|                |                 | 1.9 TDI | 66          | 1J-YW238580 | 09.98           |                 |                |                |  |   |                                  |            |        |  |   |        |  |
| 1.9 TDI        |                 | 81      | 1J-YW238580 | 09.98       |                 |                 |                |                |  |   |                                  |            |        |  |   |        |  |
| 1.9 TDI        |                 | 85      | 1J-YW238580 | 02.99       |                 |                 |                |                |  |   |                                  |            |        |  |   |        |  |
| 2.0            |                 | 85      | 1J-YW238580 | 09.98       |                 |                 |                |                |  |   |                                  |            |        |  |   |        |  |
|                | 1.4 16V         |         | 1J-YW238581 |             | 12.04           |                 | 24.3727-0173.2 | 580173         |  | 2 | L=1693                           |            |        |  |   |        |  |
|                | 1.6             |         | 1J-YW238581 |             | 12.04           |                 |                |                |  |   |                                  |            |        |  |   |        |  |
|                | 1.6 16V         |         |             | 02.00       | 12.04           |                 |                |                |  |   |                                  |            |        |  |   |        |  |
|                | 1.6 FSI         |         |             | 01.02       | 12.04           |                 |                |                |  |   |                                  |            |        |  |   |        |  |
|                | 1.8             | 92      | 1J-YW238581 |             | 12.04           |                 |                |                |  |   |                                  |            |        |  |   |        |  |
|                | 1.8 T           | 110     |             | 09.00       | 12.04           |                 |                |                |  |   |                                  |            |        |  |   |        |  |
|                | 1.8 T           | 132     |             | 05.02       | 12.04           |                 |                |                |  |   |                                  |            |        |  |   |        |  |
|                | 1.9 SDI         |         | 1J-YW238581 |             | 12.04           |                 |                |                |  |   |                                  |            |        |  |   |        |  |
|                | 1.9 TDI         | 66      | 1J-YW238581 |             | 06.01           |                 |                |                |  |   |                                  |            |        |  |   |        |  |
|                | 1.9 TDI         | 74      |             | 09.00       | 12.04           |                 |                |                |  |   |                                  |            |        |  |   |        |  |
|                | 1.9 TDI         | 81      | 1J-YW238581 |             | 06.01           |                 |                |                |  |   |                                  |            |        |  |   |        |  |
|                | 1.9 TDI         | 85      | 1J-YW238581 |             | 06.01           |                 |                |                |  |   |                                  |            |        |  |   |        |  |
|                | 1.9 TDI         | 96      |             | 04.01       | 12.04           |                 |                |                |  |   |                                  |            |        |  |   |        |  |



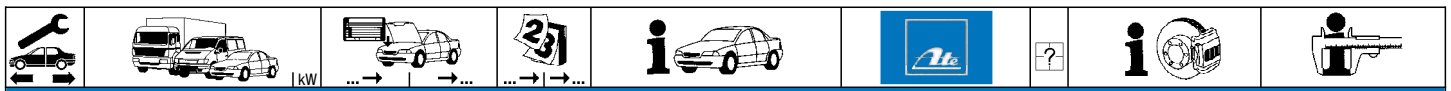





































**VOLKSWAGEN BORA (98-04)**

|                 |                 |         |             |       |       |                |                |        |   |          |          |
|-----------------|-----------------|---------|-------------|-------|-------|----------------|----------------|--------|---|----------|----------|
|                 | 1.9 TDI         | 110     |             | 10.00 | 12.04 | 24.3727-0173.2 | 580173         | 2 ↓    |   | L=1693   |          |
|                 | 2.0             | 85      | 1J-YW238581 |       | 12.04 |                |                |        |   |          |          |
|                 | 2.3 V5          |         | 1J-YW238581 |       | 12.04 |                |                |        |   |          |          |
|                 | 1.8 4motion     | 92      |             | 02.99 | 12.04 | 24.3727-0175.2 | 580175         | 2 ↓    |   | L=1723   |          |
|                 | 1.9 TDI 4motion | 66      |             | 02.99 | 06.01 |                |                |        |   |          |          |
|                 | 1.9 TDI 4motion | 74      |             | 09.00 | 12.04 |                |                |        |   |          |          |
|                 | 1.9 TDI 4motion | 85      |             | 02.99 | 06.01 |                |                |        |   |          |          |
|                 | 1.9 TDI 4motion | 96      |             | 04.01 | 12.04 |                |                |        |   |          |          |
|                 | 1.9 TDI 4motion | 110     |             | 10.00 | 12.04 |                |                |        |   |          |          |
| 2.0 4motion     | 85              |         | 04.00       | 12.04 |       |                |                |        |   |          |          |
| 2.3 V5 4motion  |                 |         | 02.99       | 12.04 |       |                |                |        |   |          |          |
| 2.8 V6 4motion  | 150             |         | 05.99       | 12.04 |       |                |                |        |   |          |          |
|                 | 1.4 16V         |         |             | 09.98 | 12.04 | 24.2415-1701.3 | 030095         |        |   | Gz 15,87 |          |
|                 | 1.6             |         |             | 09.98 | 12.04 |                |                |        |   |          |          |
|                 | 1.6 16V         |         |             | 02.00 | 12.04 |                |                |        |   |          |          |
|                 | 1.6 FSI         |         |             | 01.02 | 12.04 |                |                |        |   |          |          |
|                 | 1.8             | 92      |             | 09.98 | 12.04 |                |                |        |   |          |          |
|                 | 1.8 4motion     | 92      |             | 02.99 | 12.04 |                |                |        |   |          |          |
|                 | 1.8 T           | 110     |             | 09.00 | 12.04 |                |                |        |   |          |          |
|                 | 1.8 T           | 132     |             | 05.02 | 12.04 |                |                |        |   |          |          |
|                 | 1.9 SDI         |         |             | 09.98 | 12.04 |                |                |        |   |          |          |
|                 | 1.9 TDI         | 66      |             | 09.98 | 06.01 |                |                |        |   |          |          |
|                 | 1.9 TDI         | 74      |             | 09.00 | 12.04 |                |                |        |   |          |          |
|                 | 1.9 TDI         | 81      |             | 09.98 | 06.01 |                |                |        |   |          |          |
|                 | 1.9 TDI         | 85      |             | 02.99 | 06.01 |                |                |        |   |          |          |
|                 | 1.9 TDI         | 96      |             | 04.01 | 12.04 |                |                |        |   |          |          |
|                 | 1.9 TDI         | 110     |             | 10.00 | 12.04 |                |                |        |   |          |          |
|                 | 1.9 TDI 4motion | 66      |             | 02.99 | 06.01 |                |                |        |   |          |          |
|                 | 1.9 TDI 4motion | 74      |             | 09.00 | 12.04 |                |                |        |   |          |          |
|                 | 1.9 TDI 4motion | 85      |             | 02.99 | 06.01 |                |                |        |   |          |          |
|                 | 1.9 TDI 4motion | 96      |             | 04.01 | 12.04 |                |                |        |   |          |          |
|                 | 1.9 TDI 4motion | 110     |             | 10.00 | 12.04 |                |                |        |   |          |          |
|                 | 2.0             | 85      |             | 09.98 | 12.04 |                |                |        |   |          |          |
|                 | 2.0 4motion     | 85      |             | 04.00 | 12.04 |                |                |        |   |          |          |
|                 | 2.3 V5          |         |             | 09.98 | 12.04 |                |                |        |   |          |          |
|                 | 2.3 V5 4motion  |         |             | 02.99 | 12.04 |                |                |        |   |          |          |
|                 | 2.8 V6 4motion  | 150     |             | 05.99 | 12.04 |                |                |        |   |          |          |
|                 |                 | 1.4 16V |             |       | 09.98 | 12.04          | 24.2415-1702.3 | 030096 |   |          | Gz 15,87 |
|                 |                 | 1.6     |             |       | 09.98 | 12.04          |                |        |   |          |          |
|                 |                 | 1.6 16V |             |       | 02.00 | 12.04          |                |        |   |          |          |
| 1.6 FSI         |                 |         |             | 01.02 | 12.04 |                |                |        |   |          |          |
| 1.8             |                 | 92      |             | 09.98 | 12.04 |                |                |        |   |          |          |
| 1.8 4motion     |                 | 92      |             | 02.99 | 12.04 |                |                |        |   |          |          |
| 1.8 T           |                 | 110     |             | 09.00 | 12.04 |                |                |        |   |          |          |
| 1.8 T           |                 | 132     |             | 05.02 | 12.04 |                |                |        |   |          |          |
| 1.9 SDI         |                 |         |             | 09.98 | 12.04 |                |                |        |   |          |          |
| 1.9 TDI         |                 | 66      |             | 09.98 | 06.01 |                |                |        |   |          |          |
| 1.9 TDI         |                 | 74      |             | 09.00 | 12.04 |                |                |        |   |          |          |
| 1.9 TDI         |                 | 81      |             | 09.98 | 06.01 |                |                |        |   |          |          |
| 1.9 TDI         |                 | 85      |             | 02.99 | 06.01 |                |                |        |   |          |          |
| 1.9 TDI         |                 | 96      |             | 04.01 | 12.04 |                |                |        |   |          |          |
| 1.9 TDI         |                 | 110     |             | 10.00 | 12.04 |                |                |        |   |          |          |
| 1.9 TDI 4motion |                 | 66      |             | 02.99 | 06.01 |                |                |        |   |          |          |
| 1.9 TDI 4motion |                 | 74      |             | 09.00 | 12.04 |                |                |        |   |          |          |
| 1.9 TDI 4motion |                 | 85      |             | 02.99 | 06.01 |                |                |        |   |          |          |
| 1.9 TDI 4motion |                 | 96      |             | 04.01 | 12.04 |                |                |        |   |          |          |
| 1.9 TDI 4motion |                 | 110     |             | 10.00 | 12.04 |                |                |        |   |          |          |
| 2.0             |                 | 85      |             | 09.98 | 12.04 |                |                |        |   |          |          |
| 2.0 4motion     |                 | 85      |             | 04.00 | 12.04 |                |                |        |   |          |          |
| 2.3 V5          |                 |         |             | 09.98 | 12.04 |                |                |        |   |          |          |
| 2.3 V5 4motion  |                 |         |             | 02.99 | 12.04 |                |                |        |   |          |          |
| 2.8 V6 4motion  |                 | 150     |             | 05.99 | 12.04 |                |                |        |   |          |          |
|                 |                 | 1.4 16V |             |       | 09.98 | 12.04          | 24.2519-1701.3 | 040075 | + Schaltseilzug <sup>1)</sup><br>+ Schaltgestänge <sup>2)</sup> |          | Nz 19,05 |
|                 |                 | 1.6     |             |       | 09.98 | 12.04          | 24.2523-1701.3 | 040080 |   | Nz 23,81 |          |
|                 |                 | 1.6 16V |             |       | 02.00 | 12.04          |                |        |   |          |          |
|                 | 1.6 FSI         |         |             | 01.02 | 12.04 |                |                |        |   |          |          |
|                 | 1.8             | 92      |             | 09.98 | 12.04 |                |                |        |   |          |          |
|                 | 1.8 4motion     | 92      |             | 02.99 | 12.04 |                |                |        |   |          |          |
|                 | 1.8 T           | 110     |             | 09.00 | 12.04 |                |                |        |   |          |          |
|                 | 1.8 T           | 132     |             | 05.02 | 12.04 |                |                |        |   |          |          |
|                 | 1.9 SDI         |         |             | 09.98 | 12.04 |                |                |        |   |          |          |
|                 | 1.9 TDI         | 66      |             | 09.98 | 06.01 |                |                |        |   |          |          |
|                 | 1.9 TDI         | 74      |             | 09.00 | 12.04 |                |                |        |   |          |          |
|                 | 1.9 TDI         | 81      |             | 09.98 | 06.01 |                |                |        |   |          |          |
|                 | 1.9 TDI         | 85      |             | 02.99 | 06.01 |                |                |        |   |          |          |
|                 | 1.9 TDI         | 96      |             | 04.01 | 12.04 |                |                |        |   |          |          |
|                 | 1.9 TDI         | 110     |             | 10.00 | 12.04 |                |                |        |   |          |          |
|                 | 1.9 TDI 4motion | 66      |             | 02.99 | 06.01 |                |                |        |   |          |          |
|                 | 1.9 TDI 4motion | 74      |             | 09.00 | 12.04 |                |                |        |   |          |          |
|                 | 1.9 TDI 4motion | 85      |             | 02.99 | 06.01 |                |                |        |   |          |          |
|                 | 1.9 TDI 4motion | 96      |             | 04.01 | 12.04 |                |                |        |   |          |          |
|                 | 1.9 TDI 4motion | 110     |             | 10.00 | 12.04 |                |                |        |   |          |          |
|                 | 2.0             | 85      |             | 09.98 | 12.04 |                |                |        |   |          |          |
|                 | 2.0 4motion     | 85      |             | 04.00 | 12.04 |                |                |        |   |          |          |
|                 | 2.3 V5          |         |             | 09.98 | 12.04 |                |                |        |   |          |          |
|                 | 2.3 V5 4motion  |         |             | 02.99 | 12.04 |                |                |        |   |          |          |
|                 | 2.8 V6 4motion  | 150     |             | 05.99 | 12.04 |                |                |        |   |          |          |

<sup>1)</sup> + gearshift cable / + leva cambio con cavo / + câble de changem.de vitesse / + cable de acc. del cambio

<sup>2)</sup> + gearshift linkage / + leva cambio con tiraneria / + tige de changem.de vitesse / + varillaje del cambio

|     |    kW |  |  |  |  |  |  |     |                   |     |
|--|---|--|--|--|---|--|--|---|-------------------|-----|
| <b>VOLKSWAGEN CADDY II (96-03)</b>   |   |  |  |  |   |  |  |   |                   |     |
|    | 1.4   | ↔  |  | 11.95  | 06.03   | 03.7750-6302.4   | 300161   | - ABS   | 9"                | ATE |
|  | 1.6   | ↔  |  | 11.95  | 06.03   |  |  |   |                   |     |
|  | 1.7 SDI   | ↔  |  | 07.96  | 06.03   |  |  |   |                   |     |
|  | 1.9 D   | ↔  |  | 11.95  | 06.03   |  |  |   |                   |     |
|  | 1.9 SDI   | ↔  |  | 11.95  | 06.03   |  |  |   |                   |     |
|  | 1.9 TDI   | ↔  |  | 09.96  | 06.03   |  |  |   |                   |     |
|  | 1.4   | ↔  | 9K-1-538 270   | 11.95  |   | 10.6350-3902.4   | 300213   | + ABS   | 9"                | ATE |
|  | 1.6   | ↔  | 9K-1-538 270   | 11.95  |   |  |  |   |                   |     |
|  | 1.7 SDI   | ↔  | 9K-1-538 270   | 07.96  |   |  |  |   |                   |     |
|  | 1.9 D   | ↔  | 9K-1-538 270   | 11.95  |   |  |  |   |                   |     |
|  | 1.9 SDI   | ↔  | 9K-1-538 270   | 11.95  |   |  |  |   |                   |     |
|  | 1.9 TDI   | ↔  | 9K-1-538 270   | 09.96  |   |  |  |   |                   |     |
|  | 1.4   | ↔  | 9K-1-538 271   |  | 06.03   | 10.6350-4002.4   | 300285   | + ABS   | 9"                | ATE |
|  | 1.6   | ↔  | 9K-1-538 271   |  | 06.03   |  |  |   |                   |     |
|  | 1.7 SDI   | ↔  | 9K-1-538 271   |  | 06.03   |  |  |   |                   |     |
|  | 1.9 D   | ↔  | 9K-1-538 271   |  | 06.03   |  |  |   |                   |     |
|  | 1.9 SDI   | ↔  | 9K-1-538 271   |  | 06.03   |  |  |   |                   |     |
|  | 1.9 TDI   | ↔  | 9K-1-538 271   |  | 06.03   |  |  |   |                   |     |
|    | 1.4   | ↔  | 9K-X-514000  | 11.95  | - ABS   | 03.2122-1042.3   | 010137   |   | THz 22,20         | ATE |
|  | 1.4   | ↔  |  | 11.95  | - ABS   | 03.3517-0101.2   | 390322   |   | Verschlußschraube |     |
|  | 1.6   | ↔  | 9K-X-514000  | 11.95  | - ABS   |  |  |   |                   |     |
|  | 1.6   | ↔  |  | 11.95  | - ABS   |  |  |   |                   |     |
|  | 1.7 SDI   | ↔  | 9K-X-514000  | 07.96  | - ABS   |  |  |   |                   |     |
|  | 1.7 SDI   | ↔  |  | 07.96  | - ABS   |  |  |   |                   |     |
|  | 1.9 D   | ↔  | 9K-X-514000  | 11.95  | - ABS   |  |  |   |                   |     |
|  | 1.9 D   | ↔  |  | 11.95  | - ABS   |  |  |   |                   |     |
|  | 1.9 SDI   | ↔  | 9K-X-514000  | 11.95  | - ABS   |  |  |   |                   |     |
|  | 1.9 SDI   | ↔  |  | 11.95  | - ABS   |  |  |   |                   |     |
|  | 1.9 TDI   | ↔  | 9K-X-514000  | 09.96  | - ABS   |  |  |   |                   |     |
|  | 1.9 TDI   | ↔  |  | 09.96  | - ABS   |  |  |   |                   |     |
|  | 1.4   | ↔  |  | 11.95  | 06.03 + ABS   | 03.2123-1424.3   | 010637   |   | THz 23,81         | ATE |
|  | 1.6   | ↔  |  | 11.95  | 06.03 + ABS   |  |  |   |                   |     |
|  | 1.7 SDI   | ↔  |  | 07.96  | 06.03 + ABS   |  |  |   |                   |     |
|  | 1.9 D   | ↔  |  | 11.95  | 06.03 + ABS   |  |  |   |                   |     |
|  | 1.9 SDI   | ↔  |  | 11.95  | 06.03 + ABS   |  |  |   |                   |     |
|  | 1.9 TDI   | ↔  |  | 09.96  | 06.03 + ABS   |  |  |   |                   |     |
|  | 1.4   | ↔  |  | 11.95  | 06.03 + ABS   | 03.2123-1484.3   | 010595   |   | THz 23,81         | ATE |
|  | 1.6   | ↔  |  | 11.95  | 06.03 + ABS   |  |  |   |                   |     |
|  | 1.9 D   | ↔  |  | 11.95  | 06.03 + ABS   |  |  |   |                   |     |
|  | 1.9 SDI   | ↔  |  | 11.95  | 06.03 + ABS   |  |  |   |                   |     |
|  | 1.9 TDI   | ↔  |  | 09.96  | 06.03 + ABS   |  |  |   |                   |     |
|  | 1.4   |  |  | 11.95  | 06.03   | 24.3541-1609.5   | 240039   |  | D=54, - Halter    | LUC |
|  | 1.6   |  |  | 11.95  | 06.03   | 24.3541-1610.5   | 240040   |  | D=54, - Halter    | LUC |
|  | 1.7 SDI   |  |  | 07.96  | 06.03   | 24.0101-4301.2   | 260047   |   | Einbausatz        | LUC |
|  | 1.9 D   |  |  | 11.95  | 06.03   | 11.0101-5403.2   | 260010   |   | Faltenbalgsatz    | LUC |
|  | 1.9 SDI   |  |  | 11.95  | 06.03   |  |  |   |                   |     |
|  | 1.9 TDI   |  |  | 09.96  | 06.03   |  |  |   |                   |     |
|  | 1.4   |  |  | 11.95  | 06.03   | 83.7713-0435.3   | 330792   | 2   | L=435             |     |
|  | 1.6   |  |  | 11.95  | 06.03   |  |  |   |                   |     |
|  | 1.7 SDI   |  |  | 07.96  | 06.03   |  |  |   |                   |     |
|  | 1.9 D   |  |  | 11.95  | 06.03   |  |  |   |                   |     |
|  | 1.9 SDI   |  |  | 11.95  | 06.03   |  |  |   |                   |     |
|  | 1.9 TDI   |  |  | 09.96  | 06.03   |  |  |   |                   |     |
|  | 1.4   |  |  | 11.95  | 06.03   | 83.6236-0402.3   | 330464   | 2   | L=400             |     |
|  | 1.6   |  |  | 11.95  | 06.03   |  |  |   |                   |     |
|  | 1.7 SDI   |  |  | 07.96  | 06.03   |  |  |   |                   |     |
|  | 1.9 D   |  |  | 11.95  | 06.03   |  |  |   |                   |     |
|  | 1.9 SDI   |  |  | 11.95  | 06.03   |  |  |   |                   |     |
|  | 1.9 TDI   |  |  | 09.96  | 06.03   |  |  |   |                   |     |
|  | 1.4   |  |  | 11.95  | 06.03   | 24.3220-0909.3   | 020210   |   | Rz 20,64          |     |
|  | 1.6   |  |  | 11.95  | 06.03   |  |  |   |                   |     |
|  | 1.7 SDI   |  |  | 07.96  | 06.03   |  |  |   |                   |     |
|  | 1.9 D   |  |  | 11.95  | 06.03   |  |  |   |                   |     |
|  | 1.9 SDI   |  |  | 11.95  | 06.03   |  |  |   |                   |     |
|  | 1.9 TDI   |  |  | 09.96  | 06.03   |  |  |   |                   |     |
|  | 1.4   |  |  | 11.95  | 06.03   | 24.3727-2700.2   | 582700   | 2 ↓   | L=1671            |     |
|  | 1.6   |  |  | 11.95  | 06.03   |  |  |   |                   |     |
|  | 1.7 SDI   |  |  | 07.96  | 06.03   |  |  |   |                   |     |
|  | 1.9 D   |  |  | 11.95  | 06.03   |  |  |   |                   |     |
|  | 1.9 SDI   |  |  | 11.95  | 06.03   |  |  |   |                   |     |
|  | 1.9 TDI   |  |  | 09.96  | 06.03   |  |  |   |                   |     |
|  | 1.9 TDI   | ↔  |  | 09.96  | 06.03   | 03.2419-9510.3   | 030028   |   | Gz 19,05          |     |
|  | 1.9 TDI   |  |  | 09.96  | 06.03   | 24.2523-0908.3   | 040049   |   | Nz 23,81          |     |
|  | 1.4   | ↔  |  | 11.95  | 06.03   | 24.3728-2707.2   | 592707   |   | L=1047, + AUT     |     |
|  | 1.6   | ↔  |  | 11.95  | 06.03   | 24.3728-0128.2   | 590128   |   | L=854, + AUT      |     |
|  | 1.7 SDI   | ↔  |  | 07.96  | 06.03   |  |  |   |                   |     |
|  | 1.9 D   | ↔  |  | 11.95  | 06.03   |  |  |   |                   |     |
|  | 1.9 SDI   | ↔  |  | 11.95  | 06.03   |  |  |   |                   |     |

|     |    kW   |  |    |   |       |  |          |  |                                 |
|--|---|--|--|---|--|--|--|--|---------------------------------|
| <b>VOLKSWAGEN CADDY III (04-)</b>  |   |  |  |   |  |  |  |  |                                 |
|    | 1.2 TSI<br>1.4<br>1.4 16V<br>1.6<br>1.6 TDI<br>1.9 TDI<br>1.9 TDI<br>1.9 TDI 4motion<br>2.0 Eco Fuel<br>2.0 SDI<br>2.0 TDI<br>2.0 TDI<br>2.0 TDI 4motion            | 55<br>59<br>55<br>77<br>77<br>80<br>51<br>81<br>103<br>125<br>81                 | 09.10<br>02.04<br>05.06<br>04.04<br>08.10<br>09.05<br>02.04<br>05.08<br>04.06<br>02.04<br>10.10<br>09.07<br>05.12<br>10.10 |   | 03.7873-3602.4   | 300209   |  | 11" ATE  |                                 |
|    | 1.2 TSI<br>1.4<br>1.4 16V<br>1.6<br>1.6 TDI<br>1.9 TDI<br>1.9 TDI<br>1.9 TDI 4motion<br>2.0 Eco Fuel<br>2.0 SDI<br>2.0 TDI<br>2.0 TDI<br>2.0 TDI<br>2.0 TDI 4motion | 55<br>59<br>55<br>77<br>77<br>80<br>51<br>81<br>103<br>125<br>81                 | 09.10<br>02.04<br>05.06<br>04.04<br>08.10<br>09.05<br>02.04<br>05.08<br>04.06<br>02.04<br>10.10<br>09.07<br>05.12<br>10.10 |   | 03.2122-2129.3   | 010799   |  | 1Hz 22,20 ATE  |                                 |
|    | 1.2 TSI<br>1.4<br>1.4 16V<br>1.6<br>1.6 TDI<br>1.9 TDI<br>1.9 TDI<br>1.9 TDI 4motion<br>2.0 Eco Fuel<br>2.0 SDI<br>2.0 TDI<br>2.0 TDI<br>2.0 TDI<br>2.0 TDI 4motion | 55<br>59<br>55<br>77<br>77<br>80<br>51<br>81<br>103<br>125<br>81                 | 09.10<br>02.04<br>05.06<br>04.04<br>08.10<br>09.05<br>02.04<br>05.08<br>04.06<br>02.04<br>10.10<br>09.07<br>05.12<br>10.10 | PR: 1ZF,1ZM<br>PR: 1ZF,1ZM<br>PR: 1ZF,1ZM<br>PR: 1ZF,1ZM<br>PR: 1ZF,1ZM<br>PR: 1ZF,1ZM<br>PR: 1ZF,1ZM<br>PR: 1ZF,1ZM<br>PR: 1ZF,1ZM<br>PR: 1ZF,1ZM<br>PR: 1ZF,1ZM<br>PR: 1ZF,1ZM<br>PR: 1ZF,1ZM | 11.9541-9549.2<br>11.9541-9550.2<br>11.0101-5409.2                                     | 220575<br>220576<br>260035   |         | D=54, - Halter<br>D=54, - Halter<br>Hülsensatz                                     | ATE<br>ATE<br>ATE               |
|  | 1.2 TSI<br>1.4<br>1.4 16V<br>1.6<br>1.6 TDI<br>1.9 TDI<br>1.9 TDI<br>1.9 TDI 4motion<br>2.0 Eco Fuel<br>2.0 SDI<br>2.0 TDI<br>2.0 TDI<br>2.0 TDI<br>2.0 TDI 4motion | 55<br>59<br>55<br>77<br>77<br>80<br>51<br>81<br>103<br>125<br>81                 | 09.10<br>02.04<br>05.06<br>04.04<br>08.10<br>09.05<br>02.04<br>05.08<br>04.06<br>02.04<br>10.10<br>09.07<br>05.12<br>10.10 | PR: 1ZE<br>PR: 1ZE<br>PR: 1ZE<br>PR: 1ZE<br>PR: 1ZE<br>PR: 1ZE<br>PR: 1ZE<br>PR: 1ZE<br>PR: 1ZE<br>PR: 1ZE<br>PR: 1ZE<br>PR: 1ZE<br>PR: 1ZE   | 11.9541-9553.2<br>11.9541-9554.2<br>11.0101-5409.2<br>11.8171-0008.1<br>11.8116-0351.1 | 220563<br>220564<br>260035<br>990049<br>390538                                     | <br>2 | D=54, - Halter<br>D=54, - Halter<br>Hülsensatz<br>Führungsbolzen<br>Haltefeder     | ATE<br>ATE<br>ATE<br>ATE<br>ATE |
|  | 1.2 TSI<br>1.4<br>1.4 16V<br>1.6<br>1.6 TDI<br>1.9 TDI<br>1.9 TDI<br>1.9 TDI 4motion<br>2.0 Eco Fuel<br>2.0 SDI<br>2.0 TDI<br>2.0 TDI<br>2.0 TDI<br>2.0 TDI 4motion | 55<br>59<br>55<br>77<br>77<br>80<br>51<br>81<br>103<br>125<br>81                 | 09.10<br>02.04<br>05.06<br>04.04<br>08.10<br>09.05<br>02.04<br>05.08<br>04.06<br>02.04<br>10.10<br>09.07<br>05.12<br>10.10 | PR: 1LJ,1ZA<br>PR: 1LJ,1ZA<br>PR: 1LJ,1ZA<br>PR: 1LJ,1ZA<br>PR: 1LJ,1ZA<br>PR: 1LJ,1ZA<br>PR: 1LJ,1ZA<br>PR: 1LJ,1ZA<br>PR: 1LJ,1ZA<br>PR: 1LJ,1ZA<br>PR: 1LJ,1ZA<br>PR: 1LJ,1ZA<br>PR: 1LJ,1ZA | 11.9541-9553.2<br>11.9541-9554.2<br>11.0101-5409.2<br>11.8171-0008.1<br>11.8116-0351.1 | 220563<br>220564<br>260035<br>990049<br>390538                                     | <br>2 | D=54, - Halter<br>D=54, - Halter<br>Hülsensatz<br>Führungsbolzen<br>Haltefeder     | ATE<br>ATE<br>ATE<br>ATE<br>ATE |
|  | 1.2 TSI<br>1.4<br>1.4 16V<br>1.6<br>1.6 TDI<br>1.9 TDI<br>1.9 TDI<br>1.9 TDI 4motion<br>2.0 Eco Fuel<br>2.0 SDI<br>2.0 TDI<br>2.0 TDI<br>2.0 TDI<br>2.0 TDI 4motion | 55<br>59<br>55<br>77<br>77<br>80<br>51<br>81<br>103<br>125<br>81                 | 09.10<br>02.04<br>05.06<br>04.04<br>08.10<br>09.05<br>02.04<br>05.08<br>04.06<br>02.04<br>10.10<br>09.07<br>05.12<br>10.10 |   | 83.7847-0563.3   | 331124   | 2  | L=562  |                                 |

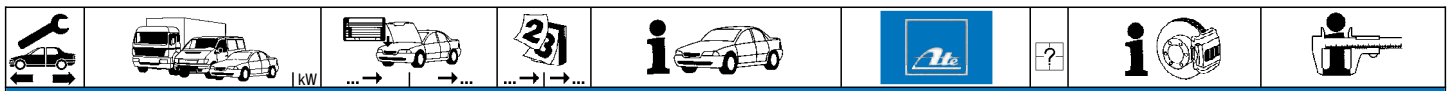

**VOLKSWAGEN CADDY III (04-)**























|                 |                 |              |              |       |             |                |                |        |        |  |                                      |            |        |  |                                  |            |
|-----------------|-----------------|--------------|--------------|-------|-------------|----------------|----------------|--------|--------|--|--------------------------------------|------------|--------|--|----------------------------------|------------|
|                 | 1.4             | 55           |              | 02.04 | 11.07       |                | 24.3417-1701.7 | 220679 | ☐<br>☐ |  | D=41, - Halter<br>D=41, - Halter     | LUC<br>LUC |        |  |                                  |            |
|                 | 1.4 16V         | 59           |              | 05.06 | 11.07       |                | 24.3417-1702.7 | 220680 |        |  |                                      |            |        |  |                                  |            |
|                 | 1.6             |              |              | 04.04 | 11.07       |                |                |        |        |  |                                      |            |        |  |                                  |            |
|                 | 1.9 TDI         | 55           |              | 09.05 | 11.07       |                |                |        |        |  |                                      |            |        |  |                                  |            |
|                 | 1.9 TDI         | 77           |              | 02.04 | 11.07       |                |                |        |        |  |                                      |            |        |  |                                  |            |
|                 | 2.0 Eco Fuel    | 80           |              | 04.06 | 11.07       |                |                |        |        |  |                                      |            |        |  |                                  |            |
|                 | 2.0 SDI         | 51           |              | 02.04 | 11.07       |                |                |        |        |  |                                      |            |        |  |                                  |            |
|                 | 2.0 TDI         | 103          |              | 09.07 | 11.07       |                |                |        |        |  |                                      |            |        |  |                                  |            |
|                 | 1.2 TSI         |              |              | 09.10 |             | PR: 1ZF,2E2    | 24.3387-1719.7 | 220773 |        |  |                                      |            | ☐<br>☐ |  | D=38, - Halter<br>D=38, - Halter | LUC<br>LUC |
|                 | 1.4             | 55           |              | 12.07 |             | PR: 1ZF,2E2    | 24.3387-1720.7 | 220774 |        |  |                                      |            |        |  |                                  |            |
| 1.4 16V         | 59              |              | 12.07        |       | PR: 1ZF,2E2 |                |                |        |        |  |                                      |            |        |  |                                  |            |
| 1.6             |                 |              | 12.07        |       | PR: 1ZF,2E2 |                |                |        |        |  |                                      |            |        |  |                                  |            |
| 1.6 TDI         |                 |              | 08.10        |       | PR: 1ZF,2E2 |                |                |        |        |  |                                      |            |        |  |                                  |            |
| 1.9 TDI         | 55              |              | 12.07        |       | PR: 1ZF,2E2 |                |                |        |        |  |                                      |            |        |  |                                  |            |
| 1.9 TDI         | 77              |              | 12.07        |       | PR: 1ZF,2E2 |                |                |        |        |  |                                      |            |        |  |                                  |            |
| 1.9 TDI 4motion | 77              |              | 05.08        |       | PR: 1ZF,2E2 |                |                |        |        |  |                                      |            |        |  |                                  |            |
| 2.0 Eco Fuel    | 80              |              | 12.07        |       | PR: 1ZF,2E2 |                |                |        |        |  |                                      |            |        |  |                                  |            |
| 2.0 SDI         | 51              |              | 12.07        |       | PR: 1ZF,2E2 |                |                |        |        |  |                                      |            |        |  |                                  |            |
| 2.0 TDI         | 81              |              | 10.10        |       | PR: 1ZF,2E2 |                |                |        |        |  |                                      |            |        |  |                                  |            |
| 2.0 TDI         | 103             |              | 12.07        |       | PR: 1ZF,2E2 |                |                |        |        |  |                                      |            |        |  |                                  |            |
| 2.0 TDI 4motion | 125             |              | 05.12        |       | PR: 1ZF,2E2 |                |                |        |        |  |                                      |            |        |  |                                  |            |
| 2.0 TDI 4motion | 81              |              | 10.10        |       | PR: 1ZF,2E2 |                |                |        |        |  |                                      |            |        |  |                                  |            |
|                 | 1.2 TSI         |              |              | 09.10 |             | PR: 1ZE,1LJ    | 24.3387-1719.7 | 220773 | ☐<br>☐ |  | D=38, - Halter<br>D=38, - Halter     | LUC<br>LUC |        |  |                                  |            |
|                 | 1.4             | 55           | 2K-B-200 000 | 12.07 |             | PR: 1ZE,1LJ    | 24.3387-1720.7 | 220774 |        |  |                                      |            |        |  |                                  |            |
|                 | 1.4 16V         | 59           | 2K-B-200 000 | 12.07 |             | PR: 1ZE,1LJ    |                |        |        |  |                                      |            |        |  |                                  |            |
|                 | 1.6             |              | 2K-B-200 000 | 12.07 |             | PR: 1ZE,1LJ    |                |        |        |  |                                      |            |        |  |                                  |            |
|                 | 1.6 TDI         |              | 2K-B-200 000 | 08.10 |             | PR: 1ZE,1LJ    |                |        |        |  |                                      |            |        |  |                                  |            |
|                 | 1.9 TDI         | 55           | 2K-B-200 000 | 12.07 |             | PR: 1ZE,1LJ    |                |        |        |  |                                      |            |        |  |                                  |            |
|                 | 1.9 TDI         | 77           | 2K-B-200 000 | 12.07 |             | PR: 1ZE,1LJ    |                |        |        |  |                                      |            |        |  |                                  |            |
|                 | 1.9 TDI 4motion | 77           | 2K-B-200 000 | 05.08 |             | PR: 1ZE,1LJ    |                |        |        |  |                                      |            |        |  |                                  |            |
|                 | 2.0 Eco Fuel    | 80           | 2K-B-200 000 | 12.07 |             | PR: 1ZE,1LJ    |                |        |        |  |                                      |            |        |  |                                  |            |
|                 | 2.0 SDI         | 51           | 2K-B-200 000 | 12.07 |             | PR: 1ZE,1LJ    |                |        |        |  |                                      |            |        |  |                                  |            |
| 2.0 TDI         | 81              | 2K-B-200 000 | 10.10        |       | PR: 1ZE,1LJ |                |                |        |        |  |                                      |            |        |  |                                  |            |
| 2.0 TDI         | 103             | 2K-B-200 000 | 12.07        |       | PR: 1ZE,1LJ |                |                |        |        |  |                                      |            |        |  |                                  |            |
| 2.0 TDI 4motion | 81              | 2K-B-200 000 | 10.10        |       | PR: 1ZE,1LJ |                |                |        |        |  |                                      |            |        |  |                                  |            |
|                 | 1.2 TSI         |              |              | 09.10 |             | PR: OE1        | 24.5280-0500.3 | 330953 | 2      | + verstärktes Fahrwerk / - kalte Zonen <sup>1)</sup> | L=500                                |            |        |  |                                  |            |
|                 | 1.4             | 55           |              | 02.04 |             | PR: OE1        |                |        |        |  |                                      |            |        |  |                                  |            |
|                 | 1.4 16V         | 59           |              | 05.06 |             | PR: OE1        |                |        |        |  |                                      |            |        |  |                                  |            |
|                 | 1.6             |              |              | 04.04 |             | PR: OE1        |                |        |        |  |                                      |            |        |  |                                  |            |
|                 | 1.6 TDI         |              |              | 08.10 |             | PR: OE1        |                |        |        |  |                                      |            |        |  |                                  |            |
|                 | 1.9 TDI         | 55           |              | 09.05 |             | PR: OE1        |                |        |        |  |                                      |            |        |  |                                  |            |
|                 | 1.9 TDI         | 77           |              | 02.04 |             | PR: OE1        |                |        |        |  |                                      |            |        |  |                                  |            |
|                 | 2.0 Eco Fuel    | 80           |              | 04.06 |             | PR: OE1        |                |        |        |  |                                      |            |        |  |                                  |            |
|                 | 2.0 SDI         | 51           |              | 02.04 |             | PR: OE1        |                |        |        |  |                                      |            |        |  |                                  |            |
|                 | 2.0 TDI         | 81           |              | 10.10 |             | PR: OE1        |                |        |        |  |                                      |            |        |  |                                  |            |
| 2.0 TDI         | 103             |              | 09.07        |       | PR: OE1     |                |                |        |        |  |                                      |            |        |  |                                  |            |
|                 | 1.4             | 55           | 2K-8-075000  | 02.04 |             |                | 24.3727-0188.2 | 580188 | 2      | ↓  | L=1713                               |            |        |  |                                  |            |
|                 | 1.4 16V         | 59           | 2K-8-075000  | 05.06 |             |                |                |        |        |  |                                      |            |        |  |                                  |            |
|                 | 1.6             |              | 2K-8-075000  | 04.04 |             |                |                |        |        |  |                                      |            |        |  |                                  |            |
|                 | 1.9 TDI         | 55           | 2K-8-075000  | 09.05 |             |                |                |        |        |  |                                      |            |        |  |                                  |            |
|                 | 1.9 TDI         | 77           | 2K-8-075000  | 02.04 |             |                |                |        |        |  |                                      |            |        |  |                                  |            |
|                 | 1.9 TDI 4motion | 77           | 2K-8-075000  | 05.08 |             |                |                |        |        |  |                                      |            |        |  |                                  |            |
|                 | 2.0 Eco Fuel    | 80           | 2K-8-075000  | 04.06 |             |                |                |        |        |  |                                      |            |        |  |                                  |            |
|                 | 2.0 SDI         | 51           | 2K-8-075000  | 02.04 |             |                |                |        |        |  |                                      |            |        |  |                                  |            |
|                 | 2.0 TDI         | 103          | 2K-8-075000  | 09.07 |             |                |                |        |        |  |                                      |            |        |  |                                  |            |
|                 | 1.4             | 55           | 2K-8-075001  |       | 10.09       | PR: OE1        | 24.3727-0188.2 | 580188 | 2      | ↓  | L=1713                               |            |        |  |                                  |            |
| 1.4 16V         | 59              | 2K-8-075001  |              | 10.09 | PR: OE1     |                |                |        |        |  |                                      |            |        |  |                                  |            |
| 1.6             |                 | 2K-8-075001  |              | 10.09 | PR: OE1     |                |                |        |        |  |                                      |            |        |  |                                  |            |
| 1.9 TDI         | 55              | 2K-8-075001  |              | 10.09 | PR: OE1     |                |                |        |        |  |                                      |            |        |  |                                  |            |
| 1.9 TDI         | 77              | 2K-8-075001  |              | 10.09 | PR: OE1     |                |                |        |        |  |                                      |            |        |  |                                  |            |
| 1.9 TDI 4motion | 77              | 2K-8-075001  |              | 10.09 | PR: OE1     |                |                |        |        |  |                                      |            |        |  |                                  |            |
| 2.0 Eco Fuel    | 80              | 2K-8-075001  |              | 10.09 | PR: OE1     |                |                |        |        |  |                                      |            |        |  |                                  |            |
| 2.0 SDI         | 51              | 2K-8-075001  |              | 10.09 | PR: OE1     |                |                |        |        |  |                                      |            |        |  |                                  |            |
| 2.0 TDI         | 103             | 2K-8-075001  |              | 10.09 | PR: OE1     |                |                |        |        |  |                                      |            |        |  |                                  |            |
| 1.4             | 55              | 2K-8-075001  |              | 10.09 | PR: OE2     | 24.3727-0194.2 | 580194         | 2      | ↓      | L=2025   |                                      |            |        |  |                                  |            |
| 1.4 16V         | 59              | 2K-8-075001  |              | 10.09 | PR: OE2     |                |                |        |        |  |                                      |            |        |  |                                  |            |
| 1.6             |                 | 2K-8-075001  |              | 10.09 | PR: OE2     |                |                |        |        |  |                                      |            |        |  |                                  |            |
| 1.9 TDI         | 55              | 2K-8-075001  |              | 10.09 | PR: OE2     |                |                |        |        |  |                                      |            |        |  |                                  |            |
| 1.9 TDI         | 77              | 2K-8-075001  |              | 10.09 | PR: OE2     |                |                |        |        |  |                                      |            |        |  |                                  |            |
| 1.9 TDI 4motion | 77              | 2K-8-075001  |              | 10.09 | PR: OE2     |                |                |        |        |  |                                      |            |        |  |                                  |            |
| 2.0 Eco Fuel    | 80              | 2K-8-075001  |              | 10.09 | PR: OE2     |                |                |        |        |  |                                      |            |        |  |                                  |            |
| 2.0 SDI         | 51              | 2K-8-075001  |              | 10.09 | PR: OE2     |                |                |        |        |  |                                      |            |        |  |                                  |            |
| 2.0 TDI         | 103             | 2K-8-075001  |              | 10.09 | PR: OE2     |                |                |        |        |  |                                      |            |        |  |                                  |            |
| 1.2 TSI         |                 |              |              | 09.10 |             | PR: OE1        | 24.3727-0188.2 | 580188 | 2      | ↓  | + verstärktes Fahrwerk <sup>2)</sup> | L=1713     |        |  |                                  |            |
| 1.4             | 55              |              |              | 11.09 |             | PR: OE1        |                |        |        |  |                                      |            |        |  |                                  |            |
| 1.4 16V         | 59              |              |              | 11.09 |             | PR: OE1        |                |        |        |  |                                      |            |        |  |                                  |            |
| 1.6             |                 |              |              | 11.09 |             | PR: OE1        |                |        |        |  |                                      |            |        |  |                                  |            |
| 1.6 TDI         |                 |              |              | 08.10 |             | PR: OE1        |                |        |        |  |                                      |            |        |  |                                  |            |
| 1.9 TDI         | 55              |              |              | 11.09 |             | PR: OE1        |                |        |        |  |                                      |            |        |  |                                  |            |
| 1.9 TDI         | 77              |              |              | 11.09 |             | PR: OE1        |                |        |        |  |                                      |            |        |  |                                  |            |
| 2.0 Eco Fuel    | 80              |              |              | 11.09 |             | PR: OE1        |                |        |        |  |                                      |            |        |  |                                  |            |
| 2.0 SDI         | 51              |              |              | 11.09 |             | PR: OE1        |                |        |        |  |                                      |            |        |  |                                  |            |
| 2.0 TDI         | 81              |              |              | 10.10 |             | PR: OE1        |                |        |        |  |                                      |            |        |  |                                  |            |
| 2.0 TDI         | 103             |              |              | 11.09 |             | PR: OE1        |                |        |        |  |                                      |            |        |  |                                  |            |
| 2.0 TDI         | 125             |              |              | 05.12 |             | PR: OE1        |                |        |        |  |                                      |            |        |  |                                  |            |
| 1.2 TSI         |                 |              |              | 09.10 |             | PR: OE2        | 24.3727-0194.2 | 580194 | 2      | ↓  | L=2025                               |            |        |  |                                  |            |



















<sup>1)</sup> + reinforced suspens. / - cold zones / + autotel.rinforzato / - zone fredde / + châssis renforcé / - zones froides / + suspens.reforzada / - zonas frias

<sup>2)</sup> + reinforced suspension / + sospensione rinforzata / + châssis renforcé / + suspensión reforzada





|     |   |  |    |   |  |  |  |  |
|--|---|--|--|---|---|--|--|--|
| <b>VOLKSWAGEN CADDY III (04-)</b>  |   |  |  |   |   |  |  |  |
|    | 1.4<br>1.4 16V<br>1.6<br>1.6 TDI<br>1.9 TDI<br>1.9 TDI<br>2.0 Eco Fuel<br>2.0 SDI<br>2.0 TDI<br>2.0 TDI<br>2.0 TDI  | 55<br>59<br><br>55<br>77<br>80<br>51<br>81<br>103<br>125                         | 11.09<br>11.09<br>11.09<br>08.10<br>11.09<br>11.09<br>11.09<br>11.09<br>10.10<br>11.09<br>05.12                            | PR: OE2<br>PR: OE2<br>PR: OE2<br>PR: OE2<br>PR: OE2<br>PR: OE2<br>PR: OE2<br>PR: OE2<br>PR: OE2<br>PR: OE2  | 24.3727-0194.2  | 580194   | 2 ↓  | L=2025   |
|    | 1.2 TSI<br>1.4<br>1.4 16V<br>1.6<br>1.6 TDI<br>1.9 TDI<br>1.9 TDI<br>1.9 TDI 4motion<br>2.0 Eco Fuel<br>2.0 SDI<br>2.0 TDI<br>2.0 TDI<br>2.0 TDI<br>2.0 TDI 4motion | 55<br>59<br><br>55<br>77<br>77<br>80<br>51<br>81<br>103<br>125<br>81             | 09.10<br>02.04<br>05.06<br>04.04<br>08.10<br>09.05<br>02.04<br>05.08<br>04.06<br>02.04<br>10.10<br>09.07<br>05.12<br>10.10 |   | 24.2415-1711.3<br>24.2415-1713.3  | 030130<br>030132   |  | Gz 15,87<br>Gz 15,87, + Sensor   |
|    | 1.2 TSI<br>1.4<br>1.4 16V<br>1.6<br>1.6 TDI<br>1.9 TDI<br>1.9 TDI<br>1.9 TDI 4motion<br>2.0 Eco Fuel<br>2.0 SDI<br>2.0 TDI<br>2.0 TDI<br>2.0 TDI<br>2.0 TDI 4motion | 55<br>59<br><br>55<br>77<br>77<br>80<br>51<br>81<br>103<br>125<br>81             | 09.10<br>02.04<br>05.06<br>04.04<br>08.10<br>09.05<br>02.04<br>05.08<br>04.06<br>02.04<br>10.10<br>09.07<br>05.12<br>10.10 |   | 24.2519-1705.3  | 040095   | PR: OEJ  | Nz 19,05   |
| <b>VOLKSWAGEN CADDY Pickup (97-02)</b>   |   |  |  |   |   |  |  |  |
|  | 1.6<br>1.9 D  |  | 10.97<br>10.97   | 12.00<br>12.00  | 24.2122-1731.3<br>03.2123-1428.3  | 010656<br>010476   | - ABS<br>+ ABS   | THz 22,20<br>THz 23,81<br><b>ATE</b>   |
|  | 1.6<br>1.9 D  |  | 10.97<br>10.97   | 12.00<br>12.00  | 24.3541-1737.5<br>24.3541-1738.5  | 240197<br>240198   | <input type="checkbox"/><br><input type="checkbox"/>                               | D=54, - Halter<br>D=54, - Halter<br><b>LUC</b><br><b>LUC</b>                       |
|  | 1.6<br>1.9 D  |  | 10.97<br>10.97   | 12.00<br>12.00  | 24.5166-0325.3  | 331293   | 2  | L=325  |
|  | 1.6<br>1.9 D  |  | 10.97<br>10.97   | 12.00<br>12.00  | 83.6236-0175.3  | 330710   | 2  | L=175  |
|  | 1.6<br>1.9 D  |  | 10.97<br>10.97   | 12.00<br>12.00  | 24.3222-1712.3  | 020424   | - ABS<br>- ABS   | Rz 22,20   |
|  | 1.6<br>1.9 D  |  | 10.97<br>10.97   | 12.00<br>12.00  | 24.3219-1721.3  | 020422   | + ABS<br>+ ABS   | Rz 19,05   |
|  | 1.6<br>1.9 D  |  | 10.97<br>10.97   | 12.00<br>12.00  | 24.3727-2508.2  | 582508   | 2 ↓  | L=1782   |
|  | 1.6<br>1.9 D  |  | 10.97<br>10.97   | 12.00<br>12.00  | 03.6583-0167.3<br>03.6584-0107.3  | 320140<br>320110   |  | BRL 8/3 (4)<br>BRL 8/4 (4)<br><b>ATE</b><br><b>ATE</b>                             |
|  | 1.6   |  | 10.97  | 12.00   | 24.3728-2500.2  | 592500   |  | L=742  |
| <b>VOLKSWAGEN CC COUPE (11-)</b>   |   |  |  |   |   |  |  |  |
|  | 1.4 TSI<br>1.8 TSI<br>2.0 TDI<br>2.0 TDI<br>2.0 TDI<br>2.0 TDI<br>2.0 TDI 4motion<br>2.0 TDI 4motion<br>2.0 TDI 4motion<br>2.0 TSI<br>3.6 V6 4motion                | 118<br>118<br>100<br>103<br>125<br>130<br>103<br>125<br>130<br>155<br>220        | 11.11<br>11.11<br>11.11<br>11.11<br>11.11<br>12.12<br>11.11<br>11.11<br>12.12<br>11.11<br>11.11                            | PR: 1LA,1LB,1ZM<br>PR: 1LA,1LB,1ZM<br>PR: 1LA,1LB,1ZM<br>PR: 1LA,1LB,1ZM<br>PR: 1LA,1LB,1ZM<br>PR: 1LA,1LB,1ZM<br>PR: 1LA,1LB,1ZM<br>PR: 1LA,1LB,1ZM<br>PR: 1LA,1LB,1ZM<br>PR: 1LA,1LB,1ZM<br>PR: 1LA,1LB,1ZM | 03.7873-4502.4  | 300284   |  | 11"<br><b>ATE</b>  |
|  | 1.4 TSI<br>1.8 TSI<br>2.0 TDI<br>2.0 TDI<br>2.0 TDI<br>2.0 TDI  | 118<br>118<br>100<br>103<br>125<br>130   | 11.11<br>11.11<br>11.11<br>11.11<br>11.11<br>12.12   | PR: 1LA,1LB,1ZM<br>PR: 1LA,1LB,1ZM<br>PR: 1LA,1LB,1ZM<br>PR: 1LA,1LB,1ZM<br>PR: 1LA,1LB,1ZM<br>PR: 1LA,1LB,1ZM  | 03.4153-0186.3  | 010816   |  | THz 23,81<br><b>ATE</b>  |

|     |    kW |  |  |  |  |  |   |  |                               |     |
|--|---|--|--|--|---|--|---|--|-------------------------------|-----|
| <b>VOLKSWAGEN CC COUPE (11-)</b>   |   |  |  |  |   |  |   |  |                               |     |
|    | 2.0 TDI 4motion   | 1103   | 11.11  | PR: 1LA,1LB,1ZM  | 03.4153-0186.3  | 010816   |   | Thz 23,81  | ATE                           |     |
|  | 2.0 TDI 4motion   | 1125   | 11.11  | PR: 1LA,1LB,1ZM  |   |  |   |  |                               |     |
|  | 2.0 TDI 4motion   | 1130   | 12.12  | PR: 1LA,1LB,1ZM  |   |  |   |  |                               |     |
|  | 2.0 TSI   | 1155   | 11.11  | PR: 1LA,1LB,1ZM  |   |  |   |  |                               |     |
|  | 3.6 V6 4motion  | 1220   | 11.11  | PR: 1LA,1LB,1ZM  |   |  |   |  |                               |     |
|  |       | 1.4 TSI  | 1118   | 11.11  | PR: 1ZG   | 03.4152-0116.3   | 010814  |  | Thz 22,20                     | ATE |
|  |   | 1.8 TSI  | 1118   | 11.11  | PR: 1ZG   |  |   |  |                               |     |
|  |   | 2.0 TDI  | 1100   | 11.11  | PR: 1ZG   |  |   |  |                               |     |
|  |   | 2.0 TDI  | 1103   | 11.11  | PR: 1ZG   |  |   |  |                               |     |
|  |   | 2.0 TDI  | 1125   | 11.11  | PR: 1ZG   |  |   |  |                               |     |
| 2.0 TDI  |   | 1130   | 12.12  | PR: 1ZG  |   |  |   |  |                               |     |
| 2.0 TDI 4motion  |   | 1103   | 11.11  | PR: 1ZG  |   |  |   |  |                               |     |
| 2.0 TDI 4motion  |   | 1125   | 11.11  | PR: 1ZG  |   |  |   |  |                               |     |
| 2.0 TDI 4motion  |   | 1130   | 12.12  | PR: 1ZG  |   |  |   |  |                               |     |
| 2.0 TSI  |   | 1155   | 11.11  | PR: 1ZG  |   |  |   |  |                               |     |
| 3.6 V6 4motion   | 1220  | 11.11  | PR: 1ZG  |  |   |  |   |  |                               |     |
|    | 1.4 TSI   | 118  | 11.11  | PR: 1ZM,1ZG  | 11.9541-9553.2  | 220563   |  | D=54, - Halter   | ATE                           |     |
|  | 1.8 TSI   | 118  | 11.11  | PR: 1ZM,1ZG  |   |  |   |  |                               |     |
|  | 2.0 TDI   | 100  | 11.11  | PR: 1ZM,1ZG  |   |  |   |  |                               |     |
|  | 2.0 TDI   | 103  | 11.11  | PR: 1ZM,1ZG  |   |  |   |  |                               |     |
|  | 2.0 TDI   | 125  | 11.11  | PR: 1ZM,1ZG  |   |  |   |  |                               |     |
|  | 2.0 TDI   | 130  | 12.12  | PR: 1ZM,1ZG  |   |  |   |  |                               |     |
|  | 2.0 TDI 4motion   | 103  | 11.11  | PR: 1ZM,1ZG  |   |  |   |  |                               |     |
|  | 2.0 TDI 4motion   | 125  | 11.11  | PR: 1ZM,1ZG  |   |  |   |  |                               |     |
|  | 2.0 TDI 4motion   | 130  | 12.12  | PR: 1ZM,1ZG  |   |  |   |  |                               |     |
|  | 2.0 TSI   | 155  | 11.11  | PR: 1ZM,1ZG  |   |  |   |  |                               |     |
| 3.6 V6 4motion   | 220   | 11.11  | PR: 1ZM,1ZG  |  |   |  |   |  |                               |     |
|    | 1.4 TSI   | 118  | 11.11  | PR: 2EA  | 83.7849-0231.3  | 330872   | 2   | L=233  |                               |     |
|  | 1.8 TSI   | 118  | 11.11  | PR: 2EA  |   |  |   |  |                               |     |
|  | 2.0 TDI   | 100  | 11.11  | PR: 2EA  |   |  |   |  |                               |     |
|  | 2.0 TDI   | 103  | 11.11  | PR: 2EA  |   |  |   |  |                               |     |
|  | 2.0 TDI   | 125  | 11.11  | PR: 2EA  |   |  |   |  |                               |     |
|  | 2.0 TDI   | 130  | 12.12  | PR: 2EA  |   |  |   |  |                               |     |
|  | 2.0 TDI 4motion   | 103  | 11.11  | PR: 2EA  |   |  |   |  |                               |     |
|  | 2.0 TDI 4motion   | 125  | 11.11  | PR: 2EA  |   |  |   |  |                               |     |
|  | 2.0 TDI 4motion   | 130  | 12.12  | PR: 2EA  |   |  |   |  |                               |     |
|  | 2.0 TSI   | 155  | 11.11  | PR: 2EA  |   |  |   |  |                               |     |
| 3.6 V6 4motion   | 220   | 11.11  | PR: 2EA  |  |   |  |   |  |                               |     |
| <b>VOLKSWAGEN CRAFTER (06-)</b>  |   |  |  |  |   |  |   |  |                               |     |
|  | 2.0 TDI 4motion   | 120  | 11.11  | PR: OWC, OWF, OWL  | 24.5137-0385.3  | 331089   | 2   | L=385  |                               |     |
|  | 2.0 TDI BlueMotion  | 80   | 07.11  | PR: OWC, OWF, OWL  |   |  |   |  |                               |     |
|  | 2.0 TDI BlueMotion  | 100  | 07.11  | PR: OWC, OWF, OWL  |   |  |   |  |                               |     |
|  | 2.0 TDI BlueMotion  | 120  | 07.11  | PR: OWC, OWF, OWL  |   |  |   |  |                               |     |
|  | 2.5 TDI   | 65   | 04.06  | PR: OWC, OWF, OWL  |   |  |   |  |                               |     |
|  | 2.5 TDI   | 80   | 04.06  | PR: OWC, OWF, OWL  |   |  |   |  |                               |     |
|  | 2.5 TDI   | 100  | 04.06  | PR: OWC, OWF, OWL  |   |  |   |  |                               |     |
| 2.5 TDI  | 120   | 04.06  | PR: OWC, OWF, OWL  |  |   |  |   |  |                               |     |
|  | 2.0 TDI BlueMotion  | 80   | 07.11  | PR: OWC, OWL   | 24.5137-0385.3  | 331089   | 2   | L=385  |                               |     |
|  | 2.0 TDI BlueMotion  | 100  | 07.11  | PR: OWC, OWL   |   |  |   |  |                               |     |
|  | 2.0 TDI BlueMotion  | 120  | 07.11  | PR: OWC, OWL   |   |  |   |  |                               |     |
|  | 2.5 TDI   | 65   | 04.06  | PR: OWC, OWL   |   |  |   |  |                               |     |
|  | 2.5 TDI   | 80   | 04.06  | PR: OWC, OWL   |   |  |   |  |                               |     |
|  | 2.5 TDI   | 100  | 04.06  | PR: OWC, OWL   |   |  |   |  |                               |     |
|  | 2.5 TDI   | 120  | 04.06  | PR: OWC, OWL   |   |  |   |  |                               |     |
|  | 2.0 TDI BlueMotion  | 80   | 07.11  | PR: OWF  | 24.5131-0415.3  | 331238   | 2   | L=415  |                               |     |
|  | 2.0 TDI BlueMotion  | 100  | 07.11  | PR: OWF  |   |  |   |  |                               |     |
|  | 2.0 TDI BlueMotion  | 120  | 07.11  | PR: OWF  | 24.5137-0470.3  | 331090   | 2   | L=470  | + Reifen 285/65 <sup>1)</sup> |     |
|  | 2.5 TDI   | 65   | 04.06  | PR: OWF  |   |  |   |  |                               |     |
|  | 2.5 TDI   | 80   | 04.06  | PR: OWF  |   |  |   |  |                               |     |
|  | 2.5 TDI   | 100  | 04.06  | PR: OWF  |   |  |   |  |                               |     |
|  | 2.5 TDI   | 120  | 04.06  | PR: OWF  |   |  |   |  |                               |     |
| <b>VOLKSWAGEN EOS (06-)</b>  |   |  |  |  |   |  |   |  |                               |     |
|  | 2.0 FSI   | 1110   | 05.06  | PR: 1ZD  | 03.7863-9502.4  | 300204   |   | Kolbendurchmesser Ø 22,20mm <sup>2)</sup>  | 10"                           | ATE |
|  | 2.0 TFSI  | 1147   | 05.06  | PR: 1ZD  |   |  |   |  |                               |     |
|  | 2.0 TFSI  | 1162   | 11.13  | PR: 1ZD  |   |  |   |  |                               |     |
|  | 2.0 TSI   | 1155   | 11.09  | PR: 1ZD  |   |  |   |  |                               |     |
|  | 3.2 V6  | 1184   | 05.06  | PR: 1ZD  |   |  |   |  |                               |     |
|  | 3.6 V6  | 1191   | 05.09  | PR: 1ZD  |   |  |   |  |                               |     |
|  | 1.4 TSI   | 90   | 10.07  | PR: 1ZA,1ZE,1LJ  | 03.7863-9702.4  | 300207   |   | Kolbendurchmesser Ø 23,81mm <sup>3)</sup>  | 10"                           | ATE |
|  | 1.4 TSI   | 92   | 11.13  |  |   |  |   |  |                               |     |
|  | 1.4 TSI   | 1110   | 11.13  |  |   |  |   |  |                               |     |
|  | 1.4 TSI   | 1118   | 05.08  |  |   |  |   |  |                               |     |
|  | 1.6 FSI   | 85   | 05.06  |  |   |  |   |  |                               |     |
|  | 2.0 FSI   | 1110   | 05.06  |  |   |  |   |  |                               |     |
|  | 2.0 TDI   | 1100   | 11.10  |  |   |  |   |  |                               |     |
|  | 2.0 TDI   | 1103   | 05.06  |  |   |  |   |  |                               |     |
|  | 2.0 TDI 16V   | 1103   | 05.08  |  |   |  |   |  |                               |     |
|  | 2.0 TFSI  | 1147   | 05.06  |  |   |  |   |  |                               |     |
|  | 2.0 TFSI  | 1162   | 11.13  |  |   |  |   |  |                               |     |
|  | 2.0 TSI   | 1155   | 11.09  |  |   |  |   |  |                               |     |
|  | 3.2 V6  | 1184   | 05.06  |  |   |  |   |  |                               |     |
|  | 3.6 V6  | 1191   | 05.09  |  |   |  |   |  |                               |     |

<sup>1)</sup> + tyre 285/65 / + cerchio 285/65 / + pneu 285/65 / + cerco 285/65

<sup>2)</sup> piston diameter Ø 22,20mm / diametro del pistone Ø 22,20mm / diamètre de piston Ø 22,20mm / diámetro del pistón Ø 22,20mm



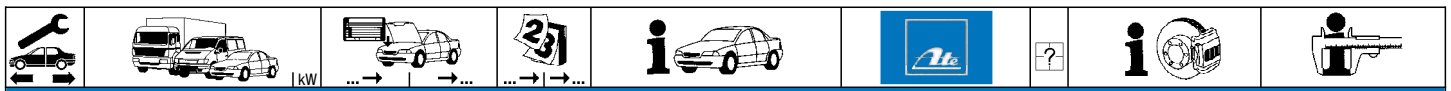













<sup>3)</sup> piston diameter Ø 23,81mm / diametro del pistone Ø 23,81mm / diamètre de piston Ø 23,81mm / diámetro del pistón Ø 23,81mm

















**VOLKSWAGEN EOS (06-)**

|  |   |  |  |  |   |  |   |  |
|--|---|--|--|--|---|--|---|--|
|  | <p>1.4 TSI 90<br/>1.4 TSI 92<br/>1.4 TSI 110<br/>1.4 TSI 118<br/>1.6 FSI 85<br/>2.0 FSI 110<br/>2.0 TDI 100<br/>2.0 TDI 103<br/>2.0 TDI 16V 103<br/>2.0 TFSI 147<br/>2.0 TFSI 162<br/>2.0 TSI 155<br/>3.2 V6 184<br/>3.6 V6 191</p> | <p>10.07<br/>11.13<br/>11.13<br/>05.08<br/>05.06<br/>05.06<br/>11.10<br/>05.06<br/>05.08<br/>05.06<br/>11.13<br/>11.09<br/>05.06<br/>05.09</p> |  | <p>03.2123-3449.3 010808<br/>03.2122-2129.3 010799</p>   |   | <p>PR: 1ZA,1ZE,1LJ,1LK<br/>PR: 1AT,1ZD</p> | <p>Thz 23,81<br/>Thz 22,20</p>  | <p>ATE<br/>ATE</p>                         |
|  | <p>1.4 TSI 90<br/>1.4 TSI 92<br/>1.4 TSI 110<br/>1.4 TSI 118<br/>1.6 FSI 85<br/>2.0 FSI 110<br/>2.0 TDI 100<br/>2.0 TDI 103<br/>2.0 TDI 16V 103<br/>2.0 TFSI 147<br/>2.0 TFSI 162<br/>2.0 TSI 155<br/>3.2 V6 184<br/>3.6 V6 191</p> | <p>10.07<br/>11.13<br/>11.13<br/>05.08<br/>05.06<br/>05.06<br/>11.10<br/>05.06<br/>05.08<br/>05.06<br/>11.13<br/>11.09<br/>05.06<br/>05.09</p> | <p>PR: 1ZE<br/>PR: 1ZE<br/>PR: 1ZE<br/>PR: 1ZE<br/>PR: 1ZE<br/>PR: 1ZE<br/>PR: 1ZE<br/>PR: 1ZE<br/>PR: 1ZE<br/>PR: 1ZE<br/>PR: 1ZE<br/>PR: 1ZE<br/>PR: 1ZE</p>   | <p>11.9541-9553.2 220563<br/>11.9541-9554.2 220564<br/>11.0101-5409.2 260035<br/>11.8171-0008.1 990049<br/>11.8116-0351.1 390538</p> | 2 |  | <p>D=54, - Halter<br/>D=54, - Halter<br/>Hülzensatz<br/>Führungsbolzen<br/>Haltefeder</p> | <p>ATE<br/>ATE<br/>ATE<br/>ATE<br/>ATE</p> |
|  | <p>1.4 TSI 90<br/>1.4 TSI 92<br/>1.4 TSI 110<br/>1.4 TSI 118<br/>1.6 FSI 85<br/>2.0 FSI 110<br/>2.0 TDI 100<br/>2.0 TDI 103<br/>2.0 TDI 16V 103<br/>2.0 TFSI 147<br/>2.0 TFSI 162<br/>2.0 TSI 155<br/>3.2 V6 184<br/>3.6 V6 191</p> | <p>10.07<br/>11.13<br/>11.13<br/>05.08<br/>05.06<br/>05.06<br/>11.10<br/>05.06<br/>05.08<br/>05.06<br/>11.13<br/>11.09<br/>05.06<br/>05.09</p> | <p>PR: 1LJ,1ZA,1ZD<br/>PR: 1LJ,1ZA,1ZD<br/>PR: 1LJ,1ZA,1ZD<br/>PR: 1LJ,1ZA,1ZD<br/>PR: 1LJ,1ZA,1ZD<br/>PR: 1LJ,1ZA,1ZD<br/>PR: 1LJ,1ZA,1ZD<br/>PR: 1LJ,1ZA,1ZD<br/>PR: 1LJ,1ZA,1ZD<br/>PR: 1LJ,1ZA,1ZD<br/>PR: 1LJ,1ZA,1ZD<br/>PR: 1LJ,1ZA,1ZD<br/>PR: 1LJ,1ZA,1ZD</p> | <p>11.9541-9553.2 220563<br/>11.9541-9554.2 220564<br/>11.0101-5409.2 260035<br/>11.8171-0008.1 990049<br/>11.8116-0351.1 390538</p> | 2 |  | <p>D=54, - Halter<br/>D=54, - Halter<br/>Hülzensatz<br/>Führungsbolzen<br/>Haltefeder</p> | <p>ATE<br/>ATE<br/>ATE<br/>ATE<br/>ATE</p> |
|  | <p>1.4 TSI 90<br/>1.4 TSI 92<br/>1.4 TSI 110<br/>1.4 TSI 118<br/>1.6 FSI 85<br/>2.0 FSI 110<br/>2.0 TDI 100<br/>2.0 TDI 103<br/>2.0 TDI 16V 103<br/>2.0 TFSI 147<br/>2.0 TFSI 162<br/>2.0 TSI 155<br/>3.2 V6 184<br/>3.6 V6 191</p> | <p>10.07<br/>11.13<br/>11.13<br/>05.08<br/>05.06<br/>05.06<br/>11.10<br/>05.06<br/>05.08<br/>05.06<br/>11.13<br/>11.09<br/>05.06<br/>05.09</p> | <p>PR: 1LK<br/>PR: 1LK<br/>PR: 1LK<br/>PR: 1LK<br/>PR: 1LK<br/>PR: 1LK<br/>PR: 1LK<br/>PR: 1LK<br/>PR: 1LK<br/>PR: 1LK<br/>PR: 1LK<br/>PR: 1LK<br/>PR: 1LK</p>   | <p>11.9576-9995.2 220651<br/>11.9576-9996.2 220652<br/>11.0101-5409.2 260035<br/>11.8171-0008.1 990049<br/>11.8116-0410.2 390589</p> | 2 |  | <p>D=57, - Halter<br/>D=57, - Halter<br/>Hülzensatz<br/>Führungsbolzen<br/>Haltefeder</p> | <p>ATE<br/>ATE<br/>ATE<br/>ATE<br/>ATE</p> |
|  | <p>1.4 TSI 90<br/>1.4 TSI 118<br/>1.6 FSI 85<br/>2.0 FSI 110<br/>2.0 TDI 100<br/>2.0 TDI 103<br/>2.0 TDI 16V 103<br/>2.0 TFSI 147<br/>2.0 TSI 155<br/>3.2 V6 184<br/>3.6 V6 191</p>   | <p>10.07<br/>05.08<br/>05.06<br/>05.06<br/>11.10<br/>05.06<br/>05.08<br/>05.06<br/>11.09<br/>05.06<br/>05.09</p>                               | <p>PR: 1LJ,1ZD,1ZE<br/>PR: 1LJ,1ZD,1ZE<br/>PR: 1LJ,1ZD,1ZE<br/>PR: 1LJ,1ZD,1ZE<br/>PR: 1LJ,1ZD,1ZE<br/>PR: 1LJ,1ZD,1ZE<br/>PR: 1LJ,1ZD,1ZE<br/>PR: 1LJ,1ZD,1ZE<br/>PR: 1LJ,1ZD,1ZE<br/>PR: 1LJ,1ZD,1ZE</p>   | <p>83.7847-0563.3 331124</p>   | 2 |  | L=562   |  |
|  | <p>1.4 TSI 90<br/>1.4 TSI 118<br/>1.6 FSI 85<br/>2.0 FSI 110<br/>2.0 TDI 100<br/>2.0 TDI 103<br/>2.0 TDI 16V 103<br/>2.0 TFSI 147<br/>2.0 TSI 155<br/>3.2 V6 184<br/>3.6 V6 191</p>   | <p>10.07<br/>05.08<br/>05.06<br/>05.06<br/>11.10<br/>05.06<br/>05.08<br/>05.06<br/>11.09<br/>05.06<br/>05.09</p>                               | <p>PR: 1LK<br/>PR: 1LK<br/>PR: 1LK<br/>PR: 1LK<br/>PR: 1LK<br/>PR: 1LK<br/>PR: 1LK<br/>PR: 1LK<br/>PR: 1LK<br/>PR: 1LK</p>   | <p>83.7849-0502.3 331125</p>   | 2 |  | L=504   |  |
|  | <p>1.4 TSI 92<br/>1.4 TSI 110<br/>2.0 TFSI 162</p>  | <p>11.13<br/>11.13<br/>11.13</p>   |  | <p>83.7847-0563.3 331124</p>   | 2 |  | L=562   |  |
|  | <p>1.4 TSI 90<br/>1.4 TSI 92<br/>1.4 TSI 110<br/>1.4 TSI 118<br/>1.6 FSI 85</p>   | <p>10.07<br/>11.13<br/>11.13<br/>05.08<br/>05.06</p>   | <p>PR: 1KD<br/>PR: 1KD<br/>PR: 1KD<br/>PR: 1KD</p>   | <p>24.3384-1755.7 220635<br/>24.3384-1756.7 220636</p>   |   |  | <p>D=38, - Halter<br/>D=38, - Halter</p>  | <p>LUC<br/>LUC</p>                         |



|     |  |  |  |  |  |   |   |  |   |
|--|--|--|--|--|---|---|---|--|---|
| <b>VOLKSWAGEN EOS (06-)</b>  |  |  |  |  |   |   |   |  |   |
|    | 2.0 FSI  | 110  | 05.06  | PR: 1KD  | 24.3384-1755.7  | 220635  |  | D=38, - Halter<br>D=38, - Halter   | LUC   |
|  | 2.0 TDI  | 100  | 11.10  | PR: 1KD  | 24.3384-1756.7  | 220636  |   |  | LUC   |
|  | 2.0 TDI  | 103  | 05.06  | PR: 1KD  |   |   |   |  |   |
|  | 2.0 TDI 16V  | 103  | 05.08  | PR: 1KD  |   |   |   |  |   |
|  | 2.0 TFSI   | 147  | 05.06  | PR: 1KD  |   |   |   |  |   |
|  | 2.0 TFSI   | 162  | 11.13  | PR: 1KD  |   |   |   |  |   |
|  | 2.0 TSI  | 155  | 11.09  | PR: 1KD  |   |   |   |  |   |
|  | 3.2 V6   | 184  | 05.06  | PR: 1KD  |   |   |   |  |   |
|  | 3.6 V6   | 191  | 05.09  | PR: 1KD  |   |   |   |  |   |
|  | 1.4 TSI  | 90   | 10.07  | PR: 1KZ  | 24.3387-1717.7  | 220757  |   |  |  |
| 1.4 TSI  | 92   | 11.13  | PR: 1KZ  | 24.3387-1718.7   | 220758  | LUC   |   |  |   |
| 1.4 TSI  | 110  | 11.13  | PR: 1KZ  | 24.0101-3803.2   | 260101  | LUC   |   |  |   |
| 1.4 TSI  | 118  | 05.08  | PR: 1KZ  |  |   |   |   |  |   |
| 1.6 FSI  | 85   | 05.06  | PR: 1KZ  |  |   |   |   |  |   |
| 2.0 FSI  | 110  | 05.06  | PR: 1KZ  |  |   |   |   |  |   |
| 2.0 TDI  | 100  | 11.10  | PR: 1KZ  |  |   |   |   |  |   |
| 2.0 TDI  | 103  | 05.06  | PR: 1KZ  |  |   |   |   |  |   |
| 2.0 TDI 16V  | 103  | 05.08  | PR: 1KZ  |  |   |   |   |  |   |
| 2.0 TFSI   | 147  | 05.06  | PR: 1KZ  |  |   |   |   |  |   |
| 2.0 TFSI   | 162  | 11.13  | PR: 1KZ  |  |   |   |   |  |   |
| 2.0 TSI  | 155  | 11.09  | PR: 1KZ  |  |   |   |   |  |   |
| 3.2 V6   | 184  | 05.06  | PR: 1KZ  |  |   |   |   |  |   |
| 3.6 V6   | 191  | 05.09  | PR: 1KZ  |  |   |   |   |  |   |
| 1.4 TSI  | 90   | 10.07  | PR: 1KJ  | 24.3414-1709.7   | 220631  |  | D=41, - Halter<br>D=41, - Halter  | LUC  |   |
| 1.4 TSI  | 92   | 11.13  | PR: 1KJ  | 24.3414-1710.7   | 220632  |   |   | LUC  |   |
| 1.4 TSI  | 110  | 11.13  | PR: 1KJ  |  |   |   |   |  |   |
| 1.4 TSI  | 118  | 05.08  | PR: 1KJ  |  |   |   |   |  |   |
| 1.6 FSI  | 85   | 05.06  | PR: 1KJ  |  |   |   |   |  |   |
| 2.0 FSI  | 110  | 05.06  | PR: 1KJ  |  |   |   |   |  |   |
| 2.0 TDI  | 100  | 11.10  | PR: 1KJ  |  |   |   |   |  |   |
| 2.0 TDI  | 103  | 05.06  | PR: 1KJ  |  |   |   |   |  |   |
| 2.0 TDI 16V  | 103  | 05.08  | PR: 1KJ  |  |   |   |   |  |   |
| 2.0 TFSI   | 147  | 05.06  | PR: 1KJ  |  |   |   |   |  |   |
| 2.0 TFSI   | 162  | 11.13  | PR: 1KJ  |  |   |   |   |  |   |
| 2.0 TSI  | 155  | 11.09  | PR: 1KJ  |  |   |   |   |  |   |
| 3.2 V6   | 184  | 05.06  | PR: 1KJ  |  |   |   |   |  |   |
| 3.6 V6   | 191  | 05.09  | PR: 1KJ  |  |   |   |   |  |   |
| 1.4 TSI  | 90   | 10.07  | PR: 2EA  | 24.3417-1711.7   | 220883  |  | D=41, - Halter<br>D=41, - Halter  | LUC  |   |
| 1.4 TSI  | 92   | 11.13  | PR: 2EA  | 24.3417-1712.7   | 220884  |   |   | LUC  |   |
| 1.4 TSI  | 110  | 11.13  | PR: 2EA  |  |   |   |   |  |   |
| 1.4 TSI  | 118  | 05.08  | PR: 2EA  |  |   |   |   |  |   |
| 1.6 FSI  | 85   | 05.06  | PR: 2EA  |  |   |   |   |  |   |
| 2.0 FSI  | 110  | 05.06  | PR: 2EA  |  |   |   |   |  |   |
| 2.0 TDI  | 100  | 11.10  | PR: 2EA  |  |   |   |   |  |   |
| 2.0 TDI  | 103  | 05.06  | PR: 2EA  |  |   |   |   |  |   |
| 2.0 TDI 16V  | 103  | 05.08  | PR: 2EA  |  |   |   |   |  |   |
| 2.0 TFSI   | 147  | 05.06  | PR: 2EA  |  |   |   |   |  |   |
| 2.0 TFSI   | 162  | 11.13  | PR: 2EA  |  |   |   |   |  |   |
| 2.0 TSI  | 155  | 11.09  | PR: 2EA  |  |   |   |   |  |   |
| 3.2 V6   | 184  | 05.06  | PR: 2EA  |  |   |   |   |  |   |
| 3.6 V6   | 191  | 05.09  | PR: 2EA  |  |   |   |   |  |   |
|  | 1.4 TSI  | 90   | 10.07  | PR: 1KD,1KJ,1KZ,2EA  | 83.7849-0243.3  | 331099  | 2   | L=243  |   |
|  | 1.4 TSI  | 92   | 11.13  | PR: 1KD,1KJ,1KZ,2EA  |   |   |   |  |   |
|  | 1.4 TSI  | 110  | 11.13  | PR: 1KD,1KJ,1KZ,2EA  |   |   |   |  |   |
|  | 1.4 TSI  | 118  | 05.08  | PR: 1KD,1KJ,1KZ,2EA  |   |   |   |  |   |
|  | 1.6 FSI  | 85   | 05.06  | PR: 1KD,1KJ,1KZ,2EA  |   |   |   |  |   |
|  | 2.0 FSI  | 110  | 05.06  | PR: 1KD,1KJ,1KZ,2EA  |   |   |   |  |   |
|  | 2.0 TDI  | 100  | 11.10  | PR: 1KD,1KJ,1KZ,2EA  |   |   |   |  |   |
|  | 2.0 TDI  | 103  | 05.06  | PR: 1KD,1KJ,1KZ,2EA  |   |   |   |  |   |
|  | 2.0 TDI 16V  | 103  | 05.08  | PR: 1KD,1KJ,1KZ,2EA  |   |   |   |  |   |
|  | 2.0 TFSI   | 147  | 05.06  | PR: 1KD,1KJ,1KZ,2EA  |   |   |   |  |   |
| 2.0 TFSI   | 162  | 11.13  | PR: 1KD,1KJ,1KZ,2EA  |  |   |   |   |  |   |
| 2.0 TSI  | 155  | 11.09  | PR: 1KD,1KJ,1KZ,2EA  |  |   |   |   |  |   |
| 3.2 V6   | 184  | 05.06  | PR: 1KD,1KJ,1KZ,2EA  |  |   |   |   |  |   |
| 3.6 V6   | 191  | 05.09  | PR: 1KD,1KJ,1KZ,2EA  |  |   |   |   |  |   |
|  | 1.4 TSI  | 90   | 10.07  |  | 24.3727-2708.2  | 582708  | 2   | L=1447   |   |
|  | 1.4 TSI  | 92   | 11.13  |  |   |   |   |  |   |
|  | 1.4 TSI  | 110  | 11.13  |  |   |   |   |  |   |
|  | 1.4 TSI  | 118  | 05.08  |  |   |   |   |  |   |
|  | 1.6 FSI  | 85   | 05.06  |  |   |   |   |  |   |
|  | 2.0 FSI  | 110  | 05.06  |  |   |   |   |  |   |
|  | 2.0 TDI  | 100  | 11.10  |  |   |   |   |  |   |
|  | 2.0 TDI  | 103  | 05.06  |  |   |   |   |  |   |
|  | 2.0 TDI  | 103  | 05.06  |  |   |   |   |  |   |
|  | 2.0 TFSI   | 147  | 05.06  |  |   |   |   |  |   |
| 2.0 TFSI   | 162  | 11.13  |  |  |   |   |   |  |   |
| 2.0 TSI  | 155  | 11.09  |  |  |   |   |   |  |   |
| 3.2 V6   | 184  | 05.06  |  |  |   |   |   |  |   |
| 3.6 V6   | 191  | 05.09  |  |  |   |   |   |  |   |
|  | 1.4 TSI  | 90   | 10.07  |  | 24.2415-1711.3  | 030130  |   | Gz 15,87   |   |
|  | 1.4 TSI  | 92   | 11.13  |  |   |   |   |  |   |
|  | 1.4 TSI  | 110  | 11.13  |  |   |   |   |  |   |
|  | 1.4 TSI  | 118  | 05.08  |  |   |   |   |  |   |
|  | 1.6 FSI  | 85   | 05.06  |  |   |   |   |  |   |
|  | 2.0 TDI  | 100  | 11.10  |  |   |   |   |  |   |
| 2.0 TDI  | 103  | 05.06  |  |  |   |   |   |  |   |

| VOLKSWAGEN EOS (06-)   |             |     |  |       |                                     |                |        |   |                |     |
|--|-------------|-----|--|-------|-------------------------------------|----------------|--------|---|----------------|-----|
|     | 2.0 TDI     | 103 |  | 05.06 |                                     | 24.2415-1711.3 | 030130 |   | Gz 15,87       |     |
|  | 2.0 TFSI    | 147 |  | 05.06 |                                     |                |        |   |                |     |
|  | 2.0 TFSI    | 162 |  | 11.13 |                                     |                |        |   |                |     |
|  | 2.0 TSI     | 155 |  | 11.09 |                                     |                |        |   |                |     |
|  | 3.2 V6      | 184 |  | 05.06 |                                     |                |        |   |                |     |
|  | 3.6 V6      | 191 |  | 05.09 |                                     |                |        |   |                |     |
|    | 1.4 TSI     | 90  |  | 10.07 | PR: 0EJ                             | 24.2519-1705.3 | 040095 |   | Nz 19,05       |     |
|  | 1.4 TSI     | 92  |  | 11.13 | PR: 0EJ                             |                |        |   |                |     |
|  | 1.4 TSI     | 110 |  | 11.13 | PR: 0EJ                             |                |        |   |                |     |
|  | 1.4 TSI     | 118 |  | 05.08 | PR: 0EJ                             |                |        |   |                |     |
|  | 1.6 FSI     | 85  |  | 05.06 | PR: 0EJ                             |                |        |   |                |     |
|  | 2.0 FSI     | 110 |  | 05.06 | PR: 0EJ                             |                |        |   |                |     |
|  | 2.0 TDI     | 100 |  | 11.10 | PR: 0EJ                             |                |        |   |                |     |
|  | 2.0 TDI     | 103 |  | 05.06 | PR: 0EJ                             |                |        |   |                |     |
|  | 2.0 TDI     | 103 |  | 05.06 | PR: 0EJ                             |                |        |   |                |     |
|  | 2.0 TFSI    | 147 |  | 05.06 | PR: 0EJ                             |                |        |   |                |     |
|  | 2.0 TFSI    | 162 |  | 11.13 | PR: 0EJ                             |                |        |   |                |     |
|  | 2.0 TSI     | 155 |  | 11.09 | PR: 0EJ                             |                |        |   |                |     |
|  | 3.2 V6      | 184 |  | 05.06 | PR: 0EJ                             |                |        |   |                |     |
|  | 3.6 V6      | 191 |  | 05.09 | PR: 0EJ                             |                |        |   |                |     |
| VOLKSWAGEN FOX (05-)   |             |     |  |       |                                     |                |        |   |                |     |
|    | 1.0         |     |  | 10.03 | PR: 1ZN                             | 24.2120-1734.3 | 010702 | + ABS   | THz 20,64      |     |
|  | 1.2         |     |  | 04.05 | PR: 1ZN                             |                |        |   |                |     |
|  | 1.4         | 55  |  | 04.05 | PR: 1ZN                             |                |        |   |                |     |
|  | 1.4 TDI     | 51  |  | 04.05 | PR: 1ZN                             |                |        |   |                |     |
|  | 1.6         |     |  | 10.03 | PR: 1ZN                             |                |        |   |                |     |
|  | 1.9 D       | 47  |  | 12.07 | PR: 1ZN                             |                |        |   |                |     |
|  | 1.0         |     |  | 10.03 | PR: 1ZF, 1AC, 1AT                   | 24.2120-1734.3 | 010702 | + ABS   | THz 20,64      |     |
|  | 1.2         |     |  | 04.05 | PR: 1ZF, 1AC, 1AT                   |                |        |   |                |     |
|  | 1.4         | 55  |  | 04.05 | PR: 1ZF, 1AC, 1AT                   |                |        |   |                |     |
|  | 1.4 TDI     | 51  |  | 04.05 | PR: 1ZF, 1AC, 1AT                   |                |        |   |                |     |
|  | 1.6         |     |  | 10.03 | PR: 1ZF, 1AC, 1AT                   |                |        |   |                |     |
|  | 1.9 D       | 47  |  | 12.07 | PR: 1ZF, 1AC, 1AT                   |                |        |   |                |     |
|    | 1.0         |     |  | 10.03 | PR: 1ZN                             | 24.3481-1735.5 | 240283 |    | D=48, - Halter | ATE |
|  | 1.2         |     |  | 04.05 | PR: 1ZN                             | 24.3481-1736.5 | 240284 |    | D=48, - Halter | ATE |
|  | 1.4         | 55  |  | 04.05 | PR: 1ZN                             |                |        |   |                |     |
|  | 1.4 TDI     | 51  |  | 04.05 | PR: 1ZN                             |                |        |   |                |     |
|  | 1.6         |     |  | 10.03 | PR: 1ZN                             |                |        |   |                |     |
|  | 1.9 D       | 47  |  | 12.07 | PR: 1ZN                             |                |        |   |                |     |
|  | 1.0         |     |  | 10.03 | PR: 1ZF                             | 11.9541-9549.2 | 220575 |  | D=54, - Halter | ATE |
|  | 1.2         |     |  | 04.05 | PR: 1ZF                             | 11.9541-9550.2 | 220576 |  | D=54, - Halter | ATE |
|  | 1.4         | 55  |  | 04.05 | PR: 1ZF                             | 11.0101-5409.2 | 260035 |   | Hülsensatz     | ATE |
|  | 1.4 TDI     | 51  |  | 04.05 | PR: 1ZF                             |                |        |   |                |     |
|  | 1.6         |     |  | 10.03 | PR: 1ZF                             |                |        |   |                |     |
|  | 1.9 D       | 47  |  | 12.07 | PR: 1ZF                             |                |        |   |                |     |
|  | 1.0         |     |  | 10.03 |                                     | 83.6247-0522.3 | 330595 | 2   | L=522          |     |
|  | 1.2         |     |  | 04.05 |                                     |                |        |   |                |     |
|  | 1.4         | 55  |  | 04.05 |                                     |                |        |   |                |     |
|  | 1.4 TDI     | 51  |  | 04.05 |                                     |                |        |   |                |     |
|  | 1.6         |     |  | 10.03 |                                     |                |        |   |                |     |
|  | 1.9 D       | 47  |  | 12.07 |                                     |                |        |   |                |     |
|  | 1.0         |     |  | 10.03 |                                     | 83.7858-0140.3 | 330837 | 2   | L=140          |     |
|  | 1.2         |     |  | 04.05 |                                     |                |        |   |                |     |
|  | 1.4         | 55  |  | 04.05 |                                     |                |        |   |                |     |
|  | 1.4 TDI     | 51  |  | 04.05 |                                     |                |        |   |                |     |
|  | 1.6         |     |  | 10.03 |                                     |                |        |   |                |     |
|  | 1.9 D       | 47  |  | 12.07 |                                     |                |        |   |                |     |
|  | 1.0         |     |  | 10.03 |                                     | 24.3217-0908.3 | 020167 |   | Rz 17,46       |     |
|  | 1.2         |     |  | 04.05 |                                     |                |        |   |                |     |
|  | 1.4         | 55  |  | 04.05 |                                     |                |        |   |                |     |
|  | 1.4 TDI     | 51  |  | 04.05 |                                     |                |        |   |                |     |
|  | 1.6         |     |  | 10.03 |                                     |                |        |   |                |     |
|  | 1.9 D       | 47  |  | 12.07 |                                     |                |        |   |                |     |
|  | 1.0         |     |  | 10.03 | PR: 1BA                             | 24.3727-0199.2 | 580199 | 2 ↓   | L=1580         |     |
|  | 1.2         |     |  | 04.05 | PR: 1BA                             |                |        |   |                |     |
|  | 1.4         | 55  |  | 04.05 | PR: 1BA                             |                |        |   |                |     |
|  | 1.4 TDI     | 51  |  | 04.05 | PR: 1BA                             |                |        |   |                |     |
|  | 1.6         |     |  | 10.03 | PR: 1BA                             |                |        |   |                |     |
|  | 1.9 D       | 47  |  | 12.07 | PR: 1BA                             |                |        |   |                |     |
|  | 1.0         |     |  | 10.03 |                                     | 03.6584-0120.3 | 320279 | - ABS   | BRL 8/4 (4)    | ATE |
|  | 1.2         |     |  | 04.05 |                                     |                |        |   |                |     |
|  | 1.4         | 55  |  | 04.05 |                                     |                |        |   |                |     |
|  | 1.4 TDI     | 51  |  | 04.05 |                                     |                |        |   |                |     |
|  | 1.6         |     |  | 10.03 |                                     |                |        |   |                |     |
|  | 1.9 D       | 47  |  | 12.07 |                                     |                |        |   |                |     |
| VOLKSWAGEN GOLF II (84-93)   |             |     |  |       |                                     |                |        |   |                |     |
|  | 1.6         |     |  | 08.87 | 12.93 - ABS                         | 03.6750-0202.4 | 300033 |   | 9"             | ATE |
|  | 1.6         |     |  | 08.83 | 07.87 - ABS/ + Automatikgetriebe 1) |                |        |   |                |     |
|  | 1.6 D       |     |  | 08.83 | 07.89 - ABS/ + Automatikgetriebe 1) |                |        |   |                |     |
|  | 1.6 TD      |     |  | 08.83 | 07.89 - ABS                         |                |        |   |                |     |
|  | 1.8         |     |  | 08.83 | 07.89 - ABS                         |                |        |   |                |     |
|  | 1.8 GTI     |     |  | 01.84 | - ABS                               |                |        |   |                |     |
|  | 1.8 GTI     |     |  | 01.84 | - ABS                               |                |        |   |                |     |
|  | 1.8 GTI 16V |     |  | 02.86 | - ABS                               |                |        |   |                |     |
| ↓  |             |     |  |       |                                     |                |        |   |                |     |

1) - ABS/ + autom.transmission / - ABS/ + scatola cambio autom. / - ABS/ + transmission automatique / - ABS/ + cambio automático

| VOLKSWAGEN GOLF II (84-93) |                 |             |             |   |                                      |                |                |                      |                      |                |     |
|----------------------------|-----------------|-------------|-------------|---|--------------------------------------|----------------|----------------|----------------------|----------------------|----------------|-----|
|                            | 1.8 GTI 16V     |             | 1G-KB075000 | 02.86                                   | - ABS                                | 03.6750-0202.4 | 300033         |                      | 9"                   | ATE            |     |
|                            | 1.8 Rallye      |             |             | 04.89                                   | 07.92 - ABS                          |                |                |                      |                      |                |     |
|                            | 1.8 Syncro      |             |             | 08.85                                   | 07.92 - ABS                          |                |                |                      |                      |                |     |
|                            | 1.8 Syncro G 60 |             |             | 04.89                                   | 07.92 - ABS                          |                |                |                      |                      |                |     |
|                            | 1.6 D           |             |             | 08.89                                   | 07.92 - ABS                          | 03.7750-4302.4 | 300076         |                      | 9"                   | ATE            |     |
|                            | 1.6 TD          |             |             | 08.89                                   | 12.93 - ABS                          |                |                |                      |                      |                |     |
|                            | 1.8             |             |             | 08.89                                   | 07.92 - ABS                          |                |                |                      |                      |                |     |
|                            | 1.8 G 60        |             |             | 04.90                                   | 07.92 - ABS                          |                |                |                      |                      |                |     |
|                            | 1.8 GTI         | 1G-KB075001 |             |   | 07.92 - ABS                          |                |                |                      |                      |                |     |
|                            | 1.8 GTI         | 1G-KW240001 |             |   | 07.92 - ABS                          |                |                |                      |                      |                |     |
| 1.8 GTI 16V                | 1G-KB075001     |             |             | 07.92 - ABS                             |                                      |                |                |                      |                      |                |     |
| 1.8 GTI 16V                | 1G-KW240001     |             |             | 07.92 - ABS                             |                                      |                |                |                      |                      |                |     |
|                            | 1.6             |             |             | 08.89                                   | 12.93 - ABS                          | 03.7750-4902.4 | 300079         |                      | 9"                   | ATE            |     |
|                            | 1.6 D           |             |             | 08.89                                   | 07.92 - ABS                          |                |                |                      |                      |                |     |
|                            | 1.6 TD          |             |             | 08.89                                   | 12.93 - ABS                          |                |                |                      |                      |                |     |
|                            | 1.8             |             |             | 08.89                                   | 07.92 - ABS                          |                |                |                      |                      |                |     |
|                            | 1.8 G 60        |             |             | 04.90                                   | 07.92 - ABS                          |                |                |                      |                      |                |     |
|                            | 1.8 GTI         | 1G-KB075001 |             |   | 07.92 - ABS                          |                |                |                      |                      |                |     |
|                            | 1.8 GTI         | 1G-KW240001 |             |   | 07.92 - ABS                          |                |                |                      |                      |                |     |
|                            | 1.8 GTI 16V     | 1G-KB075001 |             |   | 07.92 - ABS                          |                |                |                      |                      |                |     |
|                            | 1.8 GTI 16V     | 1G-KW240001 |             |   | 07.92 - ABS                          |                |                |                      |                      |                |     |
|                            |                 | 1.0         |             |   | 08.83                                | 10.91 - ABS    | 03.2120-2031.3 | 010106               |                      | THz 20,64      | ATE |
| 1.3                        |                 |             |             | 08.83                                   | 12.93 - ABS                          | 03.3517-0101.2 | 390322         |                      | Verschlußschraube    |                |     |
| 1.6                        |                 |             |             | 08.83                                   | 12.93 - ABS                          |                |                |                      |                      |                |     |
| 1.6 D                      |                 |             |             | 08.83                                   | 07.89 - ABS                          |                |                |                      |                      |                |     |
| 1.6 TD                     |                 |             |             | 08.83                                   | 07.89 - ABS                          |                |                |                      |                      |                |     |
| 1.8                        |                 |             |             | 08.83                                   | 07.89 - ABS                          |                |                |                      |                      |                |     |
| 1.8 GTI                    |                 | 1G-KW240000 |             | 01.84                                   | - ABS                                |                |                |                      |                      |                |     |
| 1.8 GTI                    |                 | 1G-KB075000 |             | 01.84                                   | - ABS                                |                |                |                      |                      |                |     |
| 1.8 GTI 16V                |                 | 1G-KW240000 |             | 02.86                                   | - ABS                                |                |                |                      |                      |                |     |
| 1.8 GTI 16V                |                 | 1G-KB075000 |             | 02.86                                   | - ABS                                |                |                |                      |                      |                |     |
| 1.8 Rallye                 |                 |             | 04.89       | 07.92 - ABS                             |                                      |                |                |                      |                      |                |     |
| 1.8 Syncro                 |                 |             | 08.85       | 07.92 - ABS                             |                                      |                |                |                      |                      |                |     |
| 1.8 Syncro G 60            |                 |             | 04.89       | 07.92 - ABS                             |                                      |                |                |                      |                      |                |     |
|                            | 1.6 D           |             |             | 08.89                                   | 07.92 - ABS                          | 03.2120-3943.3 | 010532         |                      | THz 20,64            | ATE            |     |
|                            | 1.6 TD          |             |             | 08.89                                   | 12.93 - ABS                          | 03.3517-0101.2 | 390322         |                      | Verschlußschraube    |                |     |
|                            | 1.8             |             |             | 08.89                                   | 07.92 - ABS                          |                |                |                      |                      |                |     |
|                            | 1.8 G 60        |             |             | 04.90                                   | 07.92 - ABS                          | 03.2122-1042.3 | 010137         |                      | THz 22,20            | ATE            |     |
|                            | 1.8 GTI         | 1G-KW240001 |             |   | 07.92 - ABS                          | 03.3517-0101.2 | 390322         |                      | Verschlußschraube    |                |     |
|                            | 1.8 GTI         | 1G-KB075001 |             |   | 07.92 - ABS                          |                |                |                      |                      |                |     |
|                            | 1.8 GTI 16V     | 1G-KW240001 |             |   | 07.92 - ABS                          |                |                |                      |                      |                |     |
|                            | 1.8 GTI 16V     | 1G-KB075001 |             |   | 07.92 - ABS                          |                |                |                      |                      |                |     |
|                            |                 | 1.0         |             | 19-E-855000                             | 08.83                                | - ABS          | 24.3481-1745.5 | 240277               |                      | D=48, - Halter | ATE |
|                            |                 | 1.0         |             |   | 08.86                                | 10.91 - ABS    | 24.3481-1746.5 | 240278               |                      | D=48, - Halter | ATE |
| 1.0                        |                 |             |             | 08.83                                   | 07.86                                | 11.0441-4808.2 | 250022         |                      | Dichtungssatz        | ATE            |     |
| 1.3                        |                 |             | 19-E-855000 | 08.83                                   | - ABS                                | 11.0101-4803.2 | 260008         |                      | Hülzensatz           | ATE            |     |
| 1.3                        |                 |             |             | 08.86                                   | 12.93 - ABS                          | 24.0102-4803.2 | 260086         |                      | Hülzensatz+Schrauben | ATE            |     |
| 1.3                        |                 |             |             | 08.83                                   | 07.86                                |                |                |                      |                      |                |     |
| 1.6 D                      |                 |             | 19-E-855000 | 08.83                                   | -                                    |                |                |                      |                      |                |     |
| 1.6 D                      |                 |             |             | 08.86                                   | 07.92 + Schaltgetriebe <sup>1)</sup> |                |                |                      |                      |                |     |
| 1.6 D                      |                 |             |             | 08.83                                   | 07.86 -                              |                |                |                      |                      |                |     |
| 1.0                        |                 |             |             | 08.89                                   | 10.91 + ABS                          | 11.0441-4808.2 | 250022         |                      | Dichtungssatz        | ATE            |     |
| 1.0                        | 19-E-855001     |             |             | 07.86                                   | 11.0101-4801.2                       | 260006         |                | Hülzensatz           | ATE                  |                |     |
| 1.3                        |                 |             | 08.89       | 12.93 + ABS                             | 24.0102-4801.2                       | 260085         |                | Hülzensatz+Schrauben | ATE                  |                |     |
| 1.3                        | 19-E-855001     |             |             | 07.86                                   |                                      |                |                |                      |                      |                |     |
| 1.6                        |                 |             | 08.83       | 12.93                                   |                                      |                |                |                      |                      |                |     |
| 1.6 D                      |                 |             | 08.86       | 07.92 + Automatikgetriebe <sup>2)</sup> |                                      |                |                |                      |                      |                |     |
| 1.6 D                      |                 |             | 08.83       | 07.86 +                                 |                                      |                |                |                      |                      |                |     |
| 1.6 D                      | 19-E-855001     |             |             | 07.86 -                                 |                                      |                |                |                      |                      |                |     |
| 1.6 TD                     |                 |             | 08.83       | 12.93                                   |                                      |                |                |                      |                      |                |     |
| 1.8                        |                 |             | 08.83       | 07.92                                   |                                      |                |                |                      |                      |                |     |
| 1.8 GT                     |                 |             | 08.85       | 07.92                                   |                                      |                |                |                      |                      |                |     |
| 1.8 GT Special             |                 |             | 08.85       | 07.92                                   |                                      |                |                |                      |                      |                |     |
| 1.8 GTI                    |                 |             | 01.84       | 07.92                                   |                                      |                |                |                      |                      |                |     |
| 1.8 GTI 16V                | 1G-KW240000     |             | 02.86       |   |                                      |                |                |                      |                      |                |     |
| 1.8 GTI 16V                | 1G-KB075000     |             | 02.86       |   |                                      |                |                |                      |                      |                |     |
| 1.8 Syncro                 |                 |             | 08.85       | 07.92                                   |                                      |                |                |                      |                      |                |     |
|                            | 1.8 GTI 16V     | 1G-KB075001 |             | 07.92                                   |                                      | 24.3541-1609.5 | 240039         |                      | D=54, - Halter       | LUC            |     |
|                            | 1.8 GTI 16V     | 1G-KW240001 |             | 07.92                                   |                                      | 24.3541-1610.5 | 240040         |                      | D=54, - Halter       | LUC            |     |
|                            |                 |             |             |   |                                      | 24.0101-4301.2 | 260047         |                      | Einbausatz           | LUC            |     |
|                            |                 |             |             |   |                                      | 11.0101-5403.2 | 260010         |                      | Faltenbalgsatz       | LUC            |     |
|                            | 1.8 G 60        |             | 1G-MW720000 | 04.90                                   |                                      | 24.0101-4301.2 | 260047         |                      | Einbausatz           | LUC            |     |
|                            | 1.8 G 60        |             | 1G-MB225000 | 04.90                                   |                                      | 11.0101-5403.2 | 260010         |                      | Faltenbalgsatz       | LUC            |     |
|                            | 1.8 Rallye      |             | 1G-MW720000 | 04.89                                   |                                      |                |                |                      |                      |                |     |
|                            | 1.8 Rallye      |             | 1G-MB225000 | 04.89                                   |                                      |                |                |                      |                      |                |     |
|                            | 1.8 Syncro G 60 |             | 1G-MW720000 | 04.89                                   |                                      |                |                |                      |                      |                |     |
|                            | 1.8 Syncro G 60 |             | 1G-MB225000 | 04.89                                   |                                      |                |                |                      |                      |                |     |
|                            | 1.8 G 60        | 1G-MB225001 |             | 07.92                                   |                                      | 24.3541-1731.5 | 240061         |                      | D=54, - Halter       | LUC            |     |
|                            | 1.8 G 60        | 1G-MW720001 |             | 07.92                                   |                                      | 24.3541-1732.5 | 240062         |                      | D=54, - Halter       | LUC            |     |
|                            | 1.8 Rallye      | 1G-MB225001 |             | 07.92                                   |                                      |                |                |                      |                      |                |     |
|                            | 1.8 Rallye      | 1G-MW720001 |             | 07.92                                   |                                      |                |                |                      |                      |                |     |
|                            | 1.8 Syncro G 60 | 1G-MB225001 |             | 07.92                                   |                                      |                |                |                      |                      |                |     |
|                            | 1.8 Syncro G 60 | 1G-MW720001 |             | 07.92                                   |                                      |                |                |                      |                      |                |     |

<sup>1)</sup> + manual transmission / + scatola cambio velocità / + transmission mécanique / + cambio de velocidad

<sup>2)</sup> + autom.transmission / + scatola cambio automatico / + transmission automatique / + cambio automático











**VOLKSWAGEN GOLF II (84-93)**

|                 |                 |             |             |             |                       |                       |                |        |          |          |                |     |
|-----------------|-----------------|-------------|-------------|-------------|-----------------------|-----------------------|----------------|--------|----------|----------|----------------|-----|
|                 | 1.0             |             |             | 08.83       | 10.91                 |                       | 83.7775-0312.3 | 330795 | 2        |          | L=310          |     |
|                 | 1.3             |             |             | 08.83       | 12.93                 |                       |                |        |          |          |                |     |
|                 | 1.6             |             |             | 08.83       | 12.93                 |                       |                |        |          |          |                |     |
|                 | 1.6 D           |             |             | 08.83       | 07.92                 |                       |                |        |          |          |                |     |
|                 | 1.6 TD          |             |             | 08.83       | 12.93                 |                       |                |        |          |          |                |     |
|                 | 1.8             |             |             | 08.83       | 07.92                 |                       |                |        |          |          |                |     |
|                 | 1.8 GTI         |             |             | 1G-KW240000 | 01.84                 |                       |                |        |          |          |                |     |
|                 | 1.8 GTI         |             |             | 1G-KB075000 | 01.84                 |                       |                |        |          |          |                |     |
|                 | 1.8 GTI 16V     |             |             | 1G-KW240000 | 02.86                 |                       |                |        |          |          |                |     |
|                 | 1.8 GTI 16V     |             |             | 1G-KB075000 | 02.86                 |                       |                |        |          |          |                |     |
| 1.8 Syncro      |                 |             |             | 08.85       | 07.92                 |                       |                |        |          |          |                |     |
|                 | 1.8 GTI         |             | 1G-KB075001 |             | 07.92                 |                       | 83.6225-0287.3 | 330735 | 2        |          | L=285          |     |
|                 | 1.8 GTI         |             | 1G-KW240001 |             | 07.92                 |                       |                |        |          |          |                |     |
|                 | 1.8 GTI 16V     |             | 1G-KB075001 |             | 07.92                 |                       |                |        |          |          |                |     |
|                 | 1.8 GTI 16V     |             | 1G-KW240001 |             | 07.92                 |                       |                |        |          |          |                |     |
|                 | 1.8 G 60        |             |             | 04.90       | 07.92                 |                       | 83.7813-0330.3 | 330800 | 2        |          | L=330          |     |
|                 | 1.8 Rallye      |             |             | 04.89       | 07.92                 |                       |                |        |          |          |                |     |
|                 | 1.8 Syncro G 60 |             |             | 04.89       | 07.92                 |                       |                |        |          |          |                |     |
|                 | 1.8 GT          |             |             | 08.85       | 07.88                 | - ABS/ - Special 1)   | 24.3364-1605.5 | 240011 |          |          | D=36, - Halter | LUC |
|                 | 1.8 GTI         |             |             | 01.84       | 07.88                 | - ABS                 | 24.3364-1606.5 | 240012 |          |          | D=36, - Halter | LUC |
|                 | 1.8 GTI 16V     |             |             | 02.86       | 07.88                 | - ABS                 | 24.0101-3601.2 | 260044 |          |          | Einbausatz     | LUC |
|                 |                 |             |             |             |                       |                       | 11.0101-5403.2 | 260010 |          |          | Faltenbalgsatz | LUC |
|                 | 1.8             | 62          | 19-JH480001 |             | 07.88                 | + ABS                 | 24.3384-1603.5 | 240015 |          |          | D=38, - Halter | LUC |
|                 | 1.8             | 66          | 19-JH480001 |             | 07.88                 | + ABS                 | 24.3384-1604.5 | 240016 |          |          | D=38, - Halter | LUC |
|                 | 1.8 GT          |             | 19-JH480001 |             | 07.88                 | + ABS/ - Special 2)   | 24.0101-3601.2 | 260044 |          |          | Einbausatz     | LUC |
|                 | 1.8 GTI         |             | 19-JH480001 |             | 07.88                 | + ABS                 |                |        |          |          |                |     |
|                 | 1.8 GTI 16V     |             | 19-JH480001 |             | 07.88                 | + ABS                 |                |        |          |          |                |     |
|                 | 1.8 Rallye      |             |             | 1G-LW330000 | 04.89                 |                       |                |        |          |          |                |     |
|                 | 1.8             | 62          |             | 08.88       | 07.89                 | + ABS                 | 24.3364-1605.5 | 240011 |          |          | D=36, - Halter | LUC |
|                 | 1.8             | 66          |             | 08.88       | 07.89                 | + ABS                 | 24.3364-1606.5 | 240012 |          |          | D=36, - Halter | LUC |
|                 | 1.8 GT          |             |             | 08.88       | 07.89                 | - Special 3)          | 24.0101-3601.2 | 260044 |          |          | Einbausatz     | LUC |
|                 | 1.8 GTI         |             |             | 08.88       | 07.89                 |                       | 11.0101-5403.2 | 260010 |          |          | Faltenbalgsatz | LUC |
|                 | 1.8 GTI 16V     |             |             | 08.88       | 07.89                 |                       |                |        |          |          |                |     |
|                 | 1.8             | 62          |             | 08.89       | 07.92                 | + ABS                 | 24.3384-1603.5 | 240015 |          |          | D=38, - Halter | LUC |
|                 | 1.8             | 66          |             | 08.89       | 07.92                 | + ABS                 | 24.3384-1604.5 | 240016 |          |          | D=38, - Halter | LUC |
|                 | 1.8 G 60        |             |             | 04.90       | 07.92                 |                       | 24.0101-3601.2 | 260044 |          |          | Einbausatz     | LUC |
|                 | 1.8 GT          |             |             | 08.89       | 07.92                 |                       |                |        |          |          |                |     |
|                 | 1.8 GT Special  |             |             | 08.85       | 07.92                 |                       |                |        |          |          |                |     |
|                 | 1.8 GTI         |             |             | 08.89       | 07.92                 |                       |                |        |          |          |                |     |
|                 | 1.8 GTI 16V     |             |             | 08.89       | 07.92                 |                       |                |        |          |          |                |     |
|                 | 1.8 Rallye      |             | 1G-LW330001 |             | 07.92                 |                       |                |        |          |          |                |     |
|                 | 1.8 Rallye      |             | 1G-LB085001 |             | 07.92                 |                       |                |        |          |          |                |     |
|                 | 1.8 Syncro G 60 |             | 1G-LW330001 |             | 07.92                 |                       |                |        |          |          |                |     |
|                 | 1.8 Syncro G 60 |             | 1G-LB085001 |             | 07.92                 |                       |                |        |          |          |                |     |
|                 | 1.0             |             |             | 08.83       | 07.88                 |                       | 83.7824-0180.3 | 330812 | 2        |          | L=180          |     |
|                 | 1.3             |             |             | 08.83       | 07.88                 |                       |                |        |          |          |                |     |
|                 | 1.6             |             |             | 08.83       | 07.88                 |                       |                |        |          |          |                |     |
|                 | 1.6 D           |             |             | 08.83       | 07.88                 |                       |                |        |          |          |                |     |
| 1.6 TD          |                 |             | 08.83       | 07.88       |                       |                       |                |        |          |          |                |     |
| 1.8             | 62              |             | 01.84       | 07.88       | - ABS                 |                       |                |        |          |          |                |     |
| 1.8             | 66              |             | 01.84       | 07.88       | - ABS                 |                       |                |        |          |          |                |     |
| 1.8 Rallye      |                 |             | 04.89       | 07.92       |                       |                       |                |        |          |          |                |     |
| 1.8 Syncro G 60 |                 |             | 04.89       | 07.92       |                       |                       |                |        |          |          |                |     |
|                 | 1.0             |             |             | 08.88       | 10.91                 |                       | 83.7804-0160.3 | 330811 | 2        |          | L=160          |     |
|                 | 1.3             |             |             | 08.88       | 12.93                 |                       |                |        |          |          |                |     |
|                 | 1.6             |             |             | 08.88       | 12.93                 |                       |                |        |          |          |                |     |
|                 | 1.6 D           |             |             | 08.88       | 07.92                 |                       |                |        |          |          |                |     |
|                 | 1.6 TD          |             |             | 08.88       | 12.93                 |                       |                |        |          |          |                |     |
|                 | 1.8             | 62          |             | 08.88       | 07.92                 | - ABS                 |                |        |          |          |                |     |
|                 | 1.8             | 66          |             | 08.88       | 07.92                 | - ABS                 |                |        |          |          |                |     |
|                 | 1.8             | 62          | 19-JH480001 |             | 07.92                 | + ABS                 | 83.7704-0160.3 | 330805 | 2        |          | L=160          |     |
|                 | 1.8             | 66          | 19-JH480001 |             | 07.92                 | + ABS                 |                |        |          |          |                |     |
|                 | 1.8 G 60        |             |             | 04.90       | 07.92                 |                       |                |        |          |          |                |     |
| 1.8 GT          |                 |             | 08.85       | 07.92       |                       |                       |                |        |          |          |                |     |
| 1.8 GTI         |                 |             | 01.84       | 07.92       |                       |                       |                |        |          |          |                |     |
| 1.8 GTI 16V     |                 |             | 02.86       | 07.92       |                       |                       |                |        |          |          |                |     |
| 1.8 Syncro      |                 |             | 08.85       | 07.92       |                       | 83.7804-0160.3        | 330811         | 2      |          | L=160    |                |     |
|                 | 1.0             |             |             | 08.83       | 10.91                 | - Bremskraftregler 4) | 03.3214-0812.3 | 020011 |          | + GG 5)  | Rz 14,29       |     |
|                 | 1.3             |             |             | 08.83       | 12.93                 | - Bremskraftregler 4) | 24.3214-0902.3 | 020147 |          | + ALU 6) | Rz 14,29       |     |
|                 | 1.6             |             |             | 08.83       | 12.93                 | - Bremskraftregler 4) |                |        |          |          |                |     |
|                 | 1.6 D           |             |             | 08.83       | 07.92                 | - Bremskraftregler 4) |                |        |          |          |                |     |
|                 | 1.6 TD          |             |             | 08.83       | 12.93                 | - Bremskraftregler 4) |                |        |          |          |                |     |
|                 | 1.8             | 62          |             | 01.84       | 07.92                 | - Bremskraftregler 4) |                |        |          |          |                |     |
|                 | 1.8             | 66          |             | 01.84       | 07.92                 | - Bremskraftregler 4) |                |        |          |          |                |     |
|                 | 1.8             | 77          |             | 01.84       | 07.92                 | - Bremskraftregler 4) |                |        |          |          |                |     |
|                 | 1.8             |             | 1G-KW593279 |             | 08.88                 | + 2)                  |                |        |          |          |                |     |
|                 | 1.0             |             |             | 08.83       | 10.91                 | + Bremskraftregler 7) | 03.3217-2112.3 | 020027 |          | + GG 5)  | Rz 17,46       |     |
| 1.3             |                 |             | 08.83       | 12.93       | + Bremskraftregler 7) | 24.3217-0908.3        | 020167         |        | + ALU 6) | Rz 17,46 |                |     |
| 1.6             |                 |             | 08.83       | 12.93       | + Bremskraftregler 7) |                       |                |        |          |          |                |     |
| 1.6 D           |                 |             | 08.83       | 07.92       | + Bremskraftregler 7) |                       |                |        |          |          |                |     |
| 1.6 TD          |                 |             | 08.83       | 12.93       | + Bremskraftregler 7) |                       |                |        |          |          |                |     |
| 1.8             | 62              |             | 01.84       | 07.92       | + Bremskraftregler 7) |                       |                |        |          |          |                |     |
| 1.8             | 66              |             | 01.84       | 07.92       | + Bremskraftregler 7) |                       |                |        |          |          |                |     |
| 1.8             | 77              | 1G-KW593280 |             | 01.84       | 07.92                 | + Bremskraftregler 7) |                |        |          |          |                |     |
| 1.8             |                 |             |             | 07.92       | + 2)                  |                       |                |        |          |          |                |     |

1) - ABS/ - Special / - ABS/ - Speciale / - ABS/ - Spécial / - ABS/ - Especial  
 2) + ABS/ - Special / + ABS/ - Speciale / + ABS/ - Spécial / + ABS/ - Especial  
 3) - Special / - Speciale / - Spécial / - Especial  
 4) - brake pressure regulator / - correttore di frenata / - correcteur de freinage / - corrector de frenado  
 5) + cast iron / + ghisa / + fonte grise / + fundición de gris  
 6) + aluminium / + alluminio / + aluminium / + aluminio  
 7) + brake pressure regulator / + correttore di frenata / + correcteur de freinage / + corrector de frenado

| VOLKSWAGEN GOLF II (84-93)   |  |          |             |                |                |        |   |   |  |        |                 |                |                |        |  |  |  |        |          |
|--|--|----------|-------------|----------------|----------------|--------|---|---|--|--------|-----------------|----------------|----------------|--------|--|--|--|--------|----------|
|    | 1.8 Syncro   |          | 08.85       | 07.92          | 24.3219-0909.3 | 020188 |   |   |  |        | Rz 19,05        |                |                |        |  |  |  |        |          |
|    | 1.0  |          | 08.83       | 07.88          | 24.3727-0118.2 | 580118 | 2 | ↓ |  |        | L=1748          |                |                |        |  |  |  |        |          |
|  | 1.3  |          | 08.83       | 07.88          |                |        |   |   |  |        |                 |                |                |        |  |  |  |        |          |
|  | 1.6  |          | 08.83       | 07.88          |                |        |   |   |  |        |                 |                |                |        |  |  |  |        |          |
|  | 1.6 D  |          | 08.83       | 07.88          |                |        |   |   |  |        |                 |                |                |        |  |  |  |        |          |
|  | 1.6 TD   |          | 08.83       | 07.88          |                |        |   |   |  |        |                 |                |                |        |  |  |  |        |          |
|  | 1.8  | 62       | 01.84       | 07.88 - ABS    |                |        |   |   |  |        |                 |                |                |        |  |  |  |        |          |
|  | 1.8  | 66       | 01.84       | 07.88 - ABS    |                |        |   |   |  |        |                 |                |                |        |  |  |  |        |          |
|  | 1.0  |          | 08.88       | 10.91          | 24.3727-0132.2 | 580132 | 2 | ↓ |  |        | L=1527          |                |                |        |  |  |  |        |          |
|  | 1.3  |          | 08.88       | 12.93          |                |        |   |   |  |        |                 |                |                |        |  |  |  |        |          |
|  | 1.6  |          | 08.88       | 12.93          |                |        |   |   |  |        |                 |                |                |        |  |  |  |        |          |
|  | 1.6 D  |          | 08.88       | 07.92          |                |        |   |   |  |        |                 |                |                |        |  |  |  |        |          |
|  | 1.6 TD   |          | 08.88       | 12.93          |                |        |   |   |  |        |                 |                |                |        |  |  |  |        |          |
|  | 1.8  | 62       | 08.88       | 07.92 - ABS    |                |        |   |   |  |        |                 |                |                |        |  |  |  |        |          |
|  | 1.8  | 66       | 08.88       | 07.92 - ABS    |                |        |   |   |  |        |                 |                |                |        |  |  |  |        |          |
|  | 1.8 GT   |          | 08.85       | 07.88 - ABS    | 24.3727-0123.2 | 580123 | 2 | ↓ |  |        | L=1800          |                |                |        |  |  |  |        |          |
| 1.8 GTI  |  | 01.84    | 07.88 - ABS |                |                |        |   |   |  |        |                 |                |                |        |  |  |  |        |          |
| 1.8 GTI 16V  |  | 02.86    | 07.88 - ABS |                |                |        |   |   |  |        |                 |                |                |        |  |  |  |        |          |
| 1.8  | 19-JH480001  |          | 07.88 + ABS | 24.3727-0124.2 | 580124         | 2      | ↓ |   |  | L=1840 |                 |                |                |        |  |  |  |        |          |
| 1.8 GT   | 19-JH480001  |          | 07.88 + ABS |                |                |        |   |   |  |        |                 |                |                |        |  |  |  |        |          |
| 1.8 GTI  | 19-JH480001  |          | 07.88 + ABS |                |                |        |   |   |  |        |                 |                |                |        |  |  |  |        |          |
| 1.8 GTI 16V  | 19-JH480001  |          | 07.88 + ABS |                |                |        |   |   |  |        |                 |                |                |        |  |  |  |        |          |
| 1.8  |  | 08.88    | 07.92 + ABS | 24.3727-0133.2 | 580133         | 2      | ↓ |   |  | L=1622 |                 |                |                |        |  |  |  |        |          |
| 1.8 GT   |  | 08.88    | 07.92       |                |                |        |   |   |  |        |                 |                |                |        |  |  |  |        |          |
| 1.8 GTI  |  | 08.88    | 07.92       |                |                |        |   |   |  |        |                 |                |                |        |  |  |  |        |          |
| 1.8 GTI 16V  |  | 08.88    | 07.92       |                |                |        |   |   |  |        |                 |                |                |        |  |  |  |        |          |
| 1.8 Syncro   |  | 08.85    | 07.92       | 24.3727-0166.2 | 580166         | 2      | ↓ |   |  | L=1567 |                 |                |                |        |  |  |  |        |          |
| 1.8 G 60   |  | 04.90    | 07.92       |                |                |        |   |   |  |        |                 |                |                |        |  |  |  |        |          |
|    | 1.0  |          | 08.83       | 10.91          | 03.6584-0015.3 | 320109 |   |   |  |        | BRL 8/4 (4) ATE |                |                |        |  |  |  |        |          |
|  | 1.3  |          | 08.83       | 12.93          |                |        |   |   |  |        |                 |                |                |        |  |  |  |        |          |
|  | 1.6  |          | 08.83       | 12.93          |                |        |   |   |  |        |                 |                |                |        |  |  |  |        |          |
|  | 1.6 D  |          | 08.83       | 07.92          |                |        |   |   |  |        |                 |                |                |        |  |  |  |        |          |
|  | 1.6 TD   |          | 08.83       | 12.93          |                |        |   |   |  |        |                 |                |                |        |  |  |  |        |          |
|  | 1.8  |          | 08.83       | 07.92          |                |        |   |   |  |        |                 |                |                |        |  |  |  |        |          |
|  | 1.8 G 60   |          | 08.89       | 07.92          |                |        |   |   |  |        |                 |                |                |        |  |  |  |        |          |
|  | 1.8 GTI  |          | 01.84       | 07.92          |                |        |   |   |  |        |                 |                |                |        |  |  |  |        |          |
|  | 1.8 GTI 16V  |          | 02.86       | 07.92          |                |        |   |   |  |        |                 |                |                |        |  |  |  |        |          |
|  | 1.8 Rallye   |          | 04.89       | 07.92          |                |        |   |   |  |        |                 |                |                |        |  |  |  |        |          |
|  | 1.8 Syncro   |          | 04.89       | 07.92          |                |        |   |   |  |        |                 |                |                |        |  |  |  |        |          |
|  | 1.8 Syncro G 60  |          | 04.89       | 07.92          |                |        |   |   |  |        |                 |                |                |        |  |  |  |        |          |
|  |  | 1.8 G 60 |             | 04.90          |                |        |   |   |  |        |                 | 07.92          | 03.2419-9310.3 | 030027 |  |  |  |        | Gz 19,05 |
|  |  | 1.8 GTI  |             | 08.89          |                |        |   |   |  |        |                 | 07.92          |                |        |  |  |  |        |          |
| 1.8 GTI 16V  |  |          | 08.89       | 07.92          |                |        |   |   |  |        |                 |                |                |        |  |  |  |        |          |
| 1.8 Rallye   |  |          | 04.89       | 07.92          |                |        |   |   |  |        |                 |                |                |        |  |  |  |        |          |
| 1.8 Syncro G 60  |  |          | 04.89       | 07.92          |                |        |   |   |  |        |                 |                |                |        |  |  |  |        |          |
|  | 1.8 G 60   |          | 04.90       | 07.92          | 24.2523-0908.3 | 040049 |   |   |  |        | Nz 23,81        |                |                |        |  |  |  |        |          |
|  | 1.8 GTI  |          | 08.89       | 07.92          |                |        |   |   |  |        |                 |                |                |        |  |  |  |        |          |
|  | 1.8 GTI 16V  |          | 08.89       | 07.92          |                |        |   |   |  |        |                 |                |                |        |  |  |  |        |          |
|  | 1.8 Rallye   |          | 04.89       | 07.92          |                |        |   |   |  |        |                 |                |                |        |  |  |  |        |          |
|  | 1.8 Syncro G 60  |          | 04.89       | 07.92          |                |        |   |   |  |        |                 |                |                |        |  |  |  |        |          |
|  | 1.0  | ‡        | 08.83       | 10.91          | 24.3728-0113.2 | 590113 |   |   |  |        | L=1098          |                |                |        |  |  |  |        |          |
|  | 1.3  | ‡        | 08.83       | 12.93          |                |        |   |   |  |        |                 |                |                |        |  |  |  |        |          |
|  | 1.6  | ‡        | 08.83       | 12.93          | 24.3728-0111.2 | 590111 |   |   |  |        | L=806           |                |                |        |  |  |  |        |          |
|  | 1.8  | ‡        | 08.83       | 07.92          |                |        |   |   |  |        |                 |                |                |        |  |  |  |        |          |
|  | 1.6  | ‡        | 08.83       | 12.93          | 24.3728-0121.2 | 590121 |   |   |  |        | L=800, + AUT    |                |                |        |  |  |  |        |          |
|  | 1.6 D  | ‡        | 08.83       | 07.92          |                |        |   |   |  |        |                 |                |                |        |  |  |  |        |          |
|  | 1.6 TD   | ‡ 51     | 08.83       | 12.93          | 24.3728-0120.2 | 590120 |   |   |  |        | L=1081, + AUT   |                |                |        |  |  |  |        |          |
|  | 1.8  | ‡        | 08.38       | 07.92          |                |        |   |   |  |        |                 |                |                |        |  |  |  |        |          |
|  | 1.6 TD   | ‡ 59     | 04.89       | 12.93          | 24.3728-0111.2 | 590111 |   |   |  |        | L=806           |                |                |        |  |  |  |        |          |
| 1.8 Syncro   | ‡  | 08.85    | 07.92       |                |                |        |   |   |  |        |                 |                |                |        |  |  |  |        |          |
|  |  |          |             |                | 24.3728-0121.2 | 590121 |   |   |  |        | L=800, + AUT    |                |                |        |  |  |  |        |          |
| VOLKSWAGEN GOLF III (92-97)  |  |          |             |                |                |        |   |   |  |        |                 |                |                |        |  |  |  |        |          |
|  | 1.4  | ‡        | 11.91       | 08.97 - ABS    | 03.7750-5502.4 | 300081 |   |   |  |        | 9" ATE          |                |                |        |  |  |  |        |          |
|  | 1.6  | ‡        | 09.92       | 08.97 - ABS    |                |        |   |   |  |        |                 |                |                |        |  |  |  |        |          |
|  | 1.8  | ‡        | 11.91       | 08.97 - ABS    |                |        |   |   |  |        |                 |                |                |        |  |  |  |        |          |
|  | 1.8 Syncro   | ‡        | 01.93       | 08.97 - ABS    |                |        |   |   |  |        |                 |                |                |        |  |  |  |        |          |
|  | 1.9 D  | ‡        | 11.91       | 08.97 - ABS    |                |        |   |   |  |        |                 |                |                |        |  |  |  |        |          |
|  | 1.9 D Ecomatic   | ‡        | 08.93       | 07.95 - ABS    |                |        |   |   |  |        |                 |                |                |        |  |  |  |        |          |
|  | 1.9 SDI  | ‡        | 07.95       | 08.97 - ABS    |                |        |   |   |  |        |                 |                |                |        |  |  |  |        |          |
|  | 1.9 TD   | ‡ 55     | 11.91       | 08.97 - ABS    |                |        |   |   |  |        |                 |                |                |        |  |  |  |        |          |
|  | 1.9 TDI  | ‡ 66     | 10.93       | 08.97 - ABS    |                |        |   |   |  |        |                 |                |                |        |  |  |  |        |          |
|  | 1.9 TDI  | ‡ 81     | 02.96       | 08.97 - ABS    |                |        |   |   |  |        |                 |                |                |        |  |  |  |        |          |
|  | 1.9 TDI Syncro   | ‡ 66     | 03.95       | 08.97 - ABS    |                |        |   |   |  |        |                 |                |                |        |  |  |  |        |          |
|  | 2.0  | ‡        | 11.91       | 08.97 - ABS    |                |        |   |   |  |        |                 |                |                |        |  |  |  |        |          |
|  | 2.0 GTI  | ‡ 85     | 11.91       | 08.97 - ABS    |                |        |   |   |  |        |                 |                |                |        |  |  |  |        |          |
|  | 2.0 GTI 16V  | ‡        | 08.92       | 08.97 - ABS    |                |        |   |   |  |        |                 |                |                |        |  |  |  |        |          |
|  | 2.0 Syncro   | ‡        | 07.95       | 08.97 - ABS    |                |        |   |   |  |        |                 |                |                |        |  |  |  |        |          |
|  | 2.8 VR6  | ‡        | 01.92       | 08.97 - ABS    |                |        |   |   |  |        |                 |                |                |        |  |  |  |        |          |
|  | 1.4  | ‡        | 11.91       | 08.97 - ABS    |                |        |   |   |  |        |                 | 03.7750-5602.4 | 300082         |        |  |  |  | 9" ATE |          |
| 1.6  | ‡  | 09.92    | 08.97 - ABS |                |                |        |   |   |  |        |                 |                |                |        |  |  |  |        |          |
| 1.8  | ‡  | 11.91    | 08.97 - ABS |                |                |        |   |   |  |        |                 |                |                |        |  |  |  |        |          |

1) - automatic adjustment / - correzione automatica / - ajustage automatique / - reajuste automatico

2) + automatic adjustment / + correzione automatica / + ajustage automatique / + reajuste automatico

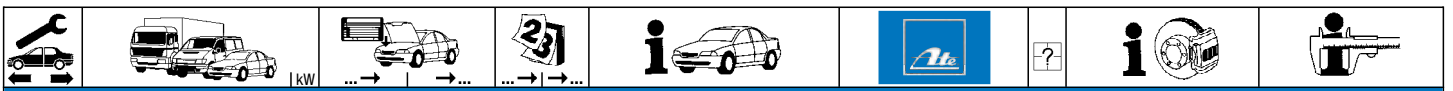

**VOLKSWAGEN GOLF III (92-97)**

|                |                |             |             |             |       |             |                |        |  |           |     |
|----------------|----------------|-------------|-------------|-------------|-------|-------------|----------------|--------|--|-----------|-----|
|                | 1.9 D          |             |             | 11.91       | 08.97 | - ABS       | 03.7750-5602.4 | 300082 |  | 9"        | ATE |
|                | 1.9 D Ecomatic |             |             | 08.93       | 07.95 | - ABS       |                |        |  |           |     |
|                | 1.9 SDI        |             |             | 07.95       | 08.97 | - ABS       |                |        |  |           |     |
|                | 1.9 TD         | 55          |             | 11.91       | 08.97 | - ABS       |                |        |  |           |     |
|                | 1.9 TDI        | 66          |             | 10.93       | 08.97 | - ABS       |                |        |  |           |     |
|                | 1.9 TDI        | 81          |             | 02.96       | 08.97 | - ABS       |                |        |  |           |     |
|                | 2.0            |             |             | 11.91       | 08.97 | - ABS       |                |        |  |           |     |
|                | 2.0 GTI        | 85          |             | 11.91       | 08.97 | - ABS       |                |        |  |           |     |
|                | 2.0 GTI 16V    |             |             | 08.92       | 08.97 | - ABS       |                |        |  |           |     |
|                | 2.8 VR6        |             |             | 01.92       | 08.97 | - ABS       |                |        |  |           |     |
|                | 1.4            |             | 1H-S-088704 | 11.91       |       | + ABS       | 10.6360-1003.4 | 300156 |  | 10"       | ATE |
|                | 1.6            | 55          | 1H-S-088704 | 09.92       |       | + ABS       |                |        |  |           |     |
|                | 1.6            | 74          | 1H-S-088704 | 07.94       |       | + ABS       |                |        |  |           |     |
|                | 1.8            |             | 1H-S-088704 | 11.91       |       | + ABS       |                |        |  |           |     |
|                | 1.8 GT         |             | 1H-S-088704 | 11.91       |       | + ABS       |                |        |  |           |     |
|                | 1.8 Syncro     |             | 1H-S-088704 | 01.93       |       | + ABS       |                |        |  |           |     |
|                | 1.9 D          |             | 1H-S-088704 | 11.91       |       | + ABS       |                |        |  |           |     |
|                | 1.9 D Ecomatic |             | 1H-S-088704 | 08.93       |       | + ABS       |                |        |  |           |     |
|                | 1.9 TD         | 55          | 1H-S-088704 | 11.91       |       | + ABS       |                |        |  |           |     |
|                | 1.9 TDI        | 66          | 1H-S-088704 | 10.93       |       | + ABS       |                |        |  |           |     |
|                | 2.0            |             | 1H-S-088704 | 11.91       |       | + ABS       |                |        |  |           |     |
|                | 2.0 GTI 16V    |             | 1H-S-088704 | 08.92       |       | + ABS       |                |        |  |           |     |
|                | 2.8 VR6        |             | 1H-S-088704 | 01.92       |       | + ABS       |                |        |  |           |     |
|                | 2.9 VR6 Syncro |             | 1H-S-088704 | 10.94       |       | + ABS       |                |        |  |           |     |
|                |                | 1.4         |             | 1H-S-088705 |       | 08.97       |                |        |  |           |     |
| 1.6            |                | 55          | 1H-S-088705 |             | 08.97 | + ABS       |                |        |  |           |     |
| 1.6            |                | 74          | 1H-S-088705 |             | 08.97 | + ABS       |                |        |  |           |     |
| 1.8            |                |             | 1H-S-088705 |             | 08.97 | + ABS       |                |        |  |           |     |
| 1.8 GT         |                |             | 1H-S-088705 |             | 08.97 | + ABS       |                |        |  |           |     |
| 1.8 Syncro     |                |             | 1H-S-088705 |             | 08.97 | + ABS       |                |        |  |           |     |
| 1.9 D          |                |             | 1H-S-088705 |             | 08.97 | + ABS       |                |        |  |           |     |
| 1.9 D Ecomatic |                |             | 1H-S-088705 |             | 07.95 | + ABS       |                |        |  |           |     |
| 1.9 SDI        |                |             |             | 07.95       | 08.97 | + ABS       |                |        |  |           |     |
| 1.9 TD         |                | 55          | 1H-S-088705 |             | 08.97 | + ABS       |                |        |  |           |     |
| 1.9 TDI        |                | 66          | 1H-S-088705 |             | 08.97 | + ABS       |                |        |  |           |     |
| 1.9 TDI        |                | 81          |             | 02.96       | 08.97 | + ABS       |                |        |  |           |     |
| 1.9 TDI Syncro |                | 66          |             | 03.95       | 08.97 | + ABS       |                |        |  |           |     |
| 2.0            |                |             | 1H-S-088705 |             | 08.97 | + ABS       |                |        |  |           |     |
| 2.0 GTI 16V    |                |             | 1H-S-088705 |             | 08.97 | + ABS       |                |        |  |           |     |
| 2.0 Syncro     |                |             | 07.95       | 08.97       | + ABS |             |                |        |  |           |     |
| 2.8 VR6        |                | 1H-S-088705 |             | 08.97       | + ABS |             |                |        |  |           |     |
| 2.9 VR6 Syncro |                | 1H-S-088705 |             | 08.97       | + ABS |             |                |        |  |           |     |
|                | 1.4            |             |             | 11.91       | 08.97 | - ABS       | 03.2122-1042.3 | 010137 |  | THz 20,64 | ATE |
|                | 1.6            | 55          |             | 09.92       | 08.97 | - ABS       |                |        |  |           |     |
|                | 1.8            |             |             | 11.91       | 08.97 | - ABS/ - GT |                |        |  |           |     |
|                | 1.9 D          |             |             | 11.91       | 08.97 | - ABS       |                |        |  |           |     |
|                | 1.9 D Ecomatic |             |             | 08.93       | 07.95 | - ABS       |                |        |  |           |     |
|                | 1.9 SDI        |             |             | 07.95       | 08.97 | - ABS       |                |        |  |           |     |
|                | 1.9 TD         | 55          |             | 11.91       | 08.97 | - ABS       |                |        |  |           |     |
|                | 1.6            | 74          |             | 07.94       | 08.97 | - ABS       |                |        |  |           |     |
|                | 1.8 GT         |             |             | 11.91       | 08.97 | - ABS       |                |        |  |           |     |
|                | 1.8 Syncro     |             |             | 01.93       | 08.97 | - ABS       |                |        |  |           |     |
| 1.9 TDI        | 66             |             | 10.93       | 08.97       | - ABS |             |                |        |  |           |     |
| 1.9 TDI        | 81             |             | 02.96       | 08.97       | - ABS |             |                |        |  |           |     |
| 1.9 TDI Syncro | 66             |             | 03.95       | 08.97       | - ABS |             |                |        |  |           |     |
| 2.0            |                |             | 11.91       | 08.97       | - ABS |             |                |        |  |           |     |
| 2.0 GTI        | 85             |             | 11.91       | 08.97       | - ABS |             |                |        |  |           |     |
| 2.0 GTI 16V    |                |             | 08.92       | 08.97       | - ABS |             |                |        |  |           |     |
| 2.0 Syncro     |                |             | 07.95       | 08.97       | - ABS |             |                |        |  |           |     |
|                | 1.4            |             | 1H-S-088704 | 11.91       |       | + ABS       | 10.6122-0144.3 | 010638 |  | THz 22,20 | ATE |
|                | 1.6            | 55          | 1H-S-088704 | 09.92       |       | + ABS       |                |        |  |           |     |
|                | 1.8            |             | 1H-S-088704 | 11.91       |       | + ABS/ - GT |                |        |  |           |     |
|                | 1.8 Syncro     |             | 1H-S-088704 | 01.93       |       | + ABS       |                |        |  |           |     |
|                | 1.9 D          |             | 1H-S-088704 | 11.91       |       | + ABS       |                |        |  |           |     |
|                | 1.9 D Ecomatic |             | 1H-S-088704 | 08.93       |       | + ABS       |                |        |  |           |     |
|                | 1.9 TD         | 55          | 1H-S-088704 | 11.91       |       | + ABS       |                |        |  |           |     |
|                | 1.4            |             | 1H-S-088705 |             | 08.97 | + ABS       | 03.2122-1144.3 | 010636 |  | THz 22,20 | ATE |
|                | 1.6            | 55          | 1H-S-088705 |             | 08.97 | + ABS       |                |        |  |           |     |
|                | 1.8            |             | 1H-S-088705 |             | 08.97 | + ABS/ - GT |                |        |  |           |     |
|                | 1.9 D          |             | 1H-S-088705 |             | 08.97 | + ABS       |                |        |  |           |     |
|                | 1.9 D Ecomatic |             | 1H-S-088705 |             | 07.95 | + ABS       |                |        |  |           |     |
|                | 1.9 SDI        |             |             | 07.95       | 08.97 | + ABS       |                |        |  |           |     |
|                | 1.9 TD         | 55          | 1H-S-088705 |             | 08.97 | + ABS       |                |        |  |           |     |
|                | 1.6            | 74          | 1H-S-088704 | 07.94       |       | + ABS       | 10.6123-0674.3 | 010639 |  | THz 23,81 | ATE |
|                | 1.8 GT         |             | 1H-S-088704 | 11.91       |       | + ABS       |                |        |  |           |     |
|                | 1.9 TDI        | 66          | 1H-S-088704 | 10.93       |       | + ABS       |                |        |  |           |     |
|                | 2.0            |             | 1H-S-088704 | 11.91       |       | + ABS       |                |        |  |           |     |
|                | 2.0 GTI 16V    |             | 1H-S-088704 | 08.92       |       | + ABS       |                |        |  |           |     |
|                | 2.8 VR6        |             | 1H-S-088704 | 01.92       |       | + ABS       |                |        |  |           |     |
|                | 2.9 VR6 Syncro |             | 1H-S-088704 | 10.94       |       | + ABS       |                |        |  |           |     |
|                | 1.6            | 74          | 1H-S-088705 |             | 08.97 | + ABS       | 03.2123-1424.3 | 010637 |  | THz 23,81 | ATE |
|                | 1.8 GT         |             | 1H-S-088705 |             | 08.97 | + ABS       |                |        |  |           |     |
|                | 1.8 Syncro     |             | 1H-S-088705 |             | 08.97 | + ABS       |                |        |  |           |     |
|                | 1.9 TDI        | 66          | 1H-S-088705 |             | 08.97 | + ABS       |                |        |  |           |     |
|                | 1.9 TDI        | 81          |             | 02.96       | 08.97 | + ABS       |                |        |  |           |     |
|                | 1.9 TDI Syncro | 66          |             | 03.95       | 08.97 | + ABS       |                |        |  |           |     |

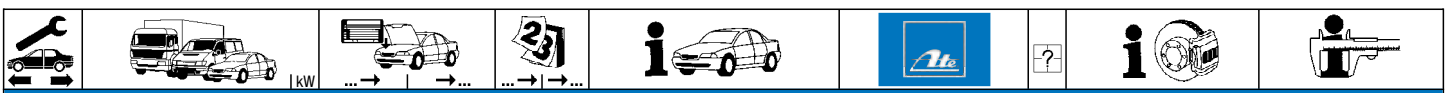

**VOLKSWAGEN GOLF III (92-97)**

|                |                |             |             |       |             |  |  |                |                |                |                      |     |
|----------------|----------------|-------------|-------------|-------|-------------|--|--|----------------|----------------|----------------|----------------------|-----|
|                | 2.0            |             | 1H-S-088705 |       |             | 08.97 + ABS  |  | 03.2123-1424.3 | 010637         |                | Thz 23,81            | ATE |
|                | 2.0 GTI 16V    |             | 1H-S-088705 |       |             | 08.97 + ABS  |  |                |                |                |                      |     |
|                | 2.0 Syncro     |             |             |       | 07.95       | 08.97 + ABS  |  |                |                |                |                      |     |
|                | 2.8 VR6        |             | 1H-S-088705 |       |             | 08.97 + ABS  |  |                |                |                |                      |     |
| 2.9 VR6 Syncro |                | 1H-S-088705 |             |       | 08.97 + ABS |  |  |                |                |                |                      |     |
|                | 1.4            |             | 1H-S-088705 |       |             | 08.97 + ABS  |  | 03.2122-1184.3 | 010592         |                | Thz 22,20            | ATE |
|                | 1.6            | 55          | 1H-S-088705 |       |             | 08.97 + ABS  |  |                |                |                |                      |     |
|                | 1.8            |             | 1H-S-088705 |       |             | 08.97 + ABS/- GT                                     |  |                |                |                |                      |     |
|                | 1.9 D          |             | 1H-S-088705 |       |             | 08.97 + ABS  |  |                |                |                |                      |     |
|                | 1.9 SDI        |             |             |       | 07.95       | 08.97 + ABS  |  |                |                |                |                      |     |
|                | 1.9 TD         | 55          | 1H-S-088705 |       |             | 08.97 + ABS  |  |                |                |                |                      |     |
|                | 1.6            | 74          | 1H-S-088705 |       |             | 08.97 + ABS  |  | 03.2123-1484.3 | 010595         |                | Thz 23,81            | ATE |
| 1.8 GT         |                | 1H-S-088705 |             |       | 08.97 + ABS |  |  |                |                |                |                      |     |
| 1.9 TDI        | 66             | 1H-S-088705 |             |       | 08.97 + ABS |  |  |                |                |                |                      |     |
| 1.9 TDI        | 81             |             |             |       | 02.96       | 08.97 + ABS  |  |                |                |                |                      |     |
| 2.0            |                | 1H-S-088705 |             |       |             | 08.97 + ABS  |  |                |                |                |                      |     |
| 2.0 GTI 16V    |                | 1H-S-088705 |             |       |             | 08.97 + ABS  |  |                |                |                |                      |     |
| 2.8 VR6        |                | 1H-S-088705 |             |       |             | 08.97 + ABS  |  |                |                |                |                      |     |
|                | 1.4            | 55          | 1H-T-028354 | 11.91 |             |  |  | 11.0441-4808.2 | 250022         |                | Dichtungssatz        | ATE |
|                | 1.6            |             | 1H-T-028354 | 09.92 |             |  |  | 11.0101-4801.2 | 260006         |                | Hülsensatz           | ATE |
|                | 1.8            |             | 1H-T-028354 | 11.91 |             |  | - GT/ + Schaltgetriebe <sup>1)</sup>             | 24.0102-4801.2 | 260085         |                | Hülsensatz+Schrauben | ATE |
|                | 1.8            |             | 1H-S-246940 | 11.91 |             |  | - GT/ + Automatikgetriebe <sup>2)</sup>          |                |                |                |                      |     |
|                | 1.8 Syncro     |             | 1H-S-089450 | 01.93 |             |  |  |                |                |                |                      |     |
|                | 1.9 D          |             | 1H-T-028354 | 11.91 |             |  |  |                |                |                |                      |     |
|                | 1.9 D Ecomatic |             | 1H-S-246940 | 08.93 |             |  |  |                |                |                |                      |     |
|                | 1.9 SDI        |             | 1H-T-028354 | 07.95 |             |  |  |                |                |                |                      |     |
|                | 1.9 TD         | 55          | 1H-T-028354 | 11.91 |             |  |  |                |                |                |                      |     |
|                | 1.4            |             | 1H-T-028355 |       |             |  | 08.97 - ABS                                      |                | 11.0441-4808.2 | 250022         | Dichtungssatz        | ATE |
|                | 1.6            | 55          | 1H-T-028355 |       |             |  | 08.97 - ABS                                      |                | 11.0101-4801.2 | 260006         | Hülsensatz           | ATE |
|                | 1.8            |             | 1H-T-028355 |       |             |  | 08.97 - ABS/ - GT/+ Schaltgetriebe <sup>3)</sup> |                | 24.0102-4801.2 | 260085         | Hülsensatz+Schrauben | ATE |
| 1.9 D          |                | 1H-T-028355 |             |       |             | 08.97 - ABS  |  |                |                |                |                      |     |
| 1.9 SDI        |                | 1H-T-028355 |             |       |             | 08.97 - ABS  |  |                |                |                |                      |     |
| 1.9 TD         | 55             | 1H-T-028355 |             |       |             | 08.97 - ABS  |  |                |                |                |                      |     |
|                | 1.6 CL/GL      | 74          |             |       | 07.94       | 08.97 - ABS  |  | 24.3541-1739.5 | 240223         |                | D=54, - Halter       | LUC |
|                | 1.8            |             | 1H-S-246941 |       |             | 08.97 - ABS/ - GT/ + Automatikgetriebe <sup>4)</sup> |  | 24.3541-1740.5 | 240224         |                | D=54, - Halter       | LUC |
|                | 1.8 Syncro     |             | 1H-S-089451 |       |             | 08.97  |  | 11.0101-5403.2 | 260010         |                | Faltenbalgsatz       | LUC |
|                | 1.9 TDI        | 66          |             |       | 10.93       | 04.96  |  |                |                |                |                      |     |
| 1.9 TDI Syncro | 66             |             |             | 03.95 | 04.96       |  |  |                |                |                |                      |     |
|                | 1.4            |             |             |       | 05.96       | 09.96 + ABS  |  | 24.3541-1609.5 | 240039         |                | D=54, - Halter       | LUC |
|                | 1.6            | 55          |             |       | 05.96       | 09.96 + ABS  |  | 24.3541-1610.5 | 240040         |                | D=54, - Halter       | LUC |
|                | 1.6 GT         | 74          |             |       | 07.94       | 08.97  |  | 24.0101-4301.2 | 260047         |                | Einbausatz           | LUC |
|                | 1.8            |             |             |       | 05.96       | 08.97 + ABS  |  | 11.0101-5403.2 | 260010         |                | Faltenbalgsatz       | LUC |
|                | 1.8 GT         |             |             |       | 11.91       | 08.97  |  |                |                |                |                      |     |
|                | 1.9 D          |             |             |       | 05.96       | 09.96 + ABS  |  |                |                |                |                      |     |
|                | 1.9 D Ecomatic |             | 1H-S-246941 |       | 07.95       | 07.95  |  |                |                |                |                      |     |
|                | 1.9 SDI        |             |             |       | 05.96       | 09.96 + ABS  |  |                |                |                |                      |     |
|                | 1.9 TD         | 55          |             |       | 05.96       | 09.96 + ABS  |  |                |                |                |                      |     |
|                | 1.9 TDI        | 66          |             |       | 05.96       | 08.97  |  |                |                |                |                      |     |
|                | 1.9 TDI        | 81          |             |       | 02.96       | 08.97  |  |                |                |                |                      |     |
|                | 1.9 TDI Syncro | 66          |             |       | 05.96       | 08.97  |  |                |                |                |                      |     |
|                | 2.0            |             |             |       | 11.91       | 08.97  |  |                |                |                |                      |     |
| 2.0 Syncro     |                |             |             | 07.95 | 08.97       |  |  |                |                |                |                      |     |
|                | 1.4            |             |             |       | 10.96       | 08.97 + ABS  |  | 11.0441-4808.2 | 250022         |                | Dichtungssatz        | ATE |
|                | 1.6            | 55          |             |       | 10.96       | 08.97 + ABS  |  | 11.0101-4801.2 | 260006         |                | Hülsensatz           | ATE |
|                | 1.9 D          |             |             |       | 10.96       | 08.97 + ABS  |  | 24.0102-4801.2 | 260085         |                | Hülsensatz+Schrauben | ATE |
|                | 1.9 SDI        |             |             |       | 10.96       | 08.97 + ABS  |  |                |                |                |                      |     |
|                | 1.9 TD         | 55          |             |       | 10.96       | 08.97 + ABS  |  |                |                |                |                      |     |
|                | 2.0 GTI        | 85          |             |       | 11.91       | 04.96  |  | 24.3541-1731.5 | 240061         |                | D=54, - Halter       | LUC |
|                | 2.0 GTI 16V    |             |             |       | 08.92       | 04.96  |  | 24.3541-1732.5 | 240062         |                | D=54, - Halter       | LUC |
|                | 2.8 VR6        |             | 1H-S-399999 | 01.92 |             |  |  | 24.0101-4301.2 | 260047         |                | Einbausatz           | LUC |
|                | 2.0 GTI        | 85          |             |       | 05.96       | 08.97  |  | 11.3541-8523.2 | 220115         |                | D=54, - Halter       | ATE |
|                | 2.0 GTI 16V    |             |             |       | 05.96       | 08.97  |  | 11.3541-8524.2 | 220116         |                | D=54, - Halter       | ATE |
|                | 2.8 VR6        |             | 1H-S-400001 |       |             | 08.97  |  | 24.3541-8523.5 | 240551         |                | D=54, - Halter       | ATE |
|                | 2.9 VR6 Syncro |             |             |       | 10.94       | 08.97  |  | 24.3541-8524.5 | 240552         |                | D=54, - Halter       | ATE |
|                |                |             |             |       |             |  |  | 11.8170-0306.1 | 260102         | 2              | Halter               | ATE |
|                |                |             |             |       |             |  |  | 11.0441-5409.2 | 250031         |                | Dichtungssatz        | ATE |
|                |                |             |             |       |             |  |  | 11.0101-5409.2 | 260035         |                | Hülsensatz           | ATE |
|                |                |             |             |       |             |  | 11.8171-0008.1                                   | 990049         |                | Führungsbolzen | ATE                  |     |
|                |                |             |             |       |             |  | 11.8116-0143.1                                   | 390513         | 2              |                | Haltefeder           | ATE |
|                | 1.4            |             |             |       | 11.91       | 08.97  |  | 83.7713-0435.3 | 330792         | 2              | L=435                |     |
|                | 1.6            |             |             |       | 09.92       | 08.97  |  |                |                |                |                      |     |
|                | 1.8            |             |             |       | 11.91       | 08.97  |  |                |                |                |                      |     |
|                | 1.8 Syncro     |             |             |       | 01.93       | 08.97  |  |                |                |                |                      |     |
|                | 1.9 D          |             |             |       | 11.91       | 08.97  |  |                |                |                |                      |     |
|                | 1.9 D Ecomatic |             |             |       | 08.93       | 07.95  |  |                |                |                |                      |     |
|                | 1.9 SDI        |             |             |       | 07.95       | 08.97  |  |                |                |                |                      |     |
|                | 1.9 TD         |             |             |       | 11.91       | 08.97  |  |                |                |                |                      |     |
|                | 1.9 TDI        | 55          |             |       | 10.93       | 08.97  |  |                |                |                |                      |     |
|                | 1.9 TDI Syncro | 66          |             |       | 03.95       | 08.97  |  |                |                |                |                      |     |
|                | 2.0            |             |             |       | 11.91       | 08.97  |  |                |                |                |                      |     |
|                | 2.0 Syncro     |             |             |       | 07.95       | 08.97  |  |                |                |                |                      |     |
|                | 2.8 VR6        |             |             |       | 01.92       | 02.95  |  |                |                |                |                      |     |
|                | 1.9 TDI        | 81          |             |       | 02.96       | 08.97  |  | 83.6232-0465.3 | 330736         | 2              | L=465                |     |
| 2.0 GTI        | 85             |             |             | 11.91 | 08.97       |  |  |                |                |                |                      |     |
| 2.0 GTI 16V    |                |             |             | 08.92 | 08.97       |  |  |                |                |                |                      |     |
| 2.8 VR6        |                |             |             | 03.95 | 08.97       |  |  |                |                |                |                      |     |

<sup>1)</sup> - GT/ + manual transm. / - GT/+ scatola cambio velocità / - GT/ + transmission mécanique / - GT/ + cambio de velocidad













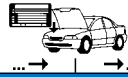





<sup>2)</sup> - GT/ + autom.transmission / - GT/+ scatola cambio autom. / - GT/ + transmission automatique / - GT/ + cambio automático

<sup>3)</sup> - ABS/ - GT/ + manual transm. / - ABS/- GT/+ scatola camb.velocità / - ABS/ - GT/ + transmiss. mécanique / - ABS/ - GT/ + cambio de velocidad

<sup>4)</sup> - ABS/ - GT/ + autom.transm. / - ABS/- GT/+ scatola camb.autom. / - ABS/ - GT/ + transmiss. automatique / - ABS/ - GT/ + cambio automático

<sup>5)</sup> - red caliper / - pinza rossa / - étrier rouge / - pinza roja



| VOLKSWAGEN GOLF III (92-97)  |  |  |  |  |  |  |  |  |  |  |                   |        |        |        |
|--|--|--|--|--|--|--|--|--|--|--|-------------------|--------|--------|--------|
|     |    |  |        |                          |                         |  |  |    |  |  |                   |        |        |        |
|    | 2.9 VR6 Syncro   |  |  | 10.94  | 08.97  | 83.6232-0465.3   | 330736   | 2  | L=465  |  |                   |        |        |        |
|    | 1.8 GT<br>2.0 GL<br>2.0 GTI<br>2.8 VR6   | 85   | 1H-P-240000<br>1H-P-240000<br>1H-P-240000<br>1H-P-240000                               | 11.91<br>11.91<br>11.91<br>01.92   |  | 24.3384-1603.5<br>24.3384-1604.5<br>24.0101-3601.2                                 | 240015<br>240016<br>260044   |   | D=38, - Halter<br>D=38, - Halter<br>Einbausatz                   | LUC<br>LUC<br>LUC                                  |                   |        |        |        |
|  | 1.6 GT<br>1.8 GT<br>2.0 GL<br>2.0 GTI<br>2.0 GTI 16V<br>2.8 VR6<br>2.9 VR6 Syncro  | 74<br>85   | 1H-P-240001<br>1H-P-240001<br>1H-P-240001  | 07.94<br>06.95<br>06.95<br>08.97<br>08.92<br>08.97<br>10.94  | 08.97<br>06.95<br>06.95<br>08.97<br>08.97<br>08.97   | 24.3384-1707.5<br>24.3384-1708.5<br>24.0101-3601.2<br>11.0101-5403.2               | 240171<br>240172<br>260044<br>260010   |   | D=38, - Halter<br>D=38, - Halter<br>Einbausatz<br>Faltenbalgsatz | LUC<br>LUC<br>LUC<br>LUC                           |                   |        |        |        |
|  | 1.6<br>1.8 GT<br>1.9 TDI<br>2.0 GL   | 74<br>81   |  | 07.95<br>07.95<br>02.96<br>07.95   | 08.97<br>08.97<br>08.97<br>08.97   | 24.3384-1707.5<br>24.3384-1708.5<br>11.0101-5403.2                                 | 240171<br>240172<br>260010   | <br> | - roter Sattel <sup>1)</sup><br>- roter Sattel <sup>1)</sup>     | D=38, - Halter<br>D=38, - Halter<br>Faltenbalgsatz | LUC<br>LUC<br>LUC |        |        |        |
|    | 1.4<br>1.6<br>1.8<br>1.8 Syncro<br>1.9 D<br>1.9 D Ecomatic<br>1.9 SDI<br>1.9 TD<br>1.9 TDI<br>1.9 TDI Syncro<br>2.0 Syncro | 55<br>66<br>66   |  | 11.91<br>09.92<br>11.91<br>01.93<br>11.91<br>08.93<br>07.95<br>07.95<br>11.91<br>10.93<br>03.95<br>07.95 | 08.97<br>08.97<br>08.97<br>08.97<br>08.97<br>07.95<br>08.97<br>08.97<br>08.97<br>08.97<br>08.97<br>08.97 |  |  |  | - GT<br>- GT   | 83.7836-0135.3                                     | 330816            | 2      | L=135  |        |
|  | 1.6 GT<br>1.8 GT<br>1.9 TDI<br>2.0<br>2.0 GTI<br>2.0 GTI 16V<br>2.8 VR6<br>2.9 VR6 Syncro                                  | 74<br>81<br>85   |  | 07.94<br>11.91<br>02.96<br>11.91<br>11.91<br>08.92<br>01.92<br>10.94                                     | 08.97<br>08.97<br>08.97<br>08.97<br>08.97<br>08.97<br>08.97  | 83.7836-0135.3<br>83.7704-0160.3   | 330816<br>330805   | 2<br>2   | am Bremssattel <sup>2)</sup>                                     | L=135<br>L=160                                     |                   |        |        |        |
|   | 1.4<br>1.8 CL/GL<br>1.9 D Ecomatic<br>1.9 TD   | 55   | 1H-S-246940<br>1H-S-246940   | 11.91<br>11.91<br>08.93<br>11.91   | 08.97<br>08.97<br>08.97<br>08.97   | 03.3215-2311.3<br>24.3215-0903.3   | 020018<br>020154   |  | + GG <sup>3)</sup><br>+ ALU <sup>4)</sup>                        | Rz 15,87<br>Rz 15,87                               |                   |        |        |        |
|  | 1.6<br>1.6 CL/GL<br>1.6 CL/GL<br>1.8 CL/GL<br>1.8 CL/GL<br>1.9 D<br>1.9 D Ecomatic<br>1.9 SDI<br>1.9 TDI                   | 55<br>74<br>74<br>66   | 1H-S-246940<br>1H-S-246940<br>1H-S-246941<br>1H-S-246941                               | 09.92<br>07.94<br>07.94<br>11.91<br>11.91<br>07.95<br>07.95<br>10.93                                     | 08.97<br>08.97<br>08.97<br>08.97<br>08.97<br>08.97<br>08.97  | 03.3217-2112.3<br>24.3217-0908.3   | 020027<br>020167   |  | + GG <sup>3)</sup><br>+ ALU <sup>4)</sup>                        | Rz 17,46<br>Rz 17,46                               |                   |        |        |        |
|  | 1.6 CL/GL<br>1.8 CL/GL   | 74   | 1H-S-246941<br>1H-S-246941   | 08.97<br>08.97   | + Schaltgetriebe <sup>6)</sup><br>+ Schaltgetriebe <sup>6)</sup>   | 24.3219-0909.3   | 020188   |  |  | Rz 19,05   |                   |        |        |        |
|  | 1.8 Syncro<br>1.8 Syncro<br>1.9 TDI Syncro<br>2.0 Syncro   | 66   | 1H-S-400000<br>1H-S-400001   | 01.93<br>08.97<br>03.95<br>07.95   | 08.97<br>08.97<br>08.97  | 24.3220-0909.3<br>24.3222-0913.3   | 020210<br>020255   |  |  | Rz 20,64<br>Rz 22,20                               |                   |        |        |        |
|  | 1.4<br>1.6<br>1.8<br>1.9 D<br>1.9 D Ecomatic<br>1.9 TD<br>1.9 TDI  | 55<br>66   | 1H-S-037799<br>1H-S-037799<br>1H-S-037799<br>1H-S-037799<br>1H-S-037799<br>1H-S-037799 | 11.91<br>09.92<br>11.91<br>11.91<br>08.93<br>11.91<br>10.93  | 08.97<br>08.97<br>08.97<br>08.97<br>08.97<br>08.97   |  |  |  | - GT<br>- GT   | 24.3727-0135.2                                     | 580135            | 2      | L=1500 |        |
|  | 1.4<br>1.6<br>1.8<br>1.9 D<br>1.9 D Ecomatic<br>1.9 SDI<br>1.9 TD<br>1.9 TDI   | 55<br>66   | 1H-S-037800<br>1H-S-037800<br>1H-S-037800<br>1H-S-037800                               | 08.97<br>08.97<br>08.97<br>07.95<br>08.97<br>08.97<br>08.97  | 08.97<br>08.97<br>08.97<br>08.97   | 24.3727-0160.2   | 580160   |  |  | - GT<br>- GT                                       | 24.3727-0160.2    | 580160 | 2      | L=1498 |
|  | 1.8 GT<br>2.0<br>2.0 GTI<br>2.0 GTI 16V<br>2.8 VR6   | 85   | 1H-S-037799<br>1H-S-037799<br>1H-S-037799<br>1H-S-037799                               | 11.91<br>11.91<br>11.91<br>08.92<br>01.92  | 08.97<br>08.97<br>08.97<br>08.97   | 24.3727-0134.2   | 580134   |  |  |  | 24.3727-0134.2    | 580134 | 2      | L=1604 |
|  | 1.6 GT<br>1.8 GT<br>1.9 TDI<br>2.0<br>2.0 GTI<br>2.0 GTI 16V<br>2.8 VR6  | 74<br>81<br>85   | 1H-S-037800<br>1H-S-037800<br>1H-S-037800<br>1H-S-037800                               | 07.94<br>02.96<br>08.97<br>08.97<br>08.97<br>08.97   | 08.97<br>08.97<br>08.97<br>08.97   | 24.3727-0156.2   | 580156   |  |  |  | 24.3727-0156.2    | 580156 | 2      | L=1616 |

1) - red caliper / - pinza rossa / - étrier rouge / - pinza roja  
2) on the brake caliper / sulla pinza freno / sur l'étrier de frein / a la pinza de freno  
3) + cast iron / + ghisa / + fonte grise / + fundición de gris  
4) + aluminium / + alluminio / + aluminium / + aluminio  
5) + autom.transmission / + scatola cambio automatico / + transmission automatique / + cambio automático  
6) + manual transmission / + scatola cambio velocità / + transmission mécanique / + cambio de velocidad

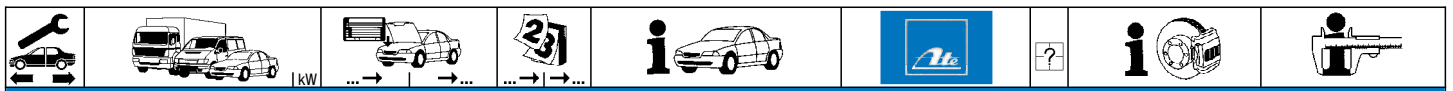

**VOLKSWAGEN GOLF III (92-97)**

|  |                |      |             |       |       |                               |                |        |  |               |     |
|--|----------------|------|-------------|-------|-------|-------------------------------|----------------|--------|--|---------------|-----|
|  | 1.4            |      | 1H-V-040000 | 11.91 |       |                               | 03.0101-0025.2 | 320014 |  | BRES 3/35     | ATE |
|  | 1.4            |      | 1H-V-040001 |       | 08.97 |                               | 03.6584-0107.3 | 320110 |  | BRL 8/4 (4)   | ATE |
|  | 1.6            |      |             | 09.92 | 08.97 | - GT                          |                |        |  |               |     |
|  | 1.8            |      |             | 11.91 | 08.97 | - GT                          |                |        |  |               |     |
|  | 1.9 D          |      |             | 11.91 | 08.97 |                               |                |        |  |               |     |
|  | 1.9 D Ecomatic |      |             | 08.93 | 07.95 |                               |                |        |  |               |     |
|  | 1.9 SDI        |      |             | 07.95 | 08.97 |                               |                |        |  |               |     |
|  | 1.9 TD         | 55   |             | 11.91 | 08.97 |                               |                |        |  |               |     |
|  | 1.9 TDI        | 66   |             | 10.93 | 08.97 |                               |                |        |  |               |     |
|  | 1.6 GT         | 74   |             | 07.94 | 08.97 |                               | 03.6584-0113.3 | 320111 |  | BRL 8/4 (4)   | ATE |
|  | 1.8 GT         |      |             | 11.91 | 08.97 |                               |                |        |  |               |     |
|  | 1.9 TDI        | 81   |             | 02.96 | 08.97 |                               |                |        |  |               |     |
|  | 2.0            |      |             | 11.91 | 08.97 |                               |                |        |  |               |     |
|  | 2.0 GTI        | 85   |             | 11.91 | 08.97 |                               |                |        |  |               |     |
|  | 2.0 GTI 16V    |      |             | 08.92 | 08.97 |                               |                |        |  |               |     |
|  | 2.8 VR6        |      |             | 01.92 | 08.97 |                               |                |        |  |               |     |
|  | 1.8 Syncro     |      |             | 01.93 | 08.97 |                               | 03.6584-0015.3 | 320109 |  | BRL 8/4 (4)   | ATE |
|  | 1.9 TDI Syncro | 66   |             | 03.95 | 08.97 |                               |                |        |  |               |     |
|  | 2.0 Syncro     |      |             | 07.95 | 08.97 |                               |                |        |  |               |     |
|  | 2.9 VR6 Syncro |      |             | 10.94 | 08.97 |                               |                |        |  |               |     |
|  | 1.8 Syncro     | ↓    |             | 01.93 | 08.97 |                               | 03.2419-9510.3 | 030028 |  | Gz 19,05      |     |
|  | 1.9 TDI        | ↓ 66 |             | 10.93 | 08.97 |                               |                |        |  |               |     |
|  | 1.9 TDI        | ↓ 81 |             | 02.96 | 08.97 |                               |                |        |  |               |     |
|  | 1.9 TDI Syncro | ↓ 66 |             | 03.95 | 08.97 |                               |                |        |  |               |     |
|  | 2.0 GTI        | ↓ 85 |             | 11.91 | 08.97 |                               |                |        |  |               |     |
|  | 2.0 GTI 16V    | ↓    |             | 08.92 | 08.97 |                               |                |        |  |               |     |
|  | 2.0 Syncro     | ↓    |             | 07.95 | 08.97 |                               |                |        |  |               |     |
|  | 2.8 VR6        | ↓    |             | 01.92 | 08.97 |                               |                |        |  |               |     |
|  | 2.9 VR6 Syncro | ↓    |             | 10.94 | 08.97 |                               |                |        |  |               |     |
|  | 1.9 TDI        | ↓ 66 |             | 10.93 | 08.97 |                               | 03.2419-9910.3 | 030031 |  | Gz 19,05      |     |
|  | 1.9 TDI        | ↓ 81 |             | 02.96 | 08.97 |                               |                |        |  |               |     |
|  | 2.0 GTI        | ↓ 85 |             | 11.91 | 08.97 |                               |                |        |  |               |     |
|  | 2.0 GTI 16V    | ↓    |             | 08.92 | 08.97 |                               |                |        |  |               |     |
|  | 2.8 VR6        | ↓    |             | 01.92 | 08.97 |                               |                |        |  |               |     |
|  | 2.9 VR6 Syncro | ↓    |             | 10.94 | 08.97 |                               |                |        |  |               |     |
|  | 1.8 Syncro     | ↓    |             | 01.93 | 08.97 |                               | 24.2523-0908.3 | 040049 |  | Nz 23,81      |     |
|  | 1.9 TDI        | ↓ 66 |             | 10.93 | 08.97 |                               |                |        |  |               |     |
|  | 1.9 TDI        | ↓ 81 |             | 02.96 | 08.97 |                               |                |        |  |               |     |
|  | 1.9 TDI Syncro | ↓ 66 |             | 03.95 | 08.97 |                               |                |        |  |               |     |
|  | 2.0 GTI        | ↓ 85 |             | 11.91 | 08.97 |                               |                |        |  |               |     |
|  | 2.0 GTI 16V    | ↓    |             | 08.92 | 08.97 |                               |                |        |  |               |     |
|  | 2.0 Syncro     | ↓    |             | 07.95 | 08.97 |                               |                |        |  |               |     |
|  | 2.8 VR6        | ↓    |             | 01.92 | 08.97 |                               |                |        |  |               |     |
|  | 2.9 VR6 Syncro | ↓    |             | 10.94 | 08.97 |                               |                |        |  |               |     |
|  | 1.4            | ↓    |             | 11.91 | 08.97 | - Motorcode AEX <sup>1)</sup> | 24.3728-0130.2 | 590130 |  | L=1025, + AUT |     |
|  | 1.6            | ↓ 55 |             | 09.92 | 08.97 | - Motorcode AEE <sup>2)</sup> |                |        |  |               |     |
|  | 1.6            | ↓ 74 |             | 07.94 | 12.95 |                               |                |        |  |               |     |
|  | 1.4            | ↓    |             | 11.91 | 08.97 | + Motorcode AEX <sup>3)</sup> | 24.3728-0127.2 | 590127 |  | L=824, + AUT  |     |
|  | 1.6            | ↓ 55 |             | 09.92 | 08.97 | + Motorcode AEE <sup>4)</sup> |                |        |  |               |     |
|  | 1.6            | ↓ 74 |             | 07.94 | 08.97 |                               |                |        |  |               |     |
|  | 1.8            | ↓    |             | 11.91 | 08.97 |                               |                |        |  |               |     |
|  | 1.9 D          | ↓    |             | 11.91 | 08.97 |                               |                |        |  |               |     |
|  | 1.9 D Ecomatic | ↓    |             | 08.93 | 07.95 |                               |                |        |  |               |     |
|  | 1.9 SDI        | ↓    |             | 07.95 | 08.97 |                               |                |        |  |               |     |
|  | 1.9 TD         | ↓ 55 |             | 11.91 | 08.97 |                               |                |        |  |               |     |
|  | 2.0            | ↓    |             | 11.91 | 08.97 |                               |                |        |  |               |     |

**VOLKSWAGEN GOLF III Variant (93-99)**

|  |                |      |             |       |       |       |                |        |  |     |     |
|--|----------------|------|-------------|-------|-------|-------|----------------|--------|--|-----|-----|
|  | 1.4            | ↓    |             | 07.93 | 04.99 | - ABS | 03.7750-5502.4 | 300081 |  | 9"  | ATE |
|  | 1.6            | ↓ 74 |             | 07.94 | 04.99 | - ABS |                |        |  |     |     |
|  | 1.8            | ↓    |             | 07.93 | 04.99 | - ABS |                |        |  |     |     |
|  | 1.8 Syncro     | ↓    |             | 07.94 | 04.99 | - ABS |                |        |  |     |     |
|  | 1.9 D          | ↓    |             | 07.93 | 04.99 | - ABS |                |        |  |     |     |
|  | 1.9 SDI        | ↓    |             | 07.95 | 04.99 | - ABS |                |        |  |     |     |
|  | 1.9 TD         | ↓ 55 |             | 07.93 | 04.99 | - ABS |                |        |  |     |     |
|  | 1.9 TDI        | ↓ 66 |             | 07.93 | 04.99 | - ABS |                |        |  |     |     |
|  | 1.9 TDI        | ↓ 81 |             | 02.96 | 04.99 | - ABS |                |        |  |     |     |
|  | 1.9 TDI Syncro | ↓ 66 |             | 07.95 | 04.99 | - ABS |                |        |  |     |     |
|  | 2.0            | ↓    |             | 07.93 | 04.99 | - ABS |                |        |  |     |     |
|  | 2.0 Syncro     | ↓    |             | 07.95 | 04.99 | - ABS |                |        |  |     |     |
|  | 1.4            | ↓    |             | 07.93 | 04.99 | - ABS | 03.7750-5602.4 | 300082 |  | 9"  | ATE |
|  | 1.6            | ↓ 74 |             | 07.94 | 04.99 | - ABS |                |        |  |     |     |
|  | 1.8            | ↓    |             | 07.93 | 04.99 | - ABS |                |        |  |     |     |
|  | 1.9 D          | ↓    |             | 07.93 | 04.99 | - ABS |                |        |  |     |     |
|  | 1.9 SDI        | ↓    |             | 07.95 | 04.99 | - ABS |                |        |  |     |     |
|  | 1.9 TD         | ↓ 55 |             | 07.93 | 04.99 | - ABS |                |        |  |     |     |
|  | 1.9 TDI        | ↓ 66 |             | 07.93 | 04.99 | - ABS |                |        |  |     |     |
|  | 1.9 TDI        | ↓ 81 |             | 02.96 | 04.99 | - ABS |                |        |  |     |     |
|  | 2.0            | ↓    |             | 07.93 | 04.99 | - ABS |                |        |  |     |     |
|  | 1.4            | ↓    | 1H-SW385334 | 07.93 |       | + ABS | 10.6360-1003.4 | 300156 |  | 10" | ATE |
|  | 1.6            | ↓ 74 | 1H-SW385334 | 07.94 |       | + ABS |                |        |  |     |     |
|  | 1.8            | ↓    | 1H-SW385334 | 07.93 |       | + ABS |                |        |  |     |     |
|  | 1.8 Syncro     | ↓    | 1H-SW385334 | 07.94 |       | + ABS |                |        |  |     |     |
|  | 1.9 D          | ↓    | 1H-SW385334 | 07.93 |       | + ABS |                |        |  |     |     |
|  | 1.9 TD         | ↓ 55 | 1H-SW385334 | 07.93 |       | + ABS |                |        |  |     |     |
|  | 1.9 TDI        | ↓ 66 | 1H-SW385334 | 07.93 |       | + ABS |                |        |  |     |     |
|  | 1.9 TDI Syncro | ↓ 66 | 1H-SW385334 | 07.95 |       | + ABS |                |        |  |     |     |

1) - engine code AEX / - codice motore AEX / - moteur code AEX / - motor code AEX  
 2) - engine code AEE / - codice motore AEE / - moteur code AEE / - motor code AEE  
 3) + engine code AEX / + codice motore AEX / + moteur code AEX / + motor code AEX  
 4) + engine code AEE / + codice motore AEE / + moteur code AEE / + motor code AEE





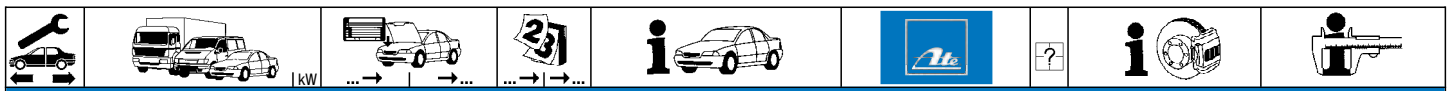

**VOLKSWAGEN GOLF III Variant (93-99)**

|                |                |             |             |             |       |                |                |        |           |                |                |                |        |
|----------------|----------------|-------------|-------------|-------------|-------|----------------|----------------|--------|-----------|----------------|----------------|----------------|--------|
|                | 2.0            |             | 1H-SW385334 | 07.93       | + ABS | 10.6360-1003.4 | 300156         |        | 10"       | ATE            |                |                |        |
|                | 2.0 Syncro     |             | 1H-SW385334 | 07.95       | + ABS |                |                |        |           |                |                |                |        |
|                | 2.9 VR6        |             | 1H-SW385334 | 07.95       | + ABS |                |                |        |           |                |                |                |        |
|                | 1.4            |             | 1H-SW385335 |             | 04.99 | + ABS          | 10.6360-2002.4 | 300143 |           | 10"            | ATE            |                |        |
|                | 1.6            | 74          | 1H-SW385335 |             | 04.99 | + ABS          |                |        |           |                |                |                |        |
|                | 1.8            |             | 1H-SW385335 |             | 04.99 | + ABS          |                |        |           |                |                |                |        |
|                | 1.8 Syncro     |             | 1H-SW385335 |             | 04.99 | + ABS          |                |        |           |                |                |                |        |
|                | 1.9 D          |             | 1H-SW385335 |             | 04.99 | + ABS          |                |        |           |                |                |                |        |
|                | 1.9 SDI        |             |             | 07.95       | 04.99 | + ABS          |                |        |           |                |                |                |        |
|                | 1.9 TD         | 55          | 1H-SW385335 |             | 04.99 | + ABS          |                |        |           |                |                |                |        |
| 1.9 TDI        | 66             | 1H-SW385335 |             | 04.99       | + ABS |                |                |        |           |                |                |                |        |
| 1.9 TDI        | 81             |             | 02.96       | 04.99       | + ABS |                |                |        |           |                |                |                |        |
| 1.9 TDI Syncro | 66             | 1H-SW385335 |             | 04.99       | + ABS |                |                |        |           |                |                |                |        |
| 2.0            |                | 1H-SW385335 |             | 04.99       | + ABS |                |                |        |           |                |                |                |        |
| 2.0 Syncro     |                | 1H-SW385335 |             | 04.99       | + ABS |                |                |        |           |                |                |                |        |
| 2.9 VR6        |                | 1H-SW385335 |             | 04.99       | + ABS |                |                |        |           |                |                |                |        |
|                | 1.4            |             |             | 07.93       | 04.99 | - ABS          | 03.2120-3943.3 | 010532 | 2         | THz 20,64      | ATE            |                |        |
|                |                |             |             |             |       |                |                |        |           |                |                | 03.3517-0101.2 | 390322 |
|                | 1.6            | 74          |             | 07.94       | 04.99 | - ABS          | 03.2122-1042.3 | 010137 |           | THz 22,20      | ATE            |                |        |
|                | 1.8            |             |             | 07.93       | 04.99 | - ABS          |                |        |           |                |                |                |        |
|                | 1.8 Syncro     |             |             | 07.94       | 04.99 | - ABS          |                |        |           |                |                |                |        |
|                | 1.9 D          |             |             | 07.93       | 04.99 | - ABS          |                |        |           |                |                |                |        |
|                | 1.9 SDI        |             |             | 07.95       | 04.99 | - ABS          |                |        |           |                |                |                |        |
|                | 1.9 TD         | 55          |             | 07.93       | 04.99 | - ABS          |                |        |           |                |                |                |        |
|                | 1.9 TDI        | 66          |             | 07.93       | 04.99 | - ABS          |                |        |           |                |                |                |        |
|                | 1.9 TDI        | 81          |             | 02.96       | 04.99 | - ABS          |                |        |           |                |                |                |        |
|                | 1.9 TDI Syncro | 66          |             | 07.95       | 04.99 | - ABS          |                |        |           |                |                |                |        |
|                | 2.0            |             |             | 07.93       | 04.99 | - ABS          |                |        |           |                |                |                |        |
|                | 2.0 Syncro     |             |             | 07.95       | 04.99 | - ABS          |                |        |           |                |                |                |        |
|                | 1.4            |             |             | 1H-SW385334 | 07.93 | + ABS          | 10.6122-0144.3 | 010638 |           | THz 22,20      | ATE            |                |        |
|                | 1.8 Syncro     |             |             | 1H-SW385334 | 07.94 | + ABS          |                |        |           |                |                |                |        |
|                | 1.9 D          |             |             | 1H-SW385334 | 07.93 | + ABS          |                |        |           |                |                |                |        |
|                | 1.9 TD         | 55          |             | 1H-SW385334 | 07.93 | + ABS          |                |        |           |                |                |                |        |
|                | 1.9 TDI Syncro | 66          |             | 1H-SW385334 | 07.95 | + ABS          |                |        |           |                |                |                |        |
|                | 2.0 Syncro     |             |             | 1H-SW385334 | 07.95 | + ABS          |                |        |           |                |                |                |        |
|                | 1.4            |             | 1H-SW385335 |             | 04.99 | + ABS          | 03.2122-1144.3 | 010636 |           | THz 22,20      | ATE            |                |        |
| 1.9 D          |                | 1H-SW385335 |             | 04.99       | + ABS |                |                |        |           |                |                |                |        |
| 1.9 SDI        |                |             | 07.95       | 04.99       | + ABS |                |                |        |           |                |                |                |        |
| 1.9 TD         | 55             | 1H-SW385335 |             | 04.99       | + ABS |                |                |        |           |                |                |                |        |
| 1.6            | 74             |             | 1H-SW385334 | 07.94       | + ABS | 10.6123-0674.3 | 010639         |        | THz 23,81 | ATE            |                |                |        |
| 1.8            |                |             | 1H-SW385334 | 07.93       | + ABS |                |                |        |           |                |                |                |        |
| 1.9 TDI        | 66             |             | 1H-SW385334 | 09.93       | + ABS |                |                |        |           |                |                |                |        |
| 2.0            |                |             | 1H-SW385334 | 07.93       | + ABS |                |                |        |           |                |                |                |        |
| 2.9 VR6        |                |             | 1H-SW385334 | 07.95       | + ABS |                |                |        |           |                |                |                |        |
| 1.6            | 74             | 1H-SW385335 |             | 04.99       | + ABS | 03.2123-1424.3 | 010637         |        | THz 23,81 | ATE            |                |                |        |
| 1.8            |                | 1H-SW385335 |             | 04.99       | + ABS |                |                |        |           |                |                |                |        |
| 1.8 Syncro     |                | 1H-SW385335 |             | 04.99       | + ABS |                |                |        |           |                |                |                |        |
| 1.9 TDI        | 66             | 1H-SW385335 |             | 04.99       | + ABS |                |                |        |           |                |                |                |        |
| 1.9 TDI        | 81             |             | 02.96       | 04.99       | + ABS |                |                |        |           |                |                |                |        |
| 1.9 TDI Syncro | 66             | 1H-SW385335 |             | 04.99       | + ABS |                |                |        |           |                |                |                |        |
| 2.0            |                | 1H-SW385335 |             | 04.99       | + ABS |                |                |        |           |                |                |                |        |
| 2.0 Syncro     |                | 1H-SW385335 |             | 04.99       | + ABS |                |                |        |           |                |                |                |        |
| 2.9 VR6        |                | 1H-SW385335 |             | 04.99       | + ABS |                |                |        |           |                |                |                |        |
| 1.4            |                | 1H-SW385335 |             | 04.99       | + ABS |                |                |        |           |                | 03.2122-1184.3 | 010592         |        |
| 1.9 D          |                | 1H-SW385335 |             | 04.99       | + ABS |                |                |        |           |                |                |                |        |
| 1.9 SDI        |                |             | 07.95       | 04.99       | + ABS |                |                |        |           |                |                |                |        |
| 1.9 TD         | 55             | 1H-SW385335 |             | 04.99       | + ABS |                |                |        |           |                |                |                |        |
| 1.6            | 74             | 1H-SW385335 |             | 04.99       | + ABS | 03.2123-1484.3 | 010595         |        | THz 23,81 | ATE            |                |                |        |
| 1.8            |                | 1H-SW385335 |             | 04.99       | + ABS |                |                |        |           |                |                |                |        |
| 1.9 TDI        | 66             | 1H-SW385335 |             | 04.99       | + ABS |                |                |        |           |                |                |                |        |
| 1.9 TDI        | 81             |             | 02.96       | 04.99       | + ABS |                |                |        |           |                |                |                |        |
| 2.0            |                | 1H-SW385335 |             | 04.99       | + ABS |                |                |        |           |                |                |                |        |
|                | 1.4            |             | 1H-TB015953 | 07.93       |       | 11.0441-4808.2 | 250022         |        |           | Dichtungssatz  | ATE            |                |        |
|                | 1.8 Syncro     |             | 1H-SW369000 | 07.94       |       |                |                |        |           |                |                | 11.0101-4801.2 | 260006 |
|                |                |             |             |             |       |                |                |        |           |                |                | 24.0102-4801.2 | 260085 |
|                | 1.4            |             |             | 05.96       | 04.99 | - ABS          | 11.0441-4808.2 | 250022 |           | Dichtungssatz  | ATE            |                |        |
|                | 1.4            |             | 1H-TB015954 |             | 04.96 |                |                |        |           |                |                | 11.0101-4801.2 | 260006 |
|                |                |             |             |             |       | 24.0102-4801.2 |                |        |           |                |                | 260085         |        |
|                | 1.6            | 55          |             | 09.92       | 04.96 |                | 24.3541-1739.5 | 240223 |           | D=54, - Halter | LUC            |                |        |
|                | 1.8            |             |             | 05.96       | 04.99 | - ABS          |                |        |           |                |                | 24.3541-1740.5 | 240224 |
|                | 1.8            |             |             | 07.93       | 04.96 |                | 11.0101-5403.2 | 260010 |           | Fallenbalgsatz | LUC            |                |        |
|                | 1.8 Syncro     |             | 1H-SW369001 | 1H-TD365209 | 05.96 | 04.99          |                |        |           |                |                | - ABS          |        |
|                | 1.9 D          |             |             |             | 07.93 | 04.96          |                |        |           |                |                |                |        |
|                | 1.9 SDI        |             |             |             | 05.96 | 04.99          |                |        |           |                |                | - ABS          |        |
|                | 1.9 SDI        |             |             |             | 07.95 | 04.96          |                |        |           |                |                |                |        |
|                | 1.9 TD         | 55          |             |             | 05.96 | 04.99          |                |        |           |                |                | - ABS          |        |
|                | 1.9 TD         | 55          |             |             | 07.93 | 04.96          |                |        |           |                |                |                |        |
|                | 1.9 TDI        | 66          |             |             | 05.96 | 04.99          |                |        |           |                |                | - ABS          |        |
|                | 1.9 TDI        | 66          |             |             | 07.93 | 04.96          |                |        |           |                |                |                |        |
| 1.4            |                |             | 05.96       | 09.96       | + ABS | 24.3541-1609.5 |                |        |           |                |                | 240039         |        |
| 1.6            | 55             |             | 05.96       | 09.96       | + ABS |                | 24.3541-1610.5 | 240040 |           |                |                |                |        |
| 1.8            |                |             | 05.96       | 04.99       | + ABS |                | 24.0101-4301.2 | 260047 |           |                |                |                |        |
| 1.8 Syncro     |                | 1H-TD365210 |             | 04.99       |       |                | 11.0101-5403.2 | 260010 |           |                |                |                |        |
| 1.9 D          |                |             | 05.96       | 09.96       | + ABS |                |                |        |           |                |                |                |        |



| VOLKSWAGEN GOLF III Variant (93-99) |                |             |             |                |        |                |                |        |   |  |                          |
|-------------------------------------|----------------|-------------|-------------|----------------|--------|----------------|----------------|--------|---|--|--------------------------|
|                                     | 1.9 SDI        |             |             | 05.96          | 09.96  | + ABS          | 24.3541-1609.5 | 240039 |   | D=54, - Halter<br>D=54, - Halter<br>Einbausatz<br>Faltenbalgsatz   | LUC<br>LUC<br>LUC<br>LUC |
|                                     | 1.9 TD         | 55          |             | 05.96          | 09.96  | + ABS          | 24.3541-1610.5 | 240040 |   |  |                          |
|                                     | 1.9 TDI        | 66          |             | 05.96          | 04.99  | + ABS          | 24.0101-4301.2 | 260047 |   |  |                          |
|                                     | 1.9 TDI        | 81          |             | 02.96          | 04.99  |                | 11.0101-5403.2 | 260010 |   |  |                          |
|                                     | 1.9 TDI Syncro | 66          |             | 07.95          | 04.99  |                |                |        |   |  |                          |
|                                     | 2.0            |             |             | 07.93          | 04.99  |                |                |        |   |  |                          |
|                                     | 2.0 Syncro     |             |             | 07.95          | 04.99  |                |                |        |   |  |                          |
|                                     | 1.4            |             |             | 10.96          | 04.99  | + ABS          | 11.0441-4808.2 | 250022 |   |  |                          |
|                                     | 1.6            | 55          |             | 10.96          | 04.99  | + ABS          | 11.0101-4801.2 | 260006 |   |  |                          |
|                                     | 1.9 D          |             |             | 10.96          | 04.99  | + ABS          | 24.0102-4801.2 | 260085 |   |  |                          |
| 1.9 SDI                             |                |             | 10.96       | 04.99          | + ABS  |                |                |        |   |  |                          |
| 1.9 TD                              | 55             |             | 10.96       | 04.99          | + ABS  |                |                |        |   |  |                          |
| 2.9 VR6                             |                |             | 07.95       | 04.99          |        | 11.3541-8523.2 | 220115         |        | D=54, - Halter<br>D=54, - Halter<br>D=54, - Halter<br>D=54, - Halter<br>Halter<br>Dichtungssatz<br>Hülensatz<br>Hülensatz+Schrauben | ATE<br>ATE<br>ATE<br>ATE<br>ATE<br>ATE<br>ATE<br>ATE<br>ATE<br>ATE |                          |
| 1.4                                 |                |             | 07.93       | 04.99          |        | 11.3541-8524.2 | 220116         |        |   |  |                          |
| 1.6                                 | 55             |             | 07.94       | 04.99          |        | 24.3541-8523.5 | 240551         |        |   |  |                          |
| 1.6                                 | 74             |             | 07.93       | 04.99          |        | 24.3541-8524.5 | 240552         |        |   |  |                          |
| 1.8                                 |                |             | 07.93       | 04.99          |        | 11.8170-0306.1 | 260102         |        |   |  |                          |
| 1.8 Syncro                          |                |             | 07.94       | 04.99          |        | 11.0441-5409.2 | 250031         |        |   |  |                          |
| 1.9 D                               |                |             | 07.93       | 04.99          |        | 11.0101-5409.2 | 260035         |        |   |  |                          |
| 1.9 SDI                             |                |             | 07.95       | 04.99          |        | 11.8171-0008.1 | 990049         |        |   |  |                          |
| 1.9 TD                              | 55             |             | 07.93       | 04.99          |        | 11.8116-0143.1 | 390513         |        |   |  |                          |
| 1.9 TDI                             | 66             |             | 07.93       | 04.99          |        | 83.7713-0435.3 | 330792         |        |   |  |                          |
| 1.9 TDI                             | 81             |             | 02.96       | 04.99          |        |                |                |        |   |  |                          |
| 1.9 TDI Syncro                      | 66             |             | 07.95       | 04.99          |        |                |                |        |   |  |                          |
| 2.0                                 |                |             | 07.93       | 04.99          |        |                |                |        |   |  |                          |
| 2.0 Syncro                          |                |             | 07.95       | 04.99          |        |                |                |        |   |  |                          |
| 2.9 VR6                             |                |             | 07.95       | 04.99          |        | 83.6232-0465.3 | 330736         | 2      |   | L=465  |                          |
|                                     | 2.9 VR6        |             |             | 07.95          | 04.99  |                | 24.3384-1707.5 | 240171 |   | D=38, - Halter<br>D=38, - Halter<br>Einbausatz<br>Faltenbalgsatz   | LUC<br>LUC<br>LUC<br>LUC |
|                                     | 1.4            |             |             | 07.93          | 04.99  |                | 24.3384-1708.5 | 240172 |   |  |                          |
|                                     | 1.6            | 55          |             | 07.94          | 04.99  |                | 24.0101-3601.2 | 260044 |   |  |                          |
|                                     | 1.6            | 74          |             | 11.0101-5403.2 | 260010 |                | 83.7836-0135.3 | 330816 |   |  |                          |
|                                     | 1.8            |             |             | 07.93          | 04.99  |                |                |        |   |  |                          |
|                                     | 1.8 Syncro     |             |             | 07.94          | 04.99  |                |                |        |   |  |                          |
|                                     | 1.9 D          |             |             | 07.93          | 04.99  |                |                |        |   |  |                          |
|                                     | 1.9 SDI        |             |             | 07.95          | 04.99  |                |                |        |   |  |                          |
|                                     | 1.9 TD         | 55          |             | 07.93          | 04.99  |                |                |        |   |  |                          |
|                                     | 1.9 TDI        | 66          |             | 07.93          | 04.99  |                |                |        |   |  |                          |
| 1.9 TDI                             | 81             |             | 02.96       | 04.99          |        |                |                |        |   |  |                          |
| 1.9 TDI Syncro                      | 66             |             | 07.95       | 04.99          |        |                |                |        |   |  |                          |
| 2.0                                 |                |             | 07.93       | 04.99          |        |                |                |        |   |  |                          |
| 2.0 Syncro                          |                |             | 07.95       | 04.99          |        |                |                |        |   |  |                          |
| 2.9 VR6                             |                |             | 07.95       | 04.99          |        | 83.7836-0135.3 | 330816         | 2      | am Bremssattel <sup>1)</sup>  | L=135  |                          |
|                                     |                |             |             |                |        | 83.7704-0160.3 | 330805         | 2      |   | L=160  |                          |
|                                     | 1.4            |             |             | 07.93          | 06.95  |                | 03.3217-2112.3 | 020027 |   | + GG <sup>2)</sup><br>+ ALU <sup>3)</sup>                          | Rz 17,46<br>Rz 17,46     |
|                                     | 1.4            |             |             | 07.95          | 04.99  |                | 24.3217-0908.3 | 020167 |   |  |                          |
|                                     | 1.6            | 55          |             | 09.92          | 04.99  |                | 24.3219-0909.3 | 020188 |   |  |                          |
|                                     | 1.6            | 74          |             | 07.94          | 04.99  |                |                |        |   |  |                          |
|                                     | 1.8            |             |             | 07.93          | 04.99  |                |                |        |   |  |                          |
|                                     | 1.9 D          |             |             | 07.93          | 04.99  |                |                |        |   |  |                          |
|                                     | 1.9 SDI        |             |             | 07.95          | 04.99  |                |                |        |   |  |                          |
|                                     | 1.9 TD         | 55          |             | 07.93          | 04.99  |                |                |        |   |  |                          |
|                                     | 1.9 TDI        | 66          |             | 07.93          | 04.99  |                |                |        |   |  |                          |
|                                     | 1.9 TDI        | 81          |             | 02.96          | 04.99  |                |                |        |   |  |                          |
| 2.0                                 |                |             | 07.93       | 04.99          |        |                |                |        |   |  |                          |
| 1.8 Syncro                          |                |             | 07.94       | 04.99          |        | 24.3222-0913.3 | 020255         |        |   | Rz 22,20   |                          |
| 1.9 TDI Syncro                      | 66             |             | 07.95       | 04.99          |        |                |                |        |   |  |                          |
| 2.0 Syncro                          |                |             | 07.95       | 04.99          |        |                |                |        |   |  |                          |
|                                     | 1.4            |             |             | 07.93          |        |                | 24.3727-0135.2 | 580135 |   |  | L=1500                   |
|                                     | 1.6            | 55          | 1H-SW037527 | 07.93          |        |                |                |        |   |  |                          |
|                                     | 1.6            | 74          | 1H-SW037527 | 09.92          |        |                |                |        |   |  |                          |
|                                     | 1.6            |             | 1H-SW037527 | 07.94          |        |                |                |        |   |  |                          |
|                                     | 1.8            |             | 1H-SW037527 | 07.93          |        |                |                |        |   |  |                          |
|                                     | 1.9 D          |             | 1H-SW037527 | 07.93          |        |                |                |        |   |  |                          |
|                                     | 1.9 TD         | 55          | 1H-SW037527 | 07.93          |        |                |                |        |   |  |                          |
|                                     | 1.9 TDI        | 66          | 1H-SW037527 | 07.93          |        |                |                |        |   |  |                          |
|                                     | 1.9 TDI        | 81          | 1H-SW037527 | 07.93          |        |                |                |        |   |  |                          |
|                                     | 2.0            |             | 1H-SW037527 | 07.93          |        |                |                |        |   |  |                          |
| 1.4                                 |                | 1H-SW037528 | 04.99       |                |        | 24.3727-0160.2 | 580160         | 2      |   | L=1498   |                          |
| 1.6                                 | 55             | 1H-SW037528 | 04.99       |                |        |                |                |        |   |  |                          |
| 1.6                                 | 74             | 1H-SW037528 | 04.99       |                |        |                |                |        |   |  |                          |
| 1.8                                 |                | 1H-SW037528 | 04.99       |                |        |                |                |        |   |  |                          |
| 1.9 D                               |                | 1H-SW037528 | 04.99       |                |        |                |                |        |   |  |                          |
| 1.9 SDI                             |                |             | 07.95       | 04.99          |        |                |                |        |   |  |                          |
| 1.9 TD                              | 55             | 1H-SW037528 | 04.99       |                |        |                |                |        |   |  |                          |
| 1.9 TDI                             | 66             | 1H-SW037528 | 04.99       |                |        |                |                |        |   |  |                          |
| 1.9 TDI                             | 81             |             | 02.96       | 04.99          |        |                |                |        |   |  |                          |

<sup>1)</sup> on the brake caliper / sulla pinza freno / sur l'étrier de frein / a la pinza de freno

<sup>2)</sup> + cast iron / + ghisa / + fonte grise / + fundición de gris

<sup>3)</sup> + aluminium / + aluminio / + aluminium / + aluminio



**VOLKSWAGEN GOLF III Variant (93-99)**

















|        |                |             |      |       |       |                |        |     |  |             |     |       |                |        |  |  |               |  |
|--------|----------------|-------------|------|-------|-------|----------------|--------|-----|--|-------------|-----|-------|----------------|--------|--|--|---------------|--|
|        | 2.0            | 1H-SW037528 |      | 04.99 |       | 24.3727-0160.2 | 580160 | 2 ↓ |  | L=1498      |     |       |                |        |  |  |               |  |
|        | 1.4            |             |      | 07.93 | 04.99 | 03.6584-0107.3 | 320110 |     |  | BRL 8/4 (4) | ATE |       |                |        |  |  |               |  |
|        | 1.6            | 55          |      | 09.92 | 04.99 |                |        |     |  |             |     |       |                |        |  |  |               |  |
|        | 1.6            | 74          |      | 07.94 | 04.99 |                |        |     |  |             |     |       |                |        |  |  |               |  |
|        | 1.8            |             |      | 07.93 | 04.99 |                |        |     |  |             |     |       |                |        |  |  |               |  |
|        | 1.9 D          |             |      | 07.93 | 04.99 |                |        |     |  |             |     |       |                |        |  |  |               |  |
|        | 1.9 SDI        |             |      | 07.95 | 04.99 |                |        |     |  |             |     |       |                |        |  |  |               |  |
|        | 1.9 TD         | 55          |      | 07.93 | 04.99 |                |        |     |  |             |     |       |                |        |  |  |               |  |
|        | 1.9 TDI        | 66          |      | 07.93 | 04.99 |                |        |     |  |             |     |       |                |        |  |  |               |  |
|        | 1.9 TDI        | 81          |      | 02.96 | 04.99 |                |        |     |  |             |     |       |                |        |  |  |               |  |
|        | 2.0            |             |      | 07.93 | 04.99 |                |        |     |  |             |     |       |                |        |  |  |               |  |
|        | 1.8 Syncro     |             |      | 07.94 | 04.99 | 03.6584-0015.3 | 320109 |     |  | BRL 8/4 (4) | ATE |       |                |        |  |  |               |  |
|        | 1.9 TDI Syncro | 66          |      | 07.95 | 04.99 |                |        |     |  |             |     |       |                |        |  |  |               |  |
|        | 2.0 Syncro     |             |      | 07.95 | 04.99 |                |        |     |  |             |     |       |                |        |  |  |               |  |
|        | 2.9 VR6        |             |      | 07.95 | 04.99 |                |        |     |  |             |     |       |                |        |  |  |               |  |
|        | 1.8 Syncro     | ↓           |      | 07.94 | 04.99 | 03.2419-9510.3 | 030028 |     |  | Gz 19,05    |     |       |                |        |  |  |               |  |
|        | 1.9 TDI        | ↓ 66        |      | 07.93 | 04.99 |                |        |     |  |             |     |       |                |        |  |  |               |  |
|        | 1.9 TDI        | ↓ 81        |      | 02.96 | 04.99 |                |        |     |  |             |     |       |                |        |  |  |               |  |
|        | 1.9 TDI Syncro | ↓ 66        |      | 07.95 | 04.99 |                |        |     |  |             |     |       |                |        |  |  |               |  |
|        | 2.0 Syncro     | ↓           |      | 07.95 | 04.99 |                |        |     |  |             |     |       |                |        |  |  |               |  |
|        | 2.9 VR6        | ↓           |      | 07.95 | 04.99 |                |        |     |  |             |     |       |                |        |  |  |               |  |
|        | 1.9 TDI        | ↓ 66        |      | 07.93 | 04.99 | 03.2419-9910.3 | 030031 |     |  | Gz 19,05    |     |       |                |        |  |  |               |  |
|        | 1.9 TDI        | ↓ 81        |      | 02.96 | 04.99 |                |        |     |  |             |     |       |                |        |  |  |               |  |
|        | 1.8 Syncro     | ↓           |      | 07.94 | 04.99 | 24.2523-0908.3 | 040049 |     |  | Nz 23,81    |     |       |                |        |  |  |               |  |
|        | 1.9 TDI        | ↓ 66        |      | 07.93 | 04.99 |                |        |     |  |             |     |       |                |        |  |  |               |  |
|        | 1.9 TDI        | ↓ 81        |      | 02.96 | 04.99 |                |        |     |  |             |     |       |                |        |  |  |               |  |
|        | 1.9 TDI Syncro | ↓ 66        |      | 07.95 | 04.99 |                |        |     |  |             |     |       |                |        |  |  |               |  |
|        | 2.0 Syncro     | ↓           |      | 07.95 | 04.99 |                |        |     |  |             |     |       |                |        |  |  |               |  |
|        | 2.9 VR6        | ↓           |      | 07.95 | 04.99 |                |        |     |  |             |     |       |                |        |  |  |               |  |
|        |                | 1.4         | ↓    |       | 07.93 |                |        |     |  |             |     | 04.99 | 24.3728-0130.2 | 590130 |  |  | L=1025, + AUT |  |
|        |                | 1.6         | ↓ 74 |       | 07.94 |                |        |     |  |             |     | 04.99 |                |        |  |  |               |  |
|        |                | 1.4         | ↓    |       | 07.93 |                |        |     |  |             |     | 04.99 |                |        |  |  |               |  |
|        |                | 1.6         | ↓ 55 |       | 09.92 |                |        |     |  |             |     | 04.99 |                |        |  |  |               |  |
| 1.6    |                | ↓ 74        |      | 07.94 | 04.99 |                |        |     |  |             |     |       |                |        |  |  |               |  |
| 1.8    |                | ↓           |      | 07.93 | 04.99 |                |        |     |  |             |     |       |                |        |  |  |               |  |
| 1.9 D  |                | ↓           |      | 07.93 | 04.99 |                |        |     |  |             |     |       |                |        |  |  |               |  |
| 1.9 TD |                | ↓ 55        |      | 07.93 | 04.99 |                |        |     |  |             |     |       |                |        |  |  |               |  |
| 2.0    |                | ↓           |      | 07.93 | 04.99 |                |        |     |  |             |     |       |                |        |  |  |               |  |

**VOLKSWAGEN GOLF III Cabriolet (94-02)**

|         |         |             |             |             |       |                |        |  |  |                |     |
|---------|---------|-------------|-------------|-------------|-------|----------------|--------|--|--|----------------|-----|
|         | 1.6     | ↓           |             | 10.94       | 02.02 | 03.7750-5502.4 | 300081 |  |  | 9"             | ATE |
|         | 1.8     | ↓           |             | 09.93       | 02.02 |                |        |  |  |                |     |
|         | 1.9 TDI | ↓ 66        |             | 08.95       | 02.02 |                |        |  |  |                |     |
|         | 1.9 TDI | ↓ 81        |             | 09.96       | 02.02 |                |        |  |  |                |     |
|         | 2.0     | ↓ 85        |             | 09.93       | 02.02 |                |        |  |  |                |     |
|         | 1.6     | ↓           |             | 10.94       | 02.02 | 03.7750-5602.4 | 300082 |  |  | 9"             | ATE |
|         | 1.8     | ↓           |             | 09.93       | 02.02 |                |        |  |  |                |     |
|         | 1.9 TDI | ↓ 66        |             | 08.95       | 02.02 |                |        |  |  |                |     |
|         | 1.9 TDI | ↓ 81        |             | 09.96       | 02.02 |                |        |  |  |                |     |
|         | 2.0     | ↓ 85        |             | 09.93       | 02.02 |                |        |  |  |                |     |
|         | 1.6     | ↓           | 1E-S-021846 | 10.94       |       | 10.6360-1003.4 | 300156 |  |  | 10"            | ATE |
|         | 1.8     | ↓           | 1E-S-021846 | 09.93       |       |                |        |  |  |                |     |
|         | 1.9 TDI | ↓ 66        | 1E-S-021846 | 08.95       |       |                |        |  |  |                |     |
|         | 2.0     | ↓ 85        | 1E-S-021846 | 09.93       |       |                |        |  |  |                |     |
|         | 1.6     | ↓           | 1E-S-021847 |             | 02.02 |                |        |  |  |                |     |
| 1.8     | ↓       | 1E-S-021847 |             | 02.02       |       |                |        |  |  |                |     |
| 1.9 TDI | ↓ 66    | 1E-S-021847 |             | 02.02       |       |                |        |  |  |                |     |
| 1.9 TDI | ↓ 81    |             | 09.96       | 02.02       |       |                |        |  |  |                |     |
| 2.0     | ↓ 85    | 1E-S-021847 |             | 02.02       |       |                |        |  |  |                |     |
|         | 1.6     | ↓           |             | 10.94       | 02.02 | 03.2122-1042.3 | 010137 |  |  | THz 22,20      | ATE |
|         | 1.8     | ↓           |             | 09.93       | 02.02 |                |        |  |  |                |     |
|         | 1.9 TDI | ↓ 66        |             | 08.95       | 02.02 |                |        |  |  |                |     |
|         | 1.9 TDI | ↓ 81        |             | 09.96       | 02.02 |                |        |  |  |                |     |
|         | 2.0     | ↓ 85        |             | 09.93       | 02.02 |                |        |  |  |                |     |
|         | 1.6     | ↓           | 1E-S-021846 | 10.94       |       | 10.6123-0674.3 | 010639 |  |  | THz 23,81      | ATE |
|         | 1.8     | ↓           | 1E-S-021846 | 09.93       |       |                |        |  |  |                |     |
|         | 1.9 TDI | ↓ 66        | 1E-S-021846 | 08.95       |       |                |        |  |  |                |     |
|         | 2.0     | ↓ 85        | 1E-S-021846 | 09.93       |       |                |        |  |  |                |     |
|         | 1.6     | ↓           | 1E-S-021847 |             | 02.02 |                |        |  |  |                |     |
| 1.8     | ↓       | 1E-S-021847 |             | 02.02       |       |                |        |  |  |                |     |
| 1.9 TDI | ↓ 66    | 1E-S-021847 |             | 02.02       |       |                |        |  |  |                |     |
| 1.9 TDI | ↓ 81    |             | 09.96       | 02.02       |       |                |        |  |  |                |     |
| 2.0     | ↓ 85    | 1E-S-021847 |             | 02.02       |       |                |        |  |  |                |     |
|         | 1.6     | ↓           | 1E-S-021847 |             | 02.02 | 03.2123-1484.3 | 010595 |  |  | THz 23,81      | ATE |
|         | 1.8     | ↓           | 1E-S-021847 |             | 02.02 |                |        |  |  |                |     |
|         | 1.9 TDI | ↓ 66        | 1E-S-021847 |             | 02.02 |                |        |  |  |                |     |
|         | 1.9 TDI | ↓ 81        |             | 09.96       | 02.02 |                |        |  |  |                |     |
|         | 2.0     | ↓ 85        | 1E-S-021847 |             | 02.02 |                |        |  |  |                |     |
|         | 1.6     |             | 1E-T-030000 | 10.94       |       | 24.3541-1739.5 | 240223 |  |  | D=54, - Halter | LUC |
|         | 1.8     | 55          |             | 09.93       | 02.02 |                |        |  |  |                |     |
|         | 1.8     | 66          |             | 1E-T-030000 | 09.93 |                |        |  |  |                |     |
|         | 1.9 TDI | 66          |             | 1E-T-030000 | 08.95 |                |        |  |  |                |     |

1) + engine code ABD,ABU,AEA,AEK / + codice motore ABD,ABU,AEA,AEK / + moteur code ABD,ABU,AEA,AEK / + motor code ABD,ABU,AEA,AEK  
 2) - engine code ABD,ABU,AEA,AEK / - codice motore ABD,ABU,AEA,AEK / - moteur code ABD,ABU,AEA,AEK / - motor code ABD,ABU,AEA,AEK



| VOLKSWAGEN GOLF III Cabriolet (94-02)  |  |  |   |   |   |  |                                      |   |  |                          |
|--|--|--|---|---|---|--|--------------------------------------|---|--|--------------------------|
|    | 1.6<br>1.8<br>1.9 TDI<br>1.9 TDI<br>2.0  | 1E-Z-000001<br>66 1E-Z-000001<br>66 1E-Z-000001<br>81<br>85                      |   | 02.02<br>02.02<br>02.02<br>09.96 02.02<br>09.93 02.02   |   | 24.3541-1609.5<br>24.3541-1610.5<br>24.0101-4301.2<br>11.0101-5403.2 | 240039<br>240040<br>260047<br>260010 |      | D=54, - Halter<br>D=54, - Halter<br>Einbausatz<br>Faltenbalgsatz | LUC<br>LUC<br>LUC<br>LUC |
|    | 1.6<br>1.8<br>1.9 TDI<br>1.9 TDI<br>2.0  |  |   | 10.94 02.02<br>09.93 02.02<br>08.95 02.02<br>09.96 02.02<br>09.93 02.02                               |   | 83.7713-0435.3   | 330792                               | 2   | L=435  |                          |
|    | 1.6<br>1.8<br>1.9 TDI<br>1.9 TDI<br>2.0  |  | 1E-X-016000<br>1E-X-016000<br>1E-X-016000<br>1E-X-016000<br>1E-X-016000 | 04.98<br>04.98<br>04.98<br>09.96<br>04.98   |   | 24.3384-1707.5<br>24.3384-1708.5<br>11.0101-5403.2                   | 240171<br>240172<br>260010           |      | D=38, - Halter<br>D=38, - Halter<br>Faltenbalgsatz               | LUC<br>LUC<br>LUC        |
|  | 1.6<br>1.8<br>1.9 TDI<br>1.9 TDI<br>2.0  | 1E-X-016001<br>1E-X-016001<br>66 1E-X-016001<br>81 1E-X-016001<br>85 1E-X-016001 |   | 02.02<br>02.02<br>02.02<br>02.02  |   | 24.3384-1723.7<br>24.3384-1724.7                                     | 220523<br>220524                     |      | D=38(M12x1), - Halter<br>D=38(M12x1), - Halter                   | LUC<br>LUC               |
|    | 1.9 TDI<br>2.0   | 81<br>85   | 1E-X-016000<br>1E-X-016000  | 09.96<br>09.93  |   | 83.7836-0135.3<br>83.7704-0160.3                                     | 330816<br>330805                     | 2<br>2  | am Bremssattel <sup>1)</sup>                                     | L=135<br>L=160           |
|  | 1.6<br>1.8<br>1.9 TDI<br>1.9 TDI<br>2.0  |  |   | 10.94 02.02<br>09.93 02.02<br>08.95 02.02<br>02.02  |   | 83.7836-0135.3   | 330816                               | 2   | L=135  |                          |
|    | 1.6<br>1.8<br>1.9 TDI<br>2.0   |  | 1E-SK016363<br>1E-SK016363<br>1E-SK016363<br>1E-SK016363                | 10.94<br>09.93<br>08.95<br>09.93  |   | 03.3217-2112.3<br>24.3217-0908.3                                     | 020027<br>020167                     |   | + GG <sup>2)</sup><br>+ ALU <sup>3)</sup>                        | Rz 17,46<br>Rz 17,46     |
|  | 1.6<br>1.8<br>1.9 TDI<br>2.0   | 1E-SK016364<br>1E-SK016364<br>66 1E-SK016364<br>85 1E-SK016364                   |   | 03.98<br>03.98<br>03.98   |   | 24.3219-0909.3   | 020188                               |   | Rz 19,05   |                          |
|   | 1.8<br>2.0   |  | 1E-S-005031<br>1E-S-005031  | 09.93<br>09.93  |   | 24.3727-0135.2   | 580135                               | 2    | L=1500   |                          |
|  | 1.6<br>1.8<br>1.9 TDI<br>2.0   |  | 1E-S-005032   | 10.94 03.98<br>08.95 03.98  |   | 24.3727-0160.2   | 580160                               | 2   | L=1498   |                          |
|  | 1.6<br>1.8<br>1.9 TDI<br>1.9 TDI<br>2.0  |  |   | 04.98 02.02<br>04.98 02.02<br>04.98 02.02<br>09.96 02.02<br>04.98 02.02                               |   | 24.3727-0156.2   | 580156                               | 2  | L=1616   |                          |
|  | 1.6<br>1.8<br>1.9 TDI<br>2.0   |  |   | 10.94 02.02<br>09.93 02.02<br>08.95 02.02<br>09.93 02.02  |   | 03.6584-0107.3   | 320110                               |   | BRL 8/4 (4)  | ATE                      |
|  | 1.9 TDI  | 81   |   | 09.96 02.02   |   | 03.6584-0113.3   | 320111                               |   | BRL 8/4 (4)  | ATE                      |
|  | 1.6<br>1.8<br>1.9 TDI<br>1.9 TDI<br>2.0  | ⌄ 66<br>⌄ 66<br>⌄ 81<br>⌄ 85   |   | 10.94 02.02<br>07.95 02.02<br>08.95 02.02<br>09.96 02.02<br>07.95 02.02                               |   | 03.2419-9510.3   | 030028                               |   | Gz 19,05   |                          |
|  | 1.6<br>1.8<br>1.9 TDI<br>1.9 TDI<br>2.0  | ⌄ 66<br>⌄ 66<br>⌄ 81<br>⌄ 85   |   | 10.94 02.02<br>07.95 02.02<br>08.95 02.02<br>09.96 02.02<br>07.95 02.02                               |   | 03.2419-9910.3   | 030031                               |   | Gz 19,05   |                          |
|  | 1.6<br>1.8<br>1.9 TDI<br>1.9 TDI<br>2.0  | 66<br>66<br>81<br>81<br>85   | 1E-2-002000<br>1E-2-002000<br>1E-2-002000<br>1E-2-002000<br>1E-2-002000 | 10.94<br>07.95<br>08.95<br>09.96<br>07.95   |   | 24.2523-0908.3   | 040049                               |   | Nz 23,81   |                          |
|  | 1.6<br>1.8<br>1.9 TDI<br>1.9 TDI<br>2.0  | 66<br>66<br>81<br>81<br>85   | 1E-2-002001<br>1E-2-002001<br>1E-2-002001<br>1E-2-002001<br>1E-2-002001 | 02.02<br>02.02<br>02.02<br>02.02<br>02.02   |   | 24.2519-1701.3   | 040075                               |   | Nz 19,05   |                          |
|  | 1.8<br>1.8<br>2.0  | ⌄ 55<br>⌄ 66<br>⌄ 85   |   | 09.93 02.02<br>09.93 06.95<br>09.93 06.95   |   | 24.3728-0127.2   | 590127                               |   | L=824, + AUT   |                          |
| VOLKSWAGEN GOLF IV (98-05)   |  |  |   |   |   |  |                                      |   |  |                          |
|  | 1.4<br>1.6<br>1.8<br>1.8 4motion<br>1.8 T GTI<br>1.9 SDI<br>1.9 TDI<br>1.9 TDI | ⌄<br>⌄<br>⌄<br>⌄ 92<br>⌄ 132<br>⌄ 50<br>⌄ 66<br>⌄ 81                             |   | 10.97 08.00<br>10.97 08.00<br>10.97 08.00<br>07.98 08.00<br>10.97 08.00<br>10.97 08.00<br>10.97 08.00 | PR: 1AT<br>PR: 1AT<br>PR: 1AT<br>PR: 1AT<br>PR: 1AT<br>PR: 1AT<br>PR: 1AT | 03.7863-0402.4   | 300124                               |   | 10"  | ATE                      |

<sup>1)</sup> on the brake caliper / sulla pinza freno / sur l'étrier de frein / a la pinza de freno

<sup>2)</sup> + cast iron / + ghisa / + fonte grise / + fundición de gris

<sup>3)</sup> + aluminium / + aluminio / + aluminium / + aluminio

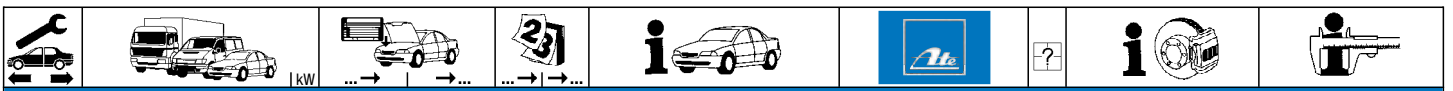

**VOLKSWAGEN GOLF IV (98-05)**

|                 |                 |       |       |                     |                     |                |        |  |           |     |
|-----------------|-----------------|-------|-------|---------------------|---------------------|----------------|--------|--|-----------|-----|
|                 | 1.9 TDI         | 85    | 05.99 | 08.00               | PR: 1AT             | 03.7863-0402.4 | 300124 |  | 10"       | ATE |
|                 | 1.9 TDI 4motion | 66    | 07.98 | 08.00               | PR: 1AT             |                |        |  |           |     |
|                 | 1.9 TDI 4motion | 85    | 11.99 | 08.00               | PR: 1AT             |                |        |  |           |     |
|                 | 2.0             | 85    | 08.98 | 08.00               | PR: 1AT             |                |        |  |           |     |
|                 | 2.0 4motion     | 85    | 04.00 | 08.00               | PR: 1AT             |                |        |  |           |     |
|                 | 2.3 V5          |       | 10.97 | 08.00               | PR: 1AT             |                |        |  |           |     |
|                 | 2.3 V5 4motion  |       | 11.98 | 08.00               | PR: 1AT             |                |        |  |           |     |
|                 | 2.8 V6 4motion  |       | 01.99 | 08.00               | PR: 1AT             |                |        |  |           |     |
|                 | 1.4             |       | 09.00 | 10.01               | PR: 1AT             | 03.7860-0602.4 | 300141 |  | 10"       | ATE |
|                 | 1.6             |       | 09.00 | 10.01               | PR: 1AT             |                |        |  |           |     |
|                 | 1.8             |       | 09.00 | 10.01               | PR: 1AT             |                |        |  |           |     |
|                 | 1.8 4motion     | 92    | 09.00 | 10.01               | PR: 1AT             |                |        |  |           |     |
|                 | 1.8 T GTI       | 132   | 09.00 | 10.01               | PR: 1AT             |                |        |  |           |     |
|                 | 1.9 SDI         | 50    | 09.00 | 10.01               | PR: 1AT             |                |        |  |           |     |
|                 | 1.9 TDI         | 66    | 09.00 | 06.01               | PR: 1AT             |                |        |  |           |     |
|                 | 1.9 TDI         | 74    | 09.00 | 10.01               | PR: 1AT             |                |        |  |           |     |
|                 | 1.9 TDI         | 81    | 09.00 | 10.01               | PR: 1AT             |                |        |  |           |     |
|                 | 1.9 TDI         | 85    | 09.00 | 06.01               | PR: 1AT             |                |        |  |           |     |
|                 | 1.9 TDI         | 96    | 04.01 | 10.01               | PR: 1AT             |                |        |  |           |     |
|                 | 1.9 TDI         | 110   | 09.00 | 10.01               | PR: 1AT             |                |        |  |           |     |
|                 | 1.9 TDI 4motion | 66    | 09.00 | 06.01               | PR: 1AT             |                |        |  |           |     |
|                 | 1.9 TDI 4motion | 74    | 09.00 | 10.01               | PR: 1AT             |                |        |  |           |     |
|                 | 1.9 TDI 4motion | 85    | 09.00 | 06.01               | PR: 1AT             |                |        |  |           |     |
|                 | 1.9 TDI 4motion | 96    | 04.01 | 10.01               | PR: 1AT             |                |        |  |           |     |
|                 | 1.9 TDI 4motion | 110   | 09.00 | 10.01               | PR: 1AT             |                |        |  |           |     |
|                 | 2.0             | 85    | 09.00 | 10.01               | PR: 1AT             |                |        |  |           |     |
|                 | 2.0 4motion     | 85    | 09.00 | 10.01               | PR: 1AT             |                |        |  |           |     |
|                 | 2.3 V5          |       | 09.00 | 10.03               | PR: 1AT             |                |        |  |           |     |
|                 | 2.3 V5 4motion  |       | 09.00 | 10.03               | PR: 1AT             |                |        |  |           |     |
|                 | 2.8 V6 4motion  |       | 09.00 | 10.03               | PR: 1AT             |                |        |  |           |     |
|                 | 1.4             |       | 11.01 | 10.03               | PR: 1AT             | 03.7863-3502.4 | 300128 |  | 10"       | ATE |
|                 | 1.6             |       | 11.01 | 10.03               | PR: 1AT             |                |        |  |           |     |
|                 | 1.6 FSI         |       | 01.02 | 10.03               | PR: 1AT             |                |        |  |           |     |
|                 | 1.8             |       | 11.01 | 10.03               | PR: 1AT             |                |        |  |           |     |
|                 | 1.8 4motion     | 92    | 11.01 | 10.03               | PR: 1AT             |                |        |  |           |     |
|                 | 1.8 T GTI       | 132   | 11.01 | 10.03               | PR: 1AT             |                |        |  |           |     |
|                 | 1.9 SDI         | 50    | 11.01 | 10.03               | PR: 1AT             |                |        |  |           |     |
|                 | 1.9 TDI         | 74    | 11.01 | 06.05               | PR: 1AT             |                |        |  |           |     |
|                 | 1.9 TDI         | 81    | 11.01 | 10.03               | PR: 1AT             |                |        |  |           |     |
|                 | 1.9 TDI         | 96    | 11.01 | 10.03               | PR: 1AT             |                |        |  |           |     |
|                 | 1.9 TDI         | 110   | 11.01 | 10.03               | PR: 1AT             |                |        |  |           |     |
|                 | 1.9 TDI 4motion | 74    | 11.01 | 06.05               | PR: 1AT             |                |        |  |           |     |
|                 | 1.9 TDI 4motion | 96    | 11.01 | 10.03               | PR: 1AT             |                |        |  |           |     |
|                 | 1.9 TDI 4motion | 110   | 11.01 | 10.03               | PR: 1AT             |                |        |  |           |     |
|                 | 2.0             | 85    | 11.01 | 10.03               | PR: 1AT             |                |        |  |           |     |
|                 | 2.0 4motion     | 85    | 11.01 | 10.03               | PR: 1AT             |                |        |  |           |     |
| 2.3 V5          |                 | 11.01 | 10.03 | PR: 1AT             |                     |                |        |  |           |     |
| 2.3 V5 4motion  |                 | 11.01 | 10.03 | PR: 1AT             |                     |                |        |  |           |     |
| 2.8 V6 4motion  |                 | 11.01 | 10.03 | PR: 1AT             |                     |                |        |  |           |     |
| 3.2 R32 4motion |                 | 06.02 | 10.03 | PR: 1AT             |                     |                |        |  |           |     |
|                 | 1.4             |       | 10.97 | 10.03               | PR: 1AM,1AC,1AH,1AJ | 24.2123-1709.3 | 010503 |  | Thz 23,81 |     |
|                 | 1.6             |       | 10.97 | 10.03               | PR: 1AM,1AC,1AH,1AJ |                |        |  |           |     |
|                 | 1.6 FSI         |       | 01.02 | 10.03               | PR: 1AM,1AC,1AH,1AJ |                |        |  |           |     |
|                 | 1.8             |       | 10.97 | 10.03               | PR: 1AM,1AC,1AH,1AJ |                |        |  |           |     |
|                 | 1.8 4motion     | 92    | 07.98 | 10.03               | PR: 1AM,1AC,1AH,1AJ |                |        |  |           |     |
|                 | 1.8 T GTI       | 132   | 10.97 | 10.03               | PR: 1AM,1AC,1AH,1AJ |                |        |  |           |     |
|                 | 1.9 SDI         | 50    | 10.97 | 10.03               | PR: 1AM,1AC,1AH,1AJ |                |        |  |           |     |
|                 | 1.9 TDI         | 66    | 10.97 | 06.01               | PR: 1AM,1AC,1AH,1AJ |                |        |  |           |     |
|                 | 1.9 TDI         | 74    | 09.00 | 06.05               | PR: 1AM,1AC,1AH,1AJ |                |        |  |           |     |
|                 | 1.9 TDI         | 81    | 10.97 | 10.03               | PR: 1AM,1AC,1AH,1AJ |                |        |  |           |     |
|                 | 1.9 TDI         | 85    | 05.99 | 06.01               | PR: 1AM,1AC,1AH,1AJ |                |        |  |           |     |
|                 | 1.9 TDI         | 96    | 04.01 | 10.03               | PR: 1AM,1AC,1AH,1AJ |                |        |  |           |     |
|                 | 1.9 TDI         | 110   | 09.00 | 10.03               | PR: 1AM,1AC,1AH,1AJ |                |        |  |           |     |
|                 | 1.9 TDI 4motion | 66    | 07.98 | 06.01               | PR: 1AM,1AC,1AH,1AJ |                |        |  |           |     |
|                 | 1.9 TDI 4motion | 74    | 09.00 | 06.05               | PR: 1AM,1AC,1AH,1AJ |                |        |  |           |     |
|                 | 1.9 TDI 4motion | 85    | 11.99 | 06.01               | PR: 1AM,1AC,1AH,1AJ |                |        |  |           |     |
| 1.9 TDI 4motion | 96              | 04.01 | 10.03 | PR: 1AM,1AC,1AH,1AJ |                     |                |        |  |           |     |
| 1.9 TDI 4motion | 110             | 09.00 | 10.03 | PR: 1AM,1AC,1AH,1AJ |                     |                |        |  |           |     |
| 2.0             | 85              | 08.98 | 10.03 | PR: 1AM,1AC,1AH,1AJ |                     |                |        |  |           |     |
| 2.0 4motion     | 85              | 04.00 | 10.03 | PR: 1AM,1AC,1AH,1AJ |                     |                |        |  |           |     |
| 2.3 V5          |                 | 10.97 | 10.03 | PR: 1AM,1AC,1AH,1AJ |                     |                |        |  |           |     |
| 2.3 V5 4motion  |                 | 11.98 | 10.03 | PR: 1AM,1AC,1AH,1AJ |                     |                |        |  |           |     |
| 2.8 V6 4motion  |                 | 01.99 | 10.03 | PR: 1AM,1AC,1AH,1AJ |                     |                |        |  |           |     |
| 3.2 R32 4motion |                 | 06.02 | 10.03 | PR: 1AM,1AC,1AH,1AJ |                     |                |        |  |           |     |
|                 | 1.4             |       | 10.97 | 08.00               | PR: 1AT             | 03.2123-2024.3 | 010597 |  | Thz 23,81 | ATE |
|                 | 1.6             |       | 10.97 | 08.00               | PR: 1AT             |                |        |  |           |     |
|                 | 1.8             |       | 10.97 | 08.00               | PR: 1AT             |                |        |  |           |     |
|                 | 1.8 4motion     | 92    | 07.98 | 08.00               | PR: 1AT             |                |        |  |           |     |
|                 | 1.8 T GTI       | 132   | 10.97 | 08.00               | PR: 1AT             |                |        |  |           |     |
|                 | 1.9 SDI         | 50    | 10.97 | 08.00               | PR: 1AT             |                |        |  |           |     |
|                 | 1.9 TDI         | 66    | 10.97 | 08.00               | PR: 1AT             |                |        |  |           |     |
|                 | 1.9 TDI         | 81    | 10.97 | 08.00               | PR: 1AT             |                |        |  |           |     |
|                 | 1.9 TDI         | 85    | 05.99 | 08.00               | PR: 1AT             |                |        |  |           |     |
|                 | 1.9 TDI 4motion | 66    | 07.98 | 08.00               | PR: 1AT             |                |        |  |           |     |
| 1.9 TDI 4motion | 85              | 11.99 | 08.00 | PR: 1AT             |                     |                |        |  |           |     |
| 2.0             | 85              | 08.98 | 08.00 | PR: 1AT             |                     |                |        |  |           |     |
| 2.0 4motion     | 85              | 04.00 | 08.00 | PR: 1AT             |                     |                |        |  |           |     |

| VOLKSWAGEN GOLF IV (98-05) |                 |  |     |       |       |                         |  |                |        |                |     |
|----------------------------|-----------------|--|-----|-------|-------|-------------------------|--|----------------|--------|----------------|-----|
|                            | 2.3 V5          |  |     | 10.97 | 08.00 | PR: 1AT                 |  | 03.2123-2024.3 | 010597 | THz 23,81      | ATE |
|                            | 2.3 V5 4motion  |  |     | 11.98 | 08.00 | PR: 1AT                 |  |                |        |                |     |
|                            | 2.8 V6 4motion  |  |     | 01.99 | 08.00 | PR: 1AT                 |  |                |        |                |     |
|                            | 1.4             |  |     | 09.00 | 10.03 | PR: 1AT                 |  | 03.2123-2715.3 | 010802 | THz 23,81      | ATE |
|                            | 1.6             |  |     | 09.00 | 10.03 | PR: 1AT                 |  |                |        |                |     |
|                            | 1.6 FSI         |  |     | 01.02 | 10.03 | PR: 1AT                 |  |                |        |                |     |
|                            | 1.8             |  |     | 09.00 | 10.03 | PR: 1AT                 |  |                |        |                |     |
|                            | 1.8 4motion     |  | 92  | 09.00 | 10.03 | PR: 1AT                 |  |                |        |                |     |
|                            | 1.8 T GTI       |  | 132 | 09.00 | 10.03 | PR: 1AT                 |  |                |        |                |     |
|                            | 1.9 SDI         |  | 50  | 09.00 | 10.03 | PR: 1AT                 |  |                |        |                |     |
|                            | 1.9 TDI         |  | 66  | 09.00 | 04.02 | PR: 1AT                 |  |                |        |                |     |
|                            | 1.9 TDI         |  | 74  | 09.00 | 06.05 | PR: 1AT                 |  |                |        |                |     |
|                            | 1.9 TDI         |  | 81  | 09.00 | 10.03 | PR: 1AT                 |  |                |        |                |     |
|                            | 1.9 TDI         |  | 85  | 09.00 | 06.01 | PR: 1AT                 |  |                |        |                |     |
|                            | 1.9 TDI         |  | 96  | 04.01 | 10.03 | PR: 1AT                 |  |                |        |                |     |
|                            | 1.9 TDI         |  | 110 | 09.00 | 10.03 | PR: 1AT                 |  |                |        |                |     |
|                            | 1.9 TDI 4motion |  | 66  | 09.00 | 06.01 | PR: 1AT                 |  |                |        |                |     |
|                            | 1.9 TDI 4motion |  | 74  | 09.00 | 06.05 | PR: 1AT                 |  |                |        |                |     |
|                            | 1.9 TDI 4motion |  | 85  | 09.00 | 06.01 | PR: 1AT                 |  |                |        |                |     |
|                            | 1.9 TDI 4motion |  | 96  | 04.01 | 10.03 | PR: 1AT                 |  |                |        |                |     |
|                            | 1.9 TDI 4motion |  | 110 | 09.00 | 10.03 | PR: 1AT                 |  |                |        |                |     |
|                            | 2.0             |  | 85  | 09.00 | 10.03 | PR: 1AT                 |  |                |        |                |     |
|                            | 2.0 4motion     |  | 85  | 09.00 | 10.03 | PR: 1AT                 |  |                |        |                |     |
|                            | 2.3 V5          |  |     | 09.00 | 10.03 | PR: 1AT                 |  |                |        |                |     |
|                            | 2.3 V5 4motion  |  |     | 09.00 | 10.03 | PR: 1AT                 |  |                |        |                |     |
|                            | 2.8 V6 4motion  |  |     | 09.00 | 10.03 | PR: 1AT                 |  |                |        |                |     |
|                            | 3.2 R32 4motion |  |     | 06.02 | 10.03 | PR: 1AT                 |  |                |        |                |     |
|                            | 1.4             |  |     | 10.97 | 08.00 | PR: 1AT                 |  | 03.2123-2064.3 | 010598 | THz 23,81      | ATE |
|                            | 1.6             |  |     | 10.97 | 08.00 | PR: 1AT                 |  |                |        |                |     |
|                            | 1.8             |  |     | 10.97 | 08.00 | PR: 1AT                 |  |                |        |                |     |
|                            | 1.8 4motion     |  | 92  | 07.98 | 08.00 | PR: 1AT                 |  |                |        |                |     |
|                            | 1.8 T GTI       |  | 132 | 10.97 | 08.00 | PR: 1AT                 |  |                |        |                |     |
|                            | 1.9 SDI         |  | 50  | 10.97 | 08.00 | PR: 1AT                 |  |                |        |                |     |
|                            | 1.9 TDI         |  | 66  | 10.97 | 08.00 | PR: 1AT                 |  |                |        |                |     |
|                            | 1.9 TDI         |  | 81  | 10.97 | 08.00 | PR: 1AT                 |  |                |        |                |     |
|                            | 1.9 TDI         |  | 85  | 05.99 | 08.00 | PR: 1AT                 |  |                |        |                |     |
|                            | 1.9 TDI 4motion |  | 66  | 07.98 | 08.00 | PR: 1AT                 |  |                |        |                |     |
|                            | 1.9 TDI 4motion |  | 85  | 11.99 | 08.00 | PR: 1AT                 |  |                |        |                |     |
|                            | 2.0             |  | 85  | 08.98 | 08.00 | PR: 1AT                 |  |                |        |                |     |
|                            | 2.0 4motion     |  | 85  | 04.00 | 08.00 | PR: 1AT                 |  |                |        |                |     |
|                            | 2.3 V5          |  |     | 10.97 | 08.00 | PR: 1AT                 |  |                |        |                |     |
|                            | 2.3 V5 4motion  |  |     | 11.98 | 08.00 | PR: 1AT                 |  |                |        |                |     |
|                            | 2.8 V6 4motion  |  |     | 01.99 | 08.00 | PR: 1AT                 |  |                |        |                |     |
|                            | 1.4             |  |     | 09.00 | 10.03 | PR: 1AT                 |  | 03.2123-2774.3 | 010803 | THz 23,81      | ATE |
|                            | 1.6             |  |     | 09.00 | 10.03 | PR: 1AT                 |  |                |        |                |     |
|                            | 1.6 FSI         |  |     | 01.02 | 10.03 | PR: 1AT                 |  |                |        |                |     |
|                            | 1.8             |  |     | 09.00 | 10.03 | PR: 1AT                 |  |                |        |                |     |
|                            | 1.8 4motion     |  | 92  | 09.00 | 10.03 | PR: 1AT                 |  |                |        |                |     |
|                            | 1.8 T GTI       |  | 132 | 09.00 | 10.03 | PR: 1AT                 |  |                |        |                |     |
|                            | 1.9 SDI         |  | 50  | 09.00 | 10.03 | PR: 1AT                 |  |                |        |                |     |
|                            | 1.9 TDI         |  | 66  | 09.00 | 06.01 | PR: 1AT                 |  |                |        |                |     |
|                            | 1.9 TDI         |  | 74  | 09.00 | 06.05 | PR: 1AT                 |  |                |        |                |     |
|                            | 1.9 TDI         |  | 81  | 09.00 | 10.03 | PR: 1AT                 |  |                |        |                |     |
|                            | 1.9 TDI         |  | 85  | 09.00 | 06.01 | PR: 1AT                 |  |                |        |                |     |
|                            | 1.9 TDI         |  | 96  | 04.01 | 10.03 | PR: 1AT                 |  |                |        |                |     |
|                            | 1.9 TDI         |  | 110 | 09.00 | 10.03 | PR: 1AT                 |  |                |        |                |     |
|                            | 1.9 TDI 4motion |  | 66  | 09.00 | 06.01 | PR: 1AT                 |  |                |        |                |     |
|                            | 1.9 TDI 4motion |  | 74  | 09.00 | 06.05 | PR: 1AT                 |  |                |        |                |     |
|                            | 1.9 TDI 4motion |  | 85  | 09.00 | 06.01 | PR: 1AT                 |  |                |        |                |     |
|                            | 1.9 TDI 4motion |  | 96  | 04.01 | 10.03 | PR: 1AT                 |  |                |        |                |     |
|                            | 1.9 TDI 4motion |  | 110 | 09.00 | 10.03 | PR: 1AT                 |  |                |        |                |     |
|                            | 2.0             |  | 85  | 09.00 | 10.03 | PR: 1AT                 |  |                |        |                |     |
|                            | 2.0 4motion     |  | 85  | 09.00 | 10.03 | PR: 1AT                 |  |                |        |                |     |
|                            | 2.3 V5          |  |     | 09.00 | 10.03 | PR: 1AT                 |  |                |        |                |     |
|                            | 2.3 V5 4motion  |  |     | 09.00 | 10.03 | PR: 1AT                 |  |                |        |                |     |
|                            | 2.8 V6 4motion  |  |     | 09.00 | 10.03 | PR: 1AT                 |  |                |        |                |     |
|                            | 3.2 R32 4motion |  |     | 06.02 | 10.03 | PR: 1AT                 |  |                |        |                |     |
|                            | 1.4             |  |     | 10.97 | 10.03 | PR: 1LR,1LS,1LQ,1ZF,1ZM |  | 11.9541-9549.2 | 220575 | D=54, - Halter | ATE |
|                            | 1.6             |  |     | 10.97 | 10.03 | PR: 1LR,1LS,1LQ,1ZF,1ZM |  | 11.9541-9550.2 | 220576 | D=54, - Halter | ATE |
|                            | 1.6 FSI         |  |     | 01.02 | 10.03 | PR: 1LR,1LS,1LQ,1ZF,1ZM |  | 11.0101-5409.2 | 260035 | Hülzensatz     | ATE |
|                            | 1.8             |  |     | 10.97 | 10.03 | PR: 1LR,1LS,1LQ,1ZF,1ZM |  |                |        |                |     |
|                            | 1.8 4motion     |  | 92  | 07.98 | 10.03 | PR: 1LR,1LS,1LQ,1ZF,1ZM |  |                |        |                |     |
|                            | 1.9 SDI         |  | 50  | 10.97 | 10.03 | PR: 1LR,1LS,1LQ,1ZF,1ZM |  |                |        |                |     |
|                            | 1.9 TDI         |  | 66  | 10.97 | 06.01 | PR: 1LR,1LS,1LQ,1ZF,1ZM |  |                |        |                |     |
|                            | 1.9 TDI         |  | 74  | 09.00 | 06.05 | PR: 1LR,1LS,1LQ,1ZF,1ZM |  |                |        |                |     |
|                            | 1.9 TDI         |  | 81  | 10.97 | 10.03 | PR: 1LR,1LS,1LQ,1ZF,1ZM |  |                |        |                |     |
|                            | 1.9 TDI         |  | 85  | 05.99 | 06.01 | PR: 1LR,1LS,1LQ,1ZF,1ZM |  |                |        |                |     |
|                            | 1.9 TDI 4motion |  | 66  | 07.98 | 06.01 | PR: 1LR,1LS,1LQ,1ZF,1ZM |  |                |        |                |     |
|                            | 1.9 TDI 4motion |  | 74  | 09.00 | 06.05 | PR: 1LR,1LS,1LQ,1ZF,1ZM |  |                |        |                |     |
|                            | 1.9 TDI 4motion |  | 85  | 11.99 | 06.01 | PR: 1LR,1LS,1LQ,1ZF,1ZM |  |                |        |                |     |
|                            | 1.9 TDI 4motion |  | 96  | 04.01 | 10.03 | PR: 1LR,1LS,1LQ,1ZF,1ZM |  |                |        |                |     |
|                            | 2.0             |  | 85  | 08.98 | 10.03 | PR: 1LR,1LS,1LQ,1ZF,1ZM |  |                |        |                |     |
|                            | 2.0 4motion     |  | 85  | 04.00 | 10.03 | PR: 1LR,1LS,1LQ,1ZF,1ZM |  |                |        |                |     |



| VOLKSWAGEN GOLF IV (98-05) |                 | KW              |             | 23          |                 | i                   |                 | ate            |                | ?                     |     | i              |     | key            |                       |     |
|----------------------------|-----------------|-----------------|-------------|-------------|-----------------|---------------------|-----------------|----------------|----------------|-----------------------|-----|----------------|-----|----------------|-----------------------|-----|
|                            | 1.9 TDI         | 96              |             | 04.01       | 10.03           | PR: 1LE,1LN,1ZE,1ZH |                 | 11.3541-8523.2 | 220115         | 2                     |     | D=54, - Halter | ATE |                |                       |     |
|                            | 1.9 TDI         | 110             |             | 09.00       | 10.03           | PR: 1LE,1LN,1ZE,1ZH |                 | 11.3541-8524.2 | 220116         |                       |     | D=54, - Halter | ATE |                |                       |     |
|                            | 1.9 TDI 4motion | 96              |             | 04.01       | 10.03           | PR: 1LE,1LN,1ZE,1ZH |                 | 11.8170-0306.1 | 260102         |                       |     | Halter         | ATE |                |                       |     |
|                            | 1.9 TDI 4motion | 110             |             | 09.00       | 10.03           | PR: 1LE,1LN,1ZE,1ZH |                 | 24.3541-8523.5 | 240551         |                       |     | D=54, - Halter | ATE |                |                       |     |
|                            | 2.3 V5          |                 |             | 10.97       | 10.03           | PR: 1LE,1LN,1ZE,1ZH |                 | 24.3541-8524.5 | 240552         |                       |     | D=54, - Halter | ATE |                |                       |     |
|                            | 2.3 V5 4motion  |                 |             | 11.98       | 10.03           | PR: 1LE,1LN,1ZE,1ZH |                 | 11.0441-5409.2 | 250031         |                       |     | Dichtungssatz  | ATE |                |                       |     |
|                            | 2.8 V6 4motion  |                 |             | 01.99       | 10.03           | PR: 1LE,1LN,1ZE,1ZH |                 | 11.0101-5409.2 | 260035         |                       |     | Hülsensatz     | ATE |                |                       |     |
|                            |                 |                 |             |             |                 |                     |                 | 11.8171-0008.1 | 990049         |                       |     | Führungsbolzen | ATE |                |                       |     |
|                            |                 |                 |             |             |                 |                     |                 | 11.8116-0143.1 | 390513         |                       |     | Haltefeder     | ATE |                |                       |     |
|                            |                 |                 |             |             |                 |                     |                 |                |                |                       |     |                |     |                |                       |     |
|                            | 2.3 V5          |                 | 1J-YB115040 | 10.97       |                 | PR: 1LJ,1ZQ         |                 | 11.9541-9595.2 | 220501         | 2                     |     | D=54, - Halter | ATE |                |                       |     |
|                            | 2.3 V5 4motion  |                 | 1J-YB115040 | 11.98       |                 | PR: 1LJ,1ZQ         |                 | 11.9541-9596.2 | 220502         |                       |     | D=54, - Halter | ATE |                |                       |     |
|                            | 2.8 V6 4motion  |                 | 1J-YB115040 | 01.99       |                 | PR: 1LJ,1ZQ         |                 | 11.0441-5409.2 | 250031         |                       |     | Dichtungssatz  | ATE |                |                       |     |
|                            |                 |                 |             |             |                 |                     |                 | 11.0101-5409.2 | 260035         |                       |     | Hülsensatz     | ATE |                |                       |     |
|                            |                 |                 |             |             |                 |                     |                 | 11.8171-0008.1 | 990049         |                       |     | Führungsbolzen | ATE |                |                       |     |
|                            |                 |                 |             |             |                 |                     |                 | 11.8116-0143.1 | 390513         |                       |     | Haltefeder     | ATE |                |                       |     |
|                            | 2.3 V5          |                 | 1J-Y-115041 | 1J-2-315308 |                 | PR: 1LJ,1ZQ         |                 | 11.9541-9595.2 | 220501         |                       |     | 2              |     | D=54, - Halter | ATE                   |     |
|                            | 2.3 V5 4motion  |                 | 1J-Y-115041 | 1J-2-315308 |                 | PR: 1LJ,1ZQ         |                 | 11.9541-9596.2 | 220502         |                       |     |                |     | D=54, - Halter | ATE                   |     |
|                            | 2.8 V6 4motion  |                 | 1J-Y-115041 | 1J-2-315308 |                 | PR: 1LJ,1ZQ         |                 | 11.0441-5409.2 | 250031         |                       |     |                |     | Dichtungssatz  | ATE                   |     |
|                            |                 |                 |             |             |                 |                     |                 | 11.0101-5409.2 | 260035         |                       |     |                |     | Hülsensatz     | ATE                   |     |
|                            |                 |                 |             |             |                 |                     | 11.8171-0008.1  | 990049         | Führungsbolzen | ATE                   |     |                |     |                |                       |     |
|                            |                 |                 |             |             |                 |                     | 11.8116-0143.1  | 390513         | Haltefeder     | ATE                   |     |                |     |                |                       |     |
|                            | 2.3 V5          |                 | 1J-2-315309 |             | 10.03           | PR: 1LJ,1ZQ         |                 | 11.9541-9595.2 | 220501         | 2                     |     | D=54, - Halter | ATE |                |                       |     |
|                            | 2.3 V5 4motion  |                 | 1J-2-315309 |             | 10.03           | PR: 1LJ,1ZQ         |                 | 11.9541-9596.2 | 220502         |                       |     | D=54, - Halter | ATE |                |                       |     |
|                            | 2.8 V6 4motion  |                 | 1J-2-315309 |             | 10.03           | PR: 1LJ,1ZQ         |                 | 11.0441-5409.2 | 250031         |                       |     | Dichtungssatz  | ATE |                |                       |     |
|                            |                 |                 |             |             |                 |                     |                 | 11.0101-5409.2 | 260035         |                       |     | Hülsensatz     | ATE |                |                       |     |
|                            |                 |                 |             |             |                 |                     |                 | 11.8171-0008.1 | 990049         |                       |     | Führungsbolzen | ATE |                |                       |     |
|                            |                 |                 |             |             |                 |                     |                 | 11.8116-0143.1 | 390513         |                       |     | Haltefeder     | ATE |                |                       |     |
|                            |                 | 1.8 T GTI       | 132         |             | 10.97           | 10.03               |                 |                | 11.9541-9595.2 |                       |     | 220501         | 2   |                | D=54, - Halter        | ATE |
|                            |                 |                 |             |             |                 |                     |                 |                | 11.9541-9596.2 |                       |     | 220502         |     |                | D=54, - Halter        | ATE |
|                            |                 |                 |             |             |                 |                     |                 |                | 11.0441-5409.2 |                       |     | 250031         |     |                | Dichtungssatz         | ATE |
|                            |                 |                 |             |             |                 |                     |                 |                | 11.0101-5409.2 |                       |     | 260035         |     |                | Hülsensatz            | ATE |
|                            |                 |                 |             |             |                 |                     |                 | 11.8171-0008.1 | 990049         | Führungsbolzen        | ATE |                |     |                |                       |     |
|                            |                 |                 |             |             |                 |                     |                 | 11.8116-0143.1 | 390513         | Haltefeder            | ATE |                |     |                |                       |     |
|                            |                 | 3.2 R32 4motion |             |             | 06.02           | 10.03               | PR: 1ZT         |                | 11.9421-9915.2 | 220869                | 2   |                |     |                | D=42, - Halter        | ATE |
|                            |                 |                 |             |             |                 |                     |                 |                | 11.9421-9916.2 | 220870                |     |                |     |                | D=42, - Halter        | ATE |
|                            |                 |                 |             |             |                 |                     |                 |                | 11.8171-0008.1 | 990049                |     |                |     |                | Führungsbolzen        | ATE |
|                            |                 |                 |             |             |                 |                     |                 |                | 11.8116-0260.1 | 390597                |     |                |     |                | Haltefeder            | ATE |
|                            |                 | 1.4             |             |             | 10.97           | 10.03               |                 |                | 83.7838-0435.3 | 330834                |     |                | 2   |                | L=435                 |     |
|                            |                 | 1.6             |             |             | 10.97           | 10.03               |                 |                |                |                       |     |                |     |                |                       |     |
|                            |                 | 1.6 FSI         |             |             | 01.02           | 10.03               |                 |                |                |                       |     |                |     |                |                       |     |
|                            |                 | 1.8             |             |             | 10.97           | 10.03               |                 |                |                |                       |     |                |     |                |                       |     |
|                            |                 | 1.8 T GTI       | 132         |             | 10.97           | 10.03               |                 |                |                |                       |     |                |     |                |                       |     |
|                            |                 | 1.9 SDI         | 50          |             | 10.97           | 10.03               |                 |                |                |                       |     |                |     |                |                       |     |
| 1.9 TDI                    |                 | 66              |             | 10.97       | 06.01           |                     |                 |                |                |                       |     |                |     |                |                       |     |
| 1.9 TDI                    |                 | 74              |             | 09.00       | 06.05           |                     |                 |                |                |                       |     |                |     |                |                       |     |
| 1.9 TDI                    |                 | 81              |             | 10.97       | 10.03           |                     |                 |                |                |                       |     |                |     |                |                       |     |
| 1.9 TDI                    |                 | 85              |             | 05.99       | 06.01           |                     |                 |                |                |                       |     |                |     |                |                       |     |
| 1.9 TDI                    | 96              |                 | 04.01       | 10.03       |                 |                     |                 |                |                |                       |     |                |     |                |                       |     |
| 1.9 TDI                    | 110             |                 | 09.00       | 10.03       |                 |                     |                 |                |                |                       |     |                |     |                |                       |     |
| 2.0                        | 85              |                 | 08.98       | 10.03       |                 |                     |                 |                |                |                       |     |                |     |                |                       |     |
| 2.3 V5                     |                 |                 | 10.97       | 10.03       |                 |                     |                 |                |                |                       |     |                |     |                |                       |     |
|                            | 1.8 4motion     | 92              |             | 07.98       | 10.03           |                     |                 | 83.6247-0562.3 | 330594         | 2                     |     | L=560          |     |                |                       |     |
|                            | 1.9 TDI 4motion | 66              |             | 07.98       | 06.01           |                     |                 |                |                |                       |     |                |     |                |                       |     |
|                            | 1.9 TDI 4motion | 74              |             | 09.00       | 06.05           |                     |                 |                |                |                       |     |                |     |                |                       |     |
|                            | 1.9 TDI 4motion | 85              |             | 11.99       | 06.01           |                     |                 |                |                |                       |     |                |     |                |                       |     |
|                            | 1.9 TDI 4motion | 96              |             | 04.01       | 10.03           |                     |                 |                |                |                       |     |                |     |                |                       |     |
|                            | 1.9 TDI 4motion | 110             |             | 09.00       | 10.03           |                     |                 |                |                |                       |     |                |     |                |                       |     |
|                            | 2.0 4motion     | 85              |             | 04.00       | 10.03           |                     |                 |                |                |                       |     |                |     |                |                       |     |
|                            | 2.3 V5 4motion  |                 |             | 11.98       | 10.03           |                     |                 |                |                |                       |     |                |     |                |                       |     |
|                            | 2.8 V6 4motion  |                 |             | 01.99       | 10.03           |                     |                 |                |                |                       |     |                |     |                |                       |     |
|                            |                 | 1.4             |             | 1J-Y-238580 | 10.97           |                     | PR: 1KK,1KS,1KV |                | 24.3384-1723.7 |                       |     | 220523         | 2   |                | D=38(M12x1), - Halter | LUC |
| 1.6                        |                 |                 | 1J-Y-238580 | 10.97       |                 | PR: 1KK,1KS,1KV     |                 | 24.3384-1724.7 | 220524         | D=38(M12x1), - Halter | LUC |                |     |                |                       |     |
| 1.8                        |                 |                 | 1J-Y-238580 | 10.97       |                 | PR: 1KK,1KS,1KV     |                 |                |                |                       |     |                |     |                |                       |     |
| 1.9 SDI                    |                 | 50              | 1J-Y-238580 | 10.97       |                 | PR: 1KK,1KS,1KV     |                 |                |                |                       |     |                |     |                |                       |     |
| 1.9 TDI                    |                 | 66              | 1J-Y-238580 | 10.97       |                 | PR: 1KK,1KS,1KV     |                 |                |                |                       |     |                |     |                |                       |     |
| 1.9 TDI                    |                 | 81              | 1J-Y-238580 | 10.97       |                 | PR: 1KK,1KS,1KV     |                 |                |                |                       |     |                |     |                |                       |     |
| 1.9 TDI                    |                 | 85              | 1J-Y-238580 | 05.99       |                 | PR: 1KK,1KS,1KV     |                 |                |                |                       |     |                |     |                |                       |     |
| 2.0                        |                 | 85              | 1J-Y-238580 | 08.98       |                 | PR: 1KK,1KS,1KV     |                 |                |                |                       |     |                |     |                |                       |     |
| 2.3 V5                     |                 |                 | 1J-Y-238580 | 10.97       |                 | PR: 1KK,1KS,1KV     |                 |                |                |                       |     |                |     |                |                       |     |
|                            |                 | 1.4             |             | 1J-Y-238581 | 10.03           |                     | PR: 1KK,1KS,1KV |                | 24.3384-1729.7 | 220541                | 2   |                |     |                | D=38(M12x1), - Halter | LUC |
|                            | 1.6             |                 | 1J-Y-238581 | 10.03       |                 | PR: 1KK,1KS,1KV     |                 | 24.3384-1730.7 | 220542         | D=38(M12x1), - Halter |     |                | LUC |                |                       |     |
|                            | 1.6 FSI         |                 |             | 01.02       | 10.03           | PR: 1KK,1KS,1KV     |                 |                |                |                       |     |                |     |                |                       |     |
|                            | 1.8             |                 | 1J-Y-238581 | 10.03       |                 | PR: 1KK,1KS,1KV     |                 |                |                |                       |     |                |     |                |                       |     |
|                            | 1.9 SDI         | 50              | 1J-Y-238581 | 10.03       |                 | PR: 1KK,1KS,1KV     |                 |                |                |                       |     |                |     |                |                       |     |
|                            | 1.9 TDI         | 66              | 1J-Y-238581 | 06.01       |                 | PR: 1KK,1KS,1KV     |                 |                |                |                       |     |                |     |                |                       |     |
|                            | 1.9 TDI         | 74              |             | 09.00       | 06.05           | PR: 1KK,1KS,1KV     |                 |                |                |                       |     |                |     |                |                       |     |
|                            | 1.9 TDI         | 81              | 1J-Y-238581 | 10.03       |                 | PR: 1KK,1KS,1KV     |                 |                |                |                       |     |                |     |                |                       |     |
|                            | 1.9 TDI         | 85              | 1J-Y-238581 | 06.01       |                 | PR: 1KK,1KS,1KV     |                 |                |                |                       |     |                |     |                |                       |     |
|                            | 1.9 TDI         | 96              |             | 04.01       | 10.03           | PR: 1KK,1KS,1KV     |                 |                |                |                       |     |                |     |                |                       |     |
| 1.9 TDI                    | 110             |                 | 09.00       | 10.03       | PR: 1KK,1KS,1KV |                     |                 |                |                |                       |     |                |     |                |                       |     |
| 2.0                        | 85              | 1J-Y-238581     | 10.03       |             | PR: 1KK,1KS,1KV |                     |                 |                |                |                       |     |                |     |                |                       |     |
| 2.3 V5                     |                 | 1J-Y-238581     | 10.03       |             | PR: 1KK,1KS,1KV |                     |                 |                |                |                       |     |                |     |                |                       |     |
|                            | 1.4             |                 |             | 10.97       | 10.03           | PR: 1KY             |                 | 24.3384-1745.7 | 220609         | 2                     |     | D=38, - Halter | LUC |                |                       |     |
|                            | 1.6             |                 |             | 10.97       | 10.03           | PR: 1KY             |                 | 24.3384-1746.7 | 220610         |                       |     | D=38, - Halter | LUC |                |                       |     |
|                            | 1.6 FSI         |                 |             | 01.02       | 10.03           | PR: 1KY             |                 |                |                |                       |     |                |     |                |                       |     |
|                            | 1.8             |                 |             | 10.97       | 10.03           | PR: 1KY             |                 |                |                |                       |     |                |     |                |                       |     |
|                            | 1.9 SDI         | 50              |             | 10.97       | 10.03           | PR: 1KY             |                 |                |                |                       |     |                |     |                |                       |     |
|                            | 1.9 TDI         | 66              |             | 10.97       | 06.01           | PR: 1KY             |                 |                |                |                       |     |                |     |                |                       |     |

| VOLKSWAGEN GOLF IV (98-05) |                 | KW          |             | 23    |             | i       |                | Ate            |        | ? |  | i |                | Key            |     |
|----------------------------|-----------------|-------------|-------------|-------|-------------|---------|----------------|----------------|--------|---|--|---|----------------|----------------|-----|
|                            | 1.9 TDI         | 74          |             | 09.00 | 06.05       | PR: 1KY |                | 24.3384-1745.7 | 220609 |   |  |   |                | D=38, - Halter | LUC |
|                            | 1.9 TDI         | 81          |             | 10.97 | 10.03       | PR: 1KY |                | 24.3384-1746.7 | 220610 |   |  |   |                | D=38, - Halter | LUC |
|                            | 1.9 TDI         | 85          |             | 05.99 | 06.01       | PR: 1KY |                |                |        |   |  |   |                |                |     |
|                            | 1.9 TDI         | 96          |             | 04.01 | 10.03       | PR: 1KY |                |                |        |   |  |   |                |                |     |
|                            | 1.9 TDI         | 110         |             | 09.00 | 10.03       | PR: 1KY |                |                |        |   |  |   |                |                |     |
|                            | 2.0             | 85          |             | 08.98 | 10.03       | PR: 1KY |                |                |        |   |  |   |                |                |     |
|                            | 2.3 V5          |             |             | 10.97 | 10.03       | PR: 1KY |                |                |        |   |  |   |                |                |     |
|                            | 1.8 4motion     | 92          |             | 07.98 | 10.03       | PR: 1KE |                | 24.3414-1705.7 | 220549 |   |  |   |                | D=41, - Halter | LUC |
|                            | 1.9 TDI 4motion | 66          |             | 07.98 | 06.01       | PR: 1KE |                | 24.3414-1706.7 | 220550 |   |  |   |                | D=41, - Halter | LUC |
|                            | 1.9 TDI 4motion | 74          |             | 09.00 | 06.05       | PR: 1KE |                |                |        |   |  |   |                |                |     |
|                            | 1.9 TDI 4motion | 85          |             | 11.99 | 06.01       | PR: 1KE |                |                |        |   |  |   |                |                |     |
|                            | 1.9 TDI 4motion | 96          |             | 04.01 | 10.03       | PR: 1KE |                |                |        |   |  |   |                |                |     |
|                            | 1.9 TDI 4motion | 110         |             | 09.00 | 10.03       | PR: 1KE |                |                |        |   |  |   |                |                |     |
| 2.0 4motion                | 85              |             | 04.00       | 10.03 | PR: 1KE     |         |                |                |        |   |  |   |                |                |     |
| 2.3 V5 4motion             |                 |             | 11.98       | 10.03 | PR: 1KE     |         |                |                |        |   |  |   |                |                |     |
| 2.8 V6 4motion             |                 |             | 01.99       | 10.03 | PR: 1KU,2EE |         | 24.3384-1745.7 | 220609         |        |   |  |   | D=38, - Halter | LUC            |     |
|                            |                 |             |             |       |             |         | 24.3384-1746.7 | 220610         |        |   |  |   | D=38, - Halter | LUC            |     |
|                            |                 |             |             |       |             |         |                |                |        |   |  |   |                |                |     |
|                            | 1.4             |             |             | 10.97 | 10.03       |         |                | 83.7858-0140.3 | 330837 | 2 |  |   |                | L=140          |     |
|                            | 1.6             |             |             | 10.97 | 10.03       |         |                |                |        |   |  |   |                |                |     |
|                            | 1.6 FSI         |             |             | 01.02 | 10.03       |         |                |                |        |   |  |   |                |                |     |
|                            | 1.8             |             |             | 10.97 | 10.03       |         |                |                |        |   |  |   |                |                |     |
|                            | 1.8 T GTI       | 132         |             | 10.97 | 10.03       |         |                |                |        |   |  |   |                |                |     |
|                            | 1.9 SDI         | 50          |             | 10.97 | 10.03       |         |                |                |        |   |  |   |                |                |     |
|                            | 1.9 TDI         | 66          |             | 10.97 | 06.01       |         |                |                |        |   |  |   |                |                |     |
|                            | 1.9 TDI         | 74          |             | 09.00 | 06.05       |         |                |                |        |   |  |   |                |                |     |
|                            | 1.9 TDI         | 81          |             | 10.97 | 10.03       |         |                |                |        |   |  |   |                |                |     |
|                            | 1.9 TDI         | 85          |             | 05.99 | 06.01       |         |                |                |        |   |  |   |                |                |     |
|                            | 1.9 TDI         | 96          |             | 04.01 | 10.03       |         |                |                |        |   |  |   |                |                |     |
|                            | 1.9 TDI         | 110         |             | 09.00 | 10.03       |         |                |                |        |   |  |   |                |                |     |
|                            | 2.0             | 85          |             | 08.98 | 10.03       |         |                |                |        |   |  |   |                |                |     |
|                            | 2.3 V5          |             |             | 10.97 | 10.03       |         |                |                |        |   |  |   |                |                |     |
|                            | 1.8 4motion     | 92          |             | 07.98 | 10.03       |         |                | 83.7858-0140.3 | 330837 | 2 |  |   |                | L=140          |     |
|                            | 1.9 TDI 4motion | 66          |             | 07.98 | 06.01       |         |                |                |        |   |  |   |                |                |     |
|                            | 1.9 TDI 4motion | 74          |             | 09.00 | 06.05       |         |                |                |        |   |  |   |                |                |     |
|                            | 1.9 TDI 4motion | 85          |             | 11.99 | 06.01       |         |                |                |        |   |  |   |                |                |     |
|                            | 1.9 TDI 4motion | 96          |             | 04.01 | 10.03       |         |                |                |        |   |  |   |                |                |     |
|                            | 1.9 TDI 4motion | 110         |             | 09.00 | 10.03       |         |                |                |        |   |  |   |                |                |     |
|                            | 2.0 4motion     | 85          |             | 04.00 | 10.03       |         |                |                |        |   |  |   |                |                |     |
|                            | 2.3 V5 4motion  |             |             | 11.98 | 10.03       |         |                |                |        |   |  |   |                |                |     |
|                            | 2.8 V6 4motion  |             |             | 01.99 | 10.03       |         |                |                |        |   |  |   |                |                |     |
| 3.2 R32 4motion            |                 |             | 06.02       | 10.03 |             |         |                |                |        |   |  |   |                |                |     |
|                            | 1.4             |             | 1J-Y-238580 | 10.97 | 10.03       |         |                | 24.3727-0149.2 | 580149 | 2 |  |   |                | L=1688         |     |
|                            | 1.6             |             | 1J-Y-238580 | 10.97 | 10.03       |         |                |                |        |   |  |   |                |                |     |
|                            | 1.8             |             | 1J-Y-238580 | 10.97 | 10.03       |         |                |                |        |   |  |   |                |                |     |
|                            | 1.8 T GTI       | 132         | 1J-Y-238580 | 10.97 | 10.03       |         |                |                |        |   |  |   |                |                |     |
|                            | 1.9 SDI         | 50          | 1J-Y-238580 | 10.97 | 10.03       |         |                |                |        |   |  |   |                |                |     |
|                            | 1.9 TDI         | 66          | 1J-Y-238580 | 10.97 | 10.03       |         |                |                |        |   |  |   |                |                |     |
|                            | 1.9 TDI         | 81          | 1J-Y-238580 | 10.97 | 10.03       |         |                |                |        |   |  |   |                |                |     |
|                            | 1.9 TDI         | 85          | 1J-Y-238580 | 05.99 | 10.03       |         |                |                |        |   |  |   |                |                |     |
|                            | 2.0             | 85          | 1J-Y-238580 | 08.98 | 10.03       |         |                |                |        |   |  |   |                |                |     |
|                            | 1.4             |             | 1J-Y-238581 |       | 10.03       |         |                | 24.3727-0173.2 | 580173 | 2 |  |   |                | L=1693         |     |
|                            | 1.6             |             | 1J-Y-238581 |       | 10.03       |         |                |                |        |   |  |   |                |                |     |
|                            | 1.6 FSI         |             |             | 01.02 | 10.03       |         |                |                |        |   |  |   |                |                |     |
|                            | 1.8             |             | 1J-Y-238581 |       | 10.03       |         |                |                |        |   |  |   |                |                |     |
| 1.8 T GTI                  | 132             | 1J-Y-238581 |             | 10.03 |             |         |                |                |        |   |  |   |                |                |     |
| 1.9 SDI                    | 50              | 1J-Y-238581 |             | 10.03 |             |         |                |                |        |   |  |   |                |                |     |
| 1.9 TDI                    | 66              | 1J-Y-238581 |             | 06.01 |             |         |                |                |        |   |  |   |                |                |     |
| 1.9 TDI                    | 74              |             | 09.00       | 06.05 |             |         |                |                |        |   |  |   |                |                |     |
| 1.9 TDI                    | 81              | 1J-Y-238581 |             | 10.03 |             |         |                |                |        |   |  |   |                |                |     |
| 1.9 TDI                    | 85              | 1J-Y-238581 |             | 06.01 |             |         |                |                |        |   |  |   |                |                |     |
| 1.9 TDI                    | 96              |             | 04.01       | 10.03 |             |         |                |                |        |   |  |   |                |                |     |
| 1.9 TDI                    | 110             |             | 09.00       | 10.03 |             |         |                |                |        |   |  |   |                |                |     |
| 2.0                        | 85              | 1J-Y-238581 |             | 10.03 |             |         |                |                |        |   |  |   |                |                |     |
| 2.3 V5                     |                 |             | 10.97       | 10.03 |             |         |                |                |        |   |  |   |                |                |     |
| 1.8 4motion                | 92              |             | 07.98       | 10.03 |             |         | 24.3727-0175.2 | 580175         | 2      |   |  |   | L=1723         |                |     |
| 1.9 TDI 4motion            | 66              |             | 07.98       | 10.03 |             |         |                |                |        |   |  |   |                |                |     |
| 1.9 TDI 4motion            | 74              |             | 09.00       | 06.05 |             |         |                |                |        |   |  |   |                |                |     |
| 1.9 TDI 4motion            | 85              |             | 11.99       | 10.03 |             |         |                |                |        |   |  |   |                |                |     |
| 1.9 TDI 4motion            | 96              |             | 04.01       | 10.03 |             |         |                |                |        |   |  |   |                |                |     |
| 1.9 TDI 4motion            | 110             |             | 09.00       | 10.03 |             |         |                |                |        |   |  |   |                |                |     |
| 2.0 4motion                | 85              |             | 04.00       | 10.03 |             |         |                |                |        |   |  |   |                |                |     |
| 2.3 V5 4motion             |                 |             | 11.98       | 10.03 |             |         |                |                |        |   |  |   |                |                |     |
| 2.8 V6 4motion             |                 |             | 01.99       | 10.03 |             |         |                |                |        |   |  |   |                |                |     |
| 3.2 R32 4motion            |                 |             | 06.02       | 10.03 |             |         |                |                |        |   |  |   |                |                |     |
|                            | 1.4             |             |             | 10.97 | 10.03       |         |                | 24.2415-1701.3 | 030095 |   |  |   |                | Gz 15,87       |     |
|                            | 1.6             |             |             | 10.97 | 10.03       |         |                |                |        |   |  |   |                |                |     |
|                            | 1.6 FSI         |             |             | 01.02 | 10.03       |         |                |                |        |   |  |   |                |                |     |
|                            | 1.8             |             |             | 10.97 | 10.03       |         |                |                |        |   |  |   |                |                |     |
|                            | 1.8 4motion     | 92          |             | 07.98 | 10.03       |         |                |                |        |   |  |   |                |                |     |
|                            | 1.8 T GTI       | 132         |             | 10.97 | 10.03       |         |                |                |        |   |  |   |                |                |     |
|                            | 1.9 SDI         | 50          |             | 10.97 | 10.03       |         |                |                |        |   |  |   |                |                |     |
|                            | 1.9 TDI         | 66          |             | 10.97 | 06.01       |         |                |                |        |   |  |   |                |                |     |
|                            | 1.9 TDI         | 74          |             | 09.00 | 06.05       |         |                |                |        |   |  |   |                |                |     |
|                            | 1.9 TDI         | 81          |             | 10.97 | 10.03       |         |                |                |        |   |  |   |                |                |     |
|                            | 1.9 TDI         | 85          |             | 05.99 | 06.01       |         |                |                |        |   |  |   |                |                |     |
|                            | 1.9 TDI         | 96          |             | 04.01 | 10.03       |         |                |                |        |   |  |   |                |                |     |

1) - red caliper / - pinza rossa / - étrier rouge / - pinza roja

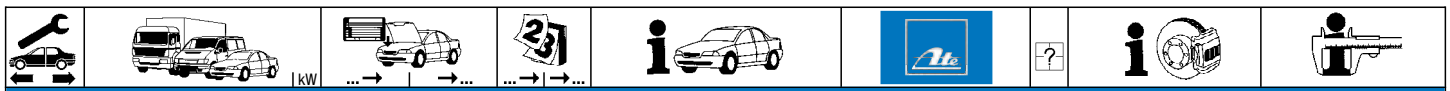

**VOLKSWAGEN GOLF IV (98-05)**

|                 |                 |             |       |       |                |                |        |  |          |          |                |        |  |  |          |
|-----------------|-----------------|-------------|-------|-------|----------------|----------------|--------|--|----------|----------|----------------|--------|--|--|----------|
|                 | 1.9 TDI         | 110         | 09.00 | 10.03 | 24.2415-1701.3 | 030095         |        |  | Gz 15,87 |          |                |        |  |  |          |
|                 | 1.9 TDI 4motion | 66          | 07.98 | 06.01 |                |                |        |  |          |          |                |        |  |  |          |
|                 | 1.9 TDI 4motion | 74          | 09.00 | 06.05 |                |                |        |  |          |          |                |        |  |  |          |
|                 | 1.9 TDI 4motion | 85          | 11.99 | 06.01 |                |                |        |  |          |          |                |        |  |  |          |
|                 | 1.9 TDI 4motion | 96          | 04.01 | 10.03 |                |                |        |  |          |          |                |        |  |  |          |
|                 | 1.9 TDI 4motion | 110         | 09.00 | 10.03 |                |                |        |  |          |          |                |        |  |  |          |
|                 | 2.0             | 85          | 08.98 | 10.03 |                |                |        |  |          |          |                |        |  |  |          |
|                 | 2.0 4motion     | 85          | 04.00 | 10.03 |                |                |        |  |          |          |                |        |  |  |          |
|                 | 2.3 V5          |             | 10.97 | 10.03 |                |                |        |  |          |          |                |        |  |  |          |
|                 | 2.3 V5 4motion  |             | 11.98 | 10.03 |                |                |        |  |          |          |                |        |  |  |          |
|                 | 2.8 V6 4motion  |             | 01.99 | 10.03 |                |                |        |  |          |          |                |        |  |  |          |
|                 | 3.2 R32 4motion |             | 06.02 | 10.03 |                |                |        |  |          |          |                |        |  |  |          |
|                 |                 | 1.4         |       | 10.97 |                |                |        |  |          | 10.03    | 24.2415-1702.3 | 030096 |  |  | Gz 15,87 |
|                 |                 | 1.6         |       | 10.97 |                |                |        |  |          | 10.03    |                |        |  |  |          |
|                 |                 | 1.6 FSI     |       | 01.02 |                |                |        |  |          | 10.03    |                |        |  |  |          |
|                 |                 | 1.8         |       | 10.97 |                |                |        |  |          | 10.03    |                |        |  |  |          |
|                 |                 | 1.8 4motion | 92    | 07.98 |                |                |        |  |          | 10.03    |                |        |  |  |          |
| 1.8 T GTI       |                 | 132         | 10.97 | 10.03 |                |                |        |  |          |          |                |        |  |  |          |
| 1.9 SDI         |                 | 50          | 10.97 | 10.03 |                |                |        |  |          |          |                |        |  |  |          |
| 1.9 TDI         |                 | 66          | 10.97 | 06.01 |                |                |        |  |          |          |                |        |  |  |          |
| 1.9 TDI         |                 | 74          | 09.00 | 06.05 |                |                |        |  |          |          |                |        |  |  |          |
| 1.9 TDI         |                 | 81          | 10.97 | 10.03 |                |                |        |  |          |          |                |        |  |  |          |
| 1.9 TDI         |                 | 85          | 05.99 | 06.01 |                |                |        |  |          |          |                |        |  |  |          |
| 1.9 TDI         |                 | 96          | 04.01 | 10.03 |                |                |        |  |          |          |                |        |  |  |          |
| 1.9 TDI         |                 | 110         | 09.00 | 10.03 |                |                |        |  |          |          |                |        |  |  |          |
| 1.9 TDI 4motion |                 | 66          | 07.98 | 06.01 |                |                |        |  |          |          |                |        |  |  |          |
| 1.9 TDI 4motion |                 | 74          | 09.00 | 06.05 |                |                |        |  |          |          |                |        |  |  |          |
| 1.9 TDI 4motion |                 | 85          | 11.99 | 06.01 |                |                |        |  |          |          |                |        |  |  |          |
| 1.9 TDI 4motion |                 | 96          | 04.01 | 10.03 |                |                |        |  |          |          |                |        |  |  |          |
| 1.9 TDI 4motion |                 | 110         | 09.00 | 10.03 |                |                |        |  |          |          |                |        |  |  |          |
| 2.0             |                 | 85          | 08.98 | 10.03 |                |                |        |  |          |          |                |        |  |  |          |
| 2.0 4motion     |                 | 85          | 04.00 | 10.03 |                |                |        |  |          |          |                |        |  |  |          |
|                 |                 | 1.4         |       | 10.97 | 10.03          | 24.2519-1701.3 | 040075 |  |          | Nz 19,05 |                |        |  |  |          |
|                 | 1.6             |             | 10.97 | 10.03 |                |                |        |  |          |          |                |        |  |  |          |
|                 | 1.6 FSI         |             | 01.02 | 10.03 |                |                |        |  |          |          |                |        |  |  |          |
|                 | 1.8             |             | 10.97 | 10.03 |                |                |        |  |          |          |                |        |  |  |          |
|                 | 1.8 4motion     | 92          | 07.98 | 10.03 |                |                |        |  |          |          |                |        |  |  |          |
|                 | 1.8 T GTI       | 132         | 10.97 | 10.03 |                |                |        |  |          |          |                |        |  |  |          |
|                 | 1.9 SDI         | 50          | 10.97 | 10.03 |                |                |        |  |          |          |                |        |  |  |          |
|                 | 1.9 TDI         | 66          | 10.97 | 06.01 |                |                |        |  |          |          |                |        |  |  |          |
|                 | 1.9 TDI         | 74          | 09.00 | 06.05 |                |                |        |  |          |          |                |        |  |  |          |
|                 | 1.9 TDI         | 81          | 10.97 | 10.03 |                |                |        |  |          |          |                |        |  |  |          |
|                 | 1.9 TDI         | 96          | 04.01 | 10.03 |                |                |        |  |          |          |                |        |  |  |          |
|                 | 1.9 TDI         | 110         | 09.00 | 10.03 |                |                |        |  |          |          |                |        |  |  |          |
|                 | 1.9 TDI 4motion | 66          | 07.98 | 06.01 |                |                |        |  |          |          |                |        |  |  |          |
|                 | 2.0             | 85          | 08.98 | 10.03 |                |                |        |  |          |          |                |        |  |  |          |
|                 | 2.0 4motion     | 85          | 04.00 | 10.03 |                |                |        |  |          |          |                |        |  |  |          |
|                 | 2.3 V5          |             | 10.97 | 10.03 |                |                |        |  |          |          |                |        |  |  |          |
|                 |                 | 1.4         |       | 10.97 | 10.03          |                |        |  |          |          | 24.2523-1701.3 | 040080 |  |  | Nz 23,81 |
| 1.6             |                 |             | 10.97 | 10.03 |                |                |        |  |          |          |                |        |  |  |          |
| 1.6 FSI         |                 |             | 01.02 | 10.03 |                |                |        |  |          |          |                |        |  |  |          |
| 1.8             |                 |             | 10.97 | 10.03 |                |                |        |  |          |          |                |        |  |  |          |
| 1.8 4motion     |                 | 92          | 07.98 | 10.03 |                |                |        |  |          |          |                |        |  |  |          |
| 1.8 T GTI       |                 | 132         | 10.97 | 10.03 |                |                |        |  |          |          |                |        |  |  |          |
| 1.9 SDI         |                 | 50          | 10.97 | 10.03 |                |                |        |  |          |          |                |        |  |  |          |
| 1.9 TDI         |                 | 66          | 10.97 | 06.01 |                |                |        |  |          |          |                |        |  |  |          |
| 1.9 TDI         |                 | 74          | 09.00 | 06.05 |                |                |        |  |          |          |                |        |  |  |          |
| 1.9 TDI         |                 | 81          | 10.97 | 10.03 |                |                |        |  |          |          |                |        |  |  |          |
| 1.9 TDI         |                 | 96          | 04.01 | 10.03 |                |                |        |  |          |          |                |        |  |  |          |
| 1.9 TDI         |                 | 110         | 09.00 | 10.03 |                |                |        |  |          |          |                |        |  |  |          |
| 1.9 TDI 4motion |                 | 66          | 07.98 | 06.01 |                |                |        |  |          |          |                |        |  |  |          |
| 2.0             |                 | 85          | 08.98 | 10.03 |                |                |        |  |          |          |                |        |  |  |          |
| 2.0 4motion     |                 | 85          | 04.00 | 10.03 |                |                |        |  |          |          |                |        |  |  |          |
| 2.3 V5          |                 |             | 10.97 | 10.03 |                |                |        |  |          |          |                |        |  |  |          |

**VOLKSWAGEN GOLF IV Variant (99-06)**

|                 |                 |       |       |       |                |        |  |  |     |     |       |                |        |  |  |     |     |
|-----------------|-----------------|-------|-------|-------|----------------|--------|--|--|-----|-----|-------|----------------|--------|--|--|-----|-----|
|                 | 1.4             |       | 05.99 | 08.00 | 03.7863-0402.4 | 300124 |  |  | 10" | ATE |       |                |        |  |  |     |     |
|                 | 1.6             |       | 05.99 | 08.00 |                |        |  |  |     |     |       |                |        |  |  |     |     |
|                 | 1.8 4motion     | 92    | 05.99 | 08.00 |                |        |  |  |     |     |       |                |        |  |  |     |     |
|                 | 1.8 T           | 110   | 05.00 | 08.00 |                |        |  |  |     |     |       |                |        |  |  |     |     |
|                 | 1.9 SDI         |       | 05.99 | 08.00 |                |        |  |  |     |     |       |                |        |  |  |     |     |
|                 | 1.9 TDI         | 66    | 05.99 | 08.00 |                |        |  |  |     |     |       |                |        |  |  |     |     |
|                 | 1.9 TDI         | 81    | 05.99 | 08.00 |                |        |  |  |     |     |       |                |        |  |  |     |     |
|                 | 1.9 TDI         | 85    | 05.99 | 08.00 |                |        |  |  |     |     |       |                |        |  |  |     |     |
|                 | 1.9 TDI 4motion | 66    | 05.99 | 08.00 |                |        |  |  |     |     |       |                |        |  |  |     |     |
|                 | 1.9 TDI 4motion | 85    | 11.99 | 08.00 |                |        |  |  |     |     |       |                |        |  |  |     |     |
|                 | 2.0             | 85    | 05.99 | 08.00 |                |        |  |  |     |     |       |                |        |  |  |     |     |
|                 | 2.0 4motion     |       | 04.00 | 08.00 |                |        |  |  |     |     |       |                |        |  |  |     |     |
|                 | 2.3 V5          |       | 05.99 | 08.00 |                |        |  |  |     |     |       |                |        |  |  |     |     |
|                 | 2.3 V5 4motion  |       | 05.99 | 08.00 |                |        |  |  |     |     |       |                |        |  |  |     |     |
|                 | 2.8 V6 4motion  |       | 05.99 | 08.00 |                |        |  |  |     |     |       |                |        |  |  |     |     |
|                 |                 | 1.4   |       | 09.00 |                |        |  |  |     |     | 10.01 | 03.7860-0602.4 | 300141 |  |  | 10" | ATE |
|                 |                 | 1.6   |       | 09.00 |                |        |  |  |     |     | 10.01 |                |        |  |  |     |     |
| 1.8 4motion     |                 | 92    | 09.00 | 10.01 |                |        |  |  |     |     |       |                |        |  |  |     |     |
| 1.8 T           |                 | 110   | 09.00 | 10.01 |                |        |  |  |     |     |       |                |        |  |  |     |     |
| 1.9 SDI         |                 |       | 09.00 | 10.01 |                |        |  |  |     |     |       |                |        |  |  |     |     |
| 1.9 TDI         |                 | 66    | 09.00 | 10.01 |                |        |  |  |     |     |       |                |        |  |  |     |     |
| 1.9 TDI         |                 | 74    | 09.00 | 10.01 |                |        |  |  |     |     |       |                |        |  |  |     |     |
| 1.9 TDI         |                 | 81    | 09.00 | 10.01 |                |        |  |  |     |     |       |                |        |  |  |     |     |
| 1.9 TDI         |                 | 85    | 09.00 | 10.01 |                |        |  |  |     |     |       |                |        |  |  |     |     |
| 1.9 TDI         |                 | 96    | 04.01 | 10.01 |                |        |  |  |     |     |       |                |        |  |  |     |     |
| 1.9 TDI 4motion |                 |       | 04.01 | 10.01 |                |        |  |  |     |     |       |                |        |  |  |     |     |
| 1.9 TDI 4motion |                 | 66    | 09.00 | 10.01 |                |        |  |  |     |     |       |                |        |  |  |     |     |
| 1.9 TDI 4motion |                 | 74    | 09.00 | 10.01 |                |        |  |  |     |     |       |                |        |  |  |     |     |
| 1.9 TDI 4motion |                 | 85    | 09.00 | 10.01 |                |        |  |  |     |     |       |                |        |  |  |     |     |
| 2.0             |                 | 85    | 09.00 | 10.01 |                |        |  |  |     |     |       |                |        |  |  |     |     |
| 2.0 4motion     |                 |       | 09.00 | 10.01 |                |        |  |  |     |     |       |                |        |  |  |     |     |
| 2.3 V5          |                 |       | 09.00 | 10.01 |                |        |  |  |     |     |       |                |        |  |  |     |     |
| 2.3 V5 4motion  |                 | 09.00 | 10.01 |       |                |        |  |  |     |     |       |                |        |  |  |     |     |

1) + gearshift cable / + leva cambio con cavo / + câble de changem.de vitesse / + cable de acc. del cambio

2) + gearshift linkage / + leva cambio con tirantera / + tige de changem.de vitesse / + varillaje del cambio

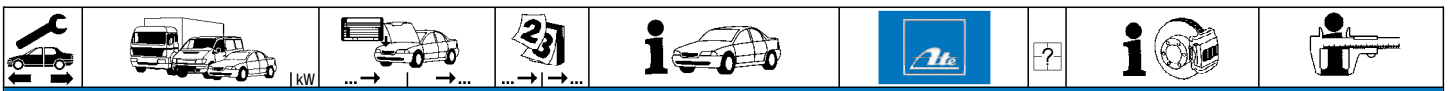

**VOLKSWAGEN GOLF IV Variant (99-06)**

|                 |                 |             |       |         |                     |                |                |           |           |     |
|-----------------|-----------------|-------------|-------|---------|---------------------|----------------|----------------|-----------|-----------|-----|
|                 | 2.8 V6 4motion  | ↕           | 09.00 | 10.01   | PR: 1AT             | 03.7860-0602.4 | 300141         | 10"       | ATE       |     |
|                 | 1.4             | ↕           | 11.01 | 06.06   | PR: 1AT             | 03.7863-3502.4 | 300128         | 10"       | ATE       |     |
|                 | 1.6             | ↕           | 11.01 | 06.06   | PR: 1AT             |                |                |           |           |     |
|                 | 1.6 FSI         | ↕           | 01.02 | 06.06   | PR: 1AT             |                |                |           |           |     |
|                 | 1.8 4motion     | ↕ 92        | 11.01 | 06.06   | PR: 1AT             |                |                |           |           |     |
|                 | 1.8 T           | ↕110        | 11.01 | 06.06   | PR: 1AT             |                |                |           |           |     |
|                 | 1.9 SDI         | ↕           | 11.01 | 06.06   | PR: 1AT             |                |                |           |           |     |
|                 | 1.9 TDI         | ↕ 66        | 11.01 | 06.06   | PR: 1AT             |                |                |           |           |     |
|                 | 1.9 TDI         | ↕ 74        | 11.01 | 06.06   | PR: 1AT             |                |                |           |           |     |
|                 | 1.9 TDI         | ↕ 81        | 11.01 | 06.06   | PR: 1AT             |                |                |           |           |     |
|                 | 1.9 TDI         | ↕ 85        | 11.01 | 06.06   | PR: 1AT             |                |                |           |           |     |
|                 | 1.9 TDI         | ↕ 96        | 11.01 | 06.06   | PR: 1AT             |                |                |           |           |     |
|                 | 1.9 TDI 4motion | ↕           | 11.01 | 06.06   | PR: 1AT             |                |                |           |           |     |
|                 | 1.9 TDI 4motion | ↕ 66        | 11.01 | 06.06   | PR: 1AT             |                |                |           |           |     |
|                 | 1.9 TDI 4motion | ↕ 74        | 11.01 | 06.06   | PR: 1AT             |                |                |           |           |     |
|                 | 1.9 TDI 4motion | ↕ 85        | 11.01 | 06.06   | PR: 1AT             |                |                |           |           |     |
|                 | 2.0             | ↕ 85        | 11.01 | 06.06   | PR: 1AT             |                |                |           |           |     |
|                 | 2.0 4motion     | ↕           | 11.01 | 06.06   | PR: 1AT             |                |                |           |           |     |
|                 | 2.3 V5          | ↕           | 11.01 | 06.06   | PR: 1AT             |                |                |           |           |     |
|                 | 2.3 V5 4motion  | ↕           | 11.01 | 06.06   | PR: 1AT             |                |                |           |           |     |
| 2.8 V6 4motion  | ↕               | 11.01       | 06.06 | PR: 1AT |                     |                |                |           |           |     |
|                 | 1.4             | ↕           | 05.99 | 06.06   | PR: 1AM,1AC,1AH,1AJ | 24.2123-1709.3 | 010503         | THz 23,81 |           |     |
|                 | 1.6             | ↕           | 05.99 | 06.06   | PR: 1AM,1AC,1AH,1AJ |                |                |           |           |     |
|                 | 1.6 FSI         | ↕           | 01.02 | 06.06   | PR: 1AM,1AC,1AH,1AJ |                |                |           |           |     |
|                 | 1.8 4motion     | ↕ 92        | 05.99 | 06.06   | PR: 1AM,1AC,1AH,1AJ |                |                |           |           |     |
|                 | 1.8 T           | ↕110        | 05.00 | 06.06   | PR: 1AM,1AC,1AH,1AJ |                |                |           |           |     |
|                 | 1.9 SDI         | ↕           | 05.99 | 06.06   | PR: 1AM,1AC,1AH,1AJ |                |                |           |           |     |
|                 | 1.9 TDI         | ↕ 66        | 05.99 | 06.06   | PR: 1AM,1AC,1AH,1AJ |                |                |           |           |     |
|                 | 1.9 TDI         | ↕ 74        | 09.00 | 06.06   | PR: 1AM,1AC,1AH,1AJ |                |                |           |           |     |
|                 | 1.9 TDI         | ↕ 81        | 05.99 | 06.06   | PR: 1AM,1AC,1AH,1AJ |                |                |           |           |     |
|                 | 1.9 TDI         | ↕ 85        | 05.99 | 06.06   | PR: 1AM,1AC,1AH,1AJ |                |                |           |           |     |
|                 | 1.9 TDI         | ↕ 96        | 04.01 | 06.06   | PR: 1AM,1AC,1AH,1AJ |                |                |           |           |     |
|                 | 1.9 TDI 4motion | ↕           | 04.01 | 06.06   | PR: 1AM,1AC,1AH,1AJ |                |                |           |           |     |
|                 | 1.9 TDI 4motion | ↕ 66        | 05.99 | 06.06   | PR: 1AM,1AC,1AH,1AJ |                |                |           |           |     |
|                 | 1.9 TDI 4motion | ↕ 74        | 09.00 | 06.06   | PR: 1AM,1AC,1AH,1AJ |                |                |           |           |     |
|                 | 1.9 TDI 4motion | ↕ 85        | 11.99 | 06.06   | PR: 1AM,1AC,1AH,1AJ |                |                |           |           |     |
|                 | 2.0             | ↕ 85        | 05.99 | 06.06   | PR: 1AM,1AC,1AH,1AJ |                |                |           |           |     |
|                 | 2.0 4motion     | ↕           | 04.00 | 06.06   | PR: 1AM,1AC,1AH,1AJ |                |                |           |           |     |
|                 | 2.3 V5          | ↕           | 05.99 | 06.06   | PR: 1AM,1AC,1AH,1AJ |                |                |           |           |     |
|                 | 2.3 V5 4motion  | ↕           | 05.99 | 06.06   | PR: 1AM,1AC,1AH,1AJ |                |                |           |           |     |
|                 | 2.8 V6 4motion  | ↕           | 05.99 | 06.06   | PR: 1AM,1AC,1AH,1AJ |                |                |           |           |     |
|                 | 1.4             | ↕           | 05.99 | 08.00   | PR: 1AT             | 03.2123-2024.3 | 010597         | THz 23,81 | ATE       |     |
|                 | 1.6             | ↕           | 05.99 | 08.00   | PR: 1AT             |                |                |           |           |     |
|                 | 1.8 4motion     | ↕ 92        | 05.99 | 08.00   | PR: 1AT             |                |                |           |           |     |
|                 | 1.8 T           | ↕110        | 05.00 | 08.00   | PR: 1AT             |                |                |           |           |     |
|                 | 1.9 SDI         | ↕           | 05.99 | 08.00   | PR: 1AT             |                |                |           |           |     |
|                 | 1.9 TDI         | ↕ 66        | 05.99 | 08.00   | PR: 1AT             |                |                |           |           |     |
|                 | 1.9 TDI         | ↕ 81        | 05.99 | 08.00   | PR: 1AT             |                |                |           |           |     |
|                 | 1.9 TDI         | ↕ 85        | 05.99 | 08.00   | PR: 1AT             |                |                |           |           |     |
|                 | 1.9 TDI 4motion | ↕ 66        | 05.99 | 08.00   | PR: 1AT             |                |                |           |           |     |
|                 | 1.9 TDI 4motion | ↕ 85        | 11.99 | 08.00   | PR: 1AT             |                |                |           |           |     |
|                 | 2.0             | ↕ 85        | 05.99 | 08.00   | PR: 1AT             |                |                |           |           |     |
|                 | 2.0 4motion     | ↕           | 04.00 | 08.00   | PR: 1AT             |                |                |           |           |     |
|                 | 2.3 V5          | ↕           | 05.99 | 08.00   | PR: 1AT             |                |                |           |           |     |
|                 | 2.3 V5 4motion  | ↕           | 05.99 | 08.00   | PR: 1AT             |                |                |           |           |     |
|                 | 2.8 V6 4motion  | ↕           | 05.99 | 08.00   | PR: 1AT             |                |                |           |           |     |
|                 |                 | 1.4         | ↕     | 09.00   | 06.06               | PR: 1AT        | 03.2123-2715.3 | 010802    | THz 23,81 | ATE |
|                 |                 | 1.6         | ↕     | 09.00   | 06.06               | PR: 1AT        |                |           |           |     |
|                 |                 | 1.6 FSI     | ↕     | 01.02   | 06.06               | PR: 1AT        |                |           |           |     |
|                 |                 | 1.8 4motion | ↕ 92  | 09.00   | 06.06               | PR: 1AT        |                |           |           |     |
|                 |                 | 1.8 T       | ↕110  | 09.00   | 06.06               | PR: 1AT        |                |           |           |     |
| 1.9 SDI         |                 | ↕           | 09.00 | 06.06   | PR: 1AT             |                |                |           |           |     |
| 1.9 TDI         |                 | ↕ 66        | 09.00 | 06.06   | PR: 1AT             |                |                |           |           |     |
| 1.9 TDI         |                 | ↕ 74        | 09.00 | 06.06   | PR: 1AT             |                |                |           |           |     |
| 1.9 TDI         |                 | ↕ 81        | 09.00 | 06.06   | PR: 1AT             |                |                |           |           |     |
| 1.9 TDI         |                 | ↕ 85        | 09.00 | 06.06   | PR: 1AT             |                |                |           |           |     |
| 1.9 TDI         |                 | ↕ 96        | 04.01 | 06.06   | PR: 1AT             |                |                |           |           |     |
| 1.9 TDI 4motion |                 | ↕           | 04.01 | 06.06   | PR: 1AT             |                |                |           |           |     |
| 1.9 TDI 4motion |                 | ↕ 66        | 09.00 | 06.06   | PR: 1AT             |                |                |           |           |     |
| 1.9 TDI 4motion |                 | ↕ 74        | 09.00 | 06.06   | PR: 1AT             |                |                |           |           |     |
| 1.9 TDI 4motion |                 | ↕ 85        | 09.00 | 06.06   | PR: 1AT             |                |                |           |           |     |
| 2.0             |                 | ↕ 85        | 09.00 | 06.06   | PR: 1AT             |                |                |           |           |     |
| 2.0 4motion     |                 | ↕           | 09.00 | 06.06   | PR: 1AT             |                |                |           |           |     |
| 2.3 V5          |                 | ↕           | 09.00 | 06.06   | PR: 1AT             |                |                |           |           |     |
| 2.3 V5 4motion  |                 | ↕           | 09.00 | 06.06   | PR: 1AT             |                |                |           |           |     |
| 2.8 V6 4motion  |                 | ↕           | 09.00 | 06.06   | PR: 1AT             |                |                |           |           |     |
|                 | 1.4             | ↕           | 05.99 | 08.00   | PR: 1AT             | 03.2123-2064.3 | 010598         | THz 23,81 | ATE       |     |
|                 | 1.6             | ↕           | 05.99 | 08.00   | PR: 1AT             |                |                |           |           |     |
|                 | 1.8 4motion     | ↕ 92        | 05.99 | 08.00   | PR: 1AT             |                |                |           |           |     |
|                 | 1.8 T           | ↕110        | 05.00 | 08.00   | PR: 1AT             |                |                |           |           |     |
|                 | 1.9 SDI         | ↕           | 05.99 | 08.00   | PR: 1AT             |                |                |           |           |     |
|                 | 1.9 TDI         | ↕ 66        | 05.99 | 08.00   | PR: 1AT             |                |                |           |           |     |
|                 | 1.9 TDI         | ↕ 81        | 05.99 | 08.00   | PR: 1AT             |                |                |           |           |     |
|                 | 1.9 TDI         | ↕ 85        | 05.99 | 08.00   | PR: 1AT             |                |                |           |           |     |
|                 | 1.9 TDI 4motion | ↕ 66        | 05.99 | 08.00   | PR: 1AT             |                |                |           |           |     |
|                 | 1.9 TDI 4motion | ↕ 85        | 11.99 | 08.00   | PR: 1AT             |                |                |           |           |     |
|                 | 2.0             | ↕ 85        | 05.99 | 08.00   | PR: 1AT             |                |                |           |           |     |



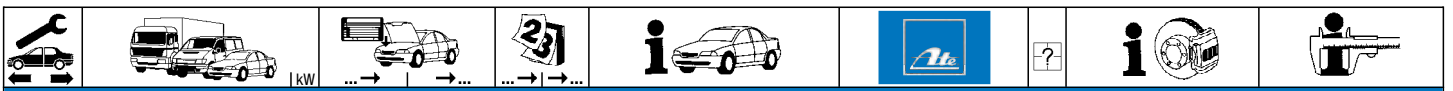

**VOLKSWAGEN GOLF IV Variant (99-06)**

|  |   |  |   |   |   |  |  |  |   |
|--|---|--|---|---|---|--|--|--|---|
|  | 2.0 4motion<br>2.3 V5<br>2.3 V5 4motion<br>2.8 V6 4motion   |  | 04.00<br>05.99<br>05.99<br>05.99  | 08.00<br>08.00<br>08.00<br>08.00  | PR: 1AT<br>PR: 1AT<br>PR: 1AT<br>PR: 1AT  | 03.2123-2064.3<br>010598   |  | THz 23,81  | ATE   |
|  | 1.4<br>1.6<br>1.6 FSI<br>1.8 4motion<br>1.8 T<br>1.9 SDI<br>1.9 TDI<br>1.9 TDI<br>1.9 TDI<br>1.9 TDI<br>1.9 TDI<br>1.9 TDI 4motion<br>1.9 TDI 4motion<br>1.9 TDI 4motion<br>1.9 TDI 4motion<br>2.0<br>2.0 4motion<br>2.3 V5<br>2.3 V5 4motion<br>2.8 V6 4motion |  | 09.00<br>09.00<br>01.02<br>09.00<br>09.00<br>09.00<br>09.00<br>09.00<br>09.00<br>04.01<br>04.01<br>09.00<br>09.00<br>09.00<br>09.00<br>09.00<br>09.00<br>09.00<br>09.00<br>09.00<br>09.00 | 06.06<br>06.06<br>06.06<br>06.06<br>06.06<br>06.06<br>06.06<br>06.06<br>06.06<br>06.06<br>06.06<br>06.06<br>06.06<br>06.06<br>06.06<br>06.06<br>06.06<br>06.06<br>06.06<br>06.06<br>06.06 | PR: 1AT<br>PR: 1AT<br>PR: 1AT<br>PR: 1AT<br>PR: 1AT<br>PR: 1AT<br>PR: 1AT<br>PR: 1AT<br>PR: 1AT<br>PR: 1AT<br>PR: 1AT<br>PR: 1AT<br>PR: 1AT<br>PR: 1AT<br>PR: 1AT<br>PR: 1AT<br>PR: 1AT<br>PR: 1AT<br>PR: 1AT<br>PR: 1AT<br>PR: 1AT   | 03.2123-2774.3<br>010803   |  | THz 23,81  | ATE   |
|  | 1.4<br>1.6<br>1.6 FSI<br>1.8 4motion<br>1.9 SDI<br>1.9 TDI<br>1.9 TDI<br>1.9 TDI<br>1.9 TDI<br>1.9 TDI 4motion<br>1.9 TDI 4motion<br>1.9 TDI 4motion<br>2.0<br>2.0 4motion  | 92   | 05.99<br>05.99<br>01.02<br>05.99<br>05.99<br>09.00<br>05.99<br>05.99<br>05.99<br>05.99<br>09.00<br>09.00<br>11.99<br>05.99<br>04.00   | 06.06<br>06.06<br>06.06<br>06.06<br>06.06<br>06.06<br>06.06<br>06.06<br>06.06<br>06.06<br>06.06<br>06.06<br>06.06<br>06.06<br>06.06   | PR: 1LR,1LS,1ZF,1ZP,1ZM<br>PR: 1LR,1LS,1ZF,1ZP,1ZM<br>PR: 1LR,1LS,1ZF,1ZP,1ZM<br>PR: 1LR,1LS,1ZF,1ZP,1ZM<br>PR: 1LR,1LS,1ZF,1ZP,1ZM<br>PR: 1LR,1LS,1ZF,1ZP,1ZM<br>PR: 1LR,1LS,1ZF,1ZP,1ZM<br>PR: 1LR,1LS,1ZF,1ZP,1ZM<br>PR: 1LR,1LS,1ZF,1ZP,1ZM<br>PR: 1LR,1LS,1ZF,1ZP,1ZM<br>PR: 1LR,1LS,1ZF,1ZP,1ZM<br>PR: 1LR,1LS,1ZF,1ZP,1ZM<br>PR: 1LR,1LS,1ZF,1ZP,1ZM<br>PR: 1LR,1LS,1ZF,1ZP,1ZM<br>PR: 1LR,1LS,1ZF,1ZP,1ZM | 11.9541-9549.2<br>11.9541-9550.2<br>11.0101-5409.2<br>220575<br>220576<br>260035   |  | D=54, - Halter<br>D=54, - Halter<br>Hülsensatz   | ATE<br>ATE<br>ATE   |
|  | 1.8 T<br>1.9 TDI<br>1.9 TDI 4motion<br>2.3 V5<br>2.3 V5 4motion   | 110<br>96  | 05.00<br>04.01<br>04.01<br>05.99<br>05.99   | 06.06<br>06.06<br>06.06<br>06.06<br>06.06   | PR: 1ZD,1ZE<br>PR: 1ZD,1ZE<br>PR: 1ZD,1ZE<br>PR: 1ZD,1ZE<br>PR: 1ZD,1ZE   | 11.3541-8523.2<br>11.3541-8524.2<br>24.3541-8523.5<br>24.3541-8524.5<br>11.8170-0306.1<br>11.0441-5409.2<br>11.0101-5409.2<br>11.8171-0008.1<br>11.8116-0143.1<br>220115<br>220116<br>240551<br>240552<br>260102<br>250031<br>260035<br>990049<br>390513 |  | D=54, - Halter<br>D=54, - Halter<br>D=54, - Halter<br>D=54, - Halter<br>Halter<br>Dichtungssatz<br>Hülsensatz<br>Führungsbolzen<br>Halterfeder | ATE<br>ATE<br>ATE<br>ATE<br>ATE<br>ATE<br>ATE<br>ATE<br>ATE |
|  | 2.8 V6 4motion  |  | 05.99   | 06.06   |   | 11.9541-9595.2<br>11.9541-9596.2<br>11.0441-5409.2<br>11.0101-5409.2<br>11.8171-0008.1<br>11.8116-0143.1<br>220501<br>220502<br>250031<br>260035<br>990049<br>390513   |  | D=54, - Halter<br>D=54, - Halter<br>Dichtungssatz<br>Hülsensatz<br>Führungsbolzen<br>Halterfeder   | ATE<br>ATE<br>ATE<br>ATE<br>ATE<br>ATE                      |
|  | 1.4<br>1.6<br>1.6 FSI<br>1.8 T<br>1.9 SDI<br>1.9 TDI<br>1.9 TDI<br>1.9 TDI<br>1.9 TDI<br>1.9 TDI<br>2.0<br>2.3 V5   | 110  | 05.99<br>05.99<br>01.02<br>05.00<br>05.99<br>05.99<br>09.00<br>05.99<br>05.99<br>04.01<br>05.99<br>05.99  | 06.06<br>06.06<br>06.06<br>06.06<br>06.06<br>06.06<br>06.06<br>06.06<br>06.06<br>06.06<br>06.06<br>06.06  |   | 83.7838-0435.3<br>330834   |  | L=435  |   |
|  | 1.8 4motion<br>1.9 TDI 4motion<br>1.9 TDI 4motion<br>1.9 TDI 4motion<br>1.9 TDI 4motion<br>2.0 4motion<br>2.3 V5 4motion<br>2.8 V6 4motion  | 92   | 05.99<br>04.01<br>05.99<br>09.00<br>11.99<br>04.00<br>05.99<br>05.99  | 06.06<br>06.06<br>06.06<br>06.06<br>06.06<br>06.06<br>06.06<br>06.06  |   | 83.6247-0562.3<br>330594   |  | L=560  |   |
|  | 1.4<br>1.6<br>1.9 SDI<br>1.9 TDI<br>1.9 TDI<br>1.9 TDI<br>2.0<br>2.3 V5   | 66<br>81<br>85   | 1J-Y-238580<br>1J-Y-238580<br>1J-Y-238580<br>1J-Y-238580<br>1J-Y-238580<br>1J-Y-238580<br>1J-Y-238580   | 05.99<br>05.99<br>05.99<br>05.99<br>05.99<br>05.99<br>05.99   | PR: 1KP,1KT<br>PR: 1KP,1KT<br>PR: 1KP,1KT<br>PR: 1KP,1KT<br>PR: 1KP,1KT<br>PR: 1KP,1KT<br>PR: 1KP,1KT   | 24.3414-1703.7<br>24.3414-1704.7<br>220535<br>220536   |  | D=41, - Halter<br>D=41, - Halter   | LUC<br>LUC  |
|  | 1.4<br>1.6<br>1.6 FSI<br>1.8 4motion<br>1.8 T<br>1.9 SDI  | 1J-Y-238581<br>1J-Y-238581<br>92<br>110<br>1J-Y-238581 |   | 06.06<br>06.06<br>01.02<br>05.99<br>05.00<br>06.06  | PR: 1KP,1KT<br>PR: 1KP,1KT<br>PR: 1KP,1KT<br>PR: 1KE<br>PR: 1KP,1KT<br>PR: 1KP,1KT  | 24.3414-1705.7<br>24.3414-1706.7<br>220549<br>220550   |  | D=41, - Halter<br>D=41, - Halter   | LUC<br>LUC  |

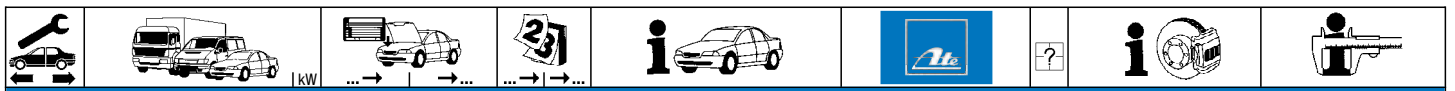

**VOLKSWAGEN GOLF IV Variant (99-06)**

|                 |                 |             |             |             |       |             |                |                |        |                                  |            |        |     |        |  |
|-----------------|-----------------|-------------|-------------|-------------|-------|-------------|----------------|----------------|--------|----------------------------------|------------|--------|-----|--------|--|
|                 | 1.9 TDI         | 66          | 1J-Y-238581 |             | 06.06 | PR: 1KP,1KT | 24.3414-1705.7 | 220549         | ☐<br>☐ | D=41, - Halter<br>D=41, - Halter | LUC<br>LUC |        |     |        |  |
|                 | 1.9 TDI         | 74          |             | 09.00       | 06.06 | PR: 1KP,1KT | 24.3414-1706.7 | 220550         |        |                                  |            |        |     |        |  |
|                 | 1.9 TDI         | 81          | 1J-Y-238581 |             | 06.06 | PR: 1KP,1KT |                |                |        |                                  |            |        |     |        |  |
|                 | 1.9 TDI         | 85          | 1J-Y-238581 |             | 06.06 | PR: 1KP,1KT |                |                |        |                                  |            |        |     |        |  |
|                 | 1.9 TDI         | 96          |             | 04.01       | 06.06 | PR: 1KP,1KT |                |                |        |                                  |            |        |     |        |  |
|                 | 1.9 TDI 4motion |             |             | 04.01       | 06.06 | PR: 1KE     |                |                |        |                                  |            |        |     |        |  |
|                 | 1.9 TDI 4motion | 66          |             | 05.99       | 06.06 | PR: 1KE     |                |                |        |                                  |            |        |     |        |  |
|                 | 1.9 TDI 4motion | 74          |             | 09.00       | 06.06 | PR: 1KE     |                |                |        |                                  |            |        |     |        |  |
|                 | 1.9 TDI 4motion | 85          |             | 11.99       | 06.06 | PR: 1KE     |                |                |        |                                  |            |        |     |        |  |
|                 | 2.0             | 85          | 1J-Y-238581 |             | 06.06 | PR: 1KP,1KT |                |                |        |                                  |            |        |     |        |  |
|                 | 2.0 4motion     |             |             | 04.00       | 06.06 | PR: 1KE     |                |                |        |                                  |            |        |     |        |  |
|                 | 2.3 V5          |             | 1J-Y-238581 |             | 06.06 | PR: 1KP,1KT |                |                |        |                                  |            |        |     |        |  |
|                 | 2.3 V5 4motion  |             |             | 05.99       | 06.06 | PR: 1KE     |                |                |        |                                  |            |        |     |        |  |
|                 | 1.8 4motion     | 92          |             | 05.99       | 06.06 | PR: 2EE     | 24.3384-1745.7 | 220609         | ☐<br>☐ | D=38, - Halter<br>D=38, - Halter | LUC<br>LUC |        |     |        |  |
|                 | 1.9 TDI 4motion |             |             | 04.01       | 06.06 | PR: 2EE     | 24.3384-1746.7 | 220610         |        |                                  |            |        |     |        |  |
|                 | 1.9 TDI 4motion | 66          |             | 05.99       | 06.06 | PR: 2EE     |                |                |        |                                  |            |        |     |        |  |
|                 | 1.9 TDI 4motion | 74          |             | 09.00       | 06.06 | PR: 2EE     |                |                |        |                                  |            |        |     |        |  |
|                 | 1.9 TDI 4motion | 85          |             | 11.99       | 06.06 | PR: 2EE     |                |                |        |                                  |            |        |     |        |  |
|                 | 2.0 4motion     |             |             | 04.00       | 06.06 | PR: 2EE     |                |                |        |                                  |            |        |     |        |  |
|                 | 2.3 V5 4motion  |             |             | 05.99       | 06.06 | PR: 2EE     |                |                |        |                                  |            |        |     |        |  |
|                 | 2.8 V6 4motion  |             |             | 05.99       | 06.06 |             |                |                |        |                                  |            |        |     |        |  |
|                 |                 | 1.4         |             |             | 05.99 | 06.06       |                | 83.7858-0140.3 |        |                                  |            | 330837 | 2   | L=140  |  |
|                 |                 | 1.6         |             |             | 05.99 | 06.06       |                |                |        |                                  |            |        |     |        |  |
|                 |                 | 1.6 FSI     |             |             | 01.02 | 06.06       |                |                |        |                                  |            |        |     |        |  |
|                 |                 | 1.8 T       | 110         |             | 05.00 | 06.06       |                |                |        |                                  |            |        |     |        |  |
|                 |                 | 1.9 SDI     |             |             | 05.99 | 06.06       |                |                |        |                                  |            |        |     |        |  |
| 1.9 TDI         |                 | 66          |             | 05.99       | 06.06 |             |                |                |        |                                  |            |        |     |        |  |
| 1.9 TDI         |                 | 74          |             | 09.00       | 06.06 |             |                |                |        |                                  |            |        |     |        |  |
| 1.9 TDI         |                 | 81          |             | 05.99       | 06.06 |             |                |                |        |                                  |            |        |     |        |  |
| 1.9 TDI         |                 | 85          |             | 05.99       | 06.06 |             |                |                |        |                                  |            |        |     |        |  |
| 1.9 TDI         |                 | 96          |             | 04.01       | 06.06 |             |                |                |        |                                  |            |        |     |        |  |
| 2.0             |                 | 85          |             | 05.99       | 06.06 |             |                |                |        |                                  |            |        |     |        |  |
| 2.3 V5          |                 |             |             | 05.99       | 06.06 |             |                |                |        |                                  |            |        |     |        |  |
|                 |                 | 1.8 4motion | 92          |             | 05.99 | 06.06       |                | 83.7858-0140.3 | 330837 | 2                                | L=140      |        |     |        |  |
|                 | 1.9 TDI 4motion |             |             | 04.01       | 06.06 |             |                |                |        |                                  |            |        |     |        |  |
|                 | 1.9 TDI 4motion | 66          |             | 05.99       | 06.06 |             |                |                |        |                                  |            |        |     |        |  |
|                 | 1.9 TDI 4motion | 74          |             | 09.00       | 06.06 |             |                |                |        |                                  |            |        |     |        |  |
|                 | 1.9 TDI 4motion | 85          |             | 11.99       | 06.06 |             |                |                |        |                                  |            |        |     |        |  |
|                 | 2.0 4motion     |             |             | 04.00       | 06.06 |             |                |                |        |                                  |            |        |     |        |  |
|                 | 2.3 V5 4motion  |             |             | 05.99       | 06.06 |             |                |                |        |                                  |            |        |     |        |  |
|                 | 2.8 V6 4motion  |             |             | 05.99       | 06.06 |             |                |                |        |                                  |            |        |     |        |  |
|                 |                 | 1.4         |             | 1J-Y-238580 | 05.99 |             |                | 24.3727-0149.2 | 580149 |                                  |            |        | 2 ↓ | L=1688 |  |
|                 |                 | 1.6         |             | 1J-Y-238580 | 05.99 |             |                |                |        |                                  |            |        |     |        |  |
|                 |                 | 1.9 SDI     |             | 1J-Y-238580 | 05.99 |             |                |                |        |                                  |            |        |     |        |  |
|                 |                 | 1.9 TDI     | 66          | 1J-Y-238580 | 05.99 |             |                |                |        |                                  |            |        |     |        |  |
|                 |                 | 1.9 TDI     | 81          | 1J-Y-238580 | 05.99 |             |                |                |        |                                  |            |        |     |        |  |
| 1.9 TDI         |                 | 85          | 1J-Y-238580 | 05.99       |       |             |                |                |        |                                  |            |        |     |        |  |
| 2.0             |                 | 85          | 1J-Y-238580 | 05.99       |       |             |                |                |        |                                  |            |        |     |        |  |
|                 |                 | 1.4         |             | 1J-Y-238581 |       | 06.06       |                | 24.3727-0173.2 | 580173 | 2 ↓                              | L=1693     |        |     |        |  |
|                 |                 | 1.6         |             | 1J-Y-238581 |       | 06.06       |                |                |        |                                  |            |        |     |        |  |
|                 |                 | 1.6 FSI     |             |             | 01.02 | 06.06       |                |                |        |                                  |            |        |     |        |  |
|                 |                 | 1.8 T       | 110         |             | 05.00 | 06.06       |                |                |        |                                  |            |        |     |        |  |
|                 |                 | 1.9 SDI     |             | 1J-Y-238581 |       | 06.06       |                |                |        |                                  |            |        |     |        |  |
|                 |                 | 1.9 TDI     | 66          | 1J-Y-238581 |       | 06.06       |                |                |        |                                  |            |        |     |        |  |
|                 | 1.9 TDI         | 74          |             | 09.00       | 06.06 |             |                |                |        |                                  |            |        |     |        |  |
|                 | 1.9 TDI         | 81          | 1J-Y-238581 |             | 06.06 |             |                |                |        |                                  |            |        |     |        |  |
|                 | 1.9 TDI         | 85          | 1J-Y-238581 |             | 06.06 |             |                |                |        |                                  |            |        |     |        |  |
|                 | 1.9 TDI         | 96          |             | 04.01       | 06.06 |             |                |                |        |                                  |            |        |     |        |  |
|                 | 2.0             | 85          | 1J-Y-238581 |             | 06.06 |             |                |                |        |                                  |            |        |     |        |  |
|                 | 2.3 V5          |             |             | 05.99       | 06.06 |             |                |                |        |                                  |            |        |     |        |  |
|                 |                 | 1.8 4motion | 92          |             | 05.99 | 06.06       |                | 24.3727-0175.2 | 580175 |                                  |            |        | 2 ↓ | L=1723 |  |
| 1.9 TDI 4motion |                 |             |             | 04.01       | 06.06 |             |                |                |        |                                  |            |        |     |        |  |
| 1.9 TDI 4motion |                 | 66          |             | 05.99       | 06.06 |             |                |                |        |                                  |            |        |     |        |  |
| 1.9 TDI 4motion |                 | 74          |             | 09.00       | 06.06 |             |                |                |        |                                  |            |        |     |        |  |
| 1.9 TDI 4motion |                 | 85          |             | 11.99       | 06.06 |             |                |                |        |                                  |            |        |     |        |  |
| 2.0 4motion     |                 |             |             | 04.00       | 06.06 |             |                |                |        |                                  |            |        |     |        |  |
| 2.3 V5 4motion  |                 |             |             | 05.99       | 06.06 |             |                |                |        |                                  |            |        |     |        |  |
| 2.8 V6 4motion  |                 |             |             | 05.99       | 06.06 |             |                |                |        |                                  |            |        |     |        |  |
|                 |                 | 1.4         | ↓           |             | 05.99 | 06.06       |                | 24.2415-1701.3 | 030095 |                                  | Gz 15,87   |        |     |        |  |
|                 |                 | 1.6         | ↓           |             | 05.99 | 06.06       |                |                |        |                                  |            |        |     |        |  |
|                 |                 | 1.6 FSI     | ↓           |             | 01.02 | 06.06       |                |                |        |                                  |            |        |     |        |  |
|                 |                 | 1.8 4motion | ↓ 92        |             | 05.99 | 06.06       |                |                |        |                                  |            |        |     |        |  |
|                 |                 | 1.8 T       | ↓ 110       |             | 05.00 | 06.06       |                |                |        |                                  |            |        |     |        |  |
|                 | 1.9 SDI         | ↓           |             | 05.99       | 06.06 |             |                |                |        |                                  |            |        |     |        |  |
|                 | 1.9 TDI         | ↓ 66        |             | 05.99       | 06.06 |             |                |                |        |                                  |            |        |     |        |  |
|                 | 1.9 TDI         | ↓ 74        |             | 09.00       | 06.06 |             |                |                |        |                                  |            |        |     |        |  |
|                 | 1.9 TDI         | ↓ 81        |             | 05.99       | 06.06 |             |                |                |        |                                  |            |        |     |        |  |
|                 | 1.9 TDI         | ↓ 85        |             | 05.99       | 06.06 |             |                |                |        |                                  |            |        |     |        |  |
|                 | 1.9 TDI         | ↓ 96        |             | 04.01       | 06.06 |             |                |                |        |                                  |            |        |     |        |  |
|                 | 1.9 TDI 4motion | ↓           |             | 04.01       | 06.06 |             |                |                |        |                                  |            |        |     |        |  |
|                 | 1.9 TDI 4motion | ↓ 66        |             | 05.99       | 06.06 |             |                |                |        |                                  |            |        |     |        |  |
| 1.9 TDI 4motion | ↓ 74            |             | 09.00       | 06.06       |       |             |                |                |        |                                  |            |        |     |        |  |
| 1.9 TDI 4motion | ↓ 85            |             | 11.99       | 06.06       |       |             |                |                |        |                                  |            |        |     |        |  |
| 2.0             | ↓ 85            |             | 05.99       | 06.06       |       |             |                |                |        |                                  |            |        |     |        |  |
| 2.0 4motion     | ↓               |             | 04.00       | 06.06       |       |             |                |                |        |                                  |            |        |     |        |  |
| 2.3 V5          | ↓               |             | 05.99       | 06.06       |       |             |                |                |        |                                  |            |        |     |        |  |







**VOLKSWAGEN GOLF IV Variant (99-06)**

|        |                 |       |       |       |                |        |  |          |
|--------|-----------------|-------|-------|-------|----------------|--------|--|----------|
|        | 2.3 V5 4motion  |       | 05.99 | 06.06 | 24.2415-1701.3 | 030095 |  | Gz 15,87 |
|        | 2.8 V6 4motion  |       | 05.99 | 06.06 |                |        |  |          |
|        | 1.4             |       | 05.99 | 06.06 | 24.2415-1702.3 | 030096 |  | Gz 15,87 |
|        | 1.6             |       | 05.99 | 06.06 |                |        |  |          |
|        | 1.6 FSI         |       | 01.02 | 06.06 |                |        |  |          |
|        | 1.8 4motion     | 92    | 05.99 | 06.06 |                |        |  |          |
|        | 1.8 T           | 110   | 05.00 | 06.06 |                |        |  |          |
|        | 1.9 SDI         |       | 05.99 | 06.06 |                |        |  |          |
|        | 1.9 TDI         | 66    | 05.99 | 06.06 |                |        |  |          |
|        | 1.9 TDI         | 74    | 09.00 | 06.06 |                |        |  |          |
|        | 1.9 TDI         | 81    | 05.99 | 06.06 |                |        |  |          |
|        | 1.9 TDI         | 85    | 05.99 | 06.06 |                |        |  |          |
|        | 1.9 TDI         | 96    | 04.01 | 06.06 |                |        |  |          |
|        | 1.9 TDI 4motion |       | 04.01 | 06.06 |                |        |  |          |
|        | 1.9 TDI 4motion | 66    | 05.99 | 06.06 |                |        |  |          |
|        | 1.9 TDI 4motion | 74    | 09.00 | 06.06 |                |        |  |          |
|        | 1.9 TDI 4motion | 85    | 11.99 | 06.06 |                |        |  |          |
|        | 2.0             | 85    | 05.99 | 06.06 |                |        |  |          |
|        | 2.0 4motion     |       | 04.00 | 06.06 |                |        |  |          |
|        | 2.3 V5          |       | 05.99 | 06.06 |                |        |  |          |
|        | 2.3 V5 4motion  |       | 05.99 | 06.06 |                |        |  |          |
|        | 2.8 V6 4motion  |       | 05.99 | 06.06 |                |        |  |          |
|        | 1.4             |       | 05.99 | 06.06 | 24.2523-1701.3 | 040080 |  | Nz 23,81 |
|        | 1.6             |       | 05.99 | 06.06 |                |        |  |          |
|        | 1.6 FSI         |       | 01.02 | 06.06 |                |        |  |          |
|        | 1.9 SDI         |       | 05.99 | 06.06 |                |        |  |          |
|        | 1.8 4motion     | 92    | 05.99 | 06.06 | 24.2519-1701.3 | 040075 |  | Nz 19,05 |
|        | 1.8 T           | 110   | 05.00 | 06.06 |                |        |  |          |
|        | 1.9 TDI         | 66    | 05.99 | 06.06 |                |        |  |          |
|        | 1.9 TDI         | 74    | 09.00 | 06.06 |                |        |  |          |
|        | 1.9 TDI         | 81    | 05.99 | 06.06 |                |        |  |          |
|        | 1.9 TDI 4motion | 66    | 05.99 | 06.06 |                |        |  |          |
|        | 2.0             | 85    | 05.99 | 06.06 |                |        |  |          |
|        | 2.0 4motion     |       | 04.00 | 06.06 |                |        |  |          |
| 2.3 V5 |                 | 05.99 | 06.06 |       |                |        |  |          |

**VOLKSWAGEN GOLF V (03-08)**

|                 |                 |             |             |             |                |                |   |   |           |     |
|-----------------|-----------------|-------------|-------------|-------------|----------------|----------------|---|---|-----------|-----|
|                 | 1.4 16V         |             | 10.03       | 09.08       | PR: 1AC,1AT    | 03.7863-9502.4 | 300204                                    | Kolbendurchmesser Ø 22,20mm <sup>1)</sup> | 10"       | ATE |
|                 | 1.4 FSI         | 66          | 10.03       | 09.08       | PR: 1AC,1AT    |                |   |   |           |     |
|                 | 1.4 TSI         | 90          | 05.07       | 09.08       | PR: 1AC,1AT    |                |   |   |           |     |
|                 | 1.4 TSI         | 103         | 05.06       | 09.08       | PR: 1AC,1AT    |                |   |   |           |     |
|                 | 1.4 TSI         | 125         | 11.05       | 09.08       | PR: 1AC,1AT    |                |   |   |           |     |
|                 | 1.6 16V         | 75          | 01.04       | 09.08       | PR: 1AC,1AT    |                |   |   |           |     |
|                 | 1.6 FSI         | 85          | 10.03       | 09.08       | PR: 1AC,1AT    |                |   |   |           |     |
|                 | 1.9 TDI         | 66          | 05.04       | 09.08       | PR: 1AC,1AT    |                |   |   |           |     |
|                 | 1.9 TDI         | 77          | 10.03       | 09.08       | PR: 1AC,1AT    |                |   |   |           |     |
|                 | 2.0 FSI         | 110         | 10.03       | 09.08       | PR: 1AC,1AT    |                |   |   |           |     |
|                 | 2.0 SDI         | 55          | 01.04       | 09.08       | PR: 1AC,1AT    |                |   |   |           |     |
|                 | 2.0 TDI         | 100         | 10.03       | 09.08       | PR: 1AC,1AT    |                |   |   |           |     |
|                 | 2.0 TDI         | 103         | 10.03       | 09.08       | PR: 1AC,1AT    |                |   |   |           |     |
|                 | 2.0 TDI         | 125         | 11.05       | 09.08       | PR: 1AC,1AT    |                |   |   |           |     |
|                 | 1.4 16V         |             | 10.03       | 09.08       | PR: 1AS        | 03.7863-9602.4 | 300206                                    | Kolbendurchmesser Ø 22,20mm <sup>1)</sup> | 10"       | ATE |
|                 | 1.4 FSI         | 66          | 10.03       | 09.08       | PR: 1AS        | 03.7863-9802.4 | 300281                                    | PR: 1AS,1LJ                               | 10"       | ATE |
|                 | 1.4 TSI         | 90          | 05.07       | 09.08       | PR: 1AS        |                |   |   |           |     |
|                 | 1.4 TSI         | 103         | 05.06       | 09.08       | PR: 1AS        |                |   |   |           |     |
|                 | 1.4 TSI         | 125         | 11.05       | 09.08       | PR: 1AS        |                |   |   |           |     |
|                 | 1.6 16V         | 75          | 01.04       | 09.08       | PR: 1AS        |                |   |   |           |     |
| 1.6 FSI         | 85              | 10.03       | 09.08       | PR: 1AS     |                |                |   |   |           |     |
| 1.9 TDI         | 66              | 05.04       | 09.08       | PR: 1AS     |                |                |   |   |           |     |
| 1.9 TDI         | 77              | 10.03       | 09.08       | PR: 1AS     |                |                |   |   |           |     |
| 2.0 FSI         | 110             | 10.03       | 09.08       | PR: 1AS     |                |                |   |   |           |     |
| 2.0 SDI         | 55              | 01.04       | 09.08       | PR: 1AS     |                |                |   |   |           |     |
| 2.0 TDI         | 100             | 10.03       | 09.08       | PR: 1AS     |                |                |   |   |           |     |
| 2.0 TDI         | 103             | 10.03       | 09.08       | PR: 1AS     |                |                |   |   |           |     |
| 2.0 TDI         | 125             | 11.05       | 09.08       | PR: 1AS     |                |                |   |   |           |     |
| 2.0 GTI         | 147             | 09.04       | 09.08       | PR: 1AC,1AT | 03.7863-9702.4 | 300207         | Kolbendurchmesser Ø 23,81mm <sup>2)</sup> | 10"                                       | ATE       |     |
| 3.2 R32         | 184             | 11.05       | 09.08       | PR: 1AC,1AT |                |                |   |   |           |     |
|                 | 1.4 16V         |             | 1K-6W078889 | 10.03       |                | 03.2122-2129.3 | 010799                                    |   | Thz 22,20 | ATE |
|                 | 1.4 FSI         | 66          | 1K-6W078889 | 10.03       |                |                |   |   |           |     |
|                 | 1.4 TSI         | 103         | 1K-6W078889 | 05.06       |                |                |   |   |           |     |
|                 | 1.4 TSI         | 125         | 1K-6W078889 | 11.05       |                |                |   |   |           |     |
|                 | 1.6 16V         | 75          | 1K-6W078889 | 01.04       |                |                |   |   |           |     |
|                 | 1.6 FSI         | 85          | 1K-6W078889 | 10.03       |                |                |   |   |           |     |
|                 | 1.9 TDI         | 66          | 1K-6W078889 | 05.04       |                |                |   |   |           |     |
|                 | 1.9 TDI         | 77          | 1K-6W078889 | 10.03       |                |                |   |   |           |     |
|                 | 1.9 TDI 4motion | 77          | 1K-6W078889 | 08.04       |                |                |   |   |           |     |
|                 | 2.0 FSI         | 110         | 1K-6W078889 | 10.03       |                |                |   |   |           |     |
|                 | 2.0 FSI 4motion | 110         | 1K-6W078889 | 08.04       |                |                |   |   |           |     |
|                 | 2.0 SDI         | 55          | 1K-6W078889 | 01.04       |                |                |   |   |           |     |
| 2.0 TDI         | 100             | 1K-6W078889 | 10.03       |             |                |                |   |   |           |     |
| 2.0 TDI         | 103             | 1K-6W078889 | 10.03       |             |                |                |   |   |           |     |
| 2.0 TDI         | 125             | 1K-6W078889 | 11.05       |             |                |                |   |   |           |     |
| 2.0 TDI 4motion | 103             | 1K-6W078889 | 08.04       |             |                |                |   |   |           |     |
| 2.0 GTI         | 147             | 1K-6W078889 | 09.04       |             | 03.2123-3223.3 | 010807         |   | Thz 23,81                                 | ATE       |     |
| 3.2 R32         | 184             | 1K-6W078889 | 11.05       |             |                |                |   |   |           |     |
| 1.4 16V         |                 | 1K-6W078890 |             | 09.08       |                | 03.2122-2129.3 | 010799                                    |   | Thz 22,20 | ATE |

<sup>1)</sup> piston diameter Ø 22,20mm / diametro del pistone Ø 22,20mm / diamètre de piston Ø 22,20mm / diametro del pistón Ø 22,20mm

<sup>2)</sup> piston diameter Ø 23,81mm / diametro del pistone Ø 23,81mm / diamètre de piston Ø 23,81mm / diametro del pistón Ø 23,81mm





**VOLKSWAGEN GOLF V (03-08)**

|                 |                 |             |             |       |                 |                 |  |                |        |  |                |     |
|-----------------|-----------------|-------------|-------------|-------|-----------------|-----------------|--|----------------|--------|--|----------------|-----|
|                 | 1.4 FSI         | 66          | 1K-6W078890 |       | 09.08           |                 |  | 03.2122-2129.3 | 010799 |  | Thz 22,20      | ATE |
|                 | 1.4 TSI         | 90          |             | 05.07 | 09.08           |                 |  |                |        |  |                |     |
|                 | 1.4 TSI         | 103         | 1K-6W078890 |       | 09.08           |                 |  |                |        |  |                |     |
|                 | 1.4 TSI         | 125         | 1K-6W078890 |       | 09.08           |                 |  |                |        |  |                |     |
|                 | 1.6 16V         | 75          | 1K-6W078890 |       | 09.08           |                 |  |                |        |  |                |     |
|                 | 1.6 FSI         | 85          | 1K-6W078890 |       | 09.08           |                 |  |                |        |  |                |     |
|                 | 1.9 TDI         | 66          | 1K-6W078890 |       | 09.08           |                 |  |                |        |  |                |     |
|                 | 1.9 TDI         | 77          | 1K-6W078890 |       | 09.08           |                 |  |                |        |  |                |     |
|                 | 1.9 TDI 4motion | 77          | 1K-6W078890 |       | 09.08           |                 |  |                |        |  |                |     |
|                 | 2.0 FSI         | 110         | 1K-6W078890 |       | 09.08           |                 |  |                |        |  |                |     |
|                 | 2.0 FSI 4motion | 110         | 1K-6W078890 |       | 09.08           |                 |  |                |        |  |                |     |
|                 | 2.0 SDI         | 55          | 1K-6W078890 |       | 09.08           |                 |  |                |        |  |                |     |
|                 | 2.0 TDI         | 100         | 1K-6W078890 |       | 09.08           |                 |  |                |        |  |                |     |
|                 | 2.0 TDI         | 103         | 1K-6W078890 |       | 09.08           |                 |  |                |        |  |                |     |
| 2.0 TDI         | 125             | 1K-6W078890 |             | 09.08 |                 |                 |  |                |        |  |                |     |
| 2.0 TDI 4motion | 103             | 1K-6W078890 |             | 09.08 |                 |                 |  |                |        |  |                |     |
| 2.0 GTI         | 147             | 1K-6W078890 |             | 09.08 |                 |                 |  | 03.2123-3449.3 | 010808 |  | Thz 23,81      | ATE |
| 3.2 R32         | 184             | 1K-6W078890 |             | 09.08 |                 |                 |  |                |        |  |                |     |
|                 | 1.4 16V         | 66          |             | 10.03 | 09.08           | PR: 1ZF,1ZM,1ZC |  | 11.9541-9549.2 | 220575 |  | D=54, - Halter | ATE |
|                 | 1.4 FSI         | 66          |             | 10.03 | 09.08           | PR: 1ZF,1ZM,1ZC |  | 11.9541-9550.2 | 220576 |  | D=54, - Halter | ATE |
|                 | 1.4 TSI         | 90          |             | 05.07 | 09.08           | PR: 1ZF,1ZM,1ZC |  | 11.0101-5409.2 | 260035 |  | Hülzensatz     | ATE |
|                 | 1.4 TSI         | 103         |             | 05.06 | 09.08           | PR: 1ZF,1ZM,1ZC |  |                |        |  |                |     |
|                 | 1.4 TSI         | 125         |             | 11.05 | 09.08           | PR: 1ZF,1ZM,1ZC |  |                |        |  |                |     |
|                 | 1.6 16V         | 75          |             | 01.04 | 09.08           | PR: 1ZF,1ZM,1ZC |  |                |        |  |                |     |
|                 | 1.6 FSI         | 85          |             | 10.03 | 09.08           | PR: 1ZF,1ZM,1ZC |  |                |        |  |                |     |
|                 | 1.9 TDI         | 66          |             | 05.04 | 09.08           | PR: 1ZF,1ZM,1ZC |  |                |        |  |                |     |
|                 | 1.9 TDI         | 77          |             | 10.03 | 09.08           | PR: 1ZF,1ZM,1ZC |  |                |        |  |                |     |
|                 | 1.9 TDI 4motion | 77          |             | 08.04 | 09.08           | PR: 1ZF,1ZM,1ZC |  |                |        |  |                |     |
|                 | 2.0 FSI         | 110         |             | 10.03 | 09.08           | PR: 1ZF,1ZM,1ZC |  |                |        |  |                |     |
|                 | 2.0 FSI 4motion | 110         |             | 08.04 | 09.08           | PR: 1ZF,1ZM,1ZC |  |                |        |  |                |     |
|                 | 2.0 GTI         | 147         |             | 09.04 | 09.08           | PR: 1ZF,1ZM,1ZC |  |                |        |  |                |     |
|                 | 2.0 GTI         | 169         |             | 09.06 | 09.08           | PR: 1ZF,1ZM,1ZC |  |                |        |  |                |     |
| 2.0 SDI         | 55              |             | 01.04       | 09.08 | PR: 1ZF,1ZM,1ZC |                 |  |                |        |  |                |     |
| 2.0 TDI         | 100             |             | 10.03       | 09.08 | PR: 1ZF,1ZM,1ZC |                 |  |                |        |  |                |     |
| 2.0 TDI         | 103             |             | 10.03       | 09.08 | PR: 1ZF,1ZM,1ZC |                 |  |                |        |  |                |     |
| 2.0 TDI         | 125             |             | 11.05       | 09.08 | PR: 1ZF,1ZM,1ZC |                 |  |                |        |  |                |     |
| 2.0 TDI 4motion | 103             |             | 08.04       | 09.08 | PR: 1ZF,1ZM,1ZC |                 |  |                |        |  |                |     |
| 3.2 R32         | 184             |             | 11.05       | 09.08 | PR: 1ZF,1ZM,1ZC |                 |  |                |        |  |                |     |
|                 | 1.4 16V         | 66          |             | 10.03 | 09.08           | PR: 1ZE,1ZP     |  | 11.9541-9553.2 | 220563 |  | D=54, - Halter | ATE |
|                 | 1.4 FSI         | 66          |             | 10.03 | 09.08           | PR: 1ZE,1ZP     |  | 11.9541-9554.2 | 220564 |  | D=54, - Halter | ATE |
|                 | 1.4 TSI         | 90          |             | 05.07 | 09.08           | PR: 1ZE,1ZP     |  | 11.0101-5409.2 | 260035 |  | Hülzensatz     | ATE |
|                 | 1.4 TSI         | 103         |             | 05.06 | 09.08           | PR: 1ZE,1ZP     |  | 11.8171-0008.1 | 990049 |  | Führungsbolzen | ATE |
|                 | 1.4 TSI         | 125         |             | 11.05 | 09.08           | PR: 1ZE,1ZP     |  | 11.8116-0351.1 | 390538 |  | Haltefeder     | ATE |
|                 | 1.6 16V         | 75          |             | 01.04 | 09.08           | PR: 1ZE,1ZP     |  |                |        |  |                |     |
|                 | 1.6 FSI         | 85          |             | 10.03 | 09.08           | PR: 1ZE,1ZP     |  |                |        |  |                |     |
|                 | 1.9 TDI         | 66          |             | 05.04 | 09.08           | PR: 1ZE,1ZP     |  |                |        |  |                |     |
|                 | 1.9 TDI         | 77          |             | 10.03 | 09.08           | PR: 1ZE,1ZP     |  |                |        |  |                |     |
|                 | 1.9 TDI 4motion | 77          |             | 08.04 | 09.08           | PR: 1ZE,1ZP     |  |                |        |  |                |     |
|                 | 2.0 FSI         | 110         |             | 10.03 | 09.08           | PR: 1ZE,1ZP     |  |                |        |  |                |     |
|                 | 2.0 FSI 4motion | 110         |             | 08.04 | 09.08           | PR: 1ZE,1ZP     |  |                |        |  |                |     |
|                 | 2.0 GTI         | 147         |             | 09.04 | 09.08           | PR: 1ZE,1ZP     |  |                |        |  |                |     |
|                 | 2.0 GTI         | 169         |             | 09.06 | 09.08           | PR: 1ZE,1ZP     |  |                |        |  |                |     |
| 2.0 SDI         | 55              |             | 01.04       | 09.08 | PR: 1ZE,1ZP     |                 |  |                |        |  |                |     |
| 2.0 TDI         | 100             |             | 10.03       | 09.08 | PR: 1ZE,1ZP     |                 |  |                |        |  |                |     |
| 2.0 TDI         | 103             |             | 10.03       | 09.08 | PR: 1ZE,1ZP     |                 |  |                |        |  |                |     |
| 2.0 TDI         | 125             |             | 11.05       | 09.08 | PR: 1ZE,1ZP     |                 |  |                |        |  |                |     |
| 2.0 TDI 4motion | 103             |             | 08.04       | 09.08 | PR: 1ZE,1ZP     |                 |  |                |        |  |                |     |
| 3.2 R32         | 184             |             | 11.05       | 09.08 | PR: 1ZE,1ZP     |                 |  |                |        |  |                |     |
|                 | 1.4 16V         | 66          |             | 10.03 | 09.08           | PR: 1LJ,1ZD     |  | 11.9541-9553.2 | 220563 |  | D=54, - Halter | ATE |
|                 | 1.4 FSI         | 66          |             | 10.03 | 09.08           | PR: 1LJ,1ZD     |  | 11.9541-9554.2 | 220564 |  | D=54, - Halter | ATE |
|                 | 1.4 TSI         | 90          |             | 05.07 | 09.08           | PR: 1LJ,1ZD     |  | 11.0101-5409.2 | 260035 |  | Hülzensatz     | ATE |
|                 | 1.4 TSI         | 103         |             | 05.06 | 09.08           | PR: 1LJ,1ZD     |  | 11.8171-0008.1 | 990049 |  | Führungsbolzen | ATE |
|                 | 1.4 TSI         | 125         |             | 11.05 | 09.08           | PR: 1LJ,1ZD     |  | 11.8116-0351.1 | 390538 |  | Haltefeder     | ATE |
|                 | 1.6 16V         | 75          |             | 01.04 | 09.08           | PR: 1LJ,1ZD     |  |                |        |  |                |     |
|                 | 1.6 FSI         | 85          |             | 10.03 | 09.08           | PR: 1LJ,1ZD     |  |                |        |  |                |     |
|                 | 1.9 TDI         | 66          |             | 05.04 | 09.08           | PR: 1LJ,1ZD     |  |                |        |  |                |     |
|                 | 1.9 TDI         | 77          |             | 10.03 | 09.08           | PR: 1LJ,1ZD     |  |                |        |  |                |     |
|                 | 1.9 TDI 4motion | 77          |             | 08.04 | 09.08           | PR: 1LJ,1ZD     |  |                |        |  |                |     |
|                 | 2.0 FSI         | 110         |             | 10.03 | 09.08           | PR: 1LJ,1ZD     |  |                |        |  |                |     |
|                 | 2.0 FSI 4motion | 110         |             | 08.04 | 09.08           | PR: 1LJ,1ZD     |  |                |        |  |                |     |
|                 | 2.0 GTI         | 147         |             | 09.04 | 09.08           | PR: 1LJ,1ZD     |  |                |        |  |                |     |
|                 | 2.0 GTI         | 169         |             | 09.06 | 09.08           | PR: 1LJ,1ZD     |  |                |        |  |                |     |
| 2.0 SDI         | 55              |             | 01.04       | 09.08 | PR: 1LJ,1ZD     |                 |  |                |        |  |                |     |
| 2.0 TDI         | 100             |             | 10.03       | 09.08 | PR: 1LJ,1ZD     |                 |  |                |        |  |                |     |
| 2.0 TDI         | 103             |             | 10.03       | 09.08 | PR: 1LJ,1ZD     |                 |  |                |        |  |                |     |
| 2.0 TDI         | 125             |             | 11.05       | 09.08 | PR: 1LJ,1ZD     |                 |  |                |        |  |                |     |
| 2.0 TDI 4motion | 103             |             | 08.04       | 09.08 | PR: 1LJ,1ZD     |                 |  |                |        |  |                |     |
| 3.2 R32         | 184             |             | 11.05       | 09.08 | PR: 1LJ,1ZD     |                 |  |                |        |  |                |     |
|                 | 1.4 16V         | 66          |             | 10.03 | 09.08           | PR: 1LL,1LV     |  | 11.9541-9553.2 | 220563 |  | D=54, - Halter | ATE |
|                 | 1.4 FSI         | 66          |             | 10.03 | 09.08           | PR: 1LL,1LV     |  | 11.9541-9554.2 | 220564 |  | D=54, - Halter | ATE |
|                 | 1.4 TSI         | 90          |             | 05.07 | 09.08           | PR: 1LL,1LV     |  | 11.0101-5409.2 | 260035 |  | Hülzensatz     | ATE |
|                 | 1.4 TSI         | 103         |             | 05.06 | 09.08           | PR: 1LL,1LV     |  | 11.8171-0008.1 | 990049 |  | Führungsbolzen | ATE |
|                 | 1.4 TSI         | 125         |             | 11.05 | 09.08           | PR: 1LL,1LV     |  | 11.8116-0351.1 | 390538 |  | Haltefeder     | ATE |
|                 | 1.6 16V         | 75          |             | 01.04 | 09.08           | PR: 1LL,1LV     |  |                |        |  |                |     |
|                 | 1.6 FSI         | 85          |             | 10.03 | 09.08           | PR: 1LL,1LV     |  |                |        |  |                |     |
|                 | 1.9 TDI         | 66          |             | 05.04 | 09.08           | PR: 1LL,1LV     |  |                |        |  |                |     |
| 1.9 TDI         | 77              |             | 10.03       | 09.08 | PR: 1LL,1LV     |                 |  |                |        |  |                |     |











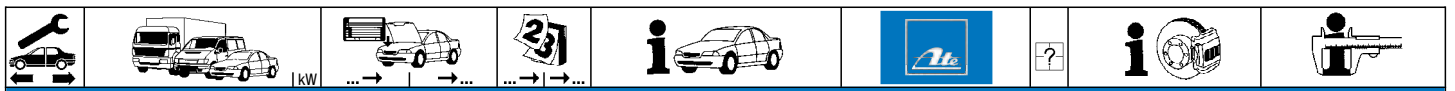

**VOLKSWAGEN GOLF V (03-08)**

|                 |                 |       |       |             |                     |                |        |   |                            |  |                                 |   |  |  |                                 |
|-----------------|-----------------|-------|-------|-------------|---------------------|----------------|--------|---|----------------------------|--|---------------------------------|---|--|--|---------------------------------|
|                 | 1.9 TDI 4motion | 77    | 08.04 | 09.08       | PR: 1LL,1LV         | 11.9541-9553.2 | 220563 | 2 |                            | D=54, - Halter<br>D=54, - Halter<br>Hülzensatz<br>Führungsbolzen<br>Haltefeder | ATE<br>ATE<br>ATE<br>ATE<br>ATE |   |  |  |                                 |
|                 | 2.0 FSI         | 110   | 10.03 | 09.08       | PR: 1LL,1LV         | 11.9541-9554.2 | 220564 |   |                            |  |                                 |   |  |  |                                 |
|                 | 2.0 FSI 4motion | 110   | 08.04 | 09.08       | PR: 1LL,1LV         | 11.0101-5409.2 | 260035 |   |                            |  |                                 |   |  |  |                                 |
|                 | 2.0 GTI         | 147   | 09.04 | 09.08       | PR: 1LL,1LV         | 11.8171-0008.1 | 990049 |   |                            |  |                                 |   |  |  |                                 |
|                 | 2.0 GTI         | 169   | 09.06 | 09.08       | PR: 1LL,1LV         | 11.8116-0351.1 | 390538 |   |                            |  |                                 |   |  |  |                                 |
|                 | 2.0 SDI         | 55    | 01.04 | 09.08       | PR: 1LL,1LV         |                |        |   |                            |  |                                 |   |  |  |                                 |
|                 | 2.0 TDI         | 100   | 10.03 | 09.08       | PR: 1LL,1LV         |                |        |   |                            |  |                                 |   |  |  |                                 |
|                 | 2.0 TDI         | 103   | 10.03 | 09.08       | PR: 1LL,1LV         |                |        |   |                            |  |                                 |   |  |  |                                 |
|                 | 2.0 TDI         | 125   | 11.05 | 09.08       | PR: 1LL,1LV         |                |        |   |                            |  |                                 |   |  |  |                                 |
|                 | 2.0 TDI 4motion | 103   | 08.04 | 09.08       | PR: 1LL,1LV         |                |        |   |                            |  |                                 |   |  |  |                                 |
|                 | 3.2 R32         | 184   | 11.05 | 09.08       | PR: 1LL,1LV         |                |        |   |                            |  |                                 |   |  |  |                                 |
|                 | 1.4 16V         | 66    | 10.03 | 09.08       | PR: 1LK,1LM         | 11.9576-9995.2 | 220651 |   |                            |  |                                 | 2 |  | D=57, - Halter<br>D=57, - Halter<br>Hülzensatz<br>Führungsbolzen<br>Haltefeder | ATE<br>ATE<br>ATE<br>ATE<br>ATE |
|                 | 1.4 FSI         | 90    | 10.03 | 09.08       | PR: 1LK,1LM         | 11.9576-9996.2 | 220652 |   |                            |  |                                 |   |  |  |                                 |
| 1.4 TSI         | 103             | 05.07 | 09.08 | PR: 1LK,1LM | 11.0101-5409.2      | 260035         |        |   |                            |  |                                 |   |  |  |                                 |
| 1.4 TSI         | 103             | 05.06 | 09.08 | PR: 1LK,1LM | 11.8171-0008.1      | 990049         |        |   |                            |  |                                 |   |  |  |                                 |
| 1.4 TSI         | 125             | 11.05 | 09.08 | PR: 1LK,1LM | 11.8116-0410.2      | 390589         |        |   |                            |  |                                 |   |  |  |                                 |
| 1.6 16V         | 75              | 01.04 | 09.08 | PR: 1LK,1LM |                     |                |        |   |                            |  |                                 |   |  |  |                                 |
| 1.6 FSI         | 85              | 10.03 | 09.08 | PR: 1LK,1LM |                     |                |        |   |                            |  |                                 |   |  |  |                                 |
| 1.9 TDI         | 66              | 05.04 | 09.08 | PR: 1LK,1LM |                     |                |        |   |                            |  |                                 |   |  |  |                                 |
| 1.9 TDI         | 77              | 10.03 | 09.08 | PR: 1LK,1LM |                     |                |        |   |                            |  |                                 |   |  |  |                                 |
| 1.9 TDI 4motion | 77              | 08.04 | 09.08 | PR: 1LK,1LM |                     |                |        |   |                            |  |                                 |   |  |  |                                 |
| 2.0 FSI         | 110             | 10.03 | 09.08 | PR: 1LK,1LM |                     |                |        |   |                            |  |                                 |   |  |  |                                 |
| 2.0 FSI 4motion | 110             | 08.04 | 09.08 | PR: 1LK,1LM |                     |                |        |   |                            |  |                                 |   |  |  |                                 |
| 2.0 GTI         | 147             | 09.04 | 09.08 | PR: 1LK,1LM |                     |                |        |   |                            |  |                                 |   |  |  |                                 |
| 2.0 GTI         | 169             | 09.06 | 09.08 | PR: 1LK,1LM |                     |                |        |   |                            |  |                                 |   |  |  |                                 |
| 2.0 SDI         | 55              | 01.04 | 09.08 | PR: 1LK,1LM |                     |                |        |   |                            |  |                                 |   |  |  |                                 |
| 2.0 TDI         | 100             | 10.03 | 09.08 | PR: 1LK,1LM |                     |                |        |   |                            |  |                                 |   |  |  |                                 |
| 2.0 TDI         | 103             | 10.03 | 09.08 | PR: 1LK,1LM |                     |                |        |   |                            |  |                                 |   |  |  |                                 |
| 2.0 TDI         | 125             | 11.05 | 09.08 | PR: 1LK,1LM |                     |                |        |   |                            |  |                                 |   |  |  |                                 |
| 2.0 TDI 4motion | 103             | 08.04 | 09.08 | PR: 1LK,1LM |                     |                |        |   |                            |  |                                 |   |  |  |                                 |
| 3.2 R32         | 184             | 11.05 | 09.08 | PR: 1LK,1LM |                     |                |        |   |                            |  |                                 |   |  |  |                                 |
|                 | 1.4 16V         | 66    | 10.03 | 09.08       |                     | 83.7847-0563.3 | 331124 | 2 |                            | L=562  |                                 |   |  |  |                                 |
|                 | 1.4 FSI         | 90    | 10.03 | 09.08       |                     |                |        |   |                            |  |                                 |   |  |  |                                 |
|                 | 1.4 TSI         | 103   | 05.07 | 09.08       |                     |                |        |   |                            |  |                                 |   |  |  |                                 |
|                 | 1.4 TSI         | 103   | 05.06 | 09.08       |                     |                |        |   |                            |  |                                 |   |  |  |                                 |
|                 | 1.4 TSI         | 125   | 11.05 | 09.08       |                     |                |        |   |                            |  |                                 |   |  |  |                                 |
|                 | 1.6 16V         | 75    | 01.04 | 09.08       |                     |                |        |   |                            |  |                                 |   |  |  |                                 |
|                 | 1.6 FSI         | 85    | 10.03 | 09.08       |                     |                |        |   |                            |  |                                 |   |  |  |                                 |
|                 | 1.9 TDI         | 66    | 05.04 | 09.08       |                     |                |        |   |                            |  |                                 |   |  |  |                                 |
|                 | 1.9 TDI         | 77    | 10.03 | 09.08       |                     |                |        |   |                            |  |                                 |   |  |  |                                 |
|                 | 2.0 FSI         | 110   | 10.03 | 09.08       |                     |                |        |   |                            |  |                                 |   |  |  |                                 |
|                 | 2.0 GTI         | 147   | 09.04 | 09.08       |                     |                |        |   |                            |  |                                 |   |  |  |                                 |
|                 | 2.0 GTI         | 169   | 09.06 | 09.08       |                     |                |        |   |                            |  |                                 |   |  |  |                                 |
|                 | 2.0 SDI         | 55    | 01.04 | 09.08       |                     |                |        |   |                            |  |                                 |   |  |  |                                 |
| 2.0 TDI         | 100             | 10.03 | 09.08 |             |                     |                |        |   |                            |  |                                 |   |  |  |                                 |
| 2.0 TDI         | 103             | 10.03 | 09.08 |             |                     |                |        |   |                            |  |                                 |   |  |  |                                 |
| 2.0 TDI         | 125             | 11.05 | 09.08 |             |                     |                |        |   |                            |  |                                 |   |  |  |                                 |
|                 | 1.9 TDI 4motion | 77    | 08.04 | 09.08       |                     | 83.7847-0563.3 | 331124 | 2 | PR: 1ZE,1ZP<br>PR: 1LK,1LM | L=562<br>L=504   |                                 |   |  |  |                                 |
|                 | 2.0 FSI 4motion | 110   | 08.04 | 09.08       |                     | 83.7849-0502.3 | 331125 |   |                            |  |                                 |   |  |  |                                 |
|                 | 2.0 TDI 4motion | 103   | 08.04 | 09.08       |                     |                |        |   |                            |  |                                 |   |  |  |                                 |
|                 | 3.2 R32         | 184   | 11.05 | 09.08       |                     |                |        |   |                            |  |                                 |   |  |  |                                 |
|                 | 1.4 16V         | 66    | 10.03 | 09.08       | PR: 1KD,1KQ         | 24.3384-1755.7 | 220635 |   |                            | D=38, - Halter<br>D=38, - Halter   | LUC<br>LUC                      |   |  |  |                                 |
|                 | 1.4 FSI         | 90    | 10.03 | 09.08       | PR: 1KD,1KQ         | 24.3384-1756.7 | 220636 |   |                            |  |                                 |   |  |  |                                 |
|                 | 1.4 TSI         | 103   | 05.07 | 09.08       | PR: 1KD,1KQ         |                |        |   |                            |  |                                 |   |  |  |                                 |
|                 | 1.4 TSI         | 103   | 05.06 | 09.08       | PR: 1KD,1KQ         |                |        |   |                            |  |                                 |   |  |  |                                 |
|                 | 1.4 TSI         | 125   | 11.05 | 09.08       | PR: 1KD,1KQ         |                |        |   |                            |  |                                 |   |  |  |                                 |
|                 | 1.6 16V         | 75    | 01.04 | 09.08       | PR: 1KD,1KQ         |                |        |   |                            |  |                                 |   |  |  |                                 |
|                 | 1.6 FSI         | 85    | 10.03 | 09.08       | PR: 1KD,1KQ         |                |        |   |                            |  |                                 |   |  |  |                                 |
|                 | 1.9 TDI         | 66    | 05.04 | 09.08       | PR: 1KD,1KQ         |                |        |   |                            |  |                                 |   |  |  |                                 |
|                 | 1.9 TDI         | 77    | 10.03 | 09.08       | PR: 1KD,1KQ         |                |        |   |                            |  |                                 |   |  |  |                                 |
|                 | 2.0 FSI         | 110   | 10.03 | 09.08       | PR: 1KD,1KQ         |                |        |   |                            |  |                                 |   |  |  |                                 |
|                 | 2.0 GTI         | 147   | 09.04 | 09.08       | PR: 1KD,1KQ         |                |        |   |                            |  |                                 |   |  |  |                                 |
|                 | 2.0 GTI         | 169   | 09.06 | 09.08       | PR: 1KD,1KQ         |                |        |   |                            |  |                                 |   |  |  |                                 |
|                 | 2.0 SDI         | 55    | 01.04 | 09.08       | PR: 1KD,1KQ         |                |        |   |                            |  |                                 |   |  |  |                                 |
| 2.0 TDI         | 100             | 10.03 | 09.08 | PR: 1KD,1KQ |                     |                |        |   |                            |  |                                 |   |  |  |                                 |
| 2.0 TDI         | 103             | 10.03 | 09.08 | PR: 1KD,1KQ |                     |                |        |   |                            |  |                                 |   |  |  |                                 |
| 2.0 TDI         | 125             | 11.05 | 09.08 | PR: 1KD,1KQ |                     |                |        |   |                            |  |                                 |   |  |  |                                 |
|                 | 1.4 16V         | 66    | 10.03 | 09.08       | PR: 1KZ             | 24.3387-1717.7 | 220757 |   |                            | D=38, - Halter<br>D=38, - Halter<br>Einbausatz                                 | LUC<br>LUC<br>LUC               |   |  |  |                                 |
|                 | 1.4 FSI         | 90    | 10.03 | 09.08       | PR: 1KZ             | 24.3387-1718.7 | 220758 |   |                            |  |                                 |   |  |  |                                 |
|                 | 1.4 TSI         | 103   | 05.07 | 09.08       | PR: 1KZ             | 24.0101-3803.2 | 260101 |   |                            |  |                                 |   |  |  |                                 |
|                 | 1.4 TSI         | 103   | 05.06 | 09.08       | PR: 1KZ             |                |        |   |                            |  |                                 |   |  |  |                                 |
|                 | 1.4 TSI         | 125   | 11.05 | 09.08       | PR: 1KZ             |                |        |   |                            |  |                                 |   |  |  |                                 |
|                 | 1.6 16V         | 75    | 01.04 | 09.08       | PR: 1KZ             |                |        |   |                            |  |                                 |   |  |  |                                 |
|                 | 1.6 FSI         | 85    | 10.03 | 09.08       | PR: 1KZ             |                |        |   |                            |  |                                 |   |  |  |                                 |
|                 | 1.9 TDI         | 66    | 05.04 | 09.08       | PR: 1KZ             |                |        |   |                            |  |                                 |   |  |  |                                 |
|                 | 1.9 TDI         | 77    | 10.03 | 09.08       | PR: 1KZ             |                |        |   |                            |  |                                 |   |  |  |                                 |
|                 | 2.0 FSI         | 110   | 10.03 | 09.08       | PR: 1KZ             |                |        |   |                            |  |                                 |   |  |  |                                 |
|                 | 2.0 GTI         | 147   | 09.04 | 09.08       | PR: 1KZ             |                |        |   |                            |  |                                 |   |  |  |                                 |
|                 | 2.0 GTI         | 169   | 09.06 | 09.08       | PR: 1KZ             |                |        |   |                            |  |                                 |   |  |  |                                 |
|                 | 2.0 SDI         | 55    | 01.04 | 09.08       | PR: 1KZ             |                |        |   |                            |  |                                 |   |  |  |                                 |
| 2.0 TDI         | 100             | 10.03 | 09.08 | PR: 1KZ     |                     |                |        |   |                            |  |                                 |   |  |  |                                 |
| 2.0 TDI         | 103             | 10.03 | 09.08 | PR: 1KZ     |                     |                |        |   |                            |  |                                 |   |  |  |                                 |
| 2.0 TDI         | 125             | 11.05 | 09.08 | PR: 1KZ     |                     |                |        |   |                            |  |                                 |   |  |  |                                 |
|                 | 1.4 16V         | 66    | 10.03 | 09.08       | PR: 1KE,1KF,1KV,1KY | 24.3414-1709.7 | 220631 |   |                            | D=41, - Halter<br>D=41, - Halter   | LUC<br>LUC                      |   |  |  |                                 |
|                 | 1.4 FSI         | 90    | 10.03 | 09.08       | PR: 1KE,1KF,1KV,1KY | 24.3414-1710.7 | 220632 |   |                            |  |                                 |   |  |  |                                 |
|                 | 1.4 TSI         | 103   | 05.07 | 09.08       | PR: 1KE,1KF,1KV,1KY |                |        |   |                            |  |                                 |   |  |  |                                 |
|                 | 1.4 TSI         | 103   | 05.06 | 09.08       | PR: 1KE,1KF,1KV,1KY |                |        |   |                            |  |                                 |   |  |  |                                 |





**VOLKSWAGEN GOLF V (03-08)**

|  |   |  |  |  |  |                                  |            |
|--|---|--|--|--|--|----------------------------------|------------|
|    | 1.4 TSI 125<br>1.6 16V 75<br>1.6 FSI 85<br>1.9 TDI 66<br>1.9 TDI 77<br>1.9 TDI 4motion 77<br>2.0 FSI 110<br>2.0 FSI 4motion 110<br>2.0 GTI 147<br>2.0 GTI 169<br>2.0 SDI 55<br>2.0 TDI 100<br>2.0 TDI 103<br>2.0 TDI 125<br>2.0 TDI 4motion 103<br>3.2 R32 184  |  | 11.05 09.08 PR: 1KE,1KF,1KV,1KY<br>01.04 09.08 PR: 1KE,1KF,1KV,1KY<br>10.03 09.08 PR: 1KE,1KF,1KV,1KY<br>05.04 09.08 PR: 1KE,1KF,1KV,1KY<br>10.03 09.08 PR: 1KE,1KF,1KV,1KY<br>08.04 09.08 PR: 1KE,1KF,1KV,1KY<br>10.03 09.08 PR: 1KE,1KF,1KV,1KY<br>08.04 09.08 PR: 1KE,1KF,1KV,1KY<br>09.04 09.08 PR: 1KE,1KF,1KV,1KY<br>09.06 09.08 PR: 1KE,1KF,1KV,1KY<br>01.04 09.08 PR: 1KE,1KF,1KV,1KY<br>10.03 09.08 PR: 1KE,1KF,1KV,1KY<br>10.03 09.08 PR: 1KE,1KF,1KV,1KY<br>11.05 09.08 PR: 1KE,1KF,1KV,1KY<br>08.04 09.08 PR: 1KE,1KF,1KV,1KY<br>11.05 09.08 PR: 1KE,1KF,1KV,1KY | 24.3414-1709.7 220631<br>24.3414-1710.7 220632 | <br> | D=41, - Halter<br>D=41, - Halter | LUC<br>LUC |
|    | 1.4 16V 75<br>1.4 FSI 66<br>1.4 TSI 90<br>1.4 TSI 103<br>1.4 TSI 125<br>1.6 16V 75<br>1.6 FSI 85<br>1.9 TDI 66<br>1.9 TDI 77<br>1.9 TDI 4motion 77<br>2.0 FSI 110<br>2.0 FSI 4motion 110<br>2.0 GTI 147<br>2.0 GTI 169<br>2.0 SDI 55<br>2.0 TDI 100<br>2.0 TDI 103<br>2.0 TDI 125<br>2.0 TDI 4motion 103<br>3.2 R32 184 |  | 10.03 09.08<br>10.03 09.08<br>05.07 09.08<br>05.06 09.08<br>11.05 09.08<br>01.04 09.08<br>10.03 09.08<br>05.04 09.08<br>10.03 09.08<br>08.04 09.08<br>10.03 09.08<br>08.04 09.08<br>09.04 09.08<br>09.06 09.08<br>01.04 09.08<br>10.03 09.08<br>10.03 09.08<br>11.05 09.08<br>08.04 09.08<br>11.05 09.08   | 83.7849-0231.3 330872                          | 2  | L=233                            |            |
|    | 1.4 16V 75<br>1.4 FSI 66<br>1.4 TSI 103<br>1.4 TSI 125<br>1.6 16V 75<br>1.6 FSI 85<br>1.9 TDI 66<br>1.9 TDI 77<br>1.9 TDI 4motion 77<br>2.0 FSI 110<br>2.0 FSI 4motion 110<br>2.0 GTI 147<br>2.0 GTI 169<br>2.0 SDI 55<br>2.0 TDI 100<br>2.0 TDI 103<br>2.0 TDI 125<br>2.0 TDI 4motion 103<br>3.2 R32 184               |  | 10.03 09.08<br>10.03 09.08<br>05.06 09.08<br>11.05 09.08<br>01.04 09.08<br>10.03 09.08<br>05.04 09.08<br>10.03 09.08<br>08.04 09.08<br>10.03 09.08<br>08.04 09.08<br>09.04 09.08<br>09.06 09.08<br>01.04 09.08<br>10.03 09.08<br>10.03 09.08<br>11.05 09.08<br>08.04 09.08<br>11.05 09.08  | 24.3727-2708.2 582708                          | 2   | L=1447                           |            |
|  | 1.4 16V 75<br>1.4 FSI 66<br>1.4 TSI 90<br>1.4 TSI 103<br>1.4 TSI 125<br>1.6 16V 75<br>1.6 FSI 85<br>1.9 TDI 66<br>1.9 TDI 77<br>1.9 TDI 4motion 77<br>2.0 FSI 110<br>2.0 FSI 4motion 110<br>2.0 GTI 147<br>2.0 GTI 169<br>2.0 SDI 55<br>2.0 TDI 100<br>2.0 TDI 103<br>2.0 TDI 125<br>2.0 TDI 4motion 103<br>3.2 R32 184 |  | 10.03 09.08<br>10.03 09.08<br>05.07 09.08<br>05.06 09.08<br>11.05 09.08<br>01.04 09.08<br>10.03 09.08<br>05.04 09.08<br>10.03 09.08<br>08.04 09.08<br>10.03 09.08<br>08.04 09.08<br>09.04 09.08<br>09.06 09.08<br>01.04 09.08<br>10.03 09.08<br>10.03 09.08<br>11.05 09.08<br>08.04 09.08<br>11.05 09.08   | 24.2415-1711.3 030130                          |  | Gz 15,87                         |            |
|  | 1.4 TSI 103<br>1.4 TSI 125<br>1.9 TDI 77<br>1.9 TDI 4motion 77<br>2.0 FSI 110<br>2.0 FSI 4motion 110<br>2.0 TDI 4motion 103<br>3.2 R32 184  |  | 05.06 09.08<br>11.05 09.08<br>10.03 09.08<br>08.04 09.08<br>10.03 09.08<br>08.04 09.08<br>08.04 09.08<br>11.05 09.08   | 24.2519-1705.3 040095                          |  | Nz 19,05                         |            |



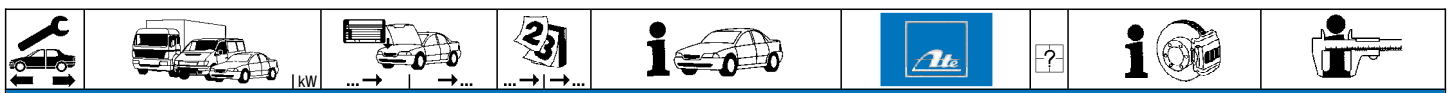

**VOLKSWAGEN GOLF V Variant (07-09)**

|                 |                 |         |       |             |                 |                 |                |        |   |                |                |                |                |        |   |           |                |     |
|-----------------|-----------------|---------|-------|-------------|-----------------|-----------------|----------------|--------|---|----------------|----------------|----------------|----------------|--------|---|-----------|----------------|-----|
|                 | 1.4             | 59      | 06.07 | 06.09       | PR: 1AC,1AT     | 03.7863-9502.4  | 300204         |        | Kolbendurchmesser Ø 22,20mm <sup>1)</sup> | 10"            | ATE            |                |                |        |   |           |                |     |
|                 | 1.4 TSI         | 90      | 06.07 | 06.09       | PR: 1AC,1AT     |                 |                |        |   |                |                |                |                |        |   |           |                |     |
|                 | 1.4 TSI         | 103     | 05.07 | 06.09       | PR: 1AC,1AT     |                 |                |        |   |                |                |                |                |        |   |           |                |     |
|                 | 1.6             | 75      | 05.07 | 06.09       | PR: 1AC,1AT     |                 |                |        |   |                |                |                |                |        |   |           |                |     |
|                 | 1.9 TDI         | 77      | 05.07 | 06.09       | PR: 1AC,1AT     |                 |                |        |   |                |                |                |                |        |   |           |                |     |
|                 | 1.9 TDI 4motion | 77      | 12.07 | 06.09       | PR: 1AC,1AT     |                 |                |        |   |                |                |                |                |        |   |           |                |     |
|                 | 2.0 TDI         | 77      | 05.07 | 06.09       | PR: 1AC,1AT     |                 |                |        |   |                |                |                |                |        |   |           |                |     |
|                 | 1.4 TSI         | 90      | 06.07 | 06.09       | PR: 1AS         | 03.7863-9602.4  | 300206         |        | Kolbendurchmesser Ø 22,20mm <sup>1)</sup> | 10"            | ATE            |                |                |        |   |           |                |     |
|                 | 1.4 TSI         | 118     | 07.08 | 06.09       | PR: 1AS         |                 |                |        |   |                |                |                |                |        |   |           |                |     |
|                 | 1.6             | 75      | 05.07 | 06.09       | PR: 1AS         |                 |                |        |   |                |                |                |                |        |   |           |                |     |
|                 | 2.0 TDI         | 77      | 05.07 | 06.09       | PR: 1AS         |                 |                |        |   |                |                |                |                |        |   |           |                |     |
|                 | 1.4 TSI         | 118     | 07.08 | 06.09       | PR: 1AC,1AT     | 03.7863-9702.4  | 300207         |        | Kolbendurchmesser Ø 23,81mm <sup>2)</sup> | 10"            | ATE            |                |                |        |   |           |                |     |
|                 | 1.4 TSI         | 125     | 05.07 | 06.09       | PR: 1AC,1AT     |                 |                |        |   |                |                |                |                |        |   |           |                |     |
|                 | 2.0             | 147     | 06.07 | 06.09       | PR: 1AC,1AT     |                 |                |        |   |                |                |                |                |        |   |           |                |     |
|                 | 1.4 TSI         | 125     | 05.07 | 06.09       | PR: 1AS         |                 |                |        |   |                |                |                |                |        |   |           |                |     |
|                 | 1.4             | 59      | 06.07 | 06.09       | PR: 1AC,1AT     | 03.2122-2129.3  | 010799         |        |   | Thz 22,20      | ATE            |                |                |        |   |           |                |     |
|                 | 1.4 TSI         | 90      | 06.07 | 06.09       | PR: 1AS         |                 |                |        |   |                |                |                |                |        |   |           |                |     |
|                 | 1.4 TSI         | 103     | 05.07 | 06.09       | PR: 1AS         |                 |                |        |   |                |                |                |                |        |   |           |                |     |
|                 | 1.4 TSI         | 118     | 07.08 | 06.09       | PR: 1AC,1AT     |                 |                |        |   |                |                |                |                |        |   |           |                |     |
|                 | 1.4 TSI         | 125     | 05.07 | 06.09       | PR: 1AS         |                 |                |        |   |                |                |                |                |        |   |           |                |     |
|                 | 1.6             | 75      | 05.07 | 06.09       | PR: 1AS         |                 |                |        |   |                |                |                |                |        |   |           |                |     |
|                 | 1.9 TDI         | 77      | 05.07 | 06.09       | PR: 1AC,1AT     |                 |                |        |   |                |                |                |                |        |   |           |                |     |
|                 | 1.9 TDI 4motion | 77      | 12.07 | 06.09       | PR: 1AC,1AT     |                 |                |        |   |                |                |                |                |        |   |           |                |     |
|                 | 2.0             | 147     | 06.07 | 06.09       | PR: 1AC,1AT     |                 |                |        |   |                |                |                |                |        |   |           |                |     |
|                 | 2.0 TDI         | 147     | 05.07 | 06.09       | PR: 1AC,1AT     |                 |                |        |   |                |                |                |                |        |   |           |                |     |
|                 | 1.4 TSI         | 118     | 07.08 | 06.09       | PR: 1LJ,1LL     |                 |                |        |   |                |                | 03.2123-3449.3 | 010808         |        |   | Thz 23,81 | ATE            |     |
|                 | 1.4 TSI         | 125     | 05.07 | 06.09       | PR: 1LJ,1LL     |                 |                |        |   |                |                |                |                |        |   |           |                |     |
| 2.0             | 147             | 06.07   | 06.09 | PR: 1LJ,1LL |                 |                 |                |        |   |                |                |                |                |        |   |           |                |     |
|                 | 1.4             | 59      | 06.07 | 06.09       | PR: 12M         | 11.9541-9549.2  | 220575         |        |   | D=54, - Halter | ATE            |                |                |        |   |           |                |     |
|                 | 1.4 TSI         | 90      | 06.07 | 06.09       | PR: 12M         |                 |                |        |   |                |                |                |                |        |   |           |                |     |
|                 | 1.4 TSI         | 103     | 05.07 | 06.09       | PR: 12M         |                 |                |        |   |                |                |                |                |        |   |           |                |     |
|                 | 1.4 TSI         | 118     | 07.08 | 06.09       | PR: 12M         |                 |                |        |   |                |                |                |                |        |   |           |                |     |
|                 | 1.4 TSI         | 125     | 05.07 | 06.09       | PR: 12M         |                 |                |        |   |                |                |                |                |        |   |           |                |     |
|                 | 1.6             | 75      | 05.07 | 06.09       | PR: 12M         |                 |                |        |   |                |                |                |                |        |   |           |                |     |
|                 | 1.9 TDI         | 77      | 05.07 | 06.09       | PR: 12M         |                 |                |        |   |                |                |                |                |        |   |           |                |     |
|                 | 1.9 TDI 4motion | 77      | 12.07 | 06.09       | PR: 12M         |                 |                |        |   |                |                |                |                |        |   |           |                |     |
|                 | 2.0             | 147     | 06.07 | 06.09       | PR: 12M         |                 |                |        |   |                |                |                |                |        |   |           |                |     |
|                 | 2.0 TDI         | 147     | 05.07 | 06.09       | PR: 12M         |                 |                |        |   |                |                |                |                |        |   |           |                |     |
|                 |                 | 1.4     | 59    | 06.07       | 06.09           |                 |                |        |   |                |                | PR: 12E,1ZP    | 11.9541-9553.2 | 220563 |   |           | D=54, - Halter | ATE |
|                 |                 | 1.4 TSI | 90    | 06.07       | 06.09           |                 |                |        |   |                |                | PR: 12E,1ZP    |                |        |   |           |                |     |
| 1.4 TSI         |                 | 103     | 05.07 | 06.09       | PR: 12E,1ZP     |                 |                |        |   |                |                |                |                |        |   |           |                |     |
| 1.4 TSI         |                 | 118     | 07.08 | 06.09       | PR: 12E,1ZP     |                 |                |        |   |                |                |                |                |        |   |           |                |     |
| 1.4 TSI         |                 | 125     | 05.07 | 06.09       | PR: 12E,1ZP     |                 |                |        |   |                |                |                |                |        |   |           |                |     |
| 1.6             |                 | 75      | 05.07 | 06.09       | PR: 12E,1ZP     |                 |                |        |   |                |                |                |                |        |   |           |                |     |
| 1.9 TDI         |                 | 77      | 05.07 | 06.09       | PR: 12E,1ZP     |                 |                |        |   |                |                |                |                |        |   |           |                |     |
| 1.9 TDI 4motion |                 | 77      | 12.07 | 06.09       | PR: 12E,1ZP     |                 |                |        |   |                |                |                |                |        |   |           |                |     |
| 2.0             |                 | 147     | 06.07 | 06.09       | PR: 12E,1ZP     |                 |                |        |   |                |                |                |                |        |   |           |                |     |
| 2.0 TDI         |                 | 147     | 05.07 | 06.09       | PR: 12E,1ZP     |                 |                |        |   |                |                |                |                |        |   |           |                |     |
|                 |                 | 1.4     | 59    | 06.07       | 06.09           | PR: 1LJ,1ZD     | 11.9541-9553.2 | 220563 |   |                | D=54, - Halter | ATE            |                |        |   |           |                |     |
|                 |                 | 1.4 TSI | 90    | 06.07       | 06.09           | PR: 1LJ,1ZD     |                |        |   |                |                |                |                |        |   |           |                |     |
|                 | 1.4 TSI         | 103     | 05.07 | 06.09       | PR: 1LJ,1ZD     |                 |                |        |   |                |                |                |                |        |   |           |                |     |
|                 | 1.4 TSI         | 118     | 07.08 | 06.09       | PR: 1LJ,1ZD     |                 |                |        |   |                |                |                |                |        |   |           |                |     |
|                 | 1.4 TSI         | 125     | 05.07 | 06.09       | PR: 1LJ,1ZD     |                 |                |        |   |                |                |                |                |        |   |           |                |     |
|                 | 1.6             | 75      | 05.07 | 06.09       | PR: 1LJ,1ZD     |                 |                |        |   |                |                |                |                |        |   |           |                |     |
|                 | 1.9 TDI         | 77      | 05.07 | 06.09       | PR: 1LJ,1ZD     |                 |                |        |   |                |                |                |                |        |   |           |                |     |
|                 | 1.9 TDI 4motion | 77      | 12.07 | 06.09       | PR: 1LJ,1ZD     |                 |                |        |   |                |                |                |                |        |   |           |                |     |
|                 | 2.0             | 147     | 06.07 | 06.09       | PR: 1LJ,1ZD     |                 |                |        |   |                |                |                |                |        |   |           |                |     |
|                 | 2.0 TDI         | 147     | 05.07 | 06.09       | PR: 1LJ,1ZD     |                 |                |        |   |                |                |                |                |        |   |           |                |     |
|                 |                 | 1.4     | 59    | 06.07       | 06.09           |                 |                |        |   |                |                |                | 83.7847-0563.3 | 331124 | 2 |           | L=562          |     |
|                 |                 | 1.4 TSI | 90    | 06.07       | 06.09           |                 |                |        |   |                |                |                |                |        |   |           |                |     |
| 1.4 TSI         |                 | 103     | 05.07 | 06.09       |                 |                 |                |        |   |                |                |                |                |        |   |           |                |     |
| 1.4 TSI         |                 | 118     | 07.08 | 06.09       |                 |                 |                |        |   |                |                |                |                |        |   |           |                |     |
| 1.4 TSI         |                 | 125     | 05.07 | 06.09       |                 |                 |                |        |   |                |                |                |                |        |   |           |                |     |
| 1.6             |                 | 75      | 05.07 | 06.09       |                 |                 |                |        |   |                |                |                |                |        |   |           |                |     |
| 1.9 TDI         |                 | 77      | 05.07 | 06.09       |                 |                 |                |        |   |                |                |                |                |        |   |           |                |     |
| 1.9 TDI 4motion |                 | 77      | 12.07 | 06.09       |                 |                 |                |        |   |                |                |                |                |        |   |           |                |     |
| 2.0             |                 | 147     | 06.07 | 06.09       |                 |                 |                |        |   |                |                |                |                |        |   |           |                |     |
| 2.0 TDI         |                 | 147     | 05.07 | 06.09       |                 |                 |                |        |   |                |                |                |                |        |   |           |                |     |
|                 |                 | 1.4     | 59    | 06.07       | 06.09           | PR: 1KE,1KF,1KJ | 24.3414-1709.7 | 220631 |   |                | D=41, - Halter | LUC            |                |        |   |           |                |     |
|                 |                 | 1.4 TSI | 90    | 06.07       | 06.09           | PR: 1KE,1KF,1KJ |                |        |   |                |                |                |                |        |   |           |                |     |
|                 | 1.4 TSI         | 103     | 05.07 | 06.09       | PR: 1KE,1KF,1KJ |                 |                |        |   |                |                |                |                |        |   |           |                |     |
|                 | 1.4 TSI         | 118     | 07.08 | 06.09       | PR: 1KE,1KF,1KJ |                 |                |        |   |                |                |                |                |        |   |           |                |     |
|                 | 1.4 TSI         | 125     | 05.07 | 06.09       | PR: 1KE,1KF,1KJ |                 |                |        |   |                |                |                |                |        |   |           |                |     |
|                 | 1.6             | 75      | 05.07 | 06.09       | PR: 1KE,1KF,1KJ |                 |                |        |   |                |                |                |                |        |   |           |                |     |
|                 | 1.9 TDI         | 77      | 05.07 | 06.09       | PR: 1KE,1KF,1KJ |                 |                |        |   |                |                |                |                |        |   |           |                |     |
|                 | 1.9 TDI 4motion | 77      | 12.07 | 06.09       | PR: 1KE,1KF,1KJ |                 |                |        |   |                |                |                |                |        |   |           |                |     |
|                 | 2.0             | 147     | 06.07 | 06.09       | PR: 1KE,1KF,1KJ |                 |                |        |   |                |                |                |                |        |   |           |                |     |
|                 | 2.0 TDI         | 147     | 05.07 | 06.09       | PR: 1KE,1KF,1KJ |                 |                |        |   |                |                |                |                |        |   |           |                |     |
|                 |                 | 1.4     | 59    | 06.07       | 06.09           |                 |                |        |   |                |                |                | 83.7849-0231.3 | 330872 | 2 |           | L=233          |     |
|                 |                 | 1.4 TSI | 90    | 06.07       | 06.09           |                 |                |        |   |                |                |                |                |        |   |           |                |     |
| 1.4 TSI         |                 | 103     | 05.07 | 06.09       |                 |                 |                |        |   |                |                |                |                |        |   |           |                |     |
| 1.4 TSI         |                 | 118     | 07.08 | 06.09       |                 |                 |                |        |   |                |                |                |                |        |   |           |                |     |
| 1.4 TSI         |                 | 125     | 05.07 | 06.09       |                 |                 |                |        |   |                |                |                |                |        |   |           |                |     |
| 1.6             |                 | 75      | 05.07 | 06.09       |                 |                 |                |        |   |                |                |                |                |        |   |           |                |     |
| 1.9 TDI         |                 | 77      | 05.07 | 06.09       |                 |                 |                |        |   |                |                |                |                |        |   |           |                |     |
| 1.9 TDI 4motion | 77              | 12.07   | 06.09 |             |                 |                 |                |        |   |                |                |                |                |        |   |           |                |     |

<sup>1)</sup> piston diameter Ø 22,20mm / diametro del pistone Ø 22,20mm / diamètre de piston Ø 22,20mm / diametro del pistón Ø 22,20mm

<sup>2)</sup> piston diameter Ø 23,81mm / diametro del pistone Ø 23,81mm / diamètre de piston Ø 23,81mm / diametro del pistón Ø 23,81mm



### VOLKSWAGEN GOLF V Variant (07-09)

|  |  |  |  |  |  |  |                                  |                  |        |  |                  |
|--|--|--|--|--|--|--|----------------------------------|------------------|--------|--|------------------|
|  | 2.0<br>2.0 TDI   | 147  |  | 06.07<br>05.07   | 06.09<br>06.09   |  | 83.7849-0231.3                   | 330872           | 2      |  | L=233            |
|  | 1.4<br>1.4 TSI<br>1.4 TSI<br>1.4 TSI<br>1.4 TSI<br>1.6<br>2.0<br>2.0 TDI                               | 59<br>90<br>103<br>118<br>125<br>75<br>147             |  | 06.07<br>06.07<br>05.07<br>07.08<br>05.07<br>05.07<br>06.07<br>05.07                   | 06.09<br>06.09<br>06.09<br>06.09<br>06.09<br>06.09<br>06.09<br>06.09                   |  | 24.3727-2708.2<br>24.3727-0195.2 | 582708<br>580195 | 2<br>2 |  | L=1447<br>L=1447 |
|  | 1.9 TDI<br>1.9 TDI 4motion   | 77<br>77   |  | 05.07<br>12.07   | 06.09<br>06.09   |  | 24.3727-0195.2                   | 580195           | 2      |  | L=1447           |
|  | 1.4<br>1.4 TSI<br>1.4 TSI<br>1.4 TSI<br>1.4 TSI<br>1.6<br>1.9 TDI<br>1.9 TDI 4motion<br>2.0<br>2.0 TDI | 59<br>90<br>103<br>118<br>125<br>75<br>77<br>77<br>147 |  | 06.07<br>06.07<br>05.07<br>07.08<br>05.07<br>05.07<br>05.07<br>12.07<br>06.07<br>05.07 | 06.09<br>06.09<br>06.09<br>06.09<br>06.09<br>06.09<br>06.09<br>06.09<br>06.09<br>06.09 |  | 24.2415-1711.3                   | 030130           |        |  | Gz 15,87         |

### VOLKSWAGEN GOLF VI (08-)





















|  |  |  |  |  |  |                |        |  |  |   |     |     |
|--|--|--|--|--|--|----------------|--------|--|--|---|-----|-----|
|  | 1.2 TSI<br>1.4<br>1.4 TSI<br>1.4 TSI<br>1.6<br>1.6 Bi-Fuel<br>1.6 TDI<br>1.6 TDI<br>1.8 TSI<br>2.0 GTi<br>2.0 R 4motion<br>2.0 TDI<br>2.0 TDI<br>2.0 TDI<br>2.0 TDI<br>2.0 TDI 4motion | 1<br>59<br>90<br>118<br>75<br>75<br>66<br>77<br>118<br>1<br>81<br>100<br>103<br>125<br>103 | 1K-9-200 000<br>1K-9-200 000<br>1K-9-200 000<br>1K-9-200 000<br>1K-9-200 000<br>1K-9-200 000<br>1K-9-200 000<br>1K-9-200 000<br>1K-9-200 000<br>1K-9-200 000<br>1K-9-200 000<br>1K-9-200 000<br>1K-9-200 000<br>1K-9-200 000<br>1K-9-200 000<br>1K-9-200 000 | 05.09<br>10.08<br>10.08<br>10.08<br>10.08<br>03.09<br>02.09<br>02.09<br>06.09<br>04.09<br>11.09<br>10.08<br>10.08<br>10.08<br>04.09<br>10.08 | PR: 1LJ,1LL,1LM<br>PR: 1LJ,1LL,1LM<br>PR: 1LJ,1LL,1LM<br>PR: 1LJ,1LL,1LM<br>PR: 1LJ,1LL,1LM<br>PR: 1LJ,1LL,1LM<br>PR: 1LJ,1LL,1LM<br>PR: 1LJ,1LL,1LM<br>PR: 1LJ,1LL,1LM<br>PR: 1LJ,1LL,1LM<br>PR: 1LJ,1LL,1LM<br>PR: 1LJ,1LL,1LM<br>PR: 1LJ,1LL,1LM<br>PR: 1LJ,1LL,1LM<br>PR: 1LJ,1LL,1LM  | 03.7863-9702.4 | 300207 |  |  | Kolbendurchmesser Ø 23,81mm <sup>1)</sup> | 10" | ATE |
|  | 1.2 TSI<br>1.4<br>1.4 TSI<br>1.4 TSI<br>1.6<br>1.6 Bi-Fuel<br>1.6 TDI<br>1.6 TDI<br>1.8 TSI<br>2.0 GTi<br>2.0 R 4motion<br>2.0 TDI<br>2.0 TDI<br>2.0 TDI<br>2.0 TDI<br>2.0 TDI 4motion | 1<br>59<br>90<br>118<br>75<br>75<br>66<br>77<br>118<br>1<br>81<br>100<br>103<br>125<br>103 | 1K-9-400 001<br>1K-9-400 001<br>1K-9-400 001<br>1K-9-400 001<br>1K-9-400 001<br>1K-9-400 001<br>1K-9-400 001<br>1K-9-400 001<br>1K-9-400 001<br>1K-9-400 001<br>1K-9-400 001<br>1K-9-400 001<br>1K-9-400 001<br>1K-9-400 001<br>1K-9-400 001<br>1K-9-400 001 | 11.10<br>11.10<br>11.10<br>11.10<br>11.10<br>11.10<br>11.10<br>11.10<br>11.10<br>11.10<br>11.10<br>11.10<br>11.10<br>11.10<br>11.10<br>11.10 | PR: 1ZA,1ZB,1ZE,1LJ<br>PR: 1ZA,1ZB,1ZE,1LJ<br>PR: 1ZA,1ZB,1ZE,1LJ<br>PR: 1ZA,1ZB,1ZE,1LJ<br>PR: 1ZA,1ZB,1ZE,1LJ<br>PR: 1ZA,1ZB,1ZE,1LJ<br>PR: 1ZA,1ZB,1ZE,1LJ<br>PR: 1ZA,1ZB,1ZE,1LJ<br>PR: 1ZA,1ZB,1ZE,1LJ<br>PR: 1ZA,1ZB,1ZE,1LJ<br>PR: 1ZA,1ZB,1ZE,1LJ<br>PR: 1ZA,1ZB,1ZE,1LJ<br>PR: 1ZA,1ZB,1ZE,1LJ<br>PR: 1ZA,1ZB,1ZE,1LJ<br>PR: 1ZA,1ZB,1ZE,1LJ<br>PR: 1ZA,1ZB,1ZE,1LJ | 03.7863-9702.4 | 300207 |  |  | Kolbendurchmesser Ø 23,81mm <sup>1)</sup> | 10" | ATE |
|  | 1.2 TSI<br>1.4<br>1.4 TSI<br>1.4 TSI<br>1.6<br>1.6 Bi-Fuel<br>1.6 TDI<br>1.6 TDI<br>1.8 TSI<br>2.0 GTi<br>2.0 R 4motion<br>2.0 TDI<br>2.0 TDI<br>2.0 TDI<br>2.0 TDI<br>2.0 TDI 4motion | 1<br>59<br>90<br>118<br>75<br>75<br>66<br>77<br>118<br>1<br>81<br>100<br>103<br>125<br>103 | 1K-9-400 001<br>1K-9-400 001<br>1K-9-400 001<br>1K-9-400 001<br>1K-9-400 001<br>1K-9-400 001<br>1K-9-400 001<br>1K-9-400 001<br>1K-9-400 001<br>1K-9-400 001<br>1K-9-400 001<br>1K-9-400 001<br>1K-9-400 001<br>1K-9-400 001<br>1K-9-400 001<br>1K-9-400 001 | 11.10<br>11.10<br>11.10<br>11.10<br>11.10<br>11.10<br>11.10<br>11.10<br>11.10<br>11.10<br>11.10<br>11.10<br>11.10<br>11.10<br>11.10          | PR: 1ZK<br>PR: 1ZK<br>PR: 1ZK<br>PR: 1ZK<br>PR: 1ZK<br>PR: 1ZK<br>PR: 1ZK<br>PR: 1ZK<br>PR: 1ZK<br>PR: 1ZK<br>PR: 1ZK<br>PR: 1ZK<br>PR: 1ZK<br>PR: 1ZK<br>PR: 1ZK  | 03.7860-3902.4 | 300278 |  |  | Kolbendurchmesser Ø 23,81mm <sup>1)</sup> | 10" | ATE |
|  | 1.2 TSI<br>1.4<br>1.4 TSI<br>1.4 TSI<br>1.6<br>1.6 Bi-Fuel<br>1.6 TDI<br>1.6 TDI<br>1.8 TSI<br>2.0 GTi<br>2.0 R 4motion<br>2.0 TDI<br>2.0 TDI<br>2.0 TDI<br>2.0 TDI<br>2.0 TDI 4motion | 1<br>59<br>90<br>118<br>75<br>75<br>66<br>77<br>118<br>1<br>81<br>100<br>103<br>125<br>103 | 1K-9-400 001<br>1K-9-400 001<br>1K-9-400 001<br>1K-9-400 001<br>1K-9-400 001<br>1K-9-400 001<br>1K-9-400 001<br>1K-9-400 001<br>1K-9-400 001<br>1K-9-400 001<br>1K-9-400 001<br>1K-9-400 001<br>1K-9-400 001<br>1K-9-400 001<br>1K-9-400 001<br>1K-9-400 001 | 05.09<br>10.08<br>10.08<br>10.08<br>10.08<br>03.09<br>02.09<br>02.09<br>06.09<br>04.09<br>11.09<br>10.08<br>10.08<br>10.08<br>10.08          | PR: 1ZD,1ZF,1ZP,1LV<br>PR: 1ZD,1ZF,1ZP,1LV<br>PR: 1ZD,1ZF,1ZP,1LV<br>PR: 1ZD,1ZF,1ZP,1LV<br>PR: 1ZD,1ZF,1ZP,1LV<br>PR: 1ZD,1ZF,1ZP,1LV<br>PR: 1ZD,1ZF,1ZP,1LV<br>PR: 1ZD,1ZF,1ZP,1LV<br>PR: 1ZD,1ZF,1ZP,1LV<br>PR: 1ZD,1ZF,1ZP,1LV<br>PR: 1ZD,1ZF,1ZP,1LV<br>PR: 1ZD,1ZF,1ZP,1LV<br>PR: 1ZD,1ZF,1ZP,1LV<br>PR: 1ZD,1ZF,1ZP,1LV<br>PR: 1ZD,1ZF,1ZP,1LV                        | 03.7863-9502.4 | 300204 |  |  | Kolbendurchmesser Ø 22,20mm <sup>2)</sup> | 10" | ATE |

<sup>1)</sup> piston diameter Ø 23,81mm / diametro del pistone Ø 23,81mm / diamètre de piston Ø 23,81mm / diámetro del pistón Ø 23,81mm

<sup>2)</sup> piston diameter Ø 22,20mm / diametro del pistone Ø 22,20mm / diamètre de piston Ø 22,20mm / diámetro del pistón Ø 22,20mm





































|     |    kW   |  |    |   |       |  |    |                  |
|--|---|--|--|---|--|--|--|--|
| VOLKSWAGEN GOLF VI (08-)   |   |  |  |   |  |  |  |  |
|    | 2.0 TDI #125<br>2.0 TDI 4motion #103  |  | 04.09<br>10.08   | PR: 1ZD,1ZF,1ZP,1LV<br>PR: 1ZD,1ZF,1ZP,1LV  | 03.7863-9502.4   | 300204   |  | Kolbendurchmesser Ø 22,20mm <sup>1)</sup> 10" ATE  |
|    | 1.2 TSI #<br>1.4 # 59<br>1.4 TSI # 90<br>1.4 TSI #118<br>1.6 # 75<br>1.6 Bi-Fuel # 75<br>1.6 TDI # 66<br>1.6 TDI # 77<br>1.8 TSI #118<br>2.0 GTi #<br>2.0 R 4motion #<br>2.0 TDI # 81<br>2.0 TDI #100<br>2.0 TDI #103<br>2.0 TDI #125<br>2.0 TDI 4motion #103 |  | 05.09<br>10.08<br>10.08<br>10.08<br>10.08<br>03.09<br>02.09<br>02.09<br>06.09<br>04.09<br>11.09<br>10.08<br>10.08<br>10.08<br>04.09<br>10.08 | PR: 1ZD,1ZF,1ZP,1LV<br>PR: 1ZD,1ZF,1ZP,1LV<br>PR: 1ZD,1ZF,1ZP,1LV<br>PR: 1ZD,1ZF,1ZP,1LV<br>PR: 1ZD,1ZF,1ZP,1LV<br>PR: 1ZD,1ZF,1ZP,1LV<br>PR: 1ZD,1ZF,1ZP,1LV<br>PR: 1ZD,1ZF,1ZP,1LV<br>PR: 1ZD,1ZF,1ZP,1LV<br>PR: 1ZD,1ZF,1ZP,1LV<br>PR: 1ZD,1ZF,1ZP,1LV<br>PR: 1ZD,1ZF,1ZP,1LV<br>PR: 1ZD,1ZF,1ZP,1LV<br>PR: 1ZD,1ZF,1ZP,1LV<br>PR: 1ZD,1ZF,1ZP,1LV<br>PR: 1ZD,1ZF,1ZP,1LV  | 03.2122-2129.3   | 010799   |  | Thz 22,20 ATE  |
|    | 1.2 TSI #<br>1.4 # 59<br>1.4 TSI # 90<br>1.4 TSI #118<br>1.6 # 75<br>1.6 Bi-Fuel # 75<br>1.6 TDI # 66<br>1.6 TDI # 77<br>1.8 TSI #118<br>2.0 GTi #<br>2.0 R 4motion #<br>2.0 TDI # 81<br>2.0 TDI #100<br>2.0 TDI #103<br>2.0 TDI #125<br>2.0 TDI 4motion #103 |  | 05.09<br>10.08<br>10.08<br>10.08<br>10.08<br>03.09<br>02.09<br>02.09<br>06.09<br>04.09<br>11.09<br>10.08<br>10.08<br>10.08<br>04.09<br>10.08 | PR: 1ZA,1ZB,1ZE,1LJ<br>PR: 1ZA,1ZB,1ZE,1LJ<br>PR: 1ZA,1ZB,1ZE,1LJ<br>PR: 1ZA,1ZB,1ZE,1LJ<br>PR: 1ZA,1ZB,1ZE,1LJ<br>PR: 1ZA,1ZB,1ZE,1LJ<br>PR: 1ZA,1ZB,1ZE,1LJ<br>PR: 1ZA,1ZB,1ZE,1LJ<br>PR: 1ZA,1ZB,1ZE,1LJ<br>PR: 1ZA,1ZB,1ZE,1LJ<br>PR: 1ZA,1ZB,1ZE,1LJ<br>PR: 1ZA,1ZB,1ZE,1LJ<br>PR: 1ZA,1ZB,1ZE,1LJ<br>PR: 1ZA,1ZB,1ZE,1LJ<br>PR: 1ZA,1ZB,1ZE,1LJ<br>PR: 1ZA,1ZB,1ZE,1LJ  | 03.2123-3449.3   | 010808   |  | Thz 23,81 ATE  |
|    | 1.2 TSI<br>1.4 59<br>1.4 TSI 90<br>1.4 TSI 118<br>1.6 75<br>1.6 Bi-Fuel 75<br>1.6 TDI 66<br>1.6 TDI 77<br>1.8 TSI 118<br>2.0 GTi<br>2.0 R 4motion<br>2.0 TDI 81<br>2.0 TDI 100<br>2.0 TDI 103<br>2.0 TDI 125<br>2.0 TDI 4motion 103                           |  | 05.09<br>10.08<br>10.08<br>10.08<br>10.08<br>03.09<br>02.09<br>02.09<br>06.09<br>04.09<br>11.09<br>10.08<br>10.08<br>10.08<br>04.09<br>10.08 | PR: 1ZF<br>PR: 1ZF<br>PR: 1ZF<br>PR: 1ZF<br>PR: 1ZF<br>PR: 1ZF<br>PR: 1ZF<br>PR: 1ZF<br>PR: 1ZF<br>PR: 1ZF<br>PR: 1ZF<br>PR: 1ZF<br>PR: 1ZF<br>PR: 1ZF<br>PR: 1ZF   | 11.9541-9549.2<br>11.9541-9550.2<br>11.0101-5409.2                                     | 220575<br>220576<br>260035   | <br>     | D=54, - Halter ATE<br>D=54, - Halter ATE<br>Hülzensatz ATE   |
|  | 1.2 TSI<br>1.4 59<br>1.4 TSI 90<br>1.4 TSI 118<br>1.6 75<br>1.6 Bi-Fuel 75<br>1.6 TDI 66<br>1.6 TDI 77<br>1.8 TSI 118<br>2.0 GTi<br>2.0 R 4motion<br>2.0 TDI 81<br>2.0 TDI 100<br>2.0 TDI 103<br>2.0 TDI 125<br>2.0 TDI 4motion 103                           |  | 05.09<br>10.08<br>10.08<br>10.08<br>10.08<br>03.09<br>02.09<br>02.09<br>06.09<br>04.09<br>11.09<br>10.08<br>10.08<br>10.08<br>04.09<br>10.08 | PR: 1ZE,1ZP<br>PR: 1ZE,1ZP<br>PR: 1ZE,1ZP<br>PR: 1ZE,1ZP<br>PR: 1ZE,1ZP<br>PR: 1ZE,1ZP<br>PR: 1ZE,1ZP<br>PR: 1ZE,1ZP<br>PR: 1ZE,1ZP<br>PR: 1ZE,1ZP<br>PR: 1ZE,1ZP<br>PR: 1ZE,1ZP<br>PR: 1ZE,1ZP<br>PR: 1ZE,1ZP<br>PR: 1ZE,1ZP   | 11.9541-9553.2<br>11.9541-9554.2<br>11.0101-5409.2<br>11.8171-0008.1<br>11.8116-0351.1 | 220563<br>220564<br>260035<br>990049<br>390538                                     | <br> | D=54, - Halter ATE<br>D=54, - Halter ATE<br>Hülzensatz ATE<br>Führungsbolzen ATE<br>Haltefeder ATE |
|  | 1.2 TSI<br>1.4 59<br>1.4 TSI 90<br>1.4 TSI 118<br>1.6 75<br>1.6 Bi-Fuel 75<br>1.6 TDI 66<br>1.6 TDI 77<br>1.8 TSI 118<br>2.0 GTi<br>2.0 R 4motion<br>2.0 TDI 81<br>2.0 TDI 100<br>2.0 TDI 103<br>2.0 TDI 125<br>2.0 TDI 4motion 103                           |  | 05.09<br>10.08<br>10.08<br>10.08<br>10.08<br>03.09<br>02.09<br>02.09<br>06.09<br>04.09<br>11.09<br>10.08<br>10.08<br>10.08<br>04.09<br>10.08 | PR: 1LJ,1LL,1LV,1ZA,1ZB,1ZD<br>PR: 1LJ,1LL,1LV,1ZA,1ZB,1ZD<br>PR: 1LJ,1LL,1LV,1ZA,1ZB,1ZD<br>PR: 1LJ,1LL,1LV,1ZA,1ZB,1ZD<br>PR: 1LJ,1LL,1LV,1ZA,1ZB,1ZD<br>PR: 1LJ,1LL,1LV,1ZA,1ZB,1ZD<br>PR: 1LJ,1LL,1LV,1ZA,1ZB,1ZD<br>PR: 1LJ,1LL,1LV,1ZA,1ZB,1ZD<br>PR: 1LJ,1LL,1LV,1ZA,1ZB,1ZD<br>PR: 1LJ,1LL,1LV,1ZA,1ZB,1ZD<br>PR: 1LJ,1LL,1LV,1ZA,1ZB,1ZD<br>PR: 1LJ,1LL,1LV,1ZA,1ZB,1ZD<br>PR: 1LJ,1LL,1LV,1ZA,1ZB,1ZD<br>PR: 1LJ,1LL,1LV,1ZA,1ZB,1ZD<br>PR: 1LJ,1LL,1LV,1ZA,1ZB,1ZD | 11.9541-9553.2<br>11.9541-9554.2<br>11.0101-5409.2<br>11.8171-0008.1<br>11.8116-0351.1 | 220563<br>220564<br>260035<br>990049<br>390538                                     | <br> | D=54, - Halter ATE<br>D=54, - Halter ATE<br>Hülzensatz ATE<br>Führungsbolzen ATE<br>Haltefeder ATE |

<sup>1)</sup> piston diameter Ø 22,20mm / diametro del pistone Ø 22,20mm / diamètre de piston Ø 22,20mm / diámetro del pistón Ø 22,20mm

**VOLKSWAGEN GOLF VI (08-)**













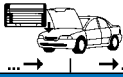















|                 |               |       |   |   |                |        |   |  |                       |     |
|-----------------|---------------|-------|---|---|----------------|--------|---|--|-----------------------|-----|
|                 | 1.2 TSI       |       | 05.09                                   | PR: 1LM                                 | 11.9576-9995.2 | 220651 | 2 |  | D=57, - Halter<br>ATE | ATE |
|                 | 1.4           | 59    | 10.08                                   | PR: 1LM                                 | 11.9576-9996.2 | 220652 |   |  |                       |     |
|                 | 1.4 TSI       | 90    | 10.08                                   | PR: 1LM                                 | 11.0101-5409.2 | 260035 |   |  |                       |     |
|                 | 1.4 TSI       | 118   | 10.08                                   | PR: 1LM                                 | 11.8171-0008.1 | 990049 |   |  |                       |     |
|                 | 1.6           | 75    | 10.08                                   | PR: 1LM                                 | 11.8116-0410.2 | 390589 |   |  |                       |     |
|                 | 1.6 Bi-Fuel   | 75    | 03.09                                   | PR: 1LM                                 |                |        |   |  |                       |     |
|                 | 1.6 TDI       | 66    | 02.09                                   | PR: 1LM                                 |                |        |   |  |                       |     |
|                 | 1.6 TDI       | 77    | 02.09                                   | PR: 1LM                                 |                |        |   |  |                       |     |
|                 | 1.8 TSI       | 118   | 06.09                                   | PR: 1LM                                 |                |        |   |  |                       |     |
|                 | 2.0 GTi       |       | 04.09                                   | PR: 1LM                                 |                |        |   |  |                       |     |
|                 | 2.0 R 4motion |       | 11.09                                   | PR: 1LM                                 |                |        |   |  |                       |     |
|                 | 2.0 TDI       | 81    | 10.08                                   | PR: 1LM                                 |                |        |   |  |                       |     |
|                 | 2.0 TDI       | 100   | 10.08                                   | PR: 1LM                                 |                |        |   |  |                       |     |
| 2.0 TDI         | 103           | 10.08 | PR: 1LM                                 |   |                |        |   |  |                       |     |
| 2.0 TDI         | 125           | 04.09 | PR: 1LM                                 |   |                |        |   |  |                       |     |
| 2.0 TDI 4motion | 103           | 10.08 | PR: 1LM                                 |   |                |        |   |  |                       |     |
|                 | 1.2 TSI       |       | 05.09                                   | PR: 12K                                 | 11.9576-9947.2 | 220809 | 2 |  | D=57, - Halter<br>ATE | ATE |
|                 | 1.4           | 59    | 10.08                                   | PR: 12K                                 | 11.9576-9948.2 | 220810 |   |  |                       |     |
|                 | 1.4 TSI       | 90    | 10.08                                   | PR: 12K                                 | 11.0101-5409.2 | 260035 |   |  |                       |     |
|                 | 1.4 TSI       | 118   | 10.08                                   | PR: 12K                                 | 11.8171-0008.1 | 990049 |   |  |                       |     |
|                 | 1.6           | 75    | 10.08                                   | PR: 12K                                 |                |        |   |  |                       |     |
|                 | 1.6 Bi-Fuel   | 75    | 03.09                                   | PR: 12K                                 |                |        |   |  |                       |     |
|                 | 1.6 TDI       | 66    | 02.09                                   | PR: 12K                                 |                |        |   |  |                       |     |
|                 | 1.6 TDI       | 77    | 02.09                                   | PR: 12K                                 |                |        |   |  |                       |     |
|                 | 1.8 TSI       | 118   | 06.09                                   | PR: 12K                                 |                |        |   |  |                       |     |
|                 | 2.0 GTi       |       | 04.09                                   | PR: 12K                                 |                |        |   |  |                       |     |
|                 | 2.0 R 4motion |       | 11.09                                   | PR: 12K                                 |                |        |   |  |                       |     |
|                 | 2.0 TDI       | 81    | 10.08                                   | PR: 12K                                 |                |        |   |  |                       |     |
|                 | 2.0 TDI       | 100   | 10.08                                   | PR: 12K                                 |                |        |   |  |                       |     |
| 2.0 TDI         | 103           | 10.08 | PR: 12K                                 |   |                |        |   |  |                       |     |
| 2.0 TDI         | 125           | 04.09 | PR: 12K                                 |   |                |        |   |  |                       |     |
| 2.0 TDI 4motion | 103           | 10.08 | PR: 12K                                 |   |                |        |   |  |                       |     |
|                 | 1.2 TSI       |       | 05.09                                   | PR: 1LJ,1LL,1LV,1ZA,1ZB,1ZD,1ZE,1ZF,1ZP | 83.7847-0563.3 | 331124 | 2 |  | L=562                 |     |
|                 | 1.4           | 59    | 10.08                                   | PR: 1LJ,1LL,1LV,1ZA,1ZB,1ZD,1ZE,1ZF,1ZP |                |        |   |  |                       |     |
|                 | 1.4 TSI       | 90    | 10.08                                   | PR: 1LJ,1LL,1LV,1ZA,1ZB,1ZD,1ZE,1ZF,1ZP |                |        |   |  |                       |     |
|                 | 1.4 TSI       | 118   | 10.08                                   | PR: 1LJ,1LL,1LV,1ZA,1ZB,1ZD,1ZE,1ZF,1ZP |                |        |   |  |                       |     |
|                 | 1.6           | 75    | 10.08                                   | PR: 1LJ,1LL,1LV,1ZA,1ZB,1ZD,1ZE,1ZF,1ZP |                |        |   |  |                       |     |
|                 | 1.6 Bi-Fuel   | 75    | 03.09                                   | PR: 1LJ,1LL,1LV,1ZA,1ZB,1ZD,1ZE,1ZF,1ZP |                |        |   |  |                       |     |
|                 | 1.6 TDI       | 66    | 02.09                                   | PR: 1LJ,1LL,1LV,1ZA,1ZB,1ZD,1ZE,1ZF,1ZP |                |        |   |  |                       |     |
|                 | 1.6 TDI       | 77    | 02.09                                   | PR: 1LJ,1LL,1LV,1ZA,1ZB,1ZD,1ZE,1ZF,1ZP |                |        |   |  |                       |     |
|                 | 1.8 TSI       | 118   | 06.09                                   | PR: 1LJ,1LL,1LV,1ZA,1ZB,1ZD,1ZE,1ZF,1ZP |                |        |   |  |                       |     |
|                 | 2.0 GTi       |       | 04.09                                   | PR: 1LJ,1LL,1LV,1ZA,1ZB,1ZD,1ZE,1ZF,1ZP |                |        |   |  |                       |     |
|                 | 2.0 R 4motion |       | 11.09                                   | PR: 1LJ,1LL,1LV,1ZA,1ZB,1ZD,1ZE,1ZF,1ZP |                |        |   |  |                       |     |
|                 | 2.0 TDI       | 81    | 10.08                                   | PR: 1LJ,1LL,1LV,1ZA,1ZB,1ZD,1ZE,1ZF,1ZP |                |        |   |  |                       |     |
|                 | 2.0 TDI       | 100   | 10.08                                   | PR: 1LJ,1LL,1LV,1ZA,1ZB,1ZD,1ZE,1ZF,1ZP |                |        |   |  |                       |     |
| 2.0 TDI         | 103           | 10.08 | PR: 1LJ,1LL,1LV,1ZA,1ZB,1ZD,1ZE,1ZF,1ZP |   |                |        |   |  |                       |     |
| 2.0 TDI         | 125           | 04.09 | PR: 1LJ,1LL,1LV,1ZA,1ZB,1ZD,1ZE,1ZF,1ZP |   |                |        |   |  |                       |     |
| 2.0 TDI 4motion | 103           | 10.08 | PR: 1LJ,1LL,1LV,1ZA,1ZB,1ZD,1ZE,1ZF,1ZP |   |                |        |   |  |                       |     |
|                 | 1.2 TSI       |       | 05.09                                   | PR: 12K                                 | 83.7849-0502.3 | 331125 | 2 |  | L=504                 |     |
|                 | 1.4           | 59    | 10.08                                   | PR: 12K                                 |                |        |   |  |                       |     |
|                 | 1.4 TSI       | 90    | 10.08                                   | PR: 12K                                 |                |        |   |  |                       |     |
|                 | 1.4 TSI       | 118   | 10.08                                   | PR: 12K                                 |                |        |   |  |                       |     |
|                 | 1.6           | 75    | 10.08                                   | PR: 12K                                 |                |        |   |  |                       |     |
|                 | 1.6 Bi-Fuel   | 75    | 03.09                                   | PR: 12K                                 |                |        |   |  |                       |     |
|                 | 1.6 TDI       | 66    | 02.09                                   | PR: 12K                                 |                |        |   |  |                       |     |
|                 | 1.6 TDI       | 77    | 02.09                                   | PR: 12K                                 |                |        |   |  |                       |     |
|                 | 1.8 TSI       | 118   | 06.09                                   | PR: 12K                                 |                |        |   |  |                       |     |
|                 | 2.0 GTi       |       | 04.09                                   | PR: 12K                                 |                |        |   |  |                       |     |
|                 | 2.0 R 4motion |       | 11.09                                   | PR: 12K                                 |                |        |   |  |                       |     |
|                 | 2.0 TDI       | 81    | 10.08                                   | PR: 12K                                 |                |        |   |  |                       |     |
|                 | 2.0 TDI       | 100   | 10.08                                   | PR: 12K                                 |                |        |   |  |                       |     |
| 2.0 TDI         | 103           | 10.08 | PR: 12K                                 |   |                |        |   |  |                       |     |
| 2.0 TDI         | 125           | 04.09 | PR: 12K                                 |   |                |        |   |  |                       |     |
| 2.0 TDI 4motion | 103           | 10.08 | PR: 12K                                 |   |                |        |   |  |                       |     |
|                 | 1.2 TSI       |       | 05.09                                   | PR: 1KD                                 | 24.3384-1755.7 | 220635 | 2 |  | D=38, - Halter<br>LUC | LUC |
|                 | 1.4           | 59    | 10.08                                   | PR: 1KD                                 | 24.3384-1756.7 | 220636 |   |  |                       |     |
|                 | 1.4 TSI       | 90    | 10.08                                   | PR: 1KD                                 |                |        |   |  |                       |     |
|                 | 1.4 TSI       | 118   | 10.08                                   | PR: 1KD                                 |                |        |   |  |                       |     |
|                 | 1.6           | 75    | 10.08                                   | PR: 1KD                                 |                |        |   |  |                       |     |
|                 | 1.6 Bi-Fuel   | 75    | 03.09                                   | PR: 1KD                                 |                |        |   |  |                       |     |
|                 | 1.6 TDI       | 66    | 02.09                                   | PR: 1KD                                 |                |        |   |  |                       |     |
|                 | 1.6 TDI       | 77    | 02.09                                   | PR: 1KD                                 |                |        |   |  |                       |     |
|                 | 1.8 TSI       | 118   | 06.09                                   | PR: 1KD                                 |                |        |   |  |                       |     |
|                 | 2.0 GTi       |       | 04.09                                   | PR: 1KD                                 |                |        |   |  |                       |     |
|                 | 2.0 TDI       | 81    | 10.08                                   | PR: 1KD                                 |                |        |   |  |                       |     |
|                 | 2.0 TDI       | 100   | 10.08                                   | PR: 1KD                                 |                |        |   |  |                       |     |
|                 | 2.0 TDI       | 103   | 10.08                                   | PR: 1KD                                 |                |        |   |  |                       |     |
| 2.0 TDI         | 125           | 04.09 | PR: 1KD                                 |   |                |        |   |  |                       |     |
|                 | 1.2 TSI       |       | 05.09                                   | PR: 1KZ                                 | 24.3387-1717.7 | 220757 | 2 |  | D=38, - Halter<br>LUC | LUC |
|                 | 1.4           | 59    | 10.08                                   | PR: 1KZ                                 | 24.3387-1718.7 | 220758 |   |  |                       |     |
|                 | 1.4 TSI       | 90    | 10.08                                   | PR: 1KZ                                 | 24.0101-3803.2 | 260101 |   |  |                       |     |
|                 | 1.4 TSI       | 118   | 10.08                                   | PR: 1KZ                                 |                |        |   |  |                       |     |
|                 | 1.6           | 75    | 10.08                                   | PR: 1KZ                                 |                |        |   |  |                       |     |
|                 | 1.6 Bi-Fuel   | 75    | 03.09                                   | PR: 1KZ                                 |                |        |   |  |                       |     |
|                 | 1.6 TDI       | 66    | 02.09                                   | PR: 1KZ                                 |                |        |   |  |                       |     |
|                 | 1.6 TDI       | 77    | 02.09                                   | PR: 1KZ                                 |                |        |   |  |                       |     |
|                 | 1.8 TSI       | 118   | 06.09                                   | PR: 1KZ                                 |                |        |   |  |                       |     |

| VOLKSWAGEN GOLF VI (08-)   |  |  |  |  |   |  |  |   |                |          |
|--|--|--|--|--|---|--|--|---|----------------|----------|
|     |  |  |  |  |  |  |  |   |                |          |
|    | 2.0 GTI  | 81   | 04.09  | 10.09  | PR: 1KZ   | 24.3387-1717.7   | 220757   |  | D=38, - Halter | LUC      |
|  | 2.0 TDI  | 100  | 10.08  | 10.09  | PR: 1KZ   | 24.3387-1718.7   | 220758   |  | D=38, - Halter | LUC      |
|  | 2.0 TDI  | 103  | 10.08  | 10.09  | PR: 1KZ   | 24.0101-3803.2   | 260101   |   | Einbausatz     | LUC      |
|  | 2.0 TDI  | 125  | 04.09  | 10.09  | PR: 1KZ   |  |  |   |                |          |
|  | 1.2 TSI  | 59   | 05.09  | 10.09  | PR: 1KE,1KF   | 24.3414-1709.7   | 220631   |  | D=41, - Halter | LUC      |
|  | 1.4  | 90   | 10.08  | 10.09  | PR: 1KE,1KF   | 24.3414-1710.7   | 220632   |  | D=41, - Halter | LUC      |
|  | 1.4 TSI  | 118  | 10.08  | 10.09  | PR: 1KE,1KF   |  |  |   |                |          |
|  | 1.4 TSI  | 118  | 10.08  | 10.09  | PR: 1KE,1KF   |  |  |   |                |          |
|  | 1.6  | 75   | 10.08  | 10.09  | PR: 1KE,1KF   |  |  |   |                |          |
|  | 1.6 Bi-Fuel  | 75   | 03.09  | 10.09  | PR: 1KE,1KF   |  |  |   |                |          |
|  | 1.6 TDI  | 66   | 02.09  | 10.09  | PR: 1KE,1KF   |  |  |   |                |          |
|  | 1.6 TDI  | 77   | 02.09  | 10.09  | PR: 1KE,1KF   |  |  |   |                |          |
|  | 1.8 TSI  | 118  | 06.09  | 10.09  | PR: 1KE,1KF   |  |  |   |                |          |
|  | 2.0 GTi  | 81   | 04.09  | 10.09  | PR: 1KE,1KF   |  |  |   |                |          |
|  | 2.0 TDI  | 100  | 10.08  | 10.09  | PR: 1KE,1KF   |  |  |   |                |          |
|  | 2.0 TDI  | 100  | 10.08  | 10.09  | PR: 1KE,1KF   |  |  |   |                |          |
|  | 2.0 TDI  | 103  | 10.08  | 10.09  | PR: 1KE,1KF   |  |  |   |                |          |
|  | 2.0 TDI  | 125  | 04.09  | 10.09  | PR: 1KE,1KF   |  |  |   |                |          |
|  | 2.0 TDI 4motion  | 103  | 10.08  | 10.09  | PR: 1KE,1KF   |  |  |   |                |          |
|    | 1.2 TSI  | 59   | 05.09  |  | PR: 1KD   | 83.7849-0231.3   | 330872   | 2   |                | L=233    |
|  | 1.4  | 90   | 10.08  |  | PR: 1KD   |  |  |   |                |          |
|  | 1.4 TSI  | 118  | 10.08  |  | PR: 1KD   |  |  |   |                |          |
|  | 1.4 TSI  | 118  | 10.08  |  | PR: 1KD   |  |  |   |                |          |
|  | 1.6  | 75   | 10.08  |  | PR: 1KD   |  |  |   |                |          |
|  | 1.6 Bi-Fuel  | 75   | 03.09  |  | PR: 1KD   |  |  |   |                |          |
|  | 1.6 TDI  | 66   | 02.09  |  | PR: 1KD   |  |  |   |                |          |
|  | 1.6 TDI  | 77   | 02.09  |  | PR: 1KD   |  |  |   |                |          |
|  | 1.8 TSI  | 118  | 06.09  |  | PR: 1KD   |  |  |   |                |          |
|  | 2.0 GTi  | 81   | 04.09  |  | PR: 1KD   |  |  |   |                |          |
|  | 2.0 TDI  | 100  | 10.08  |  | PR: 1KD   |  |  |   |                |          |
|  | 2.0 TDI  | 100  | 10.08  |  | PR: 1KD   |  |  |   |                |          |
|  | 2.0 TDI  | 103  | 10.08  |  | PR: 1KD   |  |  |   |                |          |
|  | 2.0 TDI  | 125  | 04.09  |  | PR: 1KD   |  |  |   |                |          |
|  | 1.2 TSI  | 59   | 05.09  | 10.09  | PR: 1KE,1KF,1KV,1KY,1KZ   | 83.7849-0231.3   | 330872   | 2   |                | L=233    |
|  | 1.4  | 90   | 10.08  | 10.09  | PR: 1KE,1KF,1KV,1KY,1KZ   |  |  |   |                |          |
|  | 1.4 TSI  | 118  | 10.08  | 10.09  | PR: 1KE,1KF,1KV,1KY,1KZ   |  |  |   |                |          |
|  | 1.4 TSI  | 118  | 10.08  | 10.09  | PR: 1KE,1KF,1KV,1KY,1KZ   |  |  |   |                |          |
|  | 1.6  | 75   | 10.08  | 10.09  | PR: 1KE,1KF,1KV,1KY,1KZ   |  |  |   |                |          |
|  | 1.6 Bi-Fuel  | 75   | 03.09  | 10.09  | PR: 1KE,1KF,1KV,1KY,1KZ   |  |  |   |                |          |
|  | 1.6 TDI  | 66   | 02.09  | 10.09  | PR: 1KE,1KF,1KV,1KY,1KZ   |  |  |   |                |          |
|  | 1.6 TDI  | 77   | 02.09  | 10.09  | PR: 1KE,1KF,1KV,1KY,1KZ   |  |  |   |                |          |
|  | 1.8 TSI  | 118  | 06.09  | 10.09  | PR: 1KE,1KF,1KV,1KY,1KZ   |  |  |   |                |          |
|  | 2.0 GTi  | 81   | 04.09  | 10.09  | PR: 1KE,1KF,1KV,1KY,1KZ   |  |  |   |                |          |
|  | 2.0 TDI  | 100  | 10.08  | 10.09  | PR: 1KE,1KF,1KV,1KY,1KZ   |  |  |   |                |          |
|  | 2.0 TDI  | 100  | 10.08  | 10.09  | PR: 1KE,1KF,1KV,1KY,1KZ   |  |  |   |                |          |
|  | 2.0 TDI  | 103  | 10.08  | 10.09  | PR: 1KE,1KF,1KV,1KY,1KZ   |  |  |   |                |          |
|  | 2.0 TDI  | 125  | 04.09  | 10.09  | PR: 1KE,1KF,1KV,1KY,1KZ   |  |  |   |                |          |
|  | 2.0 R 4motion  | 103  | 11.09  |  | PR: 1KF,1KW   | 83.7849-0231.3   | 330872   | 2   |                | L=233    |
|  | 2.0 TDI 4motion  | 103  | 10.08  | 10.09  | PR: 1KF   |  |  |   |                |          |
|  | 1.2 TSI  | 59   | 05.09  |  |   | 24.3727-0195.2   | 580195   | 2   |                | L=1447   |
|  | 1.4  | 90   | 10.08  |  |   |  |  |   |                |          |
|  | 1.4 TSI  | 118  | 10.08  |  |   |  |  |   |                |          |
|  | 1.4 TSI  | 118  | 10.08  |  |   |  |  |   |                |          |
|  | 1.6  | 75   | 10.08  |  |   |  |  |   |                |          |
|  | 1.6 Bi-Fuel  | 75   | 03.09  |  |   |  |  |   |                |          |
|  | 1.6 TDI  | 66   | 02.09  |  |   |  |  |   |                |          |
|  | 1.6 TDI  | 77   | 02.09  |  |   |  |  |   |                |          |
|  | 1.8 TSI  | 118  | 06.09  |  |   |  |  |   |                |          |
|  | 2.0 GTi  | 81   | 04.09  |  |   |  |  |   |                |          |
|  | 2.0 R 4motion  | 103  | 11.09  |  |   |  |  |   |                |          |
|  | 2.0 TDI  | 100  | 10.08  |  |   |  |  |   |                |          |
|  | 2.0 TDI  | 100  | 10.08  |  |   |  |  |   |                |          |
|  | 2.0 TDI  | 103  | 10.08  |  |   |  |  |   |                |          |
|  | 2.0 TDI  | 125  | 04.09  |  |   |  |  |   |                |          |
|  | 2.0 TDI 4motion  | 103  | 10.08  |  |   |  |  |   |                |          |
|  | 1.2 TSI  | 59   | 05.09  |  |   | 24.2415-1711.3   | 030130   |   |                | Gz 15,87 |
|  | 1.4  | 90   | 10.08  |  |   |  |  |   |                |          |
|  | 1.4 TSI  | 118  | 10.08  |  |   |  |  |   |                |          |
|  | 1.4 TSI  | 118  | 10.08  |  |   |  |  |   |                |          |
|  | 1.6  | 75   | 10.08  |  |   |  |  |   |                |          |
|  | 1.6 Bi-Fuel  | 75   | 03.09  |  |   |  |  |   |                |          |
|  | 1.6 TDI  | 66   | 02.09  |  |   |  |  |   |                |          |
|  | 1.6 TDI  | 77   | 02.09  |  |   |  |  |   |                |          |
|  | 1.8 TSI  | 118  | 06.09  |  |   |  |  |   |                |          |
|  | 2.0 GTi  | 81   | 04.09  |  |   |  |  |   |                |          |
|  | 2.0 R 4motion  | 103  | 11.09  |  |   |  |  |   |                |          |
|  | 2.0 TDI  | 100  | 10.08  |  |   |  |  |   |                |          |
|  | 2.0 TDI  | 100  | 10.08  |  |   |  |  |   |                |          |
|  | 2.0 TDI  | 103  | 10.08  |  |   |  |  |   |                |          |
|  | 2.0 TDI  | 125  | 04.09  |  |   |  |  |   |                |          |
|  | 2.0 TDI 4motion  | 103  | 10.08  |  |   |  |  |   |                |          |
|  | 1.4 TSI  | 90   | 10.08  | 06.11  | PR: 0EJ   | 24.2519-1705.3   | 040095   |   |                | Nz 19,05 |
|  | 1.4 TSI  | 118  | 10.08  | 06.11  | PR: 0EJ   |  |  |   |                |          |
|  | 1.8 TSI  | 118  | 06.09  | 06.11  | PR: 0EJ   |  |  |   |                |          |
|  | 1.6 TDI  | 66   | 02.09  | 06.11  | PR: 0EJ   | 24.2519-1705.3   | 040095   |   |                | Nz 19,05 |

| VOLKSWAGEN GOLF VI (08-)   |  |  |  |   |   |   |  |  |   |   |
|--|--|--|--|---|---|---|--|--|---|---|
|    | 1.6 TDI<br>2.0 TDI   | 77<br>81   |  | 02.09<br>10.08  | 06.11<br>06.11  | PR: 0EJ<br>PR: 0EJ  | 24.2519-1705.3   | 040095   |   | Nz 19,05  |
| VOLKSWAGEN GOLF VI Variant (09-)   |  |  |  |   |   |   |  |  |   |   |
|    | 1.4 TSI<br>1.6<br>1.6 MultiFuel  | 90<br>75<br>75                                       |  | 07.09<br>07.09<br>07.09   | 11.09<br>11.09<br>11.09   | PR: 1AS<br>PR: 1AS<br>PR: 1AS   | 03.7863-9602.4   | 300206   | Kolbendurchmesser Ø 22,20mm <sup>1)</sup>   | 10" ATE   |
|  | 1.4 TSI  | 118  |  | 07.09   | 11.09   | PR: 1AC,1AT   | 03.7863-9702.4   | 300207   | Kolbendurchmesser Ø 23,81mm <sup>2)</sup>   | 10" ATE   |
|  | 1.2 TSI<br>1.4<br>1.4 TSI<br>1.6<br>1.6 MultiFuel<br>1.6 TDI<br>1.6 TDI 4motion<br>2.0 TDI                   | 90<br>59<br>90<br>75<br>75<br>90<br>77               |  | 08.09<br>07.09<br>07.09<br>07.09<br>07.09<br>07.09<br>07.09                   | 11.09<br>11.09<br>11.09<br>11.09<br>11.09<br>11.09<br>11.09                   | PR: 1AC,1AT<br>PR: 1AC,1AT<br>PR: 1AC,1AT<br>PR: 1AC,1AT<br>PR: 1AC,1AT<br>PR: 1AC,1AT<br>PR: 1AC,1AT   | 03.7863-9502.4   | 300204   | Kolbendurchmesser Ø 22,20mm <sup>1)</sup>   | 10" ATE   |
|    | 1.4 TSI<br>1.6<br>1.6 MultiFuel  | 90<br>75<br>75                                       |  | 07.09<br>07.09<br>07.09   | 11.09<br>11.09<br>11.09   | PR: 1AS<br>PR: 1AS<br>PR: 1AS   | 03.2122-2129.3   | 010799   |   | THz 22,20 ATE   |
|  | 1.4 TSI<br>2.0   | 118<br>147   |  | 07.09<br>07.09  | 11.09<br>11.09  | PR: 1LJ,1LL<br>PR: 1LJ,1ZA  | 03.2123-3449.3   | 010808   |   | THz 23,81 ATE   |
|  | 1.2 TSI<br>1.4<br>1.4 TSI<br>1.4 TSI<br>1.6<br>1.6 MultiFuel<br>1.6 TDI<br>1.6 TDI 4motion<br>2.0 TDI        | 90<br>59<br>90<br>118<br>75<br>75<br>90<br>77<br>147 |  | 08.09<br>07.09<br>07.09<br>07.09<br>07.09<br>07.09<br>07.09<br>07.09<br>12.09 | 11.09<br>11.09<br>11.09<br>11.09<br>11.09<br>11.09<br>11.09<br>11.09<br>12.09 | PR: 1AC,1AT<br>PR: 1AC,1AT<br>PR: 1AC,1AT<br>PR: 1AC,1AT<br>PR: 1AC,1AT<br>PR: 1AC,1AT<br>PR: 1AC,1AT<br>PR: 1AC,1AT<br>PR: 1ZP<br>PR: 1ZD,1ZP                          | 03.2122-2129.3   | 010799   |   | THz 22,20 ATE   |
|  | 1.2 TSI<br>1.4<br>1.4 TSI<br>1.4 TSI<br>1.6<br>1.6 MultiFuel<br>1.6 TDI<br>1.6 TDI 4motion<br>2.0 TDI        | 90<br>59<br>90<br>118<br>75<br>75<br>90<br>77<br>147 |  | 12.09<br>12.09<br>12.09<br>12.09<br>12.09<br>12.09<br>12.09<br>12.09<br>07.09 |   | PR: 1ZP<br>PR: 1ZP,1ZM<br>PR: 1ZP,1ZM<br>PR: 1ZD  | 03.2122-2129.3   | 010799   |   | THz 22,20 ATE   |
|  | 1.2 TSI<br>1.4<br>1.4 TSI<br>1.4 TSI<br>1.6<br>1.6 MultiFuel<br>1.6 TDI<br>1.6 TDI 4motion<br>2.0<br>2.0 TDI | 59<br>90<br>118<br>75<br>75<br>75<br>77<br>147       |  | 08.09<br>07.09<br>07.09<br>07.09<br>07.09<br>07.09<br>07.09<br>07.09<br>07.09 |   | PR: 1ZM<br>PR: 1ZM<br>PR: 1ZM<br>PR: 1ZM<br>PR: 1ZM<br>PR: 1ZM<br>PR: 1ZM<br>PR: 1ZM  | 11.9541-9549.2<br>11.9541-9550.2<br>11.0101-5409.2                                     | 220575<br>220576<br>260035                     | <br>          | D=54, - Halter<br>D=54, - Halter<br>Hülzensatz<br>ATE<br>ATE<br>ATE   |
|  | 1.2 TSI<br>1.4<br>1.4 TSI<br>1.4 TSI<br>1.6<br>1.6 MultiFuel<br>1.6 TDI<br>1.6 TDI 4motion<br>2.0<br>2.0 TDI | 59<br>90<br>118<br>75<br>75<br>75<br>77<br>147       |  | 08.09<br>07.09<br>07.09<br>07.09<br>07.09<br>07.09<br>07.09<br>07.09<br>07.09 |   | PR: 1LJ,1ZA,1ZD<br>PR: 1LJ,1ZA,1ZD<br>PR: 1LJ,1ZA,1ZD<br>PR: 1LJ,1ZA,1ZD<br>PR: 1LJ,1ZA,1ZD<br>PR: 1LJ,1ZA,1ZD<br>PR: 1LJ,1ZA,1ZD<br>PR: 1LJ,1ZA,1ZD<br>PR: 1LJ,1ZA,1ZD | 11.9541-9553.2<br>11.9541-9554.2<br>11.0101-5409.2<br>11.8171-0008.1<br>11.8116-0351.1 | 220563<br>220564<br>260035<br>990049<br>390538 | <br><br><br>2 | D=54, - Halter<br>D=54, - Halter<br>Hülzensatz<br>Führungsbolzen<br>Haltefeder<br>ATE<br>ATE<br>ATE<br>ATE<br>ATE |
|  | 1.2 TSI<br>1.4<br>1.4 TSI<br>1.4 TSI<br>1.6<br>1.6 MultiFuel<br>1.6 TDI<br>1.6 TDI 4motion<br>2.0<br>2.0 TDI | 59<br>90<br>118<br>75<br>75<br>75<br>77<br>147       |  | 08.09<br>07.09<br>07.09<br>07.09<br>07.09<br>07.09<br>07.09<br>07.09<br>07.09 |   | PR: 1ZE,1ZP<br>PR: 1ZE,1ZP<br>PR: 1ZE,1ZP<br>PR: 1ZE,1ZP<br>PR: 1ZE,1ZP<br>PR: 1ZE,1ZP<br>PR: 1ZE,1ZP<br>PR: 1ZE,1ZP<br>PR: 1ZE,1ZP                                     | 11.9541-9553.2<br>11.9541-9554.2<br>11.0101-5409.2<br>11.8171-0008.1<br>11.8116-0351.1 | 220563<br>220564<br>260035<br>990049<br>390538 | <br><br><br>2 | D=54, - Halter<br>D=54, - Halter<br>Hülzensatz<br>Führungsbolzen<br>Haltefeder<br>ATE<br>ATE<br>ATE<br>ATE<br>ATE |
|  | 1.2 TSI<br>1.4<br>1.4 TSI<br>1.4 TSI<br>1.6<br>1.6 MultiFuel<br>1.6 TDI<br>1.6 TDI 4motion<br>2.0<br>2.0 TDI | 59<br>90<br>118<br>75<br>75<br>75<br>77<br>147       |  | 08.09<br>07.09<br>07.09<br>07.09<br>07.09<br>07.09<br>07.09<br>07.09          | 11.11<br>11.11<br>11.11<br>11.11<br>11.11<br>11.11<br>11.11<br>11.11          |   | 83.7847-0563.3   | 331124   | 2   | L=562   |
|  | 1.2 TSI<br>1.4<br>1.4 TSI<br>1.4 TSI   | 59<br>90<br>90<br>118                                |  | 08.09<br>07.09<br>07.09<br>07.09  |   | PR: 1KE,1KF,1KJ<br>PR: 1KE,1KF,1KJ<br>PR: 1KE,1KF,1KJ<br>PR: 1KE,1KF,1KJ  | 24.3414-1709.7<br>24.3414-1710.7   | 220631<br>220632                               | <br>          | D=41, - Halter<br>D=41, - Halter<br>LUC<br>LUC  |

<sup>1)</sup> piston diameter Ø 22,20mm / diametro del pistone Ø 22,20mm / diamètre de piston Ø 22,20mm / diámetro del pistón Ø 22,20mm

<sup>2)</sup> piston diameter Ø 23,81mm / diametro del pistone Ø 23,81mm / diamètre de piston Ø 23,81mm / diámetro del pistón Ø 23,81mm

|     |                              |  |        |   |       |  |   |  |                                 |
|--|--|--|--|---|--|--|---|--|---------------------------------|
| <b>VOLKSWAGEN GOLF VI Variant (09-)</b>  |  |  |  |   |  |  |   |  |                                 |
|    | 1.6 MultiFuel<br>1.6 TDI<br>1.6 TDI 4motion<br>2.0<br>2.0 TDI  | 75<br>75<br>77<br>147  | 07.09<br>07.09<br>07.09<br>07.09<br>07.09  | PR: 1KE,1KF,1KJ<br>PR: 1KE,1KF,1KJ<br>PR: 1KE,1KF,1KJ<br>PR: 1KE,1KF,1KJ<br>PR: 1KE,1KF,1KJ   | 24.3414-1709.7<br>24.3414-1710.7   | 220631<br>220632   | <br>          | D=41, - Halter<br>D=41, - Halter   | LUC<br>LUC                      |
|    | 1.2 TSI<br>1.4<br>1.4 TSI<br>1.4 TSI<br>1.6<br>1.6 MultiFuel<br>1.6 TDI<br>1.6 TDI 4motion<br>2.0<br>2.0 TDI | 59<br>90<br>118<br>75<br>75<br>77<br>147   | 08.09<br>07.09<br>07.09<br>07.09<br>07.09<br>07.09<br>07.09<br>07.09<br>07.09<br>07.09 | 11.09<br>11.09<br>11.09<br>11.09<br>11.09<br>11.09<br>11.09<br>11.09<br>11.09<br>11.09  | 83.7849-0231.3   | 330872   | 2   | L=233  |                                 |
|    | 1.2 TSI<br>1.4<br>1.4 TSI<br>1.4 TSI<br>1.6<br>1.6 MultiFuel<br>1.6 TDI<br>1.6 TDI 4motion<br>2.0<br>2.0 TDI | 59<br>90<br>118<br>75<br>75<br>77<br>147   | 08.09<br>07.09<br>07.09<br>07.09<br>07.09<br>07.09<br>07.09<br>07.09<br>07.09<br>07.09 |   | 24.3727-0195.2   | 580195   | 2    | L=1447   |                                 |
|    | 1.2 TSI<br>1.4<br>1.4 TSI<br>1.4 TSI<br>1.6<br>1.6 MultiFuel<br>1.6 TDI<br>1.6 TDI 4motion<br>2.0<br>2.0 TDI | 59<br>90<br>118<br>75<br>75<br>77<br>147   | 08.09<br>07.09<br>07.09<br>07.09<br>07.09<br>07.09<br>07.09<br>07.09<br>07.09<br>07.09 |   | 24.2415-1713.3   | 030132   |   | Gz 15,87, + Sensor   |                                 |
|   | 1.4 TSI<br>1.6 TDI<br>1.6 TDI 4motion<br>2.0 TDI   | 118<br>77  | 07.09<br>07.09<br>07.09<br>07.09   | PR: 0EJ<br>PR: 0EJ<br>PR: 0EJ<br>PR: 0EJ  | 24.2519-1705.3   | 040095   |   | Nz 19,05   |                                 |
| <b>VOLKSWAGEN GOLF VI Cabriolet (11-)</b>  |  |  |  |   |  |  |   |  |                                 |
|  | 1.2 TSI<br>1.4 TSI<br>1.4 TSI<br>1.6 TDI<br>2.0 R<br>2.0 TDI<br>2.0 TSI                                      | 77<br>90<br>118<br>77<br>195<br>103<br>155                                       | 06.11<br>06.11<br>06.11<br>06.11<br>01.13<br>06.11<br>06.11                            | PR: 1ZD,1ZP,1LV<br>PR: 1ZD,1ZP,1LV<br>PR: 1ZD,1ZP,1LV<br>PR: 1ZD,1ZP,1LV<br>PR: 1ZD,1ZP,1LV<br>PR: 1ZD,1ZP,1LV<br>PR: 1ZD,1ZP,1LV                             | 03.2122-2129.3   | 010799   |   | Thz 22,20  | ATE                             |
|  | 1.2 TSI<br>1.4 TSI<br>1.4 TSI<br>1.6 TDI<br>2.0 R<br>2.0 TDI<br>2.0 TSI                                      | 77<br>90<br>118<br>77<br>195<br>103<br>155                                       | 06.11<br>06.11<br>06.11<br>06.11<br>01.13<br>06.11<br>06.11                            | PR: 1ZA,1ZB,1ZE,1ZK<br>PR: 1ZA,1ZB,1ZE,1ZK<br>PR: 1ZA,1ZB,1ZE,1ZK<br>PR: 1ZA,1ZB,1ZE,1ZK<br>PR: 1ZA,1ZB,1ZE,1ZK<br>PR: 1ZA,1ZB,1ZE,1ZK<br>PR: 1ZA,1ZB,1ZE,1ZK | 03.2123-3449.3   | 010808   |   | Thz 23,81  | ATE                             |
|  | 1.2 TSI<br>1.4 TSI<br>1.4 TSI<br>1.6 TDI<br>2.0 R<br>2.0 TDI<br>2.0 TSI                                      | 77<br>90<br>118<br>77<br>195<br>103<br>155                                       | 06.11<br>06.11<br>06.11<br>06.11<br>01.13<br>06.11<br>06.11                            | PR: 1ZE,1ZP<br>PR: 1ZE,1ZP<br>PR: 1ZE,1ZP<br>PR: 1ZE,1ZP<br>PR: 1ZE,1ZP<br>PR: 1ZE,1ZP<br>PR: 1ZE,1ZP   | 11.9541-9553.2<br>11.9541-9554.2<br>11.8171-0008.1<br>11.0101-5409.2<br>11.8116-0351.1 | 220563<br>220564<br>990049<br>260035<br>390538                                     | <br><br>2 | D=54, - Halter<br>D=54, - Halter<br>Führungsbolzen<br>Hülzensatz<br>Haltefeder     | ATE<br>ATE<br>ATE<br>ATE<br>ATE |
|  | 1.2 TSI<br>1.4 TSI<br>1.4 TSI<br>1.6 TDI<br>2.0 R<br>2.0 TDI<br>2.0 TSI                                      | 77<br>90<br>118<br>77<br>195<br>103<br>155                                       | 06.11<br>06.11<br>06.11<br>06.11<br>01.13<br>06.11<br>06.11                            | PR: 1ZA,1ZD,1ZB<br>PR: 1ZA,1ZD,1ZB<br>PR: 1ZA,1ZD,1ZB<br>PR: 1ZA,1ZD,1ZB<br>PR: 1ZA,1ZD,1ZB<br>PR: 1ZA,1ZD,1ZB<br>PR: 1ZA,1ZD,1ZB                             | 11.9541-9553.2<br>11.9541-9554.2<br>11.0101-5409.2<br>11.8171-0008.1<br>11.8116-0351.1 | 220563<br>220564<br>260035<br>990049<br>390538                                     | <br><br>2 | D=54, - Halter<br>D=54, - Halter<br>Hülzensatz<br>Führungsbolzen<br>Haltefeder     | ATE<br>ATE<br>ATE<br>ATE<br>ATE |
|  | 1.2 TSI<br>1.4 TSI<br>1.4 TSI<br>1.6 TDI<br>2.0 R<br>2.0 TDI<br>2.0 TSI                                      | 77<br>90<br>118<br>77<br>195<br>103<br>155                                       | 06.11<br>06.11<br>06.11<br>06.11<br>01.13<br>06.11<br>06.11                            | PR: 1ZK<br>PR: 1ZK<br>PR: 1ZK<br>PR: 1ZK<br>PR: 1ZK<br>PR: 1ZK<br>PR: 1ZK   | 11.9576-9947.2<br>11.9576-9948.2<br>11.8171-0008.1<br>11.0101-5407.2                   | 220809<br>220810<br>990049<br>260011   | <br><br>2 | D=57, - Halter<br>D=57, - Halter<br>Führungsbolzen<br>Hülzensatz                   | ATE<br>ATE<br>ATE<br>ATE        |
|  | 1.2 TSI<br>1.4 TSI<br>1.4 TSI<br>1.6 TDI<br>2.0 R<br>2.0 TDI<br>2.0 TSI                                      | 77<br>90<br>118<br>77<br>195<br>103<br>155                                       | 06.11<br>06.11<br>06.11<br>06.11<br>01.13<br>06.11<br>06.11                            |   | 83.7847-0563.3   | 331124   | 2   | L=562  |                                 |

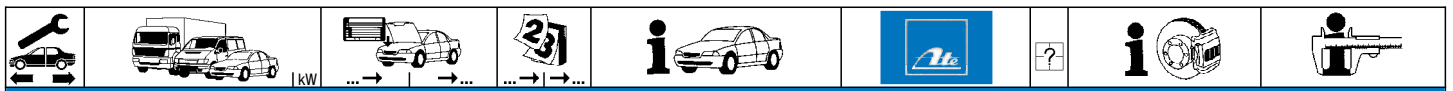

**VOLKSWAGEN GOLF VI Cabriolet (11-)**

|  |         |     |       |         |                |        |   |                                  |            |
|--|---------|-----|-------|---------|----------------|--------|---|----------------------------------|------------|
|  | 1.2 TSI | 77  | 06.11 | PR: 1KD | 24.3384-1755.7 | 220635 |   | D=38, - Halter<br>D=38, - Halter | <b>LUC</b> |
|  | 1.4 TSI | 90  | 06.11 | PR: 1KD | 24.3384-1756.7 | 220636 |   |                                  |            |
|  | 1.4 TSI | 118 | 06.11 | PR: 1KD |                |        |   |                                  |            |
|  | 1.6 TDI | 77  | 06.11 | PR: 1KD |                |        |   |                                  |            |
|  | 2.0 R   | 195 | 01.13 | PR: 1KD |                |        |   |                                  |            |
|  | 2.0 TDI | 103 | 06.11 | PR: 1KD |                |        |   |                                  |            |
|  | 2.0 TSI | 155 | 06.11 | PR: 1KD |                |        |   |                                  |            |
|  | 1.2 TSI | 77  | 06.11 | PR: 1KD | 83.7849-0231.3 | 330872 | 2 | L=233                            |            |
|  | 1.4 TSI | 90  | 06.11 | PR: 1KD |                |        |   |                                  |            |
|  | 1.4 TSI | 118 | 06.11 | PR: 1KD |                |        |   |                                  |            |
|  | 1.6 TDI | 77  | 06.11 | PR: 1KD |                |        |   |                                  |            |
|  | 2.0 R   | 195 | 01.13 | PR: 1KD |                |        |   |                                  |            |
|  | 2.0 TDI | 103 | 06.11 | PR: 1KD |                |        |   |                                  |            |
|  | 2.0 TSI | 155 | 06.11 | PR: 1KD |                |        |   |                                  |            |
|  | 1.2 TSI | 77  | 06.11 |         | 24.3727-0195.2 | 580195 | 2 | L=1447                           |            |
|  | 1.4 TSI | 90  | 06.11 |         |                |        |   |                                  |            |
|  | 1.4 TSI | 118 | 06.11 |         |                |        |   |                                  |            |
|  | 1.6 TDI | 77  | 06.11 |         |                |        |   |                                  |            |
|  | 2.0 R   | 195 | 01.13 |         |                |        |   |                                  |            |
|  | 2.0 TDI | 103 | 06.11 |         |                |        |   |                                  |            |
|  | 2.0 TSI | 155 | 06.11 |         |                |        |   |                                  |            |
|  | 1.2 TSI | 77  | 06.11 |         | 24.2415-1713.3 | 030132 |   | Gz 15,87, + Sensor               |            |
|  | 1.4 TSI | 90  | 06.11 |         |                |        |   |                                  |            |
|  | 1.4 TSI | 118 | 06.11 |         |                |        |   |                                  |            |
|  | 1.6 TDI | 77  | 06.11 |         |                |        |   |                                  |            |
|  | 2.0 R   | 195 | 01.13 |         |                |        |   |                                  |            |
|  | 2.0 TDI | 103 | 06.11 |         |                |        |   |                                  |            |
|  | 2.0 TSI | 155 | 06.11 |         |                |        |   |                                  |            |
|  | 1.4 TSI | 118 | 06.11 | PR: 0EJ | 24.2519-1705.3 | 040095 |   | Nz 19,05                         |            |
|  | 1.6 TDI | 77  | 06.11 | PR: 0EJ |                |        |   |                                  |            |

**VOLKSWAGEN GOLF Plus (05-)**

|            |         |             |             |             |                |        |  |   |     |            |
|------------|---------|-------------|-------------|-------------|----------------|--------|--|---|-----|------------|
|            | 1.4 16V | 77          | 01.05       | PR: 1AC,1AT | 03.7863-9502.4 | 300204 |  | Kolbendurchmesser Ø 22,20mm <sup>1)</sup> | 10" | <b>ATE</b> |
|            | 1.4 FSI | 66          | 07.05       | PR: 1AC,1AT |                |        |  |   |     |            |
|            | 1.4 TSI | 90          | 06.07       | PR: 1AC,1AT |                |        |  |   |     |            |
|            | 1.4 TSI | 103         | 05.06       | PR: 1AC,1AT |                |        |  |   |     |            |
|            | 1.4 TSI | 118         | 06.08       | PR: 1AC,1AT |                |        |  |   |     |            |
|            | 1.4 TSI | 125         | 05.06       | PR: 1AC,1AT |                |        |  |   |     |            |
|            | 1.6     | 75          | 05.05       | PR: 1AC,1AT |                |        |  |   |     |            |
|            | 1.6 FSI | 85          | 01.05       | PR: 1AC,1AT |                |        |  |   |     |            |
|            | 1.9 TDI | 66          | 05.05       | PR: 1AC,1AT |                |        |  |   |     |            |
|            | 1.9 TDI | 77          | 01.05       | PR: 1AC,1AT |                |        |  |   |     |            |
|            | 2.0 FSI | 110         | 05.05       | PR: 1AC,1AT |                |        |  |   |     |            |
|            | 2.0 TDI | 77          | 05.05       | PR: 1AC,1AT |                |        |  |   |     |            |
|            | 2.0 TDI | 103         | 01.05       | PR: 1AC,1AT |                |        |  |   |     |            |
|            | 1.4 16V | 77          | 01.05       | PR: 1AS     | 03.7863-9602.4 | 300206 |  | Kolbendurchmesser Ø 22,20mm <sup>1)</sup> | 10" | <b>ATE</b> |
|            | 1.4 FSI | 66          | 07.05       | PR: 1AS     |                |        |  |   |     |            |
|            | 1.4 TSI | 90          | 06.07       | PR: 1AS     |                |        |  |   |     |            |
|            | 1.4 TSI | 103         | 05.06       | PR: 1AS     |                |        |  |   |     |            |
| 1.4 TSI    | 118     | 06.08       | PR: 1AS     |             |                |        |  |   |     |            |
| 1.4 TSI    | 125     | 05.06       | PR: 1AS     |             |                |        |  |   |     |            |
| 1.6        | 75      | 05.05       | PR: 1AS     |             |                |        |  |   |     |            |
| 1.6 FSI    | 85      | 01.05       | PR: 1AS     |             |                |        |  |   |     |            |
| 1.9 TDI    | 66      | 05.05       | PR: 1AS     |             |                |        |  |   |     |            |
| 1.9 TDI    | 77      | 01.05       | PR: 1AS     |             |                |        |  |   |     |            |
| 2.0 FSI    | 110     | 05.05       | PR: 1AS     |             |                |        |  |   |     |            |
| 2.0 TDI    | 77      | 05.05       | PR: 1AS     |             |                |        |  |   |     |            |
| 2.0 TDI    | 103     | 01.05       | PR: 1AS     |             |                |        |  |   |     |            |
| 1.4 TSI    | 125     | 1K-6-565001 | 1K-9-899999 | PR: 1AC,1AT | 03.7863-9702.4 | 300207 |  | Kolbendurchmesser Ø 23,81mm <sup>2)</sup> | 10" | <b>ATE</b> |
| 1.4 TSI    | 125     | 1K-6-565001 | 1K-9-899999 | PR: 1AS     | 03.7863-9802.4 | 300281 |  |   | 10" | <b>ATE</b> |
| 1.2 TSI    | 77      | 1K-9-900001 |             | 11.10       | 03.7860-3902.4 | 300278 |  | PR: 12K                                   | 10" | <b>ATE</b> |
| 1.4 16V    | 77      | 1K-9-900001 |             | 11.10       | 03.7863-9702.4 | 300207 |  | PR: 12A,12B,12E                           | 10" | <b>ATE</b> |
| 1.4 FSI    | 66      | 1K-9-900001 |             | 11.10       |                |        |  |   |     |            |
| 1.4 TSI    | 90      | 1K-9-900001 |             | 11.10       |                |        |  |   |     |            |
| 1.4 TSI    | 103     | 1K-9-900001 |             | 11.10       |                |        |  |   |     |            |
| 1.4 TSI    | 118     | 1K-9-900001 |             | 11.10       |                |        |  |   |     |            |
| 1.4 TSI    | 125     | 1K-9-900001 |             | 11.10       |                |        |  |   |     |            |
| 1.6        | 75      | 1K-9-900001 |             | 11.10       |                |        |  |   |     |            |
| 1.6 BiFuel | 75      | 1K-9-900001 |             | 11.10       |                |        |  |   |     |            |
| 1.6 FSI    | 85      | 1K-9-900001 |             | 11.10       |                |        |  |   |     |            |
| 1.6 TDI    | 77      | 1K-9-900001 |             | 11.10       |                |        |  |   |     |            |
| 1.9 TDI    | 66      | 1K-9-900001 |             | 11.10       |                |        |  |   |     |            |
| 1.9 TDI    | 77      | 1K-9-900001 |             | 11.10       |                |        |  |   |     |            |
| 2.0 FSI    | 110     | 1K-9-900001 |             | 11.10       |                |        |  |   |     |            |
| 2.0 TDI    | 77      | 1K-9-900001 |             | 11.10       |                |        |  |   |     |            |
| 2.0 TDI    | 81      | 1K-9-900001 |             | 11.10       |                |        |  |   |     |            |
| 2.0 TDI    | 103     | 1K-9-900001 |             | 11.10       |                |        |  |   |     |            |
|            | 1.4 16V | 77          | 01.05       |             | 03.2122-2129.3 | 010799 |  | Thz 22,20                                 |     | <b>ATE</b> |
|            | 1.4 FSI | 66          | 07.05       |             |                |        |  |   |     |            |
|            | 1.4 TSI | 103         | 05.06       |             |                |        |  |   |     |            |
|            | 1.4 TSI | 125         | 05.06       |             |                |        |  |   |     |            |
|            | 1.6     | 75          | 05.05       |             |                |        |  |   |     |            |
|            | 1.6 FSI | 85          | 01.05       |             |                |        |  |   |     |            |
|            | 1.9 TDI | 66          | 05.05       |             |                |        |  |   |     |            |
| 1.9 TDI    | 77      | 01.05       |             |             |                |        |  |   |     |            |

<sup>1)</sup> piston diameter Ø 22,20mm / diametro del pistone Ø 22,20mm / diamètre de piston Ø 22,20mm / diametro del pistón Ø 22,20mm

<sup>2)</sup> piston diameter Ø 23,81mm / diametro del pistone Ø 23,81mm / diamètre de piston Ø 23,81mm / diametro del pistón Ø 23,81mm





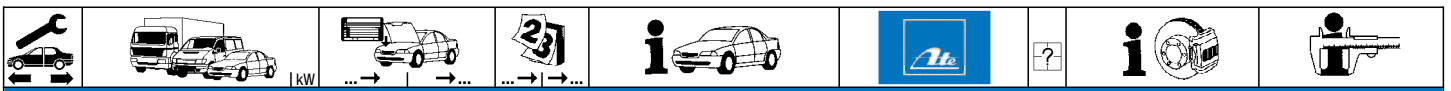

**VOLKSWAGEN GOLF Plus (05-)**

|            |            |             |             |             |                |                |        |                            |                                     |           |     |
|------------|------------|-------------|-------------|-------------|----------------|----------------|--------|----------------------------|-------------------------------------|-----------|-----|
|            | 2.0 FSI    | 110         | 1K-6-565000 | 05.05       |                | 03.2122-2129.3 | 010799 |                            | THz 22,20                           | ATE       |     |
|            | 2.0 TDI    |             | 1K-6-565000 | 05.05       |                |                |        |                            |                                     |           |     |
|            | 2.0 TDI    | 103         | 1K-6-565000 | 01.05       |                |                |        |                            |                                     |           |     |
|            | 1.4 16V    |             | 1K-6-565001 | 1K-8-500000 |                | 03.2122-2129.3 | 010799 |                            | THz 22,20                           | ATE       |     |
|            | 1.4 FSI    | 66          | 1K-6-565001 | 1K-8-500000 |                | 03.2123-3449.3 | 010808 | PR: 1AC,1AT,1AS<br>PR: 1LJ | THz 23,81                           | ATE       |     |
|            | 1.4 TSI    | 90          | 1K-6-565001 | 1K-8-500000 |                |                |        |                            |                                     |           |     |
|            | 1.4 TSI    | 103         | 1K-6-565001 | 1K-8-500000 |                |                |        |                            |                                     |           |     |
|            | 1.4 TSI    | 125         | 1K-6-565001 | 1K-8-500000 |                |                |        |                            |                                     |           |     |
|            | 1.6        | 75          | 1K-6-565001 | 1K-8-500000 |                |                |        |                            |                                     |           |     |
|            | 1.6 FSI    | 85          | 1K-6-565001 | 1K-8-500000 |                |                |        |                            |                                     |           |     |
|            | 1.9 TDI    | 66          | 1K-6-565001 | 1K-8-500000 |                |                |        |                            |                                     |           |     |
|            | 1.9 TDI    | 77          | 1K-6-565001 | 1K-8-500000 |                |                |        |                            |                                     |           |     |
|            | 2.0 FSI    | 110         | 1K-6-565001 | 1K-8-500000 |                |                |        |                            |                                     |           |     |
|            | 2.0 TDI    |             | 1K-6-565001 | 1K-8-500000 |                |                |        |                            |                                     |           |     |
|            | 2.0 TDI    | 103         | 1K-6-565001 | 1K-8-500000 |                |                |        |                            |                                     |           |     |
|            | 1.4 16V    |             | 1K-8-500001 | 1K-9-899999 |                | 03.2122-2129.3 | 010799 |                            | PR: 1LK,1ZA,1ZC,1ZD,1ZE,1ZF,1ZM,1ZP | THz 22,20 | ATE |
|            | 1.4 FSI    | 66          | 1K-8-500001 | 1K-9-899999 |                | 03.2123-3449.3 | 010808 |                            | PR: 1LJ                             | THz 23,81 | ATE |
|            | 1.4 TSI    | 90          | 1K-8-500001 | 1K-9-899999 |                |                |        |                            |                                     |           |     |
|            | 1.4 TSI    | 103         | 1K-8-500001 | 1K-9-899999 |                |                |        |                            |                                     |           |     |
|            | 1.4 TSI    | 118         | 1K-8-500001 | 1K-9-899999 |                |                |        |                            |                                     |           |     |
| 1.4 TSI    | 125        | 1K-8-500001 | 1K-9-899999 |             |                |                |        |                            |                                     |           |     |
| 1.6        | 75         | 1K-8-500001 | 1K-9-899999 |             |                |                |        |                            |                                     |           |     |
| 1.6 FSI    | 85         | 1K-8-500001 | 1K-9-899999 |             |                |                |        |                            |                                     |           |     |
| 1.9 TDI    | 66         | 1K-8-500001 | 1K-9-899999 |             |                |                |        |                            |                                     |           |     |
| 1.9 TDI    | 77         | 1K-8-500001 | 1K-9-899999 |             |                |                |        |                            |                                     |           |     |
| 2.0 FSI    | 110        | 1K-8-500001 | 1K-9-899999 |             |                |                |        |                            |                                     |           |     |
| 2.0 TDI    |            | 1K-8-500001 | 1K-9-899999 |             |                |                |        |                            |                                     |           |     |
| 2.0 TDI    | 103        | 1K-8-500001 | 1K-9-899999 |             |                |                |        |                            |                                     |           |     |
| 1.2 TSI    |            | 1K-9-900001 | 1K-C-500000 |             | 03.2122-2129.3 | 010799         |        | PR: 1ZF                    | THz 22,20                           | ATE       |     |
| 1.4 16V    |            | 1K-9-900001 | 1K-C-500000 |             | 03.2123-3449.3 | 010808         |        | PR: 1ZE,1LJ,1ZA            | THz 23,81                           | ATE       |     |
| 1.4 FSI    | 66         | 1K-9-900001 | 1K-C-500000 |             |                |                |        |                            |                                     |           |     |
| 1.4 TSI    | 90         | 1K-9-900001 | 1K-C-500000 |             |                |                |        |                            |                                     |           |     |
| 1.4 TSI    | 103        | 1K-9-900001 | 1K-C-500000 |             |                |                |        |                            |                                     |           |     |
| 1.4 TSI    | 118        | 1K-9-900001 | 1K-C-500000 |             |                |                |        |                            |                                     |           |     |
| 1.4 TSI    | 125        | 1K-9-900001 | 1K-C-500000 |             |                |                |        |                            |                                     |           |     |
| 1.6        | 75         | 1K-9-900001 | 1K-C-500000 |             |                |                |        |                            |                                     |           |     |
| 1.6 BiFuel | 75         | 1K-9-900001 | 1K-C-500000 |             |                |                |        |                            |                                     |           |     |
| 1.6 FSI    | 85         | 1K-9-900001 | 1K-C-500000 |             |                |                |        |                            |                                     |           |     |
| 1.6 TDI    |            | 1K-9-900001 | 1K-C-500000 |             |                |                |        |                            |                                     |           |     |
| 1.9 TDI    | 66         | 1K-9-900001 | 1K-C-500000 |             |                |                |        |                            |                                     |           |     |
| 1.9 TDI    | 77         | 1K-9-900001 | 1K-C-500000 |             |                |                |        |                            |                                     |           |     |
| 2.0 FSI    | 110        | 1K-9-900001 | 1K-C-500000 |             |                |                |        |                            |                                     |           |     |
| 2.0 TDI    |            | 1K-9-900001 | 1K-C-500000 |             |                |                |        |                            |                                     |           |     |
| 2.0 TDI    | 81         | 1K-9-900001 | 1K-C-500000 |             |                |                |        |                            |                                     |           |     |
| 2.0 TDI    | 103        | 1K-9-900001 | 1K-C-500000 |             |                |                |        |                            |                                     |           |     |
| 1.2 TSI    |            | 1K-C-500001 |             |             | 03.2122-2129.3 | 010799         |        | PR: 1ZF,1AC                | THz 22,20                           | ATE       |     |
| 1.4 16V    |            | 1K-C-500001 |             |             | 03.2123-3449.3 | 010808         |        | PR: 1ZA,1ZE,1AS,1AT        | THz 23,81                           | ATE       |     |
| 1.4 FSI    | 66         | 1K-C-500001 |             |             |                |                |        |                            |                                     |           |     |
| 1.4 TSI    | 90         | 1K-C-500001 |             |             |                |                |        |                            |                                     |           |     |
| 1.4 TSI    | 103        | 1K-C-500001 |             |             |                |                |        |                            |                                     |           |     |
| 1.4 TSI    | 118        | 1K-C-500001 |             |             |                |                |        |                            |                                     |           |     |
| 1.4 TSI    | 125        | 1K-C-500001 |             |             |                |                |        |                            |                                     |           |     |
| 1.6        | 75         | 1K-C-500001 |             |             |                |                |        |                            |                                     |           |     |
| 1.6 BiFuel | 75         | 1K-C-500001 |             |             |                |                |        |                            |                                     |           |     |
| 1.6 FSI    | 85         | 1K-C-500001 |             |             |                |                |        |                            |                                     |           |     |
| 1.6 TDI    |            | 1K-C-500001 |             |             |                |                |        |                            |                                     |           |     |
| 1.9 TDI    | 66         | 1K-C-500001 |             |             |                |                |        |                            |                                     |           |     |
| 1.9 TDI    | 77         | 1K-C-500001 |             |             |                |                |        |                            |                                     |           |     |
| 2.0 FSI    | 110        | 1K-C-500001 |             |             |                |                |        |                            |                                     |           |     |
| 2.0 TDI    |            | 1K-C-500001 |             |             |                |                |        |                            |                                     |           |     |
| 2.0 TDI    | 81         | 1K-C-500001 |             |             |                |                |        |                            |                                     |           |     |
| 2.0 TDI    | 103        | 1K-C-500001 |             |             |                |                |        |                            |                                     |           |     |
|            | 1.2 TSI    |             |             | 08.09       | PR: 1ZF,1ZM    | 11.9541-9549.2 | 220575 | <input type="checkbox"/>   | D=54, - Halter                      | ATE       |     |
|            | 1.4 16V    |             |             | 01.05       | PR: 1ZF,1ZM    | 11.9541-9550.2 | 220576 | <input type="checkbox"/>   | D=54, - Halter                      | ATE       |     |
|            | 1.4 FSI    | 66          |             | 07.05       | PR: 1ZF,1ZM    | 11.0101-5409.2 | 260035 |                            | Hülsensatz                          | ATE       |     |
|            | 1.4 TSI    | 90          |             | 06.07       | PR: 1ZF,1ZM    |                |        |                            |                                     |           |     |
|            | 1.4 TSI    | 103         |             | 05.06       | PR: 1ZF,1ZM    |                |        |                            |                                     |           |     |
|            | 1.4 TSI    | 118         |             | 06.08       | PR: 1ZF,1ZM    |                |        |                            |                                     |           |     |
|            | 1.4 TSI    | 125         |             | 05.06       | PR: 1ZF,1ZM    |                |        |                            |                                     |           |     |
|            | 1.6        | 75          |             | 05.05       | PR: 1ZF,1ZM    |                |        |                            |                                     |           |     |
|            | 1.6 BiFuel | 75          |             | 05.09       | PR: 1ZF,1ZM    |                |        |                            |                                     |           |     |
|            | 1.6 FSI    | 85          |             | 01.05       | PR: 1ZF,1ZM    |                |        |                            |                                     |           |     |
|            | 1.6 TDI    |             |             | 02.09       | PR: 1ZF,1ZM    |                |        |                            |                                     |           |     |
|            | 1.9 TDI    | 66          |             | 05.05       | PR: 1ZF,1ZM    |                |        |                            |                                     |           |     |
|            | 1.9 TDI    | 77          |             | 01.05       | PR: 1ZF,1ZM    |                |        |                            |                                     |           |     |
|            | 2.0 FSI    | 110         |             | 05.05       | PR: 1ZF,1ZM    |                |        |                            |                                     |           |     |
|            | 2.0 TDI    |             |             | 05.05       | PR: 1ZF,1ZM    |                |        |                            |                                     |           |     |
|            | 2.0 TDI    | 81          |             | 01.09       | PR: 1ZF,1ZM    |                |        |                            |                                     |           |     |
|            | 2.0 TDI    | 103         |             | 01.05       | PR: 1ZF,1ZM    |                |        |                            |                                     |           |     |
|            | 1.2 TSI    |             |             | 08.09       | PR: 1ZE,1ZP    | 11.9541-9553.2 | 220563 | <input type="checkbox"/>   | D=54, - Halter                      | ATE       |     |
|            | 1.4 16V    |             |             | 01.05       | PR: 1ZE,1ZP    | 11.9541-9554.2 | 220564 | <input type="checkbox"/>   | D=54, - Halter                      | ATE       |     |
|            | 1.4 FSI    | 66          |             | 07.05       | PR: 1ZE,1ZP    | 11.0101-5409.2 | 260035 |                            | Hülsensatz                          | ATE       |     |
| 1.4 TSI    | 90         |             | 06.07       | PR: 1ZE,1ZP | 11.8171-0008.1 | 990049         |        | Führungsbolzen             | ATE                                 |           |     |
| 1.4 TSI    | 103        |             | 05.06       | PR: 1ZE,1ZP | 11.8116-0351.1 | 390538         | 2      | Haltefeder                 | ATE                                 |           |     |
| 1.4 TSI    | 118        |             | 06.08       | PR: 1ZE,1ZP |                |                |        |                            |                                     |           |     |
| 1.4 TSI    | 125        |             | 05.06       | PR: 1ZE,1ZP |                |                |        |                            |                                     |           |     |
| 1.6        | 75         |             | 05.05       | PR: 1ZE,1ZP |                |                |        |                            |                                     |           |     |

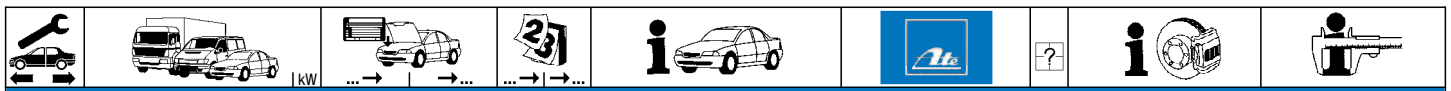

**VOLKSWAGEN GOLF Plus (05-)**

|            |            |             |             |                |                |                |   |   |                                 |
|------------|------------|-------------|-------------|----------------|----------------|----------------|---|---|---------------------------------|
|            | 1.6 BiFuel | 75          | 05.09       | PR: 1ZE,1ZP    | 11.9541-9553.2 | 220563         | 2 | D=54, - Halter<br>ATE<br>D=54, - Halter<br>ATE<br>Hülzensatz<br>ATE<br>Führungsbolzen<br>ATE<br>Haltefeder<br>ATE | ATE<br>ATE<br>ATE<br>ATE<br>ATE |
|            | 1.6 FSI    | 85          | 01.05       | PR: 1ZE,1ZP    | 11.9541-9554.2 | 220564         |   |   |                                 |
|            | 1.6 TDI    |             | 02.09       | PR: 1ZE,1ZP    | 11.0101-5409.2 | 260035         |   |   |                                 |
|            | 1.9 TDI    | 66          | 05.05       | PR: 1ZE,1ZP    | 11.8171-0008.1 | 990049         |   |   |                                 |
|            | 1.9 TDI    | 77          | 01.05       | PR: 1ZE,1ZP    | 11.8116-0351.1 | 390538         |   |   |                                 |
|            | 2.0 FSI    | 110         | 05.05       | PR: 1ZE,1ZP    |                |                |   |   |                                 |
|            | 2.0 TDI    |             | 05.05       | PR: 1ZE,1ZP    |                |                |   |   |                                 |
|            | 2.0 TDI    | 81          | 01.09       | PR: 1ZE,1ZP    |                |                |   |   |                                 |
|            | 2.0 TDI    | 103         | 01.05       | PR: 1ZE,1ZP    |                |                |   |   |                                 |
|            | 1.2 TSI    |             | 08.09       | PR: 1LJ,1ZA    | 11.9541-9553.2 | 220563         |   |   |                                 |
| 1.4 16V    |            | 01.05       | PR: 1LJ,1ZA | 11.9541-9554.2 | 220564         |                |   |   |                                 |
| 1.4 FSI    | 66         | 07.05       | PR: 1LJ,1ZA | 11.0101-5409.2 | 260035         |                |   |   |                                 |
| 1.4 TSI    | 90         | 06.07       | PR: 1LJ,1ZA | 11.8171-0008.1 | 990049         |                |   |   |                                 |
| 1.4 TSI    | 103        | 05.06       | PR: 1LJ,1ZA | 11.8116-0351.1 | 390538         |                |   |   |                                 |
| 1.4 TSI    | 118        | 06.08       | PR: 1LJ,1ZA |                |                |                |   |   |                                 |
| 1.4 TSI    | 125        | 05.06       | PR: 1LJ,1ZA |                |                |                |   |   |                                 |
| 1.6        | 75         | 05.05       | PR: 1LJ,1ZA |                |                |                |   |   |                                 |
| 1.6 BiFuel | 75         | 05.09       | PR: 1LJ,1ZA |                |                |                |   |   |                                 |
| 1.6 FSI    | 85         | 01.05       | PR: 1LJ,1ZA |                |                |                |   |   |                                 |
| 1.6 TDI    |            | 02.09       | PR: 1LJ,1ZA |                |                |                |   |   |                                 |
| 1.9 TDI    | 66         | 05.05       | PR: 1LJ,1ZA |                |                |                |   |   |                                 |
| 1.9 TDI    | 77         | 01.05       | PR: 1LJ,1ZA |                |                |                |   |   |                                 |
| 2.0 FSI    | 110        | 05.05       | PR: 1LJ,1ZA |                |                |                |   |   |                                 |
| 2.0 TDI    |            | 05.05       | PR: 1LJ,1ZA |                |                |                |   |   |                                 |
| 2.0 TDI    | 81         | 01.09       | PR: 1LJ,1ZA |                |                |                |   |   |                                 |
| 2.0 TDI    | 103        | 01.05       | PR: 1LJ,1ZA |                |                |                |   |   |                                 |
|            | 1.2 TSI    |             | 08.09       |                | 83.7847-0563.3 | 331124         | 2 | L=562   |                                 |
|            | 1.4 16V    |             | 01.05       |                |                |                |   |   |                                 |
|            | 1.4 FSI    | 66          | 07.05       |                |                |                |   |   |                                 |
|            | 1.4 TSI    | 90          | 06.07       |                |                |                |   |   |                                 |
|            | 1.4 TSI    | 103         | 05.06       |                |                |                |   |   |                                 |
|            | 1.4 TSI    | 118         | 06.08       |                |                |                |   |   |                                 |
|            | 1.4 TSI    | 125         | 05.06       |                |                |                |   |   |                                 |
|            | 1.6        | 75          | 05.05       |                |                |                |   |   |                                 |
|            | 1.6 BiFuel | 75          | 05.09       |                |                |                |   |   |                                 |
|            | 1.6 FSI    | 85          | 01.05       |                |                |                |   |   |                                 |
| 1.6 TDI    |            | 02.09       |             |                |                |                |   |   |                                 |
| 1.9 TDI    | 66         | 05.05       |             |                |                |                |   |   |                                 |
| 1.9 TDI    | 77         | 01.05       |             |                |                |                |   |   |                                 |
| 2.0 FSI    | 110        | 05.05       |             |                |                |                |   |   |                                 |
| 2.0 TDI    |            | 05.05       |             |                |                |                |   |   |                                 |
| 2.0 TDI    | 81         | 01.09       |             |                |                |                |   |   |                                 |
| 2.0 TDI    | 103        | 01.05       |             |                |                |                |   |   |                                 |
|            | 1.2 TSI    |             | 08.09       | PR: 1KD        | 24.3384-1755.7 | 220635         | 2 | D=38, - Halter<br>LUC<br>D=38, - Halter<br>LUC  | LUC<br>LUC                      |
|            | 1.4 16V    |             | 01.05       | PR: 1KD        | 24.3384-1756.7 | 220636         |   |   |                                 |
|            | 1.4 FSI    | 66          | 07.05       | PR: 1KD        |                |                |   |   |                                 |
|            | 1.4 TSI    | 90          | 06.07       | PR: 1KD        |                |                |   |   |                                 |
|            | 1.4 TSI    | 103         | 05.06       | PR: 1KD        |                |                |   |   |                                 |
|            | 1.4 TSI    | 118         | 06.08       | PR: 1KD        |                |                |   |   |                                 |
|            | 1.4 TSI    | 125         | 05.06       | PR: 1KD        |                |                |   |   |                                 |
|            | 1.6        | 75          | 05.05       | PR: 1KD        |                |                |   |   |                                 |
|            | 1.6 BiFuel | 75          | 05.09       | PR: 1KD        |                |                |   |   |                                 |
|            | 1.6 FSI    | 85          | 01.05       | PR: 1KD        |                |                |   |   |                                 |
| 1.6 TDI    |            | 02.09       | PR: 1KD     |                |                |                |   |   |                                 |
| 1.9 TDI    | 66         | 05.05       | PR: 1KD     |                |                |                |   |   |                                 |
| 1.9 TDI    | 77         | 01.05       | PR: 1KD     |                |                |                |   |   |                                 |
| 2.0 FSI    | 110        | 05.05       | PR: 1KD     |                |                |                |   |   |                                 |
| 2.0 TDI    |            | 05.05       | PR: 1KD     |                |                |                |   |   |                                 |
| 2.0 TDI    | 81         | 01.09       | PR: 1KD     |                |                |                |   |   |                                 |
| 2.0 TDI    | 103        | 01.05       | PR: 1KD     |                |                |                |   |   |                                 |
|            | 1.2 TSI    |             | 08.09       | PR: 1KE        | 24.3414-1709.7 | 220631         | 2 | D=41, - Halter<br>LUC<br>D=41, - Halter<br>LUC  | LUC<br>LUC                      |
|            | 1.4 16V    |             | 01.05       | PR: 1KE        | 24.3414-1710.7 | 220632         |   |   |                                 |
|            | 1.4 FSI    | 66          | 07.05       | PR: 1KE        |                |                |   |   |                                 |
|            | 1.4 TSI    | 90          | 06.07       | PR: 1KE        |                |                |   |   |                                 |
|            | 1.4 TSI    | 103         | 05.06       | PR: 1KE        |                |                |   |   |                                 |
|            | 1.4 TSI    | 118         | 06.08       | PR: 1KE        |                |                |   |   |                                 |
|            | 1.4 TSI    | 125         | 05.06       | PR: 1KE        |                |                |   |   |                                 |
|            | 1.6        | 75          | 05.05       | PR: 1KE        |                |                |   |   |                                 |
|            | 1.6 BiFuel | 75          | 05.09       | PR: 1KE        |                |                |   |   |                                 |
|            | 1.6 FSI    | 85          | 01.05       | PR: 1KE        |                |                |   |   |                                 |
| 1.6 TDI    |            | 02.09       | PR: 1KE     |                |                |                |   |   |                                 |
| 1.9 TDI    | 66         | 05.05       | PR: 1KE     |                |                |                |   |   |                                 |
| 1.9 TDI    | 77         | 01.05       | PR: 1KE     |                |                |                |   |   |                                 |
| 2.0 FSI    | 110        | 05.05       | PR: 1KE     |                |                |                |   |   |                                 |
| 2.0 TDI    |            | 05.05       | PR: 1KE     |                |                |                |   |   |                                 |
| 2.0 TDI    | 103        | 01.05       | PR: 1KE     |                |                |                |   |   |                                 |
|            | 1.4 16V    |             | 1K-8-500000 | 01.05          | PR: 1KZ        | 24.0101-3803.2 |   | Einbausatz  | LUC                             |
|            | 1.4 FSI    | 66          | 1K-8-500000 | 07.05          | PR: 1KZ        |                |   |   |                                 |
|            | 1.4 TSI    | 90          | 1K-8-500000 | 06.07          | PR: 1KZ        |                |   |   |                                 |
|            | 1.4 TSI    | 103         | 1K-8-500000 | 05.06          | PR: 1KZ        |                |   |   |                                 |
|            | 1.4 TSI    | 125         | 1K-8-500000 | 05.06          | PR: 1KZ        |                |   |   |                                 |
|            | 1.6        | 75          | 1K-8-500000 | 05.05          | PR: 1KZ        |                |   |   |                                 |
|            | 1.6 FSI    | 85          | 1K-8-500000 | 01.05          | PR: 1KZ        |                |   |   |                                 |
|            | 1.9 TDI    | 66          | 1K-8-500000 | 05.05          | PR: 1KZ        |                |   |   |                                 |
|            | 1.9 TDI    | 77          | 1K-8-500000 | 01.05          | PR: 1KZ        |                |   |   |                                 |
|            | 2.0 FSI    | 110         | 1K-8-500000 | 05.05          | PR: 1KZ        |                |   |   |                                 |
| 2.0 TDI    |            | 1K-8-500000 | 05.05       | PR: 1KZ        |                |                |   |   |                                 |
| 2.0 TDI    |            | 1K-8-500000 | 05.05       | PR: 1KZ        |                |                |   |   |                                 |



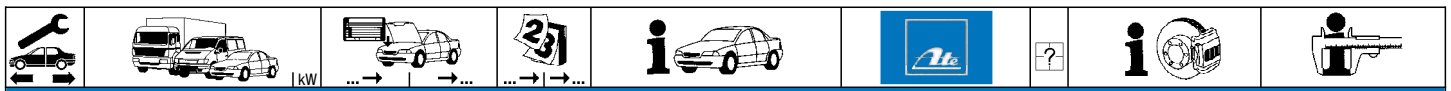

**VOLKSWAGEN GOLF Plus (05-)**

|  |            |             |             |       |         |                |        |   |                    |     |
|--|------------|-------------|-------------|-------|---------|----------------|--------|---|--------------------|-----|
|  | 2.0 TDI    | 103         | 1K-8-500000 | 01.05 | PR: 1KZ | 24.0101-3803.2 | 260101 |   | Einbausatz         | LUC |
|  | 1.2 TSI    |             |             | 08.09 | PR: 1KZ | 24.3387-1717.7 | 220757 |   | D=38, - Halter     | LUC |
|  | 1.4 16V    | 1K-8-500001 |             |       | PR: 1KZ | 24.3387-1718.7 | 220758 |   | D=38, - Halter     | LUC |
|  | 1.4 FSI    | 66          | 1K-8-500001 |       | PR: 1KZ | 24.0101-3803.2 | 260101 |   | Einbausatz         | LUC |
|  | 1.4 TSI    | 90          | 1K-8-500001 |       | PR: 1KZ |                |        |   |                    |     |
|  | 1.4 TSI    | 103         | 1K-8-500001 |       | PR: 1KZ |                |        |   |                    |     |
|  | 1.4 TSI    | 118         |             | 06.08 | PR: 1KZ |                |        |   |                    |     |
|  | 1.4 TSI    | 125         | 1K-8-500001 |       | PR: 1KZ |                |        |   |                    |     |
|  | 1.6        | 75          | 1K-8-500001 |       | PR: 1KZ |                |        |   |                    |     |
|  | 1.6 BiFuel | 75          |             | 05.09 | PR: 1KZ |                |        |   |                    |     |
|  | 1.6 FSI    | 85          | 1K-8-500001 |       | PR: 1KZ |                |        |   |                    |     |
|  | 1.6 TDI    |             |             | 02.09 | PR: 1KZ |                |        |   |                    |     |
|  | 1.9 TDI    | 66          | 1K-8-500001 |       | PR: 1KZ |                |        |   |                    |     |
|  | 1.9 TDI    | 77          | 1K-8-500001 |       | PR: 1KZ |                |        |   |                    |     |
|  | 2.0 FSI    | 110         | 1K-8-500001 |       | PR: 1KZ |                |        |   |                    |     |
|  | 2.0 TDI    |             | 1K-8-500001 |       | PR: 1KZ |                |        |   |                    |     |
|  | 2.0 TDI    | 81          |             | 01.09 | PR: 1KZ |                |        |   |                    |     |
|  | 2.0 TDI    | 103         | 1K-8-500001 |       | PR: 1KZ |                |        |   |                    |     |
|  | 1.2 TSI    |             |             | 08.09 |         | 83.7849-0231.3 | 330872 | 2 | L=233              |     |
|  | 1.4 16V    |             |             | 01.05 |         |                |        |   |                    |     |
|  | 1.4 FSI    | 66          |             | 07.05 |         |                |        |   |                    |     |
|  | 1.4 TSI    | 90          |             | 06.07 |         |                |        |   |                    |     |
|  | 1.4 TSI    | 103         |             | 05.06 |         |                |        |   |                    |     |
|  | 1.4 TSI    | 118         |             | 06.08 |         |                |        |   |                    |     |
|  | 1.4 TSI    | 125         |             | 05.06 |         |                |        |   |                    |     |
|  | 1.6        | 75          |             | 05.05 |         |                |        |   |                    |     |
|  | 1.6 BiFuel | 75          |             | 05.09 |         |                |        |   |                    |     |
|  | 1.6 FSI    | 85          |             | 01.05 |         |                |        |   |                    |     |
|  | 1.6 TDI    |             |             | 02.09 |         |                |        |   |                    |     |
|  | 1.9 TDI    | 66          |             | 05.05 |         |                |        |   |                    |     |
|  | 1.9 TDI    | 77          |             | 01.05 |         |                |        |   |                    |     |
|  | 2.0 FSI    | 110         |             | 05.05 |         |                |        |   |                    |     |
|  | 2.0 TDI    |             |             | 05.05 |         |                |        |   |                    |     |
|  | 2.0 TDI    | 81          |             | 01.09 |         |                |        |   |                    |     |
|  | 2.0 TDI    | 103         |             | 01.05 |         |                |        |   |                    |     |
|  | 1.4 16V    |             | 1K-9-899999 | 01.05 |         | 24.3727-2708.2 | 582708 | 2 | L=1447             |     |
|  | 1.4 FSI    | 66          | 1K-9-899999 | 07.05 |         |                |        |   |                    |     |
|  | 1.4 TSI    | 90          | 1K-9-899999 | 06.07 |         |                |        |   |                    |     |
|  | 1.4 TSI    | 103         | 1K-9-899999 | 05.06 |         |                |        |   |                    |     |
|  | 1.4 TSI    | 118         | 1K-9-899999 | 06.08 |         |                |        |   |                    |     |
|  | 1.4 TSI    | 125         | 1K-9-899999 | 05.06 |         |                |        |   |                    |     |
|  | 1.6        | 75          | 1K-9-899999 | 05.05 |         |                |        |   |                    |     |
|  | 1.6 FSI    | 85          | 1K-9-899999 | 01.05 |         |                |        |   |                    |     |
|  | 1.9 TDI    | 66          | 1K-9-899999 | 05.05 |         |                |        |   |                    |     |
|  | 1.9 TDI    | 77          | 1K-9-899999 | 01.05 |         |                |        |   |                    |     |
|  | 2.0 FSI    | 110         | 1K-9-899999 | 05.05 |         |                |        |   |                    |     |
|  | 2.0 TDI    |             | 1K-9-899999 | 05.05 |         |                |        |   |                    |     |
|  | 2.0 TDI    | 103         | 1K-9-899999 | 01.05 |         |                |        |   |                    |     |
|  | 1.2 TSI    |             |             | 08.09 |         | 24.3727-0195.2 | 580195 | 2 | L=1447             |     |
|  | 1.4 16V    | 1K-9-900001 |             |       |         |                |        |   |                    |     |
|  | 1.4 FSI    | 66          | 1K-9-900001 |       |         |                |        |   |                    |     |
|  | 1.4 TSI    | 90          | 1K-9-900001 |       |         |                |        |   |                    |     |
|  | 1.4 TSI    | 103         | 1K-9-900001 |       |         |                |        |   |                    |     |
|  | 1.4 TSI    | 118         | 1K-9-900001 |       |         |                |        |   |                    |     |
|  | 1.4 TSI    | 125         | 1K-9-900001 |       |         |                |        |   |                    |     |
|  | 1.6        | 75          | 1K-9-900001 |       |         |                |        |   |                    |     |
|  | 1.6 BiFuel | 75          |             | 05.09 |         |                |        |   |                    |     |
|  | 1.6 FSI    | 85          | 1K-9-900001 |       |         |                |        |   |                    |     |
|  | 1.6 TDI    |             |             | 02.09 |         |                |        |   |                    |     |
|  | 1.9 TDI    | 66          | 1K-9-900001 |       |         |                |        |   |                    |     |
|  | 1.9 TDI    | 77          | 1K-9-900001 |       |         |                |        |   |                    |     |
|  | 2.0 FSI    | 110         | 1K-9-900001 |       |         |                |        |   |                    |     |
|  | 2.0 TDI    |             | 1K-9-900001 |       |         |                |        |   |                    |     |
|  | 2.0 TDI    | 81          | 1K-9-900001 |       |         |                |        |   |                    |     |
|  | 2.0 TDI    | 103         | 1K-9-900001 |       |         |                |        |   |                    |     |
|  | 1.2 TSI    |             |             | 08.09 |         | 24.2415-1711.3 | 030130 |   | Gz 15,87           |     |
|  | 1.4 16V    |             |             | 01.05 |         | 24.2415-1713.3 | 030132 |   | Gz 15,87, + Sensor |     |
|  | 1.4 FSI    | 66          |             | 07.05 |         |                |        |   |                    |     |
|  | 1.4 TSI    | 90          |             | 06.07 |         |                |        |   |                    |     |
|  | 1.4 TSI    | 103         |             | 05.06 |         |                |        |   |                    |     |
|  | 1.4 TSI    | 118         |             | 06.08 |         |                |        |   |                    |     |
|  | 1.4 TSI    | 125         |             | 05.06 |         |                |        |   |                    |     |
|  | 1.6        | 75          |             | 05.05 |         |                |        |   |                    |     |
|  | 1.6 BiFuel | 75          |             | 05.09 |         |                |        |   |                    |     |
|  | 1.6 FSI    | 85          |             | 01.05 |         |                |        |   |                    |     |
|  | 1.6 TDI    |             |             | 02.09 |         |                |        |   |                    |     |
|  | 1.9 TDI    | 66          |             | 05.05 |         |                |        |   |                    |     |
|  | 1.9 TDI    | 77          |             | 01.05 |         |                |        |   |                    |     |
|  | 2.0 FSI    | 110         |             | 05.05 |         |                |        |   |                    |     |
|  | 2.0 TDI    |             |             | 05.05 |         |                |        |   |                    |     |
|  | 2.0 TDI    | 81          |             | 01.09 |         |                |        |   |                    |     |
|  | 2.0 TDI    | 103         |             | 01.05 |         |                |        |   |                    |     |
|  | 1.2 TSI    |             |             | 08.09 | PR: OEJ | 24.2519-1705.3 | 040095 |   | Nz 19,05           |     |
|  | 1.4 16V    |             |             | 01.05 | PR: OEJ |                |        |   |                    |     |
|  | 1.4 FSI    | 66          |             | 07.05 | PR: OEJ |                |        |   |                    |     |
|  | 1.4 TSI    | 90          |             | 06.07 | PR: OEJ |                |        |   |                    |     |



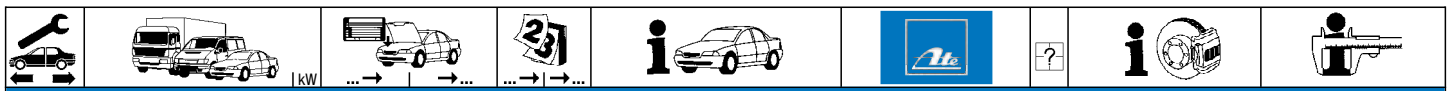

















**VOLKSWAGEN GOLF Plus (05-)**



















|  |            |     |  |       |         |                |        |  |  |          |
|--|------------|-----|--|-------|---------|----------------|--------|--|--|----------|
|  | 1.4 TSI    | 103 |  | 05.06 | PR: OEJ | 24.2519-1705.3 | 040095 |  |  | Nz 19,05 |
|  | 1.4 TSI    | 118 |  | 06.08 | PR: OEJ |                |        |  |  |          |
|  | 1.4 TSI    | 125 |  | 05.06 | PR: OEJ |                |        |  |  |          |
|  | 1.6        | 75  |  | 05.05 | PR: OEJ |                |        |  |  |          |
|  | 1.6 BiFuel | 75  |  | 05.09 | PR: OEJ |                |        |  |  |          |
|  | 1.6 FSI    | 85  |  | 01.05 | PR: OEJ |                |        |  |  |          |
|  | 1.6 TDI    |     |  | 02.09 | PR: OEJ |                |        |  |  |          |
|  | 1.9 TDI    | 66  |  | 05.05 | PR: OEJ |                |        |  |  |          |
|  | 1.9 TDI    | 77  |  | 01.05 | PR: OEJ |                |        |  |  |          |
|  | 2.0 FSI    | 110 |  | 05.05 | PR: OEJ |                |        |  |  |          |
|  | 2.0 TDI    |     |  | 05.05 | PR: OEJ |                |        |  |  |          |
|  | 2.0 TDI    | 81  |  | 01.09 | PR: OEJ |                |        |  |  |          |
|  | 2.0 TDI    | 103 |  | 01.05 | PR: OEJ |                |        |  |  |          |

**VOLKSWAGEN JETTA V (05-10)**

|  |           |     |             |       |       |                |        |             |                |     |
|--|-----------|-----|-------------|-------|-------|----------------|--------|-------------|----------------|-----|
|  | 1.4 TSI   | 90  |             | 05.07 | 10.10 | 03.7863-9602.4 | 300206 | PR: 1AS     | 10"            | ATE |
|  | 1.4 TSI   | 103 |             | 06.06 | 10.10 | 03.7863-9802.4 | 300281 | PR: 1AS,1LJ | 10"            | ATE |
|  | 1.4 TSI   | 118 |             | 07.08 | 10.10 |                |        |             |                |     |
|  | 1.4 TSI   | 125 |             | 06.06 | 10.10 |                |        |             |                |     |
|  | 1.6 FSI   | 85  |             | 08.05 | 10.10 |                |        |             |                |     |
|  | 1.6 i 16V | 75  |             | 08.05 | 10.10 |                |        |             |                |     |
|  | 1.6 TDI   |     |             | 06.09 | 10.10 |                |        |             |                |     |
|  | 1.9 TDI   | 77  |             | 08.05 | 10.10 |                |        |             |                |     |
|  | 2.0 FSI   | 110 |             | 08.05 | 10.10 |                |        |             |                |     |
|  | 2.0 TDI   | 100 |             | 09.05 | 10.10 |                |        |             |                |     |
|  | 2.0 TDI   | 103 |             | 08.05 | 10.10 |                |        |             |                |     |
|  | 2.0 TDI   | 125 |             | 06.06 | 10.10 |                |        |             |                |     |
|  | 2.0 TFSI  |     |             | 10.05 | 10.10 |                |        |             |                |     |
|  | 2.5 FSI   |     |             | 07.08 | 10.10 |                |        |             |                |     |
|  | 1.4 TSI   | 103 | 1K-6-741206 | 06.06 |       | 03.2122-2129.3 | 010799 | PR: 1AS     | THz 22,20      | ATE |
|  | 1.4 TSI   | 125 | 1K-6-741206 | 06.06 |       |                |        |             |                |     |
|  | 1.6 FSI   | 85  | 1K-6-741206 | 08.05 |       |                |        |             |                |     |
|  | 1.6 i 16V | 75  | 1K-6-741206 | 08.05 |       |                |        |             |                |     |
|  | 1.9 TDI   | 77  | 1K-6-741206 | 08.05 |       |                |        |             |                |     |
|  | 2.0 FSI   | 110 | 1K-6-741206 | 08.05 |       |                |        |             |                |     |
|  | 2.0 TDI   | 100 | 1K-6-741206 | 09.05 |       |                |        |             |                |     |
|  | 2.0 TDI   | 103 | 1K-6-741206 | 08.05 |       |                |        |             |                |     |
|  | 2.0 TDI   | 125 | 1K-6-741206 | 06.06 |       |                |        |             |                |     |
|  | 2.0 TFSI  |     | 1K-6-741206 | 10.05 |       |                |        |             |                |     |
|  | 1.4 TSI   | 90  |             | 05.07 | 10.10 | 03.2122-2129.3 | 010799 | PR: 1AS     | THz 22,20      | ATE |
|  | 1.4 TSI   | 103 | 1K-6-741207 | 10.10 |       |                |        |             |                |     |
|  | 1.4 TSI   | 118 |             | 07.08 | 10.10 |                |        |             |                |     |
|  | 1.4 TSI   | 125 | 1K-6-741207 | 10.10 |       |                |        |             |                |     |
|  | 1.6 FSI   | 85  | 1K-6-741207 | 10.10 |       |                |        |             |                |     |
|  | 1.6 i 16V | 75  | 1K-6-741207 | 10.10 |       |                |        |             |                |     |
|  | 1.6 TDI   |     |             | 06.09 | 10.10 |                |        |             |                |     |
|  | 1.9 TDI   | 77  | 1K-6-741207 | 10.10 |       |                |        |             |                |     |
|  | 2.0 FSI   | 110 | 1K-6-741207 | 10.10 |       |                |        |             |                |     |
|  | 2.0 TDI   | 100 | 1K-6-741207 | 10.10 |       |                |        |             |                |     |
|  | 2.0 TDI   | 103 | 1K-6-741207 | 10.10 |       |                |        |             |                |     |
|  | 2.0 TDI   | 125 | 1K-6-741207 | 10.10 |       |                |        |             |                |     |
|  | 2.0 TFSI  |     | 1K-6-741207 | 10.10 |       |                |        |             |                |     |
|  | 2.5 FSI   |     |             | 07.08 | 10.10 |                |        |             |                |     |
|  | 1.4 TSI   | 90  |             | 05.07 | 10.10 | 11.9541-9549.2 | 220575 |             | D=54, - Halter | ATE |
|  | 1.4 TSI   | 103 |             | 06.06 | 10.10 | 11.9541-9550.2 | 220576 |             | D=54, - Halter | ATE |
|  | 1.4 TSI   | 118 |             | 07.08 | 10.10 | 11.0101-5409.2 | 260035 |             | Hülsensatz     | ATE |
|  | 1.4 TSI   | 125 |             | 06.06 | 10.10 |                |        |             |                |     |
|  | 1.6 FSI   | 85  |             | 08.05 | 10.10 |                |        |             |                |     |
|  | 1.6 i 16V | 75  |             | 08.05 | 10.10 |                |        |             |                |     |
|  | 1.6 TDI   |     |             | 06.09 | 10.10 |                |        |             |                |     |
|  | 1.9 TDI   | 77  |             | 08.05 | 10.10 |                |        |             |                |     |
|  | 2.0 FSI   | 110 |             | 08.05 | 10.10 |                |        |             |                |     |
|  | 2.0 TDI   | 100 |             | 09.05 | 10.10 |                |        |             |                |     |
|  | 2.0 TDI   | 103 |             | 08.05 | 10.10 |                |        |             |                |     |
|  | 2.0 TDI   | 125 |             | 06.06 | 10.10 |                |        |             |                |     |
|  | 2.0 TFSI  |     |             | 10.05 | 10.10 |                |        |             |                |     |
|  | 2.5 FSI   |     |             | 07.08 | 10.10 |                |        |             |                |     |
|  | 1.4 TSI   | 90  |             | 05.07 | 10.10 | 11.9541-9553.2 | 220563 |             | D=54, - Halter | ATE |
|  | 1.4 TSI   | 103 |             | 06.06 | 10.10 | 11.9541-9554.2 | 220564 |             | D=54, - Halter | ATE |
|  | 1.4 TSI   | 118 |             | 07.08 | 10.10 | 11.0101-5409.2 | 260035 |             | Hülsensatz     | ATE |
|  | 1.4 TSI   | 125 |             | 06.06 | 10.10 | 11.8171-0008.1 | 990049 |             | Führungsbolzen | ATE |
|  | 1.6 FSI   | 85  |             | 08.05 | 10.10 | 11.8116-0351.1 | 390538 | 2           | Haltefeder     | ATE |
|  | 1.6 i 16V | 75  |             | 08.05 | 10.10 |                |        |             |                |     |
|  | 1.6 TDI   |     |             | 06.09 | 10.10 |                |        |             |                |     |
|  | 1.9 TDI   | 77  |             | 08.05 | 10.10 |                |        |             |                |     |
|  | 2.0 FSI   | 110 |             | 08.05 | 10.10 |                |        |             |                |     |
|  | 2.0 TDI   | 100 |             | 09.05 | 10.10 |                |        |             |                |     |
|  | 2.0 TDI   | 103 |             | 08.05 | 10.10 |                |        |             |                |     |
|  | 2.0 TDI   | 125 |             | 06.06 | 10.10 |                |        |             |                |     |
|  | 2.0 TFSI  |     |             | 10.05 | 10.10 |                |        |             |                |     |
|  | 2.5 FSI   |     |             | 07.08 | 10.10 |                |        |             |                |     |
|  | 1.4 TSI   | 90  |             | 05.07 | 10.10 | 11.9541-9553.2 | 220563 |             | D=54, - Halter | ATE |
|  | 1.4 TSI   | 103 |             | 06.06 | 10.10 | 11.9541-9554.2 | 220564 |             | D=54, - Halter | ATE |
|  | 1.4 TSI   | 118 |             | 07.08 | 10.10 | 11.0101-5409.2 | 260035 |             | Hülsensatz     | ATE |
|  | 1.4 TSI   | 125 |             | 06.06 | 10.10 | 11.8171-0008.1 | 990049 |             | Führungsbolzen | ATE |
|  | 1.6 FSI   | 85  |             | 08.05 | 10.10 | 11.8116-0351.1 | 390538 | 2           | Haltefeder     | ATE |
|  | 1.6 i 16V | 75  |             | 08.05 | 10.10 |                |        |             |                |     |
|  |           |     |             | 08.05 | 10.10 |                |        |             |                |     |



|     |   |  |   |    |   |      |  |                                      |
|--|---|--|---|--|--|--|--|--|
| <b>VOLKSWAGEN JETTA V (05-10)</b>  |   |  |   |  |  |  |  |  |
|    | 1.6 TDI<br>1.9 TDI<br>2.0 FSI<br>2.0 TDI<br>2.0 TDI<br>2.0 TDI<br>2.0 TFSI<br>2.5 FSI   | 77<br>110<br>100<br>103<br>125   | 06.09<br>08.05<br>08.05<br>09.05<br>08.05<br>06.06<br>10.05<br>07.08  | 10.10<br>10.10<br>10.10<br>10.10<br>10.10<br>10.10<br>10.10<br>10.10   | PR: 1LJ,1ZD<br>PR: 1LJ,1ZD<br>PR: 1LJ,1ZD<br>PR: 1LJ,1ZD<br>PR: 1LJ,1ZD<br>PR: 1LJ,1ZD<br>PR: 1LJ,1ZD<br>PR: 1LJ,1ZD   | 11.9541-9553.2<br>11.9541-9554.2<br>11.0101-5409.2<br>11.8171-0008.1<br>11.8116-0351.1 | 220563<br>220564<br>260035<br>990049<br>390538                                     | 2<br>D=54, - Halter<br>D=54, - Halter<br>Hülzensatz<br>Führungsbolzen<br>Haltefeder<br>ATE<br>ATE<br>ATE<br>ATE<br>ATE |
|    | 1.4 TSI<br>1.4 TSI<br>1.4 TSI<br>1.4 TSI<br>1.6 FSI<br>1.6 i 16V<br>1.6 TDI<br>1.9 TDI<br>2.0 FSI<br>2.0 TDI<br>2.0 TDI<br>2.0 TDI<br>2.0 TFSI<br>2.5 FSI | 90<br>103<br>118<br>125<br>85<br>75<br>77<br>110<br>100<br>103<br>125            | 05.07<br>06.06<br>07.08<br>06.06<br>08.05<br>08.05<br>06.09<br>08.05<br>08.05<br>09.05<br>08.05<br>06.06<br>10.05<br>07.08  | 10.10<br>10.10<br>10.10<br>10.10<br>10.10<br>10.10<br>10.10<br>10.10<br>10.10<br>10.10<br>10.10<br>10.10<br>10.10<br>10.10 |  | 83.7847-0563.3   | 331124   | 2<br>L=562   |
|    | 1.4 TSI<br>1.4 TSI<br>1.4 TSI<br>1.4 TSI<br>1.6 FSI<br>1.6 i 16V<br>1.6 TDI<br>1.9 TDI<br>2.0 FSI<br>2.0 TDI<br>2.0 TDI<br>2.0 TDI<br>2.0 TFSI<br>2.5 FSI | 90<br>103<br>118<br>125<br>85<br>75<br>77<br>110<br>100<br>103<br>125            | 05.07<br>06.06<br>07.08<br>06.06<br>08.05<br>08.05<br>06.09<br>08.05<br>08.05<br>09.05<br>08.05<br>06.06<br>10.05<br>07.08  | 10.10<br>10.10<br>10.10<br>10.10<br>10.10<br>10.10<br>10.10<br>10.10<br>10.10<br>10.10<br>10.10<br>10.10<br>10.10<br>10.10 | PR: 1KE,1KF,1KJ<br>PR: 1KE,1KF,1KJ<br>PR: 1KE,1KF,1KJ<br>PR: 1KE,1KF,1KJ<br>PR: 1KE,1KF,1KJ<br>PR: 1KE,1KF,1KJ<br>PR: 1KE,1KF,1KJ<br>PR: 1KE,1KF,1KJ<br>PR: 1KE,1KF,1KJ<br>PR: 1KE,1KF,1KJ<br>PR: 1KE,1KF,1KJ<br>PR: 1KE,1KF,1KJ<br>PR: 1KE,1KF,1KJ<br>PR: 1KE,1KF,1KJ | 24.3414-1709.7<br>24.3414-1710.7   | 220631<br>220632   | 2<br>D=41, - Halter<br>D=41, - Halter<br>LUC<br>LUC  |
|    | 1.4 TSI<br>1.4 TSI<br>1.4 TSI<br>1.4 TSI<br>1.6 FSI<br>1.6 i 16V<br>1.6 TDI<br>1.9 TDI<br>2.0 FSI<br>2.0 TDI<br>2.0 TDI<br>2.0 TDI<br>2.0 TFSI<br>2.5 FSI | 90<br>103<br>118<br>125<br>85<br>75<br>77<br>110<br>100<br>103<br>125            | 05.07<br>06.06<br>07.08<br>06.06<br>08.05<br>08.05<br>06.09<br>08.05<br>08.05<br>09.05<br>08.05<br>06.06<br>10.05<br>07.08  | 10.10<br>10.10<br>10.10<br>10.10<br>10.10<br>10.10<br>10.10<br>10.10<br>10.10<br>10.10<br>10.10<br>10.10<br>10.10<br>10.10 |  | 83.7849-0231.3   | 330872   | 2<br>L=233   |
|  | 1.4 TSI<br>1.4 TSI<br>1.4 TSI<br>1.6 FSI<br>1.6 i 16V<br>1.9 TDI<br>2.0 FSI<br>2.0 TDI<br>2.0 TDI<br>2.0 TDI<br>2.0 TFSI<br>2.5 FSI                       | 90<br>103<br>125<br>85<br>75<br>77<br>110<br>100<br>103<br>125                   | 1K-6-899000 05.07<br>1K-6-899000 06.06<br>1K-6-899000 06.06<br>1K-6-899000 08.05<br>1K-6-899000 08.05<br>1K-6-899000 08.05<br>1K-6-899000 08.05<br>1K-6-899000 09.05<br>1K-6-899000 08.05<br>1K-6-899000 06.06<br>1K-6-899000 10.05 | 10.10<br>10.10<br>10.10<br>10.10<br>10.10<br>10.10<br>10.10<br>10.10<br>10.10<br>10.10<br>10.10                            |  | 24.3727-2708.2   | 582708   | 2<br>L=1447  |
|  | 1.4 TSI<br>1.4 TSI<br>1.4 TSI<br>1.4 TSI<br>1.6 FSI<br>1.6 i 16V<br>1.6 TDI<br>1.9 TDI<br>2.0 FSI<br>2.0 TDI<br>2.0 TDI<br>2.0 TFSI<br>2.5 FSI            | 90<br>103<br>118<br>125<br>85<br>75<br>77<br>110<br>100<br>103<br>125            | 1K-7-000001<br>1K-7-000001<br>1K-7-000001<br>1K-7-000001<br>1K-7-000001<br>1K-7-000001<br>1K-7-000001<br>1K-7-000001<br>1K-7-000001<br>1K-7-000001<br>1K-7-000001<br>1K-7-000001<br>1K-7-000001                                     | 07.08<br>06.09<br>10.10<br>10.10<br>10.10<br>10.10<br>10.10<br>10.10<br>10.10<br>10.10<br>10.10<br>10.10<br>10.10          |  | 24.3727-0195.2   | 580195   | 2<br>L=1447  |
|  | 1.4 TSI<br>1.4 TSI<br>1.4 TSI<br>1.4 TSI<br>1.6 FSI<br>1.6 i 16V<br>1.6 TDI<br>1.9 TDI<br>2.0 FSI<br>2.0 TDI<br>2.0 TDI<br>2.0 TDI                        | 90<br>103<br>118<br>125<br>85<br>75<br>77<br>110<br>100<br>103<br>125            | 05.07<br>06.06<br>07.08<br>06.06<br>08.05<br>08.05<br>06.09<br>08.05<br>08.05<br>09.05<br>08.05<br>06.06  | 10.10<br>10.10<br>10.10<br>10.10<br>10.10<br>10.10<br>10.10<br>10.10<br>10.10<br>10.10<br>10.10<br>10.10                   |  | 24.2415-1711.3   | 030130   | Gz 15,87   |

| VOLKSWAGEN JETTA V (05-10)   |   |  |   |   |  |                                      |  |  |  |                          |
|--|---|--|---|---|--|--------------------------------------|--|--|--|--------------------------|
|     | 2.0 TFSI<br>2.5 FSI   |  | 10.05<br>07.08  | 10.10<br>10.10  | 24.2415-1711.3   | 030130                               |  | Gz 15,87                                       |  |                          |
|    | 1.4 TSI<br>1.4 TSI<br>1.4 TSI<br>1.6 FSI<br>1.6 i 16V<br>1.6 TDI<br>1.9 TDI<br>2.0 FSI<br>2.0 TDI<br>2.0 TDI<br>2.0 TDI | 90<br>103<br>125<br>85<br>75<br>77<br>110<br>100<br>103<br>125 | 05.07<br>06.06<br>06.06<br>08.05<br>08.05<br>06.09<br>08.05<br>08.05<br>09.05<br>08.05<br>06.06 | 10.10<br>10.10<br>10.10<br>10.10<br>10.10<br>10.10<br>10.10<br>10.10<br>10.10<br>10.10<br>10.10   | 24.2519-1705.3   | 040095                               | für Getriebe MQ-250 <sup>1)</sup>  | Nz 19,05                                       |  |                          |
| VOLKSWAGEN JETTA VI (11-)  |   |  |   |   |  |                                      |  |  |  |                          |
|    | 1.2 TSI<br>1.4 TSI<br>1.4 TSI<br>1.4 TSI Hybrid<br>1.6<br>1.6 TDI<br>2.0 TDI<br>2.0 TSI<br>2.0 TSI                      | 77<br>90<br>110<br>77<br>77<br>103<br>147<br>155               | 04.11<br>04.11<br>04.11<br>04.11<br>12.11<br>04.11<br>04.11<br>04.11<br>12.12                   | PR: 1ZM,1ZQ<br>PR: 1ZM,1ZQ<br>PR: 1ZM,1ZQ<br>PR: 1ZM,1ZQ<br>PR: 1ZM,1ZQ<br>PR: 1ZM,1ZQ<br>PR: 1ZM,1ZQ<br>PR: 1ZM,1ZQ<br>PR: 1ZM,1ZQ                                     | 11.9541-9549.2<br>11.9541-9550.2<br>11.0101-5409.2                   | 220575<br>220576<br>260035           | <br>     | D=54, - Halter<br>D=54, - Halter<br>Hülzensatz | ATE<br>ATE<br>ATE  |                          |
|    | 1.2 TSI<br>1.4 TSI<br>1.4 TSI<br>1.4 TSI Hybrid<br>1.6<br>1.6 TDI<br>2.0 TDI<br>2.0 TSI<br>2.0 TSI                      | 77<br>90<br>110<br>77<br>77<br>103<br>147<br>155               | 04.11<br>04.11<br>04.11<br>04.11<br>12.11<br>04.11<br>04.11<br>04.11<br>12.12                   | PR: 1ZE,1ZP<br>PR: 1ZE,1ZP<br>PR: 1ZE,1ZP<br>PR: 1ZE,1ZP<br>PR: 1ZE,1ZP<br>PR: 1ZE,1ZP<br>PR: 1ZE,1ZP<br>PR: 1ZE,1ZP<br>PR: 1ZE,1ZP                                     | 11.9541-9553.2<br>11.9541-9554.2<br>11.0101-5409.2                   | 220563<br>220564<br>260035           | <br>     | D=54, - Halter<br>D=54, - Halter<br>Hülzensatz | ATE<br>ATE<br>ATE  |                          |
|    | 1.2 TSI<br>1.4 TSI<br>1.4 TSI<br>1.4 TSI Hybrid<br>1.6<br>1.6 TDI<br>2.0 TDI<br>2.0 TSI<br>2.0 TSI                      | 77<br>90<br>110<br>77<br>77<br>103<br>147<br>155               | 04.11<br>04.11<br>04.11<br>04.11<br>12.11<br>04.11<br>04.11<br>04.11<br>12.12                   | PR: 1ZA,1ZB,1LV<br>PR: 1ZA,1ZB,1LV<br>PR: 1ZA,1ZB,1LV<br>PR: 1ZA,1ZB,1LV<br>PR: 1ZA,1ZB,1LV<br>PR: 1ZA,1ZB,1LV<br>PR: 1ZA,1ZB,1LV<br>PR: 1ZA,1ZB,1LV<br>PR: 1ZA,1ZB,1LV | 11.9541-9553.2<br>11.9541-9554.2<br>11.0101-5409.2<br>11.8171-0008.1 | 220563<br>220564<br>260035<br>990049 | <br>     | 2  | D=54, - Halter<br>D=54, - Halter<br>Hülzensatz<br>Führungsbolzen | ATE<br>ATE<br>ATE<br>ATE |
|  | 1.2 TSI<br>1.4 TSI<br>1.4 TSI<br>1.4 TSI Hybrid<br>1.6 TDI<br>2.0 TDI<br>2.0 TSI  | 77<br>90<br>110<br>77<br>103<br>147                            | 04.11<br>04.11<br>04.11<br>04.11<br>04.11<br>04.11<br>04.11                                     | 11.11<br>11.11<br>11.11<br>11.11<br>11.11<br>11.11<br>11.11   | 83.7847-0563.3   | 331124                               | 2  | L=562  |  |                          |
|  | 1.2 TSI<br>1.4 TSI<br>1.4 TSI<br>1.4 TSI Hybrid<br>1.6<br>1.6 TDI<br>2.0 TDI<br>2.0 TSI                                 | 77<br>90<br>110<br>77<br>77<br>103<br>147<br>155               | 04.11<br>04.11<br>04.11<br>04.11<br>12.11<br>04.11<br>04.11<br>12.12                            | PR: 1KD<br>PR: 1KD<br>PR: 1KD<br>PR: 1KD<br>PR: 1KD<br>PR: 1KD<br>PR: 1KD<br>PR: 1KD  | 24.3384-1755.7<br>24.3384-1756.7                                     | 220635<br>220636                     | <br> | D=38, - Halter<br>D=38, - Halter               | LUC<br>LUC   |                          |
|  | 1.2 TSI<br>1.4 TSI<br>1.4 TSI<br>1.4 TSI Hybrid<br>1.6<br>1.6 TDI<br>2.0 TDI<br>2.0 TSI<br>2.0 TSI                      | 77<br>90<br>110<br>77<br>77<br>103<br>147<br>155               | 04.11<br>04.11<br>04.11<br>04.11<br>12.11<br>04.11<br>04.11<br>04.11<br>12.12                   |   | 83.7849-0231.3   | 330872                               | 2  | + HA-Trommelbremse <sup>2)</sup>               | L=233  |                          |
|  | 1.2 TSI<br>1.4 TSI<br>1.4 TSI<br>1.4 TSI Hybrid<br>1.6<br>1.6 TDI<br>2.0 TDI<br>2.0 TSI<br>2.0 TSI                      | 77<br>90<br>110<br>77<br>77<br>103<br>147<br>155               | 04.11<br>04.11<br>04.11<br>04.11<br>12.11<br>04.11<br>04.11<br>04.11<br>12.12                   | PR: VF1<br>PR: VF1<br>PR: VF1<br>PR: VF1<br>PR: VF1<br>PR: VF1<br>PR: VF1<br>PR: VF1<br>PR: VF1   | 24.2415-1713.3   | 030132                               |  | Gz 15,87, + Sensor                             |  |                          |
|  | 1.2 TSI<br>1.4 TSI<br>1.4 TSI<br>1.4 TSI Hybrid<br>2.0 TSI  | 77<br>90<br>110<br>147   | 04.11<br>04.11<br>04.11<br>04.11<br>04.11   | PR: 0EJ<br>PR: 0EJ<br>PR: 0EJ<br>PR: 0EJ<br>PR: 0EJ   | 24.2519-1705.3   | 040095                               |  | Nz 19,05                                       |  |                          |

<sup>1)</sup> for transmission MQ-250 / per scatola camb.MQ-250 / pour boîte de vitesse MQ-250 / caja de cambios para MQ-250

<sup>2)</sup> + RA drum brake / + P freno a tamburo / + frein à tambour essieu AR / + ET-tambores de freno



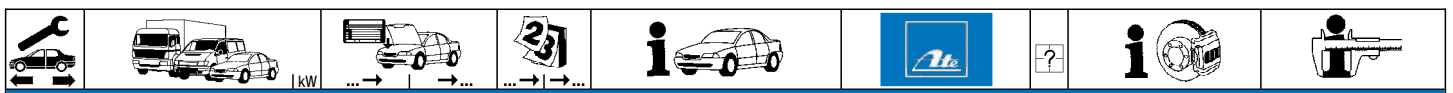

**VOLKSWAGEN LT/LT 4x4 (75-96)**

|  |   |   |   |  |  |  |  |   |                                 |
|--|---|---|---|--|--|--|--|---|---------------------------------|
|  | LT 28<br>LT 31<br>LT 35                                     |   |   | 04.75 07.96<br>04.75 07.96<br>04.75 07.96 - Doppelbereifung <sup>1)</sup>  | 03.6850-5402.4   | 300055   |  | 9"  | ATE                             |
|  | LT 28<br>LT 31<br>LT 35                                     |   |   | 04.75 07.96 - ABS<br>04.75 07.96 - ABS<br>04.75 07.96 - ABS/ - Doppelbereifung <sup>2)</sup>   | 03.2123-5212.3   | 010183   |  | THz 23,81                                     | ATE                             |
|  | LT 35<br>LT 40<br>LT 45<br>LT 50<br>LT 55                   |   |   | 04.75 07.96 - ABS/ + Doppelbereifung <sup>3)</sup><br>08.78 07.96 - ABS<br>08.78 07.96 - ABS<br>12.82 07.96 - ABS<br>08.85 07.96 - ABS   | 03.2125-1712.3   | 010204   |  | THz 25,40                                     | ATE                             |
|  | LT 28<br>LT 31<br>LT 35                                     |   |   | 04.75 07.96<br>04.75 07.96<br>04.75 07.96  | 13.2571-8027.2<br>13.2571-8028.2<br>24.9257-8027.5<br>24.9257-8028.5<br>13.0441-5720.2 | 210129<br>210130<br>230039<br>230040<br>250122 | <input type="checkbox"/><br><input type="checkbox"/><br><input type="checkbox"/><br><input type="checkbox"/><br><input type="checkbox"/> | D=57<br>D=57<br>D=57<br>D=57<br>Dichtungssatz | ATE<br>ATE<br>ATE<br>ATE<br>ATE |
|  | LT 40<br>LT 45<br>LT 50<br>LT 55                            |   |   | 08.78 07.96<br>08.78 07.96<br>12.82 07.96<br>08.85 07.96   | 13.9571-0041.2<br>13.9571-0042.2<br>24.9257-0041.5<br>24.9257-0042.5<br>13.0441-5720.2 | 210259<br>210260<br>230049<br>230050<br>250122 | <input type="checkbox"/><br><input type="checkbox"/><br><input type="checkbox"/><br><input type="checkbox"/>                             | D=57<br>D=57<br>D=57<br>D=57<br>Dichtungssatz | ATE<br>ATE<br>ATE<br>ATE<br>ATE |
|  | LT 28<br>LT 31<br>LT 35                                     |   |   | 04.75 07.96<br>04.75 07.96<br>04.75 07.96  | 24.5224-0299.3   | 331262   | 2  | L=300   |                                 |
|  | LT 40<br>LT 45<br>LT 50<br>LT 55                            |   |   | 08.78 07.96<br>08.78 07.96<br>12.82 07.96<br>08.85 07.96   | 83.7834-0440.3   | 330813   | 2  | L=440   |                                 |
|  | LT 28<br>LT 31<br>LT 35<br>LT 40<br>LT 45                   |   | 28-D-007273<br>28-D-007273<br>28-D-007273<br>28-D-007273<br>28-D-007273 | 04.75<br>04.75<br>04.75<br>08.78<br>08.78  | 83.6301-0355.3   | 330343   | 2  | L=355   |                                 |
|  | LT 28<br>LT 31<br>LT 35<br>LT 40<br>LT 45<br>LT 50<br>LT 55 | 28-D-007274<br>28-D-007274<br>28-D-007274<br>28-D-007274<br>28-D-007274 |   | 07.96<br>07.96<br>07.96<br>07.96<br>12.82 07.96<br>08.85 07.96   | 83.6124-0362.3   | 330715   | 1  | L=360   |                                 |
|  | LT 28<br>LT 31<br>LT 35                                     |   |   | 04.75 07.96<br>04.75 07.96<br>04.75 07.96 - Doppelbereifung <sup>1)</sup>  | 03.3225-5511.3   | 020102   |  | Rz 25,40                                      |                                 |
|  | LT 35<br>LT 35<br>LT 40<br>LT 45<br>LT 50<br>LT 55          | 29-M-009907   |   | 04.75 07.96<br>04.75 10.90 + Doppelbereifung <sup>4)</sup><br>08.78 07.96 - Radstand 3650 mm <sup>5)</sup><br>08.78 07.96 - Radstand 3650 mm <sup>5)</sup><br>12.82 07.96 - Radstand 3650 mm <sup>5)</sup><br>08.85 07.96 - Radstand 3650 mm <sup>5)</sup> | 03.3225-5512.3   | 020103   |  | Rz 25,40                                      |                                 |
|  | LT 40<br>LT 45<br>LT 50<br>LT 55                            |   |   | 08.78 07.96 + Radstand 3650 mm <sup>6)</sup><br>08.78 07.96 + Radstand 3650 mm <sup>6)</sup><br>12.82 07.96 + Radstand 3650 mm <sup>6)</sup><br>08.85 07.96 + Radstand 3650 mm <sup>6)</sup>   | 24.3226-0901.3   | 020295   |  | Rz 26,99                                      |                                 |
|  | LT 28<br>LT 31  |   | 28ZD007246<br>28ZD007246  | 04.75<br>04.75   | 24.3727-0112.2<br>24.3727-0113.2   | 580112<br>580113                               | <input type="checkbox"/><br><input type="checkbox"/>   | L=1042<br>L=1683                              |                                 |
|  | LT 28<br>LT 31  |   | 28-D-007246<br>28-D-007246  | 04.75<br>04.75   | 24.3727-0113.2<br>24.3727-0112.2   | 580113<br>580112                               | <input type="checkbox"/><br><input type="checkbox"/>   | L=1683<br>L=1042                              |                                 |
|  | LT 28<br>LT 31  | 28-D-007247<br>28-D-007247  |   | 07.96<br>07.96   | 24.3727-0112.2<br>24.3727-0113.2   | 580112<br>580113                               | <input type="checkbox"/><br><input type="checkbox"/>   | L=1042<br>L=1683                              |                                 |
|  | LT 35   | 29-G-014001   |   | 07.96 + Einfachbereifung <sup>7)</sup>   | 24.3727-0112.2<br>24.3727-0113.2   | 580112<br>580113                               | <input type="checkbox"/><br><input type="checkbox"/>   | L=1042<br>L=1683                              |                                 |
|  | LT 50<br>LT 55  | 29-G-014001   |   | 07.96<br>08.85 07.96   | 24.3727-0120.2   | 580120   | 2 <input type="checkbox"/>   | L=1400  |                                 |
|  | LT 28<br>LT 31<br>LT 35<br>LT 40<br>LT 45<br>LT 50<br>LT 55 | 28-D-007274<br>28-D-007274<br>28-D-007274<br>28-D-007274<br>28-D-007274 |   | 07.96<br>07.96<br>07.96<br>07.96<br>07.96<br>12.82 07.96<br>08.85 07.96  | 24.3728-0126.2   | 590126   |  | L=1819  |                                 |

**VOLKSWAGEN LT/LT 4x4 (96-06)**

|  |                         |                            |   |                         |                         |                |        |  |                  |
|--|-------------------------|----------------------------|---|-------------------------|-------------------------|----------------|--------|--|------------------|
|  | LT 28<br>LT 35<br>LT 46 |                            | 2D-2-011024<br>2D-2-011024<br>2D-2-011024 | 05.96<br>05.96<br>05.96 | - ABS<br>- ABS<br>- ABS | 24.2123-1728.3 | 010558 |  | THz 23,81        |
|  | LT 28<br>LT 35<br>LT 46 |                            | 2D-2-011024<br>2D-2-011024<br>2D-X-012290 | 05.96<br>05.96<br>05.96 | + ABS<br>+ ABS<br>+ ABS | 24.2123-1711.3 | 010518 |  | THz 23,81        |
|  | LT 46                   | 2D-X-012291                | 2D-2-011024                               |                         | + ABS                   | 24.2125-1727.3 | 010723 |  | THz 25,40        |
|  | LT 28<br>LT 35          | 2D-2-011025<br>2D-2-011025 |   | 07.06<br>07.06          |                         | 24.2123-1755.3 | 010750 |  | THz 23,81        |
|  | LT 46                   | 2D-2-011025                |   | 07.06                   | + ABS                   | 24.2125-1735.3 | 010879 |  | THz 25,40<br>LUC |

1) - twin tyres / - ruote gemellate / - roue jumelée / - cubierta doble  
 2) - ABS/ - twin tyres / - ABS/ - ruote gemellate / - ABS/ - roue jumelée / - ABS/ - cubierta doble  
 3) - ABS/ + twin tyres / - ABS/ + ruote gemellate / - ABS/ + roue jumelée / - ABS/ + cubierta doble  
 4) + twin tyres / + ruote gemellate / + roue jumelée / + cubierta doble  
 5) - wheel base 3650mm / - passo 3650mm / - empattement 3650mm / - distancia entre ejes 3650mm  
 6) + wheel base 3650 mm / + passo 3650 mm / + empattement 3650 mm / + distancia entre ejes 3650 mm  
 7) + single tyre / + ruota singola / + roue simple / + cubierta simple

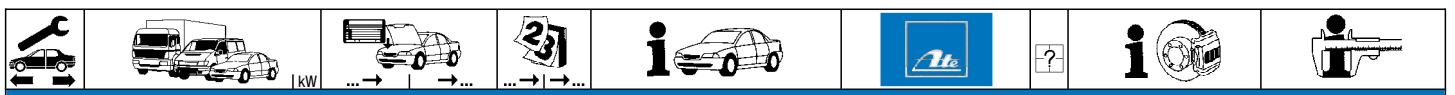

### VOLKSWAGEN LT/LT 4x4 (96-06)













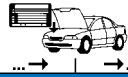





|  |                         |  |              |                         |                         |                                  |  |  |        |  |  |  |
|--|-------------------------|--|--------------|-------------------------|-------------------------|----------------------------------|--|--|--------|--|--|--|
|  | LT 28<br>LT 35          |  |              | 05.96<br>05.96          | 07.06<br>07.06          |                                  | 11.3601-8513.2<br>11.3601-8514.2<br>11.0441-6007.2<br>11.0101-5704.2<br>11.8171-0008.1<br>11.8116-0200.1 | 220393<br>220394<br>250146<br>260095<br>990049<br>390505 | 2      |  | D=60, - Halter<br>D=60, - Halter<br>Dichtungssatz<br>Hülssensatz<br>Führungsbolzen<br>Haltefeder | ATE<br>ATE<br>ATE<br>ATE<br>ATE<br>ATE |
|  | LT 46                   |  | 2D-3-003239  | 05.96                   |                         |                                  | 24.3441-1701.5<br>24.3441-1702.5   | 240331<br>240332   |        |  | D=44, - Halter<br>D=44, - Halter   | PER<br>PER                             |
|  | LT 28<br>LT 35<br>LT 46 |  |              | 05.96<br>05.96<br>05.96 | 07.06<br>07.06<br>07.06 |                                  | 83.7716-0363.3   | 330829   | 2      |  | L=363  |  |
|  | LT 28                   |  |              | 05.96                   | 07.06                   |                                  | 11.3451-8501.2<br>11.3451-8502.2<br>11.0441-4502.2<br>11.0101-5409.2<br>11.8171-0008.1<br>11.8116-0172.1 | 220389<br>220390<br>250143<br>260035<br>990049<br>390500 | 2      |  | D=45, - Halter<br>D=45, - Halter<br>Dichtungssatz<br>Hülssensatz<br>Führungsbolzen<br>Haltefeder | ATE<br>ATE<br>ATE<br>ATE<br>ATE<br>ATE |
|  | LT 35                   |  | 2D-X-002 119 | 05.96                   |                         |                                  | 11.3521-8501.2<br>11.3521-8502.2<br>11.0441-5203.2<br>11.0101-5409.2<br>11.8171-0008.1<br>11.8116-0191.1 | 220391<br>220392<br>250144<br>260035<br>990049<br>390522 | 2      |  | D=52, - Halter<br>D=52, - Halter<br>Dichtungssatz<br>Hülssensatz<br>Führungsbolzen<br>Haltefeder | ATE<br>ATE<br>ATE<br>ATE<br>ATE<br>ATE |
|  | LT 35                   |  | 2D-X-002 120 |                         | 07.06                   |                                  | 24.3521-1707.5<br>24.3521-1708.5   | 240471<br>240472   |        |  | D=52, - Halter<br>D=52, - Halter   | BOS<br>BOS                             |
|  | LT 46                   |  | 2D-2H005 686 | 05.96                   |                         |                                  | 24.3441-1701.5<br>24.3441-1702.5   | 240331<br>240332   |        |  | D=44, - Halter<br>D=44, - Halter   | PER<br>PER                             |
|  | LT 28<br>LT 35<br>LT 46 |  |              | 05.96<br>05.96<br>05.96 | 07.06<br>07.06<br>07.06 |                                  | 83.7716-0363.3   | 330829   | 2      |  | L=363  |  |
|  | LT 28<br>LT 35<br>LT 46 |  |              | 05.96<br>05.96<br>05.96 | 07.06<br>07.06<br>07.06 |                                  | 24.3727-0442.2<br>24.3727-0438.2   | 580442<br>580438   | 1<br>2 |  | L=1435<br>L=1513   |  |
|  | LT 28<br>LT 35          |  |              | 05.96<br>05.96          | 07.06<br>07.06          | + Radstand 3000 mm <sup>2)</sup> | 24.3727-0443.2<br>24.3727-0438.2   | 580443<br>580438   | 1<br>2 |  | L=1990<br>L=1513   |  |
|  | LT 28<br>LT 35          |  |              | 05.96<br>05.96          | 07.06<br>07.06          | + Radstand 3550 mm <sup>3)</sup> | 24.3727-0441.2<br>24.3727-0438.2   | 580441<br>580438   | 1<br>2 |  | L=2460<br>L=1513   |  |
|  | LT 35                   |  |              | 05.96                   | 07.06                   | + Radstand 4025 mm <sup>4)</sup> | 24.3727-0441.2<br>24.3727-0438.2   | 580441<br>580438   | 1<br>2 |  | L=1970<br>L=1525<br>L=1526   |  |
|  | LT 46                   |  |              | 05.96                   | 07.06                   | + Radstand 3550 mm <sup>3)</sup> | 24.3727-0444.2<br>24.3727-0179.2<br>24.3727-0180.2   | 580444<br>580179<br>580180                               | 1<br>2 |  | L=2440<br>L=1525<br>L=1526   |  |
|  | LT 28<br>LT 35<br>LT 46 |  |              | 05.96<br>05.96<br>05.96 | 07.06<br>07.06<br>07.06 |                                  | 24.2419-1712.3   | 030105   |        |  | Gz 19,05   |  |
|  | LT 28<br>LT 35<br>LT 46 |  |              | 05.96<br>05.96<br>05.96 | 07.06<br>07.06<br>07.06 |                                  | 24.2522-1703.3   | 040077   |        |  | Nz 22,20   |  |















### VOLKSWAGEN LUPO (98-05)

















































|  |  |  |  |   |   |  |                |        |  |                 |           |     |
|--|--|--|--|---|---|--|----------------|--------|--|-----------------|-----------|-----|
|  | 1.4 16V<br>1.4 FSI<br>1.6 GTI  | 74<br>77<br>92                         |  | 01.99<br>09.00<br>09.00                                     | 08.05<br>08.05<br>08.05                                     | + ESP<br>+ ESP<br>+ ESP  | 03.7853-0102.4 | 300252 |  | PR: 1AT,1LX,1ZE | 9"        | ATE |
|  | 1.0<br>1.2 TDI 3L<br>1.4<br>1.4 16V<br>1.4 TDI<br>1.7 SDI                                  | 45<br>44<br>55<br>55                   |  | 04.98<br>05.99<br>09.00<br>10.98<br>01.99<br>04.98          | 08.05<br>08.05<br>08.05<br>08.05<br>08.05<br>08.05          | - ABS<br>- ABS<br>- ABS<br>- ABS<br>- ABS<br>- ABS   | 03.2120-3943.3 | 010532 |  |                 | Thz 20,64 | ATE |
|  | 1.0<br>1.2 TDI 3L<br>1.4<br>1.4 16V<br>1.4 TDI<br>1.7 SDI                                  | 45<br>44<br>55<br>55                   |  | 04.98<br>06.99<br>09.00<br>10.98<br>01.99<br>04.98          | 08.05<br>08.05<br>08.05<br>08.05<br>08.05<br>08.05          | + ABS/ - ESP<br>+ ABS/ - ESP<br>+ ABS/ - ESP<br>+ ABS/ - ESP<br>+ ABS/ - ESP<br>+ ABS/ - ESP | 03.2122-1344.3 | 010593 |  |                 | Thz 22,20 | ATE |
|  | 1.0<br>1.2 TDI 3L<br>1.4<br>1.4 16V<br>1.4 16V<br>1.4 FSI<br>1.4 TDI<br>1.6 GTI<br>1.7 SDI | 45<br>44<br>55<br>74<br>77<br>55<br>92 |  | 04.98<br>06.99<br>09.00<br>10.98<br>01.99<br>09.00<br>04.98 | 08.05<br>08.05<br>08.05<br>08.05<br>08.05<br>08.05<br>08.05 | + ABS<br>+ ABS<br>+ ABS<br>+ ABS<br>+ ABS<br>+ ABS<br>+ ABS                                  | 03.2122-1184.3 | 010592 |  |                 | Thz 22,20 | ATE |
|  | 1.0<br>1.2 TDI 3L<br>1.4<br>1.4 16V<br>1.4 TDI<br>1.7 SDI                                  | 45<br>44<br>55<br>55                   |  | 04.98<br>06.99<br>09.00<br>10.98<br>01.99<br>04.98          | 08.05<br>08.05<br>08.05<br>08.05<br>08.05<br>08.05          | + ABS/ + ESP<br>+ ABS/ + ESP<br>+ ABS/ + ESP<br>+ ABS/ + ESP<br>+ ABS/ + ESP<br>+ ABS/ + ESP | 03.2122-1724.3 | 010648 |  |                 | Thz 22,20 | ATE |
|  | 1.4 16V<br>1.4 FSI<br>1.6 GTI  | 74<br>77<br>92                         |  | 01.99<br>09.00<br>09.00                                     | 08.05<br>08.05<br>08.05                                     | + ABS/ - ESP<br>+ ABS/ - ESP<br>+ ABS/ - ESP   | 03.2123-1824.3 | 010596 |  |                 | Thz 23,81 | ATE |
|  | 1.4 16V  | 74                                     |  | 01.99   | 08.05   | + ABS/ + ESP   | 03.2123-2350.3 | 010745 |  |                 | Thz 23,81 | ATE |

1) on the brake caliper / sulla pinza freno / sur l'étrier de frein / a la pinza de freno  
 2) + wheel base 3000 mm / + passo 3000 mm / + empattement 3000 mm / + distancia entre ejes 3000 mm  
 3) + wheel base 3550 mm / + passo 3550 mm / + empattement 3550 mm / + distancia entre ejes 3550 mm  
 4) + wheel base 4025 mm / + passo 4025 mm / + empattement 4025 mm / + distancia entre ejes 4025 mm



|     |            |  |  |  |    |      |  |   |
|--|--|--|--|--|---|--|--|---|
| <b>VOLKSWAGEN LUPO (98-05)</b>   |  |  |  |  |   |  |  |   |
|    | 1.4 FSI<br>1.6 GTI   | 77<br>92   |  | 09.00<br>09.00   | 08.05 + ABS/ + ESP<br>08.05 + ABS/ + ESP  | 03.2123-2350.3   | 010745   | ThZ 23,81<br><b>ATE</b>   |
|    | 1.2 TDI 3L   | 45   |  | 06.99  | 08.05 PR: 1ZB   | 11.9486-0009.2<br>11.9486-0010.2<br>11.0101-5409.2<br>11.8171-0008.1                   | 220841<br>220842<br>260035<br>990049   | D=48, - Halter<br>D=48, - Halter<br>Hülzensatz<br>Führungsbolzen<br><b>ATE</b><br><b>ATE</b><br><b>ATE</b><br><b>ATE</b>                        |
|  | 1.0<br>1.4<br>1.4 16V<br>1.4 16V<br>1.4 FSI<br>1.4 TDI<br>1.6 GTI<br>1.7 SDI               | 44<br>55<br>74<br>77<br>55<br>92   |  | 04.98<br>09.00<br>10.98<br>01.99<br>09.00<br>09.00<br>04.98                      | 08.05 PR: 1LM,1ZN,1LB,1ZC<br>08.05 PR: 1LM,1ZN,1LB,1ZC<br>08.05 PR: 1LM,1ZN,1LB,1ZC<br>08.05 PR: 1LM,1ZN,1LB,1ZC<br>08.05 PR: 1LM,1ZN,1LB,1ZC<br>08.05 PR: 1LM,1ZN,1LB,1ZC<br>08.05 PR: 1LM,1ZN,1LB,1ZC | 24.3481-1735.5<br>24.3481-1736.5<br>11.0101-4801.2<br>24.0102-4801.2<br>11.0441-4808.2 | 240283<br>240284<br>260006<br>260085<br>250022                                     | D=48, - Halter<br>D=48, - Halter<br>Hülzensatz<br>Hülzensatz+Schrauben<br>Dichtungssatz<br><b>ATE</b><br><b>ATE</b><br><b>ATE</b><br><b>ATE</b> |
|  | 1.0<br>1.4<br>1.4 16V<br>1.4 16V<br>1.4 FSI<br>1.4 TDI<br>1.6 GTI<br>1.7 SDI               | 44<br>55<br>74<br>77<br>55<br>92   |  | 04.98<br>09.00<br>10.98<br>01.99<br>09.00<br>09.00<br>04.98                      | 08.05 PR: 1ZE,1ZJ,1ZK<br>08.05 PR: 1ZE,1ZJ,1ZK<br>08.05 PR: 1ZE,1ZJ,1ZK<br>08.05 PR: 1ZE,1ZJ,1ZK<br>08.05 PR: 1ZE,1ZJ,1ZK<br>08.05 PR: 1ZE,1ZJ,1ZK<br>08.05 PR: 1ZE,1ZJ,1ZK                             | 24.3541-1779.5<br>24.3541-1780.5<br>11.0101-5403.2                                     | 240249<br>240250<br>260010   | D=54, - Halter<br>D=54, - Halter<br>Fallenbalgsatz<br><b>LUC</b><br><b>LUC</b><br><b>LUC</b>  |
|  | 1.0<br>1.4<br>1.4 16V<br>1.4 16V<br>1.4 FSI<br>1.4 TDI<br>1.6 GTI<br>1.7 SDI               | 44<br>55<br>74<br>77<br>55<br>92   |  | 04.98<br>09.00<br>10.98<br>01.99<br>09.00<br>09.00<br>04.98                      | 08.05 PR: 1LX<br>08.05 PR: 1LX<br>08.05 PR: 1LX<br>08.05 PR: 1LX<br>08.05 PR: 1LX<br>08.05 PR: 1LX<br>08.05 PR: 1LX   | 24.3541-1779.5<br>24.3541-1780.5<br>11.0101-5403.2                                     | 240249<br>240250<br>260010   | D=54, - Halter<br>D=54, - Halter<br>Fallenbalgsatz<br><b>LUC</b><br><b>LUC</b><br><b>LUC</b>  |
|    | 1.0<br>1.4<br>1.4 16V<br>1.4 16V<br>1.4 TDI<br>1.7 SDI                                     | 44<br>55<br>74<br>55   |  | 04.98<br>09.00<br>10.98<br>01.99<br>01.99<br>04.98                               | 08.05<br>08.05<br>08.05<br>08.05<br>08.05<br>08.05  | 83.7852-0377.3   | 330835   | 2<br>L=375  |
|  | 1.2 TDI 3L   | 45   |  | 06.99  | 08.05   | 83.6243-0393.3   | 330629   | 2<br>L=390  |
|   | 1.4 16V<br>1.4 FSI<br>1.6 GTI  | 74<br>77<br>92   |  | 05.99<br>09.00<br>09.00  | 08.05<br>08.05<br>08.05   | 24.3344-1711.7<br>24.3344-1712.7   | 220539<br>220540   | D=34, - Halter<br>D=34, - Halter<br><b>LUC</b><br><b>LUC</b>  |
|  | 1.4 16V<br>1.4 FSI<br>1.4 TDI<br>1.6 GTI<br>1.7 SDI  | 74<br>77<br>55<br>92   |  | 01.99<br>01.99<br>09.00<br>04.98   | 08.05<br>08.05<br>08.05<br>08.05  | 24.3344-1711.7<br>24.3344-1712.7   | 220539<br>220540   | D=34, - Halter<br>D=34, - Halter<br><b>LUC</b><br><b>LUC</b>  |
|  | 1.0<br>1.2 TDI 3L<br>1.4<br>1.4 16V<br>1.4 16V<br>1.4 FSI<br>1.4 TDI<br>1.6 GTI<br>1.7 SDI | 44<br>45<br>44<br>55<br>74<br>77<br>55<br>92                                     |  | 04.98<br>06.99<br>09.00<br>10.98<br>01.99<br>01.99<br>09.00<br>04.98             | 08.05<br>08.05<br>08.05<br>08.05<br>08.05<br>08.05<br>08.05<br>08.05  | 83.7858-0140.3   | 330837   | 2<br>L=140  |
|  | 1.0<br>1.2 TDI 3L<br>1.4<br>1.4 16V<br>1.4 TDI<br>1.7 SDI                                  | 45<br>44<br>55<br>55   |  | 04.98<br>06.99<br>09.00<br>10.98<br>01.99<br>04.98                               | 08.05 - ABS<br>08.05 - ABS<br>08.05 - ABS<br>08.05 - ABS<br>08.05 - ABS   | 24.3215-0903.3   | 020154   | Rz 15,87  |
|  | 1.0<br>1.4<br>1.4 16V<br>1.4 TDI<br>1.7 SDI  | 44<br>55<br>55   |  | 04.98<br>09.00<br>10.98<br>01.99<br>04.98  | 08.05 + ABS<br>08.05 + ABS<br>08.05 + ABS<br>08.05 + ABS<br>08.05 + ABS   | 24.3217-0908.3   | 020167   | Rz 17,46  |
|  | 1.0<br>1.2 TDI 3L<br>1.4<br>1.4 16V<br>1.4 TDI<br>1.7 SDI                                  | 45<br>44<br>55<br>55   |  | 04.98<br>06.99<br>09.00<br>10.98<br>01.99<br>04.98                               | 08.05<br>08.05<br>08.05<br>08.05<br>08.05<br>08.05  | 24.3727-0159.2   | 580159   | 2<br>L=1392   |
|  | 1.4 16V<br>1.4 FSI<br>1.6 GTI  | 74<br>77<br>92   |  | 01.99<br>09.00<br>09.00  | 08.05<br>08.05<br>08.05   | 24.3727-2707.2   | 582707   | 2<br>L=1496   |
|  | 1.0<br>1.2 TDI 3L<br>1.4<br>1.4 16V<br>1.4 TDI<br>1.7 SDI                                  | 45<br>44<br>55<br>55   |  | 04.98<br>06.99<br>09.00<br>10.98<br>01.99<br>04.98                               | 08.05<br>08.05<br>08.05<br>08.05<br>08.05<br>08.05  | 03.6583-0184.3   | 320229   | BRL 8/3 (4)<br><b>ATE</b>   |
|  | 1.4 TDI  | 55   |  | 01.99  | 08.05   | 24.2519-1701.3   | 040075   | Nz 19,05  |
|  | 1.0<br>1.2 TDI 3L<br>1.4<br>1.4 16V<br>1.4 16V   | 44<br>45<br>44<br>55<br>74   |  | 04.98<br>06.99<br>09.00<br>10.98<br>01.99  | 08.05<br>08.05<br>08.05<br>08.05<br>08.05   | 24.3728-2707.2   | 592707   | L=1047, + AUT   |

|     |  |  |   |  |  |  |  |  |   |                      |  |  |                            |    |  |  |  |                   |
|--|--|--|---|--|--|--|--|--|---|---|--|--|----------------------------|--|--|--|--|-------------------|
| VOLKSWAGEN LUPO (98-05)  |  |  |   |  |  |  |  |  |   |   |  |  |                            |  |  |  |  |                   |
|    | 1.4 FSI<br>1.7 SDI   | 77<br>77   |   |  |  |  |  | 09.00<br>04.98   | 08.05<br>08.05  |   |  | 24.3728-2707.2   | 592707                     |  |  |  | L=1047, + AUT                                  |                   |
| VOLKSWAGEN NEW BEETLE (98-10)  |  |  |   |  |  |  |  |  |   |   |  |  |                            |  |  |  |  |                   |
|    | 1.6<br>1.8 T<br>1.9 TDI<br>1.9 TDI<br>2.0<br>2.3 V5<br>3.2 RSI                 | 77<br>110<br>66<br>74<br>85<br>125<br>77   |   |  |  |  |  | 08.01<br>08.01   |   | + ESP<br>+ ESP<br>+ ESP<br>+ ESP<br>+ ESP<br>+ ESP<br>+ ESP   |  | 03.7863-0402.4   | 300124                     |  |  |  | 10"  |                   |
|  | 1.4<br>1.6<br>1.8 T<br>1.8 T<br>1.9 TDI<br>1.9 TDI<br>2.0<br>2.3 V5<br>3.2 RSI | 55<br>66<br>110<br>132<br>74<br>77<br>85<br>125<br>77                            | 9C-2-620000<br>9C-Y-613783<br>9C-Y-613783<br>9C-2-620000<br>9C-2-620000<br>9C-2-620000<br>9C-2-620000<br>9C-2-620000<br>9C-2-620000 |  |  |  |  | 08.01<br>11.01   | 02.01   | + ESP<br>+ ESP<br>+ ESP<br>+ ESP<br>+ ESP<br>+ ESP<br>+ ESP<br>+ ESP<br>+ ESP                         |  | 03.7860-0602.4   | 300141                     |  |  |  | 10"  | ATE               |
|  | 1.4<br>1.6<br>1.8 T<br>1.8 T<br>1.9 TDI<br>1.9 TDI<br>2.0<br>2.3 V5<br>3.2 RSI | 55<br>66<br>110<br>132<br>74<br>77<br>85<br>125<br>77                            | 9C-2-620001<br>9C-2-620001<br>9C-2-620001<br>9C-2-620001<br>9C-2-620001<br>9C-2-620001<br>9C-2-620001<br>9C-2-620001<br>9C-2-620001 |  |  |  |  | 05.10<br>05.10<br>05.10<br>06.05<br>05.10<br>07.05                               | 05.10<br>05.10<br>05.10<br>05.10<br>05.10<br>05.10<br>05.10<br>05.05<br>03.03 | + ESP<br>+ ESP<br>+ ESP<br>+ ESP<br>+ ESP<br>+ ESP<br>+ ESP<br>+ ESP<br>+ ESP                         |  | 03.7863-3502.4   | 300128                     |  |  |  | 10"  |                   |
|    | 1.4<br>1.6<br>1.8 T<br>1.8 T<br>1.9 TDI<br>1.9 TDI<br>2.0<br>2.3 V5<br>3.2 RSI | 55<br>66<br>110<br>132<br>66<br>74<br>85<br>125<br>77                            |   |  |  |  |  | 08.01<br>11.99<br>10.99<br>11.01<br>01.98<br>10.00<br>01.98<br>10.00<br>04.00    | 06.05<br>06.05<br>06.05<br>06.05<br>02.01<br>06.05<br>06.05<br>05.05<br>03.03 | - ESP<br>- ESP<br>- ESP<br>- ESP<br>- ESP<br>- ESP<br>- ESP<br>- ESP<br>- ESP                         |  | 24.2123-1709.3   | 010503                     |  |  |  | Thz 23,81                                      |                   |
|  | 1.6<br>1.8 T<br>1.9 TDI<br>1.9 TDI<br>2.0<br>2.3 V5<br>3.2 RSI                 | 66<br>110<br>66<br>74<br>85<br>125<br>77   | 9C-Y-613782<br>9C-Y-613782<br>9C-Y-613782<br>9C-Y-613782<br>9C-Y-613782<br>9C-Y-613782<br>9C-Y-613782                               |  |  |  |  | 11.99<br>10.99<br>01.98<br>10.00<br>01.98<br>10.00<br>04.00                      |   | + ESP<br>+ ESP<br>+ ESP<br>+ ESP<br>+ ESP<br>+ ESP<br>+ ESP   |  | 03.2123-2024.3   | 010597                     |  |  |  | Thz 23,81                                      | ATE               |
|  | 1.4<br>1.6<br>1.8 T<br>1.8 T<br>1.9 TDI<br>1.9 TDI<br>2.0<br>2.3 V5<br>3.2 RSI | 55<br>66<br>110<br>132<br>66<br>74<br>85<br>125<br>77                            | 9C-Y-613783<br>9C-Y-613783<br>9C-Y-613783<br>9C-Y-613783<br>9C-Y-613783<br>9C-Y-613783<br>9C-Y-613783<br>9C-Y-613783<br>9C-Y-613783 |  |  |  |  | 08.01<br>11.01   | 05.10<br>06.05<br>02.01<br>05.10<br>07.05                                     | + ESP<br>+ ESP<br>+ ESP<br>+ ESP<br>+ ESP<br>+ ESP<br>+ ESP<br>+ ESP<br>+ ESP                         |  | 03.2123-2715.3   | 010802                     |  |  |  | Thz 23,81                                      | ATE               |
|  | 1.6<br>1.8 T<br>1.9 TDI<br>1.9 TDI<br>2.0<br>2.3 V5<br>3.2 RSI                 | 66<br>110<br>66<br>74<br>85<br>125<br>77   | 9C-Y-613782<br>9C-Y-613782<br>9C-Y-613782<br>9C-Y-613782<br>9C-Y-613782<br>9C-Y-613782<br>9C-Y-613782                               |  |  |  |  | 11.99<br>10.99<br>01.98<br>10.00<br>01.98<br>10.00<br>04.00                      |   | + ESP<br>+ ESP<br>+ ESP<br>+ ESP<br>+ ESP<br>+ ESP<br>+ ESP   |  | 03.2123-2064.3   | 010598                     |  |  |  | Thz 23,81                                      | ATE               |
|  | 1.4<br>1.6<br>1.8 T<br>1.8 T<br>1.9 TDI<br>1.9 TDI<br>2.0<br>2.3 V5<br>3.2 RSI | 55<br>66<br>110<br>132<br>66<br>74<br>85<br>125<br>77                            | 9C-7-557428<br>9C-7-557428<br>9C-Y-613783<br>9C-7-557428<br>9C-7-557428<br>9C-7-557428<br>9C-7-557428<br>9C-7-557428<br>9C-7-557428 |  |  |  |  | 08.01<br>11.01   | 06.05<br>02.01<br>07.05   | + ESP<br>+ ESP<br>+ ESP<br>+ ESP<br>+ ESP<br>+ ESP<br>+ ESP<br>+ ESP<br>+ ESP                         |  | 03.2123-2774.3   | 010803                     |  |  |  | Thz 23,81                                      | ATE               |
|  | 1.4<br>1.6<br>1.8 T<br>1.9 TDI<br>1.9 TDI<br>2.0                               | 55<br>66<br>110<br>74<br>77<br>85  | 9C-7-557429<br>9C-7-557429<br>9C-7-557429<br>9C-7-557429<br>9C-7-557429<br>9C-7-557429  |  |  |  |  |  | 05.10<br>05.10<br>05.10<br>05.10<br>05.10                                     | + ESP<br>+ ESP<br>+ ESP<br>+ ESP<br>+ ESP   |  | 03.2123-2774.3   | 010803                     |  |  |  | Thz 23,81                                      | ATE               |
|  | 1.4<br>1.6<br>1.8 T<br>1.8 T<br>1.9 TDI<br>1.9 TDI<br>1.9 TDI                  | 55<br>110<br>132<br>66<br>74<br>77   |   |  |  |  |  | 08.01<br>11.99<br>10.99<br>11.01<br>01.98<br>10.00<br>07.05                      | 05.10<br>05.10<br>05.10<br>06.05<br>02.01<br>05.10                            | PR: 1ZP,1ZM<br>PR: 1ZP,1ZM<br>PR: 1ZP,1ZM<br>PR: 1ZP,1ZM<br>PR: 1ZP,1ZM<br>PR: 1ZP,1ZM<br>PR: 1ZP,1ZM |  | 11.9541-9549.2<br>11.9541-9550.2<br>11.0101-5409.2                                 | 220575<br>220576<br>260035 | <br> |  |  | D=54, - Halter<br>D=54, - Halter<br>Hülsensatz | ATE<br>ATE<br>ATE |

|     |  |  |  |  |  |  |    |    |   |  |
|--|--|--|--|--|---|--|--|--|---|--|
| <b>VOLKSWAGEN NEW BEETLE (98-10)</b>   |  |  |  |  |   |  |  |  |   |  |
|    | 2.0  | 85   |  | <b>01.98</b>   | <b>05.10</b>  | PR: 1ZP,1ZM  | <b>11.9541-9549.2</b> 220575<br><b>11.9541-9550.2</b> 220576<br><b>11.0101-5409.2</b> 260035   | <br><br>  | D=54, - Halter<br>D=54, - Halter<br>Hülzensatz  | <b>ATE</b><br><b>ATE</b><br><b>ATE</b>   |
|  | 1.4  | 55   |  | <b>08.01</b>   | <b>05.10</b>  | PR: 1ZD,1ZE  | <b>11.3541-8523.2</b> 220115   | <br>   | D=54, - Halter  | <b>ATE</b>   |
|  | 1.6  |  |  | <b>11.99</b>   | <b>05.10</b>  | PR: 1ZD,1ZE  | <b>11.3541-8524.2</b> 220116   |   | D=54, - Halter  | <b>ATE</b>   |
|  | 1.8 T  | 110  |  | <b>10.99</b>   | <b>05.10</b>  | PR: 1ZD,1ZE  | <b>24.3541-8523.5</b> 240551   |   | D=54, - Halter  | <b>ATE</b>   |
|  | 1.8 T  | 132  |  | <b>11.01</b>   | <b>06.05</b>  | PR: 1ZD,1ZE  | <b>24.3541-8524.5</b> 240552   |   | D=54, - Halter  | <b>ATE</b>   |
|  | 1.9 TDI  | 66   |  | <b>01.98</b>   | <b>02.01</b>  | PR: 1ZD,1ZE  | <b>11.8170-0306.1</b> 260102   | 2<br>   | Halter  | <b>ATE</b>   |
|  | 1.9 TDI  | 74   |  | <b>10.00</b>   | <b>05.10</b>  | PR: 1ZD,1ZE  | <b>11.0441-5409.2</b> 250031   |   | Dichtungssatz   | <b>ATE</b>   |
|  | 1.9 TDI  | 77   |  | <b>07.05</b>   | <b>05.10</b>  | PR: 1ZD,1ZE  | <b>11.0101-5409.2</b> 260035   |   | Hülzensatz  | <b>ATE</b>   |
|  | 2.0  | 85   |  | <b>01.98</b>   | <b>05.10</b>  | PR: 1ZD,1ZE  | <b>11.8171-0008.1</b> 990049<br><b>11.8116-0143.1</b> 390513   | 2<br>   | Führungsbolzen<br>Haltefeder  | <b>ATE</b><br><b>ATE</b>   |
|  | 2.3 V5   | 125  |  | <b>10.00</b>   | <b>12.05</b>  |  | <b>11.9541-9595.2</b> 220501<br><b>11.9541-9596.2</b> 220502<br><b>11.0441-5409.2</b> 250031<br><b>11.0101-5409.2</b> 260035<br><b>11.8171-0008.1</b> 990049<br><b>11.8116-0143.1</b> 390513 | <br><br><br><br><br> | D=54, - Halter<br>D=54, - Halter<br>Dichtungssatz<br>Hülzensatz<br>Führungsbolzen<br>Haltefeder | <b>ATE</b><br><b>ATE</b><br><b>ATE</b><br><b>ATE</b><br><b>ATE</b><br><b>ATE</b> |
|  | 3.2 RSI  |  |  | <b>04.00</b>   | <b>03.03</b>  |  | <b>11.9541-9595.2</b> 220501<br><b>11.9541-9596.2</b> 220502<br><b>11.0441-5409.2</b> 250031<br><b>11.0101-5409.2</b> 260035<br><b>11.8171-0008.1</b> 990049<br><b>11.8116-0143.1</b> 390513 | <br><br><br><br><br> | D=54, - Halter<br>D=54, - Halter<br>Dichtungssatz<br>Hülzensatz<br>Führungsbolzen<br>Haltefeder | <b>ATE</b><br><b>ATE</b><br><b>ATE</b><br><b>ATE</b><br><b>ATE</b><br><b>ATE</b> |
|    | 1.4  | 55   |  | <b>08.01</b>   | <b>05.10</b>  |  | <b>83.7838-0435.3</b> 330834   | 2  |   | L=435  |
|  | 1.6  |  |  | <b>11.99</b>   | <b>05.10</b>  |  |  |  |   |  |
|  | 1.8 T  | 110  |  | <b>10.99</b>   | <b>05.10</b>  |  |  |  |   |  |
|  | 1.8 T  | 132  |  | <b>11.01</b>   | <b>06.05</b>  |  |  |  |   |  |
|  | 1.9 TDI  | 66   |  | <b>01.98</b>   | <b>02.01</b>  |  |  |  |   |  |
|  | 1.9 TDI  | 74   |  | <b>10.00</b>   | <b>05.10</b>  |  |  |  |   |  |
|  | 1.9 TDI  | 77   |  | <b>07.05</b>   | <b>05.10</b>  |  |  |  |   |  |
|  | 2.0  | 85   |  | <b>01.98</b>   | <b>05.10</b>  |  |  |  |   |  |
|  | 2.3 V5   | 125  |  | <b>10.00</b>   | <b>05.05</b>  |  |  |  |   |  |
|  | 3.2 RSI  |  |  | <b>04.00</b>   | <b>03.03</b>  |  |  |  |   |  |
|    | 1.6  |  | 9C-Y-607008  | <b>11.99</b>   |   | PR: 1KS,1KV  | <b>24.3384-1723.7</b> 220523   | <br>   | D=38(M12x1), - Halter<br>D=38(M12x1), - Halter  | <b>LUC</b><br><b>LUC</b>   |
|  | 1.8 T  | 110  | 9C-Y-607008  | <b>10.99</b>   |   | PR: 1KS,1KV  | <b>24.3384-1724.7</b> 220524   |   |   |  |
|  | 1.9 TDI  | 66   | 9C-Y-607008  | <b>01.98</b>   |   | PR: 1KS,1KV  |  |  |   |  |
|  | 2.0  | 85   | 9C-Y-607008  | <b>01.98</b>   |   | PR: 1KS,1KV  |  |  |   |  |
|  | 1.4  | 55   |  | <b>08.01</b>   | <b>05.10</b>  | PR: 1KS,1KV  | <b>24.3384-1729.7</b> 220541   | <br>   | D=38(M12x1), - Halter<br>D=38(M12x1), - Halter  | <b>LUC</b><br><b>LUC</b>   |
|  | 1.6  |  | 9C-Y-607009  |  | <b>05.10</b>  | PR: 1KS,1KV  | <b>24.3384-1730.7</b> 220542   |    |   |  |
|  | 1.8 T  | 110  | 9C-Y-607009  |  | <b>05.10</b>  | PR: 1KS,1KV  |  |  |   |  |
|  | 1.8 T  | 132  |  | <b>11.01</b>   | <b>06.05</b>  | PR: 1KS,1KV  |  |  |   |  |
|  | 1.9 TDI  | 66   | 9C-Y-607009  |  | <b>02.01</b>  | PR: 1KS,1KV  |  |  |   |  |
|  | 1.9 TDI  | 74   |  | <b>10.00</b>   | <b>05.10</b>  | PR: 1KS,1KV  |  |  |   |  |
|  | 1.9 TDI  | 77   |  | <b>07.05</b>   | <b>05.10</b>  | PR: 1KS,1KV  |  |  |   |  |
|  | 2.0  | 85   | 9C-Y-607009  |  | <b>05.10</b>  | PR: 1KS,1KV  |  |  |   |  |
|  | 2.3 V5   | 125  |  | <b>10.00</b>   | <b>05.05</b>  | PR: 1KS,1KV  |  |  |   |  |
|  | 1.8 T  | 132  |  | <b>11.01</b>   | <b>06.05</b>  | PR: 1KY  | <b>24.3384-1745.7</b> 220609   |   | D=38, - Halter  | <b>LUC</b>   |
|  | 2.3 V5   | 125  |  | <b>10.00</b>   | <b>05.05</b>  | PR: 1KY  | <b>24.3384-1746.7</b> 220610   |   | D=38, - Halter  | <b>LUC</b>   |
|  | 3.2 RSI  |  |  | <b>04.00</b>   | <b>03.03</b>  |  |  |  |   |  |
|  | 1.4  | 55   |  | <b>08.01</b>   | <b>05.10</b>  |  | <b>83.7858-0140.3</b> 330837   | 2  |   | L=140  |
|  | 1.6  |  |  | <b>11.99</b>   | <b>05.10</b>  |  |  |  |   |  |
|  | 1.8 T  | 110  |  | <b>10.99</b>   | <b>05.10</b>  |  |  |  |   |  |
|  | 1.8 T  | 132  |  | <b>11.01</b>   | <b>05.10</b>  |  |  |  |   |  |
|  | 1.9 TDI  | 66   |  | <b>01.98</b>   | <b>05.10</b>  |  |  |  |   |  |
|  | 1.9 TDI  | 74   |  | <b>10.00</b>   | <b>05.10</b>  |  |  |  |   |  |
|  | 1.9 TDI  | 77   |  | <b>07.05</b>   | <b>05.10</b>  |  |  |  |   |  |
|  | 2.0  | 85   |  | <b>01.98</b>   | <b>05.10</b>  |  |  |  |   |  |
|  | 2.3 V5   | 125  |  | <b>10.00</b>   | <b>05.10</b>  |  |  |  |   |  |
|  | 3.2 RSI  |  |  | <b>04.00</b>   | <b>05.10</b>  |  |  |  |   |  |
|  | 1.6  |  | 9C-Y-607008  | <b>11.99</b>   |   |  | <b>24.3727-0149.2</b> 580149   | 2   |   | L=1688   |
|  | 1.8 T  | 110  | 9C-Y-607008  | <b>10.99</b>   |   |  |  |  |   |  |
|  | 1.9 TDI  | 66   | 9C-Y-607008  | <b>01.98</b>   |   |  |  |  |   |  |
|  | 1.9 TDI  | 74   | 9C-Y-607008  | <b>10.00</b>   |   |  |  |  |   |  |
|  | 2.0  | 85   | 9C-Y-607008  | <b>01.98</b>   |   |  |  |  |   |  |
|  | 1.4  | 55   |  | <b>08.01</b>   | <b>05.10</b>  |  | <b>24.3727-0173.2</b> 580173   | 2   |   | L=1693   |
|  | 1.6  |  | 9C-Y-607009  |  | <b>05.10</b>  |  |  |  |   |  |
|  | 1.8 T  | 110  | 9C-Y-607009  |  | <b>05.10</b>  |  |  |  |   |  |
|  | 1.8 T  | 132  |  | <b>11.01</b>   | <b>05.10</b>  |  |  |  |   |  |
|  | 1.9 TDI  | 66   | 9C-Y-607009  |  | <b>05.10</b>  |  |  |  |   |  |
|  | 1.9 TDI  | 74   | 9C-Y-607009  |  | <b>05.10</b>  |  |  |  |   |  |
|  | 1.9 TDI  | 77   |  | <b>07.05</b>   | <b>05.10</b>  |  |  |  |   |  |
|  | 2.0  | 85   | 9C-Y-607009  |  | <b>05.10</b>  |  |  |  |   |  |
|  | 2.3 V5   | 125  |  | <b>10.00</b>   | <b>05.05</b>  | - verstärktes Fahrwerk <sup>1)</sup>   |  |  |   |  |
|  | 3.2 RSI  |  |  | <b>04.00</b>   | <b>03.03</b>  | - verstärktes Fahrwerk <sup>1)</sup>   |  |  |   |  |
|  | 1.4  | 55   |  | <b>08.01</b>   | <b>06.05</b>  | - ABS  | <b>03.6583-0179.3</b> 320228   |  | BRL 8/3 (4)   | <b>ATE</b>   |
|  | 1.6  |  |  | <b>11.99</b>   | <b>06.05</b>  | - ABS  |  |  |   |  |
|  | 1.8 T  | 110  |  | <b>10.99</b>   | <b>06.05</b>  | - ABS  |  |  |   |  |
|  | 1.8 T  | 132  |  | <b>11.01</b>   | <b>06.05</b>  | - ABS  |  |  |   |  |
|  | 1.9 TDI  | 66   |  | <b>01.98</b>   | <b>02.01</b>  | - ABS  |  |  |   |  |
|  | 1.9 TDI  | 74   |  | <b>10.00</b>   | <b>06.05</b>  | - ABS  |  |  |   |  |
|  | 2.0  | 85   |  | <b>01.98</b>   | <b>06.05</b>  | - ABS  |  |  |   |  |
|  | 2.3 V5   | 125  |  | <b>10.00</b>   | <b>05.05</b>  | - ABS  |  |  |   |  |
|  | 3.2 RSI  |  |  | <b>04.00</b>   | <b>03.03</b>  | - ABS  |  |  |   |  |

<sup>1)</sup> - reinforced suspension / - sospensione rinforzata / - châssis renforcé / - suspensión reforzada

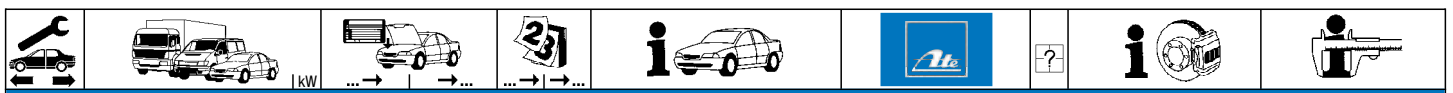

**VOLKSWAGEN NEW BEETLE (98-10)**

|  |         |     |  |       |       |                |        |                                   |          |
|--|---------|-----|--|-------|-------|----------------|--------|-----------------------------------|----------|
|  | 1.4     | 55  |  | 08.01 | 05.10 | 24.2415-1701.3 | 030095 |                                   | Gz 15,87 |
|  | 1.6     |     |  | 11.99 | 05.10 |                |        |                                   |          |
|  | 1.8 T   | 110 |  | 10.99 | 05.10 |                |        |                                   |          |
|  | 1.8 T   | 132 |  | 11.01 | 06.05 |                |        |                                   |          |
|  | 1.9 TDI | 66  |  | 01.98 | 02.01 |                |        |                                   |          |
|  | 1.9 TDI | 74  |  | 10.00 | 05.10 |                |        |                                   |          |
|  | 1.9 TDI | 77  |  | 07.05 | 05.10 |                |        |                                   |          |
|  | 2.0     | 85  |  | 01.98 | 05.10 |                |        |                                   |          |
|  | 2.3 V5  | 125 |  | 10.00 | 05.05 |                |        |                                   |          |
|  | 3.2 RSI |     |  | 04.00 | 03.03 |                |        |                                   |          |
|  | 1.4     | 55  |  | 08.01 | 05.10 | 24.2415-1702.3 | 030096 |                                   | Gz 15,87 |
|  | 1.6     |     |  | 11.99 | 05.10 |                |        |                                   |          |
|  | 1.8 T   | 110 |  | 10.99 | 05.10 |                |        |                                   |          |
|  | 1.8 T   | 132 |  | 11.01 | 06.05 |                |        |                                   |          |
|  | 1.9 TDI | 66  |  | 01.98 | 02.01 |                |        |                                   |          |
|  | 1.9 TDI | 74  |  | 10.00 | 05.10 |                |        |                                   |          |
|  | 1.9 TDI | 77  |  | 07.05 | 05.10 |                |        |                                   |          |
|  | 2.0     | 85  |  | 01.98 | 05.10 |                |        |                                   |          |
|  | 2.3 V5  | 125 |  | 10.00 | 05.05 |                |        |                                   |          |
|  | 3.2 RSI |     |  | 04.00 | 03.03 |                |        |                                   |          |
|  | 1.4     | 55  |  | 08.01 | 05.10 | 24.2519-1701.3 | 040075 | für Getriebe MQ-250 <sup>1)</sup> | Nz 19,05 |
|  | 1.6     |     |  | 11.99 | 05.10 |                |        |                                   |          |
|  | 1.8 T   | 110 |  | 10.99 | 05.10 |                |        |                                   |          |
|  | 1.8 T   | 132 |  | 11.01 | 06.05 |                |        |                                   |          |
|  | 1.9 TDI | 66  |  | 01.98 | 02.01 |                |        |                                   |          |
|  | 1.9 TDI | 74  |  | 10.00 | 05.10 |                |        |                                   |          |
|  | 1.9 TDI | 77  |  | 07.05 | 05.10 |                |        |                                   |          |
|  | 2.0     | 85  |  | 01.98 | 05.10 |                |        |                                   |          |
|  | 2.3 V5  | 125 |  | 10.00 | 05.05 |                |        |                                   |          |
|  | 3.2 RSI |     |  | 04.00 | 03.03 |                |        |                                   |          |























**VOLKSWAGEN NEW BEETLE Cabriolet (03-10)**

|         |         |     |             |       |                   |                |        |  |                       |     |
|---------|---------|-----|-------------|-------|-------------------|----------------|--------|--|-----------------------|-----|
|         | 1.4     | 55  |             | 01.03 | 05.10 + ESP       | 03.7863-3502.4 | 300128 |  | 10"                   | ATE |
|         | 1.6     | 75  |             | 01.03 | 05.10 + ESP       |                |        |  |                       |     |
|         | 1.8 T   | 110 |             | 12.03 | 05.10 + ESP       |                |        |  |                       |     |
|         | 1.9 TDI | 74  |             | 07.03 | 05.10 + ESP       |                |        |  |                       |     |
|         | 1.9 TDI | 77  |             | 07.05 | 05.10 + ESP       |                |        |  |                       |     |
|         | 2.0     | 85  |             | 01.03 | 05.10 + ESP       |                |        |  |                       |     |
|         | 1.4     | 55  |             | 01.03 | 06.05 - ESP       | 24.2123-1709.3 | 010503 |  | Thz 23,81             |     |
|         | 1.6     | 75  |             | 01.03 | 06.05 - ESP       |                |        |  |                       |     |
|         | 1.8 T   | 110 |             | 12.03 | 06.05 - ESP       |                |        |  |                       |     |
|         | 1.9 TDI | 74  |             | 07.03 | 06.05 - ESP       |                |        |  |                       |     |
|         | 2.0     | 85  |             | 01.03 | 06.05 - ESP       |                |        |  |                       |     |
|         |         | 1.4 | 55          |       | 01.03             |                |        |  |                       |     |
| 1.6     |         | 75  |             | 01.03 | 05.10 + ESP       |                |        |  |                       |     |
| 1.8 T   |         | 110 |             | 12.03 | 05.10 + ESP       |                |        |  |                       |     |
| 1.9 TDI |         | 74  |             | 07.03 | 05.10 + ESP       |                |        |  |                       |     |
| 1.9 TDI |         | 77  |             | 07.05 | 05.10 + ESP       |                |        |  |                       |     |
| 2.0     |         | 85  |             | 01.03 | 05.10 + ESP       |                |        |  |                       |     |
|         | 1.4     | 55  | 1Y-7-413420 | 01.03 | + ESP             | 03.2123-2774.3 | 010803 |  | Thz 23,81             | ATE |
|         | 1.6     | 75  | 1Y-7-413420 | 01.03 | + ESP             |                |        |  |                       |     |
|         | 1.8 T   | 110 | 1Y-7-413420 | 12.03 | + ESP             |                |        |  |                       |     |
|         | 1.9 TDI | 74  | 1Y-7-413420 | 07.03 | + ESP             |                |        |  |                       |     |
|         | 1.9 TDI | 77  | 1Y-7-413420 | 07.05 | + ESP             |                |        |  |                       |     |
|         | 2.0     | 85  | 1Y-7-413420 | 01.03 | + ESP             |                |        |  |                       |     |
|         | 1.4     | 55  | 1Y-7-413421 |       | 05.10 + ESP       | 03.2123-2774.3 | 010803 |  | Thz 23,81             | ATE |
|         | 1.6     | 75  | 1Y-7-413421 |       | 05.10 + ESP       |                |        |  |                       |     |
|         | 1.8 T   | 110 | 1Y-7-413421 |       | 05.10 + ESP       |                |        |  |                       |     |
|         | 1.9 TDI | 74  | 1Y-7-413421 |       | 05.10 + ESP       |                |        |  |                       |     |
|         | 1.9 TDI | 77  | 1Y-7-413421 |       | 05.10 + ESP       |                |        |  |                       |     |
|         | 2.0     | 85  | 1Y-7-413421 |       | 05.10 + ESP       |                |        |  |                       |     |
|         | 1.4     | 55  |             | 01.03 | 05.10 PR: 1ZP,1ZM | 11.9541-9549.2 | 220575 |  | D=54, - Halter        | ATE |
|         | 1.6     | 75  |             | 01.03 | 05.10 PR: 1ZP,1ZM |                |        |  |                       |     |
|         | 1.8 T   | 110 |             | 12.03 | 05.10 PR: 1ZP,1ZM |                |        |  |                       |     |
|         | 1.9 TDI | 74  |             | 07.03 | 05.10 PR: 1ZP,1ZM |                |        |  |                       |     |
|         | 1.9 TDI | 77  |             | 07.05 | 05.10 PR: 1ZP,1ZM |                |        |  |                       |     |
|         | 2.0     | 85  |             | 01.03 | 05.10 PR: 1ZP,1ZM |                |        |  |                       |     |
|         | 1.4     | 55  |             | 01.03 | 05.10 PR: 1ZD,1ZE | 11.3541-8523.2 | 220115 |  | D=54, - Halter        | ATE |
|         | 1.6     | 75  |             | 01.03 | 05.10 PR: 1ZD,1ZE |                |        |  |                       |     |
|         | 1.8 T   | 110 |             | 12.03 | 05.10 PR: 1ZD,1ZE |                |        |  |                       |     |
|         | 1.9 TDI | 74  |             | 07.03 | 05.10 PR: 1ZD,1ZE |                |        |  |                       |     |
|         | 1.9 TDI | 77  |             | 07.05 | 05.10 PR: 1ZD,1ZE |                |        |  |                       |     |
|         | 2.0     | 85  |             | 01.03 | 05.10 PR: 1ZD,1ZE |                |        |  |                       |     |
|         | 1.4     | 55  |             | 01.03 | 05.10 PR: 1ZD,1ZE | 11.3541-8524.2 | 220116 |  | D=54, - Halter        | ATE |
|         | 1.6     | 75  |             | 01.03 | 05.10 PR: 1ZD,1ZE |                |        |  |                       |     |
|         | 1.8 T   | 110 |             | 12.03 | 05.10 PR: 1ZD,1ZE |                |        |  |                       |     |
|         | 1.9 TDI | 74  |             | 07.03 | 05.10 PR: 1ZD,1ZE |                |        |  |                       |     |
|         | 1.9 TDI | 77  |             | 07.05 | 05.10 PR: 1ZD,1ZE |                |        |  |                       |     |
|         | 2.0     | 85  |             | 01.03 | 05.10 PR: 1ZD,1ZE |                |        |  |                       |     |
|         | 1.4     | 55  |             | 01.03 | 05.10 PR: 1ZD,1ZE | 11.8170-0306.1 | 260102 |  | D=54, - Halter        | ATE |
|         | 1.6     | 75  |             | 01.03 | 05.10 PR: 1ZD,1ZE |                |        |  |                       |     |
|         | 1.8 T   | 110 |             | 12.03 | 05.10 PR: 1ZD,1ZE |                |        |  |                       |     |
|         | 1.9 TDI | 74  |             | 07.03 | 05.10 PR: 1ZD,1ZE |                |        |  |                       |     |
|         | 1.9 TDI | 77  |             | 07.05 | 05.10 PR: 1ZD,1ZE |                |        |  |                       |     |
|         | 2.0     | 85  |             | 01.03 | 05.10 PR: 1ZD,1ZE |                |        |  |                       |     |
|         | 1.4     | 55  |             | 01.03 | 05.10 PR: 1ZD,1ZE | 11.0441-5409.2 | 250031 |  | D=54, - Halter        | ATE |
|         | 1.6     | 75  |             | 01.03 | 05.10 PR: 1ZD,1ZE |                |        |  |                       |     |
|         | 1.8 T   | 110 |             | 12.03 | 05.10 PR: 1ZD,1ZE |                |        |  |                       |     |
|         | 1.9 TDI | 74  |             | 07.03 | 05.10 PR: 1ZD,1ZE |                |        |  |                       |     |
|         | 1.9 TDI | 77  |             | 07.05 | 05.10 PR: 1ZD,1ZE |                |        |  |                       |     |
|         | 2.0     | 85  |             | 01.03 | 05.10 PR: 1ZD,1ZE |                |        |  |                       |     |
|         | 1.4     | 55  |             | 01.03 | 05.10 PR: 1ZD,1ZE | 11.0101-5409.2 | 260035 |  | D=54, - Halter        | ATE |
|         | 1.6     | 75  |             | 01.03 | 05.10 PR: 1ZD,1ZE |                |        |  |                       |     |
|         | 1.8 T   | 110 |             | 12.03 | 05.10 PR: 1ZD,1ZE |                |        |  |                       |     |
|         | 1.9 TDI | 74  |             | 07.03 | 05.10 PR: 1ZD,1ZE |                |        |  |                       |     |
|         | 1.9 TDI | 77  |             | 07.05 | 05.10 PR: 1ZD,1ZE |                |        |  |                       |     |
|         | 2.0     | 85  |             | 01.03 | 05.10 PR: 1ZD,1ZE |                |        |  |                       |     |
|         | 1.4     | 55  |             | 01.03 | 05.10 PR: 1ZD,1ZE | 11.8171-0008.1 | 990049 |  | D=54, - Halter        | ATE |
|         | 1.6     | 75  |             | 01.03 | 05.10 PR: 1ZD,1ZE |                |        |  |                       |     |
|         | 1.8 T   | 110 |             | 12.03 | 05.10 PR: 1ZD,1ZE |                |        |  |                       |     |
|         | 1.9 TDI | 74  |             | 07.03 | 05.10 PR: 1ZD,1ZE |                |        |  |                       |     |
|         | 1.9 TDI | 77  |             | 07.05 | 05.10 PR: 1ZD,1ZE |                |        |  |                       |     |
|         | 2.0     | 85  |             | 01.03 | 05.10 PR: 1ZD,1ZE |                |        |  |                       |     |
|         | 1.4     | 55  |             | 01.03 | 05.10 PR: 1ZD,1ZE | 11.8116-0143.1 | 390513 |  | D=54, - Halter        | ATE |
|         | 1.6     | 75  |             | 01.03 | 05.10 PR: 1ZD,1ZE |                |        |  |                       |     |
|         | 1.8 T   | 110 |             | 12.03 | 05.10 PR: 1ZD,1ZE |                |        |  |                       |     |
|         | 1.9 TDI | 74  |             | 07.03 | 05.10 PR: 1ZD,1ZE |                |        |  |                       |     |
|         | 1.9 TDI | 77  |             | 07.05 | 05.10 PR: 1ZD,1ZE |                |        |  |                       |     |
|         | 2.0     | 85  |             | 01.03 | 05.10 PR: 1ZD,1ZE |                |        |  |                       |     |
|         | 1.4     | 55  |             | 01.03 | 05.10 PR: 1KS,1KV | 24.3384-1729.7 | 220541 |  | D=38(M12x1), - Halter | LUC |
|         | 1.6     | 75  |             | 01.03 | 05.10 PR: 1KS,1KV |                |        |  |                       |     |
|         | 1.8 T   | 110 |             | 12.03 | 05.10 PR: 1KS,1KV |                |        |  |                       |     |
|         | 1.9 TDI | 74  |             | 07.03 | 05.10 PR: 1KS,1KV |                |        |  |                       |     |
|         | 1.9 TDI | 77  |             | 07.05 | 05.10 PR: 1KS,1KV |                |        |  |                       |     |
|         | 2.0     | 85  |             | 01.03 | 05.10 PR: 1KS,1KV |                |        |  |                       |     |
|         | 1.4     | 55  |             | 01.03 | 05.10 PR: 1KS,1KV | 24.3384-1730.7 | 220542 |  | D=38(M12x1), - Halter | LUC |
|         | 1.6     | 75  |             | 01.03 | 05.10 PR: 1KS,1KV |                |        |  |                       |     |
|         | 1.8 T   | 110 |             | 12.03 | 05.10 PR: 1KS,1KV |                |        |  |                       |     |
|         | 1.9 TDI | 74  |             | 07.03 | 05.10 PR: 1KS,1KV |                |        |  |                       |     |
|         | 1.9 TDI | 77  |             | 07.05 | 05.10 PR: 1KS,1KV |                |        |  |                       |     |
|         | 2.0     | 85  |             | 01.03 | 05.10 PR: 1KS,1KV |                |        |  |                       |     |

<sup>1)</sup> for transmission MQ-250 / per scatola camb.MQ-250 / pour boîte de vitesse MQ-250 / caja de cambios para MQ-250





|     |  |  |  |  |    |  |  |  |   |                          |
|--|--|--|--|--|---|--|--|--|---|--------------------------|
| <b>VOLKSWAGEN NEW BEETLE Cabriolet (03-10)</b>                                     |  |  |  |  |   |  |  |  |   |                          |
|    | 1.9 TDI<br>2.0   | 77<br>85   | 07.05<br>01.03   | 05.10<br>05.10   | PR: 1KS,1KV<br>PR: 1KS,1KV  | 24.3384-1729.7<br>24.3384-1730.7   | 220541<br>220542   | D=38(M12x1), - Halter<br>D=38(M12x1), - Halter                                     | LUC<br>LUC  |                          |
|    | 1.4<br>1.6<br>1.8 T<br>1.9 TDI<br>1.9 TDI<br>2.0                                 | 55<br>75<br>110<br>74<br>77<br>85  | 01.03<br>01.03<br>12.03<br>07.03<br>07.05<br>01.03                               | 05.10<br>05.10<br>05.10<br>05.10<br>05.10<br>05.10                               |   | 83.7858-0140.3   | 330837   | 2  | L=140   |                          |
|    | 1.4<br>1.6<br>1.8 T<br>1.9 TDI<br>1.9 TDI<br>2.0                                 | 55<br>75<br>110<br>74<br>77<br>85  | 01.03<br>01.03<br>12.03<br>07.03<br>07.05<br>01.03                               | 05.10<br>05.10<br>05.10<br>05.10<br>05.10<br>05.10                               |   | 24.3727-0173.2   | 580173   | 2  | L=1693  |                          |
|    | 1.4<br>1.6<br>1.8 T<br>1.9 TDI<br>1.9 TDI<br>2.0                                 | 55<br>75<br>110<br>74<br>77<br>85  | 01.03<br>01.03<br>12.03<br>07.03<br>07.05<br>01.03                               | 05.10<br>05.10<br>05.10<br>05.10<br>05.10<br>05.10                               |   | 24.2415-1701.3   | 030095   |  | Gz 15,87  |                          |
|    | 1.4<br>1.6<br>1.8 T<br>1.9 TDI<br>1.9 TDI<br>2.0                                 | 55<br>75<br>110<br>74<br>77<br>85  | 01.03<br>01.03<br>12.03<br>07.03<br>07.05<br>01.03                               | 05.10<br>05.10<br>05.10<br>05.10<br>05.10<br>05.10                               |   | 24.2415-1702.3   | 030096   |  | Gz 15,87  |                          |
|    | 1.4<br>1.6<br>1.8 T<br>1.9 TDI<br>1.9 TDI<br>2.0                                 | 55<br>75<br>110<br>74<br>77<br>85  | 01.03<br>01.03<br>12.03<br>07.03<br>07.05<br>01.03                               | 05.10<br>05.10<br>05.10<br>05.10<br>05.10<br>05.10                               |   | 24.2519-1701.3   | 040075   | für Getriebe MQ-250 <sup>1)</sup>  | Nz 19,05  |                          |
| <b>VOLKSWAGEN BEETLE (11-)</b>   |  |  |  |  |   |  |  |  |   |                          |
|    | 1.2 TSI<br>1.4 TSI<br>1.6 TDI<br>2.0 TDI<br>2.0 TSI<br>2.0 TSI<br>2.5            | 77<br>118<br>77<br>103<br>147<br>155<br>125                                      | 07.11<br>04.11<br>10.11<br>04.11<br>04.11<br>05.13<br>04.11                      |  | PR: 1ZM,1ZQ<br>PR: 1ZM,1ZQ<br>PR: 1ZM,1ZQ<br>PR: 1ZM,1ZQ<br>PR: 1ZM,1ZQ<br>PR: 1ZM,1ZQ<br>PR: 1ZM,1ZQ                             | 11.9541-9549.2<br>11.9541-9550.2<br>11.0101-5409.2                                 | 220575<br>220576<br>260035   |  | D=54, - Halter<br>D=54, - Halter<br>Hülensatz                   | ATE<br>ATE<br>ATE        |
|  | 1.2 TSI<br>1.4 TSI<br>1.6 TDI<br>2.0 TDI<br>2.0 TSI<br>2.0 TSI<br>2.5            | 77<br>118<br>77<br>103<br>147<br>155<br>125                                      | 07.11<br>04.11<br>10.11<br>04.11<br>04.11<br>05.13<br>04.11                      |  | PR: 1ZA,1ZE,1ZP<br>PR: 1ZA,1ZE,1ZP<br>PR: 1ZA,1ZE,1ZP<br>PR: 1ZA,1ZE,1ZP<br>PR: 1ZA,1ZE,1ZP<br>PR: 1ZA,1ZE,1ZP<br>PR: 1ZA,1ZE,1ZP | 11.9541-9553.2<br>11.9541-9554.2<br>11.0101-5409.2<br>11.8171-0008.1               | 220563<br>220564<br>260035<br>990049   | 2  | D=54, - Halter<br>D=54, - Halter<br>Hülensatz<br>Führungsbolzen | ATE<br>ATE<br>ATE<br>ATE |
|  | 1.2 TSI<br>1.4 TSI<br>1.6 TDI<br>2.0 TDI<br>2.0 TSI<br>2.0 TSI<br>2.5            | 77<br>118<br>77<br>103<br>147<br>155<br>125                                      | 07.11<br>04.11<br>10.11<br>04.11<br>04.11<br>05.13<br>04.11                      |  | PR: 1LV,1ZB,1ZD<br>PR: 1LV,1ZB,1ZD<br>PR: 1LV,1ZB,1ZD<br>PR: 1LV,1ZB,1ZD<br>PR: 1LV,1ZB,1ZD<br>PR: 1LV,1ZB,1ZD<br>PR: 1LV,1ZB,1ZD | 11.9541-9553.2<br>11.9541-9554.2<br>11.0101-5409.2<br>11.8171-0008.1               | 220563<br>220564<br>260035<br>990049   | 2  | D=54, - Halter<br>D=54, - Halter<br>Hülensatz<br>Führungsbolzen | ATE<br>ATE<br>ATE<br>ATE |
|  | 1.2 TSI<br>1.4 TSI<br>1.6 TDI<br>2.0 TDI<br>2.0 TSI<br>2.0 TSI<br>2.5            | 77<br>118<br>77<br>103<br>147<br>155<br>125                                      | 07.11<br>04.11<br>10.11<br>04.11<br>04.11<br>05.13<br>04.11                      |  | PR: 1KD,1KU<br>PR: 1KD,1KU<br>PR: 1KD,1KU<br>PR: 1KD,1KU<br>PR: 1KD,1KU<br>PR: 1KD,1KU<br>PR: 1KD,1KU                             | 24.3384-1755.7<br>24.3384-1756.7   | 220635<br>220636   |  | D=38, - Halter<br>D=38, - Halter                                | LUC<br>LUC               |
|  | 1.2 TSI<br>1.4 TSI<br>1.6 TDI<br>2.0 TDI<br>2.0 TSI<br>2.0 TSI<br>2.5            | 77<br>118<br>77<br>103<br>147<br>155<br>125                                      | 07.11<br>04.11<br>10.11<br>04.11<br>04.11<br>05.13<br>04.11                      |  | PR: VF1<br>PR: VF1<br>PR: VF1<br>PR: VF1<br>PR: VF1<br>PR: VF1<br>PR: VF1   | 24.2415-1713.3   | 030132   |  | Gz 15,87, + Sensor  |                          |
|  | 1.4 TSI  | 118  | 04.11  |  | PR: 0EJ   | 24.2519-1705.3   | 040095   |  | Nz 19,05  |                          |
| <b>VOLKSWAGEN BEETLE Cabriolet (12-)</b>   |  |  |  |  |   |  |  |  |   |                          |
|  | 1.2 TSI<br>1.4 TSI<br>1.6 TDI<br>2.0 TDI<br>2.0 TSI<br>2.0 TSI                   | 77<br>118<br>77<br>103<br>147<br>155   | 11.12<br>11.12<br>11.12<br>11.12<br>11.12<br>05.13                               |  | PR: 1ZM,1ZQ<br>PR: 1ZM,1ZQ<br>PR: 1ZM,1ZQ<br>PR: 1ZM,1ZQ<br>PR: 1ZM,1ZQ<br>PR: 1ZM,1ZQ  | 11.9541-9549.2<br>11.9541-9550.2<br>11.0101-5409.2                                 | 220575<br>220576<br>260035   |  | D=54, - Halter<br>D=54, - Halter<br>Hülensatz                   | ATE<br>ATE<br>ATE        |

<sup>1)</sup> for transmission MQ-250 / per scatola camb.MQ-250 / pour boîte de vitesse MQ-250 / caja de cambios para MQ-250

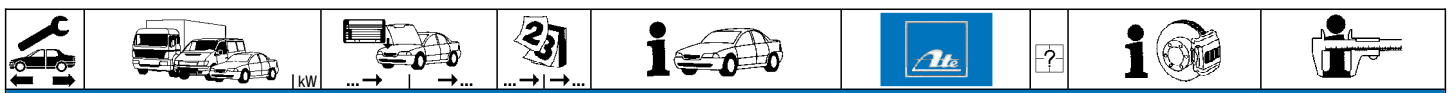





























**VOLKSWAGEN BEETLE Cabriolet (12-)**

|  |         |     |  |       |             |                |        |   |   |                                 |
|--|---------|-----|--|-------|-------------|----------------|--------|---|---|---------------------------------|
|  | 1.2 TSI | 77  |  | 11.12 | PR: 1ZE,1ZP | 11.9541-9553.2 | 220563 | 2 | D=54, - Halter<br>D=54, - Halter<br>Führungsbolzen<br>Haltefeder<br>Hülensatz | ATE<br>ATE<br>ATE<br>ATE<br>ATE |
|  | 1.4 TSI | 118 |  | 11.12 | PR: 1ZE,1ZP | 11.9541-9554.2 | 220564 |   |   |                                 |
|  | 1.6 TDI | 77  |  | 11.12 | PR: 1ZE,1ZP | 11.8171-0008.1 | 990049 |   |   |                                 |
|  | 2.0 TDI | 103 |  | 11.12 | PR: 1ZE,1ZP | 11.8116-0351.1 | 390538 |   |   |                                 |
|  | 2.0 TSI | 147 |  | 11.12 | PR: 1ZE,1ZP | 11.0101-5409.2 | 260035 |   |   |                                 |
|  | 2.0 TSI | 155 |  | 05.13 | PR: 1ZE,1ZP |                |        |   |   |                                 |
|  | 1.2 TSI | 77  |  | 11.12 | PR: 1ZA     | 11.9541-9553.2 | 220563 | 2 | D=54, - Halter<br>D=54, - Halter<br>Führungsbolzen<br>Haltefeder<br>Hülensatz | ATE<br>ATE<br>ATE<br>ATE<br>ATE |
|  | 1.4 TSI | 118 |  | 11.12 | PR: 1ZA     | 11.9541-9554.2 | 220564 |   |   |                                 |
|  | 1.6 TDI | 77  |  | 11.12 | PR: 1ZA     | 11.8171-0008.1 | 990049 |   |   |                                 |
|  | 2.0 TDI | 103 |  | 11.12 | PR: 1ZA     | 11.8116-0351.1 | 390538 |   |   |                                 |
|  | 2.0 TSI | 147 |  | 11.12 | PR: 1ZA     | 11.0101-5409.2 | 260035 |   |   |                                 |
|  | 2.0 TSI | 155 |  | 05.13 | PR: 1ZA     |                |        |   |   |                                 |
|  | 1.2 TSI | 77  |  | 11.12 | PR: 1LV,1ZB | 11.9541-9553.2 | 220563 | 2 | D=54, - Halter<br>D=54, - Halter<br>Führungsbolzen<br>Haltefeder<br>Hülensatz | ATE<br>ATE<br>ATE<br>ATE<br>ATE |
|  | 1.4 TSI | 118 |  | 11.12 | PR: 1LV,1ZB | 11.9541-9554.2 | 220564 |   |   |                                 |
|  | 1.6 TDI | 77  |  | 11.12 | PR: 1LV,1ZB | 11.8171-0008.1 | 990049 |   |   |                                 |
|  | 2.0 TDI | 103 |  | 11.12 | PR: 1LV,1ZB | 11.8116-0351.1 | 390538 |   |   |                                 |
|  | 2.0 TSI | 147 |  | 11.12 | PR: 1LV,1ZB | 11.0101-5409.2 | 260035 |   |   |                                 |
|  | 2.0 TSI | 155 |  | 05.13 | PR: 1LV,1ZB |                |        |   |   |                                 |
|  | 1.2 TSI | 77  |  | 11.12 | PR: 1KD,1KU | 24.3384-1755.7 | 220635 |   | D=38, - Halter<br>D=38, - Halter  | LUC<br>LUC                      |
|  | 1.4 TSI | 118 |  | 11.12 | PR: 1KD,1KU | 24.3384-1756.7 | 220636 |   |   |                                 |
|  | 1.6 TDI | 77  |  | 11.12 | PR: 1KD,1KU |                |        |   |   |                                 |
|  | 2.0 TDI | 103 |  | 11.12 | PR: 1KD,1KU |                |        |   |   |                                 |
|  | 2.0 TSI | 147 |  | 11.12 | PR: 1KD,1KU |                |        |   |   |                                 |
|  | 2.0 TSI | 155 |  | 05.13 | PR: 1KD,1KU |                |        |   |   |                                 |
|  | 1.2 TSI | 77  |  | 11.12 | PR: VF1     | 24.2415-1713.3 | 030132 |   | Gz 15,87, + Sensor  |                                 |
|  | 1.4 TSI | 118 |  | 11.12 | PR: VF1     |                |        |   |   |                                 |
|  | 1.6 TDI | 77  |  | 11.12 | PR: VF1     |                |        |   |   |                                 |
|  | 2.0 TDI | 103 |  | 11.12 | PR: VF1     |                |        |   |   |                                 |
|  | 2.0 TSI | 147 |  | 11.12 | PR: VF1     |                |        |   |   |                                 |
|  | 2.0 TSI | 155 |  | 05.13 | PR: VF1     |                |        |   |   |                                 |

















**VOLKSWAGEN PASSAT (88-93)**



















|             |               |    |       |             |                |                |        |   |   |  |
|-------------|---------------|----|-------|-------------|----------------|----------------|--------|---|---|--|
|             | 1.6           |    |       | 04.88       | 10.93 - ABS    | 03.7750-4302.4 | 300076 |   | 9"  | ATE                                    |
|             | 1.6 TD        |    |       | 08.88       | 10.93 - ABS    |                |        |   |   |  |
|             | 1.8           |    |       | 04.88       | 10.93 - ABS    |                |        |   |   |  |
|             | 1.8 16V       |    |       | 04.88       | 07.92 - ABS    |                |        |   |   |  |
|             | 1.9 D         |    |       | 05.89       | 10.93 - ABS    |                |        |   |   |  |
|             | 1.9 TD        |    |       | 03.91       | 10.93 - ABS    |                |        |   |   |  |
|             | 2.0           |    |       | 03.90       | 10.93 - ABS    |                |        |   |   |  |
|             | 2.0 16V       |    |       | 04.88       | 10.93 - ABS    |                |        |   |   |  |
|             | 2.8 VR6       |    |       | 06.91       | 10.93 - ABS    |                |        |   |   |  |
|             | 1.6           |    |       | 04.88       | 10.93 - ABS    | 03.7750-4902.4 | 300079 |   |   |  |
| 1.6 TD      |               |    | 08.88 | 10.93 - ABS |                |                |        |   |   |  |
| 1.8         |               |    | 04.88 | 10.93 - ABS |                |                |        |   |   |  |
| 1.8 16V     |               |    | 04.88 | 07.92 - ABS |                |                |        |   |   |  |
| 1.9 D       |               |    | 05.89 | 10.93 - ABS |                |                |        |   |   |  |
| 1.9 TD      |               |    | 03.91 | 10.93 - ABS |                |                |        |   |   |  |
| 2.0         |               |    | 03.90 | 10.93 - ABS |                |                |        |   |   |  |
| 2.0 16V     |               |    | 04.88 | 10.93 - ABS |                |                |        |   |   |  |
| 2.8 VR6     |               |    | 06.91 | 10.93 - ABS |                |                |        |   |   |  |
|             | 1.6           |    |       | 04.88       | 07.91 - ABS    | 03.2120-3943.3 | 010532 |   | THz 20,64<br>Verschlusschraube  | ATE                                    |
|             | 1.6 TD        |    |       | 08.88       | 07.91 - ABS    | 03.3517-0101.2 | 390322 |   |   |  |
|             | 1.8           | 55 |       | 08.90       | 07.91 - ABS    |                |        |   |   |  |
|             | 1.9 D         |    |       | 05.89       | 07.91 - ABS    |                |        |   |   |  |
|             | 1.9 TD        |    |       | 03.91       | 07.91 - ABS    |                |        |   |   |  |
|             | 2.0           |    |       | 03.90       | 07.91 - ABS    |                |        |   |   |  |
|             | 1.6           |    |       | 08.91       | 10.93 - ABS    | 03.2122-1042.3 | 010137 |   |   |  |
|             | 1.6 TD        |    |       | 08.91       | 10.93 - ABS    | 03.3517-0101.2 | 390322 |   |   |  |
|             | 1.8           | 55 |       | 08.91       | 10.93 - ABS    |                |        |   |   |  |
|             | 1.8           | 66 |       | 04.88       | 10.93 - ABS    |                |        |   |   |  |
| 1.8         | 79            |    | 04.88 | 07.90 - ABS |                |                |        |   |   |  |
| 1.8         | 82            |    | 04.88 | 07.90 - ABS |                |                |        |   |   |  |
| 1.8 16V     |               |    | 04.88 | 07.91 - ABS |                |                |        |   |   |  |
| 1.9 D       |               |    | 08.91 | 10.93 - ABS |                |                |        |   |   |  |
| 1.9 TD      |               |    | 08.91 | 10.93 - ABS |                |                |        |   |   |  |
| 2.0         |               |    | 08.91 | 10.93 - ABS |                |                |        |   |   |  |
| 2.0 16V     |               |    | 08.88 | 07.91 - ABS |                |                |        |   |   |  |
|             | 1.6 Limousine |    |       | 04.88       | 09.89 - ABS    | 24.3541-1609.5 | 240039 | 2 | D=54, - Halter<br>D=54, - Halter<br>Dichtungssatz<br>Hülensatz<br>Hülensatz+Schrauben<br>Einbausatz<br>Faltenbalgsatz | LUC<br>LUC<br>ATE<br>ATE<br>LUC<br>LUC |
|             |               |    |       |             |                | 24.3541-1610.5 | 240040 |   |   |  |
|             |               |    |       |             |                | 11.0441-4808.2 | 250022 |   |   |  |
|             |               |    |       |             |                | 11.0101-4801.2 | 260006 |   |   |  |
|             |               |    |       |             |                | 24.0102-4801.2 | 260085 |   |   |  |
|             |               |    |       |             |                | 24.0101-4301.2 | 260047 |   |   |  |
|             |               |    |       |             |                | 11.0101-5403.2 | 260010 |   |   |  |
|             | 1.6           |    |       | 10.89       | 10.93          | 24.3541-1609.5 | 240039 |   |   |  |
|             | 1.6 Limousine |    |       | 04.88       | 09.89 + ABS    | 24.3541-1610.5 | 240040 |   |   |  |
|             | 1.6 TD        |    |       | 08.88       | 10.93          | 24.0101-4301.2 | 260047 |   |   |  |
| 1.6 Variant |               |    | 04.88 | 09.89       | 11.0101-5403.2 | 260010         |        |   |   |  |
| 1.8         |               |    | 04.88 | 10.93       |                |                |        |   |   |  |
| 1.8 16V     |               |    | 04.88 | 07.92       |                |                |        |   |   |  |
| 1.9 D       |               |    | 05.89 | 10.93       |                |                |        |   |   |  |
| 1.9 TD      |               |    | 03.91 | 10.93       |                |                |        |   |   |  |
| 2.0         |               |    | 03.90 | 10.93       |                |                |        |   |   |  |
| 2.0 16V     |               |    | 08.88 | 10.93       |                |                |        |   |   |  |
| 2.0 Syncro  |               |    | 10.90 | 10.93       |                |                |        |   |   |  |



| VOLKSWAGEN PASSAT (88-93)  |   |  |  |   |   |  |  |   |   |  |                          |
|--|---|--|--|---|---|--|--|---|---|--|--------------------------|
|     |                                 |                                      |  |                 |                |  |  |   |   |  |                          |
|    | 1.8 Syncro G60<br>2.8 VR6   |  |  | 08.88<br>06.91  | 10.93<br>10.93  | 24.3541-1731.5<br>24.3541-1732.5   | 240061<br>240062   |  |   | D=54, - Halter<br>D=54, - Halter                                 | LUC<br>LUC               |
|    | 1.6<br>1.6 TD<br>1.8<br>1.8 16V<br>1.8 Syncro G60<br>1.9 D<br>1.9 TD<br>2.0<br>2.0 16V<br>2.0 Syncro<br>2.8 VR6 |  |  | 04.88<br>08.88<br>04.88<br>04.88<br>08.88<br>05.89<br>03.91<br>03.90<br>08.88<br>10.90<br>06.91 | 10.93<br>10.93<br>10.93<br>07.92<br>10.93<br>10.93<br>10.93<br>10.93<br>10.93<br>10.93<br>10.93 | 83.7813-0330.3   | 330800   | 2   |   | L=330  |                          |
|    | 1.8<br>1.8<br>1.8 16V<br>1.8 Syncro G60<br>2.0<br>2.0<br>2.0 16V<br>2.0 16V<br>2.0 Syncro<br>2.8 VR6<br>2.8 VR6 | 79<br>82   |  | 04.88<br>04.88<br>04.88<br>08.88<br>03.90<br>08.88<br>08.88<br>10.90<br>06.91<br>06.91          | 07.90<br>07.90<br>07.92<br>08.88<br>03.90<br>08.88<br>08.88<br>10.93<br>06.91<br>06.91          | 24.3384-1603.5<br>24.3384-1604.5<br>24.0101-3601.2                                 | 240015<br>240016<br>260044   |  |   | D=38, - Halter<br>D=38, - Halter<br>Einbausatz                   | LUC<br>LUC<br>LUC        |
|    | 1.8 Syncro G60<br>2.0<br>2.0<br>2.0 16V<br>2.0 16V<br>2.0 Syncro<br>2.8 VR6<br>2.8 VR6                          | 31-P-080001<br>31-PB080001<br>31-PE080001<br>31-PB080001<br>31-PE080001<br>31-P-080001<br>31-PB080001<br>31-PE080001 |  | 10.93<br>10.93<br>10.93<br>10.93<br>10.93<br>10.93<br>10.93<br>10.93                            | 10.93<br>10.93<br>10.93<br>10.93<br>10.93<br>10.93<br>10.93<br>10.93                            | 24.3384-1707.5<br>24.3384-1708.5<br>24.0101-3601.2<br>11.0101-5403.2               | 240171<br>240172<br>260044<br>260010   |  |   | D=38, - Halter<br>D=38, - Halter<br>Einbausatz<br>Fallenbalgsatz | LUC<br>LUC<br>LUC<br>LUC |
|    | 1.6<br>1.6 TD<br>1.8<br>1.8<br>1.9 D<br>1.9 TD  | 55<br>66   |  | 04.88<br>08.88<br>04.88<br>04.88<br>05.89<br>03.91  | 10.93<br>10.93<br>10.93<br>10.93<br>10.93<br>10.93  | 83.7824-0180.3   | 330812   | 2   |   | L=180  |                          |
|  | 1.8<br>1.8<br>2.0<br>2.0 16V<br>2.8 VR6   | 79<br>82   |  | 04.88<br>04.88<br>03.90<br>08.88<br>06.91   | 07.90<br>07.90<br>10.93<br>10.93<br>10.93   | 83.7824-0180.3<br>83.7704-0160.3   | 330812<br>330805   | 2<br>2  | am Bremssattel <sup>1)</sup>  | L=180<br>L=160   |                          |
|  | 1.8 Syncro G60<br>2.0 Syncro  |  |  | 08.88<br>10.90  | 10.93<br>10.93  | 83.7804-0160.3<br>83.7704-0160.3   | 330811<br>330805   | 2<br>2  | am Bremssattel <sup>1)</sup>  | L=160<br>L=160   |                          |
|  | 1.6 Limousine<br>1.6 Limousine<br>1.6 TD<br>1.6 Variant<br>1.8<br>1.8<br>1.9 D<br>1.9 TD                        | 31-L-085001<br>55<br>66  | 31-L-085000  | 04.88<br>08.88<br>04.88<br>04.88<br>05.89<br>03.91  | 10.93<br>10.93<br>10.93<br>10.93<br>10.93<br>10.93  | 24.3219-0909.3<br>24.3220-0909.3   | 020188<br>020210   |   |   | Rz 19,05<br>Rz 20,64   |                          |
|  | 1.6<br>1.6 TD<br>1.8<br>1.8<br>1.9 D<br>1.9 TD  | 55<br>66   |  | 04.88<br>08.88<br>04.88<br>04.88<br>05.89<br>03.91  | 10.93<br>10.93<br>10.93<br>10.93<br>10.93<br>10.93  | 24.3727-0125.2   | 580125   | 2   |  | L=1628   |                          |
|  | 1.8<br>1.8<br>1.8 16V<br>2.0<br>2.0 16V<br>2.8 VR6  | 79<br>82   |  | 04.88<br>04.88<br>04.88<br>03.90<br>08.88<br>06.91  | 07.90<br>07.90<br>07.92<br>10.93<br>10.93<br>10.93  | 24.3727-0126.2   | 580126   | 2   |  | L=1740   |                          |
|  | 1.8 Syncro G60<br>2.0 Syncro  |  |  | 08.88<br>10.90  | 10.93<br>10.93  | 24.3727-0167.2   | 580167   | 2   |  | L=1718   |                          |
|  | 1.6<br>1.6 TD<br>1.8<br>1.8 16V<br>1.8 Syncro G60<br>1.9 D<br>1.9 TD<br>2.0<br>2.0 16V<br>2.0 Syncro<br>2.8 VR6 |  |  | 04.88<br>08.88<br>04.88<br>04.88<br>08.88<br>05.89<br>03.91<br>03.90<br>08.88<br>10.90<br>06.91 | 10.93<br>10.93<br>10.93<br>10.93<br>10.93<br>10.93<br>10.93<br>10.93<br>10.93<br>10.93<br>10.93 | 03.6584-0015.3   | 320109   |   |   | BRL 8/4 (4)  | ATE                      |
|  | 1.6 TD<br>1.8<br>1.8<br>1.8 16V<br>1.8 Syncro G60<br>1.9 D  | 79<br>82   |  | 08.88<br>04.88<br>04.88<br>04.88<br>08.88<br>05.89  | 10.93<br>07.90<br>07.90<br>07.92<br>10.93<br>10.93  | 03.2419-9310.3   | 030027   |   |   | Gz 19,05   |                          |

<sup>1)</sup> on the brake caliper / sulla pinza freno / sur l'étrier de frein / a la pinza de freno

| VOLKSWAGEN PASSAT (88-93)  |  |  |  |  |   |  |  |  |   |  |                   |     |
|--|--|--|--|--|---|--|--|--|---|--|-------------------|-----|
|     |  |  |  |  |  |  |  |  |   |  |                   |     |
|    | 1.9 TD   | ↓  |  | 03.91  | 10.93   |  | 03.2419-9310.3   | 030027   |   |  | Gz 19,05          |     |
|  | 2.0  | ↓  |  | 03.90  | 10.93   |  |  |  |   |  |                   |     |
|  | 2.0 16V  | ↓  |  | 08.88  | 10.93   |  |  |  |   |  |                   |     |
|  | 2.0 Syncro   | ↓  |  | 10.90  | 10.93   |  |  |  |   |  |                   |     |
|  | 2.8 VR6  | ↓  |  | 06.91  | 10.93   |  |  |  |   |  |                   |     |
|    | 1.6 TD   | ↓  |  | 08.88  | 10.93   |  | 24.2523-0908.3   | 040049   |   |  | Nz 23,81          |     |
|  | 1.8  | ↓  | 79   | 04.88  | 07.90   |  |  |  |   |  |                   |     |
|  | 1.8  | ↓  | 82   | 04.88  | 07.90   |  |  |  |   |  |                   |     |
|  | 1.8 16V  | ↓  |  | 04.88  | 07.92   |  |  |  |   |  |                   |     |
|  | 1.8 Syncro G60   | ↓  |  | 08.88  | 10.93   |  |  |  |   |  |                   |     |
|  | 1.9 D  | ↓  |  | 05.89  | 10.93   |  |  |  |   |  |                   |     |
|  | 1.9 TD   | ↓  |  | 03.91  | 10.93   |  |  |  |   |  |                   |     |
|  | 2.0  | ↓  |  | 03.90  | 10.93   |  |  |  |   |  |                   |     |
|  | 2.0 16V  | ↓  |  | 08.88  | 10.93   |  |  |  |   |  |                   |     |
|  | 2.0 Syncro   | ↓  |  | 10.90  | 10.93   |  |  |  |   |  |                   |     |
|  | 2.8 VR6  | ↓  |  | 06.91  | 10.93   |  |  |  |   |  |                   |     |
|    | 1.6  | ↓  |  | 04.88  | 10.93   |  | 24.3728-0124.2   | 590124   |   |  | L=1295, + AUT     |     |
|  | 1.6 TD   | ↓  |  | 08.88  | 10.93   |  |  |  |   |  |                   |     |
|  | 1.8  | ↓  | 55   | 04.88  | 10.93   |  |  |  |   |  |                   |     |
|  | 1.8  | ↓  | 66   | 04.88  | 10.93   |  |  |  |   |  |                   |     |
|  | 1.9 D  | ↓  |  | 05.89  | 10.93   |  |  |  |   |  |                   |     |
|  | 1.9 TD   | ↓  |  | 03.91  | 10.93   |  |  |  |   |  |                   |     |
| VOLKSWAGEN PASSAT (94-96)  |  |  |  |  |   |  |  |  |   |  |                   |     |
|    | 1.6  | ↓  |  | 10.94  | 12.96   | - ABS  | 03.7750-4302.4   | 300076   |   |  | 9"                | ATE |
|  | 1.8  | ↓  |  | 10.93  | 12.96   | - ABS  |  |  |   |  |                   |     |
|  | 1.9 TD   | ↓  | 55   | 10.93  | 12.96   | - ABS  |  |  |   |  |                   |     |
|  | 1.9 TDI  | ↓  |  | 10.93  | 12.96   | - ABS  |  |  |   |  |                   |     |
|  | 2.0  | ↓  |  | 10.93  | 12.96   | - ABS  |  |  |   |  |                   |     |
|  | 2.0 16V  | ↓  |  | 01.94  | 12.96   | - ABS  |  |  |   |  |                   |     |
|  | 2.8 VR6  | ↓  |  | 10.93  | 12.96   | - ABS  |  |  |   |  |                   |     |
|  | 1.6  | ↓  |  | 10.94  | 12.95   | - ABS  | 03.7750-4902.4   | 300079   |   |  | 9"                | ATE |
|  | 1.8  | ↓  |  | 10.93  | 12.95   | - ABS  |  |  |   |  |                   |     |
|  | 1.9 TD   | ↓  | 55   | 10.93  | 12.95   | - ABS  |  |  |   |  |                   |     |
|  | 1.9 TDI  | ↓  |  | 10.93  | 12.95   | - ABS  |  |  |   |  |                   |     |
|  | 2.0  | ↓  |  | 10.93  | 12.95   | - ABS  |  |  |   |  |                   |     |
|  | 2.0 16V  | ↓  |  | 01.94  | 12.95   | - ABS  |  |  |   |  |                   |     |
|  | 2.8 VR6  | ↓  |  | 10.93  | 12.95   | - ABS  |  |  |   |  |                   |     |
|  | 1.6  | ↓  |  |  | 12.96   | + ABS  | 10.6360-2102.4   | 300147   |   |  | 10"               | ATE |
|  | 1.8  | ↓  |  |  | 12.96   | + ABS  |  |  |   |  |                   |     |
|  | 1.9 TD   | ↓  | 55   |  | 12.96   | + ABS  |  |  |   |  |                   |     |
|  | 1.9 TDI  | ↓  |  |  | 12.96   | + ABS  |  |  |   |  |                   |     |
|  | 2.0  | ↓  |  |  | 12.96   | + ABS  |  |  |   |  |                   |     |
|  | 2.0 16V  | ↓  |  |  | 12.96   | + ABS  |  |  |   |  |                   |     |
|  | 2.0 Syncro   | ↓  |  |  | 12.96   | + ABS  |  |  |   |  |                   |     |
|  | 2.8 VR6  | ↓  |  |  | 12.96   | + ABS  |  |  |   |  |                   |     |
|  | 2.9 VR6 Syncro   | ↓  |  |  | 12.96   | + ABS  |  |  |   |  |                   |     |
|  | 1.6  | ↓  |  | 10.94  | 12.96   | - ABS  | 03.2122-1042.3   | 010137   |   |  | THz 22,20         | ATE |
|  | 1.8  | ↓  |  | 10.93  | 12.96   | - ABS  | 03.3517-0101.2   | 390322   |   |  | Verschlußschraube |     |
|  | 1.9 TD   | ↓  | 55   | 10.93  | 12.96   | - ABS  |  |  |   |  |                   |     |
|  | 1.9 TDI  | ↓  |  | 10.93  | 12.96   | - ABS  |  |  |   |  |                   |     |
|  | 2.0  | ↓  |  | 10.93  | 12.96   | - ABS  |  |  |   |  |                   |     |
|  | 2.0 16V  | ↓  |  | 01.94  | 12.96   | - ABS  |  |  |   |  |                   |     |
|  | 2.8 VR6  | ↓  |  | 10.93  | 12.96   | - ABS  |  |  |   |  |                   |     |
|  | 1.6  | ↓  |  |  | 12.96   | + ABS  | 10.6123-0674.3   | 010639   |   |  | THz 23,81         | ATE |
|  | 1.8  | ↓  |  |  | 12.96   | + ABS  |  |  |   |  |                   |     |
|  | 1.9 TD   | ↓  | 55   |  | 12.96   | + ABS  |  |  |   |  |                   |     |
|  | 1.9 TDI  | ↓  |  |  | 12.96   | + ABS  |  |  |   |  |                   |     |
|  | 2.0  | ↓  |  |  | 12.96   | + ABS  |  |  |   |  |                   |     |
|  | 2.0 16V  | ↓  |  |  | 12.96   | + ABS  |  |  |   |  |                   |     |
|  | 2.0 Syncro   | ↓  |  |  | 12.96   | + ABS  |  |  |   |  |                   |     |
|  | 2.8 VR6  | ↓  |  |  | 12.96   | + ABS  |  |  |   |  |                   |     |
|  | 2.9 VR6 Syncro   | ↓  |  |  | 12.96   | + ABS  |  |  |   |  |                   |     |
|  | 1.6  | ↓  |  |  | 12.96   | + ABS  | 03.2123-1424.3   | 010637   |   |  | THz 23,81         | ATE |
|  | 1.8  | ↓  |  |  | 12.96   | + ABS  |  |  |   |  |                   |     |
|  | 1.9 TD   | ↓  | 55   |  | 12.96   | + ABS  |  |  |   |  |                   |     |
|  | 1.9 TDI  | ↓  |  |  | 12.96   | + ABS  |  |  |   |  |                   |     |
|  | 2.0  | ↓  |  |  | 12.96   | + ABS  |  |  |   |  |                   |     |
|  | 2.0 16V  | ↓  |  |  | 12.96   | + ABS  |  |  |   |  |                   |     |
|  | 2.0 Syncro   | ↓  |  |  | 12.96   | + ABS  |  |  |   |  |                   |     |
|  | 2.8 VR6  | ↓  |  |  | 12.96   | + ABS  |  |  |   |  |                   |     |
|  | 2.9 VR6 Syncro   | ↓  |  |  | 12.96   | + ABS  |  |  |   |  |                   |     |
|  | 1.6  | ↓  |  |  | 12.96   | + ABS  | 03.2123-1484.3   | 010595   |   |  | THz 23,81         | ATE |
|  | 1.8  | ↓  |  |  | 12.96   | + ABS  |  |  |   |  |                   |     |
|  | 1.9 TD   | ↓  | 55   |  | 12.96   | + ABS  |  |  |   |  |                   |     |
|  | 1.9 TDI  | ↓  |  |  | 12.96   | + ABS  |  |  |   |  |                   |     |
|  | 2.0  | ↓  |  |  | 12.96   | + ABS  |  |  |   |  |                   |     |
|  | 2.0 16V  | ↓  |  |  | 12.96   | + ABS  |  |  |   |  |                   |     |
|  | 2.8 VR6  | ↓  |  |  | 12.96   | + ABS  |  |  |   |  |                   |     |
|  | 1.6  | ↓  |  | 10.94  | 12.96   |  | 24.3541-1609.5   | 240039   |  |  | D=54, - Halter    | LUC |
|  | 1.8  | ↓  |  | 10.93  | 12.96   |  | 24.3541-1610.5   | 240040   |  |  | D=54, - Halter    | LUC |
|  | 1.9 TD   | ↓  | 55   | 10.93  | 12.96   |  | 24.0101-4301.2   | 260047   |   |  | Einbausatz        | LUC |
|  | 1.9 TDI  | ↓  | 66   | 10.93  | 12.96   |  | 11.0101-5403.2   | 260010   |   |  | Fallenbausatz     | LUC |
|  | 2.0  | ↓  |  | 10.93  | 12.96   |  |  |  |   |  |                   |     |
|  | 2.0 Syncro   | ↓  |  | 01.94  | 12.96   |  |  |  |   |  |                   |     |

|     |  |  |  |  |  |  |  |  |     |
|--|--|--|--|--|---|--|--|--|-----|
| <b>VOLKSWAGEN PASSAT (94-96)</b>   |  |  |  |  |   |  |  |  |     |
|    | 1.9 TDI  | 81   |  | 03.96  | 12.96   | 24.3541-1731.5   | 240061   | D=54, - Halter   | LUC |
|  | 2.0 16V  |  |  | 01.94  | 12.96   | 24.3541-1732.5   | 240062   | D=54, - Halter   | LUC |
|  | 2.8 VR6  |  |  | 10.93  | 12.96   | 11.3541-8523.2   | 220115   | D=54, - Halter   | ATE |
|  | 2.9 VR6 Syncro   |  |  | 10.94  | 12.96   | 11.3541-8524.2   | 220116   | D=54, - Halter   | ATE |
|  |  |  |  |  |   | 24.3541-8523.5   | 240551   | D=54, - Halter   | ATE |
|  |  |  |  |  |   | 24.3541-8524.5   | 240552   | D=54, - Halter   | ATE |
|  |  |  |  |  |   | 11.8170-0306.1   | 260102   | Halter   | ATE |
|  |  |  |  |  |   | 11.0441-5409.2   | 250031   | Dichtungssatz  | ATE |
|  |  |  |  |  |   | 11.0101-5409.2   | 260035   | Hülzensatz   | ATE |
|  |  |  |  |  |   | 11.8171-0008.1   | 990049   | Führungsbolzen   | ATE |
|  |  |  |  |  |   | 11.8116-0143.1   | 390513   | Haltefeder   | ATE |
|    | 1.6  |  |  | 10.94  | 12.96   | 83.7813-0330.3   | 330800   | L=330  |     |
|  | 1.8  |  |  | 10.93  | 12.96   |  |  |  |     |
|  | 1.9 TD   | 55   |  | 10.93  | 12.96   |  |  |  |     |
|  | 1.9 TDI  |  |  | 10.93  | 12.96   |  |  |  |     |
|  | 2.0  |  |  | 10.93  | 12.96   |  |  |  |     |
|  | 2.0 Syncro   |  |  | 01.94  | 12.96   |  |  |  |     |
|  | 2.0 16V  |  |  | 01.94  | 12.96   | 83.7852-0377.3   | 330835   | L=375  |     |
|  | 2.8 VR6  |  |  | 10.93  | 12.96   |  |  |  |     |
|  | 2.9 VR6 Syncro   |  |  | 10.94  | 12.96   |  |  |  |     |
|    | 1.9 TDI  | 66   | 3A-T-000001  |  | 12.96   | 24.3384-1707.5   | 240171   | D=38, - Halter   | LUC |
|  | 1.9 TDI  | 81   |  | 03.96  | 12.96   | 24.3384-1708.5   | 240172   | D=38, - Halter   | LUC |
|  | 2.0  |  |  | 10.93  | 12.96   | 11.0101-5403.2   | 260010   | Faltenbalsatz  | LUC |
|  | 2.0 16V  |  |  | 01.94  | 12.96   |  |  |  |     |
|  | 2.0 Syncro   |  |  | 01.94  | 12.96   |  |  |  |     |
|  | 2.8 VR6  |  |  | 10.93  | 12.96   |  |  |  |     |
|  | 2.9 VR6 Syncro   |  |  | 10.94  | 12.96   |  |  |  |     |
|    | 1.6  |  |  | 10.94  | 12.96   | 83.7804-0160.3   | 330811   | L=160  |     |
|  | 1.8  |  |  | 10.93  | 12.96   |  |  |  |     |
|  | 1.9 TD   | 55   |  | 10.93  | 12.96   |  |  |  |     |
|  | 1.9 TDI  | 66   | 3A-S-300000  | 10.93  | 12.96   |  |  |  |     |
|  | 1.9 TDI  | 66   | 3A-T-000001  |  | 12.96   | 83.7804-0160.3   | 330811   | L=160  |     |
|  | 1.9 TDI  | 81   |  | 03.96  | 12.96   | 83.7704-0160.3   | 330805   | L=160  |     |
|  | 2.0  |  |  | 10.93  | 12.96   |  |  |  |     |
|  | 2.0 16V  |  |  | 01.94  | 12.96   |  |  |  |     |
|  | 2.0 Syncro   |  |  | 01.94  | 12.96   |  |  |  |     |
|  | 2.8 VR6  |  |  | 10.93  | 12.96   |  |  |  |     |
|  | 2.9 VR6 Syncro   |  |  | 10.94  | 12.96   |  |  |  |     |
|   | 1.6  |  |  | 10.94  | 12.96   | 24.3220-0909.3   | 020210   | Rz 20,64   |     |
|  | 1.8  |  |  | 10.93  | 12.96   |  |  |  |     |
|  | 1.9 TD   | 55   |  | 10.93  | 12.96   |  |  |  |     |
|  | 1.9 TDI  | 66   | 3A-S-300000  | 06.95  | 12.96   |  |  |  |     |
|  | 1.6  |  |  | 10.94  | 12.96   | 24.3727-0153.2   | 580153   | L=1624   |     |
|  | 1.8  |  |  | 10.93  | 12.96   |  |  |  |     |
|  | 1.9 TD   | 55   |  | 10.93  | 12.96   |  |  |  |     |
|  | 1.9 TDI  | 66   | 3A-S-300000  | 10.93  | 12.96   |  |  |  |     |
|  | 1.9 TDI  | 66   | 3A-T-000001  |  | 12.96   | 24.3727-0152.2   | 580152   | L=1721   |     |
|  | 1.9 TDI  | 81   |  | 03.96  | 12.96   |  |  |  |     |
|  | 2.0  |  |  | 10.93  | 12.96   |  |  |  |     |
|  | 2.0 16V  |  |  | 01.94  | 12.96   |  |  |  |     |
|  | 2.8 VR6  |  |  | 10.93  | 12.96   |  |  |  |     |
|  | 2.0 Syncro   |  |  | 01.94  | 12.96   | 24.3727-0167.2   | 580167   | L=1718   |     |
|  | 2.9 VR6 Syncro   |  |  | 10.94  | 12.96   |  |  |  |     |
|  | 1.6  |  |  | 10.94  | 12.96   | 03.6584-0015.3   | 320109   | BRL 8/4 (4)  | ATE |
|  | 1.8  |  |  | 10.93  | 12.96   |  |  |  |     |
|  | 1.9 TD   | 55   |  | 10.93  | 12.96   |  |  |  |     |
|  | 1.9 TDI  |  |  | 10.93  | 12.96   |  |  |  |     |
|  | 2.0  |  |  | 10.93  | 12.96   |  |  |  |     |
|  | 2.0 16V  |  |  | 01.94  | 12.96   |  |  |  |     |
|  | 2.0 Syncro   |  |  | 01.94  | 12.96   |  |  |  |     |
|  | 2.8 VR6  |  |  | 10.93  | 12.96   |  |  |  |     |
|  | 2.9 VR6 Syncro   |  |  | 10.94  | 12.96   |  |  |  |     |
|  | 1.6  |  |  | 10.94  | 12.96   | 03.2419-1206.3   | 030074   | Gz 19,05   |     |
|  | 1.8  |  |  | 10.93  | 12.96   |  |  |  |     |
|  | 1.9 TD   | 55   |  | 10.93  | 12.96   |  |  |  |     |
|  | 1.9 TDI  |  |  | 10.93  | 12.96   |  |  |  |     |
|  | 2.0  |  |  | 10.93  | 12.96   |  |  |  |     |
|  | 2.0 16V  |  |  | 01.94  | 12.96   |  |  |  |     |
|  | 2.0 Syncro   |  |  | 01.94  | 12.96   |  |  |  |     |
|  | 2.8 VR6  |  |  | 10.93  | 12.96   |  |  |  |     |
|  | 2.9 VR6 Syncro   |  |  | 10.94  | 12.96   |  |  |  |     |
|  | 1.6  |  |  | 10.94  | 12.96   | 24.2523-0908.3   | 040049   | Nz 23,81   |     |
|  | 1.8  |  |  | 10.93  | 12.96   |  |  |  |     |
|  | 1.9 TD   | 55   |  | 10.93  | 12.96   |  |  |  |     |
|  | 1.9 TDI  |  |  | 10.93  | 12.96   |  |  |  |     |
|  | 2.0  |  |  | 10.93  | 12.96   |  |  |  |     |
|  | 2.0 16V  |  |  | 01.94  | 12.96   |  |  |  |     |
|  | 2.0 Syncro   |  |  | 01.94  | 12.96   |  |  |  |     |
|  | 2.8 VR6  |  |  | 10.93  | 12.96   |  |  |  |     |
|  | 2.9 VR6 Syncro   |  |  | 10.94  | 12.96   |  |  |  |     |

<sup>1)</sup> on the brake caliper / sulla pinza freno / sur l'étrier de frein / a la pinza de freno

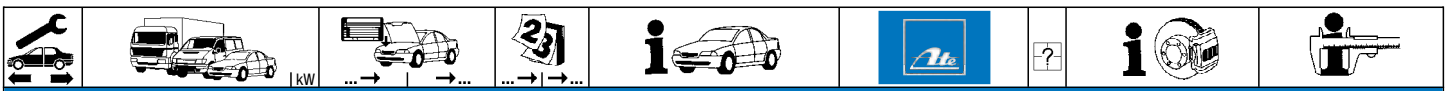

**VOLKSWAGEN PASSAT (97-05)**

|  |                 |     |                 |              |  |                |        |  |           |     |
|--|-----------------|-----|-----------------|--------------|--|----------------|--------|--|-----------|-----|
|  | 1.6             |     | 3B-X-800000     | <b>10.96</b> | - ESP  | 24.2123-1717.3 | 010521 |  | THz 23,81 |     |
|  | 1.8             | 85  | 3B-X-800000     | <b>01.97</b> | - ESP/ +  / + GUS-Staaten <sup>1)</sup>              |                |        |  |           |     |
|  | 1.8             | 92  | 3B-X-800000     | <b>10.96</b> | - ESP  |                |        |  |           |     |
|  | 1.8 4motion     |     | 3B-X-800000     | <b>10.96</b> | - ESP  |                |        |  |           |     |
|  | 1.8 T           |     | 3B-X-800000     | <b>10.96</b> | - ESP  |                |        |  |           |     |
|  | 1.9 TDI         | 66  | 3B-X-800000     | <b>10.96</b> | - ESP  |                |        |  |           |     |
|  | 1.9 TDI         | 81  | 3B-X-800000     | <b>10.96</b> | - ESP  |                |        |  |           |     |
|  | 1.9 TDI         | 85  | 3B-X-800000     | <b>08.98</b> | - ESP  |                |        |  |           |     |
|  | 1.9 TDI 4motion |     | 3B-X-800000     | <b>10.96</b> | - ESP  |                |        |  |           |     |
|  | 2.3             |     | 3B-X-800000     | <b>10.96</b> | - ESP  |                |        |  |           |     |
|  | 2.3 4motion     |     | 3B-X-800000     | <b>06.97</b> | - ESP  |                |        |  |           |     |
|  | 2.5 TDI         |     | 3B-X-800000     | <b>08.98</b> | - ESP  |                |        |  |           |     |
|  | 2.5 TDI 4motion |     | 3B-X-800000     | <b>08.98</b> | - ESP  |                |        |  |           |     |
|  | 2.8             | 132 | 3B-X-800000     | <b>01.97</b> | - ESP/ +  / + GUS-Staaten <sup>1)</sup>              |                |        |  |           |     |
|  | 2.8             | 142 | 3B-X-800000     | <b>08.96</b> | - ESP  |                |        |  |           |     |
|  | 2.8 4motion     |     | 3B-X-800000     | <b>10.96</b> | - ESP  |                |        |  |           |     |
|  | 1.6             |     | 3B-Y-000001     | 3B-1-400000  | - ESP  | 24.2125-1712.3 | 010622 |  | THz 25,40 |     |
|  | 1.8             |     | 85 3B-Y-000001  |              | <b>09.00</b> - ESP/ +  / + GUS-Staaten <sup>1)</sup> |                |        |  |           |     |
|  | 1.8             |     | 92 3B-Y-000001  |              | <b>09.00</b> - ESP                                   |                |        |  |           |     |
|  | 1.8 4motion     |     | 3B-Y-000001     |              | <b>09.00</b> - ESP                                   |                |        |  |           |     |
|  | 1.8 T           |     | 3B-Y-000001     | 3B-1-400000  | - ESP  |                |        |  |           |     |
|  | 1.9 TDI         |     | 66 3B-Y-000001  |              | <b>09.00</b> - ESP                                   |                |        |  |           |     |
|  | 1.9 TDI         |     | 74              | 3B-1-400000  | <b>10.00</b> - ESP                                   |                |        |  |           |     |
|  | 1.9 TDI         |     | 81 3B-Y-000001  | 3B-1-400000  | - ESP  |                |        |  |           |     |
|  | 1.9 TDI         |     | 85 3B-Y-000001  | 3B-1-400000  | - ESP  |                |        |  |           |     |
|  | 1.9 TDI         |     | 96              | 3B-1-400000  | <b>10.00</b> - ESP                                   |                |        |  |           |     |
|  | 1.9 TDI 4motion |     | 3B-Y-000001     | 3B-1-400000  | - ESP  |                |        |  |           |     |
|  | 1.9 TDI 4motion |     | 96              | 3B-1-400000  | <b>10.00</b> - ESP                                   |                |        |  |           |     |
|  | 2.0             |     | 85              | 3B-1-400000  | <b>10.00</b> - ESP                                   |                |        |  |           |     |
|  | 2.0 4motion     |     | 85              | 3B-1-400000  | <b>10.00</b> - ESP                                   |                |        |  |           |     |
|  | 2.3             |     | 3B-Y-000001     | 3B-1-400000  | - ESP  |                |        |  |           |     |
|  | 2.3 4motion     |     | 3B-Y-000001     | 3B-1-400000  | - ESP  |                |        |  |           |     |
|  | 2.5 TDI         |     | 3B-Y-000001     | 3B-1-400000  | - ESP  |                |        |  |           |     |
|  | 2.5 TDI 4motion |     | 3B-Y-000001     | 3B-1-400000  | - ESP  |                |        |  |           |     |
|  | 2.8             |     | 132 3B-Y-000001 | 3B-1-400000  | - ESP/ +  / + GUS-Staaten <sup>1)</sup>              |                |        |  |           |     |
|  | 2.8             |     | 142 3B-Y-000001 | 3B-1-400000  | - ESP  |                |        |  |           |     |
|  | 2.8 4motion     |     | 3B-Y-000001     | 3B-1-400000  | - ESP  |                |        |  |           |     |
|  | 1.6             |     | 3B-X-800000     | <b>10.96</b> | + ESP  | 24.2123-1730.3 | 010620 |  | THz 23,81 |     |
|  | 1.8             | 85  | 3B-X-800000     | <b>01.97</b> | + ESP/ +  / + GUS-Staaten <sup>2)</sup>              |                |        |  |           |     |
|  | 1.8             | 92  | 3B-X-800000     | <b>10.96</b> | + ESP  |                |        |  |           |     |
|  | 1.8 4motion     |     | 3B-X-800000     | <b>10.96</b> | + ESP  |                |        |  |           |     |
|  | 1.8 T           |     | 3B-X-800000     | <b>10.96</b> | + ESP  |                |        |  |           |     |
|  | 1.9 TDI         | 66  | 3B-X-800000     | <b>10.96</b> | + ESP  |                |        |  |           |     |
|  | 1.9 TDI         | 81  | 3B-X-800000     | <b>10.96</b> | + ESP  |                |        |  |           |     |
|  | 1.9 TDI         | 85  | 3B-X-800000     | <b>08.98</b> | + ESP  |                |        |  |           |     |
|  | 1.9 TDI 4motion |     | 3B-X-800000     | <b>10.96</b> | + ESP  |                |        |  |           |     |
|  | 2.3             |     | 3B-X-800000     | <b>10.96</b> | + ESP  |                |        |  |           |     |
|  | 2.3 4motion     |     | 3B-X-800000     | <b>06.97</b> | + ESP  |                |        |  |           |     |
|  | 2.5 TDI         |     | 3B-X-800000     | <b>08.98</b> | + ESP  |                |        |  |           |     |
|  | 2.5 TDI 4motion |     | 3B-X-800000     | <b>08.98</b> | + ESP  |                |        |  |           |     |
|  | 2.8             | 132 | 3B-X-800000     | <b>01.97</b> | + ESP/ +  / + GUS-Staaten <sup>2)</sup>              |                |        |  |           |     |
|  | 2.8             | 142 | 3B-X-800000     | <b>08.96</b> | + ESP  |                |        |  |           |     |
|  | 2.8 4motion     |     | 3B-X-800000     | <b>10.96</b> | + ESP  |                |        |  |           |     |
|  | 1.6             |     | 3B-Y-000001     | 3B-1-400000  | + ESP  | 24.2125-1713.3 | 010623 |  | THz 25,40 |     |
|  | 1.8             |     | 85 3B-Y-000001  |              | <b>09.00</b> + ESP/ +  / + GUS-Staaten <sup>2)</sup> |                |        |  |           |     |
|  | 1.8             |     | 92 3B-Y-000001  |              | <b>09.00</b> + ESP                                   |                |        |  |           |     |
|  | 1.8 4motion     |     | 3B-Y-000001     |              | <b>09.00</b> + ESP                                   |                |        |  |           |     |
|  | 1.8 T           |     | 3B-Y-000001     | 3B-1-400000  | + ESP  |                |        |  |           |     |
|  | 1.9 TDI         |     | 66 3B-Y-000001  |              | <b>09.00</b> + ESP                                   |                |        |  |           |     |
|  | 1.9 TDI         |     | 74              | 3B-1-400000  | <b>10.00</b> + ESP                                   |                |        |  |           |     |
|  | 1.9 TDI         |     | 81 3B-Y-000001  | 3B-1-400000  | + ESP  |                |        |  |           |     |
|  | 1.9 TDI         |     | 85 3B-Y-000001  | 3B-1-400000  | + ESP  |                |        |  |           |     |
|  | 1.9 TDI         |     | 96              | 3B-1-400000  | <b>10.00</b> + ESP                                   |                |        |  |           |     |
|  | 1.9 TDI 4motion |     | 3B-Y-000001     | 3B-1-400000  | + ESP  |                |        |  |           |     |
|  | 1.9 TDI 4motion |     | 96              | 3B-1-400000  | <b>10.00</b> + ESP                                   |                |        |  |           |     |
|  | 2.0             |     | 85              | 3B-1-400000  | <b>10.00</b> + ESP                                   |                |        |  |           |     |
|  | 2.0 4motion     |     | 85              | 3B-1-400000  | <b>10.00</b> + ESP                                   |                |        |  |           |     |
|  | 2.3             |     | 3B-Y-000001     | 3B-1-400000  | + ESP  |                |        |  |           |     |
|  | 2.3 4motion     |     | 3B-Y-000001     | 3B-1-400000  | + ESP  |                |        |  |           |     |
|  | 2.5 TDI         |     | 3B-Y-000001     | 3B-1-400000  | + ESP  |                |        |  |           |     |
|  | 2.5 TDI 4motion |     | 3B-Y-000001     | 3B-1-400000  | + ESP  |                |        |  |           |     |
|  | 2.8             |     | 132 3B-Y-000001 | 3B-1-400000  | + ESP/ +  / + GUS-Staaten <sup>2)</sup>              |                |        |  |           |     |
|  | 2.8             |     | 142 3B-Y-000001 | 3B-1-400000  | + ESP  |                |        |  |           |     |
|  | 2.8 4motion     |     | 3B-Y-000001     | 3B-1-400000  | + ESP  |                |        |  |           |     |
|  | 1.6             |     |                 | <b>05.02</b> | <b>06.05</b>   | 03.2125-0373.3 | 010810 |  | THz 25,40 | ATE |
|  | 1.8 T           |     |                 | <b>05.02</b> | <b>06.05</b>   |                |        |  |           |     |
|  | 1.9 TDI         | 74  |                 | <b>05.02</b> | <b>06.05</b>   |                |        |  |           |     |
|  | 1.9 TDI         | 81  |                 | <b>05.02</b> | <b>06.05</b>   |                |        |  |           |     |
|  | 1.9 TDI         | 85  |                 | <b>05.02</b> | <b>06.05</b>   |                |        |  |           |     |
|  | 1.9 TDI         | 96  |                 | <b>05.02</b> | <b>06.05</b>   |                |        |  |           |     |
|  | 1.9 TDI 4motion |     |                 | <b>05.02</b> | <b>06.05</b>   |                |        |  |           |     |
|  | 1.9 TDI 4motion | 96  |                 | <b>05.02</b> | <b>06.05</b>   |                |        |  |           |     |
|  | 2.0             | 85  |                 | <b>05.02</b> | <b>06.05</b>   |                |        |  |           |     |
|  | 2.0             | 96  |                 | <b>05.02</b> | <b>06.05</b>   |                |        |  |           |     |
|  | 2.0 4motion     | 85  |                 | <b>05.02</b> | <b>06.05</b>   |                |        |  |           |     |
|  | 2.0 TDI         | 100 |                 | <b>12.03</b> | <b>06.05</b>   |                |        |  |           |     |
|  | 2.3             |     |                 | <b>05.02</b> | <b>06.05</b>   |                |        |  |           |     |















<sup>1)</sup> - ESP/ + / + GUS States / - ESP/ + / + Stati del GUS / - ESP/ + / + Etats de la CEI / - ESP/ + / + estados del GUS

<sup>2)</sup> + ESP/ + / + GUS States / + ESP/ + / + Stati del GUS / + ESP/ + / + Etats de la CEI / + ESP/ + / + estados del GUS





**VOLKSWAGEN PASSAT (97-05)**

|  |                 |             |             |       |                          |                          |                |   |   |                |           |     |
|--|-----------------|-------------|-------------|-------|--------------------------|--------------------------|----------------|---|---|----------------|-----------|-----|
|    | 2.3 4motion     |             |             | 05.02 | 06.05                    |                          | 03.2125-0373.3 | 010810  |   | THz 25,40      | ATE       |     |
|  | 2.5 TDI         |             |             | 05.02 | 06.05                    |                          |                |   |   |                |           |     |
|  | 2.5 TDI 4motion |             |             | 05.02 | 06.05                    |                          |                |   |   |                |           |     |
|  | 2.8             | 132         |             | 05.02 | 06.05                    | + (M) / + GUS-Staaten 1) |                |   |   |                |           |     |
|  | 2.8             | 142         |             | 05.02 | 06.05                    |                          |                |   |   |                |           |     |
|  | 2.8 4motion     |             |             | 05.02 | 06.05                    |                          |                |   |   |                |           |     |
|  | 4.0 W8 4motion  |             |             | 05.02 | 06.05                    |                          |                |   |   |                |           |     |
|  | 1.6             |             | 3B-2-000001 |       | 06.05                    |                          | 24.2125-1720.3 | 010688  |   |                | THz 25,40 | LUC |
|  | 1.8 T           |             | 3B-2-000001 |       | 06.05                    |                          |                |   |   |                |           |     |
|  | 1.9 TDI         | 74          | 3B-2-000001 |       | 06.05                    |                          |                |   |   |                |           |     |
|  | 1.9 TDI         | 81          | 3B-2-000001 |       | 06.05                    |                          |                |   |   |                |           |     |
| 1.9 TDI  | 85              | 3B-2-000001 |             | 06.05 |                          |                          |                |   |   |                |           |     |
| 1.9 TDI  | 96              | 3B-2-000001 |             | 06.05 |                          |                          |                |   |   |                |           |     |
| 1.9 TDI 4motion  |                 | 3B-2-000001 |             | 06.05 |                          |                          |                |   |   |                |           |     |
| 1.9 TDI 4motion  | 96              | 3B-2-000001 |             | 06.05 |                          |                          |                |   |   |                |           |     |
| 2.0  | 85              | 3B-2-000001 |             | 06.05 |                          |                          |                |   |   |                |           |     |
| 2.0  | 96              |             | 05.02       | 06.05 |                          |                          |                |   |   |                |           |     |
| 2.0 4motion  | 85              | 3B-2-000001 |             | 06.05 |                          |                          |                |   |   |                |           |     |
| 2.0 TDI  | 100             |             | 12.03       | 06.05 |                          |                          |                |   |   |                |           |     |
| 2.3  |                 | 3B-2-000001 |             | 06.05 |                          |                          |                |   |   |                |           |     |
| 2.3 4motion  |                 | 3B-2-000001 |             | 06.05 |                          |                          |                |   |   |                |           |     |
| 2.5 TDI  |                 | 3B-2-000001 |             | 06.05 |                          |                          |                |   |   |                |           |     |
| 2.5 TDI 4motion  |                 | 3B-2-000001 |             | 06.05 |                          |                          |                |   |   |                |           |     |
| 2.8  | 132             | 3B-2-000001 |             | 06.05 | + (M) / + GUS-Staaten 1) |                          |                |   |   |                |           |     |
| 2.8  | 142             | 3B-2-000001 |             | 06.05 |                          |                          |                |   |   |                |           |     |
| 2.8 4motion  |                 | 3B-2-000001 |             | 06.05 |                          |                          |                |   |   |                |           |     |
| 4.0 W8 4motion   |                 |             | 09.01       | 06.05 |                          |                          |                |   |   |                |           |     |
|    | 1.6             |             |             | 10.96 | 09.00                    | PR: 1LZ,1ZJ              | 24.3541-1763.5 | 240231  |  | D=54, - Halter | LUC       |     |
|  | 1.8             | 85          |             | 01.97 | 09.00                    | + (M) / + GUS-Staaten 1) | 24.3541-1764.5 | 240232  |  | D=54, - Halter | LUC       |     |
|  | 1.8             | 92          |             | 10.96 | 09.00                    | PR: 1LZ,1ZJ              |                |   |   |                |           |     |
|  | 1.8 4motion     |             |             | 10.96 | 09.00                    | PR: 1LZ,1ZJ              |                |   |   |                |           |     |
|  | 1.9 TDI         | 66          |             | 10.96 | 09.00                    | PR: 1LZ,1ZJ              |                |   |   |                |           |     |
|  | 1.6             |             | 3B-X-124107 | 10.96 | 09.00                    | PR: 1LB,1LE,1ZC          | 11.3571-8522.2 | 220320  |  | D=57, - Halter | ATE       |     |
|  | 1.8             | 92          | 3B-X-124107 | 10.96 | 09.00                    | PR: 1LB,1LE,1ZC          | 11.3571-8521.2 | 220319  |  | D=57, - Halter | ATE       |     |
|  | 1.8 4motion     |             | 3B-X-124107 | 10.96 | 09.00                    | PR: 1LB,1LE,1ZC          | 24.3571-8522.5 | 240496  |  | D=57, - Halter | ATE       |     |
|  | 1.8 T           |             | 3B-X-124107 | 10.96 | 09.00                    | PR: 1LB,1LE,1ZC          | 24.3571-8521.5 | 240495  |  | D=57, - Halter | ATE       |     |
|  | 1.9 TDI         | 66          | 3B-X-124107 | 10.96 | 09.00                    | PR: 1LB,1LE,1ZC          | 11.0441-5704.2 | 250034  |   | Dichtungssatz  | ATE       |     |
|  | 1.9 TDI         | 81          | 3B-X-124107 | 10.96 | 09.00                    | PR: 1LB,1LE,1ZC          | 11.0101-5409.2 | 260035  |   | Hülssensatz    | ATE       |     |
| 1.9 TDI  | 85              | 3B-X-124107 | 08.98       | 09.00 | PR: 1LB,1LE,1ZC          | 11.8171-0008.1           | 990049         |   | Führungsbolzen  | ATE            |           |     |
| 1.9 TDI 4motion  |                 | 3B-X-124107 | 10.96       | 09.00 | PR: 1LB,1LE,1ZC          | 11.8116-0143.1           | 390513         | 2   | Haltefeder  | ATE            |           |     |
| 2.3  |                 | 3B-X-124107 | 10.96       | 09.00 | PR: 1LB,1LE,1ZC          |                          |                |   |   |                |           |     |
| 2.3 4motion  |                 | 3B-X-124107 | 06.97       | 09.00 | PR: 1LB,1LE,1ZC          |                          |                |   |   |                |           |     |
| 2.8  | 132             | 3B-X-124107 | 01.97       | 09.00 | + (M) / + GUS-Staaten 1) |                          |                |   |   |                |           |     |
| 2.8  | 142             | 3B-X-124107 | 08.96       | 09.00 | PR: 1LB,1LE,1ZC          |                          |                |   |   |                |           |     |
| 2.8 4motion  |                 | 3B-X-124107 | 10.96       | 09.00 | PR: 1LB,1LE,1ZC          |                          |                |   |   |                |           |     |
| 1.6  |                 | 3B-X-124108 |             | 06.05 | PR: 1LB,1LE,1ZC          | 11.3571-8522.2           | 220320         |  | D=57, - Halter  | ATE            |           |     |
| 1.8  | 92              | 3B-X-124108 |             | 06.05 | PR: 1LB,1LE,1ZC          | 11.3571-8521.2           | 220319         |  | D=57, - Halter  | ATE            |           |     |
| 1.8 4motion  |                 | 3B-X-124108 |             | 06.05 | PR: 1LB,1LE,1ZC          | 24.3571-8522.5           | 240496         |  | D=57, - Halter  | ATE            |           |     |
| 1.8 T  |                 | 3B-X-124108 |             | 06.05 | PR: 1LB,1LE,1ZC          | 24.3571-8521.5           | 240495         |  | D=57, - Halter  | ATE            |           |     |
| 1.9 TDI  | 66              | 3B-X-124108 |             | 06.05 | PR: 1LB,1LE,1ZC          | 11.8170-0306.1           | 260102         | 2   | Halter  | ATE            |           |     |
| 1.9 TDI  | 74              |             | 10.00       | 06.05 | PR: 1LB,1LE,1ZC          | 11.0441-5704.2           | 250034         |   | Dichtungssatz   | ATE            |           |     |
| 1.9 TDI  | 81              | 3B-X-124108 |             | 06.05 | PR: 1LB,1LE,1ZC          | 11.0101-5409.2           | 260035         |   | Hülssensatz   | ATE            |           |     |
| 1.9 TDI  | 85              | 3B-X-124108 |             | 06.05 | PR: 1LB,1LE,1ZC          | 11.8171-0008.1           | 990049         |   | Führungsbolzen  | ATE            |           |     |
| 1.9 TDI  | 96              |             | 10.00       | 06.05 | PR: 1LB,1LE,1ZC          | 11.8116-0143.1           | 390513         | 2   | Haltefeder  | ATE            |           |     |
| 1.9 TDI 4motion  |                 | 3B-X-124108 |             | 06.05 | PR: 1LB,1LE,1ZC          |                          |                |   |   |                |           |     |
| 1.9 TDI 4motion  | 96              |             | 10.00       | 06.05 | PR: 1LB,1LE,1ZC          |                          |                |   |   |                |           |     |
| 2.0  | 85              |             | 10.00       | 06.05 | PR: 1LB,1LE,1ZC          |                          |                |   |   |                |           |     |
| 2.0  | 96              |             | 05.02       | 06.05 | PR: 1LB,1LE,1ZC          |                          |                |   |   |                |           |     |
| 2.0 4motion  | 85              |             | 10.00       | 06.05 | PR: 1LB,1LE,1ZC          |                          |                |   |   |                |           |     |
| 2.0 TDI  | 100             |             | 12.03       | 06.05 | PR: 1LB,1LE,1ZC          |                          |                |   |   |                |           |     |
| 2.3  |                 | 3B-X-124108 |             | 09.00 | PR: 1LB,1LE,1ZC          |                          |                |   |   |                |           |     |
| 2.3 4motion  |                 | 3B-X-124108 |             | 09.00 | PR: 1LB,1LE,1ZC          |                          |                |   |   |                |           |     |
| 2.5 TDI  |                 |             | 08.98       | 09.00 | PR: 1LB,1LE,1ZC          |                          |                |   |   |                |           |     |
| 2.5 TDI 4motion  |                 |             | 08.98       | 09.00 | PR: 1LB,1LE,1ZC          |                          |                |   |   |                |           |     |
| 2.8  | 132             | 3B-X-124108 |             | 06.05 | + (M) / + GUS-Staaten 1) |                          |                |   |   |                |           |     |
| 2.8  | 142             | 3B-X-124108 |             | 09.00 | PR: 1LB,1LE,1ZC          |                          |                |   |   |                |           |     |
| 2.8 4motion  |                 | 3B-X-124108 |             | 09.00 | PR: 1LB,1LE,1ZC          |                          |                |   |   |                |           |     |
| 2.0 TDI  | 100             |             | 12.03       | 06.05 | PR: 1LT                  | 11.9571-9836.2           | 220428         |  | D=57, - Halter  | ATE            |           |     |
| 2.3  |                 |             | 10.00       | 06.05 | PR: 1LT                  | 11.9571-9835.2           | 220427         |  | D=57, - Halter  | ATE            |           |     |
| 2.3 4motion  |                 |             | 10.00       | 06.05 | PR: 1LT                  | 11.0441-5704.2           | 250034         |   | Dichtungssatz   | ATE            |           |     |
| 2.5 TDI  |                 |             | 10.00       | 06.05 | PR: 1LT                  | 11.0101-5409.2           | 260035         |   | Hülssensatz   | ATE            |           |     |
| 2.5 TDI 4motion  |                 |             | 10.00       | 06.05 | PR: 1LT                  | 11.8171-0008.1           | 990049         |   | Führungsbolzen  | ATE            |           |     |
| 2.8  | 142             |             | 10.00       | 06.05 | PR: 1LT                  | 11.8116-0143.1           | 390513         | 2   | Haltefeder  | ATE            |           |     |
| 2.8 4motion  |                 |             | 10.00       | 06.05 | PR: 1LT                  |                          |                |   |   |                |           |     |
| 4.0 W8 4motion   |                 |             | 09.01       | 06.05 | PR: 1ZF,1ZG              | 11.8171-0008.1           | 990049         |   | Führungsbolzen  | ATE            |           |     |
|  |                 |             |             |       |                          | 11.8116-0260.1           | 390597         | 2   | Haltefeder  | ATE            |           |     |
|  | 1.6             |             |             | 10.96 | 06.05                    |                          | 83.7813-0295.3 | 330799  | 2   | L=295          |           |     |
|  | 1.8             | 85          |             | 01.97 | 09.00                    | + (M) / + GUS-Staaten 1) |                |   |   |                |           |     |
|  | 1.8             | 92          |             | 10.96 | 09.00                    |                          |                |   |   |                |           |     |
|  | 1.8 4motion     |             |             | 10.96 | 09.00                    |                          |                |   |   |                |           |     |
|  | 1.8 T           |             |             | 10.96 | 06.05                    |                          |                |   |   |                |           |     |
|  | 1.9 TDI         | 66          |             | 10.96 | 09.00                    |                          |                |   |   |                |           |     |
|  | 1.9 TDI         | 74          |             | 10.00 | 06.05                    |                          |                |   |   |                |           |     |
|  | 1.9 TDI         | 81          |             | 10.96 | 06.05                    |                          |                |   |   |                |           |     |
|  | 1.9 TDI         | 85          |             | 08.98 | 06.05                    |                          |                |   |   |                |           |     |
|  | 1.9 TDI         | 96          |             | 10.00 | 06.05                    |                          |                |   |   |                |           |     |

1) + (M) / + GUS States / + (M) / + Stati del GUS / + (M) / + Etats de la CEI / + (M) / + estados del GUS

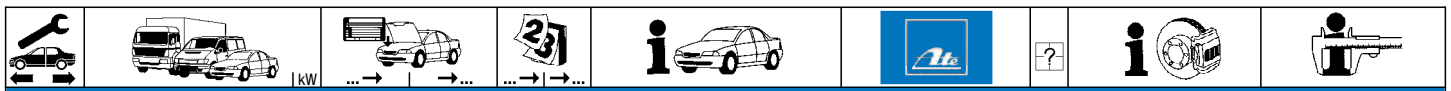

**VOLKSWAGEN PASSAT (97-05)**

|                 |                 |       |                                |                                |                |        |   |                   |        |                     |                |        |                |                |     |
|-----------------|-----------------|-------|--------------------------------|--------------------------------|----------------|--------|---|-------------------|--------|---------------------|----------------|--------|----------------|----------------|-----|
|                 | 1.9 TDI 4motion |       | 10.96                          | 06.05                          | 83.7813-0295.3 | 330799 | 2 |                   | L=295  |                     |                |        |                |                |     |
|                 | 1.9 TDI 4motion | 96    | 10.00                          | 06.05                          |                |        |   |                   |        |                     |                |        |                |                |     |
|                 | 2.0             | 85    | 10.00                          | 06.05                          |                |        |   |                   |        |                     |                |        |                |                |     |
|                 | 2.0             | 96    | 05.02                          | 06.05                          |                |        |   |                   |        |                     |                |        |                |                |     |
|                 | 2.0 4motion     | 85    | 10.00                          | 06.05                          |                |        |   |                   |        |                     |                |        |                |                |     |
|                 | 2.0 TDI         | 100   | 12.03                          | 06.05                          |                |        |   |                   |        |                     |                |        |                |                |     |
|                 | 2.3             |       | 10.96                          | 06.05                          |                |        |   |                   |        |                     |                |        |                |                |     |
|                 | 2.3 4motion     |       | 06.97                          | 06.05                          |                |        |   |                   |        |                     |                |        |                |                |     |
|                 | 2.5 TDI         |       | 08.98                          | 06.05                          |                |        |   |                   |        |                     |                |        |                |                |     |
|                 | 2.5 TDI 4motion |       | 08.98                          | 06.05                          |                |        |   |                   |        |                     |                |        |                |                |     |
| 2.8             | 132             | 01.97 | 06.05 + (V) / + GUS-Staaten 1) |                                |                |        |   |                   |        |                     |                |        |                |                |     |
| 2.8             | 142             | 08.96 | 06.05                          |                                |                |        |   |                   |        |                     |                |        |                |                |     |
| 2.8 4motion     |                 | 10.96 | 06.05                          |                                |                |        |   |                   |        |                     |                |        |                |                |     |
| 4.0 W8 4motion  |                 | 09.01 | 06.05                          | 24.5237-0360.3                 | 331212         | 2      |   | L=360             |        |                     |                |        |                |                |     |
|                 | 1.6             |       | 10.96                          | 06.05                          | 24.3384-1731.7 | 220543 |   | D=38, - Halter    | LUC    |                     |                |        |                |                |     |
|                 | 1.8             | 85    | 01.97                          | 09.00 + (V) / + GUS-Staaten 1) |                |        |   |                   |        | 24.3384-1732.7      | 220544         |        | D=38, - Halter | LUC            |     |
|                 | 1.8             | 92    | 10.96                          | 09.00                          |                |        |   |                   |        | PR: 1KD,1KE,1KF,1KW |                |        |                |                |     |
|                 | 1.8 T           |       | 10.96                          | 06.05                          |                |        |   |                   |        | PR: 1KD,1KE,1KF,1KW |                |        |                |                |     |
|                 | 1.9 TDI         | 66    | 10.96                          | 09.00                          |                |        |   |                   |        | PR: 1KD,1KE,1KF,1KW |                |        |                |                |     |
|                 | 1.9 TDI         | 74    | 10.00                          | 06.05                          |                |        |   |                   |        | PR: 1KD,1KE,1KF,1KW |                |        |                |                |     |
|                 | 1.9 TDI         | 81    | 10.96                          | 06.05                          |                |        |   |                   |        | PR: 1KD,1KE,1KF,1KW |                |        |                |                |     |
|                 | 1.9 TDI         | 85    | 08.98                          | 06.05                          |                |        |   |                   |        | PR: 1KD,1KE,1KF,1KW |                |        |                |                |     |
|                 | 1.9 TDI         | 96    | 10.00                          | 06.05                          |                |        |   |                   |        | PR: 1KD,1KE,1KF,1KW |                |        |                |                |     |
|                 | 2.0             | 96    | 05.02                          | 06.05                          |                |        |   |                   |        | PR: 1KD,1KE,1KF,1KW |                |        |                |                |     |
|                 | 2.0 TDI         | 100   | 12.03                          | 06.05                          |                |        |   |                   |        | PR: 1KD,1KE,1KF,1KW |                |        |                |                |     |
|                 | 2.3             |       | 10.96                          | 06.05                          |                |        |   |                   |        | PR: 1KD,1KE,1KF,1KW |                |        |                |                |     |
|                 | 2.5 TDI         |       | 08.98                          | 06.05                          |                |        |   |                   |        | PR: 1KD,1KE,1KF,1KW |                |        |                |                |     |
|                 | 2.8             | 132   | 01.97                          | 06.05 + (V) / + GUS-Staaten 1) |                |        |   |                   |        |                     |                |        |                |                |     |
|                 | 2.8             | 142   | 08.96                          | 06.05                          |                |        |   |                   |        | PR: 1KD,1KE,1KF,1KW |                |        |                |                |     |
|                 | 1.8 4motion     |       | 10.00                          | 06.05                          |                |        |   |                   |        | PR: 1KD,1KF         | 24.3384-1733.7 | 220545 |                | D=38, - Halter | LUC |
|                 | 1.9 TDI 4motion |       | 10.00                          | 06.05                          |                |        |   |                   |        | PR: 1KD,1KF         | 24.3384-1734.7 | 220546 |                | D=38, - Halter | LUC |
|                 | 1.9 TDI 4motion | 96    | 10.00                          | 06.05                          |                |        |   |                   |        | PR: 1KD,1KF         |                |        |                |                |     |
|                 | 2.0 4motion     | 85    | 10.00                          | 06.05                          |                |        |   |                   |        | PR: 1KD,1KF         |                |        |                |                |     |
|                 | 2.3 4motion     |       | 10.00                          | 06.05                          |                |        |   |                   |        | PR: 1KD,1KF         |                |        |                |                |     |
| 2.5 TDI 4motion |                 | 10.00 | 06.05                          | PR: 1KD,1KF                    |                |        |   |                   |        |                     |                |        |                |                |     |
| 2.8 4motion     |                 | 10.00 | 06.05                          | PR: 1KD,1KF                    |                |        |   |                   |        |                     |                |        |                |                |     |
| 4.0 W8 4motion  |                 | 09.01 | 06.05                          | PR: 1KD,1KF                    |                |        |   |                   |        |                     |                |        |                |                |     |
| 1.8 4motion     |                 | 10.00 | 06.05                          | PR: 1KE,1KW                    | 24.3437-1701.7 | 220761 |   | D=43, - Halter    | LUC    |                     |                |        |                |                |     |
| 1.9 TDI 4motion |                 | 10.00 | 06.05                          | PR: 1KE,1KW                    | 24.3437-1702.7 | 220762 |   | D=43, - Halter    | LUC    |                     |                |        |                |                |     |
| 1.9 TDI 4motion | 96              | 10.00 | 06.05                          | PR: 1KE,1KW                    |                |        |   |                   |        |                     |                |        |                |                |     |
| 2.0 4motion     | 85              | 10.00 | 06.05                          | PR: 1KE,1KW                    |                |        |   |                   |        |                     |                |        |                |                |     |
| 2.3 4motion     |                 | 10.00 | 06.05                          | PR: 1KE,1KW                    |                |        |   |                   |        |                     |                |        |                |                |     |
| 2.5 TDI 4motion |                 | 10.00 | 06.05                          | PR: 1KE,1KW                    |                |        |   |                   |        |                     |                |        |                |                |     |
| 2.8 4motion     |                 | 10.00 | 06.05                          | PR: 1KE,1KW                    |                |        |   |                   |        |                     |                |        |                |                |     |
| 4.0 W8 4motion  |                 | 09.01 | 06.05                          | PR: 1KE,1KW                    |                |        |   |                   |        |                     |                |        |                |                |     |
|                 | 1.6             |       | 10.96                          | 06.05                          | 83.7812-0180.3 | 330854 | 2 | am Bremssattel 2) | L=180  |                     |                |        |                |                |     |
|                 | 1.8             | 85    | 01.97                          | 09.00 + (V) / + GUS-Staaten 1) |                |        |   |                   |        | 24.5243-0190.3      | 330678         | 2      | L=190          |                |     |
|                 | 1.8             | 92    | 10.96                          | 09.00                          |                |        |   |                   |        |                     |                |        |                |                |     |
|                 | 1.8 T           |       | 10.96                          | 06.05                          |                |        |   |                   |        |                     |                |        |                |                |     |
|                 | 1.9 TDI         | 66    | 10.96                          | 09.00                          |                |        |   |                   |        |                     |                |        |                |                |     |
|                 | 1.9 TDI         | 74    | 10.00                          | 06.05                          |                |        |   |                   |        |                     |                |        |                |                |     |
|                 | 1.9 TDI         | 81    | 10.96                          | 06.05                          |                |        |   |                   |        |                     |                |        |                |                |     |
|                 | 1.9 TDI         | 85    | 08.98                          | 06.05                          |                |        |   |                   |        |                     |                |        |                |                |     |
|                 | 1.9 TDI         | 96    | 10.00                          | 06.05                          |                |        |   |                   |        |                     |                |        |                |                |     |
|                 | 2.0             | 85    | 10.00                          | 06.05                          |                |        |   |                   |        |                     |                |        |                |                |     |
|                 | 2.0             | 96    | 05.02                          | 06.05                          |                |        |   |                   |        |                     |                |        |                |                |     |
|                 | 2.0 TDI         | 100   | 12.03                          | 06.05                          |                |        |   |                   |        |                     |                |        |                |                |     |
|                 | 2.3             |       | 10.96                          | 06.05                          |                |        |   |                   |        |                     |                |        |                |                |     |
|                 | 2.5 TDI         |       | 08.98                          | 06.05                          |                |        |   |                   |        |                     |                |        |                |                |     |
|                 | 2.8             | 132   | 01.97                          | 06.05 + (V) / + GUS-Staaten 1) |                |        |   |                   |        |                     |                |        |                |                |     |
|                 | 2.8             | 142   | 08.96                          | 06.05                          |                |        |   |                   |        |                     |                |        |                |                |     |
|                 | 1.8 4motion     |       | 10.96                          | 09.00                          |                |        |   |                   |        | 24.5243-0310.3      | 330755         | 2      |                | L=310          |     |
|                 | 1.9 TDI 4motion |       | 10.96                          | 06.05                          |                |        |   |                   |        |                     |                |        |                |                |     |
|                 | 1.9 TDI 4motion | 96    | 10.00                          | 06.05                          |                |        |   |                   |        |                     |                |        |                |                |     |
|                 | 2.0 4motion     | 85    | 10.00                          | 06.05                          |                |        |   |                   |        |                     |                |        |                |                |     |
| 2.3 4motion     |                 | 06.97 | 09.00                          |                                |                |        |   |                   |        |                     |                |        |                |                |     |
| 2.5 TDI 4motion |                 | 08.98 | 09.00                          |                                |                |        |   |                   |        |                     |                |        |                |                |     |
| 2.8 4motion     |                 | 10.96 | 09.00                          |                                |                |        |   |                   |        |                     |                |        |                |                |     |
| 2.3 4motion     |                 | 10.00 | 06.05                          | 24.5142-0290.3                 | 330950         | 2      |   | L=290             |        |                     |                |        |                |                |     |
| 2.5 TDI 4motion |                 | 10.00 | 06.05                          |                                |                |        |   |                   |        |                     |                |        |                |                |     |
| 2.8 4motion     |                 | 10.00 | 06.05                          |                                |                |        |   |                   |        |                     |                |        |                |                |     |
|                 | 1.6             |       | 10.96                          | 06.05                          | 24.3727-0174.2 | 580174 |   |                   | L=1890 |                     |                |        |                |                |     |
|                 | 1.8             | 85    | 01.97                          | 09.00 + (V) / + GUS-Staaten 1) |                |        |   |                   |        | 24.3727-0170.2      | 580170         |        | L=1890         |                |     |
|                 | 1.8             | 92    | 10.96                          | 09.00                          |                |        |   |                   |        |                     |                |        |                |                |     |
|                 | 1.8 T           |       | 10.96                          | 06.05                          |                |        |   |                   |        |                     |                |        |                |                |     |
|                 | 1.9 TDI         | 66    | 10.96                          | 09.00                          |                |        |   |                   |        |                     |                |        |                |                |     |
|                 | 1.9 TDI         | 74    | 10.00                          | 06.05                          |                |        |   |                   |        |                     |                |        |                |                |     |
|                 | 1.9 TDI         | 81    | 10.96                          | 06.05                          |                |        |   |                   |        |                     |                |        |                |                |     |
|                 | 1.9 TDI         | 85    | 08.98                          | 06.05                          |                |        |   |                   |        |                     |                |        |                |                |     |
|                 | 1.9 TDI         | 96    | 10.00                          | 06.05                          |                |        |   |                   |        |                     |                |        |                |                |     |
|                 | 2.0             | 85    | 10.00                          | 06.05                          |                |        |   |                   |        |                     |                |        |                |                |     |
|                 | 2.0             | 96    | 05.02                          | 06.05                          |                |        |   |                   |        |                     |                |        |                |                |     |
|                 | 2.0 TDI         | 100   | 12.03                          | 06.05                          |                |        |   |                   |        |                     |                |        |                |                |     |
|                 | 2.3             |       | 10.96                          | 06.05                          |                |        |   |                   |        |                     |                |        |                |                |     |
|                 | 2.5 TDI         |       | 08.98                          | 06.05                          |                |        |   |                   |        |                     |                |        |                |                |     |
| 2.8             | 132             | 01.97 | 06.05 + (V) / + GUS-Staaten 1) |                                |                |        |   |                   |        |                     |                |        |                |                |     |

1) + (V) / + GUS States / + (V) / + Stati del GUS / + (V) / + Etats de la CEI / + (V) / + estados del GUS

2) on the brake caliper / sulla pinza freno / sur l'étrier de frein / a la pinza de freno



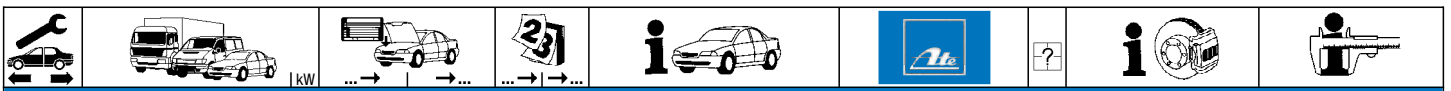















**VOLKSWAGEN PASSAT (97-05)**

|  |                 |     |             |             |       |                                       |                |        |                          |  |          |
|--|-----------------|-----|-------------|-------------|-------|---------------------------------------|----------------|--------|--------------------------|--|----------|
|  | 2.8             | 142 |             | 08.96       | 06.05 |                                       | 24.3727-0174.2 | 580174 | <input type="checkbox"/> |  | L=1890   |
|  |                 |     |             |             |       |                                       | 24.3727-0170.2 | 580170 | <input type="checkbox"/> |  | L=1890   |
|  | 1.6             |     | 3B-V-100000 | 10.96       |       |                                       | 24.2419-1706.3 | 030091 |                          |  | Gz 19,05 |
|  | 1.8             | 85  | 3B-V-100000 | 01.97       |       | + (VRS) / + GUS-Staaten <sup>1)</sup> |                |        |                          |  |          |
|  | 1.8             | 92  | 3B-V-100000 | 10.96       |       |                                       |                |        |                          |  |          |
|  | 1.8 T           |     | 3B-V-100000 | 10.96       |       |                                       |                |        |                          |  |          |
|  | 1.9 TDI         | 66  | 3B-W-070000 | 10.96       |       |                                       |                |        |                          |  |          |
|  | 1.9 TDI         | 81  | 3B-W-070000 | 10.96       |       |                                       |                |        |                          |  |          |
|  | 1.9 TDI         | 85  |             | 08.98       | 06.05 |                                       |                |        |                          |  |          |
|  | 2.3             |     | 3B-V-100000 | 10.96       |       |                                       |                |        |                          |  |          |
|  | 2.5 TDI         |     |             | 08.98       | 06.05 |                                       |                |        |                          |  |          |
|  | 2.8             | 132 | 3B-V-100000 | 01.97       |       | + (VRS) / + GUS-Staaten <sup>1)</sup> |                |        |                          |  |          |
|  | 2.8             | 142 | 3B-V-100000 | 08.96       |       |                                       |                |        |                          |  |          |
|  | 1.6             |     | 3B-V-100001 |             | 06.05 |                                       | 24.2419-1707.3 | 030092 |                          |  | Gz 19,05 |
|  | 1.8             | 85  | 3B-V-100001 |             | 09.00 | + (VRS) / + GUS-Staaten <sup>1)</sup> |                |        |                          |  |          |
|  | 1.8             | 92  | 3B-V-100001 |             | 09.00 |                                       |                |        |                          |  |          |
|  | 1.8 4motion     |     |             | 10.96       | 09.00 |                                       |                |        |                          |  |          |
|  | 1.8 T           |     | 3B-V-100001 |             | 06.05 |                                       |                |        |                          |  |          |
|  | 1.9 TDI         | 66  | 3B-W-070001 |             | 09.00 |                                       |                |        |                          |  |          |
|  | 1.9 TDI         | 74  |             | 10.00       | 06.05 |                                       |                |        |                          |  |          |
|  | 1.9 TDI         | 81  | 3B-W-070001 |             | 06.05 |                                       |                |        |                          |  |          |
|  | 1.9 TDI         | 96  |             | 10.00       | 06.05 |                                       |                |        |                          |  |          |
|  | 1.9 TDI 4motion |     |             | 10.96       | 06.05 |                                       |                |        |                          |  |          |
|  | 1.9 TDI 4motion | 96  |             | 10.00       | 06.05 |                                       |                |        |                          |  |          |
|  | 2.0             | 85  |             | 10.00       | 06.05 |                                       |                |        |                          |  |          |
|  | 2.0             | 96  |             | 05.02       | 06.05 |                                       |                |        |                          |  |          |
|  | 2.0 4motion     | 85  |             | 10.00       | 06.05 |                                       |                |        |                          |  |          |
|  | 2.0 TDI         | 100 |             | 12.03       | 06.05 |                                       |                |        |                          |  |          |
|  | 2.3             |     | 3B-V-100001 |             | 06.05 |                                       |                |        |                          |  |          |
|  | 2.3 4motion     |     |             | 06.97       | 06.05 |                                       |                |        |                          |  |          |
|  | 2.5 TDI 4motion |     |             | 08.98       | 06.05 |                                       |                |        |                          |  |          |
|  | 2.8             | 132 | 3B-V-100001 |             | 06.05 | + (VRS) / + GUS-Staaten <sup>1)</sup> |                |        |                          |  |          |
|  | 2.8             | 142 | 3B-V-100001 |             | 06.05 |                                       |                |        |                          |  |          |
|  | 2.8 4motion     |     |             | 10.96       | 06.05 |                                       |                |        |                          |  |          |
|  | 4.0 W8 4motion  |     |             | 09.01       | 06.05 |                                       |                |        |                          |  |          |
|  | 1.6             |     | 3B-V-100001 | 3B-Y-125000 |       |                                       | 24.2419-1705.3 | 030090 |                          |  | Gz 19,05 |
|  | 1.8             | 85  | 3B-V-100001 | 3B-Y-125000 |       | + (VRS) / + GUS-Staaten <sup>1)</sup> |                |        |                          |  |          |
|  | 1.8             | 92  | 3B-V-100001 | 3B-Y-125000 |       |                                       |                |        |                          |  |          |
|  | 1.8 4motion     |     |             | 3B-Y-125000 | 10.96 |                                       |                |        |                          |  |          |
|  | 1.8 T           |     | 3B-V-100001 | 3B-Y-125000 |       |                                       |                |        |                          |  |          |
|  | 1.9 TDI         | 66  | 3B-W-070001 | 3B-Y-125000 |       |                                       |                |        |                          |  |          |
|  | 1.9 TDI         | 81  | 3B-W-070001 | 3B-Y-125000 |       |                                       |                |        |                          |  |          |
|  | 1.9 TDI 4motion |     |             | 3B-Y-125000 | 10.96 |                                       |                |        |                          |  |          |
|  | 2.3             |     | 3B-V-100001 | 3B-Y-125000 |       |                                       |                |        |                          |  |          |
|  | 2.3 4motion     |     |             | 3B-Y-125000 | 06.97 |                                       |                |        |                          |  |          |
|  | 2.5 TDI 4motion |     |             | 3B-Y-125000 | 08.98 |                                       |                |        |                          |  |          |
|  | 2.8             | 132 | 3B-V-100001 | 3B-Y-125000 |       | + (VRS) / + GUS-Staaten <sup>1)</sup> |                |        |                          |  |          |
|  | 2.8             | 142 | 3B-V-100001 | 3B-Y-125000 |       |                                       |                |        |                          |  |          |
|  | 2.8 4motion     |     |             | 3B-Y-125000 | 10.96 |                                       |                |        |                          |  |          |
|  | 1.6             |     | 3B-V-100000 | 10.96       |       |                                       | 24.2519-1702.3 | 040074 |                          |  | Nz 19,05 |
|  | 1.8             | 85  | 3B-V-100000 | 01.97       |       | + (VRS) / + GUS-Staaten <sup>1)</sup> |                |        |                          |  |          |
|  | 1.8             | 92  | 3B-V-100000 | 10.96       |       |                                       |                |        |                          |  |          |
|  | 1.8 4motion     |     |             | 10.96       |       |                                       |                |        |                          |  |          |
|  | 1.8 T           |     | 3B-V-100000 | 10.96       |       |                                       |                |        |                          |  |          |
|  | 1.9 TDI         | 66  | 3B-W-070000 | 10.96       |       |                                       |                |        |                          |  |          |
|  | 1.9 TDI         | 81  | 3B-W-070000 | 10.96       |       |                                       |                |        |                          |  |          |
|  | 1.9 TDI         | 85  | 3B-W-070000 | 08.98       |       |                                       |                |        |                          |  |          |
|  | 1.9 TDI 4motion |     |             | 06.97       |       |                                       |                |        |                          |  |          |
|  | 2.3             |     | 3B-V-100000 | 10.96       |       |                                       |                |        |                          |  |          |
|  | 2.3 4motion     |     |             | 06.97       |       |                                       |                |        |                          |  |          |
|  | 2.5 TDI         |     | 3B-W-070000 | 08.98       |       |                                       |                |        |                          |  |          |
|  | 2.5 TDI 4motion |     |             | 08.98       |       |                                       |                |        |                          |  |          |
|  | 2.8             | 132 | 3B-V-100000 | 01.97       |       | + (VRS) / + GUS-Staaten <sup>1)</sup> |                |        |                          |  |          |
|  | 2.8             | 142 | 3B-V-100000 | 08.96       |       |                                       |                |        |                          |  |          |
|  | 2.8 4motion     |     |             | 10.96       |       |                                       |                |        |                          |  |          |
|  | 1.6             |     | 3B-V-100001 |             | 06.05 |                                       | 24.2522-1706.3 | 040090 |                          |  | Nz 22,20 |
|  | 1.8             | 85  | 3B-V-100001 |             | 06.05 | + (VRS) / + GUS-Staaten <sup>1)</sup> |                |        |                          |  |          |
|  | 1.8             | 92  | 3B-V-100001 |             | 06.05 |                                       |                |        |                          |  |          |
|  | 1.8 4motion     |     | 3B-V-100001 |             | 06.05 |                                       |                |        |                          |  |          |
|  | 1.8 T           |     | 3B-V-100001 |             | 06.05 |                                       |                |        |                          |  |          |
|  | 1.9 TDI         | 66  | 3B-W-070001 |             | 06.05 |                                       |                |        |                          |  |          |
|  | 1.9 TDI         | 74  |             | 10.00       | 06.05 |                                       |                |        |                          |  |          |
|  | 1.9 TDI         | 81  | 3B-W-070001 |             | 06.05 |                                       |                |        |                          |  |          |
|  | 1.9 TDI         | 85  | 3B-W-070001 |             | 06.05 |                                       |                |        |                          |  |          |
|  | 1.9 TDI         | 96  |             | 10.00       | 06.05 |                                       |                |        |                          |  |          |
|  | 1.9 TDI 4motion |     | 3B-W-070001 |             | 06.05 |                                       |                |        |                          |  |          |
|  | 1.9 TDI 4motion | 96  |             | 10.00       | 06.05 |                                       |                |        |                          |  |          |
|  | 2.0             | 85  |             | 10.00       | 06.05 |                                       |                |        |                          |  |          |
|  | 2.0             | 96  |             | 05.02       | 06.05 |                                       |                |        |                          |  |          |
|  | 2.0 TDI         | 100 |             | 12.03       | 06.05 |                                       |                |        |                          |  |          |
|  | 2.3             |     | 3B-V-100001 |             | 06.05 |                                       |                |        |                          |  |          |
|  | 2.3 4motion     |     | 3B-V-100001 |             | 06.05 |                                       |                |        |                          |  |          |
|  | 2.5 TDI         |     | 3B-W-070001 |             | 06.05 |                                       |                |        |                          |  |          |
|  | 2.5 TDI 4motion |     | 3B-W-070001 |             | 06.05 |                                       |                |        |                          |  |          |
|  | 2.8             | 132 | 3B-V-100001 |             | 06.05 | + (VRS) / + GUS-Staaten <sup>1)</sup> |                |        |                          |  |          |
|  | 2.8             | 142 | 3B-V-100001 |             | 06.05 |                                       |                |        |                          |  |          |

1) + (VRS) / + GUS States / + (VRS) / + Stati del GUS / + (VRS) / + Etats de la CEI / + (VRS) / + estados del GUS

| VOLKSWAGEN PASSAT (97-05)  |  |  |  |  |   |  |  |   |          |                |     |
|--|--|--|--|--|---|--|--|---|----------|----------------|-----|
|     |  |  |  |  |  |  |  |     |          |                |     |
|    | 2.8 4motion  | 3B-V-100001  |  | 06.05  | 24.2522-1706.3  | 040090   |  |   | Nz 22,20 |                |     |
| VOLKSWAGEN PASSAT Limousine (05-10)  |  |  |  |  |   |  |  |   |          |                |     |
|    | 1.4 TSI  | 75   |  | 10.07 07.10  | - ESP   | 03.7873-3802.4   | 300210   |   |          | 11"            | ATE |
|  | 1.6  | 85   |  | 03.05 07.10  | - ESP   |  |  |   |          |                |     |
|  | 1.6 FSI  | 85   |  | 03.05 07.10  | - ESP   |  |  |   |          |                |     |
|  | 1.6 TDI  | 77   |  | 08.09 07.10  | - ESP   |  |  |   |          |                |     |
|  | 1.8 TSI  | 112  |  | 11.09 07.10  | - ESP   |  |  |   |          |                |     |
|  | 1.8 TSI  | 118  |  | 10.07 07.10  | - ESP   |  |  |   |          |                |     |
|  | 1.9 TDI  | 77   |  | 03.05 07.10  | - ESP   |  |  |   |          |                |     |
|  | 2.0 FSI  | 110  |  | 03.05 07.10  | - ESP   |  |  |   |          |                |     |
|  | 2.0 FSI 4motion  | 110  |  | 03.05 07.10  | - ESP   |  |  |   |          |                |     |
|  | 2.0 TDI  | 77   |  | 03.05 07.10  | - ESP   |  |  |   |          |                |     |
|  | 2.0 TDI  | 120  |  | 03.05 07.10  | - ESP   |  |  |   |          |                |     |
|  | 2.0 TDI  | 125  |  | 08.05 07.10  | - ESP   |  |  |   |          |                |     |
|  | 2.0 TDI 16V  | 103  |  | 03.05 07.10  | - ESP   |  |  |   |          |                |     |
|  | 2.0 TDI 4motion  | 103  |  | 03.05 07.10  | - ESP   |  |  |   |          |                |     |
|  | 2.0 TDI 4motion  | 125  |  | 05.09 07.10  | - ESP   |  |  |   |          |                |     |
|  | 2.0 TFSI   | 147  |  | 03.05 07.10  | - ESP   |  |  |   |          |                |     |
|  | 3.2 V6 FSI   | 184  |  | 11.05 07.10  | - ESP   |  |  |   |          |                |     |
|  | 3.2 V6 FSI 4motion   | 184  |  | 09.05 07.10  | - ESP   |  |  |   |          |                |     |
|  | 1.4 TSI  | 75   |  | 10.07 07.10  | + ESP   | 03.7873-3902.4   | 300254   |   |          | 11"            | ATE |
|  | 1.6  | 85   |  | 03.05 07.10  | + ESP   |  |  |   |          |                |     |
|  | 1.6 FSI  | 85   |  | 03.05 07.10  | + ESP   |  |  |   |          |                |     |
|  | 1.6 TDI  | 77   |  | 08.09 07.10  | + ESP   |  |  |   |          |                |     |
|  | 1.8 TSI  | 112  |  | 11.09 07.10  | + ESP   |  |  |   |          |                |     |
|  | 1.8 TSI  | 118  |  | 10.07 07.10  | + ESP   |  |  |   |          |                |     |
|  | 1.9 TDI  | 77   |  | 03.05 07.10  | + ESP   |  |  |   |          |                |     |
|  | 2.0 FSI  | 110  |  | 03.05 07.10  | + ESP   |  |  |   |          |                |     |
|  | 2.0 FSI 4motion  | 110  |  | 03.05 07.10  | + ESP   |  |  |   |          |                |     |
|  | 2.0 TDI  | 77   |  | 03.05 07.10  | + ESP   |  |  |   |          |                |     |
|  | 2.0 TDI  | 120  |  | 03.05 07.10  | + ESP   |  |  |   |          |                |     |
|  | 2.0 TDI  | 125  |  | 08.05 07.10  | + ESP   |  |  |   |          |                |     |
|  | 2.0 TDI 16V  | 103  |  | 03.05 07.10  | + ESP   |  |  |   |          |                |     |
|  | 2.0 TDI 4motion  | 103  |  | 03.05 07.10  | + ESP   |  |  |   |          |                |     |
|  | 2.0 TDI 4motion  | 125  |  | 05.09 07.10  | + ESP   |  |  |   |          |                |     |
|  | 2.0 TFSI   | 147  |  | 03.05 07.10  | + ESP   |  |  |   |          |                |     |
|  | 3.2 V6 FSI   | 184  |  | 11.05 07.10  | + ESP   |  |  |   |          |                |     |
|  | 3.2 V6 FSI 4motion   | 184  |  | 09.05 07.10  | + ESP   |  |  |   |          |                |     |
|  | 1.4 TSI  | 75   |  | 10.07 07.10  | PR: 12G   | 03.4152-0116.3   | 010814   |   |          | Thz 22,20      | ATE |
|  | 1.6  | 85   |  | 03.05 07.10  | PR: 12G   |  |  |   |          |                |     |
|  | 1.6 FSI  | 85   |  | 03.05 07.10  | PR: 12G   |  |  |   |          |                |     |
|  | 1.6 TDI  | 77   |  | 08.09 07.10  | PR: 12G   |  |  |   |          |                |     |
|  | 1.8 TSI  | 112  |  | 11.09 07.10  | PR: 12G   |  |  |   |          |                |     |
|  | 1.8 TSI  | 118  |  | 10.07 07.10  | PR: 12G   |  |  |   |          |                |     |
|  | 1.9 TDI  | 77   |  | 03.05 07.10  | PR: 12G   |  |  |   |          |                |     |
|  | 2.0 FSI  | 110  |  | 03.05 07.10  | PR: 12G   |  |  |   |          |                |     |
|  | 2.0 FSI 4motion  | 110  |  | 03.05 07.10  | PR: 12G   |  |  |   |          |                |     |
|  | 2.0 TDI  | 77   |  | 03.05 07.10  | PR: 12G   |  |  |   |          |                |     |
|  | 2.0 TDI  | 120  |  | 03.05 07.10  | PR: 12G   |  |  |   |          |                |     |
|  | 2.0 TDI  | 125  |  | 08.05 07.10  | PR: 12G   |  |  |   |          |                |     |
|  | 2.0 TDI 16V  | 103  |  | 03.05 07.10  | PR: 12G   |  |  |   |          |                |     |
|  | 2.0 TDI 4motion  | 103  |  | 03.05 07.10  | PR: 12G   |  |  |   |          |                |     |
|  | 2.0 TDI 4motion  | 125  |  | 05.09 07.10  | PR: 12G   |  |  |   |          |                |     |
|  | 2.0 TFSI   | 147  |  | 03.05 07.10  | PR: 12G   |  |  |   |          |                |     |
|  | 3.2 V6 FSI   | 184  |  | 11.05 07.10  | PR: 12G   |  |  |   |          |                |     |
|  | 3.2 V6 FSI 4motion   | 184  |  | 09.05 07.10  | PR: 12G   |  |  |   |          |                |     |
|  | 1.4 TSI  | 75   |  | 10.07 07.10  | PR: 1LJ,1LK,1LH,1LM   | 03.4153-0186.3   | 010816   |   |          | Thz 23,81      | ATE |
|  | 1.6  | 85   |  | 03.05 07.10  | PR: 1LJ,1LK,1LH,1LM   |  |  |   |          |                |     |
|  | 1.6 FSI  | 85   |  | 03.05 07.10  | PR: 1LJ,1LK,1LH,1LM   |  |  |   |          |                |     |
|  | 1.6 TDI  | 77   |  | 08.09 07.10  | PR: 1LJ,1LK,1LH,1LM   |  |  |   |          |                |     |
|  | 1.8 TSI  | 112  |  | 11.09 07.10  | PR: 1LJ,1LK,1LH,1LM   |  |  |   |          |                |     |
|  | 1.8 TSI  | 118  |  | 10.07 07.10  | PR: 1LJ,1LK,1LH,1LM   |  |  |   |          |                |     |
|  | 1.9 TDI  | 77   |  | 03.05 07.10  | PR: 1LJ,1LK,1LH,1LM   |  |  |   |          |                |     |
|  | 2.0 FSI  | 110  |  | 03.05 07.10  | PR: 1LJ,1LK,1LH,1LM   |  |  |   |          |                |     |
|  | 2.0 FSI 4motion  | 110  |  | 03.05 07.10  | PR: 1LJ,1LK,1LH,1LM   |  |  |   |          |                |     |
|  | 2.0 TDI  | 77   |  | 03.05 07.10  | PR: 1LJ,1LK,1LH,1LM   |  |  |   |          |                |     |
|  | 2.0 TDI  | 120  |  | 03.05 07.10  | PR: 1LJ,1LK,1LH,1LM   |  |  |   |          |                |     |
|  | 2.0 TDI  | 125  |  | 08.05 07.10  | PR: 1LJ,1LK,1LH,1LM   |  |  |   |          |                |     |
|  | 2.0 TDI 16V  | 103  |  | 03.05 07.10  | PR: 1LJ,1LK,1LH,1LM   |  |  |   |          |                |     |
|  | 2.0 TDI 4motion  | 103  |  | 03.05 07.10  | PR: 1LJ,1LK,1LH,1LM   |  |  |   |          |                |     |
|  | 2.0 TDI 4motion  | 125  |  | 05.09 07.10  | PR: 1LJ,1LK,1LH,1LM   |  |  |   |          |                |     |
|  | 2.0 TFSI   | 147  |  | 03.05 07.10  | PR: 1LJ,1LK,1LH,1LM   |  |  |   |          |                |     |
|  | 3.2 V6 FSI   | 184  |  | 11.05 07.10  | PR: 1LJ,1LK,1LH,1LM   |  |  |   |          |                |     |
|  | 3.2 V6 FSI 4motion   | 184  |  | 09.05 07.10  | PR: 1LJ,1LK,1LH,1LM   |  |  |   |          |                |     |
|  | 1.4 TSI  | 75   |  | 10.07 07.10  | PR: 1LJ,1LH,1ZG,1ZM   | 11.9541-9553.2   | 220563   |  |          | D=54, - Halter | ATE |
|  | 1.6  | 85   |  | 03.05 07.10  | PR: 1LJ,1LH,1ZG,1ZM   | 11.9541-9554.2   | 220564   |  |          | D=54, - Halter | ATE |
|  | 1.6 FSI  | 85   |  | 03.05 07.10  | PR: 1LJ,1LH,1ZG,1ZM   | 11.0101-5409.2   | 260035   |   |          | Hülsensatz     | ATE |
|  | 1.6 TDI  | 77   |  | 08.09 07.10  | PR: 1LJ,1LH,1ZG,1ZM   | 11.8171-0008.1   | 990049   |   |          | Führungsbolzen | ATE |
|  | 1.8 TSI  | 112  |  | 11.09 07.10  | PR: 1LJ,1LH,1ZG,1ZM   | 11.8116-0351.1   | 390538   | 2   |          | Haltefeder     | ATE |
|  | 1.8 TSI  | 118  |  | 10.07 07.10  | PR: 1LJ,1LH,1ZG,1ZM   |  |  |   |          |                |     |

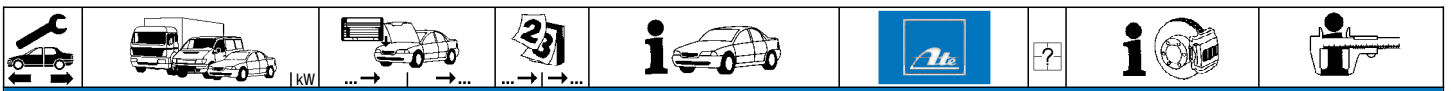

**VOLKSWAGEN PASSAT Limousine (05-10)**

|                    |                    |         |       |       |                 |                     |                |                |   |  |   |                                 |
|--------------------|--------------------|---------|-------|-------|-----------------|---------------------|----------------|----------------|---|--|---|---------------------------------|
|                    | 1.9 TDI            | 77      |       | 03.05 | 07.10           | PR: 1LJ,1LH,1ZG,1ZM | 11.9541-9553.2 | 220563         | 2 |  | D=54, - Halter<br>ATE<br>D=54, - Halter<br>ATE<br>Hülzensatz<br>ATE<br>Führungsbolzen<br>ATE<br>Haltefeder<br>ATE | ATE<br>ATE<br>ATE<br>ATE<br>ATE |
|                    | 2.0 FSI            | 110     |       | 03.05 | 07.10           | PR: 1LJ,1LH,1ZG,1ZM | 11.9541-9554.2 | 220564         |   |  |   |                                 |
|                    | 2.0 FSI 4motion    | 110     |       | 03.05 | 07.10           | PR: 1LJ,1LH,1ZG,1ZM | 11.0101-5409.2 | 260035         |   |  |   |                                 |
|                    | 2.0 TDI            |         |       | 03.05 | 07.10           | PR: 1LJ,1LH,1ZG,1ZM | 11.8171-0008.1 | 990049         |   |  |   |                                 |
|                    | 2.0 TDI            |         |       | 03.05 | 07.10           | PR: 1LJ,1LH,1ZG,1ZM | 11.8116-0351.1 | 390538         |   |  |   |                                 |
|                    | 2.0 TDI            | 120     |       | 08.05 | 07.10           | PR: 1LJ,1LH,1ZG,1ZM |                |                |   |  |   |                                 |
|                    | 2.0 TDI            | 125     |       | 08.05 | 07.10           | PR: 1LJ,1LH,1ZG,1ZM |                |                |   |  |   |                                 |
|                    | 2.0 TDI 16V        | 103     |       | 03.05 | 07.10           | PR: 1LJ,1LH,1ZG,1ZM |                |                |   |  |   |                                 |
|                    | 2.0 TDI 4motion    | 103     |       | 03.05 | 07.10           | PR: 1LJ,1LH,1ZG,1ZM |                |                |   |  |   |                                 |
|                    | 2.0 TDI 4motion    | 125     |       | 05.09 | 07.10           | PR: 1LJ,1LH,1ZG,1ZM |                |                |   |  |   |                                 |
|                    | 2.0 TFSI           | 147     |       | 03.05 | 07.10           | PR: 1LJ,1LH,1ZG,1ZM |                |                |   |  |   |                                 |
|                    | 3.2 V6 FSI         | 184     |       | 11.05 | 07.10           | PR: 1LJ,1LH,1ZG,1ZM |                |                |   |  |   |                                 |
|                    | 3.2 V6 FSI 4motion | 184     |       | 09.05 | 07.10           | PR: 1LJ,1LH,1ZG,1ZM |                |                |   |  |   |                                 |
|                    | 3.6 R36            | 220     |       | 04.07 | 07.10           | PR: 1LJ,1LH,1ZG,1ZM |                |                |   |  |   |                                 |
|                    |                    | 1.4 TSI | 75    |       | 10.07           | 07.10               | PR: 1LK,1LM    | 11.9576-9995.2 |   |  |   |                                 |
| 1.6                |                    | 85      |       | 03.05 | 07.10           | PR: 1LK,1LM         | 11.9576-9996.2 | 220652         |   |  |   |                                 |
| 1.6 FSI            |                    | 85      |       | 03.05 | 07.10           | PR: 1LK,1LM         | 11.0101-5409.2 | 260035         |   |  |   |                                 |
| 1.6 TDI            |                    | 77      |       | 08.09 | 07.10           | PR: 1LK,1LM         | 11.8171-0008.1 | 990049         |   |  |   |                                 |
| 1.8 TSI            |                    | 112     |       | 11.09 | 07.10           | PR: 1LK,1LM         | 11.8116-0410.2 | 390589         |   |  |   |                                 |
| 1.8 TSI            |                    | 118     |       | 10.07 | 07.10           | PR: 1LK,1LM         |                |                |   |  |   |                                 |
| 1.9 TDI            |                    | 77      |       | 03.05 | 07.10           | PR: 1LK,1LM         |                |                |   |  |   |                                 |
| 2.0 FSI            |                    | 110     |       | 03.05 | 07.10           | PR: 1LK,1LM         |                |                |   |  |   |                                 |
| 2.0 FSI 4motion    |                    | 110     |       | 03.05 | 07.10           | PR: 1LK,1LM         |                |                |   |  |   |                                 |
| 2.0 TDI            |                    |         |       | 03.05 | 07.10           | PR: 1LK,1LM         |                |                |   |  |   |                                 |
| 2.0 TDI            |                    | 120     |       | 08.05 | 07.10           | PR: 1LK,1LM         |                |                |   |  |   |                                 |
| 2.0 TDI            |                    | 125     |       | 08.05 | 07.10           | PR: 1LK,1LM         |                |                |   |  |   |                                 |
| 2.0 TDI 16V        |                    | 103     |       | 03.05 | 07.10           | PR: 1LK,1LM         |                |                |   |  |   |                                 |
| 2.0 TDI 4motion    |                    | 103     |       | 03.05 | 07.10           | PR: 1LK,1LM         |                |                |   |  |   |                                 |
| 2.0 TDI 4motion    |                    | 125     |       | 05.09 | 07.10           | PR: 1LK,1LM         |                |                |   |  |   |                                 |
| 2.0 TFSI           | 147                |         | 03.05 | 07.10 | PR: 1LK,1LM     |                     |                |                |   |  |   |                                 |
| 3.2 V6 FSI         | 184                |         | 11.05 | 07.10 | PR: 1LK,1LM     |                     |                |                |   |  |   |                                 |
| 3.2 V6 FSI 4motion | 184                |         | 09.05 | 07.10 | PR: 1LK,1LM     |                     |                |                |   |  |   |                                 |
| 3.6 R36            | 220                |         | 04.07 | 07.10 | PR: 1LK,1LM     |                     |                |                |   |  |   |                                 |
|                    | 1.4 TSI            | 75      |       | 10.07 | 07.10           | PR: 1LJ,1LH,1ZG     | 83.7247-0603.3 | 330899         | 2 |  | L=603   |                                 |
|                    | 1.6                | 85      |       | 03.05 | 07.10           | PR: 1LJ,1LH,1ZG     |                |                |   |  |   |                                 |
|                    | 1.6 FSI            | 85      |       | 03.05 | 07.10           | PR: 1LJ,1LH,1ZG     |                |                |   |  |   |                                 |
|                    | 1.6 TDI            | 77      |       | 08.09 | 07.10           | PR: 1LJ,1LH,1ZG     |                |                |   |  |   |                                 |
|                    | 1.8 TSI            | 112     |       | 11.09 | 07.10           | PR: 1LJ,1LH,1ZG     |                |                |   |  |   |                                 |
|                    | 1.8 TSI            | 118     |       | 10.07 | 07.10           | PR: 1LJ,1LH,1ZG     |                |                |   |  |   |                                 |
|                    | 1.9 TDI            | 77      |       | 03.05 | 07.10           | PR: 1LJ,1LH,1ZG     |                |                |   |  |   |                                 |
|                    | 2.0 FSI            | 110     |       | 03.05 | 07.10           | PR: 1LJ,1LH,1ZG     |                |                |   |  |   |                                 |
|                    | 2.0 FSI 4motion    | 110     |       | 03.05 | 07.10           | PR: 1LJ,1LH,1ZG     |                |                |   |  |   |                                 |
|                    | 2.0 TDI            |         |       | 03.05 | 07.10           | PR: 1LJ,1LH,1ZG     |                |                |   |  |   |                                 |
|                    | 2.0 TDI            | 120     |       | 08.05 | 07.10           | PR: 1LJ,1LH,1ZG     |                |                |   |  |   |                                 |
|                    | 2.0 TDI            | 125     |       | 08.05 | 07.10           | PR: 1LJ,1LH,1ZG     |                |                |   |  |   |                                 |
|                    | 2.0 TDI 16V        | 103     |       | 03.05 | 07.10           | PR: 1LJ,1LH,1ZG     |                |                |   |  |   |                                 |
|                    | 2.0 TDI 4motion    | 103     |       | 03.05 | 07.10           | PR: 1LJ,1LH,1ZG     |                |                |   |  |   |                                 |
|                    | 2.0 TDI 4motion    | 125     |       | 05.09 | 07.10           | PR: 1LJ,1LH,1ZG     |                |                |   |  |   |                                 |
| 2.0 TFSI           | 147                |         | 03.05 | 07.10 | PR: 1LJ,1LH,1ZG |                     |                |                |   |  |   |                                 |
| 3.2 V6 FSI         | 184                |         | 11.05 | 07.10 | PR: 1LJ,1LH,1ZG |                     |                |                |   |  |   |                                 |
| 3.2 V6 FSI 4motion | 184                |         | 09.05 | 07.10 | PR: 1LJ,1LH,1ZG |                     |                |                |   |  |   |                                 |
| 3.6 R36            | 220                |         | 04.07 | 07.10 | PR: 1LJ,1LH,1ZG |                     |                |                |   |  |   |                                 |
|                    | 1.4 TSI            | 75      |       | 10.07 | 07.10           | PR: 1LK             | 83.7249-0536.3 | 330900         | 2 |  | L=536   |                                 |
|                    | 1.6                | 85      |       | 03.05 | 07.10           | PR: 1LK             |                |                |   |  |   |                                 |
|                    | 1.6 FSI            | 85      |       | 03.05 | 07.10           | PR: 1LK             |                |                |   |  |   |                                 |
|                    | 1.6 TDI            | 77      |       | 08.09 | 07.10           | PR: 1LK             |                |                |   |  |   |                                 |
|                    | 1.8 TSI            | 112     |       | 11.09 | 07.10           | PR: 1LK             |                |                |   |  |   |                                 |
|                    | 1.8 TSI            | 118     |       | 10.07 | 07.10           | PR: 1LK             |                |                |   |  |   |                                 |
|                    | 1.9 TDI            | 77      |       | 03.05 | 07.10           | PR: 1LK             |                |                |   |  |   |                                 |
|                    | 2.0 FSI            | 110     |       | 03.05 | 07.10           | PR: 1LK             |                |                |   |  |   |                                 |
|                    | 2.0 FSI 4motion    | 110     |       | 03.05 | 07.10           | PR: 1LK             |                |                |   |  |   |                                 |
|                    | 2.0 TDI            |         |       | 03.05 | 07.10           | PR: 1LK             |                |                |   |  |   |                                 |
|                    | 2.0 TDI            | 120     |       | 08.05 | 07.10           | PR: 1LK             |                |                |   |  |   |                                 |
|                    | 2.0 TDI            | 125     |       | 08.05 | 07.10           | PR: 1LK             |                |                |   |  |   |                                 |
|                    | 2.0 TDI 16V        | 103     |       | 03.05 | 07.10           | PR: 1LK             |                |                |   |  |   |                                 |
|                    | 2.0 TDI 4motion    | 103     |       | 03.05 | 07.10           | PR: 1LK             |                |                |   |  |   |                                 |
|                    | 2.0 TDI 4motion    | 125     |       | 05.09 | 07.10           | PR: 1LK             |                |                |   |  |   |                                 |
| 2.0 TFSI           | 147                |         | 03.05 | 07.10 | PR: 1LK         |                     |                |                |   |  |   |                                 |
| 3.2 V6 FSI         | 184                |         | 11.05 | 07.10 | PR: 1LK         |                     |                |                |   |  |   |                                 |
| 3.2 V6 FSI 4motion | 184                |         | 09.05 | 07.10 | PR: 1LK         |                     |                |                |   |  |   |                                 |
| 3.6 R36            | 220                |         | 04.07 | 07.10 | PR: 1LK         |                     |                |                |   |  |   |                                 |
|                    | 1.6                | 75      |       | 03.05 | 04.07           | PR: 1KU             | 24.6238-1701.7 | 220819         | 2 | ☐ elektrische Feststellbremse <sup>1)</sup><br>☐ elektrische Feststellbremse <sup>1)</sup> | D=38, - Halter<br>LUC<br>D=38, - Halter<br>LUC  | LUC<br>LUC                      |
|                    | 1.6 FSI            | 85      |       | 03.05 | 04.07           | PR: 1KU             | 24.6238-1702.7 | 220820         |   |  |   |                                 |
|                    | 1.9 TDI            | 77      |       | 03.05 | 04.07           | PR: 1KU             |                |                |   |  |   |                                 |
|                    | 2.0 FSI            | 110     |       | 03.05 | 04.07           | PR: 1KU             |                |                |   |  |   |                                 |
|                    | 2.0 FSI 4motion    | 110     |       | 03.05 | 04.07           | PR: 1KU             |                |                |   |  |   |                                 |
|                    | 2.0 TDI            |         |       | 03.05 | 04.07           | PR: 1KU             |                |                |   |  |   |                                 |
|                    | 2.0 TDI            |         |       | 03.05 | 04.07           | PR: 1KU             |                |                |   |  |   |                                 |
|                    | 2.0 TDI            | 120     |       | 08.05 | 04.07           | PR: 1KU             |                |                |   |  |   |                                 |
|                    | 2.0 TDI            | 125     |       | 08.05 | 04.07           | PR: 1KU             |                |                |   |  |   |                                 |
|                    | 2.0 TDI 16V        | 103     |       | 03.05 | 04.07           | PR: 1KU             |                |                |   |  |   |                                 |
| 2.0 TDI 4motion    | 103                |         | 03.05 | 04.07 | PR: 1KU         |                     |                |                |   |  |   |                                 |
| 2.0 TFSI           | 147                |         | 03.05 | 04.07 | PR: 1KU         |                     |                |                |   |  |   |                                 |
| 3.2 V6 FSI         | 184                |         | 11.05 | 04.07 | PR: 1KU         |                     |                |                |   |  |   |                                 |

<sup>1)</sup> electric parking brake / fr.di stazionamento elettrico / frein à main électrique / freno de mano eléctrico

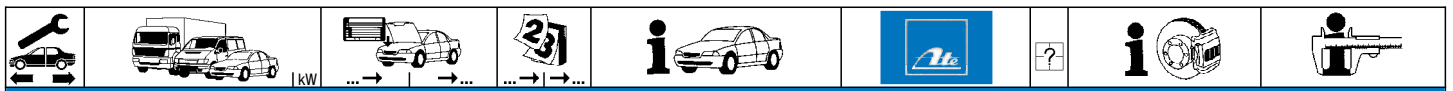

**VOLKSWAGEN PASSAT Limousine (05-10)**

|  |  |   |   |   |                    |                                  |                  |  |                                  |            |
|--|--|---|---|---|--------------------|----------------------------------|------------------|--|----------------------------------|------------|
|  | 3.2 V6 FSI 4motion<br>3.6 R36  | 184<br>220  | 09.05<br>04.07  | 04.07<br>04.07  | PR: 1KU<br>PR: 1KU | 24.6238-1701.7<br>24.6238-1702.7 | 220819<br>220820 | <input type="checkbox"/> elektrische Feststellbremse <sup>1)</sup><br><input type="checkbox"/> elektrische Feststellbremse <sup>1)</sup> | D=38, - Halter<br>D=38, - Halter | LUC<br>LUC |
|  | 1.4 TSI<br>1.6<br>1.6 FSI<br>1.6 TDI<br>1.8 TSI<br>1.8 TSI<br>1.9 TDI<br>2.0 FSI<br>2.0 FSI 4motion<br>2.0 TDI<br>2.0 TDI<br>2.0 TDI<br>2.0 TDI 16V<br>2.0 TDI 4motion<br>2.0 TDI 4motion<br>2.0 TFSI<br>3.2 V6 FSI<br>3.2 V6 FSI 4motion<br>3.6 R36 | 75<br>85<br>77<br>112<br>118<br>77<br>110<br>110<br>120<br>125<br>103<br>103<br>125<br>147<br>184<br>184<br>220 | 10.07<br>03.05<br>03.05<br>08.09<br>11.09<br>10.07<br>03.05<br>03.05<br>03.05<br>08.05<br>08.05<br>03.05<br>05.09<br>03.05<br>11.05<br>09.05<br>04.07 | 07.10<br>07.10<br>07.10<br>07.10<br>07.10<br>07.10<br>07.10<br>07.10<br>07.10<br>07.10<br>07.10<br>07.10<br>07.10<br>07.10<br>07.10<br>07.10<br>07.10 |                    | 83.7849-0231.3                   | 330872           | 2  | L=233                            |            |
|  | 1.9 TDI<br>2.0 FSI<br>2.0 FSI 4motion  | 77<br>110<br>110  | 03.05<br>03.05<br>03.05   | 07.10<br>07.10<br>07.10   |                    | 24.2519-1705.3                   | 040095           | für Getriebe MQ-250 <sup>2)</sup>  | Nz 19,05                         |            |

**VOLKSWAGEN PASSAT Variant (05-10)**

|  |  |  |  |  |  |                |        |  |     |     |
|--|--|--|--|--|--|----------------|--------|--|-----|-----|
|  | 1.4 TSI<br>1.6<br>1.6 FSI<br>1.6 TDI<br>1.8 TSI<br>1.8 TSI<br>1.9 TDI<br>2.0 FSI<br>2.0 FSI 4motion<br>2.0 TDI<br>2.0 TDI<br>2.0 TDI<br>2.0 TDI<br>2.0 TDI 16V<br>2.0 TDI 4motion<br>2.0 TDI 4motion<br>2.0 TFSI<br>3.2 V6 FSI<br>3.2 V6 FSI 4motion | 90<br>75<br>85<br>77<br>112<br>118<br>77<br>110<br>110<br>90<br>100<br>125<br>103<br>103<br>125<br>147<br>184<br>184 | 10.07<br>07.05<br>07.05<br>08.09<br>11.09<br>10.07<br>07.05<br>07.05<br>07.05<br>07.05<br>07.05<br>07.05<br>08.05<br>09.05<br>05.09<br>07.05<br>11.05<br>11.05 | 07.10<br>07.10<br>07.10<br>07.10<br>07.10<br>07.10<br>07.10<br>07.10<br>07.10<br>07.10<br>07.10<br>07.10<br>07.10<br>07.10<br>07.10<br>07.10<br>07.10<br>07.10 | PR: 1LJ<br>PR: 1LJ<br>PR: 1LJ<br>PR: 1LJ<br>PR: 1LJ<br>PR: 1LJ<br>PR: 1LJ<br>PR: 1LJ<br>PR: 1LJ<br>PR: 1LJ<br>PR: 1LJ<br>PR: 1LJ<br>PR: 1LJ<br>PR: 1LJ<br>PR: 1LJ<br>PR: 1LJ<br>PR: 1LJ<br>PR: 1LJ | 03.7873-4002.4 | 300211 |  | 11" | ATE |
|  | 1.4 TSI<br>1.6<br>1.6 FSI<br>1.6 TDI<br>1.8 TSI<br>1.8 TSI<br>1.9 TDI<br>2.0 FSI<br>2.0 FSI 4motion<br>2.0 TDI<br>2.0 TDI<br>2.0 TDI<br>2.0 TDI<br>2.0 TDI 16V<br>2.0 TDI 4motion<br>2.0 TDI 4motion<br>2.0 TFSI<br>3.2 V6 FSI<br>3.2 V6 FSI 4motion | 90<br>75<br>85<br>77<br>112<br>118<br>77<br>110<br>110<br>90<br>100<br>125<br>103<br>103<br>125<br>147<br>184<br>184 | 10.07<br>07.05<br>07.05<br>08.09<br>11.09<br>10.07<br>07.05<br>07.05<br>07.05<br>07.05<br>07.05<br>07.05<br>08.05<br>09.05<br>05.09<br>07.05<br>11.05<br>11.05 | 07.10<br>07.10<br>07.10<br>07.10<br>07.10<br>07.10<br>07.10<br>07.10<br>07.10<br>07.10<br>07.10<br>07.10<br>07.10<br>07.10<br>07.10<br>07.10<br>07.10<br>07.10 | PR: 1LK<br>PR: 1LK<br>PR: 1LK<br>PR: 1LK<br>PR: 1LK<br>PR: 1LK<br>PR: 1LK<br>PR: 1LK<br>PR: 1LK<br>PR: 1LK<br>PR: 1LK<br>PR: 1LK<br>PR: 1LK<br>PR: 1LK<br>PR: 1LK<br>PR: 1LK<br>PR: 1LK<br>PR: 1LK | 03.7873-4102.4 | 300212 |  | 11" | ATE |
|  | 1.6<br>1.6 FSI<br>1.6 TDI<br>1.8 TSI<br>1.8 TSI<br>1.9 TDI<br>2.0 FSI<br>2.0 FSI 4motion<br>2.0 TDI<br>2.0 TDI<br>2.0 TDI<br>2.0 TDI<br>2.0 TDI 16V<br>2.0 TDI 4motion<br>2.0 TDI 4motion<br>2.0 TFSI<br>3.2 V6 FSI<br>3.2 V6 FSI 4motion            | 75<br>85<br>77<br>112<br>118<br>77<br>110<br>110<br>90<br>100<br>125<br>103<br>103<br>125<br>147<br>184<br>184       | 07.05<br>07.05<br>08.09<br>11.09<br>10.07<br>07.05<br>07.05<br>07.05<br>07.05<br>07.05<br>07.05<br>08.05<br>09.05<br>05.09<br>07.05<br>11.05<br>11.05          | 07.10<br>07.10<br>07.10<br>07.10<br>07.10<br>07.10<br>07.10<br>07.10<br>07.10<br>07.10<br>07.10<br>07.10<br>07.10<br>07.10<br>07.10<br>07.10<br>07.10          | PR: 1ZG<br>PR: 1ZG<br>PR: 1ZG<br>PR: 1ZG<br>PR: 1ZG<br>PR: 1ZG<br>PR: 1ZG<br>PR: 1ZG<br>PR: 1ZG<br>PR: 1ZG<br>PR: 1ZG<br>PR: 1ZG<br>PR: 1ZG<br>PR: 1ZG<br>PR: 1ZG<br>PR: 1ZG<br>PR: 1ZG            | 03.7873-3802.4 | 300210 |  | 11" | ATE |

<sup>1)</sup> electric parking brake / fr.di stazionamento elettrico / frein à main électrique / freno de mano eléctrico

<sup>2)</sup> for transmission MQ-250 / per scatola camb.MQ-250 / pour boîte de vitesse MQ-250 / caja de cambios para MQ-250





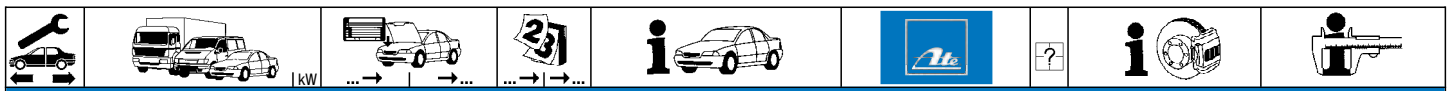

**VOLKSWAGEN PASSAT Variant (05-10)**

|         |                    |       |       |                     |                     |                |        |   |                |     |
|---------|--------------------|-------|-------|---------------------|---------------------|----------------|--------|---|----------------|-----|
|         | 1.4 TSI            | 90    | 10.07 | 07.10               | PR: 1LJ,1LK,1LH,1LM | 03.4153-0186.3 | 010816 |   | Thz 23,81      | ATE |
|         | 1.6                | 75    | 07.05 | 07.10               | PR: 1LJ,1LK,1LH,1LM |                |        |   |                |     |
|         | 1.6 FSI            | 85    | 07.05 | 07.10               | PR: 1LJ,1LK,1LH,1LM |                |        |   |                |     |
|         | 1.6 TDI            | 77    | 08.09 | 07.10               | PR: 1LJ,1LK,1LH,1LM |                |        |   |                |     |
|         | 1.8 TSI            | 112   | 11.09 | 07.10               | PR: 1LJ,1LK,1LH,1LM |                |        |   |                |     |
|         | 1.8 TSI            | 118   | 10.07 | 07.10               | PR: 1LJ,1LK,1LH,1LM |                |        |   |                |     |
|         | 1.9 TDI            | 77    | 07.05 | 07.10               | PR: 1LJ,1LK,1LH,1LM |                |        |   |                |     |
|         | 2.0 FSI            | 110   | 07.05 | 07.10               | PR: 1LJ,1LK,1LH,1LM |                |        |   |                |     |
|         | 2.0 FSI 4motion    | 110   | 09.05 | 07.10               | PR: 1LJ,1LK,1LH,1LM |                |        |   |                |     |
|         | 2.0 TDI            |       | 07.05 | 07.10               | PR: 1LJ,1LK,1LH,1LM |                |        |   |                |     |
|         | 2.0 TDI            |       | 11.05 | 07.10               | PR: 1LJ,1LK,1LH,1LM |                |        |   |                |     |
|         | 2.0 TDI            | 90    | 07.05 | 07.10               | PR: 1LJ,1LK,1LH,1LM |                |        |   |                |     |
|         | 2.0 TDI            | 100   | 07.05 | 07.10               | PR: 1LJ,1LK,1LH,1LM |                |        |   |                |     |
|         | 2.0 TDI            | 125   | 07.05 | 07.10               | PR: 1LJ,1LK,1LH,1LM |                |        |   |                |     |
|         | 2.0 TDI 16V        | 103   | 08.05 | 07.10               | PR: 1LJ,1LK,1LH,1LM |                |        |   |                |     |
|         | 2.0 TDI 4motion    | 103   | 09.05 | 07.10               | PR: 1LJ,1LK,1LH,1LM |                |        |   |                |     |
|         | 2.0 TDI 4motion    | 125   | 05.09 | 07.10               | PR: 1LJ,1LK,1LH,1LM |                |        |   |                |     |
|         | 2.0 TFSI           | 147   | 07.05 | 07.10               | PR: 1LJ,1LK,1LH,1LM |                |        |   |                |     |
|         | 3.2 V6 FSI         | 184   | 11.05 | 07.10               | PR: 1LJ,1LK,1LH,1LM |                |        |   |                |     |
|         | 3.2 V6 FSI 4motion | 184   | 11.05 | 07.10               | PR: 1LJ,1LK,1LH,1LM |                |        |   |                |     |
|         | 1.4 TSI            | 90    | 10.07 | 07.10               | PR: 1ZG             | 03.4152-0116.3 | 010814 |   | Thz 22,20      | ATE |
|         | 1.6                | 75    | 07.05 | 07.10               | PR: 1ZG             |                |        |   |                |     |
|         | 1.6 FSI            | 85    | 07.05 | 07.10               | PR: 1ZG             |                |        |   |                |     |
|         | 1.6 TDI            | 77    | 08.09 | 07.10               | PR: 1ZG             |                |        |   |                |     |
|         | 1.8 TSI            | 112   | 11.09 | 07.10               | PR: 1ZG             |                |        |   |                |     |
|         | 1.8 TSI            | 118   | 10.07 | 07.10               | PR: 1ZG             |                |        |   |                |     |
|         | 1.9 TDI            | 77    | 07.05 | 07.10               | PR: 1ZG             |                |        |   |                |     |
|         | 2.0 FSI            | 110   | 07.05 | 07.10               | PR: 1ZG             |                |        |   |                |     |
|         | 2.0 FSI 4motion    | 110   | 09.05 | 07.10               | PR: 1ZG             |                |        |   |                |     |
|         | 2.0 TDI            |       | 07.05 | 07.10               | PR: 1ZG             |                |        |   |                |     |
|         | 2.0 TDI            |       | 11.05 | 07.10               | PR: 1ZG             |                |        |   |                |     |
|         | 2.0 TDI            | 90    | 07.05 | 07.10               | PR: 1ZG             |                |        |   |                |     |
|         | 2.0 TDI            | 100   | 07.05 | 07.10               | PR: 1ZG             |                |        |   |                |     |
|         | 2.0 TDI            | 125   | 07.05 | 07.10               | PR: 1ZG             |                |        |   |                |     |
|         | 2.0 TDI 16V        | 103   | 08.05 | 07.10               | PR: 1ZG             |                |        |   |                |     |
|         | 2.0 TDI 4motion    | 103   | 09.05 | 07.10               | PR: 1ZG             |                |        |   |                |     |
|         | 2.0 TDI 4motion    | 125   | 05.09 | 07.10               | PR: 1ZG             |                |        |   |                |     |
|         | 2.0 TFSI           | 147   | 07.05 | 07.10               | PR: 1ZG             |                |        |   |                |     |
|         | 3.2 V6 FSI         | 184   | 11.05 | 07.10               | PR: 1ZG             |                |        |   |                |     |
|         | 3.2 V6 FSI 4motion | 184   | 11.05 | 07.10               | PR: 1ZG             |                |        |   |                |     |
|         | 1.4 TSI            | 90    | 10.07 | 07.10               | PR: 1LJ,1LH,1ZG,1ZM | 11.9541-9553.2 | 220563 | 2 | D=54, - Halter | ATE |
|         | 1.6                | 75    | 07.05 | 07.10               | PR: 1LJ,1LH,1ZG,1ZM |                |        |   |                |     |
|         | 1.6 FSI            | 85    | 07.05 | 07.10               | PR: 1LJ,1LH,1ZG,1ZM |                |        |   |                |     |
|         | 1.6 TDI            | 77    | 08.09 | 07.10               | PR: 1LJ,1LH,1ZG,1ZM |                |        |   |                |     |
|         | 1.8 TSI            | 112   | 11.09 | 07.10               | PR: 1LJ,1LH,1ZG,1ZM |                |        |   |                |     |
|         | 1.8 TSI            | 118   | 10.07 | 07.10               | PR: 1LJ,1LH,1ZG,1ZM |                |        |   |                |     |
|         | 1.9 TDI            | 77    | 07.05 | 07.10               | PR: 1LJ,1LH,1ZG,1ZM |                |        |   |                |     |
|         | 2.0 FSI            | 110   | 07.05 | 07.10               | PR: 1LJ,1LH,1ZG,1ZM |                |        |   |                |     |
|         | 2.0 FSI 4motion    | 110   | 09.05 | 07.10               | PR: 1LJ,1LH,1ZG,1ZM |                |        |   |                |     |
|         | 2.0 TDI            |       | 07.05 | 07.10               | PR: 1LJ,1LH,1ZG,1ZM |                |        |   |                |     |
|         | 2.0 TDI            |       | 11.05 | 07.10               | PR: 1LJ,1LH,1ZG,1ZM |                |        |   |                |     |
|         | 2.0 TDI            | 90    | 07.05 | 07.10               | PR: 1LJ,1LH,1ZG,1ZM |                |        |   |                |     |
|         | 2.0 TDI            | 100   | 07.05 | 07.10               | PR: 1LJ,1LH,1ZG,1ZM |                |        |   |                |     |
|         | 2.0 TDI            | 125   | 07.05 | 07.10               | PR: 1LJ,1LH,1ZG,1ZM |                |        |   |                |     |
|         | 2.0 TDI 16V        | 103   | 08.05 | 07.10               | PR: 1LJ,1LH,1ZG,1ZM |                |        |   |                |     |
|         | 2.0 TDI 4motion    | 103   | 09.05 | 07.10               | PR: 1LJ,1LH,1ZG,1ZM |                |        |   |                |     |
|         | 2.0 TDI 4motion    | 125   | 05.09 | 07.10               | PR: 1LJ,1LH,1ZG,1ZM |                |        |   |                |     |
|         | 2.0 TFSI           | 147   | 07.05 | 07.10               | PR: 1LJ,1LH,1ZG,1ZM |                |        |   |                |     |
|         | 3.2 V6 FSI         | 184   | 11.05 | 07.10               | PR: 1LJ,1LH,1ZG,1ZM |                |        |   |                |     |
|         | 3.2 V6 FSI 4motion | 184   | 11.05 | 07.10               | PR: 1LJ,1LH,1ZG,1ZM |                |        |   |                |     |
| 3.6 R36 | 220                | 04.07 | 07.10 | PR: 1LJ,1LH,1ZG,1ZM |                     |                |        |   |                |     |
|         | 1.4 TSI            | 90    | 10.07 | 07.10               | PR: 1LK,1LM         | 11.9576-9995.2 | 220651 | 2 | D=57, - Halter | ATE |
|         | 1.6                | 75    | 07.05 | 07.10               | PR: 1LK,1LM         |                |        |   |                |     |
|         | 1.6 FSI            | 85    | 07.05 | 07.10               | PR: 1LK,1LM         |                |        |   |                |     |
|         | 1.6 TDI            | 77    | 08.09 | 07.10               | PR: 1LK,1LM         |                |        |   |                |     |
|         | 1.8 TSI            | 112   | 11.09 | 07.10               | PR: 1LK,1LM         |                |        |   |                |     |
|         | 1.8 TSI            | 118   | 10.07 | 07.10               | PR: 1LK,1LM         |                |        |   |                |     |
|         | 1.9 TDI            | 77    | 07.05 | 07.10               | PR: 1LK,1LM         |                |        |   |                |     |
|         | 2.0 FSI            | 110   | 07.05 | 07.10               | PR: 1LK,1LM         |                |        |   |                |     |
|         | 2.0 FSI 4motion    | 110   | 09.05 | 07.10               | PR: 1LK,1LM         |                |        |   |                |     |
|         | 2.0 TDI            |       | 07.05 | 07.10               | PR: 1LK,1LM         |                |        |   |                |     |
|         | 2.0 TDI            |       | 11.05 | 07.10               | PR: 1LK,1LM         |                |        |   |                |     |
|         | 2.0 TDI            | 90    | 07.05 | 07.10               | PR: 1LK,1LM         |                |        |   |                |     |
|         | 2.0 TDI            | 100   | 07.05 | 07.10               | PR: 1LK,1LM         |                |        |   |                |     |
|         | 2.0 TDI            | 125   | 07.05 | 07.10               | PR: 1LK,1LM         |                |        |   |                |     |
|         | 2.0 TDI 16V        | 103   | 08.05 | 07.10               | PR: 1LK,1LM         |                |        |   |                |     |
|         | 2.0 TDI 4motion    | 103   | 09.05 | 07.10               | PR: 1LK,1LM         |                |        |   |                |     |
|         | 2.0 TDI 4motion    | 125   | 05.09 | 07.10               | PR: 1LK,1LM         |                |        |   |                |     |
|         | 2.0 TFSI           | 147   | 07.05 | 07.10               | PR: 1LK,1LM         |                |        |   |                |     |
|         | 3.2 V6 FSI         | 184   | 11.05 | 07.10               | PR: 1LK,1LM         |                |        |   |                |     |
|         | 3.2 V6 FSI 4motion | 184   | 11.05 | 07.10               | PR: 1LK,1LM         |                |        |   |                |     |
| 3.6 R36 | 220                | 04.07 | 07.10 | PR: 1LK,1LM         |                     |                |        |   |                |     |
|         | 1.4 TSI            | 90    | 10.07 | 07.10               | PR: 1LJ,1LH,1ZG     | 83.7247-0603.3 | 330899 | 2 | L=603          |     |
|         | 1.6                | 75    | 07.05 | 07.10               | PR: 1LJ,1LH,1ZG     |                |        |   |                |     |
|         | 1.6 FSI            | 85    | 07.05 | 07.10               | PR: 1LJ,1LH,1ZG     |                |        |   |                |     |
|         | 1.6 TDI            | 77    | 08.09 | 07.10               | PR: 1LJ,1LH,1ZG     |                |        |   |                |     |
|         | 1.8 TSI            | 112   | 11.09 | 07.10               | PR: 1LJ,1LH,1ZG     |                |        |   |                |     |



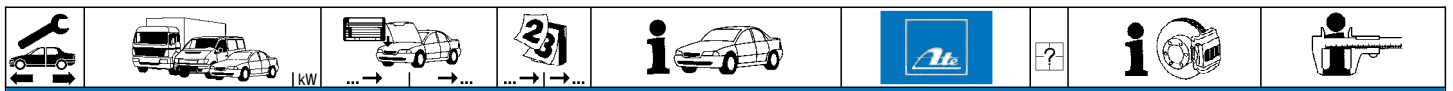

**VOLKSWAGEN PASSAT Variant (05-10)**

|  |   |  |   |  |   |  |                                  |            |
|--|---|--|---|--|---|--|----------------------------------|------------|
|  | 1.8 TSI 118<br>1.9 TDI 77<br>2.0 FSI 110<br>2.0 FSI 4motion 110<br>2.0 TDI 90<br>2.0 TDI 100<br>2.0 TDI 125<br>2.0 TDI 16V 103<br>2.0 TDI 4motion 103<br>2.0 TDI 4motion 125<br>2.0 TFSI 147<br>3.2 V6 FSI 184<br>3.2 V6 FSI 4motion 184<br>3.6 R36 220   |  | 10.07 07.10 PR: 1LJ,1LH,1ZG<br>07.05 07.10 PR: 1LJ,1LH,1ZG<br>07.05 07.10 PR: 1LJ,1LH,1ZG<br>09.05 07.10 PR: 1LJ,1LH,1ZG<br>07.05 07.10 PR: 1LJ,1LH,1ZG<br>11.05 07.10 PR: 1LJ,1LH,1ZG<br>07.05 07.10 PR: 1LJ,1LH,1ZG<br>07.05 07.10 PR: 1LJ,1LH,1ZG<br>07.05 07.10 PR: 1LJ,1LH,1ZG<br>07.05 07.10 PR: 1LJ,1LH,1ZG<br>08.05 07.10 PR: 1LJ,1LH,1ZG<br>09.05 07.10 PR: 1LJ,1LH,1ZG<br>05.09 07.10 PR: 1LJ,1LH,1ZG<br>07.05 07.10 PR: 1LJ,1LH,1ZG<br>11.05 07.10 PR: 1LJ,1LH,1ZG<br>11.05 07.10 PR: 1LJ,1LH,1ZG<br>04.07 07.10 PR: 1LJ,1LH,1ZG | 83.7247-0603.3 330899                          | 2 |  | L=603                            |            |
|  | 1.4 TSI 90<br>1.6 75<br>1.6 FSI 85<br>1.6 TDI 77<br>1.8 TSI 112<br>1.8 TSI 118<br>1.9 TDI 77<br>2.0 FSI 110<br>2.0 FSI 4motion 110<br>2.0 TDI 90<br>2.0 TDI 100<br>2.0 TDI 125<br>2.0 TDI 16V 103<br>2.0 TDI 4motion 103<br>2.0 TDI 4motion 125<br>2.0 TFSI 147<br>3.2 V6 FSI 184<br>3.2 V6 FSI 4motion 184 |  | 10.07 07.10 PR: 1LK<br>07.05 07.10 PR: 1LK<br>07.05 07.10 PR: 1LK<br>08.09 07.10 PR: 1LK<br>11.09 07.10 PR: 1LK<br>10.07 07.10 PR: 1LK<br>07.05 07.10 PR: 1LK<br>07.05 07.10 PR: 1LK<br>09.05 07.10 PR: 1LK<br>07.05 07.10 PR: 1LK<br>11.05 07.10 PR: 1LK<br>07.05 07.10 PR: 1LK<br>07.05 07.10 PR: 1LK<br>07.05 07.10 PR: 1LK<br>08.05 07.10 PR: 1LK<br>09.05 07.10 PR: 1LK<br>05.09 07.10 PR: 1LK<br>07.05 07.10 PR: 1LK<br>11.05 07.10 PR: 1LK<br>11.05 07.10 PR: 1LK  | 83.7249-0536.3 330900                          | 2 |  | L=536                            |            |
|  | 1.6 75<br>1.6 FSI 85<br>1.9 TDI 77<br>2.0 FSI 110<br>2.0 FSI 4motion 110<br>2.0 TDI 90<br>2.0 TDI 100<br>2.0 TDI 125<br>2.0 TDI 16V 103<br>2.0 TDI 4motion 103<br>2.0 TFSI 147<br>3.2 V6 FSI 184<br>3.2 V6 FSI 4motion 184<br>3.6 R36 220   |  | 07.05 04.07 PR: 1KU<br>07.05 04.07 PR: 1KU<br>07.05 04.07 PR: 1KU<br>09.05 04.07 PR: 1KU<br>07.05 04.07 PR: 1KU<br>07.05 04.07 PR: 1KU<br>07.05 04.07 PR: 1KU<br>08.05 04.07 PR: 1KU<br>09.05 04.07 PR: 1KU<br>07.05 04.07 PR: 1KU<br>11.05 04.07 PR: 1KU<br>11.05 04.07 PR: 1KU<br>04.07 04.07 PR: 1KU   | 24.6238-1701.7 220819<br>24.6238-1702.7 220820 |   | <input type="checkbox"/> elektrische Feststellbremse <sup>1)</sup><br><input type="checkbox"/> elektrische Feststellbremse <sup>1)</sup> | D=38, - Halter<br>D=38, - Halter | LUC<br>LUC |
|  | 1.4 TSI 90<br>1.6 75<br>1.6 FSI 85<br>1.6 TDI 77<br>1.8 TSI 112<br>1.8 TSI 118<br>1.9 TDI 77<br>2.0 FSI 110<br>2.0 FSI 4motion 110<br>2.0 TDI 90<br>2.0 TDI 100<br>2.0 TDI 125<br>2.0 TDI 16V 103<br>2.0 TDI 4motion 103<br>2.0 TFSI 147<br>3.2 V6 FSI 184<br>3.2 V6 FSI 4motion 184<br>3.6 R36 220         |  | 10.07 07.10<br>07.05 07.10<br>07.05 07.10<br>08.09 07.10<br>11.09 07.10<br>10.07 07.10<br>07.05 07.10<br>07.05 07.10<br>09.05 07.10<br>07.05 07.10<br>11.05 07.10<br>07.05 07.10<br>07.05 07.10<br>08.05 07.10<br>09.05 07.10<br>05.09 07.10<br>07.05 07.10<br>11.05 07.10<br>11.05 07.10<br>04.07 07.10  | 83.7849-0231.3 330872                          | 2 |  | L=233                            |            |
|  | 1.9 TDI 77<br>2.0 FSI 110   |  | 07.05 07.10<br>07.05 07.10  | 24.2519-1705.3 040095                          |   | für Getriebe MQ-250 <sup>2)</sup>  | Nz 19,05                         |            |















**VOLKSWAGEN PASSAT CC (08-11)**













|  |  |  |  |                       |  |  |         |
|--|--|--|--|-----------------------|--|--|---------|
|  | 1.8 TSI $\ddagger$<br>2.0 TDI $\ddagger$<br>2.0 TDI $\ddagger$ 125<br>2.0 TDI 4motion $\ddagger$ 103<br>2.0 TDI 4motion $\ddagger$ 125<br>2.0 TSI $\ddagger$ |  | 04.08 05.10 PR: 1AT,1ZG<br>04.08 05.10 PR: 1AT,1ZG<br>06.08 05.10 PR: 1AT,1ZG<br>08.09 05.10 PR: 1AT,1ZG<br>11.09 05.10 PR: 1AT,1ZG<br>04.08 05.10 PR: 1AT,1ZG | 03.7873-3802.4 300210 |  |  | 11" ATE |
|  | 1.8 TSI $\ddagger$<br>2.0 TDI $\ddagger$<br>2.0 TDI $\ddagger$ 125   |  | 04.08 10.10 PR: 1AS,1ZG<br>04.08 10.10 PR: 1AS,1ZG<br>06.08 10.10 PR: 1AS,1ZG  | 03.7873-3902.4 300254 |  |  | 11" ATE |

<sup>1)</sup> electric parking brake / fr.di stazionamento elettrico / frein à main électrique / freno de mano eléctrico

<sup>2)</sup> for transmission MQ-250 / per scatola camb.MQ-250 / pour boîte de vitesse MQ-250 / caja de cambios para MQ-250



|     |    kW |  |  |  |  |  |  |  |                |       |
|--|---|--|--|--|---|--|--|--|----------------|-------|
| <b>VOLKSWAGEN PASSAT CC (08-11)</b>  |   |  |  |  |   |  |  |  |                |       |
|    | 2.0 TDI 4motion   | #103   |  | 08.09  | 10.10   | PR: 1AS,1ZG  | 03.7873-3902.4   | 300254   | 11"            | ATE   |
|  | 2.0 TDI 4motion   | #125   |  | 11.09  | 10.10   | PR: 1AS,1ZG  |  |  |                |       |
|  | 2.0 TSI   | #  |  | 04.08  | 10.10   | PR: 1AS,1ZG  |  |  |                |       |
|  | 3.6 V6 4motion  | #220   |  | 04.08  | 10.10   | PR: 1AS,1ZG  |  |  |                |       |
|  | 1.8 TSI   | #  |  | 04.08  | 10.10   | PR: 1AT,1LH,1LK,1ZM  | 03.7873-4002.4   | 300211   | 11"            | ATE   |
|  | 2.0 TDI   | #  |  | 04.08  | 10.10   | PR: 1AT,1LH,1LK,1ZM  |  |  |                |       |
|  | 2.0 TDI   | #125   |  | 06.08  | 10.10   | PR: 1AT,1LH,1LK,1ZM  |  |  |                |       |
|  | 2.0 TDI 4motion   | #103   |  | 08.09  | 10.10   | PR: 1AT,1LH,1LK,1ZM  |  |  |                |       |
|  | 2.0 TDI 4motion   | #125   |  | 11.09  | 10.10   | PR: 1AT,1LH,1LK,1ZM  |  |  |                |       |
|  | 2.0 TSI   | #  |  | 04.08  | 10.10   | PR: 1AT,1LH,1LK,1ZM  |  |  |                |       |
| 3.6 V6 4motion   | #220  |  | 04.08  | 10.10  | PR: 1AT,1LH,1LK,1ZM   |  |  |  |                |       |
|    | 1.4 TSI MultiFuel   | #118   |  | 01.11  | 09.11   | PR: 1LA,1LB,1ZM  | 03.7873-4502.4   | 300284   | 11"            | ATE   |
|  | 1.8 TSI   | #  |  | 11.10  | 09.11   | PR: 1LA,1LB,1ZM  |  |  |                |       |
|  | 2.0 TDI   | #  |  | 11.10  | 09.11   | PR: 1LA,1LB,1ZM  |  |  |                |       |
|  | 2.0 TDI   | #125   |  | 11.10  | 09.11   | PR: 1LA,1LB,1ZM  |  |  |                |       |
|  | 2.0 TDI 4motion   | #103   |  | 11.10  | 09.11   | PR: 1LA,1LB,1ZM  |  |  |                |       |
|  | 2.0 TDI 4motion   | #125   |  | 11.10  | 09.11   | PR: 1LA,1LB,1ZM  |  |  |                |       |
|  | 2.0 TSI   | #  |  | 11.10  | 09.11   | PR: 1LA,1LB,1ZM  |  |  |                |       |
|  | 3.6 V6 4motion  | #220   |  | 11.10  | 09.11   | PR: 1LA,1LB,1ZM  |  |  |                |       |
|  | 1.4 TSI MultiFuel   | #118   |  | 01.11  | 09.11   | PR: 1ZG  | 03.4152-0116.3   | 010814   | Thz 22,20      | ATE   |
|  | 1.8 TSI   | #  |  | 04.08  | 09.11   | PR: 1ZG  |  |  |                |       |
| 2.0 TDI  | #   |  | 04.08  | 09.11  | PR: 1ZG   |  |  |  |                |       |
| 2.0 TDI  | #125  |  | 06.08  | 09.11  | PR: 1ZG   |  |  |  |                |       |
| 2.0 TDI 4motion  | #103  |  | 08.09  | 09.11  | PR: 1ZG   |  |  |  |                |       |
| 2.0 TDI 4motion  | #125  |  | 11.09  | 09.11  | PR: 1ZG   |  |  |  |                |       |
| 2.0 TSI  | #   |  | 04.08  | 09.11  | PR: 1ZG   |  |  |  |                |       |
| 3.6 V6 4motion   | #220  |  | 04.08  | 09.11  | PR: 1ZG   |  |  |  |                |       |
|    | 1.4 TSI MultiFuel   | #118   |  | 01.11  | 09.11   | PR: 1LH,1LK,1ZM  | 03.4153-0186.3   | 010816   | Thz 23,81      | ATE   |
|  | 1.8 TSI   | #  |  | 04.08  | 09.11   | PR: 1LH,1LK,1ZM  |  |  |                |       |
|  | 2.0 TDI   | #  |  | 04.08  | 09.11   | PR: 1LH,1LK,1ZM  |  |  |                |       |
|  | 2.0 TDI   | #125   |  | 06.08  | 09.11   | PR: 1LH,1LK,1ZM  |  |  |                |       |
|  | 2.0 TDI 4motion   | #103   |  | 08.09  | 09.11   | PR: 1LH,1LK,1ZM  |  |  |                |       |
|  | 2.0 TDI 4motion   | #125   |  | 11.09  | 09.11   | PR: 1LH,1LK,1ZM  |  |  |                |       |
|  | 2.0 TSI   | #  |  | 04.08  | 09.11   | PR: 1LH,1LK,1ZM  |  |  |                |       |
|  | 3.6 V6 4motion  | #220   |  | 04.08  | 09.11   | PR: 1LH,1LK,1ZM  |  |  |                |       |
|  | 1.4 TSI MultiFuel   | 118  |  | 01.11  | 09.11   | PR: 1LH,1ZM,1ZG  | 11.9541-9553.2   | 220563   | D=54, - Halter | ATE   |
|  | 1.8 TSI   |  |  | 04.08  | 09.11   | PR: 1LH,1ZM,1ZG  | 11.9541-9554.2   | 220564   | D=54, - Halter | ATE   |
| 2.0 TDI  |   |  | 04.08  | 09.11  | PR: 1LH,1ZM,1ZG   | 11.8171-0008.1   | 990049   | Führungsbolzen   | ATE            |       |
| 2.0 TDI  | 125   |  | 06.08  | 09.11  | PR: 1LH,1ZM,1ZG   | 11.0101-5409.2   | 260035   | Hülzensatz   | ATE            |       |
| 2.0 TDI 4motion  | 103   |  | 08.09  | 09.11  | PR: 1LH,1ZM,1ZG   | 11.8116-0351.1   | 390538   | Haltefeder   | ATE            |       |
| 2.0 TDI 4motion  | 125   |  | 11.09  | 09.11  | PR: 1LH,1ZM,1ZG   |  |  |  |                |       |
| 2.0 TSI  |   |  | 04.08  | 09.11  | PR: 1LH,1ZM,1ZG   |  |  |  |                |       |
| 3.6 V6 4motion   | 220   |  | 04.08  | 09.11  | PR: 1LH,1ZM,1ZG   |  |  |  |                |       |
|  | 1.4 TSI MultiFuel   | 118  |  | 01.11  | 09.11   | PR: 1LK  | 11.9576-9995.2   | 220651   | D=57, - Halter | ATE   |
|  | 1.8 TSI   |  |  | 04.08  | 09.11   | PR: 1LK  | 11.9576-9996.2   | 220652   | D=57, - Halter | ATE   |
|  | 2.0 TDI   |  |  | 04.08  | 09.11   | PR: 1LK  | 11.8171-0008.1   | 990049   | Führungsbolzen | ATE   |
|  | 2.0 TDI   | 125  |  | 06.08  | 09.11   | PR: 1LK  | 11.0101-5409.2   | 260035   | Hülzensatz     | ATE   |
|  | 2.0 TDI 4motion   | 103  |  | 08.09  | 09.11   | PR: 1LK  | 11.8116-0410.2   | 390589   | Haltefeder     | ATE   |
|  | 2.0 TDI 4motion   | 125  |  | 11.09  | 09.11   | PR: 1LK  |  |  |                |       |
|  | 2.0 TSI   |  |  | 04.08  | 09.11   | PR: 1LK  |  |  |                |       |
|  | 3.6 V6 4motion  | 220  |  | 04.08  | 09.11   | PR: 1LK  |  |  |                |       |
|  | 1.4 TSI MultiFuel   | 118  |  | 01.11  | 09.11   | PR: 1LH,1ZM,1ZG  | 83.7247-0603.3   | 330899   | 2              | L=603 |
|  | 1.8 TSI   |  |  | 04.08  | 09.11   | PR: 1LH,1ZM,1ZG  |  |  |                |       |
| 2.0 TDI  |   |  | 04.08  | 09.11  | PR: 1LH,1ZM,1ZG   |  |  |  |                |       |
| 2.0 TDI  | 125   |  | 06.08  | 09.11  | PR: 1LH,1ZM,1ZG   |  |  |  |                |       |
| 2.0 TDI 4motion  | 103   |  | 08.09  | 09.11  | PR: 1LH,1ZM,1ZG   |  |  |  |                |       |
| 2.0 TDI 4motion  | 125   |  | 11.09  | 09.11  | PR: 1LH,1ZM,1ZG   |  |  |  |                |       |
| 2.0 TSI  |   |  | 04.08  | 09.11  | PR: 1LH,1ZM,1ZG   |  |  |  |                |       |
| 3.6 V6 4motion   | 220   |  | 04.08  | 09.11  | PR: 1LH,1ZM,1ZG   |  |  |  |                |       |
|  | 1.4 TSI MultiFuel   | 118  |  | 01.11  | 09.11   | PR: 1LK  | 83.7249-0536.3   | 330900   | 2              | L=536 |
|  | 1.8 TSI   |  |  | 04.08  | 09.11   | PR: 1LK  |  |  |                |       |
|  | 2.0 TDI   |  |  | 04.08  | 09.11   | PR: 1LK  |  |  |                |       |
|  | 2.0 TDI   | 125  |  | 06.08  | 09.11   | PR: 1LK  |  |  |                |       |
|  | 2.0 TDI 4motion   | 103  |  | 08.09  | 09.11   | PR: 1LK  |  |  |                |       |
|  | 2.0 TDI 4motion   | 125  |  | 11.09  | 09.11   | PR: 1LK  |  |  |                |       |
|  | 2.0 TSI   |  |  | 04.08  | 09.11   | PR: 1LK  |  |  |                |       |
|  | 3.6 V6 4motion  | 220  |  | 04.08  | 09.11   | PR: 1LK  |  |  |                |       |
|  | 1.4 TSI MultiFuel   | 118  |  | 01.11  | 09.11   | PR: 1KU,2EA  | 83.7849-0231.3   | 330872   | 2              | L=233 |
|  | 1.8 TSI   |  |  | 04.08  | 09.11   | PR: 1KU,2EA  |  |  |                |       |
| 2.0 TDI  |   |  | 04.08  | 09.11  | PR: 1KU,2EA   |  |  |  |                |       |
| 2.0 TDI  | 125   |  | 06.08  | 09.11  | PR: 1KU,2EA   |  |  |  |                |       |
| 2.0 TDI 4motion  | 103   |  | 08.09  | 09.11  | PR: 1KU,2EA   |  |  |  |                |       |
| 2.0 TDI 4motion  | 125   |  | 11.09  | 09.11  | PR: 1KU,2EA   |  |  |  |                |       |
| 2.0 TSI  |   |  | 04.08  | 09.11  | PR: 1KU,2EA   |  |  |  |                |       |
| 3.6 V6 4motion   | 220   |  | 04.08  | 09.11  | PR: 1KU,2EA   |  |  |  |                |       |
|  | 1.4 TSI MultiFuel   | 118  |  | 01.11  | 09.11   | PR: 1KW  | 24.5143-0257.3   | 331167   | 2              | L=257 |
|  | 1.8 TSI   |  |  | 04.08  | 09.11   | PR: 1KW  |  |  |                |       |
|  | 2.0 TDI   |  |  | 04.08  | 09.11   | PR: 1KW  |  |  |                |       |
|  | 2.0 TDI   | 125  |  | 06.08  | 09.11   | PR: 1KW  |  |  |                |       |
|  | 2.0 TDI 4motion   | 103  |  | 08.09  | 09.11   | PR: 1KW  |  |  |                |       |
|  | 2.0 TDI 4motion   | 125  |  | 11.09  | 09.11   | PR: 1KW  |  |  |                |       |
|  | 2.0 TSI   |  |  | 04.08  | 09.11   | PR: 1KW  |  |  |                |       |
|  | 3.6 V6 4motion  | 220  |  | 04.08  | 09.11   | PR: 1KW  |  |  |                |       |

| VOLKSWAGEN PASSAT CC (08-11)   |  |                   |       |                 |                |                 |   |                |   |                |         |         |       |       |         |                 |                |        |   |                |     |         |       |         |  |                 |                |        |         |                |       |         |         |       |  |                 |                |                 |     |            |       |         |     |       |  |                 |                 |        |       |            |         |         |  |       |  |                 |  |       |       |         |  |         |     |       |                |                 |       |       |         |  |  |         |     |       |  |                 |  |  |  |  |  |                 |     |       |  |                 |  |  |  |  |  |                 |     |       |  |                 |  |  |  |  |  |                 |     |       |  |                 |  |  |  |  |  |         |     |       |  |                 |  |  |  |  |  |                 |     |       |  |                 |  |  |  |  |  |                 |     |       |  |                 |  |  |  |  |  |
|--|--|-------------------|-------|-----------------|----------------|-----------------|---|----------------|---|----------------|---------|---------|-------|-------|---------|-----------------|----------------|--------|---|----------------|-----|---------|-------|---------|--|-----------------|----------------|--------|---------|----------------|-------|---------|---------|-------|--|-----------------|----------------|-----------------|-----|------------|-------|---------|-----|-------|--|-----------------|-----------------|--------|-------|------------|---------|---------|--|-------|--|-----------------|--|-------|-------|---------|--|---------|-----|-------|----------------|-----------------|-------|-------|---------|--|--|---------|-----|-------|--|-----------------|--|--|--|--|--|-----------------|-----|-------|--|-----------------|--|--|--|--|--|-----------------|-----|-------|--|-----------------|--|--|--|--|--|-----------------|-----|-------|--|-----------------|--|--|--|--|--|---------|-----|-------|--|-----------------|--|--|--|--|--|-----------------|-----|-------|--|-----------------|--|--|--|--|--|-----------------|-----|-------|--|-----------------|--|--|--|--|--|
|     | <table border="1"> <tr> <td>1.4 TSI MultiFuel</td> <td>118</td> <td>01.11</td> <td>09.11</td> <td>PR: 0EJ</td> <td>24.2519-1705.3</td> <td>040095</td> <td></td> <td>Nz 19,05</td> </tr> <tr> <td>1.8 TSI</td> <td></td> <td>04.08</td> <td>09.11</td> <td>PR: 0EJ</td> <td></td> <td></td> <td></td> <td></td> </tr> <tr> <td>2.0 TDI</td> <td></td> <td>04.08</td> <td>09.11</td> <td>PR: 0EJ</td> <td></td> <td></td> <td></td> <td></td> </tr> <tr> <td>2.0 TDI</td> <td>125</td> <td>06.08</td> <td>09.11</td> <td>PR: 0EJ</td> <td></td> <td></td> <td></td> <td></td> </tr> <tr> <td>2.0 TDI 4motion</td> <td>103</td> <td>08.09</td> <td>09.11</td> <td>PR: 0EJ</td> <td></td> <td></td> <td></td> <td></td> </tr> <tr> <td>2.0 TDI 4motion</td> <td>125</td> <td>11.09</td> <td>09.11</td> <td>PR: 0EJ</td> <td></td> <td></td> <td></td> <td></td> </tr> <tr> <td>2.0 TSI</td> <td></td> <td>04.08</td> <td>09.11</td> <td>PR: 0EJ</td> <td></td> <td></td> <td></td> <td></td> </tr> <tr> <td>3.6 V6 4motion</td> <td>220</td> <td>04.08</td> <td>09.11</td> <td>PR: 0EJ</td> <td></td> <td></td> <td></td> <td></td> </tr> </table>  | 1.4 TSI MultiFuel | 118   | 01.11           | 09.11          | PR: 0EJ         | 24.2519-1705.3  | 040095         |   | Nz 19,05       | 1.8 TSI |         | 04.08 | 09.11 | PR: 0EJ |                 |                |        |   | 2.0 TDI        |     | 04.08   | 09.11 | PR: 0EJ |  |                 |                |        | 2.0 TDI | 125            | 06.08 | 09.11   | PR: 0EJ |       |  |                 |                | 2.0 TDI 4motion | 103 | 08.09      | 09.11 | PR: 0EJ |     |       |  |                 | 2.0 TDI 4motion | 125    | 11.09 | 09.11      | PR: 0EJ |         |  |       |  | 2.0 TSI         |  | 04.08 | 09.11 | PR: 0EJ |  |         |     |       | 3.6 V6 4motion | 220             | 04.08 | 09.11 | PR: 0EJ |  |  |         |     |       |  |                 |  |  |  |  |  |                 |     |       |  |                 |  |  |  |  |  |                 |     |       |  |                 |  |  |  |  |  |                 |     |       |  |                 |  |  |  |  |  |         |     |       |  |                 |  |  |  |  |  |                 |     |       |  |                 |  |  |  |  |  |                 |     |       |  |                 |  |  |  |  |  |
| 1.4 TSI MultiFuel  | 118  | 01.11             | 09.11 | PR: 0EJ         | 24.2519-1705.3 | 040095          |   | Nz 19,05       |   |                |         |         |       |       |         |                 |                |        |   |                |     |         |       |         |  |                 |                |        |         |                |       |         |         |       |  |                 |                |                 |     |            |       |         |     |       |  |                 |                 |        |       |            |         |         |  |       |  |                 |  |       |       |         |  |         |     |       |                |                 |       |       |         |  |  |         |     |       |  |                 |  |  |  |  |  |                 |     |       |  |                 |  |  |  |  |  |                 |     |       |  |                 |  |  |  |  |  |                 |     |       |  |                 |  |  |  |  |  |         |     |       |  |                 |  |  |  |  |  |                 |     |       |  |                 |  |  |  |  |  |                 |     |       |  |                 |  |  |  |  |  |
| 1.8 TSI  |  | 04.08             | 09.11 | PR: 0EJ         |                |                 |   |                |   |                |         |         |       |       |         |                 |                |        |   |                |     |         |       |         |  |                 |                |        |         |                |       |         |         |       |  |                 |                |                 |     |            |       |         |     |       |  |                 |                 |        |       |            |         |         |  |       |  |                 |  |       |       |         |  |         |     |       |                |                 |       |       |         |  |  |         |     |       |  |                 |  |  |  |  |  |                 |     |       |  |                 |  |  |  |  |  |                 |     |       |  |                 |  |  |  |  |  |                 |     |       |  |                 |  |  |  |  |  |         |     |       |  |                 |  |  |  |  |  |                 |     |       |  |                 |  |  |  |  |  |                 |     |       |  |                 |  |  |  |  |  |
| 2.0 TDI  |  | 04.08             | 09.11 | PR: 0EJ         |                |                 |   |                |   |                |         |         |       |       |         |                 |                |        |   |                |     |         |       |         |  |                 |                |        |         |                |       |         |         |       |  |                 |                |                 |     |            |       |         |     |       |  |                 |                 |        |       |            |         |         |  |       |  |                 |  |       |       |         |  |         |     |       |                |                 |       |       |         |  |  |         |     |       |  |                 |  |  |  |  |  |                 |     |       |  |                 |  |  |  |  |  |                 |     |       |  |                 |  |  |  |  |  |                 |     |       |  |                 |  |  |  |  |  |         |     |       |  |                 |  |  |  |  |  |                 |     |       |  |                 |  |  |  |  |  |                 |     |       |  |                 |  |  |  |  |  |
| 2.0 TDI  | 125  | 06.08             | 09.11 | PR: 0EJ         |                |                 |   |                |   |                |         |         |       |       |         |                 |                |        |   |                |     |         |       |         |  |                 |                |        |         |                |       |         |         |       |  |                 |                |                 |     |            |       |         |     |       |  |                 |                 |        |       |            |         |         |  |       |  |                 |  |       |       |         |  |         |     |       |                |                 |       |       |         |  |  |         |     |       |  |                 |  |  |  |  |  |                 |     |       |  |                 |  |  |  |  |  |                 |     |       |  |                 |  |  |  |  |  |                 |     |       |  |                 |  |  |  |  |  |         |     |       |  |                 |  |  |  |  |  |                 |     |       |  |                 |  |  |  |  |  |                 |     |       |  |                 |  |  |  |  |  |
| 2.0 TDI 4motion  | 103  | 08.09             | 09.11 | PR: 0EJ         |                |                 |   |                |   |                |         |         |       |       |         |                 |                |        |   |                |     |         |       |         |  |                 |                |        |         |                |       |         |         |       |  |                 |                |                 |     |            |       |         |     |       |  |                 |                 |        |       |            |         |         |  |       |  |                 |  |       |       |         |  |         |     |       |                |                 |       |       |         |  |  |         |     |       |  |                 |  |  |  |  |  |                 |     |       |  |                 |  |  |  |  |  |                 |     |       |  |                 |  |  |  |  |  |                 |     |       |  |                 |  |  |  |  |  |         |     |       |  |                 |  |  |  |  |  |                 |     |       |  |                 |  |  |  |  |  |                 |     |       |  |                 |  |  |  |  |  |
| 2.0 TDI 4motion  | 125  | 11.09             | 09.11 | PR: 0EJ         |                |                 |   |                |   |                |         |         |       |       |         |                 |                |        |   |                |     |         |       |         |  |                 |                |        |         |                |       |         |         |       |  |                 |                |                 |     |            |       |         |     |       |  |                 |                 |        |       |            |         |         |  |       |  |                 |  |       |       |         |  |         |     |       |                |                 |       |       |         |  |  |         |     |       |  |                 |  |  |  |  |  |                 |     |       |  |                 |  |  |  |  |  |                 |     |       |  |                 |  |  |  |  |  |                 |     |       |  |                 |  |  |  |  |  |         |     |       |  |                 |  |  |  |  |  |                 |     |       |  |                 |  |  |  |  |  |                 |     |       |  |                 |  |  |  |  |  |
| 2.0 TSI  |  | 04.08             | 09.11 | PR: 0EJ         |                |                 |   |                |   |                |         |         |       |       |         |                 |                |        |   |                |     |         |       |         |  |                 |                |        |         |                |       |         |         |       |  |                 |                |                 |     |            |       |         |     |       |  |                 |                 |        |       |            |         |         |  |       |  |                 |  |       |       |         |  |         |     |       |                |                 |       |       |         |  |  |         |     |       |  |                 |  |  |  |  |  |                 |     |       |  |                 |  |  |  |  |  |                 |     |       |  |                 |  |  |  |  |  |                 |     |       |  |                 |  |  |  |  |  |         |     |       |  |                 |  |  |  |  |  |                 |     |       |  |                 |  |  |  |  |  |                 |     |       |  |                 |  |  |  |  |  |
| 3.6 V6 4motion   | 220  | 04.08             | 09.11 | PR: 0EJ         |                |                 |   |                |   |                |         |         |       |       |         |                 |                |        |   |                |     |         |       |         |  |                 |                |        |         |                |       |         |         |       |  |                 |                |                 |     |            |       |         |     |       |  |                 |                 |        |       |            |         |         |  |       |  |                 |  |       |       |         |  |         |     |       |                |                 |       |       |         |  |  |         |     |       |  |                 |  |  |  |  |  |                 |     |       |  |                 |  |  |  |  |  |                 |     |       |  |                 |  |  |  |  |  |                 |     |       |  |                 |  |  |  |  |  |         |     |       |  |                 |  |  |  |  |  |                 |     |       |  |                 |  |  |  |  |  |                 |     |       |  |                 |  |  |  |  |  |
| VOLKSWAGEN PASSAT / PASSAT VARIANT (10-)   |  |                   |       |                 |                |                 |   |                |   |                |         |         |       |       |         |                 |                |        |   |                |     |         |       |         |  |                 |                |        |         |                |       |         |         |       |  |                 |                |                 |     |            |       |         |     |       |  |                 |                 |        |       |            |         |         |  |       |  |                 |  |       |       |         |  |         |     |       |                |                 |       |       |         |  |  |         |     |       |  |                 |  |  |  |  |  |                 |     |       |  |                 |  |  |  |  |  |                 |     |       |  |                 |  |  |  |  |  |                 |     |       |  |                 |  |  |  |  |  |         |     |       |  |                 |  |  |  |  |  |                 |     |       |  |                 |  |  |  |  |  |                 |     |       |  |                 |  |  |  |  |  |
|    | <table border="1"> <tr> <td>1.4 TSI</td> <td>90</td> <td>08.10</td> <td></td> <td>PR: 1LA,1LB,1ZM</td> <td>03.7873-4502.4</td> <td>300284</td> <td></td> <td>11"</td> <td>ATE</td> </tr> <tr> <td>1.4 TSI</td> <td>110</td> <td>08.10</td> <td></td> <td>PR: 1LA,1LB,1ZM</td> <td></td> <td></td> <td></td> <td></td> <td></td> </tr> <tr> <td>1.4 TSI</td> <td>118</td> <td>11.12</td> <td></td> <td>PR: 1LA,1LB,1ZM</td> <td></td> <td></td> <td></td> <td></td> <td></td> </tr> <tr> <td>1.6 TDI</td> <td>77</td> <td>08.10</td> <td></td> <td>PR: 1LA,1LB,1ZM</td> <td></td> <td></td> <td></td> <td></td> <td></td> </tr> <tr> <td>1.8 TSI</td> <td>118</td> <td>08.10</td> <td></td> <td>PR: 1LA,1LB,1ZM</td> <td></td> <td></td> <td></td> <td></td> <td></td> </tr> <tr> <td>2.0 TDI</td> <td></td> <td>08.10</td> <td></td> <td>PR: 1LA,1LB,1ZM</td> <td></td> <td></td> <td></td> <td></td> <td></td> </tr> <tr> <td>2.0 TDI</td> <td>125</td> <td>08.10</td> <td></td> <td>PR: 1LA,1LB,1ZM</td> <td></td> <td></td> <td></td> <td></td> <td></td> </tr> <tr> <td>2.0 TDI</td> <td>130</td> <td>12.12</td> <td></td> <td>PR: 1LA,1LB,1ZM</td> <td></td> <td></td> <td></td> <td></td> <td></td> </tr> <tr> <td>2.0 TDI 4motion</td> <td>103</td> <td>08.10</td> <td></td> <td>PR: 1LA,1LB,1ZM</td> <td></td> <td></td> <td></td> <td></td> <td></td> </tr> <tr> <td>2.0 TDI 4motion</td> <td>125</td> <td>08.10</td> <td></td> <td>PR: 1LA,1LB,1ZM</td> <td></td> <td></td> <td></td> <td></td> <td></td> </tr> <tr> <td>2.0 TDI 4motion</td> <td>130</td> <td>01.13</td> <td></td> <td>PR: 1LA,1LB,1ZM</td> <td></td> <td></td> <td></td> <td></td> <td></td> </tr> <tr> <td>2.0 TSI</td> <td>155</td> <td>11.10</td> <td></td> <td>PR: 1LA,1LB,1ZM</td> <td></td> <td></td> <td></td> <td></td> <td></td> </tr> <tr> <td>2.0 TSI 4motion</td> <td>155</td> <td>01.12</td> <td></td> <td>PR: 1LA,1LB,1ZM</td> <td></td> <td></td> <td></td> <td></td> <td></td> </tr> <tr> <td>3.6 FSI 4motion</td> <td>220</td> <td>01.11</td> <td></td> <td>PR: 1LA,1LB,1ZM</td> <td></td> <td></td> <td></td> <td></td> <td></td> </tr> </table>   | 1.4 TSI           | 90    | 08.10           |                | PR: 1LA,1LB,1ZM | 03.7873-4502.4  | 300284         |   | 11"            | ATE     | 1.4 TSI | 110   | 08.10 |         | PR: 1LA,1LB,1ZM |                |        |   |                |     | 1.4 TSI | 118   | 11.12   |  | PR: 1LA,1LB,1ZM |                |        |         |                |       | 1.6 TDI | 77      | 08.10 |  | PR: 1LA,1LB,1ZM |                |                 |     |            |       | 1.8 TSI | 118 | 08.10 |  | PR: 1LA,1LB,1ZM |                 |        |       |            |         | 2.0 TDI |  | 08.10 |  | PR: 1LA,1LB,1ZM |  |       |       |         |  | 2.0 TDI | 125 | 08.10 |                | PR: 1LA,1LB,1ZM |       |       |         |  |  | 2.0 TDI | 130 | 12.12 |  | PR: 1LA,1LB,1ZM |  |  |  |  |  | 2.0 TDI 4motion | 103 | 08.10 |  | PR: 1LA,1LB,1ZM |  |  |  |  |  | 2.0 TDI 4motion | 125 | 08.10 |  | PR: 1LA,1LB,1ZM |  |  |  |  |  | 2.0 TDI 4motion | 130 | 01.13 |  | PR: 1LA,1LB,1ZM |  |  |  |  |  | 2.0 TSI | 155 | 11.10 |  | PR: 1LA,1LB,1ZM |  |  |  |  |  | 2.0 TSI 4motion | 155 | 01.12 |  | PR: 1LA,1LB,1ZM |  |  |  |  |  | 3.6 FSI 4motion | 220 | 01.11 |  | PR: 1LA,1LB,1ZM |  |  |  |  |  |
| 1.4 TSI  | 90   | 08.10             |       | PR: 1LA,1LB,1ZM | 03.7873-4502.4 | 300284          |   | 11"            | ATE   |                |         |         |       |       |         |                 |                |        |   |                |     |         |       |         |  |                 |                |        |         |                |       |         |         |       |  |                 |                |                 |     |            |       |         |     |       |  |                 |                 |        |       |            |         |         |  |       |  |                 |  |       |       |         |  |         |     |       |                |                 |       |       |         |  |  |         |     |       |  |                 |  |  |  |  |  |                 |     |       |  |                 |  |  |  |  |  |                 |     |       |  |                 |  |  |  |  |  |                 |     |       |  |                 |  |  |  |  |  |         |     |       |  |                 |  |  |  |  |  |                 |     |       |  |                 |  |  |  |  |  |                 |     |       |  |                 |  |  |  |  |  |
| 1.4 TSI  | 110  | 08.10             |       | PR: 1LA,1LB,1ZM |                |                 |   |                |   |                |         |         |       |       |         |                 |                |        |   |                |     |         |       |         |  |                 |                |        |         |                |       |         |         |       |  |                 |                |                 |     |            |       |         |     |       |  |                 |                 |        |       |            |         |         |  |       |  |                 |  |       |       |         |  |         |     |       |                |                 |       |       |         |  |  |         |     |       |  |                 |  |  |  |  |  |                 |     |       |  |                 |  |  |  |  |  |                 |     |       |  |                 |  |  |  |  |  |                 |     |       |  |                 |  |  |  |  |  |         |     |       |  |                 |  |  |  |  |  |                 |     |       |  |                 |  |  |  |  |  |                 |     |       |  |                 |  |  |  |  |  |
| 1.4 TSI  | 118  | 11.12             |       | PR: 1LA,1LB,1ZM |                |                 |   |                |   |                |         |         |       |       |         |                 |                |        |   |                |     |         |       |         |  |                 |                |        |         |                |       |         |         |       |  |                 |                |                 |     |            |       |         |     |       |  |                 |                 |        |       |            |         |         |  |       |  |                 |  |       |       |         |  |         |     |       |                |                 |       |       |         |  |  |         |     |       |  |                 |  |  |  |  |  |                 |     |       |  |                 |  |  |  |  |  |                 |     |       |  |                 |  |  |  |  |  |                 |     |       |  |                 |  |  |  |  |  |         |     |       |  |                 |  |  |  |  |  |                 |     |       |  |                 |  |  |  |  |  |                 |     |       |  |                 |  |  |  |  |  |
| 1.6 TDI  | 77   | 08.10             |       | PR: 1LA,1LB,1ZM |                |                 |   |                |   |                |         |         |       |       |         |                 |                |        |   |                |     |         |       |         |  |                 |                |        |         |                |       |         |         |       |  |                 |                |                 |     |            |       |         |     |       |  |                 |                 |        |       |            |         |         |  |       |  |                 |  |       |       |         |  |         |     |       |                |                 |       |       |         |  |  |         |     |       |  |                 |  |  |  |  |  |                 |     |       |  |                 |  |  |  |  |  |                 |     |       |  |                 |  |  |  |  |  |                 |     |       |  |                 |  |  |  |  |  |         |     |       |  |                 |  |  |  |  |  |                 |     |       |  |                 |  |  |  |  |  |                 |     |       |  |                 |  |  |  |  |  |
| 1.8 TSI  | 118  | 08.10             |       | PR: 1LA,1LB,1ZM |                |                 |   |                |   |                |         |         |       |       |         |                 |                |        |   |                |     |         |       |         |  |                 |                |        |         |                |       |         |         |       |  |                 |                |                 |     |            |       |         |     |       |  |                 |                 |        |       |            |         |         |  |       |  |                 |  |       |       |         |  |         |     |       |                |                 |       |       |         |  |  |         |     |       |  |                 |  |  |  |  |  |                 |     |       |  |                 |  |  |  |  |  |                 |     |       |  |                 |  |  |  |  |  |                 |     |       |  |                 |  |  |  |  |  |         |     |       |  |                 |  |  |  |  |  |                 |     |       |  |                 |  |  |  |  |  |                 |     |       |  |                 |  |  |  |  |  |
| 2.0 TDI  |  | 08.10             |       | PR: 1LA,1LB,1ZM |                |                 |   |                |   |                |         |         |       |       |         |                 |                |        |   |                |     |         |       |         |  |                 |                |        |         |                |       |         |         |       |  |                 |                |                 |     |            |       |         |     |       |  |                 |                 |        |       |            |         |         |  |       |  |                 |  |       |       |         |  |         |     |       |                |                 |       |       |         |  |  |         |     |       |  |                 |  |  |  |  |  |                 |     |       |  |                 |  |  |  |  |  |                 |     |       |  |                 |  |  |  |  |  |                 |     |       |  |                 |  |  |  |  |  |         |     |       |  |                 |  |  |  |  |  |                 |     |       |  |                 |  |  |  |  |  |                 |     |       |  |                 |  |  |  |  |  |
| 2.0 TDI  | 125  | 08.10             |       | PR: 1LA,1LB,1ZM |                |                 |   |                |   |                |         |         |       |       |         |                 |                |        |   |                |     |         |       |         |  |                 |                |        |         |                |       |         |         |       |  |                 |                |                 |     |            |       |         |     |       |  |                 |                 |        |       |            |         |         |  |       |  |                 |  |       |       |         |  |         |     |       |                |                 |       |       |         |  |  |         |     |       |  |                 |  |  |  |  |  |                 |     |       |  |                 |  |  |  |  |  |                 |     |       |  |                 |  |  |  |  |  |                 |     |       |  |                 |  |  |  |  |  |         |     |       |  |                 |  |  |  |  |  |                 |     |       |  |                 |  |  |  |  |  |                 |     |       |  |                 |  |  |  |  |  |
| 2.0 TDI  | 130  | 12.12             |       | PR: 1LA,1LB,1ZM |                |                 |   |                |   |                |         |         |       |       |         |                 |                |        |   |                |     |         |       |         |  |                 |                |        |         |                |       |         |         |       |  |                 |                |                 |     |            |       |         |     |       |  |                 |                 |        |       |            |         |         |  |       |  |                 |  |       |       |         |  |         |     |       |                |                 |       |       |         |  |  |         |     |       |  |                 |  |  |  |  |  |                 |     |       |  |                 |  |  |  |  |  |                 |     |       |  |                 |  |  |  |  |  |                 |     |       |  |                 |  |  |  |  |  |         |     |       |  |                 |  |  |  |  |  |                 |     |       |  |                 |  |  |  |  |  |                 |     |       |  |                 |  |  |  |  |  |
| 2.0 TDI 4motion  | 103  | 08.10             |       | PR: 1LA,1LB,1ZM |                |                 |   |                |   |                |         |         |       |       |         |                 |                |        |   |                |     |         |       |         |  |                 |                |        |         |                |       |         |         |       |  |                 |                |                 |     |            |       |         |     |       |  |                 |                 |        |       |            |         |         |  |       |  |                 |  |       |       |         |  |         |     |       |                |                 |       |       |         |  |  |         |     |       |  |                 |  |  |  |  |  |                 |     |       |  |                 |  |  |  |  |  |                 |     |       |  |                 |  |  |  |  |  |                 |     |       |  |                 |  |  |  |  |  |         |     |       |  |                 |  |  |  |  |  |                 |     |       |  |                 |  |  |  |  |  |                 |     |       |  |                 |  |  |  |  |  |
| 2.0 TDI 4motion  | 125  | 08.10             |       | PR: 1LA,1LB,1ZM |                |                 |   |                |   |                |         |         |       |       |         |                 |                |        |   |                |     |         |       |         |  |                 |                |        |         |                |       |         |         |       |  |                 |                |                 |     |            |       |         |     |       |  |                 |                 |        |       |            |         |         |  |       |  |                 |  |       |       |         |  |         |     |       |                |                 |       |       |         |  |  |         |     |       |  |                 |  |  |  |  |  |                 |     |       |  |                 |  |  |  |  |  |                 |     |       |  |                 |  |  |  |  |  |                 |     |       |  |                 |  |  |  |  |  |         |     |       |  |                 |  |  |  |  |  |                 |     |       |  |                 |  |  |  |  |  |                 |     |       |  |                 |  |  |  |  |  |
| 2.0 TDI 4motion  | 130  | 01.13             |       | PR: 1LA,1LB,1ZM |                |                 |   |                |   |                |         |         |       |       |         |                 |                |        |   |                |     |         |       |         |  |                 |                |        |         |                |       |         |         |       |  |                 |                |                 |     |            |       |         |     |       |  |                 |                 |        |       |            |         |         |  |       |  |                 |  |       |       |         |  |         |     |       |                |                 |       |       |         |  |  |         |     |       |  |                 |  |  |  |  |  |                 |     |       |  |                 |  |  |  |  |  |                 |     |       |  |                 |  |  |  |  |  |                 |     |       |  |                 |  |  |  |  |  |         |     |       |  |                 |  |  |  |  |  |                 |     |       |  |                 |  |  |  |  |  |                 |     |       |  |                 |  |  |  |  |  |
| 2.0 TSI  | 155  | 11.10             |       | PR: 1LA,1LB,1ZM |                |                 |   |                |   |                |         |         |       |       |         |                 |                |        |   |                |     |         |       |         |  |                 |                |        |         |                |       |         |         |       |  |                 |                |                 |     |            |       |         |     |       |  |                 |                 |        |       |            |         |         |  |       |  |                 |  |       |       |         |  |         |     |       |                |                 |       |       |         |  |  |         |     |       |  |                 |  |  |  |  |  |                 |     |       |  |                 |  |  |  |  |  |                 |     |       |  |                 |  |  |  |  |  |                 |     |       |  |                 |  |  |  |  |  |         |     |       |  |                 |  |  |  |  |  |                 |     |       |  |                 |  |  |  |  |  |                 |     |       |  |                 |  |  |  |  |  |
| 2.0 TSI 4motion  | 155  | 01.12             |       | PR: 1LA,1LB,1ZM |                |                 |   |                |   |                |         |         |       |       |         |                 |                |        |   |                |     |         |       |         |  |                 |                |        |         |                |       |         |         |       |  |                 |                |                 |     |            |       |         |     |       |  |                 |                 |        |       |            |         |         |  |       |  |                 |  |       |       |         |  |         |     |       |                |                 |       |       |         |  |  |         |     |       |  |                 |  |  |  |  |  |                 |     |       |  |                 |  |  |  |  |  |                 |     |       |  |                 |  |  |  |  |  |                 |     |       |  |                 |  |  |  |  |  |         |     |       |  |                 |  |  |  |  |  |                 |     |       |  |                 |  |  |  |  |  |                 |     |       |  |                 |  |  |  |  |  |
| 3.6 FSI 4motion  | 220  | 01.11             |       | PR: 1LA,1LB,1ZM |                |                 |   |                |   |                |         |         |       |       |         |                 |                |        |   |                |     |         |       |         |  |                 |                |        |         |                |       |         |         |       |  |                 |                |                 |     |            |       |         |     |       |  |                 |                 |        |       |            |         |         |  |       |  |                 |  |       |       |         |  |         |     |       |                |                 |       |       |         |  |  |         |     |       |  |                 |  |  |  |  |  |                 |     |       |  |                 |  |  |  |  |  |                 |     |       |  |                 |  |  |  |  |  |                 |     |       |  |                 |  |  |  |  |  |         |     |       |  |                 |  |  |  |  |  |                 |     |       |  |                 |  |  |  |  |  |                 |     |       |  |                 |  |  |  |  |  |
|    | <table border="1"> <tr> <td>1.4 TSI</td> <td>90</td> <td>08.10</td> <td></td> <td>PR: 1LA,1LB,1ZM</td> <td>03.4153-0186.3</td> <td>010816</td> <td></td> <td>Thz 23,81</td> <td>ATE</td> </tr> <tr> <td>1.4 TSI</td> <td>110</td> <td>08.10</td> <td></td> <td>PR: 1LA,1LB,1ZM</td> <td></td> <td></td> <td></td> <td></td> <td></td> </tr> <tr> <td>1.4 TSI</td> <td>118</td> <td>11.12</td> <td></td> <td>PR: 1LA,1LB,1ZM</td> <td></td> <td></td> <td></td> <td></td> <td></td> </tr> <tr> <td>1.6 TDI</td> <td>77</td> <td>08.10</td> <td></td> <td>PR: 1LA,1LB,1ZM</td> <td></td> <td></td> <td></td> <td></td> <td></td> </tr> <tr> <td>1.8 TSI</td> <td>118</td> <td>08.10</td> <td></td> <td>PR: 1LA,1LB,1ZM</td> <td></td> <td></td> <td></td> <td></td> <td></td> </tr> <tr> <td>2.0 TDI</td> <td></td> <td>08.10</td> <td></td> <td>PR: 1LA,1LB,1ZM</td> <td></td> <td></td> <td></td> <td></td> <td></td> </tr> <tr> <td>2.0 TDI</td> <td>125</td> <td>08.10</td> <td></td> <td>PR: 1LA,1LB,1ZM</td> <td></td> <td></td> <td></td> <td></td> <td></td> </tr> <tr> <td>2.0 TDI</td> <td>130</td> <td>12.12</td> <td></td> <td>PR: 1LA,1LB,1ZM</td> <td></td> <td></td> <td></td> <td></td> <td></td> </tr> <tr> <td>2.0 TDI 4motion</td> <td>103</td> <td>08.10</td> <td></td> <td>PR: 1LA,1LB,1ZM</td> <td></td> <td></td> <td></td> <td></td> <td></td> </tr> <tr> <td>2.0 TDI 4motion</td> <td>125</td> <td>08.10</td> <td></td> <td>PR: 1LA,1LB,1ZM</td> <td></td> <td></td> <td></td> <td></td> <td></td> </tr> <tr> <td>2.0 TDI 4motion</td> <td>130</td> <td>01.13</td> <td></td> <td>PR: 1LA,1LB,1ZM</td> <td></td> <td></td> <td></td> <td></td> <td></td> </tr> <tr> <td>2.0 TSI</td> <td>155</td> <td>11.10</td> <td></td> <td>PR: 1LA,1LB,1ZM</td> <td></td> <td></td> <td></td> <td></td> <td></td> </tr> <tr> <td>2.0 TSI 4motion</td> <td>155</td> <td>01.12</td> <td></td> <td>PR: 1LA,1LB,1ZM</td> <td></td> <td></td> <td></td> <td></td> <td></td> </tr> <tr> <td>3.6 FSI 4motion</td> <td>220</td> <td>01.11</td> <td></td> <td>PR: 1LA,1LB,1ZM</td> <td></td> <td></td> <td></td> <td></td> <td></td> </tr> </table>   | 1.4 TSI           | 90    | 08.10           |                | PR: 1LA,1LB,1ZM | 03.4153-0186.3  | 010816         |   | Thz 23,81      | ATE     | 1.4 TSI | 110   | 08.10 |         | PR: 1LA,1LB,1ZM |                |        |   |                |     | 1.4 TSI | 118   | 11.12   |  | PR: 1LA,1LB,1ZM |                |        |         |                |       | 1.6 TDI | 77      | 08.10 |  | PR: 1LA,1LB,1ZM |                |                 |     |            |       | 1.8 TSI | 118 | 08.10 |  | PR: 1LA,1LB,1ZM |                 |        |       |            |         | 2.0 TDI |  | 08.10 |  | PR: 1LA,1LB,1ZM |  |       |       |         |  | 2.0 TDI | 125 | 08.10 |                | PR: 1LA,1LB,1ZM |       |       |         |  |  | 2.0 TDI | 130 | 12.12 |  | PR: 1LA,1LB,1ZM |  |  |  |  |  | 2.0 TDI 4motion | 103 | 08.10 |  | PR: 1LA,1LB,1ZM |  |  |  |  |  | 2.0 TDI 4motion | 125 | 08.10 |  | PR: 1LA,1LB,1ZM |  |  |  |  |  | 2.0 TDI 4motion | 130 | 01.13 |  | PR: 1LA,1LB,1ZM |  |  |  |  |  | 2.0 TSI | 155 | 11.10 |  | PR: 1LA,1LB,1ZM |  |  |  |  |  | 2.0 TSI 4motion | 155 | 01.12 |  | PR: 1LA,1LB,1ZM |  |  |  |  |  | 3.6 FSI 4motion | 220 | 01.11 |  | PR: 1LA,1LB,1ZM |  |  |  |  |  |
| 1.4 TSI  | 90   | 08.10             |       | PR: 1LA,1LB,1ZM | 03.4153-0186.3 | 010816          |   | Thz 23,81      | ATE   |                |         |         |       |       |         |                 |                |        |   |                |     |         |       |         |  |                 |                |        |         |                |       |         |         |       |  |                 |                |                 |     |            |       |         |     |       |  |                 |                 |        |       |            |         |         |  |       |  |                 |  |       |       |         |  |         |     |       |                |                 |       |       |         |  |  |         |     |       |  |                 |  |  |  |  |  |                 |     |       |  |                 |  |  |  |  |  |                 |     |       |  |                 |  |  |  |  |  |                 |     |       |  |                 |  |  |  |  |  |         |     |       |  |                 |  |  |  |  |  |                 |     |       |  |                 |  |  |  |  |  |                 |     |       |  |                 |  |  |  |  |  |
| 1.4 TSI  | 110  | 08.10             |       | PR: 1LA,1LB,1ZM |                |                 |   |                |   |                |         |         |       |       |         |                 |                |        |   |                |     |         |       |         |  |                 |                |        |         |                |       |         |         |       |  |                 |                |                 |     |            |       |         |     |       |  |                 |                 |        |       |            |         |         |  |       |  |                 |  |       |       |         |  |         |     |       |                |                 |       |       |         |  |  |         |     |       |  |                 |  |  |  |  |  |                 |     |       |  |                 |  |  |  |  |  |                 |     |       |  |                 |  |  |  |  |  |                 |     |       |  |                 |  |  |  |  |  |         |     |       |  |                 |  |  |  |  |  |                 |     |       |  |                 |  |  |  |  |  |                 |     |       |  |                 |  |  |  |  |  |
| 1.4 TSI  | 118  | 11.12             |       | PR: 1LA,1LB,1ZM |                |                 |   |                |   |                |         |         |       |       |         |                 |                |        |   |                |     |         |       |         |  |                 |                |        |         |                |       |         |         |       |  |                 |                |                 |     |            |       |         |     |       |  |                 |                 |        |       |            |         |         |  |       |  |                 |  |       |       |         |  |         |     |       |                |                 |       |       |         |  |  |         |     |       |  |                 |  |  |  |  |  |                 |     |       |  |                 |  |  |  |  |  |                 |     |       |  |                 |  |  |  |  |  |                 |     |       |  |                 |  |  |  |  |  |         |     |       |  |                 |  |  |  |  |  |                 |     |       |  |                 |  |  |  |  |  |                 |     |       |  |                 |  |  |  |  |  |
| 1.6 TDI  | 77   | 08.10             |       | PR: 1LA,1LB,1ZM |                |                 |   |                |   |                |         |         |       |       |         |                 |                |        |   |                |     |         |       |         |  |                 |                |        |         |                |       |         |         |       |  |                 |                |                 |     |            |       |         |     |       |  |                 |                 |        |       |            |         |         |  |       |  |                 |  |       |       |         |  |         |     |       |                |                 |       |       |         |  |  |         |     |       |  |                 |  |  |  |  |  |                 |     |       |  |                 |  |  |  |  |  |                 |     |       |  |                 |  |  |  |  |  |                 |     |       |  |                 |  |  |  |  |  |         |     |       |  |                 |  |  |  |  |  |                 |     |       |  |                 |  |  |  |  |  |                 |     |       |  |                 |  |  |  |  |  |
| 1.8 TSI  | 118  | 08.10             |       | PR: 1LA,1LB,1ZM |                |                 |   |                |   |                |         |         |       |       |         |                 |                |        |   |                |     |         |       |         |  |                 |                |        |         |                |       |         |         |       |  |                 |                |                 |     |            |       |         |     |       |  |                 |                 |        |       |            |         |         |  |       |  |                 |  |       |       |         |  |         |     |       |                |                 |       |       |         |  |  |         |     |       |  |                 |  |  |  |  |  |                 |     |       |  |                 |  |  |  |  |  |                 |     |       |  |                 |  |  |  |  |  |                 |     |       |  |                 |  |  |  |  |  |         |     |       |  |                 |  |  |  |  |  |                 |     |       |  |                 |  |  |  |  |  |                 |     |       |  |                 |  |  |  |  |  |
| 2.0 TDI  |  | 08.10             |       | PR: 1LA,1LB,1ZM |                |                 |   |                |   |                |         |         |       |       |         |                 |                |        |   |                |     |         |       |         |  |                 |                |        |         |                |       |         |         |       |  |                 |                |                 |     |            |       |         |     |       |  |                 |                 |        |       |            |         |         |  |       |  |                 |  |       |       |         |  |         |     |       |                |                 |       |       |         |  |  |         |     |       |  |                 |  |  |  |  |  |                 |     |       |  |                 |  |  |  |  |  |                 |     |       |  |                 |  |  |  |  |  |                 |     |       |  |                 |  |  |  |  |  |         |     |       |  |                 |  |  |  |  |  |                 |     |       |  |                 |  |  |  |  |  |                 |     |       |  |                 |  |  |  |  |  |
| 2.0 TDI  | 125  | 08.10             |       | PR: 1LA,1LB,1ZM |                |                 |   |                |   |                |         |         |       |       |         |                 |                |        |   |                |     |         |       |         |  |                 |                |        |         |                |       |         |         |       |  |                 |                |                 |     |            |       |         |     |       |  |                 |                 |        |       |            |         |         |  |       |  |                 |  |       |       |         |  |         |     |       |                |                 |       |       |         |  |  |         |     |       |  |                 |  |  |  |  |  |                 |     |       |  |                 |  |  |  |  |  |                 |     |       |  |                 |  |  |  |  |  |                 |     |       |  |                 |  |  |  |  |  |         |     |       |  |                 |  |  |  |  |  |                 |     |       |  |                 |  |  |  |  |  |                 |     |       |  |                 |  |  |  |  |  |
| 2.0 TDI  | 130  | 12.12             |       | PR: 1LA,1LB,1ZM |                |                 |   |                |   |                |         |         |       |       |         |                 |                |        |   |                |     |         |       |         |  |                 |                |        |         |                |       |         |         |       |  |                 |                |                 |     |            |       |         |     |       |  |                 |                 |        |       |            |         |         |  |       |  |                 |  |       |       |         |  |         |     |       |                |                 |       |       |         |  |  |         |     |       |  |                 |  |  |  |  |  |                 |     |       |  |                 |  |  |  |  |  |                 |     |       |  |                 |  |  |  |  |  |                 |     |       |  |                 |  |  |  |  |  |         |     |       |  |                 |  |  |  |  |  |                 |     |       |  |                 |  |  |  |  |  |                 |     |       |  |                 |  |  |  |  |  |
| 2.0 TDI 4motion  | 103  | 08.10             |       | PR: 1LA,1LB,1ZM |                |                 |   |                |   |                |         |         |       |       |         |                 |                |        |   |                |     |         |       |         |  |                 |                |        |         |                |       |         |         |       |  |                 |                |                 |     |            |       |         |     |       |  |                 |                 |        |       |            |         |         |  |       |  |                 |  |       |       |         |  |         |     |       |                |                 |       |       |         |  |  |         |     |       |  |                 |  |  |  |  |  |                 |     |       |  |                 |  |  |  |  |  |                 |     |       |  |                 |  |  |  |  |  |                 |     |       |  |                 |  |  |  |  |  |         |     |       |  |                 |  |  |  |  |  |                 |     |       |  |                 |  |  |  |  |  |                 |     |       |  |                 |  |  |  |  |  |
| 2.0 TDI 4motion  | 125  | 08.10             |       | PR: 1LA,1LB,1ZM |                |                 |   |                |   |                |         |         |       |       |         |                 |                |        |   |                |     |         |       |         |  |                 |                |        |         |                |       |         |         |       |  |                 |                |                 |     |            |       |         |     |       |  |                 |                 |        |       |            |         |         |  |       |  |                 |  |       |       |         |  |         |     |       |                |                 |       |       |         |  |  |         |     |       |  |                 |  |  |  |  |  |                 |     |       |  |                 |  |  |  |  |  |                 |     |       |  |                 |  |  |  |  |  |                 |     |       |  |                 |  |  |  |  |  |         |     |       |  |                 |  |  |  |  |  |                 |     |       |  |                 |  |  |  |  |  |                 |     |       |  |                 |  |  |  |  |  |
| 2.0 TDI 4motion  | 130  | 01.13             |       | PR: 1LA,1LB,1ZM |                |                 |   |                |   |                |         |         |       |       |         |                 |                |        |   |                |     |         |       |         |  |                 |                |        |         |                |       |         |         |       |  |                 |                |                 |     |            |       |         |     |       |  |                 |                 |        |       |            |         |         |  |       |  |                 |  |       |       |         |  |         |     |       |                |                 |       |       |         |  |  |         |     |       |  |                 |  |  |  |  |  |                 |     |       |  |                 |  |  |  |  |  |                 |     |       |  |                 |  |  |  |  |  |                 |     |       |  |                 |  |  |  |  |  |         |     |       |  |                 |  |  |  |  |  |                 |     |       |  |                 |  |  |  |  |  |                 |     |       |  |                 |  |  |  |  |  |
| 2.0 TSI  | 155  | 11.10             |       | PR: 1LA,1LB,1ZM |                |                 |   |                |   |                |         |         |       |       |         |                 |                |        |   |                |     |         |       |         |  |                 |                |        |         |                |       |         |         |       |  |                 |                |                 |     |            |       |         |     |       |  |                 |                 |        |       |            |         |         |  |       |  |                 |  |       |       |         |  |         |     |       |                |                 |       |       |         |  |  |         |     |       |  |                 |  |  |  |  |  |                 |     |       |  |                 |  |  |  |  |  |                 |     |       |  |                 |  |  |  |  |  |                 |     |       |  |                 |  |  |  |  |  |         |     |       |  |                 |  |  |  |  |  |                 |     |       |  |                 |  |  |  |  |  |                 |     |       |  |                 |  |  |  |  |  |
| 2.0 TSI 4motion  | 155  | 01.12             |       | PR: 1LA,1LB,1ZM |                |                 |   |                |   |                |         |         |       |       |         |                 |                |        |   |                |     |         |       |         |  |                 |                |        |         |                |       |         |         |       |  |                 |                |                 |     |            |       |         |     |       |  |                 |                 |        |       |            |         |         |  |       |  |                 |  |       |       |         |  |         |     |       |                |                 |       |       |         |  |  |         |     |       |  |                 |  |  |  |  |  |                 |     |       |  |                 |  |  |  |  |  |                 |     |       |  |                 |  |  |  |  |  |                 |     |       |  |                 |  |  |  |  |  |         |     |       |  |                 |  |  |  |  |  |                 |     |       |  |                 |  |  |  |  |  |                 |     |       |  |                 |  |  |  |  |  |
| 3.6 FSI 4motion  | 220  | 01.11             |       | PR: 1LA,1LB,1ZM |                |                 |   |                |   |                |         |         |       |       |         |                 |                |        |   |                |     |         |       |         |  |                 |                |        |         |                |       |         |         |       |  |                 |                |                 |     |            |       |         |     |       |  |                 |                 |        |       |            |         |         |  |       |  |                 |  |       |       |         |  |         |     |       |                |                 |       |       |         |  |  |         |     |       |  |                 |  |  |  |  |  |                 |     |       |  |                 |  |  |  |  |  |                 |     |       |  |                 |  |  |  |  |  |                 |     |       |  |                 |  |  |  |  |  |         |     |       |  |                 |  |  |  |  |  |                 |     |       |  |                 |  |  |  |  |  |                 |     |       |  |                 |  |  |  |  |  |
|   | <table border="1"> <tr> <td>1.4 TSI</td> <td>90</td> <td>08.10</td> <td></td> <td>PR: 1ZG</td> <td>03.4152-0116.3</td> <td>010814</td> <td></td> <td>Thz 22,20</td> <td>ATE</td> </tr> <tr> <td>1.4 TSI</td> <td>110</td> <td>08.10</td> <td></td> <td>PR: 1ZG</td> <td></td> <td></td> <td></td> <td></td> <td></td> </tr> <tr> <td>1.4 TSI</td> <td>118</td> <td>11.12</td> <td></td> <td>PR: 1ZG</td> <td></td> <td></td> <td></td> <td></td> <td></td> </tr> <tr> <td>1.6 TDI</td> <td>77</td> <td>08.10</td> <td></td> <td>PR: 1ZG</td> <td></td> <td></td> <td></td> <td></td> <td></td> </tr> <tr> <td>1.8 TSI</td> <td>118</td> <td>08.10</td> <td></td> <td>PR: 1ZG</td> <td></td> <td></td> <td></td> <td></td> <td></td> </tr> <tr> <td>2.0 TDI</td> <td></td> <td>08.10</td> <td></td> <td>PR: 1ZG</td> <td></td> <td></td> <td></td> <td></td> <td></td> </tr> <tr> <td>2.0 TDI</td> <td>125</td> <td>08.10</td> <td></td> <td>PR: 1ZG</td> <td></td> <td></td> <td></td> <td></td> <td></td> </tr> <tr> <td>2.0 TDI</td> <td>130</td> <td>12.12</td> <td></td> <td>PR: 1ZG</td> <td></td> <td></td> <td></td> <td></td> <td></td> </tr> <tr> <td>2.0 TDI 4motion</td> <td>103</td> <td>08.10</td> <td></td> <td>PR: 1ZG</td> <td></td> <td></td> <td></td> <td></td> <td></td> </tr> <tr> <td>2.0 TDI 4motion</td> <td>125</td> <td>08.10</td> <td></td> <td>PR: 1ZG</td> <td></td> <td></td> <td></td> <td></td> <td></td> </tr> <tr> <td>2.0 TDI 4motion</td> <td>130</td> <td>01.13</td> <td></td> <td>PR: 1ZG</td> <td></td> <td></td> <td></td> <td></td> <td></td> </tr> <tr> <td>2.0 TSI</td> <td>155</td> <td>11.10</td> <td></td> <td>PR: 1ZG</td> <td></td> <td></td> <td></td> <td></td> <td></td> </tr> <tr> <td>2.0 TSI 4motion</td> <td>155</td> <td>01.12</td> <td></td> <td>PR: 1ZG</td> <td></td> <td></td> <td></td> <td></td> <td></td> </tr> <tr> <td>3.6 FSI 4motion</td> <td>220</td> <td>01.11</td> <td></td> <td>PR: 1ZG</td> <td></td> <td></td> <td></td> <td></td> <td></td> </tr> </table>   | 1.4 TSI           | 90    | 08.10           |                | PR: 1ZG         | 03.4152-0116.3  | 010814         |   | Thz 22,20      | ATE     | 1.4 TSI | 110   | 08.10 |         | PR: 1ZG         |                |        |   |                |     | 1.4 TSI | 118   | 11.12   |  | PR: 1ZG         |                |        |         |                |       | 1.6 TDI | 77      | 08.10 |  | PR: 1ZG         |                |                 |     |            |       | 1.8 TSI | 118 | 08.10 |  | PR: 1ZG         |                 |        |       |            |         | 2.0 TDI |  | 08.10 |  | PR: 1ZG         |  |       |       |         |  | 2.0 TDI | 125 | 08.10 |                | PR: 1ZG         |       |       |         |  |  | 2.0 TDI | 130 | 12.12 |  | PR: 1ZG         |  |  |  |  |  | 2.0 TDI 4motion | 103 | 08.10 |  | PR: 1ZG         |  |  |  |  |  | 2.0 TDI 4motion | 125 | 08.10 |  | PR: 1ZG         |  |  |  |  |  | 2.0 TDI 4motion | 130 | 01.13 |  | PR: 1ZG         |  |  |  |  |  | 2.0 TSI | 155 | 11.10 |  | PR: 1ZG         |  |  |  |  |  | 2.0 TSI 4motion | 155 | 01.12 |  | PR: 1ZG         |  |  |  |  |  | 3.6 FSI 4motion | 220 | 01.11 |  | PR: 1ZG         |  |  |  |  |  |
| 1.4 TSI  | 90   | 08.10             |       | PR: 1ZG         | 03.4152-0116.3 | 010814          |   | Thz 22,20      | ATE   |                |         |         |       |       |         |                 |                |        |   |                |     |         |       |         |  |                 |                |        |         |                |       |         |         |       |  |                 |                |                 |     |            |       |         |     |       |  |                 |                 |        |       |            |         |         |  |       |  |                 |  |       |       |         |  |         |     |       |                |                 |       |       |         |  |  |         |     |       |  |                 |  |  |  |  |  |                 |     |       |  |                 |  |  |  |  |  |                 |     |       |  |                 |  |  |  |  |  |                 |     |       |  |                 |  |  |  |  |  |         |     |       |  |                 |  |  |  |  |  |                 |     |       |  |                 |  |  |  |  |  |                 |     |       |  |                 |  |  |  |  |  |
| 1.4 TSI  | 110  | 08.10             |       | PR: 1ZG         |                |                 |   |                |   |                |         |         |       |       |         |                 |                |        |   |                |     |         |       |         |  |                 |                |        |         |                |       |         |         |       |  |                 |                |                 |     |            |       |         |     |       |  |                 |                 |        |       |            |         |         |  |       |  |                 |  |       |       |         |  |         |     |       |                |                 |       |       |         |  |  |         |     |       |  |                 |  |  |  |  |  |                 |     |       |  |                 |  |  |  |  |  |                 |     |       |  |                 |  |  |  |  |  |                 |     |       |  |                 |  |  |  |  |  |         |     |       |  |                 |  |  |  |  |  |                 |     |       |  |                 |  |  |  |  |  |                 |     |       |  |                 |  |  |  |  |  |
| 1.4 TSI  | 118  | 11.12             |       | PR: 1ZG         |                |                 |   |                |   |                |         |         |       |       |         |                 |                |        |   |                |     |         |       |         |  |                 |                |        |         |                |       |         |         |       |  |                 |                |                 |     |            |       |         |     |       |  |                 |                 |        |       |            |         |         |  |       |  |                 |  |       |       |         |  |         |     |       |                |                 |       |       |         |  |  |         |     |       |  |                 |  |  |  |  |  |                 |     |       |  |                 |  |  |  |  |  |                 |     |       |  |                 |  |  |  |  |  |                 |     |       |  |                 |  |  |  |  |  |         |     |       |  |                 |  |  |  |  |  |                 |     |       |  |                 |  |  |  |  |  |                 |     |       |  |                 |  |  |  |  |  |
| 1.6 TDI  | 77   | 08.10             |       | PR: 1ZG         |                |                 |   |                |   |                |         |         |       |       |         |                 |                |        |   |                |     |         |       |         |  |                 |                |        |         |                |       |         |         |       |  |                 |                |                 |     |            |       |         |     |       |  |                 |                 |        |       |            |         |         |  |       |  |                 |  |       |       |         |  |         |     |       |                |                 |       |       |         |  |  |         |     |       |  |                 |  |  |  |  |  |                 |     |       |  |                 |  |  |  |  |  |                 |     |       |  |                 |  |  |  |  |  |                 |     |       |  |                 |  |  |  |  |  |         |     |       |  |                 |  |  |  |  |  |                 |     |       |  |                 |  |  |  |  |  |                 |     |       |  |                 |  |  |  |  |  |
| 1.8 TSI  | 118  | 08.10             |       | PR: 1ZG         |                |                 |   |                |   |                |         |         |       |       |         |                 |                |        |   |                |     |         |       |         |  |                 |                |        |         |                |       |         |         |       |  |                 |                |                 |     |            |       |         |     |       |  |                 |                 |        |       |            |         |         |  |       |  |                 |  |       |       |         |  |         |     |       |                |                 |       |       |         |  |  |         |     |       |  |                 |  |  |  |  |  |                 |     |       |  |                 |  |  |  |  |  |                 |     |       |  |                 |  |  |  |  |  |                 |     |       |  |                 |  |  |  |  |  |         |     |       |  |                 |  |  |  |  |  |                 |     |       |  |                 |  |  |  |  |  |                 |     |       |  |                 |  |  |  |  |  |
| 2.0 TDI  |  | 08.10             |       | PR: 1ZG         |                |                 |   |                |   |                |         |         |       |       |         |                 |                |        |   |                |     |         |       |         |  |                 |                |        |         |                |       |         |         |       |  |                 |                |                 |     |            |       |         |     |       |  |                 |                 |        |       |            |         |         |  |       |  |                 |  |       |       |         |  |         |     |       |                |                 |       |       |         |  |  |         |     |       |  |                 |  |  |  |  |  |                 |     |       |  |                 |  |  |  |  |  |                 |     |       |  |                 |  |  |  |  |  |                 |     |       |  |                 |  |  |  |  |  |         |     |       |  |                 |  |  |  |  |  |                 |     |       |  |                 |  |  |  |  |  |                 |     |       |  |                 |  |  |  |  |  |
| 2.0 TDI  | 125  | 08.10             |       | PR: 1ZG         |                |                 |   |                |   |                |         |         |       |       |         |                 |                |        |   |                |     |         |       |         |  |                 |                |        |         |                |       |         |         |       |  |                 |                |                 |     |            |       |         |     |       |  |                 |                 |        |       |            |         |         |  |       |  |                 |  |       |       |         |  |         |     |       |                |                 |       |       |         |  |  |         |     |       |  |                 |  |  |  |  |  |                 |     |       |  |                 |  |  |  |  |  |                 |     |       |  |                 |  |  |  |  |  |                 |     |       |  |                 |  |  |  |  |  |         |     |       |  |                 |  |  |  |  |  |                 |     |       |  |                 |  |  |  |  |  |                 |     |       |  |                 |  |  |  |  |  |
| 2.0 TDI  | 130  | 12.12             |       | PR: 1ZG         |                |                 |   |                |   |                |         |         |       |       |         |                 |                |        |   |                |     |         |       |         |  |                 |                |        |         |                |       |         |         |       |  |                 |                |                 |     |            |       |         |     |       |  |                 |                 |        |       |            |         |         |  |       |  |                 |  |       |       |         |  |         |     |       |                |                 |       |       |         |  |  |         |     |       |  |                 |  |  |  |  |  |                 |     |       |  |                 |  |  |  |  |  |                 |     |       |  |                 |  |  |  |  |  |                 |     |       |  |                 |  |  |  |  |  |         |     |       |  |                 |  |  |  |  |  |                 |     |       |  |                 |  |  |  |  |  |                 |     |       |  |                 |  |  |  |  |  |
| 2.0 TDI 4motion  | 103  | 08.10             |       | PR: 1ZG         |                |                 |   |                |   |                |         |         |       |       |         |                 |                |        |   |                |     |         |       |         |  |                 |                |        |         |                |       |         |         |       |  |                 |                |                 |     |            |       |         |     |       |  |                 |                 |        |       |            |         |         |  |       |  |                 |  |       |       |         |  |         |     |       |                |                 |       |       |         |  |  |         |     |       |  |                 |  |  |  |  |  |                 |     |       |  |                 |  |  |  |  |  |                 |     |       |  |                 |  |  |  |  |  |                 |     |       |  |                 |  |  |  |  |  |         |     |       |  |                 |  |  |  |  |  |                 |     |       |  |                 |  |  |  |  |  |                 |     |       |  |                 |  |  |  |  |  |
| 2.0 TDI 4motion  | 125  | 08.10             |       | PR: 1ZG         |                |                 |   |                |   |                |         |         |       |       |         |                 |                |        |   |                |     |         |       |         |  |                 |                |        |         |                |       |         |         |       |  |                 |                |                 |     |            |       |         |     |       |  |                 |                 |        |       |            |         |         |  |       |  |                 |  |       |       |         |  |         |     |       |                |                 |       |       |         |  |  |         |     |       |  |                 |  |  |  |  |  |                 |     |       |  |                 |  |  |  |  |  |                 |     |       |  |                 |  |  |  |  |  |                 |     |       |  |                 |  |  |  |  |  |         |     |       |  |                 |  |  |  |  |  |                 |     |       |  |                 |  |  |  |  |  |                 |     |       |  |                 |  |  |  |  |  |
| 2.0 TDI 4motion  | 130  | 01.13             |       | PR: 1ZG         |                |                 |   |                |   |                |         |         |       |       |         |                 |                |        |   |                |     |         |       |         |  |                 |                |        |         |                |       |         |         |       |  |                 |                |                 |     |            |       |         |     |       |  |                 |                 |        |       |            |         |         |  |       |  |                 |  |       |       |         |  |         |     |       |                |                 |       |       |         |  |  |         |     |       |  |                 |  |  |  |  |  |                 |     |       |  |                 |  |  |  |  |  |                 |     |       |  |                 |  |  |  |  |  |                 |     |       |  |                 |  |  |  |  |  |         |     |       |  |                 |  |  |  |  |  |                 |     |       |  |                 |  |  |  |  |  |                 |     |       |  |                 |  |  |  |  |  |
| 2.0 TSI  | 155  | 11.10             |       | PR: 1ZG         |                |                 |   |                |   |                |         |         |       |       |         |                 |                |        |   |                |     |         |       |         |  |                 |                |        |         |                |       |         |         |       |  |                 |                |                 |     |            |       |         |     |       |  |                 |                 |        |       |            |         |         |  |       |  |                 |  |       |       |         |  |         |     |       |                |                 |       |       |         |  |  |         |     |       |  |                 |  |  |  |  |  |                 |     |       |  |                 |  |  |  |  |  |                 |     |       |  |                 |  |  |  |  |  |                 |     |       |  |                 |  |  |  |  |  |         |     |       |  |                 |  |  |  |  |  |                 |     |       |  |                 |  |  |  |  |  |                 |     |       |  |                 |  |  |  |  |  |
| 2.0 TSI 4motion  | 155  | 01.12             |       | PR: 1ZG         |                |                 |   |                |   |                |         |         |       |       |         |                 |                |        |   |                |     |         |       |         |  |                 |                |        |         |                |       |         |         |       |  |                 |                |                 |     |            |       |         |     |       |  |                 |                 |        |       |            |         |         |  |       |  |                 |  |       |       |         |  |         |     |       |                |                 |       |       |         |  |  |         |     |       |  |                 |  |  |  |  |  |                 |     |       |  |                 |  |  |  |  |  |                 |     |       |  |                 |  |  |  |  |  |                 |     |       |  |                 |  |  |  |  |  |         |     |       |  |                 |  |  |  |  |  |                 |     |       |  |                 |  |  |  |  |  |                 |     |       |  |                 |  |  |  |  |  |
| 3.6 FSI 4motion  | 220  | 01.11             |       | PR: 1ZG         |                |                 |   |                |   |                |         |         |       |       |         |                 |                |        |   |                |     |         |       |         |  |                 |                |        |         |                |       |         |         |       |  |                 |                |                 |     |            |       |         |     |       |  |                 |                 |        |       |            |         |         |  |       |  |                 |  |       |       |         |  |         |     |       |                |                 |       |       |         |  |  |         |     |       |  |                 |  |  |  |  |  |                 |     |       |  |                 |  |  |  |  |  |                 |     |       |  |                 |  |  |  |  |  |                 |     |       |  |                 |  |  |  |  |  |         |     |       |  |                 |  |  |  |  |  |                 |     |       |  |                 |  |  |  |  |  |                 |     |       |  |                 |  |  |  |  |  |
|  | <table border="1"> <tr> <td>1.4 TSI</td> <td>90</td> <td>08.10</td> <td></td> <td>PR: 1ZM,1ZG</td> <td>11.9541-9553.2</td> <td>220563</td> <td></td> <td>D=54, - Halter</td> <td>ATE</td> </tr> <tr> <td>1.4 TSI</td> <td>110</td> <td>08.10</td> <td></td> <td>PR: 1ZM,1ZG</td> <td>11.9541-9554.2</td> <td>220564</td> <td></td> <td>D=54, - Halter</td> <td>ATE</td> </tr> <tr> <td>1.4 TSI</td> <td>118</td> <td>11.12</td> <td></td> <td>PR: 1ZM,1ZG</td> <td>11.8171-0008.1</td> <td>990049</td> <td></td> <td>Führungsbolzen</td> <td>ATE</td> </tr> <tr> <td>1.6 TDI</td> <td>77</td> <td>08.10</td> <td></td> <td>PR: 1ZM,1ZG</td> <td>11.8116-0351.1</td> <td>390538</td> <td>2</td> <td>Haltefeder</td> <td>ATE</td> </tr> <tr> <td>1.8 TSI</td> <td>118</td> <td>08.10</td> <td></td> <td>PR: 1ZM,1ZG</td> <td>11.0101-5409.2</td> <td>260035</td> <td></td> <td>Hülsensatz</td> <td>ATE</td> </tr> <tr> <td>2.0 TDI</td> <td></td> <td>08.10</td> <td></td> <td>PR: 1ZM,1ZG</td> <td></td> <td></td> <td></td> <td></td> <td></td> </tr> <tr> <td>2.0 TDI</td> <td>125</td> <td>08.10</td> <td></td> <td>PR: 1ZM,1ZG</td> <td></td> <td></td> <td></td> <td></td> <td></td> </tr> <tr> <td>2.0 TDI</td> <td>130</td> <td>12.12</td> <td></td> <td>PR: 1ZM,1ZG</td> <td></td> <td></td> <td></td> <td></td> <td></td> </tr> <tr> <td>2.0 TDI 4motion</td> <td>103</td> <td>08.10</td> <td></td> <td>PR: 1ZM,1ZG</td> <td></td> <td></td> <td></td> <td></td> <td></td> </tr> <tr> <td>2.0 TDI 4motion</td> <td>125</td> <td>08.10</td> <td></td> <td>PR: 1ZM,1ZG</td> <td></td> <td></td> <td></td> <td></td> <td></td> </tr> <tr> <td>2.0 TDI 4motion</td> <td>130</td> <td>01.13</td> <td></td> <td>PR: 1ZM,1ZG</td> <td></td> <td></td> <td></td> <td></td> <td></td> </tr> <tr> <td>2.0 TSI</td> <td>155</td> <td>11.10</td> <td></td> <td>PR: 1ZM,1ZG</td> <td></td> <td></td> <td></td> <td></td> <td></td> </tr> <tr> <td>2.0 TSI 4motion</td> <td>155</td> <td>01.12</td> <td></td> <td>PR: 1ZM,1ZG</td> <td></td> <td></td> <td></td> <td></td> <td></td> </tr> <tr> <td>3.6 FSI 4motion</td> <td>220</td> <td>01.11</td> <td></td> <td>PR: 1ZM,1ZG</td> <td></td> <td></td> <td></td> <td></td> <td></td> </tr> </table> | 1.4 TSI           | 90    | 08.10           |                | PR: 1ZM,1ZG     | 11.9541-9553.2  | 220563         |  | D=54, - Halter | ATE     | 1.4 TSI | 110   | 08.10 |         | PR: 1ZM,1ZG     | 11.9541-9554.2 | 220564 |  | D=54, - Halter | ATE | 1.4 TSI | 118   | 11.12   |  | PR: 1ZM,1ZG     | 11.8171-0008.1 | 990049 |         | Führungsbolzen | ATE   | 1.6 TDI | 77      | 08.10 |  | PR: 1ZM,1ZG     | 11.8116-0351.1 | 390538          | 2   | Haltefeder | ATE   | 1.8 TSI | 118 | 08.10 |  | PR: 1ZM,1ZG     | 11.0101-5409.2  | 260035 |       | Hülsensatz | ATE     | 2.0 TDI |  | 08.10 |  | PR: 1ZM,1ZG     |  |       |       |         |  | 2.0 TDI | 125 | 08.10 |                | PR: 1ZM,1ZG     |       |       |         |  |  | 2.0 TDI | 130 | 12.12 |  | PR: 1ZM,1ZG     |  |  |  |  |  | 2.0 TDI 4motion | 103 | 08.10 |  | PR: 1ZM,1ZG     |  |  |  |  |  | 2.0 TDI 4motion | 125 | 08.10 |  | PR: 1ZM,1ZG     |  |  |  |  |  | 2.0 TDI 4motion | 130 | 01.13 |  | PR: 1ZM,1ZG     |  |  |  |  |  | 2.0 TSI | 155 | 11.10 |  | PR: 1ZM,1ZG     |  |  |  |  |  | 2.0 TSI 4motion | 155 | 01.12 |  | PR: 1ZM,1ZG     |  |  |  |  |  | 3.6 FSI 4motion | 220 | 01.11 |  | PR: 1ZM,1ZG     |  |  |  |  |  |
| 1.4 TSI  | 90   | 08.10             |       | PR: 1ZM,1ZG     | 11.9541-9553.2 | 220563          |  | D=54, - Halter | ATE   |                |         |         |       |       |         |                 |                |        |   |                |     |         |       |         |  |                 |                |        |         |                |       |         |         |       |  |                 |                |                 |     |            |       |         |     |       |  |                 |                 |        |       |            |         |         |  |       |  |                 |  |       |       |         |  |         |     |       |                |                 |       |       |         |  |  |         |     |       |  |                 |  |  |  |  |  |                 |     |       |  |                 |  |  |  |  |  |                 |     |       |  |                 |  |  |  |  |  |                 |     |       |  |                 |  |  |  |  |  |         |     |       |  |                 |  |  |  |  |  |                 |     |       |  |                 |  |  |  |  |  |                 |     |       |  |                 |  |  |  |  |  |
| 1.4 TSI  | 110  | 08.10             |       | PR: 1ZM,1ZG     | 11.9541-9554.2 | 220564          |  | D=54, - Halter | ATE   |                |         |         |       |       |         |                 |                |        |   |                |     |         |       |         |  |                 |                |        |         |                |       |         |         |       |  |                 |                |                 |     |            |       |         |     |       |  |                 |                 |        |       |            |         |         |  |       |  |                 |  |       |       |         |  |         |     |       |                |                 |       |       |         |  |  |         |     |       |  |                 |  |  |  |  |  |                 |     |       |  |                 |  |  |  |  |  |                 |     |       |  |                 |  |  |  |  |  |                 |     |       |  |                 |  |  |  |  |  |         |     |       |  |                 |  |  |  |  |  |                 |     |       |  |                 |  |  |  |  |  |                 |     |       |  |                 |  |  |  |  |  |
| 1.4 TSI  | 118  | 11.12             |       | PR: 1ZM,1ZG     | 11.8171-0008.1 | 990049          |   | Führungsbolzen | ATE   |                |         |         |       |       |         |                 |                |        |   |                |     |         |       |         |  |                 |                |        |         |                |       |         |         |       |  |                 |                |                 |     |            |       |         |     |       |  |                 |                 |        |       |            |         |         |  |       |  |                 |  |       |       |         |  |         |     |       |                |                 |       |       |         |  |  |         |     |       |  |                 |  |  |  |  |  |                 |     |       |  |                 |  |  |  |  |  |                 |     |       |  |                 |  |  |  |  |  |                 |     |       |  |                 |  |  |  |  |  |         |     |       |  |                 |  |  |  |  |  |                 |     |       |  |                 |  |  |  |  |  |                 |     |       |  |                 |  |  |  |  |  |
| 1.6 TDI  | 77   | 08.10             |       | PR: 1ZM,1ZG     | 11.8116-0351.1 | 390538          | 2   | Haltefeder     | ATE   |                |         |         |       |       |         |                 |                |        |   |                |     |         |       |         |  |                 |                |        |         |                |       |         |         |       |  |                 |                |                 |     |            |       |         |     |       |  |                 |                 |        |       |            |         |         |  |       |  |                 |  |       |       |         |  |         |     |       |                |                 |       |       |         |  |  |         |     |       |  |                 |  |  |  |  |  |                 |     |       |  |                 |  |  |  |  |  |                 |     |       |  |                 |  |  |  |  |  |                 |     |       |  |                 |  |  |  |  |  |         |     |       |  |                 |  |  |  |  |  |                 |     |       |  |                 |  |  |  |  |  |                 |     |       |  |                 |  |  |  |  |  |
| 1.8 TSI  | 118  | 08.10             |       | PR: 1ZM,1ZG     | 11.0101-5409.2 | 260035          |   | Hülsensatz     | ATE   |                |         |         |       |       |         |                 |                |        |   |                |     |         |       |         |  |                 |                |        |         |                |       |         |         |       |  |                 |                |                 |     |            |       |         |     |       |  |                 |                 |        |       |            |         |         |  |       |  |                 |  |       |       |         |  |         |     |       |                |                 |       |       |         |  |  |         |     |       |  |                 |  |  |  |  |  |                 |     |       |  |                 |  |  |  |  |  |                 |     |       |  |                 |  |  |  |  |  |                 |     |       |  |                 |  |  |  |  |  |         |     |       |  |                 |  |  |  |  |  |                 |     |       |  |                 |  |  |  |  |  |                 |     |       |  |                 |  |  |  |  |  |
| 2.0 TDI  |  | 08.10             |       | PR: 1ZM,1ZG     |                |                 |   |                |   |                |         |         |       |       |         |                 |                |        |   |                |     |         |       |         |  |                 |                |        |         |                |       |         |         |       |  |                 |                |                 |     |            |       |         |     |       |  |                 |                 |        |       |            |         |         |  |       |  |                 |  |       |       |         |  |         |     |       |                |                 |       |       |         |  |  |         |     |       |  |                 |  |  |  |  |  |                 |     |       |  |                 |  |  |  |  |  |                 |     |       |  |                 |  |  |  |  |  |                 |     |       |  |                 |  |  |  |  |  |         |     |       |  |                 |  |  |  |  |  |                 |     |       |  |                 |  |  |  |  |  |                 |     |       |  |                 |  |  |  |  |  |
| 2.0 TDI  | 125  | 08.10             |       | PR: 1ZM,1ZG     |                |                 |   |                |   |                |         |         |       |       |         |                 |                |        |   |                |     |         |       |         |  |                 |                |        |         |                |       |         |         |       |  |                 |                |                 |     |            |       |         |     |       |  |                 |                 |        |       |            |         |         |  |       |  |                 |  |       |       |         |  |         |     |       |                |                 |       |       |         |  |  |         |     |       |  |                 |  |  |  |  |  |                 |     |       |  |                 |  |  |  |  |  |                 |     |       |  |                 |  |  |  |  |  |                 |     |       |  |                 |  |  |  |  |  |         |     |       |  |                 |  |  |  |  |  |                 |     |       |  |                 |  |  |  |  |  |                 |     |       |  |                 |  |  |  |  |  |
| 2.0 TDI  | 130  | 12.12             |       | PR: 1ZM,1ZG     |                |                 |   |                |   |                |         |         |       |       |         |                 |                |        |   |                |     |         |       |         |  |                 |                |        |         |                |       |         |         |       |  |                 |                |                 |     |            |       |         |     |       |  |                 |                 |        |       |            |         |         |  |       |  |                 |  |       |       |         |  |         |     |       |                |                 |       |       |         |  |  |         |     |       |  |                 |  |  |  |  |  |                 |     |       |  |                 |  |  |  |  |  |                 |     |       |  |                 |  |  |  |  |  |                 |     |       |  |                 |  |  |  |  |  |         |     |       |  |                 |  |  |  |  |  |                 |     |       |  |                 |  |  |  |  |  |                 |     |       |  |                 |  |  |  |  |  |
| 2.0 TDI 4motion  | 103  | 08.10             |       | PR: 1ZM,1ZG     |                |                 |   |                |   |                |         |         |       |       |         |                 |                |        |   |                |     |         |       |         |  |                 |                |        |         |                |       |         |         |       |  |                 |                |                 |     |            |       |         |     |       |  |                 |                 |        |       |            |         |         |  |       |  |                 |  |       |       |         |  |         |     |       |                |                 |       |       |         |  |  |         |     |       |  |                 |  |  |  |  |  |                 |     |       |  |                 |  |  |  |  |  |                 |     |       |  |                 |  |  |  |  |  |                 |     |       |  |                 |  |  |  |  |  |         |     |       |  |                 |  |  |  |  |  |                 |     |       |  |                 |  |  |  |  |  |                 |     |       |  |                 |  |  |  |  |  |
| 2.0 TDI 4motion  | 125  | 08.10             |       | PR: 1ZM,1ZG     |                |                 |   |                |   |                |         |         |       |       |         |                 |                |        |   |                |     |         |       |         |  |                 |                |        |         |                |       |         |         |       |  |                 |                |                 |     |            |       |         |     |       |  |                 |                 |        |       |            |         |         |  |       |  |                 |  |       |       |         |  |         |     |       |                |                 |       |       |         |  |  |         |     |       |  |                 |  |  |  |  |  |                 |     |       |  |                 |  |  |  |  |  |                 |     |       |  |                 |  |  |  |  |  |                 |     |       |  |                 |  |  |  |  |  |         |     |       |  |                 |  |  |  |  |  |                 |     |       |  |                 |  |  |  |  |  |                 |     |       |  |                 |  |  |  |  |  |
| 2.0 TDI 4motion  | 130  | 01.13             |       | PR: 1ZM,1ZG     |                |                 |   |                |   |                |         |         |       |       |         |                 |                |        |   |                |     |         |       |         |  |                 |                |        |         |                |       |         |         |       |  |                 |                |                 |     |            |       |         |     |       |  |                 |                 |        |       |            |         |         |  |       |  |                 |  |       |       |         |  |         |     |       |                |                 |       |       |         |  |  |         |     |       |  |                 |  |  |  |  |  |                 |     |       |  |                 |  |  |  |  |  |                 |     |       |  |                 |  |  |  |  |  |                 |     |       |  |                 |  |  |  |  |  |         |     |       |  |                 |  |  |  |  |  |                 |     |       |  |                 |  |  |  |  |  |                 |     |       |  |                 |  |  |  |  |  |
| 2.0 TSI  | 155  | 11.10             |       | PR: 1ZM,1ZG     |                |                 |   |                |   |                |         |         |       |       |         |                 |                |        |   |                |     |         |       |         |  |                 |                |        |         |                |       |         |         |       |  |                 |                |                 |     |            |       |         |     |       |  |                 |                 |        |       |            |         |         |  |       |  |                 |  |       |       |         |  |         |     |       |                |                 |       |       |         |  |  |         |     |       |  |                 |  |  |  |  |  |                 |     |       |  |                 |  |  |  |  |  |                 |     |       |  |                 |  |  |  |  |  |                 |     |       |  |                 |  |  |  |  |  |         |     |       |  |                 |  |  |  |  |  |                 |     |       |  |                 |  |  |  |  |  |                 |     |       |  |                 |  |  |  |  |  |
| 2.0 TSI 4motion  | 155  | 01.12             |       | PR: 1ZM,1ZG     |                |                 |   |                |   |                |         |         |       |       |         |                 |                |        |   |                |     |         |       |         |  |                 |                |        |         |                |       |         |         |       |  |                 |                |                 |     |            |       |         |     |       |  |                 |                 |        |       |            |         |         |  |       |  |                 |  |       |       |         |  |         |     |       |                |                 |       |       |         |  |  |         |     |       |  |                 |  |  |  |  |  |                 |     |       |  |                 |  |  |  |  |  |                 |     |       |  |                 |  |  |  |  |  |                 |     |       |  |                 |  |  |  |  |  |         |     |       |  |                 |  |  |  |  |  |                 |     |       |  |                 |  |  |  |  |  |                 |     |       |  |                 |  |  |  |  |  |
| 3.6 FSI 4motion  | 220  | 01.11             |       | PR: 1ZM,1ZG     |                |                 |   |                |   |                |         |         |       |       |         |                 |                |        |   |                |     |         |       |         |  |                 |                |        |         |                |       |         |         |       |  |                 |                |                 |     |            |       |         |     |       |  |                 |                 |        |       |            |         |         |  |       |  |                 |  |       |       |         |  |         |     |       |                |                 |       |       |         |  |  |         |     |       |  |                 |  |  |  |  |  |                 |     |       |  |                 |  |  |  |  |  |                 |     |       |  |                 |  |  |  |  |  |                 |     |       |  |                 |  |  |  |  |  |         |     |       |  |                 |  |  |  |  |  |                 |     |       |  |                 |  |  |  |  |  |                 |     |       |  |                 |  |  |  |  |  |
|  | <table border="1"> <tr> <td>1.4 TSI</td> <td>90</td> <td>08.10</td> <td></td> <td>PR: 2EA</td> <td>83.7849-0231.3</td> <td>330872</td> <td>2</td> <td>L=233</td> <td></td> </tr> <tr> <td>1.4 TSI</td> <td>110</td> <td>08.10</td> <td></td> <td>PR: 2EA</td> <td></td> <td></td> <td></td> <td></td> <td></td> </tr> <tr> <td>1.4 TSI</td> <td>118</td> <td>11.12</td> <td></td> <td>PR: 2EA</td> <td></td> <td></td> <td></td> <td></td> <td></td> </tr> <tr> <td>1.6 TDI</td> <td>77</td> <td>08.10</td> <td></td> <td>PR: 2EA</td> <td></td> <td></td> <td></td> <td></td> <td></td> </tr> <tr> <td>1.8 TSI</td> <td>118</td> <td>08.10</td> <td></td> <td>PR: 2EA</td> <td></td> <td></td> <td></td> <td></td> <td></td> </tr> <tr> <td>2.0 TDI</td> <td></td> <td>08.10</td> <td></td> <td>PR: 2EA</td> <td></td> <td></td> <td></td> <td></td> <td></td> </tr> <tr> <td>2.0 TDI</td> <td>125</td> <td>08.10</td> <td></td> <td>PR: 2EA</td> <td></td> <td></td> <td></td> <td></td> <td></td> </tr> <tr> <td>2.0 TDI</td> <td>130</td> <td>12.12</td> <td></td> <td>PR: 2EA</td> <td></td> <td></td> <td></td> <td></td> <td></td> </tr> <tr> <td>2.0 TDI 4motion</td> <td>103</td> <td>08.10</td> <td></td> <td>PR: 2EA</td> <td></td> <td></td> <td></td> <td></td> <td></td> </tr> <tr> <td>2.0 TDI 4motion</td> <td>125</td> <td>08.10</td> <td></td> <td>PR: 2EA</td> <td></td> <td></td> <td></td> <td></td> <td></td> </tr> <tr> <td>2.0 TDI 4motion</td> <td>130</td> <td>01.13</td> <td></td> <td>PR: 2EA</td> <td></td> <td></td> <td></td> <td></td> <td></td> </tr> <tr> <td>2.0 TSI</td> <td>155</td> <td>11.10</td> <td></td> <td>PR: 2EA</td> <td></td> <td></td> <td></td> <td></td> <td></td> </tr> <tr> <td>2.0 TSI 4motion</td> <td>155</td> <td>01.12</td> <td></td> <td>PR: 2EA</td> <td></td> <td></td> <td></td> <td></td> <td></td> </tr> <tr> <td>3.6 FSI 4motion</td> <td>220</td> <td>01.11</td> <td></td> <td>PR: 2EA</td> <td></td> <td></td> <td></td> <td></td> <td></td> </tr> </table>   | 1.4 TSI           | 90    | 08.10           |                | PR: 2EA         | 83.7849-0231.3  | 330872         | 2   | L=233          |         | 1.4 TSI | 110   | 08.10 |         | PR: 2EA         |                |        |   |                |     | 1.4 TSI | 118   | 11.12   |  | PR: 2EA         |                |        |         |                |       | 1.6 TDI | 77      | 08.10 |  | PR: 2EA         |                |                 |     |            |       | 1.8 TSI | 118 | 08.10 |  | PR: 2EA         |                 |        |       |            |         | 2.0 TDI |  | 08.10 |  | PR: 2EA         |  |       |       |         |  | 2.0 TDI | 125 | 08.10 |                | PR: 2EA         |       |       |         |  |  | 2.0 TDI | 130 | 12.12 |  | PR: 2EA         |  |  |  |  |  | 2.0 TDI 4motion | 103 | 08.10 |  | PR: 2EA         |  |  |  |  |  | 2.0 TDI 4motion | 125 | 08.10 |  | PR: 2EA         |  |  |  |  |  | 2.0 TDI 4motion | 130 | 01.13 |  | PR: 2EA         |  |  |  |  |  | 2.0 TSI | 155 | 11.10 |  | PR: 2EA         |  |  |  |  |  | 2.0 TSI 4motion | 155 | 01.12 |  | PR: 2EA         |  |  |  |  |  | 3.6 FSI 4motion | 220 | 01.11 |  | PR: 2EA         |  |  |  |  |  |
| 1.4 TSI  | 90   | 08.10             |       | PR: 2EA         | 83.7849-0231.3 | 330872          | 2   | L=233          |   |                |         |         |       |       |         |                 |                |        |   |                |     |         |       |         |  |                 |                |        |         |                |       |         |         |       |  |                 |                |                 |     |            |       |         |     |       |  |                 |                 |        |       |            |         |         |  |       |  |                 |  |       |       |         |  |         |     |       |                |                 |       |       |         |  |  |         |     |       |  |                 |  |  |  |  |  |                 |     |       |  |                 |  |  |  |  |  |                 |     |       |  |                 |  |  |  |  |  |                 |     |       |  |                 |  |  |  |  |  |         |     |       |  |                 |  |  |  |  |  |                 |     |       |  |                 |  |  |  |  |  |                 |     |       |  |                 |  |  |  |  |  |
| 1.4 TSI  | 110  | 08.10             |       | PR: 2EA         |                |                 |   |                |   |                |         |         |       |       |         |                 |                |        |   |                |     |         |       |         |  |                 |                |        |         |                |       |         |         |       |  |                 |                |                 |     |            |       |         |     |       |  |                 |                 |        |       |            |         |         |  |       |  |                 |  |       |       |         |  |         |     |       |                |                 |       |       |         |  |  |         |     |       |  |                 |  |  |  |  |  |                 |     |       |  |                 |  |  |  |  |  |                 |     |       |  |                 |  |  |  |  |  |                 |     |       |  |                 |  |  |  |  |  |         |     |       |  |                 |  |  |  |  |  |                 |     |       |  |                 |  |  |  |  |  |                 |     |       |  |                 |  |  |  |  |  |
| 1.4 TSI  | 118  | 11.12             |       | PR: 2EA         |                |                 |   |                |   |                |         |         |       |       |         |                 |                |        |   |                |     |         |       |         |  |                 |                |        |         |                |       |         |         |       |  |                 |                |                 |     |            |       |         |     |       |  |                 |                 |        |       |            |         |         |  |       |  |                 |  |       |       |         |  |         |     |       |                |                 |       |       |         |  |  |         |     |       |  |                 |  |  |  |  |  |                 |     |       |  |                 |  |  |  |  |  |                 |     |       |  |                 |  |  |  |  |  |                 |     |       |  |                 |  |  |  |  |  |         |     |       |  |                 |  |  |  |  |  |                 |     |       |  |                 |  |  |  |  |  |                 |     |       |  |                 |  |  |  |  |  |
| 1.6 TDI  | 77   | 08.10             |       | PR: 2EA         |                |                 |   |                |   |                |         |         |       |       |         |                 |                |        |   |                |     |         |       |         |  |                 |                |        |         |                |       |         |         |       |  |                 |                |                 |     |            |       |         |     |       |  |                 |                 |        |       |            |         |         |  |       |  |                 |  |       |       |         |  |         |     |       |                |                 |       |       |         |  |  |         |     |       |  |                 |  |  |  |  |  |                 |     |       |  |                 |  |  |  |  |  |                 |     |       |  |                 |  |  |  |  |  |                 |     |       |  |                 |  |  |  |  |  |         |     |       |  |                 |  |  |  |  |  |                 |     |       |  |                 |  |  |  |  |  |                 |     |       |  |                 |  |  |  |  |  |
| 1.8 TSI  | 118  | 08.10             |       | PR: 2EA         |                |                 |   |                |   |                |         |         |       |       |         |                 |                |        |   |                |     |         |       |         |  |                 |                |        |         |                |       |         |         |       |  |                 |                |                 |     |            |       |         |     |       |  |                 |                 |        |       |            |         |         |  |       |  |                 |  |       |       |         |  |         |     |       |                |                 |       |       |         |  |  |         |     |       |  |                 |  |  |  |  |  |                 |     |       |  |                 |  |  |  |  |  |                 |     |       |  |                 |  |  |  |  |  |                 |     |       |  |                 |  |  |  |  |  |         |     |       |  |                 |  |  |  |  |  |                 |     |       |  |                 |  |  |  |  |  |                 |     |       |  |                 |  |  |  |  |  |
| 2.0 TDI  |  | 08.10             |       | PR: 2EA         |                |                 |   |                |   |                |         |         |       |       |         |                 |                |        |   |                |     |         |       |         |  |                 |                |        |         |                |       |         |         |       |  |                 |                |                 |     |            |       |         |     |       |  |                 |                 |        |       |            |         |         |  |       |  |                 |  |       |       |         |  |         |     |       |                |                 |       |       |         |  |  |         |     |       |  |                 |  |  |  |  |  |                 |     |       |  |                 |  |  |  |  |  |                 |     |       |  |                 |  |  |  |  |  |                 |     |       |  |                 |  |  |  |  |  |         |     |       |  |                 |  |  |  |  |  |                 |     |       |  |                 |  |  |  |  |  |                 |     |       |  |                 |  |  |  |  |  |
| 2.0 TDI  | 125  | 08.10             |       | PR: 2EA         |                |                 |   |                |   |                |         |         |       |       |         |                 |                |        |   |                |     |         |       |         |  |                 |                |        |         |                |       |         |         |       |  |                 |                |                 |     |            |       |         |     |       |  |                 |                 |        |       |            |         |         |  |       |  |                 |  |       |       |         |  |         |     |       |                |                 |       |       |         |  |  |         |     |       |  |                 |  |  |  |  |  |                 |     |       |  |                 |  |  |  |  |  |                 |     |       |  |                 |  |  |  |  |  |                 |     |       |  |                 |  |  |  |  |  |         |     |       |  |                 |  |  |  |  |  |                 |     |       |  |                 |  |  |  |  |  |                 |     |       |  |                 |  |  |  |  |  |
| 2.0 TDI  | 130  | 12.12             |       | PR: 2EA         |                |                 |   |                |   |                |         |         |       |       |         |                 |                |        |   |                |     |         |       |         |  |                 |                |        |         |                |       |         |         |       |  |                 |                |                 |     |            |       |         |     |       |  |                 |                 |        |       |            |         |         |  |       |  |                 |  |       |       |         |  |         |     |       |                |                 |       |       |         |  |  |         |     |       |  |                 |  |  |  |  |  |                 |     |       |  |                 |  |  |  |  |  |                 |     |       |  |                 |  |  |  |  |  |                 |     |       |  |                 |  |  |  |  |  |         |     |       |  |                 |  |  |  |  |  |                 |     |       |  |                 |  |  |  |  |  |                 |     |       |  |                 |  |  |  |  |  |
| 2.0 TDI 4motion  | 103  | 08.10             |       | PR: 2EA         |                |                 |   |                |   |                |         |         |       |       |         |                 |                |        |   |                |     |         |       |         |  |                 |                |        |         |                |       |         |         |       |  |                 |                |                 |     |            |       |         |     |       |  |                 |                 |        |       |            |         |         |  |       |  |                 |  |       |       |         |  |         |     |       |                |                 |       |       |         |  |  |         |     |       |  |                 |  |  |  |  |  |                 |     |       |  |                 |  |  |  |  |  |                 |     |       |  |                 |  |  |  |  |  |                 |     |       |  |                 |  |  |  |  |  |         |     |       |  |                 |  |  |  |  |  |                 |     |       |  |                 |  |  |  |  |  |                 |     |       |  |                 |  |  |  |  |  |
| 2.0 TDI 4motion  | 125  | 08.10             |       | PR: 2EA         |                |                 |   |                |   |                |         |         |       |       |         |                 |                |        |   |                |     |         |       |         |  |                 |                |        |         |                |       |         |         |       |  |                 |                |                 |     |            |       |         |     |       |  |                 |                 |        |       |            |         |         |  |       |  |                 |  |       |       |         |  |         |     |       |                |                 |       |       |         |  |  |         |     |       |  |                 |  |  |  |  |  |                 |     |       |  |                 |  |  |  |  |  |                 |     |       |  |                 |  |  |  |  |  |                 |     |       |  |                 |  |  |  |  |  |         |     |       |  |                 |  |  |  |  |  |                 |     |       |  |                 |  |  |  |  |  |                 |     |       |  |                 |  |  |  |  |  |
| 2.0 TDI 4motion  | 130  | 01.13             |       | PR: 2EA         |                |                 |   |                |   |                |         |         |       |       |         |                 |                |        |   |                |     |         |       |         |  |                 |                |        |         |                |       |         |         |       |  |                 |                |                 |     |            |       |         |     |       |  |                 |                 |        |       |            |         |         |  |       |  |                 |  |       |       |         |  |         |     |       |                |                 |       |       |         |  |  |         |     |       |  |                 |  |  |  |  |  |                 |     |       |  |                 |  |  |  |  |  |                 |     |       |  |                 |  |  |  |  |  |                 |     |       |  |                 |  |  |  |  |  |         |     |       |  |                 |  |  |  |  |  |                 |     |       |  |                 |  |  |  |  |  |                 |     |       |  |                 |  |  |  |  |  |
| 2.0 TSI  | 155  | 11.10             |       | PR: 2EA         |                |                 |   |                |   |                |         |         |       |       |         |                 |                |        |   |                |     |         |       |         |  |                 |                |        |         |                |       |         |         |       |  |                 |                |                 |     |            |       |         |     |       |  |                 |                 |        |       |            |         |         |  |       |  |                 |  |       |       |         |  |         |     |       |                |                 |       |       |         |  |  |         |     |       |  |                 |  |  |  |  |  |                 |     |       |  |                 |  |  |  |  |  |                 |     |       |  |                 |  |  |  |  |  |                 |     |       |  |                 |  |  |  |  |  |         |     |       |  |                 |  |  |  |  |  |                 |     |       |  |                 |  |  |  |  |  |                 |     |       |  |                 |  |  |  |  |  |
| 2.0 TSI 4motion  | 155  | 01.12             |       | PR: 2EA         |                |                 |   |                |   |                |         |         |       |       |         |                 |                |        |   |                |     |         |       |         |  |                 |                |        |         |                |       |         |         |       |  |                 |                |                 |     |            |       |         |     |       |  |                 |                 |        |       |            |         |         |  |       |  |                 |  |       |       |         |  |         |     |       |                |                 |       |       |         |  |  |         |     |       |  |                 |  |  |  |  |  |                 |     |       |  |                 |  |  |  |  |  |                 |     |       |  |                 |  |  |  |  |  |                 |     |       |  |                 |  |  |  |  |  |         |     |       |  |                 |  |  |  |  |  |                 |     |       |  |                 |  |  |  |  |  |                 |     |       |  |                 |  |  |  |  |  |
| 3.6 FSI 4motion  | 220  | 01.11             |       | PR: 2EA         |                |                 |   |                |   |                |         |         |       |       |         |                 |                |        |   |                |     |         |       |         |  |                 |                |        |         |                |       |         |         |       |  |                 |                |                 |     |            |       |         |     |       |  |                 |                 |        |       |            |         |         |  |       |  |                 |  |       |       |         |  |         |     |       |                |                 |       |       |         |  |  |         |     |       |  |                 |  |  |  |  |  |                 |     |       |  |                 |  |  |  |  |  |                 |     |       |  |                 |  |  |  |  |  |                 |     |       |  |                 |  |  |  |  |  |         |     |       |  |                 |  |  |  |  |  |                 |     |       |  |                 |  |  |  |  |  |                 |     |       |  |                 |  |  |  |  |  |
|  | <table border="1"> <tr> <td>1.4 TSI</td> <td>90</td> <td>08.10</td> <td></td> <td>PR: 1KW</td> <td>24.5143-0257.3</td> <td>331167</td> <td>2</td> <td>L=257</td> <td></td> </tr> <tr> <td>1.4 TSI</td> <td>110</td> <td>08.10</td> <td></td> <td>PR: 1KW</td> <td></td> <td></td> <td></td> <td></td> <td></td> </tr> <tr> <td>1.4 TSI</td> <td>118</td> <td>11.12</td> <td></td> <td>PR: 1KW</td> <td></td> <td></td> <td></td> <td></td> <td></td> </tr> <tr> <td>1.6 TDI</td> <td>77</td> <td>08.10</td> <td></td> <td>PR: 1KW</td> <td></td> <td></td> <td></td> <td></td> <td></td> </tr> <tr> <td>1.8 TSI</td> <td>118</td> <td>08.10</td> <td></td> <td>PR: 1KW</td> <td></td> <td></td> <td></td> <td></td> <td></td> </tr> <tr> <td>2.0 TDI</td> <td></td> <td>08.10</td> <td></td> <td>PR: 1KW</td> <td></td> <td></td> <td></td> <td></td> <td></td> </tr> <tr> <td>2.0 TDI</td> <td>125</td> <td>08.10</td> <td></td> <td>PR: 1KW</td> <td></td> <td></td> <td></td> <td></td> <td></td> </tr> </table>  | 1.4 TSI           | 90    | 08.10           |                | PR: 1KW         | 24.5143-0257.3  | 331167         | 2   | L=257          |         | 1.4 TSI | 110   | 08.10 |         | PR: 1KW         |                |        |   |                |     | 1.4 TSI | 118   | 11.12   |  | PR: 1KW         |                |        |         |                |       | 1.6 TDI | 77      | 08.10 |  | PR: 1KW         |                |                 |     |            |       | 1.8 TSI | 118 | 08.10 |  | PR: 1KW         |                 |        |       |            |         | 2.0 TDI |  | 08.10 |  | PR: 1KW         |  |       |       |         |  | 2.0 TDI | 125 | 08.10 |                | PR: 1KW         |       |       |         |  |  |         |     |       |  |                 |  |  |  |  |  |                 |     |       |  |                 |  |  |  |  |  |                 |     |       |  |                 |  |  |  |  |  |                 |     |       |  |                 |  |  |  |  |  |         |     |       |  |                 |  |  |  |  |  |                 |     |       |  |                 |  |  |  |  |  |                 |     |       |  |                 |  |  |  |  |  |
| 1.4 TSI  | 90   | 08.10             |       | PR: 1KW         | 24.5143-0257.3 | 331167          | 2   | L=257          |   |                |         |         |       |       |         |                 |                |        |   |                |     |         |       |         |  |                 |                |        |         |                |       |         |         |       |  |                 |                |                 |     |            |       |         |     |       |  |                 |                 |        |       |            |         |         |  |       |  |                 |  |       |       |         |  |         |     |       |                |                 |       |       |         |  |  |         |     |       |  |                 |  |  |  |  |  |                 |     |       |  |                 |  |  |  |  |  |                 |     |       |  |                 |  |  |  |  |  |                 |     |       |  |                 |  |  |  |  |  |         |     |       |  |                 |  |  |  |  |  |                 |     |       |  |                 |  |  |  |  |  |                 |     |       |  |                 |  |  |  |  |  |
| 1.4 TSI  | 110  | 08.10             |       | PR: 1KW         |                |                 |   |                |   |                |         |         |       |       |         |                 |                |        |   |                |     |         |       |         |  |                 |                |        |         |                |       |         |         |       |  |                 |                |                 |     |            |       |         |     |       |  |                 |                 |        |       |            |         |         |  |       |  |                 |  |       |       |         |  |         |     |       |                |                 |       |       |         |  |  |         |     |       |  |                 |  |  |  |  |  |                 |     |       |  |                 |  |  |  |  |  |                 |     |       |  |                 |  |  |  |  |  |                 |     |       |  |                 |  |  |  |  |  |         |     |       |  |                 |  |  |  |  |  |                 |     |       |  |                 |  |  |  |  |  |                 |     |       |  |                 |  |  |  |  |  |
| 1.4 TSI  | 118  | 11.12             |       | PR: 1KW         |                |                 |   |                |   |                |         |         |       |       |         |                 |                |        |   |                |     |         |       |         |  |                 |                |        |         |                |       |         |         |       |  |                 |                |                 |     |            |       |         |     |       |  |                 |                 |        |       |            |         |         |  |       |  |                 |  |       |       |         |  |         |     |       |                |                 |       |       |         |  |  |         |     |       |  |                 |  |  |  |  |  |                 |     |       |  |                 |  |  |  |  |  |                 |     |       |  |                 |  |  |  |  |  |                 |     |       |  |                 |  |  |  |  |  |         |     |       |  |                 |  |  |  |  |  |                 |     |       |  |                 |  |  |  |  |  |                 |     |       |  |                 |  |  |  |  |  |
| 1.6 TDI  | 77   | 08.10             |       | PR: 1KW         |                |                 |   |                |   |                |         |         |       |       |         |                 |                |        |   |                |     |         |       |         |  |                 |                |        |         |                |       |         |         |       |  |                 |                |                 |     |            |       |         |     |       |  |                 |                 |        |       |            |         |         |  |       |  |                 |  |       |       |         |  |         |     |       |                |                 |       |       |         |  |  |         |     |       |  |                 |  |  |  |  |  |                 |     |       |  |                 |  |  |  |  |  |                 |     |       |  |                 |  |  |  |  |  |                 |     |       |  |                 |  |  |  |  |  |         |     |       |  |                 |  |  |  |  |  |                 |     |       |  |                 |  |  |  |  |  |                 |     |       |  |                 |  |  |  |  |  |
| 1.8 TSI  | 118  | 08.10             |       | PR: 1KW         |                |                 |   |                |   |                |         |         |       |       |         |                 |                |        |   |                |     |         |       |         |  |                 |                |        |         |                |       |         |         |       |  |                 |                |                 |     |            |       |         |     |       |  |                 |                 |        |       |            |         |         |  |       |  |                 |  |       |       |         |  |         |     |       |                |                 |       |       |         |  |  |         |     |       |  |                 |  |  |  |  |  |                 |     |       |  |                 |  |  |  |  |  |                 |     |       |  |                 |  |  |  |  |  |                 |     |       |  |                 |  |  |  |  |  |         |     |       |  |                 |  |  |  |  |  |                 |     |       |  |                 |  |  |  |  |  |                 |     |       |  |                 |  |  |  |  |  |
| 2.0 TDI  |  | 08.10             |       | PR: 1KW         |                |                 |   |                |   |                |         |         |       |       |         |                 |                |        |   |                |     |         |       |         |  |                 |                |        |         |                |       |         |         |       |  |                 |                |                 |     |            |       |         |     |       |  |                 |                 |        |       |            |         |         |  |       |  |                 |  |       |       |         |  |         |     |       |                |                 |       |       |         |  |  |         |     |       |  |                 |  |  |  |  |  |                 |     |       |  |                 |  |  |  |  |  |                 |     |       |  |                 |  |  |  |  |  |                 |     |       |  |                 |  |  |  |  |  |         |     |       |  |                 |  |  |  |  |  |                 |     |       |  |                 |  |  |  |  |  |                 |     |       |  |                 |  |  |  |  |  |
| 2.0 TDI  | 125  | 08.10             |       | PR: 1KW         |                |                 |   |                |   |                |         |         |       |       |         |                 |                |        |   |                |     |         |       |         |  |                 |                |        |         |                |       |         |         |       |  |                 |                |                 |     |            |       |         |     |       |  |                 |                 |        |       |            |         |         |  |       |  |                 |  |       |       |         |  |         |     |       |                |                 |       |       |         |  |  |         |     |       |  |                 |  |  |  |  |  |                 |     |       |  |                 |  |  |  |  |  |                 |     |       |  |                 |  |  |  |  |  |                 |     |       |  |                 |  |  |  |  |  |         |     |       |  |                 |  |  |  |  |  |                 |     |       |  |                 |  |  |  |  |  |                 |     |       |  |                 |  |  |  |  |  |

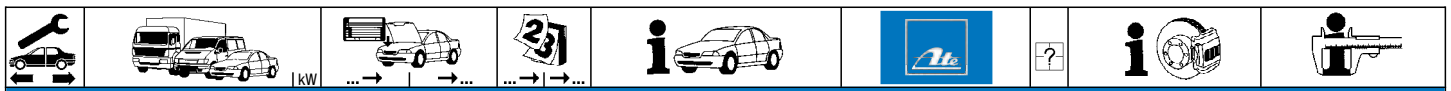

**VOLKSWAGEN PASSAT / PASSAT VARIANT (10-)**

|  |                 |     |       |         |                |        |   |  |          |
|--|-----------------|-----|-------|---------|----------------|--------|---|--|----------|
|  | 2.0 TDI         | 130 | 12.12 | PR: 1KW | 24.5143-0257.3 | 331167 | 2 |  | L=257    |
|  | 2.0 TDI 4motion | 103 | 08.10 | PR: 1KW |                |        |   |  |          |
|  | 2.0 TDI 4motion | 125 | 08.10 | PR: 1KW |                |        |   |  |          |
|  | 2.0 TDI 4motion | 130 | 01.13 | PR: 1KW |                |        |   |  |          |
|  | 2.0 TSI         | 155 | 11.10 | PR: 1KW |                |        |   |  |          |
|  | 2.0 TSI 4motion | 155 | 01.12 | PR: 1KW |                |        |   |  |          |
|  | 3.6 FSI 4motion | 220 | 01.11 | PR: 1KW |                |        |   |  |          |
|  | 1.4 TSI         | 90  | 08.10 | PR: 0EJ | 24.2519-1705.3 | 040095 |   |  | Nz 19,05 |
|  | 1.4 TSI         | 110 | 08.10 | PR: 0EJ |                |        |   |  |          |
|  | 1.4 TSI         | 118 | 11.12 | PR: 0EJ |                |        |   |  |          |
|  | 1.6 TDI         | 77  | 08.10 | PR: 0EJ |                |        |   |  |          |
|  | 1.8 TSI         | 118 | 08.10 | PR: 0EJ |                |        |   |  |          |
|  | 2.0 TDI         |     | 08.10 | PR: 0EJ |                |        |   |  |          |
|  | 2.0 TDI         | 125 | 08.10 | PR: 0EJ |                |        |   |  |          |
|  | 2.0 TDI         | 130 | 12.12 | PR: 0EJ |                |        |   |  |          |
|  | 2.0 TDI 4motion | 103 | 08.10 | PR: 0EJ |                |        |   |  |          |
|  | 2.0 TDI 4motion | 125 | 08.10 | PR: 0EJ |                |        |   |  |          |
|  | 2.0 TDI 4motion | 130 | 01.13 | PR: 0EJ |                |        |   |  |          |
|  | 2.0 TSI         | 155 | 11.10 | PR: 0EJ |                |        |   |  |          |
|  | 2.0 TSI 4motion | 155 | 01.12 | PR: 0EJ |                |        |   |  |          |
|  | 3.6 FSI 4motion | 220 | 01.11 | PR: 0EJ |                |        |   |  |          |

**VOLKSWAGEN PASSAT ALLTRACK (12-)**

|  |                 |     |       |                 |                |        |   |  |                    |
|--|-----------------|-----|-------|-----------------|----------------|--------|---|--|--------------------|
|  | 1.8 TSI         | 112 | 01.12 | PR: 1LA,1LB,1ZM | 03.7873-4502.4 | 300284 |   |  | 11" ATE            |
|  | 1.8 TSI         | 118 | 01.12 | PR: 1LA,1LB,1ZM |                |        |   |  |                    |
|  | 2.0 TDI         | 103 | 01.12 | PR: 1LA,1LB,1ZM |                |        |   |  |                    |
|  | 2.0 TDI 4motion | 103 | 01.12 | PR: 1LA,1LB,1ZM |                |        |   |  |                    |
|  | 2.0 TDI 4motion | 125 | 01.12 | PR: 1LA,1LB,1ZM |                |        |   |  |                    |
|  | 2.0 TDI 4motion | 130 | 01.13 | PR: 1LA,1LB,1ZM |                |        |   |  |                    |
|  | 2.0 TSI 4motion | 155 | 01.12 | PR: 1LA,1LB,1ZM |                |        |   |  |                    |
|  | 1.8 TSI         | 112 | 01.12 | PR: 1LA,1LB,1ZM | 03.4153-0186.3 | 010816 |   |  | Thz 23,81 ATE      |
|  | 1.8 TSI         | 118 | 01.12 | PR: 1LA,1LB,1ZM |                |        |   |  |                    |
|  | 2.0 TDI         | 103 | 01.12 | PR: 1LA,1LB,1ZM |                |        |   |  |                    |
|  | 2.0 TDI 4motion | 103 | 01.12 | PR: 1LA,1LB,1ZM |                |        |   |  |                    |
|  | 2.0 TDI 4motion | 125 | 01.12 | PR: 1LA,1LB,1ZM |                |        |   |  |                    |
|  | 2.0 TDI 4motion | 130 | 01.13 | PR: 1LA,1LB,1ZM |                |        |   |  |                    |
|  | 2.0 TSI 4motion | 155 | 01.12 | PR: 1LA,1LB,1ZM |                |        |   |  |                    |
|  | 1.8 TSI         | 112 | 01.12 | PR: 1ZG         | 03.4152-0116.3 | 010814 |   |  | Thz 22,20 ATE      |
|  | 1.8 TSI         | 118 | 01.12 | PR: 1ZG         |                |        |   |  |                    |
|  | 2.0 TDI         | 103 | 01.12 | PR: 1ZG         |                |        |   |  |                    |
|  | 2.0 TDI 4motion | 103 | 01.12 | PR: 1ZG         |                |        |   |  |                    |
|  | 2.0 TDI 4motion | 125 | 01.12 | PR: 1ZG         |                |        |   |  |                    |
|  | 2.0 TDI 4motion | 130 | 01.13 | PR: 1ZG         |                |        |   |  |                    |
|  | 2.0 TSI 4motion | 155 | 01.12 | PR: 1ZG         |                |        |   |  |                    |
|  | 1.8 TSI         | 112 | 01.12 | PR: 1ZM,1ZG     | 11.9541-9553.2 | 220563 |   |  | D=54, - Halter ATE |
|  | 1.8 TSI         | 118 | 01.12 | PR: 1ZM,1ZG     | 11.9541-9554.2 | 220564 |   |  | D=54, - Halter ATE |
|  | 2.0 TDI         | 103 | 01.12 | PR: 1ZM,1ZG     | 11.0101-5409.2 | 260035 |   |  | Hülsensatz ATE     |
|  | 2.0 TDI 4motion | 103 | 01.12 | PR: 1ZM,1ZG     | 11.8171-0008.1 | 990049 |   |  | Führungsbolzen ATE |
|  | 2.0 TDI 4motion | 125 | 01.12 | PR: 1ZM,1ZG     | 11.8116-0351.1 | 390538 | 2 |  | Haltefeder ATE     |
|  | 2.0 TDI 4motion | 130 | 01.13 | PR: 1ZM,1ZG     |                |        |   |  |                    |
|  | 2.0 TSI 4motion | 155 | 01.12 | PR: 1ZM,1ZG     |                |        |   |  |                    |
|  | 1.8 TSI         | 112 | 01.12 | PR: 1KW         | 24.5143-0257.3 | 331167 | 2 |  | L=257              |
|  | 1.8 TSI         | 118 | 01.12 | PR: 1KW         |                |        |   |  |                    |
|  | 2.0 TDI         | 103 | 01.12 | PR: 1KW         |                |        |   |  |                    |
|  | 2.0 TDI 4motion | 103 | 01.12 | PR: 1KW         |                |        |   |  |                    |
|  | 2.0 TDI 4motion | 125 | 01.12 | PR: 1KW         |                |        |   |  |                    |
|  | 2.0 TDI 4motion | 130 | 01.13 | PR: 1KW         |                |        |   |  |                    |
|  | 2.0 TSI 4motion | 155 | 01.12 | PR: 1KW         |                |        |   |  |                    |
|  | 1.8 TSI         | 112 | 01.12 | PR: 2EA         | 83.7849-0231.3 | 330872 | 2 |  | L=233              |
|  | 1.8 TSI         | 118 | 01.12 | PR: 2EA         |                |        |   |  |                    |
|  | 2.0 TDI         | 103 | 01.12 | PR: 2EA         |                |        |   |  |                    |
|  | 2.0 TDI 4motion | 103 | 01.12 | PR: 2EA         |                |        |   |  |                    |
|  | 2.0 TDI 4motion | 125 | 01.12 | PR: 2EA         |                |        |   |  |                    |
|  | 2.0 TDI 4motion | 130 | 01.13 | PR: 2EA         |                |        |   |  |                    |
|  | 2.0 TSI 4motion | 155 | 01.12 | PR: 2EA         |                |        |   |  |                    |
|  | 1.8 TSI         | 112 | 01.12 | PR: 0EJ         | 24.2519-1705.3 | 040095 |   |  | Nz 19,05           |
|  | 1.8 TSI         | 118 | 01.12 | PR: 0EJ         |                |        |   |  |                    |
|  | 2.0 TDI         | 103 | 01.12 | PR: 0EJ         |                |        |   |  |                    |
|  | 2.0 TDI 4motion | 103 | 01.12 | PR: 0EJ         |                |        |   |  |                    |
|  | 2.0 TDI 4motion | 125 | 01.12 | PR: 0EJ         |                |        |   |  |                    |
|  | 2.0 TDI 4motion | 130 | 01.13 | PR: 0EJ         |                |        |   |  |                    |
|  | 2.0 TSI 4motion | 155 | 01.12 | PR: 0EJ         |                |        |   |  |                    |

**VOLKSWAGEN PHAETON (02-)**

|  |                     |     |       |             |                |        |   |  |                    |
|--|---------------------|-----|-------|-------------|----------------|--------|---|--|--------------------|
|  | 3.0 TDI 4motion     | 165 | 09.04 | PR: 1ZK,1ZL | 11.0101-6010.2 | 260099 |   |  | Hülsensatz ATE     |
|  | 3.0 V6 TDI 4motion  |     | 04.08 | PR: 1ZK,1ZL | 11.8171-0067.1 | 250153 |   |  | Führungsbolzen ATE |
|  | 3.2 V6              |     | 04.02 | PR: 1ZK,1ZL | 11.8116-0347.2 | 390535 | 2 |  | Haltefeder ATE     |
|  | 3.2 V6 4motion      |     | 02.04 | PR: 1ZK,1ZL |                |        |   |  |                    |
|  | 3.6 V6 4motion      |     | 11.08 | PR: 1ZK,1ZL |                |        |   |  |                    |
|  | 4.2 V8 4motion      |     | 05.03 | PR: 1ZK,1ZL |                |        |   |  |                    |
|  | 5.0 V10 TDI 4motion |     | 11.02 | PR: 1ZK,1ZL |                |        |   |  |                    |
|  | 6.0 W12 4motion     |     | 04.02 | PR: 1ZK,1ZL |                |        |   |  |                    |
|  | 3.0 TDI 4motion     | 165 | 09.04 |             | 83.7849-0419.3 | 331114 | 2 |  | L=422              |
|  | 3.0 V6 TDI 4motion  |     | 04.08 |             |                |        |   |  |                    |
|  | 3.2 V6              |     | 04.02 |             |                |        |   |  |                    |
|  | 3.2 V6 4motion      |     | 02.04 |             |                |        |   |  |                    |



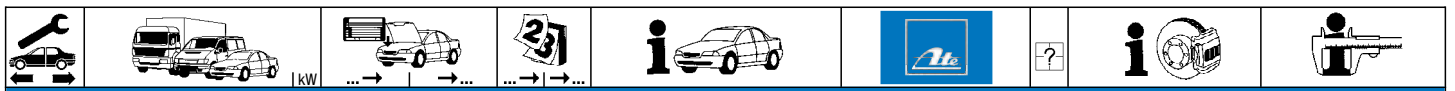

**VOLKSWAGEN PHAETON (02-)**

|  |                     |     |  |       |  |  |                |        |   |  |       |
|--|---------------------|-----|--|-------|--|--|----------------|--------|---|--|-------|
|  | 3.6 V6 4motion      |     |  | 11.08 |  |  | 83.7849-0419.3 | 331114 | 2 |  | L=422 |
|  | 4.2 V8 4motion      |     |  | 05.03 |  |  |                |        |   |  |       |
|  | 5.0 V10 TDI 4motion |     |  | 11.02 |  |  |                |        |   |  |       |
|  | 6.0 W12 4motion     |     |  | 04.02 |  |  |                |        |   |  |       |
|  | 3.0 TDI 4motion     | 165 |  | 09.04 |  |  | 83.7858-0165.3 | 331107 |   |  | L=165 |
|  | 3.0 V6 TDI 4motion  |     |  | 04.08 |  |  | 83.7849-0145.3 | 331106 |   |  | L=145 |
|  | 3.2 V6              |     |  | 04.02 |  |  |                |        |   |  |       |
|  | 3.2 V6 4motion      |     |  | 02.04 |  |  |                |        |   |  |       |
|  | 3.6 V6 4motion      |     |  | 11.08 |  |  |                |        |   |  |       |
|  | 4.2 V8 4motion      |     |  | 05.03 |  |  |                |        |   |  |       |
|  | 5.0 V10 TDI 4motion |     |  | 11.02 |  |  |                |        |   |  |       |
|  | 6.0 W12 4motion     |     |  | 04.02 |  |  |                |        |   |  |       |

**VOLKSWAGEN POLO II (81-94)**

|         |         |              |              |       |                                  |                                  |                |        |   |                      |                      |     |
|---------|---------|--------------|--------------|-------|----------------------------------|----------------------------------|----------------|--------|---|----------------------|----------------------|-----|
|         | 1.0     |              |              | 10.90 | 09.94                            | - Bremsgerät <sup>1)</sup>       | 03.2117-3311.3 | 010040 |   |                      | Thz 17,46            | ATE |
|         | 1.0     |              |              | 10.81 | 09.90                            | - Bremsgerät <sup>1)</sup>       | 03.3517-0101.2 | 390322 |   |                      | Verschlußschraube    |     |
|         | 1.0     |              | ...-F-127903 | 10.81 |                                  | + Bremsgerät <sup>2)</sup>       | 03.2120-1531.3 | 010092 |   |                      | Thz 20,64            | ATE |
|         | 1.1     |              |              | 10.81 | 07.83                            |                                  |                |        |   |                      |                      |     |
|         | 1.3     |              | ...-F-127903 | 10.81 |                                  |                                  |                |        |   |                      |                      |     |
|         | 1.0     |              | ...-F-127904 |       | 09.94                            | + Bremsgerät <sup>2)</sup>       | 03.2120-2031.3 | 010106 |   |                      | Thz 20,64            | ATE |
|         | 1.3     |              | ...-F-127904 |       | 09.94                            |                                  |                |        |   |                      |                      |     |
|         | 1.3 D   |              |              | 08.86 | 09.90                            |                                  |                |        |   |                      |                      |     |
|         | 1.3 G40 |              |              | 01.87 | 09.94                            |                                  |                |        |   |                      |                      |     |
|         | 1.4 D   |              |              | 08.90 | 09.94                            |                                  |                |        |   |                      |                      |     |
|         | 1.0     |              |              | 10.81 | 02.85                            |                                  | 11.0441-4402.2 | 250014 |   |                      | Dichtungssatz        | ATE |
|         | 1.1     |              |              | 10.81 | 07.83                            |                                  |                |        |   |                      |                      |     |
|         | 1.3     |              |              | 10.81 | 02.85                            |                                  |                |        |   |                      |                      |     |
|         | 1.0     |              |              | 03.85 | 09.94                            |                                  | 24.3481-1745.5 | 240277 |   |                      | D=48, - Halter       | ATE |
|         | 1.3     |              |              | 03.85 | 09.94                            |                                  | 24.3481-1746.5 | 240278 |   |                      | D=48, - Halter       | ATE |
|         | 1.3 D   |              |              | 08.86 | 09.90                            |                                  | 11.0441-4808.2 | 250022 |   |                      | Dichtungssatz        | ATE |
|         | 1.3 G40 |              |              | 01.87 | 09.94                            |                                  | 11.0101-4803.2 | 260008 |   |                      | Hülzensatz           | ATE |
|         | 1.4 D   |              |              | 08.90 | 09.94                            |                                  | 24.0102-4803.2 | 260086 |   |                      | Hülzensatz+Schrauben | ATE |
|         | 1.3 G40 |              |              | 01.87 | 09.94                            |                                  | 11.0441-4808.2 | 250022 |   |                      | Dichtungssatz        | ATE |
|         |         |              |              |       |                                  |                                  | 11.0101-4801.2 | 260006 |   |                      | Hülzensatz           | ATE |
|         |         |              |              |       |                                  | 24.0102-4801.2                   | 260085         |        |   | Hülzensatz+Schrauben | ATE                  |     |
|         | 1.0     |              |              | 10.81 | 09.94                            |                                  | 83.7734-0290.3 | 330809 | 2 |                      | L=290                |     |
|         | 1.1     |              |              | 10.81 | 07.83                            |                                  |                |        |   |                      |                      |     |
|         | 1.3     |              |              | 10.81 | 09.94                            |                                  |                |        |   |                      |                      |     |
|         | 1.3 D   |              |              | 08.86 | 09.90                            |                                  |                |        |   |                      |                      |     |
|         | 1.3 G40 |              |              | 01.87 | 09.94                            |                                  |                |        |   |                      |                      |     |
|         | 1.4 D   |              |              | 08.90 | 09.94                            |                                  |                |        |   |                      |                      |     |
|         | 1.0     |              |              | 10.81 | 09.94                            |                                  | 83.7824-0180.3 | 330812 | 2 |                      | L=180                |     |
|         | 1.1     |              |              | 10.81 | 07.83                            |                                  |                |        |   |                      |                      |     |
|         | 1.3     |              |              | 10.81 | 09.94                            |                                  |                |        |   |                      |                      |     |
|         | 1.3 D   |              |              | 08.86 | 09.90                            |                                  |                |        |   |                      |                      |     |
|         | 1.3 G40 |              |              | 01.87 | 09.94                            |                                  |                |        |   |                      |                      |     |
|         | 1.4 D   |              |              | 08.90 | 09.94                            |                                  |                |        |   |                      |                      |     |
|         | 1.0     |              | ...-F-127903 | 10.81 |                                  | - Bremskraftregler <sup>3)</sup> | 03.3214-0812.3 | 020011 |   | + GG <sup>4)</sup>   | Rz 14,29             |     |
|         | 1.1     |              |              | 10.81 | 07.83                            | - Bremskraftregler <sup>3)</sup> | 24.3214-0902.3 | 020147 |   | + ALU <sup>5)</sup>  | Rz 14,29             |     |
|         | 1.3     |              | ...-F-127903 | 10.81 |                                  | - Bremskraftregler <sup>3)</sup> |                |        |   |                      |                      |     |
|         | 1.0     |              | ...-F-127904 |       | 09.94                            | - Bremskraftregler <sup>3)</sup> | 03.3215-2311.3 | 020018 |   | + GG <sup>4)</sup>   | Rz 15,87             |     |
|         | 1.3     |              | ...-F-127904 |       | 09.94                            | - Bremskraftregler <sup>3)</sup> | 24.3215-0903.3 | 020154 |   | + ALU <sup>5)</sup>  | Rz 15,87             |     |
|         | 1.3 D   |              |              | 08.86 | 09.90                            | - Bremskraftregler <sup>3)</sup> |                |        |   |                      |                      |     |
|         | 1.3 G40 |              |              | 01.87 | 09.94                            | - Bremskraftregler <sup>3)</sup> |                |        |   |                      |                      |     |
|         | 1.4 D   |              |              | 08.90 | 09.94                            | - Bremskraftregler <sup>3)</sup> |                |        |   |                      |                      |     |
|         | 1.0     |              | ...-F-127903 | 10.81 |                                  | + Bremskraftregler <sup>6)</sup> | 03.3217-2112.3 | 020027 |   | + GG <sup>4)</sup>   | Rz 17,46             |     |
|         | 1.1     |              |              | 10.81 | 07.83                            | + Bremskraftregler <sup>6)</sup> | 24.3217-0908.3 | 020167 |   | + ALU <sup>5)</sup>  | Rz 17,46             |     |
|         | 1.3     |              | ...-F-127903 | 10.81 |                                  | + Bremskraftregler <sup>6)</sup> |                |        |   |                      |                      |     |
|         | 1.0     |              | ...-F-127904 |       | 09.94                            | + Bremskraftregler <sup>6)</sup> | 24.3219-0909.3 | 020188 |   |                      | Rz 19,05             |     |
| 1.3     |         | ...-F-127904 |              | 09.94 | + Bremskraftregler <sup>6)</sup> |                                  |                |        |   |                      |                      |     |
| 1.3 D   |         |              | 08.86        | 09.90 | + Bremskraftregler <sup>6)</sup> |                                  |                |        |   |                      |                      |     |
| 1.3 G40 |         |              | 01.87        | 09.94 | + Bremskraftregler <sup>6)</sup> |                                  |                |        |   |                      |                      |     |
| 1.4 D   |         |              | 08.90        | 09.94 | + Bremskraftregler <sup>6)</sup> |                                  |                |        |   |                      |                      |     |
|         | 1.0     |              | ...-E-200000 | 10.81 |                                  |                                  | 24.3727-0146.2 | 580146 | 1 |                      | L=794                |     |
|         | 1.1     |              |              | 10.81 | 07.83                            |                                  | 24.3727-0103.2 | 580103 | 1 |                      | L=1960               |     |
|         | 1.3     |              | ...-E-200000 | 10.81 |                                  |                                  |                |        |   |                      |                      |     |
|         | 1.0     |              | ...-F-000001 |       | 09.94                            |                                  | 24.3727-0137.2 | 580137 | 1 |                      | L=1594               |     |
|         | 1.3     |              | ...-F-000001 |       | 09.94                            |                                  | 24.3727-0129.2 | 580129 | 2 |                      | L=633                |     |
|         | 1.3 D   |              |              | 08.86 | 09.90                            |                                  |                |        |   |                      |                      |     |
|         | 1.3 G40 |              |              | 01.87 | 09.94                            |                                  |                |        |   |                      |                      |     |
|         | 1.4 D   |              |              | 08.90 | 09.94                            |                                  |                |        |   |                      |                      |     |
|         | 1.0     |              | ...-F-000001 |       | 09.94                            |                                  | 03.6584-0015.3 | 320109 |   |                      | BRL 8/4 (4)          | ATE |
|         | 1.3     |              | ...-F-000001 |       | 09.94                            |                                  |                |        |   |                      |                      |     |
|         | 1.3 D   |              |              | 08.86 | 09.90                            |                                  |                |        |   |                      |                      |     |
|         | 1.3 G40 |              |              | 01.87 | 09.94                            |                                  |                |        |   |                      |                      |     |
|         | 1.4 D   |              |              | 08.90 | 09.94                            |                                  |                |        |   |                      |                      |     |
|         | 1.0     |              |              | 10.81 | 02.85                            |                                  | 24.3728-0101.2 | 590101 |   |                      | L=607                |     |
|         | 1.1     |              |              | 10.81 | 07.83                            |                                  |                |        |   |                      |                      |     |
|         | 1.3     |              |              | 10.81 | 02.85                            |                                  |                |        |   |                      |                      |     |
|         | 1.0     |              |              | 03.85 | 09.94                            |                                  | 24.3728-0118.2 | 590118 |   |                      | L=607                |     |
|         | 1.3     |              |              | 03.85 | 09.94                            |                                  |                |        |   |                      |                      |     |
| 1.3 G40 |         |              | 01.87        | 09.94 |                                  |                                  |                |        |   |                      |                      |     |

1) - booster unit / - servofreno / - servo-frein / - servofreno  
2) + booster unit / + servofreno / + servo-frein / + servofreno  
3) - brake pressure regulator / - correttore di frenata / - correcteur de freinage / - corrector de frenado  
4) + cast iron / + ghisa / + fonte grise / + fundición de gris  
5) + aluminium / + alluminio / + aluminium / + aluminio  
6) + brake pressure regulator / + correttore di frenata / + correcteur de freinage / + corrector de frenado





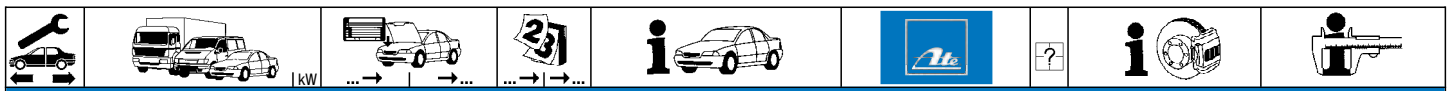

**VOLKSWAGEN POLO III (95-01)**

|         |         |             |             |             |                |                |                |                         |                |               |             |                |                |     |           |                |        |   |                |     |
|---------|---------|-------------|-------------|-------------|----------------|----------------|----------------|-------------------------|----------------|---------------|-------------|----------------|----------------|-----|-----------|----------------|--------|---|----------------|-----|
|         | 1.05    |             | 6N-T-300000 | 10.94       | + ABS          | 03.7750-6002.4 | 300134         |                         | 9"             | ATE           |             |                |                |     |           |                |        |   |                |     |
|         | 1.3     |             | 6N-T-300000 | 10.94       | + ABS          |                |                |                         |                |               |             |                |                |     |           |                |        |   |                |     |
|         | 1.4     |             | 6N-T-300000 | 07.95       | + ABS          |                |                |                         |                |               |             |                |                |     |           |                |        |   |                |     |
|         | 1.4     | 40          | 6N-T-300000 | 07.95       | + ABS          |                |                |                         |                |               |             |                |                |     |           |                |        |   |                |     |
|         | 1.4 16V | 74          | 6N-T-300000 | 04.96       | + ABS          |                |                |                         |                |               |             |                |                |     |           |                |        |   |                |     |
|         | 1.6     | 55          | 6N-T-300000 | 10.94       | + ABS          |                |                |                         |                |               |             |                |                |     |           |                |        |   |                |     |
|         | 1.9 D   |             | 6N-T-300000 | 10.94       | + ABS          |                |                |                         |                |               |             |                |                |     |           |                |        |   |                |     |
|         | 1.9 SDI |             | 6N-T-300000 | 10.94       | + ABS          |                |                |                         |                |               |             |                |                |     |           |                |        |   |                |     |
|         | 1.0     |             |             | 07.96       | 09.01 + ESP    | 03.7853-0102.4 | 300252         | PR: 1AT,1LX,1ZE,1ZJ,1ZK | 9"             | ATE           |             |                |                |     |           |                |        |   |                |     |
|         | 1.05    |             |             | 10.94       | 09.96 + ESP    |                |                |                         |                |               |             |                |                |     |           |                |        |   |                |     |
|         | 1.3     |             |             | 10.94       | 04.97 + ESP    |                |                |                         |                |               |             |                |                |     |           |                |        |   |                |     |
|         | 1.4     |             |             | 07.95       | 09.01 + ESP    |                |                |                         |                |               |             |                |                |     |           |                |        |   |                |     |
|         | 1.4     | 40          |             | 07.95       | 09.01 + ESP    |                |                |                         |                |               |             |                |                |     |           |                |        |   |                |     |
|         | 1.4 16V | 55          |             | 01.99       | 09.01 + ESP    |                |                |                         |                |               |             |                |                |     |           |                |        |   |                |     |
|         | 1.4 16V | 74          |             | 04.96       | 09.01 + ESP    |                |                |                         |                |               |             |                |                |     |           |                |        |   |                |     |
|         | 1.4 TDI | 55          |             | 01.99       | 09.01 + ESP    |                |                |                         |                |               |             |                |                |     |           |                |        |   |                |     |
|         | 1.6     | 55          |             | 10.94       | 09.99 + ESP    |                |                |                         |                |               |             |                |                |     |           |                |        |   |                |     |
|         | 1.6 GTI |             |             | 04.98       | 09.01 + ESP    |                |                |                         |                |               |             |                |                |     |           |                |        |   |                |     |
|         | 1.7 SDI |             |             | 05.97       | 09.01 + ESP    |                |                |                         |                |               |             |                |                |     |           |                |        |   |                |     |
|         | 1.9 D   |             |             | 10.94       | 09.01 + ESP    |                |                |                         |                |               |             |                |                |     |           |                |        |   |                |     |
|         | 1.9 SDI |             |             | 10.94       | 09.01 + ESP    |                |                |                         |                |               |             |                |                |     |           |                |        |   |                |     |
|         |         | 1.0         |             |             | 07.96          |                |                |                         |                |               | 09.01 - ABS | 03.2120-3943.3 | 010532         |     | THz 20,64 | ATE            |        |   |                |     |
| 1.05    |         |             |             | 10.94       | 09.96 - ABS    |                |                |                         |                |               |             |                |                |     |           |                |        |   |                |     |
| 1.3     |         |             |             | 10.94       | 04.97 - ABS    |                |                |                         |                |               |             |                |                |     |           |                |        |   |                |     |
| 1.4     |         | 40          |             | 07.95       | 09.01 - ABS    |                |                |                         |                |               |             |                |                |     |           |                |        |   |                |     |
| 1.4     |         | 44          |             | 07.95       | 09.01 - ABS    |                |                |                         |                |               |             |                |                |     |           |                |        |   |                |     |
| 1.4 16V |         | 55          |             | 01.99       | 09.01 - ABS    |                |                |                         |                |               |             |                |                |     |           |                |        |   |                |     |
| 1.6     |         | 55          |             | 10.94       | 09.99 - ABS    |                |                |                         |                |               |             |                |                |     |           |                |        |   |                |     |
| 1.7 SDI |         |             |             | 05.97       | 09.01 - ABS    |                |                |                         |                |               |             |                |                |     |           |                |        |   |                |     |
| 1.9 D   |         |             |             | 10.94       | 09.01 - ABS    |                |                |                         |                |               |             |                |                |     |           |                |        |   |                |     |
| 1.9 SDI |         |             |             | 10.94       | 09.01 - ABS    |                |                |                         |                |               |             |                |                |     |           |                |        |   |                |     |
| 1.05    |         |             | 6N-T-250000 | 10.94       | + ABS          | 03.2122-1184.3 | 010592         |                         | THz 22,20      | ATE           |             |                |                |     |           |                |        |   |                |     |
| 1.3     |         |             | 6N-T-250000 | 10.94       | + ABS          |                |                |                         |                |               |             |                |                |     |           |                |        |   |                |     |
| 1.4     |         | 44          | 6N-T-250000 | 07.95       | + ABS          |                |                |                         |                |               |             |                |                |     |           |                |        |   |                |     |
| 1.4 16V |         | 74          |             | 04.96       | 09.01 - ABS    |                |                |                         |                |               |             |                |                |     |           |                |        |   |                |     |
| 1.4 TDI | 55      |             | 01.99       | 09.01 - ABS |                |                |                |                         |                |               |             |                |                |     |           |                |        |   |                |     |
| 1.6     | 55      | 6N-T-250000 | 10.94       | + ABS       |                |                |                |                         |                |               |             |                |                |     |           |                |        |   |                |     |
| 1.9 D   |         | 6N-T-250000 | 10.94       | + ABS       |                |                |                |                         |                |               |             |                |                |     |           |                |        |   |                |     |
| 1.9 SDI |         | 6N-T-250000 | 10.94       | + ABS       |                |                |                |                         |                |               |             |                |                |     |           |                |        |   |                |     |
| 1.0     |         |             | 07.96       | 09.01 + ABS | 03.2122-1344.3 |                |                |                         |                |               | 010593      |                | THz 22,20      | ATE |           |                |        |   |                |     |
| 1.05    |         | 6N-V-000001 | 09.96       | + ABS       |                |                |                |                         |                |               |             |                |                |     |           |                |        |   |                |     |
| 1.3     |         | 6N-V-000001 | 04.97       | + ABS       |                |                |                |                         |                |               |             |                |                |     |           |                |        |   |                |     |
| 1.4     | 44      | 6N-V-000001 | 09.01       | + ABS       |                |                |                |                         |                |               |             |                |                |     |           |                |        |   |                |     |
| 1.6     | 55      | 6N-V-000001 | 09.99       | + ABS       |                |                |                |                         |                |               |             |                |                |     |           |                |        |   |                |     |
| 1.7 SDI |         |             | 05.97       | 09.01 + ABS |                |                |                |                         |                |               |             |                |                |     |           |                |        |   |                |     |
| 1.9 D   |         | 6N-V-000001 | 09.01       | + ABS       |                |                |                |                         |                |               |             |                |                |     |           |                |        |   |                |     |
| 1.9 SDI |         | 6N-V-000001 | 09.01       | + ABS       |                |                |                |                         |                |               |             |                |                |     |           |                |        |   |                |     |
| 1.4 16V | 74      | 6N-T-300000 | 04.96       | + ABS       |                | 03.2123-1484.3 | 010595         |                         | THz 23,81      | ATE           |             |                |                |     |           |                |        |   |                |     |
| 1.4 16V | 74      | 6N-V-000001 | 09.01       | + ABS       |                |                |                |                         |                |               |             |                |                |     |           |                |        |   |                |     |
| 1.4 TDI | 55      |             | 01.99       | 09.01 + ABS |                |                |                |                         |                |               |             |                |                |     |           |                |        |   |                |     |
| 1.6 GTI | 55      |             | 04.98       | 09.01 + ABS |                |                |                |                         |                |               |             |                |                |     |           |                |        |   |                |     |
|         | 1.05    |             | 6N-SY087410 | 10.94       |                |                | 11.0441-4808.2 | 250022                  |                | Dichtungssatz |             |                |                |     | ATE       |                |        |   |                |     |
|         | 1.3     |             | 6N-SY087410 | 10.94       |                |                |                |                         |                |               |             |                |                |     |           |                |        |   |                |     |
|         | 1.6     | 55          | 6N-SY087410 | 10.94       |                |                |                |                         |                |               |             |                |                |     |           |                |        |   |                |     |
|         | 1.9 D   |             | 6N-SY087410 | 10.94       |                |                |                |                         |                |               |             |                |                |     |           |                |        |   |                |     |
|         | 1.9 SDI |             | 6N-SY087410 | 10.94       |                |                |                |                         |                |               |             |                |                |     |           |                |        |   |                |     |
|         | 1.05    |             | 6N-SW008500 | 10.94       |                | 11.0441-4808.2 |                |                         |                |               | 250022      |                | Dichtungssatz  | ATE |           |                |        |   |                |     |
|         | 1.3     |             | 6N-SW008500 | 10.94       |                |                |                |                         |                |               |             |                |                |     |           |                |        |   |                |     |
|         | 1.6     | 55          | 6N-SW008500 | 10.94       |                |                |                |                         |                |               |             |                |                |     |           |                |        |   |                |     |
|         | 1.9 D   |             | 6N-SW008500 | 10.94       |                |                |                |                         |                |               |             |                |                |     |           |                |        |   |                |     |
|         | 1.9 SDI |             | 6N-SW008500 | 10.94       |                |                |                |                         |                |               |             |                |                |     |           |                |        |   |                |     |
|         | 1.05    |             | 6N-TY140000 |             |                |                |                |                         |                |               |             |                |                |     |           | 24.3481-1749.5 | 240281 | ☐ | D=48, - Halter | ATE |
|         | 1.3     |             | 6N-SY087411 |             |                |                |                |                         |                |               |             |                |                |     |           |                |        |   |                |     |
|         | 1.4     | 40          | 6N-SY087411 |             |                |                |                |                         |                |               |             |                |                |     |           |                |        |   |                |     |
|         | 1.4     | 44          | 6N-SY087411 |             |                |                |                |                         |                |               |             |                |                |     |           |                |        |   |                |     |
| 1.6     | 55      | 6N-SY087411 |             |             |                |                |                |                         |                |               |             |                |                |     |           |                |        |   |                |     |
| 1.9 D   |         | 6N-SY087411 |             |             |                |                |                |                         |                |               |             |                |                |     |           |                |        |   |                |     |
| 1.9 SDI |         | 6N-SY087411 |             |             |                |                |                |                         |                |               |             |                |                |     |           |                |        |   |                |     |
| 1.05    |         | 6N-SW008501 |             |             | 24.3481-1749.5 |                | 240281         | ☐                       | D=48, - Halter | ATE           |             |                |                |     |           |                |        |   |                |     |
| 1.3     |         | 6N-SW008501 |             |             |                |                |                |                         |                |               |             |                |                |     |           |                |        |   |                |     |
| 1.4     | 40      | 6N-SW008501 |             |             |                |                |                |                         |                |               |             |                |                |     |           |                |        |   |                |     |
| 1.4     | 44      | 6N-SW008501 |             |             |                |                |                |                         |                |               |             |                |                |     |           |                |        |   |                |     |
| 1.6     | 55      | 6N-SW008501 |             |             |                |                |                |                         |                |               |             |                |                |     |           |                |        |   |                |     |
| 1.9 D   |         | 6N-SW008501 |             |             |                |                |                |                         |                |               |             |                |                |     |           |                |        |   |                |     |
| 1.9 SDI |         | 6N-SW008501 |             |             |                |                |                |                         |                |               |             |                |                |     |           |                |        |   |                |     |
| 1.0     |         |             | 07.96       | 09.01       |                | 24.3481-1735.5 |                |                         |                |               | 240283      | ☐              | D=48, - Halter | ATE |           |                |        |   |                |     |
| 1.05    |         | 6N-TY140001 |             | 09.96       |                |                |                |                         |                |               |             |                |                |     |           |                |        |   |                |     |
| 1.3     |         | 6N-TY140001 |             | 04.97       |                |                |                |                         |                |               |             |                |                |     |           |                |        |   |                |     |
| 1.4     | 40      | 6N-TY140001 |             | 09.01       |                |                |                |                         |                |               |             |                |                |     |           |                |        |   |                |     |
| 1.4     | 44      | 6N-TY140001 |             | 09.01       |                |                |                |                         |                |               |             |                |                |     |           |                |        |   |                |     |
| 1.4 16V | 55      |             | 01.99       | 09.01 - ABS |                |                |                |                         |                |               |             |                |                |     |           |                |        |   |                |     |
| 1.6     | 55      | 6N-TY140001 |             | 09.99       |                |                |                |                         |                |               |             |                |                |     |           |                |        |   |                |     |
| 1.7 SDI |         |             | 05.97       | 09.01       |                |                |                |                         |                |               |             |                |                |     |           |                |        |   |                |     |
| 1.9 D   |         | 6N-TY140001 |             | 09.01       |                |                |                |                         |                |               |             |                |                |     |           |                |        |   |                |     |
| 1.9 SDI |         | 6N-TY140001 |             | 09.01       |                |                |                |                         |                |               |             |                |                |     |           |                |        |   |                |     |



| VOLKSWAGEN POLO III (95-01) |         |                |             |       |             |                 |                |        |   |                      |                |     |
|-----------------------------|---------|----------------|-------------|-------|-------------|-----------------|----------------|--------|---|----------------------|----------------|-----|
|                             | 1.05    | 6N-TW082001    |             | 09.96 |             | 24.3481-1735.5  | 240283         |        |   | D=48, - Halter       | ATE            |     |
|                             | 1.3     | 6N-TW082001    |             | 04.97 |             | 24.3481-1736.5  | 240284         |        |   | D=48, - Halter       | ATE            |     |
|                             | 1.4     | 40 6N-TW082001 |             | 09.01 |             | 11.0441-4808.2  | 250022         |        |   | Dichtungssatz        | ATE            |     |
|                             | 1.4     | 44 6N-TW082001 |             | 09.01 |             | 11.0101-4801.2  | 260006         |        |   | Hülsensatz           | ATE            |     |
|                             | 1.6     | 55 6N-TW082001 |             | 09.99 |             | 24.0102-4801.2  | 260085         |        |   | Hülsensatz+Schrauben | ATE            |     |
|                             | 1.9 D   | 6N-TW082001    |             | 09.01 |             |                 |                |        |   |                      |                |     |
|                             | 1.9 SDI | 6N-TW082001    |             | 09.01 |             |                 |                |        |   |                      |                |     |
|                             | 1.4 16V | 55             |             | 01.99 | 09.01       | + ABS           | 24.3541-1779.5 | 240249 |   |                      | D=54, - Halter | LUC |
|                             | 1.4 16V | 74             |             | 04.96 | 09.01       | - ⊕             | 24.3541-1780.5 | 240250 |   |                      | D=54, - Halter | LUC |
|                             | 1.4 TDI | 55             |             | 01.99 | 09.01       |                 | 11.0101-5403.2 | 260010 |   |                      | Faltenbalgsatz | LUC |
| 1.4 16V                     | 74      |                | 04.96       | 09.01 | + ⊕         | 24.3541-1779.5  | 240249         |        |   | D=54, - Halter       | LUC            |     |
|                             |         |                |             |       |             | 24.3541-1780.5  | 240250         |        |   | D=54, - Halter       | LUC            |     |
|                             |         |                |             |       |             | 11.0101-5403.2  | 260010         |        |   | Faltenbalgsatz       | LUC            |     |
| 1.6 GTI                     |         |                | 04.98       | 09.01 |             | 24.3541-1779.5  | 240249         |        |   | D=54, - Halter       | LUC            |     |
|                             |         |                |             |       |             | 24.3541-1780.5  | 240250         |        |   | D=54, - Halter       | LUC            |     |
|                             |         |                |             |       |             | 11.0101-5403.2  | 260010         |        |   | Faltenbalgsatz       | LUC            |     |
|                             | 1.0     |                |             | 07.96 | 09.01       |                 | 83.7852-0377.3 | 330835 | 2 |                      | L=375          |     |
|                             | 1.05    |                |             | 10.94 | 09.96       |                 |                |        |   |                      |                |     |
|                             | 1.3     |                |             | 10.94 | 04.97       |                 |                |        |   |                      |                |     |
|                             | 1.4     | 40             |             | 07.95 | 09.01       |                 |                |        |   |                      |                |     |
|                             | 1.4     | 44             |             | 07.95 | 09.01       |                 |                |        |   |                      |                |     |
|                             | 1.4 16V | 55             |             | 01.99 | 09.01       |                 |                |        |   |                      |                |     |
|                             | 1.4 16V | 74             |             | 04.96 | 09.01       | - Motorsport 1) |                |        |   |                      |                |     |
|                             | 1.4 TDI | 55             |             | 01.99 | 09.01       |                 |                |        |   |                      |                |     |
|                             | 1.6     | 55             |             | 10.94 | 09.99       |                 |                |        |   |                      |                |     |
|                             | 1.6 GTI |                |             | 04.98 | 09.01       |                 |                |        |   |                      |                |     |
|                             | 1.7 SDI |                |             | 05.97 | 09.01       |                 |                |        |   |                      |                |     |
|                             | 1.9 D   |                |             | 10.94 | 09.01       |                 |                |        |   |                      |                |     |
|                             | 1.9 SDI |                |             | 10.94 | 09.01       |                 |                |        |   |                      |                |     |
|                             | 1.4 16V | 74             |             | 04.96 | 09.01       | + Motorsport 2) | 83.7838-0435.3 | 330834 | 2 |                      | L=435          |     |
|                             | 1.4 16V | 74             |             | 04.96 | 09.99       | + ⊕             | 24.3384-1737.5 | 240301 |   |                      | D=38, - Halter | LUC |
|                             |         |                |             |       |             | 24.3384-1738.5  | 240302         |        |   | D=38, - Halter       | LUC            |     |
| 1.4 16V                     | 55      |                | 01.99       | 09.01 | + ABS       | 24.3344-1711.7  | 220539         |        |   | D=34, - Halter       | LUC            |     |
| 1.4 16V                     | 74      |                | 10.99       | 09.01 | + ⊕         | 24.3344-1712.7  | 220540         |        |   | D=34, - Halter       | LUC            |     |
| 1.4 TDI                     | 55      |                | 01.99       | 09.01 | + ABS       |                 |                |        |   |                      |                |     |
| 1.6 GTI                     |         |                | 04.98       | 09.99 |             | 24.3384-1737.5  | 240301         |        |   | + roter Sattel 3)    | LUC            |     |
|                             |         |                |             |       |             | 24.3384-1738.5  | 240302         |        |   | + roter Sattel 3)    | LUC            |     |
| 1.6 GTI                     |         |                | 10.99       | 09.01 |             | 24.3344-1711.7  | 220539         |        |   | D=34, - Halter       | LUC            |     |
|                             |         |                |             |       |             | 24.3344-1712.7  | 220540         |        |   | D=34, - Halter       | LUC            |     |
|                             | 1.0     |                |             | 07.96 | 09.99       |                 | 24.5230-0143.3 | 330402 | 2 |                      | L=143          |     |
|                             | 1.05    |                |             | 10.94 | 09.96       |                 |                |        |   |                      |                |     |
|                             | 1.3     |                |             | 10.94 | 04.97       |                 |                |        |   |                      |                |     |
|                             | 1.4     | 40             |             | 07.95 | 09.99       |                 |                |        |   |                      |                |     |
|                             | 1.4     | 44             |             | 07.95 | 09.99       |                 |                |        |   |                      |                |     |
|                             | 1.4 16V | 55             |             | 01.99 | 09.99       | - ABS           |                |        |   |                      |                |     |
|                             | 1.4 16V | 74             |             | 04.96 | 09.99       | - ⊕             |                |        |   |                      |                |     |
|                             | 1.4 TDI | 55             |             | 01.99 | 09.99       | - ABS           |                |        |   |                      |                |     |
|                             | 1.6     | 55             |             | 10.94 | 09.99       |                 |                |        |   |                      |                |     |
|                             | 1.7 SDI |                |             | 05.97 | 09.99       |                 |                |        |   |                      |                |     |
|                             | 1.9 D   |                |             | 10.94 | 09.99       |                 |                |        |   |                      |                |     |
|                             | 1.9 SDI |                |             | 10.94 | 09.99       |                 |                |        |   |                      |                |     |
|                             | 1.4 16V | 55             |             | 01.99 | 09.99       | + ABS           | 83.7858-0140.3 | 330837 | 2 |                      | L=140          |     |
|                             | 1.4     | 40             |             | 10.99 | 09.01       |                 |                |        |   |                      |                |     |
|                             | 1.4     | 44             |             | 10.99 | 09.01       |                 |                |        |   |                      |                |     |
| 1.4 16V                     | 55      |                | 10.99       | 09.01 | - ABS       |                 |                |        |   |                      |                |     |
| 1.4 16V                     | 74      |                | 10.99       | 09.01 | - ⊕         |                 |                |        |   |                      |                |     |
| 1.4 TDI                     | 55      |                | 10.99       | 09.01 | - ABS       |                 |                |        |   |                      |                |     |
| 1.7 SDI                     |         |                | 10.99       | 09.01 |             |                 |                |        |   |                      |                |     |
| 1.9 D                       |         |                | 10.99       | 09.01 |             |                 |                |        |   |                      |                |     |
| 1.9 SDI                     |         |                | 10.99       | 09.01 |             |                 |                |        |   |                      |                |     |
| 1.4 16V                     | 55      |                | 01.99       | 09.99 | + ABS       | 83.7704-0160.3  | 330805         | 2      |   | L=160                |                |     |
| 1.4 16V                     | 74      |                | 04.96       | 09.99 | + ⊕         |                 |                |        |   |                      |                |     |
| 1.4 TDI                     | 55      |                | 01.99       | 09.99 | + ABS       |                 |                |        |   |                      |                |     |
| 1.6 GTI                     |         |                | 04.98       | 09.99 |             |                 |                |        |   |                      |                |     |
|                             | 1.0     |                |             | 07.96 | 09.01       |                 | 03.3217-2112.3 | 020027 |   | + GG 4)              | Rz 17,46       |     |
|                             | 1.05    |                |             | 10.94 | 09.96       |                 | 24.3217-0908.3 | 020167 |   | + ALU 5)             | Rz 17,46       |     |
|                             | 1.3     |                |             | 10.94 | 04.97       |                 |                |        |   |                      |                |     |
|                             | 1.4     | 40             |             | 07.95 | 09.01       |                 |                |        |   |                      |                |     |
|                             | 1.4     | 44             |             | 07.95 | 09.01       |                 |                |        |   |                      |                |     |
|                             | 1.4 16V | 55             |             | 01.99 | 09.01       | + ABS           |                |        |   |                      |                |     |
|                             | 1.4 16V | 74             |             | 04.96 | 09.01       | - ⊕             |                |        |   |                      |                |     |
|                             | 1.4 TDI | 55             |             | 01.99 | 09.01       | + ABS           |                |        |   |                      |                |     |
|                             | 1.6     | 55             |             | 10.94 | 09.99       |                 |                |        |   |                      |                |     |
|                             | 1.7 SDI |                |             | 05.97 | 09.01       |                 |                |        |   |                      |                |     |
| 1.9 D                       |         |                | 10.94       | 09.01 |             |                 |                |        |   |                      |                |     |
| 1.9 SDI                     |         |                | 10.94       | 09.01 |             |                 |                |        |   |                      |                |     |
| 1.4 16V                     | 55      |                | 01.99       | 09.01 | - ABS       | 24.3219-0909.3  | 020188         |        |   | Rz 19,05             |                |     |
| 1.4 TDI                     | 55      |                | 01.99       | 09.01 | - ABS       |                 |                |        |   |                      |                |     |
|                             | 1.0     |                | 6N-V-045000 | 07.96 | - ABS       | 24.3727-0161.2  | 580161         | 2      | ↓ |                      | L=1512         |     |
|                             | 1.05    |                |             | 10.94 | - ABS       |                 |                |        |   |                      |                |     |
|                             | 1.3     |                |             | 10.94 | 04.97       | - ABS           |                |        |   |                      |                |     |
|                             | 1.4     | 40             | 6N-V-045000 | 07.95 | - ABS       |                 |                |        |   |                      |                |     |
|                             | 1.4     | 44             | 6N-V-045000 | 07.95 | - ABS       |                 |                |        |   |                      |                |     |
|                             | 1.4 16V | 74             | 6N-V-045000 | 04.96 | - ABS / - ⊕ |                 |                |        |   |                      |                |     |
|                             | 1.6     | 55             | 6N-V-045000 | 10.94 | - ABS       |                 |                |        |   |                      |                |     |

1) - motorsports / - motorsports / - Motorsport / - motorismo  
2) + motorsports / + motorsports / + Motorsport / + motorismo  
3) + red caliper / + pinza rossa / + étrier rouge / + pinza roja  
4) + cast iron / + ghisa / + fonte grise / + fundición de gris  
5) + aluminium / + aluminio / + aluminium / + aluminio



**VOLKSWAGEN POLO III (95-01)**

|         |         |             |             |                   |                       |                           |                |        |                 |               |
|---------|---------|-------------|-------------|-------------------|-----------------------|---------------------------|----------------|--------|-----------------|---------------|
|         | 1.7 SDI |             | 6N-V-045000 | 05.97             | - ABS                 | 24.3727-0161.2            | 580161         | 2 ↓    | L=1512          |               |
|         | 1.9 D   |             | 6N-V-045000 | 10.94             | - ABS                 |                           |                |        |                 |               |
|         | 1.9 SDI |             | 6N-V-045000 | 10.94             | - ABS                 |                           |                |        |                 |               |
|         | 1.0     |             | 6N-V-045001 |                   | 09.01 - ABS           | 24.3727-0161.2            | 580161         | 2 ↓    | L=1512          |               |
|         | 1.4     | 40          | 6N-V-045001 |                   | 09.01 - ABS           |                           |                |        |                 |               |
|         | 1.4     | 44          | 6N-V-045001 |                   | 09.01 - ABS           |                           |                |        |                 |               |
|         | 1.4 16V | 55          |             | 01.99             | 09.01 - ABS           |                           |                |        |                 |               |
|         | 1.4 16V | 74          | 6N-V-045001 |                   | 09.01 - ABS / - ⊕     |                           |                |        |                 |               |
|         | 1.4 TDI | 55          |             | 01.99             | 09.01 - ABS           |                           |                |        |                 |               |
|         | 1.6     | 55          | 6N-V-045001 |                   | 09.99 - ABS           |                           |                |        |                 |               |
|         | 1.7 SDI |             | 6N-V-045001 |                   | 09.01 - ABS           |                           |                |        |                 |               |
|         | 1.9 D   |             | 6N-V-045001 |                   | 09.01 - ABS           |                           |                |        |                 |               |
|         | 1.9 SDI |             | 6N-V-045001 |                   | 09.01 - ABS           |                           |                |        |                 |               |
|         | 1.0     |             | 6N-WW130000 | 07.96             | + ABS                 | 24.3727-0161.2            | 580161         | 2 ↓    | L=1512          |               |
|         | 1.05    |             |             | 10.94             | 09.96 + ABS           |                           |                |        |                 |               |
| 1.3     |         |             | 10.94       | 04.97 + ABS       |                       |                           |                |        |                 |               |
| 1.4     | 40      | 6N-WW130000 | 07.95       | + ABS             |                       |                           |                |        |                 |               |
| 1.4     | 44      | 6N-WW130000 | 07.95       | + ABS             |                       |                           |                |        |                 |               |
| 1.4 16V | 74      | 6N-WW130000 | 04.96       | + ABS / - ⊕       |                       |                           |                |        |                 |               |
| 1.6     | 55      | 6N-WW130000 | 10.94       | + ABS             |                       |                           |                |        |                 |               |
| 1.7 SDI |         | 6N-WW130000 | 05.97       | + ABS             |                       |                           |                |        |                 |               |
| 1.9 D   |         | 6N-WW130000 | 10.94       | + ABS             |                       |                           |                |        |                 |               |
| 1.9 SDI |         | 6N-WW130000 | 10.94       | + ABS             |                       |                           |                |        |                 |               |
| 1.0     |         | 6N-WW130001 |             | 09.01 + ABS       | 24.3727-0162.2        | 580162                    | 2 ↓            | L=1514 |                 |               |
| 1.4     | 40      | 6N-WW130001 |             | 09.01 + ABS       |                       |                           |                |        |                 |               |
| 1.4     | 44      | 6N-WW130001 |             | 09.01 + ABS       |                       |                           |                |        |                 |               |
| 1.4 16V | 74      | 6N-WW130001 |             | 09.01 + ABS / - ⊕ |                       |                           |                |        |                 |               |
| 1.6     | 55      | 6N-WW130001 |             | 09.99 + ABS       |                       |                           |                |        |                 |               |
| 1.7 SDI |         | 6N-WW130001 |             | 09.01 + ABS       |                       |                           |                |        |                 |               |
| 1.9 D   |         | 6N-WW130001 |             | 09.01 + ABS       |                       |                           |                |        |                 |               |
| 1.9 SDI |         | 6N-WW130001 |             | 09.01 + ABS       |                       |                           |                |        |                 |               |
| 1.4 16V | 55      |             | 01.99       | 09.99 + ABS       | 24.3727-0165.2        | 580165                    | 2 ↓            | L=1641 |                 |               |
| 1.4 16V | 74      | 6N-WW130001 |             | 09.99 + ⊕         |                       |                           |                |        |                 |               |
| 1.4 TDI | 55      |             | 01.99       | 09.99 + ABS       |                       |                           |                |        |                 |               |
| 1.6 GTI |         | 6N-WW130001 |             | 09.99             |                       |                           |                |        |                 |               |
| 1.4 16V | 55      |             | 10.99       | 09.01 + ABS       | 24.3727-0165.2        | 580165                    | 2 ↓            | L=1641 |                 |               |
| 1.4 16V | 74      |             | 10.99       | 09.01 + ⊕         |                       |                           |                |        |                 |               |
| 1.4 TDI | 55      |             | 10.99       | 09.01 + ABS       |                       |                           |                |        |                 |               |
| 1.6 GTI |         |             | 10.99       | 09.01             |                       |                           |                |        |                 |               |
|         | 1.0     |             |             | 07.96             | 09.01                 | 03.6583-0184.3            | 320229         |        | BRL 8/3 (4) ATE |               |
|         | 1.05    |             |             | 10.94             | 09.96                 |                           |                |        |                 |               |
|         | 1.3     |             |             | 10.94             | 04.97                 |                           |                |        |                 |               |
|         | 1.4     | 40          |             | 07.95             | 09.01                 |                           |                |        |                 |               |
|         | 1.4     | 44          |             | 07.95             | 09.01                 |                           |                |        |                 |               |
|         | 1.4 16V | 55          |             | 01.99             | 09.01 - ABS           |                           |                |        |                 |               |
|         | 1.4 16V | 74          |             | 04.96             | 09.01 - Motorsport 1) |                           |                |        |                 |               |
|         | 1.4 TDI | 55          |             | 01.99             | 09.01 - ABS           |                           |                |        |                 |               |
|         | 1.6     | 55          |             | 10.94             | 09.99                 |                           |                |        |                 |               |
|         | 1.7 SDI |             |             | 05.97             | 09.01                 |                           |                |        |                 |               |
|         | 1.9 D   |             |             | 10.94             | 09.01                 |                           |                |        |                 |               |
|         | 1.9 SDI |             |             | 10.94             | 09.01                 |                           |                |        |                 |               |
|         | 1.4 16V | 74          |             | 04.96             | 09.01 + Motorsport 2) | 03.6583-0167.3            | 320140         |        | BRL 8/3 (4) ATE |               |
|         | 1.4 16V | 55          |             | 01.99             | 09.01 + ABS           | 03.6583-0179.3            | 320228         |        | BRL 8/3 (4) ATE |               |
|         | 1.4 16V | 74          |             | 04.96             | 09.01 + ⊕             |                           |                |        |                 |               |
| 1.4 TDI | 55      |             | 01.99       | 09.01 + ABS       |                       |                           |                |        |                 |               |
| 1.6 GTI |         |             | 04.98       | 09.01             |                       |                           |                |        |                 |               |
|         | 1.4 TDI | 55          |             | 01.99             | 09.01                 | 24.2519-1701.3            | 040075         |        | Nz 19,05        |               |
|         |         | 1.0         | ↓           |                   | 07.96                 | 09.01 - Fahrschulwagen 3) | 24.3728-2707.2 | 592707 |                 | L=1047, + AUT |
|         |         | 1.05        | ↓           |                   | 10.94                 | 09.96 - Fahrschulwagen 3) |                |        |                 |               |
|         |         | 1.3         | ↓           |                   | 10.94                 | 04.97 - Fahrschulwagen 3) |                |        |                 |               |
|         |         | 1.4         | ↓ 40        |                   | 07.95                 | 09.01 - Fahrschulwagen 3) |                |        |                 |               |
|         |         | 1.4         | ↓ 44        |                   | 07.95                 | 09.01 - Fahrschulwagen 3) |                |        |                 |               |
|         |         | 1.4 16V     | ↓ 55        |                   | 01.99                 | 09.01 - Fahrschulwagen 3) |                |        |                 |               |
|         |         | 1.4 16V     | ↓ 74        |                   | 04.96                 | 09.01 - Fahrschulwagen 3) |                |        |                 |               |
|         |         | 1.6         | ↓ 55        |                   | 10.94                 | 09.99 - Fahrschulwagen 3) |                |        |                 |               |
|         |         | 1.6 GTI     | ↓           |                   | 04.98                 | 09.01 - Fahrschulwagen 3) |                |        |                 |               |
|         |         | 1.7 SDI     | ↓           |                   | 05.97                 | 09.01 - Fahrschulwagen 3) |                |        |                 |               |
|         |         | 1.9 D       | ↓           |                   | 10.94                 | 09.01 - Fahrschulwagen 3) |                |        |                 |               |
|         |         | 1.9 SDI     | ↓           |                   | 10.94                 | 09.01 - Fahrschulwagen 3) |                |        |                 |               |

**VOLKSWAGEN POLO IV (02-09)**

|  |         |    |             |       |                          |                |        |  |           |
|--|---------|----|-------------|-------|--------------------------|----------------|--------|--|-----------|
|  | 1.2     | 40 | 9N-5-180000 | 11.01 | - ABS/ + Servolenkung 4) | 24.2120-1736.3 | 010732 |  | Thz 20,64 |
|  | 1.4 16V |    | 9N-5-180000 | 11.01 | - ABS                    |                |        |  |           |
|  | 1.4 16V | 63 | 9N-5-180000 | 05.06 | - ABS                    |                |        |  |           |
|  | 1.4 16V | 74 | 9N-5-180000 | 11.01 | - ABS                    |                |        |  |           |
|  | 1.4 FSI |    | 9N-5-180000 | 11.01 | - ABS                    |                |        |  |           |
|  | 1.4 TDI |    | 9N-5-180000 | 11.01 | - ABS                    |                |        |  |           |
|  | 1.6 16V | 77 | 9N-5-180000 | 05.06 | - ABS                    |                |        |  |           |
|  | 1.9 SDI |    | 9N-5-180000 | 11.01 | - ABS                    |                |        |  |           |
|  | 1.9 TDI | 74 | 9N-5-180000 | 11.01 | - ABS                    |                |        |  |           |
|  | 1.9 TDI | 96 | 9N-5-180000 | 10.03 | - ABS                    |                |        |  |           |
|  | 2.0     | 85 | 9N-5-180000 | 04.02 | - ABS                    |                |        |  |           |
|  | 1.4 16V |    | 9N-5-180000 | 11.01 | + ABS                    | 24.2120-1734.3 | 010702 |  | Thz 20,64 |
|  | 1.4 16V | 63 | 9N-5-180000 | 05.06 | + ABS                    |                |        |  |           |

1) - motorsports / - motorsports / - Motorsport / - motorismo  
 2) + motorsports / + motorsports / + Motorsport / + motorismo  
 3) - driving school vehicle / - veicolo scuola guida / - véhicule auto école / - vehiculo autoescuela  
 4) - ABS/ + power steering / - ABS/ + servosterzo / - ABS/ + direction assistée / - ABS/ + dirección asistida



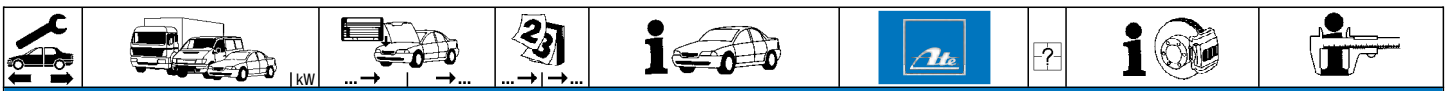

**VOLKSWAGEN POLO IV (02-09)**















|  |   |  |  |   |   |  |                            |  |  |                   |
|--|---|--|--|---|---|--|----------------------------|--|--|-------------------|
|  | 1.4 16V<br>1.4 FSI<br>1.4 TDI<br>1.6 16V<br>1.9 SDI<br>1.9 TDI<br>1.9 TDI<br>2.0  | 74<br>77<br>74<br>96<br>85                                       | 9N-5-180000<br>9N-5-180000<br>9N-5-180000<br>9N-5-180000<br>9N-5-180000<br>9N-5-180000<br>9N-5-180000  | 11.01<br>11.01<br>11.01<br>05.06<br>11.01<br>11.01<br>10.03<br>04.02  | + ABS<br>+ ABS<br>+ ABS<br>+ ABS<br>+ ABS<br>+ ABS<br>+ ABS   | 24.2120-1734.3                                     | 010702                     |  | THz 20,64                                      |                   |
|  | 1.2<br>1.2<br>1.4 16V<br>1.4 16V<br>1.4 16V<br>1.4 FSI<br>1.4 TDI<br>1.6 16V<br>1.8 GTI<br>1.8 GTI<br>1.9 SDI<br>1.9 TDI<br>1.9 TDI<br>2.0        | 40<br>51<br>63<br>74<br>74<br>77<br>110<br>132<br>74<br>96<br>85 | 9N-5-500001<br>9N-5-500001<br>9N-5-500001<br>9N-5-500001<br>9N-5-500001<br>9N-5-500001<br>9N-5-500001<br>9N-5-500001<br>9N-5-500001<br>9N-5-500001<br>9N-5-500001<br>9N-5-500001<br>9N-5-500001<br>9N-5-500001 | 11.01<br>04.07<br>05.09<br>05.09<br>05.09<br>05.09<br>05.09<br>05.09<br>09.05<br>06.06<br>05.09<br>05.09<br>05.09<br>05.09          | 05.09<br>05.09<br>05.09<br>05.09<br>05.09<br>05.09<br>05.09<br>05.09<br>05.09<br>05.09<br>05.09<br>05.09<br>05.09<br>05.09  | 24.2120-1736.3                                     | 010732                     | - ABS  | THz 20,64                                      |                   |
|  | 1.2<br>1.2<br>1.4 16V<br>1.4 16V<br>1.4 16V<br>1.4 FSI<br>1.4 TDI<br>1.6 16V<br>1.8 GTI<br>1.8 GTI<br>1.9 SDI<br>1.9 TDI<br>1.9 TDI<br>2.0        | 40<br>51<br>63<br>74<br>74<br>77<br>110<br>132<br>74<br>96<br>85 | 9N-5-500001<br>9N-5-500001<br>9N-5-500001<br>9N-5-500001<br>9N-5-500001<br>9N-5-500001<br>9N-5-500001<br>9N-5-500001<br>9N-5-500001<br>9N-5-500001<br>9N-5-500001<br>9N-5-500001<br>9N-5-500001<br>9N-5-500001 | 11.01<br>04.07<br>05.09<br>05.09<br>05.09<br>05.09<br>05.09<br>05.09<br>09.05<br>06.06<br>05.09<br>05.09<br>05.09<br>05.09          | 05.09<br>05.09<br>05.09<br>05.09<br>05.09<br>05.09<br>05.09<br>05.09<br>05.09<br>05.09<br>05.09<br>05.09<br>05.09<br>05.09  | 24.2119-1712.3<br>24.2120-1734.3                   | 010912<br>010702           | + ABS<br>+ ABS                                       | THz 19,05 - Behälter<br>THz 20,64              |                   |
|  | 1.2<br>1.2<br>1.2<br>1.4 16V<br>1.4 16V<br>1.4 16V<br>1.4 FSI<br>1.4 TDI<br>1.6 16V<br>1.8 GTI<br>1.8 GTI<br>1.9 SDI<br>1.9 TDI<br>1.9 TDI<br>2.0 | 40<br>51<br>63<br>74<br>74<br>77<br>110<br>132<br>74<br>96<br>85 |  | 11.01<br>11.01<br>04.07<br>11.01<br>05.06<br>11.01<br>11.01<br>11.01<br>05.06<br>09.05<br>06.06<br>11.01<br>11.01<br>10.03<br>04.02 | 05.09 PR: 1LM,1ZN<br>05.09 PR: 1LM,1ZN<br>05.09 PR: 1LM,1ZN<br>05.09 PR: 1LM,1ZN<br>05.09 PR: 1LM,1ZN<br>05.09 PR: 1LM,1ZN<br>05.09 PR: 1LM,1ZN<br>05.09 PR: 1LM,1ZN<br>05.09 PR: 1LM,1ZN<br>05.09 PR: 1LM,1ZN<br>05.09 PR: 1LM,1ZN<br>05.09 PR: 1LM,1ZN<br>05.09 PR: 1LM,1ZN<br>05.09 PR: 1LM,1ZN<br>05.09 PR: 1LM,1ZN   | 24.3481-1735.5<br>24.3481-1736.5                   | 240283<br>240284           | <input type="checkbox"/><br><input type="checkbox"/> | D=48, - Halter<br>D=48, - Halter               | ATE<br>ATE        |
|  | 1.2<br>1.2<br>1.2<br>1.4 16V<br>1.4 16V<br>1.4 16V<br>1.4 FSI<br>1.4 TDI<br>1.6 16V<br>1.8 GTI<br>1.8 GTI<br>1.9 SDI<br>1.9 TDI<br>1.9 TDI<br>2.0 | 40<br>51<br>63<br>74<br>74<br>77<br>110<br>132<br>74<br>96<br>85 |  | 11.01<br>11.01<br>04.07<br>11.01<br>05.06<br>11.01<br>11.01<br>11.01<br>05.06<br>09.05<br>06.06<br>11.01<br>11.01<br>10.03<br>04.02 | 05.09 PR: 1LQ,1LR,1ZF,1ZG<br>05.09 PR: 1LQ,1LR,1ZF,1ZG<br>05.09 PR: 1LQ,1LR,1ZF,1ZG<br>05.09 PR: 1LQ,1LR,1ZF,1ZG<br>05.09 PR: 1LQ,1LR,1ZF,1ZG<br>05.09 PR: 1LQ,1LR,1ZF,1ZG<br>05.09 PR: 1LQ,1LR,1ZF,1ZG<br>05.09 PR: 1LQ,1LR,1ZF,1ZG<br>05.09 PR: 1LQ,1LR,1ZF,1ZG<br>05.09 PR: 1LQ,1LR,1ZF,1ZG<br>05.09 PR: 1LQ,1LR,1ZF,1ZG<br>05.09 PR: 1LQ,1LR,1ZF,1ZG<br>05.09 PR: 1LQ,1LR,1ZF,1ZG<br>05.09 PR: 1LQ,1LR,1ZF,1ZG<br>05.09 PR: 1LQ,1LR,1ZF,1ZG | 11.9541-9549.2<br>11.9541-9550.2<br>11.0101-5409.2 | 220575<br>220576<br>260035 | <input type="checkbox"/><br><input type="checkbox"/> | D=54, - Halter<br>D=54, - Halter<br>Hülsensatz | ATE<br>ATE<br>ATE |
|  | 1.2<br>1.2<br>1.2<br>1.4 16V<br>1.4 16V<br>1.4 16V<br>1.4 FSI<br>1.4 TDI<br>1.6 16V<br>1.8 GTI<br>1.8 GTI<br>1.9 SDI<br>1.9 TDI<br>1.9 TDI<br>2.0 | 40<br>51<br>63<br>74<br>74<br>77<br>110<br>132<br>74<br>96<br>85 |  | 11.01<br>11.01<br>04.07<br>11.01<br>05.06<br>11.01<br>11.01<br>11.01<br>05.06<br>09.05<br>06.06<br>11.01<br>11.01<br>10.03<br>04.02 | 05.09 PR: 1LN,1ZD,1ZH<br>05.09 PR: 1LN,1ZD,1ZH<br>05.09 PR: 1LN,1ZD,1ZH<br>05.09 PR: 1LN,1ZD,1ZH<br>05.09 PR: 1LN,1ZD,1ZH<br>05.09 PR: 1LN,1ZD,1ZH<br>05.09 PR: 1LN,1ZD,1ZH<br>05.09 PR: 1LN,1ZD,1ZH<br>05.09 PR: 1LN,1ZD,1ZH<br>05.09 PR: 1LN,1ZD,1ZH<br>05.09 PR: 1LN,1ZD,1ZH<br>05.09 PR: 1LN,1ZD,1ZH<br>05.09 PR: 1LN,1ZD,1ZH<br>05.09 PR: 1LN,1ZD,1ZH<br>05.09 PR: 1LN,1ZD,1ZH   | 24.3541-1797.7<br>24.3541-1798.7                   | 220553<br>220554           | <input type="checkbox"/><br><input type="checkbox"/> | D=54, - Halter<br>D=54, - Halter               | LUC<br>LUC        |



| VOLKSWAGEN POLO IV (02-09) |         | kW      |       | PR: 1LJ |                 | PR: 1LJ         |                | PR: 1LJ |   | PR: 1LJ |  | PR: 1LJ |  | PR: 1LJ |  | PR: 1LJ |  | PR: 1LJ |  |        |   |  |  |  |  |  |  |  |  |  |  |  |  |  |
|----------------------------|---------|---------|-------|---------|-----------------|-----------------|----------------|---------|---|---------|--|---------|--|---------|--|---------|--|---------|--|--------|---|--|--|--|--|--|--|--|--|--|--|--|--|--|
|                            | 1.2     | 40      | 11.01 | 05.09   | PR: 1LJ         | 11.9541-9595.2  | 220501         | 2       |   |         |  |         |  |         |  |         |  |         |  |        |   |  |  |  |  |  |  |  |  |  |  |  |  |  |
|                            | 1.2     | 51      | 11.01 | 05.09   | PR: 1LJ         | 11.9541-9596.2  | 220502         |         |   |         |  |         |  |         |  |         |  |         |  |        |   |  |  |  |  |  |  |  |  |  |  |  |  |  |
|                            | 1.4 16V | 63      | 04.07 | 05.09   | PR: 1LJ         | 11.0441-5409.2  | 250031         |         |   |         |  |         |  |         |  |         |  |         |  |        |   |  |  |  |  |  |  |  |  |  |  |  |  |  |
|                            | 1.4 16V | 74      | 11.01 | 05.09   | PR: 1LJ         | 11.0101-5409.2  | 260035         |         |   |         |  |         |  |         |  |         |  |         |  |        |   |  |  |  |  |  |  |  |  |  |  |  |  |  |
|                            | 1.4 FSI | 77      | 05.06 | 05.09   | PR: 1LJ         | 11.8171-0008.1  | 990049         |         |   |         |  |         |  |         |  |         |  |         |  |        |   |  |  |  |  |  |  |  |  |  |  |  |  |  |
|                            | 1.4 TDI | 110     | 11.01 | 05.09   | PR: 1LJ         | 11.8116-0143.1  | 390513         |         |   |         |  |         |  |         |  |         |  |         |  |        |   |  |  |  |  |  |  |  |  |  |  |  |  |  |
|                            | 1.6 16V | 110     | 05.06 | 05.09   | PR: 1LJ         |                 |                |         |   |         |  |         |  |         |  |         |  |         |  |        |   |  |  |  |  |  |  |  |  |  |  |  |  |  |
|                            | 1.8 GTI | 132     | 09.05 | 05.09   | PR: 1LJ         |                 |                |         |   |         |  |         |  |         |  |         |  |         |  |        |   |  |  |  |  |  |  |  |  |  |  |  |  |  |
|                            | 1.8 GTI | 132     | 06.06 | 05.09   | PR: 1LJ         |                 |                |         |   |         |  |         |  |         |  |         |  |         |  |        |   |  |  |  |  |  |  |  |  |  |  |  |  |  |
|                            | 1.9 SDI | 74      | 11.01 | 05.09   | PR: 1LJ         |                 |                |         |   |         |  |         |  |         |  |         |  |         |  |        |   |  |  |  |  |  |  |  |  |  |  |  |  |  |
|                            | 1.9 TDI | 96      | 11.01 | 05.09   | PR: 1LJ         |                 |                |         |   |         |  |         |  |         |  |         |  |         |  |        |   |  |  |  |  |  |  |  |  |  |  |  |  |  |
|                            | 1.9 TDI | 96      | 10.03 | 05.09   | PR: 1LJ         |                 |                |         |   |         |  |         |  |         |  |         |  |         |  |        |   |  |  |  |  |  |  |  |  |  |  |  |  |  |
|                            | 2.0     | 85      | 04.02 | 05.09   | PR: 1LJ         |                 |                |         |   |         |  |         |  |         |  |         |  |         |  |        |   |  |  |  |  |  |  |  |  |  |  |  |  |  |
|                            |         | 1.2     | 40    | 11.01   | 05.09           |                 | 83.6247-0522.3 |         |   |         |  |         |  |         |  |         |  |         |  | 330595 | 2 |  |  |  |  |  |  |  |  |  |  |  |  |  |
|                            |         | 1.2     | 51    | 11.01   | 05.09           |                 |                |         |   |         |  |         |  |         |  |         |  |         |  |        |   |  |  |  |  |  |  |  |  |  |  |  |  |  |
|                            |         | 1.4 16V | 63    | 04.07   | 05.09           |                 |                |         |   |         |  |         |  |         |  |         |  |         |  |        |   |  |  |  |  |  |  |  |  |  |  |  |  |  |
| 1.4 16V                    |         | 74      | 11.01 | 05.09   |                 |                 |                |         |   |         |  |         |  |         |  |         |  |         |  |        |   |  |  |  |  |  |  |  |  |  |  |  |  |  |
| 1.4 FSI                    |         | 77      | 11.01 | 05.09   |                 |                 |                |         |   |         |  |         |  |         |  |         |  |         |  |        |   |  |  |  |  |  |  |  |  |  |  |  |  |  |
| 1.4 TDI                    |         | 110     | 11.01 | 05.09   |                 |                 |                |         |   |         |  |         |  |         |  |         |  |         |  |        |   |  |  |  |  |  |  |  |  |  |  |  |  |  |
| 1.6 16V                    |         | 110     | 05.06 | 05.09   |                 |                 |                |         |   |         |  |         |  |         |  |         |  |         |  |        |   |  |  |  |  |  |  |  |  |  |  |  |  |  |
| 1.8 GTI                    |         | 132     | 09.05 | 05.09   |                 |                 |                |         |   |         |  |         |  |         |  |         |  |         |  |        |   |  |  |  |  |  |  |  |  |  |  |  |  |  |
| 1.8 GTI                    |         | 132     | 06.06 | 05.09   |                 |                 |                |         |   |         |  |         |  |         |  |         |  |         |  |        |   |  |  |  |  |  |  |  |  |  |  |  |  |  |
| 1.9 SDI                    |         | 74      | 11.01 | 05.09   |                 |                 |                |         |   |         |  |         |  |         |  |         |  |         |  |        |   |  |  |  |  |  |  |  |  |  |  |  |  |  |
| 1.9 TDI                    |         | 96      | 11.01 | 05.09   |                 |                 |                |         |   |         |  |         |  |         |  |         |  |         |  |        |   |  |  |  |  |  |  |  |  |  |  |  |  |  |
| 1.9 TDI                    |         | 96      | 10.03 | 05.09   |                 |                 |                |         |   |         |  |         |  |         |  |         |  |         |  |        |   |  |  |  |  |  |  |  |  |  |  |  |  |  |
| 2.0                        |         | 85      | 04.02 | 05.09   |                 |                 |                |         |   |         |  |         |  |         |  |         |  |         |  |        |   |  |  |  |  |  |  |  |  |  |  |  |  |  |
|                            |         | 1.2     | 40    | 11.01   | 05.09           | PR: 1KD,1KS,1KV | 24.3344-1709.7 | 220537  | 2 |         |  |         |  |         |  |         |  |         |  |        |   |  |  |  |  |  |  |  |  |  |  |  |  |  |
|                            |         | 1.2     | 51    | 11.01   | 05.09           | PR: 1KD,1KS,1KV | 24.3344-1710.7 | 220538  |   |         |  |         |  |         |  |         |  |         |  |        |   |  |  |  |  |  |  |  |  |  |  |  |  |  |
|                            |         | 1.4 16V | 63    | 04.07   | 05.09           | PR: 1KD,1KS,1KV |                |         |   |         |  |         |  |         |  |         |  |         |  |        |   |  |  |  |  |  |  |  |  |  |  |  |  |  |
|                            | 1.4 16V | 74      | 11.01 | 05.09   | PR: 1KD,1KS,1KV |                 |                |         |   |         |  |         |  |         |  |         |  |         |  |        |   |  |  |  |  |  |  |  |  |  |  |  |  |  |
|                            | 1.4 FSI | 77      | 11.01 | 05.09   | PR: 1KD,1KS,1KV |                 |                |         |   |         |  |         |  |         |  |         |  |         |  |        |   |  |  |  |  |  |  |  |  |  |  |  |  |  |
|                            | 1.4 TDI | 110     | 11.01 | 05.09   | PR: 1KD,1KS,1KV |                 |                |         |   |         |  |         |  |         |  |         |  |         |  |        |   |  |  |  |  |  |  |  |  |  |  |  |  |  |
|                            | 1.6 16V | 110     | 05.06 | 05.09   | PR: 1KD,1KS,1KV |                 |                |         |   |         |  |         |  |         |  |         |  |         |  |        |   |  |  |  |  |  |  |  |  |  |  |  |  |  |
|                            | 1.8 GTI | 132     | 09.05 | 05.09   | PR: 1KD,1KS,1KV |                 |                |         |   |         |  |         |  |         |  |         |  |         |  |        |   |  |  |  |  |  |  |  |  |  |  |  |  |  |
|                            | 1.8 GTI | 132     | 06.06 | 05.09   | PR: 1KD,1KS,1KV |                 |                |         |   |         |  |         |  |         |  |         |  |         |  |        |   |  |  |  |  |  |  |  |  |  |  |  |  |  |
|                            | 1.9 SDI | 74      | 11.01 | 05.09   | PR: 1KD,1KS,1KV |                 |                |         |   |         |  |         |  |         |  |         |  |         |  |        |   |  |  |  |  |  |  |  |  |  |  |  |  |  |
|                            | 1.9 TDI | 96      | 11.01 | 05.09   | PR: 1KD,1KS,1KV |                 |                |         |   |         |  |         |  |         |  |         |  |         |  |        |   |  |  |  |  |  |  |  |  |  |  |  |  |  |
|                            | 1.9 TDI | 96      | 10.03 | 05.09   | PR: 1KD,1KS,1KV |                 |                |         |   |         |  |         |  |         |  |         |  |         |  |        |   |  |  |  |  |  |  |  |  |  |  |  |  |  |
|                            | 2.0     | 85      | 04.02 | 05.09   | PR: 1KD,1KS,1KV |                 |                |         |   |         |  |         |  |         |  |         |  |         |  |        |   |  |  |  |  |  |  |  |  |  |  |  |  |  |
|                            |         | 1.2     | 40    | 11.01   | 05.09           | PR: 1KK,1KT     | 24.3384-1729.7 | 220541  |   |         |  |         |  |         |  |         |  |         |  |        | 2 |  |  |  |  |  |  |  |  |  |  |  |  |  |
|                            |         | 1.2     | 51    | 11.01   | 05.09           | PR: 1KK,1KT     | 24.3384-1730.7 | 220542  |   |         |  |         |  |         |  |         |  |         |  |        |   |  |  |  |  |  |  |  |  |  |  |  |  |  |
|                            |         | 1.4 16V | 63    | 04.07   | 05.09           | PR: 1KK,1KT     |                |         |   |         |  |         |  |         |  |         |  |         |  |        |   |  |  |  |  |  |  |  |  |  |  |  |  |  |
| 1.4 16V                    |         | 74      | 11.01 | 05.09   | PR: 1KK,1KT     |                 |                |         |   |         |  |         |  |         |  |         |  |         |  |        |   |  |  |  |  |  |  |  |  |  |  |  |  |  |
| 1.4 FSI                    |         | 77      | 11.01 | 05.09   | PR: 1KK,1KT     |                 |                |         |   |         |  |         |  |         |  |         |  |         |  |        |   |  |  |  |  |  |  |  |  |  |  |  |  |  |
| 1.4 TDI                    |         | 110     | 11.01 | 05.09   | PR: 1KK,1KT     |                 |                |         |   |         |  |         |  |         |  |         |  |         |  |        |   |  |  |  |  |  |  |  |  |  |  |  |  |  |
| 1.6 16V                    |         | 110     | 05.06 | 05.09   | PR: 1KK,1KT     |                 |                |         |   |         |  |         |  |         |  |         |  |         |  |        |   |  |  |  |  |  |  |  |  |  |  |  |  |  |
| 1.8 GTI                    |         | 132     | 09.05 | 05.09   | PR: 1KK,1KT     |                 |                |         |   |         |  |         |  |         |  |         |  |         |  |        |   |  |  |  |  |  |  |  |  |  |  |  |  |  |
| 1.8 GTI                    |         | 132     | 06.06 | 05.09   | PR: 1KK,1KT     |                 |                |         |   |         |  |         |  |         |  |         |  |         |  |        |   |  |  |  |  |  |  |  |  |  |  |  |  |  |
| 1.9 SDI                    |         | 74      | 11.01 | 05.09   | PR: 1KK,1KT     |                 |                |         |   |         |  |         |  |         |  |         |  |         |  |        |   |  |  |  |  |  |  |  |  |  |  |  |  |  |
| 1.9 TDI                    |         | 96      | 11.01 | 05.09   | PR: 1KK,1KT     |                 |                |         |   |         |  |         |  |         |  |         |  |         |  |        |   |  |  |  |  |  |  |  |  |  |  |  |  |  |
| 1.9 TDI                    |         | 96      | 10.03 | 05.09   | PR: 1KK,1KT     |                 |                |         |   |         |  |         |  |         |  |         |  |         |  |        |   |  |  |  |  |  |  |  |  |  |  |  |  |  |
| 2.0                        |         | 85      | 04.02 | 05.09   | PR: 1KK,1KT     |                 |                |         |   |         |  |         |  |         |  |         |  |         |  |        |   |  |  |  |  |  |  |  |  |  |  |  |  |  |
|                            |         | 1.2     | 40    | 11.01   | 05.09           |                 | 83.7858-0140.3 | 330837  | 2 |         |  |         |  |         |  |         |  |         |  |        |   |  |  |  |  |  |  |  |  |  |  |  |  |  |
|                            |         | 1.2     | 51    | 11.01   | 05.09           |                 |                |         |   |         |  |         |  |         |  |         |  |         |  |        |   |  |  |  |  |  |  |  |  |  |  |  |  |  |
|                            |         | 1.4 16V | 63    | 04.07   | 05.09           |                 |                |         |   |         |  |         |  |         |  |         |  |         |  |        |   |  |  |  |  |  |  |  |  |  |  |  |  |  |
|                            | 1.4 16V | 74      | 11.01 | 05.09   |                 |                 |                |         |   |         |  |         |  |         |  |         |  |         |  |        |   |  |  |  |  |  |  |  |  |  |  |  |  |  |
|                            | 1.4 FSI | 77      | 11.01 | 05.09   |                 |                 |                |         |   |         |  |         |  |         |  |         |  |         |  |        |   |  |  |  |  |  |  |  |  |  |  |  |  |  |
|                            | 1.4 TDI | 110     | 11.01 | 05.09   |                 |                 |                |         |   |         |  |         |  |         |  |         |  |         |  |        |   |  |  |  |  |  |  |  |  |  |  |  |  |  |
|                            | 1.6 16V | 110     | 05.06 | 05.09   |                 |                 |                |         |   |         |  |         |  |         |  |         |  |         |  |        |   |  |  |  |  |  |  |  |  |  |  |  |  |  |
|                            | 1.8 GTI | 132     | 09.05 | 05.09   |                 |                 |                |         |   |         |  |         |  |         |  |         |  |         |  |        |   |  |  |  |  |  |  |  |  |  |  |  |  |  |
|                            | 1.8 GTI | 132     | 06.06 | 05.09   |                 |                 |                |         |   |         |  |         |  |         |  |         |  |         |  |        |   |  |  |  |  |  |  |  |  |  |  |  |  |  |
|                            | 1.9 SDI | 74      | 11.01 | 05.09   |                 |                 |                |         |   |         |  |         |  |         |  |         |  |         |  |        |   |  |  |  |  |  |  |  |  |  |  |  |  |  |
|                            | 1.9 TDI | 96      | 11.01 | 05.09   |                 |                 |                |         |   |         |  |         |  |         |  |         |  |         |  |        |   |  |  |  |  |  |  |  |  |  |  |  |  |  |
|                            | 1.9 TDI | 96      | 10.03 | 05.09   |                 |                 |                |         |   |         |  |         |  |         |  |         |  |         |  |        |   |  |  |  |  |  |  |  |  |  |  |  |  |  |
|                            | 2.0     | 85      | 04.02 | 05.09   |                 |                 |                |         |   |         |  |         |  |         |  |         |  |         |  |        |   |  |  |  |  |  |  |  |  |  |  |  |  |  |
|                            |         | 1.2     | 40    | 11.01   | 05.09           | PR: 1KB         | 24.3217-0908.3 | 020167  |   |         |  |         |  |         |  |         |  |         |  |        | 2 |  |  |  |  |  |  |  |  |  |  |  |  |  |
|                            |         | 1.2     | 51    | 11.01   | 05.09           | PR: 1KB         |                |         |   |         |  |         |  |         |  |         |  |         |  |        |   |  |  |  |  |  |  |  |  |  |  |  |  |  |
|                            |         | 1.4 16V | 63    | 04.07   | 05.09           | PR: 1KB         |                |         |   |         |  |         |  |         |  |         |  |         |  |        |   |  |  |  |  |  |  |  |  |  |  |  |  |  |
| 1.4 FSI                    |         | 77      | 11.01 | 05.09   | PR: 1KB         |                 |                |         |   |         |  |         |  |         |  |         |  |         |  |        |   |  |  |  |  |  |  |  |  |  |  |  |  |  |
| 1.4 TDI                    |         | 110     | 11.01 | 05.09   | PR: 1KB         |                 |                |         |   |         |  |         |  |         |  |         |  |         |  |        |   |  |  |  |  |  |  |  |  |  |  |  |  |  |
|                            | 1.2     | 40      | 11.01 | 05.09   |                 | 24.3727-0199.2  | 580199         | 2       |   |         |  |         |  |         |  |         |  |         |  |        |   |  |  |  |  |  |  |  |  |  |  |  |  |  |
|                            | 1.2     | 51      | 11.01 | 05.09   |                 |                 |                |         |   |         |  |         |  |         |  |         |  |         |  |        |   |  |  |  |  |  |  |  |  |  |  |  |  |  |
|                            | 1.4 16V | 63      | 04.07 | 05.09   |                 |                 |                |         |   |         |  |         |  |         |  |         |  |         |  |        |   |  |  |  |  |  |  |  |  |  |  |  |  |  |
|                            | 1.4 16V | 74      | 11.01 | 05.09   |                 |                 |                |         |   |         |  |         |  |         |  |         |  |         |  |        |   |  |  |  |  |  |  |  |  |  |  |  |  |  |
|                            | 1.4 16V | 74      | 05.06 | 05.09   |                 |                 |                |         |   |         |  |         |  |         |  |         |  |         |  |        |   |  |  |  |  |  |  |  |  |  |  |  |  |  |

1) - rough road construction / - versione per percorsi accidentati / - version pour mauvaise route / - versión 4x4



|     |  |  |  |  |  |  |  |  |   |                |          |
|--|--|--|--|--|---|--|--|--|---|----------------|----------|
| <b>VOLKSWAGEN POLO IV (02-09)</b>  |  |  |  |  |   |  |  |  |   |                |          |
|    | 1.4 16V  | 74   |  | 11.01  | 05.09   | 24.3727-0199.2   | 580199   | 2 ↓ - Schlechtwegeausführung <sup>1)</sup>   | L=1580  |                |          |
|  | 1.4 FSI  |  |  | 11.01  | 05.09   |  |  |  |   |                |          |
|  | 1.4 TDI  |  |  | 11.01  | 05.09   |  |  |  |   |                |          |
|  | 1.6 16V  | 77   |  | 05.06  | 05.09   |  |  |  |   |                |          |
|  | 1.9 SDI  |  |  | 11.01  | 05.09   |  |  |  |   |                |          |
|  | 1.9 TDI  | 74   |  | 11.01  | 05.09   |  |  |  |   |                |          |
|  | 1.9 TDI  | 96   |  | 10.03  | 05.09   |  |  |  |   |                |          |
|  | 2.0  | 85   |  | 04.02  | 05.09   |  |  |  |   |                |          |
|  | 1.2  |  |  | 11.01  | 05.09   | PR: 1JB,1KD,1KK,1KS,1KT  | 24.3727-0176.2   | 580176   | 2 ↓ + Schlechtwegeausführung <sup>2)</sup>  | L=1640         |          |
|  | 1.2  | 40   |  | 11.01  | 05.09   | PR: 1JB,1KD,1KK,1KS,1KT  | 24.3727-0198.2   | 580198   | 2 ↓ + Schlechtwegeausführung <sup>2)</sup>  | L=1645         |          |
|  | 1.2  | 51   |  | 04.07  | 05.09   | PR: 1JB,1KD,1KK,1KS,1KT  |  |  |   |                |          |
|  | 1.4 16V  |  |  | 11.01  | 05.09   | PR: 1JB,1KD,1KK,1KS,1KT  |  |  |   |                |          |
| 1.4 16V  | 63   |  | 05.06  | 05.09  | PR: 1JB,1KD,1KK,1KS,1KT   |  |  |  |   |                |          |
| 1.4 16V  | 74   |  | 11.01  | 05.09  | PR: 1JB,1KD,1KK,1KS,1KT   |  |  |  |   |                |          |
| 1.4 FSI  |  |  | 11.01  | 05.09  | PR: 1JB,1KD,1KK,1KS,1KT   |  |  |  |   |                |          |
| 1.4 TDI  |  |  | 11.01  | 05.09  | PR: 1JB,1KD,1KK,1KS,1KT   |  |  |  |   |                |          |
| 1.6 16V  | 77   |  | 05.06  | 05.09  | PR: 1JB,1KD,1KK,1KS,1KT   |  |  |  |   |                |          |
| 1.9 SDI  |  |  | 11.01  | 05.09  | PR: 1JB,1KD,1KK,1KS,1KT   |  |  |  |   |                |          |
| 1.9 TDI  | 74   |  | 11.01  | 05.09  | PR: 1JB,1KD,1KK,1KS,1KT   |  |  |  |   |                |          |
| 1.9 TDI  | 96   |  | 10.03  | 05.09  | PR: 1JB,1KD,1KK,1KS,1KT   |  |  |  |   |                |          |
| 2.0  | 85   |  | 04.02  | 05.09  | PR: 1JB,1KD,1KK,1KS,1KT   |  |  |  |   |                |          |
| 1.2  |  |  | 11.01  | 05.09  | PR: 1JB,1KB   | 24.3727-2504.2   | 582504   | 2 ↓ + Schlechtwegeausführung <sup>2)</sup>   | L=1580  |                |          |
| 1.2  | 40   |  | 11.01  | 05.09  | PR: 1JB,1KB   |  |  |  |   |                |          |
| 1.2  | 51   |  | 04.07  | 05.09  | PR: 1JB,1KB   |  |  |  |   |                |          |
| 1.4 16V  |  |  | 11.01  | 05.09  | PR: 1JB,1KB   |  |  |  |   |                |          |
| 1.4 16V  | 63   |  | 05.06  | 05.09  | PR: 1JB,1KB   |  |  |  |   |                |          |
| 1.4 16V  | 74   |  | 11.01  | 05.09  | PR: 1JB,1KB   |  |  |  |   |                |          |
| 1.4 FSI  |  |  | 11.01  | 05.09  | PR: 1JB,1KB   |  |  |  |   |                |          |
| 1.4 TDI  |  |  | 11.01  | 05.09  | PR: 1JB,1KB   |  |  |  |   |                |          |
| 1.6 16V  | 77   |  | 05.06  | 05.09  | PR: 1JB,1KB   |  |  |  |   |                |          |
| 1.9 SDI  |  |  | 11.01  | 05.09  | PR: 1JB,1KB   |  |  |  |   |                |          |
| 1.9 TDI  | 74   |  | 11.01  | 05.09  | PR: 1JB,1KB   |  |  |  |   |                |          |
| 1.9 TDI  | 96   |  | 10.03  | 05.09  | PR: 1JB,1KB   |  |  |  |   |                |          |
| 2.0  | 85   |  | 04.02  | 05.09  | PR: 1JB,1KB   |  |  |  |   |                |          |
| 1.2  |  |  | 11.01  | 05.09  | PR: 1JC,1JL,1JP,1JS,1KD,1KS,1KK,1KT,1KV,2EJ                                       | 24.3727-0197.2   | 580197   | 2 ↓  | L=1645  |                |          |
| 1.2  | 40   |  | 11.01  | 05.09  | PR: 1JC,1JL,1JP,1JS,1KD,1KS,1KK,1KT,1KV,2EJ                                       |  |  |  |   |                |          |
| 1.2  | 51   |  | 04.07  | 05.09  | PR: 1JC,1JL,1JP,1JS,1KD,1KS,1KK,1KT,1KV,2EJ                                       |  |  |  |   |                |          |
| 1.4 16V  |  |  | 11.01  | 05.09  | PR: 1JC,1JL,1JP,1JS,1KD,1KS,1KK,1KT,1KV,2EJ                                       |  |  |  |   |                |          |
| 1.4 16V  | 63   |  | 05.06  | 05.09  | PR: 1JC,1JL,1JP,1JS,1KD,1KS,1KK,1KT,1KV,2EJ                                       |  |  |  |   |                |          |
| 1.4 16V  | 74   |  | 11.01  | 05.09  | PR: 1JC,1JL,1JP,1JS,1KD,1KS,1KK,1KT,1KV,2EJ                                       |  |  |  |   |                |          |
| 1.4 FSI  |  |  | 11.01  | 05.09  | PR: 1JC,1JL,1JP,1JS,1KD,1KS,1KK,1KT,1KV,2EJ                                       |  |  |  |   |                |          |
| 1.4 TDI  |  |  | 11.01  | 05.09  | PR: 1JC,1JL,1JP,1JS,1KD,1KS,1KK,1KT,1KV,2EJ                                       |  |  |  |   |                |          |
| 1.6 16V  | 77   |  | 05.06  | 05.09  | PR: 1JC,1JL,1JP,1JS,1KD,1KS,1KK,1KT,1KV,2EJ                                       |  |  |  |   |                |          |
| 1.9 SDI  |  |  | 11.01  | 05.09  | PR: 1JC,1JL,1JP,1JS,1KD,1KS,1KK,1KT,1KV,2EJ                                       |  |  |  |   |                |          |
| 1.9 TDI  | 74   |  | 11.01  | 05.09  | PR: 1JC,1JL,1JP,1JS,1KD,1KS,1KK,1KT,1KV,2EJ                                       |  |  |  |   |                |          |
| 1.9 TDI  | 96   |  | 10.03  | 05.09  | PR: 1JC,1JL,1JP,1JS,1KD,1KS,1KK,1KT,1KV,2EJ                                       |  |  |  |   |                |          |
| 2.0  | 85   |  | 04.02  | 05.09  | PR: 1JC,1JL,1JP,1JS,1KD,1KS,1KK,1KT,1KV,2EJ                                       |  |  |  |   |                |          |
|  | 1.2  | 40   |  | 11.01  | 05.09   | - ABS  | 03.6583-0216.3   | 320247   |   | BRL 8/3 (4)    | ATE      |
|  | 1.4 16V  |  |  | 11.01  | 05.09   | - ABS  | 03.6584-0120.3   | 320279   |   | BRL 8/4 (4)    | ATE      |
|  | 1.4 16V  | 63   |  | 05.06  | 05.09   | - ABS  |  |  |   |                |          |
|  | 1.4 16V  | 74   |  | 11.01  | 05.09   | - ABS  |  |  |   |                |          |
|  | 1.4 FSI  |  |  | 11.01  | 05.09   | - ABS  |  |  |   |                |          |
|  | 1.4 TDI  |  |  | 11.01  | 05.09   | - ABS  |  |  |   |                |          |
|  | 1.6 16V  | 77   |  | 05.06  | 05.09   | - ABS  |  |  |   |                |          |
|  | 1.9 SDI  |  |  | 11.01  | 05.09   | - ABS  |  |  |   |                |          |
|  | 1.9 TDI  | 74   |  | 11.01  | 05.09   | - ABS  |  |  |   |                |          |
|  | 1.9 TDI  | 96   |  | 10.03  | 05.09   | - ABS  |  |  |   |                |          |
| 2.0  | 85   |  | 04.02  | 05.09  | - ABS   |  |  |  |   |                |          |
|  | 1.2  |  |  | 11.01  | 05.09   |  | 24.2415-1702.3   | 030096   |   |                | Gz 15,87 |
|  | 1.2  | 40   |  | 11.01  | 05.09   |  |  |  |   |                |          |
|  | 1.2  | 51   |  | 04.07  | 05.09   |  |  |  |   |                |          |
|  | 1.4 16V  |  |  | 11.01  | 05.09   |  |  |  |   |                |          |
|  | 1.4 16V  | 63   |  | 05.06  | 05.09   |  |  |  |   |                |          |
|  | 1.4 16V  | 74   |  | 11.01  | 05.09   |  |  |  |   |                |          |
|  | 1.4 FSI  |  |  | 11.01  | 05.09   |  |  |  |   |                |          |
|  | 1.4 TDI  |  |  | 11.01  | 05.09   |  |  |  |   |                |          |
|  | 1.6 16V  | 77   |  | 05.06  | 05.09   |  |  |  |   |                |          |
|  | 1.8 GTI  | 110  |  | 09.05  | 05.09   |  |  |  |   |                |          |
|  | 1.8 GTI  | 132  |  | 06.06  | 05.09   |  |  |  |   |                |          |
|  | 1.9 SDI  |  |  | 11.01  | 05.09   |  |  |  |   |                |          |
|  | 1.9 TDI  | 74   |  | 11.01  | 05.09   |  |  |  |   |                |          |
| 1.9 TDI  | 96   |  | 10.03  | 05.09  |   |  |  |  |   |                |          |
| 2.0  | 85   |  | 04.02  | 05.09  |   |  |  |  |   |                |          |
| <b>VOLKSWAGEN POLO V (09-)</b>   |  |  |  |  |   |  |  |  |   |                |          |
|  | 1.2  | 44   |  | 03.09  |   | PR: 1ZG,1LR,1ZJ  | 11.9541-9549.2   | 220575   |  | D=54, - Halter | ATE      |
|  | 1.2  | 51   |  | 03.09  |   | PR: 1ZG,1LR,1ZJ  | 11.9541-9550.2   | 220576   |  | D=54, - Halter | ATE      |
|  | 1.2 TDI  | 55   |  | 10.09  |   | PR: 1ZG,1LR,1ZJ  | 11.0101-5409.2   | 260035   |   | Hülsensatz     | ATE      |
|  | 1.2 TSI  | 66   |  | 05.11  |   | PR: 1ZG,1LR,1ZJ  | 11.8171-0008.1   | 990049   |   | Führungsbolzen | ATE      |
|  | 1.2 TSI  | 77   |  | 06.09  |   | PR: 1ZG,1LR,1ZJ  |  |  |   |                |          |
|  | 1.4  | 63   |  | 03.09  |   | PR: 1ZG,1LR,1ZJ  |  |  |   |                |          |
|  | 1.4 BiFuel   | 60   |  | 03.10  |   | PR: 1ZG,1LR,1ZJ  |  |  |   |                |          |
|  | 1.4 GTI  | 132  |  | 05.10  |   | PR: 1ZG,1LR,1ZJ  |  |  |   |                |          |
|  | 1.4 TSI  | 103  |  | 10.12  |   | PR: 1ZG,1LR,1ZJ  |  |  |   |                |          |
|  | 1.6 BiFuel   | 60   |  | 01.11  |   | PR: 1ZG,1LR,1ZJ  |  |  |   |                |          |
|  | 1.6 TDI  | 55   |  | 03.09  |   | PR: 1ZG,1LR,1ZJ  |  |  |   |                |          |
|  | ↓  |  |  |  |   |  |  |  |   |                |          |

<sup>1)</sup> - rough road construction / - versione per percorsi accidentati / - version pour mauvaise route / - versión 4x4





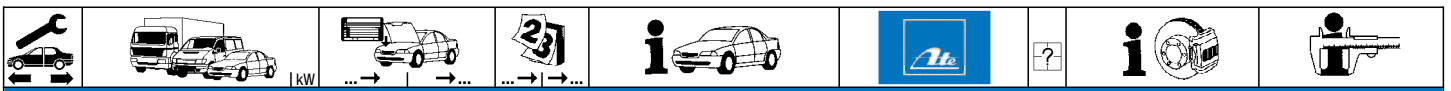









<sup>2)</sup> + rough road construction / + versione per percorsi accidentati / + version pour mauvaise route / + versión 4x4





**VOLKSWAGEN POLO V (09-)**

|            |            |       |             |                 |                |        |   |  |     |  |     |
|------------|------------|-------|-------------|-----------------|----------------|--------|---|--|-----|--|-----|
|            | 1.6 TDI    | 66    | 06.09       | PR: 1ZG,1LR,1ZJ | 11.9541-9549.2 | 220575 | 2 | D=54, - Halter<br>D=54, - Halter<br>Hülsensatz<br>Führungsbolzen               | ATE |  |     |
|            | 1.6 TDI    | 77    | 06.09       | PR: 1ZG,1LR,1ZJ | 11.9541-9550.2 | 220576 |   |  | ATE |  |     |
|            | 2.0 R WRC  | 162   | 08.13       | PR: 1ZG,1LR,1ZJ | 11.0101-5409.2 | 260035 |   |  | ATE |  |     |
|            |            |       |             |                 | 11.8171-0008.1 | 990049 |   |  | ATE |  |     |
|            | 1.2        | 44    | 03.09       | PR: 1LN,1ZC     | 11.9541-9553.2 | 220563 |   |  | 2   | D=54, - Halter<br>D=54, - Halter<br>Führungsbolzen<br>Hülsensatz<br>Haltefeder | ATE |
|            | 1.2        | 51    | 03.09       | PR: 1LN,1ZC     | 11.9541-9554.2 | 220564 |   |  |     |  | ATE |
|            | 1.2 TDI    | 55    | 10.09       | PR: 1LN,1ZC     | 11.8171-0008.1 | 990049 |   |  |     |  | ATE |
|            | 1.2 TSI    | 66    | 05.11       | PR: 1LN,1ZC     | 11.0101-5409.2 | 260035 |   |  |     |  | ATE |
|            | 1.2 TSI    | 77    | 06.09       | PR: 1LN,1ZC     | 11.8116-0351.1 | 390538 |   |  |     |  | ATE |
|            | 1.4        | 63    | 03.09       | PR: 1LN,1ZC     |                |        |   |  |     |  |     |
|            | 1.4 BiFuel | 60    | 03.10       | PR: 1LN,1ZC     |                |        |   |  |     |  |     |
|            | 1.4 GTI    | 132   | 05.10       | PR: 1LN,1ZC     |                |        |   |  |     |  |     |
|            | 1.4 TSI    | 103   | 10.12       | PR: 1LN,1ZC     |                |        |   |  |     |  |     |
| 1.6 BiFuel | 60         | 01.11 | PR: 1LN,1ZC |                 |                |        |   |  |     |  |     |
| 1.6 TDI    | 55         | 03.09 | PR: 1LN,1ZC |                 |                |        |   |  |     |  |     |
| 1.6 TDI    | 66         | 06.09 | PR: 1LN,1ZC |                 |                |        |   |  |     |  |     |
| 1.6 TDI    | 77         | 06.09 | PR: 1LN,1ZC |                 |                |        |   |  |     |  |     |
| 2.0 R WRC  | 162        | 08.13 | PR: 1LN,1ZC |                 |                |        |   |  |     |  |     |
|            | 1.2        | 44    | 03.09       | PR: 1ZD         | 11.9541-9553.2 | 220563 | 2 | D=54, - Halter<br>D=54, - Halter<br>Hülsensatz<br>Führungsbolzen<br>Haltefeder | ATE |  |     |
|            | 1.2        | 51    | 03.09       | PR: 1ZD         | 11.9541-9554.2 | 220564 |   |  | ATE |  |     |
|            | 1.2 TDI    | 55    | 10.09       | PR: 1ZD         | 11.0101-5409.2 | 260035 |   |  | ATE |  |     |
|            | 1.2 TSI    | 66    | 05.11       | PR: 1ZD         | 11.8171-0008.1 | 990049 |   |  | ATE |  |     |
|            | 1.2 TSI    | 77    | 06.09       | PR: 1ZD         | 11.8116-0351.1 | 390538 |   |  | ATE |  |     |
|            | 1.4        | 63    | 03.09       | PR: 1ZD         |                |        |   |  |     |  |     |
|            | 1.4 BiFuel | 60    | 03.10       | PR: 1ZD         |                |        |   |  |     |  |     |
|            | 1.4 GTI    | 132   | 05.10       | PR: 1ZD         |                |        |   |  |     |  |     |
|            | 1.4 TSI    | 103   | 10.12       | PR: 1ZD         |                |        |   |  |     |  |     |
|            | 1.6 BiFuel | 60    | 01.11       | PR: 1ZD         |                |        |   |  |     |  |     |
|            | 1.6 TDI    | 55    | 03.09       | PR: 1ZD         |                |        |   |  |     |  |     |
|            | 1.6 TDI    | 66    | 06.09       | PR: 1ZD         |                |        |   |  |     |  |     |
|            | 1.6 TDI    | 77    | 06.09       | PR: 1ZD         |                |        |   |  |     |  |     |
| 2.0 R WRC  | 162        | 08.13 | PR: 1ZD     |                 |                |        |   |  |     |  |     |
|            | 1.2        | 44    | 03.09       | PR: 1ZP,1ZR     | 11.9541-9553.2 | 220563 | 2 | D=54, - Halter<br>D=54, - Halter<br>Hülsensatz<br>Führungsbolzen<br>Haltefeder | ATE |  |     |
|            | 1.2        | 51    | 03.09       | PR: 1ZP,1ZR     | 11.9541-9554.2 | 220564 |   |  | ATE |  |     |
|            | 1.2 TDI    | 55    | 10.09       | PR: 1ZP,1ZR     | 11.0101-5409.2 | 260035 |   |  | ATE |  |     |
|            | 1.2 TSI    | 66    | 05.11       | PR: 1ZP,1ZR     | 11.8171-0008.1 | 990049 |   |  | ATE |  |     |
|            | 1.2 TSI    | 77    | 06.09       | PR: 1ZP,1ZR     | 11.8116-0351.1 | 390538 |   |  | ATE |  |     |
|            | 1.4        | 63    | 03.09       | PR: 1ZP,1ZR     |                |        |   |  |     |  |     |
|            | 1.4 BiFuel | 60    | 03.10       | PR: 1ZP,1ZR     |                |        |   |  |     |  |     |
|            | 1.4 GTI    | 132   | 05.10       | PR: 1ZP,1ZR     |                |        |   |  |     |  |     |
|            | 1.4 TSI    | 103   | 10.12       | PR: 1ZP,1ZR     |                |        |   |  |     |  |     |
|            | 1.6 BiFuel | 60    | 01.11       | PR: 1ZP,1ZR     |                |        |   |  |     |  |     |
|            | 1.6 TDI    | 55    | 03.09       | PR: 1ZP,1ZR     |                |        |   |  |     |  |     |
|            | 1.6 TDI    | 66    | 06.09       | PR: 1ZP,1ZR     |                |        |   |  |     |  |     |
|            | 1.6 TDI    | 77    | 06.09       | PR: 1ZP,1ZR     |                |        |   |  |     |  |     |
| 2.0 R WRC  | 162        | 08.13 | PR: 1ZP,1ZR |                 |                |        |   |  |     |  |     |
|            | 1.2        | 44    | 03.09       |                 | 83.7858-0140.3 | 330837 | 2 | L=140  |     |  |     |
|            | 1.2        | 51    | 03.09       |                 |                |        |   |  |     |  |     |
|            | 1.2 TDI    | 55    | 10.09       |                 |                |        |   |  |     |  |     |
|            | 1.2 TSI    | 66    | 05.11       |                 |                |        |   |  |     |  |     |
|            | 1.2 TSI    | 77    | 06.09       |                 |                |        |   |  |     |  |     |
|            | 1.4        | 63    | 03.09       |                 |                |        |   |  |     |  |     |
|            | 1.4 BiFuel | 60    | 03.10       |                 |                |        |   |  |     |  |     |
|            | 1.4 GTI    | 132   | 05.10       |                 |                |        |   |  |     |  |     |
|            | 1.4 TSI    | 103   | 10.12       |                 |                |        |   |  |     |  |     |
|            | 1.6 BiFuel | 60    | 01.11       |                 |                |        |   |  |     |  |     |
|            | 1.6 TDI    | 55    | 03.09       |                 |                |        |   |  |     |  |     |
|            | 1.6 TDI    | 66    | 06.09       |                 |                |        |   |  |     |  |     |
|            | 1.6 TDI    | 77    | 06.09       |                 |                |        |   |  |     |  |     |
| 2.0 R WRC  | 162        | 08.13 |             |                 |                |        |   |  |     |  |     |
|            | 1.2        | 44    | 03.09       | PR: 1KB         | 24.3217-0908.3 | 020167 |   | Rz 17,46   |     |  |     |
|            | 1.2        | 51    | 03.09       | PR: 1KB         |                |        |   |  |     |  |     |
|            | 1.2 TDI    | 55    | 10.09       | PR: 1KB         |                |        |   |  |     |  |     |
|            | 1.2 TSI    | 66    | 05.11       | PR: 1KB         |                |        |   |  |     |  |     |
|            | 1.2 TSI    | 77    | 06.09       | PR: 1KB         |                |        |   |  |     |  |     |
|            | 1.4        | 63    | 03.09       | PR: 1KB         |                |        |   |  |     |  |     |
|            | 1.4 BiFuel | 60    | 03.10       | PR: 1KB         |                |        |   |  |     |  |     |
|            | 1.4 TSI    | 103   | 10.12       | PR: 1KB         |                |        |   |  |     |  |     |
|            | 1.6 BiFuel | 60    | 01.11       | PR: 1KB         |                |        |   |  |     |  |     |
|            | 1.6 TDI    | 55    | 03.09       | PR: 1KB         |                |        |   |  |     |  |     |
|            | 1.6 TDI    | 66    | 06.09       | PR: 1KB         |                |        |   |  |     |  |     |
|            | 1.6 TDI    | 77    | 06.09       | PR: 1KB         |                |        |   |  |     |  |     |
|            | 1.2        | 44    | 03.09       | PR: 1KM         | 24.3219-0909.3 | 020188 |   |  |     | Rz 19,05   |     |
| 1.2        | 51         | 03.09 | PR: 1KM     |                 |                |        |   |  |     |  |     |

|     |  |  |  |  |  |  |  |  |
|--|--|--|--|--|---|--|--|--|
| <b>VOLKSWAGEN POLO V (09-)</b>   |  |  |  |  |   |  |  |  |
|    | 1.2 TDI  | 55   |  | 10.09  | PR: 1KM   | 24.3219-0909.3   | 020188   | Rz 19,05   |
|  | 1.2 TSI  | 66   |  | 05.11  | PR: 1KM   |  |  |  |
|  | 1.2 TSI  | 77   |  | 06.09  | PR: 1KM   |  |  |  |
|  | 1.4  | 63   |  | 03.09  | PR: 1KM   |  |  |  |
|  | 1.4 BiFuel   | 60   |  | 03.10  | PR: 1KM   |  |  |  |
|  | 1.4 TSI  | 103  |  | 10.12  | PR: 1KM   |  |  |  |
|  | 1.6 BiFuel   | 60   |  | 01.11  | PR: 1KM   |  |  |  |
|  | 1.6 TDI  | 55   |  | 03.09  | PR: 1KM   |  |  |  |
|  | 1.6 TDI  | 66   |  | 06.09  | PR: 1KM   |  |  |  |
|  | 1.6 TDI  | 77   |  | 06.09  | PR: 1KM   |  |  |  |
| <b>VOLKSWAGEN POLO Classic (96-01)</b>   |  |  |  |  |   |  |  |  |
|    | 1.4  | ↔  |  | 12.95  | 09.01 - ABS   | 03.7740-1402.4   | 300133   | 8" ATE   |
|  | 1.6  | ↔ 55   |  | 09.97  | 09.01 - ABS   |  |  |  |
|  | 1.7 SDI  | ↔  |  | 07.97  | 09.01 - ABS   |  |  |  |
|  | 1.9 SDI  | ↔  |  | 12.95  | 09.01 - ABS   |  |  |  |
|  | 1.6  | ↔ 74   |  | 12.95  | 09.01 - ABS   | 03.7750-6302.4   | 300161   | 9" ATE   |
|  | 1.8  | ↔  |  | 03.98  | 09.01 - ABS/ + MEX  |  |  |  |
|  | 1.9 TDI  | ↔ 66   |  | 09.96  | 09.01 - ABS   |  |  |  |
|  | 1.9 TDI  | ↔ 81   |  | 06.98  | 09.01 - ABS   |  |  |  |
|  | 2.0  | ↔ 85   |  | 03.99  | 09.01 - ABS/ + MEX  |  |  |  |
|  | 1.4  | ↔  |  | 12.95  | 09.01 + ABS   | 10.6350-3902.4   | 300213   | 9" ATE   |
|  | 1.6  | ↔ 55   |  | 11.95  | 09.01 + ABS   | 10.6350-4002.4   | 300285   | 9" ATE   |
|  | 1.6  | ↔ 74   |  | 05.96  | 09.01 + ABS   |  |  |  |
|  | 1.7 SDI  | ↔  |  | 07.97  | 09.01 + ABS   |  |  |  |
|  | 1.8  | ↔  |  | 03.98  | 09.01 + ABS/ + MEX  |  |  |  |
|  | 1.9 SDI  | ↔  |  | 12.95  | 09.01 + ABS   |  |  |  |
|  | 1.9 TDI  | ↔ 66   |  | 09.96  | 09.01 + ABS   |  |  |  |
|  | 1.9 TDI  | ↔ 81   |  | 06.98  | 09.01 + ABS   |  |  |  |
|  | 2.0  | ↔ 85   |  | 03.99  | 09.01 + ABS/ + MEX  |  |  |  |
|    | 1.4  | ↔  | 6K-X-523000  | 12.95  | - ABS   | 03.2120-3943.3   | 010532   | Thz 20,64 ATE  |
|  | 1.4  | ↔  |  | 12.95  | 09.01 - ABS   |  |  |  |
|  | 1.6  | ↔ 55   | 6K-V-022629  |  | - ABS   |  |  |  |
|  | 1.6  | ↔ 55   | 6K-V-022629  |  | 09.01 - ABS   |  |  |  |
|  | 1.7 SDI  | ↔  | 6K-X-523000  | 11.97  | - ABS   |  |  |  |
|  | 1.7 SDI  | ↔  |  | 07.97  | 09.01 - ABS   |  |  |  |
|  | 1.9 SDI  | ↔  | 6K-X-523000  | 12.95  | - ABS   |  |  |  |
|  | 1.9 SDI  | ↔  |  | 12.95  | 09.01 - ABS   |  |  |  |
|  | 1.6  | ↔ 55   | 6K-V-022628  | 11.95  | - ABS   | 03.2122-1042.3   | 010137   | Thz 22,20 ATE  |
|  | 1.6  | ↔ 74   | 6K-X-523000  | 12.95  | - ABS   |  |  |  |
|  | 1.6  | ↔ 74   |  | 12.95  | 09.01 - ABS   |  |  |  |
|  | 1.9 TDI  | ↔ 66   | 6K-X-523000  | 09.96  | - ABS   |  |  |  |
|  | 1.9 TDI  | ↔ 66   |  | 09.96  | 09.01 - ABS   |  |  |  |
|  | 1.9 TDI  | ↔ 81   | 6K-X-523000  | 06.98  | - ABS   |  |  |  |
|  | 1.9 TDI  | ↔ 81   |  | 06.98  | 09.01 - ABS   |  |  |  |
|  | 2.0  | ↔ 85   |  | 03.99  | 09.01 - ABS/ + MEX  |  |  |  |
|  | 1.4  | ↔  |  | 12.95  | 09.01 + ABS   | 03.2122-1144.3   | 010636   | Thz 22,20 ATE  |
|  | 1.6  | ↔ 55   |  | 11.95  | 09.01 + ABS   |  |  |  |
|  | 1.6  | ↔ 74   |  | 05.96  | 09.01 + ABS   |  |  |  |
|  | 1.7 SDI  | ↔  |  | 07.97  | 09.01 + ABS   |  |  |  |
|  | 1.8  | ↔  |  | 03.98  | 09.01 + ABS/ + MEX  |  |  |  |
|  | 1.9 SDI  | ↔  |  | 12.95  | 09.01 + ABS   |  |  |  |
|  | 1.9 TDI  | ↔ 66   |  | 09.96  | 09.01 + ABS   |  |  |  |
|  | 1.9 TDI  | ↔ 81   |  | 06.98  | 09.01 + ABS   |  |  |  |
|  | 1.4  | ↔  |  | 12.95  | 09.01 + ABS   | 03.2122-1184.3   | 010592   | Thz 22,20 ATE  |
|  | 1.6  | ↔ 55   |  | 11.95  | 09.01 + ABS   |  |  |  |
|  | 1.6  | ↔ 74   |  | 05.96  | 09.01 + ABS   |  |  |  |
|  | 1.7 SDI  | ↔  |  | 07.97  | 09.01 + ABS   |  |  |  |
|  | 1.9 SDI  | ↔  |  | 12.95  | 09.01 + ABS   |  |  |  |
|  | 1.9 TDI  | ↔ 66   |  | 09.96  | 09.01 + ABS   |  |  |  |
|  | 1.9 TDI  | ↔ 81   |  | 06.98  | 09.01 + ABS   |  |  |  |
|  | 1.4  |  | 6K-V-022628  | 12.95  | - ABS   | 24.3481-1745.5   | 240277   | D=48, - Halter ATE   |
|  |  |  |  |  |   | 24.3481-1746.5   | 240278   | D=48, - Halter ATE   |
|  |  |  |  |  |   | 11.0441-4808.2   | 250022   | Dichtungssatz ATE  |
|  |  |  |  |  |   | 11.0101-4803.2   | 260008   | Hülzensatz ATE   |
|  |  |  |  |  |   | 24.0102-4803.2   | 260086   | Hülzensatz+Schrauben ATE   |
|  | 1.4  |  | 6K-V-022629  | 12.95  | + ABS   | 11.0441-4808.2   | 250022   | Dichtungssatz ATE  |
|  | 1.4  |  |  | 09.01  |   | 11.0101-4801.2   | 260006   | Hülzensatz ATE   |
|  | 1.6  | 55   |  | 05.96  | 09.01   | 24.0102-4801.2   | 260085   | Hülzensatz+Schrauben ATE   |
|  | 1.7 SDI  |  |  | 07.97  | 09.01   |  |  |  |
|  | 1.9 SDI  |  |  | 12.95  | 09.01   |  |  |  |
|  | 1.6  | 55   |  | 05.96  | 09.01   | 24.3541-1609.5   | 240039   | D=54, - Halter LUC   |
|  | 1.6  | 74   |  | 05.96  | 09.01   | 24.3541-1610.5   | 240040   | D=54, - Halter LUC   |
|  | 1.8  |  |  | 03.98  | 09.01 + MEX   | 24.0101-4301.2   | 260047   | Einbausatz LUC   |
|  | 1.9 TDI  | 66   |  | 09.96  | 09.01   | 11.0101-5403.2   | 260010   | Faltenbalgsatz LUC   |
|  | 1.9 TDI  | 81   |  | 06.98  | 09.01   |  |  |  |
|  | 2.0  | 85   |  | 03.99  | 09.01 + MEX   |  |  |  |
|  | 1.4  |  |  | 12.95  | 09.01   | 83.7713-0435.3   | 330792   | L=435  |
|  | 1.6  | 55   |  | 11.95  | 09.01   |  |  |  |
|  | 1.6  | 74   |  | 05.96  | 09.01   |  |  |  |
|  | 1.7 SDI  |  |  | 07.97  | 09.01   |  |  |  |
|  | 1.8  |  |  | 03.98  | 09.01 + MEX   |  |  |  |
|  | 1.9 SDI  |  |  | 12.95  | 09.01   |  |  |  |
|  | 1.9 TDI  | 66   |  | 09.96  | 09.01   |  |  |  |
|  | 1.9 TDI  | 81   |  | 06.98  | 09.01   |  |  |  |
|  | 2.0  | 85   |  | 03.99  | 09.01 + MEX   |  |  |  |



**VOLKSWAGEN POLO Classic (96-01)**























|  |         |    |             |       |       |       |                |        |  |   |                |               |
|--|---------|----|-------------|-------|-------|-------|----------------|--------|--|---|----------------|---------------|
|  | 1.9 TDI | 81 |             | 06.98 | 09.99 |       | 24.3384-1737.5 | 240301 |  |   | D=38, - Halter | LUC           |
|  | 1.9 TDI | 81 |             | 10.99 | 09.01 |       | 24.3384-1738.5 | 240302 |  |   | D=38, - Halter | LUC           |
|  | 1.4     |    |             | 12.95 | 09.99 |       | 24.3344-1711.7 | 220539 |  |   | D=34, - Halter | LUC           |
|  | 1.6     | 55 |             | 11.95 | 09.99 |       | 24.3344-1712.7 | 220540 |  |   | D=34, - Halter | LUC           |
|  | 1.6     | 74 |             | 05.96 | 09.99 |       |                |        |  |   |                |               |
|  | 1.7 SDI |    |             | 07.97 | 09.99 |       |                |        |  |   |                |               |
|  | 1.8     |    |             | 03.98 | 09.99 | + MEX |                |        |  |   |                |               |
|  | 1.9 SDI |    |             | 12.95 | 09.99 |       |                |        |  |   |                |               |
|  | 1.9 TDI | 66 |             | 09.96 | 09.99 |       |                |        |  |   |                |               |
|  | 1.9 TDI | 81 |             | 06.98 | 09.99 |       |                |        |  |   |                |               |
|  | 2.0     | 85 |             | 03.99 | 09.99 | + MEX |                |        |  |   |                |               |
|  | 1.4     |    |             | 10.99 | 09.01 |       | 83.7858-0140.3 | 330837 |  | 2 |                | L=140         |
|  | 1.6     | 55 |             | 10.99 | 09.01 |       |                |        |  |   |                |               |
|  | 1.6     | 74 |             | 10.99 | 09.01 |       |                |        |  |   |                |               |
|  | 1.7 SDI |    |             | 10.99 | 09.01 |       |                |        |  |   |                |               |
|  | 1.8     |    |             | 10.99 | 09.01 | + MEX |                |        |  |   |                |               |
|  | 1.9 SDI |    |             | 10.99 | 09.01 |       |                |        |  |   |                |               |
|  | 1.9 TDI | 66 |             | 10.99 | 09.01 |       |                |        |  |   |                |               |
|  | 1.9 TDI | 81 |             | 10.99 | 09.01 |       |                |        |  |   |                |               |
|  | 2.0     | 85 |             | 10.99 | 09.01 | + MEX |                |        |  |   |                |               |
|  | 1.4     |    |             | 12.95 | 09.01 | - ABS | 03.3217-2112.3 | 020027 |  |   | + GG 1)        | Rz 17,46      |
|  | 1.6     | 55 |             | 11.95 | 09.01 | - ABS | 24.3217-0908.3 | 020167 |  |   | + ALU 2)       | Rz 17,46      |
|  | 1.4     |    |             | 12.95 | 09.01 | + ABS | 24.3219-0909.3 | 020188 |  |   |                | Rz 19,05      |
|  | 1.6     | 55 |             | 11.95 | 09.01 | + ABS |                |        |  |   |                |               |
|  | 1.6     | 74 |             | 12.95 | 09.01 |       |                |        |  |   |                |               |
|  | 1.7 SDI |    |             | 07.97 | 09.01 |       |                |        |  |   |                |               |
|  | 1.8     |    |             | 03.98 | 09.01 | + MEX |                |        |  |   |                |               |
|  | 1.9 SDI |    |             | 12.95 | 09.01 |       |                |        |  |   |                |               |
|  | 1.9 TDI | 66 |             | 09.96 | 09.01 |       |                |        |  |   |                |               |
|  | 2.0     | 85 |             | 03.99 | 09.01 | + MEX |                |        |  |   |                |               |
|  | 1.4     |    | 6K-V-013236 | 12.95 |       | - ABS | 24.3727-0161.2 | 580161 |  | 2 | ↓              | L=1512        |
|  | 1.6     | 55 | 6K-V-013236 | 11.95 |       | - ABS |                |        |  |   |                |               |
|  | 1.4     |    | 6K-V-013237 |       | 09.01 | - ABS | 24.3727-0161.2 | 580161 |  | 2 | ↓              | L=1512        |
|  | 1.6     | 55 | 6K-V-013237 |       | 09.01 | - ABS |                |        |  |   |                |               |
|  | 1.4     |    | 6K-W-591018 | 12.95 |       | + ABS | 24.3727-0161.2 | 580161 |  | 2 | ↓              | L=1512        |
|  | 1.6     | 55 | 6K-W-591018 | 11.95 |       | + ABS |                |        |  |   |                |               |
|  | 1.6     | 74 | 6K-W-591018 | 12.95 |       |       |                |        |  |   |                |               |
|  | 1.7 SDI |    | 6K-W-591018 | 07.97 |       |       |                |        |  |   |                |               |
|  | 1.8     |    | 6K-W-591018 | 03.98 |       | + MEX |                |        |  |   |                |               |
|  | 1.9 SDI |    | 6K-W-591018 | 12.95 |       |       |                |        |  |   |                |               |
|  | 1.9 TDI | 66 | 6K-W-591018 | 09.96 |       |       |                |        |  |   |                |               |
|  | 1.4     |    | 6K-W-591019 |       | 09.01 | + ABS | 24.3727-0162.2 | 580162 |  | 2 | ↓              | L=1514        |
|  | 1.6     | 55 | 6K-W-591019 |       | 09.01 | + ABS |                |        |  |   |                |               |
|  | 1.6     | 74 | 6K-W-591019 |       | 09.01 |       |                |        |  |   |                |               |
|  | 1.7 SDI |    | 6K-W-591019 |       | 09.01 |       |                |        |  |   |                |               |
|  | 1.8     |    | 6K-W-591019 |       | 09.01 | + MEX |                |        |  |   |                |               |
|  | 1.9 SDI |    | 6K-W-591019 |       | 09.01 |       |                |        |  |   |                |               |
|  | 1.9 TDI | 66 | 6K-W-591019 |       | 09.01 |       |                |        |  |   |                |               |
|  | 2.0     | 85 |             | 03.99 | 09.01 | + MEX |                |        |  |   |                |               |
|  | 1.9 TDI | 81 | 6K-W-591019 |       | 09.01 |       | 24.3727-0165.2 | 580165 |  | 2 | ↓              | L=1641        |
|  | 1.4     |    |             | 12.95 | 09.01 |       | 03.6584-0113.3 | 320111 |  |   |                | BRL 8/4 (4)   |
|  | 1.6     | 55 |             | 11.95 | 09.01 |       |                |        |  |   |                |               |
|  | 1.6     | 74 |             | 05.96 | 09.01 |       |                |        |  |   |                |               |
|  | 1.7 SDI |    |             | 07.97 | 09.01 |       |                |        |  |   |                |               |
|  | 1.8     |    |             | 03.98 | 09.01 | + MEX |                |        |  |   |                |               |
|  | 1.9 SDI |    |             | 12.95 | 09.01 |       |                |        |  |   |                |               |
|  | 2.0     | 85 |             | 03.99 | 09.01 | + MEX |                |        |  |   |                |               |
|  | 1.9 TDI | 66 |             | 09.96 | 09.01 |       | 03.6583-0179.3 | 320228 |  |   |                | BRL 8/3 (4)   |
|  | 1.9 TDI | 81 |             | 06.98 | 09.01 |       |                |        |  |   |                |               |
|  | 1.9 TDI | 66 |             | 09.96 | 09.01 |       | 03.2419-9510.3 | 030028 |  |   |                | Gz 19,05      |
|  | 1.9 TDI | 81 |             | 06.98 | 09.01 |       |                |        |  |   |                |               |
|  | 1.9 TDI | 66 |             | 09.96 | 09.01 |       | 24.2523-0908.3 | 040049 |  |   |                | Nz 23,81      |
|  | 1.9 TDI | 81 |             | 06.98 | 09.01 |       |                |        |  |   |                |               |
|  | 1.4     | ↓  |             | 12.95 | 09.01 |       | 24.3728-2707.2 | 592707 |  |   |                | L=1047, + AUT |
|  | 1.6     | ↓  | 55          | 05.96 | 09.01 |       |                |        |  |   |                |               |
|  | 1.6     | ↓  | 74          | 11.95 | 09.01 |       | 24.3728-0128.2 | 590128 |  |   |                | L=854, + AUT  |
|  | 1.8     | ↓  |             | 03.98 | 09.01 | + MEX |                |        |  |   |                |               |
|  | 1.9 SDI | ↓  |             | 12.95 | 09.01 |       |                |        |  |   |                |               |
|  | 2.0     | ↓  | 85          | 03.99 | 09.01 | + MEX |                |        |  |   |                |               |

**VOLKSWAGEN POLO Variant (97-01)**

|  |         |   |    |       |       |         |                |        |  |  |  |    |     |
|--|---------|---|----|-------|-------|---------|----------------|--------|--|--|--|----|-----|
|  | 1.4     | ↓ |    | 03.97 | 09.01 | - ABS   | 03.7740-1402.4 | 300133 |  |  |  | 8" | ATE |
|  | 1.6     | ↓ |    | 05.97 | 09.01 | - ABS   | 03.7750-6302.4 | 300161 |  |  |  | 9" | ATE |
|  | 1.7 SDI | ↓ |    | 08.97 | 09.01 | - ABS   |                |        |  |  |  |    |     |
|  | 1.8     | ↓ |    | 05.97 | 09.01 | - ABS   |                |        |  |  |  |    |     |
|  | 1.9 SDI | ↓ |    | 03.97 | 09.01 | - ABS   |                |        |  |  |  |    |     |
|  | 1.9 TDI | ↓ | 66 | 01.97 | 09.01 | - ABS   |                |        |  |  |  |    |     |
|  | 1.9 TDI | ↓ | 81 | 06.98 | 09.01 | - ABS   |                |        |  |  |  |    |     |
|  | 1.4     | ↓ |    | 03.97 | 09.01 | PR: 1KB | 10.6350-3902.4 | 300213 |  |  |  | 9" | ATE |
|  | 1.6     | ↓ |    | 05.97 | 09.01 | PR: 1KB |                |        |  |  |  |    |     |

1) + cast iron / + ghisa / + fonte grise / + fundición de gris

2) + aluminium / + alluminio / + aluminium / + aluminio

|     |  |  |  |  |  |  |      |  |  |   |                                 |
|--|--|--|--|--|---|--|--|--|--|---|---------------------------------|
| <b>VOLKSWAGEN POLO Variant (97-01)</b>   |  |  |  |  |   |  |  |  |  |   |                                 |
|    | 1.7 SDI<br>1.8<br>1.9 SDI<br>1.9 TDI<br>1.9 TDI                                  |  |  | 08.97<br>05.97<br>03.97<br>01.97<br>06.98  | 09.01<br>09.01<br>09.01<br>09.01<br>09.01   | PR: 1KB<br>PR: 1KB<br>PR: 1KB<br>PR: 1KB<br>PR: 1KB                                | 10.6350-3902.4   | 300213   | + ABS  | 9"  | ATE                             |
|    | 1.4<br>1.6<br>1.7 SDI<br>1.8<br>1.9 SDI<br>1.9 TDI<br>1.9 TDI                    |  |  | 03.97<br>05.97<br>08.97<br>05.97<br>03.97<br>01.97<br>06.98                      | 09.01<br>09.01<br>09.01<br>09.01<br>09.01<br>09.01<br>09.01                       | - ABS<br>- ABS<br>- ABS<br>- ABS<br>- ABS<br>- ABS<br>- ABS                        | 03.2122-1042.3   | 010137   |  | Thz 22,20   | ATE                             |
|  | 1.4<br>1.6<br>1.7 SDI<br>1.8<br>1.9 SDI<br>1.9 TDI<br>1.9 TDI                    |  |  | 03.97<br>05.97<br>08.97<br>05.97<br>03.97<br>01.97<br>06.98                      | 09.01<br>09.01<br>09.01<br>09.01<br>09.01<br>09.01<br>09.01                       | + ABS<br>+ ABS<br>+ ABS<br>+ ABS<br>+ ABS<br>+ ABS<br>+ ABS                        | 03.2122-1144.3   | 010636   |  | Thz 22,20   | ATE                             |
|  | 1.4<br>1.6<br>1.7 SDI<br>1.8<br>1.9 SDI<br>1.9 TDI<br>1.9 TDI                    |  |  | 03.97<br>05.97<br>08.97<br>05.97<br>03.97<br>01.97<br>06.98                      | 09.01<br>09.01<br>09.01<br>09.01<br>09.01<br>09.01<br>09.01                       | + ABS<br>+ ABS<br>+ ABS<br>+ ABS<br>+ ABS<br>+ ABS<br>+ ABS                        | 03.2122-1184.3   | 010592   |  | Thz 22,20   | ATE                             |
|    | 1.4  |  |  | 03.97  | 09.01   | - ABS  | 24.3481-1745.5<br>24.3481-1746.5<br>11.0441-4808.2<br>11.0101-4803.2<br>24.0102-4803.2 | 240277<br>240278<br>250022<br>260008<br>260086                                     | <br>     | D=48, - Halter<br>D=48, - Halter<br>Dichtungssatz<br>Hülensatz<br>Hülensatz+Schrauben | ATE<br>ATE<br>ATE<br>ATE<br>ATE |
|  | 1.4<br>1.6<br>1.7 SDI<br>1.9 SDI   | 55   |  | 03.97<br>05.97<br>08.97<br>03.97   | 09.01<br>09.01<br>09.01<br>09.01  | + ABS  | 11.0441-4808.2<br>11.0101-4801.2<br>24.0102-4801.2                                     | 250022<br>260006<br>260085   |  | Dichtungssatz<br>Hülensatz<br>Hülensatz+Schrauben                                     | ATE<br>ATE<br>ATE               |
|  | 1.6<br>1.8<br>1.9 TDI<br>1.9 TDI   | 74<br>66<br>81   |  | 05.97<br>05.97<br>01.97<br>06.98   | 09.01<br>09.01<br>09.01<br>09.01  |  | 24.3541-1609.5<br>24.3541-1610.5<br>24.0101-4301.2<br>11.0101-5403.2                   | 240039<br>240040<br>260047<br>260010   | <br>     | D=54, - Halter<br>D=54, - Halter<br>Einbausatz<br>Fallenbalgsatz                      | LUC<br>LUC<br>LUC<br>LUC        |
|   | 1.4<br>1.6<br>1.7 SDI<br>1.8<br>1.9 SDI<br>1.9 TDI<br>1.9 TDI                    |  |  | 03.97<br>05.97<br>08.97<br>05.97<br>03.97<br>01.97<br>06.98                      | 09.01<br>09.01<br>09.01<br>09.01<br>09.01<br>09.01<br>09.01                       |  | 83.7713-0435.3   | 330792   | 2  | L=435   |                                 |
|  | 1.9 TDI  | 81   |  | 06.98  | 09.01   |  | 24.3384-1723.7<br>24.3384-1724.7   | 220523<br>220524   | <br> | D=38(M12x1), - Halter<br>D=38(M12x1), - Halter  | LUC<br>LUC                      |
|  | 1.4<br>1.6<br>1.7 SDI<br>1.8<br>1.9 SDI<br>1.9 TDI<br>1.9 TDI                    |  |  | 03.97<br>05.97<br>08.97<br>05.97<br>03.97<br>01.97<br>06.98                      |   |  | 24.5230-0143.3   | 330402   | 2  | L=143   |                                 |
|  | 1.4<br>1.6<br>1.7 SDI<br>1.8<br>1.9 SDI<br>1.9 TDI<br>1.9 TDI                    | 66<br>81   |  | 03.97<br>05.97<br>08.97<br>05.97<br>03.97<br>01.97<br>06.98                      | 09.01<br>09.01<br>09.01<br>09.01<br>09.01<br>09.01<br>09.01                       |  | 83.7858-0140.3   | 330837   | 2  | L=140   |                                 |
|  | 1.4<br>1.6<br>1.7 SDI<br>1.8<br>1.9 SDI<br>1.9 TDI                               |  |  | 03.97<br>05.97<br>08.97<br>05.97<br>03.97<br>01.97                               | 09.01<br>09.01<br>09.01<br>09.01<br>09.01<br>09.01                                |  | 24.3219-0909.3   | 020188   |  | Rz 19,05  |                                 |
|  | 1.4<br>1.6<br>1.7 SDI<br>1.8<br>1.9 SDI<br>1.9 TDI                               |  |  | 03.97<br>05.97<br>08.97<br>05.97<br>03.97<br>01.97                               | 09.01<br>09.01<br>09.01<br>09.01<br>09.01<br>09.01                                |  | 24.3727-0161.2   | 580161   | 2 ↓  | L=1512  |                                 |
|  | 1.4<br>1.6<br>1.7 SDI<br>1.8<br>1.9 SDI<br>1.9 TDI                               | 66   |  | 03.97<br>05.97<br>08.97<br>05.97<br>03.97<br>01.97                               | 09.01<br>09.01<br>09.01<br>09.01<br>09.01<br>09.01                                |  | 24.3727-0162.2   | 580162   | 2 ↓  | L=1514  |                                 |
|  | 1.9 TDI  | 81   |  | 06.98  | 09.01   |  | 24.3727-0165.2   | 580165   | 2 ↓  | L=1641  |                                 |

|  |                           |          |                         |                         |  |                |        |                 |
|--|---------------------------|----------|-------------------------|-------------------------|--|----------------|--------|-----------------|
|  |                           |          |                         |                         |  |                |        |                 |
| <b>VOLKSWAGEN POLO Variant (97-01)</b> |                           |          |                         |                         |  |                |        |                 |
|  | 1.4<br>1.6<br>1.9 SDI     |          | 03.97<br>05.97<br>03.97 | 09.01<br>09.01<br>09.01 |  | 03.6584-0113.3 | 320111 | BRL 8/4 (4) ATE |
|  | 1.8<br>1.9 TDI<br>1.9 TDI | 66<br>81 | 05.97<br>01.97<br>06.98 | 09.01<br>09.01<br>09.01 |  | 03.6583-0179.3 | 320228 | BRL 8/3 (4) ATE |
|  | 1.9 TDI<br>1.9 TDI        | 66<br>81 | 01.97<br>06.98          | 09.01<br>09.01          |  | 03.2419-9510.3 | 030028 | Gz 19,05        |
|  | 1.9 TDI<br>1.9 TDI        | 66<br>81 | 01.97<br>06.98          | 09.01<br>09.01          |  | 24.2523-0908.3 | 040049 | Nz 23,81        |
|  | 1.4<br>1.6<br>1.6         | 55<br>74 | 03.97<br>05.97<br>05.97 | 09.01<br>09.01<br>09.01 |  | 24.3728-2707.2 | 592707 | L=1047, + AUT   |
|  |                           |          | 05.97                   | 09.01                   |  | 24.3728-0128.2 | 590128 | L=854, + AUT    |

|                                  |   |   |   |   |  |  |  |   |
|----------------------------------|---|---|---|---|--|--|--|---|
| <b>VOLKSWAGEN SCIROCCO (08-)</b> |   |   |   |   |  |  |  |   |
|                                  | 1.4 TSI<br>1.4 TSI<br>2.0 R<br>2.0 TDI<br>2.0 TDI<br>2.0 TDI<br>2.0 TSI | 90<br>118<br>195<br>103<br>125<br>130<br>90 | 09.08<br>08.08<br>11.09<br>10.08<br>05.09<br>01.13<br>08.08 | PR: 1ZA,1ZE,1LJ<br>PR: 1ZA,1ZE,1LJ<br>PR: 1ZA,1ZE,1LJ<br>PR: 1ZA,1ZE,1LJ<br>PR: 1ZA,1ZE,1LJ<br>PR: 1ZA,1ZE,1LJ<br>PR: 1ZA,1ZE,1LJ                             |  | 03.7863-9702.4   | 300207   | Kolbendurchmesser Ø 23,81mm <sup>1)</sup> 10" ATE   |
|                                  | 1.4 TSI<br>1.4 TSI<br>2.0 R<br>2.0 TDI<br>2.0 TDI<br>2.0 TDI<br>2.0 TSI | 90<br>118<br>195<br>103<br>125<br>130<br>90 | 09.08<br>08.08<br>11.09<br>10.08<br>05.09<br>01.13<br>08.08 | PR: 1ZD,1ZP<br>PR: 1ZD,1ZP<br>PR: 1ZD,1ZP<br>PR: 1ZD,1ZP<br>PR: 1ZD,1ZP<br>PR: 1ZD,1ZP<br>PR: 1ZD,1ZP   |  | 03.7863-9502.4   | 300204   | Kolbendurchmesser Ø 22,20mm <sup>2)</sup> 10" ATE   |
|                                  | 1.4 TSI<br>1.4 TSI<br>2.0 R<br>2.0 TDI<br>2.0 TDI<br>2.0 TDI<br>2.0 TSI | 90<br>118<br>195<br>103<br>125<br>130<br>90 | 09.08<br>08.08<br>11.09<br>10.08<br>05.09<br>01.13<br>08.08 | PR: 1ZK<br>PR: 1ZK<br>PR: 1ZK<br>PR: 1ZK<br>PR: 1ZK<br>PR: 1ZK<br>PR: 1ZK   |  | 03.7860-3902.4   | 300278   | 10" ATE   |
|                                  | 1.4 TSI<br>1.4 TSI<br>2.0 R<br>2.0 TDI<br>2.0 TDI<br>2.0 TDI<br>2.0 TSI | 90<br>118<br>195<br>103<br>125<br>130<br>90 | 09.08<br>08.08<br>11.09<br>10.08<br>05.09<br>01.13<br>08.08 | PR: 1ZD,1ZP<br>PR: 1ZD,1ZP<br>PR: 1ZD,1ZP<br>PR: 1ZD,1ZP<br>PR: 1ZD,1ZP<br>PR: 1ZD,1ZP<br>PR: 1ZD,1ZP   |  | 03.2122-2129.3   | 010799   | Thz 22,20 ATE   |
|                                  | 1.4 TSI<br>1.4 TSI<br>2.0 R<br>2.0 TDI<br>2.0 TDI<br>2.0 TDI<br>2.0 TSI | 90<br>118<br>195<br>103<br>125<br>130<br>90 | 09.08<br>08.08<br>11.09<br>10.08<br>05.09<br>01.13<br>08.08 | PR: 1ZA,1ZE,1LJ,1ZK<br>PR: 1ZA,1ZE,1LJ,1ZK<br>PR: 1ZA,1ZE,1LJ,1ZK<br>PR: 1ZA,1ZE,1LJ,1ZK<br>PR: 1ZA,1ZE,1LJ,1ZK<br>PR: 1ZA,1ZE,1LJ,1ZK<br>PR: 1ZA,1ZE,1LJ,1ZK |  | 03.2123-3449.3   | 010808   | Thz 23,81 ATE   |
|                                  | 1.4 TSI<br>1.4 TSI<br>2.0 R<br>2.0 TDI<br>2.0 TDI<br>2.0 TDI<br>2.0 TSI | 90<br>118<br>195<br>103<br>125<br>130<br>90 | 09.08<br>08.08<br>11.09<br>10.08<br>05.09<br>01.13<br>08.08 | PR: 1ZE,1ZP<br>PR: 1ZE,1ZP<br>PR: 1ZE,1ZP<br>PR: 1ZE,1ZP<br>PR: 1ZE,1ZP<br>PR: 1ZE,1ZP<br>PR: 1ZE,1ZP   |  | 11.9541-9553.2<br>11.9541-9554.2<br>11.0101-5409.2<br>11.8171-0008.1<br>11.8116-0351.1 | 220563<br>220564<br>260035<br>990049<br>390538 | 2<br>D=54, - Halter ATE<br>D=54, - Halter ATE<br>Hülzensatz ATE<br>Führungsbolzen ATE<br>Haltefeder ATE |
|                                  | 1.4 TSI<br>1.4 TSI<br>2.0 R<br>2.0 TDI<br>2.0 TDI<br>2.0 TDI<br>2.0 TSI | 90<br>118<br>195<br>103<br>125<br>130<br>90 | 09.08<br>08.08<br>11.09<br>10.08<br>05.09<br>01.13<br>08.08 | PR: 1LJ,1ZA,1ZD<br>PR: 1LJ,1ZA,1ZD<br>PR: 1LJ,1ZA,1ZD<br>PR: 1LJ,1ZA,1ZD<br>PR: 1LJ,1ZA,1ZD<br>PR: 1LJ,1ZA,1ZD<br>PR: 1LJ,1ZA,1ZD                             |  | 11.9541-9553.2<br>11.9541-9554.2<br>11.0101-5409.2<br>11.8171-0008.1<br>11.8116-0351.1 | 220563<br>220564<br>260035<br>990049<br>390538 | 2<br>D=54, - Halter ATE<br>D=54, - Halter ATE<br>Hülzensatz ATE<br>Führungsbolzen ATE<br>Haltefeder ATE |
|                                  | 1.4 TSI<br>1.4 TSI<br>2.0 R<br>2.0 TDI<br>2.0 TDI<br>2.0 TDI<br>2.0 TSI | 90<br>118<br>195<br>103<br>125<br>130<br>90 | 09.08<br>08.08<br>11.09<br>10.08<br>05.09<br>01.13<br>08.08 | PR: 1ZB<br>PR: 1ZB<br>PR: 1ZB<br>PR: 1ZB<br>PR: 1ZB<br>PR: 1ZB<br>PR: 1ZB   |  | 11.9541-9553.2<br>11.9541-9554.2<br>11.0101-5409.2<br>11.8171-0008.1<br>11.8116-0351.1 | 220563<br>220564<br>260035<br>990049<br>390538 | 2<br>D=54, - Halter ATE<br>D=54, - Halter ATE<br>Hülzensatz ATE<br>Führungsbolzen ATE<br>Haltefeder ATE |
|                                  | 1.4 TSI<br>1.4 TSI<br>2.0 R<br>2.0 TDI<br>2.0 TDI<br>2.0 TDI<br>2.0 TSI | 90<br>118<br>195<br>103<br>125<br>130<br>90 | 09.08<br>08.08<br>11.09<br>10.08<br>05.09<br>01.13<br>08.08 | PR: 1ZK<br>PR: 1ZK<br>PR: 1ZK<br>PR: 1ZK<br>PR: 1ZK<br>PR: 1ZK<br>PR: 1ZK   |  | 11.9576-9947.2<br>11.9576-9948.2<br>11.0101-5409.2                                     | 220809<br>220810<br>260035                     | 2<br>D=57, - Halter ATE<br>D=57, - Halter ATE<br>Hülzensatz ATE   |
|                                  | 1.4 TSI<br>1.4 TSI<br>2.0 R<br>2.0 TDI<br>2.0 TDI                       | 90<br>118<br>195<br>103<br>125              | 09.08<br>08.08<br>11.09<br>10.08<br>05.09                   | PR: G03,G07,G08,G11,G45<br>PR: G03,G07,G08,G11,G45<br>PR: G03,G07,G08,G11,G45<br>PR: G03,G07,G08,G11,G45<br>PR: G03,G07,G08,G11,G45                           |  | 83.7847-0563.3   | 331124   | 2<br>L=562  |

<sup>1)</sup> piston diameter Ø 23,81mm / diametro del pistone Ø 23,81mm / diamètre de piston Ø 23,81mm / diámetro del pistón Ø 23,81mm

<sup>2)</sup> piston diameter Ø 22,20mm / diametro del pistone Ø 22,20mm / diamètre de piston Ø 22,20mm / diámetro del pistón Ø 22,20mm

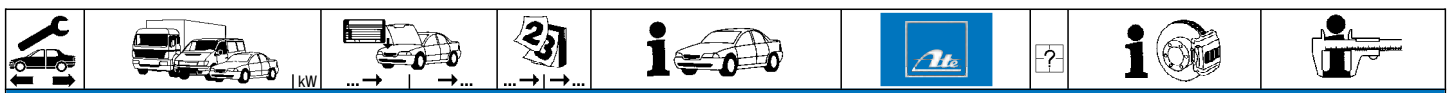

**VOLKSWAGEN SCIROCCO (08-)**













|  |         |     |  |       |                         |                |        |   |  |                    |     |
|--|---------|-----|--|-------|-------------------------|----------------|--------|---|--|--------------------|-----|
|  | 2.0 TDI | 130 |  | 01.13 | PR: G03,G07,G08,G11,G45 | 83.7847-0563.3 | 331124 | 2 |  | L=562              |     |
|  | 2.0 TSI |     |  | 08.08 | PR: G03,G07,G08,G11,G45 |                |        |   |  |                    |     |
|  | 1.4 TSI | 90  |  | 09.08 | PR: G04,G09,G33         | 83.7849-0502.3 | 331125 | 2 |  | L=504              |     |
|  | 1.4 TSI | 118 |  | 08.08 | PR: G04,G09,G33         |                |        |   |  |                    |     |
|  | 2.0 R   | 195 |  | 11.09 | PR: G04,G09,G33         |                |        |   |  |                    |     |
|  | 2.0 TDI | 103 |  | 10.08 | PR: G04,G09,G33         |                |        |   |  |                    |     |
|  | 2.0 TDI | 125 |  | 05.09 | PR: G04,G09,G33         |                |        |   |  |                    |     |
|  | 2.0 TDI | 130 |  | 01.13 | PR: G04,G09,G33         |                |        |   |  |                    |     |
|  | 2.0 TSI |     |  | 08.08 | PR: G04,G09,G33         |                |        |   |  |                    |     |
|  | 1.4 TSI | 90  |  | 09.08 | PR: 1KD                 | 24.3384-1755.7 | 220635 |   |  | D=38, - Halter     | LUC |
|  | 1.4 TSI | 118 |  | 08.08 | PR: 1KD                 | 24.3384-1756.7 | 220636 |   |  | D=38, - Halter     | LUC |
|  | 2.0 R   | 195 |  | 11.09 | PR: 1KD                 | 24.0101-3803.2 | 260101 |   |  | Einbausatz         | LUC |
|  | 2.0 TDI | 103 |  | 10.08 | PR: 1KD                 |                |        |   |  |                    |     |
|  | 2.0 TDI | 125 |  | 05.09 | PR: 1KD                 |                |        |   |  |                    |     |
|  | 2.0 TDI | 130 |  | 01.13 | PR: 1KD                 |                |        |   |  |                    |     |
|  | 2.0 TSI |     |  | 08.08 | PR: 1KD                 |                |        |   |  |                    |     |
|  | 1.4 TSI | 90  |  | 09.08 | PR: 1KE                 | 24.3414-1709.7 | 220631 |   |  | D=41, - Halter     | LUC |
|  | 1.4 TSI | 118 |  | 08.08 | PR: 1KE                 | 24.3414-1710.7 | 220632 |   |  | D=41, - Halter     | LUC |
|  | 2.0 R   | 195 |  | 11.09 | PR: 1KE                 | 24.0101-3803.2 | 260101 |   |  | Einbausatz         | LUC |
|  | 2.0 TDI | 103 |  | 10.08 | PR: 1KE                 |                |        |   |  |                    |     |
|  | 2.0 TDI | 125 |  | 05.09 | PR: 1KE                 |                |        |   |  |                    |     |
|  | 2.0 TDI | 130 |  | 01.13 | PR: 1KE                 |                |        |   |  |                    |     |
|  | 2.0 TSI |     |  | 08.08 | PR: 1KE                 |                |        |   |  |                    |     |
|  | 1.4 TSI | 90  |  | 09.08 | PR: 1KW                 | 24.0101-3803.2 | 260101 |   |  | Einbausatz         | LUC |
|  | 1.4 TSI | 118 |  | 08.08 | PR: 1KW                 |                |        |   |  |                    |     |
|  | 2.0 R   | 195 |  | 11.09 | PR: 1KW                 |                |        |   |  |                    |     |
|  | 2.0 TDI | 103 |  | 10.08 | PR: 1KW                 |                |        |   |  |                    |     |
|  | 2.0 TDI | 125 |  | 05.09 | PR: 1KW                 |                |        |   |  |                    |     |
|  | 2.0 TDI | 130 |  | 01.13 | PR: 1KW                 |                |        |   |  |                    |     |
|  | 2.0 TSI |     |  | 08.08 | PR: 1KW                 |                |        |   |  |                    |     |
|  | 1.4 TSI | 90  |  | 09.08 | PR: 1KD,1KE,1KW         | 83.7849-0243.3 | 331099 | 2 |  | L=243              |     |
|  | 1.4 TSI | 118 |  | 08.08 | PR: 1KD,1KE,1KW         |                |        |   |  |                    |     |
|  | 2.0 R   | 195 |  | 11.09 | PR: 1KD,1KE,1KW         |                |        |   |  |                    |     |
|  | 2.0 TDI | 103 |  | 10.08 | PR: 1KD,1KE,1KW         |                |        |   |  |                    |     |
|  | 2.0 TDI | 125 |  | 05.09 | PR: 1KD,1KE,1KW         |                |        |   |  |                    |     |
|  | 2.0 TDI | 130 |  | 01.13 | PR: 1KD,1KE,1KW         |                |        |   |  |                    |     |
|  | 2.0 TSI |     |  | 08.08 | PR: 1KD,1KE,1KW         |                |        |   |  |                    |     |
|  | 1.4 TSI | 90  |  | 09.08 |                         | 24.3727-0195.2 | 580195 | 2 |  | L=1447             |     |
|  | 1.4 TSI | 118 |  | 08.08 |                         |                |        |   |  |                    |     |
|  | 2.0 R   | 195 |  | 11.09 |                         |                |        |   |  |                    |     |
|  | 2.0 TDI | 103 |  | 10.08 |                         |                |        |   |  |                    |     |
|  | 2.0 TDI | 125 |  | 05.09 |                         |                |        |   |  |                    |     |
|  | 2.0 TDI | 130 |  | 01.13 |                         |                |        |   |  |                    |     |
|  | 2.0 TSI |     |  | 08.08 |                         |                |        |   |  |                    |     |
|  | 1.4 TSI | 90  |  | 09.08 |                         | 24.2415-1711.3 | 030130 |   |  | Gz 15,87           |     |
|  | 1.4 TSI | 118 |  | 08.08 |                         | 24.2415-1713.3 | 030132 |   |  | Gz 15,87, + Sensor |     |
|  | 2.0 R   | 195 |  | 11.09 |                         |                |        |   |  |                    |     |
|  | 2.0 TDI | 103 |  | 10.08 |                         |                |        |   |  |                    |     |
|  | 2.0 TDI | 125 |  | 05.09 |                         |                |        |   |  |                    |     |
|  | 2.0 TDI | 130 |  | 01.13 |                         |                |        |   |  |                    |     |
|  | 2.0 TSI |     |  | 08.08 |                         |                |        |   |  |                    |     |
|  | 1.4 TSI | 90  |  | 09.08 | PR: 0EJ                 | 24.2519-1705.3 | 040095 |   |  | Nz 19,05           |     |
|  | 1.4 TSI | 118 |  | 08.08 | PR: 0EJ                 |                |        |   |  |                    |     |
|  | 2.0 R   | 195 |  | 11.09 | PR: 0EJ                 |                |        |   |  |                    |     |
|  | 2.0 TDI | 103 |  | 10.08 | PR: 0EJ                 |                |        |   |  |                    |     |
|  | 2.0 TDI | 125 |  | 05.09 | PR: 0EJ                 |                |        |   |  |                    |     |
|  | 2.0 TDI | 130 |  | 01.13 | PR: 0EJ                 |                |        |   |  |                    |     |
|  | 2.0 TSI |     |  | 08.08 | PR: 0EJ                 |                |        |   |  |                    |     |

**VOLKSWAGEN SHARAN I (95-10)**

|  |                    |     |             |       |       |                |        |  |         |             |     |
|--|--------------------|-----|-------------|-------|-------|----------------|--------|--|---------|-------------|-----|
|  | 1.8 T              | 110 | 7M-W-060000 | 09.97 |       | 03.7760-3002.4 | 300120 |  |         | 10"         | ATE |
|  | 1.9 TDI            | 66  | 7M-W-060000 | 09.95 |       |                |        |  |         |             |     |
|  | 1.9 TDI            | 81  | 7M-W-060000 | 09.96 |       |                |        |  |         |             |     |
|  | 2.0                | 85  | 7M-W-060000 | 09.95 |       |                |        |  |         |             |     |
|  | 2.8 VR6            | 128 | 7M-W-060000 | 09.95 |       |                |        |  |         |             |     |
|  | 2.8 VR6 Syncro     | 128 | 7M-W-060000 | 11.96 |       |                |        |  |         |             |     |
|  | 1.8 T              | 110 | 7M-W-020919 |       | 04.00 | 03.7755-1902.4 | 300138 |  |         | 9" Tandem   | ATE |
|  | 1.9 TDI            | 66  | 7M-W-020919 |       | 04.00 |                |        |  |         |             |     |
|  | 1.9 TDI            | 81  | 7M-W-020919 |       | 04.00 |                |        |  |         |             |     |
|  | 2.0                | 85  | 7M-W-020919 |       | 04.00 |                |        |  |         |             |     |
|  | 2.8 VR6            | 128 | 7M-W-020919 |       | 04.00 |                |        |  |         |             |     |
|  | 2.8 VR6 Syncro     | 128 | 7M-W-020919 |       | 04.00 |                |        |  |         |             |     |
|  | 1.8 T              | 110 | 7M-W-020918 | 09.97 |       | 03.7760-3002.4 | 300120 |  |         | 10"         | ATE |
|  | 1.9 TDI            | 66  | 7M-W-020918 | 09.95 |       |                |        |  |         |             |     |
|  | 1.9 TDI            | 81  | 7M-W-020918 | 09.96 |       |                |        |  |         |             |     |
|  | 2.0                | 85  | 7M-W-020918 | 09.95 |       |                |        |  |         |             |     |
|  | 2.8 VR6            | 128 | 7M-W-020918 | 09.95 |       |                |        |  |         |             |     |
|  | 2.8 VR6 Syncro     | 128 | 7M-W-020918 | 11.96 |       |                |        |  |         |             |     |
|  | 1.8 T              | 110 |             | 05.00 | 04.02 | 03.7755-6302.4 | 300221 |  | PR: 1AT | 9/8" Tandem | ATE |
|  | 1.9 TDI            | 66  |             | 05.00 | 04.02 |                |        |  |         |             |     |
|  | 1.9 TDI            | 85  |             | 05.00 | 04.02 |                |        |  |         |             |     |
|  | 1.9 TDI 4motion    | 85  |             | 05.00 | 04.02 |                |        |  |         |             |     |
|  | 2.0                | 85  |             | 05.00 | 04.02 |                |        |  |         |             |     |
|  | 2.8 V6 24V         | 150 |             | 04.00 | 04.02 |                |        |  |         |             |     |
|  | 2.8 V6 24V 4motion | 150 |             | 04.00 | 04.02 |                |        |  |         |             |     |





|     |  |  |  |  |  |  |  |  |   |                |                   |     |
|--|--|--|--|--|---|--|--|--|---|----------------|-------------------|-----|
| <b>VOLKSWAGEN SHARAN I (95-10)</b>   |  |  |  |  |   |  |  |  |   |                |                   |     |
|    | 1.8 T  | 110  | 7M-3-029999  | 05.00  |   | + ESP  | 03.7858-3302.4   | 300122   |   | 9/8" Tandem    | ATE               |     |
|  | 1.9 TDI  | 66   | 7M-3-029999  | 05.00  |   | + ESP  |  |  |   |                |                   |     |
|  | 1.9 TDI  | 85   | 7M-3-029999  | 05.00  |   | + ESP  |  |  |   |                |                   |     |
|  | 1.9 TDI 4motion  | 85   | 7M-3-029999  | 05.00  |   | + ESP  |  |  |   |                |                   |     |
|  | 2.0  | 85   | 7M-3-029999  | 05.00  |   | + ESP  |  |  |   |                |                   |     |
|  | 2.8 V6 24V   | 150  | 7M-3-029999  | 04.00  |   | + ESP  |  |  |   |                |                   |     |
|  | 2.8 V6 24V 4motion   | 150  | 7M-3-029999  | 04.00  |   | + ESP  |  |  |   |                |                   |     |
|  | 1.8 T  | 110  |  | 05.02  | 06.10   | - ESP  | 03.7755-6302.4   | 300221   |   |                | 9/8" Tandem       | ATE |
|  | 1.9 TDI  | 66   |  | 05.02  | 06.10   | - ESP  |  |  |   |                |                   |     |
|  | 1.9 TDI  | 85   |  | 05.02  | 06.10   | - ESP  |  |  |   |                |                   |     |
|  | 1.9 TDI  | 96   |  | 11.02  | 06.10   | - ESP  |  |  |   |                |                   |     |
|  | 1.9 TDI  | 110  |  | 06.05  | 06.10   | - ESP  |  |  |   |                |                   |     |
| 1.9 TDI 4motion  | 85   |  | 05.02  | 06.10  | - ESP   |  |  |  |   |                |                   |     |
| 2.0  | 85   |  | 05.02  | 06.10  | - ESP   |  |  |  |   |                |                   |     |
| 2.0 TDI  | 110  |  | 11.05  | 06.10  | - ESP   |  |  |  |   |                |                   |     |
| 2.8 V6 24V   | 150  |  | 05.02  | 06.10  | - ESP   |  |  |  |   |                |                   |     |
| 2.8 V6 24V 4motion   | 150  |  | 05.02  | 06.10  | - ESP   |  |  |  |   |                |                   |     |
| 1.8 T  | 110  | 7M-3-030000  |  | 06.10  | + ESP   | 03.7858-9502.4   | 300205   |  |   | 9/8" Tandem    | ATE               |     |
| 1.9 TDI  | 66   | 7M-3-030000  |  | 06.10  | + ESP   |  |  |  |   |                |                   |     |
| 1.9 TDI  | 85   | 7M-3-030000  |  | 06.10  | + ESP   |  |  |  |   |                |                   |     |
| 1.9 TDI  | 96   |  | 11.02  | 06.10  | + ESP   |  |  |  |   |                |                   |     |
| 1.9 TDI  | 110  |  | 06.05  | 06.10  | + ESP   |  |  |  |   |                |                   |     |
| 1.9 TDI 4motion  | 85   | 7M-3-030000  |  | 06.10  | + ESP   |  |  |  |   |                |                   |     |
| 2.0  | 85   | 7M-3-030000  |  | 06.10  | + ESP   |  |  |  |   |                |                   |     |
| 2.0 TDI  | 110  |  | 11.05  | 06.10  | + ESP   |  |  |  |   |                |                   |     |
| 2.8 V6 24V   | 150  | 7M-3-030000  |  | 06.10  | + ESP   |  |  |  |   |                |                   |     |
| 2.8 V6 24V 4motion   | 150  | 7M-3-030000  |  | 06.10  | + ESP   |  |  |  |   |                |                   |     |
|    | 1.8 T  | 110  | 7M-W-020918  | 09.97  |   |  | 03.2123-1548.3   | 010478   |   | - ABS          | THz 23,81         | ATE |
|  | 1.9 TDI  | 66   | 7M-W-020918  | 09.95  |   |  | 03.2123-1526.3   | 010477   |   | + ABS          | THz 23,81         | ATE |
|  | 1.9 TDI  | 81   | 7M-W-020918  | 09.96  |   |  | 03.3517-5100.1   | 390326   |   |                | Verschlußschraube | ATE |
|  | 2.0  | 85   | 7M-W-020918  | 09.95  |   |  |  |  |   |                |                   |     |
|  | 2.8 VR6  | 128  | 7M-W-020918  | 09.95  |   |  |  |  |   |                |                   |     |
|  | 2.8 VR6 Syncro   | 128  | 7M-W-020918  | 11.96  |   |  |  |  |   |                |                   |     |
|  | 1.8 T  | 110  | 7M-W-020919  |  | 04.00   | - ABS  | 03.2125-8404.3   | 010583   |   |                | THz 25,40         | ATE |
|  | 1.9 TDI  | 66   | 7M-W-020919  |  | 04.00   | - ABS  |  |  |   |                |                   |     |
|  | 1.9 TDI  | 81   | 7M-W-020919  |  | 04.00   | - ABS  |  |  |   |                |                   |     |
|  | 2.0  | 85   | 7M-W-020919  |  | 04.00   | - ABS  |  |  |   |                |                   |     |
|  | 2.8 VR6  | 128  | 7M-W-020919  |  | 04.00   | - ABS  |  |  |   |                |                   |     |
|  | 2.8 VR6 Syncro   | 128  | 7M-W-020919  |  | 04.00   | - ABS  |  |  |   |                |                   |     |
| 1.8 T  | 110  | 7M-W-020919  |  | 04.02  | - ESP   | 03.2125-0343.3   | 010896   |  |   | THz 25,40      | ATE               |     |
| 1.9 TDI  | 66   | 7M-W-020919  |  | 04.02  | - ESP   |  |  |  |   |                |                   |     |
| 1.9 TDI  | 81   | 7M-W-020919  |  | 04.00  | - ESP   |  |  |  |   |                |                   |     |
| 2.0  | 85   | 7M-W-020919  |  | 04.02  | - ESP   |  |  |  |   |                |                   |     |
| 2.8 VR6  | 128  | 7M-W-020919  |  | 04.02  | - ESP   |  |  |  |   |                |                   |     |
| 2.8 VR6 Syncro   | 128  | 7M-W-020919  |  | 04.02  | - ESP   |  |  |  |   |                |                   |     |
| 1.8 T  | 110  | 7M-3-029999  | 05.00  |  | + ESP   | 03.2125-9604.3   | 010581   |  |   | THz 25,40      | ATE               |     |
| 1.9 TDI  | 66   | 7M-3-029999  | 05.00  |  | + ESP   |  |  |  |   |                |                   |     |
| 1.9 TDI  | 85   | 7M-3-029999  | 05.00  |  | + ESP   |  |  |  |   |                |                   |     |
| 1.9 TDI 4motion  | 85   | 7M-3-029999  | 05.00  |  | + ESP   |  |  |  |   |                |                   |     |
| 2.0  | 85   | 7M-3-029999  | 05.00  |  | + ESP   |  |  |  |   |                |                   |     |
| 2.8 V6 24V   | 150  | 7M-3-029999  | 04.00  |  | + ESP   |  |  |  |   |                |                   |     |
| 2.8 V6 24V 4motion   | 150  | 7M-3-029999  | 04.00  |  | + ESP   |  |  |  |   |                |                   |     |
| 1.8 T  | 110  |  | 05.02  | 06.10  | - ESP   | 03.2125-0343.3   | 010896   |  |   | THz 25,40      | ATE               |     |
| 1.9 TDI  | 66   |  | 05.02  | 05.05  | - ESP   |  |  |  |   |                |                   |     |
| 1.9 TDI  | 85   |  | 05.02  | 05.05  | - ESP   |  |  |  |   |                |                   |     |
| 1.9 TDI  | 96   |  | 11.02  | 05.05  | - ESP   |  |  |  |   |                |                   |     |
| 1.9 TDI 4motion  | 85   |  | 05.02  | 05.05  | - ESP   |  |  |  |   |                |                   |     |
| 2.0  | 85   |  | 05.02  | 05.05  | - ESP   |  |  |  |   |                |                   |     |
| 2.8 VR6  | 128  |  | 05.02  | 05.05  | - ESP   |  |  |  |   |                |                   |     |
| 2.8 VR6 Syncro   | 128  |  | 05.02  | 05.05  | - ESP   |  |  |  |   |                |                   |     |
|  | 1.8 T  | 110  |  | 09.97  | 04.00   |  | 11.0441-5704.2   | 250034   |   |                | Dichtungssatz     | ATE |
|  | 1.9 TDI  | 66   |  | 09.95  | 04.00   |  | 11.0101-5409.2   | 260035   |   |                | Hülssensatz       | ATE |
|  | 1.9 TDI  | 81   |  | 09.96  | 04.00   |  | 11.8171-0008.1   | 990049   |   |                | Führungsbolzen    | ATE |
|  | 2.0  | 85   |  | 09.95  | 04.00   |  | 11.8116-0143.1   | 390513   | 2 |                | Haltefeder        | ATE |
|  | 2.8 VR6  | 128  |  | 09.95  | 04.00   |  |  |  |   |                |                   |     |
|  | 2.8 VR6 Syncro   | 128  |  | 11.96  | 04.00   |  |  |  |   |                |                   |     |
|  | 1.8 T  | 110  | 7M-1-070000  | 05.00  |   |  | 11.0441-5704.2   | 250034   |   |                | Dichtungssatz     | ATE |
|  | 1.9 TDI  | 66   | 7M-1-070000  | 05.00  |   |  | 11.0101-5409.2   | 260035   |   |                | Hülssensatz       | ATE |
|  | 1.9 TDI  | 85   | 7M-1-070000  | 05.00  |   |  | 11.8171-0008.1   | 990049   |   |                | Führungsbolzen    | ATE |
|  | 2.0  | 85   | 7M-1-070000  | 05.00  |   |  | 11.8116-0143.1   | 390513   | 2 |                | Haltefeder        | ATE |
|  | 1.9 TDI  | 66   | 7M-2-000001  |  | 06.10   |  | 11.9571-9811.2   | 220485   |   |                | D=57, - Halter    | ATE |
|  | 1.9 TDI  | 85   | 7M-2-000001  |  | 06.10   |  | 11.9571-9812.2   | 220486   |   |                | D=57, - Halter    | ATE |
| 1.9 TDI  | 96   |  | 11.02  | 06.10  |   | 11.0441-5704.2   | 250034   |  |   | Dichtungssatz  | ATE               |     |
| 2.0  | 85   | 7M-2-000001  |  | 06.10  |   | 11.0101-5706.2   | 260097   |  |   | Hülssensatz    | ATE               |     |
| 2.0 TDI  | 110  |  | 11.05  | 06.10  |   | 11.8171-0067.1   | 250153   |  |   | Führungsbolzen | ATE               |     |
|  |  |  |  |  |   | 11.8116-0326.1   | 390471   | 2  |   | Haltefeder     | ATE               |     |
| 1.8 T  | 110  | 7M-2-000001  |  | 06.10  |   | 11.9571-9819.2   | 220469   |  |   | D=57, - Halter | ATE               |     |
| 1.9 TDI  | 110  |  | 06.05  | 06.10  |   | 11.9571-9820.2   | 220470   |  |   | D=57, - Halter | ATE               |     |
| 1.9 TDI 4motion  | 85   |  | 05.00  | 06.10  |   | 11.0101-5705.2   | 260096   |  |   | Hülssensatz    | ATE               |     |
| 2.8 V6 24V   | 150  |  | 04.00  | 06.10  |   | 11.8171-0067.1   | 250153   |  |   | Führungsbolzen | ATE               |     |
| 2.8 V6 24V 4motion   | 150  |  | 04.00  | 06.10  |   | 11.8116-0272.1   | 390598   | 2  |   | Haltefeder     | ATE               |     |
|  | 1.8 T  | 110  | 7M-1-070000  | 09.97  |   |  | 83.7717-0450.3   | 330807   | 2 |                | L=450             |     |
|  | 1.9 TDI  | 66   | 7M-1-070000  | 09.95  |   |  | 24.5166-0454.3   | 331306   | 2 |                | L=454             |     |
|  | 1.9 TDI  | 81   |  | 09.96  | 04.00   |  |  |  |   |                |                   |     |
|  | 1.9 TDI  | 85   | 7M-1-070000  | 05.00  |   | + Frontantrieb 1)  |  |  |   |                |                   |     |
|  | 2.0  | 85   | 7M-1-070000  | 09.95  |   |  |  |  |   |                |                   |     |

1) + front wheel drive / + trazione anteriore / + traction avant / + traccion delantera

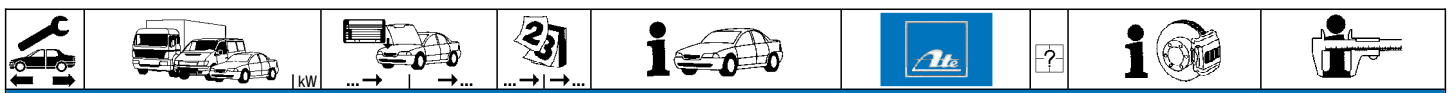

**VOLKSWAGEN SHARAN I (95-10)**

|                    |                 |     |             |       |                |                |        |   |                              |                |     |
|--------------------|-----------------|-----|-------------|-------|----------------|----------------|--------|---|------------------------------|----------------|-----|
|                    | 2.8 VR6         | 128 |             | 09.95 | 04.00          | 83.7717-0450.3 | 330807 | 2 |                              | L=450          |     |
|                    | 2.8 VR6 Syncro  | 128 |             | 11.96 | 04.00          | 24.5166-0454.3 | 331306 | 2 |                              | L=454          |     |
|                    | 1.8 T           | 110 | 7M-2-070001 |       | 06.10          | 83.6219-0455.3 | 330592 | 2 |                              | L=455          |     |
|                    | 1.9 TDI         | 66  | 7M-2-070001 |       | 06.10          |                |        |   |                              |                |     |
|                    | 1.9 TDI         | 85  |             | 05.00 | 06.10          |                |        |   |                              |                |     |
|                    | 1.9 TDI         | 96  |             | 11.02 | 06.10          |                |        |   |                              |                |     |
|                    | 1.9 TDI         | 110 |             | 06.05 | 06.10          |                |        |   |                              |                |     |
|                    | 1.9 TDI 4motion | 85  | 7M-2-070001 |       | 06.10          |                |        |   |                              |                |     |
|                    | 2.0             | 85  | 7M-2-070001 |       | 06.10          |                |        |   |                              |                |     |
|                    | 2.0 TDI         |     |             | 11.05 | 06.10          |                |        |   |                              |                |     |
| 2.8 V6 24V         | 150             |     | 04.00       | 06.10 |                |                |        |   |                              |                |     |
| 2.8 V6 24V 4motion | 150             |     | 04.00       | 06.10 |                |                |        |   |                              |                |     |
|                    | 1.8 T           | 110 | 7M-1-070000 | 09.97 | 06.10          | 24.3384-1707.5 | 240171 |   |                              | D=38, - Halter | LUC |
|                    | 1.9 TDI         | 66  |             | 09.95 | 06.10          | 24.3384-1708.5 | 240172 |   |                              | D=38, - Halter | LUC |
|                    | 1.9 TDI         | 81  |             | 09.96 | 04.00          | 11.0101-5403.2 | 260010 |   |                              | Faltenbalsatz  | LUC |
|                    | 1.9 TDI         | 85  |             | 05.00 | 06.10          |                |        |   |                              |                |     |
|                    | 1.9 TDI         | 96  |             | 11.02 | 06.10          |                |        |   |                              |                |     |
|                    | 2.0             | 85  |             | 09.95 | 06.10          |                |        |   |                              |                |     |
|                    | 2.0 TDI         |     |             | 11.05 | 06.10          |                |        |   |                              |                |     |
|                    | 2.8 VR6         | 128 |             | 09.95 | 04.00          |                |        |   |                              |                |     |
|                    | 2.8 VR6 Syncro  | 128 |             | 11.96 | 04.00          |                |        |   |                              |                |     |
|                    | 1.8 T           | 110 | 7M-2-000001 |       | 06.10          | 24.3384-1715.5 | 240265 |   |                              | D=38, - Halter | LUC |
| 1.9 TDI            | 110             |     | 06.05       | 06.10 | 24.3384-1716.5 | 240266         |        |   | D=38, - Halter               | LUC            |     |
| 1.9 TDI 4motion    | 85              |     | 05.00       | 06.10 |                |                |        |   |                              |                |     |
| 2.8 V6 24V         | 150             |     | 04.00       | 06.10 |                |                |        |   |                              |                |     |
| 2.8 V6 24V 4motion | 150             |     | 04.00       | 06.10 |                |                |        |   |                              |                |     |
|                    | 1.8 T           | 110 |             | 09.97 | 06.10          | 83.6225-0370.3 | 330768 | 2 |                              | L=370          |     |
|                    | 1.9 TDI         | 66  |             | 09.95 | 06.10          | 83.6113-0140.3 | 330482 | 2 | am Bremssattel <sup>1)</sup> | L=140          |     |
|                    | 1.9 TDI         | 81  |             | 09.96 | 04.00          |                |        |   |                              |                |     |
|                    | 1.9 TDI         | 85  |             | 05.00 | 06.10          |                |        |   |                              |                |     |
|                    | 1.9 TDI         | 96  |             | 11.02 | 06.10          |                |        |   |                              |                |     |
|                    | 1.9 TDI         | 110 |             | 06.05 | 06.10          |                |        |   |                              |                |     |
|                    | 1.9 TDI 4motion | 85  |             | 05.00 | 06.10          |                |        |   |                              |                |     |
|                    | 2.0             | 85  |             | 09.95 | 06.10          |                |        |   |                              |                |     |
|                    | 2.0 TDI         |     |             | 11.05 | 06.10          |                |        |   |                              |                |     |
|                    | 2.8 V6 24V      | 150 |             | 04.00 | 06.10          |                |        |   |                              |                |     |
| 2.8 V6 24V 4motion | 150             |     | 04.00       | 06.10 |                |                |        |   |                              |                |     |
| 2.8 VR6            | 128             |     | 09.95       | 06.10 |                |                |        |   |                              |                |     |
| 2.8 VR6 Syncro     | 128             |     | 11.96       | 06.10 |                |                |        |   |                              |                |     |
|                    | 1.8 T           | 110 | 7M-1-070000 | 09.97 | 06.10          | 24.3727-0163.2 | 580163 | 2 |                              | L=1293         |     |
|                    | 1.9 TDI         | 66  |             | 09.95 | 06.10          |                |        |   |                              |                |     |
|                    | 1.9 TDI         | 81  |             | 09.96 | 04.00          |                |        |   |                              |                |     |
|                    | 1.9 TDI         | 85  |             | 05.00 | 06.10          |                |        |   |                              |                |     |
|                    | 1.9 TDI         | 96  |             | 11.02 | 06.10          |                |        |   |                              |                |     |
|                    | 2.0             | 85  |             | 09.95 | 06.10          |                |        |   |                              |                |     |
|                    | 2.8 VR6         | 128 |             | 09.95 | 04.00          |                |        |   |                              |                |     |
|                    | 2.8 VR6 Syncro  | 128 |             | 11.96 | 04.00          |                |        |   |                              |                |     |
|                    | 1.8 T           | 110 |             | 09.97 | 06.10          | 24.2419-1722.3 | 030111 |   |                              | Gz 19,05       |     |
|                    | 1.9 TDI         | 66  |             | 09.95 | 06.10          |                |        |   |                              |                |     |
| 1.9 TDI            | 81              |     | 09.96       | 04.00 |                |                |        |   |                              |                |     |
| 1.9 TDI            | 85              |     | 05.00       | 06.10 |                |                |        |   |                              |                |     |
| 1.9 TDI            | 96              |     | 11.02       | 06.10 |                |                |        |   |                              |                |     |
| 1.9 TDI            | 110             |     | 06.05       | 06.10 |                |                |        |   |                              |                |     |
| 1.9 TDI 4motion    | 85              |     | 05.00       | 06.10 |                |                |        |   |                              |                |     |
| 2.0                | 85              |     | 09.95       | 06.10 |                |                |        |   |                              |                |     |
| 2.0 TDI            |                 |     | 11.05       | 06.10 |                |                |        |   |                              |                |     |
| 2.8 V6 24V         | 150             |     | 04.00       | 06.10 |                |                |        |   |                              |                |     |
| 2.8 V6 24V 4motion | 150             |     | 04.00       | 06.10 |                |                |        |   |                              |                |     |
| 2.8 VR6            | 128             |     | 09.95       | 06.10 |                |                |        |   |                              |                |     |
| 2.8 VR6 Syncro     | 128             |     | 11.96       | 06.10 |                |                |        |   |                              |                |     |

**VOLKSWAGEN SHARAN II (10-)**

|  |                 |      |  |       |         |                |        |  |  |                |     |
|--|-----------------|------|--|-------|---------|----------------|--------|--|--|----------------|-----|
|  | 1.4 TSI         | #110 |  | 07.10 |         | 03.7873-4502.4 | 300284 |  |  | 11"            | ATE |
|  | 1.8 TSI         | #118 |  | 05.12 |         |                |        |  |  |                |     |
|  | 2.0 TDI         | #100 |  | 07.10 |         |                |        |  |  |                |     |
|  | 2.0 TDI         | #125 |  | 07.10 |         |                |        |  |  |                |     |
|  | 2.0 TDI         | #130 |  | 01.13 |         |                |        |  |  |                |     |
|  | 2.0 TDI 4motion | #100 |  | 05.11 |         |                |        |  |  |                |     |
|  | 2.0 TSI         | #147 |  | 10.10 |         |                |        |  |  |                |     |
|  | 1.4 TSI         | #110 |  | 07.10 |         | 03.4153-0186.3 | 010816 |  |  | THz 23,81      | ATE |
|  | 1.8 TSI         | #118 |  | 05.12 |         |                |        |  |  |                |     |
|  | 2.0 TDI         | #100 |  | 07.10 |         |                |        |  |  |                |     |
|  | 2.0 TDI         | #125 |  | 07.10 |         |                |        |  |  |                |     |
|  | 2.0 TDI         | #130 |  | 01.13 |         |                |        |  |  |                |     |
|  | 2.0 TDI 4motion | #100 |  | 05.11 |         |                |        |  |  |                |     |
|  | 2.0 TSI         | #147 |  | 10.10 |         |                |        |  |  |                |     |
|  | 1.4 TSI         | 110  |  | 07.10 | PR: 1LJ | 11.9571-9759.2 | 220847 |  |  | D=57, - Halter | ATE |
|  | 1.8 TSI         | 118  |  | 05.12 | PR: 1LJ | 11.9571-9760.2 | 220848 |  |  | D=57, - Halter | ATE |
|  | 2.0 TDI         | 100  |  | 07.10 | PR: 1LJ | 11.8171-0008.1 | 990049 |  |  | Führungsbolzen | ATE |
|  | 2.0 TDI         | 125  |  | 07.10 | PR: 1LJ | 11.0101-5409.2 | 260035 |  |  | Hülsensatz     | ATE |
|  | 2.0 TDI         | 130  |  | 01.13 | PR: 1LJ |                |        |  |  |                |     |
|  | 2.0 TDI 4motion | 100  |  | 05.11 | PR: 1LJ |                |        |  |  |                |     |
|  | 2.0 TSI         | 147  |  | 10.10 | PR: 1LJ |                |        |  |  |                |     |

<sup>1)</sup> on the brake caliper / sulla pinza freno / sur l'étrier de frein / a la pinza de freno





**VOLKSWAGEN SHARAN II (10-)**

|  |                 |     |  |       |  |                |        |   |  |       |
|--|-----------------|-----|--|-------|--|----------------|--------|---|--|-------|
|  | 1.4 TSI         | 110 |  | 07.10 |  | 24.5143-0257.3 | 331167 | 2 |  | L=257 |
|  | 1.8 TSI         | 118 |  | 05.12 |  |                |        |   |  |       |
|  | 2.0 TDI         | 100 |  | 07.10 |  |                |        |   |  |       |
|  | 2.0 TDI         | 125 |  | 07.10 |  |                |        |   |  |       |
|  | 2.0 TDI         | 130 |  | 01.13 |  |                |        |   |  |       |
|  | 2.0 TDI 4motion | 100 |  | 05.11 |  |                |        |   |  |       |
|  | 2.0 TSI         | 147 |  | 10.10 |  |                |        |   |  |       |













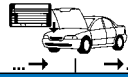









**VOLKSWAGEN TIGUAN (07-)**















|  |                  |     |  |       |             |                |        |   |  |                |     |
|--|------------------|-----|--|-------|-------------|----------------|--------|---|--|----------------|-----|
|  | 1.4 TSI          |     |  | 11.07 |             | 03.7873-4002.4 | 300211 |   |  | 11"            | ATE |
|  | 1.4 TSI          | 90  |  | 08.10 |             | 03.7873-4502.4 | 300284 |   |  | 11"            | ATE |
|  | 1.4 TSI 4motion  |     |  | 09.07 |             |                |        |   |  |                |     |
|  | 2.0 TDI          | 81  |  | 04.10 |             |                |        |   |  |                |     |
|  | 2.0 TDI          | 103 |  | 03.08 |             |                |        |   |  |                |     |
|  | 2.0 TDI 4motion  |     |  | 11.07 |             |                |        |   |  |                |     |
|  | 2.0 TDI 4motion  |     |  | 01.08 |             |                |        |   |  |                |     |
|  | 2.0 TFSI 4motion |     |  | 02.08 |             |                |        |   |  |                |     |
|  | 2.0 TSI 4motion  |     |  | 11.07 |             |                |        |   |  |                |     |
|  | 1.4 TSI          |     |  | 11.07 |             | 03.4153-0186.3 | 010816 |   |  | THz 23,81      | ATE |
|  | 1.4 TSI          | 90  |  | 08.10 |             |                |        |   |  |                |     |
|  | 1.4 TSI 4motion  |     |  | 09.07 |             |                |        |   |  |                |     |
|  | 2.0 TDI          | 81  |  | 04.10 |             |                |        |   |  |                |     |
|  | 2.0 TDI          | 103 |  | 03.08 |             |                |        |   |  |                |     |
|  | 2.0 TDI 4motion  |     |  | 11.07 |             |                |        |   |  |                |     |
|  | 2.0 TDI 4motion  |     |  | 01.08 |             |                |        |   |  |                |     |
|  | 2.0 TFSI 4motion |     |  | 02.08 |             |                |        |   |  |                |     |
|  | 2.0 TSI 4motion  |     |  | 11.07 |             |                |        |   |  |                |     |
|  | 1.4 TSI          |     |  | 11.07 | PR: 1LJ,1ZD | 11.9571-9759.2 | 220847 |   |  | D=57, - Halter | ATE |
|  | 1.4 TSI          | 90  |  | 08.10 | PR: 1LJ,1ZD | 11.9571-9760.2 | 220848 |   |  | D=57, - Halter | ATE |
|  | 1.4 TSI 4motion  |     |  | 09.07 | PR: 1LJ,1ZD | 11.8171-0008.1 | 990049 |   |  | Führungsbolzen | ATE |
|  | 2.0 TDI          | 81  |  | 04.10 | PR: 1LJ,1ZD | 11.0101-5409.2 | 260035 |   |  | Hülzensatz     | ATE |
|  | 2.0 TDI          | 103 |  | 03.08 | PR: 1LJ,1ZD |                |        |   |  |                |     |
|  | 2.0 TDI 4motion  |     |  | 11.07 | PR: 1LJ,1ZD |                |        |   |  |                |     |
|  | 2.0 TDI 4motion  |     |  | 01.08 | PR: 1LJ,1ZD |                |        |   |  |                |     |
|  | 2.0 TFSI 4motion |     |  | 02.08 | PR: 1LJ,1ZD |                |        |   |  |                |     |
|  | 2.0 TSI 4motion  |     |  | 11.07 | PR: 1LJ,1ZD |                |        |   |  |                |     |
|  | 1.4 TSI          |     |  | 11.07 |             | 24.5143-0578.3 | 331168 | 2 |  | L=578          |     |
|  | 1.4 TSI          | 90  |  | 08.10 |             |                |        |   |  |                |     |
|  | 1.4 TSI 4motion  |     |  | 09.07 |             |                |        |   |  |                |     |
|  | 2.0 TDI          | 81  |  | 04.10 |             |                |        |   |  |                |     |
|  | 2.0 TDI          | 103 |  | 03.08 |             |                |        |   |  |                |     |
|  | 2.0 TDI 4motion  |     |  | 11.07 |             |                |        |   |  |                |     |
|  | 2.0 TDI 4motion  |     |  | 01.08 |             |                |        |   |  |                |     |
|  | 2.0 TFSI 4motion |     |  | 02.08 |             |                |        |   |  |                |     |
|  | 2.0 TSI 4motion  |     |  | 11.07 |             |                |        |   |  |                |     |
|  | 1.4 TSI          |     |  | 11.07 |             | 24.5143-0257.3 | 331167 | 2 |  | L=257          |     |
|  | 1.4 TSI          | 90  |  | 08.10 |             |                |        |   |  |                |     |
|  | 1.4 TSI 4motion  |     |  | 09.07 |             |                |        |   |  |                |     |
|  | 2.0 TDI          | 81  |  | 04.10 |             |                |        |   |  |                |     |
|  | 2.0 TDI          | 103 |  | 03.08 |             |                |        |   |  |                |     |
|  | 2.0 TDI 4motion  |     |  | 11.07 |             |                |        |   |  |                |     |
|  | 2.0 TDI 4motion  |     |  | 01.08 |             |                |        |   |  |                |     |
|  | 2.0 TFSI 4motion |     |  | 02.08 |             |                |        |   |  |                |     |
|  | 2.0 TSI 4motion  |     |  | 11.07 |             |                |        |   |  |                |     |















**VOLKSWAGEN TOUAREG I (03-10)**

|  |             |     |  |       |       |                |                |        |                |                |     |
|--|-------------|-----|--|-------|-------|----------------|----------------|--------|----------------|----------------|-----|
|  | 2.5 R5 TDI  |     |  | 12.06 | 03.10 | 03.7868-3702.4 | 300208         |        | PR: 1LB,1LE,LF | 10/8" Tandem   | ATE |
|  | 3.0 V6 TDI  |     |  | 12.06 | 03.10 |                |                |        |                |                |     |
|  | 3.0 V6 TDI  | 176 |  | 10.07 | 03.10 |                |                |        |                |                |     |
|  | 3.6 V6 FSI  | 206 |  | 12.06 | 03.10 |                |                |        |                |                |     |
|  | 4.2 V8 FSI  | 257 |  | 12.06 | 03.10 |                |                |        |                |                |     |
|  | 5.0 TDI R50 | 258 |  | 01.08 | 03.10 |                |                |        |                |                |     |
|  | 5.0 V10 TDI | 230 |  | 12.06 | 03.10 |                |                |        |                |                |     |
|  | 2.5 R5 TDI  |     |  | 12.06 | 03.10 | 03.7868-5302.4 | 300251         |        | PR: 1LA        | 10/8" Tandem   | ATE |
|  | 3.0 V6 TDI  |     |  | 12.06 | 03.10 |                |                |        |                |                |     |
|  | 3.0 V6 TDI  | 176 |  | 10.07 | 03.10 |                |                |        |                |                |     |
|  | 3.6 V6 FSI  | 206 |  | 12.06 | 03.10 |                |                |        |                |                |     |
|  | 4.2 V8 FSI  | 257 |  | 12.06 | 03.10 |                |                |        |                |                |     |
|  | 5.0 TDI R50 | 258 |  | 01.08 | 03.10 |                |                |        |                |                |     |
|  | 5.0 V10 TDI | 230 |  | 12.06 | 03.10 |                |                |        |                |                |     |
|  | 2.5 R5 TDI  |     |  | 01.03 | 03.10 | 03.2126-3014.3 | 010811         |        |                | THz 26,99      | ATE |
|  | 3.0 V6 TDI  |     |  | 11.04 | 03.10 |                |                |        |                |                |     |
|  | 3.0 V6 TDI  | 176 |  | 10.07 | 03.10 |                |                |        |                |                |     |
|  | 3.2 V6      |     |  | 11.02 | 12.05 |                |                |        |                |                |     |
|  | 3.6 V6 FSI  | 206 |  | 01.06 | 03.10 |                |                |        |                |                |     |
|  | 4.2 V8      | 228 |  | 12.02 | 11.06 |                |                |        |                |                |     |
|  | 4.2 V8 FSI  | 257 |  | 12.06 | 03.10 |                |                |        |                |                |     |
|  | 5.0 TDI R50 | 258 |  | 01.08 | 03.10 |                |                |        |                |                |     |
|  | 5.0 V10 TDI | 230 |  | 11.02 | 03.10 |                |                |        |                |                |     |
|  | 6.0 W12     | 331 |  | 08.04 | 11.06 |                |                |        |                |                |     |
|  | 2.5 R5 TDI  |     |  | 01.03 | 03.10 | PR: 1LB        | 11.9601-8502.2 | 220594 |                | D=60, - Halter | ATE |
|  | 3.0 V6 TDI  |     |  | 11.04 | 03.10 | PR: 1LB        | 11.9601-9947.2 | 220903 |                | D=60, - Halter | ATE |
|  | 3.0 V6 TDI  | 176 |  | 10.07 | 03.10 | PR: 1LB        | 11.0441-6008.2 | 250038 |                | Dichtungssatz  | ATE |
|  | 3.2 V6      |     |  | 11.02 | 12.05 | PR: 1LB        | 11.0101-5706.2 | 260097 |                | Hülzensatz     | ATE |
|  | 3.6 V6 FSI  | 206 |  | 01.06 | 03.10 | PR: 1LB        | 11.8171-0067.1 | 250153 |                | Führungsbolzen | ATE |
|  | 4.2 V8      | 228 |  | 12.02 | 11.06 | PR: 1LB        | 11.8116-0237.1 | 390509 | 2              | Haltefeder     | ATE |



|     |   |  |  |        |       |    |                        |  |  |   |  |
|--|---|--|--|--|--|--|--|--|--|---|--|
| VOLKSWAGEN TOUAREG I (03-10)   |   |  |  |  |  |  |  |  |  |   |  |
|    | 4.2 V8 FSI<br>5.0 TDI R50<br>5.0 V10 TDI<br>6.0 W12   | 257<br>258<br>230<br>331   |  | 12.06<br>01.08<br>11.02<br>08.04   | 03.10<br>03.10<br>03.10<br>11.06   | PR: 1LB<br>PR: 1LB<br>PR: 1LB<br>PR: 1LB   | 11.9601-8502.2<br>11.9601-9947.2<br>11.0441-6008.2<br>11.0101-5706.2<br>11.8171-0067.1<br>11.8116-0237.1 | 220594<br>220903<br>250038<br>260097<br>250153<br>390509                           | <br>2   | D=60, - Halter<br>D=60, - Halter<br>Dichtungssatz<br>Hülzensatz<br>Führungsbolzen<br>Haltefeder | ATE<br>ATE<br>ATE<br>ATE<br>ATE<br>ATE |
|    | 2.5 R5 TDI<br>3.0 V6 TDI<br>3.0 V6 TDI<br>3.2 V6<br>3.6 V6 FSI<br>4.2 V8<br>4.2 V8 FSI<br>5.0 TDI R50<br>5.0 V10 TDI<br>6.0 W12 |  | 176  | 01.03<br>11.04<br>10.07<br>11.02<br>01.06<br>12.02<br>12.06<br>01.08<br>11.02<br>08.04 | 03.10<br>03.10<br>03.10<br>12.05<br>03.10<br>11.06<br>03.10<br>03.10<br>03.10<br>11.06 | PR: 1LB<br>PR: 1LB<br>PR: 1LB<br>PR: 1LB<br>PR: 1LB<br>PR: 1LB<br>PR: 1LB<br>PR: 1LB<br>PR: 1LB<br>PR: 1LB   | 83.6169-0685.3   | 330984   | 2  | L=685   |  |
|    | 2.5 R5 TDI<br>3.0 V6 TDI<br>3.0 V6 TDI<br>3.2 V6<br>3.6 V6 FSI<br>4.2 V8<br>4.2 V8 FSI<br>5.0 TDI R50<br>5.0 V10 TDI<br>6.0 W12 |  | 176  | 01.03<br>11.04<br>10.07<br>11.02<br>01.06<br>12.02<br>12.06<br>01.08<br>11.02<br>08.04 | 03.10<br>03.10<br>03.10<br>12.05<br>03.10<br>11.06<br>03.10<br>03.10<br>03.10<br>11.06 | PR: 1LC,1LF,1LE<br>PR: 1LC,1LF,1LE<br>PR: 1LC,1LF,1LE<br>PR: 1LC,1LF,1LE<br>PR: 1LC,1LF,1LE<br>PR: 1LC,1LF,1LE<br>PR: 1LC,1LF,1LE<br>PR: 1LC,1LF,1LE<br>PR: 1LC,1LF,1LE<br>PR: 1LC,1LF,1LE | 83.6213-0515.3   | 330866   | 2  | L=515   |  |
|    | 2.5 R5 TDI<br>3.0 V6 TDI<br>3.0 V6 TDI<br>3.6 V6 FSI<br>4.2 V8<br>4.2 V8 FSI<br>5.0 TDI R50<br>5.0 V10 TDI                      |  | 176  | 01.03<br>11.04<br>10.07<br>01.06<br>12.06<br>01.08<br>11.02                            | 03.10<br>03.10<br>03.10<br>03.10<br>03.10<br>03.10<br>03.10                            | PR: 1LT,1LU<br>PR: 1LT,1LU<br>PR: 1LT,1LU<br>PR: 1LT,1LU<br>PR: 1LT,1LU<br>PR: 1LT,1LU<br>PR: 1LT,1LU  | 83.7769-0713.3   | 331097   | 2  | L=713   |  |
|    | 2.5 R5 TDI<br>3.0 V6 TDI<br>3.0 V6 TDI<br>3.2 V6<br>3.6 V6 FSI<br>4.2 V8<br>4.2 V8 FSI<br>5.0 TDI R50<br>5.0 V10 TDI<br>6.0 W12 |  | 176  | 01.03<br>11.04<br>10.07<br>11.02<br>01.06<br>12.02<br>12.06<br>01.08<br>11.02<br>08.04 | 03.10<br>03.10<br>03.10<br>12.05<br>03.10<br>11.06<br>03.10<br>03.10<br>03.10<br>11.06 | PR: 1KE<br>PR: 1KE<br>PR: 1KE<br>PR: 1KE<br>PR: 1KE<br>PR: 1KE<br>PR: 1KE<br>PR: 1KE<br>PR: 1KE<br>PR: 1KE   | 11.9441-9967.2<br>11.9441-9968.2<br>11.0101-5409.2<br>11.8171-0008.1                                     | 220807<br>220808<br>260035<br>990049   | <br>2   | D=44, - Halter<br>D=44, - Halter<br>Hülzensatz<br>Führungsbolzen                                | ATE<br>ATE<br>ATE<br>ATE               |
|  | 2.5 R5 TDI<br>3.0 V6 TDI<br>3.0 V6 TDI<br>3.2 V6<br>3.6 V6 FSI<br>4.2 V8<br>4.2 V8 FSI<br>5.0 TDI R50<br>5.0 V10 TDI<br>6.0 W12 |  | 176  | 01.03<br>11.04<br>10.07<br>11.02<br>01.06<br>12.02<br>12.06<br>01.08<br>11.02<br>08.04 | 03.10<br>03.10<br>03.10<br>12.05<br>03.10<br>11.06<br>03.10<br>03.10<br>03.10<br>11.06 | PR: 1KE<br>PR: 1KE<br>PR: 1KE<br>PR: 1KE<br>PR: 1KE<br>PR: 1KE<br>PR: 1KE<br>PR: 1KE<br>PR: 1KE<br>PR: 1KE   | 83.6238-0408.3   | 330895   | 2  | L=408   |  |
|  | 2.5 R5 TDI<br>3.0 V6 TDI<br>3.0 V6 TDI<br>3.2 V6<br>3.6 V6 FSI<br>4.2 V8<br>4.2 V8 FSI<br>5.0 TDI R50<br>5.0 V10 TDI<br>6.0 W12 |  | 176  | 01.03<br>11.04<br>10.07<br>11.02<br>01.06<br>12.02<br>12.06<br>01.08<br>11.02<br>08.04 | 03.10<br>03.10<br>03.10<br>12.05<br>03.10<br>11.06<br>03.10<br>03.10<br>03.10<br>11.06 | PR: 1KF,1KQ,2ED<br>PR: 1KF,1KQ,2ED<br>PR: 1KF,1KQ,2ED<br>PR: 1KF,1KQ,2ED<br>PR: 1KF,1KQ,2ED<br>PR: 1KF,1KQ,2ED<br>PR: 1KF,1KQ,2ED<br>PR: 1KF,1KQ,2ED<br>PR: 1KF,1KQ,2ED<br>PR: 1KF,1KQ,2ED | 83.7812-0400.3   | 331214   | 2  | L=400   |  |
|  | 2.5 R5 TDI<br>3.0 V6 TDI<br>3.0 V6 TDI<br>3.2 V6<br>3.6 V6 FSI<br>4.2 V8<br>4.2 V8 FSI<br>5.0 TDI R50<br>5.0 V10 TDI<br>6.0 W12 | ‡<br>‡<br>‡176<br>‡<br>‡206<br>‡228<br>‡257<br>‡258<br>‡230<br>‡331              |  | 01.03<br>11.04<br>10.07<br>11.02<br>01.06<br>12.02<br>12.06<br>01.08<br>11.02<br>08.04 | 03.10<br>03.10<br>03.10<br>12.05<br>03.10<br>11.06<br>03.10<br>03.10<br>03.10<br>11.06 |  | 24.3727-3400.2<br>24.3727-3401.2   | 583400<br>583401   | 1 <br>2  | L=1890<br>L=1750  |  |
|  | 2.5 R5 TDI<br>3.0 V6 TDI<br>3.0 V6 TDI<br>3.2 V6<br>3.6 V6 FSI<br>4.2 V8<br>4.2 V8 FSI<br>5.0 TDI R50<br>5.0 V10 TDI<br>6.0 W12 | ‡<br>‡<br>‡176<br>‡<br>‡206<br>‡228<br>‡257<br>‡258<br>‡230<br>‡331              |  | 01.03<br>11.04<br>10.07<br>11.02<br>01.06<br>12.02<br>12.06<br>01.08<br>11.02<br>08.04 | 03.10<br>03.10<br>03.10<br>12.05<br>03.10<br>11.06<br>03.10<br>03.10<br>03.10<br>11.06 |  | 24.3727-3401.2   | 583401   | 2   | L=1750  |  |

|     |    |  |  |  |  |  |  |  |                |                |        |       |           |     |     |
|--|--|--|--|--|---|--|--|--|----------------|----------------|--------|-------|-----------|-----|-----|
| <b>VOLKSWAGEN TOUAREG II (10-)</b>   |  |  |  |  |   |  |  |  |                |                |        |       |           |     |     |
|    | 3.0 V6 TDI   | 150  | 04.10  | PR: 1LC,1LE  | 83.6213-0515.3  | 330866   | 2  | L=515  |                |                |        |       |           |     |     |
|  | 3.0 V6 TDI   | 165  | 06.10  | PR: 1LC,1LE  |   |  |  |  |                |                |        |       |           |     |     |
|  | 3.0 V6 TDI   | 176  | 04.10  | PR: 1LC,1LE  |   |  |  |  |                |                |        |       |           |     |     |
|  | 3.0 V6 TDI   | 180  | 05.11  | PR: 1LC,1LE  |   |  |  |  |                |                |        |       |           |     |     |
|  | 3.0 V6 TSI Hybrid  | 245  | 04.10  | PR: 1LC,1LE  |   |  |  |  |                |                |        |       |           |     |     |
|  | 3.6 V6 FSI   | 206  | 04.10  | PR: 1LC,1LE  |   |  |  |  |                |                |        |       |           |     |     |
|  | 4.2 V8 FSI   | 265  | 01.11  | PR: 1LC,1LE  |   |  |  |  |                |                |        |       |           |     |     |
|  | 4.2 V8 TDI   | 250  | 04.10  | PR: 1LC,1LE  |   |  |  |  |                |                |        |       |           |     |     |
|  | 3.0 V6 TDI   | 150  | 04.10  | PR: 1LG,1LJ,1LW  |   |  |  |  | 83.7812-0400.3 | 331214         | 2      | L=400 |           |     |     |
|  | 3.0 V6 TDI   | 165  | 06.10  | PR: 1LG,1LJ,1LW  |   |  |  |  |                |                |        |       |           |     |     |
| 3.0 V6 TDI   | 176  | 04.10  | PR: 1LG,1LJ,1LW  |  |   |  |  |  |                |                |        |       |           |     |     |
| 3.0 V6 TDI   | 180  | 05.11  | PR: 1LG,1LJ,1LW  |  |   |  |  |  |                |                |        |       |           |     |     |
| 3.0 V6 TSI Hybrid  | 245  | 04.10  | PR: 1LG,1LJ,1LW  |  |   |  |  |  |                |                |        |       |           |     |     |
| 3.6 V6 FSI   | 206  | 04.10  | PR: 1LG,1LJ,1LW  |  |   |  |  |  |                |                |        |       |           |     |     |
| 4.2 V8 FSI   | 265  | 01.11  | PR: 1LG,1LJ,1LW  |  |   |  |  |  |                |                |        |       |           |     |     |
| 4.2 V8 TDI   | 250  | 04.10  | PR: 1LG,1LJ,1LW  |  |   |  |  |  |                |                |        |       |           |     |     |
|    | 3.0 V6 TDI   | 150  | 04.10  |  | 83.7812-0400.3  | 331214   | 2  | L=400  |                |                |        |       |           |     |     |
|  | 3.0 V6 TDI   | 165  | 06.10  |  |   |  |  |  |                |                |        |       |           |     |     |
|  | 3.0 V6 TDI   | 176  | 04.10  |  |   |  |  |  |                |                |        |       |           |     |     |
|  | 3.0 V6 TDI   | 180  | 05.11  |  |   |  |  |  |                |                |        |       |           |     |     |
|  | 3.0 V6 TSI Hybrid  | 245  | 04.10  |  |   |  |  |  |                |                |        |       |           |     |     |
|  | 3.6 V6 FSI   | 206  | 04.10  |  |   |  |  |  |                |                |        |       |           |     |     |
|  | 4.2 V8 FSI   | 265  | 01.11  |  |   |  |  |  |                |                |        |       |           |     |     |
|  | 4.2 V8 TDI   | 250  | 04.10  |  |   |  |  |  |                |                |        |       |           |     |     |
|  | <b>VOLKSWAGEN TOURAN (03-)</b>   |  |  |  |   |  |  |  |                |                |        |       |           |     |     |
|  |    | 1.2 TSI  | 77   | 05.10  |   |  |  |  | PR: 1AT        | 03.7873-3602.4 | 300209 |       | 11"       | ATE |     |
| 1.4 TSI  |  | 103  | 09.06  | PR: 1AT  |   |  |  |  |                |                |        |       |           |     |     |
| 1.4 TSI  |  | 125  | 11.06  | PR: 1AT  |   |  |  |  |                |                |        |       |           |     |     |
| 1.4 TSI EcoFuel  |  | 110  | 05.09  | PR: 1AT  |   |  |  |  |                |                |        |       |           |     |     |
| 1.6  |  | 75   | 07.03  | PR: 1AT  |   |  |  |  |                |                |        |       |           |     |     |
| 1.6 FSI  |  | 85   | 02.03  | PR: 1AT  |   |  |  |  |                |                |        |       |           |     |     |
| 1.6 TDI  |  | 77   | 05.10  | PR: 1AT  |   |  |  |  |                |                |        |       |           |     |     |
| 1.9 TDI  |  | 66   | 11.04  | PR: 1AT  |   |  |  |  |                |                |        |       |           |     |     |
| 1.9 TDI  |  | 74   | 02.03  | PR: 1AT  |   |  |  |  |                |                |        |       |           |     |     |
| 1.9 TDI  |  | 77   | 08.03  | PR: 1AT  |   |  |  |  |                |                |        |       |           |     |     |
| 2.0 Eco Fuel   |  | 80   | 02.06  | PR: 1AT  |   |  |  |  |                |                |        |       |           |     |     |
| 2.0 FSI  |  | 85   | 10.04  | PR: 1AT  |   |  |  |  |                |                |        |       |           |     |     |
| 2.0 FSI  |  | 110  | 10.03  | PR: 1AT  |   |  |  |  |                |                |        |       |           |     |     |
| 2.0 TDI  |  | 81   | 02.03  | PR: 1AT  |   |  |  |  |                |                |        |       |           |     |     |
| 2.0 TDI  |  | 96   | 01.13  | PR: 1AT  |   |  |  |  |                |                |        |       |           |     |     |
| 2.0 TDI  |  | 103  | 08.03  | PR: 1AT  |   |  |  |  |                |                |        |       |           |     |     |
| 2.0 TDI  |  | 125  | 02.06  | PR: 1AT  |   |  |  |  |                |                |        |       |           |     |     |
|  |  | 1.2 TSI  | 77   | 05.10  | PR: 1AS   | 03.7873-3702.4   | 300283   |  | 11"            |                |        |       |           |     | ATE |
|  |  | 1.4 TSI  | 103  | 09.06  | PR: 1AS   |  |  |  |                |                |        |       |           |     |     |
|  |  | 1.4 TSI  | 125  | 11.06  | PR: 1AS   |  |  |  |                |                |        |       |           |     |     |
|  | 1.4 TSI EcoFuel  | 110  | 05.09  | PR: 1AS  |   |  |  |  |                |                |        |       |           |     |     |
|  | 1.6  | 75   | 07.03  | PR: 1AS  |   |  |  |  |                |                |        |       |           |     |     |
|  | 1.6 FSI  | 85   | 02.03  | PR: 1AS  |   |  |  |  |                |                |        |       |           |     |     |
|  | 1.6 TDI  | 77   | 05.10  | PR: 1AS  |   |  |  |  |                |                |        |       |           |     |     |
|  | 1.9 TDI  | 66   | 11.04  | PR: 1AS  |   |  |  |  |                |                |        |       |           |     |     |
|  | 1.9 TDI  | 74   | 02.03  | PR: 1AS  |   |  |  |  |                |                |        |       |           |     |     |
|  | 1.9 TDI  | 77   | 08.03  | PR: 1AS  |   |  |  |  |                |                |        |       |           |     |     |
|  | 2.0 Eco Fuel   | 80   | 02.06  | PR: 1AS  |   |  |  |  |                |                |        |       |           |     |     |
|  | 2.0 FSI  | 85   | 10.04  | PR: 1AS  |   |  |  |  |                |                |        |       |           |     |     |
|  | 2.0 FSI  | 110  | 10.03  | PR: 1AS  |   |  |  |  |                |                |        |       |           |     |     |
|  | 2.0 TDI  | 81   | 02.03  | PR: 1AS  |   |  |  |  |                |                |        |       |           |     |     |
|  | 2.0 TDI  | 96   | 01.13  | PR: 1AS  |   |  |  |  |                |                |        |       |           |     |     |
|  | 2.0 TDI  | 103  | 08.03  | PR: 1AS  |   |  |  |  |                |                |        |       |           |     |     |
|  | 2.0 TDI  | 125  | 02.06  | PR: 1AS  |   |  |  |  |                |                |        |       |           |     |     |
|  |  | 1.2 TSI  | 77   | 05.10  | PR: 1ZE,1ZP   |  |  |  |                | 03.2122-2129.3 | 010799 |       | Thz 22,20 | ATE |     |
|  |  | 1.4 TSI  | 103  | 09.06  | PR: 1ZE,1ZP   |  |  |  |                |                |        |       |           |     |     |
|  |  | 1.4 TSI  | 125  | 11.06  | PR: 1ZE,1ZP   |  |  |  |                |                |        |       |           |     |     |
| 1.4 TSI EcoFuel  |  | 110  | 05.09  | PR: 1ZE,1ZP  |   |  |  |  |                |                |        |       |           |     |     |
| 1.6  |  | 75   | 07.03  | PR: 1ZE,1ZP  |   |  |  |  |                |                |        |       |           |     |     |
| 1.6 FSI  |  | 85   | 02.03  | PR: 1ZE,1ZP  |   |  |  |  |                |                |        |       |           |     |     |
| 1.6 TDI  |  | 77   | 05.10  | PR: 1ZE,1ZP  |   |  |  |  |                |                |        |       |           |     |     |
| 1.9 TDI  |  | 66   | 11.04  | PR: 1ZE,1ZP  |   |  |  |  |                |                |        |       |           |     |     |
| 1.9 TDI  |  | 74   | 02.03  | PR: 1ZE,1ZP  |   |  |  |  |                |                |        |       |           |     |     |
| 1.9 TDI  |  | 77   | 08.03  | PR: 1ZE,1ZP  |   |  |  |  |                |                |        |       |           |     |     |
| 2.0 Eco Fuel   |  | 80   | 02.06  | PR: 1ZE,1ZP  |   |  |  |  |                |                |        |       |           |     |     |
| 2.0 FSI  |  | 85   | 10.04  | PR: 1ZE,1ZP  |   |  |  |  |                |                |        |       |           |     |     |
| 2.0 FSI  |  | 110  | 10.03  | PR: 1ZE,1ZP  |   |  |  |  |                |                |        |       |           |     |     |
| 2.0 TDI  |  | 81   | 02.03  | PR: 1ZE,1ZP  |   |  |  |  |                |                |        |       |           |     |     |
| 2.0 TDI  |  | 96   | 01.13  | PR: 1ZE,1ZP  |   |  |  |  |                |                |        |       |           |     |     |
| 2.0 TDI  |  | 103  | 08.03  | PR: 1ZE,1ZP  |   |  |  |  |                |                |        |       |           |     |     |
| 2.0 TDI  |  | 125  | 02.06  | PR: 1ZE,1ZP  |   |  |  |  |                |                |        |       |           |     |     |
|  |  | 1.2 TSI  | 77   | 05.10  | PR: 1ZE,1ZP   | 11.9541-9553.2   | 220563   | 2  | D=54, - Halter |                |        |       |           |     | ATE |
|  |  | 1.4 TSI  | 103  | 09.06  | PR: 1ZE,1ZP   |  |  |  |                |                |        |       |           |     |     |
|  |  | 1.4 TSI  | 125  | 11.06  | PR: 1ZE,1ZP   |  |  |  |                |                |        |       |           |     |     |
|  | 1.4 TSI EcoFuel  | 110  | 05.09  | PR: 1ZE,1ZP  |   |  |  |  |                |                |        |       |           |     |     |
|  | 1.6  | 75   | 07.03  | PR: 1ZE,1ZP  |   |  |  |  |                |                |        |       |           |     |     |
|  | 1.6 FSI  | 85   | 02.03  | PR: 1ZE,1ZP  |   |  |  |  |                |                |        |       |           |     |     |
|  | 1.6 TDI  | 77   | 05.10  | PR: 1ZE,1ZP  |   |  |  |  |                |                |        |       |           |     |     |
|  | 1.9 TDI  | 66   | 11.04  | PR: 1ZE,1ZP  |   |  |  |  |                |                |        |       |           |     |     |
|  | 1.9 TDI  | 74   | 02.03  | PR: 1ZE,1ZP  |   |  |  |  |                |                |        |       |           |     |     |
|  | 1.9 TDI  | 77   | 08.03  | PR: 1ZE,1ZP  |   |  |  |  |                |                |        |       |           |     |     |
|  |  |  |  | 11.9541-9554.2   | 220564  |  | D=54, - Halter   | ATE  |                |                |        |       |           |     |     |
|  |  |  |  | 11.0101-5407.2   | 260011  |  | Hülzensatz   | ATE  |                |                |        |       |           |     |     |
|  |  |  |  | 11.8171-0008.1   | 990049  |  | Führungsbolzen   | ATE  |                |                |        |       |           |     |     |
|  |  |  |  | 11.8116-0351.1   | 390538  |  | Haltefeder   | ATE  |                |                |        |       |           |     |     |

|     |    kW |  |  |  |  |  |  |                                 |
|--|---|--|--|--|---|--|--|---|
| VOLKSWAGEN TOURAN (03-)  |   |  |  |  |   |  |  |   |
|    | 2.0 Eco Fuel  | 80   | 02.06  | PR: 1ZE,1ZP  | 11.9541-9553.2  | 220563   | 2  | D=54, - Halter<br>ATE<br>D=54, - Halter<br>ATE<br>Hülzensatz<br>ATE<br>Führungsbolzen<br>ATE<br>Haltefeder<br>ATE |
|  | 2.0 FSI   | 85   | 10.04  | PR: 1ZE,1ZP  | 11.9541-9554.2  | 220564   |  |   |
|  | 2.0 FSI   | 110  | 10.03  | PR: 1ZE,1ZP  | 11.0101-5407.2  | 260011   |  |   |
|  | 2.0 TDI   | 81   | 02.03  | PR: 1ZE,1ZP  | 11.8171-0008.1  | 990049   |  |   |
|  | 2.0 TDI   | 96   | 01.13  | PR: 1ZE,1ZP  | 11.8116-0351.1  | 390538   |  |   |
|  | 2.0 TDI   | 103  | 08.03  | PR: 1ZE,1ZP  |   |  |  |   |
|  | 2.0 TDI   | 125  | 02.06  | PR: 1ZE,1ZP  |   |  |  |   |
|  | 1.2 TSI   | 77   | 05.10  | PR: 1LJ,1ZA,1ZD  | 11.9541-9553.2  | 220563   |  |   |
|  | 1.4 TSI   | 103  | 09.06  | PR: 1LJ,1ZA,1ZD  | 11.9541-9554.2  | 220564   |  |   |
|  | 1.4 TSI   | 125  | 11.06  | PR: 1LJ,1ZA,1ZD  | 11.0101-5407.2  | 260011   |  |   |
|  | 1.4 TSI EcoFuel   | 110  | 05.09  | PR: 1LJ,1ZA,1ZD  | 11.8171-0008.1  | 990049   |  |   |
|  | 1.6   | 75   | 07.03  | PR: 1LJ,1ZA,1ZD  | 11.8116-0351.1  | 390538   |  |   |
|  | 1.6 FSI   | 85   | 02.03  | PR: 1LJ,1ZA,1ZD  |   |  |  |   |
|  | 1.6 TDI   |  | 05.10  | PR: 1LJ,1ZA,1ZD  |   |  |  |   |
|  | 1.9 TDI   | 66   | 11.04  | PR: 1LJ,1ZA,1ZD  |   |  |  |   |
|  | 1.9 TDI   | 74   | 02.03  | PR: 1LJ,1ZA,1ZD  |   |  |  |   |
|  | 1.9 TDI   | 77   | 08.03  | PR: 1LJ,1ZA,1ZD  |   |  |  |   |
|  | 2.0 Eco Fuel  | 80   | 02.06  | PR: 1LJ,1ZA,1ZD  |   |  |  |   |
|  | 2.0 FSI   | 85   | 10.04  | PR: 1LJ,1ZA,1ZD  |   |  |  |   |
|  | 2.0 FSI   | 110  | 10.03  | PR: 1LJ,1ZA,1ZD  |   |  |  |   |
| 2.0 TDI  | 81  | 02.03  | PR: 1LJ,1ZA,1ZD  |  |   |  |  |   |
| 2.0 TDI  | 96  | 01.13  | PR: 1LJ,1ZA,1ZD  |  |   |  |  |   |
| 2.0 TDI  | 103   | 08.03  | PR: 1LJ,1ZA,1ZD  |  |   |  |  |   |
| 2.0 TDI  | 125   | 02.06  | PR: 1LJ,1ZA,1ZD  |  |   |  |  |   |
|    | 1.2 TSI   | 77   | 05.10  |  | 83.7847-0563.3  | 331124   | 2  | L=562   |
|  | 1.4 TSI   | 103  | 09.06  |  |   |  |  |   |
|  | 1.4 TSI   | 125  | 11.06  |  |   |  |  |   |
|  | 1.4 TSI EcoFuel   | 110  | 05.09  |  |   |  |  |   |
|  | 1.6   | 75   | 07.03  |  |   |  |  |   |
|  | 1.6 FSI   | 85   | 02.03  |  |   |  |  |   |
|  | 1.6 TDI   |  | 05.10  |  |   |  |  |   |
|  | 1.9 TDI   | 66   | 11.04  |  |   |  |  |   |
|  | 1.9 TDI   | 74   | 02.03  |  |   |  |  |   |
|  | 1.9 TDI   | 77   | 08.03  |  |   |  |  |   |
|  | 2.0 Eco Fuel  | 80   | 02.06  |  |   |  |  |   |
|  | 2.0 FSI   | 85   | 10.04  |  |   |  |  |   |
|  | 2.0 FSI   | 110  | 10.03  |  |   |  |  |   |
|  | 2.0 TDI   | 81   | 02.03  |  |   |  |  |   |
|  | 2.0 TDI   | 96   | 01.13  |  |   |  |  |   |
|  | 2.0 TDI   | 103  | 08.03  |  |   |  |  |   |
| 2.0 TDI  | 125   | 02.06  |  |  |   |  |  |   |
|  | 1.2 TSI   | 77   | 05.10  | PR: 1KE,1KF,1KJ  | 24.3414-1709.7  | 220631   | 2  | D=41, - Halter<br>LUC<br>D=41, - Halter<br>LUC  |
|  | 1.4 TSI   | 103  | 09.06  | PR: 1KE,1KF,1KJ  | 24.3414-1710.7  | 220632   |  |   |
|  | 1.4 TSI   | 125  | 11.06  | PR: 1KE,1KF,1KJ  |   |  |  |   |
|  | 1.4 TSI EcoFuel   | 110  | 05.09  | PR: 1KE,1KF,1KJ  |   |  |  |   |
|  | 1.6   | 75   | 07.03  | PR: 1KE,1KF,1KJ  |   |  |  |   |
|  | 1.6 FSI   | 85   | 02.03  | PR: 1KE,1KF,1KJ  |   |  |  |   |
|  | 1.6 TDI   |  | 05.10  | PR: 1KE,1KF,1KJ  |   |  |  |   |
|  | 1.9 TDI   | 66   | 11.04  | PR: 1KE,1KF,1KJ  |   |  |  |   |
|  | 1.9 TDI   | 74   | 02.03  | PR: 1KE,1KF,1KJ  |   |  |  |   |
|  | 1.9 TDI   | 77   | 08.03  | PR: 1KE,1KF,1KJ  |   |  |  |   |
|  | 2.0 Eco Fuel  | 80   | 02.06  | PR: 1KE,1KF,1KJ  |   |  |  |   |
|  | 2.0 FSI   | 85   | 10.04  | PR: 1KE,1KF,1KJ  |   |  |  |   |
|  | 2.0 FSI   | 110  | 10.03  | PR: 1KE,1KF,1KJ  |   |  |  |   |
|  | 2.0 TDI   | 81   | 02.03  | PR: 1KE,1KF,1KJ  |   |  |  |   |
|  | 2.0 TDI   | 96   | 01.13  | PR: 1KE,1KF,1KJ  |   |  |  |   |
|  | 2.0 TDI   | 103  | 08.03  | PR: 1KE,1KF,1KJ  |   |  |  |   |
| 2.0 TDI  | 125   | 02.06  | PR: 1KE,1KF,1KJ  |  |   |  |  |   |
|  | 1.6   | 75   | 07.03  | 12.05  | 83.7849-0231.3  | 330872   | 2  | L=233   |
|  | 1.6 FSI   | 85   | 02.03  | 12.05  |   |  |  |   |
|  | 1.9 TDI   | 66   | 11.04  | 12.05  |   |  |  |   |
|  | 1.9 TDI   | 74   | 02.03  | 12.05  |   |  |  |   |
|  | 1.9 TDI   | 77   | 08.03  | 12.05  |   |  |  |   |
|  | 2.0 FSI   | 85   | 10.04  | 12.05  |   |  |  |   |
|  | 2.0 FSI   | 110  | 10.03  | 12.05  |   |  |  |   |
|  | 2.0 TDI   | 81   | 02.03  | 12.05  |   |  |  |   |
|  | 2.0 TDI   | 103  | 08.03  | 12.05  |   |  |  |   |
|  | 2.0 TDI   | 125  | 02.06  | 12.05  |   |  |  |   |
|  | 1.4 TSI   | 103  | 09.06  | 10.09  | 83.7849-0236.3  | 330873   | 2  | L=233   |
|  | 1.4 TSI   | 125  | 11.06  | 10.09  |   |  |  |   |
|  | 1.4 TSI EcoFuel   | 110  | 05.09  | 10.09  |   |  |  |   |
|  | 1.6   | 75   | 01.06  | 10.09  |   |  |  |   |
|  | 1.6 FSI   | 85   | 01.06  | 10.09  |   |  |  |   |
|  | 1.9 TDI   | 66   | 01.06  | 10.09  |   |  |  |   |
|  | 1.9 TDI   | 74   | 01.06  | 10.09  |   |  |  |   |
|  | 1.9 TDI   | 77   | 01.06  | 10.09  |   |  |  |   |
|  | 2.0 Eco Fuel  | 80   | 02.06  | 10.09  |   |  |  |   |
|  | 2.0 FSI   | 85   | 01.06  | 10.09  |   |  |  |   |
|  | 2.0 FSI   | 110  | 01.06  | 10.09  |   |  |  |   |
|  | 2.0 TDI   | 81   | 01.06  | 10.09  |   |  |  |   |
| 2.0 TDI  | 103   | 01.06  | 10.09  |  |   |  |  |   |
| 2.0 TDI  | 125   | 02.06  | 10.09  |  |   |  |  |   |
|  | 1.2 TSI   | 77   | 1T-6-120000  | 05.10  | 24.3727-0186.2  | 580186   | 2  | L=1563  |
|  | 1.4 TSI   | 103  | 1T-6-120000  | 09.06  |   |  |  |   |
|  | 1.4 TSI   | 125  | 1T-6-120000  | 11.06  |   |  |  |   |
|  | 1.6   | 75   | 1T-6-120000  | 07.03  |   |  |  |   |
|  | 1.6 FSI   | 85   | 1T-6-120000  | 02.03  |   |  |  |   |
|  | 1.6 TDI   |  | 1T-6-120000  | 05.10  |   |  |  |   |



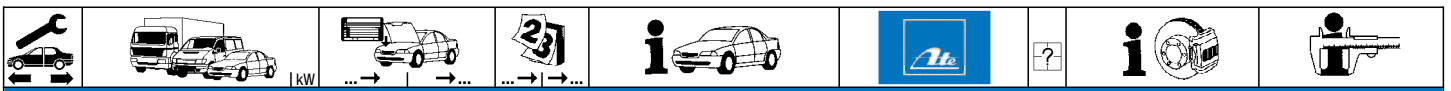

**VOLKSWAGEN TOURAN (03-)**

|         |                 |             |             |       |       |                |        |     |  |                    |
|---------|-----------------|-------------|-------------|-------|-------|----------------|--------|-----|--|--------------------|
|         | 1.9 TDI         | 66          | 1T-6-120000 | 11.04 |       | 24.3727-0186.2 | 580186 | 2 ↓ |  | L=1563             |
|         | 1.9 TDI         | 74          | 1T-6-120000 | 02.03 |       |                |        |     |  |                    |
|         | 1.9 TDI         | 77          | 1T-6-120000 | 08.03 |       |                |        |     |  |                    |
|         | 2.0 FSI         | 85          | 1T-6-120000 | 10.04 |       |                |        |     |  |                    |
|         | 2.0 FSI         | 110         | 1T-6-120000 | 10.03 |       |                |        |     |  |                    |
|         | 2.0 TDI         | 81          | 1T-6-120000 | 02.03 |       |                |        |     |  |                    |
|         | 2.0 TDI         | 103         | 1T-6-120000 | 08.03 |       |                |        |     |  |                    |
|         | 2.0 TDI         | 125         | 1T-6-120000 | 02.06 |       |                |        |     |  |                    |
|         | 1.2 TSI         | 77          | 1T-6-120001 |       |       | 24.3727-0196.2 | 580196 | 2 ↓ |  | L=1561             |
|         | 1.4 TSI         | 103         | 1T-6-120001 |       |       |                |        |     |  |                    |
|         | 1.4 TSI         | 125         | 1T-6-120001 |       |       |                |        |     |  |                    |
|         | 1.6             | 75          | 1T-6-120001 |       |       |                |        |     |  |                    |
|         | 1.6 FSI         | 85          | 1T-6-120001 |       |       |                |        |     |  |                    |
|         | 1.6 TDI         |             | 1T-6-120001 |       |       |                |        |     |  |                    |
|         | 1.9 TDI         | 66          | 1T-6-120001 |       |       |                |        |     |  |                    |
|         | 1.9 TDI         | 74          | 1T-6-120001 |       |       |                |        |     |  |                    |
|         | 1.9 TDI         | 77          | 1T-6-120001 |       |       |                |        |     |  |                    |
|         | 2.0 FSI         | 85          | 1T-6-120001 |       |       |                |        |     |  |                    |
|         | 2.0 FSI         | 110         | 1T-6-120001 |       |       |                |        |     |  |                    |
|         | 2.0 TDI         | 81          | 1T-6-120001 |       |       |                |        |     |  |                    |
|         | 2.0 TDI         | 96          |             | 01.13 |       |                |        |     |  |                    |
|         | 2.0 TDI         | 103         | 1T-6-120001 |       |       |                |        |     |  |                    |
| 2.0 TDI | 125             | 1T-6-120001 |             |       |       |                |        |     |  |                    |
|         | 1.4 TSI         | 103         |             | 09.06 | 10.09 | 24.2415-1711.3 | 030130 |     |  | Gz 15,87           |
|         | 1.4 TSI         | 125         |             | 11.06 | 10.09 |                |        |     |  |                    |
|         | 1.4 TSI EcoFuel | 110         |             | 05.09 | 10.09 |                |        |     |  |                    |
|         | 1.6             | 75          |             | 07.03 | 10.09 |                |        |     |  |                    |
|         | 1.6 FSI         | 85          |             | 02.03 | 10.09 |                |        |     |  |                    |
|         | 1.9 TDI         | 66          |             | 11.04 | 10.09 |                |        |     |  |                    |
|         | 1.9 TDI         | 74          |             | 02.03 | 10.09 |                |        |     |  |                    |
|         | 1.9 TDI         | 77          |             | 08.03 | 10.09 |                |        |     |  |                    |
|         | 2.0 Eco Fuel    | 80          |             | 02.06 | 10.09 |                |        |     |  |                    |
|         | 2.0 FSI         | 85          |             | 10.04 | 10.09 |                |        |     |  |                    |
|         | 2.0 FSI         | 110         |             | 10.03 | 10.09 |                |        |     |  |                    |
|         | 2.0 TDI         | 81          |             | 02.03 | 10.09 |                |        |     |  |                    |
|         | 2.0 TDI         | 103         |             | 08.03 | 10.09 |                |        |     |  |                    |
|         | 2.0 TDI         | 125         |             | 02.06 | 10.09 |                |        |     |  |                    |
|         | 1.2 TSI         | 77          |             | 05.10 |       | 24.2415-1713.3 | 030132 |     |  | Gz 15,87, + Sensor |
|         | 1.4 TSI         | 103         |             | 11.09 |       |                |        |     |  |                    |
|         | 1.4 TSI         | 125         |             | 11.09 |       |                |        |     |  |                    |
|         | 1.4 TSI EcoFuel | 110         |             | 11.09 |       |                |        |     |  |                    |
|         | 1.6             | 75          |             | 11.09 |       |                |        |     |  |                    |
|         | 1.6 FSI         | 85          |             | 11.09 |       |                |        |     |  |                    |
|         | 1.6 TDI         |             |             | 05.10 |       |                |        |     |  |                    |
|         | 1.9 TDI         | 66          |             | 11.09 |       |                |        |     |  |                    |
|         | 1.9 TDI         | 74          |             | 11.09 |       |                |        |     |  |                    |
|         | 1.9 TDI         | 77          |             | 11.09 |       |                |        |     |  |                    |
|         | 2.0 Eco Fuel    | 80          |             | 11.09 |       |                |        |     |  |                    |
|         | 2.0 FSI         | 85          |             | 11.09 |       |                |        |     |  |                    |
|         | 2.0 FSI         | 110         |             | 11.09 |       |                |        |     |  |                    |
|         | 2.0 TDI         | 81          |             | 11.09 |       |                |        |     |  |                    |
| 2.0 TDI | 96              |             | 01.13       |       |       |                |        |     |  |                    |
| 2.0 TDI | 103             |             | 11.09       |       |       |                |        |     |  |                    |
| 2.0 TDI | 125             |             | 11.09       |       |       |                |        |     |  |                    |
|         | 1.4 TSI         | 103         |             | 09.06 | 04.10 | 24.2519-1705.3 | 040095 |     |  | Nz 19,05           |
|         | 1.4 TSI         | 125         |             | 11.06 | 04.10 |                |        |     |  |                    |
|         | 1.4 TSI EcoFuel | 110         |             | 05.09 | 04.10 |                |        |     |  |                    |
|         | 1.6             | 75          |             | 07.03 | 04.10 |                |        |     |  |                    |
|         | 1.6 FSI         | 85          |             | 02.03 | 04.10 |                |        |     |  |                    |

**VOLKSWAGEN TRANSPORTER (T4) (90-03)**

|                |              |             |             |             |       |                |        |  |  |             |     |
|----------------|--------------|-------------|-------------|-------------|-------|----------------|--------|--|--|-------------|-----|
|                | 1.8          |             |             | 12.90       | 07.92 | 03.7750-7402.4 | 300084 |  |  | 9"          | ATE |
|                | 1.9 D        |             | 70-S-127805 | 07.90       |       |                |        |  |  |             |     |
|                | 1.9 TD       |             | 70-S-127805 | 10.92       |       |                |        |  |  |             |     |
|                | 2.0          |             | 70-S-127805 | 07.90       |       |                |        |  |  |             |     |
|                | 2.4 D        |             | 70-S-127805 | 07.90       |       |                |        |  |  |             |     |
|                | 2.4 D Syncro |             | 70-S-127805 | 11.92       |       |                |        |  |  |             |     |
|                | 2.5          |             | 70-S-127805 | 10.90       |       |                |        |  |  |             |     |
| 2.5 Syncro     |              | 70-S-127805 | 11.92       |             |       |                |        |  |  |             |     |
|                | 1.9 D        |             | 70-S-127806 |             | 06.95 | 03.7755-4202.4 | 300164 |  |  | 9/8" Tandem | ATE |
|                | 1.9 TD       |             | 70-S-127806 |             | 06.95 |                |        |  |  |             |     |
|                | 2.0          |             | 70-S-127806 |             | 06.95 |                |        |  |  |             |     |
|                | 2.4 D        |             | 70-S-127806 |             | 06.95 |                |        |  |  |             |     |
|                | 2.4 D Syncro |             | 70-S-127806 |             | 06.95 |                |        |  |  |             |     |
|                | 2.5          |             | 70-S-127806 |             | 06.95 |                |        |  |  |             |     |
| 2.5 Syncro     |              | 70-S-127806 |             | 06.95       |       |                |        |  |  |             |     |
|                | 1.9 D        | ⚡           |             | 70-T-199000 | 07.95 | 03.7755-4202.4 | 300164 |  |  | 9/8" Tandem | ATE |
|                | 1.9 TD       | ⚡           |             | 70-T-199000 | 07.95 |                |        |  |  |             |     |
|                | 2.0          | ⚡           |             | 70-T-199000 | 07.95 |                |        |  |  |             |     |
|                | 2.4 D        | ⚡           |             | 70-T-199000 | 07.95 |                |        |  |  |             |     |
|                | 2.4 D Syncro | ⚡           |             | 70-T-199000 | 07.95 |                |        |  |  |             |     |
|                | 2.5          | ⚡           |             | 70-T-199000 | 07.95 |                |        |  |  |             |     |
|                | 2.5 Syncro   | ⚡           |             | 70-T-199000 | 07.95 |                |        |  |  |             |     |
|                | 2.5 TDI      | ⚡           |             | 70-T-199000 | 09.95 |                |        |  |  |             |     |
| 2.5 TDI Syncro | ⚡            |             | 70-T-199000 | 09.95       |       |                |        |  |  |             |     |
| 2.8            | ⚡            |             | 70-T-199000 | 11.95       |       |                |        |  |  |             |     |

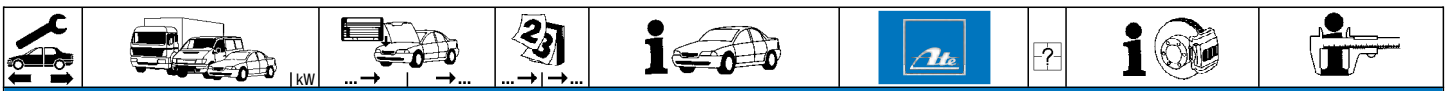

**VOLKSWAGEN TRANSPORTER (T4) (90-03)**

|                |                |             |             |   |   |                |        |           |                   |     |
|----------------|----------------|-------------|-------------|---|---|----------------|--------|-----------|-------------------|-----|
|                | 1.9 D          |             | 70-T-199000 | 07.95                                     |   | 03.7750-7402.4 | 300084 |           | 9"                | ATE |
|                | 1.9 TD         |             | 70-T-199000 | 07.95                                     |   |                |        |           |                   |     |
|                | 2.0            |             | 70-T-199000 | 07.95                                     |   |                |        |           |                   |     |
|                | 2.4 D          |             | 70-T-199000 | 07.95                                     |   |                |        |           |                   |     |
|                | 2.4 D Syncro   |             | 70-T-199000 | 07.95                                     |   |                |        |           |                   |     |
|                | 2.5            |             | 70-T-199000 | 07.95                                     |   |                |        |           |                   |     |
|                | 2.5 Syncro     |             | 70-T-199000 | 07.95                                     |   |                |        |           |                   |     |
|                | 2.5 TDI        |             | 70-T-199000 | 09.95                                     |   |                |        |           |                   |     |
|                | 2.5 TDI Syncro |             | 70-T-199000 | 09.95                                     |   |                |        |           |                   |     |
|                | 2.8            |             | 70-T-199000 | 11.95                                     |   |                |        |           |                   |     |
|                | 1.9 D          | 70-T-200001 |             | 09.03                                     | + LUCAS-Sättel <sup>1)</sup>            | 03.7755-4202.4 | 300164 |           | 9/8" Tandem       | ATE |
|                | 1.9 TD         | 70-T-200001 |             | 09.03                                     | + LUCAS-Sättel <sup>1)</sup>            |                |        |           |                   |     |
|                | 2.0            | 70-T-200001 |             | 09.03                                     | + LUCAS-Sättel <sup>1)</sup>            |                |        |           |                   |     |
|                | 2.4 D          | 70-T-200001 |             | 09.03                                     | + LUCAS-Sättel <sup>1)</sup>            |                |        |           |                   |     |
|                | 2.4 D Syncro   | 70-T-200001 |             | 09.03                                     | + LUCAS-Sättel <sup>1)</sup>            |                |        |           |                   |     |
|                | 2.5            | 70-T-200001 |             | 09.03                                     | + LUCAS-Sättel <sup>1)</sup>            |                |        |           |                   |     |
|                | 2.5 Syncro     | 70-T-200001 |             | 09.03                                     | + LUCAS-Sättel <sup>1)</sup>            |                |        |           |                   |     |
|                | 2.5 TDI        | 70-T-200001 |             | 09.03                                     | + LUCAS-Sättel <sup>1)</sup>            |                |        |           |                   |     |
|                | 2.5 TDI Syncro | 70-T-200001 |             | 09.03                                     | + LUCAS-Sättel <sup>1)</sup>            |                |        |           |                   |     |
|                | 2.8            | 70-T-200001 |             | 09.03                                     | + LUCAS-Sättel <sup>1)</sup>            |                |        |           |                   |     |
|                | 1.9 D          |             |             | 05.98                                     | 09.03 + ATE-Sättel <sup>2)</sup>        | 03.7755-4302.4 | 300165 |           | 9/8" Tandem       | ATE |
|                | 1.9 TD         |             |             | 05.98                                     | 09.03 + ATE-Sättel <sup>2)</sup>        |                |        |           |                   |     |
|                | 2.0            |             |             | 05.98                                     | 09.03 + ATE-Sättel <sup>2)</sup>        |                |        |           |                   |     |
|                | 2.4 D          |             |             | 05.98                                     | 09.03 + ATE-Sättel <sup>2)</sup>        |                |        |           |                   |     |
|                | 2.4 D Syncro   |             |             | 05.98                                     | 09.03 + ATE-Sättel <sup>2)</sup>        |                |        |           |                   |     |
|                | 2.5            |             |             | 05.98                                     | 09.03 + ATE-Sättel <sup>2)</sup>        |                |        |           |                   |     |
|                | 2.5 Syncro     |             |             | 05.98                                     | 09.03 + ATE-Sättel <sup>2)</sup>        |                |        |           |                   |     |
|                | 2.5 TDI        |             |             | 05.98                                     | 09.03 + ATE-Sättel <sup>2)</sup>        |                |        |           |                   |     |
|                | 2.5 TDI Syncro |             |             | 05.98                                     | 09.03 + ATE-Sättel <sup>2)</sup>        |                |        |           |                   |     |
|                | 2.8            |             |             | 05.98                                     | 09.03 + ATE-Sättel <sup>2)</sup>        |                |        |           |                   |     |
|                | 1.8            |             |             | 12.90                                     | 07.92 - ABS                             | 03.2122-1042.3 | 010137 |           | THz 22,20         | ATE |
|                | 1.9 D          |             | 70-S-127805 | 07.90                                     | - ABS                                   | 03.3517-0101.2 | 390322 |           | Verschlußschraube |     |
|                | 1.9 TD         |             | 70-S-127805 | 10.92                                     | - ABS                                   |                |        |           |                   |     |
|                | 2.0            |             | 70-S-127805 | 07.90                                     | - ABS                                   |                |        |           |                   |     |
|                | 2.4 D          |             | 70-S-127805 | 07.90                                     | - ABS                                   |                |        |           |                   |     |
|                | 2.4 D Syncro   |             | 70-S-127805 | 11.92                                     | - ABS                                   |                |        |           |                   |     |
|                | 2.5            |             | 70-S-127805 | 10.90                                     | - ABS                                   |                |        |           |                   |     |
|                | 2.5 Syncro     |             | 70-S-127805 | 11.92                                     | - ABS                                   |                |        |           |                   |     |
|                | 1.9 D          | 70-S-127806 |             | 09.03                                     | - ABS/ + LUCAS-Sättel <sup>3)</sup>     | 03.2123-1548.3 | 010478 |           | THz 23,81         | ATE |
|                | 1.9 TD         | 70-S-127806 |             | 09.03                                     | - ABS/ + LUCAS-Sättel <sup>3)</sup>     |                |        |           |                   |     |
| 2.0            | 70-S-127806    |             | 09.03       | - ABS/ + LUCAS-Sättel <sup>3)</sup>       |   |                |        |           |                   |     |
| 2.4 D          | 70-S-127806    |             | 09.03       | - ABS/ + LUCAS-Sättel <sup>3)</sup>       |   |                |        |           |                   |     |
| 2.4 D Syncro   | 70-S-127806    |             | 09.03       | - ABS/ + LUCAS-Sättel <sup>3)</sup>       |   |                |        |           |                   |     |
| 2.5            | 70-S-127806    |             | 09.03       | - ABS/ + LUCAS-Sättel <sup>3)</sup>       |   |                |        |           |                   |     |
| 2.5 Syncro     | 70-S-127806    |             | 09.03       | - ABS/ + LUCAS-Sättel <sup>3)</sup>       |   |                |        |           |                   |     |
| 2.5 TDI        |                |             | 09.95       | 09.03 - ABS/ + LUCAS-Sättel <sup>3)</sup> |   |                |        |           |                   |     |
| 2.5 TDI Syncro |                |             | 09.95       | 09.03 - ABS/ + LUCAS-Sättel <sup>3)</sup> |   |                |        |           |                   |     |
| 2.8            |                |             | 11.95       | 09.03 - ABS/ + LUCAS-Sättel <sup>3)</sup> |   |                |        |           |                   |     |
|                | 1.9 D          |             |             | 05.96                                     | 09.03 - ABS/+ATE-Sättel <sup>4)</sup>   | 03.2125-8111.3 | 010479 |           | THz 25,40         | ATE |
|                | 1.9 TD         |             |             | 05.96                                     | 09.03 - ABS/+ATE-Sättel <sup>4)</sup>   |                |        |           |                   |     |
|                | 2.0            |             |             | 05.96                                     | 09.03 - ABS/+ATE-Sättel <sup>4)</sup>   |                |        |           |                   |     |
|                | 2.4 D          |             |             | 05.96                                     | 09.03 - ABS/+ATE-Sättel <sup>4)</sup>   |                |        |           |                   |     |
|                | 2.4 D Syncro   |             |             | 05.96                                     | 09.03 - ABS/+ATE-Sättel <sup>4)</sup>   |                |        |           |                   |     |
|                | 2.5            |             |             | 05.96                                     | 09.03 - ABS/+ATE-Sättel <sup>4)</sup>   |                |        |           |                   |     |
|                | 2.5 Syncro     |             |             | 05.96                                     | 09.03 - ABS/+ATE-Sättel <sup>4)</sup>   |                |        |           |                   |     |
|                | 2.5 TDI        |             |             | 05.96                                     | 09.03 - ABS/+ATE-Sättel <sup>4)</sup>   |                |        |           |                   |     |
|                | 2.5 TDI Syncro |             |             | 05.96                                     | 09.03 - ABS/+ATE-Sättel <sup>4)</sup>   |                |        |           |                   |     |
|                | 2.8            |             |             | 11.95                                     | 09.03 - ABS/+ATE-Sättel <sup>4)</sup>   |                |        |           |                   |     |
|                | 1.8            |             |             | 12.90                                     | 07.92 + ABS                             | 03.2122-0646.3 | 010133 |           | THz 22,20         | ATE |
|                | 1.9 D          |             | 70-S-127805 | 07.90                                     | + ABS                                   |                |        |           |                   |     |
|                | 1.9 TD         |             | 70-S-127805 | 10.92                                     | + ABS                                   |                |        |           |                   |     |
|                | 2.0            |             | 70-S-127805 | 07.90                                     | + ABS                                   |                |        |           |                   |     |
|                | 2.4 D          |             | 70-S-127805 | 07.90                                     | + ABS                                   |                |        |           |                   |     |
|                | 2.4 D Syncro   |             | 70-S-127805 | 11.92                                     | + ABS                                   |                |        |           |                   |     |
|                | 2.5            |             | 70-S-127805 | 10.90                                     | + ABS                                   |                |        |           |                   |     |
|                | 2.5 Syncro     |             | 70-S-127805 | 11.92                                     | + ABS                                   |                |        |           |                   |     |
|                | 1.9 D          | 70-S-127806 |             | 09.03                                     | + ABS/ + LUCAS-Sättel <sup>5)</sup>     | 03.2123-1526.3 | 010477 |           | THz 23,81         | ATE |
|                | 1.9 TD         | 70-S-127806 |             | 09.03                                     | + ABS/ + LUCAS-Sättel <sup>5)</sup>     |                |        |           |                   |     |
| 2.0            | 70-S-127806    |             | 09.03       | + ABS/ + LUCAS-Sättel <sup>5)</sup>       |   |                |        |           |                   |     |
| 2.4 D          | 70-S-127806    |             | 09.03       | + ABS/ + LUCAS-Sättel <sup>5)</sup>       |   |                |        |           |                   |     |
| 2.4 D Syncro   | 70-S-127806    |             | 09.03       | + ABS/ + LUCAS-Sättel <sup>5)</sup>       |   |                |        |           |                   |     |
| 2.5            | 70-S-127806    |             | 09.03       | + ABS/ + LUCAS-Sättel <sup>5)</sup>       |   |                |        |           |                   |     |
| 2.5 Syncro     | 70-S-127806    |             | 09.03       | + ABS/ + LUCAS-Sättel <sup>5)</sup>       |   |                |        |           |                   |     |
| 2.5 TDI        |                |             | 09.95       | 09.03 + ABS/ + LUCAS-Sättel <sup>5)</sup> |   |                |        |           |                   |     |
| 2.8            |                |             | 11.95       | 09.03 + ABS/ + LUCAS-Sättel <sup>5)</sup> |   |                |        |           |                   |     |
|                | 1.9 D          |             |             | 05.96                                     | 09.03 - ESP/ + ATE-Sättel <sup>6)</sup> | 03.2125-9704.3 | 010603 |           | THz 25,40         | ATE |
|                | 1.9 TD         |             |             | 05.96                                     | 09.03 - ESP/ + ATE-Sättel <sup>6)</sup> |                |        |           |                   |     |
|                | 2.0            |             |             | 05.96                                     | 09.03 - ESP/ + ATE-Sättel <sup>6)</sup> |                |        |           |                   |     |
|                | 2.4 D          |             |             | 05.96                                     | 09.03 - ESP/ + ATE-Sättel <sup>6)</sup> |                |        |           |                   |     |
|                | 2.4 D Syncro   |             |             | 05.96                                     | 09.03 - ESP/ + ATE-Sättel <sup>6)</sup> |                |        |           |                   |     |
|                | 2.5            |             |             | 05.96                                     | 09.03 - ESP/ + ATE-Sättel <sup>6)</sup> |                |        |           |                   |     |
|                | 2.5 Syncro     |             |             | 05.96                                     | 09.03 - ESP/ + ATE-Sättel <sup>6)</sup> |                |        |           |                   |     |
|                | 2.5 TDI        |             |             | 05.96                                     | 09.03 - ESP/ + ATE-Sättel <sup>6)</sup> |                |        |           |                   |     |
|                | 2.5 TDI Syncro |             |             | 05.96                                     | 09.03 - ESP/ + ATE-Sättel <sup>6)</sup> |                |        |           |                   |     |
|                | 2.8            |             |             | 05.96                                     | 09.03 - ESP/ + ATE-Sättel <sup>6)</sup> |                |        |           |                   |     |
| 1.9 D          | 70-Y-027264    |             | 09.03       | + ESP/ + ATE-Sättel <sup>7)</sup>         | 03.2125-9704.3                          | 010603         |        | THz 25,40 | ATE               |     |

<sup>1)</sup> + LUCAS calipers / + pinze LUCAS / + étriers LUCAS / + pinzas LUCAS  
<sup>2)</sup> + ATE calipers / + pinze ATE / + étriers ATE / + pinzas ATE  
<sup>3)</sup> - ABS/ + LUCAS calipers / - ABS/ + pinze LUCAS / - ABS/ + étriers LUCAS / - ABS/ + pinzas LUCAS  
<sup>4)</sup> - ABS/ + ATE caliper / - ABS/ + pinza ATE / - ABS/ + étriers ATE / - ABS/ + pinzas ATE  
<sup>5)</sup> + ABS/ + LUCAS calipers / + ABS/ + pinze LUCAS / + ABS/ + étriers LUCAS / + ABS/ + pinzas LUCAS  
<sup>6)</sup> - ESP/ + ATE calipers / - ESP/ + pinze ATE / - ESP/ + étriers ATE / - ESP/ + pinzas ATE  
<sup>7)</sup> + ESP/ + ATE calipers / + ESP/ + pinze ATE / + ESP/ + étriers ATE / + ESP/ + pinzas ATE





**VOLKSWAGEN TRANSPORTER (T4) (90-03)**

|  |   |  |  |   |  |  |  |  |                                 |
|--|---|--|--|---|--|--|--|--|---------------------------------|
|  | 1.9 TD<br>2.0<br>2.4 D<br>2.4 D Syncro<br>2.5<br>2.5 Syncro<br>2.5 TDI<br>2.5 TDI Syncro<br>2.8                 | 70-Y-027264<br>70-Y-027264<br>70-Y-027264<br>70-Y-027264<br>70-Y-027264<br>70-Y-027264<br>70-Y-027264<br>70-Y-027264<br>70-Y-027264                |  | 09.03 + ESP/ + ATE-Sättel <sup>1)</sup><br>09.03 + ESP/ + ATE-Sättel <sup>1)</sup><br>09.03 + ESP/ + ATE-Sättel <sup>1)</sup><br>09.03 + ESP/ + ATE-Sättel <sup>1)</sup><br>09.03 + ESP/ + ATE-Sättel <sup>1)</sup><br>09.03 + ESP/ + ATE-Sättel <sup>1)</sup><br>09.03 + ESP/ + ATE-Sättel <sup>1)</sup><br>09.03 + ESP/ + ATE-Sättel <sup>1)</sup><br>09.03 + ESP/ + ATE-Sättel <sup>1)</sup> | 03.2125-9704.3<br>010603   |  |  | Thz 25,40  | ATE                             |
|  | 1.8<br>1.9 D<br>1.9 TD<br>2.0<br>2.4 D<br>2.4 D Syncro<br>2.5<br>2.5 Syncro<br>2.5 TDI<br>2.5 TDI Syncro<br>2.8 |  |  | 12.90 07.92 PR: 1LA,1LP<br>07.90 09.03 PR: 1LA,1LP<br>10.92 09.03 PR: 1LA,1LP<br>07.90 09.03 PR: 1LA,1LP<br>07.90 09.03 PR: 1LA,1LP<br>11.92 09.03 PR: 1LA,1LP<br>10.90 09.03 PR: 1LA,1LP<br>11.92 09.03 PR: 1LA,1LP<br>09.95 09.03 PR: 1LA,1LP<br>09.95 09.03 PR: 1LA,1LP<br>11.95 09.03 PR: 1LA,1LP   | 24.0101-3401.2<br>11.0101-5403.2   | 260043<br>260010                               |  | Einbausatz<br>Faltenbalgsatz   | LUC<br>LUC                      |
|  | 1.9 D<br>1.9 TD<br>2.0<br>2.4 D<br>2.4 D Syncro<br>2.5<br>2.5 Syncro<br>2.5 TDI<br>2.5 TDI Syncro<br>2.8        |  |  | 07.90 09.03 PR: 1LE<br>10.92 09.03 PR: 1LE<br>07.90 09.03 PR: 1LE<br>07.90 09.03 PR: 1LE<br>11.92 09.03 PR: 1LE<br>10.90 09.03 PR: 1LE<br>11.92 09.03 PR: 1LE<br>09.95 09.03 PR: 1LE<br>09.95 09.03 PR: 1LE<br>11.95 09.03 PR: 1LE  | 24.3541-1775.7<br>24.3541-1776.7   | 220529<br>220530                               | <input type="checkbox"/><br><input type="checkbox"/> | D=54, - Halter<br>D=54, - Halter   | LUC<br>LUC                      |
|  | 1.9 D<br>1.9 TD<br>2.0<br>2.4 D<br>2.4 D Syncro<br>2.5<br>2.5 Syncro<br>2.5 TDI<br>2.5 TDI Syncro<br>2.8        |  |  | 05.96 09.03 PR: 1LU<br>05.96 09.03 PR: 1LU<br>05.96 09.03 PR: 1LU<br>07.95 09.03 PR: 1LU<br>05.96 09.03 PR: 1LU<br>07.95 09.03 PR: 1LU<br>05.96 09.03 PR: 1LU<br>09.95 09.03 PR: 1LU<br>11.95 09.03 PR: 1LU   | 11.0441-5704.2<br>11.0101-5409.2<br>11.8171-0008.1<br>11.8116-0237.1                   | 250034<br>260035<br>990049<br>390509           | 2  | Dichtungssatz<br>Hülzensatz<br>Führungsbolzen<br>Haltefeder                    | ATE<br>ATE<br>ATE<br>ATE        |
|  | 1.9 D<br>1.9 TD<br>2.0<br>2.4 D<br>2.5<br>2.5 TDI<br>2.8  | 70-1-000954<br>70-1-000954<br>70-1-000954<br>70-1-000954<br>70-1-000954<br>70-1-000954<br>70-1-000954  |  | 05.97 PR: 1LB<br>05.97 PR: 1LB<br>05.97 PR: 1LB<br>05.97 PR: 1LB<br>05.97 PR: 1LB<br>05.97 PR: 1LB  | 11.0441-5704.2<br>11.0101-5704.2<br>11.8171-0008.1                                     | 250034<br>260095<br>990049                     |  | Dichtungssatz<br>Hülzensatz<br>Führungsbolzen                                  | ATE<br>ATE<br>ATE               |
|  | 1.9 D<br>1.9 TD<br>2.0<br>2.4 D<br>2.4 D Syncro<br>2.5<br>2.5 Syncro<br>2.5 TDI<br>2.5 TDI Syncro<br>2.8        | 70-1-000955<br>70-1-000955<br>70-1-000955<br>70-1-000955<br>70-1-000955<br>70-1-000955<br>70-1-000955<br>70-1-000955<br>70-1-000955<br>70-1-000955 |  | 09.03 PR: 1LB<br>09.03 PR: 1LB<br>09.03 PR: 1LB<br>09.03 PR: 1LB<br>07.95 09.03 PR: 1LB<br>09.03 PR: 1LB<br>07.95 09.03 PR: 1LB<br>09.03 PR: 1LB<br>09.03 PR: 1LB<br>09.95 09.03 PR: 1LB<br>09.03 PR: 1LB   | 11.9571-9819.2<br>11.9571-9820.2<br>11.0101-5705.2<br>11.8171-0067.1<br>11.8116-0272.1 | 220469<br>220470<br>260096<br>250153<br>390598 | <input type="checkbox"/><br><input type="checkbox"/> | D=57, - Halter<br>D=57, - Halter<br>Hülzensatz<br>Führungsbolzen<br>Haltefeder | ATE<br>ATE<br>ATE<br>ATE<br>ATE |
|  | 1.8<br>1.9 D<br>1.9 TD<br>2.0<br>2.4 D<br>2.4 D Syncro<br>2.5<br>2.5 Syncro                                     |  |  | 12.90 07.92<br>07.90 07.95<br>10.92 07.95<br>07.90 07.95<br>07.90 07.95<br>11.92 07.95<br>10.90 07.95<br>11.92 07.95  | 83.7813-0332.3   | 330801   | 2  | L=330  |                                 |
|  | 1.9 D<br>1.9 TD<br>2.0<br>2.4 D<br>2.4 D Syncro<br>2.5<br>2.5 Syncro<br>2.5 TDI<br>2.5 TDI Syncro<br>2.8        |  |  | 08.95 04.97<br>08.95 04.97<br>08.95 04.97<br>08.95 04.97<br>08.95 04.97<br>08.95 04.97<br>08.95 04.97<br>09.95 04.97<br>09.95 04.97<br>05.96 04.97  | 83.6213-0340.3   | 330743   | 2  | L=340  |                                 |
|  | 1.9 D<br>1.9 TD<br>2.0<br>2.4 D<br>2.4 D Syncro<br>2.5<br>2.5 Syncro<br>2.5 TDI<br>2.5 TDI Syncro<br>2.8        | 70-X-250000<br>70-X-250000<br>70-X-250000<br>70-X-250000<br>70-X-250000<br>70-X-250000<br>70-X-250000<br>70-X-250000<br>70-X-250000<br>70-X-250000 |  | 05.97<br>05.97<br>05.97<br>05.97<br>05.97<br>05.97<br>05.97<br>05.97<br>05.97<br>05.97  | 83.6213-0340.3   | 330743   | 2  | - Belagverschleiß-Anzeige <sup>2)</sup>  | L=340                           |

<sup>1)</sup> + ESP/ + ATE calipers / + ESP/ + pinze ATE / + ESP/ + étriers ATE / + ESP/ + pinzas ATE  
<sup>2)</sup> - pad wear indicator / - indicatore usura guarniz.fr. / - indicat.d'usure d.garnitures / - indicad.desgaste la guarnic.



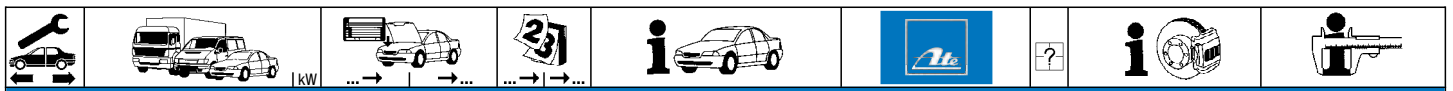

**VOLKSWAGEN TRANSPORTER (T4) (90-03)**

|                |                |             |             |       |       |                |        |   |  |                |
|----------------|----------------|-------------|-------------|-------|-------|----------------|--------|---|--|----------------|
|                | 1.9 D          |             |             | 05.97 | 04.99 | 83.6255-0353.3 | 330481 |   | + Belagverschleiß-Anzeige <sup>1)</sup>          | L=350          |
|                | 1.9 TD         |             |             | 05.97 | 04.99 | 83.6255-0340.3 | 330745 |   | + Belagverschleiß-Anzeige <sup>1)</sup>          | L=340          |
|                | 2.0            |             |             | 05.97 | 04.99 |                |        |   |  |                |
|                | 2.4 D          |             |             | 05.97 | 04.99 |                |        |   |  |                |
|                | 2.4 D Syncro   |             |             | 05.97 | 04.99 |                |        |   |  |                |
|                | 2.5            |             |             | 05.97 | 04.99 |                |        |   |  |                |
|                | 2.5 Syncro     |             |             | 05.97 | 04.99 |                |        |   |  |                |
|                | 2.5 TDI        |             |             | 05.97 | 04.99 |                |        |   |  |                |
|                | 2.5 TDI Syncro |             |             | 05.97 | 04.99 |                |        |   |  |                |
|                | 2.8            |             |             | 05.97 | 04.99 |                |        |   |  |                |
|                | 1.9 D          |             |             | 05.99 | 09.03 | 83.6255-0337.3 | 330744 |   | PR: 2E2/ + Belagverschleiß-Anzeige <sup>2)</sup> | L=335          |
|                | 1.9 TD         |             |             | 05.99 | 09.03 | 83.6213-0340.3 | 330743 |   | PR: 2E2/ + Belagverschleiß-Anzeige <sup>2)</sup> | L=340          |
|                | 2.0            |             |             | 05.99 | 09.03 | 83.6255-0353.3 | 330481 |   | PR: 2E3/ + Belagverschleiß-Anzeige <sup>3)</sup> | L=350          |
|                | 2.4 D          |             |             | 05.99 | 09.03 | 83.6255-0340.3 | 330745 |   | PR: 2E3/ + Belagverschleiß-Anzeige <sup>3)</sup> | L=340          |
|                | 2.4 D Syncro   |             |             | 05.99 | 09.03 |                |        |   |  |                |
|                | 2.5            |             |             | 05.99 | 09.03 |                |        |   |  |                |
|                | 2.5 Syncro     |             |             | 05.99 | 09.03 |                |        |   |  |                |
|                | 2.5 TDI        |             |             | 05.99 | 09.03 |                |        |   |  |                |
|                | 2.5 TDI Syncro |             |             | 05.99 | 09.03 |                |        |   |  |                |
|                | 2.8            |             |             | 05.99 | 09.03 |                |        |   |  |                |
|                | 1.9 D          | 70-T-200000 | 70-V-120000 |       |       | 24.3384-1717.5 | 240267 |   |  | D=38, - Halter |
|                | 1.9 TD         | 70-T-200000 | 70-V-120000 |       |       | 24.3384-1718.5 | 240268 |   |  | D=38, - Halter |
|                | 2.0            | 70-T-200000 | 70-V-120000 |       |       |                |        |   |  |                |
|                | 2.4 D          | 70-T-200000 | 70-V-120000 |       |       |                |        |   |  |                |
|                | 2.5            | 70-T-200000 | 70-V-120000 |       |       |                |        |   |  |                |
|                | 2.5 TDI        | 70-T-200000 | 70-V-120000 |       |       |                |        |   |  |                |
|                | 2.8            | 70-T-200000 | 70-V-120000 |       |       |                |        |   |  |                |
|                | 1.9 D          | 70-V-120001 |             | 09.03 |       | 24.3384-1715.5 | 240265 |   |  | D=38, - Halter |
|                | 1.9 TD         | 70-V-120001 |             | 09.03 |       | 24.3384-1716.5 | 240266 |   |  | D=38, - Halter |
|                | 2.0            | 70-V-120001 |             | 09.03 |       |                |        |   |  |                |
| 2.4 D          | 70-V-120001    |             | 09.03       |       |       |                |        |   |  |                |
| 2.4 D Syncro   |                |             | 05.96       | 09.03 |       |                |        |   |  |                |
| 2.5            | 70-V-120001    |             | 09.03       |       |       |                |        |   |  |                |
| 2.5 Syncro     |                |             | 05.96       | 09.03 |       |                |        |   |  |                |
| 2.5 TDI        | 70-V-120001    |             | 09.03       |       |       |                |        |   |  |                |
| 2.5 TDI Syncro |                |             | 05.96       | 09.03 |       |                |        |   |  |                |
| 2.8            | 70-V-120001    |             | 09.03       |       |       |                |        |   |  |                |
|                | 1.8            |             |             | 12.90 | 07.92 | 83.7804-0160.3 | 330811 | 2 |  | L=160          |
|                | 1.9 D          |             | 70-T-199999 | 07.90 |       |                |        |   |  |                |
|                | 1.9 TD         |             | 70-T-199999 | 10.92 |       |                |        |   |  |                |
|                | 2.0            |             | 70-T-199999 | 07.90 |       |                |        |   |  |                |
|                | 2.4 D          |             | 70-T-199999 | 07.90 |       |                |        |   |  |                |
|                | 2.4 D Syncro   |             | 70-T-199999 | 11.92 |       |                |        |   |  |                |
|                | 2.5            |             | 70-T-199999 | 10.90 |       |                |        |   |  |                |
|                | 2.5 Syncro     |             | 70-T-199999 | 11.92 |       |                |        |   |  |                |
|                | 2.5 TDI        |             | 70-T-199999 | 09.95 |       |                |        |   |  |                |
|                | 2.5 TDI Syncro |             | 70-T-199999 | 09.95 |       |                |        |   |  |                |
|                | 1.9 D          | 70-T-200000 |             | 09.03 |       | 83.7804-0160.3 | 330811 | 2 | - Schlechtwegeausführung <sup>4)</sup>           | L=160          |
|                | 1.9 TD         | 70-T-200000 |             | 09.03 |       | 83.6204-0158.3 | 330773 | 2 | + Schlechtwegeausführung <sup>5)</sup>           | L=155          |
|                | 2.0            | 70-T-200000 |             | 09.03 |       | 83.7704-0160.3 | 330805 | 2 | - 16" Rad/ am Bremsattel <sup>6)</sup>           | L=160          |
|                | 2.4 D          | 70-T-200000 |             | 09.03 |       | 83.6104-0170.3 | 330500 | 2 | + 16" Rad/ am Bremsattel <sup>7)</sup>           | L=170          |
|                | 2.4 D Syncro   | 70-T-200000 |             | 09.03 |       |                |        |   |  |                |
|                | 2.5            | 70-T-200000 |             | 09.03 |       |                |        |   |  |                |
|                | 2.5 Syncro     | 70-T-200000 |             | 09.03 |       |                |        |   |  |                |
|                | 2.5 TDI        | 70-T-200000 |             | 09.03 |       |                |        |   |  |                |
|                | 2.5 TDI Syncro | 70-T-200000 |             | 09.03 |       |                |        |   |  |                |
|                | 2.8            | 70-T-200000 |             | 09.03 |       |                |        |   |  |                |
|                | 1.8            |             |             | 12.90 | 07.92 | 24.3220-0910.3 | 020211 |   |  | Rz 20,64       |
|                | 1.9 D          |             | 70-T-199999 | 07.90 |       |                |        |   |  |                |
|                | 1.9 TD         |             | 70-T-199999 | 10.92 |       |                |        |   |  |                |
|                | 2.0            |             | 70-T-199999 | 07.90 |       |                |        |   |  |                |
|                | 2.4 D          |             | 70-T-199999 | 07.90 |       |                |        |   |  |                |
|                | 2.4 D Syncro   |             | 70-T-199999 | 11.92 |       |                |        |   |  |                |
|                | 2.5            |             | 70-T-199999 | 10.90 |       |                |        |   |  |                |
|                | 2.5 Syncro     |             | 70-T-199999 | 11.92 |       |                |        |   |  |                |
|                | 2.5 TDI        |             | 70-T-199999 | 09.95 |       |                |        |   |  |                |
|                | 2.5 TDI Syncro |             | 70-T-199999 | 09.95 |       |                |        |   |  |                |
|                | 1.8            |             |             | 12.90 | 07.92 | 24.3727-0131.2 | 580131 | 2 |  | L=844          |
|                | 1.9 D          |             | 70-T-199999 | 07.90 |       |                |        |   |  |                |
|                | 1.9 TD         |             | 70-T-199999 | 10.92 |       |                |        |   |  |                |
|                | 2.0            |             | 70-T-199999 | 07.90 |       |                |        |   |  |                |
|                | 2.4 D          |             | 70-T-199999 | 07.90 |       |                |        |   |  |                |
|                | 2.4 D Syncro   |             | 70-T-199999 | 11.92 |       |                |        |   |  |                |
|                | 2.5            |             | 70-T-199999 | 10.90 |       |                |        |   |  |                |
|                | 2.5 Syncro     |             | 70-T-199999 | 11.92 |       |                |        |   |  |                |
|                | 2.5 TDI        |             | 70-T-199999 | 09.95 |       |                |        |   |  |                |
|                | 2.5 TDI Syncro |             | 70-T-199999 | 09.95 |       |                |        |   |  |                |
|                | 1.9 D          | 70-T-200000 | 70-V-120000 |       |       | 24.3727-0157.2 | 580157 | 2 |  | L=949          |
|                | 1.9 TD         | 70-T-200000 | 70-V-120000 |       |       |                |        |   |  |                |
|                | 2.0            | 70-T-200000 | 70-V-120000 |       |       |                |        |   |  |                |
|                | 2.4 D          | 70-T-200000 | 70-V-120000 |       |       |                |        |   |  |                |
|                | 2.4 D Syncro   | 70-T-200000 | 70-V-120000 |       |       |                |        |   |  |                |
|                | 2.5            | 70-T-200000 | 70-V-120000 |       |       |                |        |   |  |                |
|                | 2.5 Syncro     | 70-T-200000 | 70-V-120000 |       |       |                |        |   |  |                |
|                | 2.5 TDI        | 70-T-200000 | 70-V-120000 |       |       |                |        |   |  |                |
|                | 2.5 TDI Syncro | 70-T-200000 | 70-V-120000 |       |       |                |        |   |  |                |
|                |                |             |             |       |       |                |        |   |  |                |

<sup>1)</sup> + pad wear indicator / + indicat.usura guarniz.freno / + indicat.d.usure d.garnitures / + indicad.desgaste la guarnic.  
<sup>2)</sup> PR: 2E2/ + brake wear indicator / PR: 2E2/ + indicatore d'usura guarnizioni freni / PR: 2E2/ + indicateur d'usage des garnitures / PR: 2E2/ + indicador de desgaste de pastillas  
<sup>3)</sup> PR: 2E3/ + brake wear indicator / PR: 2E3/ + indicatore d'usura guarnizioni freni / PR: 2E3/ + indicateur d'usage des garnitures / PR: 2E3/ + indicador de desgaste de pastillas  
<sup>4)</sup> - rough road construction / - versione per percorsi accidentati / - version pour mauvaise route / - versión 4x4  
<sup>5)</sup> + rough road construction / + versione per percorsi accidentati / + version pour mauvaise route / + versión 4x4

<sup>6)</sup> - 16" wheel/on the br.caliper / - ruota 16",sulla pinza freno / - roue 16",sur étrier frein / - rueda 16",la pinza d. freno  
<sup>7)</sup> + 16" wheel,on brake caliper / + ruota 16",sulla pinza fr. / + roue 16",sur étrier frein / + rueda 16",la pinza d. freno



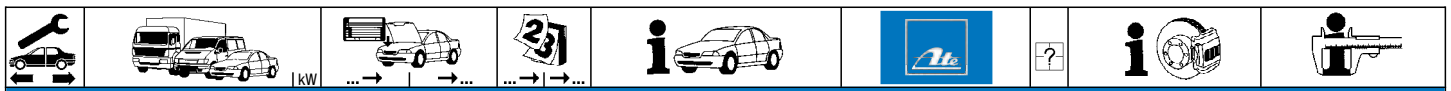



**VOLKSWAGEN TRANSPORTER (T4) (90-03)**

|  |                |             |             |       |       |                |        |     |  |               |
|--|----------------|-------------|-------------|-------|-------|----------------|--------|-----|--|---------------|
|  | 2.8            | 70-T-200000 | 70-V-120000 |       |       | 24.3727-0157.2 | 580157 | 2 ↓ |  | L=949         |
|  | 1.9 D          | 70-V-120001 | 70-W-039000 |       |       | 24.3727-0177.2 | 580177 | 2 ↓ |  | L=953         |
|  | 1.9 TD         | 70-V-120001 | 70-W-039000 |       |       |                |        |     |  |               |
|  | 2.0            | 70-V-120001 | 70-W-039000 |       |       |                |        |     |  |               |
|  | 2.4 D          | 70-V-120001 | 70-W-039000 |       |       |                |        |     |  |               |
|  | 2.4 D Syncro   | 70-V-120001 | 70-W-039000 |       |       |                |        |     |  |               |
|  | 2.5            | 70-V-120001 | 70-W-039000 |       |       |                |        |     |  |               |
|  | 2.5 Syncro     | 70-V-120001 | 70-W-039000 |       |       |                |        |     |  |               |
|  | 2.5 TDI        | 70-V-120001 | 70-W-039000 |       |       |                |        |     |  |               |
|  | 2.5 TDI Syncro | 70-V-120001 | 70-W-039000 |       |       |                |        |     |  |               |
|  | 2.8            | 70-V-120001 | 70-W-039000 |       |       |                |        |     |  |               |
|  | 1.9 D          | 70-W-039001 |             | 09.03 |       | 24.3727-0177.2 | 580177 | 2 ↓ |  | L=953         |
|  | 1.9 TD         | 70-W-039001 |             | 09.03 |       |                |        |     |  |               |
|  | 2.0            | 70-W-039001 |             | 09.03 |       |                |        |     |  |               |
|  | 2.4 D          | 70-W-039001 |             | 09.03 |       |                |        |     |  |               |
|  | 2.4 D Syncro   | 70-W-039001 |             | 09.03 |       |                |        |     |  |               |
|  | 2.5            | 70-W-039001 |             | 09.03 |       |                |        |     |  |               |
|  | 2.5 Syncro     | 70-W-039001 |             | 09.03 |       |                |        |     |  |               |
|  | 2.5 TDI        | 70-W-039001 |             | 09.03 |       |                |        |     |  |               |
|  | 2.5 TDI Syncro | 70-W-039001 |             | 09.03 |       |                |        |     |  |               |
|  | 2.8            | 70-W-039001 |             | 09.03 |       |                |        |     |  |               |
|  | 1.9 D          |             |             | 07.90 | 09.03 | 03.2419-9710.3 | 030030 |     |  | Gz 19,05      |
|  | 1.9 TD         |             |             | 10.92 | 09.03 |                |        |     |  |               |
|  | 2.0            |             |             | 07.90 | 09.03 |                |        |     |  |               |
|  | 2.4 D          |             |             | 07.90 | 09.03 |                |        |     |  |               |
|  | 2.4 D Syncro   |             |             | 11.92 | 09.03 |                |        |     |  |               |
|  | 2.5            |             |             | 10.90 | 09.03 |                |        |     |  |               |
|  | 2.5 Syncro     |             |             | 11.92 | 09.03 |                |        |     |  |               |
|  | 2.5 TDI        |             |             | 09.95 | 09.03 | 24.2415-1706.3 | 030088 |     |  | Gz 15,87      |
|  | 2.5 TDI Syncro |             |             | 09.95 | 09.03 |                |        |     |  |               |
|  | 2.8            |             |             | 11.95 | 09.03 |                |        |     |  |               |
|  | 1.8            |             |             | 12.90 | 07.92 | 24.2523-0908.3 | 040049 |     |  | Nz 23,81      |
|  | 1.9 D          |             | 70-V-020000 | 07.90 |       |                |        |     |  |               |
|  | 1.9 TD         |             | 70-V-020000 | 10.92 |       |                |        |     |  |               |
|  | 2.0            |             | 70-V-020000 | 07.90 |       |                |        |     |  |               |
|  | 2.4 D          |             | 70-V-020000 | 07.90 |       |                |        |     |  |               |
|  | 2.4 D Syncro   |             | 70-V-020000 | 11.92 |       |                |        |     |  |               |
|  | 2.5            |             | 70-V-020000 | 10.90 |       |                |        |     |  |               |
|  | 2.5 Syncro     |             | 70-V-020000 | 11.92 |       |                |        |     |  |               |
|  | 2.5 TDI        |             | 70-V-020000 | 09.95 |       |                |        |     |  |               |
|  | 2.5 TDI Syncro |             | 70-V-020000 | 09.95 |       |                |        |     |  |               |
|  | 2.8            |             | 70-V-020000 | 11.95 |       |                |        |     |  |               |
|  | 1.9 D          | 70-V-020001 |             | 09.03 |       | 24.2519-1701.3 | 040075 |     |  | Nz 19,05      |
|  | 1.9 TD         | 70-V-020001 |             | 09.03 |       |                |        |     |  |               |
|  | 2.0            | 70-V-020001 |             | 09.03 |       |                |        |     |  |               |
|  | 2.4 D          | 70-V-020001 |             | 09.03 |       |                |        |     |  |               |
|  | 2.4 D Syncro   | 70-V-020001 |             | 09.03 |       |                |        |     |  |               |
|  | 2.5            | 70-V-020001 |             | 09.03 |       |                |        |     |  |               |
|  | 2.5 Syncro     | 70-V-020001 |             | 09.03 |       |                |        |     |  |               |
|  | 2.5 TDI        | 70-V-020001 |             | 09.03 |       |                |        |     |  |               |
|  | 2.5 TDI Syncro | 70-V-020001 |             | 09.03 |       |                |        |     |  |               |
|  | 2.8            | 70-V-020001 |             | 09.03 |       |                |        |     |  |               |
|  | 1.8            | ↓           |             | 12.90 | 07.92 | 24.3728-0122.2 | 590122 |     |  | L=1225, + AUT |
|  | 1.9 D          | ↓           |             | 07.90 | 09.03 |                |        |     |  |               |
|  | 1.9 TD         | ↓           |             | 10.92 | 09.03 |                |        |     |  |               |
|  | 2.0            | ↓           |             | 07.90 | 09.03 |                |        |     |  |               |
|  | 2.4 D          | ↓           |             | 07.90 | 09.03 |                |        |     |  |               |
|  | 2.4 D Syncro   | ↓           |             | 11.92 | 09.03 |                |        |     |  |               |
|  | 2.5            | ↓           |             | 10.90 | 09.03 |                |        |     |  |               |
|  | 2.5 Syncro     | ↓           |             | 11.92 | 09.03 |                |        |     |  |               |
|  | 2.5 TDI        | ↓           |             | 09.95 | 09.03 |                |        |     |  |               |
|  | 2.5 TDI Syncro | ↓           |             | 09.95 | 09.03 |                |        |     |  |               |
|  | 2.8            | ↓           |             | 11.95 | 09.03 |                |        |     |  |               |

**VOLKSWAGEN TRANSPORTER (T5) BUS / MULTIVAN / KASTEN (03-)**

|  |                   |     |             |       |                     |                |        |  |  |              |     |
|--|-------------------|-----|-------------|-------|---------------------|----------------|--------|--|--|--------------|-----|
|  | 1.9 TDI           | 62  | 7H-A-050000 | 01.06 | PR: 1AJ,1AE,1AC,1AR | 03.7765-1002.4 | 300246 |  |  | 10/9" Tandem | ATE |
|  | 1.9 TDI           | 63  | 7H-A-050000 | 04.03 | PR: 1AJ,1AE,1AC,1AR |                |        |  |  |              |     |
|  | 1.9 TDI           | 75  | 7H-A-050000 | 06.06 | PR: 1AJ,1AE,1AC,1AR |                |        |  |  |              |     |
|  | 1.9 TDI           | 77  | 7H-A-050000 | 04.03 | PR: 1AJ,1AE,1AC,1AR |                |        |  |  |              |     |
|  | 2.0               |     | 7H-A-050000 | 06.03 | PR: 1AJ,1AE,1AC,1AR |                |        |  |  |              |     |
|  | 2.0 BiTDI         | 132 | 7H-A-050000 | 09.09 | PR: 1AJ,1AE,1AC,1AR |                |        |  |  |              |     |
|  | 2.0 BiTDI 4motion | 132 | 7H-A-050000 | 09.09 | PR: 1AJ,1AE,1AC,1AR |                |        |  |  |              |     |
|  | 2.0 TDI           | 62  | 7H-A-050000 | 09.09 | PR: 1AJ,1AE,1AC,1AR |                |        |  |  |              |     |
|  | 2.0 TDI           | 75  | 7H-A-050000 | 09.09 | PR: 1AJ,1AE,1AC,1AR |                |        |  |  |              |     |
|  | 2.0 TDI           | 103 | 7H-A-050000 | 09.09 | PR: 1AJ,1AE,1AC,1AR |                |        |  |  |              |     |
|  | 2.0 TDI 4motion   | 103 | 7H-A-050000 | 09.09 | PR: 1AJ,1AE,1AC,1AR |                |        |  |  |              |     |
|  | 2.5 TDI           |     | 7H-A-050000 | 02.03 | PR: 1AJ,1AE,1AC,1AR |                |        |  |  |              |     |
|  | 2.5 TDI           | 96  | 7H-A-050000 | 02.03 | PR: 1AJ,1AE,1AC,1AR |                |        |  |  |              |     |
|  | 2.5 TDI 4motion   | 96  | 7H-A-050000 | 07.04 | PR: 1AJ,1AE,1AC,1AR |                |        |  |  |              |     |
|  | 2.5 TDI 4motion   | 128 | 7H-A-050000 | 07.04 | PR: 1AJ,1AE,1AC,1AR |                |        |  |  |              |     |
|  | 3.2 V6            |     | 7H-A-050000 | 02.03 | PR: 1AJ,1AE,1AC,1AR |                |        |  |  |              |     |
|  | 3.2 V6 4motion    |     | 7H-A-050000 | 07.04 | PR: 1AJ,1AE,1AC,1AR |                |        |  |  |              |     |
|  | 1.9 TDI           | 62  | 7H-A-050000 | 01.06 | PR: 1AK             | 03.7868-3702.4 | 300208 |  |  | 10/8" Tandem | ATE |
|  | 1.9 TDI           | 63  | 7H-A-050000 | 04.03 | PR: 1AK             |                |        |  |  |              |     |
|  | 1.9 TDI           | 75  | 7H-A-050000 | 06.06 | PR: 1AK             |                |        |  |  |              |     |
|  | 1.9 TDI           | 77  | 7H-A-050000 | 04.03 | PR: 1AK             |                |        |  |  |              |     |



| VOLKSWAGEN TRANSPORTER (T5) BUS / MULTIVAN / KASTEN (03-)                         |   |  |   |  |   |  |  |        |   |  |
|---|---|--|---|--|---|--|--|--------|---|--|
|   | 2.0<br>2.0 BiTDI<br>2.0 BiTDI 4motion<br>2.0 TDI<br>2.0 TDI<br>2.0 TDI<br>2.0 TDI 4motion<br>2.5 TDI<br>2.5 TDI<br>2.5 TDI 4motion<br>2.5 TDI 4motion<br>3.2 V6<br>3.2 V6 4motion   | 132<br>132<br>62<br>75<br>103<br>103<br>96<br>96<br>128  | 7H-A-050000<br>7H-A-050000<br>7H-A-050000<br>7H-A-050000<br>7H-A-050000<br>7H-A-050000<br>7H-A-050000<br>7H-A-050000<br>7H-A-050000<br>7H-A-050000<br>7H-A-050000<br>7H-A-050000<br>7H-A-050000   | 06.03<br>09.09<br>09.09<br>09.09<br>09.09<br>09.09<br>02.03<br>02.03<br>07.04<br>07.04<br>02.03<br>07.04   | PR: 1AK<br>PR: 1AK<br>PR: 1AK<br>PR: 1AK<br>PR: 1AK<br>PR: 1AK<br>PR: 1AK<br>PR: 1AK<br>PR: 1AK<br>PR: 1AK<br>PR: 1AK<br>PR: 1AK  | 03.7868-3702.4   | 300208   |        | 10/8" Tandem  | ATE  |
|   | 1.9 TDI<br>1.9 TDI<br>1.9 TDI<br>1.9 TDI<br>2.0<br>2.0 BiTDI<br>2.0 BiTDI 4motion<br>2.0 TDI<br>2.0 TDI<br>2.0 TDI<br>2.0 TDI<br>2.0 TDI<br>2.0 TDI 4motion<br>2.0 TDI 4motion<br>2.5 TDI<br>2.5 TDI<br>2.5 TDI 4motion<br>2.5 TDI 4motion<br>3.2 V6<br>3.2 V6 4motion                    | 62<br>63<br>75<br>77<br>132<br>132<br>62<br>75<br>100<br>103<br>100<br>103<br>96<br>96<br>128              | 7H-A-050000<br>7H-A-050000<br>7H-A-050000<br>7H-A-050000<br>7H-A-050000<br>7H-A-050000<br>7H-A-050000<br>7H-A-050000<br>7H-A-050000<br>7H-A-050000<br>7H-A-050000<br>7H-A-050000<br>7H-A-050000<br>7H-A-050000<br>7H-A-050000<br>7H-A-050000<br>7H-A-050000<br>7H-A-050000<br>7H-A-050000<br>7H-A-050000<br>7H-A-050000 | 01.06<br>04.03<br>06.06<br>04.03<br>06.03<br>09.09<br>09.09<br>09.09<br>05.10<br>09.09<br>05.10<br>09.09<br>02.03<br>02.03<br>07.04<br>07.04<br>02.03<br>07.04                                     |   | 03.2126-3014.3   | 010811   |        | Thz 26,99   | ATE  |
|   | 1.9 TDI<br>1.9 TDI<br>1.9 TDI<br>1.9 TDI<br>2.0<br>3.2 V6   | 62<br>63<br>75<br>77   | 7H-6-200000<br>7H-6-200000<br>7H-6-200000<br>7H-6-200000<br>7H-6-200000<br>7H-6-200000  | 01.06<br>04.03<br>06.06<br>04.03<br>06.03<br>09.09   | PR: 1AT<br>PR: 1AT<br>PR: 1AT<br>PR: 1AT<br>PR: 1AT<br>PR: 1AT  | 03.2126-3014.3   | 010811   |        | Thz 26,99   | ATE  |
|  | 1.9 TDI<br>1.9 TDI<br>1.9 TDI<br>1.9 TDI<br>2.0<br>2.0 BiTDI<br>2.0 BiTDI 4motion<br>2.0 TDI<br>2.0 TDI<br>2.0 TDI<br>2.0 TDI<br>2.0 TDI 4motion<br>2.0 TDI 4motion<br>2.0 TSI<br>2.0 TSI 4motion<br>2.5 TDI<br>2.5 TDI<br>2.5 TDI 4motion<br>2.5 TDI 4motion<br>3.2 V6<br>3.2 V6 4motion | 62<br>63<br>75<br>77<br>132<br>132<br>62<br>75<br>84<br>100<br>103<br>100<br>103<br>150<br>96<br>96<br>128 | 7H-A-050000<br>7H-A-050000<br>7H-A-050000<br>7H-A-050000<br>7H-A-050000<br>7H-A-050000<br>7H-A-050000<br>7H-A-050000<br>7H-A-050000<br>7H-A-050000<br>7H-A-050000<br>7H-A-050000<br>7H-A-050000<br>7H-A-050000<br>7H-A-050000<br>7H-A-050000<br>7H-A-050000<br>7H-A-050000<br>7H-A-050000<br>7H-A-050000<br>7H-A-050000 | 01.06<br>04.03<br>06.06<br>04.03<br>06.03<br>09.09<br>09.09<br>09.09<br>05.11<br>05.10<br>09.09<br>09.09<br>05.10<br>09.09<br>05.11<br>07.11<br>02.03<br>02.03<br>07.04<br>07.04<br>02.03<br>07.04 | PR: 2E3<br>PR: 2E3<br>PR: 2E3<br>PR: 2E3<br>PR: 2E3<br>PR: 2E3<br>PR: 2E3<br>PR: 2E3<br>PR: 2E3<br>PR: 2E3<br>PR: 2E3<br>PR: 2E3<br>PR: 2E3<br>PR: 2E3<br>PR: 2E3<br>PR: 2E3<br>PR: 2E3<br>PR: 2E3<br>PR: 2E3<br>PR: 2E3<br>PR: 2E3 | 11.9601-8502.2<br>11.9601-9947.2<br>11.0441-6008.2<br>11.0101-5706.2<br>11.8171-0067.1<br>11.8116-0237.1                                     | 220594<br>220903<br>250038<br>260097<br>250153<br>390509                     | 2      | D=60, - Halter<br>D=60, - Halter<br>Dichtungssatz<br>Hülsensatz<br>Führungsbolzen<br>Haltefeder                         | ATE<br>ATE<br>ATE<br>ATE<br>ATE<br>ATE               |
|   | 1.9 TDI<br>1.9 TDI<br>1.9 TDI<br>1.9 TDI<br>2.0<br>2.0 BiTDI<br>2.0 BiTDI 4motion<br>2.0 TDI<br>2.0 TDI<br>2.0 TDI<br>2.0 TDI<br>2.0 TDI 4motion<br>2.0 TDI 4motion<br>2.5 TDI<br>2.5 TDI<br>2.5 TDI 4motion<br>2.5 TDI 4motion<br>3.2 V6<br>3.2 V6 4motion                               | 62<br>63<br>75<br>77<br>132<br>132<br>62<br>75<br>103<br>103<br>96<br>96<br>128                            | 7H-A-050000<br>7H-A-050000<br>7H-A-050000<br>7H-A-050000<br>7H-A-050000<br>7H-A-050000<br>7H-A-050000<br>7H-A-050000<br>7H-A-050000<br>7H-A-050000<br>7H-A-050000<br>7H-A-050000<br>7H-A-050000<br>7H-A-050000<br>7H-A-050000<br>7H-A-050000<br>7H-A-050000<br>7H-A-050000<br>7H-A-050000<br>7H-A-050000                | 01.06<br>04.03<br>06.06<br>04.03<br>06.03<br>09.09<br>09.09<br>09.09<br>05.11<br>05.10<br>09.09<br>09.09<br>05.10<br>09.09<br>02.03<br>02.03<br>07.04<br>07.04<br>02.03<br>07.04                   | PR: 2E4<br>PR: 2E4<br>PR: 2E4<br>PR: 2E4<br>PR: 2E4<br>PR: 2E4<br>PR: 2E4<br>PR: 2E4<br>PR: 2E4<br>PR: 2E4<br>PR: 2E4<br>PR: 2E4<br>PR: 2E4<br>PR: 2E4<br>PR: 2E4<br>PR: 2E4<br>PR: 2E4<br>PR: 2E4<br>PR: 2E4                       | 11.9601-9721.2<br>11.9601-9722.2<br>11.0441-6008.2<br>11.8170-0955.1<br>11.0101-5706.2<br>11.8171-0067.1<br>11.8116-0237.1<br>11.8116-0367.1 | 220875<br>220876<br>250038<br>260109<br>260097<br>250153<br>390509<br>390600 | 2<br>2 | D=60, - Halter<br>D=60, - Halter<br>Dichtungssatz<br>Halter<br>Hülsensatz<br>Führungsbolzen<br>Haltefeder<br>Haltefeder | ATE<br>ATE<br>ATE<br>ATE<br>ATE<br>ATE<br>ATE<br>ATE |
|   | 1.9 TDI<br>1.9 TDI<br>1.9 TDI<br>1.9 TDI<br>2.0<br>2.0 BiTDI<br>2.0 BiTDI 4motion<br>2.0 TDI<br>2.0 TDI<br>2.0 TDI<br>2.0 TDI<br>2.0 TDI 4motion<br>2.5 TDI<br>2.5 TDI<br>2.5 TDI 4motion<br>2.5 TDI 4motion<br>3.2 V6<br>3.2 V6 4motion  | 62<br>63<br>75<br>77<br>132<br>132<br>62<br>75<br>103<br>103<br>96<br>96<br>128                            | 7H-A-200001<br>7H-A-200001<br>7H-A-200001<br>7H-A-200001<br>7H-A-200001<br>7H-A-200001<br>7H-A-200001<br>7H-A-200001<br>7H-A-200001<br>7H-A-200001<br>7H-A-200001<br>7H-A-200001<br>7H-A-200001<br>7H-A-200001<br>7H-A-200001<br>7H-A-200001<br>7H-A-200001<br>7H-A-200001  | 01.06<br>04.03<br>06.06<br>04.03<br>06.03<br>09.09<br>09.09<br>09.09<br>05.11<br>05.10<br>09.09<br>09.09<br>02.03<br>02.03<br>07.04<br>07.04<br>02.03<br>07.04                                     | PR: 2E4<br>PR: 2E4<br>PR: 2E4<br>PR: 2E4<br>PR: 2E4<br>PR: 2E4<br>PR: 2E4<br>PR: 2E4<br>PR: 2E4<br>PR: 2E4<br>PR: 2E4<br>PR: 2E4<br>PR: 2E4<br>PR: 2E4<br>PR: 2E4<br>PR: 2E4<br>PR: 2E4   | 11.9441-9933.2<br>11.9441-9934.2<br>11.8116-0126.2   | 220911<br>220912<br>390608   | 2      | D=44, - Halter<br>D=44, - Halter<br>Haltefeder  | ATE<br>ATE   |
|   | 1.9 TDI<br>1.9 TDI<br>1.9 TDI<br>1.9 TDI<br>2.0<br>2.0 BiTDI<br>2.0 BiTDI 4motion<br>2.0 TDI<br>2.0 TDI<br>2.0 TDI  | 62<br>63<br>75<br>77<br>132<br>132<br>62<br>75<br>84   |   | 05.11  | PR: 2E4<br>PR: 2E4<br>PR: 2E4<br>PR: 2E4<br>PR: 2E4<br>PR: 2E4<br>PR: 2E4<br>PR: 2E4<br>PR: 2E4<br>PR: 2E4  |  |  |        |   |  |



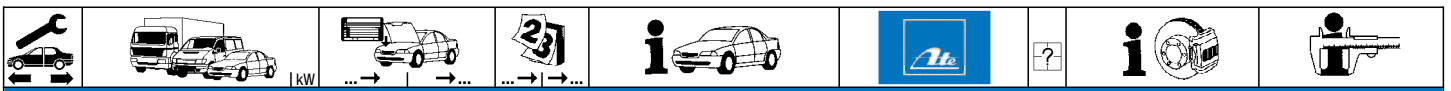

**VOLKSWAGEN TRANSPORTER (T5) BUS / MULTIVAN / KASTEN (03-)**

|                   |                 |             |             |                                 |                         |                         |                |                |  |            |        |       |       |                                  |            |                |        |   |  |                          |
|-------------------|-----------------|-------------|-------------|---------------------------------|-------------------------|-------------------------|----------------|----------------|--|------------|--------|-------|-------|----------------------------------|------------|----------------|--------|---|--|--------------------------|
|                   | 2.0 TDI         | 100         | 7H-A-200001 |                                 | PR: 2E4                 | 11.9441-9933.2          | 220911         | 2              | D=44, - Halter<br>D=44, - Halter<br>Haltefeder | ATE<br>ATE |        |       |       |                                  |            |                |        |   |  |                          |
|                   | 2.0 TDI         | 103         | 7H-A-200001 |                                 | PR: 2E4                 | 11.9441-9934.2          | 220912         |                |  |            |        |       |       |                                  |            |                |        |   |  |                          |
|                   | 2.0 TDI 4motion | 100         | 7H-A-200001 |                                 | PR: 2E4                 | 11.8116-0126.2          | 390608         |                |  |            |        |       |       |                                  |            |                |        |   |  |                          |
|                   | 2.0 TDI 4motion | 103         | 7H-A-200001 |                                 | PR: 2E4                 |                         |                |                |  |            |        |       |       |                                  |            |                |        |   |  |                          |
|                   | 2.0 TSI         |             |             | 05.11                           | PR: 2E4                 |                         |                |                |  |            |        |       |       |                                  |            |                |        |   |  |                          |
|                   | 2.0 TSI 4motion | 150         |             | 07.11                           | PR: 2E4                 |                         |                |                |  |            |        |       |       |                                  |            |                |        |   |  |                          |
|                   | 2.5 TDI         |             | 7H-A-200001 |                                 | PR: 2E4                 |                         |                |                |  |            |        |       |       |                                  |            |                |        |   |  |                          |
|                   | 2.5 TDI         | 96          | 7H-A-200001 |                                 | PR: 2E4                 |                         |                |                |  |            |        |       |       |                                  |            |                |        |   |  |                          |
|                   | 2.5 TDI 4motion | 96          | 7H-A-200001 |                                 | PR: 2E4                 |                         |                |                |  |            |        |       |       |                                  |            |                |        |   |  |                          |
|                   | 2.5 TDI 4motion | 128         | 7H-A-200001 |                                 | PR: 2E4                 |                         |                |                |  |            |        |       |       |                                  |            |                |        |   |  |                          |
|                   | 3.2 V6          |             | 7H-A-200001 |                                 | PR: 2E4                 |                         |                |                |  |            |        |       |       |                                  |            |                |        |   |  |                          |
|                   | 3.2 V6 4motion  |             | 7H-A-200001 |                                 | PR: 2E4                 |                         |                |                |  |            |        |       |       |                                  |            |                |        |   |  |                          |
|                   |                 | 1.9 TDI     | 62          |                                 | 01.06                   | PR: OWL,OWN,OWM,OWP,OWQ | 83.6113-0510.3 |                |  |            | 330863 | 2     | L=510 |                                  |            |                |        |   |  |                          |
| 1.9 TDI           |                 | 63          |             | 04.03                           | PR: OWL,OWN,OWM,OWP,OWQ |                         |                |                |  |            |        |       |       |                                  |            |                |        |   |  |                          |
| 1.9 TDI           |                 | 75          |             | 06.06                           | PR: OWL,OWN,OWM,OWP,OWQ |                         |                |                |  |            |        |       |       |                                  |            |                |        |   |  |                          |
| 1.9 TDI           |                 | 77          |             | 04.03                           | PR: OWL,OWN,OWM,OWP,OWQ |                         |                |                |  |            |        |       |       |                                  |            |                |        |   |  |                          |
| 2.0               |                 |             |             | 06.03                           | PR: OWL,OWN,OWM,OWP,OWQ |                         |                |                |  |            |        |       |       |                                  |            |                |        |   |  |                          |
| 2.0 BiTDI         |                 | 132         |             | 09.09                           | PR: OWL,OWN,OWM,OWP,OWQ |                         |                |                |  |            |        |       |       |                                  |            |                |        |   |  |                          |
| 2.0 BiTDI 4motion |                 | 132         |             | 09.09                           | PR: OWL,OWN,OWM,OWP,OWQ |                         |                |                |  |            |        |       |       |                                  |            |                |        |   |  |                          |
| 2.0 TDI           |                 | 62          |             | 09.09                           | PR: OWL,OWN,OWM,OWP,OWQ |                         |                |                |  |            |        |       |       |                                  |            |                |        |   |  |                          |
| 2.0 TDI           |                 | 75          |             | 09.09                           | PR: OWL,OWN,OWM,OWP,OWQ |                         |                |                |  |            |        |       |       |                                  |            |                |        |   |  |                          |
| 2.0 TDI           |                 | 100         |             | 05.10                           | PR: OWL,OWN,OWM,OWP,OWQ |                         |                |                |  |            |        |       |       |                                  |            |                |        |   |  |                          |
| 2.0 TDI           |                 | 103         |             | 09.09                           | PR: OWL,OWN,OWM,OWP,OWQ |                         |                |                |  |            |        |       |       |                                  |            |                |        |   |  |                          |
| 2.0 TDI 4motion   |                 | 100         |             | 05.10                           | PR: OWL,OWN,OWM,OWP,OWQ |                         |                |                |  |            |        |       |       |                                  |            |                |        |   |  |                          |
| 2.0 TDI 4motion   |                 | 103         |             | 09.09                           | PR: OWL,OWN,OWM,OWP,OWQ |                         |                |                |  |            |        |       |       |                                  |            |                |        |   |  |                          |
| 2.5 TDI           |                 |             |             | 02.03                           | PR: OWL,OWN,OWM,OWP,OWQ |                         |                |                |  |            |        |       |       |                                  |            |                |        |   |  |                          |
| 2.5 TDI           |                 | 96          |             | 02.03                           | PR: OWL,OWN,OWM,OWP,OWQ |                         |                |                |  |            |        |       |       |                                  |            |                |        |   |  |                          |
| 2.5 TDI 4motion   |                 | 96          |             | 07.04                           | PR: OWL,OWN,OWM,OWP,OWQ |                         |                |                |  |            |        |       |       |                                  |            |                |        |   |  |                          |
| 2.5 TDI 4motion   |                 | 128         |             | 07.04                           | PR: OWL,OWN,OWM,OWP,OWQ |                         |                |                |  |            |        |       |       |                                  |            |                |        |   |  |                          |
| 3.2 V6            |                 |             |             | 02.03                           | PR: OWL,OWN,OWM,OWP,OWQ |                         |                |                |  |            |        |       |       |                                  |            |                |        |   |  |                          |
| 3.2 V6 4motion    |                 |             |             | 07.04                           | PR: OWL,OWN,OWM,OWP,OWQ |                         |                |                |  |            |        |       |       |                                  |            |                |        |   |  |                          |
| 1.9 TDI           |                 | 62          |             | 01.06                           | PR: OWR                 | 83.6113-0552.3          |                | 330864         | 2  | L=552      |        |       |       |                                  |            |                |        |   |  |                          |
| 1.9 TDI           |                 | 63          |             | 04.03                           | PR: OWR                 |                         |                |                |  |            |        |       |       |                                  |            |                |        |   |  |                          |
| 1.9 TDI           |                 | 75          |             | 06.06                           | PR: OWR                 |                         |                |                |  |            |        |       |       |                                  |            |                |        |   |  |                          |
| 1.9 TDI           |                 | 77          |             | 04.03                           | PR: OWR                 |                         |                |                |  |            |        |       |       |                                  |            |                |        |   |  |                          |
| 2.0               |                 |             |             | 06.03                           | PR: OWR                 |                         |                |                |  |            |        |       |       |                                  |            |                |        |   |  |                          |
| 2.0 BiTDI         |                 | 132         |             | 09.09                           | PR: OWR                 |                         |                |                |  |            |        |       |       |                                  |            |                |        |   |  |                          |
| 2.0 BiTDI 4motion |                 | 132         |             | 09.09                           | PR: OWR                 |                         |                |                |  |            |        |       |       |                                  |            |                |        |   |  |                          |
| 2.0 TDI           |                 | 62          |             | 09.09                           | PR: OWR                 |                         |                |                |  |            |        |       |       |                                  |            |                |        |   |  |                          |
| 2.0 TDI           |                 | 75          |             | 09.09                           | PR: OWR                 |                         |                |                |  |            |        |       |       |                                  |            |                |        |   |  |                          |
| 2.0 TDI           |                 | 100         |             | 05.10                           | PR: OWR                 |                         |                |                |  |            |        |       |       |                                  |            |                |        |   |  |                          |
| 2.0 TDI           |                 | 103         |             | 09.09                           | PR: OWR                 |                         |                |                |  |            |        |       |       |                                  |            |                |        |   |  |                          |
| 2.0 TDI 4motion   |                 | 100         |             | 05.10                           | PR: OWR                 |                         |                |                |  |            |        |       |       |                                  |            |                |        |   |  |                          |
| 2.0 TDI 4motion   |                 | 103         |             | 09.09                           | PR: OWR                 |                         |                |                |  |            |        |       |       |                                  |            |                |        |   |  |                          |
| 2.5 TDI           |                 |             |             | 02.03                           | PR: OWR                 |                         |                |                |  |            |        |       |       |                                  |            |                |        |   |  |                          |
| 2.5 TDI           |                 | 96          |             | 02.03                           | PR: OWR                 |                         |                |                |  |            |        |       |       |                                  |            |                |        |   |  |                          |
| 2.5 TDI 4motion   |                 | 96          |             | 07.04                           | PR: OWR                 |                         |                |                |  |            |        |       |       |                                  |            |                |        |   |  |                          |
| 2.5 TDI 4motion   | 128             |             | 07.04       | PR: OWR                         |                         |                         |                |                |  |            |        |       |       |                                  |            |                |        |   |  |                          |
| 3.2 V6            |                 |             | 02.03       | PR: OWR                         |                         |                         |                |                |  |            |        |       |       |                                  |            |                |        |   |  |                          |
| 3.2 V6 4motion    |                 |             | 07.04       | PR: OWR                         |                         |                         |                |                |  |            |        |       |       |                                  |            |                |        |   |  |                          |
| 1.9 TDI           | 62              |             | 01.06       | PR: 1BH,1BX,1MR,2MQ,2MZ,2MU,2MT | 83.6113-0552.3          |                         | 330864         |                |  |            | 2      | L=552 |       |                                  |            |                |        |   |  |                          |
| 1.9 TDI           | 63              |             | 04.03       | PR: 1BH,1BX,1MR,2MQ,2MZ,2MU,2MT |                         |                         |                |                |  |            |        |       |       |                                  |            |                |        |   |  |                          |
| 1.9 TDI           | 75              |             | 06.06       | PR: 1BH,1BX,1MR,2MQ,2MZ,2MU,2MT |                         |                         |                |                |  |            |        |       |       |                                  |            |                |        |   |  |                          |
| 1.9 TDI           | 77              |             | 04.03       | PR: 1BH,1BX,1MR,2MQ,2MZ,2MU,2MT |                         |                         |                |                |  |            |        |       |       |                                  |            |                |        |   |  |                          |
| 2.0               |                 |             | 06.03       | PR: 1BH,1BX,1MR,2MQ,2MZ,2MU,2MT |                         |                         |                |                |  |            |        |       |       |                                  |            |                |        |   |  |                          |
| 2.0 BiTDI         | 132             |             | 09.09       | PR: 1BH,1BX,1MR,2MQ,2MZ,2MU,2MT |                         |                         |                |                |  |            |        |       |       |                                  |            |                |        |   |  |                          |
| 2.0 BiTDI 4motion | 132             |             | 09.09       | PR: 1BH,1BX,1MR,2MQ,2MZ,2MU,2MT |                         |                         |                |                |  |            |        |       |       |                                  |            |                |        |   |  |                          |
| 2.0 TDI           | 62              |             | 09.09       | PR: 1BH,1BX,1MR,2MQ,2MZ,2MU,2MT |                         |                         |                |                |  |            |        |       |       |                                  |            |                |        |   |  |                          |
| 2.0 TDI           | 75              |             | 09.09       | PR: 1BH,1BX,1MR,2MQ,2MZ,2MU,2MT |                         |                         |                |                |  |            |        |       |       |                                  |            |                |        |   |  |                          |
| 2.0 TDI           | 84              |             | 05.11       | PR: 1BH,1BX,1MR,2MQ,2MZ,2MU,2MT |                         |                         |                |                |  |            |        |       |       |                                  |            |                |        |   |  |                          |
| 2.0 TDI           | 100             |             | 05.10       | PR: 1BH,1BX,1MR,2MQ,2MZ,2MU,2MT |                         |                         |                |                |  |            |        |       |       |                                  |            |                |        |   |  |                          |
| 2.0 TDI           | 103             |             | 09.09       | PR: 1BH,1BX,1MR,2MQ,2MZ,2MU,2MT |                         |                         |                |                |  |            |        |       |       |                                  |            |                |        |   |  |                          |
| 2.0 TDI 4motion   | 100             |             | 05.10       | PR: 1BH,1BX,1MR,2MQ,2MZ,2MU,2MT |                         |                         |                |                |  |            |        |       |       |                                  |            |                |        |   |  |                          |
| 2.0 TDI 4motion   | 103             |             | 09.09       | PR: 1BH,1BX,1MR,2MQ,2MZ,2MU,2MT |                         |                         |                |                |  |            |        |       |       |                                  |            |                |        |   |  |                          |
| 2.0 TSI           |                 |             | 05.11       | PR: 1BH,1BX,1MR,2MQ,2MZ,2MU,2MT |                         |                         |                |                |  |            |        |       |       |                                  |            |                |        |   |  |                          |
| 2.0 TSI 4motion   | 150             |             | 07.11       | PR: 1BH,1BX,1MR,2MQ,2MZ,2MU,2MT |                         |                         |                |                |  |            |        |       |       |                                  |            |                |        |   |  |                          |
| 2.5 TDI           |                 |             | 02.03       | PR: 1BH,1BX,1MR,2MQ,2MZ,2MU,2MT |                         |                         |                |                |  |            |        |       |       |                                  |            |                |        |   |  |                          |
| 2.5 TDI           | 96              |             | 02.03       | PR: 1BH,1BX,1MR,2MQ,2MZ,2MU,2MT |                         |                         |                |                |  |            |        |       |       |                                  |            |                |        |   |  |                          |
| 2.5 TDI 4motion   | 96              |             | 07.04       | PR: 1BH,1BX,1MR,2MQ,2MZ,2MU,2MT |                         |                         |                |                |  |            |        |       |       |                                  |            |                |        |   |  |                          |
| 2.5 TDI 4motion   | 128             |             | 07.04       | PR: 1BH,1BX,1MR,2MQ,2MZ,2MU,2MT |                         |                         |                |                |  |            |        |       |       |                                  |            |                |        |   |  |                          |
| 3.2 V6            |                 |             | 02.03       | PR: 1BH,1BX,1MR,2MQ,2MZ,2MU,2MT |                         |                         |                |                |  |            |        |       |       |                                  |            |                |        |   |  |                          |
| 3.2 V6 4motion    |                 |             | 07.04       | PR: 1BH,1BX,1MR,2MQ,2MZ,2MU,2MT |                         |                         |                |                |  |            |        |       |       |                                  |            |                |        |   |  |                          |
|                   | 1.9 TDI         | 63          | 7H-5-120000 | 04.03                           |                         | PR: OWL,OWN,OWM,OWP,OWQ |                | 24.3414-1711.7 | 220677   | 2          |        |       |       | D=41, - Halter<br>D=41, - Halter | LUC<br>LUC |                |        |   |  |                          |
|                   | 1.9 TDI         | 77          | 7H-5-120000 | 04.03                           |                         | PR: OWL,OWN,OWM,OWP,OWQ |                |                |  |            |        |       |       |                                  |            |                |        |   |  |                          |
|                   | 2.0             |             | 7H-5-120000 | 06.03                           |                         | PR: OWL,OWN,OWM,OWP,OWQ |                |                |  |            |        |       |       |                                  |            |                |        |   |  |                          |
|                   | 2.5 TDI         |             | 7H-5-120000 | 02.03                           |                         | PR: OWL,OWN,OWM,OWP,OWQ |                |                |  |            |        |       |       |                                  |            |                |        |   |  |                          |
|                   | 2.5 TDI         | 96          | 7H-5-120000 | 02.03                           |                         | PR: OWL,OWN,OWM,OWP,OWQ |                |                |  |            |        |       |       |                                  |            |                |        |   |  |                          |
|                   | 2.5 TDI 4motion | 96          | 7H-5-120000 | 07.04                           |                         | PR: OWL,OWN,OWM,OWP,OWQ |                |                |  |            |        |       |       |                                  |            |                |        |   |  |                          |
|                   | 2.5 TDI 4motion | 128         | 7H-5-120000 | 07.04                           |                         | PR: OWL,OWN,OWM,OWP,OWQ |                |                |  |            |        |       |       |                                  |            |                |        |   |  |                          |
|                   | 3.2 V6          |             | 7H-5-120000 | 02.03                           |                         | PR: OWL,OWN,OWM,OWP,OWQ |                |                |  |            |        |       |       |                                  |            |                |        |   |  |                          |
|                   | 3.2 V6 4motion  |             | 7H-5-120000 | 07.04                           |                         | PR: OWL,OWN,OWM,OWP,OWQ |                |                |  |            |        |       |       |                                  |            |                |        |   |  |                          |
|                   | 1.9 TDI         | 62          | 7H-8-027999 | 01.06                           |                         | PR: OWR                 |                |                |  |            |        |       |       |                                  |            | 11.9441-9949.2 | 220803 | 2 | D=44, - Halter<br>D=44, - Halter<br>Hülsensatz<br>Führungsbolzen | ATE<br>ATE<br>ATE<br>ATE |
|                   | 1.9 TDI         | 63          | 7H-8-027999 | 04.03                           |                         | PR: OWR                 |                |                |  |            |        |       |       |                                  |            |                |        |   |  |                          |
|                   | 1.9 TDI         | 75          | 7H-8-027999 | 06.06                           |                         | PR: OWR                 |                |                |  |            |        |       |       |                                  |            |                |        |   |  |                          |
|                   | 1.9 TDI         | 77          | 7H-8-027999 | 04.03                           |                         | PR: OWR                 |                |                |  |            |        |       |       |                                  |            |                |        |   |  |                          |
| 2.0               |                 | 7H-8-027999 | 06.03       | PR: OWR                         |                         |                         |                |                |  |            |        |       |       |                                  |            |                |        |   |  |                          |
| 2.5 TDI           |                 | 7H-8-027999 | 02.03       | PR: OWR                         |                         |                         |                |                |  |            |        |       |       |                                  |            |                |        |   |  |                          |

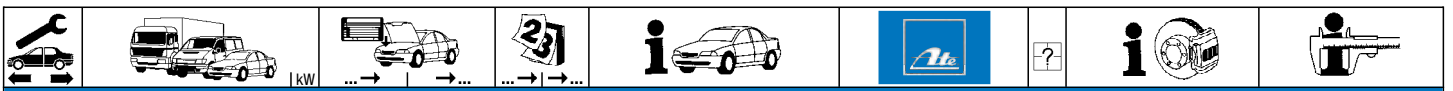

**VOLKSWAGEN TRANSPORTER (T5) BUS / MULTIVAN / KASTEN (03-)**

|                   |                   |             |              |                                  |                                  |                                  |                       |        |  |  |                          |  |  |                          |
|-------------------|-------------------|-------------|--------------|----------------------------------|----------------------------------|----------------------------------|-----------------------|--------|--|--|--------------------------|--|--|--------------------------|
|                   | 2.5 TDI           | 96          | 7H-8-027999  | <b>02.03</b>                     | PR: OWR                          | <b>11.9441-9949.2</b>            | 220803                |        | D=44, - Halter<br>D=44, - Halter<br>Hülzensatz<br>Führungsbolzen | <b>ATE</b><br><b>ATE</b><br><b>ATE</b><br><b>ATE</b> |                          |  |  |                          |
|                   | 2.5 TDI 4motion   | 96          | 7H-8-027999  | <b>07.04</b>                     | PR: OWR                          | <b>11.9441-9950.2</b>            | 220804                |        |  |  |                          |  |  |                          |
|                   | 2.5 TDI 4motion   | 128         | 7H-8-027999  | <b>07.04</b>                     | PR: OWR                          | <b>11.0101-5409.2</b>            | 260035                |        |  |  |                          |  |  |                          |
|                   | 3.2 V6            |             | 7H-8-027999  | <b>02.03</b>                     | PR: OWR                          | <b>11.8171-0008.1</b>            | 990049                |        |  |  |                          |  |  |                          |
| 3.2 V6 4motion    |                   |             | 7H-8-027999  | <b>07.04</b>                     | PR: OWR                          |                                  |                       |        |  |  |                          |  |  |                          |
|                   | 1.9 TDI           | 62          | 7H-8-028000  | 7H-8-200000                      |                                  | PR: OWR                          | <b>24.3414-1711.7</b> | 220677 |  | D=41, - Halter<br>D=41, - Halter                     | <b>LUC</b><br><b>LUC</b> |  |  |                          |
|                   | 1.9 TDI           | 63          | 7H-8-028000  | 7H-8-200000                      |                                  | PR: OWR                          | <b>24.3414-1712.7</b> | 220678 |  |  |                          |  |  |                          |
|                   | 1.9 TDI           | 75          | 7H-8-028000  | 7H-8-200000                      |                                  | PR: OWR                          |                       |        |  |  |                          |  |  |                          |
|                   | 1.9 TDI           | 77          | 7H-8-028000  | 7H-8-200000                      |                                  | PR: OWR                          |                       |        |  |  |                          |  |  |                          |
|                   | 2.0               |             | 7H-8-028000  | 7H-8-200000                      |                                  | PR: OWR                          |                       |        |  |  |                          |  |  |                          |
|                   | 2.5 TDI           |             | 7H-8-028000  | 7H-8-200000                      |                                  | PR: OWR                          |                       |        |  |  |                          |  |  |                          |
|                   | 2.5 TDI           | 96          | 7H-8-028000  | 7H-8-200000                      |                                  | PR: OWR                          |                       |        |  |  |                          |  |  |                          |
|                   | 2.5 TDI 4motion   | 96          | 7H-8-028000  | 7H-8-200000                      |                                  | PR: OWR                          |                       |        |  |  |                          |  |  |                          |
|                   | 2.5 TDI 4motion   | 128         | 7H-8-028000  | 7H-8-200000                      |                                  | PR: OWR                          |                       |        |  |  |                          |  |  |                          |
|                   | 3.2 V6            |             | 7H-8-028000  | 7H-8-200000                      |                                  | PR: OWR                          |                       |        |  |  |                          |  |  |                          |
|                   | 3.2 V6 4motion    |             |              | 7H-8-200000                      |                                  | PR: OWR                          |                       |        |  |  |                          |  |  |                          |
|                   | 1.9 TDI           | 62          | 7H-6-000001  | 7H-A-050000                      |                                  | PR: 2E3,2E4                      | <b>24.3414-1711.7</b> | 220677 |  |  |                          |  | D=41, - Halter<br>D=41, - Halter                           | <b>LUC</b><br><b>LUC</b> |
|                   | 1.9 TDI           | 63          | 7H-6-000001  | 7H-A-050000                      |                                  | PR: 2E3,2E4                      | <b>24.3414-1712.7</b> | 220678 |  |  |                          |  |  |                          |
|                   | 1.9 TDI           | 75          | 7H-6-000001  | 7H-A-050000                      |                                  | PR: 2E3,2E4                      |                       |        |  |  |                          |  |  |                          |
|                   | 1.9 TDI           | 77          | 7H-6-000001  | 7H-A-050000                      |                                  | PR: 2E3,2E4                      |                       |        |  |  |                          |  |  |                          |
|                   | 2.0               |             | 7H-6-000001  | 7H-A-050000                      |                                  | PR: 2E3,2E4                      |                       |        |  |  |                          |  |  |                          |
|                   | 2.0 BiTDI         | 132         | 7H-6-000001  | 7H-A-050000                      |                                  | PR: 2E3,2E4                      |                       |        |  |  |                          |  |  |                          |
| 2.0 BiTDI 4motion | 132               | 7H-6-000001 | 7H-A-050000  |                                  | PR: 2E3,2E4                      |                                  |                       |        |  |  |                          |  |  |                          |
| 2.0 TDI           | 62                | 7H-6-000001 | 7H-A-050000  |                                  | PR: 2E3,2E4                      |                                  |                       |        |  |  |                          |  |  |                          |
| 2.0 TDI           | 75                | 7H-6-000001 | 7H-A-050000  |                                  | PR: 2E3,2E4                      |                                  |                       |        |  |  |                          |  |  |                          |
| 2.0 TDI           | 103               | 7H-6-000001 | 7H-A-050000  |                                  | PR: 2E3,2E4                      |                                  |                       |        |  |  |                          |  |  |                          |
| 2.0 TDI 4motion   | 103               | 7H-6-000001 | 7H-A-050000  |                                  | PR: 2E3,2E4                      |                                  |                       |        |  |  |                          |  |  |                          |
| 2.5 TDI           |                   | 7H-6-000001 | 7H-A-050000  |                                  | PR: 2E3,2E4                      |                                  |                       |        |  |  |                          |  |  |                          |
| 2.5 TDI           | 96                | 7H-6-000001 | 7H-A-050000  |                                  | PR: 2E3,2E4                      |                                  |                       |        |  |  |                          |  |  |                          |
| 2.5 TDI 4motion   | 96                | 7H-6-000001 | 7H-A-050000  |                                  | PR: 2E3,2E4                      |                                  |                       |        |  |  |                          |  |  |                          |
| 2.5 TDI 4motion   | 128               | 7H-6-000001 | 7H-A-050000  |                                  | PR: 2E3,2E4                      |                                  |                       |        |  |  |                          |  |  |                          |
| 3.2 V6            |                   | 7H-6-000001 | 7H-A-050000  |                                  | PR: 2E3,2E4                      |                                  |                       |        |  |  |                          |  |  |                          |
| 3.2 V6 4motion    |                   |             | 7H-A-050000  |                                  | PR: 2E3,2E4                      |                                  |                       |        |  |  |                          |  |  |                          |
|                   | 1.9 TDI           | 62          | 7H-A-200001  |                                  |                                  | <b>24.3414-1711.7</b>            | 220677                |        | D=41, - Halter<br>D=41, - Halter                                 | <b>LUC</b><br><b>LUC</b>                             |                          |  |  |                          |
|                   | 1.9 TDI           | 63          | 7H-A-200001  |                                  |                                  | <b>24.3414-1712.7</b>            | 220678                |        |  |  |                          |  |  |                          |
|                   | 1.9 TDI           | 75          | 7H-A-200001  |                                  |                                  |                                  |                       |        |  |  |                          |  |  |                          |
|                   | 1.9 TDI           | 77          | 7H-A-200001  |                                  |                                  |                                  |                       |        |  |  |                          |  |  |                          |
|                   | 2.0               |             | 7H-A-200001  |                                  |                                  |                                  |                       |        |  |  |                          |  |  |                          |
|                   | 2.0 BiTDI         | 132         | 7H-A-200001  |                                  |                                  |                                  |                       |        |  |  |                          |  |  |                          |
|                   | 2.0 BiTDI 4motion | 132         | 7H-A-200001  |                                  |                                  |                                  |                       |        |  |  |                          |  |  |                          |
|                   | 2.0 TDI           | 62          | 7H-A-200001  |                                  |                                  |                                  |                       |        |  |  |                          |  |  |                          |
|                   | 2.0 TDI           | 75          | 7H-A-200001  |                                  |                                  |                                  |                       |        |  |  |                          |  |  |                          |
|                   | 2.0 TDI           | 84          |              | <b>05.11</b>                     |                                  |                                  |                       |        |  |  |                          |  |  |                          |
|                   | 2.0 TDI           | 100         | 7H-A-200001  |                                  |                                  |                                  |                       |        |  |  |                          |  |  |                          |
|                   | 2.0 TDI           | 103         | 7H-A-200001  |                                  |                                  |                                  |                       |        |  |  |                          |  |  |                          |
|                   | 2.0 TDI 4motion   | 100         | 7H-A-200001  |                                  |                                  |                                  |                       |        |  |  |                          |  |  |                          |
|                   | 2.0 TDI 4motion   | 103         | 7H-A-200001  |                                  |                                  |                                  |                       |        |  |  |                          |  |  |                          |
|                   | 2.0 TSI           |             |              | <b>05.11</b>                     |                                  |                                  |                       |        |  |  |                          |  |  |                          |
|                   | 2.0 TSI 4motion   | 150         |              | <b>07.11</b>                     |                                  |                                  |                       |        |  |  |                          |  |  |                          |
|                   | 2.5 TDI           |             | 7H-A-200001  |                                  |                                  |                                  |                       |        |  |  |                          |  |  |                          |
|                   | 2.5 TDI           | 96          | 7H-A-200001  |                                  |                                  |                                  |                       |        |  |  |                          |  |  |                          |
|                   | 2.5 TDI 4motion   | 96          | 7H-A-200001  |                                  |                                  |                                  |                       |        |  |  |                          |  |  |                          |
|                   | 2.5 TDI 4motion   | 128         | 7H-A-200001  |                                  |                                  |                                  |                       |        |  |  |                          |  |  |                          |
|                   | 3.2 V6            |             | 7H-A-200001  |                                  |                                  |                                  |                       |        |  |  |                          |  |  |                          |
|                   | 3.2 V6 4motion    |             |              | 7H-A-200001                      |                                  |                                  |                       |        |  |  |                          |  |  |                          |
|                   |                   | 1.9 TDI     | 62           |                                  | <b>01.06</b>                     | - Bremskraftregler <sup>1)</sup> | <b>24.5140-0241.3</b> |        |  |  | 330948                   |  | am Bremsattel <sup>2)</sup><br>am Bremsattel <sup>2)</sup> | L=240<br>L=240<br>L=250  |
| 1.9 TDI           |                   | 63          |              | <b>04.03</b>                     | - Bremskraftregler <sup>1)</sup> | <b>24.5140-0240.3</b>            | 330947                |        |  |  |                          |  |  |                          |
| 1.9 TDI           |                   | 75          |              | <b>06.06</b>                     | - Bremskraftregler <sup>1)</sup> | <b>24.5237-0250.3</b>            | 330880                |        |  |  |                          |  |  |                          |
| 1.9 TDI           |                   | 77          |              | <b>04.03</b>                     | - Bremskraftregler <sup>1)</sup> |                                  |                       |        |  |  |                          |  |  |                          |
| 2.0               |                   |             |              | <b>06.03</b>                     | - Bremskraftregler <sup>1)</sup> |                                  |                       |        |  |  |                          |  |  |                          |
| 2.0 BiTDI         |                   | 132         |              | <b>09.09</b>                     | - Bremskraftregler <sup>1)</sup> |                                  |                       |        |  |  |                          |  |  |                          |
| 2.0 BiTDI 4motion |                   | 132         |              | <b>09.09</b>                     | - Bremskraftregler <sup>1)</sup> |                                  |                       |        |  |  |                          |  |  |                          |
| 2.0 TDI           |                   | 62          |              | <b>09.09</b>                     | - Bremskraftregler <sup>1)</sup> |                                  |                       |        |  |  |                          |  |  |                          |
| 2.0 TDI           |                   | 75          |              | <b>09.09</b>                     | - Bremskraftregler <sup>1)</sup> |                                  |                       |        |  |  |                          |  |  |                          |
| 2.0 TDI           |                   | 100         |              | <b>05.10</b>                     | - Bremskraftregler <sup>1)</sup> |                                  |                       |        |  |  |                          |  |  |                          |
| 2.0 TDI           |                   | 103         |              | <b>09.09</b>                     | - Bremskraftregler <sup>1)</sup> |                                  |                       |        |  |  |                          |  |  |                          |
| 2.0 TDI 4motion   |                   | 100         |              | <b>05.10</b>                     | - Bremskraftregler <sup>1)</sup> |                                  |                       |        |  |  |                          |  |  |                          |
| 2.0 TDI 4motion   |                   | 103         |              | <b>09.09</b>                     | - Bremskraftregler <sup>1)</sup> |                                  |                       |        |  |  |                          |  |  |                          |
| 2.5 TDI           |                   |             |              | <b>02.03</b>                     | - Bremskraftregler <sup>1)</sup> |                                  |                       |        |  |  |                          |  |  |                          |
| 2.5 TDI           |                   | 96          |              | <b>02.03</b>                     | - Bremskraftregler <sup>1)</sup> |                                  |                       |        |  |  |                          |  |  |                          |
| 2.5 TDI 4motion   |                   | 96          |              | <b>07.04</b>                     | - Bremskraftregler <sup>1)</sup> |                                  |                       |        |  |  |                          |  |  |                          |
| 2.5 TDI 4motion   |                   | 128         |              | <b>07.04</b>                     | - Bremskraftregler <sup>1)</sup> |                                  |                       |        |  |  |                          |  |  |                          |
| 3.2 V6            |                   |             | <b>02.03</b> | - Bremskraftregler <sup>1)</sup> |                                  |                                  |                       |        |  |  |                          |  |  |                          |
| 3.2 V6 4motion    |                   |             | <b>07.04</b> | - Bremskraftregler <sup>1)</sup> |                                  |                                  |                       |        |  |  |                          |  |  |                          |
|                   | 1.9 TDI           | 62          |              | <b>01.06</b>                     | + Bremskraftregler <sup>3)</sup> | <b>24.5137-0190.3</b>            | 330878                |        | am Bremsattel <sup>2)</sup>                                      | L=190<br>L=250                                       |                          |  |  |                          |
|                   | 1.9 TDI           | 63          |              | <b>04.03</b>                     | + Bremskraftregler <sup>3)</sup> | <b>24.5237-0250.3</b>            | 330880                |        |  |  |                          |  |  |                          |
|                   | 1.9 TDI           | 75          |              | <b>06.06</b>                     | + Bremskraftregler <sup>3)</sup> |                                  |                       |        |  |  |                          |  |  |                          |
|                   | 1.9 TDI           | 77          |              | <b>04.03</b>                     | + Bremskraftregler <sup>3)</sup> |                                  |                       |        |  |  |                          |  |  |                          |
|                   | 2.0               |             |              | <b>06.03</b>                     | + Bremskraftregler <sup>3)</sup> |                                  |                       |        |  |  |                          |  |  |                          |
|                   | 2.0 BiTDI         | 132         |              | <b>09.09</b>                     | + Bremskraftregler <sup>3)</sup> |                                  |                       |        |  |  |                          |  |  |                          |
|                   | 2.0 BiTDI 4motion | 132         |              | <b>09.09</b>                     | + Bremskraftregler <sup>3)</sup> |                                  |                       |        |  |  |                          |  |  |                          |
|                   | 2.0 TDI           | 62          |              | <b>09.09</b>                     | + Bremskraftregler <sup>3)</sup> |                                  |                       |        |  |  |                          |  |  |                          |
|                   | 2.0 TDI           | 75          |              | <b>09.09</b>                     | + Bremskraftregler <sup>3)</sup> |                                  |                       |        |  |  |                          |  |  |                          |
|                   | 2.0 TDI           | 100         |              | <b>05.10</b>                     | + Bremskraftregler <sup>3)</sup> |                                  |                       |        |  |  |                          |  |  |                          |
|                   | 2.0 TDI           | 103         |              | <b>09.09</b>                     | + Bremskraftregler <sup>3)</sup> |                                  |                       |        |  |  |                          |  |  |                          |
| 2.0 TDI 4motion   | 100               |             | <b>05.10</b> | + Bremskraftregler <sup>3)</sup> |                                  |                                  |                       |        |  |  |                          |  |  |                          |
| 2.0 TDI 4motion   | 103               |             | <b>09.09</b> | + Bremskraftregler <sup>3)</sup> |                                  |                                  |                       |        |  |  |                          |  |  |                          |

1) - brake pressure regulator / - correttore di frenata / - correcteur de freinage / - corrector de frenado  
 2) on the brake caliper / sulla pinza freno / sur l'étrier de frein / a la pinza de freno  
 3) + brake pressure regulator / + correttore di frenata / + correcteur de freinage / + corrector de frenado



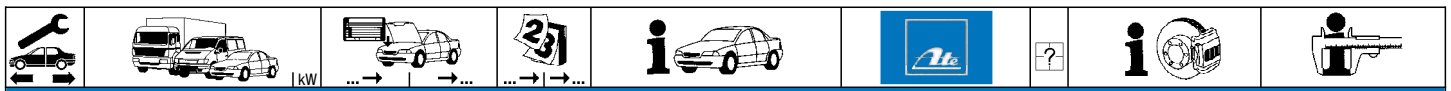

**VOLKSWAGEN TRANSPORTER (T5) BUS / MULTIVAN / KASTEN (03-)**

|                   |                 |             |       |                                 |                                  |                |        |                 |                             |        |
|-------------------|-----------------|-------------|-------|---------------------------------|----------------------------------|----------------|--------|-----------------|-----------------------------|--------|
|                   | 2.5 TDI         | 96          |       | 02.03                           | + Bremskraftregler <sup>1)</sup> | 24.5137-0190.3 | 330878 | 2               | am Bremsattel <sup>2)</sup> | L=190  |
|                   | 2.5 TDI         | 96          |       | 02.03                           | + Bremskraftregler <sup>1)</sup> | 24.5237-0250.3 | 330880 | 2               |                             | L=250  |
|                   | 2.5 TDI 4motion | 96          |       | 07.04                           | + Bremskraftregler <sup>1)</sup> |                |        |                 |                             |        |
|                   | 2.5 TDI 4motion | 128         |       | 07.04                           | + Bremskraftregler <sup>1)</sup> |                |        |                 |                             |        |
|                   | 3.2 V6          |             |       | 02.03                           | + Bremskraftregler <sup>1)</sup> |                |        |                 |                             |        |
|                   | 3.2 V6 4motion  |             |       | 07.04                           | + Bremskraftregler <sup>1)</sup> |                |        |                 |                             |        |
|                   | 1.9 TDI         | 62          |       | 01.06                           | PR: OWR                          | 24.5140-0241.3 | 330948 |                 | am Bremsattel <sup>2)</sup> | L=240  |
|                   | 1.9 TDI         | 63          |       | 04.03                           | PR: OWR                          | 24.5140-0240.3 | 330947 |                 | am Bremsattel <sup>2)</sup> | L=240  |
|                   | 1.9 TDI         | 75          |       | 06.06                           | PR: OWR                          | 24.5237-0250.3 | 330880 | 2               |                             | L=250  |
|                   | 1.9 TDI         | 77          |       | 04.03                           | PR: OWR                          |                |        |                 |                             |        |
| 2.0               |                 |             | 06.03 | PR: OWR                         |                                  |                |        |                 |                             |        |
| 2.0 BiTDI         | 132             |             | 09.09 | PR: OWR                         |                                  |                |        |                 |                             |        |
| 2.0 BiTDI 4motion | 132             |             | 09.09 | PR: OWR                         |                                  |                |        |                 |                             |        |
| 2.0 TDI           | 62              |             | 09.09 | PR: OWR                         |                                  |                |        |                 |                             |        |
| 2.0 TDI           | 75              |             | 09.09 | PR: OWR                         |                                  |                |        |                 |                             |        |
| 2.0 TDI           | 100             |             | 05.10 | PR: OWR                         |                                  |                |        |                 |                             |        |
| 2.0 TDI           | 103             |             | 09.09 | PR: OWR                         |                                  |                |        |                 |                             |        |
| 2.0 TDI 4motion   | 100             |             | 05.10 | PR: OWR                         |                                  |                |        |                 |                             |        |
| 2.0 TDI 4motion   | 103             |             | 09.09 | PR: OWR                         |                                  |                |        |                 |                             |        |
| 2.5 TDI           | 96              |             | 02.03 | PR: OWR                         |                                  |                |        |                 |                             |        |
| 2.5 TDI 4motion   | 96              |             | 07.04 | PR: OWR                         |                                  |                |        |                 |                             |        |
| 2.5 TDI 4motion   | 128             |             | 07.04 | PR: OWR                         |                                  |                |        |                 |                             |        |
| 3.2 V6            |                 |             | 02.03 | PR: OWR                         |                                  |                |        |                 |                             |        |
| 3.2 V6 4motion    |                 |             | 07.04 | PR: OWR                         |                                  |                |        |                 |                             |        |
|                   | 1.9 TDI         | 62          |       | 01.06                           | PR: OE1,OE2,OWL,OWN,OWM,OWP,OWQ  | 24.3727-0184.2 | 580184 | 2               |                             | L=1303 |
|                   | 1.9 TDI         | 63          |       | 04.03                           | PR: OE1,OE2,OWL,OWN,OWM,OWP,OWQ  |                |        |                 |                             |        |
|                   | 1.9 TDI         | 75          |       | 06.06                           | PR: OE1,OE2,OWL,OWN,OWM,OWP,OWQ  |                |        |                 |                             |        |
|                   | 1.9 TDI         | 77          |       | 04.03                           | PR: OE1,OE2,OWL,OWN,OWM,OWP,OWQ  |                |        |                 |                             |        |
|                   | 2.0             |             |       | 06.03                           | PR: OE1,OE2,OWL,OWN,OWM,OWP,OWQ  |                |        |                 |                             |        |
|                   | 2.0 BiTDI       | 132         |       | 09.09                           | PR: OE1,OE2,OWL,OWN,OWM,OWP,OWQ  |                |        |                 |                             |        |
|                   | 2.0 TDI         | 62          |       | 09.09                           | PR: OE1,OE2,OWL,OWN,OWM,OWP,OWQ  |                |        |                 |                             |        |
|                   | 2.0 TDI         | 75          |       | 09.09                           | PR: OE1,OE2,OWL,OWN,OWM,OWP,OWQ  |                |        |                 |                             |        |
|                   | 2.0 TDI         | 100         |       | 05.10                           | PR: OE1,OE2,OWL,OWN,OWM,OWP,OWQ  |                |        |                 |                             |        |
|                   | 2.0 TDI         | 103         |       | 09.09                           | PR: OE1,OE2,OWL,OWN,OWM,OWP,OWQ  |                |        |                 |                             |        |
| 2.5 TDI           | 96              |             | 02.03 | PR: OE1,OE2,OWL,OWN,OWM,OWP,OWQ |                                  |                |        |                 |                             |        |
| 2.5 TDI           | 96              |             | 02.03 | PR: OE1,OE2,OWL,OWN,OWM,OWP,OWQ |                                  |                |        |                 |                             |        |
| 3.2 V6            |                 |             | 02.03 | PR: OE1,OE2,OWL,OWN,OWM,OWP,OWQ |                                  |                |        |                 |                             |        |
| 3.2 V6 4motion    |                 |             | 07.04 | PR: OE1,OE2,OWL,OWN,OWM,OWP,OWQ |                                  |                |        |                 |                             |        |
| 2.0 BiTDI 4motion | 132             | 7H-A-200001 |       |                                 | 24.3727-0184.2                   | 580184         | 2      | PR: G0C,G0K,G1C | L=1303                      |        |
| 2.0 TDI           | 84              |             | 05.11 |                                 |                                  |                |        |                 |                             |        |
| 2.0 TDI 4motion   | 100             | 7H-A-200001 |       |                                 |                                  |                |        |                 |                             |        |
| 2.0 TDI 4motion   | 103             | 7H-A-200001 |       |                                 |                                  |                |        |                 |                             |        |
| 2.0 TSI           |                 |             | 05.11 |                                 |                                  |                |        |                 |                             |        |
| 2.0 TSI 4motion   | 150             |             | 07.11 |                                 |                                  |                |        |                 |                             |        |
| 2.5 TDI 4motion   | 96              | 7H-A-200001 |       |                                 |                                  |                |        |                 |                             |        |
| 2.5 TDI 4motion   | 128             | 7H-A-200001 |       |                                 |                                  |                |        |                 |                             |        |
| 3.2 V6 4motion    |                 | 7H-A-200001 |       |                                 |                                  |                |        |                 |                             |        |

**VOLKSWAGEN TRANSPORTER (T5) PRITSCH / FAHRGESTELL (03-)**

|  |                   |     |             |       |                     |                |        |  |  |              |     |
|--|-------------------|-----|-------------|-------|---------------------|----------------|--------|--|--|--------------|-----|
|  | 1.9 TDI           | 62  | 7J-A-010000 | 01.06 | PR: 1AJ,1AE,1AC,1AR | 03.7765-1002.4 | 300246 |  |  | 10/9" Tandem | ATE |
|  | 1.9 TDI           | 63  | 7J-A-010000 | 04.03 | PR: 1AJ,1AE,1AC,1AR |                |        |  |  |              |     |
|  | 1.9 TDI           | 75  | 7J-A-010000 | 06.06 | PR: 1AJ,1AE,1AC,1AR |                |        |  |  |              |     |
|  | 1.9 TDI           | 77  | 7J-A-010000 | 04.03 | PR: 1AJ,1AE,1AC,1AR |                |        |  |  |              |     |
|  | 2.0               | 85  | 7J-A-010000 | 06.03 | PR: 1AJ,1AE,1AC,1AR |                |        |  |  |              |     |
|  | 2.0 BiTDI         | 132 | 7J-A-010000 | 09.09 | PR: 1AJ,1AE,1AC,1AR |                |        |  |  |              |     |
|  | 2.0 BiTDI 4motion | 132 | 7J-A-010000 | 09.09 | PR: 1AJ,1AE,1AC,1AR |                |        |  |  |              |     |
|  | 2.0 TDI           | 62  | 7J-A-010000 | 09.09 | PR: 1AJ,1AE,1AC,1AR |                |        |  |  |              |     |
|  | 2.0 TDI           | 75  | 7J-A-010000 | 09.09 | PR: 1AJ,1AE,1AC,1AR |                |        |  |  |              |     |
|  | 2.0 TDI           | 103 | 7J-A-010000 | 09.09 | PR: 1AJ,1AE,1AC,1AR |                |        |  |  |              |     |
|  | 2.0 TDI 4motion   | 103 | 7J-A-010000 | 09.09 | PR: 1AJ,1AE,1AC,1AR |                |        |  |  |              |     |
|  | 2.5 TDI           | 96  | 7J-A-010000 | 02.03 | PR: 1AJ,1AE,1AC,1AR |                |        |  |  |              |     |
|  | 2.5 TDI           | 128 | 7J-A-010000 | 02.03 | PR: 1AJ,1AE,1AC,1AR |                |        |  |  |              |     |
|  | 2.5 TDI 4motion   | 96  | 7J-A-010000 | 07.04 | PR: 1AJ,1AE,1AC,1AR |                |        |  |  |              |     |
|  | 2.5 TDI 4motion   | 128 | 7J-A-010000 | 07.04 | PR: 1AJ,1AE,1AC,1AR |                |        |  |  |              |     |
|  | 3.2 V6            | 170 | 7J-A-010000 | 02.04 | PR: 1AJ,1AE,1AC,1AR |                |        |  |  |              |     |
|  | 3.2 V6            | 173 | 7J-A-010000 | 08.03 | PR: 1AJ,1AE,1AC,1AR |                |        |  |  |              |     |
|  | 1.9 TDI           | 62  | 7J-A-010000 | 01.06 | PR: 1AK             | 03.7868-3702.4 | 300208 |  |  | 10/8" Tandem | ATE |
|  | 1.9 TDI           | 63  | 7J-A-010000 | 04.03 | PR: 1AK             |                |        |  |  |              |     |
|  | 1.9 TDI           | 75  | 7J-A-010000 | 06.06 | PR: 1AK             |                |        |  |  |              |     |
|  | 1.9 TDI           | 77  | 7J-A-010000 | 04.03 | PR: 1AK             |                |        |  |  |              |     |
|  | 2.0               | 85  | 7J-A-010000 | 06.03 | PR: 1AK             |                |        |  |  |              |     |
|  | 2.0 BiTDI         | 132 | 7J-A-010000 | 09.09 | PR: 1AK             |                |        |  |  |              |     |
|  | 2.0 BiTDI 4motion | 132 | 7J-A-010000 | 09.09 | PR: 1AK             |                |        |  |  |              |     |
|  | 2.0 TDI           | 62  | 7J-A-010000 | 09.09 | PR: 1AK             |                |        |  |  |              |     |
|  | 2.0 TDI           | 75  | 7J-A-010000 | 09.09 | PR: 1AK             |                |        |  |  |              |     |
|  | 2.0 TDI           | 103 | 7J-A-010000 | 09.09 | PR: 1AK             |                |        |  |  |              |     |
|  | 2.0 TDI 4motion   | 103 | 7J-A-010000 | 09.09 | PR: 1AK             |                |        |  |  |              |     |
|  | 2.5 TDI           | 96  | 7J-A-010000 | 02.03 | PR: 1AK             |                |        |  |  |              |     |
|  | 2.5 TDI           | 128 | 7J-A-010000 | 02.03 | PR: 1AK             |                |        |  |  |              |     |
|  | 2.5 TDI 4motion   | 96  | 7J-A-010000 | 07.04 | PR: 1AK             |                |        |  |  |              |     |
|  | 2.5 TDI 4motion   | 128 | 7J-A-010000 | 07.04 | PR: 1AK             |                |        |  |  |              |     |
|  | 3.2 V6            | 170 | 7J-A-010000 | 02.04 | PR: 1AK             |                |        |  |  |              |     |
|  | 3.2 V6            | 173 | 7J-A-010000 | 08.03 | PR: 1AK             |                |        |  |  |              |     |

<sup>1)</sup> + brake pressure regulator / + correttore di frenata / + correcteur de freinage / + corrector de frenado  
<sup>2)</sup> on the brake caliper / sulla pinza freno / sur l'étrier de frein / a la pinza de freno



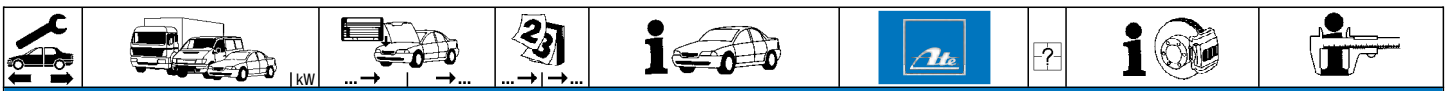

**VOLKSWAGEN TRANSPORTER (T5) PRITSCH / FAHRGESTELL (03-)**

|  |                   |     |             |       |                         |                |        |   |  |                |     |
|--|-------------------|-----|-------------|-------|-------------------------|----------------|--------|---|--|----------------|-----|
|  | 1.9 TDI           | 62  | 7J-A-010000 | 01.06 |                         | 03.2126-3014.3 | 010811 |   |  | Thz 26,99      | ATE |
|  | 1.9 TDI           | 63  | 7J-A-010000 | 04.03 |                         |                |        |   |  |                |     |
|  | 1.9 TDI           | 75  | 7J-A-010000 | 06.06 |                         |                |        |   |  |                |     |
|  | 1.9 TDI           | 77  | 7J-A-010000 | 04.03 |                         |                |        |   |  |                |     |
|  | 2.0               | 85  | 7J-A-010000 | 06.03 |                         |                |        |   |  |                |     |
|  | 2.0 BiTDI         | 132 | 7J-A-010000 | 09.09 |                         |                |        |   |  |                |     |
|  | 2.0 BiTDI 4motion | 132 | 7J-A-010000 | 09.09 |                         |                |        |   |  |                |     |
|  | 2.0 TDI           | 62  | 7J-A-010000 | 09.09 |                         |                |        |   |  |                |     |
|  | 2.0 TDI           | 75  | 7J-A-010000 | 09.09 |                         |                |        |   |  |                |     |
|  | 2.0 TDI           | 103 | 7J-A-010000 | 09.09 |                         |                |        |   |  |                |     |
|  | 2.0 TDI 4motion   | 103 | 7J-A-010000 | 09.09 |                         |                |        |   |  |                |     |
|  | 2.5 TDI           | 96  | 7J-A-010000 | 02.03 |                         |                |        |   |  |                |     |
|  | 2.5 TDI           | 128 | 7J-A-010000 | 02.03 |                         |                |        |   |  |                |     |
|  | 2.5 TDI 4motion   | 96  | 7J-A-010000 | 07.04 |                         |                |        |   |  |                |     |
|  | 2.5 TDI 4motion   | 128 | 7J-A-010000 | 07.04 |                         |                |        |   |  |                |     |
|  | 3.2 V6            | 170 | 7J-A-010000 | 02.04 |                         |                |        |   |  |                |     |
|  | 3.2 V6            | 173 | 7J-A-010000 | 08.03 |                         |                |        |   |  |                |     |
|  | 1.9 TDI           | 62  |             | 01.06 | PR: 2E3                 | 11.9601-8502.2 | 220594 |   |  | D=60, - Halter | ATE |
|  | 1.9 TDI           | 63  |             | 04.03 | PR: 2E3                 | 11.9601-9947.2 | 220903 |   |  | D=60, - Halter | ATE |
|  | 1.9 TDI           | 75  |             | 06.06 | PR: 2E3                 | 11.0441-6008.2 | 250038 |   |  | Dichtungssatz  | ATE |
|  | 1.9 TDI           | 77  |             | 04.03 | PR: 2E3                 | 11.0101-5706.2 | 260097 |   |  | Hülsensatz     | ATE |
|  | 2.0               | 85  |             | 06.03 | PR: 2E3                 | 11.8171-0067.1 | 250153 |   |  | Führungsbolzen | ATE |
|  | 2.0 BiTDI         | 132 |             | 09.09 | PR: 2E3                 | 11.8116-0237.1 | 390509 | 2 |  | Haltefeder     | ATE |
|  | 2.0 BiTDI 4motion | 132 |             | 09.09 | PR: 2E3                 |                |        |   |  |                |     |
|  | 2.0 TDI           | 62  |             | 09.09 | PR: 2E3                 |                |        |   |  |                |     |
|  | 2.0 TDI           | 75  |             | 09.09 | PR: 2E3                 |                |        |   |  |                |     |
|  | 2.0 TDI           | 84  |             | 05.11 | PR: 2E3                 |                |        |   |  |                |     |
|  | 2.0 TDI           | 100 |             | 05.10 | PR: 2E3                 |                |        |   |  |                |     |
|  | 2.0 TDI           | 103 |             | 09.09 | PR: 2E3                 |                |        |   |  |                |     |
|  | 2.0 TDI 4motion   | 100 |             | 05.10 | PR: 2E3                 |                |        |   |  |                |     |
|  | 2.0 TDI 4motion   | 103 |             | 09.09 | PR: 2E3                 |                |        |   |  |                |     |
|  | 2.0 TSI           | 110 |             | 07.12 | PR: 2E3                 |                |        |   |  |                |     |
|  | 2.5 TDI           | 96  |             | 02.03 | PR: 2E3                 |                |        |   |  |                |     |
|  | 2.5 TDI           | 128 |             | 02.03 | PR: 2E3                 |                |        |   |  |                |     |
|  | 2.5 TDI 4motion   | 96  |             | 07.04 | PR: 2E3                 |                |        |   |  |                |     |
|  | 2.5 TDI 4motion   | 128 |             | 07.04 | PR: 2E3                 |                |        |   |  |                |     |
|  | 3.2 V6            | 170 |             | 02.04 | PR: 2E3                 |                |        |   |  |                |     |
|  | 3.2 V6            | 173 |             | 08.03 | PR: 2E3                 |                |        |   |  |                |     |
|  | 1.9 TDI           | 62  | 7J-A-010000 | 01.06 | PR: 2E4                 | 11.9601-9721.2 | 220875 |   |  | D=60, - Halter | ATE |
|  | 1.9 TDI           | 63  | 7J-A-010000 | 04.03 | PR: 2E4                 | 11.9601-9722.2 | 220876 |   |  | D=60, - Halter | ATE |
|  | 1.9 TDI           | 75  | 7J-A-010000 | 06.06 | PR: 2E4                 | 11.8170-0955.1 | 260109 |   |  | Halter         | ATE |
|  | 1.9 TDI           | 77  | 7J-A-010000 | 04.03 | PR: 2E4                 | 11.0441-6008.2 | 250038 |   |  | Dichtungssatz  | ATE |
|  | 2.0               | 85  | 7J-A-010000 | 06.03 | PR: 2E4                 | 11.0101-5706.2 | 260097 |   |  | Hülsensatz     | ATE |
|  | 2.0 BiTDI         | 132 | 7J-A-010000 | 09.09 | PR: 2E4                 | 11.8171-0067.1 | 250153 |   |  | Führungsbolzen | ATE |
|  | 2.0 BiTDI 4motion | 132 | 7J-A-010000 | 09.09 | PR: 2E4                 | 11.8116-0237.1 | 390509 | 2 |  | Haltefeder     | ATE |
|  | 2.0 TDI           | 62  | 7J-A-010000 | 09.09 | PR: 2E4                 | 11.8116-0367.1 | 390600 | 2 |  | Haltefeder     | ATE |
|  | 2.0 TDI           | 75  | 7J-A-010000 | 09.09 | PR: 2E4                 |                |        |   |  |                |     |
|  | 2.0 TDI           | 103 | 7J-A-010000 | 09.09 | PR: 2E4                 |                |        |   |  |                |     |
|  | 2.0 TDI 4motion   | 103 | 7J-A-010000 | 09.09 | PR: 2E4                 |                |        |   |  |                |     |
|  | 2.5 TDI           | 96  | 7J-A-010000 | 02.03 | PR: 2E4                 |                |        |   |  |                |     |
|  | 2.5 TDI           | 128 | 7J-A-010000 | 02.03 | PR: 2E4                 |                |        |   |  |                |     |
|  | 2.5 TDI 4motion   | 96  | 7J-A-010000 | 07.04 | PR: 2E4                 |                |        |   |  |                |     |
|  | 2.5 TDI 4motion   | 128 | 7J-A-010000 | 07.04 | PR: 2E4                 |                |        |   |  |                |     |
|  | 3.2 V6            | 170 | 7J-A-010000 | 02.04 | PR: 2E4                 |                |        |   |  |                |     |
|  | 3.2 V6            | 173 | 7J-A-010000 | 08.03 | PR: 2E4                 |                |        |   |  |                |     |
|  | 1.9 TDI           | 62  | 7J-A-200001 |       | PR: 2E4                 | 11.9441-9933.2 | 220911 |   |  | D=44, - Halter | ATE |
|  | 1.9 TDI           | 63  | 7J-A-200001 |       | PR: 2E4                 | 11.9441-9934.2 | 220912 |   |  | D=44, - Halter | ATE |
|  | 1.9 TDI           | 75  | 7J-A-200001 |       | PR: 2E4                 | 11.8116-0126.2 | 390608 | 2 |  | Haltefeder     |     |
|  | 1.9 TDI           | 77  | 7J-A-200001 |       | PR: 2E4                 |                |        |   |  |                |     |
|  | 2.0               | 85  | 7J-A-200001 |       | PR: 2E4                 |                |        |   |  |                |     |
|  | 2.0 BiTDI         | 132 | 7J-A-200001 |       | PR: 2E4                 |                |        |   |  |                |     |
|  | 2.0 BiTDI 4motion | 132 | 7J-A-200001 |       | PR: 2E4                 |                |        |   |  |                |     |
|  | 2.0 TDI           | 62  | 7J-A-200001 |       | PR: 2E4                 |                |        |   |  |                |     |
|  | 2.0 TDI           | 75  | 7J-A-200001 |       | PR: 2E4                 |                |        |   |  |                |     |
|  | 2.0 TDI           | 84  |             | 05.11 | PR: 2E4                 |                |        |   |  |                |     |
|  | 2.0 TDI           | 100 |             | 05.10 | PR: 2E4                 |                |        |   |  |                |     |
|  | 2.0 TDI           | 103 | 7J-A-200001 |       | PR: 2E4                 |                |        |   |  |                |     |
|  | 2.0 TDI 4motion   | 100 |             | 05.10 | PR: 2E4                 |                |        |   |  |                |     |
|  | 2.0 TDI 4motion   | 103 | 7J-A-200001 |       | PR: 2E4                 |                |        |   |  |                |     |
|  | 2.0 TSI           | 110 |             | 07.12 | PR: 2E4                 |                |        |   |  |                |     |
|  | 2.5 TDI           | 96  | 7J-A-200001 |       | PR: 2E4                 |                |        |   |  |                |     |
|  | 2.5 TDI           | 128 | 7J-A-200001 |       | PR: 2E4                 |                |        |   |  |                |     |
|  | 2.5 TDI 4motion   | 96  | 7J-A-200001 |       | PR: 2E4                 |                |        |   |  |                |     |
|  | 2.5 TDI 4motion   | 128 | 7J-A-200001 |       | PR: 2E4                 |                |        |   |  |                |     |
|  | 3.2 V6            | 170 | 7J-A-200001 |       | PR: 2E4                 |                |        |   |  |                |     |
|  | 3.2 V6            | 173 | 7J-A-200001 |       | PR: 2E4                 |                |        |   |  |                |     |
|  | 1.9 TDI           | 62  |             | 01.06 | PR: OWL,OWN,OWM,OWP,OWQ | 83.6113-0510.3 | 330863 | 2 |  | L=510          |     |
|  | 1.9 TDI           | 63  |             | 04.03 | PR: OWL,OWN,OWM,OWP,OWQ |                |        |   |  |                |     |
|  | 1.9 TDI           | 75  |             | 06.06 | PR: OWL,OWN,OWM,OWP,OWQ |                |        |   |  |                |     |
|  | 1.9 TDI           | 77  |             | 04.03 | PR: OWL,OWN,OWM,OWP,OWQ |                |        |   |  |                |     |
|  | 2.0               | 85  |             | 06.03 | PR: OWL,OWN,OWM,OWP,OWQ |                |        |   |  |                |     |
|  | 2.0 BiTDI         | 132 |             | 09.09 | PR: OWL,OWN,OWM,OWP,OWQ |                |        |   |  |                |     |
|  | 2.0 BiTDI 4motion | 132 |             | 09.09 | PR: OWL,OWN,OWM,OWP,OWQ |                |        |   |  |                |     |
|  | 2.0 TDI           | 62  |             | 09.09 | PR: OWL,OWN,OWM,OWP,OWQ |                |        |   |  |                |     |
|  | 2.0 TDI           | 75  |             | 09.09 | PR: OWL,OWN,OWM,OWP,OWQ |                |        |   |  |                |     |
|  | 2.0 TDI           | 84  |             | 05.11 | PR: OWL,OWN,OWM,OWP,OWQ |                |        |   |  |                |     |
|  | 2.0 TDI           | 100 |             | 05.10 | PR: OWL,OWN,OWM,OWP,OWQ |                |        |   |  |                |     |



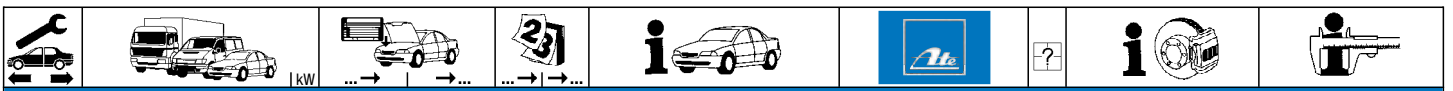

**VOLKSWAGEN TRANSPORTER (T5) PRITSCH / FAHRGESTELL (03-)**

|                   |                   |             |             |                                 |                         |                |        |   |                |                |     |
|-------------------|-------------------|-------------|-------------|---------------------------------|-------------------------|----------------|--------|---|----------------|----------------|-----|
|                   | 2.0 TDI           | 103         |             | 09.09                           | PR: OWL,OWN,OWM,OWP,OWQ | 83.6113-0510.3 | 330863 | 2 |                | L=510          |     |
|                   | 2.0 TDI 4motion   | 100         |             | 05.10                           | PR: OWL,OWN,OWM,OWP,OWQ |                |        |   |                |                |     |
|                   | 2.0 TDI 4motion   | 103         |             | 09.09                           | PR: OWL,OWN,OWM,OWP,OWQ |                |        |   |                |                |     |
|                   | 2.0 TSI           | 110         |             | 07.12                           | PR: OWL,OWN,OWM,OWP,OWQ |                |        |   |                |                |     |
|                   | 2.5 TDI           | 96          |             | 02.03                           | PR: OWL,OWN,OWM,OWP,OWQ |                |        |   |                |                |     |
|                   | 2.5 TDI           | 128         |             | 02.03                           | PR: OWL,OWN,OWM,OWP,OWQ |                |        |   |                |                |     |
|                   | 2.5 TDI 4motion   | 96          |             | 07.04                           | PR: OWL,OWN,OWM,OWP,OWQ |                |        |   |                |                |     |
|                   | 2.5 TDI 4motion   | 128         |             | 07.04                           | PR: OWL,OWN,OWM,OWP,OWQ |                |        |   |                |                |     |
|                   | 3.2 V6            | 170         |             | 02.04                           | PR: OWL,OWN,OWM,OWP,OWQ |                |        |   |                |                |     |
|                   | 3.2 V6            | 173         |             | 08.03                           | PR: OWL,OWN,OWM,OWP,OWQ |                |        |   |                |                |     |
|                   | 1.9 TDI           | 62          |             | 01.06                           | PR: OWR                 | 83.6113-0552.3 | 330864 | 2 |                | L=552          |     |
|                   | 1.9 TDI           | 63          |             | 04.03                           | PR: OWR                 |                |        |   |                |                |     |
|                   | 1.9 TDI           | 75          |             | 06.06                           | PR: OWR                 |                |        |   |                |                |     |
|                   | 1.9 TDI           | 77          |             | 04.03                           | PR: OWR                 |                |        |   |                |                |     |
|                   | 2.0               | 85          |             | 06.03                           | PR: OWR                 |                |        |   |                |                |     |
|                   | 2.0 BiTDI         | 132         |             | 09.09                           | PR: OWR                 |                |        |   |                |                |     |
| 2.0 BiTDI 4motion | 132               |             | 09.09       | PR: OWR                         |                         |                |        |   |                |                |     |
| 2.0 TDI           | 62                |             | 09.09       | PR: OWR                         |                         |                |        |   |                |                |     |
| 2.0 TDI           | 75                |             | 09.09       | PR: OWR                         |                         |                |        |   |                |                |     |
| 2.0 TDI           | 84                |             | 05.11       | PR: OWR                         |                         |                |        |   |                |                |     |
| 2.0 TDI           | 100               |             | 05.10       | PR: OWR                         |                         |                |        |   |                |                |     |
| 2.0 TDI           | 103               |             | 09.09       | PR: OWR                         |                         |                |        |   |                |                |     |
| 2.0 TDI 4motion   | 100               |             | 05.10       | PR: OWR                         |                         |                |        |   |                |                |     |
| 2.0 TDI 4motion   | 103               |             | 09.09       | PR: OWR                         |                         |                |        |   |                |                |     |
| 2.0 TSI           | 110               |             | 07.12       | PR: OWR                         |                         |                |        |   |                |                |     |
| 2.5 TDI           | 96                |             | 02.03       | PR: OWR                         |                         |                |        |   |                |                |     |
| 2.5 TDI           | 128               |             | 02.03       | PR: OWR                         |                         |                |        |   |                |                |     |
| 2.5 TDI 4motion   | 96                |             | 07.04       | PR: OWR                         |                         |                |        |   |                |                |     |
| 2.5 TDI 4motion   | 128               |             | 07.04       | PR: OWR                         |                         |                |        |   |                |                |     |
| 3.2 V6            | 170               |             | 02.04       | PR: OWR                         |                         |                |        |   |                |                |     |
| 3.2 V6            | 173               |             | 08.03       | PR: OWR                         |                         |                |        |   |                |                |     |
| 1.9 TDI           | 62                |             | 01.06       | PR: 1BH,1BX,1MR,2MQ,2MZ,2MU,2MT | 83.6113-0552.3          | 330864         | 2      |   | L=552          |                |     |
| 1.9 TDI           | 63                |             | 04.03       | PR: 1BH,1BX,1MR,2MQ,2MZ,2MU,2MT |                         |                |        |   |                |                |     |
| 1.9 TDI           | 75                |             | 06.06       | PR: 1BH,1BX,1MR,2MQ,2MZ,2MU,2MT |                         |                |        |   |                |                |     |
| 1.9 TDI           | 77                |             | 04.03       | PR: 1BH,1BX,1MR,2MQ,2MZ,2MU,2MT |                         |                |        |   |                |                |     |
| 2.0               | 85                |             | 06.03       | PR: 1BH,1BX,1MR,2MQ,2MZ,2MU,2MT |                         |                |        |   |                |                |     |
| 2.0 BiTDI         | 132               |             | 09.09       | PR: 1BH,1BX,1MR,2MQ,2MZ,2MU,2MT |                         |                |        |   |                |                |     |
| 2.0 BiTDI 4motion | 132               |             | 09.09       | PR: 1BH,1BX,1MR,2MQ,2MZ,2MU,2MT |                         |                |        |   |                |                |     |
| 2.0 TDI           | 62                |             | 09.09       | PR: 1BH,1BX,1MR,2MQ,2MZ,2MU,2MT |                         |                |        |   |                |                |     |
| 2.0 TDI           | 75                |             | 09.09       | PR: 1BH,1BX,1MR,2MQ,2MZ,2MU,2MT |                         |                |        |   |                |                |     |
| 2.0 TDI           | 84                |             | 05.11       | PR: 1BH,1BX,1MR,2MQ,2MZ,2MU,2MT |                         |                |        |   |                |                |     |
| 2.0 TDI           | 100               |             | 05.10       | PR: 1BH,1BX,1MR,2MQ,2MZ,2MU,2MT |                         |                |        |   |                |                |     |
| 2.0 TDI           | 103               |             | 09.09       | PR: 1BH,1BX,1MR,2MQ,2MZ,2MU,2MT |                         |                |        |   |                |                |     |
| 2.0 TDI 4motion   | 100               |             | 05.10       | PR: 1BH,1BX,1MR,2MQ,2MZ,2MU,2MT |                         |                |        |   |                |                |     |
| 2.0 TDI 4motion   | 103               |             | 09.09       | PR: 1BH,1BX,1MR,2MQ,2MZ,2MU,2MT |                         |                |        |   |                |                |     |
| 2.0 TSI           | 110               |             | 07.12       | PR: 1BH,1BX,1MR,2MQ,2MZ,2MU,2MT |                         |                |        |   |                |                |     |
| 2.5 TDI           | 96                |             | 02.03       | PR: 1BH,1BX,1MR,2MQ,2MZ,2MU,2MT |                         |                |        |   |                |                |     |
| 2.5 TDI           | 128               |             | 02.03       | PR: 1BH,1BX,1MR,2MQ,2MZ,2MU,2MT |                         |                |        |   |                |                |     |
| 2.5 TDI 4motion   | 96                |             | 07.04       | PR: 1BH,1BX,1MR,2MQ,2MZ,2MU,2MT |                         |                |        |   |                |                |     |
| 2.5 TDI 4motion   | 128               |             | 07.04       | PR: 1BH,1BX,1MR,2MQ,2MZ,2MU,2MT |                         |                |        |   |                |                |     |
| 3.2 V6            | 170               |             | 02.04       | PR: 1BH,1BX,1MR,2MQ,2MZ,2MU,2MT |                         |                |        |   |                |                |     |
| 3.2 V6            | 173               |             | 08.03       | PR: 1BH,1BX,1MR,2MQ,2MZ,2MU,2MT |                         |                |        |   |                |                |     |
|                   | 1.9 TDI           | 62          | 7J-A-010000 | 01.06                           | PR: 2E3,2E4             | 24.3414-1711.7 | 220677 |   |                | D=41, - Halter | LUC |
|                   | 1.9 TDI           | 63          | 7J-A-010000 | 04.03                           | PR: 2E3,2E4             | 24.3414-1712.7 | 220678 |   |                | D=41, - Halter | LUC |
|                   | 1.9 TDI           | 75          | 7J-A-010000 | 06.06                           | PR: 2E3,2E4             |                |        |   |                |                |     |
|                   | 1.9 TDI           | 77          | 7J-A-010000 | 04.03                           | PR: 2E3,2E4             |                |        |   |                |                |     |
|                   | 2.0               | 85          | 7J-A-010000 | 06.03                           | PR: 2E3,2E4             |                |        |   |                |                |     |
|                   | 2.0 BiTDI         | 132         | 7J-A-010000 | 09.09                           | PR: 2E3,2E4             |                |        |   |                |                |     |
|                   | 2.0 BiTDI 4motion | 132         | 7J-A-010000 | 09.09                           | PR: 2E3,2E4             |                |        |   |                |                |     |
|                   | 2.0 TDI           | 62          | 7J-A-010000 | 09.09                           | PR: 2E3,2E4             |                |        |   |                |                |     |
|                   | 2.0 TDI           | 75          | 7J-A-010000 | 09.09                           | PR: 2E3,2E4             |                |        |   |                |                |     |
|                   | 2.0 TDI           | 103         | 7J-A-010000 | 09.09                           | PR: 2E3,2E4             |                |        |   |                |                |     |
|                   | 2.0 TDI 4motion   | 103         | 7J-A-010000 | 09.09                           | PR: 2E3,2E4             |                |        |   |                |                |     |
|                   | 2.5 TDI           | 96          | 7J-A-010000 | 02.03                           | PR: 2E3,2E4             |                |        |   |                |                |     |
|                   | 2.5 TDI           | 128         | 7J-A-010000 | 02.03                           | PR: 2E3,2E4             |                |        |   |                |                |     |
|                   | 2.5 TDI 4motion   | 96          | 7J-A-010000 | 07.04                           | PR: 2E3,2E4             |                |        |   |                |                |     |
|                   | 2.5 TDI 4motion   | 128         | 7J-A-010000 | 07.04                           | PR: 2E3,2E4             |                |        |   |                |                |     |
|                   | 3.2 V6            | 170         | 7J-A-010000 | 02.04                           | PR: 2E3,2E4             |                |        |   |                |                |     |
| 3.2 V6            | 173               | 7J-A-010000 | 08.03       | PR: 2E3,2E4                     |                         |                |        |   |                |                |     |
| 1.9 TDI           | 62                | 7J-8-000788 | 01.06       | PR: OWR,OE0,OE9                 | 11.9441-9949.2          | 220803         |        |   | D=44, - Halter | ATE            |     |
| 1.9 TDI           | 63                | 7J-8-000788 | 04.03       | PR: OWR,OE0,OE9                 | 11.9441-9950.2          | 220804         |        |   | D=44, - Halter | ATE            |     |
| 1.9 TDI           | 75                | 7J-8-000788 | 06.06       | PR: OWR,OE0,OE9                 | 11.0101-5409.2          | 260035         |        |   | Hülsensatz     | ATE            |     |
| 1.9 TDI           | 77                | 7J-8-000788 | 04.03       | PR: OWR,OE0,OE9                 | 11.8171-0008.1          | 990049         |        |   | Führungsbolzen | ATE            |     |
| 2.0               | 85                | 7J-8-000788 | 06.03       | PR: OWR,OE0,OE9                 |                         |                |        |   |                |                |     |
| 2.5 TDI           | 96                | 7J-8-000788 | 02.03       | PR: OWR,OE0,OE9                 |                         |                |        |   |                |                |     |
| 2.5 TDI           | 128               | 7J-8-000788 | 02.03       | PR: OWR,OE0,OE9                 |                         |                |        |   |                |                |     |
| 2.5 TDI 4motion   | 96                | 7J-8-000788 | 07.04       | PR: OWR,OE0,OE9                 |                         |                |        |   |                |                |     |
| 2.5 TDI 4motion   | 128               | 7J-8-000788 | 07.04       | PR: OWR,OE0,OE9                 |                         |                |        |   |                |                |     |
| 3.2 V6            | 170               | 7J-8-000788 | 02.04       | PR: OWR,OE0,OE9                 |                         |                |        |   |                |                |     |
| 3.2 V6            | 173               | 7J-8-000788 | 08.03       | PR: OWR,OE0,OE9                 |                         |                |        |   |                |                |     |
| 1.9 TDI           | 62                | 7J-8-000789 | 7J-8-030000 |                                 | PR: OWR,OE0,OE9         | 24.3414-1711.7 | 220677 |   |                | D=41, - Halter | LUC |
| 1.9 TDI           | 63                | 7J-8-000789 | 7J-8-030000 |                                 | PR: OWR,OE0,OE9         | 24.3414-1712.7 | 220678 |   |                | D=41, - Halter | LUC |
| 1.9 TDI           | 75                | 7J-8-000789 | 7J-8-030000 |                                 | PR: OWR,OE0,OE9         |                |        |   |                |                |     |
| 1.9 TDI           | 77                | 7J-8-000789 | 7J-8-030000 |                                 | PR: OWR,OE0,OE9         |                |        |   |                |                |     |
| 2.0               | 85                | 7J-8-000789 | 7J-8-030000 |                                 | PR: OWR,OE0,OE9         |                |        |   |                |                |     |
| 2.5 TDI           | 96                | 7J-8-000789 | 7J-8-030000 |                                 | PR: OWR,OE0,OE9         |                |        |   |                |                |     |
| 2.5 TDI           | 128               | 7J-8-000789 | 7J-8-030000 |                                 | PR: OWR,OE0,OE9         |                |        |   |                |                |     |





**VOLKSWAGEN TRANSPORTER (T5) PRITSCH / FAHRGESTELL (03-)**

|        |                   |                 |                                  |                                  |                |        |   |                |     |
|--------|-------------------|-----------------|----------------------------------|----------------------------------|----------------|--------|---|----------------|-----|
|        | 2.5 TDI 4motion   | 96 7J-8-000789  | 7J-8-030000                      | PR: OWR,OE0,OE9                  | 24.3414-1711.7 | 220677 |   | D=41, - Halter | LUC |
|        | 2.5 TDI 4motion   | 128 7J-8-000789 | 7J-8-030000                      | PR: OWR,OE0,OE9                  | 24.3414-1712.7 | 220678 |   | D=41, - Halter | LUC |
|        | 3.2 V6            | 170 7J-8-000789 | 7J-8-030000                      | PR: OWR,OE0,OE9                  |                |        |   |                |     |
|        | 3.2 V6            | 173 7J-8-000789 | 7J-8-030000                      | PR: OWR,OE0,OE9                  |                |        |   |                |     |
|        | 1.9 TDI           | 62 7J-A-200001  |                                  |                                  | 24.3414-1711.7 | 220677 |   | D=41, - Halter | LUC |
|        | 1.9 TDI           | 63 7J-A-200001  |                                  |                                  | 24.3414-1712.7 | 220678 |   | D=41, - Halter | LUC |
|        | 1.9 TDI           | 75 7J-A-200001  |                                  |                                  |                |        |   |                |     |
|        | 1.9 TDI           | 77 7J-A-200001  |                                  |                                  |                |        |   |                |     |
|        | 2.0               | 85 7J-A-200001  |                                  |                                  |                |        |   |                |     |
|        | 2.0 BiTDI         | 132 7J-A-200001 |                                  |                                  |                |        |   |                |     |
|        | 2.0 BiTDI 4motion | 132 7J-A-200001 |                                  |                                  |                |        |   |                |     |
|        | 2.0 TDI           | 62 7J-A-200001  |                                  |                                  |                |        |   |                |     |
|        | 2.0 TDI           | 75 7J-A-200001  |                                  |                                  |                |        |   |                |     |
|        | 2.0 TDI           | 84              |                                  | 05.11                            |                |        |   |                |     |
|        | 2.0 TDI           | 100             |                                  | 05.10                            |                |        |   |                |     |
|        | 2.0 TDI           | 103 7J-A-200001 |                                  |                                  |                |        |   |                |     |
|        | 2.0 TDI 4motion   | 100             |                                  | 05.10                            |                |        |   |                |     |
|        | 2.0 TDI 4motion   | 103 7J-A-200001 |                                  |                                  |                |        |   |                |     |
|        | 2.0 TSI           | 110             |                                  | 07.12                            |                |        |   |                |     |
|        | 2.5 TDI           | 96 7J-A-200001  |                                  |                                  |                |        |   |                |     |
|        | 2.5 TDI           | 128 7J-A-200001 |                                  |                                  |                |        |   |                |     |
|        | 2.5 TDI 4motion   | 96 7J-A-200001  |                                  |                                  |                |        |   |                |     |
|        | 2.5 TDI 4motion   | 128 7J-A-200001 |                                  |                                  |                |        |   |                |     |
|        | 3.2 V6            | 170 7J-A-200001 |                                  |                                  |                |        |   |                |     |
| 3.2 V6 | 173 7J-A-200001   |                 |                                  |                                  |                |        |   |                |     |
|        | 1.9 TDI           | 62              | 01.06                            | - Bremskraftregler <sup>1)</sup> | 24.5140-0241.3 | 330948 |   | L=240          |     |
|        | 1.9 TDI           | 63              | 04.03                            | - Bremskraftregler <sup>1)</sup> | 24.5140-0240.3 | 330947 |   | L=240          |     |
|        | 1.9 TDI           | 75              | 06.06                            | - Bremskraftregler <sup>1)</sup> | 24.5237-0250.3 | 330880 | 2 | L=250          |     |
|        | 1.9 TDI           | 77              | 04.03                            | - Bremskraftregler <sup>1)</sup> |                |        |   |                |     |
|        | 2.0               | 85              | 06.03                            | - Bremskraftregler <sup>1)</sup> |                |        |   |                |     |
|        | 2.0 BiTDI         | 132             | 09.09                            | - Bremskraftregler <sup>1)</sup> |                |        |   |                |     |
|        | 2.0 BiTDI 4motion | 132             | 09.09                            | - Bremskraftregler <sup>1)</sup> |                |        |   |                |     |
|        | 2.0 TDI           | 62              | 09.09                            | - Bremskraftregler <sup>1)</sup> |                |        |   |                |     |
|        | 2.0 TDI           | 75              | 09.09                            | - Bremskraftregler <sup>1)</sup> |                |        |   |                |     |
|        | 2.0 TDI           | 84              | 05.11                            | - Bremskraftregler <sup>1)</sup> |                |        |   |                |     |
|        | 2.0 TDI           | 100             | 05.10                            | - Bremskraftregler <sup>1)</sup> |                |        |   |                |     |
|        | 2.0 TDI           | 103             | 09.09                            | - Bremskraftregler <sup>1)</sup> |                |        |   |                |     |
|        | 2.0 TDI 4motion   | 100             | 05.10                            | - Bremskraftregler <sup>1)</sup> |                |        |   |                |     |
|        | 2.0 TDI 4motion   | 103             | 09.09                            | - Bremskraftregler <sup>1)</sup> |                |        |   |                |     |
|        | 2.0 TSI           | 110             | 07.12                            | - Bremskraftregler <sup>1)</sup> |                |        |   |                |     |
|        | 2.5 TDI           | 96              | 02.03                            | - Bremskraftregler <sup>1)</sup> |                |        |   |                |     |
|        | 2.5 TDI           | 128             | 02.03                            | - Bremskraftregler <sup>1)</sup> |                |        |   |                |     |
|        | 2.5 TDI 4motion   | 96              | 07.04                            | - Bremskraftregler <sup>1)</sup> |                |        |   |                |     |
|        | 2.5 TDI 4motion   | 128             | 07.04                            | - Bremskraftregler <sup>1)</sup> |                |        |   |                |     |
|        | 3.2 V6            | 170             | 02.04                            | - Bremskraftregler <sup>1)</sup> |                |        |   |                |     |
| 3.2 V6 | 173               | 08.03           | - Bremskraftregler <sup>1)</sup> |                                  |                |        |   |                |     |
|        | 1.9 TDI           | 62              | 01.06                            | + Bremskraftregler <sup>3)</sup> | 24.5137-0190.3 | 330878 | 2 | L=190          |     |
|        | 1.9 TDI           | 63              | 04.03                            | + Bremskraftregler <sup>3)</sup> | 24.5237-0250.3 | 330880 | 2 | L=250          |     |
|        | 1.9 TDI           | 75              | 06.06                            | + Bremskraftregler <sup>3)</sup> |                |        |   |                |     |
|        | 1.9 TDI           | 77              | 04.03                            | + Bremskraftregler <sup>3)</sup> |                |        |   |                |     |
|        | 2.0               | 85              | 06.03                            | + Bremskraftregler <sup>3)</sup> |                |        |   |                |     |
|        | 2.0 BiTDI         | 132             | 09.09                            | + Bremskraftregler <sup>3)</sup> |                |        |   |                |     |
|        | 2.0 BiTDI 4motion | 132             | 09.09                            | + Bremskraftregler <sup>3)</sup> |                |        |   |                |     |
|        | 2.0 TDI           | 62              | 09.09                            | + Bremskraftregler <sup>3)</sup> |                |        |   |                |     |
|        | 2.0 TDI           | 75              | 09.09                            | + Bremskraftregler <sup>3)</sup> |                |        |   |                |     |
|        | 2.0 TDI           | 84              | 05.11                            | + Bremskraftregler <sup>3)</sup> |                |        |   |                |     |
|        | 2.0 TDI           | 100             | 05.10                            | + Bremskraftregler <sup>3)</sup> |                |        |   |                |     |
|        | 2.0 TDI           | 103             | 09.09                            | + Bremskraftregler <sup>3)</sup> |                |        |   |                |     |
|        | 2.0 TDI 4motion   | 100             | 05.10                            | + Bremskraftregler <sup>3)</sup> |                |        |   |                |     |
|        | 2.0 TDI 4motion   | 103             | 09.09                            | + Bremskraftregler <sup>3)</sup> |                |        |   |                |     |
|        | 2.0 TSI           | 110             | 07.12                            | + Bremskraftregler <sup>3)</sup> |                |        |   |                |     |
|        | 2.5 TDI           | 96              | 02.03                            | + Bremskraftregler <sup>3)</sup> |                |        |   |                |     |
|        | 2.5 TDI           | 128             | 02.03                            | + Bremskraftregler <sup>3)</sup> |                |        |   |                |     |
|        | 2.5 TDI 4motion   | 96              | 07.04                            | + Bremskraftregler <sup>3)</sup> |                |        |   |                |     |
|        | 2.5 TDI 4motion   | 128             | 07.04                            | + Bremskraftregler <sup>3)</sup> |                |        |   |                |     |
|        | 3.2 V6            | 170             | 02.04                            | + Bremskraftregler <sup>3)</sup> |                |        |   |                |     |
| 3.2 V6 | 173               | 08.03           | + Bremskraftregler <sup>3)</sup> |                                  |                |        |   |                |     |
|        | 1.9 TDI           | 62              | 01.06                            | PR: OWR                          | 24.5140-0241.3 | 330948 |   | L=240          |     |
|        | 1.9 TDI           | 63              | 04.03                            | PR: OWR                          | 24.5140-0240.3 | 330947 |   | L=240          |     |
|        | 1.9 TDI           | 75              | 06.06                            | PR: OWR                          | 24.5237-0250.3 | 330880 | 2 | L=250          |     |
|        | 1.9 TDI           | 77              | 04.03                            | PR: OWR                          |                |        |   |                |     |
|        | 2.0               | 85              | 06.03                            | PR: OWR                          |                |        |   |                |     |
|        | 2.0 BiTDI         | 132             | 09.09                            | PR: OWR                          |                |        |   |                |     |
|        | 2.0 BiTDI 4motion | 132             | 09.09                            | PR: OWR                          |                |        |   |                |     |
|        | 2.0 TDI           | 62              | 09.09                            | PR: OWR                          |                |        |   |                |     |
|        | 2.0 TDI           | 75              | 09.09                            | PR: OWR                          |                |        |   |                |     |
|        | 2.0 TDI           | 84              | 05.11                            | PR: OWR                          |                |        |   |                |     |
|        | 2.0 TDI           | 100             | 05.10                            | PR: OWR                          |                |        |   |                |     |
|        | 2.0 TDI           | 103             | 09.09                            | PR: OWR                          |                |        |   |                |     |
|        | 2.0 TDI 4motion   | 100             | 05.10                            | PR: OWR                          |                |        |   |                |     |
|        | 2.0 TDI 4motion   | 103             | 09.09                            | PR: OWR                          |                |        |   |                |     |
|        | 2.0 TSI           | 110             | 07.12                            | PR: OWR                          |                |        |   |                |     |
|        | 2.5 TDI           | 96              | 02.03                            | PR: OWR                          |                |        |   |                |     |
|        | 2.5 TDI           | 128             | 02.03                            | PR: OWR                          |                |        |   |                |     |
|        | 2.5 TDI 4motion   | 96              | 07.04                            | PR: OWR                          |                |        |   |                |     |
|        | 2.5 TDI 4motion   | 128             | 07.04                            | PR: OWR                          |                |        |   |                |     |
|        | 3.2 V6            | 170             | 02.04                            | PR: OWR                          |                |        |   |                |     |

<sup>1)</sup> - brake pressure regulator / - correttore di frenata / - correcteur de freinage / - corrector de frenado

<sup>2)</sup> on the brake caliper / sulla pinza freno / sur l'étrier de frein / a la pinza de freno

<sup>3)</sup> + brake pressure regulator / + correttore di frenata / + correcteur de freinage / + corrector de frenado







**VOLKSWAGEN TRANSPORTER (T5) PRITSCH / FAHRGESTELL (03-)**

|  |                  |     |  |              |                                 |  |  |                         |
|--|------------------|-----|--|--------------|---------------------------------|--|--|-------------------------|
|  | <b>3.2 V6</b>    | 173 |  | <b>08.03</b> | PR: OWR                         | <b>24.5140-0241.3</b> 330948<br><b>24.5140-0240.3</b> 330947<br><b>24.5237-0250.3</b> 330880 | <input type="checkbox"/> am Bremssattel <sup>1)</sup><br><input type="checkbox"/> am Bremssattel <sup>1)</sup> | L=240<br>L=240<br>L=250 |
|  | <b>1.9 TDI</b>   | 62  |  | <b>01.06</b> | PR: 0E1,0E2,0WL,0WN,0WM,0WP,0WQ | <b>24.3727-0184.2</b> 580184   | 2  | L=1303                  |
|  | <b>1.9 TDI</b>   | 63  |  | <b>04.03</b> | PR: 0E1,0E2,0WL,0WN,0WM,0WP,0WQ |  |  |                         |
|  | <b>1.9 TDI</b>   | 75  |  | <b>06.06</b> | PR: 0E1,0E2,0WL,0WN,0WM,0WP,0WQ |  |  |                         |
|  | <b>1.9 TDI</b>   | 77  |  | <b>04.03</b> | PR: 0E1,0E2,0WL,0WN,0WM,0WP,0WQ |  |  |                         |
|  | <b>2.0</b>       | 85  |  | <b>06.03</b> | PR: 0E1,0E2,0WL,0WN,0WM,0WP,0WQ |  |  |                         |
|  | <b>2.0 BitDI</b> | 132 |  | <b>09.09</b> | PR: 0E1,0E2,0WL,0WN,0WM,0WP,0WQ |  |  |                         |
|  | <b>2.0 TDI</b>   | 62  |  | <b>09.09</b> | PR: 0E1,0E2,0WL,0WN,0WM,0WP,0WQ |  |  |                         |
|  | <b>2.0 TDI</b>   | 75  |  | <b>09.09</b> | PR: 0E1,0E2,0WL,0WN,0WM,0WP,0WQ |  |  |                         |
|  | <b>2.0 TDI</b>   | 84  |  | <b>05.11</b> |                                 |  |  |                         |
|  | <b>2.0 TDI</b>   | 100 |  | <b>05.10</b> | PR: 0E1,0E2,0WL,0WN,0WM,0WP,0WQ |  |  |                         |
|  | <b>2.0 TDI</b>   | 103 |  | <b>09.09</b> | PR: 0E1,0E2,0WL,0WN,0WM,0WP,0WQ |  |  |                         |
|  | <b>2.0 TSI</b>   | 110 |  | <b>07.12</b> |                                 |  |  |                         |
|  | <b>2.5 TDI</b>   | 96  |  | <b>02.03</b> | PR: 0E1,0E2,0WL,0WN,0WM,0WP,0WQ |  |  |                         |
|  | <b>2.5 TDI</b>   | 128 |  | <b>02.03</b> | PR: 0E1,0E2,0WL,0WN,0WM,0WP,0WQ |  |  |                         |
|  | <b>3.2 V6</b>    | 170 |  | <b>02.04</b> | PR: 0E1,0E2,0WL,0WN,0WM,0WP,0WQ |  |  |                         |
|  | <b>3.2 V6</b>    | 173 |  | <b>08.03</b> | PR: 0E1,0E2,0WL,0WN,0WM,0WP,0WQ |  |  |                         |

**VOLKSWAGEN VENTO (92-98)**

|  |                |    |             |              |   |  |  |                                |     |  |  |                                |     |                              |  |           |     |
|--|----------------|----|-------------|--------------|---|--|--|--------------------------------|-----|--|--|--------------------------------|-----|------------------------------|--|-----------|-----|
|  | <b>1.4</b>     |    |             | <b>11.91</b> | <b>09.98</b> - ABS                                    | <b>03.7750-5502.4</b> 300081                                 |  | 9"                             | ATE |  |  |                                |     |                              |  |           |     |
|  | <b>1.6</b>     |    |             | <b>09.92</b> | <b>09.98</b> - ABS                                    |  |  |                                |     |  |  |                                |     |                              |  |           |     |
|  | <b>1.8</b>     |    |             | <b>01.92</b> | <b>09.98</b> - ABS                                    |  |  |                                |     |  |  |                                |     |                              |  |           |     |
|  | <b>1.9 D</b>   |    |             | <b>11.91</b> | <b>09.98</b> - ABS                                    |  |  |                                |     |  |  |                                |     |                              |  |           |     |
|  | <b>1.9 SDI</b> |    |             | <b>04.97</b> | <b>09.98</b> - ABS                                    |  |  |                                |     |  |  |                                |     |                              |  |           |     |
|  | <b>1.9 TD</b>  | 55 |             | <b>11.91</b> | <b>09.98</b> - ABS                                    |  |  |                                |     |  |  |                                |     |                              |  |           |     |
|  | <b>1.9 TDI</b> | 66 |             | <b>07.93</b> | <b>09.98</b> - ABS                                    |  |  |                                |     |  |  |                                |     |                              |  |           |     |
|  | <b>1.9 TDI</b> | 81 |             | <b>02.96</b> | <b>09.98</b> - ABS                                    |  |  |                                |     |  |  |                                |     |                              |  |           |     |
|  | <b>2.0</b>     |    |             | <b>11.91</b> | <b>09.98</b> - ABS                                    |  |  |                                |     |  |  |                                |     |                              |  |           |     |
|  | <b>1.4</b>     |    |             | <b>11.91</b> | <b>09.98</b> - ABS                                    |  |  |                                |     | <b>03.7750-5602.4</b> 300082                                 |  | 9"                             | ATE |                              |  |           |     |
|  | <b>1.6</b>     |    |             | <b>09.92</b> | <b>09.98</b> - ABS                                    |  |  |                                |     |  |  |                                |     |                              |  |           |     |
|  | <b>1.8</b>     |    |             | <b>01.92</b> | <b>09.98</b> - ABS                                    |  |  |                                |     |  |  |                                |     |                              |  |           |     |
|  | <b>1.9 D</b>   |    |             | <b>11.91</b> | <b>09.98</b> - ABS                                    |  |  |                                |     |  |  |                                |     |                              |  |           |     |
|  | <b>1.9 SDI</b> |    |             | <b>04.97</b> | <b>09.98</b> - ABS                                    |  |  |                                |     |  |  |                                |     |                              |  |           |     |
|  | <b>1.9 TD</b>  | 55 |             | <b>11.91</b> | <b>09.98</b> - ABS                                    |  |  |                                |     |  |  |                                |     |                              |  |           |     |
|  | <b>1.9 TDI</b> | 66 |             | <b>07.93</b> | <b>09.98</b> - ABS                                    |  |  |                                |     |  |  |                                |     |                              |  |           |     |
|  | <b>1.9 TDI</b> | 81 |             | <b>02.96</b> | <b>09.98</b> - ABS                                    |  |  |                                |     |  |  |                                |     |                              |  |           |     |
|  | <b>2.0</b>     |    |             | <b>11.91</b> | <b>09.98</b> - ABS                                    |  |  |                                |     |  |  |                                |     |                              |  |           |     |
|  | <b>1.4</b>     |    | 1H-S-385334 | <b>11.91</b> | + ABS   | <b>10.6360-1003.4</b> 300156                                 |  | 10"                            | ATE |  |  |                                |     |                              |  |           |     |
|  | <b>1.6</b>     |    | 1H-S-385334 | <b>09.92</b> | + ABS   |  |  |                                |     |  |  |                                |     |                              |  |           |     |
|  | <b>1.8</b>     |    | 1H-S-385334 | <b>01.92</b> | + ABS   |  |  |                                |     |  |  |                                |     |                              |  |           |     |
|  | <b>1.9 D</b>   |    | 1H-S-385334 | <b>11.91</b> | + ABS   |  |  |                                |     |  |  |                                |     |                              |  |           |     |
|  | <b>1.9 TD</b>  | 55 | 1H-S-385334 | <b>11.91</b> | + ABS   |  |  |                                |     |  |  |                                |     |                              |  |           |     |
|  | <b>1.9 TDI</b> | 66 | 1H-S-385334 | <b>07.93</b> | + ABS   |  |  |                                |     |  |  |                                |     |                              |  |           |     |
|  | <b>2.0</b>     |    | 1H-S-385334 | <b>11.91</b> | + ABS   |  |  |                                |     |  |  |                                |     |                              |  |           |     |
|  | <b>2.8 VR6</b> |    | 1H-S-385334 | <b>01.92</b> | + ABS   |  |  |                                |     |  |  |                                |     |                              |  |           |     |
|  | <b>1.4</b>     |    | 1H-S-385335 |              | <b>09.98</b> + ABS                                    |  |  |                                |     | <b>10.6360-2002.4</b> 300143                                 |  | 10"                            | ATE |                              |  |           |     |
|  | <b>1.6</b>     |    | 1H-S-385335 |              | <b>09.98</b> + ABS                                    |  |  |                                |     |  |  |                                |     |                              |  |           |     |
|  | <b>1.8</b>     |    | 1H-S-385335 |              | <b>09.98</b> + ABS                                    |  |  |                                |     |  |  |                                |     |                              |  |           |     |
|  | <b>1.9 D</b>   |    | 1H-S-385335 |              | <b>09.98</b> + ABS                                    |  |  |                                |     |  |  |                                |     |                              |  |           |     |
|  | <b>1.9 SDI</b> |    |             | <b>04.97</b> | <b>09.98</b> + ABS                                    |  |  |                                |     |  |  |                                |     |                              |  |           |     |
|  | <b>1.9 TD</b>  | 55 | 1H-S-385335 |              | <b>09.98</b> + ABS                                    |  |  |                                |     |  |  |                                |     |                              |  |           |     |
|  | <b>1.9 TDI</b> | 66 | 1H-S-385335 |              | <b>09.98</b> + ABS                                    |  |  |                                |     |  |  |                                |     |                              |  |           |     |
|  | <b>1.9 TDI</b> | 81 |             | <b>02.96</b> | <b>09.98</b> + ABS                                    |  |  |                                |     |  |  |                                |     |                              |  |           |     |
|  | <b>2.0</b>     |    | 1H-S-385335 |              | <b>09.98</b> + ABS                                    |  |  |                                |     |  |  |                                |     |                              |  |           |     |
|  | <b>2.8 VR6</b> |    | 1H-S-385335 |              | <b>09.98</b> + ABS                                    |  |  |                                |     |  |  |                                |     |                              |  |           |     |
|  | <b>1.4</b>     |    |             | <b>11.91</b> | <b>09.98</b> - ABS                                    | <b>03.2120-3943.3</b> 010532<br><b>03.3517-0101.2</b> 390322 |  | Thz 20,64<br>Verschlußschraube | ATE |  |  |                                |     |                              |  |           |     |
|  | <b>1.6</b>     |    |             | <b>09.92</b> | <b>09.98</b> - ABS                                    |  |  |                                |     |  |  |                                |     |                              |  |           |     |
|  | <b>1.8</b>     |    |             | <b>01.92</b> | <b>09.98</b> - ABS/ - GT                              |  |  |                                |     |  |  |                                |     |                              |  |           |     |
|  | <b>1.9 D</b>   |    |             | <b>11.91</b> | <b>09.98</b> - ABS                                    |  |  |                                |     |  |  |                                |     |                              |  |           |     |
|  | <b>1.9 SDI</b> |    |             | <b>04.97</b> | <b>09.98</b> - ABS                                    |  |  |                                |     |  |  |                                |     |                              |  |           |     |
|  | <b>1.9 TD</b>  | 55 |             | <b>11.91</b> | <b>09.98</b> - ABS                                    |  |  |                                |     |  |  |                                |     |                              |  |           |     |
|  | <b>1.6</b>     | 55 | 1H-S-430001 |              | <b>09.98</b> - ABS/ + Automatikgetriebe <sup>2)</sup> |  |  |                                |     | <b>03.2122-1042.3</b> 010137<br><b>03.3517-0101.2</b> 390322 |  | Thz 22,20<br>Verschlußschraube | ATE |                              |  |           |     |
|  | <b>1.6</b>     | 74 |             | <b>07.94</b> | <b>09.98</b> - ABS                                    |  |  |                                |     |  |  |                                |     |                              |  |           |     |
|  | <b>1.8 GT</b>  |    |             | <b>01.92</b> | <b>09.98</b> - ABS                                    |  |  |                                |     |  |  |                                |     |                              |  |           |     |
|  | <b>1.9 TD</b>  | 55 | 1H-S-430001 |              | <b>09.98</b> - ABS                                    |  |  |                                |     |  |  |                                |     |                              |  |           |     |
|  | <b>1.9 TDI</b> | 66 |             | <b>07.93</b> | <b>09.98</b> - ABS                                    |  |  |                                |     |  |  |                                |     |                              |  |           |     |
|  | <b>1.9 TDI</b> | 81 |             | <b>02.96</b> | <b>09.98</b> - ABS                                    |  |  |                                |     |  |  |                                |     |                              |  |           |     |
|  | <b>2.0</b>     |    |             | <b>11.91</b> | <b>09.98</b> - ABS                                    |  |  |                                |     |  |  |                                |     |                              |  |           |     |
|  | <b>1.4</b>     |    | 1H-S-385334 | <b>11.91</b> | + ABS   |  |  |                                |     |  |  |                                |     | <b>10.6122-0144.3</b> 010638 |  | Thz 22,20 | ATE |
|  | <b>1.6</b>     | 55 | 1H-S-385334 | <b>09.92</b> | + ABS   |  |  |                                |     |  |  |                                |     |                              |  |           |     |
|  | <b>1.8</b>     |    | 1H-S-385334 | <b>01.92</b> | + ABS/ - GT   |  |  |                                |     |  |  |                                |     |                              |  |           |     |
|  | <b>1.9 D</b>   |    | 1H-S-385334 | <b>11.91</b> | + ABS   |  |  |                                |     |  |  |                                |     |                              |  |           |     |
|  | <b>1.9 TD</b>  | 55 | 1H-S-385334 | <b>11.91</b> | + ABS   |  |  |                                |     |  |  |                                |     |                              |  |           |     |
|  | <b>1.4</b>     |    | 1H-S-385335 |              | <b>09.98</b> + ABS                                    | <b>03.2122-1144.3</b> 010636                                 |  | Thz 22,20                      | ATE |  |  |                                |     |                              |  |           |     |
|  | <b>1.6</b>     | 55 | 1H-S-385335 |              | <b>09.98</b> + ABS                                    |  |  |                                |     |  |  |                                |     |                              |  |           |     |
|  | <b>1.8</b>     |    | 1H-S-385335 |              | <b>09.98</b> + ABS/ - GT                              |  |  |                                |     |  |  |                                |     |                              |  |           |     |
|  | <b>1.9 D</b>   |    | 1H-S-385335 |              | <b>09.98</b> + ABS                                    |  |  |                                |     |  |  |                                |     |                              |  |           |     |
|  | <b>1.9 SDI</b> |    |             | <b>04.97</b> | <b>09.98</b> + ABS                                    |  |  |                                |     |  |  |                                |     |                              |  |           |     |
|  | <b>1.9 TD</b>  | 55 | 1H-S-385335 |              | <b>09.98</b> + ABS                                    |  |  |                                |     |  |  |                                |     |                              |  |           |     |
|  | <b>1.6</b>     | 74 | 1H-S-385334 | <b>07.94</b> | + ABS   |  |  |                                |     | <b>10.6123-0674.3</b> 010639                                 |  | Thz 23,81                      | ATE |                              |  |           |     |
|  | <b>1.8 GT</b>  |    | 1H-S-385334 | <b>01.92</b> | + ABS   |  |  |                                |     |  |  |                                |     |                              |  |           |     |
|  | <b>1.9 TDI</b> | 66 | 1H-S-385334 | <b>07.93</b> | + ABS   |  |  |                                |     |  |  |                                |     |                              |  |           |     |
|  | <b>2.0</b>     |    | 1H-S-385334 | <b>11.91</b> | + ABS   |  |  |                                |     |  |  |                                |     |                              |  |           |     |
|  | <b>2.8 VR6</b> |    | 1H-S-385334 | <b>01.92</b> | + ABS   |  |  |                                |     |  |  |                                |     |                              |  |           |     |

<sup>1)</sup> on the brake caliper / sulla pinza freno / sur l'étrier de frein / a la pinza de freno  
<sup>2)</sup> - ABS/ + autom.transmission / - ABS/ + scatola cambio autom. / - ABS/ + transmission automatique / - ABS/ + cambio automático



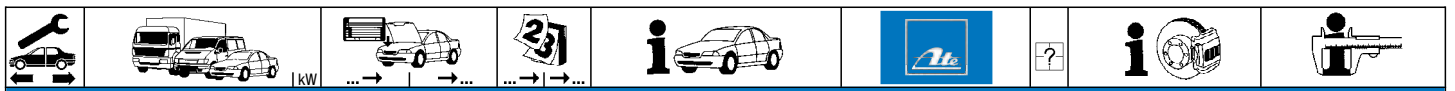

















**VOLKSWAGEN VENTO (92-98)**

|            |           |        |             |             |             |                        |                        |                |        |                      |                |
|------------|-----------|--------|-------------|-------------|-------------|------------------------|------------------------|----------------|--------|----------------------|----------------|
|            | 1.6       | 74     | 1H-S-385335 |             | 09.98       | + ABS                  | 03.2123-1424.3         | 010637         |        | ThZ 23,81            | ATE            |
|            | 1.8 GT    |        | 1H-S-385335 |             | 09.98       | + ABS                  |                        |                |        |                      |                |
|            | 1.9 TDI   | 66     | 1H-S-385335 |             | 09.98       | + ABS                  |                        |                |        |                      |                |
|            | 1.9 TDI   | 81     |             | 02.96       | 09.98       | + ABS                  |                        |                |        |                      |                |
|            | 2.0       |        | 1H-S-385335 |             | 09.98       | + ABS                  |                        |                |        |                      |                |
|            | 2.8 VR6   |        | 1H-S-385335 |             | 09.98       | + ABS                  |                        |                |        |                      |                |
|            | 1.4       |        | 1H-S-385335 |             | 09.98       | + ABS                  | 03.2122-1184.3         | 010592         |        | ThZ 22,20            | ATE            |
|            | 1.6       | 55     | 1H-S-385335 |             | 09.98       | + ABS                  |                        |                |        |                      |                |
|            | 1.8       |        | 1H-S-385335 |             | 09.98       | + ABS/ - GT            |                        |                |        |                      |                |
|            | 1.9 D     |        | 1H-S-385335 |             | 09.98       | + ABS                  |                        |                |        |                      |                |
|            | 1.9 SDI   |        |             | 04.97       | 09.98       | + ABS                  |                        |                |        |                      |                |
|            | 1.9 TD    | 55     | 1H-S-385335 |             | 09.98       | + ABS                  |                        |                |        |                      |                |
|            | 1.6       | 74     | 1H-S-385335 |             | 09.98       | + ABS                  | 03.2123-1484.3         | 010595         |        | ThZ 23,81            | ATE            |
|            | 1.8 GT    |        | 1H-S-385335 |             | 09.98       | + ABS                  |                        |                |        |                      |                |
|            | 1.9 TDI   | 66     | 1H-S-385335 |             | 09.98       | + ABS                  |                        |                |        |                      |                |
|            | 1.9 TDI   | 81     |             | 02.96       | 09.98       | + ABS                  |                        |                |        |                      |                |
|            | 2.0       |        | 1H-S-385335 |             | 09.98       | + ABS                  |                        |                |        |                      |                |
|            | 2.8 VR6   |        | 1H-S-385335 |             | 09.98       | + ABS                  |                        |                |        |                      |                |
|            | 1.4       | 55     | 1H-T-015953 | 11.91       |             | + Automatikgetriebe 1) | 11.0441-4808.2         | 250022         |        | Dichtungssatz        | ATE            |
|            | 1.6       | 55     | 1H-T-015953 | 09.92       |             | + Schaltgetriebe 2)    | 11.0101-4801.2         | 260006         |        | Hülsensatz           | ATE            |
|            | 1.8       | 55     | 1H-S-430000 | 01.92       |             | + Schaltgetriebe 2)    | 24.0102-4801.2         | 260085         |        | Hülsensatz+Schrauben | ATE            |
|            | 1.8 CL/GL | 66     | 1H-S-430000 | 01.92       |             |                        |                        |                |        |                      |                |
|            | 1.9 D     |        | 1H-T-015953 | 11.91       |             |                        |                        |                |        |                      |                |
|            | 1.9 TD    | 55     | 1H-S-430000 | 11.91       |             |                        |                        |                |        |                      |                |
|            | 1.4       |        | 1H-T-015954 |             | 09.98       | - ABS                  | 11.0441-4808.2         | 250022         |        | Dichtungssatz        | ATE            |
|            | 1.6       | 55     | 1H-T-015954 |             | 09.98       | + Schaltgetriebe 2)    | 11.0101-4801.2         | 260006         |        | Hülsensatz           | ATE            |
|            | 1.8       | 55     | 1H-T-015954 |             | 09.98       | + Schaltgetriebe 2)    | 24.0102-4801.2         | 260085         |        | Hülsensatz+Schrauben | ATE            |
|            | 1.9 D     |        | 1H-T-015954 |             | 09.98       | - ABS                  |                        |                |        |                      |                |
|            | 1.9 SDI   |        |             | 04.97       | 09.98       | - ABS                  |                        |                |        |                      |                |
|            |           | 1.6    | 55          | 1H-S-430001 |             | 09.98                  | + Automatikgetriebe 1) | 24.3541-1739.5 | 240223 | ☐                    | D=54, - Halter |
| 1.6 CL/GL  |           | 74     |             | 07.94       | 09.98       |                        | 24.3541-1740.5         | 240224         | ☐      | D=54, - Halter       | LUC            |
| 1.8        |           | 55     |             | 01.92       | 09.98       | + Automatikgetriebe 1) | 11.0101-5403.2         | 260010         |        | Faltenbalgsatz       | LUC            |
| 1.8 CL/GL  |           | 66     | 1H-S-430001 |             | 09.98       |                        |                        |                |        |                      |                |
| 1.9 TD     |           | 55     | 1H-S-430001 |             | 09.98       |                        |                        |                |        |                      |                |
| 1.9 TDI    |           | 66     |             | 07.93       | 09.98       |                        |                        |                |        |                      |                |
|            | 1.4       |        |             | 05.96       | 09.96       | + ABS                  | 24.3541-1609.5         | 240039         | ☐      | D=54, - Halter       | LUC            |
|            | 1.6 GT    | 74     |             | 07.94       | 09.98       |                        | 24.3541-1610.5         | 240040         | ☐      | D=54, - Halter       | LUC            |
|            | 1.8 GT    | 66     |             | 01.92       | 09.98       |                        | 24.0101-4301.2         | 260047         |        | Einbausatz           | LUC            |
|            | 1.9 D     |        |             | 05.96       | 09.96       | + ABS                  | 11.0101-5403.2         | 260010         |        | Faltenbalgsatz       | LUC            |
|            | 1.9 TDI   | 81     |             | 02.96       | 09.98       |                        |                        |                |        |                      |                |
|            | 2.0 CL/GL |        |             | 11.91       | 09.98       |                        |                        |                |        |                      |                |
|            | 1.4       |        |             | 10.96       | 09.98       | + ABS                  | 11.0441-4808.2         | 250022         |        | Dichtungssatz        | ATE            |
|            | 1.9 D     |        |             | 10.96       | 09.98       | + ABS                  | 11.0101-4801.2         | 260006         |        | Hülsensatz           | ATE            |
|            | 1.9 SDI   |        |             | 04.97       | 09.98       | + ABS                  | 24.0102-4801.2         | 260085         |        | Hülsensatz+Schrauben | ATE            |
|            | 2.0 GT    |        |             | 11.91       | 04.96       |                        | 24.3541-1731.5         | 240061         | ☐      | D=54, - Halter       | LUC            |
|            | 2.8 VR6   |        | 1H-S-560000 | 01.92       |             |                        | 24.3541-1732.5         | 240062         | ☐      | D=54, - Halter       | LUC            |
|            |           |        |             |             |             |                        | 24.0101-4301.2         | 260047         |        | Einbausatz           | LUC            |
|            | 2.0 GT    |        |             | 05.96       | 09.98       |                        | 11.3541-8523.2         | 220115         | ☐      | D=54, - Halter       | ATE            |
|            | 2.8 VR6   |        | 1H-S-560001 |             | 09.98       |                        | 11.3541-8524.2         | 220116         | ☐      | D=54, - Halter       | ATE            |
|            |           |        |             |             |             |                        | 24.3541-8523.5         | 240551         | ☐      | D=54, - Halter       | ATE            |
|            |           |        |             |             |             |                        | 24.3541-8524.5         | 240552         | ☐      | D=54, - Halter       | ATE            |
|            |           |        |             |             |             |                        | 11.8170-0306.1         | 260102         | 2      | Halter               | ATE            |
|            |           |        |             |             |             |                        | 11.0441-5409.2         | 250031         |        | Dichtungssatz        | ATE            |
|            | 1.4       |        |             | 11.91       | 09.98       |                        | 83.7713-0435.3         | 330792         | 2      | L=435                |                |
|            | 1.6       |        |             | 09.92       | 09.98       |                        |                        |                |        |                      |                |
|            | 1.8       |        |             | 01.92       | 09.98       |                        |                        |                |        |                      |                |
|            | 1.9 D     |        |             | 11.91       | 09.98       |                        |                        |                |        |                      |                |
|            | 1.9 SDI   |        |             | 04.97       | 09.98       |                        |                        |                |        |                      |                |
|            | 1.9 TD    | 55     |             | 11.91       | 09.98       |                        |                        |                |        |                      |                |
|            | 1.9 TDI   | 66     |             | 07.93       | 09.98       |                        |                        |                |        |                      |                |
|            | 1.9 TDI   | 81     |             | 02.96       | 09.98       |                        |                        |                |        |                      |                |
|            | 2.0       |        |             | 11.91       | 09.98       |                        |                        |                |        |                      |                |
|            | 2.8 VR6   |        | 1H-S-560000 | 01.92       |             |                        |                        |                |        |                      |                |
|            | 2.8 VR6   |        | 1H-S-560001 |             | 09.98       |                        | 83.6232-0465.3         | 330736         | 2      | L=465                |                |
|            |           | 1.8 GT |             |             | 1H-P-240000 | 01.92                  |                        | 24.3384-1603.5 | 240015 | ☐                    | D=38, - Halter |
| 2.0        |           |        |             | 1H-P-240000 | 11.91       |                        | 24.3384-1604.5         | 240016         | ☐      | D=38, - Halter       | LUC            |
| 2.8 VR6    |           |        |             | 1H-P-240000 | 01.92       |                        | 24.0101-3601.2         | 260044         |        | Einbausatz           | LUC            |
| 1.6 GT     |           | 74     |             | 07.94       | 09.98       |                        | 24.3384-1707.5         | 240171         | ☐      | D=38, - Halter       | LUC            |
| 1.8 GT     |           |        | 1H-P-240001 |             | 06.95       |                        | 24.3384-1708.5         | 240172         | ☐      | D=38, - Halter       | LUC            |
| 1.9 GT TDI |           | 66     |             | 07.93       | 09.98       |                        | 24.0101-3601.2         | 260044         |        | Einbausatz           | LUC            |
|            | 1.9 TDI   | 81     |             | 02.96       | 09.98       |                        | 11.0101-5403.2         | 260010         |        | Faltenbalgsatz       | LUC            |
|            | 2.0       |        | 1H-P-240001 |             | 09.98       |                        |                        |                |        |                      |                |
|            | 2.8 VR6   |        | 1H-P-240001 |             | 09.98       |                        |                        |                |        |                      |                |
|            | 1.8 GT    |        |             | 07.95       | 09.98       |                        | 24.3384-1707.5         | 240171         | ☐      | D=38, - Halter       | LUC            |
|            |           |        |             |             |             |                        | 24.3384-1708.5         | 240172         | ☐      | D=38, - Halter       | LUC            |
|            |           |        |             |             |             |                        | 11.0101-5403.2         | 260010         |        | Faltenbalgsatz       | LUC            |
|            | 1.4       |        |             | 11.91       | 09.98       |                        | 83.7836-0135.3         | 330816         | 2      | L=135                |                |
|            | 1.6       | 55     |             | 09.92       | 09.98       |                        |                        |                |        |                      |                |
|            | 1.8       |        |             | 01.92       | 09.98       | - GT                   |                        |                |        |                      |                |
|            | 1.9 D     |        |             | 11.91       | 09.98       |                        |                        |                |        |                      |                |
|            | 1.9 SDI   |        |             | 04.97       | 09.98       |                        |                        |                |        |                      |                |
|            | 1.9 TD    | 55     |             | 11.91       | 09.98       |                        |                        |                |        |                      |                |

1) + autom.transmission / + scatola cambio automatico / + transmission automatique / + cambio automático

2) + manual transmission / + scatola cambio velocità / + transmission mécanique / + cambio de velocidad



|     |  |  |  |  |  |  |  |  |   |                   |                    |
|--|--|--|--|--|---|--|--|--|---|-------------------|--------------------|
| <b>VOLKSWAGEN VENTO (92-98)</b>  |  |  |  |  |   |  |  |  |   |                   |                    |
|    | 1.9 TDI  | 66   |  | 07.93  | 09.98   | - GT   | 83.7836-0135.3   | 330816   | 2 |                   | L=135              |
|  | 1.6 GT   | 74   |  | 07.94  | 09.98   |  | 83.7836-0135.3   | 330816   | 2 |                   | L=135              |
|  | 1.8 GT   |  |  | 01.92  | 09.98   |  | 83.7704-0160.3   | 330805   | 2 | am Bremssattel 1) | L=160              |
|  | 1.9 GT TDI   | 66   |  | 07.93  | 09.98   |  |  |  |   |                   |                    |
|  | 1.9 TDI  | 81   |  | 02.96  | 09.98   |  |  |  |   |                   |                    |
|  | 2.0  |  |  | 11.91  | 09.98   |  |  |  |   |                   |                    |
|  | 2.8 VR6  |  |  | 01.92  | 09.98   |  |  |  |   |                   |                    |
|    | 1.4  |  |  | 11.91  | 09.98   |  | 03.3217-2112.3   | 020027   |   | + GG 2)           | Rz 17,46           |
|  | 1.6  | 55   | 1H-S-430000  | 09.92  | 09.98   |  | 24.3217-0908.3   | 020167   |   | + ALU 3)          | Rz 17,46           |
|  | 1.6  | 55   |  | 09.92  | 09.98   |  |  |  |   |                   |                    |
|  | 1.8  | 55   |  | 01.92  | 09.98   |  |  |  |   |                   |                    |
|  | 1.8 CL/GL  | 66   | 1H-S-430000  | 01.92  | 09.98   |  |  |  |   |                   |                    |
|  | 1.9 D  |  |  | 11.91  | 09.98   |  |  |  |   |                   |                    |
|  | 1.9 SDI  |  |  | 04.97  | 09.98   |  |  |  |   |                   |                    |
|  | 1.9 TD   | 55   | 1H-S-430000  | 11.91  | 09.98   |  |  |  |   |                   |                    |
|  | 1.6  | 55   | 1H-S-430001  |  | 09.98   |  | 24.3219-0909.3   | 020188   |   |                   | Rz 19,05           |
|  | 1.6 CL/GL  | 74   |  | 07.94  | 09.98   |  |  |  |   |                   |                    |
|  | 1.8  | 55   |  | 01.92  | 09.98   |  |  |  |   |                   |                    |
|  | 1.8 CL/GL  | 66   | 1H-S-430001  |  | 09.98   |  |  |  |   |                   |                    |
|  | 1.9 TD   | 55   | 1H-S-430001  |  | 09.98   |  |  |  |   |                   |                    |
|  | 1.9 TDI  | 66   |  | 07.93  | 09.98   | - GT   |  |  |   |                   |                    |
|    | 1.4  |  |  | 11.91  | 09.98   |  | 24.3727-0135.2   | 580135   | 2 | ↓                 | L=1500             |
|  | 1.6  | 55   | 1H-S-037527  | 09.92  | 09.98   | - GT   |  |  |   |                   |                    |
|  | 1.8  |  |  | 01.92  | 09.98   |  |  |  |   |                   |                    |
|  | 1.9 D  |  |  | 11.91  | 09.98   |  |  |  |   |                   |                    |
|  | 1.9 TD   | 55   | 1H-S-037527  | 11.91  | 09.98   | - GT   |  |  |   |                   |                    |
|  | 1.9 TDI  | 66   | 1H-S-037527  | 07.93  | 09.98   | - GT   |  |  |   |                   |                    |
|  | 1.4  |  | 1H-S-037528  |  | 09.98   |  | 24.3727-0160.2   | 580160   | 2 | ↓                 | L=1498             |
|  | 1.6  | 55   | 1H-S-037528  |  | 09.98   | - GT   |  |  |   |                   |                    |
|  | 1.8  |  | 1H-S-037528  |  | 09.98   |  |  |  |   |                   |                    |
|  | 1.9 D  |  | 1H-S-037528  |  | 09.98   |  |  |  |   |                   |                    |
|  | 1.9 SDI  |  |  | 04.97  | 09.98   |  |  |  |   |                   |                    |
|  | 1.9 TD   | 55   | 1H-S-037528  |  | 09.98   |  |  |  |   |                   |                    |
|  | 1.9 TDI  | 66   | 1H-S-037528  |  | 09.98   | - GT   |  |  |   |                   |                    |
|  | 1.8 GT   |  | 1H-S-037527  | 01.92  | 09.98   |  | 24.3727-0134.2   | 580134   | 2 | ↓                 | L=1604             |
|  | 1.9 GT TDI   | 66   | 1H-S-037527  | 07.93  | 09.98   |  |  |  |   |                   |                    |
|  | 2.0  |  | 1H-S-037527  | 11.91  | 09.98   |  |  |  |   |                   |                    |
|  | 2.8 VR6  |  | 1H-S-037527  | 01.92  | 09.98   |  |  |  |   |                   |                    |
|  | 1.6 GT   | 74   |  | 07.94  | 09.98   |  | 24.3727-0156.2   | 580156   | 2 | ↓                 | L=1616             |
|  | 1.8 GT   |  | 1H-S-037528  |  | 09.98   |  |  |  |   |                   |                    |
|  | 1.9 GT TDI   | 66   | 1H-S-037528  |  | 09.98   |  |  |  |   |                   |                    |
|  | 1.9 TDI  | 81   |  | 02.96  | 09.98   |  |  |  |   |                   |                    |
|  | 2.0  |  | 1H-S-037528  |  | 09.98   |  |  |  |   |                   |                    |
|  | 2.8 VR6  |  | 1H-S-037528  |  | 09.98   |  |  |  |   |                   |                    |
|  | 1.4  |  |  | 11.91  | 09.98   |  | 03.6584-0107.3   | 320110   |   |                   | BRL 8/4 (4) ATE    |
|  | 1.6  | 55   |  | 09.92  | 09.98   |  |  |  |   |                   |                    |
|  | 1.8  |  |  | 01.92  | 09.98   | - GT   |  |  |   |                   |                    |
|  | 1.9 D  |  |  | 11.91  | 09.98   |  |  |  |   |                   |                    |
|  | 1.9 SDI  |  |  | 04.97  | 09.98   |  |  |  |   |                   |                    |
|  | 1.9 TD   | 55   |  | 11.91  | 09.98   |  |  |  |   |                   |                    |
|  | 1.9 TDI  | 66   |  | 07.93  | 09.98   | - GT   |  |  |   |                   |                    |
|  | 1.6 GT   | 74   |  | 07.94  | 09.98   |  | 03.6584-0113.3   | 320111   |   |                   | BRL 8/4 (4) ATE    |
|  | 1.8 GT   |  |  | 01.92  | 09.98   |  |  |  |   |                   |                    |
|  | 1.9 GT TDI   | 66   |  | 07.93  | 09.98   |  |  |  |   |                   |                    |
|  | 1.9 TDI  | 81   |  | 02.96  | 09.98   |  |  |  |   |                   |                    |
|  | 2.0  |  |  | 11.91  | 09.98   |  |  |  |   |                   |                    |
|  | 2.8 VR6  |  |  | 01.92  | 09.98   |  |  |  |   |                   |                    |
|  | 1.8 GT   | ↓  |  | 01.92  | 09.98   |  | 03.2419-9510.3   | 030028   |   |                   | Gz 19,05           |
|  | 1.9 TDI  | ↓  | 66   | 07.93  | 09.98   |  |  |  |   |                   |                    |
|  | 1.9 TDI  | ↓  | 81   | 02.96  | 09.98   |  |  |  |   |                   |                    |
|  | 2.8 VR6  | ↓  |  | 01.92  | 09.98   |  |  |  |   |                   |                    |
|  | 1.8 GT   | ↓  |  | 01.92  | 09.98   |  | 03.2419-9910.3   | 030031   |   |                   | Gz 19,05           |
|  | 1.9 TDI  | ↓  | 66   | 07.93  | 09.98   |  |  |  |   |                   |                    |
|  | 1.9 TDI  | ↓  | 81   | 02.96  | 09.98   |  |  |  |   |                   |                    |
|  | 2.8 VR6  | ↓  |  | 01.92  | 09.98   |  |  |  |   |                   |                    |
|  | 1.8 GT   |  |  | 01.92  | 09.98   |  | 24.2523-0908.3   | 040049   |   |                   | Nz 23,81           |
|  | 1.9 TDI  | 66   |  | 07.93  | 09.98   |  |  |  |   |                   |                    |
|  | 1.9 TDI  | 81   |  | 02.96  | 09.98   |  |  |  |   |                   |                    |
|  | 2.8 VR6  |  |  | 01.92  | 09.98   |  |  |  |   |                   |                    |
|  | 1.4  | ↓  |  | 11.91  | 09.98   |  | 24.3728-0130.2   | 590130   |   |                   | L=1025, + AUT      |
|  | 1.6  | ↓  |  | 09.92  | 09.98   |  |  |  |   |                   |                    |
|  | 1.8  | ↓  |  | 01.92  | 09.98   | - GT   | 24.3728-0127.2   | 590127   |   |                   | L=824, + AUT       |
|  | 1.9 D  | ↓  |  | 11.91  | 09.98   |  |  |  |   |                   |                    |
|  | 1.9 TD   | ↓  | 55   | 11.91  | 09.98   |  |  |  |   |                   |                    |
|  | 2.0  | ↓  |  | 11.91  | 09.98   |  |  |  |   |                   |                    |
| <b>VOLKSWAGEN up (11-)</b>   |  |  |  |  |   |  |  |  |   |                   |                    |
|  | 1.0  | 44   |  | 12.11  |   | PR: 1LA,1ZQ  | 11.9541-9549.2   | 220575   | 2 |                   | D=54, - Halter ATE |
|  | 1.0  | 55   |  | 12.11  |   | PR: 1LA,1ZQ  | 11.9541-9550.2   | 220576   |   |                   | D=54, - Halter ATE |
|  | 1.0 EcoFuel  | 50   |  | 11.12  |   | PR: 1LA,1ZQ  | 11.0101-5409.2   | 260035   |   |                   | Hülensatz ATE      |
|  | e-up   | 60   |  | 09.13  |   | PR: 1LA,1ZQ  | 11.8171-0008.1   | 990049   | 2 |                   | Führungsbolzen ATE |

1) on the brake caliper / sulla pinza freno / sur l'étrier de frein / a la pinza de freno

2) + cast iron / + ghisa / + fonte grise / + fundición de gris

3) + aluminium / + aluminio / + aluminium / + aluminio

| VOLKSWAGEN up (11-) |             |               |       |       |                               |                              |                |                |                |                                     |  |  |  |  |  |  |                |                |
|---------------------|-------------|---------------|-------|-------|-------------------------------|------------------------------|----------------|----------------|----------------|-------------------------------------|--|--|--|--|--|--|----------------|----------------|
|                     | 1.0         | 44            |       | 12.11 |                               |                              |                | 24.3217-0908.3 | 020167         |                                     |  |  |  |  |  |  | Rz 17,46       |                |
|                     | 1.0         | 55            |       | 12.11 |                               |                              |                |                |                |                                     |  |  |  |  |  |  |                |                |
|                     | 1.0 EcoFuel | 50            |       | 11.12 |                               |                              |                |                |                |                                     |  |  |  |  |  |  |                |                |
|                     | e-up        | 60            |       | 09.13 |                               |                              |                | 24.3219-0909.3 | 020188         |                                     |  |  |  |  |  |  | Rz 19,05       |                |
| VOLVO 440 (88-96)   |             |               |       |       |                               |                              |                |                |                |                                     |  |  |  |  |  |  |                |                |
|                     | 1.6         | 61            |       | 09.88 | 12.96                         | - ABS                        |                | 24.2120-1702.3 | 010436         |                                     |  |  |  |  |  |  | Thz 20,64      |                |
|                     | 1.7         | 64            |       | 09.88 | 12.96                         | - ABS                        |                |                |                |                                     |  |  |  |  |  |  |                |                |
|                     | 1.7         | 70            |       | 08.88 | 07.89                         |                              |                |                |                |                                     |  |  |  |  |  |  |                |                |
|                     | 1.7         | 75            |       | 08.89 | 12.96                         | - ABS                        |                |                |                |                                     |  |  |  |  |  |  |                |                |
|                     | 1.7         | 78            |       | 09.88 | 12.96                         | - ABS                        |                |                |                |                                     |  |  |  |  |  |  |                |                |
|                     | 1.7 T       | 88            |       | 08.88 | 07.96                         | - ABS                        |                |                |                |                                     |  |  |  |  |  |  |                |                |
|                     | 1.7 T       | 90            |       | 01.91 | 12.96                         | - ABS                        |                |                |                |                                     |  |  |  |  |  |  |                |                |
|                     | 1.8         | 66            |       | 08.91 | 12.96                         | - ABS                        |                |                |                |                                     |  |  |  |  |  |  |                |                |
|                     | 1.9 TD      | 66            |       | 07.94 | 12.96                         | - ABS                        |                |                |                |                                     |  |  |  |  |  |  |                |                |
|                     | 2.0         | 80            |       | 08.93 | 07.96                         | - ABS                        |                |                |                |                                     |  |  |  |  |  |  |                |                |
|                     | 2.0         | 81            |       | 08.92 | 07.95                         | - ABS                        |                |                |                |                                     |  |  |  |  |  |  |                |                |
|                     | 1.6         | 61            |       | 09.88 | 12.96                         | - ABS                        |                | 24.2120-1702.3 | 010436         |                                     |  |  |  |  |  |  |                | Thz 20,64      |
|                     | 1.7         | 64            |       | 09.88 | 12.96                         | - ABS                        |                |                |                |                                     |  |  |  |  |  |  |                |                |
|                     | 1.7         | 70            |       | 08.88 | 07.89                         |                              |                |                |                |                                     |  |  |  |  |  |  |                |                |
|                     | 1.7         | 75            |       | 08.89 | 12.96                         | - ABS                        |                |                |                |                                     |  |  |  |  |  |  |                |                |
|                     | 1.7         | 78            |       | 09.88 | 12.96                         | - ABS                        |                |                |                |                                     |  |  |  |  |  |  |                |                |
|                     | 1.7 T       | 88            |       | 08.88 | 07.96                         | - ABS                        |                |                |                |                                     |  |  |  |  |  |  |                |                |
|                     | 1.7 T       | 90            |       | 01.91 | 12.96                         | - ABS                        |                |                |                |                                     |  |  |  |  |  |  |                |                |
|                     | 1.8         | 66            |       | 08.91 | 12.96                         | - ABS                        |                |                |                |                                     |  |  |  |  |  |  |                |                |
|                     | 1.9 TD      | 66            |       | 07.94 | 12.96                         | - ABS                        |                |                |                |                                     |  |  |  |  |  |  |                |                |
|                     | 2.0         | 80            |       | 08.93 | 07.96                         | - ABS                        |                |                |                |                                     |  |  |  |  |  |  |                |                |
|                     | 2.0         | 81            |       | 08.92 | 07.95                         | - ABS                        |                |                |                |                                     |  |  |  |  |  |  |                |                |
|                     | 1.6         | 61            |       | 09.92 | 12.96                         | + ABS                        |                | 10.6120-0287.3 | 010334         |                                     |  |  |  |  |  |  |                | Thz 20,64      |
|                     | 1.7         | 64            |       | 09.92 | 12.96                         | + ABS                        |                |                |                |                                     |  |  |  |  |  |  |                |                |
| 1.7                 | 75          |               | 09.92 | 12.96 | + ABS                         |                              |                |                |                |                                     |  |  |  |  |  |  |                |                |
| 1.7                 | 78          |               | 09.92 | 12.96 | + ABS                         |                              |                |                |                |                                     |  |  |  |  |  |  |                |                |
| 1.7 T               | 88          |               | 09.92 | 07.96 | + ABS                         |                              |                |                |                |                                     |  |  |  |  |  |  |                |                |
| 1.7 T               | 90          |               | 09.92 | 12.96 | + ABS                         |                              |                |                |                |                                     |  |  |  |  |  |  |                |                |
| 1.8                 | 66          |               | 09.92 | 12.96 | + ABS                         |                              |                |                |                |                                     |  |  |  |  |  |  |                |                |
| 1.9 TD              | 66          |               | 07.94 | 12.96 | + ABS                         |                              |                |                |                |                                     |  |  |  |  |  |  |                |                |
| 2.0                 | 80          |               | 08.93 | 07.96 | + ABS                         |                              |                |                |                |                                     |  |  |  |  |  |  |                |                |
| 2.0                 | 81          |               | 09.92 | 07.95 | + ABS                         |                              |                |                |                |                                     |  |  |  |  |  |  |                |                |
|                     | 1.6         | 61 EKC 006387 |       |       | 12.96                         |                              |                | 24.3541-1723.5 | 240077         | <input checked="" type="checkbox"/> |  |  |  |  |  |  | D=54, - Halter |                |
|                     | 1.7         | 64 EKC 006387 |       |       | 12.96                         |                              |                | 24.0101-3601.2 | 260044         |                                     |  |  |  |  |  |  | Einbausatz     |                |
|                     | 1.7         | 70 EKC 006387 |       |       | 07.89                         |                              |                |                |                |                                     |  |  |  |  |  |  |                |                |
|                     | 1.7         | 75 EKC 006387 |       |       | 12.96                         |                              |                |                |                |                                     |  |  |  |  |  |  |                |                |
|                     | 1.7         | 78 EKC 006387 |       |       | 12.96                         |                              |                |                |                |                                     |  |  |  |  |  |  |                |                |
|                     | 1.8         | 66            |       | 08.91 | 12.96                         |                              |                |                |                |                                     |  |  |  |  |  |  |                |                |
|                     | 1.9 TD      | 66            |       | 07.94 | 12.96                         |                              |                |                |                |                                     |  |  |  |  |  |  |                |                |
|                     | 2.0         | 80 EKC 006387 |       |       | 07.96                         |                              |                |                |                |                                     |  |  |  |  |  |  |                |                |
|                     | 1.7 T       | 88            |       | 08.88 | 07.96                         |                              |                | 11.9541-9806.2 | 220504         | <input checked="" type="checkbox"/> |  |  |  |  |  |  |                | D=54, - Halter |
|                     | 1.7 T       | 90            |       | 01.91 | 12.96                         |                              |                | 11.8116-0073.1 | 390498         | 2                                   |  |  |  |  |  |  |                | Haltefeder     |
|                     | 2.0         | 80            |       | 08.93 | 07.96                         |                              |                | 11.8171-0008.1 | 990049         |                                     |  |  |  |  |  |  |                | Führungsbolzen |
|                     | 2.0         | 81            |       | 08.92 | 07.95                         |                              |                | 11.0101-5407.2 | 260011         |                                     |  |  |  |  |  |  |                | Hülsensatz     |
|                     | 1.6         | 61            |       | 09.88 | 12.96                         |                              |                | 83.6104-0462.3 | 330378         | 2                                   |  |  |  |  |  |  | L=460          |                |
|                     | 1.7         | 64            |       | 09.88 | 12.96                         |                              |                |                |                |                                     |  |  |  |  |  |  |                |                |
|                     | 1.7         | 70            |       | 08.88 | 07.89                         |                              |                |                |                |                                     |  |  |  |  |  |  |                |                |
|                     | 1.7         | 75            |       | 08.89 | 12.96                         |                              |                |                |                |                                     |  |  |  |  |  |  |                |                |
|                     | 1.7         | 78            |       | 09.88 | 12.96                         |                              |                |                |                |                                     |  |  |  |  |  |  |                |                |
|                     | 1.7 T       | 88            |       | 08.88 | 07.96                         |                              |                |                |                |                                     |  |  |  |  |  |  |                |                |
|                     | 1.7 T       | 90            |       | 01.91 | 12.96                         |                              |                |                |                |                                     |  |  |  |  |  |  |                |                |
|                     | 1.8         | 66            |       | 08.91 | 12.96                         |                              |                |                |                |                                     |  |  |  |  |  |  |                |                |
|                     | 1.9 TD      | 66            |       | 07.94 | 12.96                         |                              |                |                |                |                                     |  |  |  |  |  |  |                |                |
|                     | 2.0         | 80            |       | 08.93 | 07.96                         |                              |                |                |                |                                     |  |  |  |  |  |  |                |                |
|                     | 2.0         | 81            |       | 08.92 | 07.95                         |                              |                |                |                |                                     |  |  |  |  |  |  |                |                |
|                     |             | 1.6           | 61    |       | 09.88                         | 12.96                        |                |                | 11.0441-3303.2 | 250005                              |  |  |  |  |  |  |                |                |
| 1.7                 |             | 75            |       | 08.89 | 12.96                         |                              |                | 11.0101-5402.2 | 260009         |                                     |  |  |  |  |  |  |                | Hülsensatz     |
| 1.7                 |             | 78            |       | 09.88 | 12.96                         |                              |                | 11.8171-0008.1 | 990049         |                                     |  |  |  |  |  |  |                | Führungsbolzen |
| 1.7 T               |             | 88            |       | 08.88 | 07.96                         |                              |                | 11.8116-0047.1 | 390494         | 2                                   |  |  |  |  |  |  |                | Haltefeder     |
| 1.7 T               |             | 90            |       | 01.91 | 12.96                         |                              |                |                |                |                                     |  |  |  |  |  |  |                |                |
| 1.8                 |             | 66            |       | 08.91 | 12.96                         |                              |                |                |                |                                     |  |  |  |  |  |  |                |                |
| 1.9 TD              |             | 66            |       | 07.94 | 12.96                         |                              |                |                |                |                                     |  |  |  |  |  |  |                |                |
| 2.0                 |             | 81            |       | 08.92 | 07.95                         |                              |                |                |                |                                     |  |  |  |  |  |  |                |                |
| 1.6                 |             | 61            |       | 09.88 | 12.96                         | - ABS                        |                | 83.6104-0336.3 | 330451         | 2                                   |  |  |  |  |  |  |                | L=335          |
| 1.7                 |             | 64            |       | 09.88 | 12.96                         | - ABS                        |                |                |                |                                     |  |  |  |  |  |  |                |                |
| 1.7                 |             | 70            |       | 08.88 | 07.89                         | - ABS                        |                |                |                |                                     |  |  |  |  |  |  |                |                |
| 1.7                 |             | 75            |       | 08.89 | 12.96                         | - ABS/ + HA-Trommelbremse 1) |                |                |                |                                     |  |  |  |  |  |  |                |                |
| 1.7                 | 78          |               | 09.88 | 12.96 | - ABS/ + HA-Trommelbremse 1)  |                              |                |                |                |                                     |  |  |  |  |  |  |                |                |
| 1.8                 | 66          |               | 08.91 | 12.96 | - ABS/ + HA-Trommelbremse 1)  |                              |                |                |                |                                     |  |  |  |  |  |  |                |                |
| 1.9 TD              | 66          |               | 07.94 | 12.96 | - ABS/ + HA-Trommelbremse 1)  |                              |                |                |                |                                     |  |  |  |  |  |  |                |                |
| 2.0                 | 80          |               | 08.93 | 07.96 | - ABS                         |                              |                |                |                |                                     |  |  |  |  |  |  |                |                |
| 1.7                 | 64          |               | 09.88 | 08.92 | + ABS                         |                              | 83.6104-0295.3 | 330244         | 2              |                                     |  |  |  |  |  |  | L=295          |                |
| 1.7                 | 70          |               | 08.88 | 07.89 | + ABS                         |                              |                |                |                |                                     |  |  |  |  |  |  |                |                |
| 1.7                 | 75          |               | 08.89 | 08.92 | + ABS                         |                              |                |                |                |                                     |  |  |  |  |  |  |                |                |
| 1.7                 | 75          |               | 08.89 | 12.96 | - ABS/ + HA-Scheibenbremse 2) |                              |                |                |                |                                     |  |  |  |  |  |  |                |                |
| 1.7                 | 78          |               | 09.88 | 08.92 | + ABS                         |                              |                |                |                |                                     |  |  |  |  |  |  |                |                |
| 1.7                 | 78          |               | 09.88 | 12.96 | - ABS/ + HA-Scheibenbremse 2) |                              |                |                |                |                                     |  |  |  |  |  |  |                |                |
| 1.7 T               | 88          |               | 08.88 | 08.92 | + ABS                         |                              |                |                |                |                                     |  |  |  |  |  |  |                |                |
| 1.7 T               | 88          |               | 08.88 | 07.96 | - ABS                         |                              |                |                |                |                                     |  |  |  |  |  |  |                |                |
| 1.7 T               | 90          |               | 01.91 | 08.92 | + ABS                         |                              |                |                |                |                                     |  |  |  |  |  |  |                |                |

1) - ABS/ + RA drum brake / - ABS/ + P freno a tamburo / - ABS/ + fr. à tambour essieu AR / - ABS/ + ET tambores de freno

2) - ABS/ + RA disc brake / - ABS/ + P disco freno / - ABS/ + fr. à disque essieu AR / - ABS/ + ET disco de freno



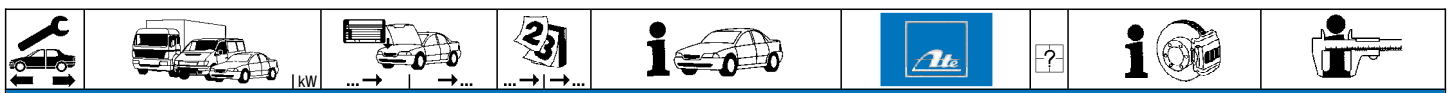

### VOLVO 440 (88-96)

|        |        |            |            |       |       |  |                |        |   |       |          |                |                |        |   |           |
|--------|--------|------------|------------|-------|-------|--|----------------|--------|---|-------|----------|----------------|----------------|--------|---|-----------|
|        | 1.7 T  | 90         |            | 01.91 | 12.96 | - ABS                                    | 83.6104-0295.3 | 330244 | 2 |       | L=295    |                |                |        |   |           |
|        | 1.8    | 66         |            | 08.91 | 08.92 | + ABS                                    |                |        |   |       |          |                |                |        |   |           |
|        | 1.8    | 66         |            | 08.91 | 12.96 | - ABS/ + HA-Scheibenbremse <sup>1)</sup> |                |        |   |       |          |                |                |        |   |           |
|        | 1.9 TD | 66         |            | 07.94 | 12.96 | - ABS/ + HA-Scheibenbremse <sup>1)</sup> |                |        |   |       |          |                |                |        |   |           |
|        | 2.0    | 81         |            | 08.92 | 07.95 | - ABS                                    |                |        |   |       |          |                |                |        |   |           |
|        | 1.6    | 61         |            | 09.92 | 12.96 | + ABS                                    |                |        |   |       |          | 83.6124-0285.3 | 330722         | 2      |   | L=285     |
|        | 1.7    | 64         |            | 09.92 | 12.96 | + ABS                                    |                |        |   |       |          |                |                |        |   |           |
|        | 1.7    | 75         |            | 09.92 | 12.96 | + ABS                                    |                |        |   |       |          |                |                |        |   |           |
|        | 1.7    | 78         |            | 09.92 | 12.96 | + ABS                                    |                |        |   |       |          |                |                |        |   |           |
|        | 1.7 T  | 88         |            | 09.92 | 07.96 | + ABS                                    |                |        |   |       |          |                |                |        |   |           |
| 1.7 T  | 90     |            | 09.92      | 12.96 | + ABS |  |                |        |   |       |          |                |                |        |   |           |
| 1.8    | 66     |            | 09.92      | 12.96 | + ABS |  |                |        |   |       |          |                |                |        |   |           |
| 1.9 TD | 66     |            | 07.94      | 12.96 | + ABS |  |                |        |   |       |          |                |                |        |   |           |
| 2.0    | 80     |            | 08.93      | 07.96 | + ABS |  |                |        |   |       |          |                |                |        |   |           |
| 2.0    | 81     |            | 09.92      | 07.95 | + ABS |  |                |        |   |       |          |                |                |        |   |           |
|        | 1.6    | 61         |            | 09.88 | 12.96 |  | 24.3220-1113.3 | 020224 |   |       | Rz 20,64 |                |                |        |   |           |
|        | 1.7    | 64         |            | 09.88 | 12.96 |  |                |        |   |       |          |                |                |        |   |           |
|        | 1.7    | 70         |            | 08.88 | 07.89 |  |                |        |   |       |          |                |                |        |   |           |
|        | 1.7    | 75         |            | 08.89 | 12.96 |  |                |        |   |       |          |                |                |        |   |           |
|        | 1.7    | 78         |            | 09.88 | 12.96 |  |                |        |   |       |          |                |                |        |   |           |
|        | 1.8    | 66         |            | 08.91 | 12.96 |  |                |        |   |       |          |                |                |        |   |           |
|        | 1.9 TD | 66         |            | 07.94 | 12.96 |  |                |        |   |       |          |                |                |        |   |           |
|        | 2.0    | 80         |            | 08.93 | 07.96 |  |                |        |   |       |          |                |                |        |   |           |
|        | 2.0    | 81         |            | 09.92 | 07.95 |  |                |        |   |       |          |                |                |        |   |           |
|        |        | 1.6        | 61         |       | 09.88 | 12.96                                    |                |        |   |       |          |                | 24.3727-1307.2 | 581307 | 2 | ↓         |
| 1.7    |        | 64         |            | 08.88 | 12.96 |  |                |        |   |       |          |                |                |        |   |           |
| 1.7    |        | 70         |            | 08.88 | 07.89 |  |                |        |   |       |          |                |                |        |   |           |
| 1.7    |        | 75         | ELC 165500 | 08.89 |       | + HA-Trommelbremse <sup>2)</sup>         |                |        |   |       |          |                |                |        |   |           |
| 1.7    |        | 78         |            | 09.88 | 12.96 | + HA-Trommelbremse <sup>2)</sup>         |                |        |   |       |          |                |                |        |   |           |
| 1.7    |        | 88         |            | 08.89 | 07.89 |  |                |        |   |       |          |                |                |        |   |           |
| 1.7 T  |        | 90         |            | 08.89 | 07.89 |  |                |        |   |       |          |                |                |        |   |           |
| 1.8    |        | 66         |            | 08.91 | 12.96 | + HA-Trommelbremse <sup>2)</sup>         |                |        |   |       |          |                |                |        |   |           |
| 1.9 TD |        | 66         | EMC 165501 | 07.94 | 12.96 | + HA-Trommelbremse <sup>2)</sup>         |                |        |   |       |          |                |                |        |   |           |
| 2.0    |        | 80         |            | 08.93 | 07.96 | + HA-Trommelbremse <sup>2)</sup>         |                |        |   |       |          |                |                |        |   |           |
|        | 1.7    | 75         | EMC 165501 |       | 12.96 | + HA-Scheibenbremse <sup>3)</sup>        | 24.3727-1310.2 | 581310 | 2 | ↓     | L=1338   |                |                |        |   |           |
|        | 1.7    | 78         | EMC 165501 |       | 12.96 | + HA-Scheibenbremse <sup>3)</sup>        |                |        |   |       |          |                |                |        |   |           |
|        | 1.7 T  | 88         | EMC 165501 |       | 07.96 | + HA-Scheibenbremse <sup>3)</sup>        |                |        |   |       |          |                |                |        |   |           |
|        | 1.7 T  | 90         | EMC 165501 |       | 12.96 | + HA-Scheibenbremse <sup>3)</sup>        |                |        |   |       |          |                |                |        |   |           |
|        | 1.8    | 66         |            | 08.91 | 12.96 | + HA-Scheibenbremse <sup>3)</sup>        |                |        |   |       |          |                |                |        |   |           |
|        | 1.9 TD | 66         |            | 07.94 | 12.96 | + HA-Scheibenbremse <sup>3)</sup>        |                |        |   |       |          |                |                |        |   |           |
|        | 2.0    | 81         |            | 08.92 | 07.95 | + HA-Scheibenbremse <sup>3)</sup>        |                |        |   |       |          |                |                |        |   |           |
|        | 1.6    | 61         |            | 09.88 | 08.92 | - ABS                                    |                |        |   |       |          | 03.0101-0014.2 | 320004         |        |   | BRES 3/25 |
|        | 1.7    | 64         |            | 09.88 | 08.92 | - ABS                                    |                |        |   |       |          |                |                |        |   |           |
|        | 1.7    | 70         |            | 08.88 | 07.89 | - ABS                                    |                |        |   |       |          |                |                |        |   |           |
| 1.7    | 75     |            | 08.89      | 08.92 | - ABS |  |                |        |   |       |          |                |                |        |   |           |
| 1.7    | 78     |            | 09.88      | 08.92 | - ABS |  |                |        |   |       |          |                |                |        |   |           |
| 1.7 T  | 88     |            | 08.88      | 08.92 | - ABS |  |                |        |   |       |          |                |                |        |   |           |
| 1.7 T  | 90     |            | 01.91      | 08.92 | - ABS |  |                |        |   |       |          |                |                |        |   |           |
| 1.8    | 66     |            | 08.91      | 08.92 | - ABS |  |                |        |   |       |          |                |                |        |   |           |
| 1.6    | 61     |            | 09.88      | 12.96 |       | 24.3728-1303.2                           | 591303         |        |   | L=782 |          |                |                |        |   |           |
| 1.7    | 64     | EMC 185081 |            | 12.96 |       |  |                |        |   |       |          |                |                |        |   |           |
| 1.7 T  | 88     | EMC 185081 |            | 07.96 |       |  |                |        |   |       |          |                |                |        |   |           |
| 1.7 T  | 90     |            | 01.91      | 12.96 |       |  |                |        |   |       |          |                |                |        |   |           |
| 1.8    | 66     |            | 08.91      | 12.96 |       |  |                |        |   |       |          |                |                |        |   |           |
| 2.0    | 80     |            | 08.93      | 07.96 |       |  |                |        |   |       |          |                |                |        |   |           |
| 2.0    | 81     |            | 08.92      | 07.95 |       |  |                |        |   |       |          |                |                |        |   |           |

















### VOLVO 460 (88-96)

|     |        |    |       |       |       |       |                |        |  |  |           |
|-----|--------|----|-------|-------|-------|-------|----------------|--------|--|--|-----------|
|     | 1.6    | 61 |       | 07.92 | 07.96 | - ABS | 24.2120-1702.3 | 010436 |  |  | Thz 20,64 |
|     | 1.7    | 64 |       | 09.88 | 07.96 | - ABS |                |        |  |  |           |
|     | 1.7    | 66 |       | 09.90 | 07.96 | - ABS |                |        |  |  |           |
|     | 1.7    | 75 |       | 08.89 | 07.92 |       |                |        |  |  |           |
|     | 1.7    | 80 |       | 08.89 | 07.92 |       |                |        |  |  |           |
|     | 1.7 T  | 88 |       | 08.89 | 07.96 | - ABS |                |        |  |  |           |
|     | 1.7 T  | 90 |       | 01.91 | 07.96 | - ABS |                |        |  |  |           |
|     | 1.8    | 66 |       | 08.91 | 07.96 | - ABS |                |        |  |  |           |
|     | 1.9 TD | 66 |       | 07.94 | 07.96 | - ABS |                |        |  |  |           |
|     | 2.0    | 80 |       | 08.93 | 07.96 | - ABS |                |        |  |  |           |
| 2.0 | 81     |    | 08.92 | 07.95 | - ABS |       |                |        |  |  |           |
|     | 1.6    | 61 |       | 07.92 | 07.96 | - ABS | 24.2120-1702.3 | 010436 |  |  | Thz 20,64 |
|     | 1.7    | 64 |       | 09.88 | 07.96 | - ABS |                |        |  |  |           |
|     | 1.7    | 66 |       | 09.90 | 07.96 | - ABS |                |        |  |  |           |
|     | 1.7    | 75 |       | 08.89 | 07.92 |       |                |        |  |  |           |
|     | 1.7    | 80 |       | 08.89 | 07.92 |       |                |        |  |  |           |
|     | 1.7 T  | 88 |       | 08.89 | 07.96 | - ABS |                |        |  |  |           |
|     | 1.7 T  | 90 |       | 01.91 | 07.96 | - ABS |                |        |  |  |           |
|     | 1.8    | 66 |       | 08.91 | 07.96 | - ABS |                |        |  |  |           |
|     | 1.9 TD | 66 |       | 07.94 | 07.96 | - ABS |                |        |  |  |           |
|     | 2.0    | 80 |       | 08.93 | 07.96 | - ABS |                |        |  |  |           |
| 2.0 | 81     |    | 08.92 | 07.95 | - ABS |       |                |        |  |  |           |
|     | 1.6    | 61 |       | 09.92 | 07.96 | + ABS | 10.6120-0287.3 | 010334 |  |  | Thz 20,64 |
|     | 1.7    | 64 |       | 09.92 | 07.96 | + ABS |                |        |  |  |           |
|     | 1.7    | 66 |       | 09.92 | 07.96 | + ABS |                |        |  |  |           |
|     | 1.7 T  | 88 |       | 09.92 | 07.96 | + ABS |                |        |  |  |           |
|     | 1.7 T  | 90 |       | 09.92 | 07.96 | + ABS |                |        |  |  |           |
|     | 1.8    | 66 |       | 09.92 | 07.96 | + ABS |                |        |  |  |           |
|     | 1.9 TD | 66 |       | 07.94 | 07.96 | + ABS |                |        |  |  |           |
|     | 2.0    | 80 |       | 08.93 | 07.96 | + ABS |                |        |  |  |           |
|     | 2.0    | 81 |       | 08.93 | 07.96 | + ABS |                |        |  |  |           |

<sup>1)</sup> - ABS/ + RA disc brake / - ABS/ + P disco freno / - ABS/ + fr. à disque essieu AR / - ABS/ + ET disco de freno

<sup>2)</sup> + RA drum brake / + P freno a tamburo / + frein à tambour essieu AR / + ET-tambores de freno

<sup>3)</sup> + RA disc brake / + P disco freno / + frein à disque essieu AR / + ET-disco de freno

|     |  |  |  |  |  |  |  |  |                |     |
|--|--|--|--|--|---|--|--|--|----------------|-----|
| <b>VOLVO 460 (88-96)</b>   |  |  |  |  |   |  |  |  |                |     |
|    | 2.0  | 81   |  | 09.92  | 07.95   | + ABS  | 10.6120-0287.3   | 010334   | Thz 20,64      | ATE |
|    | 1.6  | 61   |  | 07.92  | 07.96   |  | 24.3541-1723.5   | 240077   | D=54, - Halter | LUC |
|  | 1.7  | 64   | EKC 006387   |  | 07.96   |  | 24.0101-3601.2   | 260044   | Einbausatz     | LUC |
|  | 1.7  | 66   | EKC 006387   |  | 07.96   |  |  |  |                |     |
|  | 1.7  | 75   | EKC 006387   |  | 07.92   |  |  |  |                |     |
|  | 1.7  | 80   | EKC 006387   |  | 07.92   |  |  |  |                |     |
|  | 1.8  | 66   |  | 08.91  | 07.96   |  |  |  |                |     |
|  | 1.9 TD   | 66   |  | 07.94  | 07.96   |  |  |  |                |     |
|  | 2.0  | 80   | EKC 006387   |  | 07.96   |  |  |  |                |     |
|  | 2.0  | 81   |  | 08.92  | 07.95   |  |  |  |                |     |
|  | 1.7 T  | 88   |  | 08.89  | 07.96   |  | 11.9541-9806.2   | 220504   | D=54, - Halter | ATE |
|  | 1.7 T  | 90   |  | 01.91  | 07.96   |  | 11.8116-0073.1   | 390498   | Haltefeder     | ATE |
|  | 2.0  | 80   |  | 08.93  | 07.96   |  | 11.8171-0008.1   | 990049   | Führungsbolzen | ATE |
|  | 2.0  | 81   |  | 08.92  | 07.95   |  | 11.0101-5407.2   | 260011   | Hülzensatz     | ATE |
|    | 1.6  | 61   |  | 07.92  | 07.96   |  | 83.6104-0462.3   | 330378   | L=460          |     |
|  | 1.7  | 64   |  | 09.88  | 07.96   |  |  |  |                |     |
|  | 1.7  | 66   |  | 09.90  | 07.96   |  |  |  |                |     |
|  | 1.7  | 75   |  | 08.89  | 07.92   |  |  |  |                |     |
|  | 1.7  | 80   |  | 08.89  | 07.92   |  |  |  |                |     |
|  | 1.7 T  | 88   |  | 08.89  | 07.96   |  |  |  |                |     |
|  | 1.7 T  | 90   |  | 01.91  | 07.96   |  |  |  |                |     |
|  | 1.8  | 66   |  | 08.91  | 07.96   |  |  |  |                |     |
|  | 1.9 TD   | 66   |  | 07.94  | 07.96   |  |  |  |                |     |
|  | 2.0  | 80   |  | 08.93  | 07.96   |  |  |  |                |     |
|  | 2.0  | 81   |  | 08.92  | 07.95   |  |  |  |                |     |
|    | 1.7  | 75   |  | 08.89  | 07.92   |  | 11.0441-3303.2   | 250005   | Dichtungssatz  | ATE |
|  | 1.7  | 80   |  | 08.89  | 07.92   |  | 11.0101-5402.2   | 260009   | Hülzensatz     | ATE |
|  | 1.7 T  | 88   |  | 08.89  | 07.96   |  | 11.8171-0008.1   | 990049   | Führungsbolzen | ATE |
|  | 1.7 T  | 90   |  | 01.91  | 07.96   |  | 11.8116-0047.1   | 390494   | Haltefeder     | ATE |
|  | 1.8  | 66   |  | 08.91  | 07.96   |  |  |  |                |     |
|  | 1.9 TD   | 66   |  | 07.94  | 07.96   |  |  |  |                |     |
|  | 2.0  | 81   |  | 08.92  | 07.95   |  |  |  |                |     |
|    | 1.6  | 61   |  | 07.92  | 07.96   | - ABS  | 83.6104-0336.3   | 330451   | L=335          |     |
|  | 1.7  | 64   |  | 09.88  | 07.96   | - ABS  |  |  |                |     |
|  | 1.7  | 66   |  | 09.90  | 07.96   | - ABS  |  |  |                |     |
|  | 1.7  | 75   |  | 08.89  | 07.92   | - ABS/ + HA-Trommelbremse 1)   |  |  |                |     |
|  | 1.7  | 80   |  | 08.89  | 07.92   | - ABS/ + HA-Trommelbremse 1)   |  |  |                |     |
|  | 1.8  | 66   |  | 08.91  | 07.96   | - ABS/ + HA-Trommelbremse 1)   |  |  |                |     |
|  | 1.9 TD   | 66   |  | 07.94  | 07.96   | - ABS/ + HA-Trommelbremse 1)   |  |  |                |     |
|  | 2.0  | 80   |  | 08.93  | 07.96   | - ABS  |  |  |                |     |
|  | 1.6  | 61   |  | 07.92  | 08.92   | + ABS  | 83.6104-0295.3   | 330244   | L=295          |     |
|  | 1.7  | 64   |  | 09.88  | 08.92   | + ABS  |  |  |                |     |
|  | 1.7  | 66   |  | 09.90  | 08.92   | + ABS  |  |  |                |     |
|  | 1.7  | 75   |  | 08.89  | 07.92   | + ABS  |  |  |                |     |
|  | 1.7  | 75   |  | 08.89  | 07.92   | - ABS/ + HA-Scheibenbremse 2)  |  |  |                |     |
|  | 1.7  | 80   |  | 08.89  | 07.92   | + ABS  |  |  |                |     |
|  | 1.7  | 80   |  | 08.89  | 07.92   | - ABS/ + HA-Scheibenbremse 2)  |  |  |                |     |
|  | 1.8  | 66   |  | 08.91  | 08.92   | + ABS  |  |  |                |     |
|  | 1.8  | 66   |  | 08.91  | 07.96   | - ABS/ + HA-Scheibenbremse 2)  |  |  |                |     |
|  | 1.9 TD   | 66   |  | 07.94  | 07.96   | - ABS/ + HA-Scheibenbremse 2)  |  |  |                |     |
|  | 1.6  | 61   |  | 09.92  | 07.96   | + ABS  | 83.6124-0285.3   | 330722   | L=285          |     |
|  | 1.7  | 64   |  | 09.92  | 07.96   | + ABS  |  |  |                |     |
|  | 1.7  | 66   |  | 09.92  | 07.96   | + ABS  |  |  |                |     |
|  | 1.7 T  | 88   |  | 09.92  | 07.96   | + ABS  |  |  |                |     |
|  | 1.7 T  | 90   |  | 08.92  | 07.96   | + ABS  |  |  |                |     |
|  | 1.8  | 66   |  | 09.92  | 07.96   | + ABS  |  |  |                |     |
|  | 1.9 TD   | 66   |  | 07.94  | 07.96   | + ABS  |  |  |                |     |
|  | 2.0  | 80   |  | 08.93  | 07.96   | + ABS  |  |  |                |     |
|  | 2.0  | 81   |  | 09.92  | 07.95   | + ABS  |  |  |                |     |
|  | 1.6  | 61   |  | 07.92  | 07.96   |  | 24.3220-1113.3   | 020224   | Rz 20,64       |     |
|  | 1.7  | 64   |  | 09.88  | 07.96   |  | 24.3220-1114.3   | 020225   | Rz 20,64       |     |
|  | 1.7  | 66   |  | 09.90  | 07.96   |  |  |  |                |     |
|  | 1.7  | 75   |  | 08.89  | 07.92   |  |  |  |                |     |
|  | 1.7  | 80   |  | 08.89  | 07.92   |  |  |  |                |     |
|  | 1.8  | 66   |  | 08.91  | 07.96   |  |  |  |                |     |
|  | 1.9 TD   | 66   |  | 07.94  | 07.96   |  |  |  |                |     |
|  | 2.0  | 80   |  | 08.93  | 07.96   |  |  |  |                |     |
|  | 1.7  | 64   | ELC 165500   | 09.88  |   |  | 24.3727-1307.2   | 581307   | L=1365         |     |
|  | 1.7  | 66   | ELC 165500   | 09.90  |   |  |  |  |                |     |
|  | 1.7  | 75   | ELC 165500   | 08.89  |   | + HA-Trommelbremse 3)  |  |  |                |     |
|  | 1.7  | 80   | ELC 165500   | 08.89  |   | + HA-Trommelbremse 3)  |  |  |                |     |
|  | 1.6  | 61   |  | 07.92  | 07.96   |  | 24.3727-1310.2   | 581310   | L=1338         |     |
|  | 1.7  | 64   | ELC 165501   |  | 07.96   |  |  |  |                |     |
|  | 1.7  | 66   | ELC 165501   |  | 07.96   |  |  |  |                |     |
|  | 1.7  | 75   | ELC 165501   |  | 07.92   | + HA-Trommelbremse 3)  |  |  |                |     |
|  | 1.7  | 80   | ELC 165501   |  | 07.92   | + HA-Trommelbremse 3)  |  |  |                |     |
|  | 1.8  | 66   |  | 08.91  | 07.96   | + HA-Trommelbremse 3)  |  |  |                |     |
|  | 1.9 TD   | 66   |  | 07.94  | 07.96   | + HA-Trommelbremse 3)  |  |  |                |     |
|  | 2.0  | 80   |  | 08.93  | 07.96   |  |  |  |                |     |
|  | 1.7  | 75   | ELC 165501   |  | 07.92   | + HA-Scheibenbremse 4)   | 24.3727-1309.2   | 581309   | L=1424         |     |
|  | 1.7  | 80   | ELC 165501   |  | 07.92   | + HA-Scheibenbremse 4)   |  |  |                |     |
|  | 1.7 T  | 88   | ELC 165501   |  | 07.96   |  |  |  |                |     |
|  | 1.7 T  | 90   |  | 01.91  | 07.96   |  |  |  |                |     |
|  | 1.8  | 66   |  | 08.91  | 07.96   | + HA-Scheibenbremse 4)   |  |  |                |     |



















1) - ABS/ + RA drum brake / - ABS/ + P freno a tamburo / - ABS/ + fr. à tambour essieu AR / - ABS/ + ET tambores de freno

2) - ABS/ + RA disc brake / - ABS/ + P disco freno / - ABS/ + fr. à disque essieu AR / - ABS/ + ET disco de freno





















3) + RA drum brake / + P freno a tamburo / + frein à tambour essieu AR / + ET-tambores de freno

4) + RA disc brake / + P disco freno / + frein à disque essieu AR / + ET-disco de freno



|     |  |                                 |  |                 |                |               |  |  |        |  |
|--|--|---|--|---|---|---|--|--|--------|--|
| <b>VOLVO 460 (88-96)</b>   |  |   |  |   |   |   |  |  |        |  |
|    | 1.9 TD<br>2.0  | 66<br>81  |  | 07.94<br>08.92  | 07.96<br>07.95  | + HA-Scheibenbremse <sup>1)</sup>   | 24.3727-1309.2   | 581309   | 2 ↓    | L=1424   |
|    | 1.6<br>1.7<br>1.7<br>1.7<br>1.7<br>1.7 T<br>1.7 T<br>1.8<br>2.0                  | 61<br>64<br>66<br>75<br>80<br>88<br>90<br>66<br>81  |  | 07.92<br>09.88<br>09.90<br>08.89<br>08.89<br>08.89<br>01.91<br>08.91<br>08.92                   | 08.92<br>08.92<br>08.92<br>07.92<br>07.92<br>08.92<br>08.92<br>08.92<br>08.92                   | - ABS<br>- ABS<br>- ABS<br>- ABS<br>- ABS<br>- ABS<br>- ABS<br>- ABS<br>- ABS                   | 03.0101-0014.2   | 320004   |        | BRES 3/25<br>ATE   |
|    | 1.6<br>1.7<br>1.7<br>1.7<br>1.7<br>1.7 T<br>1.7 T<br>1.8<br>2.0<br>2.0           | 61<br>64 EMC 185081<br>66 EMC 185081<br>75 EMC 185081<br>80 EMC 185081<br>88 EMC 185081<br>90<br>66<br>80<br>81 |  | 07.92<br>07.96<br>07.96<br>07.92<br>07.92<br>07.96<br>01.91<br>08.91<br>08.93<br>08.92          | 07.96<br>07.96<br>07.96<br>07.92<br>07.92<br>07.96<br>07.96<br>07.96<br>07.96<br>07.95          |   | 24.3728-1303.2   | 591303   |        | L=782  |
| <b>VOLVO 480 (86-96)</b>   |  |   |  |   |   |   |  |  |        |  |
|    | 1.7<br>1.7<br>1.7<br>1.7<br>1.7 T<br>1.7 T<br>2.0                                | 70<br>75<br>78<br>80<br>88<br>90<br>81  |  | 08.87<br>08.89<br>04.86<br>08.86<br>08.87<br>01.91<br>08.92                                     | 07.89<br>07.96<br>07.89<br>07.88<br>07.96<br>07.96<br>09.95                                     | - ABS   | 24.2120-1702.3   | 010436   |        | THz 20,64  |
|  | 1.7<br>1.7<br>1.7<br>1.7 T<br>1.7 T<br>2.0                                       | 70<br>75<br>78<br>80<br>88<br>90<br>81  |  | 08.87<br>08.89<br>04.86<br>08.86<br>08.87<br>01.91<br>08.92                                     | 07.89<br>07.96<br>07.89<br>07.88<br>07.96<br>07.96<br>09.95                                     | - ABS   | 24.2120-1702.3   | 010436   |        | THz 20,64  |
|  | 1.7<br>1.7 T<br>1.7 T<br>2.0   | 75<br>88<br>90<br>81  |  | 09.92<br>09.92<br>09.92<br>09.92  | 07.96<br>07.96<br>07.96<br>09.95  | + ABS<br>+ ABS<br>+ ABS<br>+ ABS  | 10.6120-0287.3   | 010334   |        | THz 20,64<br>ATE   |
|  | 1.7<br>1.7<br>1.7 T<br>1.7 T<br>2.0  | 70 EKC 538520<br>75<br>78 EKC 538520<br>88<br>90<br>81  |  | 08.89<br>08.87<br>01.91<br>08.92  | 07.96<br>07.89<br>07.96<br>09.95  |   | 24.3541-1723.5<br>24.0101-3601.2   | 240077<br>260044   | ☐      | D=54, - Halter<br>Einbausatz<br>LUC<br>LUC   |
|  | 1.7 T<br>1.7 T<br>2.0  | 88<br>90<br>81  |  | 08.87<br>01.91<br>08.92   | 07.96<br>07.96<br>09.95   |   | 11.9541-9806.2<br>11.8116-0073.1<br>11.8171-0008.1<br>11.0101-5407.2               | 220504<br>390498<br>990049<br>260011   | ☐<br>2 | D=54, - Halter<br>Haltefeder<br>Führungsbolzen<br>Hülzensatz<br>ATE<br>ATE<br>ATE<br>ATE |
|  | 1.7<br>1.7<br>1.7<br>1.7<br>1.7 T<br>1.7 T<br>2.0                                | 70<br>75<br>78<br>80<br>88<br>90<br>81  |  | 08.87<br>08.89<br>09.86<br>08.86<br>08.86<br>01.91<br>08.92                                     | 07.89<br>07.96<br>07.89<br>07.88<br>07.96<br>07.96<br>09.95                                     |   | 83.6104-0462.3   | 330378   | 2      | L=460  |
|  | 1.7<br>1.7<br>1.7<br>1.7<br>1.7 T<br>1.7 T<br>2.0                                | 70<br>75<br>78<br>80<br>88<br>90<br>81  |  | 08.87<br>08.89<br>04.86<br>08.86<br>08.87<br>01.91<br>08.92                                     | 07.89<br>07.96<br>07.89<br>07.88<br>07.96<br>07.96<br>09.95                                     |   | 11.0441-3303.2<br>11.0101-5402.2<br>11.8171-0008.1<br>11.8116-0047.1               | 250005<br>260009<br>990049<br>390494   | 2      | Dichtungssatz<br>Hülzensatz<br>Führungsbolzen<br>Haltefeder<br>ATE<br>ATE<br>ATE<br>ATE  |
|  | 1.7<br>1.7<br>1.7<br>1.7<br>1.7<br>1.7<br>1.7 T<br>1.7 T<br>1.7 T<br>2.0         | 70<br>70<br>75<br>78<br>78<br>80<br>80<br>88<br>88<br>90<br>81  | EJC 522771<br>EJC 522771<br>EJC 522771<br>EJC 522771                             | 08.87<br>08.87<br>08.89<br>04.86<br>04.86<br>08.86<br>08.86<br>08.87<br>08.87<br>01.91<br>08.92 | 07.89<br>07.89<br>07.96<br>07.89<br>07.89<br>07.88<br>07.88<br>07.96<br>07.96<br>07.96<br>09.95 | - ABS<br>+ ABS<br>+ ABS<br>- ABS<br>+ ABS<br>- ABS<br>+ ABS<br>- ABS<br>+ ABS<br>+ ABS<br>+ ABS | 83.6124-0285.3   | 330722   | 2      | L=285  |
|  | 1.7<br>1.7<br>1.7<br>1.7 T<br>1.7 T<br>2.0                                       | 70<br>75<br>78<br>80<br>88<br>90<br>81  | EJC 522772<br>EJC 522772<br>EJC 522772<br>EJC 522772                             | 08.89<br>08.89<br>07.88<br>01.91<br>08.92   | 07.89<br>07.96<br>07.89<br>07.96<br>07.96<br>09.95  | - ABS<br>- ABS<br>- ABS<br>- ABS<br>- ABS<br>- ABS  | 83.6104-0295.3   | 330244   | 2      | L=295  |
|  | 1.7<br>1.7 T<br>1.7 T<br>2.0   | 75<br>88<br>90<br>81  |  | 09.90<br>09.90<br>01.91<br>08.92  | 07.96<br>07.96<br>07.96<br>09.95  |   | 24.3727-1309.2   | 581309   | 2 ↓    | L=1424   |

<sup>1)</sup> + RA disc brake / + P disco freno / + frein à disque essieu AR / + ET-disco de freno

|     |  |  |  |  |  |  |    |  |   |
|--|--|--|--|--|---|--|--|--|---|
| <b>VOLVO 480 (86-96)</b>   |  |  |  |  |   |  |  |  |   |
|    | 1.7<br>1.7<br>1.7<br>1.7<br>1.7 T<br>1.7 T                                       | 70<br>75<br>78<br>80<br>88<br>90   |  | 08.87<br>08.89<br>04.86<br>08.86<br>08.87<br>01.91                               | 08.92<br>08.92<br>07.89<br>07.88<br>08.92<br>08.92                                | - ABS<br>- ABS<br>- ABS<br>- ABS<br>- ABS<br>- ABS                                 | 03.0101-0014.2<br>320004   |  | BRES 3/25<br>ATE  |
|    | 1.7<br>1.7 T<br>1.7 T<br>2.0   | 75 EMC 565117<br>88 EMC 565117<br>90<br>81                                       |  |  | 07.96<br>07.96<br>01.91<br>08.92  |  | 24.3728-1303.2<br>591303   |  | L=782   |
| <b>VOLVO 850 Limousine (91-96)</b>   |  |  |  |  |   |  |  |  |   |
|    | 2.0<br>2.0<br>2.0 T<br>2.3 T5<br>2.3 T5 R<br>2.5<br>2.5<br>2.5<br>2.5 TDI        | 93<br>105<br>155<br>166<br>184<br>103<br>106<br>125<br>103                       |  | 08.94<br>06.91<br>08.93<br>08.93<br>08.95<br>09.93<br>08.94<br>09.93<br>08.95    | 08.95<br>08.95<br>08.95<br>08.95<br>08.95<br>07.94<br>08.95<br>08.95<br>08.95     |  | 10.6360-1602.4<br>300194   |  | 10"<br>ATE  |
|    | 2.0<br>2.0<br>2.0 T<br>2.3 T5<br>2.3 T5 R<br>2.5<br>2.5<br>2.5 TDI               | 93<br>105<br>155<br>166<br>184<br>106<br>125<br>103                              |  | 09.95<br>09.95<br>09.95<br>09.95<br>09.95<br>09.95<br>09.95<br>09.95             | 12.96<br>12.96<br>12.96<br>07.96<br>12.96<br>12.96<br>12.96<br>12.96              |  | 03.7760-3602.4<br>300176   |  | 10"<br>ATE  |
|  | 2.0<br>2.0<br>2.0 T<br>2.3 T5<br>2.3 T5 R<br>2.5<br>2.5<br>2.5 TDI               | 93<br>105<br>155<br>166<br>184<br>103<br>106<br>125<br>103                       |  | 08.94<br>06.91<br>08.93<br>08.93<br>08.95<br>06.91<br>08.94<br>08.91<br>08.95    | 08.95<br>08.95<br>08.95<br>08.95<br>08.95<br>07.94<br>08.95<br>08.95<br>08.95     |  | 10.6123-0446.4<br>010336   |  | THz 23,81 (MKIV)<br>ATE   |
|  | 2.0<br>2.0<br>2.0 T<br>2.3 T5<br>2.3 T5 R<br>2.5<br>2.5<br>2.5 TDI               | 93<br>105<br>155<br>166<br>184<br>103<br>106<br>125<br>103                       |  | 09.95<br>09.95<br>09.95<br>09.95<br>09.95<br>09.95<br>09.95<br>09.95             | 12.96<br>12.96<br>12.96<br>07.96<br>12.96<br>12.96<br>12.96<br>12.96              |  | 03.2023-1084.3<br>03.2023-1044.3<br>010591<br>010590   | - ASR<br>+ ASR   | THz 23,81/20,64<br>THz 23,81/20,64<br>ATE<br>ATE  |
|  | 2.0<br>2.0<br>2.0 T<br>2.3 T5<br>2.3 T5 R<br>2.5<br>2.5<br>2.5<br>2.5 TDI        | 93<br>105<br>155<br>166<br>184<br>103<br>106<br>125<br>103                       |  | 08.94<br>06.91<br>08.93<br>08.93<br>08.95<br>06.91<br>08.94<br>08.91<br>08.95    | 12.96<br>12.96<br>12.96<br>07.96<br>12.96<br>07.94<br>12.96<br>12.96<br>12.96     |  | 11.9571-9971.2<br>11.9571-9972.2<br>11.0441-5702.2<br>11.0101-5407.2<br>11.8171-0008.1<br>11.8116-0073.1<br>220605<br>220606<br>250033<br>260011<br>990049<br>390498 | 2  | D=57, - Halter<br>D=57, - Halter<br>Dichtungssatz<br>Hülzensatz<br>Führungsbolzen<br>Haltefeder<br>ATE<br>ATE<br>ATE<br>ATE<br>ATE<br>ATE |
|  | 2.0<br>2.0<br>2.0 T<br>2.3 T5<br>2.3 T5 R<br>2.5<br>2.5<br>2.5<br>2.5 TDI        | 93<br>105<br>155<br>166<br>184<br>103<br>106<br>125<br>103                       |  | 08.94<br>06.91<br>08.93<br>08.93<br>08.95<br>06.91<br>08.94<br>08.91<br>08.95    | 12.96<br>12.96<br>12.96<br>07.96<br>12.96<br>07.94<br>12.96<br>12.96<br>12.96     |  | 83.6134-0335.3<br>330277   | 2  | L=335   |
|  | 2.0<br>2.0<br>2.0 T<br>2.3 T5<br>2.5<br>2.5<br>2.5<br>2.5 TDI                    | 93<br>105<br>155<br>166<br>103<br>106<br>125<br>103                              |  | 08.94<br>06.91<br>08.93<br>08.93<br>06.91<br>08.94<br>08.91<br>08.95             | 12.96<br>12.96<br>12.96<br>07.96<br>07.94<br>12.96<br>12.96<br>12.96              |  | 13.2381-0097.2<br>13.2381-0098.2<br>24.9238-0097.5<br>24.9238-0098.5<br>13.0441-3815.2<br>13.0441-3819.2<br>210239<br>210240<br>230037<br>230038<br>250069<br>250072 | für Vorg. 13.2381-0065/-0066.2 <sup>1)</sup>                                       | D=38<br>D=38<br>D=38<br>D=38<br>Dichtungssatz<br>Dichtungssatz<br>ATE<br>ATE<br>ATE<br>ATE<br>ATE<br>ATE                                  |
|  | 2.3 T5 R   | 184  |  | 08.95  | 12.96   |  | 13.2381-0097.2<br>13.2381-0098.2<br>13.0441-3819.2<br>210239<br>210240<br>250072   |  | D=38<br>D=38<br>Dichtungssatz<br>ATE<br>ATE<br>ATE  |
|  | 2.0<br>2.0<br>2.0 T<br>2.3 T5<br>2.3 T5 R<br>2.5<br>2.5<br>2.5<br>2.5 TDI        | 93<br>105<br>155<br>166<br>184<br>103<br>106<br>125<br>103                       |  | 08.94<br>06.91<br>08.93<br>08.93<br>08.95<br>06.91<br>08.94<br>08.91<br>08.95    | 12.96<br>12.96<br>12.96<br>07.96<br>12.96<br>07.94<br>12.96<br>12.96<br>12.96     |  | 83.6204-0200.3<br>330306   | 2  | L=200   |

<sup>1)</sup> f.predec.13.2381-0065/-0066.2 / p.prece.13.2381-0065.2/-0066.2 / p.préd.13.2381-0065.2/-0066.2 / p. prede.13.2381-0065.2/-0066.2



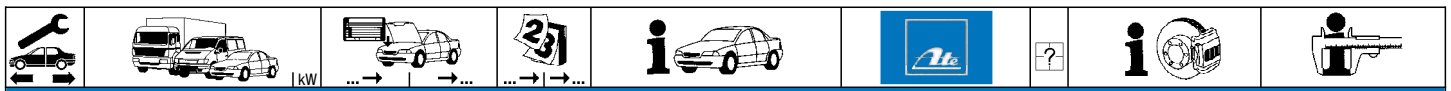

**VOLVO 850 Limousine (91-96)**

|  |          |     |        |       |       |                |        |   |  |                 |
|--|----------|-----|--------|-------|-------|----------------|--------|---|--|-----------------|
|  | 2.0      | 93  |        | 08.94 | 12.96 | 24.3727-1308.2 | 581308 | 2 |  | L=1670          |
|  | 2.0      | 105 |        | 06.91 | 12.96 |                |        |   |  |                 |
|  | 2.0 T    | 155 |        | 08.93 | 12.96 |                |        |   |  |                 |
|  | 2.3 T5   | 166 |        | 08.93 | 12.96 |                |        |   |  |                 |
|  | 2.3 T5 R | 184 |        | 08.95 | 04.96 |                |        |   |  |                 |
|  | 2.5      | 103 | 047066 |       | 07.94 |                |        |   |  |                 |
|  | 2.5      | 106 |        | 08.94 | 12.96 |                |        |   |  |                 |
|  | 2.5      | 125 | 047066 |       | 12.96 |                |        |   |  |                 |
|  | 2.5 TDI  | 103 |        | 08.95 | 12.96 |                |        |   |  |                 |
|  | 2.0      | 93  |        | 08.94 | 08.95 | 03.6055-0430.3 | 320065 |   |  | BR 5/25 (4) ATE |
|  | 2.0      | 105 |        | 06.91 | 08.95 |                |        |   |  |                 |
|  | 2.0 T    | 155 |        | 08.93 | 08.95 |                |        |   |  |                 |
|  | 2.3 T5   | 166 |        | 08.93 | 08.95 |                |        |   |  |                 |
|  | 2.3 T5 R | 184 |        | 08.95 | 08.95 |                |        |   |  |                 |
|  | 2.5      | 103 |        | 06.91 | 07.94 |                |        |   |  |                 |
|  | 2.5      | 106 |        | 08.94 | 08.95 |                |        |   |  |                 |
|  | 2.5      | 125 |        | 08.91 | 08.95 |                |        |   |  |                 |
|  | 2.5 TDI  | 103 |        | 08.95 | 08.95 |                |        |   |  |                 |
|  | 2.0      | 93  |        | 08.94 | 12.96 | 24.2419-0939.3 | 030065 |   |  | Gz 19,05        |
|  | 2.0      | 105 |        | 06.91 | 12.96 |                |        |   |  |                 |
|  | 2.0 T    | 155 |        | 08.93 | 12.96 |                |        |   |  |                 |
|  | 2.3 T5   | 166 |        | 08.93 | 07.96 |                |        |   |  |                 |
|  | 2.3 T5 R | 184 |        | 08.95 | 12.96 |                |        |   |  |                 |
|  | 2.5      | 103 |        | 06.91 | 07.94 |                |        |   |  |                 |
|  | 2.5      | 106 |        | 08.94 | 12.96 |                |        |   |  |                 |
|  | 2.5      | 125 |        | 08.91 | 12.96 |                |        |   |  |                 |
|  | 2.5 TDI  | 103 |        | 08.95 | 12.96 |                |        |   |  |                 |
|  | 2.0      | 93  |        | 08.94 | 12.96 | 24.2522-0907.3 | 040043 |   |  | Nz 22,20        |
|  | 2.0      | 105 |        | 06.91 | 12.96 |                |        |   |  |                 |
|  | 2.0 T    | 155 |        | 08.93 | 12.96 |                |        |   |  |                 |
|  | 2.3 T5   | 166 |        | 08.93 | 07.96 |                |        |   |  |                 |
|  | 2.5      | 103 |        | 06.91 | 07.94 |                |        |   |  |                 |
|  | 2.5      | 106 |        | 08.94 | 12.96 |                |        |   |  |                 |
|  | 2.5      | 125 |        | 08.91 | 12.96 |                |        |   |  |                 |
|  | 2.5 TDI  | 103 |        | 08.95 | 12.96 |                |        |   |  |                 |

**VOLVO 850 Kombi (92-96)**

|  |          |     |  |       |       |                |        |   |  |                      |
|--|----------|-----|--|-------|-------|----------------|--------|---|--|----------------------|
|  | 2.0      | 93  |  | 08.94 | 08.95 | 10.6360-1602.4 | 300194 |   |  | 10" ATE              |
|  | 2.0      | 105 |  | 02.93 | 08.95 |                |        |   |  |                      |
|  | 2.0 T    | 155 |  | 02.93 | 08.95 |                |        |   |  |                      |
|  | 2.3 T5   | 166 |  | 02.93 | 08.95 |                |        |   |  |                      |
|  | 2.3 T5 R | 184 |  | 08.95 | 08.95 |                |        |   |  |                      |
|  | 2.5      | 103 |  | 09.93 | 07.94 |                |        |   |  |                      |
|  | 2.5      | 106 |  | 08.94 | 08.95 |                |        |   |  |                      |
|  | 2.5      | 125 |  | 09.93 | 08.95 |                |        |   |  |                      |
|  | 2.5 TDI  | 103 |  | 08.95 | 08.95 |                |        |   |  |                      |
|  | 2.0      | 93  |  | 09.95 | 12.96 | 03.7760-3602.4 | 300176 |   |  | 10" ATE              |
|  | 2.0      | 105 |  | 09.95 | 12.96 |                |        |   |  |                      |
|  | 2.0 T    | 155 |  | 09.95 | 12.95 |                |        |   |  |                      |
|  | 2.3 T5   | 166 |  | 09.95 | 12.96 |                |        |   |  |                      |
|  | 2.3 T5 R | 184 |  | 09.95 | 12.96 |                |        |   |  |                      |
|  | 2.5      | 106 |  | 09.95 | 12.96 |                |        |   |  |                      |
|  | 2.5      | 125 |  | 09.85 | 12.96 |                |        |   |  |                      |
|  | 2.5 AWD  | 142 |  | 04.96 | 12.96 |                |        |   |  |                      |
|  | 2.5 TDI  | 103 |  | 09.95 | 12.96 |                |        |   |  |                      |
|  | 2.0      | 93  |  | 08.94 | 08.95 | 10.6123-0446.4 | 010336 |   |  | Thz 23,81 (MKIV) ATE |
|  | 2.0      | 105 |  | 02.93 | 08.95 |                |        |   |  |                      |
|  | 2.0 T    | 155 |  | 02.93 | 08.95 |                |        |   |  |                      |
|  | 2.3 T5   | 166 |  | 02.93 | 08.95 |                |        |   |  |                      |
|  | 2.3 T5 R | 184 |  | 08.95 | 08.95 |                |        |   |  |                      |
|  | 2.5      | 103 |  | 08.92 | 07.94 |                |        |   |  |                      |
|  | 2.5      | 106 |  | 08.94 | 08.95 |                |        |   |  |                      |
|  | 2.5      | 125 |  | 09.92 | 08.95 |                |        |   |  |                      |
|  | 2.5 TDI  | 103 |  | 08.95 | 08.95 |                |        |   |  |                      |
|  | 2.0      | 93  |  | 09.95 | 12.96 | 03.2023-1084.3 | 010591 |   |  | Thz 23,81/20,64 ATE  |
|  | 2.0      | 105 |  | 09.95 | 12.96 | 03.2023-1044.3 | 010590 |   |  | Thz 23,81/20,64 ATE  |
|  | 2.0 T    | 155 |  | 09.95 | 12.96 |                |        |   |  |                      |
|  | 2.3 T5   | 166 |  | 09.95 | 12.96 |                |        |   |  |                      |
|  | 2.3 T5 R | 184 |  | 09.95 | 12.96 |                |        |   |  |                      |
|  | 2.5      | 106 |  | 09.95 | 12.96 |                |        |   |  |                      |
|  | 2.5 AWD  | 142 |  | 04.96 | 12.96 |                |        |   |  |                      |
|  | 2.5 TDI  | 103 |  | 09.95 | 12.96 |                |        |   |  |                      |
|  | 2.0      | 93  |  | 08.94 | 12.96 | 11.9571-9971.2 | 220605 |   |  | D=57, - Halter ATE   |
|  | 2.0      | 105 |  | 02.93 | 12.96 | 11.9571-9972.2 | 220606 |   |  | D=57, - Halter ATE   |
|  | 2.0 T    | 155 |  | 02.93 | 12.96 | 11.0441-5702.2 | 250033 |   |  | Dichtungssatz ATE    |
|  | 2.3 T5   | 166 |  | 02.93 | 12.96 | 11.0101-5407.2 | 260011 |   |  | Hülssensatz ATE      |
|  | 2.3 T5 R | 184 |  | 08.95 | 12.96 | 11.8171-0008.1 | 990049 |   |  | Führungsbolzen ATE   |
|  | 2.5      | 103 |  | 08.92 | 07.94 | 11.8116-0073.1 | 390498 | 2 |  | Haltefeder ATE       |
|  | 2.5      | 106 |  | 08.94 | 12.96 |                |        |   |  |                      |
|  | 2.5      | 125 |  | 09.92 | 12.96 |                |        |   |  |                      |
|  | 2.5 AWD  | 142 |  | 04.96 | 12.96 |                |        |   |  |                      |
|  | 2.5 TDI  | 103 |  | 08.95 | 12.96 |                |        |   |  |                      |
|  | 2.0      | 93  |  | 08.94 | 12.96 | 83.6134-0335.3 | 330277 | 2 |  | L=335                |
|  | 2.0      | 105 |  | 02.93 | 12.96 |                |        |   |  |                      |
|  | 2.0 T    | 155 |  | 02.93 | 12.96 |                |        |   |  |                      |
|  | 2.3 T5   | 166 |  | 02.93 | 12.96 |                |        |   |  |                      |



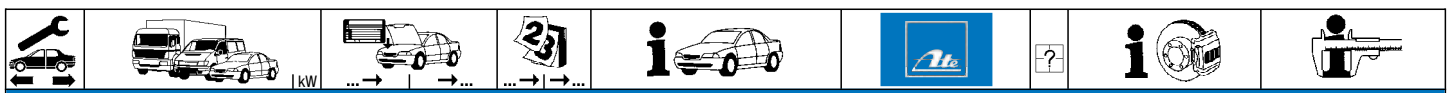

**VOLVO 850 Kombi (92-96)**

|  |   |   |  |  |  |  |  |          |  |  |  |
|--|---|---|--|--|--|--|--|----------|--|--|--|
|  | 2.3 T5 R<br>2.5<br>2.5<br>2.5<br>2.5 AWD<br>2.5 TDI                           | 184<br>103<br>106<br>125<br>142<br>103                            |  | 08.95<br>08.92<br>08.94<br>09.92<br>04.96<br>08.95                                     | 12.96<br>07.94<br>12.96<br>12.96<br>12.96<br>12.96                                     | 83.6134-0335.3   | 330277   | 2        |  | L=335  |  |
|  | 2.0<br>2.0<br>2.0 T<br>2.3 T5<br>2.3 T5<br>2.5<br>2.5<br>2.5 TDI              | 93<br>105<br>155<br>166<br>103<br>106<br>125<br>103               |  | 08.94<br>02.93<br>02.93<br>02.93<br>08.92<br>08.94<br>09.92<br>08.95                   | 12.96<br>12.96<br>12.96<br>12.96<br>07.94<br>12.96<br>12.96<br>12.96                   | 13.2381-0097.2<br>13.2381-0098.2<br>24.9238-0097.5<br>24.9238-0098.5<br>13.0441-3815.2<br>13.0441-3819.2 | 210239<br>210240<br>230037<br>230038<br>250069<br>250072 | <br><br> | für Vorg. 13.2381-0065/-0066.2 <sup>1)</sup> | D=38<br>D=38<br>D=38<br>D=38<br>Dichtungssatz<br>Dichtungssatz | ATE<br>ATE<br>ATE<br>ATE<br>ATE<br>ATE |
|  | 2.3 T5 R  | 184   |  | 08.95  | 12.96  | 13.2381-0097.2<br>13.2381-0098.2<br>13.0441-3819.2   | 210239<br>210240<br>250072                               | <br>     |  | D=38<br>D=38<br>Dichtungssatz                                  | ATE<br>ATE<br>ATE                      |
|  | 2.0<br>2.0<br>2.0 T<br>2.3 T5<br>2.3 T5 R<br>2.5<br>2.5<br>2.5 TDI            | 93<br>105<br>155<br>166<br>184<br>103<br>106<br>125<br>103        |  | 08.94<br>02.93<br>02.93<br>02.93<br>08.95<br>08.92<br>08.94<br>09.92<br>08.95          | 12.96<br>12.96<br>12.96<br>12.96<br>12.96<br>07.94<br>12.96<br>12.96<br>12.96          | 83.6204-0200.3   | 330306   | 2        |  | L=200  |  |
|  | 2.5 AWD   | 142   |  | 04.96  | 12.96  | 83.6134-0300.3<br>83.6134-0270.3   | 330725<br>330779   | 2<br>2   |  | L=300<br>L=270   |  |
|  | 2.0<br>2.0<br>2.0 T<br>2.3 T5<br>2.3 T5 R<br>2.5<br>2.5<br>2.5 TDI            | 93<br>105<br>155<br>166<br>184<br>103<br>106<br>125<br>103        |  | 08.94<br>02.93<br>02.93<br>02.93<br>08.95<br>08.92<br>08.94<br>09.92<br>08.95          | 12.96<br>12.96<br>12.96<br>12.96<br>12.96<br>07.94<br>12.96<br>12.96<br>12.96          | 24.3727-1308.2   | 581308   | 2        |  | L=1670   |  |
|  | 2.0<br>2.0<br>2.0 T<br>2.3 T5<br>2.3 T5 R<br>2.5<br>2.5<br>2.5 TDI            | 93<br>105<br>155<br>166<br>184<br>103<br>106<br>125<br>103        |  | 08.94<br>02.93<br>02.93<br>02.93<br>08.95<br>08.92<br>08.94<br>09.92<br>08.95          | 08.95<br>08.95<br>08.95<br>08.95<br>08.95<br>07.94<br>08.95<br>08.95<br>08.95          | 03.6055-0431.3   | 320142   |          |  | BR 5/35 (4)  | ATE                                    |
|  | 2.0<br>2.0<br>2.0 T<br>2.3 T5<br>2.3 T5 R<br>2.5<br>2.5<br>2.5 AWD<br>2.5 TDI | 93<br>105<br>155<br>166<br>184<br>103<br>106<br>125<br>142<br>103 |  | 08.94<br>02.93<br>02.93<br>02.93<br>08.95<br>08.92<br>08.94<br>09.92<br>04.96<br>08.95 | 12.96<br>12.96<br>12.96<br>12.96<br>12.96<br>07.94<br>12.96<br>12.96<br>12.96<br>12.96 | 24.2419-0939.3   | 030065   |          | - Rohrleitung <sup>2)</sup>                  | Gz 19,05   |  |
|  | 2.0<br>2.0<br>2.0 T<br>2.3 T5<br>2.5<br>2.5<br>2.5 AWD<br>2.5 TDI             | 93<br>105<br>155<br>166<br>103<br>106<br>125<br>142<br>103        |  | 08.94<br>02.93<br>02.93<br>02.93<br>08.92<br>08.94<br>09.92<br>04.96<br>08.95          | 12.96<br>12.96<br>12.96<br>12.96<br>07.94<br>12.96<br>12.96<br>12.96<br>12.96          | 24.2522-0907.3   | 040043   |          |  | Nz 22,20   |  |

















**VOLVO 940 I Limousine (90-95)**

|  |  |   |  |  |  |                                  |                  |  |  |   |            |
|--|--|---|--|--|--|----------------------------------|------------------|--|--|---|------------|
|  | 2.0 T<br>2.3<br>2.3<br>2.3 T<br>2.3 T<br>2.4 D<br>2.4 TD<br>2.4 TD Intercooler | 114<br>114<br>114<br>121<br>140<br>60<br>80<br>90 |  | 01.91<br>08.90<br>08.90<br>08.90<br>08.90<br>08.90<br>08.90<br>08.90 | 12.91<br>12.91<br>07.91<br>12.91<br>12.91<br>12.91<br>12.91<br>12.91 | 03.2023-0503.3<br>03.3517-5100.1 | 010022<br>390326 |  |  | Thz 23,81/16,84 + B.<br>Verschlußschraube | ATE<br>ATE |
|  | 2.0 T<br>2.3<br>2.3<br>2.3 T<br>2.3 T<br>2.4 D<br>2.4 TD<br>2.4 TD Intercooler | 114<br>114<br>114<br>121<br>140<br>60<br>80<br>90 |  | 01.91<br>08.90<br>08.90<br>08.90<br>08.91<br>08.90<br>08.90<br>08.90 | 12.91<br>12.91<br>07.91<br>12.91<br>12.91<br>12.91<br>12.91<br>12.91 | 03.2023-0164.3                   | 010014           |  |  | Thz 23,81/19,05 + B.                      | ATE        |
|  | 2.0<br>2.0 T<br>2.3  | 82<br>114<br>114                                  |  | 01.92<br>01.92<br>01.92  | 07.94<br>07.95<br>12.94  | 03.2023-0875.3                   | 010890           |  |  | Thz 23,81/20,64 - B.                      | ATE        |

<sup>1)</sup> f.predec.13.2381-0065/-0066.2 / p.prece.13.2381-0065.2/-0066.2 / p.préd.13.2381-0065.2/-0066.2 / p. prede.13.2381-0065.2/-0066.2

<sup>2)</sup> - pipe line / - tubazione / - conduite rigide / - latiguillo



|     |  |  |  |  |  |  |  |  |
|--|--|--|--|--|---|--|--|--|
| <b>VOLVO 940 I Limousine (90-95)</b>   |  |  |  |  |   |  |  |  |
|    | 2.3  | 85   |  | 08.92  | 07.94   | 03.2023-0875.3   | 010890   | THz 23,81/20,64 - B. ATE   |
|  | 2.3 T  | 121  |  | 01.92  | 07.94   |  |  |  |
|  | 2.3 T  | 140  |  | 01.92  | 07.93   |  |  |  |
|  | 2.4 D  | 60   |  | 01.92  | 12.94   |  |  |  |
|  | 2.4 TD   | 80   |  | 01.92  | 12.94   |  |  |  |
|  | 2.4 TD Intercooler   | 90   |  | 01.92  | 12.94   |  |  |  |
|    | 2.0 T  | 114  |  | 01.91  | 12.91   | 24.3571-1707.5   | 240079   | + ABS LUC  |
|  | 2.3  | 121  |  | 08.90  | 12.91   | 24.3571-1708.5   | 240080   | + ABS LUC  |
|  | 2.3  | 114  |  | 08.90  | 07.91   | 24.0101-3401.2   | 260043   | - ABS LUC  |
|  | 2.3 T  | 121  |  | 08.90  | 12.91   | 24.0101-3601.2   | 260044   | + ABS LUC  |
|  | 2.3 T  | 140  |  | 08.91  | 12.91   |  |  |  |
|  | 2.4 D  | 60   |  | 08.90  | 12.91   |  |  |  |
|  | 2.4 TD   | 80   |  | 08.90  | 12.91   |  |  |  |
|  | 2.4 TD Intercooler   | 90   |  | 08.90  | 12.91   |  |  |  |
|  | 2.0  | 82   |  | 01.92  | 07.94   | 24.3571-1707.5   | 240079   | + ABS LUC  |
|  | 2.0 T  | 114  |  | 01.92  | 07.95   | 24.3571-1708.5   | 240080   | + ABS LUC  |
|  | 2.3  | 121  |  | 01.92  | 12.94   | 24.0101-3601.2   | 260044   | - ABS LUC  |
|  | 2.3  | 85   |  | 08.92  | 07.94   |  |  |  |
|  | 2.3 T  | 121  |  | 01.92  | 07.94   |  |  |  |
|  | 2.3 T  | 140  |  | 01.92  | 07.93   |  |  |  |
|  | 2.4 D  | 60   |  | 01.92  | 12.94   |  |  |  |
|  | 2.4 TD   | 80   |  | 01.92  | 12.94   |  |  |  |
|  | 2.4 TD Intercooler   | 90   |  | 01.92  | 12.94   |  |  |  |
|    | 2.0 T  | 114  |  | 01.91  | 12.91   | 83.6134-0335.3   | 330277   | 2 L=335  |
|  | 2.3  | 114  |  | 08.90  | 12.91   |  |  |  |
|  | 2.3  | 114  |  | 08.90  | 07.91   |  |  |  |
|  | 2.3 T  | 121  |  | 08.90  | 12.91   |  |  |  |
|  | 2.3 T  | 140  |  | 08.91  | 12.91   |  |  |  |
|  | 2.4 D  | 60   |  | 08.90  | 12.91   |  |  |  |
|  | 2.4 TD   | 80   |  | 08.90  | 12.91   |  |  |  |
|  | 2.4 TD Intercooler   | 90   |  | 08.90  | 12.91   |  |  |  |
|  | 2.0  | 82   |  | 01.92  | 07.94   | 83.6134-0335.3   | 330277   | 2 L=335  |
|  | 2.0 T  | 114  |  | 01.92  | 07.95   |  |  |  |
|  | 2.0 T  | 114  |  | 01.91  | 12.91   | + ABS  |  |  |
|  | 2.3  | 121  |  | 01.92  | 12.94   | + ABS  |  |  |
|  | 2.3  | 85   |  | 08.90  | 12.91   | + ABS  |  |  |
|  | 2.3  | 114  |  | 08.92  | 07.94   | + ABS  |  |  |
|  | 2.3 T  | 121  |  | 08.90  | 07.91   | + ABS  |  |  |
|  | 2.3 T  | 121  |  | 01.92  | 07.94   | + ABS  |  |  |
|  | 2.3 T  | 140  |  | 08.90  | 12.91   | + ABS  |  |  |
|  | 2.3 T  | 140  |  | 01.92  | 07.93   | + ABS  |  |  |
|  | 2.4 D  | 60   |  | 08.91  | 12.91   | + ABS  |  |  |
|  | 2.4 D  | 60   |  | 01.92  | 12.94   | + ABS  |  |  |
|  | 2.4 TD   | 80   |  | 08.90  | 12.91   | + ABS  |  |  |
|  | 2.4 TD   | 80   |  | 01.92  | 12.94   | + ABS  |  |  |
|  | 2.4 TD Intercooler   | 90   |  | 01.92  | 12.94   | + ABS  |  |  |
|  | 2.4 TD Intercooler   | 90   |  | 08.90  | 12.91   | + ABS  |  |  |
|  | 2.0  | 82   |  | 01.92  | 07.94   | 13.2381-0087.2   | 210149   | + Multi-Link-Achse 1) D=38 ATE   |
|  | 2.0 T  | 114  |  | 01.91  | 07.95   | 13.2381-0088.2   | 210150   | + Multi-Link-Achse 1) D=38 ATE   |
|  | 2.3  | 121  |  | 08.90  | 12.94   | 24.9238-0087.5   | 230035   | - Multi-Link-Achse 1) D=38 ATE   |
|  | 2.3  | 85   |  | 08.92  | 07.94   | 24.9238-0088.5   | 230036   | - Multi-Link-Achse 1) D=38 ATE   |
|  | 2.3  | 114  |  | 08.90  | 07.91   | 13.2401-0027.2   | 210045   | - Multi-Link-Achse 1) D=40 ATE   |
|  | 2.3 T  | 121  |  | 08.90  | 07.94   | 13.2401-0028.2   | 210046   | - Multi-Link-Achse 1) D=40 ATE   |
|  | 2.3 T  | 140  |  | 08.91  | 07.93   | 24.9240-0027.5   | 230017   | - Multi-Link-Achse 1) D=40 ATE   |
|  | 2.4 D  | 60   |  | 08.90  | 12.94   | 24.9240-0028.5   | 230018   | - Multi-Link-Achse 1) D=40 ATE   |
|  | 2.4 TD   | 80   |  | 08.90  | 12.94   | 13.0441-3815.2   | 250069   | - Multi-Link-Achse 1) Dichtungssatz ATE  |
|  | 2.4 TD Intercooler   | 90   |  | 08.90  | 12.94   | 13.0441-3819.2   | 250072   | - Multi-Link-Achse 1) Dichtungssatz ATE  |
|  |  |  |  | 08.90  | 12.94   | 13.0441-4014.2   | 250079   | - Multi-Link-Achse 1) Dichtungssatz ATE  |
|  | 2.0  | 82   |  | 01.92  | 07.94   | 83.6124-0305.3   | 330723   | 2 L=305  |
|  | 2.0 T  | 114  |  | 01.91  | 07.95   |  |  |  |
|  | 2.3  | 85   |  | 08.90  | 12.94   |  |  |  |
|  | 2.3  | 114  |  | 08.92  | 07.94   |  |  |  |
|  | 2.3 T  | 121  |  | 08.90  | 07.91   |  |  |  |
|  | 2.3 T  | 140  |  | 08.90  | 07.94   |  |  |  |
|  | 2.4 D  | 60   |  | 08.91  | 07.93   |  |  |  |
|  | 2.4 TD   | 80   |  | 08.90  | 12.94   |  |  |  |
|  | 2.4 TD Intercooler   | 90   |  | 08.90  | 12.94   |  |  |  |
|  | 2.0  | 82   |  | 01.92  | 07.94   | 03.6055-0430.3   | 320065   | BR 5/25 (4) ATE  |
|  | 2.0 T  | 114  |  | 01.91  | 07.95   |  |  |  |
|  | 2.3  | 85   |  | 08.90  | 12.94   |  |  |  |
|  | 2.3  | 114  |  | 08.92  | 07.94   |  |  |  |
|  | 2.3 T  | 121  |  | 08.90  | 07.91   |  |  |  |
|  | 2.3 T  | 140  |  | 08.90  | 07.94   |  |  |  |
|  | 2.4 D  | 60   |  | 08.91  | 07.93   |  |  |  |
|  | 2.4 TD   | 80   |  | 08.90  | 12.94   |  |  |  |
|  | 2.4 TD Intercooler   | 90   |  | 08.90  | 12.94   |  |  |  |
|  | 2.0  | 82   |  | 01.92  | 07.94   | 24.2419-0941.3   | 030067   | Gz 19,05   |
|  | 2.0 T  | 114  |  | 01.91  | 07.95   |  |  |  |
|  | 2.3  | 85   |  | 08.90  | 12.94   |  |  |  |
|  | 2.3  | 114  |  | 08.92  | 07.94   |  |  |  |
|  | 2.3  | 114  |  | 08.90  | 07.91   |  |  |  |
|  | 2.4 D  | 60   |  | 08.90  | 12.94   |  |  |  |
|  | 2.3 T  | 121  |  | 08.90  | 07.94   | 24.2419-0928.3   | 030056   | Gz 19,05   |
|  | 2.3 T  | 140  |  | 08.91  | 07.93   |  |  |  |

1) - multi link axle / - assale Multi-link / - essieu multi-link / - eje Multi-Link

2) f.predec.13.2381-0067/-0068.2 / p.prece.13.2381-0067.2/-0068.2 / p.préd.13.2381-0067.2/-0068.2 / p. prede.13.2381-0067.2/-0068.2

3) f.predec.13.2401-0023/-0024.2 / p.prece.13.2401-0023.2/-0024.2 / p.préd.13.2401-0023.2/-0024.2 / p. prede.13.2401-0023.2/-0024.2

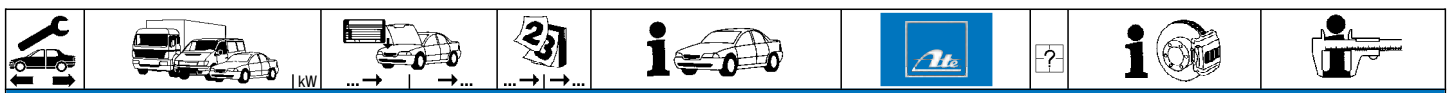

**VOLVO 940 I Limousine (90-95)**

|  |  |                                     |  |  |  |  |                |        |  |          |
|--|--|-------------------------------------|--|--|--|--|----------------|--------|--|----------|
|  | 2.4 TD<br>2.4 TD Intercooler                   | 80<br>90                            |  | 08.90<br>08.90                                     | 12.94<br>12.94                                     |  | 24.2419-0928.3 | 030056 |  | Gz 19,05 |
|  | 2.0<br>2.0 T<br>2.3<br>2.3<br>2.3<br>2.4 D     | 82<br>114<br>114<br>85<br>114<br>60 |  | 01.92<br>01.91<br>08.90<br>08.92<br>08.90<br>08.90 | 07.94<br>07.95<br>12.94<br>07.94<br>07.91<br>12.94 |  | 24.2520-0905.3 | 040057 |  | Nz 20,64 |
|  | 2.3 T<br>2.3 T<br>2.4 TD<br>2.4 TD Intercooler | 121<br>140<br>80<br>90              |  | 08.90<br>08.91<br>08.90<br>08.90                   | 07.94<br>07.93<br>12.94<br>12.94                   |  | 03.2522-0420.3 | 040086 |  | Nz 22,20 |



















**VOLVO 940 I Kombi (90-95)**

|  |  |  |  |   |   |   |  |  |  |   |   |
|--|--|--|--|---|---|---|--|--|--|---|---|
|  | 2.0 T<br>2.3<br>2.3<br>2.3 T<br>2.3 T<br>2.4 D<br>2.4 TD<br>2.4 TD Intercooler   | 114<br>96<br>114<br>121<br>140<br>60<br>80<br>90   |  | 01.91<br>08.90<br>08.90<br>08.90<br>08.91<br>08.90<br>08.90<br>08.90  | 12.91<br>12.91<br>07.91<br>12.91<br>12.91<br>12.91<br>12.91<br>12.91  | - ABS<br>- ABS<br>- ABS<br>- ABS<br>- ABS<br>- ABS<br>- ABS   | 03.2023-0503.3<br>03.3517-5100.1   | 010022<br>390326   |  | THz 23,81/16,84 + B.<br>Verschlusschraube   | ATE<br>ATE  |
|  | 2.0 T<br>2.3<br>2.3<br>2.3 T<br>2.3 T<br>2.4 D<br>2.4 TD<br>2.4 TD Intercooler   | 114<br>96<br>114<br>121<br>140<br>60<br>80<br>90   |  | 01.91<br>08.90<br>08.90<br>08.90<br>08.91<br>08.90<br>08.90<br>08.90  | 12.91<br>12.91<br>07.91<br>12.91<br>12.91<br>12.91<br>12.91<br>12.91  | + ABS<br>+ ABS<br>+ ABS<br>+ ABS<br>+ ABS<br>+ ABS<br>+ ABS   | 03.2023-0164.3   | 010014   |  | THz 23,81/19,05 + B.  | ATE   |
|  | 2.0<br>2.0 T<br>2.3<br>2.3<br>2.3 T<br>2.3 T<br>2.4 D<br>2.4 TD<br>2.4 TD Intercooler  | 82<br>114<br>85<br>96<br>121<br>140<br>60<br>80<br>90  |  | 01.92<br>01.92<br>08.92<br>01.92<br>01.92<br>01.92<br>01.92<br>01.92<br>01.92   | 07.94<br>07.95<br>07.94<br>07.94<br>07.94<br>07.93<br>07.95<br>07.94<br>07.94   |   | 03.2023-0875.3   | 010890   |  | THz 23,81/20,64 - B.  | ATE   |
|  | 2.0 T<br>2.3<br>2.3<br>2.3 T<br>2.3 T<br>2.4 D<br>2.4 TD<br>2.4 TD Intercooler   | 114<br>96<br>114<br>121<br>140<br>60<br>80<br>90   |  | 01.91<br>08.90<br>08.90<br>08.90<br>08.91<br>08.90<br>08.90<br>08.90  | 12.91<br>12.91<br>07.91<br>12.91<br>12.91<br>12.91<br>12.91<br>12.91  |   | 24.3571-1707.5<br>24.3571-1708.5<br>24.0101-3401.2<br>24.0101-3601.2   | 240079<br>240080<br>260043<br>260044   | <input type="checkbox"/> + ABS<br><input type="checkbox"/> + ABS<br>- ABS<br>+ ABS                                       | D=57, - Halter<br>D=57, - Halter<br>Einbausatz<br>Einbausatz  | LUC<br>LUC<br>LUC<br>LUC  |
|  | 2.0 T<br>2.3<br>2.3<br>2.3 T<br>2.3 T<br>2.4 D<br>2.4 TD<br>2.4 TD Intercooler   | 114<br>96<br>114<br>121<br>140<br>60<br>80<br>90   |  | 01.91<br>08.90<br>08.90<br>08.90<br>08.91<br>08.90<br>08.90<br>08.90  | 12.91<br>12.91<br>07.91<br>12.91<br>12.91<br>12.91<br>12.91<br>12.91  | - ABS<br>- ABS<br>- ABS<br>- ABS<br>- ABS<br>- ABS<br>- ABS   | 83.6134-0335.3   | 330277   | 2  | L=335   |   |
|  | 2.0<br>2.0 T<br>2.0 T<br>2.3<br>2.3<br>2.3<br>2.3<br>2.3 T<br>2.3 T<br>2.3 T<br>2.4 D<br>2.4 D<br>2.4 TD<br>2.4 TD<br>2.4 TD Intercooler<br>2.4 TD Intercooler | 82<br>114<br>114<br>85<br>96<br>114<br>121<br>140<br>140<br>60<br>60<br>80<br>80<br>90<br>90 |  | 01.92<br>01.92<br>01.91<br>08.92<br>01.92<br>08.90<br>08.90<br>08.90<br>08.91<br>01.92<br>01.92<br>08.90<br>08.90<br>01.92<br>08.90 | 07.94<br>07.95<br>12.91<br>07.94<br>07.94<br>12.91<br>07.91<br>07.94<br>12.91<br>07.93<br>07.95<br>12.91<br>07.94<br>07.94<br>12.91 | + ABS<br>+ ABS<br>+ ABS<br>+ ABS<br>+ ABS<br>+ ABS<br>+ ABS<br>+ ABS<br>+ ABS   | 83.6134-0335.3   | 330277   | 2  | L=335   |   |
|  | 2.0<br>2.0 T<br>2.3<br>2.3<br>2.3<br>2.3<br>2.3 T<br>2.3 T<br>2.4 D<br>2.4 D<br>2.4 TD<br>2.4 TD Intercooler<br>2.4 TD Intercooler                             | 82<br>114<br>85<br>96<br>114<br>121<br>140<br>60<br>60<br>80<br>80<br>90<br>90               |  | 01.92<br>01.91<br>08.92<br>08.90<br>08.90<br>08.90<br>08.91<br>01.92<br>01.92<br>08.90<br>08.90<br>01.92<br>08.90                   | 07.94<br>07.95<br>07.94<br>07.94<br>07.94<br>12.91<br>07.91<br>07.94<br>12.91<br>07.93<br>07.95<br>12.91<br>07.94<br>07.94<br>12.91 | - Multi-Link-Achse 1)<br>- Multi-Link-Achse 1)<br>- Multi-Link-Achse 1)<br>- Multi-Link-Achse 1)<br>- Multi-Link-Achse 1)<br>- Multi-Link-Achse 1)<br>- Multi-Link-Achse 1)<br>- Multi-Link-Achse 1)<br>- Multi-Link-Achse 1)<br>- Multi-Link-Achse 1)<br>- Multi-Link-Achse 1)<br>- Multi-Link-Achse 1)<br>- Multi-Link-Achse 1) | 13.2381-0087.2<br>13.2381-0088.2<br>24.9238-0087.5<br>24.9238-0088.5<br>13.2401-0027.2<br>13.2401-0028.2<br>24.9240-0027.5<br>24.9240-0028.5<br>13.0441-3815.2<br>13.0441-3819.2<br>13.0441-4014.2 | 210149<br>210150<br>230035<br>230036<br>210045<br>210046<br>230017<br>230018<br>250069<br>250072<br>250079 | <input type="checkbox"/> für Vorg. 13.2381-0067/-0068.2 2)<br><input type="checkbox"/> für Vorg. 13.2401-0023/-0024.2 3) | D=38<br>D=38<br>D=38<br>D=38<br>D=40<br>D=40<br>D=40<br>D=40<br>Dichtungssatz<br>Dichtungssatz<br>Dichtungssatz | ATE<br>ATE<br>ATE<br>ATE<br>ATE<br>ATE<br>ATE<br>ATE<br>ATE<br>ATE<br>ATE |

1) - multi link axle / - assale Multi-link / - essieu multi-link / - eje Multi-Link  
 2) f.predec.13.2381-0067/-0068.2 / p.prece.13.2381-0067.2/-0068.2 / p.préd.13.2381-0067.2/-0068.2 / p. prede.13.2381-0067.2/-0068.2  
 3) f.predec.13.2401-0023/-0024.2 / p.prece.13.2401-0023.2/-0024.2 / p.préd.13.2401-0023.2/-0024.2 / p. prede.13.2401-0023.2/-0024.2





|     |  |  |  |  |  |  |  |  |  |
|--|--|--|--|--|---|--|--|--|--|
| <b>VOLVO 940 I Kombi (90-95)</b>   |  |  |  |  |   |  |  |  |  |
|    | 2.0  | 82   |  | 01.92  | 07.94   | 83.6124-0305.3   | 330723   | 2  | L=305  |
|  | 2.0 T  | 114  |  | 01.91  | 07.95   |  |  |  |  |
|  | 2.3  | 85   |  | 08.92  | 07.94   |  |  |  |  |
|  | 2.3  | 96   |  | 08.90  | 07.94   |  |  |  |  |
|  | 2.3  | 114  |  | 08.90  | 07.91   |  |  |  |  |
|  | 2.3 T  | 121  |  | 08.90  | 07.94   |  |  |  |  |
|  | 2.3 T  | 140  |  | 08.91  | 07.93   |  |  |  |  |
|  | 2.4 D  | 60   |  | 08.90  | 07.95   |  |  |  |  |
|  | 2.4 TD   | 80   |  | 08.90  | 07.94   |  |  |  |  |
|  | 2.4 TD Intercooler   | 90   |  | 08.90  | 07.94   |  |  |  |  |
|    | 2.0  | 82   |  | 01.92  | 07.94   | 03.6055-0431.3   | 320142   |  | BR 5/35 (4) ATE                              |
|  | 2.0 T  | 114  |  | 01.91  | 07.95   |  |  |  |  |
|  | 2.3  | 85   |  | 08.92  | 07.94   |  |  |  |  |
|  | 2.3  | 96   |  | 08.90  | 07.94   |  |  |  |  |
|  | 2.3  | 114  |  | 08.90  | 07.91   |  |  |  |  |
|  | 2.3 T  | 121  |  | 08.90  | 07.94   |  |  |  |  |
|  | 2.3 T  | 140  |  | 08.91  | 07.93   |  |  |  |  |
|  | 2.4 D  | 60   |  | 08.90  | 07.95   |  |  |  |  |
|  | 2.4 TD   | 80   |  | 08.90  | 07.94   |  |  |  |  |
|  | 2.4 TD Intercooler   | 90   |  | 08.90  | 07.94   |  |  |  |  |
|    | 2.0  | 82   |  | 01.92  | 07.94   | 24.2419-0941.3   | 030067   |  | Gz 19,05                                     |
|  | 2.0 T  | 114  |  | 01.91  | 07.95   |  |  |  |  |
|  | 2.3  | 85   |  | 08.92  | 07.94   |  |  |  |  |
|  | 2.3  | 96   |  | 08.90  | 07.94   |  |  |  |  |
|  | 2.3  | 114  |  | 08.90  | 07.91   |  |  |  |  |
|  | 2.4 D  | 60   |  | 08.90  | 07.95   |  |  |  |  |
|  | 2.3 T  | 121  |  | 08.90  | 07.94   | 24.2419-0928.3   | 030056   |  | Gz 19,05                                     |
|  | 2.3 T  | 140  |  | 08.91  | 07.93   |  |  |  |  |
|  | 2.4 TD   | 80   |  | 08.90  | 07.94   |  |  |  |  |
|  | 2.4 TD Intercooler   | 90   |  | 08.90  | 07.94   |  |  |  |  |
|    | 2.0  | 82   |  | 01.92  | 07.94   | 24.2520-0905.3   | 040057   |  | Nz 20,64                                     |
|  | 2.0 T  | 114  |  | 01.91  | 07.95   |  |  |  |  |
|  | 2.3  | 85   |  | 08.92  | 07.94   |  |  |  |  |
|  | 2.3  | 96   |  | 08.90  | 07.94   |  |  |  |  |
|  | 2.3  | 114  |  | 08.90  | 07.91   |  |  |  |  |
|  | 2.4 D  | 60   |  | 08.90  | 07.95   |  |  |  |  |
|  | 2.3 T  | 121  |  | 08.90  | 07.94   | 03.2522-0420.3   | 040086   |  | Nz 22,20                                     |
|  | 2.3 T  | 140  |  | 08.91  | 07.93   |  |  |  |  |
|  | 2.4 TD   | 80   |  | 08.90  | 07.94   |  |  |  |  |
|  | 2.4 TD Intercooler   | 90   |  | 08.90  | 07.94   |  |  |  |  |
| <b>VOLVO 940 II Limousine (95-98)</b>  |  |  |  |  |   |  |  |  |  |
|  | 2.0 T  | 114  |  | 04.96  | 10.98   | 03.2023-0875.3   | 010890   |  | Thz 23,81/20,64 - B. ATE                     |
|  | 2.3  | 85   |  | 08.94  | 07.95   |  |  |  |  |
|  | 2.3  | 96   |  | 08.94  | 10.98   |  |  |  |  |
|  | 2.3 T  | 121  |  | 08.94  | 10.98   |  |  |  |  |
|  | 2.3 ti   | 99   |  | 01.95  | 10.98   |  |  |  |  |
|  | 2.4 TD Intercooler   | 90   |  | 08.94  | 10.98   |  |  |  |  |
|  | 2.0 T  | 114  |  | 04.96  | 10.98   | 24.3571-1707.5   | 240079   | <input type="checkbox"/>   | D=57, - Halter LUC                           |
|  | 2.3  | 85   |  | 08.94  | 07.95   | 24.3571-1708.5   | 240080   | <input type="checkbox"/>   | D=57, - Halter LUC                           |
|  | 2.3  | 96   |  | 08.94  | 10.98   | 24.0101-3601.2   | 260044   |  | Einbausatz LUC                               |
|  | 2.3 T  | 121  |  | 08.94  | 10.98   |  |  |  |  |
|  | 2.3 ti   | 99   |  | 01.95  | 10.98   |  |  |  |  |
|  | 2.4 TD Intercooler   | 90   |  | 08.94  | 10.98   |  |  |  |  |
|  | 2.0 T  | 114  |  | 04.96  | 10.98   | 83.6134-0335.3   | 330277   | 2  | L=335  |
|  | 2.3  | 85   |  | 08.94  | 07.95   |  |  |  |  |
|  | 2.3  | 96   |  | 08.94  | 10.98   |  |  |  |  |
|  | 2.3 T  | 121  |  | 08.94  | 10.98   |  |  |  |  |
|  | 2.3 ti   | 99   |  | 01.95  | 10.98   |  |  |  |  |
|  | 2.4 TD Intercooler   | 90   |  | 08.94  | 10.98   |  |  |  |  |
|  | 2.0 T  | 114  |  | 04.96  | 10.98   | 13.2381-0087.2   | 210149   | <input type="checkbox"/>   | D=38 ATE                                     |
|  | 2.3  | 85   |  | 08.94  | 07.95   | 13.2381-0088.2   | 210150   | <input type="checkbox"/>   | D=38 ATE                                     |
|  | 2.3  | 96   |  | 08.94  | 10.98   | 24.9238-0087.5   | 230035   | <input type="checkbox"/>   | D=38 ATE                                     |
|  | 2.3 T  | 121  |  | 08.94  | 10.98   | 24.9238-0088.5   | 230036   | <input type="checkbox"/>   | D=38 ATE                                     |
|  | 2.3 ti   | 99   |  | 01.95  | 10.98   | 13.2401-0027.2   | 210045   | <input type="checkbox"/>   | D=40 ATE                                     |
|  | 2.4 TD Intercooler   | 90   |  | 08.94  | 10.98   | 13.2401-0028.2   | 210046   | <input type="checkbox"/>   | D=40 ATE                                     |
|  |  |  |  |  |   | 24.9240-0027.5   | 230017   | <input type="checkbox"/>   | D=40 ATE                                     |
|  |  |  |  |  |   | 24.9240-0028.5   | 230018   | <input type="checkbox"/>   | D=40 ATE                                     |
|  |  |  |  |  |   | 13.0441-3815.2   | 250069   | <input type="checkbox"/>   | Dichtungssatz ATE                            |
|  |  |  |  |  |   | 13.0441-3819.2   | 250072   | <input type="checkbox"/>   | Dichtungssatz ATE                            |
|  |  |  |  |  |   | 13.0441-4014.2   | 250079   | <input type="checkbox"/>   | Dichtungssatz ATE                            |
|  |  |  |  |  |   |  |  |  | für Vorg. 13.2381-0067/-0068.2 <sup>2)</sup> |
|  |  |  |  |  |   |  |  |  | für Vorg. 13.2401-0023/-0024.2 <sup>3)</sup> |
|  | 2.0 T  | 114  |  | 04.96  | 10.98   | 83.6124-0305.3   | 330723   | 2  | L=305  |
|  | 2.3  | 85   |  | 08.94  | 07.95   |  |  |  |  |
|  | 2.3  | 96   |  | 08.94  | 10.98   |  |  |  |  |
|  | 2.3 T  | 121  |  | 08.94  | 10.98   |  |  |  |  |
|  | 2.3 ti   | 99   |  | 01.95  | 10.98   |  |  |  |  |
|  | 2.4 TD Intercooler   | 90   |  | 08.94  | 10.98   |  |  |  |  |
|  | 2.3  | 85   |  | 08.94  | 07.95   | 03.6055-0430.3   | 320065   |  | BR 5/25 (4) ATE                              |
|  | 2.3  | 96   |  | 08.94  | 10.98   |  |  |  |  |
|  | 2.3 T  | 121  |  | 08.94  | 10.98   |  |  |  |  |
|  | 2.3 ti   | 99   |  | 01.95  | 10.98   |  |  |  |  |
|  | 2.4 TD Intercooler   | 90   |  | 08.94  | 10.98   |  |  |  |  |
|  | 2.0 T  | 114  |  | 04.96  | 10.98   | 03.6055-0431.3   | 320142   |  | BR 5/35 (4) ATE                              |

1) - multi link axle / - assale Multi-link / - essieu multi-link / - eje Multi-Link

2) f.predec.13.2381-0067/-0068.2 / p.prece.13.2381-0067.2/-0068.2 / p.préd.13.2381-0067.2/-0068.2 / p. prede.13.2381-0067.2/-0068.2













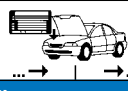











3) f.predec.13.2401-0023/-0024.2 / p.prece.13.2401-0023.2/-0024.2 / p.préd.13.2401-0023.2/-0024.2 / p. prede.13.2401-0023.2/-0024.2



| VOLVO 940 II Limousine (95-98)    |                       |     |       |       |                |                |        |   |                      |                      |     |  |  |  |  |
|-----------------------------------|-----------------------|-----|-------|-------|----------------|----------------|--------|---|----------------------|----------------------|-----|--|--|--|--|
|                                   | 2.0 T                 | 114 |       | 04.96 | 10.98          | 24.2419-0941.3 | 030067 |   |                      | Gz 19,05             |     |  |  |  |  |
|                                   | 2.3                   | 85  |       | 08.94 | 07.95          |                |        |   |                      |                      |     |  |  |  |  |
|                                   | 2.3                   | 96  |       | 08.94 | 10.98          |                |        |   |                      |                      |     |  |  |  |  |
|                                   | 2.3 ti                | 99  |       | 01.95 | 10.98          |                |        |   |                      |                      |     |  |  |  |  |
|                                   | 2.3 T                 | 121 |       | 08.94 | 10.98          |                |        |   |                      |                      |     |  |  |  |  |
| 2.4 TD Intercooler                | 90                    |     | 08.94 | 10.98 | 24.2419-0928.3 | 030056         |        |   | Gz 19,05             |                      |     |  |  |  |  |
|                                   | 2.0 T                 | 114 |       | 04.96 | 10.98          | 24.2520-0905.3 | 040057 |   |                      | Nz 20,64             |     |  |  |  |  |
|                                   | 2.3                   | 85  |       | 08.94 | 07.95          |                |        |   |                      |                      |     |  |  |  |  |
|                                   | 2.3                   | 96  |       | 08.94 | 10.98          |                |        |   |                      |                      |     |  |  |  |  |
|                                   | 2.3 ti                | 99  |       | 01.95 | 10.98          |                |        |   |                      |                      |     |  |  |  |  |
|                                   | 2.3 T                 | 121 |       | 08.94 | 10.98          |                |        |   |                      |                      |     |  |  |  |  |
| 2.4 TD Intercooler                | 90                    |     | 08.94 | 10.98 | 03.2522-0420.3 | 040086         |        |   | Nz 22,20             |                      |     |  |  |  |  |
| VOLVO 940 II Kombi (95-98)        |                       |     |       |       |                |                |        |   |                      |                      |     |  |  |  |  |
|                                   | 2.0 T                 | 114 |       | 04.96 | 10.98          | 03.2023-0875.3 | 010890 |   |                      | Thz 23,81/20,64 - B. | ATE |  |  |  |  |
|                                   | 2.3                   | 85  |       | 08.94 | 07.95          |                |        |   |                      |                      |     |  |  |  |  |
|                                   | 2.3                   | 96  |       | 08.94 | 10.98          |                |        |   |                      |                      |     |  |  |  |  |
|                                   | 2.3 T                 | 121 |       | 08.94 | 10.98          |                |        |   |                      |                      |     |  |  |  |  |
|                                   | 2.3 T                 | 126 |       | 08.95 | 10.98          |                |        |   |                      |                      |     |  |  |  |  |
|                                   | 2.3 ti                | 99  |       | 01.95 | 10.98          |                |        |   |                      |                      |     |  |  |  |  |
|                                   | 2.4 TD Intercooler    | 90  |       | 08.94 | 10.98          |                |        |   |                      |                      |     |  |  |  |  |
|                                   | 2.0 T                 | 114 |       | 04.96 | 10.98          | 24.3571-1707.5 | 240079 |   | D=57, - Halter       | LUC                  |     |  |  |  |  |
|                                   | 2.3                   | 85  |       | 08.94 | 07.95          |                |        |   |                      |                      |     |  |  |  |  |
|                                   | 2.3                   | 96  |       | 08.94 | 10.98          |                |        |   |                      |                      |     |  |  |  |  |
|                                   | 2.3 T                 | 121 |       | 08.94 | 10.98          |                |        |   |                      |                      |     |  |  |  |  |
|                                   | 2.3 T                 | 126 |       | 08.95 | 10.98          |                |        |   |                      |                      |     |  |  |  |  |
|                                   | 2.3 ti                | 99  |       | 01.95 | 10.98          |                |        |   |                      |                      |     |  |  |  |  |
|                                   | 2.4 TD Intercooler    | 90  |       | 08.94 | 10.98          |                |        |   |                      |                      |     |  |  |  |  |
|                                   | 2.0 T                 | 114 |       | 04.96 | 10.98          | 83.6134-0335.3 | 330277 | 2 |                      | L=335                |     |  |  |  |  |
|                                   | 2.3                   | 85  |       | 08.94 | 07.95          |                |        |   |                      |                      |     |  |  |  |  |
|                                   | 2.3                   | 96  |       | 08.94 | 10.98          |                |        |   |                      |                      |     |  |  |  |  |
|                                   | 2.3 T                 | 121 |       | 08.94 | 10.98          |                |        |   |                      |                      |     |  |  |  |  |
|                                   | 2.3 T                 | 126 |       | 08.95 | 10.98          |                |        |   |                      |                      |     |  |  |  |  |
|                                   | 2.3 ti                | 99  |       | 01.95 | 10.98          |                |        |   |                      |                      |     |  |  |  |  |
|                                   | 2.4 TD Intercooler    | 90  |       | 08.94 | 10.98          |                |        |   |                      |                      |     |  |  |  |  |
|                                   | 2.0 T                 | 114 |       | 04.96 | 10.98          | 13.2381-0087.2 | 210149 |   | D=38                 | ATE                  |     |  |  |  |  |
|                                   | 2.3                   | 85  |       | 08.94 | 07.95          |                |        |   |                      |                      |     |  |  |  |  |
|                                   | 2.3                   | 96  |       | 08.94 | 10.98          |                |        |   |                      |                      |     |  |  |  |  |
|                                   | 2.3 T                 | 121 |       | 08.94 | 10.98          |                |        |   |                      |                      |     |  |  |  |  |
|                                   | 2.3 T                 | 126 |       | 08.95 | 10.98          |                |        |   |                      |                      |     |  |  |  |  |
|                                   | 2.3 ti                | 99  |       | 01.95 | 10.98          |                |        |   |                      |                      |     |  |  |  |  |
|                                   | 2.4 TD Intercooler    | 90  |       | 08.94 | 10.98          |                |        |   |                      |                      |     |  |  |  |  |
|                                   | - Multi-Link-Achse 1) |     |       |       |                |                |        |   |                      |                      |     |  |  |  |  |
|                                   | 13.2381-0088.2 210150 |     |       |       |                |                |        |   |                      |                      |     |  |  |  |  |
|                                   | 24.9238-0087.5 230035 |     |       |       |                |                |        |   |                      |                      |     |  |  |  |  |
| 24.9238-0088.5 230036             |                       |     |       |       |                |                |        |   |                      |                      |     |  |  |  |  |
| 13.2401-0027.2 210045             |                       |     |       |       |                |                |        |   |                      |                      |     |  |  |  |  |
| 13.2401-0028.2 210046             |                       |     |       |       |                |                |        |   |                      |                      |     |  |  |  |  |
| 24.9240-0027.5 230017             |                       |     |       |       |                |                |        |   |                      |                      |     |  |  |  |  |
| 24.9240-0028.5 230018             |                       |     |       |       |                |                |        |   |                      |                      |     |  |  |  |  |
| 13.0441-3815.2 250069             |                       |     |       |       |                |                |        |   |                      |                      |     |  |  |  |  |
| 13.0441-3819.2 250072             |                       |     |       |       |                |                |        |   |                      |                      |     |  |  |  |  |
| 13.0441-4014.2 250079             |                       |     |       |       |                |                |        |   |                      |                      |     |  |  |  |  |
| für Vorg. 13.2381-0067/-0068.2 2) |                       |     |       |       |                |                |        |   |                      |                      |     |  |  |  |  |
| für Vorg. 13.2401-0023/-0024.2 3) |                       |     |       |       |                |                |        |   |                      |                      |     |  |  |  |  |
|                                   | 2.0 T                 | 114 |       | 04.96 | 10.98          | 83.6124-0305.3 | 330723 | 2 |                      | L=305                |     |  |  |  |  |
|                                   | 2.3                   | 85  |       | 08.94 | 07.95          |                |        |   |                      |                      |     |  |  |  |  |
|                                   | 2.3                   | 96  |       | 08.94 | 10.98          |                |        |   |                      |                      |     |  |  |  |  |
|                                   | 2.3 T                 | 121 |       | 08.94 | 10.98          |                |        |   |                      |                      |     |  |  |  |  |
|                                   | 2.3 T                 | 126 |       | 08.95 | 10.98          |                |        |   |                      |                      |     |  |  |  |  |
|                                   | 2.3 ti                | 99  |       | 01.95 | 10.98          |                |        |   |                      |                      |     |  |  |  |  |
|                                   | 2.4 TD Intercooler    | 90  |       | 08.94 | 10.98          |                |        |   |                      |                      |     |  |  |  |  |
|                                   | 2.0 T                 | 114 |       | 04.96 | 10.98          | 03.6055-0431.3 | 320142 |   |                      | BR 5/35 (4)          | ATE |  |  |  |  |
|                                   | 2.3                   | 85  |       | 08.94 | 07.95          |                |        |   |                      |                      |     |  |  |  |  |
|                                   | 2.3                   | 96  |       | 08.94 | 10.98          |                |        |   |                      |                      |     |  |  |  |  |
|                                   | 2.3 T                 | 121 |       | 08.94 | 10.98          |                |        |   |                      |                      |     |  |  |  |  |
|                                   | 2.3 T                 | 126 |       | 08.95 | 10.98          |                |        |   |                      |                      |     |  |  |  |  |
|                                   | 2.3 ti                | 99  |       | 01.95 | 10.98          |                |        |   |                      |                      |     |  |  |  |  |
|                                   | 2.4 TD Intercooler    | 90  |       | 08.94 | 10.98          |                |        |   |                      |                      |     |  |  |  |  |
|                                   | 2.0 T                 | 114 |       | 04.96 | 10.98          | 24.2419-0941.3 | 030067 |   |                      | Gz 19,05             |     |  |  |  |  |
|                                   | 2.3                   | 85  |       | 08.94 | 07.95          |                |        |   |                      |                      |     |  |  |  |  |
|                                   | 2.3                   | 96  |       | 08.94 | 10.98          |                |        |   |                      |                      |     |  |  |  |  |
|                                   | 2.3 ti                | 99  |       | 01.95 | 10.98          |                |        |   |                      |                      |     |  |  |  |  |
|                                   | 2.3 T                 | 121 |       | 08.94 | 10.98          |                |        |   |                      |                      |     |  |  |  |  |
| 2.4 TD Intercooler                | 90                    |     | 08.94 | 10.98 | 24.2419-0928.3 | 030056         |        |   | Gz 19,05             |                      |     |  |  |  |  |
|                                   | 2.0 T                 | 114 |       | 04.96 | 10.98          | 24.2520-0905.3 | 040057 |   |                      | Nz 20,64             |     |  |  |  |  |
|                                   | 2.3                   | 85  |       | 08.94 | 07.95          |                |        |   |                      |                      |     |  |  |  |  |
|                                   | 2.3                   | 96  |       | 08.94 | 10.98          |                |        |   |                      |                      |     |  |  |  |  |
|                                   | 2.3 ti                | 99  |       | 01.95 | 10.98          |                |        |   |                      |                      |     |  |  |  |  |
|                                   | 2.3 T                 | 121 |       | 08.94 | 10.98          |                |        |   |                      |                      |     |  |  |  |  |
| 2.4 TD Intercooler                | 90                    |     | 08.94 | 10.98 | 03.2522-0420.3 | 040086         |        |   | Nz 22,20             |                      |     |  |  |  |  |
| VOLVO 960 I Limousine (90-94)     |                       |     |       |       |                |                |        |   |                      |                      |     |  |  |  |  |
|                                   | 2.0                   | 103 |       | 09.90 | 12.91          | 03.2023-0164.3 | 010014 |   |                      | Thz 23,81/19,05 + B. | ATE |  |  |  |  |
|                                   | 2.0                   | 140 |       | 08.90 | 12.91          |                |        |   |                      |                      |     |  |  |  |  |
|                                   | 2.4 TD Intercooler    | 85  |       | 09.91 | 12.91          |                |        |   |                      |                      |     |  |  |  |  |
|                                   | 2.9                   | 150 |       | 08.90 | 12.91          |                |        |   |                      |                      |     |  |  |  |  |
|                                   | 2.0                   | 103 |       | 01.92 | 08.93          |                |        |   |                      |                      |     |  |  |  |  |
| 2.0                               | 140                   |     | 01.92 | 09.93 | 03.2023-0875.3 | 010890         |        |   | Thz 23,81/20,64 - B. | ATE                  |     |  |  |  |  |
| 2.4 TD Intercooler                | 85                    |     | 01.92 | 07.94 |                |                |        |   |                      |                      |     |  |  |  |  |
| 2.9                               | 150                   |     | 01.92 | 07.94 |                |                |        |   |                      |                      |     |  |  |  |  |

1) - multi link axle / - assale Multi-link / - essieu multi-link / - eje Multi-Link  
 2) f.predec.13.2381-0067/-0068.2 / p.prece.13.2381-0067.2/-0068.2 / p.préd.13.2381-0067.2/-0068.2 / p. prede.13.2381-0067.2/-0068.2  
 3) f.predec.13.2401-0023/-0024.2 / p.prece.13.2401-0023.2/-0024.2 / p.préd.13.2401-0023.2/-0024.2 / p. prede.13.2401-0023.2/-0024.2



|     |  |  |  |  |  |  |  |                               |  |                |        |
|--|--|--|--|--|---|--|--|---|--|----------------|--------|
| <b>VOLVO 960 I Limousine (90-94)</b>   |  |  |  |  |   |  |  |   |  |                |        |
|    | 2.0  | 103  |  | 09.90  | 08.93   | 24.3571-1707.5   | 240079   | D=57, - Halter<br>D=57, - Halter<br>Einbausatz  | LUC<br>LUC<br>LUC                                    |                |        |
|  | 2.0  | 140  |  | 08.90  | 09.93   | 24.3571-1708.5   | 240080   |   |  |                |        |
|  | 2.4 TD Intercooler   | 85   |  | 09.91  | 07.94   | 24.0101-3601.2   | 260044   |   |  |                |        |
|  | 2.9  | 150  |  | 08.90  | 07.94   |  |  |   |  |                |        |
|    | 2.0  | 103  |  | 09.90  | 08.93   | 83.6134-0335.3   | 330277   | 2   | L=335  |                |        |
|  | 2.0  | 140  |  | 08.90  | 09.93   |  |  |   |  |                |        |
|  | 2.4 TD Intercooler   | 85   |  | 09.91  | 07.94   |  |  |   |  |                |        |
|  | 2.9  | 150  |  | 08.90  | 07.94   |  |  |   |  |                |        |
|    | 2.0  | 103  |  | 09.90  | 08.93   | 13.2381-0087.2   | 210149   | D=38<br>D=38<br>D=38<br>D=38<br>D=40<br>D=40<br>D=40<br>D=40<br>Dichtungssatz                                   | ATE<br>ATE<br>ATE<br>ATE<br>ATE<br>ATE<br>ATE<br>ATE |                |        |
|  | 2.0  | 140  |  | 08.90  | 09.93   | 13.2381-0088.2   | 210150   |   |  |                |        |
|  | 2.4 TD Intercooler   | 85   |  | 09.91  | 07.94   | 24.9238-0087.5   | 230035   |   |  |                |        |
|  | 2.9  | 150  |  | 08.90  | 07.94   | 24.9238-0088.5   | 230036   |   |  |                |        |
|  |  |  |  |  |   | 13.2401-0027.2   | 210045   |   |  |                |        |
|  |  |  |  |  |   | 13.2401-0028.2   | 210046   |   |  |                |        |
|  |  |  |  |  |   | 24.9240-0027.5   | 230017   |   |  |                |        |
|  |  |  |  |  |   | 24.9240-0028.5   | 230018   |   |  |                |        |
|  |  |  |  |  | 13.0441-4014.2  | 250079   |  |   |  |                |        |
|    | 2.0  | 103  |  | 09.90  | 12.91   | 83.6134-0300.3   | 330725   | 2   | L=300  |                |        |
|  | 2.0  | 140  |  | 08.90  | 12.91   |  |  |   |  |                |        |
|  | 2.4 TD Intercooler   | 85   |  | 09.91  | 12.91   |  |  |   |  |                |        |
|  | 2.9  | 150  |  | 08.90  | 12.91   |  |  |   |  |                |        |
|    | 2.0  | 103  |  | 01.92  | 08.93   | 83.6124-0305.3   | 330723   | 2   | L=305  |                |        |
|  | 2.0  | 140  |  | 01.92  | 09.93   |  |  |   |  |                |        |
|  | 2.4 TD Intercooler   | 85   |  | 01.92  | 07.94   |  |  |   |  |                |        |
|  | 2.9  | 150  |  | 01.92  | 07.94   |  |  |   |  |                |        |
|    | 2.0  | 103  |  | 09.90  | 08.93   | 03.6055-0430.3   | 320065   | BR 5/25 (4)   | ATE  |                |        |
|  | 2.0  | 140  |  | 08.90  | 09.93   |  |  |   |  |                |        |
|  | 2.9  | 150  |  | 08.90  | 07.94   |  |  |   |  |                |        |
|    | 2.4 TD Intercooler   | 85   |  | 09.91  | 07.94   | 03.6055-0431.3   | 320142   | BR 5/35 (4)   | ATE  |                |        |
|  | 2.0  | 103  |  | 09.90  | 08.93   | 24.2419-0928.3   | 030056   | Gz 19,05  |  |                |        |
|    | 2.0  | 140  |  | 08.90  | 09.93   |  |  |   |  |                |        |
|  | 2.4 TD Intercooler   | 85   |  | 09.91  | 07.94   |  |  |   |  |                |        |
|  | 2.0  | 103  |  | 09.90  | 08.93   | 03.2522-0420.3   | 040086   | Nz 22,20  |  |                |        |
|  | 2.0  | 140  |  | 08.90  | 09.93   |  |  |   |  |                |        |
|  | 2.4 TD Intercooler   | 85   |  | 09.91  | 07.94   |  |  |   |  |                |        |
| <b>VOLVO 960 I Kombi (90-94)</b>   |  |  |  |  |   |  |  |   |  |                |        |
|   | 2.0  | 103  |  | 09.90  | 12.91   | 03.2023-0164.3   | 010014   |   | THz 23,81/19,05 + B.                                 | ATE            |        |
|  | 2.0  | 140  |  | 08.90  | 12.91   |  |  |   |  |                |        |
|  | 2.4 TD Intercooler   | 85   |  | 09.91  | 12.91   |  |  |   |  |                |        |
|  | 2.8  | 108  |  | 09.90  | 12.91   |  |  |   |  |                |        |
|  | 2.8  | 115  |  | 09.90  | 12.91   |  |  |   |  |                |        |
|  | 2.9  | 150  |  | 08.90  | 12.91   |  |  |   |  |                |        |
|  | 2.0  | 103  |  | 01.92  | 08.93   | 03.2023-0875.3   | 010890   |   | THz 23,81/20,64 - B.                                 | ATE            |        |
|  | 2.0  | 140  |  | 01.92  | 09.93   |  |  |   |  |                |        |
|  | 2.4 TD Intercooler   | 85   |  | 01.92  | 07.94   |  |  |   |  |                |        |
|  | 2.8  | 108  |  | 01.92  | 05.92   |  |  |   |  |                |        |
|  | 2.8  | 115  |  | 01.92  | 05.92   |  |  |   |  |                |        |
|  | 2.9  | 150  |  | 01.92  | 07.94   |  |  |   |  |                |        |
|  | 2.0  | 103  |  | 09.90  | 08.93   | 24.3571-1707.5   | 240079   | D=57, - Halter<br>D=57, - Halter<br>Einbausatz  | LUC<br>LUC<br>LUC                                    |                |        |
|  | 2.0  | 140  |  | 08.90  | 09.93   |  |  |   |  | 24.3571-1708.5 | 240080 |
|  | 2.4 TD Intercooler   | 85   |  | 09.91  | 07.94   |  |  |   |  | 24.0101-3601.2 | 260044 |
|  | 2.8  | 108  |  | 09.90  | 05.92   |  |  |   |  |                |        |
|  | 2.8  | 115  |  | 09.90  | 05.92   |  |  |   |  |                |        |
|  | 2.9  | 150  |  | 08.90  | 07.94   |  |  |   |  |                |        |
|  | 2.0  | 103  |  | 09.90  | 08.93   | 83.6134-0335.3   | 330277   | 2   | L=335  |                |        |
|  | 2.0  | 140  |  | 08.90  | 09.93   |  |  |   |  |                |        |
|  | 2.4 TD Intercooler   | 85   |  | 09.91  | 07.94   |  |  |   |  |                |        |
|  | 2.8  | 108  |  | 09.90  | 05.92   |  |  |   |  |                |        |
|  | 2.8  | 115  |  | 09.90  | 05.92   |  |  |   |  |                |        |
|  | 2.9  | 150  |  | 08.90  | 07.94   |  |  |   |  |                |        |
|  | 2.0  | 103  |  | 09.90  | 08.93   | 13.2381-0087.2   | 210149   | D=38<br>D=38<br>D=38<br>D=38<br>D=40<br>D=40<br>D=40<br>D=40<br>Dichtungssatz<br>Dichtungssatz<br>Dichtungssatz | ATE<br>ATE<br>ATE<br>ATE<br>ATE<br>ATE<br>ATE<br>ATE |                |        |
|  | 2.0  | 140  |  | 08.90  | 09.93   | 13.2381-0088.2   | 210150   |   |  |                |        |
|  | 2.4 TD Intercooler   | 85   |  | 09.91  | 07.94   | 24.9238-0087.5   | 230035   |   |  |                |        |
|  | 2.8  | 108  |  | 09.90  | 05.92   | 24.9238-0088.5   | 230036   |   |  |                |        |
|  | 2.8  | 115  |  | 09.90  | 05.92   | 13.2401-0027.2   | 210045   |   |  |                |        |
|  | 2.9  | 150  |  | 09.90  | 05.92   | 13.2401-0028.2   | 210046   |   |  |                |        |
|  |  |  |  | 08.90  | 07.94   | 24.9240-0027.5   | 230017   |   |  |                |        |
|  |  |  |  |  |   | 24.9240-0028.5   | 230018   |   |  |                |        |
|  |  |  |  |  | 13.0441-3815.2  | 250069   |  |   |  |                |        |
|  |  |  |  |  | 13.0441-3819.2  | 250072   |  |   |  |                |        |
|  |  |  |  |  | 13.0441-4014.2  | 250079   |  |   |  |                |        |
|  | 2.0  | 103  |  | 09.90  | 12.91   | 83.6134-0300.3   | 330725   | 2   | L=300  |                |        |
|  | 2.0  | 140  |  | 08.90  | 12.91   |  |  |   |  |                |        |
|  | 2.4 TD Intercooler   | 85   |  | 09.91  | 12.91   |  |  |   |  |                |        |
|  | 2.8  | 108  |  | 09.90  | 12.91   |  |  |   |  |                |        |
|  | 2.0  | 103  |  | 01.92  | 08.93   | 83.6124-0305.3   | 330723   | 2   | L=305  |                |        |
|  | 2.0  | 140  |  | 01.92  | 09.93   |  |  |   |  |                |        |
|  | 2.4 TD Intercooler   | 85   |  | 01.92  | 07.94   |  |  |   |  |                |        |
|  | 2.8  | 108  |  | 01.92  | 05.92   |  |  |   |  |                |        |
|  | 2.8  | 115  |  | 01.92  | 05.92   |  |  |   |  |                |        |
|  | 2.9  | 150  |  | 01.92  | 07.94   |  |  |   |  |                |        |

1) - multi link axle / - assale Multi-link / - essieu multi-link / - eje Multi-Link  
 2) f.predec.13.2381-0067/-0068.2 / p.prece.13.2381-0067.2/-0068.2 / p.préd.13.2381-0067.2/-0068.2 / p. prede.13.2381-0067.2/-0068.2  
 3) f.predec.13.2401-0023/-0024.2 / p.prece.13.2401-0023.2/-0024.2 / p.préd.13.2401-0023.2/-0024.2 / p. prede.13.2401-0023.2/-0024.2

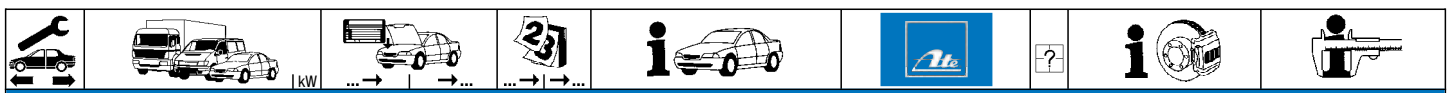

| VOLVO 960 I Kombi (90-94) |                    |     |       |       |                |                |        |  |             |             |     |
|---------------------------|--------------------|-----|-------|-------|----------------|----------------|--------|--|-------------|-------------|-----|
|                           | 2.0                | 103 |       | 09.90 | 08.93          | 03.6055-0430.3 | 320065 |  |             | BR 5/25 (4) | ATE |
|                           | 2.0                | 140 |       | 08.90 | 09.93          |                |        |  |             |             |     |
|                           | 2.8                | 108 |       | 09.90 | 05.92          |                |        |  |             |             |     |
|                           | 2.8                | 115 |       | 09.90 | 05.92          |                |        |  |             |             |     |
|                           | 2.9                | 150 |       | 08.90 | 07.94          |                |        |  |             |             |     |
| 2.4 TD Intercooler        | 85                 |     | 09.91 | 07.94 | 03.6055-0431.3 | 320142         |        |  | BR 5/35 (4) | ATE         |     |
|                           | 2.0                | 103 |       | 09.90 | 08.93          | 24.2419-0928.3 | 030056 |  |             | Gz 19,05    |     |
|                           | 2.0                | 140 |       | 08.90 | 09.93          |                |        |  |             |             |     |
|                           | 2.4 TD Intercooler | 85  |       | 09.91 | 07.94          |                |        |  |             |             |     |
|                           | 2.8                | 108 |       | 09.90 | 05.92          |                |        |  |             |             |     |
|                           | 2.8                | 115 |       | 09.90 | 05.92          |                |        |  |             |             |     |
| 2.9                       | 150                |     | 08.90 | 07.94 |                |                |        |  |             |             |     |
|                           | 2.0                | 103 |       | 09.90 | 08.93          | 03.2522-0420.3 | 040086 |  |             | Nz 22,20    |     |
|                           | 2.0                | 140 |       | 08.90 | 09.93          |                |        |  |             |             |     |
|                           | 2.4 TD Intercooler | 85  |       | 09.91 | 07.94          |                |        |  |             |             |     |
|                           | 2.8                | 108 |       | 09.90 | 05.92          |                |        |  |             |             |     |
|                           | 2.8                | 115 |       | 09.90 | 05.92          |                |        |  |             |             |     |
| 2.9                       | 150                |     | 08.90 | 07.94 |                |                |        |  |             |             |     |















| VOLVO 960 II Limousine (94-96) |     |     |  |       |       |                |        |   |  |  |               |                                  |
|--------------------------------|-----|-----|--|-------|-------|----------------|--------|---|--|--|---------------|----------------------------------|
|                                | 2.5 | 125 |  | 08.94 | 12.96 | 03.2023-0875.3 | 010890 |   |  | Thz 23,81/20,64 - B.                         | ATE           |                                  |
|                                | 2.9 | 150 |  | 08.94 | 12.96 |                |        |   |  |  |               |                                  |
|                                | 2.5 | 125 |  | 08.94 | 12.96 | 24.3571-1707.5 | 240079 |   |  | D=57, - Halter                               | LUC           |                                  |
|                                | 2.9 | 150 |  | 08.94 | 12.96 |                |        |   |  |  |               | 24.3571-1708.5                   |
|                                | 2.5 | 125 |  | 08.94 | 12.94 | 83.6134-0335.3 | 330277 | 2 |  | L=335  |               |                                  |
|                                | 2.9 | 150 |  | 08.94 | 12.94 |                |        |   |  |  |               |                                  |
|                                | 2.5 | 125 |  | 01.95 | 12.96 | 83.6124-0380.3 | 330268 | 2 |  | L=380  |               |                                  |
|                                | 2.9 | 150 |  | 01.95 | 12.96 |                |        |   |  |  |               |                                  |
|                                | 2.5 | 125 |  | 08.94 | 12.96 | 13.2401-0027.2 | 210045 |   |  | D=40   | ATE           |                                  |
|                                | 2.9 | 150 |  | 08.94 | 12.96 |                |        |   |  |  |               | - Multi-Link-Achse <sup>1)</sup> |
|                                | 2.5 | 125 |  | 08.94 | 12.96 | 13.0441-4014.2 | 250079 |   |  | für Vorg. 13.2401-0023/-0024.2 <sup>2)</sup> | Dichtungssatz | ATE                              |
|                                | 2.9 | 150 |  | 08.94 | 12.96 |                |        |   |  |  |               |                                  |
|                                | 2.5 | 125 |  | 08.94 | 12.96 | 83.6134-0300.3 | 330725 | 2 |  | L=300  |               |                                  |
|                                | 2.9 | 150 |  | 08.94 | 12.96 |                |        |   |  |  |               |                                  |
|                                | 2.5 | 125 |  | 08.94 | 12.96 | 03.6055-0430.3 | 320065 |   |  | BR 5/25 (4)                                  | ATE           |                                  |
|                                | 2.9 | 150 |  | 08.94 | 12.96 |                |        |   |  |  |               |                                  |
|                                | 2.5 | 125 |  | 08.94 | 12.96 | 24.2419-0928.3 | 030056 |   |  | Gz 19,05                                     |               |                                  |
|                                | 2.9 | 150 |  | 08.94 | 12.96 |                |        |   |  |  |               | 24.2419-0941.3                   |
|                                | 2.5 | 125 |  | 08.94 | 12.96 | 03.2522-0420.3 | 040086 |   |  | Nz 22,20                                     |               |                                  |
|                                | 2.9 | 150 |  | 08.94 | 12.96 |                |        |   |  |  |               | 24.2520-0905.3                   |

| VOLVO 960 II Kombi (94-96) |     |     |  |       |       |                |        |   |  |  |               |                                  |
|----------------------------|-----|-----|--|-------|-------|----------------|--------|---|--|--|---------------|----------------------------------|
|                            | 2.5 | 125 |  | 08.94 | 12.96 | 03.2023-0875.3 | 010890 |   |  | Thz 23,81/20,64 - B.                         | ATE           |                                  |
|                            | 2.9 | 150 |  | 08.94 | 12.96 |                |        |   |  |  |               |                                  |
|                            | 2.5 | 125 |  | 08.94 | 12.96 | 24.3571-1707.5 | 240079 |   |  | D=57, - Halter                               | LUC           |                                  |
|                            | 2.9 | 150 |  | 08.94 | 12.96 |                |        |   |  |  |               | 24.3571-1708.5                   |
|                            | 2.5 | 125 |  | 08.94 | 12.94 | 83.6134-0335.3 | 330277 | 2 |  | L=335  |               |                                  |
|                            | 2.9 | 150 |  | 08.94 | 12.94 |                |        |   |  |  |               |                                  |
|                            | 2.5 | 125 |  | 01.95 | 12.96 | 83.6124-0380.3 | 330268 | 2 |  | L=380  |               |                                  |
|                            | 2.9 | 150 |  | 01.95 | 12.96 |                |        |   |  |  |               |                                  |
|                            | 2.5 | 125 |  | 08.94 | 12.96 | 13.2401-0027.2 | 210045 |   |  | D=40   | ATE           |                                  |
|                            | 2.9 | 150 |  | 08.94 | 12.96 |                |        |   |  |  |               | - Multi-Link-Achse <sup>1)</sup> |
|                            | 2.5 | 125 |  | 08.94 | 12.96 | 13.0441-4014.2 | 250079 |   |  | für Vorg. 13.2381-0065/-0066.2 <sup>3)</sup> | Dichtungssatz | ATE                              |
|                            | 2.9 | 150 |  | 08.94 | 12.96 |                |        |   |  |  |               |                                  |
|                            | 2.5 | 125 |  | 08.94 | 12.96 | 83.6134-0300.3 | 330725 | 2 |  | L=300  |               |                                  |
|                            | 2.9 | 150 |  | 08.94 | 12.96 |                |        |   |  |  |               |                                  |
|                            | 2.5 | 125 |  | 08.94 | 12.96 | 03.6055-0430.3 | 320065 |   |  | BR 5/25 (4)                                  | ATE           |                                  |
|                            | 2.9 | 150 |  | 08.94 | 12.96 |                |        |   |  |  |               |                                  |
|                            | 2.5 | 125 |  | 08.94 | 12.96 | 24.2419-0928.3 | 030056 |   |  | Gz 19,05                                     |               |                                  |
|                            | 2.9 | 150 |  | 08.94 | 12.96 |                |        |   |  |  |               | 24.2419-0941.3                   |
|                            | 2.5 | 125 |  | 08.94 | 12.96 | 03.2522-0420.3 | 040086 |   |  | Nz 22,20                                     |               |                                  |
|                            | 2.9 | 150 |  | 08.94 | 12.96 |                |        |   |  |  |               | 24.2520-0905.3                   |

| VOLVO C30 Coupe (06-12) |                  |     |  |       |       |                |        |  |  |     |     |                |        |     |     |
|-------------------------|------------------|-----|--|-------|-------|----------------|--------|--|--|-----|-----|----------------|--------|-----|-----|
|                         | 1.6              | 74  |  | 09.06 | 12.12 | 03.7863-0832.4 | 300229 |  |  | 10" | ATE |                |        |     |     |
|                         | 1.6 D            | 80  |  | 09.06 | 12.12 |                |        |  |  |     |     | 03.7863-4132.4 | 300259 | 10" | ATE |
|                         | 1.6 D Efficiency | 77  |  | 09.08 | 12.12 |                |        |  |  |     |     |                |        |     |     |
|                         | 1.8              | 92  |  | 09.06 | 12.12 |                |        |  |  |     |     |                |        |     |     |
|                         | 1.8 FlexiFuel    | 92  |  | 04.07 | 12.12 |                |        |  |  |     |     |                |        |     |     |
|                         | 2.0              | 107 |  | 09.06 | 12.12 |                |        |  |  |     |     |                |        |     |     |



















1) - multi link axle / - assale Multi-link / - essieu multi-link / - eje Multi-Link  
 2) f.predec.13.2401-0023/-0024.2 / p.prece.13.2401-0023.2/-0024.2 / p.préd.13.2401-0023.2/-0024.2 / p. prede.13.2401-0023.2/-0024.2  
 3) f.predec.13.2381-0065/-0066.2 / p.prece.13.2381-0065.2/-0066.2 / p.préd.13.2381-0065.2/-0066.2 / p. prede.13.2381-0065.2/-0066.2



|     |   |                       |    |    |   |    |  |    |  |   |
|--|---|---|--|--|--|--|--|--|--|---|
| <b>VOLVO C30 Coupe (06-12)</b>   |   |   |  |  |  |  |  |  |  |   |
|    | 2.0 D<br>2.4 D5<br>2.4 D5<br>2.4 i<br>2.5 T5<br>2.5 T5<br>Electric  | #100<br>#120<br>#132<br>#125<br>#162<br>#169<br># 82  |  | 09.06<br>10.06<br>09.06<br>09.06<br>09.06<br>03.07<br>12.10  | 12.12<br>12.12<br>12.12<br>12.12<br>12.12<br>12.12<br>12.12  | 03.7863-0832.4<br>03.7863-4132.4   | 300229<br>300259   | 10"<br>10"   | ATE<br>ATE   |   |
|    | 1.6<br>1.6 D<br>1.6 D Efficiency<br>1.8<br>1.8 FlexiFuel<br>2.0<br>2.0 D<br>2.4 D5<br>2.4 D5<br>2.4 i<br>2.5 T5<br>2.5 T5<br>Electric                               | # 74<br># 80<br># 77<br># 92<br># 92<br>#107<br>#100<br>#120<br>#132<br>#125<br>#162<br>#169<br># 82  |  | 09.06<br>09.06<br>09.08<br>09.06<br>04.07<br>09.06<br>09.06<br>10.06<br>09.06<br>09.06<br>09.06<br>03.07<br>12.10                            | 12.12<br>12.12<br>12.12<br>12.12<br>12.12<br>12.12<br>12.12<br>12.12<br>12.12<br>12.12<br>12.12<br>12.12<br>12.12                            | 03.2123-3593.3   | 010919   | THz 23,81  | ATE  |   |
|    | 1.6<br>1.6 D<br>1.6 D Efficiency<br>1.6 D2<br>1.8<br>1.8 FlexiFuel<br>2.0<br>2.0 D<br>2.0 D3<br>2.0 D4<br>2.4 D5<br>2.4 D5<br>2.4 i<br>2.5 T5<br>2.5 T5<br>Electric | 74<br>80<br>77<br>84<br>92<br>92<br>107<br>100<br>110<br>130<br>120<br>132<br>125<br>162<br>169<br>82 |  | 09.06<br>09.06<br>09.08<br>10.10<br>09.06<br>04.07<br>09.06<br>09.06<br>10.10<br>10.10<br>10.06<br>09.06<br>09.06<br>09.06<br>03.07<br>12.10 | 12.12<br>12.12<br>12.12<br>12.12<br>12.12<br>12.12<br>12.12<br>12.12<br>12.12<br>12.12<br>12.12<br>12.12<br>12.12<br>12.12<br>12.12<br>12.12 | 11.9571-9813.2<br>11.9571-9814.2<br>24.3571-9813.5<br>24.3571-9814.5<br>11.0101-5407.2<br>11.8171-0008.1<br>11.8116-0356.1 | 220647<br>220648<br>240557<br>240558<br>260011<br>990049<br>390586                 | <input type="checkbox"/> + 15"/16" Rad 1)<br><input type="checkbox"/> + 15"/16" Rad 1)<br><input type="checkbox"/> + 15"/16" Rad 1)<br><input type="checkbox"/> + 15"/16" Rad 1) | D=57, - Halter<br>D=57, - Halter<br>D=57, - Halter<br>D=57, - Halter<br>Hülsensatz<br>Führungsbolzen<br>Haltefeder | ATE<br>ATE<br>ATE<br>ATE<br>ATE<br>ATE<br>ATE |
|    | 1.6<br>1.6 D<br>1.6 D Efficiency<br>1.6 D2<br>1.8<br>1.8 FlexiFuel<br>2.0<br>2.0 D<br>2.0 D3<br>2.0 D4<br>2.4 D5<br>2.4 D5<br>2.4 i<br>2.5 T5<br>2.5 T5<br>Electric | 74<br>80<br>77<br>84<br>92<br>92<br>107<br>100<br>110<br>130<br>120<br>132<br>125<br>162<br>169<br>82 |  | 09.06<br>09.06<br>09.08<br>10.10<br>09.06<br>04.07<br>09.06<br>09.06<br>10.10<br>10.10<br>10.06<br>09.06<br>09.06<br>09.06<br>03.07<br>12.10 | 12.12<br>12.12<br>12.12<br>12.12<br>12.12<br>12.12<br>12.12<br>12.12<br>12.12<br>12.12<br>12.12<br>12.12<br>12.12<br>12.12<br>12.12<br>12.12 | 83.7716-0398.3   | 330987   | L=395  |  |   |
|  | 1.6<br>1.6 D<br>1.6 D Efficiency<br>1.6 D2<br>1.8<br>1.8 FlexiFuel<br>2.0<br>2.0 D<br>2.0 D3<br>2.0 D4<br>2.4 D5<br>2.4 D5<br>2.4 i<br>2.5 T5<br>2.5 T5<br>Electric | 74<br>80<br>77<br>84<br>92<br>92<br>107<br>100<br>110<br>130<br>120<br>132<br>125<br>162<br>169<br>82 | 146186<br>146186<br>146186<br>146186<br>146186<br>146186<br>146186<br>146186<br>146186<br>146186<br>146186<br>146186<br>146186<br>146186<br>146186<br>146186 | 09.06<br>09.06<br>09.08<br>10.10<br>09.06<br>04.07<br>09.06<br>09.06<br>10.10<br>10.10<br>10.06<br>09.06<br>09.06<br>09.06<br>03.07<br>12.12 | 12.12<br>12.12<br>12.12<br>12.12<br>12.12<br>12.12<br>12.12<br>12.12<br>12.12<br>12.12<br>12.12<br>12.12<br>12.12<br>12.12<br>12.12<br>12.12 | 11.9387-7015.2<br>11.9387-7016.2<br>11.0230-0698.2<br>11.0101-5407.2<br>11.8171-0008.1<br>11.8116-0340.1                   | 220627<br>220628<br>260091<br>260011<br>990049<br>390595                           | <input type="checkbox"/><br><input type="checkbox"/>   | D=38, - Halter<br>D=38, - Halter<br>Halter<br>Hülsensatz<br>Führungsbolzen<br>Haltefeder                           | ATE<br>ATE<br>ATE<br>ATE<br>ATE<br>ATE        |
|  | 1.6<br>1.6 D<br>1.6 D Efficiency<br>1.6 D2<br>1.8<br>1.8 FlexiFuel<br>2.0<br>2.0 D<br>2.0 D3<br>2.0 D4<br>2.4 D5<br>2.4 D5<br>2.4 i<br>2.5 T5<br>2.5 T5<br>Electric | 74<br>80<br>77<br>84<br>92<br>92<br>107<br>100<br>110<br>130<br>120<br>132<br>125<br>162<br>169<br>82 | 146187<br>146187<br>146187<br>146187<br>146187<br>146187<br>146187<br>146187<br>146187<br>146187<br>146187<br>146187<br>146187<br>146187<br>146187<br>146187 | 12.12<br>12.12<br>12.12<br>12.12<br>12.12<br>12.12<br>12.12<br>12.12<br>12.12<br>12.12<br>12.12<br>12.12<br>12.12<br>12.12<br>12.12<br>12.12 | 12.12<br>12.12<br>12.12<br>12.12<br>12.12<br>12.12<br>12.12<br>12.12<br>12.12<br>12.12<br>12.12<br>12.12<br>12.12<br>12.12<br>12.12<br>12.12 | 11.0230-0698.2<br>11.0101-5407.2<br>11.8171-0008.1<br>11.8116-0340.1   | 260091<br>260011<br>990049<br>390595   | 2  | Halter<br>Hülsensatz<br>Führungsbolzen<br>Haltefeder   | ATE<br>ATE<br>ATE<br>ATE                      |
|  | 1.6<br>1.6 D<br>1.6 D Efficiency<br>1.6 D2<br>1.8<br>1.8 FlexiFuel<br>2.0<br>2.0 D<br>2.0 D3<br>2.0 D4<br>2.4 D5<br>2.4 D5<br>2.4 i<br>2.5 T5<br>2.5 T5<br>Electric | 74<br>80<br>77<br>84<br>92<br>92<br>107<br>100<br>110<br>130<br>120<br>132<br>125<br>162<br>169<br>82 | 127  | 12.10  | 12.12  |  |  |  |  |   |

1) + 15"/16" wheel / + ruota 15"/16" / + roue 15"/16" / + rueda 15"/16"























|     |  |  |  |  |  |  |  |  |                             |                 |     |
|--|--|--|--|--|---|--|--|--|-----------------------------|-----------------|-----|
| <b>VOLVO C30 Coupe (06-12)</b>   |  |  |  |  |   |  |  |  |                             |                 |     |
|    | 1.6  | 74   |  | 09.06  | 12.12   | 83.7788-0383.3   | 330972   | 2  |                             | L=382           |     |
|  | 1.6 D  | 80   |  | 09.06  | 12.12   |  |  |  |                             |                 |     |
|  | 1.6 D Efficiency   | 77   |  | 09.08  | 12.12   |  |  |  |                             |                 |     |
|  | 1.6 D2   | 84   |  | 10.10  | 12.12   |  |  |  |                             |                 |     |
|  | 1.8  | 92   |  | 09.06  | 12.12   |  |  |  |                             |                 |     |
|  | 1.8 FlexiFuel  | 92   |  | 04.07  | 12.12   |  |  |  |                             |                 |     |
|  | 2.0  | 107  |  | 09.06  | 12.12   |  |  |  |                             |                 |     |
|  | 2.0 D  | 100  |  | 09.06  | 12.12   |  |  |  |                             |                 |     |
|  | 2.0 D3   | 110  |  | 10.10  | 12.12   |  |  |  |                             |                 |     |
|  | 2.0 D4   | 130  |  | 10.10  | 12.12   |  |  |  |                             |                 |     |
|  | 2.4 D5   | 120  |  | 10.06  | 12.12   |  |  |  |                             |                 |     |
|  | 2.4 D5   | 132  |  | 09.06  | 12.12   |  |  |  |                             |                 |     |
|  | 2.4 i  | 125  |  | 09.06  | 12.12   |  |  |  |                             |                 |     |
|  | 2.5 T5   | 162  |  | 09.06  | 12.12   |  |  |  |                             |                 |     |
|  | 2.5 T5   | 169  |  | 03.07  | 12.12   |  |  |  |                             |                 |     |
|  | Electric   | 82   |  | 12.10  | 12.12   |  |  |  |                             |                 |     |
| <b>VOLVO C70 Coupe (97-02)</b>   |  |  |  |  |   |  |  |  |                             |                 |     |
|    | 2.0  | 132  |  | 03.97  | 12.98   | 03.7760-3602.4   | 300176   |  |                             | 10"             | ATE |
|  | 2.0 T  | 166  |  | 03.97  | 12.98   |  |  |  |                             |                 |     |
|  | 2.3 T5   | 176  |  | 03.97  | 12.98   |  |  |  |                             |                 |     |
|  | 2.5 T  | 142  |  | 03.97  | 12.98   |  |  |  |                             |                 |     |
|  | 2.0  | 132  |  | 01.99  | 09.02   | 03.7760-4902.4   | 300178   |  | - Wegsensor <sup>1)</sup>   | 10"             | ATE |
|  | 2.0 T  | 120  |  | 03.00  | 09.02   |  |  |  |                             |                 |     |
|  | 2.0 T  | 166  |  | 01.99  | 09.02   |  |  |  |                             |                 |     |
|  | 2.3 T5   | 176  |  | 01.99  | 09.02   |  |  |  |                             |                 |     |
|  | 2.5  | 121  |  | 03.99  | 09.02   |  |  |  |                             |                 |     |
|  | 2.5  | 125  |  | 11.99  | 09.02   |  |  |  |                             |                 |     |
|  | 2.5 T  | 142  |  | 01.99  | 09.02   |  |  |  |                             |                 |     |
|    | 2.0  | 132  |  | 03.97  | 12.98   | 03.2023-1084.3   | 010591   |  | - ASR                       | THz 23,81/20,64 | ATE |
|  | 2.0 T  | 166  |  | 03.97  | 12.98   | 03.2023-1044.3   | 010590   |  | + ASR                       | THz 23,81/20,64 | ATE |
|  | 2.3 T5   | 176  |  | 03.97  | 12.98   |  |  |  |                             |                 |     |
|  | 2.5 T  | 142  |  | 03.97  | 12.98   |  |  |  |                             |                 |     |
|  | 2.0  | 132  |  | 01.99  | 09.02   | 03.2123-2164.3   | 010599   |  |                             | THz 23,81       | ATE |
|  | 2.0 T  | 120  |  | 03.00  | 09.02   |  |  |  |                             |                 |     |
|  | 2.0 T  | 166  |  | 01.99  | 09.02   |  |  |  |                             |                 |     |
|  | 2.3 T5   | 176  |  | 01.99  | 09.02   |  |  |  |                             |                 |     |
|  | 2.5  | 121  |  | 03.99  | 09.02   |  |  |  |                             |                 |     |
|  | 2.5  | 125  |  | 11.99  | 09.02   |  |  |  |                             |                 |     |
|  | 2.5 T  | 142  |  | 01.99  | 09.02   |  |  |  |                             |                 |     |
|  | 2.0  | 132  |  | 03.97  | 09.02   | 11.9571-9971.2   | 220605   |  |                             | D=57, - Halter  | ATE |
|  | 2.0 T  | 120  |  | 03.00  | 09.02   | 11.9571-9972.2   | 220606   |  |                             | D=57, - Halter  | ATE |
|  | 2.0 T  | 166  |  | 03.97  | 09.02   | 11.8116-0073.1   | 390498   | 2  |                             | Haltefeder      | ATE |
|  | 2.3 T5   | 176  |  | 03.97  | 09.02   |  |  |  |                             |                 |     |
|  | 2.5  | 121  |  | 03.99  | 09.02   |  |  |  |                             |                 |     |
|  | 2.5  | 125  |  | 11.99  | 09.02   |  |  |  |                             |                 |     |
|  | 2.5 T  | 142  |  | 03.97  | 09.02   |  |  |  |                             |                 |     |
|  | 2.0  | 132  |  | 03.97  | 09.02   | 83.6113-0331.3   | 330982   | 2  | am Bremsattel <sup>2)</sup> | L=330           |     |
|  | 2.0 T  | 120  |  | 03.00  | 09.02   |  |  |  |                             |                 |     |
|  | 2.0 T  | 166  |  | 03.97  | 09.02   |  |  |  |                             |                 |     |
|  | 2.3 T5   | 176  |  | 03.97  | 09.02   |  |  |  |                             |                 |     |
|  | 2.5  | 121  |  | 03.99  | 09.02   |  |  |  |                             |                 |     |
|  | 2.5  | 125  |  | 11.99  | 09.02   |  |  |  |                             |                 |     |
|  | 2.5 T  | 142  |  | 03.97  | 09.02   |  |  |  |                             |                 |     |
|  | 2.0  | 132  |  | 03.97  | 09.02   | 13.2381-0097.2   | 210239   |  |                             | D=38            | ATE |
|  | 2.0 T  | 120  |  | 03.00  | 09.02   | 13.2381-0098.2   | 210240   |  |                             | D=38            | ATE |
|  | 2.0 T  | 166  |  | 03.97  | 09.02   | 24.9238-0097.5   | 230037   |  |                             | D=38            | ATE |
|  | 2.3 T5   | 176  |  | 03.97  | 09.02   | 24.9238-0098.5   | 230038   |  |                             | D=38            | ATE |
|  | 2.5  | 121  |  | 03.99  | 09.02   | 13.0441-3819.2   | 250072   |  |                             | Dichtungssatz   | ATE |
|  | 2.5  | 125  |  | 11.99  | 09.02   |  |  |  |                             |                 |     |
|  | 2.5 T  | 142  |  | 03.97  | 09.02   |  |  |  |                             |                 |     |
|  | 2.0  | 132  | 10849  | 03.97  |   | 83.6204-0200.3   | 330306   | 2  |                             | L=200           |     |
|  | 2.0 T  | 166  | 10849  | 03.97  |   |  |  |  |                             |                 |     |
|  | 2.3 T5   | 176  | 10849  | 03.97  |   |  |  |  |                             |                 |     |
|  | 2.5 T  | 142  | 10849  | 03.97  |   |  |  |  |                             |                 |     |
|  | 2.0  | 132  | 10850  |  | 09.02   | 83.6204-0180.3   | 330547   | 2  |                             | L=180           |     |
|  | 2.0 T  | 120  |  | 03.00  | 09.02   |  |  |  |                             |                 |     |
|  | 2.0 T  | 166  | 10850  |  | 09.02   |  |  |  |                             |                 |     |
|  | 2.3 T5   | 176  | 10850  |  | 09.02   |  |  |  |                             |                 |     |
|  | 2.5  | 121  |  | 03.99  | 09.02   |  |  |  |                             |                 |     |
|  | 2.5  | 125  |  | 11.99  | 09.02   |  |  |  |                             |                 |     |
|  | 2.5 T  | 142  | 10850  |  | 09.02   |  |  |  |                             |                 |     |
|  | 2.0  | 132  |  | 03.97  | 09.02   | 24.2419-1724.3   | 030113   |  |                             | Gz 19,05        |     |
|  | 2.0 T  | 120  |  | 03.00  | 09.02   |  |  |  |                             |                 |     |
|  | 2.0 T  | 166  |  | 03.97  | 09.02   |  |  |  |                             |                 |     |
|  | 2.3 T5   | 176  |  | 03.97  | 09.02   |  |  |  |                             |                 |     |
|  | 2.5  | 121  |  | 03.99  | 09.02   |  |  |  |                             |                 |     |
|  | 2.5  | 125  |  | 11.99  | 09.02   |  |  |  |                             |                 |     |
|  | 2.5 T  | 142  |  | 03.97  | 09.02   |  |  |  |                             |                 |     |
| <b>VOLVO C70 I Cabrio (98-06)</b>  |  |  |  |  |   |  |  |  |                             |                 |     |
|  | 2.0  | 132  |  | 03.98  | 12.98   | 03.7760-3602.4   | 300176   |  |                             | 10"             | ATE |
|  | 2.0 T  | 166  |  | 03.98  | 12.98   |  |  |  |                             |                 |     |
|  | 2.3 T5   | 176  |  | 03.98  | 12.98   |  |  |  |                             |                 |     |
|  | 2.5  | 125  |  | 06.98  | 12.98   |  |  |  |                             |                 |     |
|  | 2.5 T  | 142  |  | 03.98  | 12.98   |  |  |  |                             |                 |     |

<sup>1)</sup> - travel sensor / - sensore di corsa / - capteur de course / - sensor de recorrido

<sup>2)</sup> on the brake caliper / sulla pinza freno / sur l'étrier de frein / a la pinza de freno



|     |  |  |  |  |  |    |  |   |
|--|--|--|--|--|---|--|--|---|
| <b>VOLVO C70 I Cabrio (98-06)</b>  |  |  |  |  |   |  |  |   |
|    | 2.0<br>2.0 T<br>2.0 T<br>2.3 T5<br>2.3 T5<br>2.4 T<br>2.5<br>2.5 T               | #132<br>#120<br>#166<br>#176<br>#180<br>#147<br>#125<br>#142                     |  | 01.99<br>03.00<br>01.99<br>01.99<br>07.02<br>07.02<br>01.99<br>01.99             | 02.06<br>02.06<br>02.06<br>02.06<br>02.06<br>02.06<br>02.06<br>02.06              | 03.7760-4902.4<br>300178   |  | - Wegsensor 1)<br>10"<br>ATE  |
|    | 2.0<br>2.0 T<br>2.3 T5<br>2.5<br>2.5 T   | 132<br>166<br>176<br>125<br>142  |  | 03.98<br>03.98<br>03.98<br>06.98<br>03.98  | 12.98<br>12.98<br>12.98<br>12.98<br>12.98   | 03.2023-1084.3<br>010591<br>03.2023-1044.3<br>010590   |  | - ASR<br>+ ASR<br>THz 23,81/20,64<br>ATE<br>ATE   |
|    | 2.0<br>2.0 T<br>2.0 T<br>2.3 T5<br>2.3 T5<br>2.4 T<br>2.5<br>2.5 T               | 132<br>120<br>166<br>176<br>180<br>147<br>125<br>142                             |  | 01.99<br>03.00<br>01.99<br>01.99<br>07.02<br>07.02<br>01.99<br>01.99             | 02.06<br>02.06<br>02.06<br>02.06<br>02.06<br>02.06<br>02.06<br>02.06              | 03.2123-2164.3<br>010599   |  | THz 23,81<br>ATE  |
|    | 2.0<br>2.0 T<br>2.0 T<br>2.3 T5<br>2.3 T5<br>2.4 T<br>2.5<br>2.5 T               | 132<br>120<br>166<br>176<br>180<br>147<br>125<br>142                             |  | 03.98<br>03.00<br>03.98<br>03.98<br>07.02<br>07.02<br>06.98<br>03.98             | 02.06<br>02.06<br>02.06<br>02.06<br>02.06<br>02.06<br>02.06<br>02.06              | 11.9571-9971.2<br>220605<br>11.9571-9972.2<br>220606<br>11.8116-0073.1<br>390498   | 2  | D=57, - Halter<br>D=57, - Halter<br>Halterfeder<br>ATE<br>ATE<br>ATE  |
|    | 2.0<br>2.0 T<br>2.0 T<br>2.3 T5<br>2.3 T5<br>2.4 T<br>2.5<br>2.5 T               | 132<br>120<br>166<br>176<br>180<br>147<br>125<br>142                             |  | 03.98<br>03.00<br>03.98<br>03.98<br>07.02<br>07.02<br>06.98<br>03.98             | 02.06<br>02.06<br>02.06<br>02.06<br>02.06<br>02.06<br>02.06<br>02.06              | 83.6113-0331.3<br>330982   | 2  | am Bremsattel 2)<br>L=330   |
|   | 2.0<br>2.0 T<br>2.0 T<br>2.3 T5<br>2.3 T5<br>2.4 T<br>2.5<br>2.5 T               | 132<br>120<br>166<br>176<br>180<br>147<br>125<br>142                             |  | 03.98<br>03.00<br>03.98<br>03.98<br>07.02<br>07.02<br>06.98<br>03.98             | 02.06<br>02.06<br>02.06<br>02.06<br>02.06<br>02.06<br>02.06<br>02.06              | 13.2381-0097.2<br>210239<br>13.2381-0098.2<br>210240<br>24.9238-0097.5<br>230037<br>24.9238-0098.5<br>230038<br>13.0441-3815.2<br>250069 | 2  | D=38<br>D=38<br>D=38<br>D=38<br>Dichtungssatz<br>ATE<br>ATE<br>ATE<br>ATE   |
|  | 2.0<br>2.0 T<br>2.3 T5<br>2.5<br>2.5 T   | 132<br>166<br>176<br>125<br>142  | 1209<br>1209<br>1209<br>1209   | 03.98<br>03.98<br>03.98<br>06.98<br>03.98  |   | 83.6204-0200.3<br>330306   | 2  | L=200   |
|  | 2.0<br>2.0 T<br>2.0 T<br>2.3 T5<br>2.3 T5<br>2.4 T<br>2.5<br>2.5 T               | 132<br>120<br>166<br>176<br>180<br>147<br>125<br>142                             | 1210<br>1210<br>1210<br>1210   | 03.98<br>03.00<br>02.06<br>02.06<br>07.02<br>07.02<br>02.06<br>02.06             | 02.06<br>02.06<br>02.06<br>02.06<br>02.06<br>02.06<br>02.06<br>02.06              | 83.6204-0180.3<br>330547   | 2  | L=180   |
|  | 2.0<br>2.0 T<br>2.0 T<br>2.3 T5<br>2.3 T5<br>2.4 T<br>2.5<br>2.5 T               | #132<br>#120<br>#166<br>#176<br>#180<br>#147<br>#125<br>#142                     |  | 03.98<br>03.00<br>03.98<br>03.98<br>07.02<br>07.02<br>06.98<br>03.98             | 02.06<br>02.06<br>02.06<br>02.06<br>02.06<br>02.06<br>02.06<br>02.06              | 24.2419-1724.3<br>030113   |  | Gz 19,05  |
| <b>VOLVO C70 II Cabrio (06-13)</b>   |  |  |  |  |   |  |  |   |
|  | 2.0 D<br>2.4<br>2.4 D5<br>2.4 i<br>2.5 T5<br>2.5 T5                              | #100<br>#103<br>#132<br>#125<br>#162<br>#169                                     |  | 06.08<br>03.06<br>03.06<br>03.06<br>03.06<br>03.07                               | 07.13<br>07.13<br>07.13<br>07.13<br>07.13<br>07.13                                | 03.7863-0832.4<br>300229<br>03.7863-4132.4<br>300259   |  | 10"<br>10"<br>ATE<br>ATE  |
|  | 2.0 D<br>2.4<br>2.4 D5<br>2.4 i<br>2.5 T5<br>2.5 T5                              | #100<br>#103<br>#132<br>#125<br>#162<br>#169                                     |  | 06.08<br>03.06<br>03.06<br>03.06<br>03.06<br>03.07                               | 07.13<br>07.13<br>07.13<br>07.13<br>07.13<br>07.13                                | 03.2123-3593.3<br>010919   |  | THz 23,81<br>ATE  |
|  | 2.0 D<br>2.0 D3<br>2.0 D4<br>2.4<br>2.4 D5<br>2.4 i                              | 100<br>110<br>130<br>103<br>132<br>125   |  | 06.08<br>10.10<br>10.10<br>03.06<br>03.06<br>03.06                               | 07.13<br>07.13<br>07.13<br>07.13<br>07.13<br>07.13                                | 11.9571-9813.2<br>220647<br>11.9571-9814.2<br>220648<br>24.3571-9813.5<br>240557<br>24.3571-9814.5<br>240558<br>11.8116-0356.1<br>390586 | 2  | + 15"/16" Rad 3)<br>+ 15"/16" Rad 3)<br>+ 15"/16" Rad 3)<br>+ 15"/16" Rad 3)<br>D=57, - Halter<br>D=57, - Halter<br>D=57, - Halter<br>Halterfeder<br>ATE<br>ATE<br>ATE<br>ATE |

1) - travel sensor / - sensore di corsa / - capteur de course / - sensor de recorrido

2) on the brake caliper / sulla pinza freno / sur l'étrier de frein / a la pinza de freno

3) + 15"/16" wheel / + ruota 15"/16" / + roue 15"/16" / + rueda 15"/16"

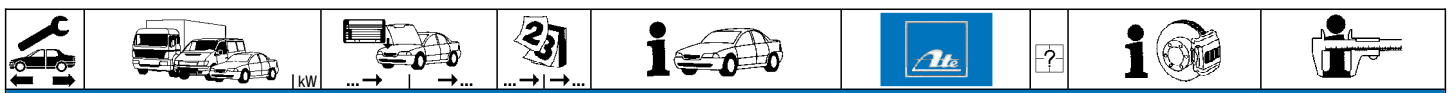

**VOLVO C70 II Cabrio (06-13)**

|        |        |       |       |       |       |                |                |  |  |  |                                 |
|--------|--------|-------|-------|-------|-------|----------------|----------------|--|--|--|---------------------------------|
|        | 2.5 T5 | 162   |       | 03.06 | 07.13 |                | 11.9571-9813.2 | 220647   | <input type="checkbox"/> + 15"/16" Rad <sup>1)</sup><br><input type="checkbox"/> + 15"/16" Rad <sup>1)</sup><br><input type="checkbox"/> + 15"/16" Rad <sup>1)</sup><br><input type="checkbox"/> + 15"/16" Rad <sup>1)</sup> | D=57, - Halter<br>D=57, - Halter<br>D=57, - Halter<br>D=57, - Halter<br>Haltefeder | ATE<br>ATE<br>ATE<br>ATE<br>ATE |
|        | 2.5 T5 | 169   |       | 03.07 | 07.13 |                | 11.9571-9814.2 | 220648   |  |  |                                 |
|        |        |       |       |       |       |                | 24.3571-9813.5 | 240557   |  |  |                                 |
|        |        |       |       |       |       |                | 11.8116-0356.1 | 390586   |  |  |                                 |
|        |        |       |       |       |       |                | 11.9576-9975.2 | 220649   |  |  |                                 |
|        |        |       |       |       |       |                | 11.9576-9976.2 | 220650   | <input type="checkbox"/> + 17" Rad <sup>2)</sup><br><input type="checkbox"/> + 17" Rad <sup>2)</sup><br><input type="checkbox"/> + 17" Rad <sup>2)</sup>   | D=57, - Halter<br>D=57, - Halter<br>Haltefeder                                     | ATE<br>ATE<br>ATE<br>ATE<br>ATE |
|        | 2.0 D  | 100   |       | 06.08 | 07.13 |                | 11.8116-0345.2 | 390596   |  |  |                                 |
|        | 2.0 D3 | 110   |       | 10.10 | 07.13 |                |                |  |  |  |                                 |
|        | 2.0 D4 | 130   |       | 10.10 | 07.13 |                |                |  |  |  |                                 |
|        | 2.4    | 103   |       | 03.06 | 07.13 |                |                |  |  |  |                                 |
| 2.4 D5 | 132    |       | 03.06 | 07.13 |       |                |                |  |  |  |                                 |
| 2.4 i  | 125    |       | 03.06 | 07.13 |       |                |                |  |  |  |                                 |
| 2.5 T5 | 162    |       | 03.06 | 07.13 |       |                |                |  |  |  |                                 |
| 2.5 T5 | 169    |       | 03.07 | 07.13 |       |                |                |  |  |  |                                 |
|        | 2.0 D  | 100   |       | 06.08 | 07.13 |                | 83.7716-0398.3 | 330987   | <input type="checkbox"/><br><input type="checkbox"/>   | L=395  |                                 |
|        | 2.4    | 103   |       | 03.06 | 07.13 |                |                |  |  |  |                                 |
|        | 2.4 D5 | 132   |       | 03.06 | 07.13 |                |                |  |  |  |                                 |
|        | 2.4 i  | 125   |       | 03.06 | 07.13 |                |                |  |  |  |                                 |
|        | 2.5 T5 | 162   |       | 03.06 | 07.13 |                | 83.7788-0414.3 | 330988   |  |  |                                 |
|        | 2.5 T5 | 169   |       | 03.07 | 07.13 |                |                |  |  |  |                                 |
|        | 2.0 D3 | 110   |       | 10.10 | 07.13 |                | 83.7788-0383.3 | 330972   |  |  |                                 |
|        | 2.0 D4 | 130   |       | 10.10 | 07.13 |                | 83.7716-0398.3 | 330987   |  |  |                                 |
|        |        |       |       |       |       | 83.7788-0414.3 | 330988         |  |  |  |                                 |
|        |        |       |       |       |       |                |                | <input type="checkbox"/> + 15"/16" Rad <sup>1)</sup><br><input type="checkbox"/> + 17" Rad <sup>2)</sup> | L=395<br>L=411   |  |                                 |
| 2.0 D  | 100    | 77106 | 06.08 |       |       | 11.9387-7015.2 | 220627         |  |  |  |                                 |
| 2.0 D3 | 110    | 77106 | 10.10 |       |       | 11.9387-7016.2 | 220628         | <input type="checkbox"/><br><input type="checkbox"/>   | D=38, - Halter<br>D=38, - Halter<br>Halter<br>Hülzensatz<br>Führungsbolzen<br>Haltefeder   | ATE<br>ATE<br>ATE<br>ATE<br>ATE<br>ATE<br>ATE<br>ATE<br>ATE<br>ATE                 |                                 |
| 2.0 D4 | 130    | 77106 | 10.10 |       |       | 11.0230-0698.2 | 260091         |  |  |  |                                 |
| 2.4    | 103    | 77106 | 03.06 |       |       | 11.0101-5407.2 | 260011         |  |  |  |                                 |
| 2.4 D5 | 132    | 77106 | 03.06 |       |       | 11.8171-0008.1 | 990049         |  |  |  |                                 |
| 2.4 i  | 125    | 77106 | 03.06 |       |       | 11.8116-0340.1 | 390595         |  |  |  |                                 |
| 2.5 T5 | 162    | 77106 | 03.06 |       |       |                |                |  |  |  |                                 |
| 2.5 T5 | 169    | 77106 | 03.07 |       |       |                |                |  |  |  |                                 |
| 2.0 D  | 100    | 77107 |       | 07.13 |       | 11.0230-0698.2 | 260091         |  |  |  |                                 |
| 2.0 D3 | 110    | 77107 |       | 07.13 |       | 11.0101-5407.2 | 260011         |  |  |  |                                 |
| 2.0 D4 | 130    | 77107 |       | 07.13 |       | 11.8171-0008.1 | 990049         |  |  |  |                                 |
| 2.4    | 103    | 77107 |       | 07.13 |       | 11.8116-0340.1 | 390595         |  |  |  |                                 |
| 2.4 D5 | 132    | 77107 |       | 07.13 |       |                |                |  |  |  |                                 |
| 2.4 i  | 125    | 77107 |       | 07.13 |       |                |                |  |  |  |                                 |
| 2.5 T5 | 162    | 77107 |       | 07.13 |       |                |                |  |  |  |                                 |
| 2.5 T5 | 169    | 77107 |       | 07.13 |       |                |                |  |  |  |                                 |
|        | 2.0 D  | 100   |       | 06.08 | 07.13 |                | 83.7788-0383.3 | 330972   | <input type="checkbox"/><br><input type="checkbox"/>   | L=382  |                                 |
|        | 2.0 D3 | 110   |       | 10.10 | 07.13 |                |                |  |  |  |                                 |
|        | 2.0 D4 | 130   |       | 10.10 | 07.13 |                |                |  |  |  |                                 |
|        | 2.4    | 103   |       | 03.06 | 07.13 |                |                |  |  |  |                                 |
|        | 2.4 D5 | 132   |       | 03.06 | 07.13 |                |                |  |  |  |                                 |
|        | 2.4 i  | 125   |       | 03.06 | 07.13 |                |                |  |  |  |                                 |
|        | 2.5 T5 | 162   |       | 03.06 | 07.13 |                |                |  |  |  |                                 |
|        | 2.5 T5 | 169   |       | 03.07 | 07.13 |                |                |  |  |  |                                 |

**VOLVO S40 I (95-03)**

|              |            |     |       |       |       |  |                |        |  |                                  |            |
|--------------|------------|-----|-------|-------|-------|--|----------------|--------|--|----------------------------------|------------|
|              | 1.6        | 77  |       | 09.95 | 08.97 |  | 24.2122-1718.3 | 010517 |  | ThZ 22,20                        |            |
|              | 1.8 (1731) | 85  |       | 07.95 | 08.97 |  |                |        |  |                                  |            |
|              | 1.9 T4     | 147 |       | 05.97 | 08.97 |  |                |        |  |                                  |            |
|              | 1.9 TD     | 66  |       | 07.95 | 08.97 |  |                |        |  |                                  |            |
|              | 2.0        | 100 |       | 07.95 | 08.97 |  |                |        |  |                                  |            |
|              | 2.0        | 103 |       | 07.95 | 08.97 |  |                |        |  |                                  |            |
|              | 1.6        | 77  |       | 09.97 | 08.99 |  | 24.2123-1746.3 | 010682 |  |                                  |            |
|              | 1.6        | 80  |       | 03.99 | 12.03 |  |                |        |  |                                  |            |
|              | 1.8 (1731) | 85  |       | 09.97 | 08.99 |  |                |        |  |                                  |            |
|              | 1.8 (1783) | 90  |       | 03.99 | 12.03 |  |                |        |  |                                  |            |
| 1.8 i (1834) | 90         |     | 06.01 | 12.03 |       |  |                |        |  |                                  |            |
| 1.8 i (1834) | 92         |     | 03.98 | 12.03 |       |  |                |        |  |                                  |            |
| 1.9 DI       | 70         |     | 03.99 | 07.00 |       |  |                |        |  |                                  |            |
| 1.9 DI       | 75         |     | 07.00 | 12.03 |       |  |                |        |  |                                  |            |
| 1.9 DI       | 85         |     | 07.00 | 12.03 |       |  |                |        |  |                                  |            |
| 1.9 T4       | 147        |     | 09.97 | 07.00 |       |  |                |        |  |                                  |            |
| 1.9 TD       | 66         |     | 09.97 | 08.99 |       |  |                |        |  |                                  |            |
| 2.0          | 100        |     | 09.97 | 12.03 |       |  |                |        |  |                                  |            |
| 2.0          | 103        |     | 09.97 | 08.99 |       |  |                |        |  |                                  |            |
| 2.0 T        | 118        |     | 10.97 | 07.00 |       |  |                |        |  |                                  |            |
| 2.0 T        | 120        |     | 06.01 | 12.03 |       |  |                |        |  |                                  |            |
| 2.0 T        | 121        |     | 07.00 | 06.01 |       |  |                |        |  |                                  |            |
| 2.0 T4       | 147        |     | 07.00 | 12.03 |       |  |                |        |  |                                  |            |
|              | 1.6        | 77  |       | 09.95 | 08.97 |  | 24.3541-1783.5 | 240269 | <input type="checkbox"/><br><input type="checkbox"/> | D=54, - Halter<br>D=54, - Halter | LUC<br>LUC |
|              | 1.8 (1731) | 85  |       | 07.95 | 08.97 |  | 24.3541-1784.5 | 240270 |  |                                  |            |
|              | 1.9 T4     | 147 |       | 05.97 | 08.97 |  |                |        |  |                                  |            |
|              | 1.9 TD     | 66  |       | 07.95 | 08.97 |  |                |        |  |                                  |            |
|              | 2.0        | 100 |       | 07.95 | 08.97 |  |                |        |  |                                  |            |
|              | 2.0        | 103 |       | 07.95 | 08.97 |  |                |        |  |                                  |            |
|              | 1.6        | 77  |       | 09.97 | 08.99 |  | 24.3541-1785.5 | 240271 |  |                                  |            |
|              | 1.6        | 80  |       | 03.99 | 12.03 |  | 24.3541-1786.5 | 240272 |  |                                  |            |
|              | 1.8 (1731) | 85  |       | 09.97 | 08.99 |  |                |        |  |                                  |            |
|              | 1.8 (1783) | 90  |       | 03.99 | 12.03 |  |                |        |  |                                  |            |
| 1.8 i (1834) | 90         |     | 06.01 | 12.03 |       |  |                |        |  |                                  |            |
| 1.8 i (1834) | 92         |     | 03.98 | 12.03 |       |  |                |        |  |                                  |            |
| 1.9 DI       | 70         |     | 03.99 | 07.00 |       |  |                |        |  |                                  |            |
| 1.9 DI       | 75         |     | 07.00 | 12.03 |       |  |                |        |  |                                  |            |
| 1.9 DI       | 85         |     | 07.00 | 12.03 |       |  |                |        |  |                                  |            |

<sup>1)</sup> + 15"/16" wheel / + ruota 15"/16" / + roue 15"/16" / + rueda 15"/16"

<sup>2)</sup> + 17" wheel / + ruota 17" / + roue 17" / + rueda 17"



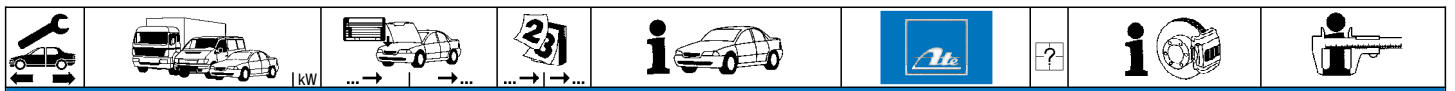

**VOLVO S40 I (95-03)**

|  |   |   |  |   |   |                                  |                  |   |  |                                  |            |
|--|---|---|--|---|---|----------------------------------|------------------|---|--|----------------------------------|------------|
|  | 1.9 T4<br>1.9 TD<br>2.0<br>2.0<br>2.0 T<br>2.0 T<br>2.0 T<br>2.0 T4   | 147<br>66<br>100<br>103<br>118<br>120<br>121<br>147   |  | 09.97<br>09.97<br>09.97<br>09.97<br>10.97<br>06.01<br>07.00<br>07.00  | 07.00<br>08.99<br>12.03<br>08.99<br>07.00<br>12.03<br>06.01<br>12.03  | 24.3541-1785.5<br>24.3541-1786.5 | 240271<br>240272 |   |  | D=54, - Halter<br>D=54, - Halter | LUC<br>LUC |
|  | 1.6<br>1.6<br>1.8 (1731)<br>1.8 (1783)<br>1.8 i (1834)<br>1.8 i (1834)<br>1.9 DI<br>1.9 DI<br>1.9 DI<br>1.9 T4<br>1.9 TD<br>2.0<br>2.0<br>2.0 T<br>2.0 T<br>2.0 T<br>2.0 T4 | 77<br>80<br>85<br>90<br>90<br>92<br>70<br>75<br>85<br>147<br>66<br>100<br>103<br>118<br>120<br>121<br>147 |  | 09.95<br>03.99<br>07.95<br>03.99<br>06.01<br>03.98<br>03.99<br>07.00<br>07.00<br>05.97<br>07.95<br>07.95<br>07.95<br>10.97<br>06.01<br>07.00<br>07.00                                     | 08.99<br>12.03<br>08.99<br>12.03<br>12.03<br>12.03<br>07.00<br>12.03<br>12.03<br>07.00<br>08.99<br>12.03<br>08.99<br>07.00<br>12.03<br>06.01<br>12.03 | 24.5248-0461.3                   | 330707           | 2 |  | L=461                            |            |
|  | 1.6<br>1.6<br>1.8 (1731)<br>1.8 (1783)<br>1.8 i (1834)<br>1.9 DI<br>1.9 T4<br>1.9 TD<br>2.0<br>2.0<br>2.0 T   | 77<br>80<br>85<br>90<br>92<br>70<br>147<br>66<br>100<br>103<br>118  | 426760<br>426760<br>426760<br>426760<br>426760<br>426760<br>426760<br>426760<br>426760<br>426760<br>426760   | 09.95<br>03.99<br>07.95<br>03.99<br>03.98<br>03.99<br>05.97<br>07.95<br>07.95<br>07.95<br>10.97   |   | 24.3384-1721.5<br>24.3384-1722.5 | 240255<br>240256 |   |  | D=38, - Halter<br>D=38, - Halter | LUC<br>LUC |
|  | 1.6<br>1.6<br>1.8 (1731)<br>1.8 (1783)<br>1.8 i (1834)<br>1.8 i (1834)<br>1.9 DI<br>1.9 DI<br>1.9 DI<br>1.9 T4<br>1.9 TD<br>2.0<br>2.0<br>2.0 T<br>2.0 T<br>2.0 T<br>2.0 T4 | 77<br>80<br>85<br>90<br>92<br>70<br>75<br>85<br>147<br>66<br>100<br>103<br>118<br>120<br>121<br>147       | 426761<br>426761<br>426761<br>426761<br>426761<br>426761<br>426761<br>426761<br>426761<br>426761<br>426761<br>426761<br>426761<br>426761<br>426761<br>426761           | 08.99<br>12.03<br>08.99<br>12.03<br>12.03<br>06.01<br>07.00<br>07.00<br>07.00<br>07.00<br>08.99<br>12.03<br>08.99<br>07.00<br>12.03<br>07.00<br>06.01<br>12.03<br>07.00<br>06.01<br>12.03 |   | 24.3384-1743.5<br>24.3384-1744.5 | 240319<br>240320 |   |  | D=38, - Halter<br>D=38, - Halter | LUC<br>LUC |
|  | 1.6<br>1.6<br>1.8 (1731)<br>1.8 (1783)<br>1.8 i (1834)<br>1.8 i (1834)<br>1.9 DI<br>1.9 DI<br>1.9 DI<br>1.9 T4<br>1.9 TD<br>2.0<br>2.0<br>2.0 T<br>2.0 T<br>2.0 T<br>2.0 T4 | 77<br>80<br>85<br>90<br>90<br>92<br>70<br>75<br>85<br>147<br>66<br>100<br>103<br>118<br>120<br>121<br>147 |  | 09.95<br>03.99<br>07.95<br>03.99<br>06.01<br>03.98<br>03.99<br>07.00<br>07.00<br>05.97<br>07.95<br>07.95<br>07.95<br>10.97<br>06.01<br>07.00<br>07.00                                     | 08.99<br>12.03<br>08.99<br>12.03<br>12.03<br>12.03<br>07.00<br>12.03<br>12.03<br>07.00<br>08.99<br>12.03<br>08.99<br>07.00<br>12.03<br>06.01<br>12.03 | 24.5249-0416.3                   | 330708           | 2 |  | L=416                            |            |
|  | 1.6<br>1.6<br>1.8 (1731)<br>1.8 (1783)<br>1.8 i (1834)<br>1.8 i (1834)<br>1.9 DI<br>1.9 DI<br>1.9 DI<br>1.9 T4<br>1.9 TD<br>2.0<br>2.0<br>2.0 T<br>2.0 T<br>2.0 T<br>2.0 T4 | 77<br>80<br>85<br>90<br>90<br>92<br>70<br>75<br>85<br>147<br>66<br>100<br>103<br>118<br>120<br>121<br>147 | 599999<br>599999<br>599999<br>599999<br>599999<br>599999<br>599999<br>599999<br>599999<br>599999<br>599999<br>599999<br>599999<br>599999<br>599999<br>599999<br>599999 | 09.95<br>03.99<br>07.95<br>03.99<br>06.01<br>03.98<br>03.99<br>07.00<br>07.00<br>05.97<br>07.95<br>07.95<br>07.95<br>10.97<br>06.01<br>07.00<br>07.00                                     | 08.99<br>08.99<br>08.99<br>08.99<br>07.00<br>07.00<br>07.00<br>07.00<br>07.00<br>07.00<br>07.00<br>08.99<br>08.99<br>07.00<br>07.00<br>07.00<br>07.00 | 24.3727-1304.2<br>24.3727-1300.2 | 581304<br>581300 |   |  | L=1590<br>L=1590                 |            |



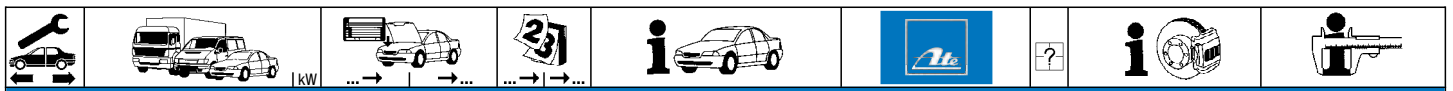

**VOLVO S40 I (95-03)**

|  |              |     |        |        |       |       |                |        |                          |  |          |
|--|--------------|-----|--------|--------|-------|-------|----------------|--------|--------------------------|--|----------|
|  | 1.6          | 80  | 600000 | 985261 |       |       | 24.3727-1315.2 | 581315 | <input type="checkbox"/> |  | L=1620   |
|  | 1.8 (1783)   | 90  | 600000 | 985261 |       |       | 24.3727-1314.2 | 581314 | <input type="checkbox"/> |  | L=1620   |
|  | 1.8 i (1834) | 90  | 600000 | 985261 |       |       |                |        |                          |  |          |
|  | 1.8 i (1834) | 90  | 600000 | 985261 |       |       |                |        |                          |  |          |
|  | 1.9 DI       | 75  | 600000 | 985261 |       |       |                |        |                          |  |          |
|  | 1.9 DI       | 85  | 600000 | 985261 |       |       |                |        |                          |  |          |
|  | 2.0          | 100 | 600000 | 985261 |       |       |                |        |                          |  |          |
|  | 2.0 T        | 120 | 600000 | 985261 |       |       |                |        |                          |  |          |
|  | 2.0 T        | 121 | 600000 | 985261 |       |       |                |        |                          |  |          |
|  | 2.0 T4       | 147 | 600000 | 985261 |       |       |                |        |                          |  |          |
|  | 1.6          | 80  | 985262 |        | 12.03 |       | 24.3727-1315.2 | 581315 | <input type="checkbox"/> |  | L=1620   |
|  | 1.8 (1783)   | 90  | 985262 |        | 12.03 |       | 24.3727-1314.2 | 581314 | <input type="checkbox"/> |  | L=1620   |
|  | 1.8 i (1834) | 90  | 985262 |        | 12.03 |       |                |        |                          |  |          |
|  | 1.8 i (1834) | 90  | 985262 |        | 12.03 |       |                |        |                          |  |          |
|  | 1.9 DI       | 75  | 985262 |        | 12.03 |       |                |        |                          |  |          |
|  | 1.9 DI       | 85  | 985262 |        | 12.03 |       |                |        |                          |  |          |
|  | 2.0          | 100 | 985262 |        | 12.03 |       |                |        |                          |  |          |
|  | 2.0 T        | 120 | 985262 |        | 12.03 |       |                |        |                          |  |          |
|  | 2.0 T        | 121 | 985262 |        | 12.03 |       |                |        |                          |  |          |
|  | 2.0 T4       | 147 | 895262 |        | 12.03 |       |                |        |                          |  |          |
|  | 1.8 (1783)   | 90  |        |        | 03.99 | 12.03 | 24.2419-1728.3 | 030117 |                          |  | Gz 19,05 |
|  | 1.9 DI       | 70  |        |        | 03.99 | 07.00 |                |        |                          |  |          |
|  | 1.9 DI       | 75  |        |        | 07.00 | 12.03 |                |        |                          |  |          |
|  | 1.9 DI       | 85  |        |        | 07.00 | 12.03 |                |        |                          |  |          |
|  | 1.9 T4       | 147 |        |        | 05.97 | 07.00 |                |        |                          |  |          |
|  | 2.0          | 100 |        |        | 07.95 | 12.03 |                |        |                          |  |          |
|  | 2.0 T        | 118 |        |        | 10.97 | 07.00 |                |        |                          |  |          |
|  | 2.0 T        | 120 |        |        | 06.01 | 12.03 |                |        |                          |  |          |
|  | 2.0 T        | 121 |        |        | 07.00 | 06.01 |                |        |                          |  |          |
|  | 2.0 T4       | 147 |        |        | 07.00 | 12.03 |                |        |                          |  |          |

**VOLVO S40 II (04-12)**

|            |               |     |  |       |       |       |                |        |                          |                         |                |     |
|------------|---------------|-----|--|-------|-------|-------|----------------|--------|--------------------------|-------------------------|----------------|-----|
|            | 1.6 D         | 80  |  |       | 04.07 | 05.12 | 03.7863-0832.4 | 300229 |                          |                         | 10"            | ATE |
|            | 1.6 D         | 81  |  |       | 01.05 | 05.12 | 03.7863-4132.4 | 300259 |                          |                         | 10"            | ATE |
|            | 1.6 i         | 74  |  |       | 01.05 | 05.12 |                |        |                          |                         |                |     |
|            | 1.8           | 92  |  |       | 04.04 | 05.12 |                |        |                          |                         |                |     |
|            | 1.8 FlexiFuel | 92  |  |       | 04.07 | 05.12 |                |        |                          |                         |                |     |
|            | 2.0 D         | 100 |  |       | 01.04 | 05.12 |                |        |                          |                         |                |     |
|            | 2.0 D4        | 96  |  |       | 07.05 | 05.12 |                |        |                          |                         |                |     |
|            | 2.0 FlexiFuel | 107 |  |       | 10.06 | 05.12 |                |        |                          |                         |                |     |
|            | 2.0 i         | 107 |  |       | 10.06 | 05.12 |                |        |                          |                         |                |     |
|            | 2.4           | 103 |  |       | 01.04 | 05.12 |                |        |                          |                         |                |     |
|            | 2.4           | 125 |  |       | 01.04 | 05.12 |                |        |                          |                         |                |     |
|            | 2.4 4X4       | 125 |  |       | 08.06 | 05.12 |                |        |                          |                         |                |     |
|            | 2.4 D5        | 132 |  |       | 03.06 | 05.12 |                |        |                          |                         |                |     |
|            | 2.5 T5        | 162 |  |       | 01.04 | 05.12 |                |        |                          |                         |                |     |
|            | 2.5 T5        | 169 |  |       | 03.07 | 05.12 |                |        |                          |                         |                |     |
|            | 2.5 T5 AWD    | 162 |  |       | 04.04 | 05.12 |                |        |                          |                         |                |     |
| 2.5 T5 AWD | 169           |     |  | 03.07 | 05.12 |       |                |        |                          |                         |                |     |
|            | 1.6 D         | 80  |  |       | 04.07 | 05.12 | 03.2123-3593.3 | 010919 |                          |                         | 17Hz 23,81     | ATE |
|            | 1.6 D         | 81  |  |       | 01.05 | 05.12 |                |        |                          |                         |                |     |
|            | 1.6 i         | 74  |  |       | 01.05 | 05.12 |                |        |                          |                         |                |     |
|            | 1.8           | 92  |  |       | 04.04 | 05.12 |                |        |                          |                         |                |     |
|            | 1.8 FlexiFuel | 92  |  |       | 04.07 | 05.12 |                |        |                          |                         |                |     |
|            | 2.0 D         | 100 |  |       | 01.04 | 05.12 |                |        |                          |                         |                |     |
|            | 2.0 D4        | 96  |  |       | 07.05 | 05.12 |                |        |                          |                         |                |     |
|            | 2.0 FlexiFuel | 107 |  |       | 10.06 | 05.12 |                |        |                          |                         |                |     |
|            | 2.0 i         | 107 |  |       | 10.06 | 05.12 |                |        |                          |                         |                |     |
|            | 2.4           | 103 |  |       | 01.04 | 05.12 |                |        |                          |                         |                |     |
|            | 2.4           | 125 |  |       | 01.04 | 05.12 |                |        |                          |                         |                |     |
|            | 2.4 4X4       | 125 |  |       | 08.06 | 05.12 |                |        |                          |                         |                |     |
|            | 2.4 D5        | 132 |  |       | 03.06 | 05.12 |                |        |                          |                         |                |     |
|            | 2.5 T5        | 162 |  |       | 01.04 | 05.12 |                |        |                          |                         |                |     |
|            | 2.5 T5        | 169 |  |       | 03.07 | 05.12 |                |        |                          |                         |                |     |
|            | 2.5 T5 AWD    | 162 |  |       | 04.04 | 05.12 |                |        |                          |                         |                |     |
| 2.5 T5 AWD | 169           |     |  | 03.07 | 05.12 |       |                |        |                          |                         |                |     |
|            | 1.6 D         | 80  |  |       | 04.07 | 05.12 | 11.9571-9813.2 | 220647 | <input type="checkbox"/> | - 17" Rad <sup>1)</sup> | D=57, - Halter | ATE |
|            | 1.6 D         | 81  |  |       | 01.05 | 05.12 | 11.9571-9814.2 | 220648 | <input type="checkbox"/> | - 17" Rad <sup>1)</sup> | D=57, - Halter | ATE |
|            | 1.6 D2        | 84  |  |       | 10.10 | 05.12 | 24.3571-9813.5 | 240557 | <input type="checkbox"/> | - 17" Rad <sup>1)</sup> | D=57, - Halter | ATE |
|            | 1.6 i         | 74  |  |       | 01.05 | 05.12 | 24.3571-9814.5 | 240558 | <input type="checkbox"/> | - 17" Rad <sup>1)</sup> | D=57, - Halter | ATE |
|            | 1.8           | 92  |  |       | 04.04 | 05.12 | 11.8116-0356.1 | 390586 | <input type="checkbox"/> | - 17" Rad <sup>1)</sup> | Haltefeder     | ATE |
|            | 1.8 FlexiFuel | 92  |  |       | 04.07 | 05.12 | 11.0101-5407.2 | 260011 | <input type="checkbox"/> |                         | Hülsensatz     | ATE |
|            | 2.0 D         | 100 |  |       | 01.04 | 05.12 | 11.8171-0008.1 | 990049 | <input type="checkbox"/> |                         | Führungsbolzen | ATE |
|            | 2.0 D3        | 110 |  |       | 10.10 | 05.12 |                |        |                          |                         |                |     |
|            | 2.0 D4        | 96  |  |       | 07.05 | 05.12 |                |        |                          |                         |                |     |
|            | 2.0 D4        | 130 |  |       | 10.10 | 05.12 |                |        |                          |                         |                |     |
|            | 2.0 FlexiFuel | 107 |  |       | 10.06 | 05.12 |                |        |                          |                         |                |     |
|            | 2.0 i         | 107 |  |       | 10.06 | 05.12 |                |        |                          |                         |                |     |
|            | 2.4           | 103 |  |       | 01.04 | 05.12 |                |        |                          |                         |                |     |
|            | 2.4           | 125 |  |       | 01.04 | 05.12 |                |        |                          |                         |                |     |
|            | 2.4 4X4       | 125 |  |       | 08.06 | 05.12 |                |        |                          |                         |                |     |
|            | 2.4 D5        | 132 |  |       | 03.06 | 05.12 |                |        |                          |                         |                |     |
| 2.5 T5     | 162           |     |  | 01.04 | 05.12 |       |                |        |                          |                         |                |     |
| 2.5 T5     | 169           |     |  | 03.07 | 05.12 |       |                |        |                          |                         |                |     |
| 2.5 T5 AWD | 162           |     |  | 04.04 | 05.12 |       |                |        |                          |                         |                |     |
| 2.5 T5 AWD | 169           |     |  | 03.07 | 05.12 |       |                |        |                          |                         |                |     |

<sup>1)</sup> - 17" wheel / - ruota 17" / - roue 17" / - rueda 17"



| VOLVO S40 II (04-12) |               | kW     |        | ...   |       | ... |  | ...            |        | ... |  | ... |   | ...   |  | ...   |  |
|----------------------|---------------|--------|--------|-------|-------|-----|--|----------------|--------|-----|--|-----|---|---|--|-------|--|
|                      | 1.6 D         | 80     |        | 04.07 | 05.12 |     |  | 11.9576-9975.2 | 220649 |     |  | 2   | + 17" Rad <sup>1)</sup><br>+ 17" Rad <sup>1)</sup><br>+ 17" Rad <sup>1)</sup> | D=57, - Halter<br>D=57, - Halter<br>Halterfeder<br>Hülsensatz<br>Führungsbolzen           | ATE<br>ATE<br>ATE<br>ATE<br>ATE        |       |  |
|                      | 1.6 D         | 81     |        | 01.05 | 05.12 |     |  | 11.9576-9976.2 | 220650 |     |  |     |   |   |  |       |  |
|                      | 1.6 D2        | 84     |        | 10.10 | 05.12 |     |  | 11.8116-0345.2 | 390596 |     |  |     |   |   |  |       |  |
|                      | 1.6 i         | 74     |        | 01.05 | 05.12 |     |  | 11.0101-5407.2 | 260011 |     |  |     |   |   |  |       |  |
|                      | 1.8           | 92     |        | 04.04 | 05.12 |     |  | 11.8171-0008.1 | 990049 |     |  |     |   |   |  |       |  |
|                      | 1.8 FlexiFuel | 92     |        | 04.07 | 05.12 |     |  |                |        |     |  |     |   |   |  |       |  |
|                      | 2.0 D         | 100    |        | 01.04 | 05.12 |     |  |                |        |     |  |     |   |   |  |       |  |
|                      | 2.0 D3        | 110    |        | 10.10 | 05.12 |     |  |                |        |     |  |     |   |   |  |       |  |
|                      | 2.0 D4        | 96     |        | 07.05 | 05.12 |     |  |                |        |     |  |     |   |   |  |       |  |
|                      | 2.0 D4        | 130    |        | 10.10 | 05.12 |     |  |                |        |     |  |     |   |   |  |       |  |
|                      | 2.0 FlexiFuel | 107    |        | 10.06 | 05.12 |     |  |                |        |     |  |     |   |   |  |       |  |
|                      | 2.0 i         | 107    |        | 10.06 | 05.12 |     |  |                |        |     |  |     |   |   |  |       |  |
|                      | 2.4           | 103    |        | 01.04 | 05.12 |     |  |                |        |     |  |     |   |   |  |       |  |
|                      | 2.4           | 125    |        | 01.04 | 05.12 |     |  |                |        |     |  |     |   |   |  |       |  |
|                      | 2.4 4X4       | 125    |        | 08.06 | 05.12 |     |  |                |        |     |  |     |   |   |  |       |  |
|                      | 2.4 D5        | 132    |        | 03.06 | 05.12 |     |  |                |        |     |  |     |   |   |  |       |  |
|                      | 2.5 T5        | 162    |        | 01.04 | 05.12 |     |  |                |        |     |  |     |   |   |  |       |  |
|                      | 2.5 T5        | 169    |        | 03.07 | 05.12 |     |  |                |        |     |  |     |   |   |  |       |  |
|                      | 2.5 T5 AWD    | 162    |        | 04.04 | 05.12 |     |  |                |        |     |  |     |   |   |  |       |  |
|                      | 2.5 T5 AWD    | 169    |        | 03.07 | 05.12 |     |  |                |        |     |  |     |   |   |  |       |  |
|                      | 1.6 D         | 80     |        | 04.07 | 05.12 |     |  | 83.7716-0398.3 | 330987 | 2   |  | 2   | - 17" Rad <sup>2)</sup><br>+ 17" Rad <sup>1)</sup>                            | L=395<br>L=411  |  |       |  |
|                      | 1.6 D         | 81     |        | 01.05 | 05.12 |     |  | 83.7788-0414.3 | 330988 |     |  |     |   |   |  |       |  |
|                      | 1.6 D2        | 84     |        | 10.10 | 05.12 |     |  |                |        |     |  |     |   |   |  |       |  |
|                      | 1.6 i         | 74     |        | 01.05 | 05.12 |     |  |                |        |     |  |     |   |   |  |       |  |
|                      | 1.8           | 92     |        | 04.04 | 05.12 |     |  |                |        |     |  |     |   |   |  |       |  |
|                      | 1.8 FlexiFuel | 92     |        | 04.07 | 05.12 |     |  |                |        |     |  |     |   |   |  |       |  |
|                      | 2.0 D         | 100    |        | 01.04 | 05.12 |     |  |                |        |     |  |     |   |   |  |       |  |
|                      | 2.0 D3        | 110    |        | 10.10 | 05.12 |     |  |                |        |     |  |     |   |   |  |       |  |
|                      | 2.0 D4        | 96     |        | 07.05 | 05.12 |     |  |                |        |     |  |     |   |   |  |       |  |
|                      | 2.0 D4        | 130    |        | 10.10 | 05.12 |     |  |                |        |     |  |     |   |   |  |       |  |
|                      | 2.0 FlexiFuel | 107    |        | 10.06 | 05.12 |     |  |                |        |     |  |     |   |   |  |       |  |
|                      | 2.0 i         | 107    |        | 10.06 | 05.12 |     |  |                |        |     |  |     |   |   |  |       |  |
|                      | 2.4           | 103    |        | 01.04 | 05.12 |     |  |                |        |     |  |     |   |   |  |       |  |
|                      | 2.4           | 125    |        | 01.04 | 05.12 |     |  |                |        |     |  |     |   |   |  |       |  |
|                      | 2.4 4X4       | 125    |        | 08.06 | 05.12 |     |  |                |        |     |  |     |   |   |  |       |  |
|                      | 2.4 D5        | 132    |        | 03.06 | 05.12 |     |  |                |        |     |  |     |   |   |  |       |  |
|                      | 2.5 T5        | 162    |        | 01.04 | 05.12 |     |  |                |        |     |  |     |   |   |  |       |  |
|                      | 2.5 T5        | 169    |        | 03.07 | 05.12 |     |  |                |        |     |  |     |   |   |  |       |  |
|                      | 2.5 T5 AWD    | 162    |        | 04.04 | 05.12 |     |  | 83.7788-0414.3 | 330988 | 2   |  |     |   |   | - 17" Rad <sup>2)</sup>                | L=411 |  |
|                      | 2.5 T5 AWD    | 169    |        | 03.07 | 05.12 |     |  |                |        |     |  |     |   |   |  |       |  |
|                      | 1.6 D         | 80     | 462752 | 04.07 |       |     |  | 11.9387-7015.2 | 220627 |     |  | 2   | + 17" Rad <sup>1)</sup><br>+ 17" Rad <sup>1)</sup>                            | D=38, - Halter<br>D=38, - Halter<br>Halter<br>Hülsensatz<br>Führungsbolzen<br>Halterfeder | ATE<br>ATE<br>ATE<br>ATE<br>ATE<br>ATE |       |  |
|                      | 1.6 D         | 81     | 462752 | 01.05 |       |     |  | 11.9387-7016.2 | 220628 |     |  |     |   |   |  |       |  |
|                      | 1.6 D2        | 84     | 462752 | 10.10 |       |     |  | 11.0230-0698.2 | 260091 |     |  |     |   |   |  |       |  |
|                      | 1.6 i         | 74     | 462752 | 01.05 |       |     |  | 11.0101-5407.2 | 260011 |     |  |     |   |   |  |       |  |
|                      | 1.8           | 92     | 462752 | 04.04 |       |     |  | 11.8171-0008.1 | 990049 |     |  |     |   |   |  |       |  |
|                      | 1.8 FlexiFuel | 92     | 462752 | 04.07 |       |     |  | 11.8116-0340.1 | 390595 |     |  |     |   |   |  |       |  |
|                      | 2.0 D         | 100    | 462752 | 01.04 |       |     |  |                |        |     |  |     |   |   |  |       |  |
|                      | 2.0 D3        | 110    | 462752 | 10.10 |       |     |  |                |        |     |  |     |   |   |  |       |  |
|                      | 2.0 D4        | 96     | 462752 | 07.05 |       |     |  |                |        |     |  |     |   |   |  |       |  |
|                      | 2.0 D4        | 130    | 462752 | 10.10 |       |     |  |                |        |     |  |     |   |   |  |       |  |
|                      | 2.0 FlexiFuel | 107    | 462752 | 10.06 |       |     |  |                |        |     |  |     |   |   |  |       |  |
|                      | 2.0 i         | 107    | 462752 | 10.06 |       |     |  |                |        |     |  |     |   |   |  |       |  |
|                      | 2.4           | 103    | 462752 | 01.04 |       |     |  |                |        |     |  |     |   |   |  |       |  |
|                      | 2.4           | 125    | 462752 | 01.04 |       |     |  |                |        |     |  |     |   |   |  |       |  |
|                      | 2.4 4X4       | 125    | 462752 | 08.06 |       |     |  |                |        |     |  |     |   |   |  |       |  |
|                      | 2.4 D5        | 132    | 462752 | 03.06 |       |     |  |                |        |     |  |     |   |   |  |       |  |
|                      | 2.5 T5        | 162    | 462752 | 01.04 |       |     |  |                |        |     |  |     |   |   |  |       |  |
|                      | 2.5 T5        | 169    | 462752 | 03.07 |       |     |  |                |        |     |  |     |   |   |  |       |  |
|                      | 2.5 T5 AWD    | 162    | 462752 | 04.04 |       |     |  |                |        |     |  |     |   |   |  |       |  |
|                      | 2.5 T5 AWD    | 169    | 462752 | 03.07 |       |     |  |                |        |     |  |     |   |   |  |       |  |
| 1.6 D                | 80            | 462753 |        | 05.12 |       |     |  | 11.0230-0698.2 | 260091 |     |  | 2   |   | Halter<br>Hülsensatz<br>Führungsbolzen<br>Halterfeder                                     | ATE<br>ATE<br>ATE<br>ATE               |       |  |
| 1.6 D                | 81            | 462753 |        | 05.12 |       |     |  | 11.0101-5407.2 | 260011 |     |  |     |   |   |  |       |  |
| 1.6 D2               | 84            | 462753 |        | 05.12 |       |     |  | 11.8171-0008.1 | 990049 |     |  |     |   |   |  |       |  |
| 1.6 i                | 74            | 462753 |        | 05.12 |       |     |  | 11.8116-0340.1 | 390595 |     |  |     |   |   |  |       |  |
| 1.8                  | 92            | 462753 |        | 05.12 |       |     |  |                |        |     |  |     |   |   |  |       |  |
| 1.8 FlexiFuel        | 92            | 462753 |        | 05.12 |       |     |  |                |        |     |  |     |   |   |  |       |  |
| 2.0 D                | 100           | 462753 |        | 05.12 |       |     |  |                |        |     |  |     |   |   |  |       |  |
| 2.0 D3               | 110           | 462753 |        | 05.12 |       |     |  |                |        |     |  |     |   |   |  |       |  |
| 2.0 D4               | 96            | 462753 |        | 05.12 |       |     |  |                |        |     |  |     |   |   |  |       |  |
| 2.0 D4               | 130           | 462753 |        | 05.12 |       |     |  |                |        |     |  |     |   |   |  |       |  |
| 2.0 FlexiFuel        | 107           | 462753 |        | 05.12 |       |     |  |                |        |     |  |     |   |   |  |       |  |
| 2.0 i                | 107           | 462753 |        | 05.12 |       |     |  |                |        |     |  |     |   |   |  |       |  |
| 2.4                  | 103           | 462753 |        | 05.12 |       |     |  |                |        |     |  |     |   |   |  |       |  |
| 2.4                  | 125           | 462753 |        | 05.12 |       |     |  |                |        |     |  |     |   |   |  |       |  |
| 2.4 4X4              | 125           | 462753 |        | 05.12 |       |     |  |                |        |     |  |     |   |   |  |       |  |
| 2.4 D5               | 132           | 462753 |        | 05.12 |       |     |  |                |        |     |  |     |   |   |  |       |  |
| 2.5 T5               | 162           | 462753 |        | 05.12 |       |     |  |                |        |     |  |     |   |   |  |       |  |
| 2.5 T5               | 169           | 462753 |        | 05.12 |       |     |  |                |        |     |  |     |   |   |  |       |  |
| 2.5 T5 AWD           | 162           | 462753 |        | 05.12 |       |     |  |                |        |     |  |     |   |   |  |       |  |
| 2.5 T5 AWD           | 169           | 462753 |        | 05.12 |       |     |  |                |        |     |  |     |   |   |  |       |  |
|                      | 1.6 D         | 80     |        | 04.07 | 05.12 |     |  | 24.5124-0390.3 | 331050 | 2   |  | 2   |   | L=390<br>L=382  |  |       |  |
|                      | 1.6 D         | 81     |        | 01.05 | 05.12 |     |  | 83.7788-0383.3 | 330972 |     |  |     |   |   |  |       |  |
|                      | 1.6 D2        | 84     |        | 10.10 | 05.12 |     |  |                |        |     |  |     |   |   |  |       |  |
|                      | 1.6 i         | 74     |        | 01.05 | 05.12 |     |  |                |        |     |  |     |   |   |  |       |  |
|                      | 1.8           | 92     |        | 04.04 | 05.12 |     |  |                |        |     |  |     |   |   |  |       |  |
|                      | 1.8 FlexiFuel | 92     |        | 04.07 | 05.12 |     |  |                |        |     |  |     |   |   |  |       |  |
|                      | 2.0 D         | 100    |        | 01.04 | 05.12 |     |  |                |        |     |  |     |   |   |  |       |  |

1) + 17" wheel / + ruota 17" / + roue 17" / + rueda 17"

2) - 17" wheel / - ruota 17" / - roue 17" / - rueda 17"

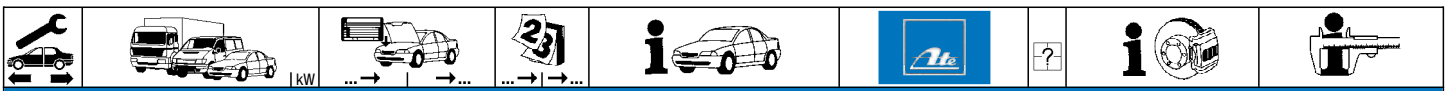

| VOLVO S40 II (04-12) |               |     |  |       |       |  |                |        |   |  |       |
|----------------------|---------------|-----|--|-------|-------|--|----------------|--------|---|--|-------|
|                      | 2.0 D3        | 110 |  | 10.10 | 05.12 |  | 24.5124-0390.3 | 331050 | 2 |  | L=390 |
|                      | 2.0 D4        | 96  |  | 07.05 | 05.12 |  | 83.7788-0383.3 | 330972 | 2 |  | L=382 |
|                      | 2.0 D4        | 130 |  | 10.10 | 05.12 |  |                |        |   |  |       |
|                      | 2.0 FlexiFuel | 107 |  | 10.06 | 05.12 |  |                |        |   |  |       |
|                      | 2.0 i         | 107 |  | 10.06 | 05.12 |  |                |        |   |  |       |
|                      | 2.4           | 103 |  | 01.04 | 05.12 |  |                |        |   |  |       |
|                      | 2.4           | 125 |  | 01.04 | 05.12 |  |                |        |   |  |       |
|                      | 2.4 4X4       | 125 |  | 08.06 | 05.12 |  |                |        |   |  |       |
|                      | 2.4 D5        | 132 |  | 03.06 | 05.12 |  |                |        |   |  |       |
|                      | 2.5 T5        | 162 |  | 01.04 | 05.12 |  |                |        |   |  |       |
|                      | 2.5 T5        | 169 |  | 03.07 | 05.12 |  |                |        |   |  |       |

| VOLVO S60 I (00-09) |             |     |      |       |       |  |                |        |  |        |             |     |
|---------------------|-------------|-----|------|-------|-------|--|----------------|--------|--|--------|-------------|-----|
|                     | 2.0 T       | 132 |      | 09.01 | 12.01 |  | 03.7755-3402.4 | 300189 |  | - DSTC | 9/8" Tandem | ATE |
|                     | 2.3 T5      | 184 |      | 08.00 | 12.01 |  |                |        |  |        |             |     |
|                     | 2.3 T5      | 195 |      | 07.00 | 12.01 |  |                |        |  |        |             |     |
|                     | 2.4         | 103 |      | 11.00 | 12.01 |  |                |        |  |        |             |     |
|                     | 2.4         | 125 |      | 11.00 | 12.01 |  |                |        |  |        |             |     |
|                     | 2.4 D5      | 120 |      | 07.01 | 12.01 |  |                |        |  |        |             |     |
|                     | 2.4 T       | 147 |      | 11.00 | 12.01 |  |                |        |  |        |             |     |
|                     | 2.4 T AWD   | 147 |      | 11.01 | 12.01 |  |                |        |  |        |             |     |
|                     | 2.0 T       | 132 |      | 01.02 | 01.09 |  | 03.7755-4702.4 | 300224 |  | - DSTC | 9/8" Tandem | ATE |
|                     | 2.3 T5      | 184 |      | 01.02 | 04.04 |  | 03.7858-3532.4 | 300233 |  | + DSTC | 9/8" Tandem | ATE |
|                     | 2.3 T5      | 195 |      | 07.00 | 09.02 |  |                |        |  |        |             |     |
|                     | 2.4         | 103 |      | 01.02 | 01.09 |  |                |        |  |        |             |     |
|                     | 2.4         | 125 |      | 01.02 | 01.09 |  |                |        |  |        |             |     |
|                     | 2.4 Bi-Fuel | 103 |      | 06.02 | 01.09 |  |                |        |  |        |             |     |
|                     | 2.4 D       | 93  |      | 09.05 | 01.09 |  |                |        |  |        |             |     |
|                     | 2.4 D       | 96  |      | 01.02 | 01.09 |  |                |        |  |        |             |     |
|                     | 2.4 D5      | 120 |      | 01.02 | 01.09 |  |                |        |  |        |             |     |
|                     | 2.4 D5      | 136 |      | 09.05 | 01.09 |  |                |        |  |        |             |     |
|                     | 2.4 T       | 147 |      | 01.02 | 01.09 |  |                |        |  |        |             |     |
|                     | 2.4 T AWD   | 147 |      | 01.02 | 01.09 |  |                |        |  |        |             |     |
|                     | 2.4 T5      | 191 |      | 04.04 | 01.09 |  |                |        |  |        |             |     |
|                     | 2.5 T       | 154 |      | 02.04 | 01.09 |  |                |        |  |        |             |     |
|                     | 2.5 T AWD   | 154 |      | 04.04 | 01.09 |  |                |        |  |        |             |     |
|                     | R 2.5 T     | 220 |      | 04.04 | 05.07 |  |                |        |  |        |             |     |
|                     | R 2.5 T AWD | 221 |      | 03.03 | 01.09 |  |                |        |  |        |             |     |
|                     | 2.0 T       | 132 | 8535 | 09.01 |       |  | 03.2125-7637.3 | 010707 |  | - DSTC | Thz 25,40   | ATE |
|                     | 2.3 T5      | 184 | 8535 | 08.00 |       |  |                |        |  |        |             |     |
|                     | 2.3 T5      | 195 | 8535 | 07.00 |       |  |                |        |  |        |             |     |
|                     | 2.4         | 103 | 8535 | 11.00 |       |  |                |        |  |        |             |     |
|                     | 2.4         | 125 | 8535 | 11.00 |       |  |                |        |  |        |             |     |
|                     | 2.4 D       | 96  | 8535 | 12.01 |       |  |                |        |  |        |             |     |
|                     | 2.4 D5      | 120 | 8535 | 07.01 |       |  |                |        |  |        |             |     |
|                     | 2.4 T       | 147 | 8535 | 11.00 |       |  |                |        |  |        |             |     |
|                     | 2.4 T AWD   | 147 | 8535 | 11.01 |       |  |                |        |  |        |             |     |
|                     | 2.0 T       | 132 | 8536 | 01.09 |       |  | 03.2125-7743.3 | 010921 |  | - DSTC | Thz 25,40   | ATE |
|                     | 2.3 T5      | 184 | 8536 | 04.04 |       |  |                |        |  |        |             |     |
|                     | 2.3 T5      | 195 | 8536 | 09.02 |       |  |                |        |  |        |             |     |
|                     | 2.4         | 103 | 8536 | 01.09 |       |  |                |        |  |        |             |     |
|                     | 2.4         | 125 | 8536 | 01.09 |       |  |                |        |  |        |             |     |
|                     | 2.4 Bi-Fuel | 103 |      | 06.02 | 01.09 |  |                |        |  |        |             |     |
|                     | 2.4 D       | 93  |      | 09.05 | 01.09 |  |                |        |  |        |             |     |
|                     | 2.4 D       | 96  | 8536 | 01.09 |       |  |                |        |  |        |             |     |
|                     | 2.4 D5      | 120 | 8536 | 01.09 |       |  |                |        |  |        |             |     |
|                     | 2.4 D5      | 136 |      | 09.05 | 01.09 |  |                |        |  |        |             |     |
|                     | 2.4 T       | 147 | 8536 | 01.09 |       |  |                |        |  |        |             |     |
|                     | 2.4 T AWD   | 147 | 8536 | 01.09 |       |  |                |        |  |        |             |     |
|                     | 2.4 T5      | 191 |      | 04.04 | 01.09 |  |                |        |  |        |             |     |
|                     | 2.5 T       | 154 |      | 02.04 | 01.09 |  |                |        |  |        |             |     |
|                     | 2.5 T AWD   | 154 |      | 04.04 | 01.09 |  |                |        |  |        |             |     |
|                     | R 2.5 T     | 220 |      | 04.04 | 05.07 |  |                |        |  |        |             |     |
|                     | R 2.5 T AWD | 221 |      | 03.03 | 01.09 |  |                |        |  |        |             |     |
|                     | 2.0 T       | 132 | 9499 | 09.01 |       |  | 03.2125-7708.3 | 010739 |  | + DSTC | Thz 25,40   | ATE |
|                     | 2.3 T5      | 184 | 9499 | 08.00 |       |  |                |        |  |        |             |     |
|                     | 2.3 T5      | 195 | 9499 | 07.00 |       |  |                |        |  |        |             |     |
|                     | 2.4         | 103 | 9499 | 11.00 |       |  |                |        |  |        |             |     |
|                     | 2.4         | 125 | 9499 | 11.00 |       |  |                |        |  |        |             |     |
|                     | 2.4 Bi-Fuel | 103 | 9499 | 06.02 | 01.09 |  |                |        |  |        |             |     |
|                     | 2.4 D       | 96  | 9499 | 12.01 |       |  |                |        |  |        |             |     |
|                     | 2.4 D5      | 120 | 9499 | 07.01 |       |  |                |        |  |        |             |     |
|                     | 2.4 T       | 147 | 9499 | 11.00 |       |  |                |        |  |        |             |     |
|                     | 2.4 T AWD   | 147 | 9499 | 11.01 |       |  |                |        |  |        |             |     |
|                     | 2.4 T5      | 191 | 9499 | 04.04 |       |  |                |        |  |        |             |     |
|                     | 2.5 T       | 154 | 9499 | 02.04 |       |  |                |        |  |        |             |     |
|                     | 2.5 T AWD   | 154 | 9499 | 04.04 |       |  |                |        |  |        |             |     |
|                     | R 2.5 T     | 220 | 9499 | 04.04 |       |  |                |        |  |        |             |     |
|                     | R 2.5 T AWD | 221 | 9499 | 03.03 |       |  |                |        |  |        |             |     |
|                     | 2.0 T       | 132 | 9500 | 01.09 |       |  | 03.2125-7713.3 | 010819 |  | + DSTC | Thz 25,40   | ATE |
|                     | 2.3 T5      | 184 | 9500 | 04.04 |       |  |                |        |  |        |             |     |
|                     | 2.3 T5      | 195 | 9500 | 09.02 |       |  |                |        |  |        |             |     |
|                     | 2.4         | 103 | 9500 | 01.09 |       |  |                |        |  |        |             |     |
|                     | 2.4         | 125 | 9500 | 01.09 |       |  |                |        |  |        |             |     |
|                     | 2.4 Bi-Fuel | 103 | 9500 | 01.09 |       |  |                |        |  |        |             |     |
|                     | 2.4 D       | 93  |      | 09.05 | 01.09 |  |                |        |  |        |             |     |
|                     | 2.4 D       | 96  | 9500 | 01.09 |       |  |                |        |  |        |             |     |







**VOLVO S60 I (00-09)**

|             |             |          |       |       |                |                |        |                  |                |       |
|-------------|-------------|----------|-------|-------|----------------|----------------|--------|------------------|----------------|-------|
|             | 2.4 D5      | 120 9500 |       | 09.05 | 01.09          | 03.2125-7713.3 | 010819 | + DSTC           | THz 25,40      | ATE   |
|             | 2.4 D5      | 136      |       |       | 01.09          |                |        |                  |                |       |
|             | 2.4 T       | 147 9500 |       |       | 01.09          |                |        |                  |                |       |
|             | 2.4 T AWD   | 147 9500 |       |       | 01.09          |                |        |                  |                |       |
|             | 2.4 T5      | 191 9500 |       |       | 01.09          |                |        |                  |                |       |
|             | 2.5 T       | 154 9500 |       |       | 01.09          |                |        |                  |                |       |
|             | 2.5 T AWD   | 154 9500 |       |       | 01.09          |                |        |                  |                |       |
|             | R 2.5 T     | 220 9500 |       |       | 05.07          |                |        |                  |                |       |
|             | R 2.5 T AWD | 221 9500 |       |       | 01.09          |                |        |                  |                |       |
|             | 2.0 T       | 132 8536 |       |       | 01.09          |                |        |                  |                |       |
| 2.3 T5      | 184 8536    |          |       | 04.04 |                |                |        |                  |                |       |
| 2.3 T5      | 195 8536    |          |       | 09.02 |                |                |        |                  |                |       |
| 2.4         | 103 8536    |          |       | 01.09 |                |                |        |                  |                |       |
| 2.4         | 125 8536    |          |       | 01.09 |                |                |        |                  |                |       |
| 2.4 Bi-Fuel | 103         |          | 06.02 | 01.09 |                |                |        |                  |                |       |
| 2.4 D       | 93          |          | 09.05 | 01.09 |                |                |        |                  |                |       |
| 2.4 D       | 96 8536     |          |       | 01.09 |                |                |        |                  |                |       |
| 2.4 D5      | 120 8536    |          |       | 01.09 |                |                |        |                  |                |       |
| 2.4 D5      | 136         |          | 09.05 | 01.09 |                |                |        |                  |                |       |
| 2.4 T       | 147 8536    |          |       | 01.09 |                |                |        |                  |                |       |
| 2.4 T AWD   | 147 8536    |          |       | 01.09 |                |                |        |                  |                |       |
| 2.4 T5      | 191         |          | 04.04 | 01.09 |                |                |        |                  |                |       |
| 2.5 T       | 154         |          | 02.04 | 01.09 |                |                |        |                  |                |       |
| 2.5 T AWD   | 154         |          | 04.04 | 01.09 |                |                |        |                  |                |       |
| R 2.5 T     | 220 8536    |          |       | 05.07 |                |                |        |                  |                |       |
| R 2.5 T AWD | 221         |          | 03.03 | 01.09 |                |                |        |                  |                |       |
| 2.0 T       | 132         | 11551    |       | 09.01 | 03.2125-7637.3 | 010707         | + DSTC | THz 25,40        | ATE            |       |
| 2.3 T5      | 184         | 11551    |       | 08.00 |                |                |        |                  |                |       |
| 2.3 T5      | 195         | 11551    |       | 07.00 |                |                |        |                  |                |       |
| 2.4         | 103         | 11551    |       | 11.00 |                |                |        |                  |                |       |
| 2.4         | 125         | 11551    |       | 11.00 |                |                |        |                  |                |       |
| 2.4 Bi-Fuel | 103         | 11551    |       | 06.02 |                |                |        |                  |                |       |
| 2.4 D       | 96          | 11551    |       | 12.01 |                |                |        |                  |                |       |
| 2.4 D5      | 120         | 11551    |       | 07.01 |                |                |        |                  |                |       |
| 2.4 T       | 147         | 11551    |       | 11.00 |                |                |        |                  |                |       |
| 2.4 T AWD   | 147         | 11551    |       | 11.01 |                |                |        |                  |                |       |
| 2.4 T5      | 191         | 11551    |       | 04.04 |                |                |        |                  |                |       |
| 2.5 T       | 154         | 11551    |       | 02.04 |                |                |        |                  |                |       |
| 2.5 T AWD   | 154         | 11551    |       | 04.04 |                |                |        |                  |                |       |
| R 2.5 T     | 220         | 11551    |       | 04.04 |                |                |        |                  |                |       |
| R 2.5 T AWD | 221         | 11551    |       | 03.03 |                |                |        |                  |                |       |
| 2.0 T       | 132 11552   |          |       | 01.09 | 03.2125-7638.3 | 010738         | + DSTC | THz 25,40        | ATE            |       |
| 2.3 T5      | 184 11552   |          |       | 04.04 |                |                |        |                  |                |       |
| 2.3 T5      | 195 11552   |          |       | 09.02 |                |                |        |                  |                |       |
| 2.4         | 103 11552   |          |       | 01.09 |                |                |        |                  |                |       |
| 2.4         | 125 11552   |          |       | 01.09 |                |                |        |                  |                |       |
| 2.4 Bi-Fuel | 103 11552   |          |       | 01.09 |                |                |        |                  |                |       |
| 2.4 D       | 93          |          | 09.05 | 01.09 |                |                |        |                  |                |       |
| 2.4 D       | 96 11552    |          |       | 01.09 |                |                |        |                  |                |       |
| 2.4 D5      | 120 11552   |          |       | 01.09 |                |                |        |                  |                |       |
| 2.4 D5      | 136         |          | 09.05 | 01.09 |                |                |        |                  |                |       |
| 2.4 T       | 147 11552   |          |       | 01.09 |                |                |        |                  |                |       |
| 2.4 T AWD   | 147 11552   |          |       | 01.09 |                |                |        |                  |                |       |
| 2.4 T5      | 191 11552   |          |       | 01.09 |                |                |        |                  |                |       |
| 2.5 T       | 154 11552   |          |       | 01.09 |                |                |        |                  |                |       |
| 2.5 T AWD   | 154 11552   |          |       | 01.09 |                |                |        |                  |                |       |
| R 2.5 T     | 220 11552   |          |       | 05.07 |                |                |        |                  |                |       |
| R 2.5 T AWD | 221 11552   |          |       | 01.09 |                |                |        |                  |                |       |
|             | 2.0 T       | 132      |       | 09.01 | 01.09          | 11.9601-9829.2 | 220505 | + 15"/16" Rad 1) | D=60, - Halter | ATE   |
|             | 2.3 T5      | 184      |       | 08.00 | 04.04          |                |        |                  |                |       |
|             | 2.3 T5      | 195      |       | 07.00 | 09.02          |                |        |                  |                |       |
|             | 2.4         | 103      |       | 11.00 | 01.09          |                |        |                  |                |       |
|             | 2.4         | 125      |       | 11.00 | 01.09          |                |        |                  |                |       |
|             | 2.4 Bi-Fuel | 103      |       | 06.02 | 01.09          |                |        |                  |                |       |
|             | 2.4 D       | 93       |       | 09.05 | 01.09          |                |        |                  |                |       |
|             | 2.4 D       | 96       |       | 12.01 | 01.09          |                |        |                  |                |       |
|             | 2.4 D5      | 120      |       | 07.01 | 01.09          |                |        |                  |                |       |
|             | 2.4 D5      | 136      |       | 09.05 | 01.09          |                |        |                  |                |       |
| 2.4 T       | 147         |          | 11.00 | 01.09 |                |                |        |                  |                |       |
| 2.4 T AWD   | 147         |          | 11.01 | 01.09 |                |                |        |                  |                |       |
| 2.4 T5      | 191         |          | 04.04 | 01.09 |                |                |        |                  |                |       |
| 2.5 T       | 154         |          | 02.04 | 01.09 |                |                |        |                  |                |       |
| 2.5 T AWD   | 154         |          | 04.04 | 01.09 |                |                |        |                  |                |       |
|             | 2.0 T       | 132      |       | 09.01 | 01.09          | 83.6113-0321.3 | 330621 | 2                | - 17" Rad 3)   | L=320 |
|             | 2.3 T5      | 184      |       | 08.00 | 04.04          |                |        |                  |                |       |
|             | 2.3 T5      | 195      |       | 07.00 | 09.02          |                |        |                  |                |       |
|             | 2.4         | 103      |       | 11.00 | 01.09          |                |        |                  |                |       |
|             | 2.4         | 125      |       | 11.00 | 01.09          |                |        |                  |                |       |
|             | 2.4 Bi-Fuel | 103      |       | 06.02 | 01.09          |                |        |                  |                |       |
|             | 2.4 D       | 93       |       | 09.05 | 01.09          |                |        |                  |                |       |
|             | 2.4 D       | 96       |       | 12.01 | 01.09          |                |        |                  |                |       |
|             | 2.4 D5      | 120      |       | 07.01 | 01.09          |                |        |                  |                |       |
|             | 2.4 D5      | 136      |       | 09.05 | 01.09          |                |        |                  |                |       |
| 2.4 T       | 147         |          | 11.00 | 01.09 |                |                |        |                  |                |       |
| 2.4 T AWD   | 147         |          | 11.01 | 01.09 |                |                |        |                  |                |       |
| 2.4 T5      | 191         |          | 04.04 | 01.09 |                |                |        |                  |                |       |
| 2.5 T       | 154         |          | 02.04 | 01.09 |                |                |        |                  |                |       |

1) + 15"/16" wheel / + ruota 15"/16" / + roue 15"/16" / + rueda 15"/16"

2) + 17" wheel / + ruota 17" / + roue 17" / + rueda 17"

3) - 17" wheel / - ruota 17" / - roue 17" / - rueda 17"

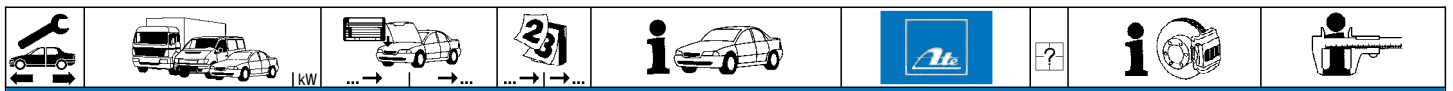

| VOLVO S60 I (00-09) |             |     |  |       |       |  |                |        |   |                         |                |     |
|---------------------|-------------|-----|--|-------|-------|--|----------------|--------|---|-------------------------|----------------|-----|
|                     | 2.5 T AWD   | 154 |  | 04.04 | 01.09 |  | 83.6113-0321.3 | 330621 | 2 | - 17" Rad <sup>1)</sup> | L=320          |     |
|                     | 2.0 T       | 132 |  | 09.01 | 01.09 |  | 83.6124-0304.3 | 330983 | 2 | + 17" Rad <sup>2)</sup> | L=300          |     |
|                     | 2.3 T5      | 184 |  | 08.00 | 04.04 |  |                |        |   |                         |                |     |
|                     | 2.3 T5      | 195 |  | 07.00 | 09.02 |  |                |        |   |                         |                |     |
|                     | 2.4         | 103 |  | 11.00 | 01.09 |  |                |        |   |                         |                |     |
|                     | 2.4         | 125 |  | 11.00 | 01.09 |  |                |        |   |                         |                |     |
|                     | 2.4 Bi-Fuel | 103 |  | 06.02 | 01.09 |  |                |        |   |                         |                |     |
|                     | 2.4 D       | 93  |  | 09.05 | 01.09 |  |                |        |   |                         |                |     |
|                     | 2.4 D       | 96  |  | 12.01 | 01.09 |  |                |        |   |                         |                |     |
|                     | 2.4 D5      | 120 |  | 07.01 | 01.09 |  |                |        |   |                         |                |     |
|                     | 2.4 D5      | 136 |  | 09.05 | 01.09 |  |                |        |   |                         |                |     |
|                     | 2.4 T       | 147 |  | 11.00 | 01.09 |  |                |        |   |                         |                |     |
|                     | 2.4 T AWD   | 147 |  | 11.00 | 01.09 |  |                |        |   |                         |                |     |
|                     | 2.4 T5      | 191 |  | 04.04 | 01.09 |  |                |        |   |                         |                |     |
|                     | 2.5 T       | 154 |  | 02.04 | 01.09 |  |                |        |   |                         |                |     |
|                     | 2.5 T AWD   | 154 |  | 04.04 | 01.09 |  |                |        |   |                         |                |     |
|                     | 2.0 T       | 132 |  | 09.01 | 01.09 |  | 11.9421-9979.2 | 220497 | 2 |                         | D=42, - Halter | ATE |
|                     | 2.3 T5      | 184 |  | 08.00 | 04.04 |  | 11.9421-9980.2 | 220498 | 2 |                         | D=42, - Halter | ATE |
|                     | 2.3 T5      | 195 |  | 07.00 | 09.02 |  | 24.3421-9979.5 | 240475 | 2 |                         | D=42, - Halter | ATE |
|                     | 2.4         | 103 |  | 11.00 | 01.09 |  | 24.3421-9980.5 | 240476 | 2 |                         | D=42, - Halter | ATE |
|                     | 2.4         | 125 |  | 11.00 | 01.09 |  | 11.0101-5407.2 | 260011 | 2 |                         | Hülzensatz     | ATE |
|                     | 2.4 Bi-Fuel | 103 |  | 06.02 | 01.09 |  | 11.8171-0008.1 | 990049 | 2 |                         | Führungsbolzen | ATE |
|                     | 2.4 D       | 93  |  | 09.05 | 01.09 |  | 11.8116-0236.1 | 390507 | 2 |                         | Haltefeder     | ATE |
|                     | 2.4 D       | 96  |  | 12.01 | 01.09 |  |                |        |   |                         |                |     |
|                     | 2.4 D5      | 120 |  | 07.01 | 01.09 |  |                |        |   |                         |                |     |
|                     | 2.4 D5      | 136 |  | 09.05 | 01.09 |  |                |        |   |                         |                |     |
|                     | 2.4 T       | 147 |  | 11.00 | 01.09 |  |                |        |   |                         |                |     |
|                     | 2.4 T AWD   | 147 |  | 11.01 | 01.09 |  |                |        |   |                         |                |     |
|                     | 2.4 T5      | 191 |  | 04.04 | 01.09 |  |                |        |   |                         |                |     |
|                     | 2.5 T       | 154 |  | 02.04 | 01.09 |  |                |        |   |                         |                |     |
|                     | 2.5 T AWD   | 154 |  | 04.04 | 01.09 |  |                |        |   |                         |                |     |
|                     | 2.0 T       | 132 |  | 09.01 | 01.09 |  | 83.7724-0268.3 | 331076 | 2 |                         | L=265          |     |
|                     | 2.3 T5      | 184 |  | 08.00 | 04.04 |  |                |        |   |                         |                |     |
|                     | 2.3 T5      | 195 |  | 07.00 | 09.02 |  |                |        |   |                         |                |     |
|                     | 2.4         | 103 |  | 11.00 | 01.09 |  |                |        |   |                         |                |     |
|                     | 2.4         | 125 |  | 11.00 | 01.09 |  |                |        |   |                         |                |     |
|                     | 2.4 Bi-Fuel | 103 |  | 06.02 | 01.09 |  |                |        |   |                         |                |     |
|                     | 2.4 D       | 93  |  | 09.05 | 01.09 |  |                |        |   |                         |                |     |
|                     | 2.4 D       | 96  |  | 12.01 | 01.09 |  |                |        |   |                         |                |     |
|                     | 2.4 D5      | 120 |  | 07.01 | 01.09 |  |                |        |   |                         |                |     |
|                     | 2.4 D5      | 136 |  | 09.05 | 01.09 |  |                |        |   |                         |                |     |
|                     | 2.4 T       | 147 |  | 11.00 | 01.09 |  |                |        |   |                         |                |     |
|                     | 2.4 T AWD   | 147 |  | 11.01 | 01.09 |  |                |        |   |                         |                |     |
|                     | 2.4 T5      | 191 |  | 04.04 | 01.09 |  |                |        |   |                         |                |     |
|                     | 2.5 T       | 154 |  | 02.04 | 01.09 |  |                |        |   |                         |                |     |
|                     | 2.5 T AWD   | 154 |  | 04.04 | 01.09 |  |                |        |   |                         |                |     |
|                     | 2.0 T       | 132 |  | 09.01 | 12.04 |  | 24.3727-1311.2 | 581311 | 2 |                         | L=1923         |     |
|                     | 2.3 T5      | 184 |  | 08.00 | 04.04 |  |                |        |   |                         |                |     |
|                     | 2.3 T5      | 195 |  | 07.00 | 09.02 |  |                |        |   |                         |                |     |
|                     | 2.4         | 103 |  | 11.00 | 12.04 |  |                |        |   |                         |                |     |
|                     | 2.4         | 125 |  | 11.00 | 12.04 |  |                |        |   |                         |                |     |
|                     | 2.4 D       | 96  |  | 12.01 | 12.04 |  |                |        |   |                         |                |     |
|                     | 2.4 D5      | 120 |  | 07.01 | 12.04 |  |                |        |   |                         |                |     |
|                     | 2.4 T       | 147 |  | 11.00 | 12.04 |  |                |        |   |                         |                |     |
|                     | 2.4 T5      | 191 |  | 04.04 | 12.04 |  |                |        |   |                         |                |     |
|                     | 2.5 T       | 154 |  | 02.04 | 12.04 |  |                |        |   |                         |                |     |

| VOLVO S60 II (10-) |             |     |  |       |  |  |                |        |   |  |                         |                |     |
|--------------------|-------------|-----|--|-------|--|--|----------------|--------|---|--|-------------------------|----------------|-----|
|                    | 1.6 D DRIVE | 84  |  | 01.11 |  |  | 11.9601-9711.2 | 220873 | 2 |  | + 16" Rad <sup>3)</sup> | D=60, - Halter | ATE |
|                    | 2.0 T       | 149 |  | 04.10 |  |  | 11.9601-9712.2 | 220874 | 2 |  | + 16" Rad <sup>3)</sup> | D=60, - Halter | ATE |
|                    | D2          | 84  |  | 04.13 |  |  | 11.8116-0206.1 | 390593 | 2 |  |                         | Haltefeder     | ATE |
|                    | D3          | 100 |  | 05.12 |  |  | 11.0101-5407.2 | 260011 | 2 |  |                         | Hülzensatz     | ATE |
|                    | D3          | 120 |  | 04.10 |  |  | 11.8171-0008.1 | 990049 | 2 |  |                         | Führungsbolzen | ATE |
|                    | D4          | 120 |  | 05.12 |  |  | 11.0441-6008.2 | 250038 | 2 |  |                         | Dichtungssatz  | ATE |
|                    | D5          | 151 |  | 04.10 |  |  |                |        |   |  |                         |                |     |
|                    | D5          | 158 |  | 06.11 |  |  |                |        |   |  |                         |                |     |
|                    | D5 AWD      | 151 |  | 04.10 |  |  |                |        |   |  |                         |                |     |
|                    | D5 AWD      | 158 |  | 06.11 |  |  |                |        |   |  |                         |                |     |
|                    | T3          | 110 |  | 04.10 |  |  |                |        |   |  |                         |                |     |
|                    | T4          | 132 |  | 04.10 |  |  |                |        |   |  |                         |                |     |
|                    | T4F         | 132 |  | 04.11 |  |  |                |        |   |  |                         |                |     |
|                    | T5          | 176 |  | 04.10 |  |  |                |        |   |  |                         |                |     |
|                    | T6 AWD      | 224 |  | 04.10 |  |  |                |        |   |  |                         |                |     |
|                    | 1.6 D DRIVE | 84  |  | 01.11 |  |  | 11.9606-9949.2 | 220879 | 2 |  | + 17" Rad <sup>2)</sup> | D=60, - Halter | ATE |
|                    | 2.0 T       | 149 |  | 04.10 |  |  | 11.9606-9950.2 | 220880 | 2 |  | + 17" Rad <sup>2)</sup> | D=60, - Halter | ATE |
|                    | D2          | 84  |  | 04.13 |  |  | 11.8116-0388.2 | 390588 | 2 |  |                         | Haltefeder     | ATE |
|                    | D3          | 100 |  | 05.12 |  |  | 11.0441-6008.2 | 250038 | 2 |  |                         | Dichtungssatz  | ATE |
|                    | D3          | 120 |  | 04.10 |  |  | 11.0101-5704.2 | 260095 | 2 |  |                         | Hülzensatz     | ATE |
|                    | D4          | 120 |  | 05.12 |  |  |                |        |   |  |                         |                |     |
|                    | D5          | 151 |  | 04.10 |  |  |                |        |   |  |                         |                |     |
|                    | D5          | 158 |  | 06.11 |  |  |                |        |   |  |                         |                |     |
|                    | D5 AWD      | 151 |  | 04.10 |  |  |                |        |   |  |                         |                |     |
|                    | D5 AWD      | 158 |  | 06.11 |  |  |                |        |   |  |                         |                |     |
|                    | T3          | 110 |  | 04.10 |  |  |                |        |   |  |                         |                |     |
|                    | T4          | 132 |  | 04.10 |  |  |                |        |   |  |                         |                |     |
|                    | T4F         | 132 |  | 04.11 |  |  |                |        |   |  |                         |                |     |
|                    | T5          | 176 |  | 04.10 |  |  |                |        |   |  |                         |                |     |

1) - 17" wheel / - ruota 17" / - roue 17" / - rueda 17"  
 2) + 17" wheel / + ruota 17" / + roue 17" / + rueda 17"  
 3) + 16" wheel / + ruota 16" / + roue 16" / + rueda 16"





**VOLVO S60 II (10-)**











|  |             |     |  |       |  |   |   |  |   |                                 |
|--|-------------|-----|--|-------|--|---|---|--|---|---------------------------------|
|  | T6 AWD      | 224 |  | 04.10 |  | 11.9606-9949.2 220879<br>11.9606-9950.2 220880<br>11.8116-0388.2 390588<br>11.0441-6008.2 250038<br>11.0101-5704.2 260095 | 2 | + 17" Rad <sup>1)</sup><br>+ 17" Rad <sup>1)</sup> | D=60, - Halter<br>D=60, - Halter<br>Haltefeder<br>Dichtungssatz<br>Hülsensatz | ATE<br>ATE<br>ATE<br>ATE<br>ATE |
|  | 1.6 D Drive | 84  |  | 01.11 |  | 24.5162-0390.3 331199<br>24.5162-0375.3 331203  | 2 | + 16" Rad <sup>2)</sup><br>+ 17" Rad <sup>1)</sup> | L=390<br>L=375  |                                 |
|  | 2.0 T       | 149 |  | 04.10 |  |   |   |  |   |                                 |
|  | D2          | 84  |  | 04.13 |  |   |   |  |   |                                 |
|  | D3          | 100 |  | 05.12 |  |   |   |  |   |                                 |
|  | D3          | 120 |  | 04.10 |  |   |   |  |   |                                 |
|  | D4          | 120 |  | 05.12 |  |   |   |  |   |                                 |
|  | D5          | 151 |  | 04.10 |  |   |   |  |   |                                 |
|  | D5          | 158 |  | 06.11 |  |   |   |  |   |                                 |
|  | D5 AWD      | 151 |  | 04.10 |  |   |   |  |   |                                 |
|  | D5 AWD      | 158 |  | 06.11 |  |   |   |  |   |                                 |
|  | T3          | 110 |  | 04.10 |  |   |   |  |   |                                 |
|  | T4          | 132 |  | 04.10 |  |   |   |  |   |                                 |
|  | T4F         | 132 |  | 04.11 |  |   |   |  |   |                                 |
|  | T5          | 176 |  | 04.10 |  |   |   |  |   |                                 |
|  | T6 AWD      | 224 |  | 04.10 |  |   |   |  |   |                                 |

**VOLVO S70 (97-00)**

|  |              |     |  |       |             |                       |  |  |                 |     |
|--|--------------|-----|--|-------|-------------|-----------------------|--|--|-----------------|-----|
|  | 2.0          | 93  |  | 01.97 | 11.00       | 03.7760-3602.4 300176 |  |  | 10"             | ATE |
|  | 2.0          | 105 |  | 01.97 | 11.00       |                       |  |  |                 |     |
|  | 2.0 20V      | 120 |  | 01.97 | 11.00       |                       |  |  |                 |     |
|  | 2.0 20V      | 132 |  | 01.97 | 11.00       |                       |  |  |                 |     |
|  | 2.0 T        | 155 |  | 01.97 | 11.00       |                       |  |  |                 |     |
|  | 2.0 T        | 166 |  | 01.97 | 11.00       |                       |  |  |                 |     |
|  | 2.3          | 195 |  | 04.99 | 09.00       |                       |  |  |                 |     |
|  | 2.3 T        | 184 |  | 01.97 | 11.00       |                       |  |  |                 |     |
|  | 2.3 T5       | 176 |  | 01.97 | 11.00       |                       |  |  |                 |     |
|  | 2.4          | 103 |  | 08.99 | 11.00       |                       |  |  |                 |     |
|  | 2.4          | 125 |  | 01.97 | 11.00       |                       |  |  |                 |     |
|  | 2.4 AWD      | 106 |  | 10.98 | 05.99       |                       |  |  |                 |     |
|  | 2.4 AWD      | 103 |  | 04.99 | 09.00       |                       |  |  |                 |     |
|  | 2.4 AWD      | 106 |  | 11.96 | 05.99       |                       |  |  |                 |     |
|  | 2.4 AWD      | 142 |  | 11.96 | 09.00       |                       |  |  |                 |     |
|  | 2.4 Blu-Fuel | 103 |  | 07.97 | 09.00       |                       |  |  |                 |     |
|  | 2.4 T        | 142 |  | 01.97 | 11.00       |                       |  |  |                 |     |
|  | 2.5          | 106 |  | 01.97 | 11.00       |                       |  |  |                 |     |
|  | 2.5          | 121 |  | 06.98 | 11.00       |                       |  |  |                 |     |
|  | 2.5 Bifuel   | 103 |  | 01.97 | 11.00       |                       |  |  |                 |     |
|  | 2.5 Bifuel   | 103 |  | 07.99 | 11.00       |                       |  |  |                 |     |
|  | 2.5 Bifuel   | 106 |  | 10.98 | 11.00       |                       |  |  |                 |     |
|  | 2.5 TDI      | 103 |  | 01.97 | 11.00       |                       |  |  |                 |     |
|  | 2.5 TDI AWD  | 103 |  | 10.99 | 09.00       |                       |  |  |                 |     |
|  | 2.0          | 93  |  | 01.97 | 12.98 - ASR | 03.2023-1084.3 010591 |  |  | Thz 23,81/20,64 | ATE |
|  | 2.0          | 105 |  | 01.97 | 12.98 - ASR |                       |  |  |                 |     |
|  | 2.0 20V      | 120 |  | 01.97 | 12.98 - ASR |                       |  |  |                 |     |
|  | 2.0 20V      | 132 |  | 01.97 | 12.98 - ASR |                       |  |  |                 |     |
|  | 2.0 T        | 155 |  | 01.97 | 12.98 - ASR |                       |  |  |                 |     |
|  | 2.0 T        | 166 |  | 01.97 | 12.98 - ASR |                       |  |  |                 |     |
|  | 2.3 T        | 184 |  | 01.97 | 12.98 - ASR |                       |  |  |                 |     |
|  | 2.3 T5       | 176 |  | 01.97 | 12.98 - ASR |                       |  |  |                 |     |
|  | 2.4          | 125 |  | 01.97 | 12.98 - ASR |                       |  |  |                 |     |
|  | 2.4 AWD      | 106 |  | 10.98 | 12.98 - ASR |                       |  |  |                 |     |
|  | 2.4 AWD      | 106 |  | 11.96 | 12.98 - ASR |                       |  |  |                 |     |
|  | 2.4 AWD      | 142 |  | 11.96 | 12.98 - ASR |                       |  |  |                 |     |
|  | 2.4 T        | 142 |  | 01.97 | 12.98 - ASR |                       |  |  |                 |     |
|  | 2.5          | 106 |  | 01.97 | 12.98 - ASR |                       |  |  |                 |     |
|  | 2.5          | 121 |  | 06.98 | 12.98 - ASR |                       |  |  |                 |     |
|  | 2.5 Bifuel   | 103 |  | 01.97 | 12.98 - ASR |                       |  |  |                 |     |
|  | 2.5 Bifuel   | 106 |  | 10.98 | 12.98 - ASR |                       |  |  |                 |     |
|  | 2.5 TDI      | 103 |  | 01.97 | 12.98 - ASR |                       |  |  |                 |     |
|  | 2.0          | 93  |  | 01.97 | 12.98 + ASR | 03.2023-1044.3 010590 |  |  | Thz 23,81/20,64 | ATE |
|  | 2.0          | 105 |  | 01.97 | 12.98 + ASR |                       |  |  |                 |     |
|  | 2.0 20V      | 120 |  | 01.97 | 12.98 + ASR |                       |  |  |                 |     |
|  | 2.0 20V      | 132 |  | 01.97 | 12.98 + ASR |                       |  |  |                 |     |
|  | 2.0 T        | 155 |  | 01.97 | 12.98 + ASR |                       |  |  |                 |     |
|  | 2.0 T        | 166 |  | 01.97 | 12.98 + ASR |                       |  |  |                 |     |
|  | 2.3 T        | 184 |  | 01.97 | 12.98 + ASR |                       |  |  |                 |     |
|  | 2.3 T5       | 176 |  | 01.97 | 12.98 + ASR |                       |  |  |                 |     |
|  | 2.4          | 125 |  | 01.97 | 12.98 + ASR |                       |  |  |                 |     |
|  | 2.4 AWD      | 106 |  | 10.98 | 12.98 + ASR |                       |  |  |                 |     |
|  | 2.4 AWD      | 106 |  | 11.96 | 12.98 + ASR |                       |  |  |                 |     |
|  | 2.4 AWD      | 142 |  | 11.96 | 12.98 + ASR |                       |  |  |                 |     |
|  | 2.4 T        | 142 |  | 01.97 | 12.98 + ASR |                       |  |  |                 |     |
|  | 2.5          | 106 |  | 01.97 | 12.98 + ASR |                       |  |  |                 |     |
|  | 2.5          | 121 |  | 06.98 | 12.98 + ASR |                       |  |  |                 |     |
|  | 2.5 Bifuel   | 103 |  | 01.97 | 12.98 + ASR |                       |  |  |                 |     |
|  | 2.5 Bifuel   | 106 |  | 10.98 | 12.98 + ASR |                       |  |  |                 |     |
|  | 2.5 TDI      | 103 |  | 01.97 | 12.98 + ASR |                       |  |  |                 |     |
|  | 2.0          | 93  |  | 01.99 | 11.00       | 03.2123-2164.3 010599 |  |  | Thz 23,81       | ATE |
|  | 2.0          | 105 |  | 01.99 | 11.00       |                       |  |  |                 |     |
|  | 2.0 20V      | 120 |  | 01.99 | 11.00       |                       |  |  |                 |     |
|  | 2.0 20V      | 132 |  | 01.99 | 11.00       |                       |  |  |                 |     |
|  | 2.0 T        | 155 |  | 01.99 | 11.00       |                       |  |  |                 |     |

<sup>1)</sup> + 17" wheel / + ruota 17" / + roue 17" / + rueda 17"  
<sup>2)</sup> + 16" wheel / + ruota 16" / + roue 16" / + rueda 16"



| VOLVO S70 (97-00)  |              |     |  |       |       |  |  |                |        |   |                             |  |                |     |
|--|--------------|-----|--|-------|-------|--|--|----------------|--------|---|-----------------------------|--|----------------|-----|
|    | 2.0 T        | 166 |  | 01.99 | 11.00 |  |  | 03.2123-2164.3 | 010599 |   |                             |  | Thz 23,81      | ATE |
|  | 2.3          | 195 |  | 04.99 | 09.00 |  |  |                |        |   |                             |  |                |     |
|  | 2.3 T        | 184 |  | 01.99 | 11.00 |  |  |                |        |   |                             |  |                |     |
|  | 2.3 T5       | 176 |  | 01.99 | 11.00 |  |  |                |        |   |                             |  |                |     |
|  | 2.4          | 103 |  | 08.99 | 11.00 |  |  |                |        |   |                             |  |                |     |
|  | 2.4          | 125 |  | 01.99 | 11.00 |  |  |                |        |   |                             |  |                |     |
|  | 2.4 AWD      |     |  | 01.99 | 05.99 |  |  |                |        |   |                             |  |                |     |
|  | 2.4 AWD      | 103 |  | 04.99 | 09.00 |  |  |                |        |   |                             |  |                |     |
|  | 2.4 AWD      | 106 |  | 01.99 | 05.99 |  |  |                |        |   |                             |  |                |     |
|  | 2.4 AWD      | 142 |  | 01.99 | 11.00 |  |  |                |        |   |                             |  |                |     |
|  | 2.4 Blu-Fuel | 103 |  | 07.97 | 09.00 |  |  |                |        |   |                             |  |                |     |
|  | 2.4 Blu-Fuel | 103 |  | 07.97 | 09.00 |  |  |                |        |   |                             |  |                |     |
|  | 2.4 T        | 142 |  | 01.99 | 11.00 |  |  |                |        |   |                             |  |                |     |
|  | 2.5          | 106 |  | 01.99 | 11.00 |  |  |                |        |   |                             |  |                |     |
|  | 2.5          | 121 |  | 01.99 | 11.00 |  |  |                |        |   |                             |  |                |     |
|  | 2.5 Bifuel   | 103 |  | 07.99 | 11.00 |  |  |                |        |   |                             |  |                |     |
|  | 2.5 Bifuel   | 106 |  | 01.99 | 11.00 |  |  |                |        |   |                             |  |                |     |
|  | 2.5 TDI      | 103 |  | 01.99 | 11.00 |  |  |                |        |   |                             |  |                |     |
|  | 2.5 TDi AWD  | 103 |  | 10.99 | 09.00 |  |  |                |        |   |                             |  |                |     |
|    | 2.0          | 93  |  | 01.97 | 11.00 |  |  | 11.9571-9971.2 | 220605 |    |                             |  | D=57, - Halter | ATE |
|  | 2.0          | 105 |  | 01.97 | 11.00 |  |  | 11.9571-9972.2 | 220606 |    |                             |  | D=57, - Halter | ATE |
|  | 2.0 20V      | 120 |  | 01.97 | 11.00 |  |  | 11.0441-5702.2 | 250033 |   |                             |  | Dichtungssatz  | ATE |
|  | 2.0 20V      | 132 |  | 01.97 | 11.00 |  |  | 11.0101-5407.2 | 260011 |   |                             |  | Hülsensatz     | ATE |
|  | 2.0 T        | 155 |  | 01.97 | 11.00 |  |  | 11.8171-0008.1 | 990049 |   |                             |  | Führungsbolzen | ATE |
|  | 2.0 T        | 166 |  | 01.97 | 11.00 |  |  | 11.8116-0073.1 | 390498 | 2   |                             |  | Haltefeder     | ATE |
|  | 2.3          | 195 |  | 04.99 | 09.00 |  |  |                |        |   |                             |  |                |     |
|  | 2.3 T        | 184 |  | 01.97 | 11.00 |  |  |                |        |   |                             |  |                |     |
|  | 2.3 T5       | 176 |  | 01.97 | 11.00 |  |  |                |        |   |                             |  |                |     |
|  | 2.4          | 103 |  | 08.99 | 11.00 |  |  |                |        |   |                             |  |                |     |
|  | 2.4          | 125 |  | 01.97 | 11.00 |  |  |                |        |   |                             |  |                |     |
|  | 2.4 AWD      |     |  | 10.98 | 05.99 |  |  |                |        |   |                             |  |                |     |
|  | 2.4 AWD      | 103 |  | 04.99 | 09.00 |  |  |                |        |   |                             |  |                |     |
|  | 2.4 AWD      | 106 |  | 11.96 | 05.99 |  |  |                |        |   |                             |  |                |     |
|  | 2.4 AWD      | 142 |  | 11.96 | 09.00 |  |  |                |        |   |                             |  |                |     |
|  | 2.4 T        | 142 |  | 01.97 | 11.00 |  |  |                |        |   |                             |  |                |     |
|  | 2.5          | 106 |  | 01.97 | 11.00 |  |  |                |        |   |                             |  |                |     |
|  | 2.5          | 121 |  | 06.98 | 11.00 |  |  |                |        |   |                             |  |                |     |
|  | 2.5 Bifuel   | 103 |  | 07.99 | 11.00 |  |  |                |        |   |                             |  |                |     |
|  | 2.5 Bifuel   | 103 |  | 07.97 | 09.00 |  |  |                |        |   |                             |  |                |     |
|  | 2.5 Bifuel   | 106 |  | 10.98 | 11.00 |  |  |                |        |   |                             |  |                |     |
|  | 2.5 TDI      | 103 |  | 01.97 | 11.00 |  |  |                |        |   |                             |  |                |     |
|  | 2.5 TDi AWD  | 103 |  | 10.99 | 09.00 |  |  |                |        |   |                             |  |                |     |
|  | 2.0          | 93  |  | 01.97 | 11.00 |  |  | 83.6134-0335.3 | 330277 | 2   | + 15" Rad <sup>1)</sup>     |  | L=335          |     |
|  | 2.0          | 105 |  | 01.97 | 11.00 |  |  | 83.6134-0355.3 | 330541 | 2   | + 16" Rad <sup>2)</sup>     |  | L=355          |     |
|  | 2.0 20V      | 120 |  | 01.97 | 11.00 |  |  | 24.5170-0361.3 | 331310 | 2   | + 16" Rad <sup>2)</sup>     |  | L=361          |     |
|  | 2.0 20V      | 132 |  | 01.97 | 11.00 |  |  | 83.6113-0331.3 | 330982 | 2   | am Bremsattel <sup>3)</sup> |  | L=330          |     |
|  | 2.0 T        | 155 |  | 01.97 | 11.00 |  |  |                |        |   |                             |  |                |     |
|  | 2.0 T        | 166 |  | 01.97 | 11.00 |  |  |                |        |   |                             |  |                |     |
|  | 2.3          | 195 |  | 04.99 | 09.00 |  |  |                |        |   |                             |  |                |     |
|  | 2.3 T        | 184 |  | 01.97 | 11.00 |  |  |                |        |   |                             |  |                |     |
|  | 2.3 T5       | 176 |  | 01.97 | 11.00 |  |  |                |        |   |                             |  |                |     |
|  | 2.4          | 103 |  | 08.99 | 11.00 |  |  |                |        |   |                             |  |                |     |
|  | 2.4          | 125 |  | 01.97 | 11.00 |  |  |                |        |   |                             |  |                |     |
|  | 2.4 AWD      |     |  | 10.98 | 05.99 |  |  |                |        |   |                             |  |                |     |
|  | 2.4 AWD      | 103 |  | 04.99 | 09.00 |  |  |                |        |   |                             |  |                |     |
|  | 2.4 AWD      | 106 |  | 11.96 | 05.99 |  |  |                |        |   |                             |  |                |     |
|  | 2.4 AWD      | 142 |  | 11.96 | 09.00 |  |  |                |        |   |                             |  |                |     |
|  | 2.4 Blu-Fuel | 103 |  | 07.97 | 09.00 |  |  |                |        |   |                             |  |                |     |
|  | 2.4 T        | 142 |  | 01.97 | 11.00 |  |  |                |        |   |                             |  |                |     |
|  | 2.5          | 106 |  | 01.97 | 11.00 |  |  |                |        |   |                             |  |                |     |
|  | 2.5          | 121 |  | 06.98 | 11.00 |  |  |                |        |   |                             |  |                |     |
|  | 2.5 Bifuel   | 103 |  | 07.99 | 11.00 |  |  |                |        |   |                             |  |                |     |
|  | 2.5 Bifuel   | 106 |  | 10.98 | 11.00 |  |  |                |        |   |                             |  |                |     |
|  | 2.5 TDI      | 103 |  | 01.97 | 11.00 |  |  |                |        |   |                             |  |                |     |
|  | 2.5 TDi AWD  | 103 |  | 10.99 | 09.00 |  |  |                |        |   |                             |  |                |     |
|  | 2.0          | 93  |  | 01.97 | 11.00 |  |  | 13.2381-0097.2 | 210239 |  |                             |  | D=38           | ATE |
|  | 2.0          | 105 |  | 01.97 | 11.00 |  |  | 13.2381-0098.2 | 210240 |  |                             |  | D=38           | ATE |
|  | 2.0 20V      | 120 |  | 01.97 | 11.00 |  |  | 24.9238-0097.5 | 230037 |  |                             |  | D=38           | ATE |
|  | 2.0 20V      | 132 |  | 01.97 | 11.00 |  |  | 24.9238-0098.5 | 230038 |  |                             |  | D=38           | ATE |
|  | 2.0 T        | 155 |  | 01.97 | 11.00 |  |  | 13.0441-3819.2 | 250072 |  |                             |  | Dichtungssatz  | ATE |
|  | 2.0 T        | 166 |  | 01.97 | 11.00 |  |  |                |        |   |                             |  |                |     |
|  | 2.3          | 195 |  | 04.99 | 09.00 |  |  |                |        |   |                             |  |                |     |
|  | 2.3 T        | 184 |  | 01.97 | 11.00 |  |  |                |        |   |                             |  |                |     |
|  | 2.3 T5       | 176 |  | 01.97 | 11.00 |  |  |                |        |   |                             |  |                |     |
|  | 2.4          | 103 |  | 08.99 | 11.00 |  |  |                |        |   |                             |  |                |     |
|  | 2.4          | 125 |  | 01.97 | 11.00 |  |  |                |        |   |                             |  |                |     |
|  | 2.4 AWD      |     |  | 10.98 | 05.99 |  |  |                |        |   |                             |  |                |     |
|  | 2.4 AWD      | 103 |  | 04.99 | 09.00 |  |  |                |        |   |                             |  |                |     |
|  | 2.4 AWD      | 106 |  | 11.96 | 05.99 |  |  |                |        |   |                             |  |                |     |
|  | 2.4 AWD      | 142 |  | 11.96 | 09.00 |  |  |                |        |   |                             |  |                |     |
|  | 2.4 T        | 142 |  | 01.97 | 11.00 |  |  |                |        |   |                             |  |                |     |
|  | 2.5          | 106 |  | 01.97 | 11.00 |  |  |                |        |   |                             |  |                |     |
|  | 2.5          | 121 |  | 06.98 | 11.00 |  |  |                |        |   |                             |  |                |     |
|  | 2.5 Bifuel   | 103 |  | 07.99 | 11.00 |  |  |                |        |   |                             |  |                |     |
|  | 2.5 Bifuel   | 106 |  | 10.98 | 11.00 |  |  |                |        |   |                             |  |                |     |
|  | 2.5 TDI      | 103 |  | 01.97 | 11.00 |  |  |                |        |   |                             |  |                |     |
|  | 2.5 TDi AWD  | 103 |  | 10.99 | 09.00 |  |  |                |        |   |                             |  |                |     |

<sup>1)</sup> + 15" wheel / + ruota 15" / + roue 15" / + rueda 15"

<sup>2)</sup> + 16" wheel / + ruota 16" / + roue 16" / + rueda 16"

<sup>3)</sup> on the brake caliper / sulla pinza freno / sur l'étrier de frein / a la pinza de freno

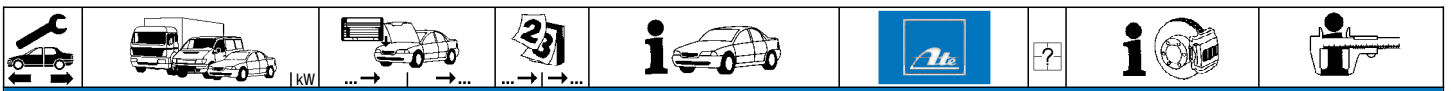

**VOLVO S70 (97-00)**

|              |              |             |             |             |                |        |     |                  |          |
|--------------|--------------|-------------|-------------|-------------|----------------|--------|-----|------------------|----------|
|              | 2.0          | 93          | 587049      | 01.97       | 83.6204-0200.3 | 330306 | 2   |                  | L=200    |
|              | 2.0          | 105         | 587049      | 01.97       |                |        |     |                  |          |
|              | 2.0 20V      | 120         | 587049      | 01.97       |                |        |     |                  |          |
|              | 2.0 20V      | 132         | 587049      | 01.97       |                |        |     |                  |          |
|              | 2.0 T        | 155         | 587049      | 01.97       |                |        |     |                  |          |
|              | 2.0 T        | 166         | 587049      | 01.97       |                |        |     |                  |          |
|              | 2.3          | 195         | 587049      | 04.99       |                |        |     |                  |          |
|              | 2.3 T        | 184         | 587049      | 01.97       |                |        |     |                  |          |
|              | 2.3 T5       | 176         | 587049      | 01.97       |                |        |     |                  |          |
|              | 2.4          | 125         | 587049      | 01.97       |                |        |     |                  |          |
|              | 2.4 AWD      |             | 587049      | 10.98       |                |        |     |                  |          |
|              | 2.4 AWD      | 103         | 587049      | 04.99       |                |        |     |                  |          |
|              | 2.4 AWD      | 106         | 587049      | 11.96       |                |        |     |                  |          |
|              | 2.4 AWD      | 142         | 587049      | 11.96       |                |        |     |                  |          |
|              | 2.4 Blu-Fuel | 103         | 587049      | 07.97       |                |        |     |                  |          |
|              | 2.4 T        | 142         | 587049      | 01.97       |                |        |     |                  |          |
|              | 2.5          | 106         | 587049      | 01.97       |                |        |     |                  |          |
|              | 2.5 TDI      | 103         | 587049      | 01.97       |                |        |     |                  |          |
|              | 2.5 Tdi AWD  | 103         | 587049      | 10.99       |                |        |     |                  |          |
|              |              | 2.0         | 93 587050   |             |                |        |     |                  |          |
| 2.0          |              | 105 587050  |             | 11.00       |                |        |     |                  |          |
| 2.0 20V      |              | 120 587050  |             | 11.00       |                |        |     |                  |          |
| 2.0 20V      |              | 132 587050  |             | 11.00       |                |        |     |                  |          |
| 2.0 T        |              | 155 587050  |             | 11.00       |                |        |     |                  |          |
| 2.0 T        |              | 166 587050  |             | 11.00       |                |        |     |                  |          |
| 2.3          |              | 195 587050  |             | 09.00       |                |        |     |                  |          |
| 2.3 T        |              | 184 587050  |             | 11.00       |                |        |     |                  |          |
| 2.3 T5       |              | 176 587050  |             | 11.00       |                |        |     |                  |          |
| 2.4          |              | 103 587050  |             | 11.00       |                |        |     |                  |          |
| 2.4          |              | 125 587050  |             | 11.00       |                |        |     |                  |          |
| 2.4 AWD      |              | 587050      |             | 05.99       |                |        |     |                  |          |
| 2.4 AWD      |              | 103 587050  |             | 09.00       |                |        |     |                  |          |
| 2.4 AWD      |              | 106 587050  |             | 05.99       |                |        |     |                  |          |
| 2.4 AWD      |              | 142 587050  |             | 09.00       |                |        |     |                  |          |
| 2.4 Blu-Fuel |              | 103 587050  |             | 09.00       |                |        |     |                  |          |
| 2.4 T        |              | 142 587050  |             | 11.00       |                |        |     |                  |          |
| 2.5          |              | 106 587050  |             | 11.00       |                |        |     |                  |          |
| 2.5          |              | 121         | 06.98       | 11.00       |                |        |     |                  |          |
| 2.5 Bifuel   |              | 103         | 07.99       | 11.00       |                |        |     |                  |          |
| 2.5 Bifuel   | 106          | 10.98       | 11.00       |             |                |        |     |                  |          |
| 2.5 TDI      | 103 587050   |             | 11.00       |             |                |        |     |                  |          |
| 2.5 TDi AWD  | 103 587050   |             | 09.00       |             |                |        |     |                  |          |
|              | 2.0          | 93          |             | 01.97 11.00 | 24.3727-1308.2 | 581308 | 2 ↓ |                  | L=1670   |
|              | 2.0          | 105         |             | 01.97 11.00 |                |        |     |                  |          |
|              | 2.0 20V      | 120         |             | 01.97 11.00 |                |        |     |                  |          |
|              | 2.0 20V      | 132         |             | 01.97 11.00 |                |        |     |                  |          |
|              | 2.0 T        | 155         |             | 01.97 11.00 |                |        |     |                  |          |
|              | 2.0 T        | 166         |             | 01.97 11.00 |                |        |     |                  |          |
|              | 2.3          | 195         |             | 04.99 09.00 |                |        |     |                  |          |
|              | 2.3 T        | 184         |             | 01.97 11.00 |                |        |     |                  |          |
|              | 2.3 T5       | 176         |             | 01.97 11.00 |                |        |     |                  |          |
|              | 2.4          | 103         |             | 08.99 11.00 |                |        |     |                  |          |
|              | 2.4          | 125         |             | 01.97 11.00 |                |        |     |                  |          |
|              | 2.4 AWD      |             |             | 10.98 05.99 |                |        |     |                  |          |
|              | 2.4 AWD      | 103         |             | 04.99 09.00 |                |        |     |                  |          |
|              | 2.4 AWD      | 106         |             | 11.96 05.99 |                |        |     |                  |          |
|              | 2.4 AWD      | 142         |             | 11.96 09.00 |                |        |     |                  |          |
|              | 2.4 Blu-Fuel | 103         |             | 07.97 09.00 |                |        |     |                  |          |
|              | 2.4 T        | 142         |             | 01.97 11.00 |                |        |     |                  |          |
|              | 2.5          | 106         |             | 01.97 11.00 |                |        |     |                  |          |
|              | 2.5          | 121         |             | 06.98 11.00 |                |        |     |                  |          |
|              | 2.5 Bifuel   | 103         |             | 07.99 11.00 |                |        |     |                  |          |
| 2.5 Bifuel   | 106          |             | 10.98 11.00 |             |                |        |     |                  |          |
| 2.5 TDI      | 103          |             | 01.97 11.00 |             |                |        |     |                  |          |
| 2.5 TDi AWD  | 103          |             | 10.99 09.00 |             |                |        |     |                  |          |
|              | 2.0          | # 93        | 459999      | 01.97       | 24.2419-0939.3 | 030065 |     | - Rohrleitung 1) | Gz 19,05 |
|              | 2.0          | #105        | 459999      | 01.97       |                |        |     |                  |          |
|              | 2.0 20V      | #120        | 459999      | 01.97       |                |        |     |                  |          |
|              | 2.0 20V      | #132        | 459999      | 01.97       |                |        |     |                  |          |
|              | 2.0 T        | #155        | 459999      | 01.97       |                |        |     |                  |          |
|              | 2.0 T        | #166        | 459999      | 01.97       |                |        |     |                  |          |
|              | 2.3          | #195        | 459999      | 04.99       |                |        |     |                  |          |
|              | 2.3 T        | #184        | 459999      | 01.97       |                |        |     |                  |          |
|              | 2.3 T5       | #176        | 459999      | 01.97       |                |        |     |                  |          |
|              | 2.4          | #125        | 459999      | 01.97       |                |        |     |                  |          |
|              | 2.4 AWD      | #           | 459999      | 10.98       |                |        |     |                  |          |
|              | 2.4 AWD      | #103        | 459999      | 04.99       |                |        |     |                  |          |
|              | 2.4 AWD      | #106        | 459999      | 11.96       |                |        |     |                  |          |
|              | 2.4 AWD      | #142        | 459999      | 11.96       |                |        |     |                  |          |
|              | 2.4 T        | #142        | 459999      | 01.97       |                |        |     |                  |          |
| 2.5          | #106         | 459999      | 01.97       |             |                |        |     |                  |          |
| 2.5 TDI      | #103         | 459999      | 01.97       |             |                |        |     |                  |          |
| 2.5 TDi AWD  | #103         | 459999      | 10.99       |             |                |        |     |                  |          |
|              | 2.0          | # 93 460000 |             | 11.00       | 24.2419-1724.3 | 030113 |     |                  | Gz 19,05 |
|              | 2.0          | #105 460000 |             | 11.00       |                |        |     |                  |          |
|              | 2.0 20V      | #120 460000 |             | 11.00       |                |        |     |                  |          |
|              | 2.0 20V      | #132 460000 |             | 11.00       |                |        |     |                  |          |

1) - pipe line / - tubazione / - conduite rigide / - latiguillo



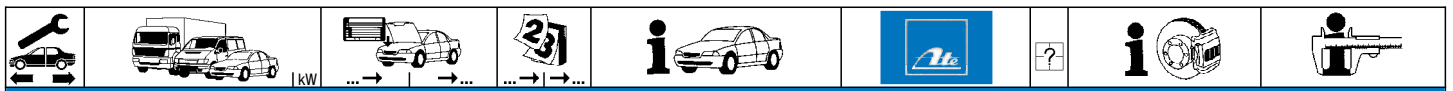

**VOLVO S70 (97-00)**

|  |              |             |        |       |       |                |        |  |  |          |
|--|--------------|-------------|--------|-------|-------|----------------|--------|--|--|----------|
|  | 2.0 T        | #155 460000 |        |       | 11.00 | 24.2419-1724.3 | 030113 |  |  | Gz 19,05 |
|  | 2.0 T        | #166 460000 |        |       | 11.00 |                |        |  |  |          |
|  | 2.3          | #195 460000 |        |       | 09.00 |                |        |  |  |          |
|  | 2.3 T        | #184 460000 |        |       | 12.98 |                |        |  |  |          |
|  | 2.3 T5       | #176 460000 |        |       | 12.98 |                |        |  |  |          |
|  | 2.4          | #103        |        | 08.99 | 11.00 |                |        |  |  |          |
|  | 2.4          | #125 460000 |        |       | 12.98 |                |        |  |  |          |
|  | 2.4 AWD      | # 460000    |        |       | 05.99 |                |        |  |  |          |
|  | 2.4 AWD      | #103 460000 |        |       | 09.00 |                |        |  |  |          |
|  | 2.4 AWD      | #106 460000 |        |       | 05.99 |                |        |  |  |          |
|  | 2.4 AWD      | #142 460000 |        |       | 09.00 |                |        |  |  |          |
|  | 2.4 Blu-Fuel | #103        |        | 07.97 | 09.00 |                |        |  |  |          |
|  | 2.4 T        | #142 460000 |        |       | 12.98 |                |        |  |  |          |
|  | 2.5          | #106 460000 |        |       | 12.98 |                |        |  |  |          |
|  | 2.5          | #121        |        | 06.98 | 11.00 |                |        |  |  |          |
|  | 2.5 Bifuel   | #103        |        | 07.99 | 11.00 |                |        |  |  |          |
|  | 2.5 Bifuel   | #106        |        | 10.98 | 11.00 |                |        |  |  |          |
|  | 2.5 TDI      | #103 460000 |        |       | 12.98 |                |        |  |  |          |
|  | 2.5 TDi AWD  | #103 460000 |        |       | 09.00 |                |        |  |  |          |
|  | 2.0          | 93          | 459999 | 01.97 |       | 24.2522-0907.3 | 040043 |  |  | Nz 22,20 |
|  | 2.0          | 105         | 459999 | 01.97 |       |                |        |  |  |          |
|  | 2.0 20V      | 120         | 459999 | 01.97 |       |                |        |  |  |          |
|  | 2.0 20V      | 132         | 459999 | 01.97 |       |                |        |  |  |          |
|  | 2.3          | 195         | 459999 | 04.99 |       |                |        |  |  |          |
|  | 2.3 T        | 184         | 459999 | 01.97 |       |                |        |  |  |          |
|  | 2.4          | 125         | 459999 | 01.97 |       |                |        |  |  |          |
|  | 2.4 AWD      |             | 459999 | 10.98 |       |                |        |  |  |          |
|  | 2.4 AWD      | 103         | 459999 | 04.99 |       |                |        |  |  |          |
|  | 2.4 AWD      | 106         | 459999 | 11.96 |       |                |        |  |  |          |
|  | 2.4 AWD      | 142         | 459999 | 11.96 |       |                |        |  |  |          |
|  | 2.4 T        | 142         | 459999 | 01.97 |       |                |        |  |  |          |
|  | 2.5          | 106         | 459999 | 01.97 |       |                |        |  |  |          |
|  | 2.5          | 121         | 459999 | 01.97 |       |                |        |  |  |          |
|  | 2.5 TDI      | 103         | 459999 | 01.97 |       |                |        |  |  |          |
|  | 2.5 TDi AWD  | 103         | 459999 | 10.99 |       |                |        |  |  |          |

**VOLVO S80 I (98-06)**

|  |             |             |        |       |       |                |        |        |  |             |     |
|--|-------------|-------------|--------|-------|-------|----------------|--------|--------|--|-------------|-----|
|  | 2.0         | 120         |        | 06.98 | 12.01 | 03.7755-3402.4 | 300189 | - DSTC |  | 9/8" Tandem | ATE |
|  | 2.0 T       | 132         |        | 12.99 | 12.01 |                |        |        |  |             |     |
|  | 2.0 T       | 166         |        | 06.98 | 12.01 |                |        |        |  |             |     |
|  | 2.4         | 103         |        | 01.99 | 12.01 |                |        |        |  |             |     |
|  | 2.4         | 125         |        | 01.99 | 12.01 |                |        |        |  |             |     |
|  | 2.4 Bi-Fuel | 103         |        | 09.01 | 12.01 |                |        |        |  |             |     |
|  | 2.4 D       | 96          |        | 10.01 | 12.01 |                |        |        |  |             |     |
|  | 2.4 D5      | 120         |        | 08.01 | 12.01 |                |        |        |  |             |     |
|  | 2.4 T       | 147         |        | 06.00 | 12.01 |                |        |        |  |             |     |
|  | 2.5 TDI     | 103         |        | 01.99 | 12.01 |                |        |        |  |             |     |
|  | 2.8 T6      | 200         |        | 05.98 | 12.01 |                |        |        |  |             |     |
|  | 2.9         | 147         |        | 03.99 | 12.01 |                |        |        |  |             |     |
|  | 2.9         | 150         |        | 05.98 | 12.01 |                |        |        |  |             |     |
|  | 3.0         | 144         |        | 06.01 | 12.01 |                |        |        |  |             |     |
|  | 3.0 T6      | 200         |        | 06.01 | 12.01 |                |        |        |  |             |     |
|  | 2.0         | 120         |        | 01.02 | 02.06 | 03.7755-4702.4 | 300224 | - DSTC |  | 9/8" Tandem | ATE |
|  | 2.0 T       | 132         |        | 01.02 | 02.06 | 03.7858-3532.4 | 300233 | + DSTC |  | 9/8" Tandem | ATE |
|  | 2.0 T       | 166         |        | 01.02 | 02.06 |                |        |        |  |             |     |
|  | 2.4         | 103         |        | 01.02 | 02.06 |                |        |        |  |             |     |
|  | 2.4         | 125         |        | 01.02 | 02.06 |                |        |        |  |             |     |
|  | 2.4 Bi-Fuel | 103         |        | 01.02 | 02.06 |                |        |        |  |             |     |
|  | 2.4 D       | 96          |        | 01.02 | 02.06 |                |        |        |  |             |     |
|  | 2.4 D5      | 120         |        | 01.02 | 02.06 |                |        |        |  |             |     |
|  | 2.4 T       | 147         |        | 01.02 | 02.06 |                |        |        |  |             |     |
|  | 2.5 T       | 154         |        | 07.03 | 02.06 |                |        |        |  |             |     |
|  | 2.5 TDI     | 103         |        | 01.02 | 02.06 |                |        |        |  |             |     |
|  | 2.8 T6      | 200         |        | 01.02 | 02.06 |                |        |        |  |             |     |
|  | 2.9         | 147         |        | 01.02 | 02.06 |                |        |        |  |             |     |
|  | 2.9         | 150         |        | 01.02 | 02.06 |                |        |        |  |             |     |
|  | 3.0         | 144         |        | 01.02 | 02.06 |                |        |        |  |             |     |
|  | 3.0 T6      | 200         |        | 01.02 | 02.06 |                |        |        |  |             |     |
|  | 2.0         | 120         | 174095 | 06.98 |       | 03.2125-7637.3 | 010707 | - DSTC |  | THz 25,40   | ATE |
|  | 2.0 T       | 166         | 174095 | 06.98 |       | 03.2125-7708.3 | 010739 | + DSTC |  | THz 25,40   | ATE |
|  | 2.4         | 103         | 174095 | 01.99 |       |                |        |        |  |             |     |
|  | 2.4         | 125         | 174095 | 01.99 |       |                |        |        |  |             |     |
|  | 2.5 TDI     | 103         | 174095 | 01.99 |       |                |        |        |  |             |     |
|  | 2.8 T6      | 200         | 174095 | 05.98 |       |                |        |        |  |             |     |
|  | 2.9         | 147         | 174095 | 03.99 |       |                |        |        |  |             |     |
|  | 2.9         | 150         | 174095 | 05.98 |       |                |        |        |  |             |     |
|  | 2.0         | #120 174096 |        |       | 02.06 | 03.2125-7743.3 | 010921 | - DSTC |  | THz 25,40   | ATE |
|  | 2.0 T       | #132        |        | 12.99 | 02.06 | 03.2125-7713.3 | 010819 | + DSTC |  | THz 25,40   | ATE |
|  | 2.0 T       | #166 174096 |        |       | 02.06 |                |        |        |  |             |     |
|  | 2.4         | #103 174096 |        |       | 02.06 |                |        |        |  |             |     |
|  | 2.4         | #125 174096 |        |       | 02.06 |                |        |        |  |             |     |
|  | 2.4 Bi-Fuel | #103        |        | 09.01 | 02.06 |                |        |        |  |             |     |
|  | 2.4 D       | # 96        |        | 10.01 | 02.06 |                |        |        |  |             |     |
|  | 2.4 D5      | #120        |        | 08.01 | 02.06 |                |        |        |  |             |     |
|  | 2.4 T       | #147        |        | 06.00 | 02.06 |                |        |        |  |             |     |
|  | 2.5 T       | #154        |        | 07.03 | 02.06 |                |        |        |  |             |     |
|  | 2.5 TDI     | #103 174096 |        |       | 02.06 |                |        |        |  |             |     |







**VOLVO S80 I (98-06)**

|  |   |   |  |  |  |  |  |  |  |
|--|---|---|--|--|--|--|--|--|--|
|  | 2.8 T6<br>2.9<br>2.9<br>3.0<br>3.0 T6   | #200 174096<br>#147 174096<br>#150 174096<br>#144<br>#200   |  | 02.06<br>02.06<br>02.06<br>02.06<br>02.06  | 03.2125-7743.3<br>03.2125-7713.3   | 010921<br>010819   | - DSTC<br>+ DSTC   | THz 25,40<br>THz 25,40   | ATE<br>ATE   |
|  | 2.0<br>2.0 T<br>2.0 T<br>2.4<br>2.4<br>2.4 Bi-Fuel<br>2.4 D<br>2.4 D5<br>2.4 T<br>2.5 T<br>2.5 TDI<br>2.8 T6<br>2.9<br>2.9<br>3.0<br>3.0 T6 | #120 174096<br>#132<br>#166 174096<br>#103 174096<br>#125 174096<br>#103<br>#96<br>#120<br>#147<br>#154<br>#103 174096<br>#200 174096<br>#147 174096<br>#150 174096<br>#144<br>#200 |  | 02.06<br>02.06<br>02.06<br>02.06<br>02.06<br>02.06<br>02.06<br>02.06<br>02.06<br>02.06<br>02.06<br>02.06<br>02.06<br>02.06<br>02.06<br>02.06   | 03.2125-7638.3   | 010738   |  | THz 25,40  | ATE  |
|  | 2.0<br>2.0 T<br>2.0 T<br>2.4<br>2.4<br>2.4 Bi-Fuel<br>2.4 D<br>2.4 D5<br>2.4 T<br>2.5 T<br>2.5 TDI<br>2.8 T6<br>2.9<br>2.9<br>3.0<br>3.0 T6 | 120<br>132<br>166<br>103<br>125<br>103<br>96<br>120<br>147<br>154<br>103<br>200<br>147<br>150<br>144<br>200   |  | 06.98 02.06<br>12.99 02.06<br>06.98 02.06<br>01.99 02.06<br>01.99 02.06<br>09.01 02.06<br>10.01 02.06<br>08.01 02.06<br>06.00 02.06<br>07.03 02.06<br>01.99 02.06<br>05.98 02.06<br>03.99 02.06<br>05.98 02.06<br>06.01 02.06<br>06.01 02.06 | 11.9601-9829.2<br>11.9601-9830.2<br>24.3601-9829.5<br>24.3601-9830.5<br>11.9571-9863.2<br>11.9571-9864.2<br>11.8116-0366.2<br>11.0101-5407.2<br>11.8171-0008.1 | 220505<br>220506<br>240507<br>240508<br>220513<br>220514<br>390587<br>260011<br>990049 | - 17" Rad 1)<br>- 17" Rad 1)<br>- 17" Rad 1)<br>- 17" Rad 1)<br>+ 17" Rad 2)<br>+ 17" Rad 2)<br>2<br>2 | D=60, - Halter<br>D=60, - Halter<br>D=60, - Halter<br>D=57, - Halter<br>D=57, - Halter<br>Haltefeder<br>Hülsensatz<br>Führungsbolzen | ATE<br>ATE<br>ATE<br>ATE<br>ATE<br>ATE<br>ATE<br>ATE |
|  | 2.0<br>2.0 T<br>2.0 T<br>2.4<br>2.4<br>2.4 Bi-Fuel<br>2.4 D<br>2.4 D5<br>2.4 T<br>2.5 T<br>2.5 TDI<br>2.8 T6<br>2.9<br>2.9<br>3.0<br>3.0 T6 | 120<br>132<br>166<br>103<br>125<br>103<br>96<br>120<br>147<br>154<br>103<br>200<br>147<br>150<br>144<br>200   |  | 06.98 02.06<br>12.99 02.06<br>06.98 02.06<br>01.99 02.06<br>01.99 02.06<br>09.01 02.06<br>10.01 02.06<br>08.01 02.06<br>06.00 02.06<br>07.03 02.06<br>01.99 02.06<br>05.98 02.06<br>03.99 02.06<br>05.98 02.06<br>06.01 02.06<br>06.01 02.06 | 83.6113-0321.3   | 330621   | 2  | L=320  |  |
|  | 2.0<br>2.0 T<br>2.0 T<br>2.4<br>2.4<br>2.4 Bi-Fuel<br>2.4 D<br>2.4 D5<br>2.4 T<br>2.5 T<br>2.5 TDI<br>2.8 T6<br>2.9<br>2.9<br>3.0<br>3.0 T6 | 120<br>132<br>166<br>103<br>125<br>103<br>96<br>120<br>147<br>154<br>103<br>200<br>147<br>150<br>144<br>200   |  | 06.98 02.06<br>12.99 02.06<br>06.98 02.06<br>01.99 02.06<br>01.99 02.06<br>09.01 02.06<br>10.01 02.06<br>08.01 02.06<br>06.00 02.06<br>07.03 02.06<br>01.99 02.06<br>05.98 02.06<br>03.99 02.06<br>05.98 02.06<br>06.01 02.06<br>06.01 02.06 | 11.9421-9979.2<br>11.9421-9980.2<br>24.3421-9979.5<br>24.3421-9980.5<br>11.0101-5407.2<br>11.8171-0008.1<br>11.8116-0236.1                                     | 220497<br>220498<br>240475<br>240476<br>260011<br>990049<br>390507                     | <br><br><br><br><br>2  | D=42, - Halter<br>D=42, - Halter<br>D=42, - Halter<br>D=42, - Halter<br>Hülsensatz<br>Führungsbolzen<br>Haltefeder                   | ATE<br>ATE<br>ATE<br>ATE<br>ATE<br>ATE<br>ATE        |
|  | 2.0<br>2.0 T<br>2.0 T<br>2.4<br>2.4<br>2.4 Bi-Fuel<br>2.4 D<br>2.4 D5<br>2.4 T<br>2.5 T<br>2.5 TDI<br>2.8 T6<br>2.9<br>2.9<br>3.0<br>3.0 T6 | 120<br>132<br>166<br>103<br>125<br>103<br>96<br>120<br>147<br>154<br>103<br>200<br>147<br>150<br>144<br>200   |  | 06.98 02.06<br>12.99 02.06<br>06.98 02.06<br>01.99 02.06<br>01.99 02.06<br>09.01 02.06<br>10.01 02.06<br>08.01 02.06<br>06.00 02.06<br>07.03 02.06<br>01.99 02.06<br>05.98 02.06<br>03.99 02.06<br>05.98 02.06<br>06.01 02.06<br>06.01 02.06 | 83.7724-0268.3   | 331076   | 2  | L=265  |  |

1) - 17" wheel / - ruota 17" / - roue 17" / - rueda 17"  
2) + 17" wheel / + ruota 17" / + roue 17" / + rueda 17"



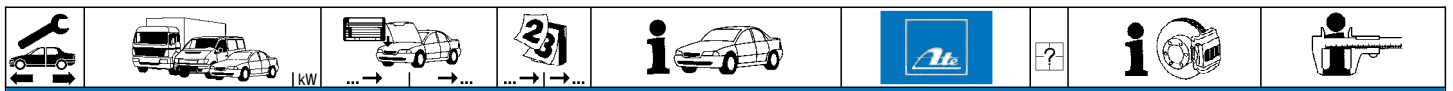

| VOLVO S80 I (98-06) |         |     |  |       |       |                |        |   |   |        |
|---------------------|---------|-----|--|-------|-------|----------------|--------|---|---|--------|
|                     | 2.0     | 120 |  | 06.98 | 02.06 | 24.3727-1312.2 | 581312 | 2 | ↓ | L=1993 |
|                     | 2.0 T   | 132 |  | 12.99 | 02.06 |                |        |   |   |        |
|                     | 2.0 T   | 166 |  | 06.98 | 02.06 |                |        |   |   |        |
|                     | 2.4     | 103 |  | 01.99 | 02.06 |                |        |   |   |        |
|                     | 2.4     | 125 |  | 01.99 | 02.06 |                |        |   |   |        |
|                     | 2.4 D   | 96  |  | 10.01 | 02.06 |                |        |   |   |        |
|                     | 2.4 D5  | 120 |  | 08.01 | 02.06 |                |        |   |   |        |
|                     | 2.4 T   | 147 |  | 06.00 | 02.06 |                |        |   |   |        |
|                     | 2.5 TDI | 103 |  | 01.99 | 02.06 |                |        |   |   |        |
|                     | 2.8 T6  | 200 |  | 05.98 | 02.06 |                |        |   |   |        |
|                     | 2.9     | 147 |  | 03.99 | 02.06 |                |        |   |   |        |
|                     | 2.9     | 150 |  | 05.98 | 02.06 |                |        |   |   |        |
|                     | 3.0     | 144 |  | 06.01 | 02.06 |                |        |   |   |        |
|                     | 3.0 T6  | 200 |  | 06.01 | 02.06 |                |        |   |   |        |

| VOLVO S80 II (06-) |                 |     |        |       |  |                |        |  |  |                                      |                |     |
|--------------------|-----------------|-----|--------|-------|--|----------------|--------|--|--|--------------------------------------|----------------|-----|
|                    | 1.6 D DRIVE     | 107 |        | 01.10 |  | 03.7755-9703.4 | 300239 |  |  | - Kollisionswarnsystem <sup>1)</sup> | 9/8" Tandem    | ATE |
|                    | 2.0             | 107 |        | 09.07 |  |                |        |  |  |                                      |                |     |
|                    | 2.0 D           | 100 |        | 09.07 |  |                |        |  |  |                                      |                |     |
|                    | 2.0 FlexiFuel   | 107 |        | 09.07 |  |                |        |  |  |                                      |                |     |
|                    | 2.0 T           | 149 |        | 01.10 |  |                |        |  |  |                                      |                |     |
|                    | 2.0 TDi         | 100 |        | 02.08 |  |                |        |  |  |                                      |                |     |
|                    | 2.4 D           | 120 |        | 03.06 |  |                |        |  |  |                                      |                |     |
|                    | 2.4 D           | 129 |        | 04.09 |  |                |        |  |  |                                      |                |     |
|                    | 2.4 D5          | 136 |        | 03.06 |  |                |        |  |  |                                      |                |     |
|                    | 2.4 D5          | 151 |        | 11.08 |  |                |        |  |  |                                      |                |     |
|                    | 2.4 D5          | 158 |        | 06.11 |  |                |        |  |  |                                      |                |     |
|                    | 2.4 D5 AWD      | 136 |        | 01.07 |  |                |        |  |  |                                      |                |     |
|                    | 2.4 D5 AWD      | 151 |        | 01.10 |  |                |        |  |  |                                      |                |     |
|                    | 2.4 D5 AWD      | 158 |        | 06.11 |  |                |        |  |  |                                      |                |     |
|                    | 2.5 T           | 147 |        | 03.06 |  |                |        |  |  |                                      |                |     |
|                    | 2.5 T           | 170 |        | 01.10 |  |                |        |  |  |                                      |                |     |
|                    | 2.5 T AWD       | 147 |        | 10.06 |  |                |        |  |  |                                      |                |     |
|                    | 2.5 T FlexFuel  | 147 |        | 04.08 |  |                |        |  |  |                                      |                |     |
|                    | 2.5 T FlexiFuel | 170 |        | 01.10 |  |                |        |  |  |                                      |                |     |
|                    | 3.0 T6 AWD      | 210 |        | 01.07 |  |                |        |  |  |                                      |                |     |
|                    | 3.2             | 107 |        | 03.06 |  |                |        |  |  |                                      |                |     |
|                    | 3.2 AWD         | 107 |        | 01.07 |  |                |        |  |  |                                      |                |     |
|                    | D2              | 84  |        | 04.13 |  |                |        |  |  |                                      |                |     |
|                    | D3              | 120 |        | 01.10 |  |                |        |  |  |                                      |                |     |
|                    | T4              | 132 |        | 10.10 |  |                |        |  |  |                                      |                |     |
|                    | T4F             | 132 |        | 05.11 |  |                |        |  |  |                                      |                |     |
|                    | T6 AWD          | 224 |        | 10.10 |  |                |        |  |  |                                      |                |     |
|                    | 1.6 D DRIVE     | 107 | 151000 | 01.10 |  | 03.7858-5032.4 | 300275 |  |  | + Kollisionswarnsystem <sup>2)</sup> | 9/8" Tandem    | ATE |
|                    | 2.4 D5          | 158 | 151000 | 06.11 |  |                |        |  |  |                                      |                |     |
|                    | 2.4 D5 AWD      | 158 | 151000 | 06.11 |  |                |        |  |  |                                      |                |     |
|                    | 2.5 T           | 170 | 151000 | 01.10 |  |                |        |  |  |                                      |                |     |
|                    | 2.5 T FlexiFuel | 170 | 151000 | 01.10 |  |                |        |  |  |                                      |                |     |
|                    | D2              | 84  | 151000 | 04.13 |  |                |        |  |  |                                      |                |     |
|                    | D3              | 120 | 151000 | 01.10 |  |                |        |  |  |                                      |                |     |
|                    | T4              | 132 | 151000 | 10.10 |  |                |        |  |  |                                      |                |     |
|                    | T4F             | 132 | 151000 | 05.11 |  |                |        |  |  |                                      |                |     |
|                    | T6 AWD          | 224 | 151000 | 10.10 |  |                |        |  |  |                                      |                |     |
|                    | 2.0             | 107 |        | 09.07 |  | 03.7858-4832.4 | 300274 |  |  | + Kollisionswarnsystem <sup>2)</sup> | 9/8" Tandem    | ATE |
|                    | 2.0 D           | 100 |        | 09.07 |  |                |        |  |  |                                      |                |     |
|                    | 2.0 FlexiFuel   | 107 |        | 09.07 |  |                |        |  |  |                                      |                |     |
|                    | 2.0 T           | 149 |        | 01.10 |  |                |        |  |  |                                      |                |     |
|                    | 2.0 TDi         | 100 |        | 02.08 |  |                |        |  |  |                                      |                |     |
|                    | 2.4 D           | 120 |        | 03.06 |  |                |        |  |  |                                      |                |     |
|                    | 2.4 D           | 129 |        | 04.09 |  |                |        |  |  |                                      |                |     |
|                    | 2.4 D5          | 136 |        | 03.06 |  |                |        |  |  |                                      |                |     |
|                    | 2.4 D5          | 151 |        | 11.08 |  |                |        |  |  |                                      |                |     |
|                    | 2.4 D5 AWD      | 136 |        | 01.07 |  |                |        |  |  |                                      |                |     |
|                    | 2.4 D5 AWD      | 151 |        | 01.10 |  |                |        |  |  |                                      |                |     |
|                    | 2.5 T           | 147 |        | 03.06 |  |                |        |  |  |                                      |                |     |
|                    | 2.5 T AWD       | 147 |        | 10.06 |  |                |        |  |  |                                      |                |     |
|                    | 2.5 T FlexFuel  | 147 |        | 04.08 |  |                |        |  |  |                                      |                |     |
|                    | 3.0 T6 AWD      | 210 |        | 01.07 |  |                |        |  |  |                                      |                |     |
|                    | 3.2             | 107 |        | 03.06 |  |                |        |  |  |                                      |                |     |
|                    | 3.2 AWD         | 107 |        | 01.07 |  |                |        |  |  |                                      |                |     |
|                    | T5              | 177 |        | 10.10 |  | 03.7755-9703.4 | 300239 |  |  | - Kollisionswarnsystem <sup>1)</sup> | 9/8" Tandem    | ATE |
|                    |                 |     |        |       |  | 03.7858-5032.4 | 300275 |  |  | + Kollisionswarnsystem <sup>2)</sup> | 9/8" Tandem    | ATE |
|                    |                 |     |        |       |  | 03.7858-4832.4 | 300274 |  |  | + Kollisionswarnsystem <sup>2)</sup> | 9/8" Tandem    | ATE |
|                    | 1.6 D DRIVE     | 107 |        | 01.10 |  | 11.9601-9711.2 | 220873 |  |  | + 16" Rad <sup>3)</sup>              | D=60, - Halter | ATE |
|                    | 2.0             | 107 |        | 09.07 |  | 11.9601-9712.2 | 220874 |  |  | + 16" Rad <sup>3)</sup>              | D=60, - Halter | ATE |
|                    | 2.0 D           | 100 |        | 09.07 |  | 11.0441-6008.2 | 250038 |  |  |                                      | Dichtungssatz  | ATE |
|                    | 2.0 FlexiFuel   | 107 |        | 09.07 |  |                |        |  |  |                                      |                |     |
|                    | 2.0 T           | 149 |        | 01.10 |  |                |        |  |  |                                      |                |     |
|                    | 2.0 TDi         | 100 |        | 02.08 |  |                |        |  |  |                                      |                |     |
|                    | 2.4 D           | 120 |        | 03.06 |  |                |        |  |  |                                      |                |     |
|                    | 2.4 D           | 129 |        | 04.09 |  |                |        |  |  |                                      |                |     |
|                    | 2.4 D5          | 136 |        | 03.06 |  |                |        |  |  |                                      |                |     |
|                    | 2.4 D5          | 151 |        | 11.08 |  |                |        |  |  |                                      |                |     |
|                    | 2.4 D5          | 158 |        | 06.11 |  |                |        |  |  |                                      |                |     |
|                    | 2.4 D5 AWD      | 136 |        | 01.07 |  |                |        |  |  |                                      |                |     |
|                    | 2.4 D5 AWD      | 151 |        | 01.10 |  |                |        |  |  |                                      |                |     |
|                    | 2.4 D5 AWD      | 158 |        | 06.11 |  |                |        |  |  |                                      |                |     |

1) - collision warning system / - sistema anti-collisione / - système anticollision / - sistema anticollisión  
 2) + collision warning system / + sistema anti-collisione / + système anticollision / + sistema anticollisión  
 3) + 16" wheel / + ruota 16" / + roue 16" / + rueda 16"



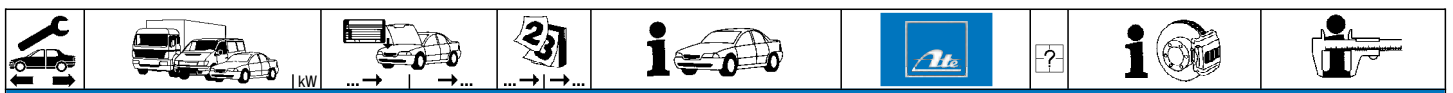

**VOLVO S80 II (06-)**

|            |                 |       |       |                |        |  |   |     |
|------------|-----------------|-------|-------|----------------|--------|--|---|-----|
|            | 2.5 T           | 147   | 03.06 | 11.9601-9711.2 | 220873 | + 16" Rad <sup>1)</sup><br>+ 16" Rad <sup>1)</sup>     | D=60, - Halter<br>D=60, - Halter<br>Dichtungssatz   | ATE |
|            | 2.5 T           | 170   | 01.10 | 11.9601-9712.2 | 220874 |  |   | ATE |
|            | 2.5 T AWD       | 147   | 10.06 | 11.0441-6008.2 | 250038 |  |   | ATE |
|            | 2.5 T FlexFuel  | 147   | 04.08 |                |        |  |   |     |
|            | 2.5 T FlexiFuel | 170   | 01.10 |                |        |  |   |     |
|            | 3.0 T6 AWD      | 210   | 01.07 |                |        |  |   |     |
|            | 3.2             |       | 03.06 |                |        |  |   |     |
|            | 3.2 AWD         |       | 01.07 |                |        |  |   |     |
|            | 4.4 V8 AWD      | 232   | 03.06 |                |        |  |   |     |
|            | D2              | 84    | 04.13 |                |        |  |   |     |
|            | D3              | 120   | 01.10 |                |        |  |   |     |
| T4         | 132             | 10.10 |       |                |        |  |   |     |
| T4F        | 132             | 05.11 |       |                |        |  |   |     |
| T5         | 177             | 10.10 |       |                |        |  |   |     |
| T6 AWD     | 224             | 10.10 |       |                |        |  |   |     |
|            | 1.6 D DRIVE     |       | 01.10 | 11.9606-9949.2 | 220879 | + 17" Rad <sup>2)</sup><br>+ 17" Rad <sup>2)</sup>     | D=60, - Halter<br>D=60, - Halter<br>Haltefeder<br>Dichtungssatz<br>Hülsensatz                   | ATE |
|            | 2.0             | 107   | 09.07 | 11.9606-9950.2 | 220880 |  |   | ATE |
|            | 2.0 D           | 100   | 09.07 | 11.8116-0206.1 | 390593 |  |   | ATE |
|            | 2.0 FlexiFuel   | 107   | 09.07 | 11.0441-6008.2 | 250038 |  |   | ATE |
|            | 2.0 T           | 149   | 01.10 | 11.0101-5704.2 | 260095 |  |   | ATE |
|            | 2.0 TDi         | 100   | 02.08 |                |        |  |   |     |
|            | 2.4 D           | 120   | 03.06 |                |        |  |   |     |
|            | 2.4 D           | 129   | 04.09 |                |        |  |   |     |
|            | 2.4 D5          | 136   | 03.06 |                |        |  |   |     |
|            | 2.4 D5          | 151   | 11.08 |                |        |  |   |     |
|            | 2.4 D5          | 158   | 06.11 |                |        |  |   |     |
|            | 2.4 D5 AWD      | 136   | 01.07 |                |        |  |   |     |
|            | 2.4 D5 AWD      | 151   | 01.10 |                |        |  |   |     |
|            | 2.4 D5 AWD      | 158   | 06.11 |                |        |  |   |     |
|            | 2.5 T           | 147   | 03.06 |                |        |  |   |     |
|            | 2.5 T           | 170   | 01.10 |                |        |  |   |     |
|            | 2.5 T AWD       | 147   | 10.06 |                |        |  |   |     |
|            | 2.5 T FlexFuel  | 147   | 04.08 |                |        |  |   |     |
|            | 2.5 T FlexiFuel | 170   | 01.10 |                |        |  |   |     |
|            | 3.0 T6 AWD      | 210   | 01.07 |                |        |  |   |     |
|            | 3.2             |       | 03.06 |                |        |  |   |     |
|            | 3.2 AWD         |       | 01.07 |                |        |  |   |     |
|            | 4.4 V8 AWD      | 232   | 03.06 |                |        |  |   |     |
|            | D2              | 84    | 04.13 |                |        |  |   |     |
| D3         | 120             | 01.10 |       |                |        |  |   |     |
| T4         | 132             | 10.10 |       |                |        |  |   |     |
| T4F        | 132             | 05.11 |       |                |        |  |   |     |
| T5         | 177             | 10.10 |       |                |        |  |   |     |
| T6 AWD     | 224             | 10.10 |       |                |        |  |   |     |
|            | 1.6 D DRIVE     |       | 01.10 | 11.9606-9945.2 | 220727 | + 18" Rad <sup>3)</sup><br>+ 18" Rad <sup>3)</sup>     | D=60, - Halter<br>D=60, - Halter<br>Haltefeder<br>Hülsensatz<br>Führungsbolzen<br>Dichtungssatz | ATE |
|            | 2.0             | 107   | 09.07 | 11.9606-9946.2 | 220728 |  |   | ATE |
|            | 2.0 D           | 100   | 09.07 | 11.8116-0388.2 | 390588 |  |   | ATE |
|            | 2.0 FlexiFuel   | 107   | 09.07 | 11.0101-5704.2 | 260095 |  |   | ATE |
|            | 2.0 T           | 149   | 01.10 | 11.8171-0008.1 | 990049 |  |   | ATE |
|            | 2.0 TDi         | 100   | 02.08 | 11.0441-6008.2 | 250038 |  |   | ATE |
|            | 2.4 D           | 120   | 03.06 |                |        |  |   |     |
|            | 2.4 D           | 129   | 04.09 |                |        |  |   |     |
|            | 2.4 D5          | 136   | 03.06 |                |        |  |   |     |
|            | 2.4 D5          | 151   | 11.08 |                |        |  |   |     |
|            | 2.4 D5          | 158   | 06.11 |                |        |  |   |     |
|            | 2.4 D5 AWD      | 136   | 01.07 |                |        |  |   |     |
|            | 2.4 D5 AWD      | 151   | 01.10 |                |        |  |   |     |
|            | 2.4 D5 AWD      | 158   | 06.11 |                |        |  |   |     |
|            | 2.5 T           | 147   | 03.06 |                |        |  |   |     |
|            | 2.5 T           | 170   | 01.10 |                |        |  |   |     |
|            | 2.5 T AWD       | 147   | 10.06 |                |        |  |   |     |
|            | 2.5 T FlexFuel  | 147   | 04.08 |                |        |  |   |     |
|            | 2.5 T FlexiFuel | 170   | 01.10 |                |        |  |   |     |
|            | 3.0 T6 AWD      | 210   | 01.07 |                |        |  |   |     |
|            | 3.2             |       | 03.06 |                |        |  |   |     |
|            | 3.2 AWD         |       | 01.07 |                |        |  |   |     |
|            | 4.4 V8 AWD      | 232   | 03.06 |                |        |  |   |     |
|            | D2              | 84    | 04.13 |                |        |  |   |     |
| D3         | 120             | 01.10 |       |                |        |  |   |     |
| T4         | 132             | 10.10 |       |                |        |  |   |     |
| T4F        | 132             | 05.11 |       |                |        |  |   |     |
| T5         | 177             | 10.10 |       |                |        |  |   |     |
| T6 AWD     | 224             | 10.10 |       |                |        |  |   |     |
|            | 1.6 D DRIVE     |       | 01.10 | 24.5162-0390.3 | 331199 | + 16" Rad <sup>1)</sup><br>+ 17"/18" Rad <sup>4)</sup> | L=390<br>L=375  |     |
|            | 2.0             | 107   | 09.07 | 24.5162-0375.3 | 331203 |  |   |     |
|            | 2.0 D           | 100   | 09.07 |                |        |  |   |     |
|            | 2.0 FlexiFuel   | 107   | 09.07 |                |        |  |   |     |
|            | 2.0 T           | 149   | 01.10 |                |        |  |   |     |
|            | 2.0 TDi         | 100   | 02.08 |                |        |  |   |     |
|            | 2.4 D           | 120   | 03.06 |                |        |  |   |     |
|            | 2.4 D           | 129   | 04.09 |                |        |  |   |     |
|            | 2.4 D5          | 136   | 03.06 |                |        |  |   |     |
|            | 2.4 D5          | 151   | 11.08 |                |        |  |   |     |
|            | 2.4 D5          | 158   | 06.11 |                |        |  |   |     |
| 2.4 D5 AWD | 136             | 01.07 |       |                |        |  |   |     |
| 2.4 D5 AWD | 151             | 01.10 |       |                |        |  |   |     |
| 2.4 D5 AWD | 158             | 06.11 |       |                |        |  |   |     |

<sup>1)</sup> + 16" wheel / + ruota 16" / + roue 16" / + rueda 16"

<sup>2)</sup> + 17" wheel / + ruota 17" / + roue 17" / + rueda 17"

<sup>3)</sup> + 18" wheel / + ruota 18" / + roue 18" / + rueda 18"

<sup>4)</sup> + 17"/18" wheel / + ruota 17"/18" / + roue 17"/18" / + rueda 17"/18"

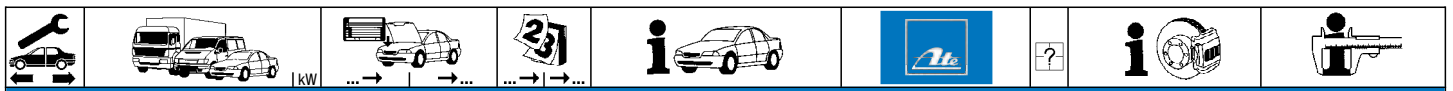

**VOLVO S80 II (06-)**

|                |                 |             |       |       |                |        |   |   |       |
|----------------|-----------------|-------------|-------|-------|----------------|--------|---|---|-------|
|                | 2.5 T           | 147         |       | 03.06 | 24.5162-0390.3 | 331199 | 2 | + 16" Rad <sup>1)</sup>                     | L=390 |
|                | 2.5 T           | 170         |       | 01.10 |                |        |   |   |       |
|                | 2.5 T AWD       | 147         |       | 10.06 |                |        |   |   |       |
|                | 2.5 T FlexFuel  | 147         |       | 04.08 |                |        |   |   |       |
|                | 2.5 T FlexiFuel | 170         |       | 01.10 |                |        |   |   |       |
|                | 3.0 T6 AWD      | 210         |       | 01.07 |                |        |   |   |       |
|                | 3.2             |             |       | 03.06 |                |        |   |   |       |
|                | 3.2 AWD         |             |       | 01.07 |                |        |   |   |       |
|                | 4.4 V8 AWD      | 232         |       | 03.06 |                |        |   |   |       |
|                | D2              | 84          |       | 04.13 |                |        |   |   |       |
|                | D3              | 120         |       | 01.10 |                |        |   |   |       |
|                | T4              | 132         |       | 10.10 |                |        |   |   |       |
|                | T4F             | 132         |       | 05.11 |                |        |   |   |       |
|                | T5              | 177         |       | 10.10 |                |        |   |   |       |
| T6 AWD         | 224             |             | 10.10 |       |                |        |   |   |       |
|                | 1.6 D DRIVE     |             |       | 01.10 | 24.5162-0185.3 | 331202 | 2 | + mechanische Feststellbremse <sup>3)</sup> | L=185 |
|                | 2.0             | 107         |       | 09.07 |                |        |   |   |       |
|                | 2.0 D           | 100         |       | 09.07 |                |        |   |   |       |
|                | 2.0 FlexiFuel   | 107         |       | 09.07 |                |        |   |   |       |
|                | 2.0 T           | 149         |       | 01.10 |                |        |   |   |       |
|                | 2.0 TDi         | 100         |       | 02.08 |                |        |   |   |       |
|                | 2.4 D           | 120         |       | 03.06 |                |        |   |   |       |
|                | 2.4 D           | 129         |       | 04.09 |                |        |   |   |       |
|                | 2.4 D5          | 136         |       | 03.06 |                |        |   |   |       |
|                | 2.4 D5          | 151         |       | 11.08 |                |        |   |   |       |
|                | 2.4 D5          | 158         |       | 06.11 |                |        |   |   |       |
|                | 2.4 D5 AWD      | 136         |       | 01.07 |                |        |   |   |       |
|                | 2.4 D5 AWD      | 151         |       | 01.10 |                |        |   |   |       |
|                | 2.4 D5 AWD      | 158         |       | 06.11 |                |        |   |   |       |
|                | 2.5 T           | 170         |       | 01.10 |                |        |   |   |       |
|                | 2.5 T AWD       | 147         |       | 10.06 |                |        |   |   |       |
|                | 2.5 T AWD       | 147         |       | 03.06 |                |        |   |   |       |
|                | 2.5 T FlexFuel  | 147         |       | 04.08 |                |        |   |   |       |
|                | 2.5 T FlexiFuel | 170         |       | 01.10 |                |        |   |   |       |
|                | 3.0 T6 AWD      | 210         |       | 01.07 |                |        |   |   |       |
|                | 3.2             |             |       | 03.06 |                |        |   |   |       |
|                | 3.2 AWD         |             |       | 01.07 |                |        |   |   |       |
|                | 4.4 V8 AWD      | 232         |       | 03.06 |                |        |   |   |       |
|                | D2              | 84          |       | 04.13 |                |        |   |   |       |
|                | D3              | 120         |       | 01.10 |                |        |   |   |       |
|                | T4              | 132         |       | 10.10 |                |        |   |   |       |
|                | T4F             | 132         |       | 05.11 |                |        |   |   |       |
|                | T5              | 177         |       | 10.10 |                |        |   |   |       |
|                | T6 AWD          | 224         |       | 10.10 |                |        |   |   |       |
|                |                 | 1.6 D DRIVE | ‡     | 36584 |                |        |   |   |       |
| 2.0            |                 | ‡107        | 36584 | 09.07 |                |        |   |   |       |
| 2.0 D          |                 | ‡100        | 36584 | 09.07 |                |        |   |   |       |
| 2.0 FlexiFuel  |                 | ‡107        | 36584 | 09.07 |                |        |   |   |       |
| 2.0 T          |                 | ‡149        | 36584 | 01.10 |                |        |   |   |       |
| 2.0 TDi        |                 | ‡100        | 36584 | 02.08 |                |        |   |   |       |
| 2.4 D          |                 | ‡120        | 36584 | 03.06 |                |        |   |   |       |
| 2.4 D          |                 | ‡129        | 36584 | 04.09 |                |        |   |   |       |
| 2.4 D5         |                 | ‡136        | 36584 | 03.06 |                |        |   |   |       |
| 2.4 D5         |                 | ‡151        | 36584 | 11.08 |                |        |   |   |       |
| 2.4 D5 AWD     |                 | ‡136        | 36584 | 01.07 |                |        |   |   |       |
| 2.4 D5 AWD     |                 | ‡151        | 36584 | 01.10 |                |        |   |   |       |
| 2.5 T          |                 | ‡147        | 36584 | 03.06 |                |        |   |   |       |
| 2.5 T          |                 | ‡170        | 36584 | 01.10 |                |        |   |   |       |
| 2.5 T AWD      |                 | ‡147        | 36584 | 10.06 |                |        |   |   |       |
| 2.5 T FlexFuel |                 | ‡147        | 36584 | 04.08 |                |        |   |   |       |
| 3.0 T6 AWD     |                 | ‡210        | 36584 | 01.07 |                |        |   |   |       |
| 3.2            | ‡               | 36584       | 03.06 |       |                |        |   |   |       |
| 3.2 AWD        | ‡               | 36584       | 01.07 |       |                |        |   |   |       |
| D3             | ‡120            | 36584       | 01.10 |       |                |        |   |   |       |
|                | 1.6 D DRIVE     |             | 66719 | 01.10 | 24.5133-0310.3 | 331197 | ☑ | + elektrische Feststellbremse <sup>4)</sup> | L=310 |
|                | 2.0             | 107         | 66719 | 09.07 |                |        |   |   |       |
|                | 2.0 D           | 100         | 66719 | 09.07 |                |        |   |   |       |
|                | 2.0 FlexiFuel   | 107         | 66719 | 09.07 |                |        |   |   |       |
|                | 2.0 T           | 149         | 66719 | 01.10 |                |        |   |   |       |
|                | 2.0 TDi         | 100         | 66719 | 02.08 |                |        |   |   |       |
|                | 2.4 D           | 120         | 66719 | 03.06 |                |        |   |   |       |
|                | 2.4 D           | 129         | 66719 | 04.09 |                |        |   |   |       |
|                | 2.4 D5          | 136         | 66719 | 03.06 |                |        |   |   |       |
|                | 2.4 D5          | 151         | 66719 | 11.08 |                |        |   |   |       |
|                | 2.4 D5          | 158         | 66719 | 06.11 |                |        |   |   |       |
|                | 2.4 D5 AWD      | 136         | 66719 | 01.07 |                |        |   |   |       |
|                | 2.4 D5 AWD      | 151         | 66719 | 01.10 |                |        |   |   |       |
|                | 2.4 D5 AWD      | 158         | 66719 | 06.11 |                |        |   |   |       |
|                | 2.5 T           | 147         | 66719 | 03.06 |                |        |   |   |       |
|                | 2.5 T           | 170         | 66719 | 01.10 |                |        |   |   |       |
|                | 2.5 T           | 170         | 66719 | 01.10 |                |        |   |   |       |
|                | 2.5 T AWD       | 147         | 66719 | 10.06 |                |        |   |   |       |
|                | 2.5 T FlexFuel  | 147         | 66719 | 04.08 |                |        |   |   |       |
|                | 2.5 T FlexiFuel | 170         | 66719 | 01.10 |                |        |   |   |       |
| 3.0 T6 AWD     | 210             | 66719       | 01.07 |       |                |        |   |   |       |
| 3.2            |                 | 66719       | 03.06 |       |                |        |   |   |       |
| 3.2 AWD        |                 | 66719       | 01.07 |       |                |        |   |   |       |

<sup>1)</sup> + 16" wheel / + ruota 16" / + roue 16" / + rueda 16"

<sup>2)</sup> + 17"/18" wheel / + ruota 17"/18" / + roue 17"/18" / + rueda 17"/18"

<sup>3)</sup> + mechanical parking brake / + fr. stazionamento meccanico / + frein à main mécanique / + freno de mano mecánica

<sup>4)</sup> + electric parking brake / + freno a mano elettrico / + frein à main électrique / + freno de mano eléctrico



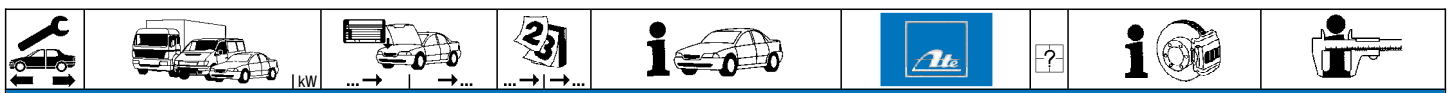

| VOLVO S80 II (06-) |                 |           |        |       |  |                |        |                          |   |       |
|--------------------|-----------------|-----------|--------|-------|--|----------------|--------|--------------------------|---|-------|
|                    | 4.4 V8 AWD      | 232       | 66719  | 03.06 |  | 24.5133-0310.3 | 331197 | <input type="checkbox"/> | + elektrische Feststellbremse <sup>1)</sup> | L=310 |
|                    | D2              | 84        | 66719  | 04.13 |  |                |        |                          |   |       |
|                    | D3              | 120       | 66719  | 01.10 |  |                |        |                          |   |       |
|                    | T4              | 132       | 66719  | 10.10 |  |                |        |                          |   |       |
|                    | T4F             | 132       | 66719  | 05.11 |  |                |        |                          |   |       |
|                    | T5              | 177       | 66719  | 10.10 |  |                |        |                          |   |       |
|                    | T6 AWD          | 224       | 66719  | 10.10 |  |                |        |                          |   |       |
|                    | 1.6 D DRIVE     | 66720     | 115163 |       |  | 24.5133-0311.3 | 331198 | <input type="checkbox"/> | + elektrische Feststellbremse <sup>1)</sup> | L=310 |
|                    | 2.0             | 107 66720 | 115163 |       |  |                |        |                          |   |       |
|                    | 2.0 D           | 100 66720 | 115163 |       |  |                |        |                          |   |       |
|                    | 2.0 FlexiFuel   | 107 66720 | 115163 |       |  |                |        |                          |   |       |
|                    | 2.0 T           | 149 66720 | 115163 |       |  |                |        |                          |   |       |
|                    | 2.0 Tdi         | 100 66720 | 115163 |       |  |                |        |                          |   |       |
|                    | 2.4 D           | 120 66720 | 115163 |       |  |                |        |                          |   |       |
|                    | 2.4 D           | 129 66720 | 115163 |       |  |                |        |                          |   |       |
|                    | 2.4 D5          | 136 66720 | 115163 |       |  |                |        |                          |   |       |
|                    | 2.4 D5          | 151 66720 | 115163 |       |  |                |        |                          |   |       |
|                    | 2.4 D5          | 158 66720 | 115163 |       |  |                |        |                          |   |       |
|                    | 2.4 D5 AWD      | 136 66720 | 115163 |       |  |                |        |                          |   |       |
|                    | 2.4 D5 AWD      | 151 66720 | 115163 |       |  |                |        |                          |   |       |
|                    | 2.4 D5 AWD      | 158 66720 | 115163 |       |  |                |        |                          |   |       |
|                    | 2.5 T           | 147 66720 | 115163 |       |  |                |        |                          |   |       |
|                    | 2.5 T           | 170 66720 | 115163 |       |  |                |        |                          |   |       |
|                    | 2.5 T AWD       | 147 66720 | 115163 |       |  |                |        |                          |   |       |
|                    | 2.5 T FlexFuel  | 147 66720 | 115163 |       |  |                |        |                          |   |       |
|                    | 2.5 T FlexiFuel | 170 66720 | 115163 |       |  |                |        |                          |   |       |
|                    | 3.0 T6 AWD      | 210 66720 | 115163 |       |  |                |        |                          |   |       |
|                    | 3.2             | 66720     | 115163 |       |  |                |        |                          |   |       |
|                    | 3.2 AWD         | 66720     | 115163 |       |  |                |        |                          |   |       |
|                    | 4.4 V8 AWD      | 232 66720 | 115163 |       |  |                |        |                          |   |       |
|                    | D2              | 84 66720  | 115163 |       |  |                |        |                          |   |       |
|                    | D3              | 120 66720 | 115163 |       |  |                |        |                          |   |       |
|                    | T4              | 132 66720 | 115163 |       |  |                |        |                          |   |       |
|                    | T4F             | 132 66720 | 115163 |       |  |                |        |                          |   |       |
|                    | T5              | 177 66720 | 115163 |       |  |                |        |                          |   |       |
|                    | T6 AWD          | 224 66720 | 115163 |       |  |                |        |                          |   |       |

| VOLVO S90 (97-98) |     |      |  |       |       |                |        |                          |  |                          |
|-------------------|-----|------|--|-------|-------|----------------|--------|--------------------------|--|--------------------------|
|                   | 2.5 | 125  |  | 11.96 | 10.98 | 03.2023-0875.3 | 010890 |                          |  | THz 23,81/20,64 - B. ATE |
|                   | 2.5 | 132  |  | 11.96 | 10.97 |                |        |                          |  |                          |
|                   | 2.9 | 132  |  | 01.97 | 05.98 |                |        |                          |  |                          |
|                   | 2.9 | 150  |  | 01.97 | 05.98 |                |        |                          |  |                          |
|                   | 2.5 | 125  |  | 11.96 | 10.98 | 24.3571-1707.5 | 240079 | <input type="checkbox"/> |  | D=57, - Halter LUC       |
|                   | 2.5 | 132  |  | 11.96 | 10.97 | 24.3571-1708.5 | 240080 | <input type="checkbox"/> |  | D=57, - Halter LUC       |
|                   | 2.9 | 132  |  | 01.97 | 05.98 | 24.0101-3601.2 | 260044 |                          |  | Einbausatz LUC           |
|                   | 2.9 | 150  |  | 01.97 | 05.98 |                |        |                          |  |                          |
|                   | 2.5 | 125  |  | 11.96 | 10.98 | 83.6124-0380.3 | 330268 | 2                        |  | L=380                    |
|                   | 2.5 | 132  |  | 11.96 | 10.97 |                |        |                          |  |                          |
|                   | 2.9 | 132  |  | 01.97 | 05.98 |                |        |                          |  |                          |
|                   | 2.9 | 150  |  | 01.97 | 05.98 |                |        |                          |  |                          |
|                   | 2.5 | 125  |  | 11.96 | 10.98 | 83.6134-0300.3 | 330725 | 2                        |  | L=300                    |
|                   | 2.5 | 132  |  | 11.96 | 10.97 |                |        |                          |  |                          |
|                   | 2.9 | 132  |  | 01.97 | 05.98 |                |        |                          |  |                          |
|                   | 2.9 | 150  |  | 01.97 | 05.98 |                |        |                          |  |                          |
|                   | 2.5 | 125  |  | 11.96 | 10.98 | 03.6055-0430.3 | 320065 |                          |  | BR 5/25 (4) ATE          |
|                   | 2.5 | 132  |  | 11.96 | 10.97 |                |        |                          |  |                          |
|                   | 2.9 | 132  |  | 01.97 | 05.98 |                |        |                          |  |                          |
|                   | 2.9 | 150  |  | 01.97 | 05.98 |                |        |                          |  |                          |
|                   | 2.5 | #125 |  | 11.96 | 10.98 | 24.2419-0941.3 | 030067 |                          |  | Gz 19,05                 |
|                   | 2.5 | #132 |  | 11.96 | 10.97 |                |        |                          |  |                          |
|                   | 2.9 | #132 |  | 01.97 | 05.98 |                |        |                          |  |                          |
|                   | 2.9 | #150 |  | 01.97 | 05.98 |                |        |                          |  |                          |
|                   | 2.5 | #125 |  | 11.96 | 10.98 | 24.2419-0928.3 | 030056 |                          |  | Gz 19,05                 |
|                   | 2.5 | #132 |  | 11.96 | 10.97 |                |        |                          |  |                          |
|                   | 2.9 | #132 |  | 01.97 | 05.98 |                |        |                          |  |                          |
|                   | 2.9 | #150 |  | 01.97 | 05.98 |                |        |                          |  |                          |
|                   | 2.5 | 125  |  | 11.96 | 10.98 | 03.2522-0420.3 | 040086 |                          |  | Nz 22,20                 |
|                   | 2.5 | 132  |  | 11.96 | 10.97 |                |        |                          |  |                          |
|                   | 2.9 | 132  |  | 01.97 | 05.98 |                |        |                          |  |                          |
|                   | 2.9 | 150  |  | 01.97 | 05.98 |                |        |                          |  |                          |

| VOLVO V40 (95-04) |              |     |  |       |       |                |        |  |  |           |
|-------------------|--------------|-----|--|-------|-------|----------------|--------|--|--|-----------|
|                   | 1.6          | 77  |  | 12.95 | 08.97 | 24.2122-1718.3 | 010517 |  |  | THz 22,20 |
|                   | 1.8 (1731)   | 85  |  | 07.95 | 08.97 |                |        |  |  |           |
|                   | 1.9 T4       | 147 |  | 05.97 | 08.97 |                |        |  |  |           |
|                   | 1.9 TD       | 66  |  | 07.95 | 08.97 |                |        |  |  |           |
|                   | 2.0          | 100 |  | 07.95 | 08.97 |                |        |  |  |           |
|                   | 2.0          | 103 |  | 07.95 | 08.97 |                |        |  |  |           |
|                   | 1.6          | 77  |  | 09.97 | 08.99 | 24.2123-1746.3 | 010682 |  |  | THz 23,81 |
|                   | 1.6          | 80  |  | 03.99 | 07.04 |                |        |  |  |           |
|                   | 1.8 (1731)   | 85  |  | 09.97 | 08.99 |                |        |  |  |           |
|                   | 1.8 (1783)   | 90  |  | 03.99 | 07.04 |                |        |  |  |           |
|                   | 1.8 i (1834) | 90  |  | 06.01 | 07.04 |                |        |  |  |           |
|                   | 1.8 i (1834) | 92  |  | 03.98 | 07.04 |                |        |  |  |           |
|                   | 1.9 DI       | 70  |  | 03.99 | 07.00 |                |        |  |  |           |
|                   | 1.9 DI       | 75  |  | 07.00 | 07.04 |                |        |  |  |           |

<sup>1)</sup> + electric parking brake / + freno a mano elettrico / + frein à main électrique / + freno de mano eléctrico



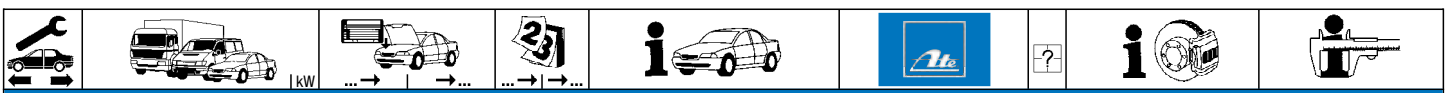

**VOLVO V40 (95-04)**

|  |   |   |  |   |   |                                  |                  |   |  |                                  |            |
|--|---|---|--|---|---|----------------------------------|------------------|---|--|----------------------------------|------------|
|  | 1.9 DI<br>1.9 T4<br>1.9 TD<br>2.0<br>2.0<br>2.0 T<br>2.0 T<br>2.0 T<br>2.0 T4   | 85<br>147<br>66<br>100<br>103<br>118<br>120<br>121<br>147   |  | 07.00<br>09.97<br>09.97<br>09.97<br>09.97<br>10.97<br>06.01<br>07.00<br>07.00   | 07.04<br>07.00<br>08.99<br>07.04<br>08.99<br>07.00<br>07.04<br>06.01<br>04.04   | 24.2123-1746.3                   | 010682           |   |  | THz 23,81                        |            |
|  | 1.6<br>1.8 (1731)<br>1.9 T4<br>1.9 TD<br>2.0<br>2.0   | 77<br>85<br>147<br>66<br>100<br>103   |  | 12.95<br>07.95<br>05.97<br>07.95<br>07.95<br>07.95  | 08.97<br>08.97<br>08.97<br>08.97<br>08.97<br>08.97  | 24.3541-1783.5<br>24.3541-1784.5 | 240269<br>240270 |   |  | D=54, - Halter<br>D=54, - Halter | LUC<br>LUC |
|  | 1.6<br>1.6<br>1.8 (1731)<br>1.8 (1783)<br>1.8 i (1834)<br>1.8 i (1834)<br>1.9 DI<br>1.9 DI<br>1.9 DI<br>1.9 T4<br>1.9 TD<br>2.0<br>2.0<br>2.0 T<br>2.0 T<br>2.0 T<br>2.0 T4 | 77<br>80<br>85<br>90<br>90<br>92<br>70<br>75<br>85<br>147<br>66<br>100<br>103<br>118<br>120<br>121<br>147 |  | 09.97<br>03.99<br>09.97<br>03.99<br>06.01<br>03.98<br>03.99<br>07.00<br>07.00<br>09.97<br>09.97<br>09.97<br>10.97<br>06.01<br>07.00<br>07.00          | 08.99<br>07.04<br>08.99<br>07.04<br>07.04<br>07.04<br>07.00<br>07.04<br>07.04<br>07.00<br>08.99<br>07.04<br>08.99<br>07.00<br>07.04<br>06.01<br>04.04 | 24.3541-1785.5<br>24.3541-1786.5 | 240271<br>240272 |   |  | D=54, - Halter<br>D=54, - Halter | LUC<br>LUC |
|  | 1.6<br>1.6<br>1.8 (1731)<br>1.8 (1783)<br>1.8 i (1834)<br>1.8 i (1834)<br>1.9 DI<br>1.9 DI<br>1.9 DI<br>1.9 T4<br>1.9 TD<br>2.0<br>2.0<br>2.0 T<br>2.0 T<br>2.0 T<br>2.0 T4 | 77<br>80<br>85<br>90<br>90<br>92<br>70<br>75<br>85<br>147<br>66<br>100<br>103<br>118<br>120<br>121<br>147 |  | 12.95<br>03.99<br>07.95<br>03.99<br>06.01<br>03.98<br>03.99<br>07.00<br>07.00<br>05.97<br>07.95<br>07.95<br>07.95<br>10.97<br>06.01<br>07.00<br>07.00 | 08.99<br>07.04<br>08.99<br>07.04<br>07.04<br>07.04<br>07.00<br>07.04<br>07.04<br>07.00<br>08.99<br>07.04<br>08.99<br>07.00<br>07.04<br>06.01<br>04.04 | 24.5248-0461.3                   | 330707           | 2 |  | L=461                            |            |
|  | 1.6<br>1.8 (1731)<br>1.9 T4<br>1.9 TD<br>2.0<br>2.0 T   | 77<br>85<br>147<br>66<br>100<br>118   | 426760<br>426760<br>426760<br>426760<br>426760<br>426760   | 12.95<br>07.95<br>05.97<br>07.95<br>07.95<br>10.97  | 08.99<br>08.99<br>08.99<br>08.99<br>08.99<br>08.99  | 24.3384-1721.5<br>24.3384-1722.5 | 240255<br>240256 |   |  | D=38, - Halter<br>D=38, - Halter | LUC<br>LUC |
|  | 1.6<br>1.6<br>1.8 (1731)<br>1.8 (1783)<br>1.8 i (1834)<br>1.8 i (1834)<br>1.9 DI<br>1.9 DI<br>1.9 DI<br>1.9 T4<br>1.9 TD<br>2.0<br>2.0<br>2.0 T<br>2.0 T<br>2.0 T<br>2.0 T4 | 77<br>80<br>85<br>90<br>90<br>92<br>70<br>75<br>85<br>147<br>66<br>100<br>103<br>118<br>120<br>121<br>147 | 426761<br>426761<br>426761<br>426761<br>426761<br>426761<br>426761<br>426761<br>426761<br>426761<br>426761<br>426761<br>426761<br>426761<br>426761<br>426761 | 12.95<br>03.99<br>03.99<br>06.01<br>03.98<br>03.99<br>07.00<br>07.00<br>07.00<br>05.97<br>07.95<br>07.95<br>07.95<br>10.97<br>06.01<br>07.00<br>07.00 | 08.99<br>07.04<br>08.99<br>07.04<br>07.04<br>07.04<br>07.00<br>07.04<br>07.04<br>07.00<br>08.99<br>07.04<br>08.99<br>07.00<br>07.04<br>06.01<br>04.04 | 24.3384-1743.5<br>24.3384-1744.5 | 240319<br>240320 |   |  | D=38, - Halter<br>D=38, - Halter | LUC<br>LUC |
|  | 1.6<br>1.6<br>1.8 (1731)<br>1.8 (1783)<br>1.8 i (1834)<br>1.8 i (1834)<br>1.9 DI<br>1.9 DI<br>1.9 DI<br>1.9 T4<br>1.9 TD<br>2.0<br>2.0<br>2.0 T<br>2.0 T<br>2.0 T           | 77<br>80<br>85<br>90<br>90<br>92<br>70<br>75<br>85<br>147<br>66<br>100<br>103<br>118<br>120               |  | 12.95<br>03.99<br>07.95<br>03.99<br>06.01<br>03.98<br>03.99<br>07.00<br>07.00<br>05.97<br>07.95<br>07.95<br>07.95<br>10.97<br>06.01                   | 08.99<br>07.04<br>08.99<br>07.04<br>07.04<br>07.04<br>07.00<br>07.04<br>07.04<br>07.00<br>08.99<br>07.04<br>08.99<br>07.00<br>07.04                   | 24.5249-0416.3                   | 330708           | 2 |  | L=416                            |            |





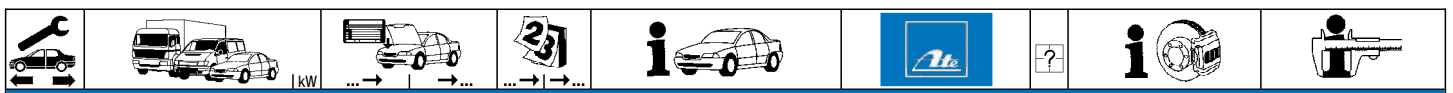

| VOLVO V40 (95-04) |  |  |  |   |  |  |  |  |  |  |   |
|-------------------|--|--|--|---|--|--|--|--|--|--|---|
|                   | 2.0 T<br>2.0 T4  | 121<br>147   |  | 07.00<br>07.00  | 06.01<br>04.04   |  | 24.5249-0416.3   | 330708   | 2  | L=416  |   |
|                   | 1.6<br>1.6<br>1.8 (1731)<br>1.8 (1783)<br>1.8 i (1834)<br>1.8 i (1834)<br>1.9 DI<br>1.9 DI<br>1.9 DI<br>1.9 T4<br>1.9 TD<br>2.0<br>2.0<br>2.0 T<br>2.0 T<br>2.0 T<br>2.0 T4      | 77<br>80<br>85<br>90<br>90<br>92<br>70<br>75<br>85<br>147<br>66<br>100<br>103<br>118<br>120<br>121<br>147            |  | 12.95<br>03.99<br>07.95<br>03.99<br>06.01<br>03.98<br>03.99<br>07.00<br>07.00<br>05.97<br>07.95<br>07.95<br>07.95<br>10.97<br>06.01<br>07.00<br>07.00 | 08.99<br>03.99<br>08.99<br>03.99<br>06.01<br>03.98<br>07.00<br>07.00<br>08.99<br>07.00<br>08.99<br>08.99<br>07.00<br>06.01<br>06.01<br>07.00                   |  | 24.3727-1304.2<br>24.3727-1300.2   | 581304<br>581300   | <input type="checkbox"/><br><input type="checkbox"/>   | L=1590<br>L=1590   |   |
|                   | 1.6<br>1.8 (1783)<br>1.8 i (1834)<br>1.8 i (1834)<br>1.9 DI<br>1.9 DI<br>2.0<br>2.0 T<br>2.0 T4  | 77 600000<br>90 600000<br>90 600000<br>92 600000<br>75 600000<br>85 600000<br>100 600000<br>120 600000<br>147 600000 | 985261<br>985261<br>985261<br>985261<br>985261<br>985261<br>985261<br>985261<br>985261 |   |  |  | 24.3727-1315.2<br>24.3727-1314.2   | 581315<br>581314   | <input type="checkbox"/><br><input type="checkbox"/>   | L=1620<br>L=1620   |   |
|                   | 1.6<br>1.8 (1783)<br>1.8 i (1834)<br>1.8 i (1834)<br>1.9 DI<br>1.9 DI<br>2.0<br>2.0 T<br>2.0 T4  | 80 985262<br>90 985262<br>90 985262<br>92 985262<br>75 985262<br>85 985262<br>100 985262<br>120 985262<br>147 985262 |  | 07.04<br>07.04<br>07.04<br>07.04<br>07.04<br>07.04<br>07.04<br>07.04<br>07.04   |  |  | 24.3727-1315.2<br>24.3727-1314.2   | 581315<br>581314   | <input type="checkbox"/><br><input type="checkbox"/>   | L=1620<br>L=1620   |   |
|                   | 1.9 DI<br>1.9 DI<br>1.9 DI<br>1.9 T4<br>2.0<br>2.0 T<br>2.0 T<br>2.0 T<br>2.0 T4   | 70<br>75<br>85<br>147<br>100<br>118<br>120<br>121<br>147   |  | 03.99<br>07.00<br>07.00<br>05.97<br>07.95<br>10.97<br>06.01<br>07.00<br>07.00   | 07.00<br>07.04<br>07.04<br>07.00<br>07.04<br>07.00<br>07.04<br>06.01<br>04.04  |  | 24.2419-1728.3   | 030117   |  | Gz 19,05   |   |
| VOLVO V40 (12-)   |  |  |  |   |  |  |  |  |  |  |   |
|                   | D2<br>D3<br>D4<br>T2 GTDi<br>T3 GTDi<br>T4<br>T4 GTDi  | 84<br>110<br>130<br>88<br>110<br>132<br>132  |  | 09.12<br>09.12<br>09.12<br>03.13<br>09.12<br>04.13<br>09.12   |  |  | 11.9571-9813.2<br>11.9571-9814.2<br>24.3571-9813.5<br>24.3571-9814.5<br>11.8171-0008.1<br>11.0101-5407.2<br>11.8116-0345.2 | 220647<br>220648<br>240557<br>240558<br>990049<br>260011<br>390596 | <input type="checkbox"/> + 15"/16" Rad 1)<br><input type="checkbox"/> + 15"/16" Rad 1)<br><input type="checkbox"/> + 15"/16" Rad 1)<br><input type="checkbox"/> + 15"/16" Rad 1) | D=57, - Halter<br>D=57, - Halter<br>D=57, - Halter<br>D=57, - Halter<br>Führungsbolzen<br>Hülzensatz<br>Haltefeder | ATE<br>ATE<br>ATE<br>ATE<br>ATE<br>ATE<br>ATE |
|                   | D2<br>D3<br>D4<br>T2 GTDi<br>T3 GTDi<br>T4<br>T4 AWD<br>T4 GTDi<br>T5<br>T5 AWD<br>T5 AWD  | 84<br>110<br>130<br>88<br>110<br>132<br>132<br>187<br>157<br>187   |  | 09.12<br>09.12<br>09.12<br>03.13<br>09.12<br>04.13<br>04.13<br>09.12<br>09.12<br>03.13<br>01.13   |  |  | 11.9576-9975.2<br>11.9576-9976.2<br>11.8171-0008.1<br>11.0101-5407.2<br>11.8116-0345.2                                     | 220649<br>220650<br>990049<br>260011<br>390596                     | <input type="checkbox"/> + 17" Rad 2)<br><input type="checkbox"/> + 17" Rad 2)   | D=57, - Halter<br>D=57, - Halter<br>Führungsbolzen<br>Hülzensatz<br>Haltefeder                                     | ATE<br>ATE<br>ATE<br>ATE<br>ATE               |
| VOLVO V50 (04-12) |  |  |  |   |  |  |  |  |  |  |   |
|                   | 1.6 D<br>1.6 D<br>1.6 i<br>1.8<br>1.8 FlexiFuel<br>2.0 D<br>2.0 FlexiFuel<br>2.0 i<br>2.4<br>2.4<br>2.4 AWD<br>2.4 D5<br>2.4 Tdi<br>2.5 T5<br>2.5 T5<br>2.5 T5 AWD<br>2.5 T5 AWD | 80<br>81<br>74<br>92<br>92<br>100<br>107<br>107<br>103<br>125<br>125<br>132<br>120<br>162<br>169<br>162<br>169       |  | 04.07<br>01.05<br>01.05<br>04.04<br>04.07<br>04.04<br>01.10<br>10.06<br>04.04<br>04.04<br>08.06<br>03.06<br>05.07<br>04.04<br>03.07<br>04.04<br>03.07 | 05.12<br>05.12<br>05.12<br>05.12<br>05.12<br>05.12<br>05.12<br>05.12<br>05.12<br>05.12<br>05.12<br>05.12<br>05.12<br>05.12<br>05.12<br>05.12<br>05.12<br>05.12 |  | 03.7863-0832.4<br>03.7863-4132.4   | 300229<br>300259   |  | 10"<br>10"   | ATE<br>ATE                                    |

1) + 15"/16" wheel / + ruota 15"/16" / + roue 15"/16" / + rueda 15"/16"

2) + 17" wheel / + ruota 17" / + roue 17" / + rueda 17"

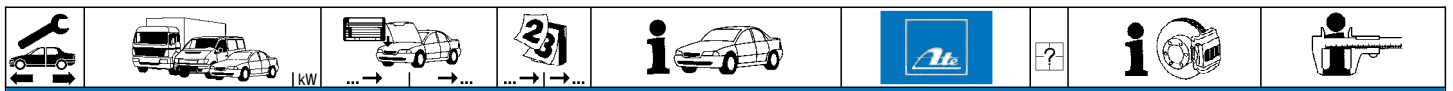

**VOLVO V50 (04-12)**

|  |  |  |  |  |  |  |  |   |
|--|--|--|--|--|--|--|--|---|
|  | 1.6 D 80<br>1.6 D 81<br>1.6 i 74<br>1.8 92<br>1.8 FlexiFuel 92<br>2.0 D 100<br>2.0 FlexiFuel 107<br>2.0 i 107<br>2.4 103<br>2.4 125<br>2.4 AWD 125<br>2.4 D5 132<br>2.4 Tdi 120<br>2.5 T5 162<br>2.5 T5 169<br>2.5 T5 AWD 162<br>2.5 T5 AWD 169  |  | 04.07 05.12<br>01.05 05.12<br>01.05 05.12<br>04.04 05.12<br>04.07 05.12<br>04.04 05.12<br>01.10 05.12<br>10.06 05.12<br>04.04 05.12<br>04.04 05.12<br>08.06 05.12<br>03.06 05.12<br>05.07 05.12<br>04.04 05.12<br>03.07 05.12<br>04.04 05.12<br>03.07 05.12  | 03.2123-3593.3   | 010919   |  | Thz 23,81  | ATE   |
|  | 1.6 D 80<br>1.6 D 81<br>1.6 D2 84<br>1.6 i 74<br>1.8 92<br>1.8 FlexiFuel 92<br>2.0 D 100<br>2.0 D3 110<br>2.0 D4 130<br>2.0 FlexiFuel 107<br>2.0 i 107<br>2.4 103<br>2.4 125<br>2.4 AWD 125<br>2.4 D5 132<br>2.4 Tdi 120<br>2.5 T5 162<br>2.5 T5 169<br>2.5 T5 AWD 162<br>2.5 T5 AWD 169 |  | 04.07 05.12<br>01.05 05.12<br>01.10 05.12<br>01.05 05.12<br>04.04 05.12<br>04.07 05.12<br>04.04 05.12<br>10.10 05.12<br>10.10 05.12<br>01.10 05.12<br>10.06 05.12<br>04.04 05.12<br>04.04 05.12<br>08.06 05.12<br>03.06 05.12<br>05.07 05.12<br>04.04 05.12<br>03.07 05.12<br>04.04 05.12<br>03.07 05.12 | 11.9571-9813.2<br>11.9571-9814.2<br>24.3571-9813.5<br>24.3571-9814.5<br>11.8116-0356.1<br>11.0101-5407.2<br>11.8171-0008.1 | 220647<br>220648<br>240557<br>240558<br>390586<br>260011<br>990049 | <input type="checkbox"/> - 17" Rad 1)<br><input type="checkbox"/> - 17" Rad 1)<br><input type="checkbox"/> - 17" Rad 1)<br><input type="checkbox"/> - 17" Rad 1) | D=57, - Halter<br>D=57, - Halter<br>D=57, - Halter<br>D=57, - Halter<br>Haltefeder<br>Hülzensatz<br>Führungsbolzen | ATE<br>ATE<br>ATE<br>ATE<br>ATE<br>ATE<br>ATE |
|  | 1.6 D 80<br>1.6 D 81<br>1.6 D2 84<br>1.6 i 74<br>1.8 92<br>1.8 FlexiFuel 92<br>2.0 D 100<br>2.0 D3 110<br>2.0 D4 130<br>2.0 FlexiFuel 107<br>2.0 i 107<br>2.4 103<br>2.4 125<br>2.4 AWD 125<br>2.4 D5 132<br>2.4 Tdi 120<br>2.5 T5 162<br>2.5 T5 169<br>2.5 T5 AWD 162<br>2.5 T5 AWD 169 |  | 04.07 05.12<br>01.05 05.12<br>01.10 05.12<br>01.05 05.12<br>04.04 05.12<br>04.07 05.12<br>04.04 05.12<br>10.10 05.12<br>10.10 05.12<br>01.10 05.12<br>10.06 05.12<br>04.04 05.12<br>04.04 05.12<br>08.06 05.12<br>03.06 05.12<br>05.07 05.12<br>04.04 05.12<br>03.07 05.12<br>04.04 05.12<br>03.07 05.12 | 11.9576-9975.2<br>11.9576-9976.2<br>11.8116-0345.2<br>11.0101-5407.2<br>11.8171-0008.1                                     | 220649<br>220650<br>390596<br>260011<br>990049                     | <input type="checkbox"/> + 17" Rad 2)<br><input type="checkbox"/> + 17" Rad 2)   | D=57, - Halter<br>D=57, - Halter<br>Haltefeder<br>Hülzensatz<br>Führungsbolzen                                     | ATE<br>ATE<br>ATE<br>ATE<br>ATE               |
|  | 1.6 D 80<br>1.6 D 81<br>1.6 D2 84<br>1.6 i 74<br>1.8 92<br>1.8 FlexiFuel 92<br>2.0 D 100<br>2.0 D3 110<br>2.0 D4 130<br>2.0 FlexiFuel 107<br>2.0 i 107<br>2.4 103<br>2.4 125<br>2.4 AWD 125<br>2.4 D5 132<br>2.4 Tdi 120<br>2.5 T5 162<br>2.5 T5 169<br>2.5 T5 AWD 162<br>2.5 T5 AWD 169 |  | 04.07 05.12<br>01.05 05.12<br>01.10 05.12<br>01.05 05.12<br>04.04 05.12<br>04.07 05.12<br>04.04 05.12<br>10.10 05.12<br>10.10 05.12<br>01.10 05.12<br>10.06 05.12<br>04.04 05.12<br>04.04 05.12<br>08.06 05.12<br>03.06 05.12<br>05.07 05.12<br>04.04 05.12<br>03.07 05.12<br>04.04 05.12<br>03.07 05.12 | 83.7716-0398.3<br>83.7788-0414.3   | 330987<br>330988   | <input type="checkbox"/> - 17" Rad 1)<br><input type="checkbox"/> + 17" Rad 2)   | L=395<br>L=411   |   |
|  | 2.5 T5 AWD 162<br>2.5 T5 AWD 169   |  | 04.04 05.12<br>03.07 05.12   | 83.7788-0414.3   | 330988   | <input type="checkbox"/> - 17" Rad 1)  | L=411  |   |
|  | 1.6 D 80<br>1.6 D 81<br>1.6 D2 84<br>1.6 i 74<br>1.8 92<br>1.8 FlexiFuel 92<br>2.0 D 100<br>2.0 D3 110<br>2.0 D4 130<br>2.0 FlexiFuel 107  | 491291<br>491291<br>491291<br>491291<br>491291<br>491291<br>491291<br>491291<br>491291<br>491291 | 04.07 05.12<br>01.05 05.12<br>01.10 05.12<br>01.05 05.12<br>04.04 05.12<br>04.07 05.12<br>04.04 05.12<br>10.10 05.12<br>10.10 05.12<br>01.10 05.12   | 11.9387-7015.2<br>11.9387-7016.2<br>11.0230-0698.2<br>11.0101-5407.2<br>11.8171-0008.1<br>11.8116-0340.1                   | 220627<br>220628<br>260091<br>260011<br>990049<br>390595           | <input type="checkbox"/><br><input type="checkbox"/>   | D=38, - Halter<br>D=38, - Halter<br>Halter<br>Hülzensatz<br>Führungsbolzen<br>Haltefeder                           | ATE<br>ATE<br>ATE<br>ATE<br>ATE<br>ATE        |

1) - 17" wheel / - ruota 17" / - roue 17" / - rueda 17"  
2) + 17" wheel / + ruota 17" / + roue 17" / + rueda 17"



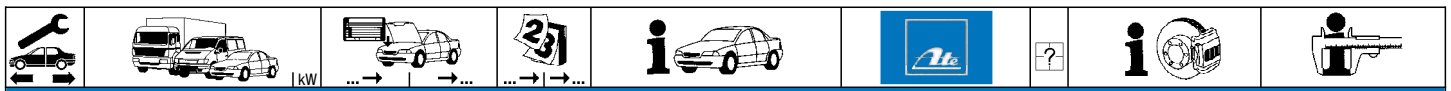

**VOLVO V50 (04-12)**







|               |               |           |        |       |       |                |        |   |  |  |  |
|---------------|---------------|-----------|--------|-------|-------|----------------|--------|---|--|--|--|
|               | 2.0 i         | 107       | 491291 | 10.06 |       | 11.9387-7015.2 | 220627 | 2 |  | D=38, - Halter<br>D=38, - Halter<br>Halter<br>Hülsensatz<br>Führungsbolzen<br>Haltefeder | ATE<br>ATE<br>ATE<br>ATE<br>ATE<br>ATE |
|               | 2.4           | 103       | 491291 | 04.04 |       | 11.9387-7016.2 | 220628 |   |  |  |  |
|               | 2.4           | 125       | 491291 | 04.04 |       | 11.0230-0698.2 | 260091 |   |  |  |  |
|               | 2.4 AWD       | 125       | 491291 | 08.06 |       | 11.0101-5407.2 | 260011 |   |  |  |  |
|               | 2.4 D5        | 132       | 491291 | 03.06 |       | 11.8171-0008.1 | 990049 |   |  |  |  |
|               | 2.4 Tdi       | 120       | 491291 | 05.07 |       | 11.8116-0340.1 | 390595 |   |  |  |  |
|               | 2.5 T5        | 162       | 491291 | 04.04 |       |                |        |   |  |  |  |
|               | 2.5 T5        | 169       | 491291 | 03.07 |       |                |        |   |  |  |  |
|               | 2.5 T5 AWD    | 162       | 491291 | 04.04 |       |                |        |   |  |  |  |
|               | 2.5 T5 AWD    | 169       | 491291 | 03.07 |       |                |        |   |  |  |  |
|               | 1.6 D         | 80 491292 |        | 05.12 |       | 11.0230-0698.2 | 260091 |   |  |  |  |
|               | 1.6 D         | 81 491292 |        | 05.12 |       | 11.0101-5407.2 | 260011 |   |  |  |  |
|               | 1.6 D2        | 84 491292 |        | 05.12 |       | 11.8171-0008.1 | 990049 |   |  |  |  |
|               | 1.6 i         | 74 491292 |        | 05.12 |       | 11.8116-0340.1 | 390595 |   |  |  |  |
|               | 1.8           | 92 491292 |        | 05.12 |       |                |        |   |  |  |  |
| 1.8 FlexiFuel | 92 491292     |           | 05.12  |       |       |                |        |   |  |  |  |
| 2.0 D         | 100 491292    |           | 05.12  |       |       |                |        |   |  |  |  |
| 2.0 D3        | 110 491292    |           | 05.12  |       |       |                |        |   |  |  |  |
| 2.0 D4        | 130 491292    |           | 05.12  |       |       |                |        |   |  |  |  |
| 2.0 FlexiFuel | 107 491292    |           | 05.12  |       |       |                |        |   |  |  |  |
| 2.0 i         | 107 491292    |           | 05.12  |       |       |                |        |   |  |  |  |
| 2.4           | 103 491292    |           | 05.12  |       |       |                |        |   |  |  |  |
| 2.4           | 125 491292    |           | 05.12  |       |       |                |        |   |  |  |  |
| 2.4 AWD       | 125 491292    |           | 05.12  |       |       |                |        |   |  |  |  |
| 2.4 D5        | 132 491292    |           | 05.12  |       |       |                |        |   |  |  |  |
| 2.4 Tdi       | 120 491292    |           | 05.12  |       |       |                |        |   |  |  |  |
| 2.5 T5        | 162 491292    |           | 05.12  |       |       |                |        |   |  |  |  |
| 2.5 T5        | 169 491292    |           | 05.12  |       |       |                |        |   |  |  |  |
| 2.5 T5 AWD    | 162 491292    |           | 05.12  |       |       |                |        |   |  |  |  |
| 2.5 T5 AWD    | 169 491292    |           | 05.12  |       |       |                |        |   |  |  |  |
|               | 1.6 D         | 80        |        | 04.07 | 05.12 | 24.5124-0390.3 | 331050 | 2 |  | L=390<br>L=382   |  |
|               | 1.6 D         | 81        |        | 01.05 | 05.12 | 83.7788-0383.3 | 330972 |   |  |  |  |
|               | 1.6 D2        | 84        |        | 01.10 | 05.12 |                |        |   |  |  |  |
|               | 1.6 i         | 74        |        | 01.05 | 05.12 |                |        |   |  |  |  |
|               | 1.8           | 92        |        | 04.04 | 05.12 |                |        |   |  |  |  |
|               | 1.8 FlexiFuel | 92        |        | 04.07 | 05.12 |                |        |   |  |  |  |
|               | 2.0 D         | 100       |        | 04.04 | 05.12 |                |        |   |  |  |  |
|               | 2.0 D3        | 110       |        | 10.10 | 05.12 |                |        |   |  |  |  |
|               | 2.0 D4        | 130       |        | 10.10 | 05.12 |                |        |   |  |  |  |
|               | 2.0 FlexiFuel | 107       |        | 01.10 | 05.12 |                |        |   |  |  |  |
|               | 2.0 i         | 107       |        | 10.06 | 05.12 |                |        |   |  |  |  |
|               | 2.4           | 103       |        | 04.04 | 05.12 |                |        |   |  |  |  |
|               | 2.4           | 125       |        | 04.04 | 05.12 |                |        |   |  |  |  |
|               | 2.4 AWD       | 125       |        | 08.06 | 05.12 |                |        |   |  |  |  |
|               | 2.4 D5        | 132       |        | 03.06 | 05.12 |                |        |   |  |  |  |
| 2.4 Tdi       | 120           |           | 05.07  | 05.12 |       |                |        |   |  |  |  |
| 2.5 T5        | 162           |           | 04.04  | 05.12 |       |                |        |   |  |  |  |
| 2.5 T5        | 169           |           | 03.07  | 05.12 |       |                |        |   |  |  |  |

**VOLVO V60 (10-)**

|                       |                       |           |    |       |       |                |                |        |   |  |   |  |
|-----------------------|-----------------------|-----------|----|-------|-------|----------------|----------------|--------|---|--|---|--|
|                       | 1.6 DRIVE             | 84        |    | 06.11 |       | 11.9601-9711.2 | 220873         | 2      |   | + 16" Rad <sup>1)</sup><br>+ 16" Rad <sup>1)</sup> | D=60, - Halter<br>D=60, - Halter<br>Haltefeder<br>Hülsensatz<br>Führungsbolzen<br>Dichtungssatz | ATE<br>ATE<br>ATE<br>ATE<br>ATE<br>ATE |
|                       | 2.0 T                 | 149       |    | 11.10 |       | 11.9601-9712.2 | 220874         |        |   |  |   |  |
|                       | 2.4 D5                | 158       |    | 06.11 |       | 11.8116-0206.1 | 390593         |        |   |  |   |  |
|                       | 2.4 D5 AWD            | 158       |    | 06.11 |       | 11.0101-5407.2 | 260011         |        |   |  |   |  |
|                       | 2.4 D6 Plug-in-Hybrid | 158       |    | 11.12 |       | 11.8171-0008.1 | 990049         |        |   |  |   |  |
|                       | D 3                   | 100       |    | 10.12 |       | 11.0441-6008.2 | 250038         |        |   |  |   |  |
|                       | D 3                   | 120       |    | 11.10 |       |                |                |        |   |  |   |  |
|                       | D 5                   | 151       |    | 11.10 |       |                |                |        |   |  |   |  |
|                       | D 5 AWD               | 151       |    | 11.10 |       |                |                |        |   |  |   |  |
|                       | T 6 AWD               | 224       |    | 11.10 |       |                |                |        |   |  |   |  |
|                       | T3                    | 110       |    | 11.10 |       |                |                |        |   |  |   |  |
|                       | T4                    | 132       |    | 11.10 |       |                |                |        |   |  |   |  |
|                       | T4F                   | 132       |    | 04.11 |       |                |                |        |   |  |   |  |
|                       | T5                    | 177       |    | 11.10 |       |                |                |        |   |  |   |  |
|                       |                       | 1.6 DRIVE | 84 |       | 06.11 |                | 11.9606-9949.2 |        |   |  |   |  |
| 2.0 T                 |                       | 149       |    | 11.10 |       | 11.9606-9950.2 | 220880         |        |   |  |   |  |
| 2.4 D5                |                       | 158       |    | 06.11 |       | 11.8116-0388.2 | 390588         |        |   |  |   |  |
| 2.4 D5 AWD            |                       | 158       |    | 06.11 |       | 11.0441-6008.2 | 250038         |        |   |  |   |  |
| 2.4 D6 Plug-in-Hybrid |                       | 158       |    | 11.12 |       | 11.0101-5704.2 | 260095         |        |   |  |   |  |
| D 3                   |                       | 100       |    | 10.12 |       |                |                |        |   |  |   |  |
| D 3                   |                       | 120       |    | 11.10 |       |                |                |        |   |  |   |  |
| D 5                   |                       | 151       |    | 11.10 |       |                |                |        |   |  |   |  |
| D 5 AWD               |                       | 151       |    | 11.10 |       |                |                |        |   |  |   |  |
| T 6 AWD               |                       | 224       |    | 11.10 |       |                |                |        |   |  |   |  |
| T3                    |                       | 110       |    | 11.10 |       |                |                |        |   |  |   |  |
| T4                    |                       | 132       |    | 11.10 |       |                |                |        |   |  |   |  |
| T4F                   |                       | 132       |    | 04.11 |       |                |                |        |   |  |   |  |
| T5                    |                       | 177       |    | 11.10 |       |                |                |        |   |  |   |  |
|                       |                       | 1.6 DRIVE | 84 |       | 06.11 |                | 24.5162-0390.3 | 331199 | 2 |  | + 16" Rad <sup>1)</sup><br>+ 17" Rad <sup>2)</sup>  | L=390<br>L=375                         |
|                       | 2.0 T                 | 149       |    | 11.10 |       | 24.5162-0375.3 | 331203         |        |   |  |   |  |
|                       | 2.4 D5                | 158       |    | 06.11 |       |                |                |        |   |  |   |  |
|                       | 2.4 D5 AWD            | 158       |    | 06.11 |       |                |                |        |   |  |   |  |
|                       | 2.4 D6 Plug-in-Hybrid | 158       |    | 11.12 |       |                |                |        |   |  |   |  |
|                       | D 3                   | 100       |    | 10.12 |       |                |                |        |   |  |   |  |

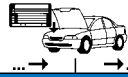
<sup>1)</sup> + 16" wheel / + ruota 16" / + roue 16" / + rueda 16"  
<sup>2)</sup> + 17" wheel / + ruota 17" / + roue 17" / + rueda 17"



| VOLVO V60 (10-)  |             | 24.5162-0390.3 |       | 331199 |       | 2 |  | + 16" Rad 1) |  | L=390   |  |
|--|-------------|----------------|-------|--------|-------|---|--|--------------|--|---------|--|
| VOLVO V70 I (97-00)  |             | 03.7760-3602.4 |       | 300176 |       |   |  |              |  | 10" ATE |  |
|   | T 6 AWD     | 224            | 11.10 |        |       |   |  |              |  |         |  |
|  | T3          | 110            | 11.10 |        |       |   |  |              |  |         |  |
|  | T4          | 132            | 11.10 |        |       |   |  |              |  |         |  |
|  | T4F         | 132            | 04.11 |        |       |   |  |              |  |         |  |
|  | T5          | 177            | 11.10 |        |       |   |  |              |  |         |  |
|  | 2.0         | 93             | 01.97 | 03.00  |       |   |  |              |  |         |  |
|  | 2.0         | 105            | 01.97 | 03.00  |       |   |  |              |  |         |  |
|  | 2.0 20V     | 120            | 01.97 | 03.00  |       |   |  |              |  |         |  |
|  | 2.0 20V     | 132            | 01.97 | 03.00  |       |   |  |              |  |         |  |
|  | 2.0 T       | 155            | 01.97 | 03.00  |       |   |  |              |  |         |  |
|  | 2.0 T       | 166            | 01.97 | 03.00  |       |   |  |              |  |         |  |
|  | 2.0 T AWD   | 166            | 01.97 | 03.00  |       |   |  |              |  |         |  |
|  | 2.3 AWD     | 166            | 04.97 | 09.98  |       |   |  |              |  |         |  |
|  | 2.3 T       | 184            | 01.97 | 03.00  |       |   |  |              |  |         |  |
|  | 2.3 T AWD   | 184            | 04.97 | 03.00  |       |   |  |              |  |         |  |
|  | 2.3 T5      | 176            | 01.97 | 03.00  |       |   |  |              |  |         |  |
|  | 2.3 T5 AWD  | 176            | 01.97 | 03.00  |       |   |  |              |  |         |  |
|  | 2.4         | 103            | 08.99 | 03.00  |       |   |  |              |  |         |  |
|  | 2.4         | 125            | 01.97 | 03.00  |       |   |  |              |  |         |  |
|  | 2.4 AWD     | 121            | 10.98 | 05.99  |       |   |  |              |  |         |  |
|  | 2.4 Bi-Fuel | 103            | 08.99 | 03.00  |       |   |  |              |  |         |  |
|  | 2.4 T       | 142            | 01.97 | 03.00  |       |   |  |              |  |         |  |
|  | 2.5         | 106            | 01.97 | 03.00  |       |   |  |              |  |         |  |
|  | 2.5         | 121            | 06.98 | 03.00  |       |   |  |              |  |         |  |
|  | 2.5 AWD     | 195            | 03.99 | 03.00  |       |   |  |              |  |         |  |
|  | 2.5 Bi-Fuel | 106            | 10.98 | 08.99  |       |   |  |              |  |         |  |
|  | 2.5 T AWD   | 142            | 01.97 | 03.00  |       |   |  |              |  |         |  |
|  | 2.5 TDI     | 103            | 01.97 | 03.00  |       |   |  |              |  |         |  |
|  | 2.0         | 93             | 01.97 | 12.98  | - ASR |   |  |              |  |         |  |
|  | 2.0         | 105            | 01.97 | 12.98  | - ASR |   |  |              |  |         |  |
|  | 2.0 20V     | 120            | 01.97 | 12.98  | - ASR |   |  |              |  |         |  |
|  | 2.0 20V     | 132            | 01.97 | 12.98  | - ASR |   |  |              |  |         |  |
|  | 2.0 T       | 155            | 01.97 | 12.98  | - ASR |   |  |              |  |         |  |
|  | 2.0 T       | 166            | 01.97 | 12.98  | - ASR |   |  |              |  |         |  |
|  | 2.0 T AWD   | 166            | 01.97 | 12.98  | - ASR |   |  |              |  |         |  |
|  | 2.3 AWD     | 166            | 04.97 | 09.98  | - ASR |   |  |              |  |         |  |
|  | 2.3 T       | 184            | 01.97 | 12.98  | - ASR |   |  |              |  |         |  |
|  | 2.3 T AWD   | 184            | 04.97 | 12.98  | - ASR |   |  |              |  |         |  |
|  | 2.3 T5      | 176            | 01.97 | 12.98  | - ASR |   |  |              |  |         |  |
|  | 2.3 T5 AWD  | 176            | 01.97 | 12.98  | - ASR |   |  |              |  |         |  |
|  | 2.4         | 125            | 01.97 | 12.98  | - ASR |   |  |              |  |         |  |
|  | 2.4 AWD     | 121            | 10.98 | 05.99  | - ASR |   |  |              |  |         |  |
|  | 2.4 T       | 142            | 01.97 | 12.98  | - ASR |   |  |              |  |         |  |
|  | 2.5         | 106            | 01.97 | 12.98  | - ASR |   |  |              |  |         |  |
|  | 2.5         | 121            | 06.98 | 12.98  | - ASR |   |  |              |  |         |  |
|  | 2.5 Bi-Fuel | 106            | 10.98 | 12.98  | - ASR |   |  |              |  |         |  |
|  | 2.5 T AWD   | 142            | 01.97 | 12.98  | - ASR |   |  |              |  |         |  |
|  | 2.5 TDI     | 103            | 01.97 | 12.98  | - ASR |   |  |              |  |         |  |
|  | 2.0         | 93             | 01.97 | 12.98  | + ASR |   |  |              |  |         |  |
|  | 2.0         | 105            | 01.97 | 12.98  | + ASR |   |  |              |  |         |  |
|  | 2.0 20V     | 120            | 01.97 | 12.98  | + ASR |   |  |              |  |         |  |
|  | 2.0 20V     | 132            | 01.97 | 12.98  | + ASR |   |  |              |  |         |  |
|  | 2.0 T       | 155            | 01.97 | 12.98  | + ASR |   |  |              |  |         |  |
|  | 2.0 T       | 166            | 01.97 | 12.98  | + ASR |   |  |              |  |         |  |
|  | 2.0 T AWD   | 166            | 01.97 | 12.98  | + ASR |   |  |              |  |         |  |
|  | 2.3 AWD     | 166            | 04.97 | 12.98  | + ASR |   |  |              |  |         |  |
|  | 2.3 T       | 184            | 01.97 | 12.98  | + ASR |   |  |              |  |         |  |
|  | 2.3 T AWD   | 184            | 04.97 | 12.98  | + ASR |   |  |              |  |         |  |
|  | 2.3 T5      | 176            | 01.97 | 12.98  | + ASR |   |  |              |  |         |  |
|  | 2.3 T5 AWD  | 176            | 01.97 | 12.98  | + ASR |   |  |              |  |         |  |
|  | 2.4         | 125            | 01.97 | 12.98  | + ASR |   |  |              |  |         |  |
|  | 2.4 AWD     | 121            | 10.98 | 12.98  | + ASR |   |  |              |  |         |  |
|  | 2.4 T       | 142            | 01.97 | 12.98  | + ASR |   |  |              |  |         |  |
|  | 2.5         | 106            | 01.97 | 12.98  | + ASR |   |  |              |  |         |  |
|  | 2.5         | 121            | 06.98 | 12.98  | + ASR |   |  |              |  |         |  |
|  | 2.5 Bi-Fuel | 106            | 10.98 | 12.98  | + ASR |   |  |              |  |         |  |
|  | 2.5 T AWD   | 142            | 01.97 | 12.98  | + ASR |   |  |              |  |         |  |
|  | 2.5 TDI     | 103            | 01.97 | 12.98  | + ASR |   |  |              |  |         |  |
|  | 2.0         | 93             | 01.99 | 03.00  |       |   |  |              |  |         |  |
|  | 2.0         | 105            | 01.99 | 03.00  |       |   |  |              |  |         |  |
|  | 2.0 20V     | 120            | 01.99 | 03.00  |       |   |  |              |  |         |  |
|  | 2.0 20V     | 132            | 01.99 | 03.00  |       |   |  |              |  |         |  |
|  | 2.0 T       | 155            | 01.99 | 03.00  |       |   |  |              |  |         |  |
|  | 2.0 T       | 166            | 01.99 | 03.00  |       |   |  |              |  |         |  |
|  | 2.0 T AWD   | 166            | 01.99 | 03.00  |       |   |  |              |  |         |  |
|  | 2.3 AWD     | 166            | 01.99 | 05.99  |       |   |  |              |  |         |  |
|  | 2.3 T       | 184            | 01.99 | 03.00  |       |   |  |              |  |         |  |
|  | 2.3 T AWD   | 184            | 01.99 | 03.00  |       |   |  |              |  |         |  |
|  | 2.3 T5      | 176            | 01.99 | 03.00  |       |   |  |              |  |         |  |
|  | 2.3 T5 AWD  | 176            | 01.99 | 03.00  |       |   |  |              |  |         |  |
|  | 2.4         | 103            | 08.99 | 03.00  |       |   |  |              |  |         |  |
|  | 2.4         | 125            | 01.99 | 03.00  |       |   |  |              |  |         |  |
|  | 2.4 AWD     | 121            | 01.99 | 05.99  |       |   |  |              |  |         |  |
|  | 2.4 Bi-Fuel | 103            | 08.99 | 03.00  |       |   |  |              |  |         |  |
|  | 2.4 T       | 142            | 01.99 | 03.00  |       |   |  |              |  |         |  |

1) + 16" wheel / + ruota 16" / + roue 16" / + rueda 16"

2) + 17" wheel / + ruota 17" / + roue 17" / + rueda 17"

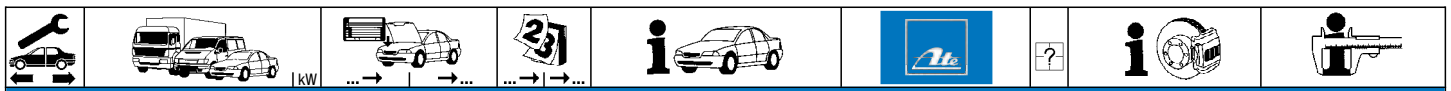

| VOLVO V70 I (97-00) |             |     |        |       |       |                |        |   |                             |                |     |
|---------------------|-------------|-----|--------|-------|-------|----------------|--------|---|-----------------------------|----------------|-----|
|                     | 2.5         | 106 |        | 01.99 | 03.00 | 03.2123-2164.3 | 010599 |   |                             | THz 23,81      | ATE |
|                     | 2.5         | 121 |        | 01.99 | 03.00 |                |        |   |                             |                |     |
|                     | 2.5 AWD     | 195 |        | 03.99 | 03.00 |                |        |   |                             |                |     |
|                     | 2.5 Bi-Fuel | 106 |        | 01.99 | 08.99 |                |        |   |                             |                |     |
|                     | 2.5 T AWD   | 142 |        | 01.99 | 03.00 |                |        |   |                             |                |     |
|                     | 2.5 TDI     | 103 |        | 01.99 | 03.00 |                |        |   |                             |                |     |
|                     | 2.0         | 93  |        | 01.97 | 03.00 | 11.9571-9971.2 | 220605 |   |                             | D=57, - Halter | ATE |
|                     | 2.0         | 105 |        | 01.97 | 03.00 | 11.9571-9972.2 | 220606 |   |                             | D=57, - Halter | ATE |
|                     | 2.0 20V     | 120 |        | 01.97 | 03.00 | 11.0441-5702.2 | 250033 |   |                             | Dichtungssatz  | ATE |
|                     | 2.0 20V     | 132 |        | 01.97 | 03.00 | 11.0101-5407.2 | 260011 |   |                             | Hülsensatz     | ATE |
|                     | 2.0 T       | 155 |        | 01.97 | 03.00 | 11.8171-0008.1 | 990049 |   |                             | Führungsbolzen | ATE |
|                     | 2.0 T       | 166 |        | 01.97 | 03.00 | 11.8116-0073.1 | 390498 | 2 |                             | Haltefeder     | ATE |
|                     | 2.0 T AWD   | 166 |        | 01.97 | 03.00 |                |        |   |                             |                |     |
|                     | 2.3 AWD     |     |        | 04.97 | 09.98 |                |        |   |                             |                |     |
|                     | 2.3 T       | 184 |        | 01.97 | 03.00 |                |        |   |                             |                |     |
|                     | 2.3 T AWD   | 184 |        | 04.97 | 03.00 |                |        |   |                             |                |     |
|                     | 2.3 T5      | 176 |        | 01.97 | 03.00 |                |        |   |                             |                |     |
|                     | 2.3 T5 AWD  | 176 |        | 01.97 | 03.00 |                |        |   |                             |                |     |
|                     | 2.4         | 103 |        | 08.99 | 03.00 |                |        |   |                             |                |     |
|                     | 2.4         | 125 |        | 01.97 | 03.00 |                |        |   |                             |                |     |
|                     | 2.4 AWD     | 121 |        | 10.98 | 05.99 |                |        |   |                             |                |     |
|                     | 2.4 Bi-Fuel | 103 |        | 08.99 | 03.00 |                |        |   |                             |                |     |
|                     | 2.4 T       | 142 |        | 01.97 | 03.00 |                |        |   |                             |                |     |
|                     | 2.5         | 106 |        | 01.97 | 03.00 |                |        |   |                             |                |     |
|                     | 2.5         | 121 |        | 06.98 | 03.00 |                |        |   |                             |                |     |
|                     | 2.5 AWD     | 195 |        | 03.99 | 03.00 |                |        |   |                             |                |     |
|                     | 2.5 Bi-Fuel | 106 |        | 10.98 | 08.99 |                |        |   |                             |                |     |
|                     | 2.5 T AWD   | 142 |        | 01.97 | 03.00 |                |        |   |                             |                |     |
|                     | 2.5 TDI     | 103 |        | 01.97 | 03.00 |                |        |   |                             |                |     |
|                     | 2.0         | 93  |        | 01.97 | 03.00 | 83.6134-0335.3 | 330277 | 2 | + 15" Rad <sup>1)</sup>     | L=335          |     |
|                     | 2.0         | 105 |        | 01.97 | 03.00 | 83.6134-0335.3 | 330541 | 2 | + 16" Rad <sup>2)</sup>     | L=355          |     |
|                     | 2.0 20V     | 120 |        | 01.97 | 03.00 | 24.5170-0361.3 | 331310 | 2 | + 16" Rad <sup>2)</sup>     | L=361          |     |
|                     | 2.0 20V     | 132 |        | 01.97 | 03.00 | 83.6113-0331.3 | 330982 | 2 | am Bremsattel <sup>3)</sup> | L=330          |     |
|                     | 2.0 T       | 155 |        | 01.97 | 03.00 |                |        |   |                             |                |     |
|                     | 2.0 T       | 166 |        | 01.97 | 03.00 |                |        |   |                             |                |     |
|                     | 2.0 T AWD   | 166 |        | 01.97 | 03.00 |                |        |   |                             |                |     |
|                     | 2.3 AWD     |     |        | 04.97 | 09.98 |                |        |   |                             |                |     |
|                     | 2.3 T       | 184 |        | 01.97 | 03.00 |                |        |   |                             |                |     |
|                     | 2.3 T AWD   | 184 |        | 04.97 | 03.00 |                |        |   |                             |                |     |
|                     | 2.3 T5      | 176 |        | 01.97 | 03.00 |                |        |   |                             |                |     |
|                     | 2.3 T5 AWD  | 176 |        | 01.97 | 03.00 |                |        |   |                             |                |     |
|                     | 2.4         | 103 |        | 08.99 | 03.00 |                |        |   |                             |                |     |
|                     | 2.4         | 125 |        | 01.97 | 03.00 |                |        |   |                             |                |     |
|                     | 2.4 AWD     | 121 |        | 10.98 | 05.99 |                |        |   |                             |                |     |
|                     | 2.4 Bi-Fuel | 103 |        | 08.99 | 03.00 |                |        |   |                             |                |     |
|                     | 2.4 T       | 142 |        | 01.97 | 03.00 |                |        |   |                             |                |     |
|                     | 2.5         | 106 |        | 01.97 | 03.00 |                |        |   |                             |                |     |
|                     | 2.5         | 121 |        | 06.98 | 03.00 |                |        |   |                             |                |     |
|                     | 2.5 AWD     | 195 |        | 03.99 | 03.00 |                |        |   |                             |                |     |
|                     | 2.5 Bi-Fuel | 106 |        | 10.98 | 08.99 |                |        |   |                             |                |     |
|                     | 2.5 T AWD   | 142 |        | 01.97 | 03.00 |                |        |   |                             |                |     |
|                     | 2.5 TDI     | 103 |        | 01.97 | 03.00 |                |        |   |                             |                |     |
|                     | 2.0         | 93  |        | 01.97 | 03.00 | 13.2381-0097.2 | 210239 |   |                             | D=38           | ATE |
|                     | 2.0         | 105 |        | 01.97 | 03.00 | 13.2381-0098.2 | 210240 |   |                             | D=38           | ATE |
|                     | 2.0 20V     | 120 |        | 01.97 | 03.00 | 24.9238-0097.5 | 230037 |   |                             | D=38           | ATE |
|                     | 2.0 20V     | 132 |        | 01.97 | 03.00 | 24.9238-0098.5 | 230038 |   |                             | D=38           | ATE |
|                     | 2.0 T       | 166 |        | 01.97 | 03.00 | 13.0441-3819.2 | 250072 |   |                             | Dichtungssatz  | ATE |
|                     | 2.3 AWD     |     |        | 04.97 | 09.98 |                |        |   |                             |                |     |
|                     | 2.3 T       | 184 |        | 01.97 | 03.00 |                |        |   |                             |                |     |
|                     | 2.3 T5      | 176 |        | 01.97 | 03.00 |                |        |   |                             |                |     |
|                     | 2.4         | 103 |        | 01.97 | 03.00 |                |        |   |                             |                |     |
|                     | 2.4         | 125 |        | 01.97 | 03.00 |                |        |   |                             |                |     |
|                     | 2.4 AWD     | 121 |        | 10.98 | 05.99 |                |        |   |                             |                |     |
|                     | 2.4 Bi-Fuel | 103 |        | 08.99 | 03.00 |                |        |   |                             |                |     |
|                     | 2.4 T       | 142 |        | 01.97 | 03.00 |                |        |   |                             |                |     |
|                     | 2.5         | 106 |        | 01.97 | 03.00 |                |        |   |                             |                |     |
|                     | 2.5         | 121 |        | 06.98 | 03.00 |                |        |   |                             |                |     |
|                     | 2.5 Bi-Fuel | 106 |        | 10.98 | 08.99 |                |        |   |                             |                |     |
|                     | 2.5 TDI     | 103 |        | 01.97 | 03.00 |                |        |   |                             |                |     |
|                     | 2.0         | 93  | 566120 | 01.97 |       | 83.6204-0200.3 | 330306 | 2 |                             | L=200          |     |
|                     | 2.0         | 105 | 566120 | 01.97 |       |                |        |   |                             |                |     |
|                     | 2.0 20V     | 120 | 566120 | 01.97 |       |                |        |   |                             |                |     |
|                     | 2.0 20V     | 132 | 566120 | 01.97 |       |                |        |   |                             |                |     |
|                     | 2.0 T       | 155 | 566120 | 01.97 |       |                |        |   |                             |                |     |
|                     | 2.0 T       | 166 | 566120 | 01.97 |       |                |        |   |                             |                |     |
|                     | 2.3 AWD     |     | 566120 | 04.97 |       |                |        |   |                             |                |     |
|                     | 2.3 T       | 184 | 566120 | 01.97 |       |                |        |   |                             |                |     |
|                     | 2.3 T5      | 176 | 566120 | 01.97 |       |                |        |   |                             |                |     |
|                     | 2.4         | 125 | 566120 | 01.97 |       |                |        |   |                             |                |     |
|                     | 2.4 AWD     | 121 | 566120 | 10.98 |       |                |        |   |                             |                |     |
|                     | 2.4 T       | 142 | 566120 | 01.97 |       |                |        |   |                             |                |     |
|                     | 2.5         | 106 | 566120 | 01.97 |       |                |        |   |                             |                |     |
|                     | 2.5         | 121 | 566120 | 06.98 |       |                |        |   |                             |                |     |
|                     | 2.5 Bi-Fuel | 106 | 566120 | 10.98 |       |                |        |   |                             |                |     |
|                     | 2.5 TDI     | 103 | 566120 | 01.97 |       |                |        |   |                             |                |     |
|                     | 2.0         | 93  | 566121 | 03.00 |       | 83.6204-0180.3 | 330547 | 2 |                             | L=180          |     |
|                     | 2.0         | 105 | 566121 | 03.00 |       |                |        |   |                             |                |     |

1) + 15" wheel / + ruota 15" / + roue 15" / + rueda 15"  
 2) + 16" wheel / + ruota 16" / + roue 16" / + rueda 16"  
 3) on the brake caliper / sulla pinza freno / sur l'étrier de frein / a la pinza de freno

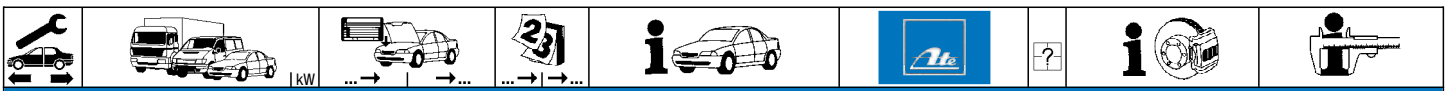

**VOLVO V70 I (97-00)**

|             |             |            |        |        |       |                |        |   |                             |          |
|-------------|-------------|------------|--------|--------|-------|----------------|--------|---|-----------------------------|----------|
|             | 2.0 20V     | 120 566121 |        |        | 03.00 | 83.6204-0180.3 | 330547 | 2 |                             | L=180    |
|             | 2.0 20V     | 132 566121 |        |        | 03.00 |                |        |   |                             |          |
|             | 2.0 T       | 155 566121 |        |        | 03.00 |                |        |   |                             |          |
|             | 2.0 T       | 166 566121 |        |        | 03.00 |                |        |   |                             |          |
|             | 2.3 AWD     | 566121     |        |        | 09.98 |                |        |   |                             |          |
|             | 2.3 T       | 184 566121 |        |        | 03.00 |                |        |   |                             |          |
|             | 2.3 T5      | 176 566121 |        |        | 03.00 |                |        |   |                             |          |
|             | 2.4         | 103        |        | 08.99  | 03.00 |                |        |   |                             |          |
|             | 2.4         | 125 566121 |        |        | 03.00 |                |        |   |                             |          |
|             | 2.4 AWD     | 121 566121 |        |        | 05.99 |                |        |   |                             |          |
|             | 2.4 Bi-Fuel | 103        |        | 08.99  | 03.00 |                |        |   |                             |          |
|             | 2.4 T       | 142 566121 |        |        | 03.00 |                |        |   |                             |          |
|             | 2.5         | 106 566121 |        |        | 03.00 |                |        |   |                             |          |
|             | 2.5         | 121 566121 |        |        | 03.00 |                |        |   |                             |          |
|             | 2.5 Bi-Fuel | 106 566121 |        |        | 08.99 |                |        |   |                             |          |
|             | 2.5 TDI     | 103 566121 |        |        | 03.00 |                |        |   |                             |          |
|             | 2.0 T AWD   | 166        | 528556 | 01.97  |       | 83.6134-0270.3 | 330779 | 2 |                             | L=270    |
|             | 2.3 T AWD   | 184        | 528556 | 04.97  |       |                |        |   |                             |          |
|             | 2.3 T5 AWD  | 176        | 528556 | 01.97  |       |                |        |   |                             |          |
|             | 2.5 T AWD   | 142        | 528556 | 01.97  |       |                |        |   |                             |          |
|             | 2.0 T AWD   | 166        | 528557 | 587043 |       | 83.7769-0275.3 | 331207 | 2 |                             | L=275    |
|             | 2.3 T AWD   | 184        | 528557 | 587043 |       |                |        |   |                             |          |
|             | 2.3 T5 AWD  | 176        | 528557 | 587043 |       |                |        |   |                             |          |
|             | 2.5 T AWD   | 142        | 528557 | 587043 |       |                |        |   |                             |          |
|             | 2.0 T AWD   | 166        | 587044 |        | 03.00 | 83.6134-0270.3 | 330779 | 2 |                             | L=270    |
|             | 2.3 T AWD   | 184        | 587044 |        | 03.00 |                |        |   |                             |          |
|             | 2.3 T5 AWD  | 176        | 587044 |        | 03.00 |                |        |   |                             |          |
|             | 2.5 AWD     | 195        |        | 03.99  | 03.00 |                |        |   |                             |          |
|             | 2.5 T AWD   | 142        | 587044 |        | 03.00 |                |        |   |                             |          |
|             | 2.0         | 93         |        | 01.97  | 03.00 | 24.3727-1308.2 | 581308 | 2 | ↓                           | L=1670   |
|             | 2.0         | 105        |        | 01.97  | 03.00 |                |        |   |                             |          |
|             | 2.0 20V     | 120        |        | 01.97  | 03.00 |                |        |   |                             |          |
|             | 2.0 20V     | 132        |        | 01.97  | 03.00 |                |        |   |                             |          |
|             | 2.0 T       | 155        |        | 01.97  | 03.00 |                |        |   |                             |          |
|             | 2.0 T       | 166        |        | 01.97  | 03.00 |                |        |   |                             |          |
|             | 2.3 AWD     |            |        | 04.97  | 09.98 |                |        |   |                             |          |
|             | 2.3 T       | 184        |        | 01.97  | 03.00 |                |        |   |                             |          |
|             | 2.3 T5      | 176        |        | 01.97  | 03.00 |                |        |   |                             |          |
|             | 2.4         | 103        |        | 08.99  | 03.00 |                |        |   |                             |          |
|             | 2.4         | 125        |        | 01.97  | 03.00 |                |        |   |                             |          |
|             | 2.4 AWD     | 121        |        | 10.98  | 05.99 |                |        |   |                             |          |
|             | 2.4 Bi-Fuel | 103        |        | 08.99  | 03.00 |                |        |   |                             |          |
|             | 2.4 T       | 142        |        | 01.97  | 03.00 |                |        |   |                             |          |
|             | 2.5         | 106        |        | 01.97  | 03.00 |                |        |   |                             |          |
|             | 2.5         | 121        |        | 06.98  | 03.00 |                |        |   |                             |          |
| 2.5 Bi-Fuel | 106         |            | 10.98  | 08.99  |       |                |        |   |                             |          |
| 2.5 TDI     | 103         |            | 01.97  | 03.00  |       |                |        |   |                             |          |
|             | 2.0         | 93         | 395001 | 01.97  |       | 24.2419-0939.3 | 030065 |   | - Rohrleitung <sup>1)</sup> | Gz 19,05 |
|             | 2.0         | 105        | 395001 | 01.97  |       |                |        |   |                             |          |
|             | 2.0 20V     | 120        | 395001 | 01.97  |       |                |        |   |                             |          |
|             | 2.0 20V     | 132        | 395001 | 01.97  |       |                |        |   |                             |          |
|             | 2.0 T       | 155        | 395001 | 01.97  |       |                |        |   |                             |          |
|             | 2.0 T       | 166        | 395001 | 01.97  |       |                |        |   |                             |          |
|             | 2.0 T AWD   | 166        | 395001 | 01.97  |       |                |        |   |                             |          |
|             | 2.3 AWD     |            | 395001 | 04.97  |       |                |        |   |                             |          |
|             | 2.3 T       | 184        | 395001 | 01.97  |       |                |        |   |                             |          |
|             | 2.3 T AWD   | 184        | 395001 | 04.97  |       |                |        |   |                             |          |
|             | 2.3 T5      | 176        | 395001 | 01.97  |       |                |        |   |                             |          |
|             | 2.3 T5 AWD  | 176        | 395001 | 01.97  |       |                |        |   |                             |          |
|             | 2.4         | 125        | 395001 | 01.97  |       |                |        |   |                             |          |
|             | 2.4 AWD     | 121        | 395001 | 10.98  |       |                |        |   |                             |          |
|             | 2.4 T       | 142        | 395001 | 01.97  |       |                |        |   |                             |          |
|             | 2.5         | 106        | 395001 | 01.97  |       |                |        |   |                             |          |
| 2.5 T AWD   | 142         | 395001     | 01.97  |        |       |                |        |   |                             |          |
| 2.5 TDI     | 103         | 395001     | 01.97  |        |       |                |        |   |                             |          |
|             | 2.0         | 93         | 395002 |        | 03.00 | 24.2419-1724.3 | 030113 |   |                             | Gz 19,05 |
|             | 2.0         | 105        | 395002 |        | 03.00 |                |        |   |                             |          |
|             | 2.0 20V     | 120        | 395002 |        | 03.00 |                |        |   |                             |          |
|             | 2.0 20V     | 132        | 395002 |        | 03.00 |                |        |   |                             |          |
|             | 2.0 T       | 155        | 395002 |        | 03.00 |                |        |   |                             |          |
|             | 2.0 T       | 166        | 395002 |        | 03.00 |                |        |   |                             |          |
|             | 2.0 T AWD   | 166        | 395002 |        | 03.00 |                |        |   |                             |          |
|             | 2.3 AWD     |            | 395002 |        | 09.98 |                |        |   |                             |          |
|             | 2.3 T       | 184        | 395002 |        | 03.00 |                |        |   |                             |          |
|             | 2.3 T AWD   | 184        | 395002 |        | 03.00 |                |        |   |                             |          |
|             | 2.3 T5      | 176        | 395002 |        | 03.00 |                |        |   |                             |          |
|             | 2.3 T5 AWD  | 176        | 395002 |        | 03.00 |                |        |   |                             |          |
|             | 2.4         | 103        |        | 08.99  | 03.00 |                |        |   |                             |          |
|             | 2.4         | 125        | 395002 |        | 03.00 |                |        |   |                             |          |
|             | 2.4 AWD     | 121        | 395002 |        | 05.99 |                |        |   |                             |          |
|             | 2.4 Bi-Fuel | 103        |        | 08.99  | 03.00 |                |        |   |                             |          |
| 2.4 T       | 142         | 395002     |        | 03.00  |       |                |        |   |                             |          |
| 2.5         | 106         | 395002     |        | 03.00  |       |                |        |   |                             |          |
| 2.5         | 121         |            | 06.98  | 03.00  |       |                |        |   |                             |          |
| 2.5 AWD     | 195         |            | 03.99  | 03.00  |       |                |        |   |                             |          |
| 2.5 Bi-Fuel | 106         |            | 10.98  | 08.99  |       |                |        |   |                             |          |
| 2.5 T AWD   | 142         | 395002     |        | 03.00  |       |                |        |   |                             |          |

<sup>1)</sup> - pipe line / - tubazione / - conduite rigide / - latiguillo





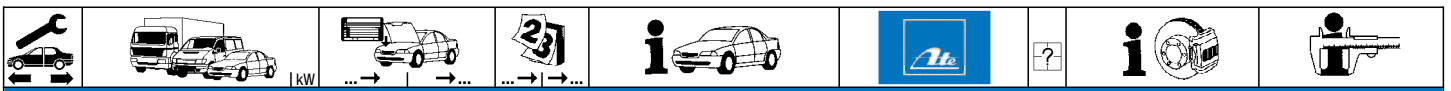

**VOLVO V70 I (97-00)**

|  |           |             |        |       |       |  |                |        |  |          |
|--|-----------|-------------|--------|-------|-------|--|----------------|--------|--|----------|
|  | 2.5 TDI   | #103 395002 |        |       | 03.00 |  | 24.2419-1724.3 | 030113 |  | Gz 19,05 |
|  | 2.0       | 93          | 395001 | 01.97 |       |  | 24.2522-0907.3 | 040043 |  | Nz 22,20 |
|  | 2.0       | 105         | 395001 | 01.97 |       |  |                |        |  |          |
|  | 2.0 20V   | 120         | 395001 | 01.97 |       |  |                |        |  |          |
|  | 2.0 20V   | 132         | 395001 | 01.97 |       |  |                |        |  |          |
|  | 2.4       | 125         | 395001 | 01.97 |       |  |                |        |  |          |
|  | 2.4 AWD   | 121         | 395001 | 10.98 |       |  |                |        |  |          |
|  | 2.4 T     | 142         | 395001 | 01.97 |       |  |                |        |  |          |
|  | 2.5       | 106         | 395001 | 01.97 |       |  |                |        |  |          |
|  | 2.5 T AWD | 142         | 395001 | 01.97 |       |  |                |        |  |          |
|  | 2.5 TDI   | 103         | 395001 | 01.97 |       |  |                |        |  |          |

**VOLVO V70 II (00-07)**

|  |             |            |       |       |       |  |                |        |        |             |     |
|--|-------------|------------|-------|-------|-------|--|----------------|--------|--------|-------------|-----|
|  | 2.0 T       | 132        |       | 07.01 | 12.01 |  | 03.7755-3402.4 | 300189 | - DSTC | 9/8" Tandem | ATE |
|  | 2.3         | 195        |       | 10.00 | 12.01 |  |                |        |        |             |     |
|  | 2.3 T5      | 184        |       | 03.00 | 12.01 |  |                |        |        |             |     |
|  | 2.4         |            |       | 03.00 | 12.01 |  |                |        |        |             |     |
|  | 2.4         | 103        |       | 03.00 | 12.01 |  |                |        |        |             |     |
|  | 2.4 4X4     | 121        |       | 03.00 | 12.01 |  |                |        |        |             |     |
|  | 2.4 Bi-Fuel | 103        |       | 09.01 | 12.01 |  |                |        |        |             |     |
|  | 2.4 D       | 96         |       | 12.01 | 12.01 |  |                |        |        |             |     |
|  | 2.4 D5      | 120        |       | 08.01 | 12.01 |  |                |        |        |             |     |
|  | 2.4 T       | 147        |       | 03.00 | 12.01 |  |                |        |        |             |     |
|  | 2.4 T AWD   | 147        |       | 09.01 | 12.01 |  |                |        |        |             |     |
|  | 2.5 TDI     | 103        |       | 03.00 | 12.01 |  |                |        |        |             |     |
|  | 2.0 T       | 132        |       | 01.02 | 07.07 |  | 03.7755-4702.4 | 300224 | - DSTC | 9/8" Tandem | ATE |
|  | 2.3         | 195        |       | 10.00 | 09.04 |  | 03.7858-3532.4 | 300233 | + DSTC | 9/8" Tandem | ATE |
|  | 2.3 T5      | 184        |       | 01.02 | 07.07 |  |                |        |        |             |     |
|  | 2.4         |            |       | 01.02 | 07.07 |  |                |        |        |             |     |
|  | 2.4         | 103        |       | 01.02 | 07.07 |  |                |        |        |             |     |
|  | 2.4 4X4     | 121        |       | 01.02 | 09.03 |  |                |        |        |             |     |
|  | 2.4 Bi-Fuel | 103        |       | 01.02 | 07.07 |  |                |        |        |             |     |
|  | 2.4 D       | 93         |       | 05.05 | 07.07 |  |                |        |        |             |     |
|  | 2.4 D       | 96         |       | 01.02 | 07.07 |  |                |        |        |             |     |
|  | 2.4 D5      | 120        |       | 01.02 | 07.07 |  |                |        |        |             |     |
|  | 2.4 D5      | 136        |       | 12.05 | 07.07 |  |                |        |        |             |     |
|  | 2.4 D5 AWD  | 120        |       | 03.03 | 07.07 |  |                |        |        |             |     |
|  | 2.4 D5 AWD  | 136        |       | 12.05 | 07.07 |  |                |        |        |             |     |
|  | 2.4 T       | 147        |       | 01.02 | 07.07 |  |                |        |        |             |     |
|  | 2.4 T AWD   | 147        |       | 01.02 | 07.07 |  |                |        |        |             |     |
|  | 2.4 T5      | 191        |       | 04.04 | 07.07 |  |                |        |        |             |     |
|  | 2.5 T       | 154        |       | 04.04 | 07.07 |  |                |        |        |             |     |
|  | 2.5 T AWD   | 154        |       | 09.02 | 07.07 |  |                |        |        |             |     |
|  | 2.5 TDI     | 103        |       | 01.02 | 07.07 |  |                |        |        |             |     |
|  | R 2.5 T AWD | 221        |       | 03.03 | 07.07 |  |                |        |        |             |     |
|  | 2.0 T       | 132        | 68132 | 07.01 |       |  | 03.2125-7637.3 | 010707 | - DSTC | Thz 25,40   | ATE |
|  | 2.3         | 195        | 68132 | 10.00 |       |  |                |        |        |             |     |
|  | 2.3 T5      | 184        | 68132 | 03.00 |       |  |                |        |        |             |     |
|  | 2.4         |            | 68132 | 03.00 |       |  |                |        |        |             |     |
|  | 2.4         | 103        | 68132 | 03.00 |       |  |                |        |        |             |     |
|  | 2.4 4X4     | 121        | 68132 | 03.00 |       |  |                |        |        |             |     |
|  | 2.4 Bi-Fuel | 103        | 68132 | 09.01 |       |  |                |        |        |             |     |
|  | 2.4 D       | 96         | 68132 | 12.01 |       |  |                |        |        |             |     |
|  | 2.4 D5      | 120        | 68132 | 08.01 |       |  |                |        |        |             |     |
|  | 2.4 T       | 147        | 68132 | 03.00 |       |  |                |        |        |             |     |
|  | 2.4 T AWD   | 147        | 68132 | 09.01 |       |  |                |        |        |             |     |
|  | 2.5 TDI     | 103        | 68132 | 03.00 |       |  |                |        |        |             |     |
|  | 2.0 T       | #132 68133 |       | 07.07 |       |  | 03.2125-7743.3 | 010921 | - DSTC | Thz 25,40   | ATE |
|  | 2.3         | #195 68133 |       | 09.04 |       |  |                |        |        |             |     |
|  | 2.3 T5      | #184 68133 |       | 07.07 |       |  |                |        |        |             |     |
|  | 2.4         | # 68133    |       | 07.07 |       |  |                |        |        |             |     |
|  | 2.4         | #103 68133 |       | 07.07 |       |  |                |        |        |             |     |
|  | 2.4 4X4     | #121 68133 |       | 09.03 |       |  |                |        |        |             |     |
|  | 2.4 Bi-Fuel | #103 68133 |       | 07.07 |       |  |                |        |        |             |     |
|  | 2.4 D       | # 93       |       | 05.05 | 07.07 |  |                |        |        |             |     |
|  | 2.4 D       | # 96 68133 |       | 07.07 |       |  |                |        |        |             |     |
|  | 2.4 D5      | #120 68133 |       | 07.07 |       |  |                |        |        |             |     |
|  | 2.4 D5      | #136       |       | 12.05 | 07.07 |  |                |        |        |             |     |
|  | 2.4 D5 AWD  | #120       |       | 03.03 | 07.07 |  |                |        |        |             |     |
|  | 2.4 D5 AWD  | #136       |       | 12.05 | 07.07 |  |                |        |        |             |     |
|  | 2.4 T       | #147 68133 |       | 07.07 |       |  |                |        |        |             |     |
|  | 2.4 T AWD   | #147 68133 |       | 07.07 |       |  |                |        |        |             |     |
|  | 2.4 T5      | #191       |       | 04.04 | 07.07 |  |                |        |        |             |     |
|  | 2.5 T       | #154       |       | 04.04 | 07.07 |  |                |        |        |             |     |
|  | 2.5 T AWD   | #154       |       | 09.02 | 07.07 |  |                |        |        |             |     |
|  | 2.5 TDI     | #103 68133 |       | 07.07 |       |  |                |        |        |             |     |
|  | R 2.5 T AWD | #221       |       | 03.03 | 07.07 |  |                |        |        |             |     |
|  | 2.0 T       | #132       | 70377 | 07.01 |       |  | 03.2125-7708.3 | 010739 | + DSTC | Thz 25,40   | ATE |
|  | 2.3         | #195       | 70377 | 10.00 |       |  |                |        |        |             |     |
|  | 2.3 T5      | #184       | 70377 | 03.00 |       |  |                |        |        |             |     |
|  | 2.4         | #          | 70377 | 03.00 |       |  |                |        |        |             |     |
|  | 2.4         | #103       | 70377 | 03.00 |       |  |                |        |        |             |     |
|  | 2.4 4X4     | #121       | 70377 | 03.00 |       |  |                |        |        |             |     |
|  | 2.4 Bi-Fuel | #103       | 70377 | 09.01 |       |  |                |        |        |             |     |
|  | 2.4 D       | # 96       | 70377 | 12.01 |       |  |                |        |        |             |     |

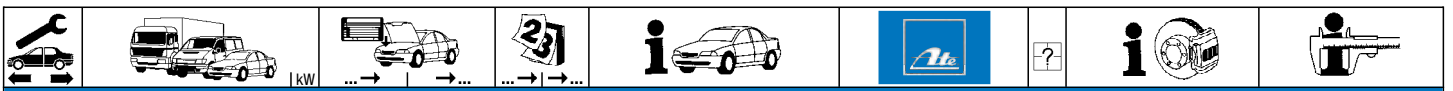

































**VOLVO V70 II (00-07)**

|             |             |           |       |       |                |                |        |                         |                |     |
|-------------|-------------|-----------|-------|-------|----------------|----------------|--------|-------------------------|----------------|-----|
|             | 2.4 D5      | 120       | 70377 | 08.01 |                | 03.2125-7708.3 | 010739 | + DSTC                  | THz 25,40      | ATE |
|             | 2.4 T       | 147       | 70377 | 03.00 |                |                |        |                         |                |     |
|             | 2.4 T AWD   | 147       | 70377 | 09.01 |                |                |        |                         |                |     |
|             | 2.5 TDI     | 103       | 70377 | 03.00 |                |                |        |                         |                |     |
|             | 2.0 T       | 132 70378 |       |       | 07.07          | 03.2125-7713.3 | 010819 | + DSTC                  | THz 25,40      | ATE |
|             | 2.3         | 195 70378 |       |       | 09.04          |                |        |                         |                |     |
|             | 2.3 T5      | 184 70378 |       |       | 07.07          |                |        |                         |                |     |
|             | 2.4         | 70378     |       |       | 07.07          |                |        |                         |                |     |
|             | 2.4         | 103 70378 |       |       | 07.07          |                |        |                         |                |     |
|             | 2.4 4X4     | 121 70378 |       |       | 09.03          |                |        |                         |                |     |
|             | 2.4 Bi-Fuel | 103 70378 |       |       | 07.07          |                |        |                         |                |     |
|             | 2.4 D       | 93        |       | 05.05 | 07.07          |                |        |                         |                |     |
|             | 2.4 D       | 96 70378  |       |       | 07.07          |                |        |                         |                |     |
|             | 2.4 D5      | 120 70378 |       |       | 07.07          |                |        |                         |                |     |
|             | 2.4 D5      | 136       |       | 12.05 | 07.07          |                |        |                         |                |     |
|             | 2.4 D5 AWD  | 120       |       | 03.03 | 07.07          |                |        |                         |                |     |
|             | 2.4 D5 AWD  | 136       |       | 12.05 | 07.07          |                |        |                         |                |     |
|             | 2.4 T       | 147 70378 |       |       | 07.07          |                |        |                         |                |     |
|             | 2.4 T AWD   | 147 70378 |       |       | 07.07          |                |        |                         |                |     |
|             | 2.4 T5      | 191       |       | 04.04 | 07.07          |                |        |                         |                |     |
| 2.5 T       | 154         |           | 04.04 | 07.07 |                |                |        |                         |                |     |
| 2.5 T AWD   | 154         |           | 09.02 | 07.07 |                |                |        |                         |                |     |
| 2.5 TDI     | 103 70378   |           |       | 07.07 |                |                |        |                         |                |     |
| R 2.5 T AWD | 221         |           | 03.03 | 07.07 |                |                |        |                         |                |     |
| 2.0 T       | 132 68133   |           |       | 07.07 | 03.2125-7638.3 | 010738         | - DSTC | THz 25,40               | ATE            |     |
| 2.3         | 195 68133   |           |       | 09.04 |                |                |        |                         |                |     |
| 2.3 T5      | 184 68133   |           |       | 07.07 |                |                |        |                         |                |     |
| 2.4         | 68133       |           |       | 07.07 |                |                |        |                         |                |     |
| 2.4         | 103 68133   |           |       | 07.07 |                |                |        |                         |                |     |
| 2.4 4X4     | 121 68133   |           |       | 09.03 |                |                |        |                         |                |     |
| 2.4 Bi-Fuel | 103 68133   |           |       | 07.07 |                |                |        |                         |                |     |
| 2.4 D       | 93          |           | 05.05 | 07.07 |                |                |        |                         |                |     |
| 2.4 D       | 96 68133    |           |       | 07.07 |                |                |        |                         |                |     |
| 2.4 D5      | 120 68133   |           |       | 07.07 |                |                |        |                         |                |     |
| 2.4 D5      | 136         |           | 12.05 | 07.07 |                |                |        |                         |                |     |
| 2.4 D5 AWD  | 120 68133   |           |       | 07.07 |                |                |        |                         |                |     |
| 2.4 D5 AWD  | 136         |           | 12.05 | 07.07 |                |                |        |                         |                |     |
| 2.4 T       | 147 68133   |           |       | 07.07 |                |                |        |                         |                |     |
| 2.4 T AWD   | 147 68133   |           |       | 07.07 |                |                |        |                         |                |     |
| 2.4 T5      | 191         |           | 04.04 | 07.07 |                |                |        |                         |                |     |
| 2.5 T       | 154         |           | 04.04 | 07.07 |                |                |        |                         |                |     |
| 2.5 T AWD   | 154         |           | 09.02 | 07.07 |                |                |        |                         |                |     |
| 2.5 TDI     | 103 68133   |           |       | 07.07 |                |                |        |                         |                |     |
| 2.0 T       | 132         | 67770     | 67770 | 07.01 |                | 03.2125-7637.3 | 010707 | + DSTC                  | THz 25,40      | ATE |
| 2.3         | 195         | 67770     | 67770 | 10.00 |                |                |        |                         |                |     |
| 2.3 T5      | 184         | 67770     | 67770 | 03.00 |                |                |        |                         |                |     |
| 2.4         | 67770       | 67770     | 67770 | 03.00 |                |                |        |                         |                |     |
| 2.4         | 103         | 67770     | 67770 | 03.00 |                |                |        |                         |                |     |
| 2.4 4X4     | 121         | 67770     | 67770 | 03.00 |                |                |        |                         |                |     |
| 2.4 Bi-Fuel | 103         | 67770     | 67770 | 09.01 |                |                |        |                         |                |     |
| 2.4 D       | 96          | 67770     | 67770 | 12.01 |                |                |        |                         |                |     |
| 2.4 D5      | 120         | 67770     | 67770 | 08.01 |                |                |        |                         |                |     |
| 2.4 T       | 147         | 67770     | 67770 | 03.00 |                |                |        |                         |                |     |
| 2.4 T AWD   | 147         | 67770     | 67770 | 09.01 |                |                |        |                         |                |     |
| 2.5 TDI     | 103         | 67770     | 67770 | 03.00 |                |                |        |                         |                |     |
| 2.0 T       | 132 67771   |           |       | 07.07 | 03.2125-7638.3 | 010738         | + DSTC | THz 25,40               | ATE            |     |
| 2.3         | 195 67771   |           |       | 09.04 |                |                |        |                         |                |     |
| 2.3 T5      | 184 67771   |           |       | 07.07 |                |                |        |                         |                |     |
| 2.4         | 67771       |           |       | 07.07 |                |                |        |                         |                |     |
| 2.4         | 103 67771   |           |       | 07.07 |                |                |        |                         |                |     |
| 2.4 4X4     | 121         |           | 03.00 | 09.03 |                |                |        |                         |                |     |
| 2.4 Bi-Fuel | 103 67771   |           |       | 07.07 |                |                |        |                         |                |     |
| 2.4 D       | 93          |           | 05.05 | 07.07 |                |                |        |                         |                |     |
| 2.4 D       | 96 67771    |           |       | 07.07 |                |                |        |                         |                |     |
| 2.4 D5      | 120 67771   |           |       | 07.07 |                |                |        |                         |                |     |
| 2.4 D5      | 136         |           | 12.05 | 07.07 |                |                |        |                         |                |     |
| 2.4 D5 AWD  | 120         |           | 03.03 | 07.07 |                |                |        |                         |                |     |
| 2.4 D5 AWD  | 136         |           | 12.05 | 07.07 |                |                |        |                         |                |     |
| 2.4 T       | 147 67771   |           |       | 07.07 |                |                |        |                         |                |     |
| 2.4 T AWD   | 147 67771   |           |       | 07.07 |                |                |        |                         |                |     |
| 2.4 T5      | 191         |           | 04.04 | 07.07 |                |                |        |                         |                |     |
| 2.5 T       | 154         |           | 04.04 | 07.07 |                |                |        |                         |                |     |
| 2.5 T AWD   | 154         |           | 09.02 | 07.07 |                |                |        |                         |                |     |
| 2.5 TDI     | 103 67771   |           |       | 07.07 |                |                |        |                         |                |     |
| R 2.5 T AWD | 221         |           | 03.03 | 07.07 |                |                |        |                         |                |     |
|             | 2.0 T       | 132       |       | 07.01 | 12.02          | 11.9601-9829.2 | 220505 | - 17" Rad <sup>1)</sup> | D=60, - Halter | ATE |
|             | 2.3         | 195       |       | 10.00 | 12.02          | 11.9601-9830.2 | 220506 | - 17" Rad <sup>1)</sup> | D=60, - Halter | ATE |
|             | 2.3 T5      | 184       |       | 03.00 | 12.02          | 24.3601-9829.5 | 240507 | - 17" Rad <sup>1)</sup> | D=60, - Halter | ATE |
|             | 2.4         |           |       | 03.00 | 12.02          | 24.3601-9830.5 | 240508 | - 17" Rad <sup>1)</sup> | D=60, - Halter | ATE |
|             | 2.4         | 103       |       | 03.00 | 12.02          | 11.0101-5407.2 | 260011 | - 17" Rad <sup>1)</sup> | Hülsensatz     | ATE |
|             | 2.4 4X4     | 121       |       | 03.00 | 09.03          | 11.8171-0008.1 | 990049 |                         | Führungsbolzen | ATE |
|             | 2.4 Bi-Fuel | 103       |       | 09.01 | 12.02          |                |        |                         |                |     |
|             | 2.4 D       | 96        |       | 12.01 | 12.02          |                |        |                         |                |     |
|             | 2.4 D5      | 120       |       | 08.01 | 12.02          |                |        |                         |                |     |
|             | 2.4 T       | 147       |       | 03.00 | 12.02          |                |        |                         |                |     |
|             | 2.4 T AWD   | 147       |       | 09.01 | 12.02          |                |        |                         |                |     |
|             | 2.5 T AWD   | 154       |       | 09.02 | 12.02          |                |        |                         |                |     |

<sup>1)</sup> - 17" wheel / - ruota 17" / - roue 17" / - rueda 17"



|     |  |  |  |  |  |  |    |    |   |  |  |
|--|--|--|--|--|---|--|--|--|---|--|--|
| <b>VOLVO V70 II (00-07)</b>  |  |  |  |  |   |  |  |  |   |  |  |
|    | 2.5 TDI  | 103  |  | 03.00  | 12.02   |  | 11.9601-9829.2 220505<br>11.9601-9830.2 220506<br>24.3601-9829.5 240507<br>24.3601-9830.5 240508<br>11.0101-5407.2 260011<br>11.8171-0008.1 990049   |  - 17" Rad <sup>1)</sup><br> - 17" Rad <sup>1)</sup><br> - 17" Rad <sup>1)</sup><br> - 17" Rad <sup>1)</sup>   | D=60, - Halter<br>D=60, - Halter<br>D=60, - Halter<br>Hülsensatz<br>Führungsbolzen  | ATE<br>ATE<br>ATE<br>ATE<br>ATE<br>ATE                             |  |
|  | 2.0 T  | 132  |  | 01.03  | 07.07   |  | 11.9601-9829.2 220505<br>11.9601-9830.2 220506<br>24.3601-9829.5 240507<br>24.3601-9830.5 240508<br>11.9571-9863.2 220513<br>11.9571-9864.2 220514<br>11.8116-0366.2 390587<br>11.8171-0067.1 250153<br>11.0101-5407.2 260011<br>11.8171-0008.1 990049 |  - 17" Rad <sup>1)</sup><br> - 17" Rad <sup>1)</sup><br> - 17" Rad <sup>1)</sup><br> - 17" Rad <sup>1)</sup><br> + 17" Rad <sup>2)</sup><br> + 17" Rad <sup>2)</sup> | D=60, - Halter<br>D=60, - Halter<br>D=60, - Halter<br>D=60, - Halter<br>D=57, - Halter<br>D=57, - Halter<br>Haltefeder<br>Führungsbolzen<br>Hülsensatz<br>Führungsbolzen    | ATE<br>ATE<br>ATE<br>ATE<br>ATE<br>ATE<br>ATE<br>ATE<br>ATE<br>ATE |  |
|    | 2.0 T  | 132  |  | 07.01  | 07.07   |  | 83.6113-0321.3 330621<br>83.6124-0304.3 330983   | 2<br>2   | - 17" Rad <sup>1)</sup><br>+ 17" Rad <sup>2)</sup>  | L=320<br>L=300   |  |
|  | 2.0 T  | 132  |  | 07.01  | 07.07   |  | 11.9421-9979.2 220497<br>11.9421-9980.2 220498<br>24.3421-9979.5 240475<br>24.3421-9980.5 240476<br>11.0101-5407.2 260011<br>11.8171-0008.1 990049<br>11.8116-0236.1 390507  |  <br> <br>   | D=42, - Halter<br>D=42, - Halter<br>D=42, - Halter<br>Hülsensatz<br>Führungsbolzen<br>Haltefeder  | ATE<br>ATE<br>ATE<br>ATE<br>ATE<br>ATE                             |  |
|  | 2.0 T  | 132  |  | 07.01  | 07.07   |  | 83.7724-0268.3 331076  | 2  |   | L=265  |  |
|  | 2.0 T  | 132  |  | 07.01  | 07.07   |  | 24.3727-1303.2 581303  | 2  |   | L=1962   |  |

1) - 17" wheel / - ruota 17" / - roue 17" / - rueda 17"  
2) + 17" wheel / + ruota 17" / + roue 17" / + rueda 17"

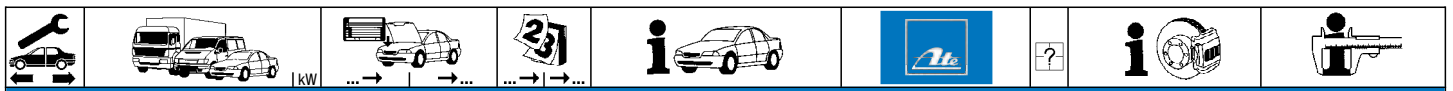

| VOLVO V70 II (00-07) |         |     |  |       |       |                |        |   |   |        |
|----------------------|---------|-----|--|-------|-------|----------------|--------|---|---|--------|
|                      | 2.4 4X4 | 121 |  | 03.00 | 09.03 | 24.3727-1303.2 | 581303 | 2 | - | L=1962 |
|                      | 2.4 D   | 93  |  | 05.05 | 07.07 |                |        |   |   |        |
|                      | 2.4 D   | 96  |  | 12.01 | 07.07 |                |        |   |   |        |
|                      | 2.4 D5  | 120 |  | 08.01 | 07.07 |                |        |   |   |        |
|                      | 2.4 D5  | 136 |  | 12.05 | 07.07 |                |        |   |   |        |
|                      | 2.4 T   | 147 |  | 03.00 | 07.07 |                |        |   |   |        |
|                      | 2.4 T5  | 191 |  | 04.04 | 07.07 |                |        |   |   |        |
|                      | 2.5 T   | 154 |  | 04.04 | 07.07 |                |        |   |   |        |
|                      | 2.5 TDI | 103 |  | 03.00 | 07.07 |                |        |   |   |        |

| VOLVO V70 III (07-) |                 |     |        |       |  |                |        |   |                                      |                |     |
|---------------------|-----------------|-----|--------|-------|--|----------------|--------|---|--------------------------------------|----------------|-----|
|                     | 1.6 T4F         | 132 | 213000 | 01.11 |  | 03.7755-9703.4 | 300239 |   | - Kollisionswarnsystem <sup>1)</sup> | 9/8" Tandem    | ATE |
|                     | 2.0 D3          | 100 | 213000 | 05.12 |  | 03.7858-5032.4 | 300275 |   | + Kollisionswarnsystem <sup>2)</sup> | 9/8" Tandem    | ATE |
|                     | 2.0 D3          | 120 | 213000 | 03.10 |  |                |        |   |                                      |                |     |
|                     | 2.4 D           | 120 | 213000 | 08.07 |  |                |        |   |                                      |                |     |
|                     | 2.4 D           | 129 | 213000 | 10.09 |  |                |        |   |                                      |                |     |
|                     | 2.4 D5          | 136 | 213000 | 08.07 |  |                |        |   |                                      |                |     |
|                     | 2.4 D5          | 151 | 213000 | 12.09 |  |                |        |   |                                      |                |     |
|                     | 2.4 D5          | 158 | 213000 | 06.11 |  |                |        |   |                                      |                |     |
|                     | 2.4 D5 AWD      | 136 | 213000 | 10.07 |  |                |        |   |                                      |                |     |
|                     | 2.4 D5 AWD      | 151 | 213000 | 12.09 |  |                |        |   |                                      |                |     |
|                     | 2.4 D5 AWD      | 158 | 213000 | 06.11 |  |                |        |   |                                      |                |     |
|                     | 2.5 T           | 147 | 213000 | 08.07 |  |                |        |   |                                      |                |     |
|                     | 2.5 T           | 170 | 213000 | 10.09 |  |                |        |   |                                      |                |     |
|                     | 2.5 T FlexiFuel | 147 | 213000 | 04.08 |  |                |        |   |                                      |                |     |
|                     | 2.5 T FlexiFuel | 170 | 213000 | 10.09 |  |                |        |   |                                      |                |     |
|                     | 3.0 T6 AWD      | 210 | 213000 | 08.07 |  |                |        |   |                                      |                |     |
|                     | 3.0 T6 AWD      | 224 | 213000 | 04.11 |  |                |        |   |                                      |                |     |
|                     | 3.2             | 175 | 213000 | 08.07 |  |                |        |   |                                      |                |     |
|                     | 3.2 AWD         | 175 | 213000 | 08.07 |  |                |        |   |                                      |                |     |
|                     | T4              | 132 | 213000 | 10.10 |  |                |        |   |                                      |                |     |
|                     | 1.6 DRIVE       | 107 |        | 01.10 |  | 03.7755-9703.4 | 300239 |   | - Kollisionswarnsystem <sup>1)</sup> | 9/8" Tandem    | ATE |
|                     | 2.0             | 107 |        | 10.07 |  |                |        |   |                                      |                |     |
|                     | 2.0 D           | 100 |        | 10.07 |  |                |        |   |                                      |                |     |
|                     | 2.0 FlexiFuel   | 107 |        | 09.07 |  |                |        |   |                                      |                |     |
|                     | 2.0 T           | 149 |        | 01.10 |  |                |        |   |                                      |                |     |
|                     | T5              | 177 |        | 01.10 |  |                |        |   |                                      |                |     |
|                     | 1.6 DRIVE       | 107 |        | 01.10 |  | 03.7858-4832.4 | 300274 |   | + Kollisionswarnsystem <sup>2)</sup> | 9/8" Tandem    | ATE |
|                     | 2.0             | 107 |        | 10.07 |  |                |        |   |                                      |                |     |
|                     | 2.0 D           | 100 |        | 10.07 |  |                |        |   |                                      |                |     |
|                     | 2.0 FlexiFuel   | 107 |        | 09.07 |  |                |        |   |                                      |                |     |
|                     | 2.0 T           | 149 |        | 01.10 |  |                |        |   |                                      |                |     |
|                     | T5              | 177 |        | 01.10 |  |                |        |   |                                      |                |     |
|                     | 1.6 DRIVE       |     |        | 01.10 |  | 11.9601-9711.2 | 220873 | 2 | + 16" Rad <sup>3)</sup>              | D=60, - Halter | ATE |
|                     | 1.6 T4F         | 132 |        | 01.11 |  | 11.9601-9712.2 | 220874 |   | + 16" Rad <sup>3)</sup>              | D=60, - Halter | ATE |
|                     | 2.0             | 107 |        | 10.07 |  | 11.8116-0206.1 | 390593 |   | + 16" Rad <sup>3)</sup>              | Haltefeder     | ATE |
|                     | 2.0 D           | 100 |        | 10.07 |  | 11.0101-5407.2 | 260011 |   |                                      | Hülzensatz     | ATE |
|                     | 2.0 D3          | 100 |        | 05.12 |  | 11.8171-0008.1 | 990049 |   |                                      | Führungsbolzen | ATE |
|                     | 2.0 D3          | 120 |        | 03.10 |  | 11.0441-6008.2 | 250038 |   |                                      | Dichtungssatz  | ATE |
|                     | 2.0 D4          | 120 |        | 01.13 |  |                |        |   |                                      |                |     |
|                     | 2.0 FlexiFuel   | 107 |        | 09.07 |  |                |        |   |                                      |                |     |
|                     | 2.0 T           | 149 |        | 01.10 |  |                |        |   |                                      |                |     |
|                     | 2.4 D           | 120 |        | 08.07 |  |                |        |   |                                      |                |     |
|                     | 2.4 D           | 129 |        | 10.09 |  |                |        |   |                                      |                |     |
|                     | 2.4 D4 AWD      | 120 |        | 01.13 |  |                |        |   |                                      |                |     |
|                     | 2.4 D5          | 136 |        | 08.07 |  |                |        |   |                                      |                |     |
|                     | 2.4 D5          | 151 |        | 12.09 |  |                |        |   |                                      |                |     |
|                     | 2.4 D5          | 158 |        | 06.11 |  |                |        |   |                                      |                |     |
|                     | 2.4 D5 AWD      | 136 |        | 10.07 |  |                |        |   |                                      |                |     |
|                     | 2.4 D5 AWD      | 151 |        | 12.09 |  |                |        |   |                                      |                |     |
|                     | 2.4 D5 AWD      | 158 |        | 06.11 |  |                |        |   |                                      |                |     |
|                     | 2.5 T           | 147 |        | 08.07 |  |                |        |   |                                      |                |     |
|                     | 2.5 T           | 170 |        | 10.09 |  |                |        |   |                                      |                |     |
|                     | 2.5 T FlexiFuel | 147 |        | 04.08 |  |                |        |   |                                      |                |     |
|                     | 2.5 T FlexiFuel | 170 |        | 10.09 |  |                |        |   |                                      |                |     |
|                     | 3.0 T6 AWD      | 210 |        | 08.07 |  |                |        |   |                                      |                |     |
|                     | 3.0 T6 AWD      | 224 |        | 04.11 |  |                |        |   |                                      |                |     |
|                     | 3.2             | 175 |        | 08.07 |  |                |        |   |                                      |                |     |
|                     | 3.2 AWD         | 175 |        | 08.07 |  |                |        |   |                                      |                |     |
|                     | T4              | 132 |        | 10.10 |  |                |        |   |                                      |                |     |
|                     | T5              | 177 |        | 01.10 |  |                |        |   |                                      |                |     |
|                     | 1.6 DRIVE       |     |        | 01.10 |  | 11.9606-9949.2 | 220879 | 2 | + 17" Rad <sup>4)</sup>              | D=60, - Halter | ATE |
|                     | 1.6 T4F         | 132 |        | 01.11 |  | 11.9606-9950.2 | 220880 |   | + 17" Rad <sup>4)</sup>              | D=60, - Halter | ATE |
|                     | 2.0             | 107 |        | 10.07 |  | 11.8116-0388.2 | 390588 |   |                                      | Haltefeder     | ATE |
|                     | 2.0 D           | 100 |        | 10.07 |  | 11.8171-0008.1 | 990049 |   |                                      | Führungsbolzen | ATE |
|                     | 2.0 D3          | 100 |        | 05.12 |  | 11.0101-5704.2 | 260095 |   |                                      | Hülzensatz     | ATE |
|                     | 2.0 D3          | 120 |        | 03.10 |  | 11.0441-6008.2 | 250038 |   |                                      | Dichtungssatz  | ATE |
|                     | 2.0 D4          | 120 |        | 01.13 |  |                |        |   |                                      |                |     |
|                     | 2.0 FlexiFuel   | 107 |        | 09.07 |  |                |        |   |                                      |                |     |
|                     | 2.0 T           | 149 |        | 01.10 |  |                |        |   |                                      |                |     |
|                     | 2.4 D           | 120 |        | 08.07 |  |                |        |   |                                      |                |     |
|                     | 2.4 D           | 129 |        | 10.09 |  |                |        |   |                                      |                |     |
|                     | 2.4 D4 AWD      | 120 |        | 01.13 |  |                |        |   |                                      |                |     |
|                     | 2.4 D5          | 136 |        | 08.07 |  |                |        |   |                                      |                |     |
|                     | 2.4 D5          | 151 |        | 12.09 |  |                |        |   |                                      |                |     |
|                     | 2.4 D5          | 158 |        | 06.11 |  |                |        |   |                                      |                |     |
|                     | 2.4 D5 AWD      | 136 |        | 10.07 |  |                |        |   |                                      |                |     |

1) - collision warning system / - sistema anti-collisione / - système anticollision / - sistema anticollision  
 2) + collision warning system / + sistema anti-collisione / + système anticollision / + sistema anticollision  
 3) + 16" wheel / + ruota 16" / + roue 16" / + rueda 16"  
 4) + 17" wheel / + ruota 17" / + roue 17" / + rueda 17"



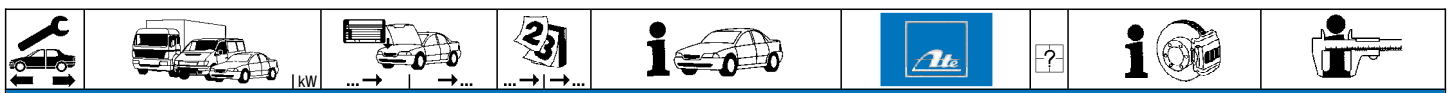

**VOLVO V70 III (07-)**

|                 |                 |       |       |       |  |                |        |   |                                  |   |  |   |                              |   |  |
|-----------------|-----------------|-------|-------|-------|--|----------------|--------|---|----------------------------------|---|--|---|------------------------------|---|--|
|                 | 2.4 D5 AWD      | 151   |       | 12.09 |  | 11.9606-9949.2 | 220879 | 2 | + 17" Rad 1)<br>+ 17" Rad 1)     | D=60, - Halter<br>D=60, - Halter<br>Haltefeder<br>Führungsbolzen<br>Hülzensatz<br>Dichtungssatz | ATE<br>ATE<br>ATE<br>ATE<br>ATE<br>ATE |   |                              |   |  |
|                 | 2.4 D5 AWD      | 158   |       | 06.11 |  | 11.9606-9950.2 | 220880 |   |                                  |   |  |   |                              |   |  |
|                 | 2.5 T           | 147   |       | 08.07 |  | 11.8116-0388.2 | 390588 |   |                                  |   |  |   |                              |   |  |
|                 | 2.5 T           | 170   |       | 10.09 |  | 11.8171-0008.1 | 990049 |   |                                  |   |  |   |                              |   |  |
|                 | 2.5 T FlexiFuel | 147   |       | 04.08 |  | 11.0101-5704.2 | 260095 |   |                                  |   |  |   |                              |   |  |
|                 | 2.5 T FlexiFuel | 170   |       | 10.09 |  | 11.0441-6008.2 | 250038 |   |                                  |   |  |   |                              |   |  |
|                 | 3.0 T6 AWD      | 210   |       | 08.07 |  |                |        |   |                                  |   |  |   |                              |   |  |
|                 | 3.0 T6 AWD      | 224   |       | 04.11 |  |                |        |   |                                  |   |  |   |                              |   |  |
|                 | 3.2             | 175   |       | 08.07 |  |                |        |   |                                  |   |  |   |                              |   |  |
|                 | 3.2 AWD         | 175   |       | 08.07 |  |                |        |   |                                  |   |  |   |                              |   |  |
|                 | T4              | 132   |       | 10.10 |  |                |        |   |                                  |   |  |   |                              |   |  |
|                 | T5              | 177   |       | 01.10 |  |                |        |   |                                  |   |  |   |                              |   |  |
|                 | 1.6 DRIVE       |       |       | 01.10 |  | 11.9606-9945.2 | 220727 |   |                                  |   |  | 2 | + 18" Rad 2)<br>+ 18" Rad 2) | D=60, - Halter<br>D=60, - Halter<br>Haltefeder<br>Hülzensatz<br>Führungsbolzen<br>Dichtungssatz | ATE<br>ATE<br>ATE<br>ATE<br>ATE<br>ATE |
|                 | 1.6 T4F         | 132   |       | 01.11 |  | 11.9606-9946.2 | 220728 |   |                                  |   |  |   |                              |   |  |
|                 | 2.0             | 107   |       | 10.07 |  | 11.8116-0388.2 | 390588 |   |                                  |   |  |   |                              |   |  |
|                 | 2.0 D           | 100   |       | 10.07 |  | 11.0101-5704.2 | 260095 |   |                                  |   |  |   |                              |   |  |
|                 | 2.0 D3          | 100   |       | 05.12 |  | 11.8171-0008.1 | 990049 |   |                                  |   |  |   |                              |   |  |
|                 | 2.0 D3          | 120   |       | 03.10 |  | 11.0441-6008.2 | 250038 |   |                                  |   |  |   |                              |   |  |
| 2.0 D4          | 120             |       | 01.13 |       |  |                |        |   |                                  |   |  |   |                              |   |  |
| 2.0 FlexiFuel   | 107             |       | 09.07 |       |  |                |        |   |                                  |   |  |   |                              |   |  |
| 2.0 T           | 149             |       | 01.10 |       |  |                |        |   |                                  |   |  |   |                              |   |  |
| 2.4 D           | 120             |       | 08.07 |       |  |                |        |   |                                  |   |  |   |                              |   |  |
| 2.4 D           | 129             |       | 10.09 |       |  |                |        |   |                                  |   |  |   |                              |   |  |
| 2.4 D4 AWD      | 120             |       | 01.13 |       |  |                |        |   |                                  |   |  |   |                              |   |  |
| 2.4 D5          | 136             |       | 08.07 |       |  |                |        |   |                                  |   |  |   |                              |   |  |
| 2.4 D5          | 151             |       | 12.09 |       |  |                |        |   |                                  |   |  |   |                              |   |  |
| 2.4 D5          | 158             |       | 06.11 |       |  |                |        |   |                                  |   |  |   |                              |   |  |
| 2.4 D5 AWD      | 136             |       | 10.07 |       |  |                |        |   |                                  |   |  |   |                              |   |  |
| 2.4 D5 AWD      | 151             |       | 12.09 |       |  |                |        |   |                                  |   |  |   |                              |   |  |
| 2.4 D5 AWD      | 158             |       | 06.11 |       |  |                |        |   |                                  |   |  |   |                              |   |  |
| 2.5 T           | 147             |       | 08.07 |       |  |                |        |   |                                  |   |  |   |                              |   |  |
| 2.5 T           | 170             |       | 10.09 |       |  |                |        |   |                                  |   |  |   |                              |   |  |
| 2.5 T FlexiFuel | 147             |       | 04.08 |       |  |                |        |   |                                  |   |  |   |                              |   |  |
| 2.5 T FlexiFuel | 170             |       | 10.09 |       |  |                |        |   |                                  |   |  |   |                              |   |  |
| 3.0 T6 AWD      | 210             |       | 08.07 |       |  |                |        |   |                                  |   |  |   |                              |   |  |
| 3.0 T6 AWD      | 224             |       | 04.11 |       |  |                |        |   |                                  |   |  |   |                              |   |  |
| 3.2             | 175             |       | 08.07 |       |  |                |        |   |                                  |   |  |   |                              |   |  |
| 3.2 AWD         | 175             |       | 08.07 |       |  |                |        |   |                                  |   |  |   |                              |   |  |
| T4              | 132             |       | 10.10 |       |  |                |        |   |                                  |   |  |   |                              |   |  |
| T5              | 177             |       | 01.10 |       |  |                |        |   |                                  |   |  |   |                              |   |  |
|                 | 1.6 DRIVE       |       |       | 01.10 |  | 24.5162-0390.3 | 331199 | 2 | + 16" Rad 3)<br>+ 17"/18" Rad 4) | L=390<br>L=375  |  |   |                              |   |  |
|                 | 1.6 T4F         | 132   |       | 01.11 |  | 24.5162-0375.3 | 331203 |   |                                  |   |  |   |                              |   |  |
|                 | 2.0             | 107   |       | 10.07 |  |                |        |   |                                  |   |  |   |                              |   |  |
|                 | 2.0 D           | 100   |       | 10.07 |  |                |        |   |                                  |   |  |   |                              |   |  |
|                 | 2.0 D3          | 100   |       | 05.12 |  |                |        |   |                                  |   |  |   |                              |   |  |
|                 | 2.0 D3          | 120   |       | 03.10 |  |                |        |   |                                  |   |  |   |                              |   |  |
|                 | 2.0 D4          | 120   |       | 01.13 |  |                |        |   |                                  |   |  |   |                              |   |  |
|                 | 2.0 FlexiFuel   | 107   |       | 09.07 |  |                |        |   |                                  |   |  |   |                              |   |  |
|                 | 2.0 T           | 149   |       | 01.10 |  |                |        |   |                                  |   |  |   |                              |   |  |
|                 | 2.4 D           | 120   |       | 08.07 |  |                |        |   |                                  |   |  |   |                              |   |  |
|                 | 2.4 D           | 129   |       | 10.09 |  |                |        |   |                                  |   |  |   |                              |   |  |
|                 | 2.4 D4 AWD      | 120   |       | 01.13 |  |                |        |   |                                  |   |  |   |                              |   |  |
|                 | 2.4 D5          | 136   |       | 08.07 |  |                |        |   |                                  |   |  |   |                              |   |  |
|                 | 2.4 D5          | 151   |       | 12.09 |  |                |        |   |                                  |   |  |   |                              |   |  |
|                 | 2.4 D5          | 158   |       | 06.11 |  |                |        |   |                                  |   |  |   |                              |   |  |
|                 | 2.4 D5 AWD      | 136   |       | 10.07 |  |                |        |   |                                  |   |  |   |                              |   |  |
|                 | 2.4 D5 AWD      | 151   |       | 12.09 |  |                |        |   |                                  |   |  |   |                              |   |  |
|                 | 2.4 D5 AWD      | 158   |       | 06.11 |  |                |        |   |                                  |   |  |   |                              |   |  |
| 2.5 T           | 147             |       | 08.07 |       |  |                |        |   |                                  |   |  |   |                              |   |  |
| 2.5 T           | 170             |       | 10.09 |       |  |                |        |   |                                  |   |  |   |                              |   |  |
| 2.5 T FlexiFuel | 147             |       | 04.08 |       |  |                |        |   |                                  |   |  |   |                              |   |  |
| 2.5 T FlexiFuel | 170             |       | 10.09 |       |  |                |        |   |                                  |   |  |   |                              |   |  |
| 3.0 T6 AWD      | 210             |       | 08.07 |       |  |                |        |   |                                  |   |  |   |                              |   |  |
| 3.0 T6 AWD      | 224             |       | 04.11 |       |  |                |        |   |                                  |   |  |   |                              |   |  |
| 3.2             | 175             |       | 08.07 |       |  |                |        |   |                                  |   |  |   |                              |   |  |
| 3.2 AWD         | 175             |       | 08.07 |       |  |                |        |   |                                  |   |  |   |                              |   |  |
| T4              | 132             |       | 10.10 |       |  |                |        |   |                                  |   |  |   |                              |   |  |
| T5              | 177             |       | 01.10 |       |  |                |        |   |                                  |   |  |   |                              |   |  |
|                 | 1.6 DRIVE       | ‡     | 24894 | 01.10 |  | 24.5162-0185.3 | 331202 | 2 | + mechanische Feststellbremse 5) | L=185   |  |   |                              |   |  |
|                 | 1.6 T4F         | ‡132  | 24894 | 01.11 |  |                |        |   |                                  |   |  |   |                              |   |  |
|                 | 2.0             | ‡107  | 24894 | 10.07 |  |                |        |   |                                  |   |  |   |                              |   |  |
|                 | 2.0 D           | ‡100  | 24894 | 10.07 |  |                |        |   |                                  |   |  |   |                              |   |  |
|                 | 2.0 D3          | ‡100  | 24894 | 05.12 |  |                |        |   |                                  |   |  |   |                              |   |  |
|                 | 2.0 D3          | ‡120  | 24894 | 03.10 |  |                |        |   |                                  |   |  |   |                              |   |  |
|                 | 2.0 D4          | ‡120  | 24894 | 01.13 |  |                |        |   |                                  |   |  |   |                              |   |  |
|                 | 2.0 FlexiFuel   | ‡107  | 24894 | 09.07 |  |                |        |   |                                  |   |  |   |                              |   |  |
|                 | 2.0 T           | ‡149  | 24894 | 01.10 |  |                |        |   |                                  |   |  |   |                              |   |  |
|                 | 2.4 D           | ‡120  | 24894 | 08.07 |  |                |        |   |                                  |   |  |   |                              |   |  |
|                 | 2.4 D           | ‡129  | 24894 | 10.09 |  |                |        |   |                                  |   |  |   |                              |   |  |
|                 | 2.4 D4 AWD      | ‡120  | 24894 | 01.13 |  |                |        |   |                                  |   |  |   |                              |   |  |
|                 | 2.4 D5          | ‡136  | 24894 | 08.07 |  |                |        |   |                                  |   |  |   |                              |   |  |
|                 | 2.4 D5          | ‡151  | 24894 | 12.09 |  |                |        |   |                                  |   |  |   |                              |   |  |
|                 | 2.4 D5          | ‡158  | 24894 | 06.11 |  |                |        |   |                                  |   |  |   |                              |   |  |
|                 | 2.4 D5 AWD      | ‡136  | 24894 | 10.07 |  |                |        |   |                                  |   |  |   |                              |   |  |
|                 | 2.4 D5 AWD      | ‡151  | 24894 | 12.09 |  |                |        |   |                                  |   |  |   |                              |   |  |
|                 | 2.4 D5 AWD      | ‡158  | 24894 | 06.11 |  |                |        |   |                                  |   |  |   |                              |   |  |
| 2.5 T           | ‡147            | 24894 | 08.07 |       |  |                |        |   |                                  |   |  |   |                              |   |  |

1) + 17" wheel / + ruota 17" / + roue 17" / + rueda 17"

2) + 18" wheel / + ruota 18" / + roue 18" / + rueda 18"

3) + 16" wheel / + ruota 16" / + roue 16" / + rueda 16"

4) + 17"/18" wheel / + ruota 17"/18" / + roue 17"/18" / + rueda 17"/18"

5) + mechanical parking brake / + fr. stazionamento meccanico / + frein à main mécanique / + freno de mano mecánica

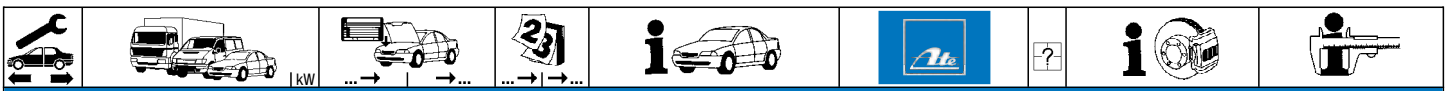

**VOLVO V70 III (07-)**



















|  |                 |           |       |       |                |        |   |   |       |
|--|-----------------|-----------|-------|-------|----------------|--------|---|---|-------|
|  | 2.5 T           | 170       | 24894 | 10.09 | 24.5162-0185.3 | 331202 | 2 | + mechanische Feststellbremse <sup>1)</sup> | L=185 |
|  | 2.5 T FlexiFuel | 147       | 24894 | 04.08 |                |        |   |   |       |
|  | 2.5 T FlexiFuel | 170       | 24894 | 10.09 |                |        |   |   |       |
|  | 3.0 T6 AWD      | 210       | 24894 | 08.07 |                |        |   |   |       |
|  | 3.0 T6 AWD      | 224       | 24894 | 04.11 |                |        |   |   |       |
|  | 3.2             | 175       | 24894 | 08.07 |                |        |   |   |       |
|  | 3.2 AWD         | 175       | 24894 | 08.07 |                |        |   |   |       |
|  | T4              | 132       | 24894 | 10.10 |                |        |   |   |       |
|  | T5              | 177       | 24894 | 01.10 |                |        |   |   |       |
|  | 1.6 DRIVE       | 24895     |       |       | 24.5162-0185.3 | 331202 | 2 | + mechanische Feststellbremse <sup>1)</sup> | L=185 |
|  | 1.6 T4F         | 132 24895 |       |       |                |        |   |   |       |
|  | 2.0             | 107 24895 |       |       |                |        |   |   |       |
|  | 2.0 D           | 100 24895 |       |       |                |        |   |   |       |
|  | 2.0 D3          | 100 24895 |       |       |                |        |   |   |       |
|  | 2.0 D3          | 120 24895 |       |       |                |        |   |   |       |
|  | 2.0 D4          | 120 24895 |       |       |                |        |   |   |       |
|  | 2.0 FlexiFuel   | 107 24895 |       |       |                |        |   |   |       |
|  | 2.0 T           | 149 24895 |       |       |                |        |   |   |       |
|  | 2.4 D           | 120 24895 |       |       |                |        |   |   |       |
|  | 2.4 D           | 129 24895 |       |       |                |        |   |   |       |
|  | 2.4 D4 AWD      | 120 24895 |       |       |                |        |   |   |       |
|  | 2.4 D5          | 136 24895 |       |       |                |        |   |   |       |
|  | 2.4 D5          | 151 24895 |       |       |                |        |   |   |       |
|  | 2.4 D5 AWD      | 136 24895 |       |       |                |        |   |   |       |
|  | 2.4 D5 AWD      | 151 24895 |       |       |                |        |   |   |       |
|  | 2.4 D5 AWD      | 158 24895 |       |       |                |        |   |   |       |
|  | 2.4 D5 AWD      | 158 24895 |       |       |                |        |   |   |       |
|  | 2.5 T           | 147 24895 |       |       |                |        |   |   |       |
|  | 2.5 T           | 170 24895 |       |       |                |        |   |   |       |
|  | 2.5 T FlexiFuel | 147 24895 |       |       |                |        |   |   |       |
|  | 2.5 T FlexiFuel | 170 24895 |       |       |                |        |   |   |       |
|  | 3.0 T6 AWD      | 210 24895 |       |       |                |        |   |   |       |
|  | 3.0 T6 AWD      | 224 24895 |       |       |                |        |   |   |       |
|  | 3.2             | 175 24895 |       |       |                |        |   |   |       |
|  | 3.2 AWD         | 175 24895 |       |       |                |        |   |   |       |
|  | T4              | 132 24895 |       |       |                |        |   |   |       |
|  | T5              | 177 24895 |       |       |                |        |   |   |       |
|  | 1.6 DRIVE       |           |       | 01.10 | 24.5162-0185.3 | 331202 | 2 | + mechanische Feststellbremse <sup>1)</sup> | L=185 |
|  | 1.6 T4F         | 132       |       | 01.10 |                |        |   |   |       |
|  | 2.0             | 107       |       | 10.07 |                |        |   |   |       |
|  | 2.0 D           | 100       |       | 10.07 |                |        |   |   |       |
|  | 2.0 D3          | 100       |       | 05.12 |                |        |   |   |       |
|  | 2.0 D3          | 120       |       | 03.10 |                |        |   |   |       |
|  | 2.0 D4          | 120       |       | 01.13 |                |        |   |   |       |
|  | 2.0 FlexiFuel   | 107       |       | 09.07 |                |        |   |   |       |
|  | 2.0 T           | 149       |       | 01.10 |                |        |   |   |       |
|  | 2.4 D           | 120       |       | 08.07 |                |        |   |   |       |
|  | 2.4 D           | 129       |       | 10.09 |                |        |   |   |       |
|  | 2.4 D4 AWD      | 120       |       | 01.13 |                |        |   |   |       |
|  | 2.4 D5          | 136       |       | 08.07 |                |        |   |   |       |
|  | 2.4 D5          | 151       |       | 12.09 |                |        |   |   |       |
|  | 2.4 D5          | 158       |       | 06.11 |                |        |   |   |       |
|  | 2.4 D5 AWD      | 136       |       | 10.07 |                |        |   |   |       |
|  | 2.4 D5 AWD      | 151       |       | 12.09 |                |        |   |   |       |
|  | 2.4 D5 AWD      | 158       |       | 06.11 |                |        |   |   |       |
|  | 2.5 T           | 147       |       | 08.07 |                |        |   |   |       |
|  | 2.5 T           | 170       |       | 10.09 |                |        |   |   |       |
|  | 2.5 T FlexiFuel | 147       |       | 04.08 |                |        |   |   |       |
|  | 2.5 T FlexiFuel | 170       |       | 10.09 |                |        |   |   |       |
|  | 3.0 T6 AWD      | 210       |       | 08.07 |                |        |   |   |       |
|  | 3.0 T6 AWD      | 224       |       | 04.11 |                |        |   |   |       |
|  | 3.2             | 175       |       | 08.07 |                |        |   |   |       |
|  | 3.2 AWD         | 175       |       | 08.07 |                |        |   |   |       |
|  | T4              | 132       |       | 10.10 |                |        |   |   |       |
|  | T5              | 177       |       | 01.10 |                |        |   |   |       |
|  | 1.6 DRIVE       |           | 24894 | 01.10 | 24.5133-0310.3 | 331197 |   | + elektrische Feststellbremse <sup>2)</sup> | L=310 |
|  | 1.6 T4F         | 132       | 24894 | 01.11 |                |        |   |   |       |
|  | 2.0             | 107       | 24894 | 10.07 |                |        |   |   |       |
|  | 2.0 D           | 100       | 24894 | 10.07 |                |        |   |   |       |
|  | 2.0 D3          | 100       | 24894 | 05.12 |                |        |   |   |       |
|  | 2.0 D3          | 120       | 24894 | 03.10 |                |        |   |   |       |
|  | 2.0 D4          | 120       | 24894 | 01.13 |                |        |   |   |       |
|  | 2.0 FlexiFuel   | 107       | 24894 | 09.07 |                |        |   |   |       |
|  | 2.0 T           | 149       | 24894 | 01.10 |                |        |   |   |       |
|  | 2.4 D           | 120       | 24894 | 08.07 |                |        |   |   |       |
|  | 2.4 D           | 129       | 24894 | 10.09 |                |        |   |   |       |
|  | 2.4 D4 AWD      | 120       | 24894 | 01.13 |                |        |   |   |       |
|  | 2.4 D5          | 136       | 24894 | 08.07 |                |        |   |   |       |
|  | 2.4 D5          | 151       | 24894 | 12.09 |                |        |   |   |       |
|  | 2.4 D5          | 158       | 24894 | 06.11 |                |        |   |   |       |
|  | 2.4 D5 AWD      | 136       | 24894 | 10.07 |                |        |   |   |       |
|  | 2.4 D5 AWD      | 151       | 24894 | 12.09 |                |        |   |   |       |
|  | 2.4 D5 AWD      | 158       | 24894 | 06.11 |                |        |   |   |       |
|  | 2.5 T           | 147       | 24894 | 08.07 |                |        |   |   |       |
|  | 2.5 T           | 170       | 24894 | 10.09 |                |        |   |   |       |
|  | 2.5 T FlexiFuel | 147       | 24894 | 04.08 |                |        |   |   |       |
|  | 2.5 T FlexiFuel | 170       | 24894 | 10.09 |                |        |   |   |       |

<sup>1)</sup> + mechanical parking brake / + fr. stazionamento meccanico / + frein à main mécanique / + freno de mano mecánica

<sup>2)</sup> + electric parking brake / + freno a mano elettrico / + frein à main électrique / + freno de mano eléctrico





| VOLVO V70 III (07-)  |  |  |  |  |   |  |  |  |     |
|--|--|--|--|--|---|--|--|--|-----|
|     |  |  |  |  |  |  |  |  |     |
|    | 3.0 T6 AWD   | 210  | 24894  | 08.07  | 24.5133-0310.3  | 331197   | + elektrische Feststellbremse <sup>1)</sup>  | L=310  |     |
|  | 3.0 T6 AWD   | 224  | 24894  | 04.11  |   |  |  |  |     |
|  | 3.2  | 175  | 24894  | 08.07  |   |  |  |  |     |
|  | 3.2 AWD  | 175  | 24894  | 08.07  |   |  |  |  |     |
|  | T4   | 132  | 24894  | 10.10  |   |  |  |  |     |
|  | T5   | 177  | 24894  | 01.10  |   |  |  |  |     |
|  | 1.6 DRIVE  | 24895  | 125608   |  | 24.5133-0311.3  | 331198   | + elektrische Feststellbremse <sup>1)</sup>  | L=310  |     |
|  | 1.6 T4F  | 132 24895  | 125608   |  |   |  |  |  |     |
|  | 2.0  | 107 24895  | 125608   |  |   |  |  |  |     |
|  | 2.0 D  | 100 24895  | 125608   |  |   |  |  |  |     |
|  | 2.0 D3   | 100 24895  | 125608   |  |   |  |  |  |     |
|  | 2.0 D3   | 120 24895  | 125608   |  |   |  |  |  |     |
|  | 2.0 D4   | 120 24895  | 125608   |  |   |  |  |  |     |
|  | 2.0 FlexiFuel  | 107 24895  | 125608   |  |   |  |  |  |     |
|  | 2.0 T  | 149 24895  | 125608   |  |   |  |  |  |     |
|  | 2.4 D  | 120 24895  | 125608   |  |   |  |  |  |     |
|  | 2.4 D  | 129 24895  | 125608   |  |   |  |  |  |     |
|  | 2.4 D4 AWD   | 120 24895  | 125608   |  |   |  |  |  |     |
|  | 2.4 D5   | 136 24895  | 125608   |  |   |  |  |  |     |
|  | 2.4 D5   | 151 24895  | 125608   |  |   |  |  |  |     |
|  | 2.4 D5   | 158 24895  | 125608   |  |   |  |  |  |     |
|  | 2.4 D5 AWD   | 136 24895  | 125608   |  |   |  |  |  |     |
|  | 2.4 D5 AWD   | 151 24895  | 125608   |  |   |  |  |  |     |
|  | 2.4 D5 AWD   | 158 24895  | 125608   |  |   |  |  |  |     |
|  | 2.5 T  | 147 24895  | 125608   |  |   |  |  |  |     |
|  | 2.5 T  | 170 24895  | 125608   |  |   |  |  |  |     |
|  | 2.5 T FlexiFuel  | 147 24895  | 125608   |  |   |  |  |  |     |
|  | 2.5 T FlexiFuel  | 170 24895  | 125608   |  |   |  |  |  |     |
|  | 3.0 T6 AWD   | 210 24895  | 125608   |  |   |  |  |  |     |
|  | 3.0 T6 AWD   | 224 24895  | 125608   |  |   |  |  |  |     |
|  | 3.2  | 175 24895  | 125608   |  |   |  |  |  |     |
|  | 3.2 AWD  | 175 24895  | 125608   |  |   |  |  |  |     |
|  | T4   | 132 24895  | 125608   |  |   |  |  |  |     |
|  | T5   | 177 24895  | 125608   |  |   |  |  |  |     |
| VOLVO V90 (97-98)  |  |  |  |  |   |  |  |  |     |
|    | 2.5  | 125  |  | 11.96 10.98  | 03.2023-0875.3  | 010890   |  | Thz 23,81/20,64 - B.   | ATE |
|  | 2.5  | 132  |  | 11.96 10.97  |   |  |  |  |     |
|  | 2.9  | 132  |  | 01.97 12.98  |   |  |  |  |     |
|  | 2.9  | 150  |  | 01.97 12.98  |   |  |  |  |     |
|  | 2.5  | 125  |  | 11.96 10.98  | 24.3571-1707.5  | 240079   | +<br>+   | D=57, - Halter   | LUC |
|  | 2.5  | 132  |  | 11.96 10.97  | 24.3571-1708.5  | 240080   |  | D=57, - Halter   | LUC |
|  | 2.9  | 132  |  | 01.97 12.98  | 24.0101-3601.2  | 260044   |  | Einbausatz   | LUC |
|  | 2.9  | 150  |  | 01.97 12.98  |   |  |  |  |     |
|  | 2.5  | 125  |  | 11.96 10.98  | 83.6124-0380.3  | 330268   | 2  | L=380  |     |
|  | 2.5  | 132  |  | 11.96 10.97  |   |  |  |  |     |
|  | 2.9  | 132  |  | 01.97 12.98  |   |  |  |  |     |
|  | 2.9  | 150  |  | 01.97 12.98  |   |  |  |  |     |
|  | 2.5  | 125  |  | 11.96 10.98  | 83.6134-0300.3  | 330725   | 2  | L=300  |     |
|  | 2.5  | 132  |  | 11.96 10.97  |   |  |  |  |     |
|  | 2.9  | 132  |  | 01.97 12.98  |   |  |  |  |     |
|  | 2.9  | 150  |  | 01.97 12.98  |   |  |  |  |     |
|  | 2.5  | 125  |  | 11.96 10.98  | 03.6055-0430.3  | 320065   |  | BR 5/25 (4)  | ATE |
|  | 2.5  | 132  |  | 11.96 10.97  |   |  |  |  |     |
|  | 2.9  | 132  |  | 01.97 12.98  |   |  |  |  |     |
|  | 2.9  | 150  |  | 01.97 12.98  |   |  |  |  |     |
|  | 2.5  | †125   |  | 11.96 10.98  | 24.2419-0941.3  | 030067   |  | Gz 19,05   |     |
|  | 2.5  | †132   |  | 11.96 10.97  |   |  |  |  |     |
|  | 2.9  | †132   |  | 01.97 12.98  |   |  |  |  |     |
|  | 2.9  | †150   |  | 01.97 12.98  |   |  |  |  |     |
|  | 2.5  | †125   |  | 11.96 10.98  | 24.2419-0928.3  | 030056   |  | Gz 19,05   |     |
|  | 2.5  | †132   |  | 11.96 10.97  |   |  |  |  |     |
|  | 2.9  | †132   |  | 01.97 12.98  |   |  |  |  |     |
|  | 2.9  | †150   |  | 01.97 12.98  |   |  |  |  |     |
|  | 2.5  | 125  |  | 11.96 10.98  | 03.2522-0420.3  | 040086   |  | Nz 22,20   |     |
|  | 2.5  | 132  |  | 11.96 10.97  |   |  |  |  |     |
|  | 2.9  | 132  |  | 01.97 12.98  |   |  |  |  |     |
|  | 2.9  | 150  |  | 01.97 12.98  |   |  |  |  |     |
| VOLVO XC60 (08-)   |  |  |  |  |   |  |  |  |     |
|  | 2.0 D3 DRIVe   | 120  |  | 03.10  | 03.7755-0132.4  | 300265   | - Kollisionswarnsystem <sup>2)</sup>   | 9/8" Tandem  | ATE |
|  | 2.4 D  | 120  |  | 07.09  | 03.7858-5132.4  | 300276   | + Kollisionswarnsystem <sup>3)</sup>   | 9/8" Tandem  | ATE |
|  | 2.4 D  | 129  |  | 04.09  |   |  |  |  |     |
|  | 2.4 D AWD  | 120  |  | 09.08  |   |  |  |  |     |
|  | 2.4 D5   | 158  |  | 06.11  |   |  |  |  |     |
|  | 2.4 D5 AWD   | 136  |  | 09.08  |   |  |  |  |     |
|  | 2.4 D5 AWD   | 151  |  | 04.09  |   |  |  |  |     |
|  | 2.4 D5 AWD   | 158  | 236999   | 06.11  |   |  |  |  |     |
|  | 3.0 T6 AWD   | 210  |  | 09.08  |   |  |  |  |     |
|  | 3.0 T6 AWD   | 224  | 236999   | 03.10  |   |  |  |  |     |
|  | 3.2 AWD  | 175  |  | 04.09  |   |  |  |  |     |
|  | 3.2 AWD  | 179  | 236999   | 03.10  |   |  |  |  |     |

<sup>1)</sup> + electric parking brake / + freno a mano elettrico / + frein à main électrique / + freno de mano eléctrico

<sup>2)</sup> - collision warning system / - sistema anti-collozione / - système anticollision / - sistema anticollision

<sup>3)</sup> + collision warning system / + sistema anti-collozione / + système anticollision / + sistema anticollision

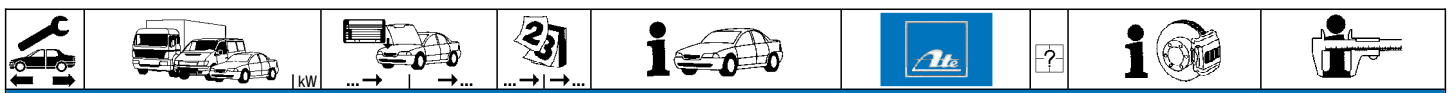

| VOLVO XC60 (08-) |              |     |  |       |  |  |  |                |        |   |  |  |            |     |
|------------------|--------------|-----|--|-------|--|--|--|----------------|--------|---|--|--|------------|-----|
|                  | 2.0 D3       | 100 |  | 04.12 |  |  |  | 11.8116-0133.1 | 390511 | 2 |  |  | Haltefeder | ATE |
|                  | 2.0 D3 DRIVe | 120 |  | 03.10 |  |  |  |                |        |   |  |  |            |     |
|                  | 2.0 T        | 149 |  | 03.10 |  |  |  |                |        |   |  |  |            |     |
|                  | 2.4 D        | 120 |  | 07.09 |  |  |  |                |        |   |  |  |            |     |
|                  | 2.4 D        | 129 |  | 04.09 |  |  |  |                |        |   |  |  |            |     |
|                  | 2.4 D AWD    | 120 |  | 09.08 |  |  |  |                |        |   |  |  |            |     |
|                  | 2.4 D5       | 158 |  | 06.11 |  |  |  |                |        |   |  |  |            |     |
|                  | 2.4 D5 AWD   | 136 |  | 09.08 |  |  |  |                |        |   |  |  |            |     |
|                  | 2.4 D5 AWD   | 151 |  | 04.09 |  |  |  |                |        |   |  |  |            |     |
|                  | 2.4 D5 AWD   | 158 |  | 06.11 |  |  |  |                |        |   |  |  |            |     |
|                  | 3.0 T6 AWD   | 210 |  | 09.08 |  |  |  |                |        |   |  |  |            |     |
|                  | 3.0 T6 AWD   | 224 |  | 03.10 |  |  |  |                |        |   |  |  |            |     |
|                  | 3.2 AWD      | 175 |  | 04.09 |  |  |  |                |        |   |  |  |            |     |
|                  | 3.2 AWD      | 179 |  | 03.10 |  |  |  |                |        |   |  |  |            |     |
|                  | T5           | 177 |  | 09.10 |  |  |  |                |        |   |  |  |            |     |

| VOLVO XC70 I CROSS COUNTRY (00-07) |               |     |       |       |       |  |  |                |        |   |        |                  |                |     |
|------------------------------------|---------------|-----|-------|-------|-------|--|--|----------------|--------|---|--------|------------------|----------------|-----|
|                                    | 2.4 T XC AWD  |     |       | 11.97 | 12.01 |  |  | 03.7755-3402.4 | 300189 |   | - DSTC |                  | 9/8" Tandem    | ATE |
|                                    | 2.4 AWD       | 121 |       | 03.00 | 09.03 |  |  | 03.7755-4702.4 | 300224 |   | - DSTC |                  | 9/8" Tandem    | ATE |
|                                    | 2.4 D5 AWD    | 136 |       | 12.05 | 07.07 |  |  |                |        |   |        |                  |                |     |
|                                    | 2.4 T XC AWD  |     |       | 01.02 | 09.02 |  |  |                |        |   |        |                  |                |     |
|                                    | 2.5 D5 XC AWD | 120 |       | 09.02 | 07.07 |  |  |                |        |   |        |                  |                |     |
|                                    | 2.5 T XC AWD  | 154 |       | 09.02 | 07.07 |  |  |                |        |   |        |                  |                |     |
|                                    | 2.4 AWD       | 121 |       | 03.00 | 09.03 |  |  | 03.7858-3532.4 | 300233 |   | + DSTC |                  | 9/8" Tandem    | ATE |
|                                    | 2.4 D5 AWD    | 136 |       | 12.05 | 07.07 |  |  |                |        |   |        |                  |                |     |
|                                    | 2.4 T XC AWD  |     |       | 11.97 | 09.02 |  |  |                |        |   |        |                  |                |     |
|                                    | 2.5 D5 XC AWD | 120 |       | 09.02 | 07.07 |  |  |                |        |   |        |                  |                |     |
|                                    | 2.5 T XC AWD  | 154 |       | 09.02 | 07.07 |  |  |                |        |   |        |                  |                |     |
|                                    | 2.4 T XC AWD  |     | 11000 | 11.97 |       |  |  | 03.2125-7637.3 | 010707 |   | - DSTC |                  | Thz 25,40      | ATE |
|                                    | 2.4 AWD       | 121 |       | 03.00 | 09.03 |  |  | 03.2125-7743.3 | 010921 |   | - DSTC |                  | Thz 25,40      | ATE |
|                                    | 2.4 D5 AWD    | 136 |       | 12.05 | 07.07 |  |  |                |        |   |        |                  |                |     |
|                                    | 2.4 T XC AWD  |     | 11001 |       | 09.02 |  |  |                |        |   |        |                  |                |     |
|                                    | 2.5 D5 XC AWD | 120 |       | 09.02 | 07.07 |  |  |                |        |   |        |                  |                |     |
|                                    | 2.5 T XC AWD  | 154 |       | 09.02 | 07.07 |  |  |                |        |   |        |                  |                |     |
|                                    | 2.4 T XC AWD  |     | 66913 | 11.97 |       |  |  | 03.2125-7708.3 | 010739 |   | + DSTC |                  | Thz 25,40      | ATE |
|                                    | 2.4 AWD       | 121 |       | 03.00 | 09.03 |  |  | 03.2125-7713.3 | 010819 |   | + DSTC |                  | Thz 25,40      | ATE |
|                                    | 2.4 D5 AWD    | 136 |       | 12.05 | 07.07 |  |  |                |        |   |        |                  |                |     |
|                                    | 2.4 T XC AWD  |     | 66914 |       | 09.02 |  |  |                |        |   |        |                  |                |     |
|                                    | 2.5 D5 XC AWD | 120 |       | 09.02 | 07.07 |  |  |                |        |   |        |                  |                |     |
|                                    | 2.5 T XC AWD  | 154 |       | 09.02 | 07.07 |  |  |                |        |   |        |                  |                |     |
|                                    | 2.4 T XC AWD  |     | 11000 | 11.97 |       |  |  | 03.2125-7638.3 | 010738 |   | - DSTC |                  | Thz 25,40      | ATE |
|                                    | 2.4 AWD       | 121 |       | 03.00 | 09.03 |  |  | 03.2125-7637.3 | 010707 |   | - DSTC |                  | Thz 25,40      | ATE |
|                                    | 2.4 D5 AWD    | 136 |       | 12.05 | 07.07 |  |  |                |        |   |        |                  |                |     |
|                                    | 2.4 T XC AWD  |     | 11001 |       | 09.02 |  |  |                |        |   |        |                  |                |     |
|                                    | 2.5 D5 XC AWD | 120 |       | 09.02 | 07.07 |  |  |                |        |   |        |                  |                |     |
|                                    | 2.5 T XC AWD  | 154 |       | 09.02 | 07.07 |  |  |                |        |   |        |                  |                |     |
|                                    | 2.4 T XC AWD  |     | 69018 | 11.97 |       |  |  | 03.2125-7637.3 | 010707 |   | + DSTC |                  | Thz 25,40      | ATE |
|                                    | 2.4 AWD       | 121 |       | 03.00 | 09.03 |  |  | 03.2125-7638.3 | 010738 |   | + DSTC |                  | Thz 25,40      | ATE |
|                                    | 2.4 T XC AWD  |     | 69019 |       | 09.02 |  |  |                |        |   |        |                  |                |     |
|                                    | 2.5 D5 XC AWD | 120 |       | 09.02 | 07.07 |  |  |                |        |   |        |                  |                |     |
|                                    | 2.5 T XC AWD  | 154 |       | 09.02 | 07.07 |  |  |                |        |   |        |                  |                |     |
|                                    | 2.4 AWD       | 121 |       | 03.00 | 09.03 |  |  | 11.9601-9829.2 | 220505 |   |        | + 15"/16" Rad 1) | D=60, - Halter | ATE |
|                                    | 2.4 D5 AWD    | 136 |       | 12.05 | 07.07 |  |  | 11.9601-9830.2 | 220506 |   |        | + 15"/16" Rad 1) | D=60, - Halter | ATE |
|                                    | 2.4 T XC AWD  |     |       | 11.97 | 09.02 |  |  | 24.3601-9829.5 | 240507 |   |        | + 15"/16" Rad 1) | D=60, - Halter | ATE |
|                                    | 2.5 D5 XC AWD | 120 |       | 09.02 | 07.07 |  |  | 24.3601-9830.5 | 240508 |   |        | + 15"/16" Rad 1) | D=60, - Halter | ATE |
|                                    | 2.5 T XC AWD  | 154 |       | 09.02 | 07.07 |  |  | 11.9571-9863.2 | 220513 |   |        | + 17" Rad 2)     | D=57, - Halter | ATE |
|                                    |               |     |       |       |       |  |  | 11.9571-9864.2 | 220514 |   |        | + 17" Rad 2)     | D=57, - Halter | ATE |
|                                    |               |     |       |       |       |  |  | 11.8116-0366.2 | 390587 | 2 |        | + 17" Rad 2)     | Haltefeder     | ATE |
|                                    |               |     |       |       |       |  |  | 11.0101-5407.2 | 260011 |   |        |                  | Hülsensatz     | ATE |
|                                    |               |     |       |       |       |  |  | 11.8171-0008.1 | 990049 |   |        |                  | Führungsbolzen | ATE |
|                                    |               |     |       |       |       |  |  | 83.7713-0347.3 | 330986 | 2 |        |                  | L=345          |     |
|                                    | 2.4 AWD       | 121 |       | 03.00 | 09.03 |  |  | 11.9421-9979.2 | 220497 |   |        |                  | D=42, - Halter | ATE |
|                                    | 2.4 D5 AWD    | 136 |       | 12.05 | 07.07 |  |  | 11.9421-9980.2 | 220498 |   |        |                  | D=42, - Halter | ATE |
|                                    | 2.4 T XC AWD  |     |       | 11.97 | 09.02 |  |  | 24.3421-9979.5 | 240475 |   |        |                  | D=42, - Halter | ATE |
|                                    | 2.5 D5 XC AWD | 120 |       | 09.02 | 07.07 |  |  | 24.3421-9980.5 | 240476 |   |        |                  | D=42, - Halter | ATE |
|                                    | 2.5 T XC AWD  | 154 |       | 09.02 | 07.07 |  |  | 11.8171-0008.1 | 990049 |   |        |                  | Führungsbolzen | ATE |
|                                    |               |     |       |       |       |  |  | 11.0101-5407.2 | 260011 |   |        |                  | Hülsensatz     | ATE |
|                                    |               |     |       |       |       |  |  | 11.8116-0236.1 | 390507 | 2 |        |                  | Haltefeder     | ATE |
|                                    |               |     |       |       |       |  |  | 83.7724-0268.3 | 331076 | 2 |        |                  | L=265          |     |



























| VOLVO XC70 II CROSS COUNTRY (07-) |            |     |  |       |  |  |  |                |        |  |   |  |             |     |
|-----------------------------------|------------|-----|--|-------|--|--|--|----------------|--------|--|---|--|-------------|-----|
|                                   | 2.0 D3     | 120 |  | 08.11 |  |  |  | 03.7755-9703.4 | 300239 |  |   |  | 9/8" Tandem | ATE |
|                                   | 2.0 D3 AWD | 120 |  | 08.11 |  |  |  | 03.7755-0132.4 | 300265 |  | + |  | 9/8" Tandem | ATE |
|                                   | 2.4 D      | 129 |  | 01.10 |  |  |  |                |        |  |   |  |             |     |
|                                   | 2.4 D AWD  | 120 |  | 08.07 |  |  |  |                |        |  |   |  |             |     |
|                                   | 2.4 D5 AWD | 136 |  | 08.07 |  |  |  |                |        |  |   |  |             |     |
|                                   | 2.4 D5 AWD | 151 |  | 12.09 |  |  |  |                |        |  |   |  |             |     |
|                                   | 2.4 D5 AWD | 158 |  | 06.11 |  |  |  |                |        |  |   |  |             |     |

1) + 15"/16" wheel / + ruota 15"/16" / + roue 15"/16" / + rueda 15"/16"

2) + 17" wheel / + ruota 17" / + roue 17" / + rueda 17"

3) - collision warning system (CMBB) / - sistema anti-collisione (CMBB) / - système anticollision (CMBB) / - sistema anticollisión (CMBB)



|     |  |  |  |  |  |   |   |    |                |     |                             |       |  |  |
|--|--|--|--|--|---|---|---|--|----------------|-----|-----------------------------|-------|--|--|
| <b>VOLVO XC70 II CROSS COUNTRY (07-)</b>   |  |  |  |  |   |   |   |  |                |     |                             |       |  |  |
|    | 3.0 T6 AWD   | 210  | 01.08  | - Kollisionswarnsystem (CMbB) <sup>1)</sup>                                      | 03.7755-9703.4  | 300239  | +     | 9/8" Tandem  | ATE            |     |                             |       |  |  |
|  | 3.0 T6 AWD   | 224  | 01.10  | - Kollisionswarnsystem (CMbB) <sup>1)</sup>                                      | 03.7755-0132.4  | 300265  |   | 9/8" Tandem  | ATE            |     |                             |       |  |  |
|  | 3.2  | 179  | 08.07  | - Kollisionswarnsystem (CMbB) <sup>1)</sup>                                      |   |   |   |  |                |     |                             |       |  |  |
|  | 3.2 AWD  | 175  | 08.07  | - Kollisionswarnsystem (CMbB) <sup>1)</sup>                                      |   |   |   |  |                |     |                             |       |  |  |
|  | 3.2 AWD  | 179  | 08.07  | - Kollisionswarnsystem (CMbB) <sup>1)</sup>                                      |   |   |   |  |                |     |                             |       |  |  |
|  | 2.0 D3   | 120  | 08.11  | + Kollisionswarnsystem (CMbB) <sup>2)</sup>                                      | 03.7858-5132.4  | 300276  |   | +    | 9/8" Tandem    | ATE |                             |       |  |  |
|  | 2.0 D3 AWD   | 120  | 08.11  | + Kollisionswarnsystem (CMbB) <sup>2)</sup>                                      | 03.7858-5032.4  | 300275  |   | -    | 9/8" Tandem    | ATE |                             |       |  |  |
|  | 2.4 D  | 129  | 01.10  | + Kollisionswarnsystem (CMbB) <sup>2)</sup>                                      |   |   |   |  |                |     |                             |       |  |  |
|  | 2.4 D AWD  | 120  | 08.07  | + Kollisionswarnsystem (CMbB) <sup>2)</sup>                                      |   |   |   |  |                |     |                             |       |  |  |
|  | 2.4 D5 AWD   | 136  | 08.07  | + Kollisionswarnsystem (CMbB) <sup>2)</sup>                                      |   |   |   |  |                |     |                             |       |  |  |
|  | 2.4 D5 AWD   | 151  | 12.09  | + Kollisionswarnsystem (CMbB) <sup>2)</sup>                                      |   |   |   |  |                |     |                             |       |  |  |
|  | 2.4 D5 AWD   | 158  | 06.11  | + Kollisionswarnsystem (CMbB) <sup>2)</sup>                                      |   |   |   |  |                |     |                             |       |  |  |
|  | 3.0 T6 AWD   | 210  | 01.08  | + Kollisionswarnsystem (CMbB) <sup>2)</sup>                                      |   |   |   |  |                |     |                             |       |  |  |
|  | 3.0 T6 AWD   | 224  | 01.10  | + Kollisionswarnsystem (CMbB) <sup>2)</sup>                                      |   |   |   |  |                |     |                             |       |  |  |
| 3.2  | 179  | 08.07  | + Kollisionswarnsystem (CMbB) <sup>2)</sup>                                      |  |   |   |   |  |                |     |                             |       |  |  |
| 3.2 AWD  | 175  | 08.07  | + Kollisionswarnsystem (CMbB) <sup>2)</sup>                                      |  |   |   |   |  |                |     |                             |       |  |  |
| 3.2 AWD  | 179  | 08.07  | + Kollisionswarnsystem (CMbB) <sup>2)</sup>                                      |  |   |   |   |  |                |     |                             |       |  |  |
|    | 2.0 D3   | 120  | 08.11  |  | 11.9601-9711.2  | 220873  | 2  + 16" Rad <sup>3)</sup><br> + 16" Rad <sup>3)</sup><br> + 16" Rad <sup>3)</sup> | D=60, - Halter   | ATE            |     |                             |       |  |  |
|  | 2.0 D3 AWD   | 120  | 08.11  |  | 11.9601-9712.2  | 220874  |   | D=60, - Halter   | ATE            |     |                             |       |  |  |
|  | 2.4 D  | 129  | 01.10  |  | 11.8116-0206.1  | 390593  |   | Haltefeder   | ATE            |     |                             |       |  |  |
|  | 2.4 D AWD  | 120  | 08.07  |  | 11.0101-5407.2  | 260011  |   | Hülsensatz   | ATE            |     |                             |       |  |  |
|  | 2.4 D5 AWD   | 136  | 08.07  |  | 11.8171-0008.1  | 990049  |   | Führungsbolzen   | ATE            |     |                             |       |  |  |
|  | 2.4 D5 AWD   | 151  | 12.09  |  | 11.0441-6008.2  | 250038  |   | Dichtungssatz  | ATE            |     |                             |       |  |  |
|  | 2.4 D5 AWD   | 158  | 06.11  |  |   |   |   |  |                |     |                             |       |  |  |
|  | 3.0 T6 AWD   | 210  | 01.08  |  |   |   |   |  |                |     |                             |       |  |  |
|  | 3.0 T6 AWD   | 224  | 01.10  |  |   |   |   |  |                |     |                             |       |  |  |
|  | 3.2  | 179  | 08.07  |  |   |   |   |  |                |     |                             |       |  |  |
|  | 3.2 AWD  | 175  | 08.07  |  |   |   |   |  |                |     |                             |       |  |  |
|  | 3.2 AWD  | 179  | 08.07  |  |   |   |   |  |                |     |                             |       |  |  |
|  | 2.0 D3   | 120  | 08.11  |  | 11.9606-9949.2  | 220879  |   | 2  + 17" Rad <sup>4)</sup><br> + 17" Rad <sup>4)</sup> | D=60, - Halter | ATE |                             |       |  |  |
|  | 2.0 D3 AWD   | 120  | 08.11  |  | 11.9606-9950.2  | 220880  |   |  | D=60, - Halter | ATE |                             |       |  |  |
| 2.4 D  | 129  | 01.10  |  | 11.8116-0388.2   | 390588  | Haltefeder  | ATE   |  |                |     |                             |       |  |  |
| 2.4 D AWD  | 120  | 08.07  |  | 11.8171-0008.1   | 990049  | Führungsbolzen  | ATE   |  |                |     |                             |       |  |  |
| 2.4 D5 AWD   | 136  | 08.07  |  | 11.0101-5704.2   | 260095  | Hülsensatz  | ATE   |  |                |     |                             |       |  |  |
| 2.4 D5 AWD   | 151  | 12.09  |  | 11.0441-6008.2   | 250038  | Dichtungssatz   | ATE   |  |                |     |                             |       |  |  |
| 2.4 D5 AWD   | 158  | 06.11  |  |  |   |   |   |  |                |     |                             |       |  |  |
| 3.0 T6 AWD   | 210  | 01.08  |  |  |   |   |   |  |                |     |                             |       |  |  |
| 3.0 T6 AWD   | 224  | 01.10  |  |  |   |   |   |  |                |     |                             |       |  |  |
| 3.2  | 179  | 08.07  |  |  |   |   |   |  |                |     |                             |       |  |  |
| 3.2 AWD  | 175  | 08.07  |  |  |   |   |   |  |                |     |                             |       |  |  |
| 3.2 AWD  | 179  | 08.07  |  |  |   |   |   |  |                |     |                             |       |  |  |
| 2.0 D3   | 120  | 08.11  |  | 11.9606-9945.2   | 220727  | 2  + 18" Rad <sup>5)</sup><br> + 18" Rad <sup>5)</sup><br> + 18" Rad <sup>5)</sup> | D=60, - Halter  |  | ATE            |     |                             |       |  |  |
| 2.0 D3 AWD   | 120  | 08.11  |  | 11.9606-9946.2   | 220728  |   | D=60, - Halter  |  | ATE            |     |                             |       |  |  |
| 2.4 D  | 129  | 01.10  |  | 11.8116-0388.2   | 390588  |   | Haltefeder  | ATE  |                |     |                             |       |  |  |
| 2.4 D AWD  | 120  | 08.07  |  | 11.8171-0008.1   | 990049  |   | Führungsbolzen  | ATE  |                |     |                             |       |  |  |
| 2.4 D5 AWD   | 136  | 08.07  |  | 11.0101-5704.2   | 260095  |   | Hülsensatz  | ATE  |                |     |                             |       |  |  |
| 2.4 D5 AWD   | 151  | 12.09  |  |  |   |   |   |  |                |     |                             |       |  |  |
| 2.4 D5 AWD   | 158  | 06.11  |  |  |   |   |   |  |                |     |                             |       |  |  |
| 3.0 T6 AWD   | 210  | 01.08  |  |  |   |   |   |  |                |     |                             |       |  |  |
| 3.0 T6 AWD   | 224  | 01.10  |  |  |   |   |   |  |                |     |                             |       |  |  |
| 3.2  | 179  | 08.07  |  |  |   |   |   |  |                |     |                             |       |  |  |
| 3.2 AWD  | 175  | 08.07  |  |  |   |   |   |  |                |     |                             |       |  |  |
| 3.2 AWD  | 179  | 08.07  |  |  |   |   |   |  |                |     |                             |       |  |  |
|  | 2.0 D3   | 120  | 08.11  |  | 24.5162-0390.3  |   | 331199  | 2 + 16" Rad <sup>3)</sup>  | L=390          |     |                             |       |  |  |
|  | 2.0 D3 AWD   | 120  | 08.11  |  | 24.5162-0405.3  |   | 331194  |  |                |     | + 17"/18" Rad <sup>6)</sup> | L=405 |  |  |
|  | 2.4 D  | 129  | 01.10  |  |   |   |   |  |                |     |                             |       |  |  |
|  | 2.4 D AWD  | 120  | 08.07  |  |   |   |   |  |                |     |                             |       |  |  |
|  | 2.4 D5 AWD   | 136  | 08.07  |  |   |   |   |  |                |     |                             |       |  |  |
|  | 2.4 D5 AWD   | 151  | 12.09  |  |   |   |   |  |                |     |                             |       |  |  |
|  | 2.4 D5 AWD   | 158  | 06.11  |  |   |   |   |  |                |     |                             |       |  |  |
|  | 3.0 T6 AWD   | 210  | 01.08  |  |   |   |   |  |                |     |                             |       |  |  |
|  | 3.0 T6 AWD   | 224  | 01.10  |  |   |   |   |  |                |     |                             |       |  |  |
|  | 3.2  | 179  | 08.07  |  |   |   |   |  |                |     |                             |       |  |  |
| 3.2 AWD  | 175  | 08.07  |  |  |   |   |   |  |                |     |                             |       |  |  |
| 3.2 AWD  | 179  | 08.07  |  |  |   |   |   |  |                |     |                             |       |  |  |
|  | 2.0 D3   | 120  | 19120  | 08.11  | 24.5162-0185.3  | 331202  | 2   | + mechanische Feststellbremse <sup>7)</sup>  | L=185          |     |                             |       |  |  |
|  | 2.0 D3 AWD   | 120  | 19120  | 08.11  |   |   |   |  |                |     |                             |       |  |  |
|  | 2.4 D  | 129  | 19120  | 01.10  |   |   |   |  |                |     |                             |       |  |  |
|  | 2.4 D AWD  | 120  | 19120  | 08.07  |   |   |   |  |                |     |                             |       |  |  |
|  | 2.4 D5 AWD   | 136  | 19120  | 08.07  |   |   |   |  |                |     |                             |       |  |  |
|  | 2.4 D5 AWD   | 151  | 19120  | 12.09  |   |   |   |  |                |     |                             |       |  |  |
|  | 2.4 D5 AWD   | 158  | 19120  | 06.11  |   |   |   |  |                |     |                             |       |  |  |
|  | 3.0 T6 AWD   | 210  | 19120  | 01.08  |   |   |   |  |                |     |                             |       |  |  |
|  | 3.0 T6 AWD   | 224  | 19120  | 01.10  |   |   |   |  |                |     |                             |       |  |  |
|  | 3.2  | 179  | 19120  | 08.07  |   |   |   |  |                |     |                             |       |  |  |
|  | 3.2 AWD  | 175  | 19120  | 08.07  |   |   |   |  |                |     |                             |       |  |  |
|  | 3.2 AWD  | 179  | 19120  | 08.07  |   |   |   |  |                |     |                             |       |  |  |
|  | 2.0 D3   | 120  | 19121  |  |   |   |   |  |                |     |                             |       |  |  |
|  | 2.0 D3 AWD   | 120  | 19121  |  |   |   |   |  |                |     |                             |       |  |  |
| 2.4 D  | 129  | 19121  |  |  |   |   |   |  |                |     |                             |       |  |  |
| 2.4 D AWD  | 120  | 19121  |  |  |   |   |   |  |                |     |                             |       |  |  |
| 2.4 D5 AWD   | 136  | 19121  |  |  |   |   |   |  |                |     |                             |       |  |  |
| 2.4 D5 AWD   | 151  | 19121  |  |  |   |   |   |  |                |     |                             |       |  |  |
| 2.4 D5 AWD   | 158  | 19121  |  |  |   |   |   |  |                |     |                             |       |  |  |
| 3.0 T6 AWD   | 210  | 19121  |  |  |   |   |   |  |                |     |                             |       |  |  |
| 3.0 T6 AWD   | 224  | 19121  |  |  |   |   |   |  |                |     |                             |       |  |  |

<sup>1)</sup> - collision warning system (CMbB) / - sistema anti-colloisione (CMbB) / - système anticollision (CMbB) / - sistema anticollisión (CMbB)  
<sup>2)</sup> + collision warning system (CMbB) / + sistema anti-colloisione (CMbB) / + système anticollision (CMbB) / + sistema anticollisión (CMbB)  
<sup>3)</sup> + 16" wheel / + ruota 16" / + roue 16" / + rueda 16"  
<sup>4)</sup> + 17" wheel / + ruota 17" / + roue 17" / + rueda 17"  
<sup>5)</sup> + 18" wheel / + ruota 18" / + roue 18" / + rueda 18"  
<sup>6)</sup> + 17"/18" wheel / + ruota 17"/18" / + roue 17"/18" / + rueda 17"/18"  
<sup>7)</sup> + mechanical parking brake / + fr. stazionamento meccanico / + frein à main mécanique / + freno de mano mecánica



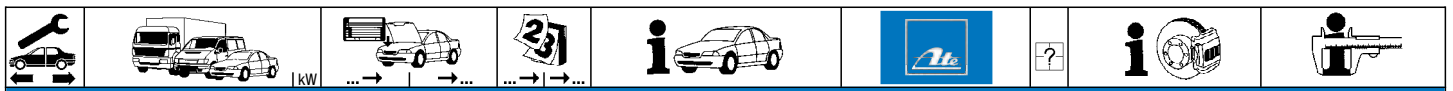

### VOLVO XC70 II CROSS COUNTRY (07-)

|  |   |  |  |  |                |        |   |   |       |
|--|---|--|--|--|----------------|--------|---|---|-------|
|  | 3.2<br>3.2 AWD<br>3.2 AWD   | 179 19121<br>175 19121<br>179 19121  |  |  | 24.5162-0185.3 | 331202 | 2 | + mechanische Feststellbremse <sup>1)</sup> | L=185 |
|  | 2.0 D3<br>2.0 D3 AWD<br>2.4 D<br>2.4 D AWD<br>2.4 D5 AWD<br>2.4 D5 AWD<br>2.4 D5 AWD<br>3.0 T6 AWD<br>3.0 T6 AWD<br>3.2<br>3.2 AWD<br>3.2 AWD | 120<br>120<br>129<br>120<br>136<br>151<br>158<br>210<br>224<br>179<br>175<br>179   | 19120<br>19120<br>19120<br>19120<br>19120<br>19120<br>19120<br>19120<br>19120<br>19120<br>19120<br>19120 | 08.11<br>08.11<br>01.10<br>08.07<br>08.07<br>12.09<br>06.11<br>01.08<br>01.10<br>08.07<br>08.07<br>08.07 | 24.5162-0185.3 | 331202 | 2 | + mechanische Feststellbremse <sup>1)</sup> | L=185 |
|  | 2.0 D3<br>2.0 D3 AWD<br>2.4 D<br>2.4 D AWD<br>2.4 D5 AWD<br>2.4 D5 AWD<br>2.4 D5 AWD<br>3.0 T6 AWD<br>3.0 T6 AWD<br>3.2<br>3.2 AWD<br>3.2 AWD | 120<br>120<br>129<br>120<br>136<br>151<br>158<br>210<br>224<br>179<br>175<br>179   | 19120<br>19120<br>19120<br>19120<br>19120<br>19120<br>19120<br>19120<br>19120<br>19120<br>19120<br>19120 | 08.11<br>08.11<br>01.10<br>08.07<br>08.07<br>12.09<br>06.11<br>01.08<br>01.10<br>08.07<br>08.07<br>08.07 | 24.5133-0310.3 | 331197 |   | + elektrische Feststellbremse <sup>2)</sup> | L=310 |
|  | 2.0 D3<br>2.0 D3 AWD<br>2.4 D<br>2.4 D AWD<br>2.4 D5 AWD<br>2.4 D5 AWD<br>2.4 D5 AWD<br>3.0 T6 AWD<br>3.0 T6 AWD<br>3.2<br>3.2 AWD<br>3.2 AWD | 120 19121<br>120 19121<br>129 19121<br>120 19121<br>136 19121<br>151 19121<br>158 19121<br>210 19121<br>224 19121<br>179 19121<br>175 19121<br>179 19121 | 75766<br>75766<br>75766<br>75766<br>75766<br>75766<br>75766<br>75766<br>75766<br>75766<br>75766<br>75766 | 08.11<br>08.11<br>01.10<br>08.07<br>08.07<br>12.09<br>06.11<br>01.08<br>01.10<br>08.07<br>08.07<br>08.07 | 24.5133-0311.3 | 331198 |   | + elektrische Feststellbremse <sup>2)</sup> | L=310 |

### VOLVO XC90 (02-)

|  |   |  |  |  |  |                            |   |                         |  |                   |
|--|---|--|--|--|--|----------------------------|---|-------------------------|--|-------------------|
|  | 2.4 D3<br>2.4 D5<br>2.4 D5<br>2.4 D5 AWD<br>2.4 D5 AWD<br>2.5 T<br>3.0 T6<br>3.2<br>3.2<br>4.0 V8 | 120<br>120<br>136<br>120<br>147<br>154<br>200<br>175<br>179<br>232 |  | 04.10<br>10.02<br>05.06<br>04.09<br>01.11<br>10.02<br>10.02<br>05.06<br>04.10<br>01.05 | 03.7858-3632.4                                     | 300234                     |   |                         | 9/8" Tandem                                | ATE               |
|  | 2.4 D5<br>2.4 D5<br>2.4 D5 AWD<br>2.5 T<br>3.0 T6<br>3.2<br>4.0 V8                                | 120<br>136<br>120<br>154<br>200<br>175<br>232                      |  | 10.02<br>05.06<br>04.09<br>10.02<br>10.02<br>05.06<br>01.05                            | 03.7858-3032.4                                     | 300257                     |   | + 18" Rad <sup>3)</sup> | 9/8" Tandem                                | ATE               |
|  | 2.4 D3<br>2.4 D5<br>2.4 D5<br>2.4 D5 AWD<br>2.4 D5 AWD<br>2.5 T<br>3.0 T6<br>3.2<br>3.2<br>4.0 V8 | 120<br>120<br>136<br>120<br>147<br>154<br>200<br>175<br>179<br>232 |  | 04.10<br>10.02<br>05.06<br>04.09<br>01.11<br>10.02<br>10.02<br>05.06<br>04.10<br>01.05 | 03.2125-7713.3                                     | 010819                     |   |                         | THz 25,40                                  | ATE               |
|  | 2.4 D5<br>2.4 D5<br>2.4 D5 AWD<br>2.4 D5 AWD<br>2.5 T   | 120<br>136<br>120<br>147<br>154                                    |  | 10.02<br>05.06<br>04.09<br>01.11<br>10.02  | 03.2125-7638.3                                     | 010738                     |   |                         | THz 25,40                                  | ATE               |
|  | 2.4 D3<br>2.4 D5<br>2.4 D5<br>2.4 D5 AWD<br>2.4 D5 AWD<br>2.5 T<br>3.0 T6<br>3.2<br>3.2<br>4.0 V8 | 120<br>120<br>136<br>120<br>147<br>154<br>200<br>175<br>179<br>232 |  | 04.10<br>10.02<br>05.06<br>04.09<br>01.11<br>10.02<br>10.02<br>05.06<br>04.10<br>01.05 | 11.8116-0366.2<br>11.8171-0067.1<br>11.0101-6006.2 | 390587<br>250153<br>260098 | 2 | + 16" Rad <sup>4)</sup> | Haltefeder<br>Führungsbolzen<br>Hülsensatz | ATE<br>ATE<br>ATE |

<sup>1)</sup> + mechanical parking brake / + fr. stazionamento meccanico / + frein à main mécanique / + freno de mano mecánica

<sup>2)</sup> + electric parking brake / + freno a mano elettrico / + frein à main électrique / + freno de mano eléctrico

<sup>3)</sup> + 18" wheel / + ruota 18" / + roue 18" / + rueda 18"

<sup>4)</sup> + 16" wheel / + ruota 16" / + roue 16" / + rueda 16"



**VOLVO XC90 (02-)**

|  |            |     |       |                |        |   |   |  |                                 |
|--|------------|-----|-------|----------------|--------|---|---|--|---------------------------------|
|  | 2.4 D3     | 120 | 04.10 | 11.9606-9959.2 | 220729 | 2 | - 16" Rad <sup>1)</sup><br>- 16" Rad <sup>1)</sup><br>- 16" Rad <sup>1)</sup> | D=60, - Halter<br>D=60, - Halter<br>Haltefeder<br>Führungsbolzen<br>Hülsensatz | ATE<br>ATE<br>ATE<br>ATE<br>ATE |
|  | 2.4 D5     | 120 | 10.02 | 11.9606-9960.2 | 220730 |   |   |  |                                 |
|  | 2.4 D5     | 136 | 05.06 | 11.8116-0133.1 | 390511 |   |   |  |                                 |
|  | 2.4 D5 AWD | 120 | 04.09 | 11.8171-0067.1 | 250153 |   |   |  |                                 |
|  | 2.4 D5 AWD | 147 | 01.11 | 11.0101-6006.2 | 260098 |   |   |  |                                 |
|  | 2.5 T      | 154 | 10.02 |                |        |   |   |  |                                 |
|  | 3.0 T6     | 200 | 10.02 |                |        |   |   |  |                                 |
|  | 3.2        | 175 | 05.06 |                |        |   |   |  |                                 |
|  | 3.2        | 179 | 04.10 |                |        |   |   |  |                                 |
|  | 4.0 V8     | 232 | 01.05 |                |        |   |   |  |                                 |
|  | 2.4 D3     | 120 | 04.10 | 83.7713-0366.3 | 331100 | 2 |   | L=365  |                                 |
|  | 2.4 D5     | 120 | 10.02 |                |        |   |   |  |                                 |
|  | 2.4 D5     | 136 | 05.06 |                |        |   |   |  |                                 |
|  | 2.4 D5 AWD | 120 | 04.09 |                |        |   |   |  |                                 |
|  | 2.4 D5 AWD | 147 | 01.11 |                |        |   |   |  |                                 |
|  | 2.5 T      | 154 | 10.02 |                |        |   |   |  |                                 |
|  | 3.0 T6     | 200 | 10.02 |                |        |   |   |  |                                 |
|  | 3.2        | 175 | 05.06 |                |        |   |   |  |                                 |
|  | 3.2        | 179 | 04.10 |                |        |   |   |  |                                 |
|  | 4.0 V8     | 232 | 01.05 |                |        |   |   |  |                                 |
|  | 2.4 D3     | 120 | 04.10 | 11.9441-9965.2 | 220735 | 2 |   | D=44, - Halter<br>D=44, - Halter<br>Haltefeder<br>Führungsbolzen<br>Hülsensatz | ATE<br>ATE<br>ATE<br>ATE<br>ATE |
|  | 2.4 D5     | 120 | 10.02 | 11.9441-9966.2 | 220736 |   |   |  |                                 |
|  | 2.4 D5     | 136 | 05.06 | 11.8116-0327.1 | 390599 |   |   |  |                                 |
|  | 2.4 D5 AWD | 120 | 04.09 | 11.8171-0008.1 | 990049 |   |   |  |                                 |
|  | 2.4 D5 AWD | 147 | 01.11 | 11.0101-5704.2 | 260095 |   |   |  |                                 |
|  | 2.5 T      | 154 | 10.02 |                |        |   |   |  |                                 |
|  | 3.0 T6     | 200 | 10.02 |                |        |   |   |  |                                 |
|  | 3.2        | 175 | 05.06 |                |        |   |   |  |                                 |
|  | 3.2        | 179 | 04.10 |                |        |   |   |  |                                 |
|  | 4.0 V8     | 232 | 01.05 |                |        |   |   |  |                                 |
|  | 2.4 D3     | 120 | 04.10 | 83.7704-0266.3 | 330979 | 2 |   | L=265  |                                 |
|  | 2.4 D5     | 120 | 10.02 |                |        |   |   |  |                                 |
|  | 2.4 D5     | 136 | 05.06 |                |        |   |   |  |                                 |
|  | 2.4 D5 AWD | 120 | 04.09 |                |        |   |   |  |                                 |
|  | 2.4 D5 AWD | 147 | 01.11 |                |        |   |   |  |                                 |
|  | 2.5 T      | 154 | 10.02 |                |        |   |   |  |                                 |
|  | 3.0 T6     | 200 | 10.02 |                |        |   |   |  |                                 |
|  | 3.2        | 175 | 05.06 |                |        |   |   |  |                                 |
|  | 3.2        | 179 | 04.10 |                |        |   |   |  |                                 |
|  | 4.0 V8     | 232 | 01.05 |                |        |   |   |  |                                 |

<sup>1)</sup> - 16" wheel / - ruota 16" / - roue 16" / - rueda 16"



A large rectangular area containing 25 horizontal lines, intended for writing or drawing.





- Ⓓ Abbildungen Hauptbremszylinder
- Ⓔ Illustrations master cylinder
- Ⓕ Illustrations Maître-cylindres
- Ⓖ Illustrazioni pompe Freno
- Ⓔ Ilustraciones cilindro freno
- Ⓗ Afbeeldingen hoofdbremscylinders
- Ⓓ Tegning hovedbremsecylinder
- Ⓔ Avbildningar huvudbromscylinder
- Ⓗ Ábrák – főfékhengerek
- Ⓗ Figuras Cilindro principal do travão
- Ⓔ Рисунки главных тормозных цилиндров
- Ⓒ Zobrazení hlavního brzdového válce
- Ⓗ Rysunki pomp hamulcowych
- Ⓔ Εικόνες κεντρικών κυλίνδρων πέδησης
- Ⓓ Ana fren silindiri resimleri
- Ⓔ 主缸制动缸图片
- Ⓖ 図版 マスターブレーキシリンダー
- Ⓒ صور إسطوانة المكبح الرئيسي

# Abbildungen Hauptbremszylinder

Illustrations master cylinder - Illustrazioni pompe freno -

Illustrations Maître cylindres - Ilustraciones cilindro maestro freno

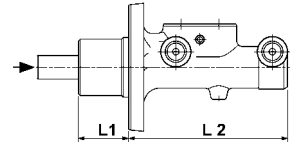

**03.2020-0402.3 010001**

Ø 20,64/19,05



3x M10x1

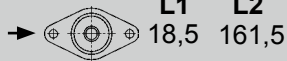

L1 L2  
18,5 161,5



**03.2022-0109.3 010003**

Ø 22,30/15,75



2x M10x1

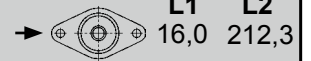

L1 L2  
16,0 212,3



**03.2022-0111.3 010004**

Ø 22,30/15,75



2x M10x1

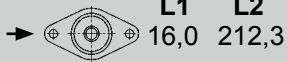

L1 L2  
16,0 212,3



**03.2022-0112.3 010005**

Ø 22,30/15,75



2x M10x1

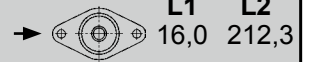

L1 L2  
16,0 212,3



**03.2022-0602.3 010006**

Ø 22,20/19,05



2x M10x1  
1x M12x1



L1 L2  
33,1 148,5

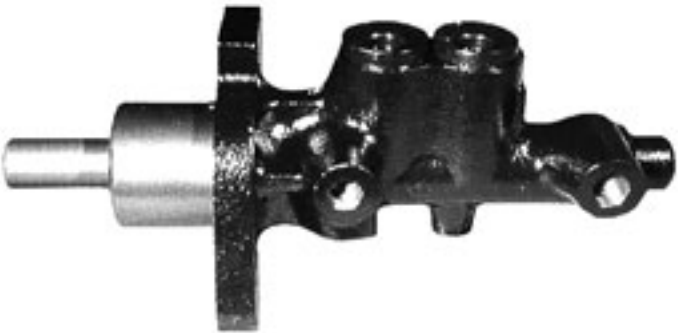

**03.2022-0702.3 010007**

Ø 22,20/15,75



2x M10x1  
1x M12x1



L1 L2  
20,0 174,5



**03.2022-1201.3 010009**

Ø 22,20/17,46



3x M10x1

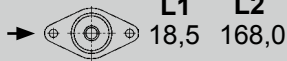

L1 L2  
18,5 168,0



**03.2022-1402.3 010010**

Ø 22,20/19,05



1x M10x1  
1x M12x1

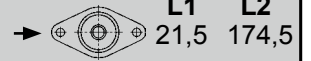

L1 L2  
21,5 174,5





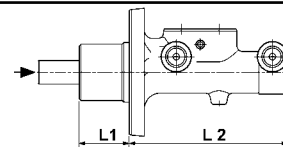

# Abbildungen Hauptbremszylinder

Illustrations master cylinder - Illustrazioni pompe freno -



Illustrations Maître cylindres - Ilustraciones cilindro maestro freno





**03.2022-1602.3 010011**  
 Ø 22,20/19,05  2x M10x1 →  L1 L2  
 21,5 174,5



**03.2022-2624.3 010588**  
 Ø 22,20/20,64  1x M10x1  
 1x M12x1 →  L1 L2  
 33,3 113,2





**03.2022-2829.3 010589**  
 Ø 22,20/20,64  5x M12x1 →  L1 L2  
 39,9 116,4

**03.2023-0164.3 010014**  
 Ø 23,81/19,05  3x M10x1 →  L1 L2  
 18,5 159,5





**03.2023-0166.3 010015**  
 Ø 23,81/19,05  3x M10x1 →  L1 L2  
 18,5 159,5

**03.2023-0172.3 010016**  
 Ø 23,81/19,05  3x M10x1 →  L1 L2  
 18,5 159,5



**03.2023-0183.3 010017**  
 Ø 23,81/19,05  2x M10x1 →  L1 L2  
 17,6 159,0

**03.2023-0230.3 010019**  
 Ø 23,81/19,05  3x M10x1 →  L1 L2  
 57,4 109,1





# Abbildungen Hauptbremszylinder

Illustrations master cylinder - Illustrazioni pompe freno -

Illustrations Maître cylindres - Ilustraciones cilindro maestro freno

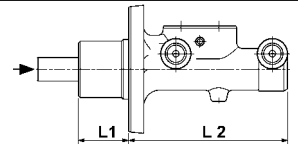

**03.2023-0262.3 010020**

Ø 23,81/20,64



2x M10x1



L1

L2

17,6 159,0

**03.2023-0503.3 010022**

Ø 23,81/16,84



4x M10x1



L1

L2

16,0 226,5



**03.2023-0542.3 010024**

Ø 23,81/20,64



3x M10x1



L1

L2

17,6 159,0

**03.2023-0562.3 010025**

Ø 23,81/20,64



3x M10x1



L1

L2

21,1 159,8



**03.2023-0642.3 010026**

Ø 23,81/20,64



1x M10x1  
1x M12x1



L1

L2

43,0 148,0

**03.2023-0825.3 010028**

Ø 23,81/19,05



3x M10x1



L1

L2

57,4 109,6



**03.2023-0875.3 010890**

Ø 23,81



4x M10x1



L1

L2

16,0 183,0

**03.2023-0987.3 010473**

Ø 23,81



1x M10x1  
1x M12x1



L1

L2

38,3 131,5



# Abbildungen Hauptbremszylinder

Illustrations master cylinder - Illustrazioni pompe freno -

Illustrations Maître cylindres - Ilustraciones cilindro maestro freno

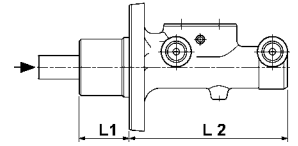

**03.2023-1044.3 010590**

Ø 23,81/20,64



2x M10x1  
1x M12x1



L1 L2  
41,7 132,5



**03.2023-1066.3 010032**

Ø 23,81/19,05



1x M10x1  
1x M12x1



L1 L2  
49,8 109,0



**03.2023-1084.3 010591**

Ø 23,81/20,64



3x M10x1



L1 L2  
38,3 132,5



**03.2023-1741.3 010703**

Ø 23,81/20,64



4x M12x1



L1 L2  
12,0 169,5



**03.2023-1812.3 010570**

Ø 23,81/19,05



1x M10x1  
2x M12x1



L1 L2  
4,0 147,0



**03.2023-1904.3 010724**

Ø 23,81/20,64



5x M12x1



L1 L2  
36,9 116,4



**03.2023-1949.3 010725**

Ø 23,81/20,64



4x M12x1



L1 L2  
35,9 116,4



**03.2023-2004.3 010788**

Ø 23,81/19,05



4x M12x1



L1 L2  
4,0 147,0



# Abbildungen Hauptbremszylinder

Illustrations master cylinder - Illustrazioni pompe freno -

Illustrations Maître cylindres - Ilustraciones cilindro maestro freno

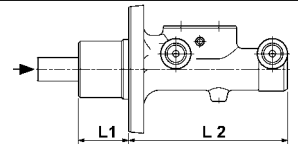

**03.2023-2204.3 010644**

Ø 23,81/22,20



5x M12x1



L1

L2

36,9 116,4



**03.2023-2233.3 010891**

Ø 23,81/22,20



4x M12x1



L1

L2

38,3 116,4



**03.2023-2249.3 010869**

Ø 23,81/22,20



4x M12x1



L1

L2

35,9 116,4



**03.2023-2256.3 010870**

Ø 23,81/22,20



2x M12x1  
1x M12x1



L1

L2

35,9 116,4



**03.2023-2304.3 010646**

Ø 23,81/22,20



1x M10x1  
1x M12x1



L1

L2

32,8 113,2



**03.2023-2344.3 010647**

Ø 23,81/22,20



1x M10x1  
1x M12x1



L1

L2

32,8 113,2



**03.2023-2407.3 010796**

Ø 23,81/22,20



2x M12x1



L1

L2

59,2 105,7



**03.2025-0111.3 010033**

Ø 25,40/19,05



3x M10x1



L1

L2

18,5 178,0







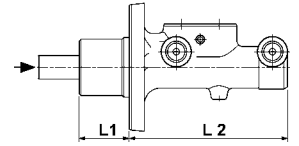

# Abbildungen Hauptbremszylinder

Illustrations master cylinder - Illustrazioni pompe freno -



Illustrations Maître cylindres - Ilustraciones cilindro maestro freno





**03.2025-0211.3 010034**  
 Ø 25,40/19,05  3x M10x1 →  L1 L2  
 57,8 108,0



**03.2025-1211.3 010475**  
 Ø 25,40/20,64  2x M10x1 →  L1 L2  
 53,9 118,0





**03.2025-1511.3 010704**  
 Ø 25,40/20,64  2x M12x1 →  L1 L2  
 17,0 134,0



**03.2025-1741.3 010705**  
 Ø 25,40/20,64  4x M12x1 →  L1 L2  
 12,0 169,5





**03.2025-1904.3 010797**  
 Ø 25,40/22,20  2x M12x1 →  L1 L2  
 59,2 105,7

**03.2025-2301.3 010895**  
 Ø 25,40/22,20  2x M12x1 →  L1 L2  
 57,6 114,3



**03.2026-0462.3 010728**  
 Ø 26,99/25,40  2x M10x1 →  L1 L2  
 57,4 115,9

**03.2026-0512.3 010038**  
 Ø 26,99/25,40  2x M10x1 →  L1 L2  
 57,6 115,9



# Abbildungen Hauptbremszylinder

Illustrations master cylinder - Illustrazioni pompe freno -

Illustrations Maître cylindres - Ilustraciones cilindro maestro freno

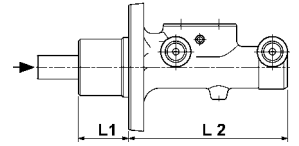

**03.2026-0562.3 010729**

Ø 26,99/25,40

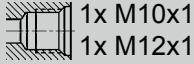

1x M10x1

1x M12x1

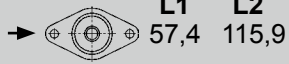

L1

L2

57,4 115,9



**03.2026-0712.3 010730**

Ø 26,99/25,40

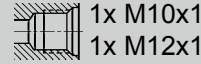

1x M10x1

1x M12x1



L1

L2

39,5 119,8



**03.2117-1601.3 010039**

Ø 17,46

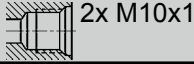

2x M10x1

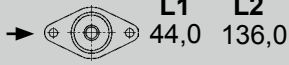

L1

L2

44,0 136,0



**03.2117-3311.3 010040**

Ø 17,46



4x M10x1

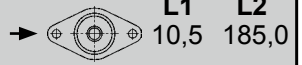

L1

L2

10,5 185,0



**03.2119-0525.3 010046**

Ø 19,05

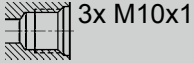

3x M10x1

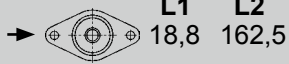

L1

L2

18,8 162,5



**03.2119-0781.3 010052**

Ø 19,05



3x M10x1

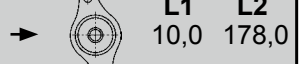

L1

L2

10,0 178,0

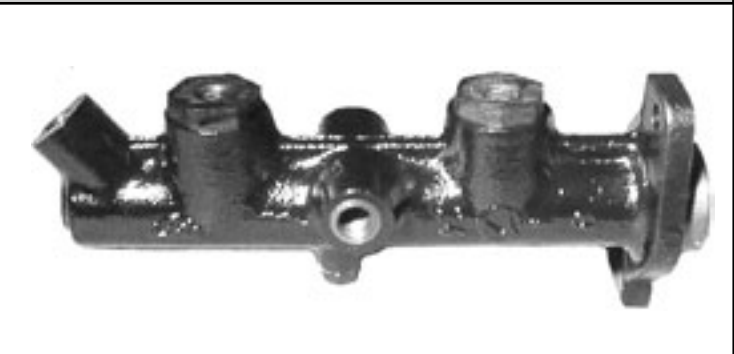

**03.2119-0881.3 010053**

Ø 19,05

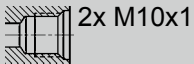

2x M10x1

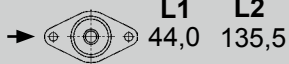

L1

L2

44,0 135,5

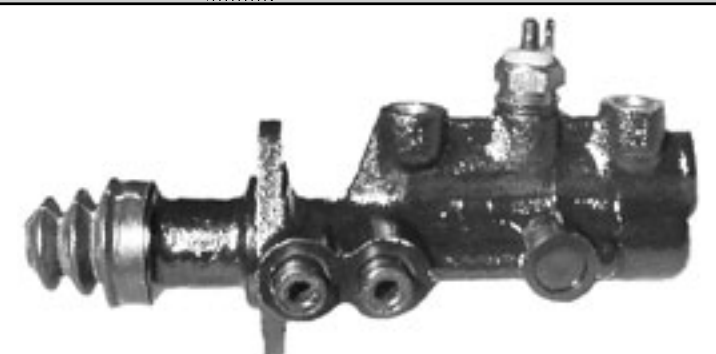

**03.2119-1281.3 010054**

Ø 19,05

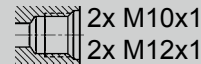

2x M10x1

2x M12x1

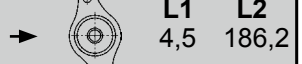

L1

L2

4,5 186,2



# Abbildungen Hauptbremszylinder

Illustrations master cylinder - Illustrazioni pompe freno -

Illustrations Maître cylindres - Ilustraciones cilindro maestro freno

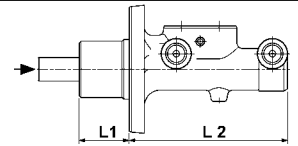

**03.2119-2301.3 010055**  
 Ø 19,05 2x M10x1 → L1 L2  
 44,0 135,5

**03.2119-3389.3 010057**  
 Ø 19,05 4x M10x1 → L1 L2  
 40,0 114,9



**03.2119-3391.3 010058**  
 Ø 19,05 2x M10x1 → L1 L2  
 40,0 114,9

**03.2119-6207.3 010060**  
 Ø 19,05 3x M10x1 → L1 L2  
 18,8 162,5



**03.2119-6713.3 010061**  
 Ø 19,05 4x M10x1 → L1 L2  
 42,5 154,0

**03.2119-8511.3 010062**  
 Ø 19,05 3x M10x1 → L1 L2  
 14,5 182,0



**03.2119-8611.3 010063**  
 Ø 19,05 3x M10x1 → L1 L2  
 14,5 182,0

**03.2119-8711.3 010064**  
 Ø 19,05 3x M10x1 → L1 L2  
 14,5 182,0



# Abbildungen Hauptbremszylinder

Illustrations master cylinder - Illustrazioni pompe freno -

Illustrations Maître cylindres - Ilustraciones cilindro maestro freno

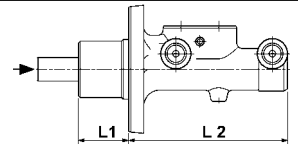

**03.2119-8911.3 010066**

Ø 19,05



2x M10x1



L1 L2  
29,5 166,9



**03.2119-9011.3 010067**

Ø 19,05



2x M10x1



L1 L2  
29,5 166,9



**03.2119-9111.3 010068**

Ø 19,05



2x M10x1



L1 L2  
29,5 167,0



**03.2120-0148.3 010070**

Ø 20,64



3x M10x1



L1 L2  
18,8 162,5



**03.2120-0151.3 010071**

Ø 20,64



3x M10x1



L1 L2  
18,8 162,5



**03.2120-0322.3 010074**

Ø 20,64



3x M10x1



L1 L2  
18,8 157,5



**03.2120-0538.3 010077**

Ø 20,64



3x M10x1



L1 L2  
18,8 181,0



**03.2120-0562.3 010078**

Ø 20,64



3x M10x1



L1 L2  
18,8 000,0





# Abbildungen Hauptbremszylinder

Illustrations master cylinder - Illustrazioni pompe freno -

Illustrations Maître cylindres - Ilustraciones cilindro maestro freno

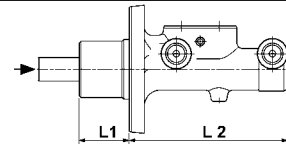

**03.2120-0622.3 010079**

Ø 20,64

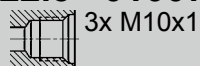

L1 L2  
18,8 162,5



**03.2120-0851.3 010082**

Ø 20,64

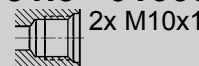

L1 L2  
14,5 197,5



**03.2120-1122.3 010084**

Ø 20,64

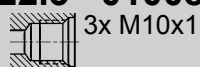

L1 L2  
10,0 206,5



**03.2120-1142.3 010085**

Ø 20,64

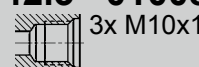

L1 L2  
18,8 167,0



**03.2120-1362.3 010087**

Ø 20,64

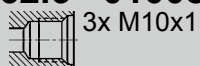

L1 L2  
18,5 162,5



**03.2120-1491.3 010089**

Ø 20,64



L1 L2  
18,5 157,5



**03.2120-1531.3 010092**

Ø 20,64

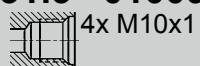

L1 L2  
18,5 157,5



**03.2120-1681.3 010097**

Ø 20,64



L1 L2  
10,0 206,5



# Abbildungen Hauptbremszylinder

Illustrations master cylinder - Illustrazioni pompe freno -

Illustrations Maître cylindres - Ilustraciones cilindro maestro freno

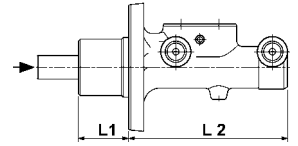

**03.2120-1802.3 010099**

Ø 20,64

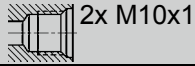

**03.2120-1821.3 010100**

Ø 20,64

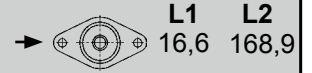

**03.2120-1897.3 010103**

Ø 20,64



**03.2120-1981.3 010105**

Ø 20,64

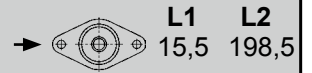
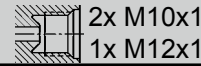

**03.2120-2031.3 010106**

Ø 20,64



**03.2120-2082.3 010107**

Ø 20,64

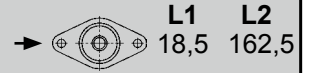

**03.2120-2191.3 010108**

Ø 20,64

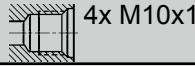

**03.2120-2331.3 010110**

Ø 20,64

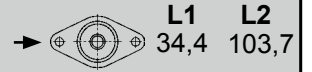
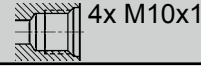



# Abbildungen Hauptbremszylinder

Illustrations master cylinder - Illustrazioni pompe freno -

Illustrations Maître cylindres - Ilustraciones cilindro maestro freno

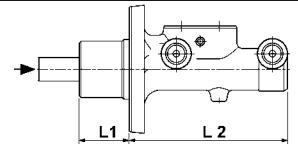

**03.2120-2381.3 010111**  
 Ø 20,64  
 2x M10x1  
 2x M15x1  
 L1 15,5 L2 198,5

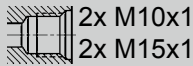

**03.2120-2421.3 010112**  
 Ø 20,64  
 4x M10x1  
 L1 15,5 L2 198,5

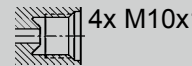

**03.2120-2462.3 010113**  
 Ø 20,64  
 3x M10x1  
 L1 18,5 L2 166,0

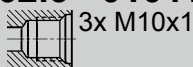

**03.2120-2482.3 010114**  
 Ø 20,64  
 3x M10x1  
 L1 36,0 L2 103,7



**03.2120-2597.3 010115**  
 Ø 20,64  
 4x M10x1  
 L1 20,0 L2 169,5

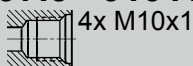

**03.2120-2598.3 010116**  
 Ø 20,64  
 4x M10x1  
 L1 20,0 L2 169,5



**03.2120-2682.3 010118**  
 Ø 20,64  
 4x M10x1  
 L1 36,0 L2 114,9



**03.2120-3412.3 010121**  
 Ø 20,64  
 5x M10x1  
 L1 18,8 L2 162,5

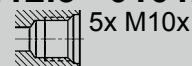

# Abbildungen Hauptbremszylinder

Illustrations master cylinder - Illustrazioni pompe freno -

Illustrations Maître cylindres - Ilustraciones cilindro maestro freno

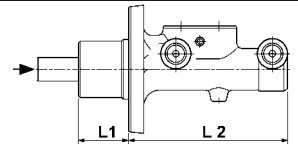

**03.2120-3943.3 010532**  
 Ø 20,64 4x M10x1 → L1 L2  
 35,4 109,7



**03.2120-4166.3 010452**  
 Ø 20,64 4x M10x1 → L1 L2  
 29,9 115,9



**03.2120-4221.3 010605**  
 Ø 20,64 2x M10x1 → L1 L2  
 29,9 115,9

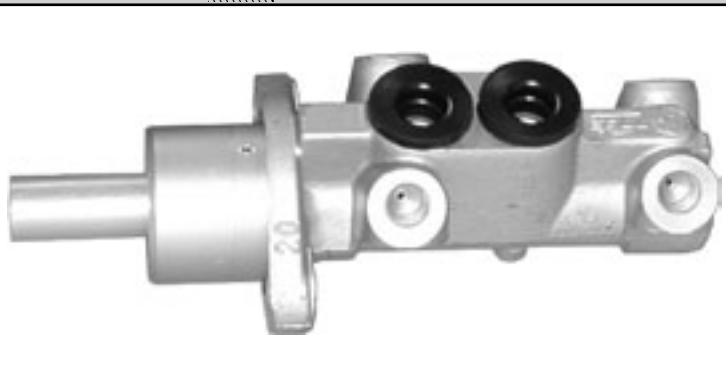

**03.2120-4241.3 010524**  
 Ø 20,64 2x M10x1 → L1 L2  
 29,9 115,9



**03.2120-4246.3 010614**  
 Ø 20,64 2x M10x1 → L1 L2  
 29,9 115,9

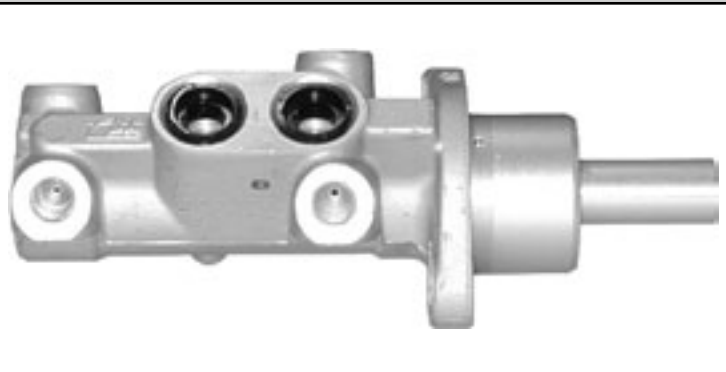

**03.2120-4321.3 010525**  
 Ø 20,64 2x M10x1  
 2x M12x1 → L1 L2  
 29,9 115,9

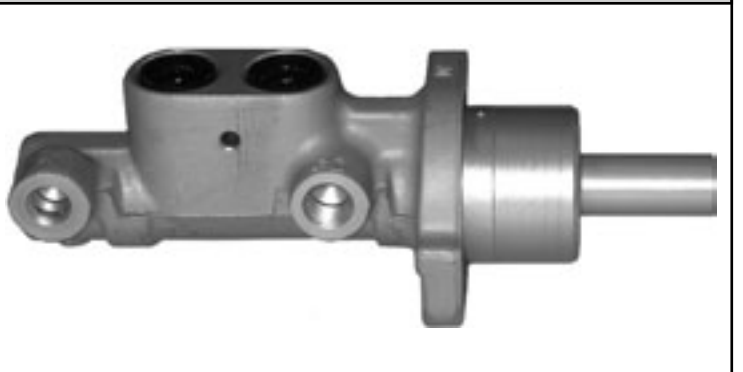

**03.2120-4381.3 010526**  
 Ø 20,64 2x M10x1  
 2x M12x1 → L1 L2  
 29,9 124,7

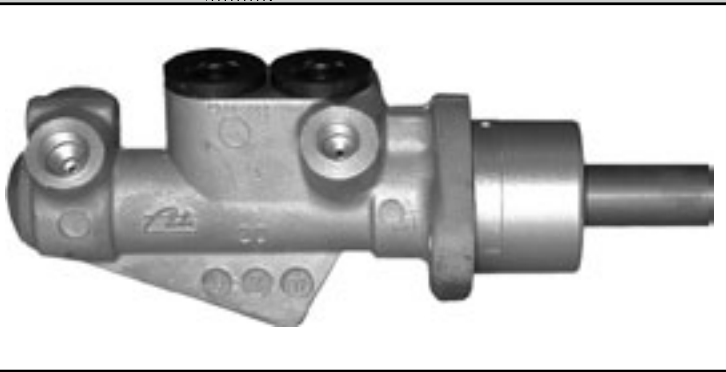

**03.2120-4441.3 010510**  
 Ø 20,64 2x M10x1 → L1 L2  
 31,5 115,9



# Abbildungen Hauptbremszylinder

Illustrations master cylinder - Illustrazioni pompe freno -

Illustrations Maître cylindres - Ilustraciones cilindro maestro freno

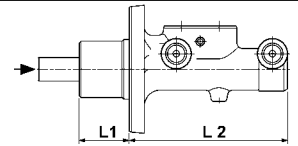

**03.2120-4461.3 010571**  
 Ø 20,64  
 1x M10x1  
 1x M12x1  
 L1 31,5 L2 124,7



**03.2120-4468.3 010789**  
 Ø 20,64  
 2x M12x1  
 L1 31,5 L2 124,7



**03.2120-4504.3 010123**  
 Ø 20,64  
 3x M10x1  
 L1 18,8 L2 162,5



**03.2120-4581.3 010915**  
 Ø 20,64  
 1x M10x1  
 1x M12x1  
 L1 31,5 L2 124,7



**03.2120-5503.3 010124**  
 Ø 20,64  
 1x M10x1  
 1x M12x1  
 L1 18,8 L2 162,5



**03.2120-8411.3 010125**  
 Ø 20,64  
 2x M10x1  
 L1 20,0 L2 192,0

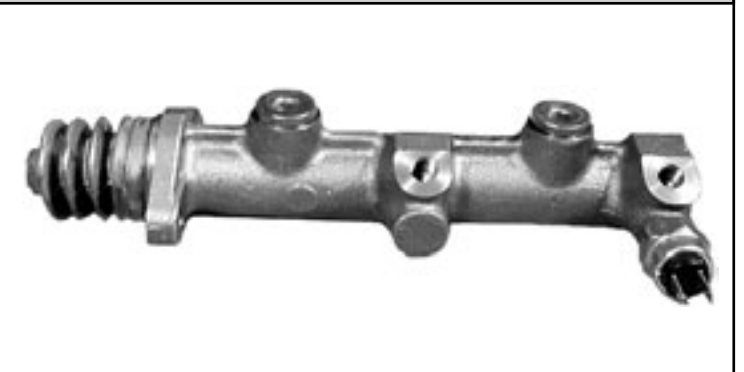

**03.2122-0142.3 010128**  
 Ø 22,20  
 3x M10x1  
 L1 18,5 L2 157,5

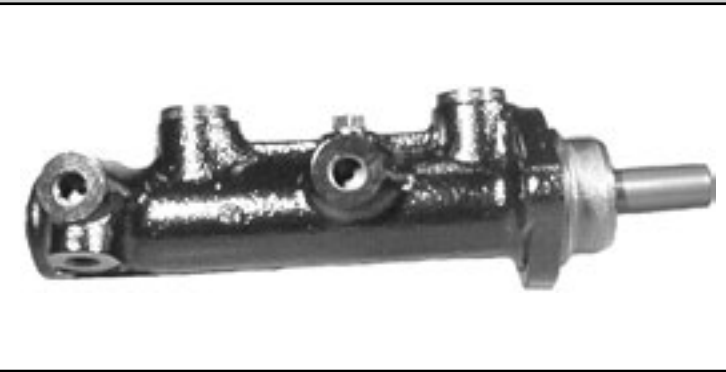

**03.2122-0264.3 010129**  
 Ø 22,20  
 2x M10x1  
 2x M12x1  
 L1 33,1 L2 118,0

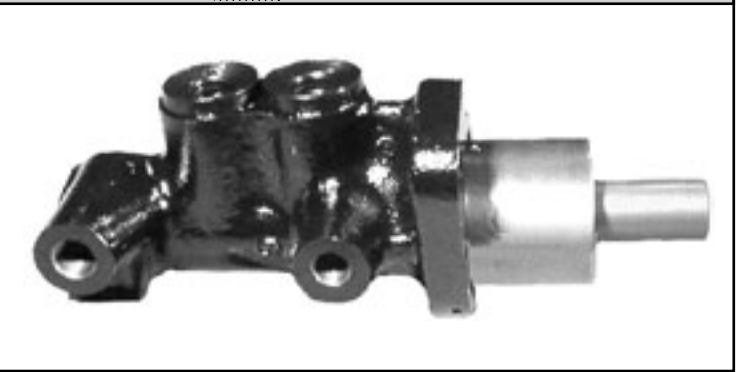

# Abbildungen Hauptbremszylinder

Illustrations master cylinder - Illustrazioni pompe freno -

Illustrations Maître cylindres - Ilustraciones cilindro maestro freno

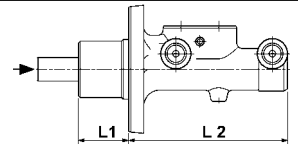

**03.2122-0282.3 010130**

Ø 22,20



1x M10x1  
1x M12x1

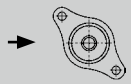

L1 L2  
28,6 134,2



**03.2122-0621.3 010131**

Ø 22,20



4x M10x1

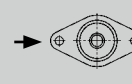

L1 L2  
33,2 131,7

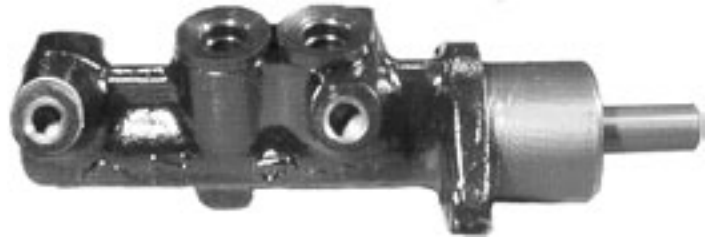

**03.2122-0626.3 010539**

Ø 22,20



2x M10x1

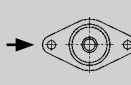

L1 L2  
33,2 131,7



**03.2122-0646.3 010133**

Ø 22,20



2x M10x1

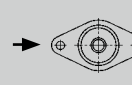

L1 L2  
36,0 115,7



**03.2122-0704.3 010134**

Ø 22,20



2x M10x1

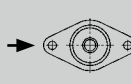

L1 L2  
19,5 182,5



**03.2122-0903.3 010136**

Ø 22,20



3x M10x1

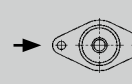

L1 L2  
14,5 208,0



**03.2122-1001.3 010562**

Ø 22,20



2x M10x1  
2x M12x1

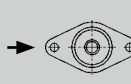

L1 L2  
27,9 131,7



**03.2122-1042.3 010137**

Ø 22,20



4x M10x1

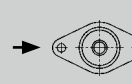

L1 L2  
36,0 109,7











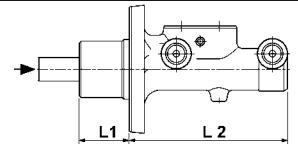

















# Abbildungen Hauptbremszylinder

Illustrations master cylinder - Illustrazioni pompe freno -

Illustrations Maître cylindres - Ilustraciones cilindro maestro freno



|   |   |
|---|---|
| <p><b>03.2122-1144.3 010636</b><br/> <math>\varnothing</math> 22,20  2x M10x1  L1 L2<br/>                     36,0 109,7</p>       | <p><b>03.2122-1184.3 010592</b><br/> <math>\varnothing</math> 22,20  2x M12x1  L1 L2<br/>                     31,5 119,6</p>        |
| <p><b>03.2122-1281.3 010606</b><br/> <math>\varnothing</math> 22,20  2x M10x1  L1 L2<br/>                     31,5 115,9</p>       | <p><b>03.2122-1291.3 010527</b><br/> <math>\varnothing</math> 22,20  2x M10x1  L1 L2<br/>                     31,5 115,9</p>       |
| <p><b>03.2122-1296.3 010609</b><br/> <math>\varnothing</math> 22,20  2x M10x1  L1 L2<br/>                     31,5 115,9</p>  | <p><b>03.2122-1326.3 010617</b><br/> <math>\varnothing</math> 22,20  2x M10x1  L1 L2<br/>                     27,9 115,9</p>  |
| <p><b>03.2122-1331.3 010607</b><br/> <math>\varnothing</math> 22,20  2x M10x1  L1 L2<br/>                     31,5 115,9</p>  | <p><b>03.2122-1344.3 010593</b><br/> <math>\varnothing</math> 22,20  2x M10x1  L1 L2<br/>                     31,5 119,6</p>  |

# Abbildungen Hauptbremszylinder

Illustrations master cylinder - Illustrazioni pompe freno -

Illustrations Maître cylindres - Ilustraciones cilindro maestro freno

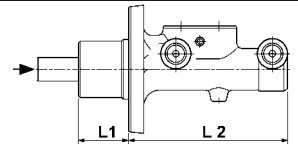

**03.2122-1351.3 010528**

Ø 22,20

1x M10x1  
1x M12x1

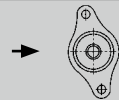

L1 L2  
31,5 115,9



**03.2122-1356.3 010529**

Ø 22,20

2x M10x1  
2x M12x1

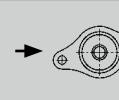

L1 L2  
27,9 115,9



**03.2122-1421.3 010615**

Ø 22,20

2x M10x1

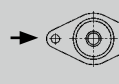

L1 L2  
31,5 115,9



**03.2122-1461.3 010610**

Ø 22,20

2x M10x1

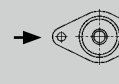

L1 L2  
31,5 109,4



**03.2122-1521.3 010494**

Ø 22,20

2x M10x1

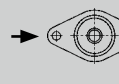

L1 L2  
31,5 119,0



**03.2122-1541.3 010511**

Ø 22,20

4x M10x1

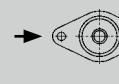

L1 L2  
27,4 119,0



**03.2122-1564.3 010594**

Ø 22,20

2x M12x1

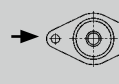

L1 L2  
26,5 124,0



**03.2122-1588.3 010733**

Ø 22,20

4x M10x1

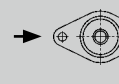

L1 L2  
27,4 124,0







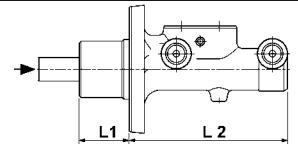

# Abbildungen Hauptbremszylinder

Illustrations master cylinder - Illustrazioni pompe freno -



Illustrations Maître cylindres - Ilustraciones cilindro maestro freno





**03.2122-1663.3 010734**  
 Ø 22,20  3x M12x1 →  L1 L2  
 4,1 143,3



**03.2122-1691.3 010918**  
 Ø 22,20  2x M10x1 →  L1 L2  
 33,1 114,5





**03.2122-1724.3 010648**  
 Ø 22,20  1x M10x1  
 3x M12x1 →  L1 L2  
 4,1 139,6



**03.2122-1824.3 010892**  
 Ø 22,20  3x M12x1 →  L1 L2  
 42,1 109,3





**03.2122-1853.3 010893**  
 Ø 22,20  2x M12x1 →  L1 L2  
 40,9 109,3

**03.2122-1883.3 010735**  
 Ø 22,20  3x M12x1 →  L1 L2  
 6,4 143,3



**03.2122-1888.3 010736**  
 Ø 22,20  3x M12x1 →  L1 L2  
 6,4 143,3

**03.2122-1906.3 010761**  
 Ø 22,20  2x 3/8"-  
 24UNF-2B →  L1 L2  
 18,8 157,5



# Abbildungen Hauptbremszylinder

Illustrations master cylinder - Illustrazioni pompe freno -

Illustrations Maître cylindres - Ilustraciones cilindro maestro freno

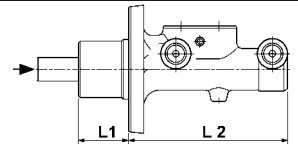

**03.2122-1942.3 010700**

Ø 22,20



3x M12x1



L1 L2  
30,5 117,7



**03.2122-2023.3 010798**

Ø 22,20



2x M10x1  
2x M12x1



L1 L2  
43,2 125,8



**03.2122-2129.3 010799**

Ø 22,20



2x M12x1



L1 L2  
36,1 134,9



**03.2122-2163.3 010800**

Ø 22,20



3x M12x1



L1 L2  
39,8 128,2



**03.2122-2202.3 010140**

Ø 22,20



2x M12x1



L1 L2  
18,8 162,0



**03.2122-2905.3 010141**

Ø 22,20



4x M10x1



L1 L2  
14,5 208,0



**03.2122-3200.3 010142**

Ø 22,20



2x 3/8"-  
24UNF-2B



L1 L2  
16,0 175,5



**03.2122-4902.3 010144**

Ø 22,20



2x M12x1



L1 L2  
18,8 157,5





# Abbildungen Hauptbremszylinder

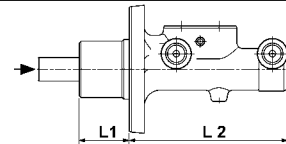

Illustrations master cylinder - Illustrazioni pompe freno -

Illustrations Maître cylindres - Ilustraciones cilindro maestro freno



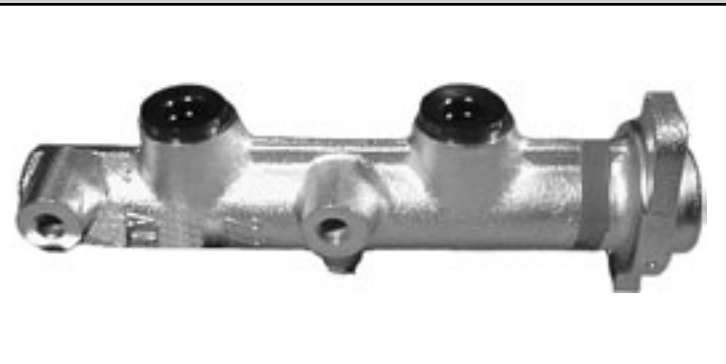

**03.2122-5801.3 010147**  
 Ø 22,20  2x M10x1 →  L1 L2  
 10,0 204,0





**03.2122-6202.3 010148**  
 Ø 22,20  5x M10x1 →  L1 L2  
 18,8 157,5





**03.2122-6911.3 010153**  
 Ø 22,20  2x M10x1 →  L1 L2  
 18,5 166,0





**03.2122-6912.3 010154**  
 Ø 22,20  2x M10x1 →  L1 L2  
 18,5 166,0





**03.2122-7513.3 010155**  
 Ø 22,20  2x M10x1 →  L1 L2  
 18,5 166,4





**03.2122-8012.3 010156**  
 Ø 22,20  4x M10x1 →  L1 L2  
 18,5 166,0



**03.2122-8806.3 010157**  
 Ø 22,20  2x M10x1  
 1x M12x1 →  L1 L2  
 20,0 181,0



**03.2122-9612.3 010159**  
 Ø 22,20  4x M10x1 →  L1 L2  
 36,0 103,7





# Abbildungen Hauptbremszylinder

Illustrations master cylinder - Illustrazioni pompe freno -

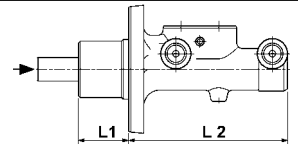

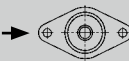
Illustrations Maître cylindres - Ilustraciones cilindro maestro freno





**03.2122-9631.3 010160**  
 Ø 22,20  4x M10x1 →  L1 L2  
 36,0 103,7



**03.2122-9812.3 010161**  
 Ø 22,20  4x M10x1 →  L1 L2  
 36,0 103,7



**03.2123-0162.3 010162**  
 Ø 23,81  2x M10x1 →  L1 L2  
 18,5 166,0



**03.2123-0242.3 010163**  
 Ø 23,81  2x M10x1 →  L1 L2  
 18,5 179,5



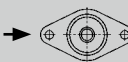

**03.2123-0271.3 010164**  
 Ø 23,81  2x M10x1 →  L1 L2  
 18,5 157,5

**03.2123-0291.3 010165**  
 Ø 23,81  2x M10x1 →  L1 L2  
 18,5 157,5



**03.2123-0491.3 010167**  
 Ø 23,81  4x M10x1 →  L1 L2  
 36,0 115,7

**03.2123-0522.3 010168**  
 Ø 23,81  1x M10x1  
 1x M14x1 →  L1 L2  
 18,5 200,5

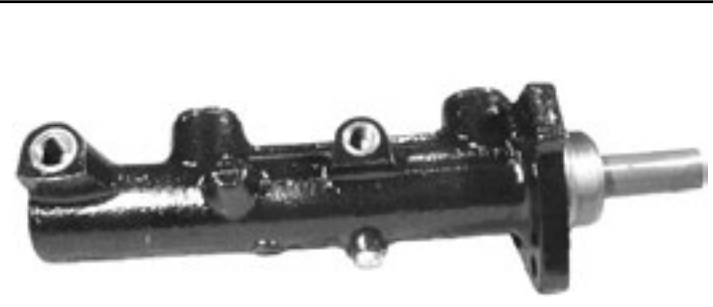
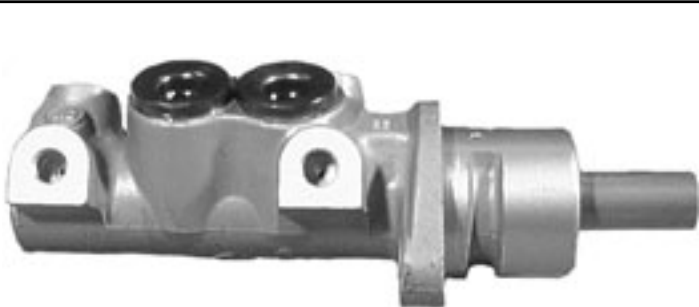



# Abbildungen Hauptbremszylinder

Illustrations master cylinder - Illustrazioni pompe freno -

Illustrations Maître cylindres - Ilustraciones cilindro maestro freno

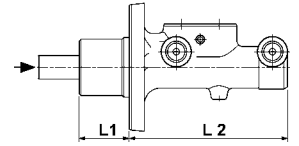

**03.2123-0566.3 010169**  
 Ø 23,81 4x M10x1 → L1 36,0 L2 115,7



**03.2123-0609.3 010171**  
 Ø 23,81 3x M10x1 → L1 18,8 L2 153,0



**03.2123-0614.3 010172**  
 Ø 23,81 3x M10x1 → L1 18,8 L2 153,0



**03.2123-0921.3 010174**  
 Ø 23,81 2x M10x1 → L1 37,9 L2 125,2



**03.2123-1003.3 010175**  
 Ø 23,81 3x M10x1 → L1 18,8 L2 153,0



**03.2123-1121.3 010176**  
 Ø 23,81 1x M10x1 1x M12x1 → L1 29,1 L2 118,0



**03.2123-1181.3 010522**  
 Ø 23,81 2x M10x1 → L1 13,2 L2 145,8

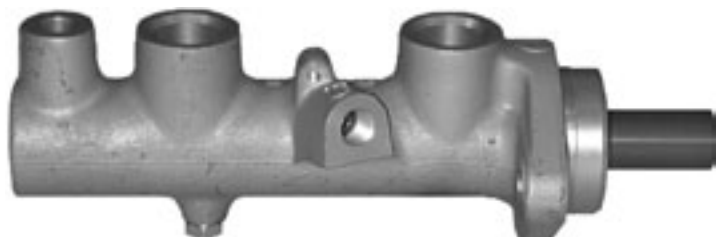

**03.2123-1424.3 010637**  
 Ø 23,81 2x M10x1 → L1 34,4 L2 116,6

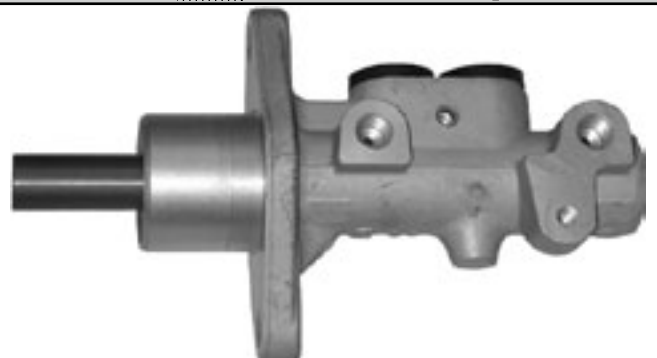

# Abbildungen Hauptbremszylinder

Illustrations master cylinder - Illustrazioni pompe freno -

Illustrations Maître cylindres - Ilustraciones cilindro maestro freno

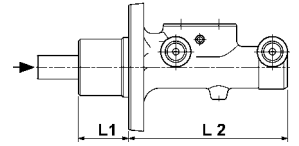

**03.2123-1428.3 010476**

Ø 23,81



2x M10x1

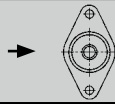

L1

L2

34,4 116,6

**03.2123-1484.3 010595**

Ø 23,81



2x M12x1

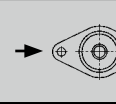

L1

L2

31,5 119,6



**03.2123-1486.3 010488**

Ø 23,81



2x M12x1

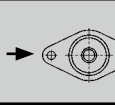

L1

L2

31,5 119,6

**03.2123-1526.3 010477**

Ø 23,81



2x M12x1

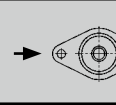

L1

L2

31,5 119,6



**03.2123-1546.3 010536**

Ø 23,81



4x M10x1

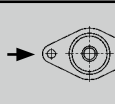

L1

L2

27,9 114,1

**03.2123-1548.3 010478**

Ø 23,81



4x M10x1

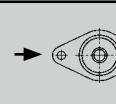

L1

L2

27,9 114,1



**03.2123-1551.3 010512**

Ø 23,81



4x M10x1

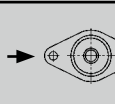

L1

L2

27,9 114,1

**03.2123-1581.3 010487**

Ø 23,81



2x M12x1

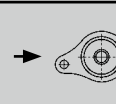

L1

L2

33,1 125,8





# Abbildungen Hauptbremszylinder

Illustrations master cylinder - Illustrazioni pompe freno -

Illustrations Maître cylindres - Ilustraciones cilindro maestro freno

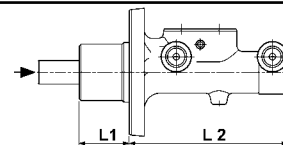

**03.2123-1622.3 010470**

Ø 23,81

1x M10x1  
2x M12x1



L1 L2  
31,5 119,6



**03.2123-1626.3 010727**

Ø 23,81

1x M10x1  
2x M12x1



L1 L2  
31,5 119,6



**03.2123-1722.3 010471**

Ø 23,81

2x M12x1



L1 L2  
56,0 95,1



**03.2123-1741.3 010537**

Ø 23,81

4x M10x1



L1 L2  
27,9 113,1



**03.2123-1824.3 010596**

Ø 23,81

2x M10x1



L1 L2  
31,5 119,6



**03.2123-1963.3 010737**

Ø 23,81

3x M10x1



L1 L2  
32,9 120,8



**03.2123-2024.3 010597**

Ø 23,81

1x M10x1  
3x M12x1



L1 L2  
4,1 137,8

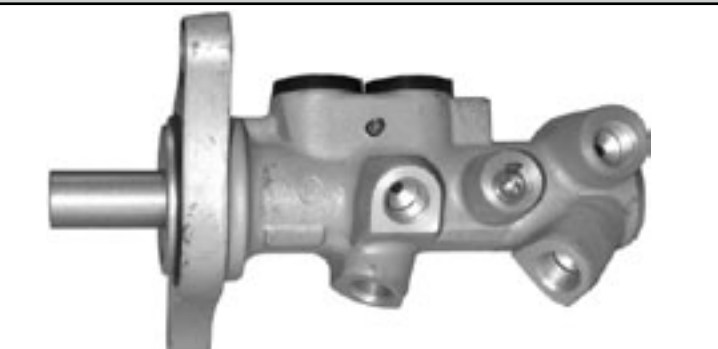

**03.2123-2064.3 010598**

Ø 23,81

4x M12x1



L1 L2  
12,5 128,9



# Abbildungen Hauptbremszylinder

Illustrations master cylinder - Illustrazioni pompe freno -

Illustrations Maître cylindres - Ilustraciones cilindro maestro freno

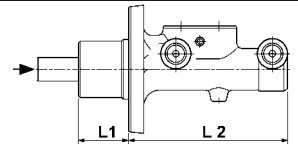

**03.2123-2146.3 010572**  
 Ø 23,81 2x M10x1 → L1 31,5 L2 119,0



**03.2123-2164.3 010599**  
 Ø 23,81 2x M12x1 → L1 40,3 L2 130,0



**03.2123-2181.3 010608**  
 Ø 23,81 2x M10x1 → L1 31,5 L2 119,0



**03.2123-2221.3 010861**  
 Ø 23,81 2x M10x1 → L1 13,2 L2 145,7



**03.2123-2243.3 010748**  
 Ø 23,81 2x M12x1 → L1 26,5 L2 124,0

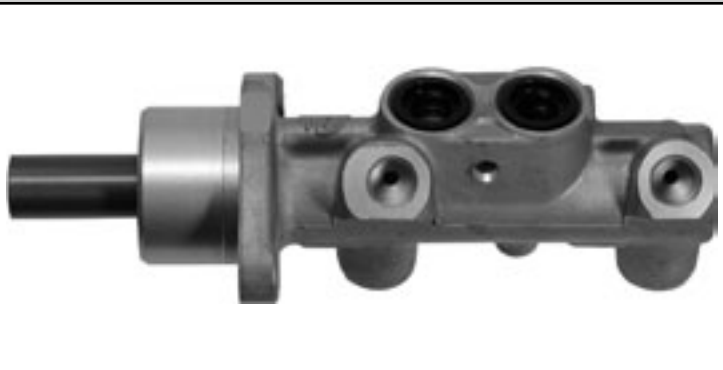

**03.2123-2350.3 010745**  
 Ø 23,81 1x M10x1 3x M12x1 → L1 4,1 L2 139,6

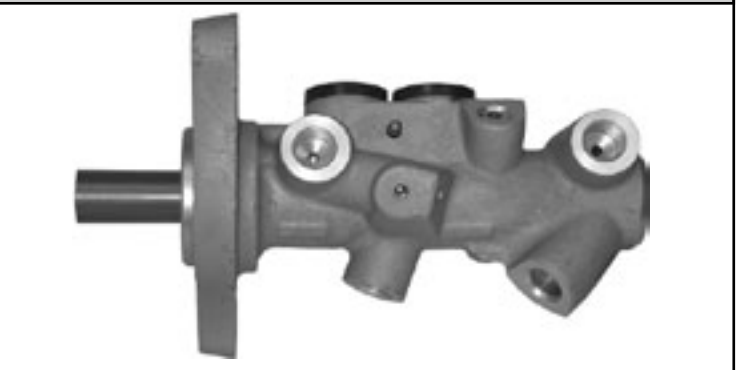

**03.2123-2561.3 010629**  
 Ø 23,81 3x M12x1 → L1 23,9 L2 133,8

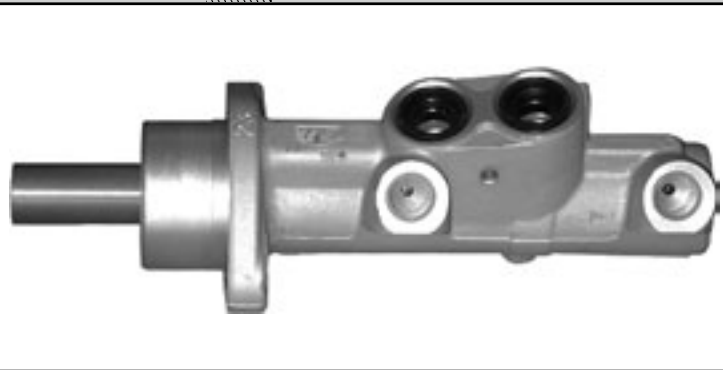

**03.2123-2581.3 010613**  
 Ø 23,81 2x M12x1 → L1 31,5 L2 119,6

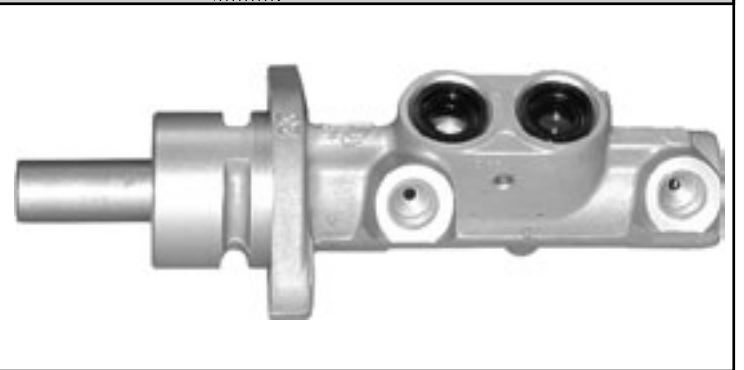

# Abbildungen Hauptbremszylinder

Illustrations master cylinder - Illustrazioni pompe freno -

Illustrations Maître cylindres - Ilustraciones cilindro maestro freno

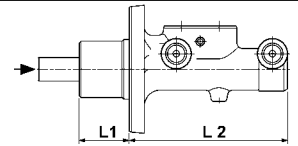

**03.2123-2604.3 010178**

Ø 23,81

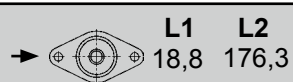
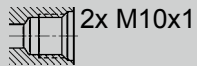

**03.2123-2621.3 010701**

Ø 23,81

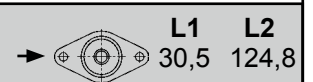
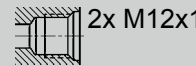

**03.2123-2654.3 010801**

Ø 23,81

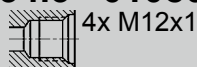

**03.2123-2715.3 010802**

Ø 23,81



**03.2123-2721.3 010632**

Ø 23,81

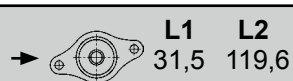
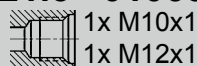

**03.2123-2761.3 010886**

Ø 23,81

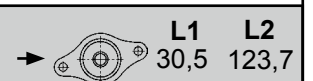

**03.2123-2774.3 010803**

Ø 23,81

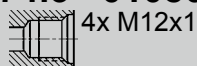

**03.2123-2781.3 010631**

Ø 23,81

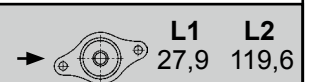

# Abbildungen Hauptbremszylinder

Illustrations master cylinder - Illustrazioni pompe freno -

Illustrations Maître cylindres - Ilustraciones cilindro maestro freno

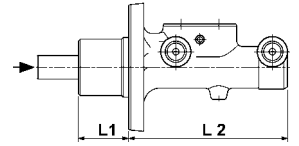

**03.2123-2863.3 010790**

Ø 23,81

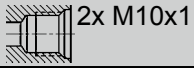

**03.2123-2923.3 010791**

Ø 23,81



**03.2123-2963.3 010804**

Ø 23,81

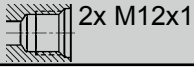

**03.2123-3041.3 010887**

Ø 23,81

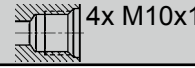

**03.2123-3103.3 010781**

Ø 23,81



**03.2123-3123.3 010806**

Ø 23,81

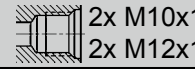

**03.2123-3223.3 010807**

Ø 23,81

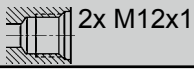

**03.2123-3241.3 010882**

Ø 23,81





# Abbildungen Hauptbremszylinder

Illustrations master cylinder - Illustrazioni pompe freno -

Illustrations Maître cylindres - Ilustraciones cilindro maestro freno

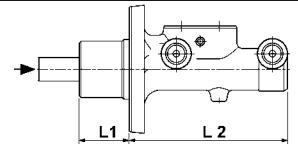

**03.2123-3281.3 010758**

Ø 23,81



4x M10x1

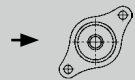

L1 L2  
39,8 126,8



**03.2123-3302.3 010180**

Ø 23,81



2x M12x1

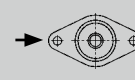

L1 L2  
18,8 159,5



**03.2123-3402.3 010181**

Ø 23,81



3x M10x1

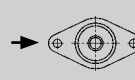

L1 L2  
18,8 153,0



**03.2123-3449.3 010808**

Ø 23,81



2x M12x1

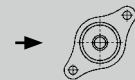

L1 L2  
36,1 134,9



**03.2123-3493.3 010792**

Ø 23,81



2x M12x1

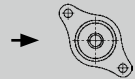

L1 L2  
28,2 119,0



**03.2123-3549.3 010809**

Ø 23,81



2x M12x1

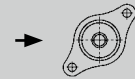

L1 L2  
36,1 134,9



**03.2123-3593.3 010919**

Ø 23,81



2x M12x1

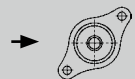

L1 L2  
37,0 116,3



**03.2123-4911.3 010182**

Ø 23,81



3x M10x1

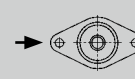

L1 L2  
18,8 181,0



# Abbildungen Hauptbremszylinder

Illustrations master cylinder - Illustrazioni pompe freno -

Illustrations Maître cylindres - Ilustraciones cilindro maestro freno

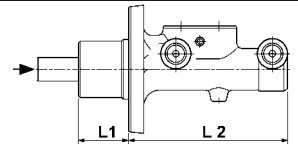

**03.2123-5212.3 010183**

Ø 23,81

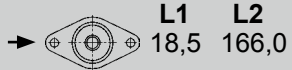
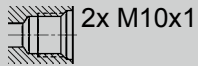

**03.2123-6002.3 010184**

Ø 23,81

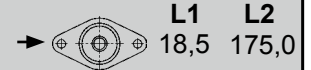

**03.2123-6207.3 010185**

Ø 23,81

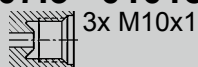

**03.2123-6802.3 010186**

Ø 23,81



**03.2123-7002.3 010187**

Ø 23,81

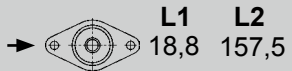
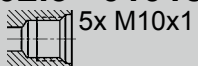

**03.2123-7902.3 010191**

Ø 23,81



**03.2123-8311.3 010192**

Ø 23,81

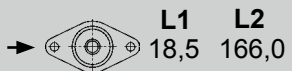
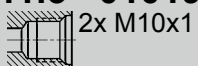

**03.2123-8312.3 010193**

Ø 23,81

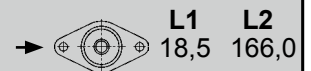



# Abbildungen Hauptbremszylinder

Illustrations master cylinder - Illustrazioni pompe freno -

Illustrations Maître cylindres - Ilustraciones cilindro maestro freno

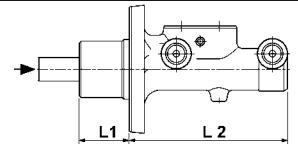

**03.2123-8512.3 010194**  
 Ø 23,81 4x M10x1 → L1 18,5 L2 166,0



**03.2123-8611.3 010195**  
 Ø 23,81 3x M10x1 → L1 18,5 L2 162,5



**03.2123-8711.3 010196**  
 Ø 23,81 2x M10x1 → L1 18,5 L2 166,4



**03.2123-8902.3 010197**  
 Ø 23,81 3x M10x1 → L1 18,5 L2 170,5



**03.2123-9002.3 010198**  
 Ø 23,81 3x M10x1 → L1 18,5 L2 170,5



**03.2123-9207.3 010199**  
 Ø 23,81 5x M10x1 → L1 18,5 L2 166,0



**03.2125-0161.3 010920**  
 Ø 25,40 2x M10x1 → L1 9,0 L2 142,0



**03.2125-0293.3 010817**  
 Ø 25,40 2x M12x1 → L1 35,2 L2 133,8





# Abbildungen Hauptbremszylinder

Illustrations master cylinder - Illustrazioni pompe freno -

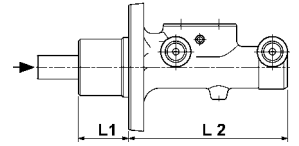

Illustrations Maître cylindres - Ilustraciones cilindro maestro freno





**03.2125-0298.3 010818**  
 Ø 25,40  2x M10x1 →  L1 L2  
 35,2 133,8



**03.2125-0343.3 010896**  
 Ø 25,40  2x M12x1 → L1 L2  
 38,2 108,0



**03.2125-0373.3 010810**  
 Ø 25,40  2x M12x1 →  L1 L2  
 64,2 93,5



**03.2125-0483.3 010783**  
 Ø 25,40  2x M12x1 →  L1 L2  
 37,0 117,5





**03.2125-0661.3 010917**  
 Ø 25,40  2x M14x1 →  L1 L2  
 37,0 117,5

**03.2125-1102.3 010202**  
 Ø 25,40  1x M10x1  
 2x M12x1 →  L1 L2  
 18,8 166,5



**03.2125-1302.3 010203**  
 Ø 25,40  2x M12x1 →  L1 L2  
 18,8 159,5

**03.2125-1712.3 010204**  
 Ø 25,40  2x M10x1 →  L1 L2  
 18,5 166,0



# Abbildungen Hauptbremszylinder

Illustrations master cylinder - Illustrazioni pompe freno -

Illustrations Maître cylindres - Ilustraciones cilindro maestro freno

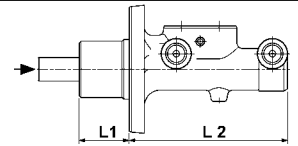

**03.2125-1902.3 010206**  
 Ø 25,40 2x M10x1 → L1 18,5 L2 155,0

**03.2125-2102.3 010207**  
 Ø 25,40 2x M10x1 → L1 18,5 L2 158,5

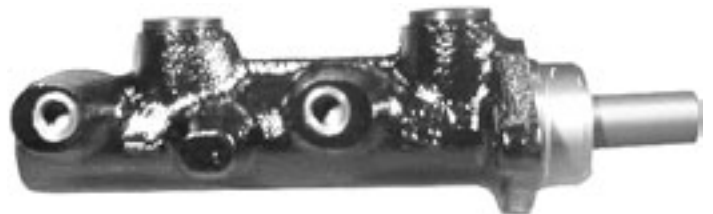
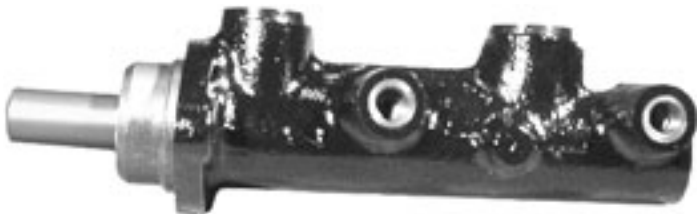

**03.2125-2510.3 010209**  
 Ø 25,40 4x M10x1 → L1 18,5 L2 166,0

**03.2125-2802.3 010210**  
 Ø 25,40 2x M10x1 → L1 18,5 L2 163,5



**03.2125-3011.3 010211**  
 Ø 25,40 2x M10x1 → L1 55,4 L2 114,5

**03.2125-3210.3 010212**  
 Ø 25,40 4x M10x1 → L1 36,0 L2 116,2



**03.2125-3610.3 010214**  
 Ø 25,40 2x M10x1 → L1 36,0 L2 116,2

**03.2125-3701.3 010627**  
 Ø 25,40 5x M10x1 → L1 18,5 L2 166,0



# Abbildungen Hauptbremszylinder

Illustrations master cylinder - Illustrazioni pompe freno -

Illustrations Maître cylindres - Ilustraciones cilindro maestro freno

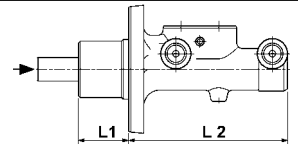

**03.2125-3801.3 010215**

Ø 25,40

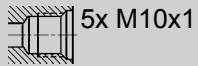

L1 L2  
18,5 166,0

**03.2125-7002.3 010628**

Ø 25,40



L1 L2  
10,2 166,0



**03.2125-7310.3 010743**

Ø 25,40

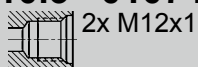

L1 L2  
11,6 141,0

**03.2125-7402.3 010541**

Ø 25,40



L1 L2  
31,5 120,8



**03.2125-7502.3 010616**

Ø 25,40

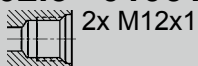

L1 L2  
56,0 96,3

**03.2125-7637.3 010707**

Ø 25,40



L1 L2  
11,6 140,7



**03.2125-7638.3 010738**

Ø 25,40

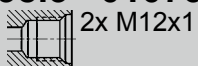

L1 L2  
11,6 140,7

**03.2125-7708.3 010739**

Ø 25,40



L1 L2  
11,6 140,7





# Abbildungen Hauptbremszylinder

Illustrations master cylinder - Illustrazioni pompe freno -

Illustrations Maître cylindres - Ilustraciones cilindro maestro freno

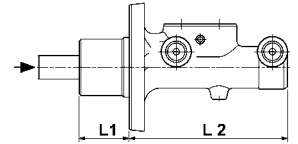

**03.2125-7713.3 010819**

Ø 25,40



4x M12x1



L1 L2  
11,6 140,7

**03.2125-8111.3 010479**

Ø 25,40



4x M10x1



L1 L2  
31,5 120,8



**03.2125-8404.3 010583**

Ø 25,40



4x M10x1



L1 L2  
34,6 108,0

**03.2125-8811.3 010563**

Ø 25,40



1x M10x1  
1x M12x1



L1 L2  
32,1 144,1



**03.2125-9604.3 010581**

Ø 25,40



1x M10x1  
4x M12x1



L1 L2  
14,6 131,5

**03.2125-9704.3 010603**

Ø 25,40



2x M12x1



L1 L2  
32,9 125,5



**03.2125-9901.3 010634**

Ø 25,40



1x M10x1  
2x M12x1



L1 L2  
44,7 110,9

**03.2125-9911.3 010883**

Ø 25,40



2x M12x1



L1 L2  
44,7 112,4



# Abbildungen Hauptbremszylinder

Illustrations master cylinder - Illustrazioni pompe freno -

Illustrations Maître cylindres - Ilustraciones cilindro maestro freno

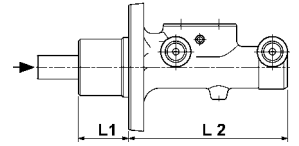

**03.2126-0512.3 010217**

Ø 26,99



2x M10x1



L1 L2  
18,5 155,0

**03.2126-3014.3 010811**

Ø 26,99



2x M12x1



L1 L2  
18,7 133,5



**03.2126-3063.3 010812**

Ø 26,99



2x M12x1



L1 L2  
23,3 128,9

**03.2130-0102.3 010221**

Ø 30,00



1x M10x1  
1x M14x1,5



L1 L2  
18,5 204,5



**03.2320-0201.3 010234**

Ø 28,57/20,64



1x M12x1



L1 L2  
23,5 198,5

**03.3115-2102.3 010247**

Ø 15,87



4x M10x1



L1 L2  
13,0 111,0

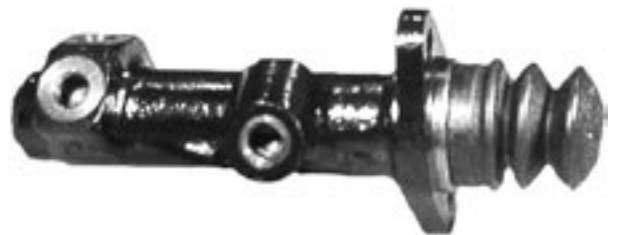

**03.3115-2651.3 010250**

Ø 15,87



3x M10x1



L1 L2  
13,0 118,5

**03.3117-1408.3 010255**

Ø 17,46



3x M10x1



L1 L2  
14,5 125,0







# Abbildungen Hauptbremszylinder

Illustrations master cylinder - Illustrazioni pompe freno -

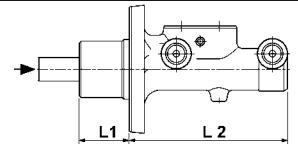
Illustrations Maître cylindres - Ilustraciones cilindro maestro freno



**03.3119-0201.3 010257**  
 Ø 19,05 3x M10x1 →  L1 L2  
 14,5 116,0



**03.3119-0211.3 010258**  
 Ø 19,05 3x M10x1 →  L1 L2  
 14,5 116,0



**03.3119-0507.3 010264**  
 Ø 19,05 3x M10x1 →  L1 L2  
 14,5 116,0



**03.3119-6457.3 010269**  
 Ø 19,05 3x M10x1 →  L1 L2  
 42,5 97,0



**03.3119-6551.3 010270**  
 Ø 19,05 3x M10x1 →  L1 L2  
 14,5 116,0

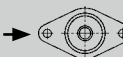

**03.3119-7251.3 010272**  
 Ø 19,05 2x M10x1 →  L1 L2  
 14,5 116,0



**03.3122-0101.3 010277**  
 Ø 22,20 3x M10x1 →  L1 L2  
 14,5 116,0



**03.3125-0401.3 010290**  
 Ø 25,40 1x M14x1,5 1x M22x1,5 →  L1 L2  
 23,5 120,5



# Abbildungen Hauptbremszylinder

Illustrations master cylinder - Illustrazioni pompe freno -

Illustrations Maître cylindres - Ilustraciones cilindro maestro freno

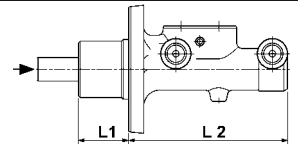









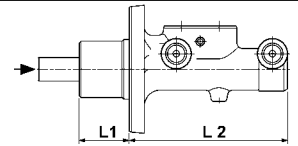













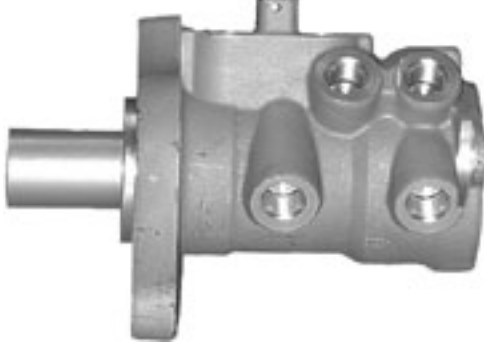

|  |  |
|--|--|
| <p><b>03.3126-0505.3 010294</b><br/>                     Ø 26,99<br/>                     1x M12x1<br/>                     1x M14x1,5<br/>                     L1 50,0 L2 117,0</p>   | <p><b>03.3128-1401.3 010295</b><br/>                     Ø 28,57<br/>                     1x M12x1<br/>                     1x M18x1,5<br/>                     L1 23,5 L2 119,0</p>   |
|  |  |
| <p><b>03.3131-0102.3 010296</b><br/>                     Ø 31,75<br/>                     4x M14x1<br/>                     1x M22x1,5<br/>                     L1 27,0 L2 140,0</p>   | <p><b>03.3131-0601.3 010299</b><br/>                     Ø 31,75<br/>                     1x M14x1,5<br/>                     1x M22x1,5<br/>                     L1 21,0 L2 177,0</p> |
|  |  |
| <p><b>03.3134-0300.3 010308</b><br/>                     Ø 34,92<br/>                     1x M14x1,5<br/>                     1x M22x1,5<br/>                     L1 31,0 L2 194,0</p> | <p><b>03.3138-2001.3 010310</b><br/>                     Ø 38,10<br/>                     1x M14x1,5<br/>                     1x M22x1,5<br/>                     L1 31,0 L2 195,5</p> |
|  |  |
| <p><b>03.3138-2010.3 010311</b><br/>                     Ø 38,10<br/>                     1x M14x1,5<br/>                     1x M22x1,5<br/>                     L1 31,0 L2 195,5</p> | <p><b>03.3150-0101.3 010321</b><br/>                     Ø 50,80<br/>                     3x M14x1,5<br/>                     1x M22x1,5<br/>                     L1 86,0 L2 172,0</p> |
|  |  |

# Abbildungen Hauptbremszylinder

Illustrations master cylinder - Illustrazioni pompe freno -

Illustrations Maître cylindres - Ilustraciones cilindro maestro freno



|  |   |
|--|---|
| <p><b>03.4055-0013.3 010793</b><br/>                     Ø 25,40  2x M12x1 →  L1 L2<br/>                     20,0 106,0</p>       | <p><b>03.4122-0031.3 010611</b><br/>                     Ø 22,20  4x M10x1 →  L1 L2<br/>                     14,0 85,1</p>        |
| <p><b>03.4122-0041.3 010612</b><br/>                     Ø 22,20  2x M10x1 →  L1 L2<br/>                     14,0 85,1</p>       | <p><b>03.4122-0054.3 010813</b><br/>                     Ø 22,20  2x M12x1 →  L1 L2<br/>                     13,7 87,9</p>       |
| <p><b>03.4123-0019.3 010584</b><br/>                     Ø 23,81  4x M12x1 →  L1 L2<br/>                     5,5 102,3</p>  | <p><b>03.4123-0081.3 010585</b><br/>                     Ø 23,81  3x M12x1 →  L1 L2<br/>                     5,5 102,3</p>  |
| <p><b>03.4123-0153.3 010659</b><br/>                     Ø 23,81  3x M12x1 →  L1 L2<br/>                     12,8 90,3</p>  | <p><b>03.4125-0014.3 010794</b><br/>                     Ø 25,40  3x M12x1 →  L1 L2<br/>                     4,2 105,0</p>  |

# Abbildungen Hauptbremszylinder

Illustrations master cylinder - Illustrazioni pompe freno -

Illustrations Maître cylindres - Ilustraciones cilindro maestro freno

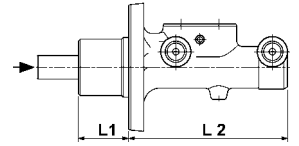

**03.4125-0021.3 010888**

Ø 25,40

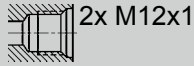

L1 L2  
4,2 105,0



**03.4152-0020.3 010929**

Ø 22,20

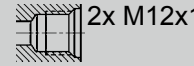

L1 L2  
27,5 98,2



**03.4152-0053.3 010884**

Ø 22,20

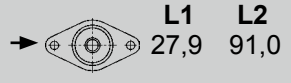
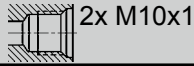

L1 L2  
27,9 91,0



**03.4152-0058.3 010885**

Ø 22,20

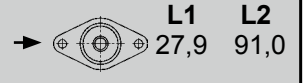
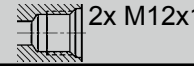

L1 L2  
27,9 91,0



**03.4152-0116.3 010814**

Ø 22,20

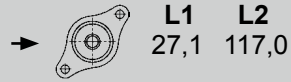
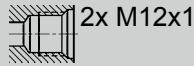

L1 L2  
27,1 117,0



**03.4153-0015.4 010784**

Ø 23,81

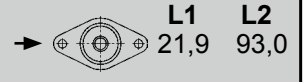
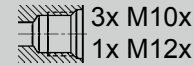

L1 L2  
21,9 93,0



**03.4153-0025.4 010785**

Ø 23,81

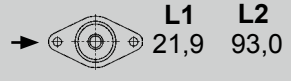
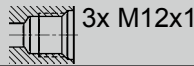

L1 L2  
21,9 93,0



**03.4153-0029.4 010786**

Ø 23,81

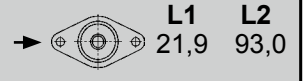
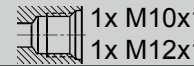

L1 L2  
21,9 93,0





# Abbildungen Hauptbremszylinder

Illustrations master cylinder - Illustrazioni pompe freno -

Illustrations Maître cylindres - Ilustraciones cilindro maestro freno

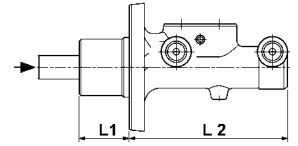

**03.4153-0063.3 010773**

Ø 23,81

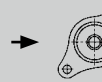
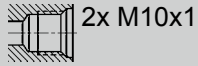

L1 L2  
9,9 105,1



**03.4153-0173.3 010815**

Ø 23,81

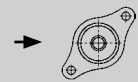

L1 L2  
31,7 92,2



**03.4153-0186.3 010816**

Ø 23,81

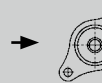
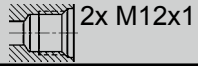

L1 L2  
27,1 117,0



**03.4155-0043.3 010795**

Ø 25,40

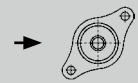

L1 L2  
9,9 105,0



**03.4155-0156.3 010862**

Ø 25,40

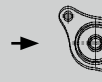
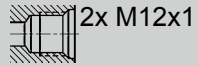

L1 L2  
24,2 90,7



**10.6120-0287.3 010334**

Ø 20,64

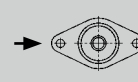

L1 L2  
39,8 121,1



**10.6122-0144.3 010638**

Ø 22,20

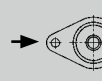
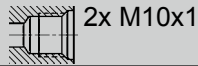

L1 L2  
41,0 127,9



**10.6123-0154.3 010578**

Ø 23,81

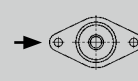
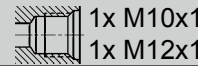

L1 L2  
12,0 174,6



# Abbildungen Hauptbremszylinder

Illustrations master cylinder - Illustrazioni pompe freno -

Illustrations Maître cylindres - Ilustraciones cilindro maestro freno

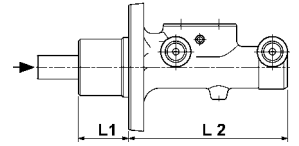

**10.6123-0239.3 010335**

Ø 23,81

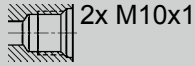

L1 43,3 L2 132,0

**10.6123-0312.3 010457**

Ø 23,81

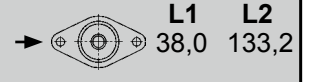
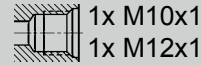

L1 38,0 L2 133,2



**10.6123-0446.4 010336**

Ø 23,81

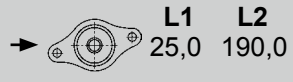
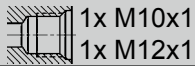

L1 25,0 L2 190,0

**10.6123-0522.3 010633**

Ø 23,81

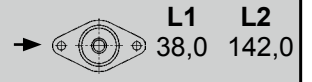

L1 38,0 L2 142,0



**10.6123-0674.3 010639**

Ø 23,81

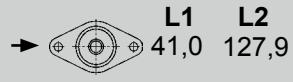
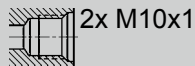

L1 41,0 L2 127,9

**10.6125-0124.3 010560**

Ø 25,40

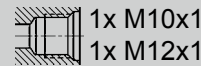

L1 33,0 L2 125,8



**10.6125-0167.3 010337**

Ø 25,40

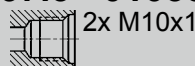

L1 42,3 L2 131,0

**20.5522-1093.3 010731**

Ø 22,20



L1 31,5 L2 120,0







# Abbildungen Hauptbremszylinder

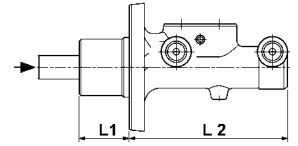

Illustrations master cylinder - Illustrazioni pompe freno -

Illustrations Maître cylindres - Ilustraciones cilindro maestro freno





**20.5522-1128.3 010747**  
 Ø 22,20  2x M10x1 →  L1 L2  
 31,5 120,0





**24.2022-1601.3 010340**  
 Ø 22,20/17,46  3x M10x1 →  L1 L2  
 58,0 113,0





**24.2023-1601.3 010341**  
 Ø 23,81  3x M10x1 →  L1 L2  
 50,0 120,5



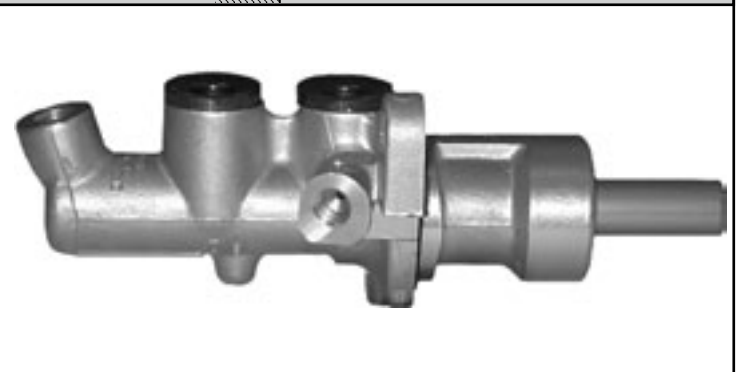

**24.2023-1701.3 010514**  
 Ø 23,81/19,05  1x M10x1  
 1x M12x1 →  L1 L2  
 51,5 106,0



**24.2023-1702.3 010534**  
 Ø 23,81/19,05  3x M12x1 →  L1 L2  
 24,0 125,0





**24.2023-1704.3 010635**  
 Ø 23,81  3x M12x1 →  L1 L2  
 14,0 135,0

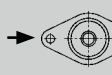

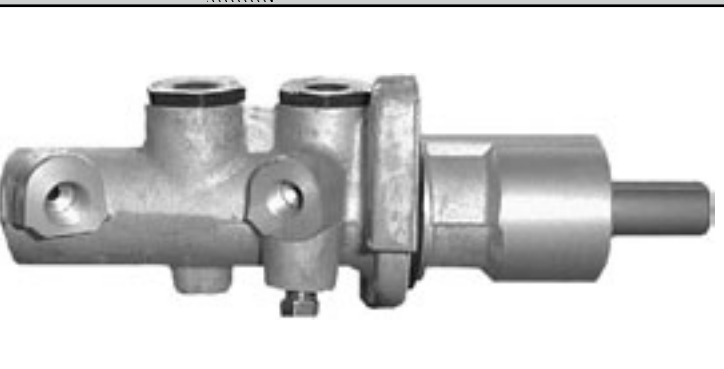
**24.2025-1701.3 010490**  
 Ø 25,40/20,64  1x M10x1  
 1x M12x1 →  L1 L2  
 57,5 118,0



**24.2025-1702.3 010515**  
 Ø 25,40/19,05  1x M10x1  
 1x M12x1 →  L1 L2  
 51,3 106,2

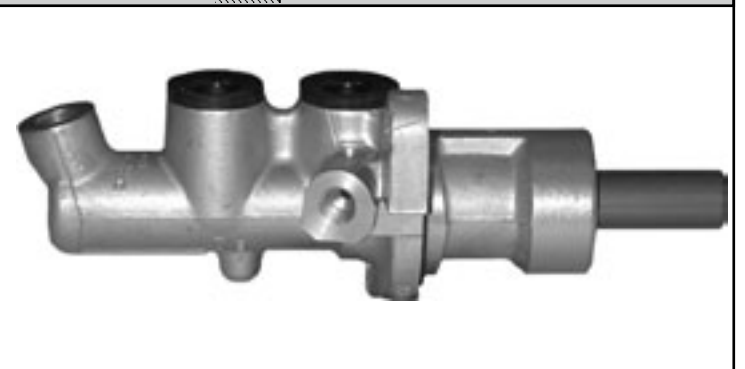

# Abbildungen Hauptbremszylinder

Illustrations master cylinder - Illustrazioni pompe freno -

Illustrations Maître cylindres - Ilustraciones cilindro maestro freno

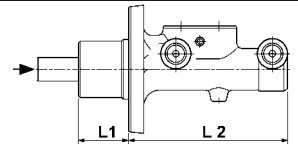

**24.2025-1703.3 010516**

Ø 25,40/19,05

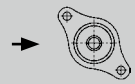
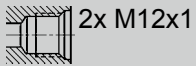

L1 L2  
51,3 106,2



**24.2025-1704.3 010619**

Ø 25,40

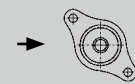
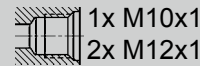

L1 L2  
51,3 107,7



**24.2025-1705.3 010624**

Ø 25,40/20,64

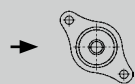
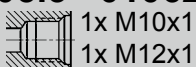

L1 L2  
51,5 108,0



**24.2025-1706.3 010676**

Ø 25,40

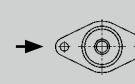

L1 L2  
33,0 127,0



**24.2025-1707.3 010691**

Ø 25,40

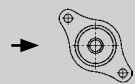
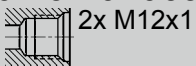

L1 L2  
51,7 108,5



**24.2025-1708.3 010692**

Ø 25,40

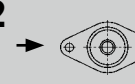
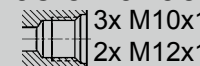

L1 L2  
33,0 127,0



**24.2025-1709.3 010693**

Ø 25,40

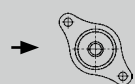
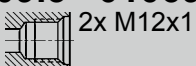

L1 L2  
51,3 108,0



**24.2025-1710.3 010833**

Ø 25,40/22,20

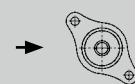
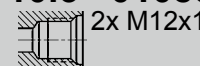

L1 L2  
69,3 90,0



# Abbildungen Hauptbremszylinder

Illustrations master cylinder - Illustrazioni pompe freno -

Illustrations Maître cylindres - Ilustraciones cilindro maestro freno

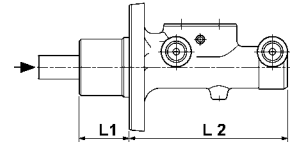

**24.2026-1701.3 010746**

Ø 26,99/20,64



3x M12x1

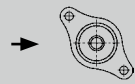

L1 L2  
51,2 107,3



**24.2026-1702.3 010850**

Ø 26,99/22,20



2x M12x1

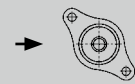

L1 L2  
69,2 90,5



**24.2117-1501.3 010398**

Ø 17,46



2x M10x1

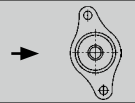

L1 L2  
8,5 182,5



**24.2117-1503.3 010400**

Ø 17,46



2x M10x1  
2x M12x1

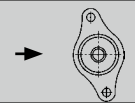

L1 L2  
10,5 176,5



**24.2119-0806.3 010345**

Ø 19,05



3x M10x1,25

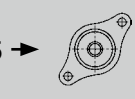

L1 L2  
12,0 178,5

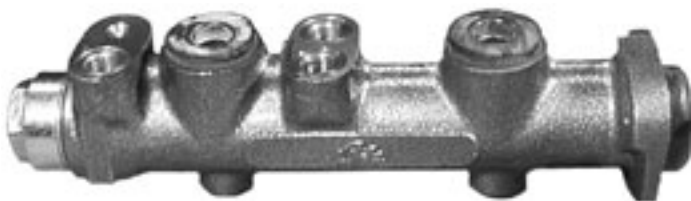

**24.2119-0815.3 010347**

Ø 19,05



3x M10x1,25

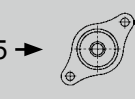

L1 L2  
12,0 177,5



**24.2119-0826.3 010349**

Ø 19,05



3x M10x1

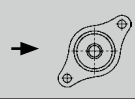

L1 L2  
12,0 178,4



**24.2119-0827.3 010350**

Ø 19,05



3x M10x1

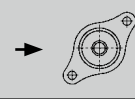

L1 L2  
12,0 178,0





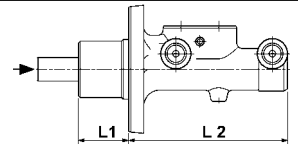

# Abbildungen Hauptbremszylinder

Illustrations master cylinder - Illustrazioni pompe freno -



Illustrations Maître cylindres - Ilustraciones cilindro maestro freno





**24.2119-0829.3 010351**  
 Ø 19,05  3x M10x1 →  L1 L2  
 9,0 194,1



**24.2119-0831.3 010416**  
 Ø 19,05  3x M10x1,25 →  L1 L2  
 9,5 190,0





**24.2119-0832.3 010417**  
 Ø 19,05  3x M10x1,25 →  L1 L2  
 9,5 190,0



**24.2119-0833.3 010418**  
 Ø 19,05  4x M10x1 →  L1 L2  
 10,5 190,0





**24.2119-0905.3 010353**  
 Ø 19,05  3x M10x1  
 1x M12x1 →  L1 L2  
 15,5 187,0

**24.2119-1503.3 010404**  
 Ø 19,05  3x M10x1 →  L1 L2  
 8,5 192,0



**24.2119-1702.3 010435**  
 Ø 19,05  4x M10x1 →  L1 L2  
 40,0 115,2

**24.2119-1703.3 010323**  
 Ø 19,05  3x M10x1 →  L1 L2  
 9,0 175,0







# Abbildungen Hauptbremszylinder

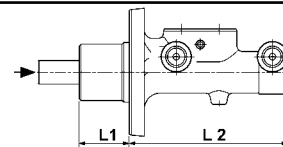

Illustrations master cylinder - Illustrazioni pompe freno -

Illustrations Maître cylindres - Ilustraciones cilindro maestro freno





**24.2119-1704.3 010339**  
 Ø 19,05  3x M10x1 →  L1 L2  
 10,0 193,0



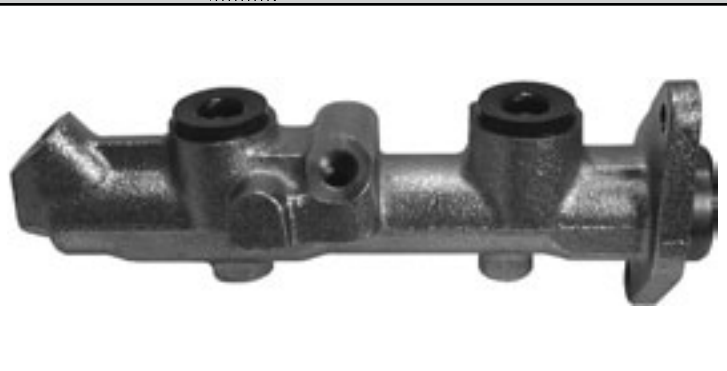

**24.2119-1705.3 010460**  
 Ø 19,05  2x M10x1 →  L1 L2  
 8,5 192,5





**24.2119-1708.3 010543**  
 Ø 19,05  4x M10x1 →  L1 L2  
 34,5 116,5





**24.2119-1709.3 010876**  
 Ø 19,05  2x M10x1 →  L1 L2  
 18,0 164,0



**24.2119-1710.3 010880**  
 Ø 19,05  2x M10x1 →  L1 L2  
 17,0 130,0





**24.2119-1711.3 010911**  
 Ø 19,05  2x M12x1 →  L1 L2  
 41,0 116,5



**24.2119-1712.3 010912**  
 Ø 19,05  2x M12x1 →  L1 L2  
 69,2 90,5



**24.2120-0702.3 010361**  
 Ø 20,64  2x M10x1  
 2x M12x1 →  L1 L2  
 16,0 130,0

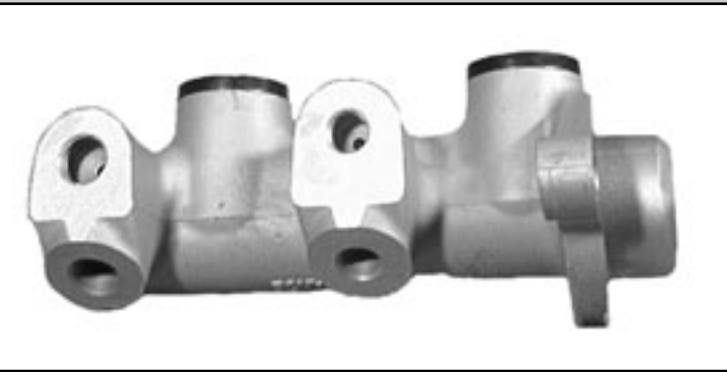



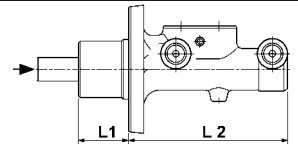

# Abbildungen Hauptbremszylinder

Illustrations master cylinder - Illustrazioni pompe freno -



Illustrations Maître cylindres - Ilustraciones cilindro maestro freno





**24.2120-0801.3 010362**  
 Ø 20,64  3x M10x1 →  L1 L2  
 9,0 190,2



**24.2120-0802.3 010363**  
 Ø 20,64  3x M10x1 →  L1 L2  
 39,1 120,4





**24.2120-0803.3 010415**  
 Ø 20,64  4x M10x1,25 →  L1 L2  
 9,0 178,5

**24.2120-0905.3 010364**  
 Ø 20,64  1x M10x1  
 1x M12x1 →  L1 L2  
 25,0 193,0





**24.2120-0912.3 010366**  
 Ø 20,64  4x M10x1 →  L1 L2  
 18,8 166,2

**24.2120-0913.3 010392**  
 Ø 20,64  1x M10x1  
 1x M12x1/2x M15x1 →  L1 L2  
 16,0 130,5



**24.2120-1502.3 010405**  
 Ø 20,64  2x M8x1,25 → L1 L2  
 0 182,5

**24.2120-1503.3 010397**  
 Ø 20,64  3x M10x1  
 1x M12x1 →  L1 L2  
 8,5 174,0





# Abbildungen Hauptbremszylinder

Illustrations master cylinder - Illustrazioni pompe freno -

Illustrations Maître cylindres - Ilustraciones cilindro maestro freno

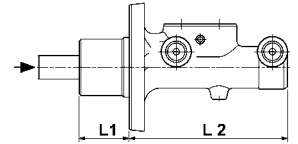

**24.2120-1604.3 010370**

Ø 20,64

1x M10x1  
1x M12x1

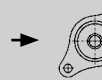

L1 L2  
16,5 172,5

**24.2120-1606.3 010582**

Ø 20,64

4x M10x1

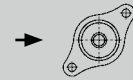

L1 L2  
17,0 174,0



**24.2120-1701.3 010427**

Ø 20,64

2x M10x1

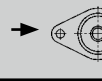

L1 L2  
38,0 114,2

**24.2120-1702.3 010436**

Ø 20,64

4x M10x1

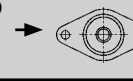

L1 L2  
40,2 115,2



**24.2120-1704.3 010429**

Ø 20,64

2x M10x1  
2x M12x1

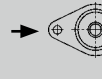

L1 L2  
40,0 114,2

**24.2120-1706.3 010262**

Ø 20,64

4x M10x1

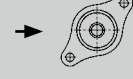

L1 L2  
40,1 118,0

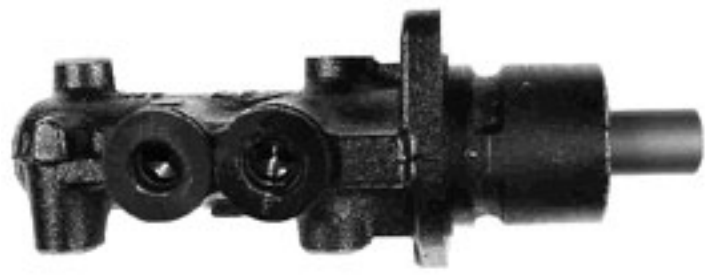

**24.2120-1709.3 010276**

Ø 20,64

2x M10x1  
2x M12x1

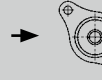

L1 L2  
10,0 201,0

**24.2120-1710.3 010468**

Ø 20,64

4x M10x1

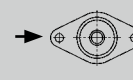

L1 L2  
33,5 130,0



# Abbildungen Hauptbremszylinder

Illustrations master cylinder - Illustrazioni pompe freno -

Illustrations Maître cylindres - Ilustraciones cilindro maestro freno

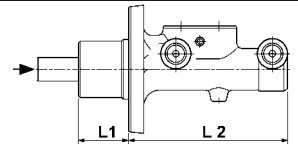

**24.2120-1715.3 010469**

Ø 20,64

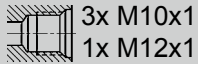

3x M10x1  
1x M12x1



L1 L2  
8,5 173,5



**24.2120-1718.3 010491**

Ø 20,64



3x M10x1



L1 L2  
9,0 173,0

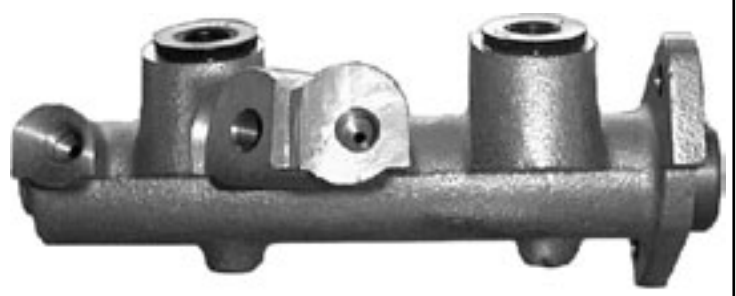

**24.2120-1720.3 010530**

Ø 20,64

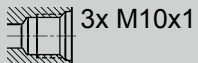

3x M10x1



L1 L2  
35,5 108,0



**24.2120-1721.3 010553**

Ø 20,64

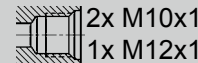

2x M10x1  
1x M12x1



L1 L2  
51,3 143,8



**24.2120-1722.3 010544**

Ø 20,64

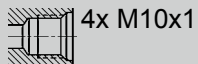

4x M10x1



L1 L2  
34,5 116,5



**24.2120-1723.3 010545**

Ø 20,64



2x M10x1



L1 L2  
34,5 118,0



**24.2120-1725.3 010579**

Ø 20,64

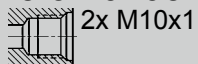

2x M10x1



L1 L2  
34,5 118,0



**24.2120-1726.3 010564**

Ø 20,64

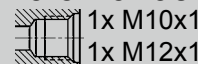

1x M10x1  
1x M12x1



L1 L2  
33,0 120,0

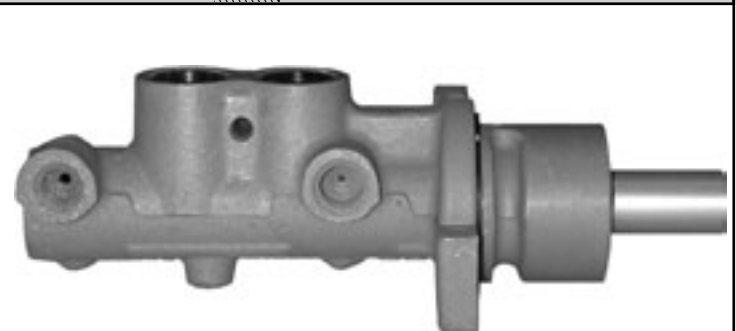



# Abbildungen Hauptbremszylinder

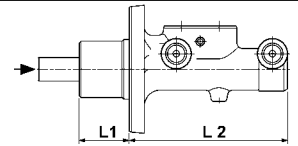

Illustrations master cylinder - Illustrazioni pompe freno -

Illustrations Maître cylindres - Ilustraciones cilindro maestro freno





**24.2120-1728.3 010626**  
 Ø 20,64  2x M10x1 →  L1 L2  
 34,5 116,2





**24.2120-1730.3 010678**  
 Ø 20,64  2x M10x1 →  L1 L2  
 34,5 116,2





**24.2120-1731.3 010667**  
 Ø 20,64  4x M10x1 →  L1 L2  
 34,5 115,5



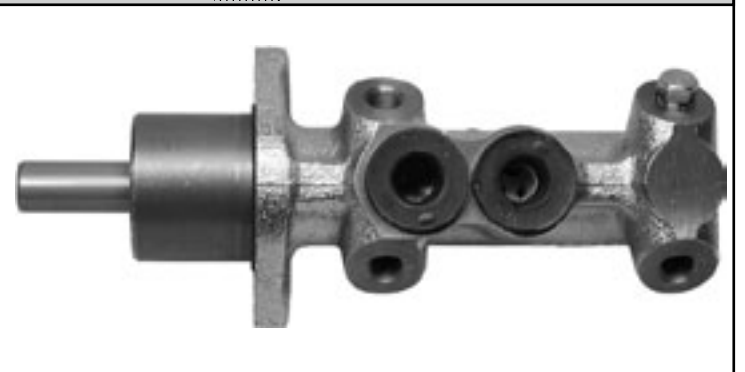

**24.2120-1733.3 010686**  
 Ø 20,64  3x M10x1 →  L1 L2  
 33,5 128,5



**24.2120-1734.3 010702**  
 Ø 20,64  2x M12x1 →  L1 L2  
 38,5 139,5





**24.2120-1735.3 010726**  
 Ø 20,64  2x M12x1 →  L1 L2  
 33,0 130,5



**24.2120-1736.3 010732**  
 Ø 20,64  4x M12x1 →  L1 L2  
 28,1 138,2



**24.2120-1737.3 010757**  
 Ø 20,64  2x M10x1  
 2x M12x1 →  L1 L2  
 30,0 117,0

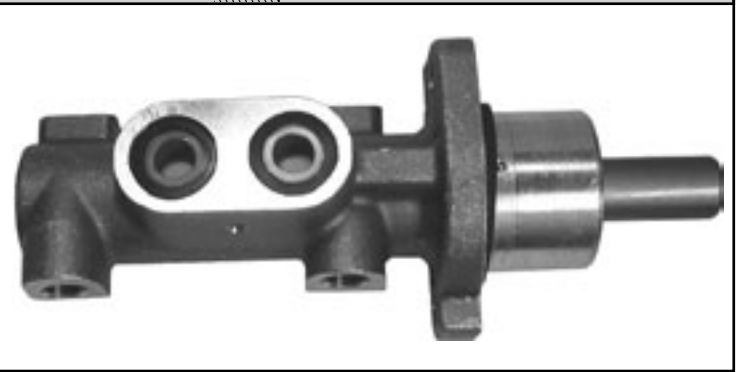

# Abbildungen Hauptbremszylinder

Illustrations master cylinder - Illustrazioni pompe freno -

Illustrations Maître cylindres - Ilustraciones cilindro maestro freno

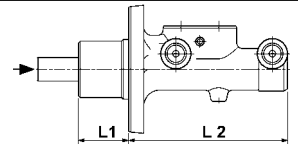

**24.2120-1738.3 010759**

Ø 20,64

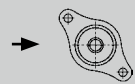
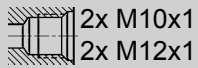

L1 L2  
51,0 139,0

**24.2120-1739.3 010762**

Ø 20,64

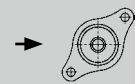
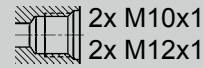

L1 L2  
19,0 171,0



**24.2120-1740.3 010764**

Ø 20,64

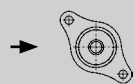
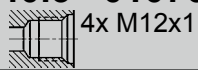

L1 L2  
51,0 139,0

**24.2120-1741.3 010775**

Ø 20,64

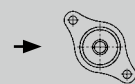

L1 L2  
24,0 132,0



**24.2120-1742.3 010776**

Ø 20,64

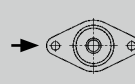
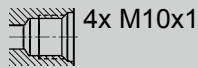

L1 L2  
33,0 125,0

**24.2120-1743.3 010777**

Ø 20,64

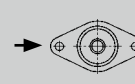
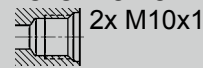

L1 L2  
33,0 125,0



**24.2120-1744.3 010820**

Ø 20,64

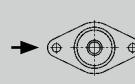

L1 L2  
36,5 132,5

**24.2120-1745.3 010834**

Ø 20,64

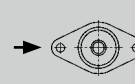

L1 L2  
30,5 131,0







# Abbildungen Hauptbremszylinder

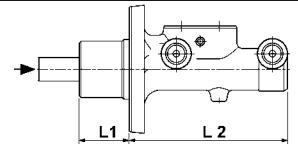

Illustrations master cylinder - Illustrazioni pompe freno -

Illustrations Maître cylindres - Ilustraciones cilindro maestro freno





**24.2120-1746.3 010835**  
 Ø 20,64  2x M12x1 →  L1 L2  
 33,0 132,0





**24.2120-1747.3 010836**  
 Ø 20,64  2x M10x1 →  L1 L2  
 36,5 134,0



**24.2120-1748.3 010894**  
 Ø 20,64  2x M12x1 →  L1 L2  
 25,0 162,0



**24.2120-1749.3 010903**  
 Ø 20,64  2x M10x1 →  L1 L2



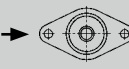

**24.2120-1751.3 010909**  
 Ø 20,64  2x M10x1 →  L1 L2  
 15,5 153,5

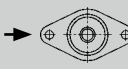

**24.2120-1752.3 010928**  
 Ø 20,64  2x M10x1 →  L1 L2  
 26,0 157,0



**24.2120-1754.3 010949**  
 Ø 20,64  2x M10x1 →  L1 L2  
 23,5 107,0

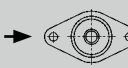

**24.2122-0801.3 010373**  
 Ø 22,20  3x M10x1 →  L1 L2  
 18,8 167,0





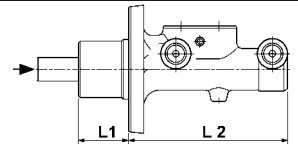

# Abbildungen Hauptbremszylinder

Illustrations master cylinder - Illustrazioni pompe freno -



Illustrations Maître cylindres - Ilustraciones cilindro maestro freno





**24.2122-0802.3 010374**  
 Ø 22,20  4x M10x1 →  L1 L2  
 18,8 167,0



**24.2122-0906.3 010378**  
 Ø 22,20  1x M10x1  
 1x M12x1 →  L1 L2  
 22,9 187,1





**24.2122-1501.3 010403**  
 Ø 22,20  2x M10x1  
 2x M12x1 →  L1 L2  
 10,5 200,0



**24.2122-1601.3 010380**  
 Ø 22,20  4x M10x1 →  L1 L2  
 39,0 115,7





**24.2122-1603.3 010381**  
 Ø 22,20  1x M10x1  
 1x M12x1 →  L1 L2  
 16,5 173,5

**24.2122-1702.3 010421**  
 Ø 22,20  1x M10x1  
 1x M12x1 →  L1 L2  
 10,0 203,5



**24.2122-1703.3 010422**  
 Ø 22,20  4x M10x1 →  L1 L2  
 36,2 115,2

**24.2122-1704.3 010423**  
 Ø 22,20  4x M10x1 →  L1 L2  
 39,0 115,5







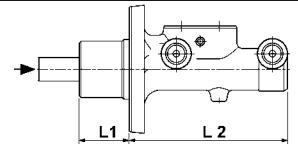

# Abbildungen Hauptbremszylinder

Illustrations master cylinder - Illustrazioni pompe freno -



Illustrations Maître cylindres - Ilustraciones cilindro maestro freno





**24.2122-1705.3 010434**  
 Ø 22,20  4x M10x1 →  L1 L2  
 36,5 118,0



**24.2122-1707.3 010438**  
 Ø 22,20  4x M10x1 →  L1 L2  
 36,5 128,0





**24.2122-1708.3 010437**  
 Ø 22,20  2x M10x1 →  L1 L2  
 35,0 131,5



**24.2122-1711.3 010461**  
 Ø 22,20  3x M10x1  
 1x M12x1 →  L1 L2  
 8,5 183,5





**24.2122-1712.3 010462**  
 Ø 22,20  3x M10x1  
 1x M12x1 →  L1 L2  
 23,0 191,0

**24.2122-1713.3 010463**  
 Ø 22,20  3x M10x1  
 1x M12x1 →  L1 L2  
 23,0 173,5



**24.2122-1714.3 010480**  
 Ø 22,20  2x M10x1 →  L1 L2  
 19,0 168,0

**24.2122-1715.3 010481**  
 Ø 22,20  5x M10x1 →  L1 L2  
 19,0 167,0



# Abbildungen Hauptbremszylinder

Illustrations master cylinder - Illustrazioni pompe freno -

Illustrations Maître cylindres - Ilustraciones cilindro maestro freno

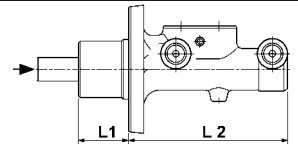

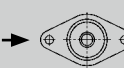

**24.2122-1716.3 010485**  
 Ø 22,20  4x M10x1 →  L1 L2  
 36,0 132,0

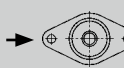



**24.2122-1717.3 010501**  
 Ø 22,20  4x M10x1 →  L1 L2  
 34,5 118,0





**24.2122-1718.3 010517**  
 Ø 22,20  2x M10x1 →  L1 L2  
 36,5 117,0



**24.2122-1720.3 010531**  
 Ø 22,20  2x M12x1 →  L1 L2  
 34,0 132,0





**24.2122-1722.3 010554**  
 Ø 22,20  2x M10x1 →  L1 L2  
 31,5 103,5

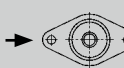



**24.2122-1723.3 010547**  
 Ø 22,20  4x M10x1 →  L1 L2  
 36,0 114,2



**24.2122-1724.3 010561**  
 Ø 22,20  1x M10x1  
 1x M12x1 →  L1 L2  
 23,5 122,5



**24.2122-1727.3 010586**  
 Ø 22,20  2x M10x1  
 2x M12x1 →  L1 L2  
 34,5 115,5





# Abbildungen Hauptbremszylinder

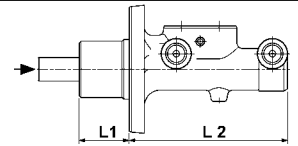

Illustrations master cylinder - Illustrazioni pompe freno -

Illustrations Maître cylindres - Ilustraciones cilindro maestro freno





**24.2122-1728.3 010643**  
 Ø 22,20  2x M10x1 →  L1 17,0 L2 174,0





**24.2122-1729.3 010650**  
 Ø 22,20  2x M10x1 →  L1 34,0 L2 120,0



**24.2122-1730.3 010651**  
 Ø 22,20  4x M10x1 →  L1 17,0 L2 174,0





**24.2122-1731.3 010656**  
 Ø 22,20  4x M10x1 →  L1 35,5 L2 183,0





**24.2122-1733.3 010668**  
 Ø 22,20  2x M10x1  
 2x M12x1 →  L1 34,5 L2 165,0





**24.2122-1739.3 010710**  
 Ø 22,20  2x M10x1  
 2x M12x1 →  L1 23,5 L2 108,0



**24.2122-1740.3 010711**  
 Ø 22,20  1x M10x1  
 1x M12x1 →  L1 27,5 L2 118,5



**24.2122-1741.3 010695**  
 Ø 22,20  4x M10x1 →  L1 36,0 L2 115,0





# Abbildungen Hauptbremszylinder

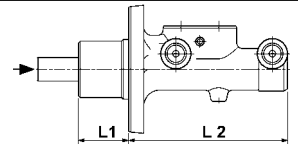

Illustrations master cylinder - Illustrazioni pompe freno -

Illustrations Maître cylindres - Ilustraciones cilindro maestro freno





**24.2122-1742.3 010696**  
 Ø 22,20  2x M10x1 →  L1 L2  
 35,0 131,5



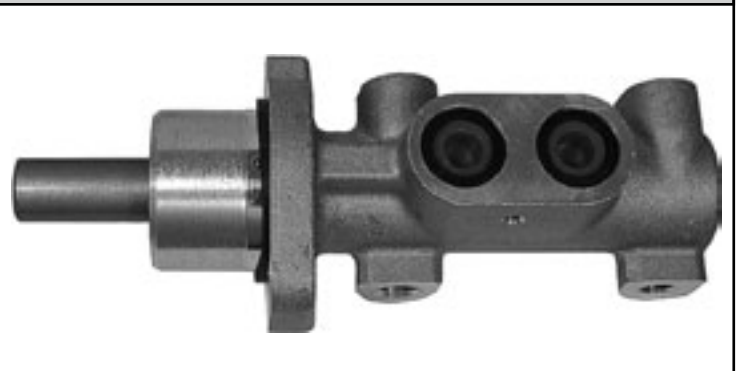

**24.2122-1743.3 010712**  
 Ø 22,20  2x M10x1  
 2x M12x1 →  L1 L2  
 29,0 117,0



**24.2122-1744.3 010697**  
 Ø 22,20  1x M10x1  
 1x M12x1 →  L1 L2  
 34,6 116,0



**24.2122-1745.3 010715**  
 Ø 22,20  1x M10x1  
 1x M12x1 →  L1 L2  
 34,6 122,5





**24.2122-1746.3 010716**  
 Ø 22,20  2x M10x1  
 2x M12x1 →  L1 L2  
 17,5 129,0





**24.2122-1748.3 010721**  
 Ø 22,20  1x M10x1  
 1x M12x1 →  L1 L2  
 33,0 138,0



**24.2122-1749.3 010722**  
 Ø 22,20  2x M12x1 →  L1 L2  
 33,0 130,5



**24.2122-1750.3 010740**  
 Ø 22,20  4x M10x1 →  L1 L2  
 29,5 120,5

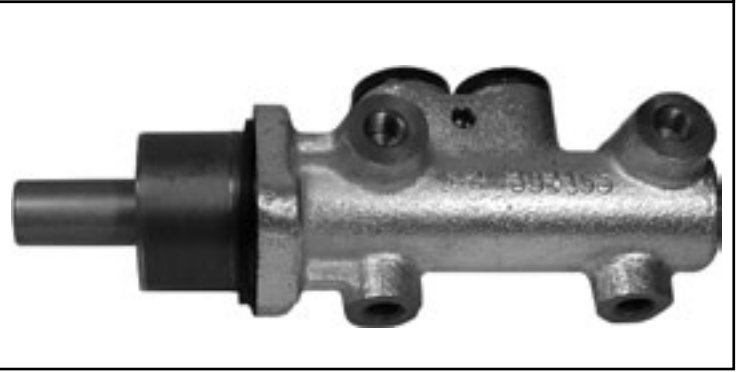





# Abbildungen Hauptbremszylinder

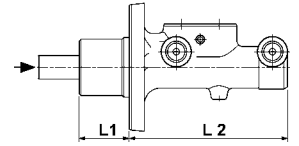

Illustrations master cylinder - Illustrazioni pompe freno -

Illustrations Maître cylindres - Ilustraciones cilindro maestro freno





**24.2122-1752.3 010749**  
 Ø 22,20  2x M12x1 →  L1 L2  
 40,0 120,0





**24.2122-1754.3 010755**  
 Ø 22,20  2x M12x1 →  L1 L2  
 33,0 138,0





**24.2122-1755.3 010763**  
 Ø 22,20  2x M10x1  
 2x M12x1 →  L1 L2  
 19,0 171,0





**24.2122-1756.3 010766**  
 Ø 22,20  2x M10x1 →  L1 L2  
 30,0 132,0



**24.2122-1757.3 010769**  
 Ø 22,20  2x M12x1 →  L1 L2  
 31,0 132,0





**24.2122-1760.3 010821**  
 Ø 22,20  4x M10x1 →  L1 L2  
 33,0 125,0



**24.2122-1761.3 010822**  
 Ø 22,20  2x M10x1 →  L1 L2  
 16,0 154,3



**24.2122-1762.3 010837**  
 Ø 22,20  2x M12x1 →  L1 L2  
 30,0 131,0





# Abbildungen Hauptbremszylinder

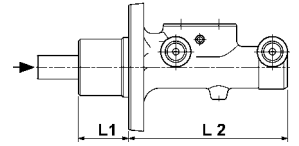

Illustrations master cylinder - Illustrazioni pompe freno -

Illustrations Maître cylindres - Ilustraciones cilindro maestro freno





**24.2122-1763.3 010838**  
 Ø 22,20  2x M12x1 →  L1 L2  
 33 125,0



**24.2122-1764.3 010851**  
 Ø 22,20  2x M12x1 →  L1 L2  
 26,5 138,0





**24.2122-1765.3 010839**  
 Ø 22,20  2x M12x1 →  L1 L2  
 16,0 154,0





**24.2122-1766.3 010840**  
 Ø 22,20  2x M12x1 →  L1 L2  
 25,0 135,0





**24.2122-1767.3 010841**  
 Ø 22,20  3x M12x1 →  L1 L2  
 25,0 135,0





**24.2122-1768.3 010853**  
 Ø 22,20  2x M12x1 →  L1 L2  
 30,0 131,0



**24.2122-1770.3 010898**  
 Ø 22,20  2x M12x1 →  L1 L2  
 45,0 114,0



**24.2122-1771.3 010901**  
 Ø 22,20  2x M10x1 →  L1 L2  
 15,5 153,5





# Abbildungen Hauptbremszylinder

Illustrations master cylinder - Illustrazioni pompe freno -

Illustrations Maître cylindres - Ilustraciones cilindro maestro freno

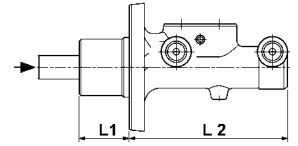

**24.2122-1772.3 010902**  
 Ø 22,20 2x M12x1 → L1 L2  
 19,0 153,0

**24.2123-0901.3 010382**  
 Ø 23,81 2x M10x1 → L1 L2  
 18,8 165,0



**24.2123-1601.3 010383**  
 Ø 23,81 3x M10x1 → L1 L2  
 39,0 117,4

**24.2123-1602.3 010384**  
 Ø 23,81 2x M10x1 → L1 L2  
 32,0 126,5



**24.2123-1606.3 010386**  
 Ø 23,81 1x M10x1 1x M12x1 → L1 L2  
 36,0 119,0

**24.2123-1701.3 010424**  
 Ø 23,81 4x M10x1 → L1 L2  
 36,5 126,7



**24.2123-1702.3 010431**  
 Ø 23,81 2x M10x1 2x M12x1 → L1 L2  
 10,5 200,0

**24.2123-1705.3 010440**  
 Ø 23,81 2x M10x1 1x M12x1 → L1 L2  
 10,0 203,0



# Abbildungen Hauptbremszylinder

Illustrations master cylinder - Illustrazioni pompe freno -

Illustrations Maître cylindres - Ilustraciones cilindro maestro freno

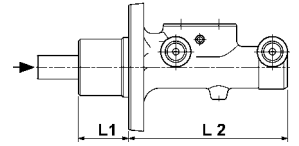

**24.2123-1707.3 010492**

Ø 23,81



4x M10x1



L1 L2  
36,0 117,5



**24.2123-1708.3 010493**

Ø 23,81



2x M10x1



L1 L2  
36,5 128,0



**24.2123-1709.3 010503**

Ø 23,81



2x M12x1



L1 L2  
32,0 122,0



**24.2123-1710.3 010504**

Ø 23,81



4x M10x1



L1 L2  
36,0 118,0



**24.2123-1711.3 010518**

Ø 23,81



2x M10x1



L1 L2  
35,0 165,0



**24.2123-1712.3 010519**

Ø 23,81



4x M10x1



L1 L2  
36,0 120,0



**24.2123-1713.3 010505**

Ø 23,81



2x M12x1



L1 L2  
34,5 127,0



**24.2123-1714.3 010587**

Ø 23,81



2x M10x1  
2x M12x1



L1 L2  
33,0 120,5



# Abbildungen Hauptbremszylinder

Illustrations master cylinder - Illustrazioni pompe freno -

Illustrations Maître cylindres - Ilustraciones cilindro maestro freno

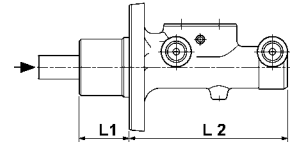

**24.2123-1715.3 010520**

Ø 23,81

1x M10x1  
1x M12x1



L1 L2  
33,0 120,5



**24.2123-1716.3 010506**

Ø 23,81

4x M10x1



L1 L2  
19,0 165,0



**24.2123-1717.3 010521**

Ø 23,81

2x M12x1



L1 L2  
39,5 121,5



**24.2123-1718.3 010507**

Ø 23,81

2x M10x1



L1 L2  
42,0 116,0



**24.2123-1725.3 010549**

Ø 23,81

2x M10x1  
2x M12x1

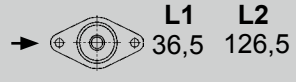

L1 L2  
36,5 126,5



**24.2123-1726.3 010557**

Ø 23,81

3x M10x1



L1 L2  
36,0 110,0



**24.2123-1728.3 010558**

Ø 23,81

2x M10x1

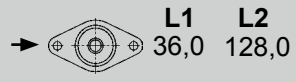

L1 L2  
36,0 128,0



**24.2123-1729.3 010567**

Ø 23,81

2x M10x1



L1 L2  
35,0 150,8



# Abbildungen Hauptbremszylinder

Illustrations master cylinder - Illustrazioni pompe freno -

Illustrations Maître cylindres - Ilustraciones cilindro maestro freno

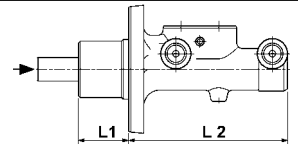

**24.2123-1724.3 010566**

Ø 23,81

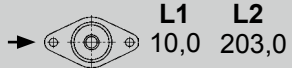
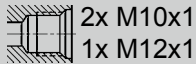

**24.2123-1730.3 010620**

Ø 23,81

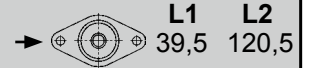
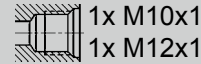

Keine Abbildung verfügbar.  
No illustration available.



**24.2123-1731.3 010621**

Ø 23,81

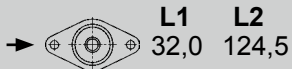
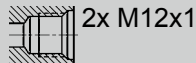

**24.2123-1732.3 010625**

Ø 23,81



**24.2123-1733.3 010657**

Ø 23,81

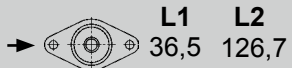
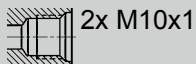

**24.2123-1734.3 010640**

Ø 23,81

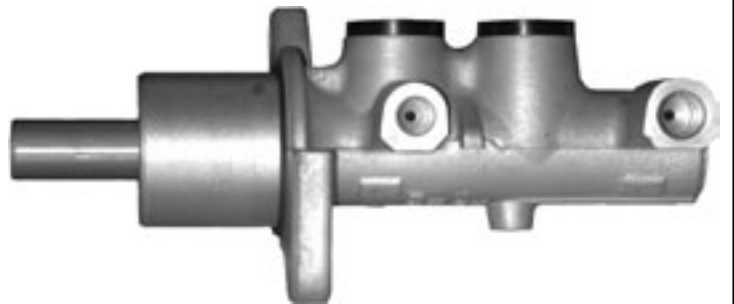
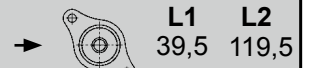
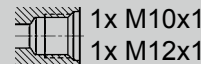

**24.2123-1735.3 010652**

Ø 23,81

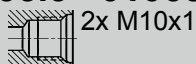

**24.2123-1736.3 010653**

Ø 23,81

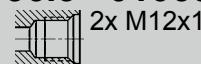





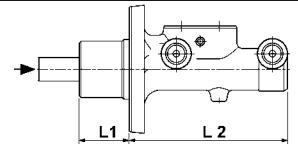

# Abbildungen Hauptbremszylinder

Illustrations master cylinder - Illustrazioni pompe freno -



Illustrations Maître cylindres - Ilustraciones cilindro maestro freno





**24.2123-1737.3 010654**  
 Ø 23,81  4x M10x1 →  L1 L2  
 17,0 174,0



**24.2123-1738.3 010658**  
 Ø 23,81  4x M10x1 →  L1 L2  
 36,0 118,5





**24.2123-1739.3 010661**  
 Ø 23,81  2x M12x1 →  L1 L2  
 40,0 121,0



**24.2123-1740.3 010662**  
 Ø 23,81  2x M12x1 →  L1 L2  
 51,5 112,0





**24.2123-1741.3 010681**  
 Ø 23,81  2x M12x1 →  L1 L2  
 33,0 127,0

**24.2123-1742.3 010671**  
 Ø 23,81  2x M12x1 →  L1 L2  
 33,0 121,0



**24.2123-1746.3 010682**  
 Ø 23,81  2x M10x1 →  L1 L2  
 36,5 116,5

**24.2123-1749.3 010713**  
 Ø 23,81  2x M10x1 →  L1 L2  
 33,0 120,0



# Abbildungen Hauptbremszylinder

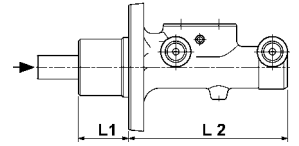

Illustrations master cylinder - Illustrazioni pompe freno -

Illustrations Maître cylindres - Ilustraciones cilindro maestro freno

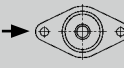

**24.2123-1750.3 010714**  
 Ø 23,81  2x M10x1 2x M12x1 →  L1 L2  
 36,4 113,0





**24.2123-1751.3 010698**  
 Ø 23,81  4x M10x1 →  L1 L2  
 36,0 118,0





**24.2123-1753.3 010744**  
 Ø 23,81  2x M12x1 →  L1 L2  
 34,5 132,0





**24.2123-1754.3 010741**  
 Ø 23,81  2x M12x1 →  L1 L2  
 67,0 111,5





**24.2123-1755.3 010750**  
 Ø 23,81  2x M10x1 →  L1 L2  
 67,0 110,0



**24.2123-1756.3 010756**  
 Ø 23,81  3x M10x1 →  L1 L2  
 10,0 203,0



**24.2123-1757.3 010765**  
 Ø 23,81  2x M12x1 →  L1 L2  
 34,5 132,0

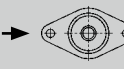

**24.2123-1759.3 010768**  
 Ø 23,81  2x M12x1 →  L1 L2  
 39,0 143,2





# Abbildungen Hauptbremszylinder

Illustrations master cylinder - Illustrazioni pompe freno -

Illustrations Maître cylindres - Ilustraciones cilindro maestro freno

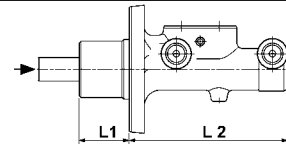

**24.2123-1760.3 010779**

Ø 23,81



2x M12x1

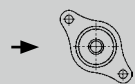

L1 L2  
25,0 155,0



**24.2123-1761.3 010780**

Ø 23,81



2x M10x1

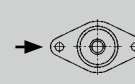

L1 L2  
15,0 152,0



**24.2123-1762.3 010823**

Ø 23,81



2x M10x1

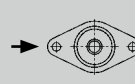

L1 L2  
15,0 161,0



**24.2123-1763.3 010842**

Ø 23,81



2x M10x1

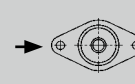

L1 L2  
32,5 131,0



**24.2123-1764.3 010824**

Ø 23,81



1x M10x1  
1x M12x1

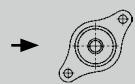

L1 L2  
29,0 132,0



**24.2123-1765.3 010829**

Ø 23,81



2x M12x1

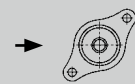

L1 L2  
29,0 132,0



**24.2123-1766.3 010825**

Ø 23,81



2x M12x1

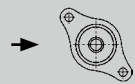

L1 L2  
40,0 121,0



**24.2123-1767.3 010844**

Ø 23,81



2x M10x1

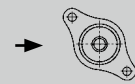

L1 L2  
30,5 132,0



# Abbildungen Hauptbremszylinder

Illustrations master cylinder - Illustrazioni pompe freno -

Illustrations Maître cylindres - Ilustraciones cilindro maestro freno

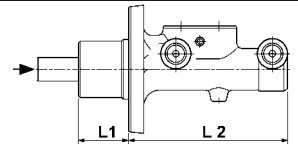

**24.2123-1768.3 010845**  
 Ø 23,81 2x M12x1 → L1 L2  
 30,5 132,0



**24.2123-1769.3 010863**  
 Ø 23,81 2x M12x1 → L1 L2  
 32,5 131,0



**24.2123-1772.3 010858**  
 Ø 23,81 2x M12x1 → L1 L2  
 73,0 122,0



**24.2123-1774.3 010877**  
 Ø 23,81 2x M10x1 → L1 L2  
 15,5 153,0



**24.2123-1777.3 010943**  
 Ø 23,81 1x M10x1 1x M12x1 → L1 L2  
 39,5 120,0



**24.2125-1701.3 010456**  
 Ø 25,40 2x M10x1 2x M12x1 (2x M10x1) → L1 L2  
 36,0 123,0



**24.2125-1702.3 010482**  
 Ø 25,40 2x M10x1 → L1 L2  
 19,0 173,5



**24.2125-1703.3 010483**  
 Ø 25,40 5x M10x1 → L1 L2  
 9,0 168,0



# Abbildungen Hauptbremszylinder

Illustrations master cylinder - Illustrazioni pompe freno -

Illustrations Maître cylindres - Ilustraciones cilindro maestro freno

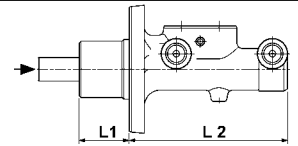

**24.2125-1704.3 010446**

Ø 25,40

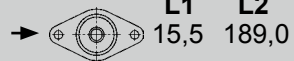
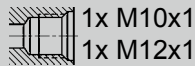

L1 L2  
15,5 189,0



**24.2125-1705.3 010495**

Ø 25,40

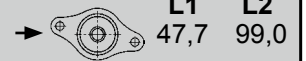
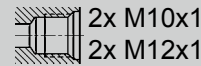

L1 L2  
47,7 99,0



**24.2125-1706.3 010496**

Ø 25,40

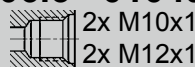

L1 L2  
43,0 99,0



**24.2125-1707.3 010497**

Ø 25,40

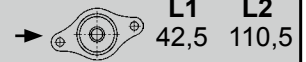

L1 L2  
42,5 110,5



**24.2125-1708.3 010498**

Ø 25,40

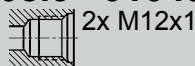

L1 L2  
46,8 112,0



**24.2125-1709.3 010499**

Ø 25,40



L1 L2  
38,0 125,0



**24.2125-1710.3 010559**

Ø 25,40



L1 L2  
36,5 109,0



**24.2125-1712.3 010622**

Ø 25,40



L1 L2  
49,5 111,5



# Abbildungen Hauptbremszylinder

Illustrations master cylinder - Illustrazioni pompe freno -

Illustrations Maître cylindres - Ilustraciones cilindro maestro freno

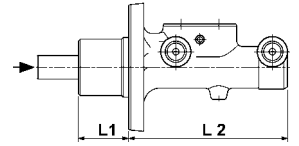

**24.2125-1713.3 010623**

Ø 25,40

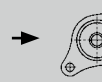
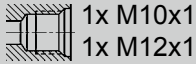

L1 L2  
49,0 111,0



**24.2125-1714.3 010641**

Ø 25,40

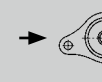
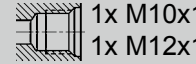

L1 L2  
39,5 120,0



**24.2125-1715.3 010655**

Ø 25,40

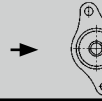
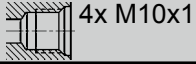

L1 L2  
36,2 118,5

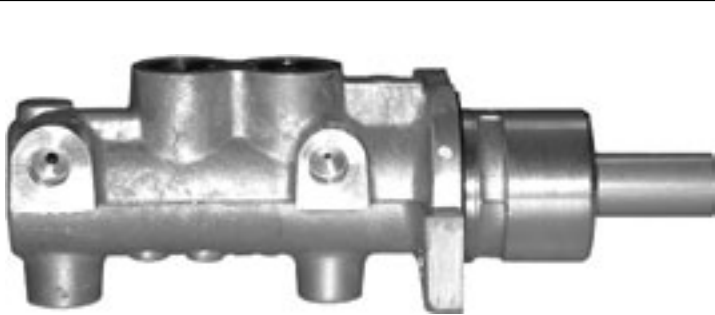

**24.2125-1716.3 010663**

Ø 25,40

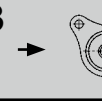

L1 L2  
57,0 120,0

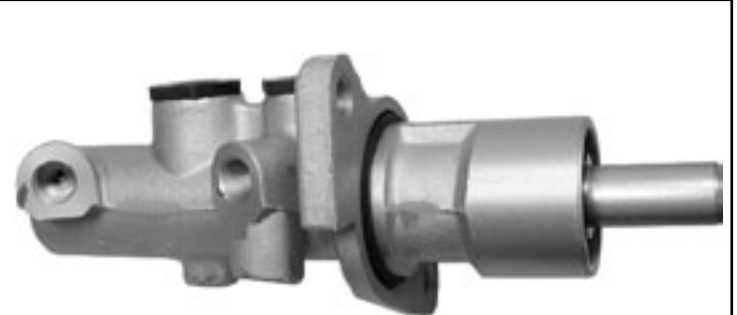

**24.2125-1717.3 010664**

Ø 25,40

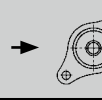
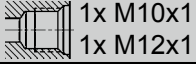

L1 L2  
51,5 112,0



**24.2125-1718.3 010665**

Ø 25,40

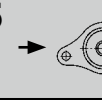
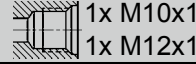

L1 L2  
38,0 110,0



**24.2125-1719.3 010666**

Ø 25,40

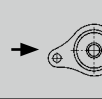
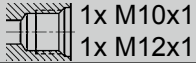

L1 L2  
38,0 110,0



**24.2125-1720.3 010688**

Ø 25,40

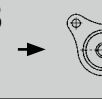

L1 L2  
69,5 92,0

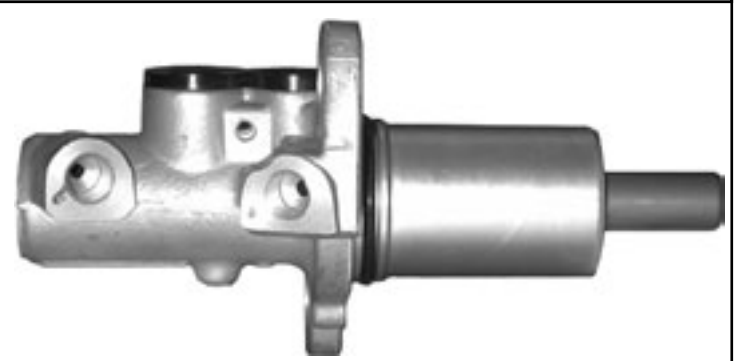





# Abbildungen Hauptbremszylinder

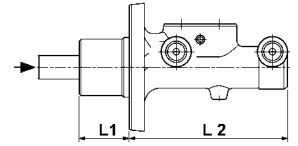

Illustrations master cylinder - Illustrazioni pompe freno -

Illustrations Maître cylindres - Ilustraciones cilindro maestro freno



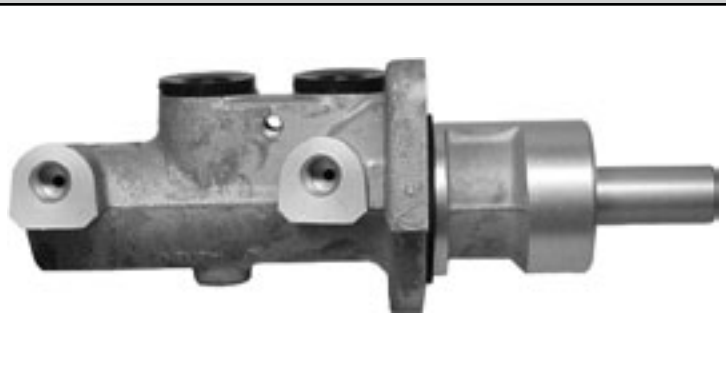

**24.2125-1723.3 010689**  
 Ø 25,40  2x M10x1 →  L1 L2  
 47,0 115,0





**24.2125-1724.3 010690**  
 Ø 25,40  1x M10x1  
 1x M12x1 →  L1 L2  
 47,5 112,5





**24.2125-1725.3 010717**  
 Ø 25,40  5x M10x1 →  L1 L2  
 33,0 147,0





**24.2125-1726.3 010718**  
 Ø 25,40  2x M10x1 →  L1 L2  
 33,0 147,0





**24.2125-1727.3 010723**  
 Ø 25,40  2x M10x1 →  L1 L2  
 35,0 165,3



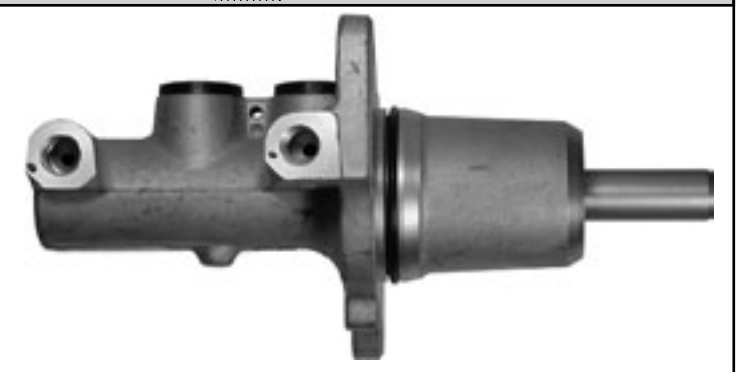

**24.2125-1728.3 010751**  
 Ø 25,40  2x M12x1 →  L1 L2  
 67,0 111,5



**24.2125-1729.3 010752**  
 Ø 25,40  2x M12x1 →  L1 L2  
 47,0 114,0



**24.2125-1730.3 010760**  
 Ø 25,40  1x M10x1  
 1x M12x1 →  L1 L2  
 47,5 113,0



# Abbildungen Hauptbremszylinder

Illustrations master cylinder - Illustrazioni pompe freno -

Illustrations Maître cylindres - Ilustraciones cilindro maestro freno

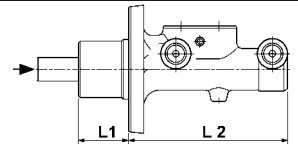

**24.2125-1731.3 010826**

Ø 25,40

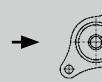
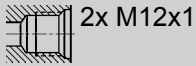

L1 L2  
47,5 113,0

**24.2125-1732.3 010827**

Ø 25,40

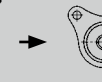

L1 L2  
40,0 122,0



**24.2125-1733.3 010830**

Ø 25,40

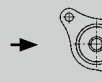
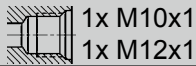

L1 L2  
40,0 122,0

**24.2125-1734.3 010878**

Ø 25,40



L1 L2  
47,5 115,0



**24.2125-1735.3 010879**

Ø 25,40

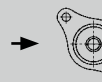
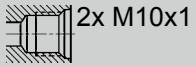

L1 L2  
67,0 111,5

**24.2125-1736.3 010904**

Ø 25,40

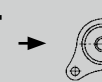

L1 L2  
31,0 129,0



**24.2125-1737.3 010906**

Ø 25,40

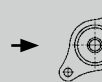
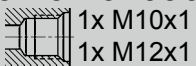

L1 L2  
31,0 129,0

**24.2133-0901.3 010387**

Ø 33,34

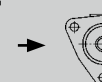
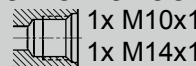

L1 L2  
65,0 155,0

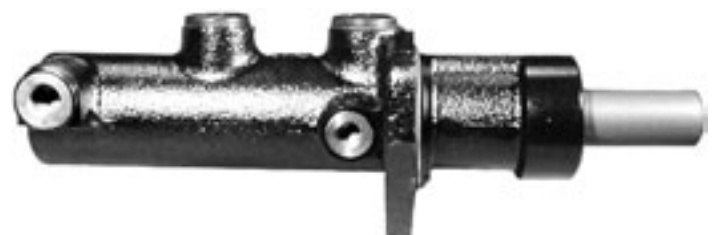





# Abbildungen Hauptbremszylinder

Illustrations master cylinder - Illustrazioni pompe freno -

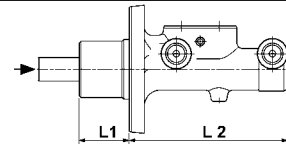
Illustrations Maître cylindres - Ilustraciones cilindro maestro freno



**24.3119-1702.3 010465**  
 Ø 19,05  
 1x M16x1,5 →   
 3x 3/8"-24 UNF-2B

|     |       |
|-----|-------|
| L1  | L2    |
| 5,5 | 135,5 |

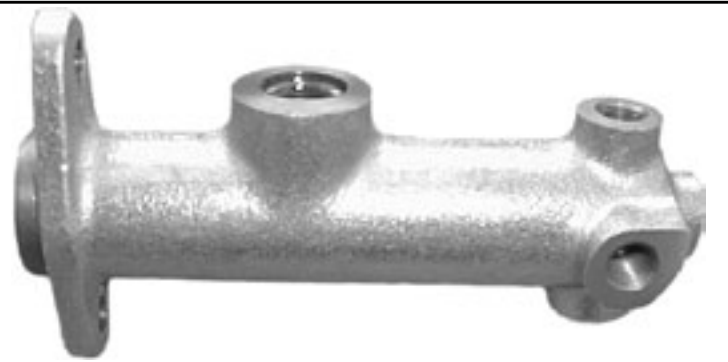

**24.3119-1703.3 010466**  
 Ø 19,05  
 1x M16x1,5 →   
 3x 3/8"-24 UNF-2B

|     |       |
|-----|-------|
| L1  | L2    |
| 5,5 | 135,5 |

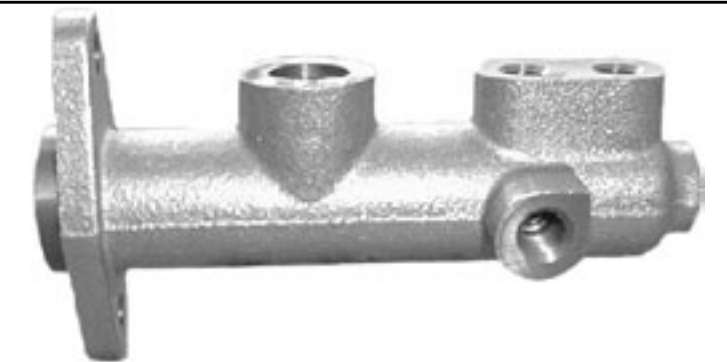

**24.3120-1702.3 010467**  
 Ø 20,64  
 1x M16x1,5 →   
 3x 3/8"-24 UNF-2B

|     |       |
|-----|-------|
| L1  | L2    |
| 5,5 | 131,5 |



**24.4025-1701.3 010719**  
 Ø 25,40  
 2x M12x1 → 

|      |      |
|------|------|
| L1   | L2   |
| 51,0 | 67,2 |



**24.4120-1701.3 010846**  
 Ø 20,64  
 2x M10x1 → 

|      |      |
|------|------|
| L1   | L2   |
| 32,0 | 83,0 |

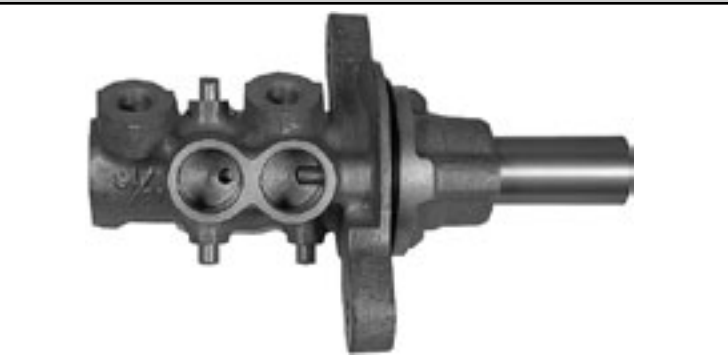

**24.4120-1702.3 010913**  
 Ø 20,64  
 2x M10x1 → 

|     |       |
|-----|-------|
| L1  | L2    |
| 6,0 | 119,0 |



**24.4122-1701.3 010533**  
 Ø 22,20  
 2x M12x1 → 

|      |       |
|------|-------|
| L1   | L2    |
| 10,2 | 109,0 |



**24.4122-1702.3 010753**  
 Ø 22,20  
 2x M12x1 → 

|      |       |
|------|-------|
| L1   | L2    |
| 10,0 | 109,0 |



# Abbildungen Hauptbremszylinder

Illustrations master cylinder - Illustrazioni pompe freno -

Illustrations Maître cylindres - Ilustraciones cilindro maestro freno

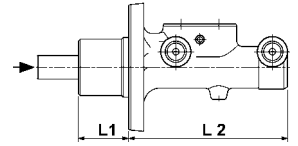

**24.4122-1703.3 010843**

Ø 22,20

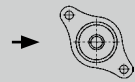
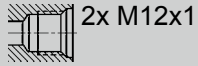

L1 L2  
6,0 112,0

**24.4122-1704.3 010847**

Ø 22,20

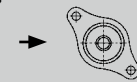

L1 L2  
6,0 112,0



**24.4122-1705.3 010852**

Ø 22,20

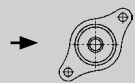
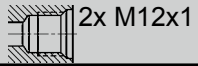

L1 L2  
32,0 78,0

**24.4122-1707.3 010864**

Ø 22,20

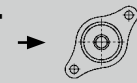

L1 L2  
32,0 85,5



**24.4122-1708.3 010865**

Ø 22,20

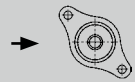
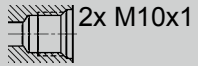

L1 L2  
20,0 95,0

**24.4122-1709.3 010871**

Ø 22,20

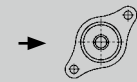

L1 L2  
32,0 78,0



**24.4122-1714.3 010914**

Ø 20,64

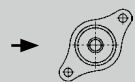
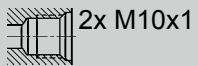

L1 L2  
6,0 119,0

**24.4123-1703.3 010831**

Ø 23,81

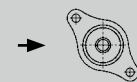

L1 L2  
55,0 53,0



# Abbildungen Hauptbremszylinder

Illustrations master cylinder - Illustrazioni pompe freno -

Illustrations Maître cylindres - Ilustraciones cilindro maestro freno

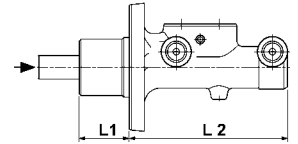

**24.4123-1704.3 010828**

Ø 23,81

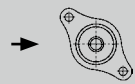
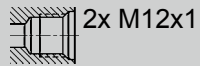

L1 L2  
6,0 112,0



**24.4123-1705.3 010832**

Ø 23,81

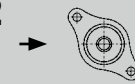

L1 L2  
6,0 112,0



**24.4123-1706.3 010848**

Ø 23,81

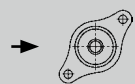
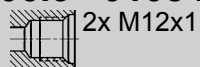

L1 L2  
32,0 115,0



**24.4123-1708.3 010859**

Ø 23,81

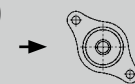

L1 L2  
32,0 83,5



**24.4123-1710.3 010866**

Ø 23,81

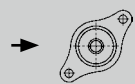
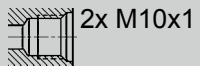

L1 L2  
32,0 85,5



**24.4123-1712.3 010897**

Ø 23,81

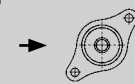

L1 L2  
14,0 95,0



**24.4123-1713.3 010905**

Ø 23,81

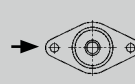
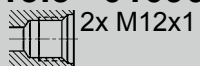

L1 L2  
31,7 93,5



**24.4125-1701.3 010867**

Ø 25,40

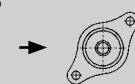

L1 L2  
10,0 123,0



# Abbildungen Hauptbremszylinder

Illustrations master cylinder - Illustrazioni pompe freno -

Illustrations Maître cylindres - Ilustraciones cilindro maestro freno

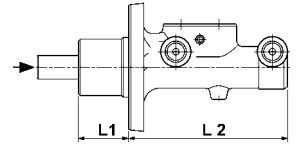

**24.4125-1702.3 010872**

Ø 25,40

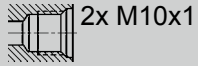

L1 L2  
10,0 123,0

**24.4125-1703.3 010907**

Ø 25,40

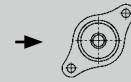

L1 L2  
18,0 90,0



**24.4125-1704.3 010908**

Ø 25,40

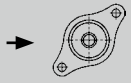
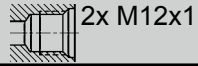

L1 L2  
18,0 90,0

**24.4126-1701.3 010868**

Ø 26,99

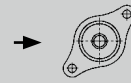

L1 L2  
10,0 123,0

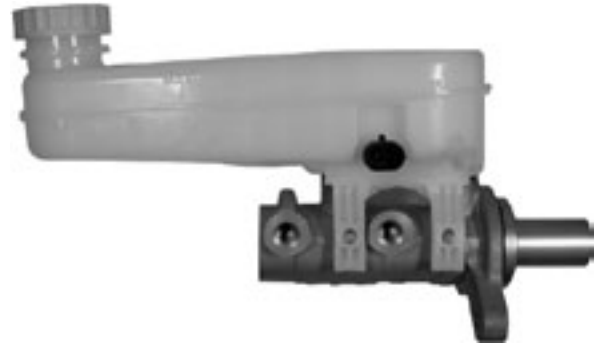
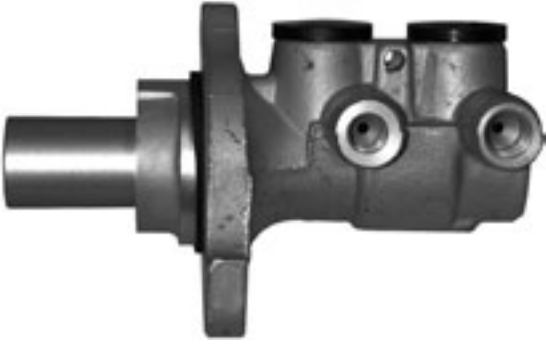





- Ⓛ Armaturen
- Ⓛ EN Fittings
- Ⓛ FR Composants et accessoires
- Ⓛ IT Attrezzature
- Ⓛ ES Accesorios
- Ⓛ NL Armaturen
- Ⓛ DA Fittings
- Ⓛ SV Tillbehör
- Ⓛ HU Tartozékok
- Ⓛ PT Equipamentos
- Ⓛ RU Приспособления
- Ⓛ CZ Armatury
- Ⓛ PL Armatury
- Ⓛ EL Εξαρτήματα συναρμολογής
- Ⓛ TR Armatürler
- Ⓛ ZH 儀軀板
- Ⓛ JA 計器類
- Ⓛ AR بطاقة المكبح

# Armaturen

Fittings - Attrezzature - Composants et accessoires - Accesorios

## Gewindedarstellung und Dichtflächen-Anordnung bei Innengewinden der Anschlußarmaturen

Representation of threads and sealing surface arrangement in case of internal-threads

Rappresentazione della filattatura e disposizione delle superfici di tenuta nella filettatura interna dei pezzi di attacco

Présentation de filet et arrangement de face d'étanchéité en case de filetage intérieure des armatures

Ilustración de roscas y disposición de superficies de contacto en roscas interiores de los accesorios de conexión

Abdichtung durch Bördel nach DIN 74234  
Sealing by flaring according to DIN 74234 tenuta  
Stagna tramite flangiatura DIN 74234  
Etanchement par colet selon DIN 74234  
Junta mediante reborde según DIN 74234

Abdichtung mit Dichtring nach DIN 7603  
Sealing by seal ring according to DIN 7603  
Tenuta stagna tramite guarnizione DIN 7603  
Etanchement par joint selon DIN 7603  
Junta con retén según DIN 7603

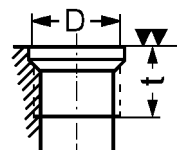
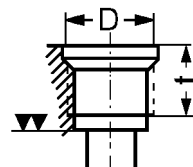
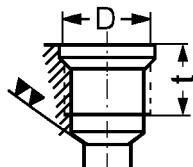
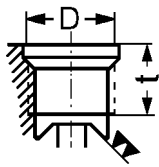

### Gewinde Ausführung

Thread design  
Esecuzione filettata  
Exécution filet  
Ejecución de rosca

**A 1**

**A 2**

**A 3**

**A 4**

### Bördel

Flare  
Bordatura tipo  
Colet  
Reborde

**E**

**F**

-

-

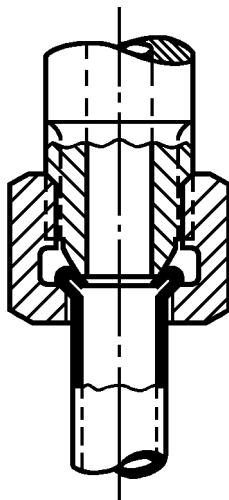

## DIN 74233

Überwurfschraube  
Union screw  
Viti con risvolto  
Vis chapeau  
Tornillos de racor

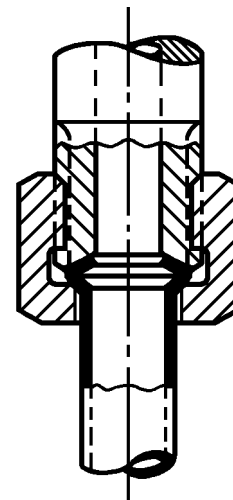

**E**

## DIN 74234





Bördel  
Flare  
Bordatura tipo  
Colet  
Reborde

**F**



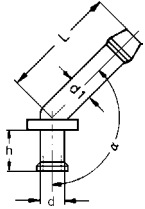

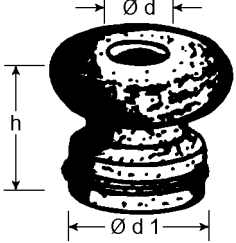
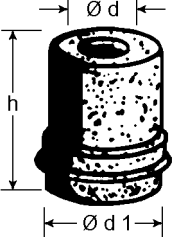
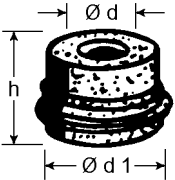
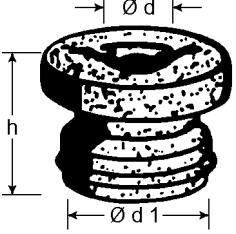
# Armaturen

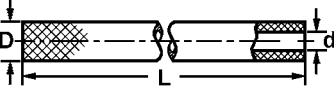
## Fittings - Attrezzature - Composants et accessoires - Accesorios

| <b>Kniestücke</b><br>Elbows<br>Raccordi a gomito<br>Raccord en équerre<br>Piezas acodadas                            | <b>Abmessungen - Dimensions -<br/>                     Dimensioni - Dimensions - Medidas [mm]</b> |                      |       |   |                       |  |
|--|---|----------------------|-------|---|-----------------------|---|
|                                     | $\varnothing d$   | $\varnothing d_1$    | h     | L   |                       |   |
|  | 8,0   | 8,0                  | 11,0  | 32,0  | 95°                   | 03.3390-0055.1 390149   |
|  | 8,0   | 8,0                  | 11,0  | 21,0  | 160°                  | 03.3390-0065.1 390150   |
|  | 12,8  | 8,0                  | 13,0  | 32,0  | 135°                  | 03.3390-0130.1 390153   |
|  | 12,8  | 8,0                  | 13,0  | 32,0  | 105°                  | 03.3390-0139.1 390154   |
|  | 13,0  | 10,5                 | 13,0  | 24,0  | 170°                  | 03.3390-0165.1 390155   |
| <b>Behälterstopfen</b><br>Reservoir seal<br>Tappi per serbatoio<br>Bouchon de réservoir<br>Tapones de depósitos      | <b>Abmessungen - Dimensions -<br/>                     Dimensioni - Dimensions - Medidas [mm]</b> |                      |       |   |                       |  |
|                                    | 4,2   | 17,0                 | 18,0  | Kautschuk ①   | 03.3304-0600.1 390081 |   |
|                                   | 6,5   | 17,0                 | 18,0  | Kautschuk ①   | 03.3304-0700.1 390082 |   |
|                                   | 6,5   | 17,0                 | 10,5  | Kautschuk ①   | 03.3304-1100.1 390084 |   |
|  | 6,5   | 17,0                 | 10,4  | EPDM  | 03.3304-1102.1 390085 |   |
|                                   | 7,3   | 17,0                 | 13,5  | Kautschuk ①   | 03.3304-1000.1 390083 |   |
|  | 7,3   | 22,0                 | 13,0  |   | 03.3304-1400.1 390088 |   |
|  | 12,3  | 22,0                 | 13,0  | EPDM  | 03.3304-2208.1 390090 |   |
|  | ① Kautschuk<br>India rubber<br>Caucciù<br>Caoutchouc<br>Caucho                                    |                      |       |   |                       |   |
| <b>Behälterschlauch</b><br>Reservoir tube<br>Flessibile per serbatoio<br>Flexible réservoir<br>Manguera del depósito | <b>Abmessungen - Dimensions -<br/>                     Dimensioni - Dimensions - Medidas</b>      |                      |       |  |                       |   |
|                                   | $\varnothing D$ [mm]  | $\varnothing d$ [mm] | L [m] |   |                       |   |
|  | 13,5  | 7,5                  | 5,0   | 03.3538-0005.1 390414   |                       |   |
|  | 13,5  | 7,5                  | 20,0  | 03.3538-0020.1 390415   |                       |   |

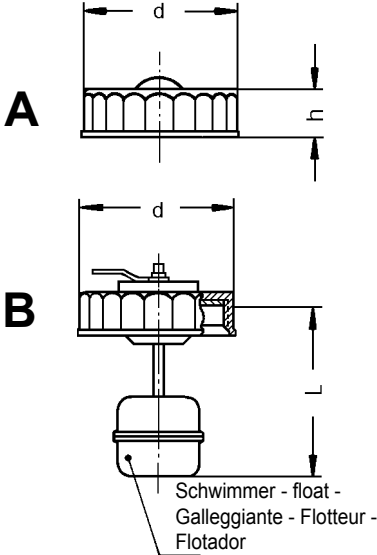

# Armaturen

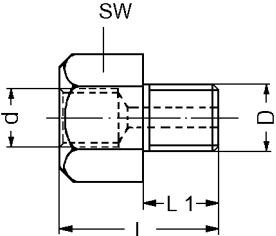
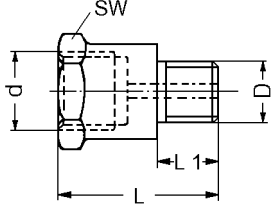
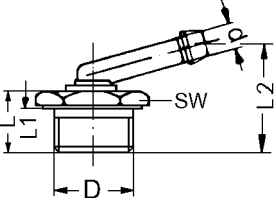
Fittings - Attrezzature - Composants et accessoires - Accesorios

| <b>Behälter Verschraubung</b><br>Reservoir screw fitting<br>Tappi filettato per serbatoio<br>Couvercle de réservoir<br>Fijación de depósito | <b>Abmessungen - Dimensions -<br/>                     Dimensioni - Dimensions - Medidas [mm]</b>   |   |          |                      |  |                         |                       |  |  |
|---|---|---|----------|----------------------|---|-------------------------|-----------------------|--|--|
| <b>Ausführung - Design -<br/>                     Esecuzione - Exécution -<br/>                     Ejecución</b>                           | <b>d</b>  | <b>h</b>  | <b>L</b> |                      |   |                         |                       |  |  |
|   | <b>A</b>  | max. 51   | 14,0     |                      |   | 03.3556-1065.2 390425   |                       |  |  |
|   |   | max. 51   | 14,0     |                      |   | 03.3556-1141.2 390434   |                       |  |  |
|   |   | max. 51   | 14,5     |                      |   | 03.3556-1147.2 390435 M |                       |  |  |
|   |   | max. 51   | 14,0     |                      |   | 03.3556-1164.2 390437   |                       |  |  |
|   | <b>B</b>  | max. 51   |          | 45,5                 |   | 03.3556-1094.2 390427   |                       |  |  |
|   |   | max. 51   |          | 51,2                 |   | 03.3556-1113.2 390428   |                       |  |  |
|   |   | max. 51   |          | 83,0                 |   | 03.3556-1115.2 390431   |                       |  |  |
|   |   | max. 51   |          | 54,0                 |   | 03.3556-1124.2 390433   |                       |  |  |
|   |   | max. 51   |          | 40,5                 |   | 03.3556-1199.2 390440   |                       |  |  |
|   | <b>M</b> nur für Mineralöl<br>only for mineral oil<br>solo per olio minerale<br>seulement pour huile minérale<br>sólo para aceite mineral |   |          |                      |   |                         |                       |  |  |
| <b>Schraubstutzen</b><br>Screw adapters<br>Raccordi filettati<br>Raccord fileté<br>Racores  | <b>Abmessungen - Dimensions -<br/>                     Dimensioni - Dimensions - Medidas [mm]</b>   |   |          |                      |   |                         |                       |  |  |
| <b>D</b>  | <b>d</b>  | Gewinde Ausführung -<br>Thread design - Esecuzione<br>filettata - Exécution filet -<br>Ejecución de rosca | <b>L</b> | <b>L<sub>1</sub></b> | <b>L<sub>2</sub></b>  | <b>SW</b>               |                       |  |  |
|    | M 10 x 1  | M 10 x 1  | A 2      | 21,0                 | 8,0   |                         | 17                    | 03.3510-0100.1 390271  |  |
|   |   | M 12 x 1  | A 1      | 24,0                 | 8,0   |                         | 17                    | 03.3510-0300.1 390273  |  |
|   | M 12 x 1  | M 10 x 1  | A 2      | 20,5                 | 8,0   |                         | 17                    | 03.3510-0054.1 390269 ①  |  |
|   |   | M 12 x 1  | A 1      | 22,0                 | 8,0   |                         | 17                    | 03.3510-0059.1 390270  |  |
|   | M 14 x 1,5  | M 10 x 1  | A 2      | 26,0                 | 14,0  |                         | 19                    | 03.3510-4100.1 390279  |  |
|   |   | M 12 x 1  | A 2      | 27,0                 | 12,0  |                         | 19                    | 03.3510-0800.1 390275  |  |
| 1/2" -20 NF 3   | M 12 x 1  | A 1   | 30,0     | 14,0                 |   | 19                      | 03.3510-2100.1 390278 |  |  |
| ① mit Drosselbohrung<br>with throttle hole<br>con foro calibrato di strozzamento<br>avec d'étranglement<br>con taladro estrangulador        |   |   |          |                      |   |                         |                       |  |  |
|    | M 10 x 1  | M 10 x 1  | A 2      | 32,0                 | 8,0   |                         | 17                    | 03.3510-0200.1 390272  |  |
|    | M 22 x 1,5  | Ø 10  |          | 16,5                 | 12,0  | 30,0                    | 27                    | 03.3510-0026.2 390266  |  |



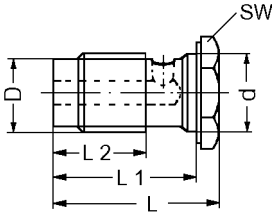
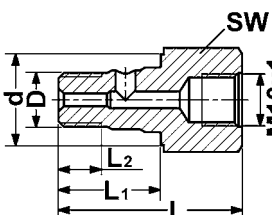

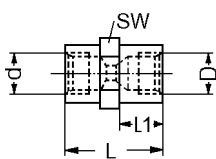
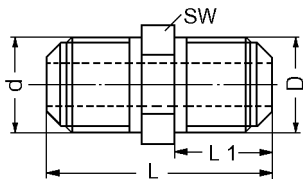
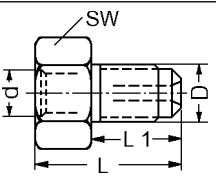
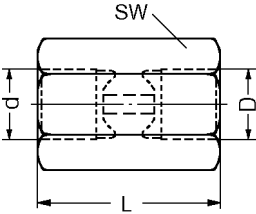
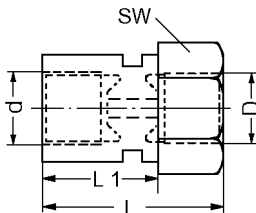
# Armaturen

## Fittings - Attrezzature - Composants et accessoires - Accesorios

| Hohlschrauben<br>Hollow screws<br>Viti cave<br>Vis creuse<br>Tornillos huecos                         | Abmessungen - Dimensions -<br>Dimensioni - Dimensions - Medidas [mm]   |      |   |                |                |      |   |                |          |
|---|--|------|---|----------------|----------------|------|--|----------------|----------|
|   | D  | d    | L   | L <sub>1</sub> | L <sub>2</sub> | SW   |  |                |          |
|                      | M 10 x 1   | 12,1 | 24,5  | 19,5           | 8,5            | 17   | 03.3520-0302.1   | 390381         |          |
|   |  | 12,1 | 30,0  | 24,5           | 12,0           | 17   | 03.3520-0501.1   | 390382         |          |
|   | M 12 x 1   | 14,1 | 28,0  | 22,5           | 10,0           | 17   | 03.3520-1003.1   | 390418         |          |
|   | M 14 x 1,5   | 14,1 | 33,5  | 27,5           | 15,0           | 17   | 03.3520-2900.1   | 390390         |          |
|                      | M 10 x 1   | 12,1 | 34,0  | 19,0           | 8,0            | 17   | 03.3520-0600.1   | 390383         |          |
|   |  |      |   |                |                |      |  |                |          |
| Zwischenstücke<br>Pipe adapters<br>Raccordi intermedi<br>Raccord intermédiaire<br>Piezas intercaladas | Abmessungen - Dimensions -<br>Dimensioni - Dimensions - Medidas [mm]   |      |   |                |                |      |  |                |          |
| D   | Gewinde Ausführung -<br>Thread design - Esecuzione<br>Filettata - Exécution filet -<br>Ejecución de rosca  | d    | Gewinde Ausführung -<br>Thread design - Esecuzione<br>Filettata - Exécution filet -<br>Ejecución de rosca | L              | L <sub>1</sub> | SW   |  |                |          |
|                    | M 10 x 1   | A 2  | M 10 x 1  | A 2            | 24,0           | 8,5  | 14   | 03.3511-0800.1 | 390285 ① |
|   | ① In Sortimentbox <b>24.3516-0210.2 390553</b> enthalten.<br>Included in collection <b>24.3516-0210.2 390553</b> .<br>Contenuto nella scatola di assortimento <b>24.3516-0210.2 390553</b> .<br>Include dans collection <b>24.3516-0210.2 390553</b> .<br>Se incluye en caja de surtido <b>24.3516-0210.2 390553</b> . |      |   |                |                |      |  |                |          |
|                    | M 12 x 1   |      | M 12 x 1  |                | 35,0           | 15,0 | 12   | 03.3511-3800.1 | 390291   |
|   |  |      |   |                |                |      |  |                |          |
|                    | M 12 x 1   |      | M 10 x 1  | A 2            | 28,0           | 15,3 | 17   | 03.3511-5200.1 | 390292   |
|   |  |      |   |                |                |      |  |                |          |
|                    | M 12 x 1   | A 1  | M 12 x 1  | A 1            | 29,0           | -    | 17   | 03.3511-1000.1 | 390286   |
|   |  |      |   |                |                |      |  |                |          |
|                    | M 12 x 1   | A 1  | M 12 x 1  | A 1            | 29,0           | 19,0 | 19   | 03.3511-1100.1 | 390287   |
|   |  |      |   |                |                |      |  |                |          |

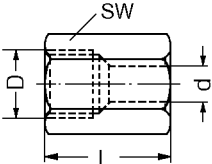
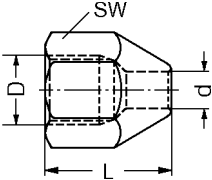

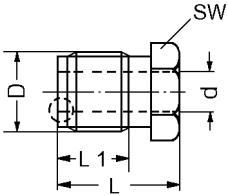
# Armaturen

## Fittings - Attrezzature - Composants et accessoires - Accesorios

| Überwurfmutter<br>Union nuts<br>Dadi con risvolto<br>Écrou-chapeau<br>Tuerca de racor   | Abmessungen - Dimensions -<br>Dimensioni - Dimensions - Medidas [mm]  |      |      |                |   |                |    |          |
|---|---|------|------|----------------|---|----------------|---|----------|
|   | D   | d    | L    | L <sub>1</sub> | für Bördel - for flare -<br>bordatura tipo - pour<br>colet - para reborde | SW             |   |          |
|    | M 10 x 1  | 5,2  | 14,0 |                | E   | 14             | 24.3516-0110.1  | 390549 ① |
|   | <p>① In Sortimentbox <b>24.3516-0210.2 390553</b> enthalten.<br/>           Included in collection <b>24.3516-0210.2 390553</b>.<br/>           Contenuto nella scatola di assortimento <b>24.3516-0210.2 390553</b>.<br/>           Include dans collection <b>24.3516-0210.2 390553</b>.<br/>           Se incluye en caja de surtido <b>24.3516-0210.2 390553</b>.</p> |      |      |                |   |                |   |          |
|   | 3/8" -24 UNF-2B   | 5,2  | 17,5 |                | E   | 14             | 24.3516-0111.1  | 390550 ① |
|   | <p>① In Sortimentbox <b>24.3516-0210.2 390553</b> enthalten.<br/>           Included in collection <b>24.3516-0210.2 390553</b>.<br/>           Contenuto nella scatola di assortimento <b>24.3516-0210.2 390553</b>.<br/>           Include dans collection <b>24.3516-0210.2 390553</b>.<br/>           Se incluye en caja de surtido <b>24.3516-0210.2 390553</b>.</p> |      |      |                |   |                |   |          |
| Überwurfschrauben<br>Union screws<br>Viti con risvolto<br>Vis chapeau<br>Tornillos de racor   | Abmessungen - Dimensions -<br>Dimensioni - Dimensions - Medidas [mm]  |      |      |                |   |                |  |          |
|   | D   | d    | L    | L <sub>1</sub> | für Bördel - for flare -<br>bordatura tipo - pour<br>colet - para reborde | SW             |   |          |
| <br> E<br> F   | M 10 x 1  | 4,75 | 17,0 | 11,0           | E   | 10             | 03.3516-2300.1  | 390317   |
|   |   | 5,2  | 16,7 | 9,5            | E   | 10             | 24.3516-0020.1  | 390541 ② |
|   |   | 5,0  | 16,5 | 10,5           | F   | 11             | 03.3516-3500.1  | 390318   |
|   |   | 5,0  | 16,5 | 9,4            | F   | 11             | 03.3516-0602.1  | 390412   |
|   |   | 5,0  | 16,0 | 10,0           | E   | 11             | 03.3516-0800.1  | 390313   |
|   |   | 5,2  | 24,8 | 15,0           | F   | 11             | 24.3516-0070.1  | 390546 ② |
|   | M 10 x 1,25   | 5,2  | 19,5 | 13,5           | F   | 10             | 24.3516-0050.1  | 390544 ② |
|   |   | 5,2  | 14,2 | 8,5            | E   | 10             | 24.3516-0060.1  | 390545 ② |
|   | M 12 x 1  | 6,0  | 18,0 | 11,4           | E   | 12             | 24.3516-0080.1  | 390547   |
|   |   | 5,0  | 20,0 | 13,0           | F   | 12             | 24.3516-0090.1  | 390548   |
|   | 3/8" -24 UNF-2A   | 5,0  | 14,0 | 7,5            | E   | 10             | 03.3516-0100.1  | 390310   |
|   |   | 5,2  | 18,0 | 12,0           | E   | 10             | 24.3516-0040.1  | 390543 ② |
|   | 5,2   | 21,0 | 16,0 | F              | 11  | 24.3516-0030.1 | 390542 ②  |          |
| <p>② In Sortimentbox <b>24.3516-0210.2 390553</b> enthalten.<br/>           Included in collection <b>24.3516-0210.2 390553</b>.<br/>           Contenuto nella scatola di assortimento <b>24.3516-0210.2 390553</b>.<br/>           Include dans collection <b>24.3516-0210.2 390553</b>.<br/>           Se incluye en caja de surtido <b>24.3516-0210.2 390553</b>.</p> |   |      |      |                |   |                |   |          |

# Armaturen

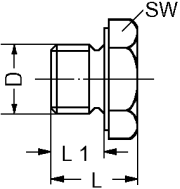
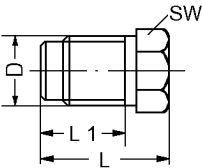
## Fittings - Attrezzature - Composants et accessoires - Accesorios

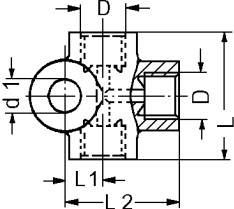
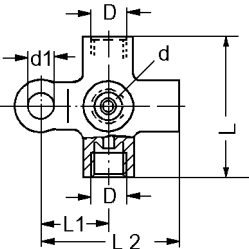
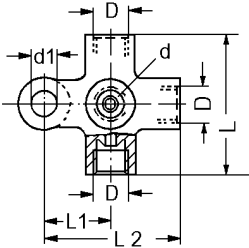
| Verschlußstopfen<br>Plugs<br>Tappi<br>Obturbateur<br>Tapón de cierre   | Abmessungen - Dimensions -<br>Dimensioni - Dimensions - Medidas [mm] |   |            |   |   |                |  |                 |  |                       |               |
|--|--|---|------------|---|---|----------------|---|-----------------|--|-----------------------|---------------|
|  | D  | d   | L          | L <sub>1</sub>  | für Bördel - for flare -<br>bordatura tipo - pour<br>colet - para reborde | SW             |   |                 |  |                       |               |
|   | M 10 x 1   |   | 12,5       | 7,5   |   | 14             | <b>03.3517-0100.1</b>   | <b>390321</b>   |  |                       |               |
|  | M 10 x 1   |   | 12,5       | 7,5   |   | 14             | <b>03.3517-0101.2</b>   | <b>390322</b> ① |  |                       |               |
| ① mit Dichtring (CU)<br>with sealing ring (CU)<br>avec joint d'étanchéité (CU)<br>con anello di tenuta (CU)<br>con junta (CU)                                      |  |   |            |   |   |                |   |                 |  |                       |               |
|   | M 10 x 1   |   | 18,0       | 11,5  | E + F   | 10             | <b>03.3517-5100.1</b>   | <b>390326</b>   |  |                       |               |
|  | M 12 x 1   |   | 20,0       | 13,0  | E   | 12             | <b>03.3517-0300.1</b>   | <b>390323</b>   |  |                       |               |
| Verteiler<br>distributors<br>ripartitore<br>distributeur<br>distribuidor   | Abmessungen - Dimensions -<br>Dimensioni - Dimensions - Medidas [mm] |   |            |   |   |                |   |                 |  |                       |               |
|  | D  | Gewinde Ausführung -<br>Thread design - Esecuzione<br>Filettata - Exécution filet -<br>Ejecución de rosca | d          | Gewinde Ausführung -<br>Thread design - Esecuzione<br>Filettata - Exécution filet -<br>Ejecución de rosca | L   | L <sub>1</sub> | L <sub>2</sub>  | d <sub>1</sub>  |  |                       |               |
| 3 Anschlüsse - 3 Connections -<br>3 Attacchi - 3 Raccords -<br>3 Conexiones<br> | M 10 x 1   | A 2   |            |   | 30,0  | 8,0            | 23,0  | 7,1             | <b>03.3513-0200.1</b>  | <b>390297</b>         |               |
|  |  | A 1   |            |   |   | 30,0           | 8,0   | 23,0            | 8,4  | <b>03.3513-1000.1</b> | <b>390299</b> |
|  | M 12 x 1   | A 1   |            |   |   | 36,0           | 9,0   | 27,0            | 8,4  | <b>03.3513-2700.1</b> | <b>390300</b> |
|  |  | A 1   |            |   |   | 36,0           | 10,0  | 31,5            | 8,3  | <b>03.3513-0300.1</b> | <b>390298</b> |
| 3 Anschlüsse - 3 Connections -<br>3 Attacchi - 3 Raccords -<br>3 Conexiones<br> | M 12 x 1   | A 1   | M 12 x 1   |   | 34,0  | 19,0           | -   | 10,5            | <b>03.3513-0109.2</b>  | <b>390296</b>         |               |
|  |  |   |            |   |   |                |   |                 |  |                       |               |
| 4 Anschlüsse - 4 Connections -<br>4 Attacchi - 4 Raccords -<br>4 Conexiones<br> | M 10 x 1   | A 2   | M 10 x 1   | A 2   | 32,0  | 17,0           | 33,0  | 8,4             | <b>03.3514-2600.1</b>  | <b>390306</b>         |               |
|  |  | A 2   | M 10 x 1 ① | A 2   | 32,0  | 17,0           | 33,0  | 8,4             | <b>03.3514-2600.2</b>  | <b>390307</b>         |               |
| ① mit Entlüfterventil<br>with bleeder valve<br>con valvola di spurgo<br>avec vis de purge<br>con válvula de ventilador   |  |   |            |   |   |                |   |                 |  |                       |               |

# Armaturen

Fittings - Attrezzature - Composants et accessoires - Accesorios

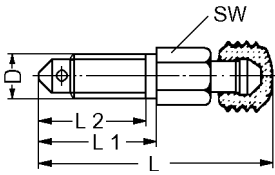
| Entlüfterventil<br>Bleeder valve<br>Valvola di spurgo<br>Vis de purge<br>Válvula de ventilador  | Abmessungen - Dimensions -<br>Dimensioni - Dimensions - Medidas [mm] |      |                |                |    |  |
|---|--|------|----------------|----------------|----|---|
|   | D  | L    | L <sub>1</sub> | L <sub>2</sub> | SW |   |
|  <p>Bestell-Nr. Staubkappe<br/>Part No. dust cap<br/>Codici ordinazione del parapolvere<br/>Référence capuchon de protection<br/>Referencia guardapolvo</p> <p><b>03.3590-0700.1 390456</b><br/><b>03.3590-0701.1 390457 M</b></p> | M 6  | 31,5 | 16,0           | 12,0           | 7  | <b>03.3518-0100.2 390329</b>  |
|   |  | 31,5 | 16,0           | 12,0           | 7  | <b>03.3518-0102.2 390330 M</b>  |
|   |  | 41,0 | 22,0           | 12,0           | 7  | <b>03.3518-0200.2 390332</b>  |
|   |  | 29,0 | 13,5           | 12,0           | 7  | <b>03.3518-0300.2 390333</b>  |
|   |  | 29,0 | 13,5           | 12,0           | 7  | <b>03.3518-0302.2 390334 M</b>  |
|   | M 7  | 33,0 | 16,5           | 15,0           | 7  | <b>03.3518-4200.2 390357</b>  |
|   |  | 41,0 | 22,0           | 15,5           | 7  | <b>03.3518-5900.2 390363</b>  |
|   |  | 22,5 | 12,5           | 11,0           | 7  | <b>03.3518-6800.2 390369 ①</b>  |
|   |  | 29,5 | 12,5           | 11,0           | 7  | <b>03.3518-6901.2 390370</b>  |
|   | M 8  | 35,0 | 18,5           | 17,0           | 9  | <b>03.3518-0500.2 390337</b>  |
|   |  | 35,0 | 18,5           | 17,0           | 9  | <b>03.3518-0502.2 390339 M</b>  |
|   |  | 44,0 | 22,0           | 20,0           | 9  | <b>03.3518-0600.2 390340</b>  |
|   |  | 49,0 | 32,0           | 20,0           | 9  | <b>03.3518-0700.2 390342</b>  |
|   |  | 59,0 | 42,0           | 20,0           | 9  | <b>03.3518-0800.2 390343</b>  |
|   |  | 52,0 | 32,0           | 20,0           | 9  | <b>03.3518-6100.2 390364</b>  |
|   |  | 90,0 | 35,0           | 18,0           | 9  | <b>03.3518-8000.2 390373</b>  |
|   | M 10 x 1   | 32,0 | 16,0           | 13,0           | 11 | <b>03.3518-0900.2 390345</b>  |
|   |  | 32,0 | 16,0           | 13,0           | 11 | <b>03.3518-0902.2 390346 M</b>  |
|   |  | 38,0 | 21,0           | 18,0           | 11 | <b>03.3518-1900.2 390354</b>  |
|   |  | 32,0 | 16,0           | 13,0           | 10 | <b>03.3518-5200.2 390358</b>  |
|   | M 12 x 1   | 31,5 | 15,5           | 13,0           | 12 | <b>03.3518-1501.2 390349 ②</b>  |
|   | M 12 x 1,5   | 43,0 | 26,0           | 24,0           | 14 | <b>03.3518-1300.2 390347</b>  |
|   | 7/16"-20 UNF-2A  | 40,0 | 23,0           | 21,0           | 11 | <b>03.3518-1700.2 390352</b>  |

M nur für Mineralöl  
only for mineral oil  
solo per olio minerale  
seulement pour huile minérale  
sólo para aceite mineral

① mit Staubkappe **03.3590-0044.1 390455**  
with dust cap **03.3590-0044.1 390455**  
con parapolvere **03.3590-0044.1 390455**  
avec capuchon de protection **03.3590-0044.1 390455**  
con guardapolvo **03.3590-0044.1 390455**

② mit 60° Innenkegel  
with 60° internal cone  
con cono interno 60°  
avec cône intérieur 60°  
con cono interior 60°

**Staubkappen**  
dust caps  
parapolvere  
capuchon de protection  
guardapolvo

**03.3590-0700.1 390456**

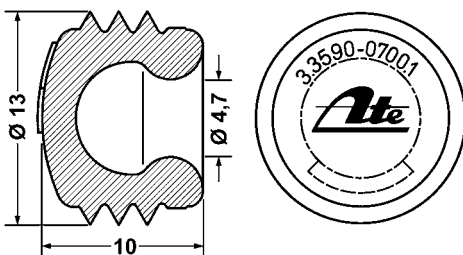

**03.3590-0701.1 390457**

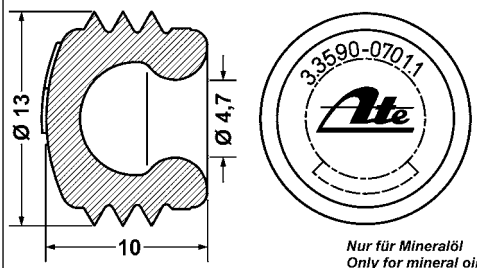



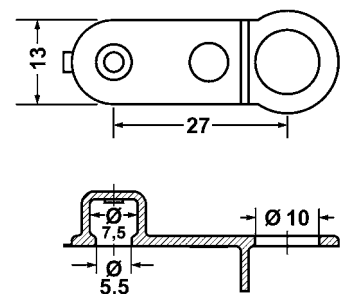

**13.8190-0296.1 390409**



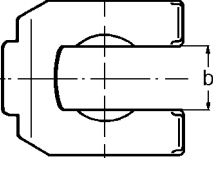
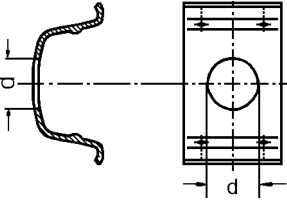
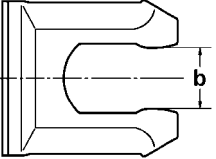

# Armaturen

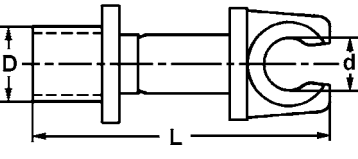
## Fittings - Attrezzature - Composants et accessoires - Accesorios

| <b>Bremsschlauchhalter</b><br>Hose spring-clamp<br>Mollette per flessibile freni<br>Ressort de retenue de flexible de frein<br>Soporte manguera de freno  | <b>Abmessungen - Dimensions -<br/>                     Dimensioni - Dimensions - Medidas [mm]</b> |   |    |
|---|---|---|---|
|   | <b>b (d)</b>  | <b>Blechstärke - Thickness of metal<br/>                     Spessore lamierino - Épaisseur de tôle -<br/>                     Espesor de chapa</b> |   |
|    | 14,0  | 1,00  | 03.5004-0101.1 990010   |
|   | 14,0  | 1,75  | 03.5004-0401.1 990014   |
|   | 12,0  | 1,00  | 24.5004-0001.1 390568 ②   |
|    | 10,0  | 0,70  | 24.5004-0002.1 390569 ②   |
|   | 11,0  | 1,00  | 24.5004-0003.1 390570 ②   |
| ② In Sortimentbox 24.3516-0230.2 390555 enthalten.<br>Included in collection 24.3516-0230.2 390555.<br>Contenuto nella scatola di assortimento 24.3516-0230.2 390555.<br>Incluse dans collection 24.3516-0230.2 390555.<br>Se incluye en caja de surtido 24.3516-0230.2 390555. |   |   |   |
| <b>Bremsrohrhalter</b><br>Brake pipe line holder<br>Supporto tubo freno<br>Support de tuyau de freinage<br>Soporte tubo de freno  | <b>Abmessungen - Dimensions -<br/>                     Dimensioni - Dimensions - Medidas [mm]</b> |   |  |
|   | <b>D</b>  | <b>d</b>  | <b>L</b>  |
|   | 6,3   | 4,7   | 28,0  |
|   |   |   |   |
| <b>Rohrleitungen DIN 74234</b><br>Pipe line DIN 74234<br>Tubazioni DIN 74234<br>Conduite tube DIN 74234<br>Tuberías DIN 74234   | <b>Abmessungen - Dimensions -<br/>                     Dimensioni - Dimensions - Medidas</b>      |   |  |
|   | <b>Ø</b>  | <b>L</b>  |   |
|   |   |   | 24.8134-0547.1 390571   |
|   |   |   | 24.8134-0560.1 390572   |
|   |   |   | 24.8134-0580.1 390573   |

# Armaturen

## Fittings - Attrezzature - Composants et accessoires - Accesorios

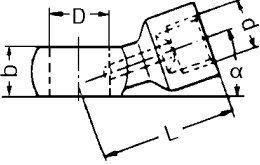
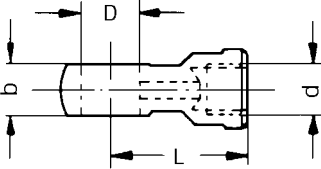
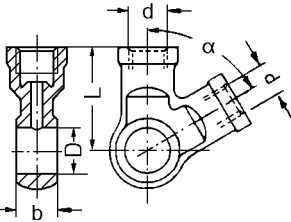
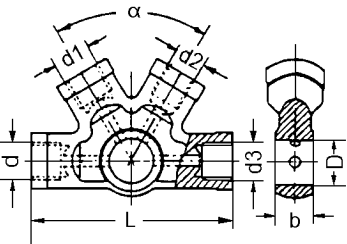
| Ringstutzen<br>Banjo fittings<br>Raccordi anulari<br>Manchon à oeillet<br>Racores anulares   | Abmessungen - Dimensions -<br>Dimensioni - Dimensions - Medidas [mm]   |            |   |      |      |     |  |                 |
|--|--|------------|---|------|------|-----|---|-----------------|
|  | D  | d          | Gewinde Ausführung -<br>Thread design - Esecuzione<br>filettata - Exécution filet -<br>Ejecución de rosca | L    | b    |     |   |                 |
| 1 Anschluss - 1 Connection -<br>1 Attaccho - 1 Raccord -<br>1 Conexión<br>        | 12,0   | M 10 x 1   | A 2   | 27,0 | 10,0 | 20° | <b>03.3521-0100.1</b>   | <b>390392</b>   |
|  |  | M 10 x 1   | A 2   | 30,0 | 10,0 | 30° | <b>03.3521-0400.1</b>   | <b>390394</b>   |
|  | 14,0   | M 10 x 1   | A 2   | 32,0 | 12,0 | 20° | <b>03.3521-0800.1</b>   | <b>390398</b>   |
|  |  | M 12 x 1   | A 1   | 32,0 | 12,0 | 20° | <b>03.3521-0600.1</b>   | <b>390395</b>   |
| 1 Anschluss - 1 Connection -<br>1 Attaccho - 1 Raccord -<br>1 Conexión<br>       | 12,0   | M 10 x 1   | A 2   | 26,0 | 10,0 |     | <b>03.3521-0200.1</b>   | <b>390393</b> ① |
|  | ① für Bremslichtschalter mit konischem Gewinde<br>for stop-light switch with conical thread<br>per interruttore luce di arresto con filettatura conica<br>pour contacteur de stop avec filetage conique<br>para interruptor de luz de freno con rosca cónica |            |   |      |      |     |   |                 |
| 2 Anschlüsse - 2 Connections -<br>2 Attacchi - 2 Raccords -<br>2 Conexiones<br> | 12,0   | M 10 x 1   | A 2   | 20,5 | 15,5 | 34° | <b>03.3522-0200.1</b>   | <b>390402</b>   |
|  |  | M 12 x 1   | A 1   | 32,0 | 12,0 | 60° | <b>03.3522-0500.1</b>   | <b>390403</b>   |
|  | 14,0   | M 12 x 1   | A 1   | 32,0 | 12,0 | 60° | <b>03.3522-1100.1</b>   | <b>390404</b>   |
|  |  | M 10 x 1 ② | A 4   |      |      |     |   |                 |
| ② für Bremslichtschalter<br>for stop-light switch<br>per interruttore luce di arresto<br>pour contacteur de stop<br>para interruptor de luz de freno               |  |            |   |      |      |     |   |                 |
| 4 Anschlüsse - 4 Connections -<br>4 Attacchi - 4 Raccords -<br>4 Conexiones<br> | 14,0   | M 10 x 1   | A 2   | 64,0 | 12,0 | 60° | <b>03.3524-0300.1</b>   | <b>390407</b>   |
|  |  |            |   |      |      |     |   |                 |



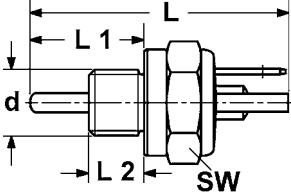
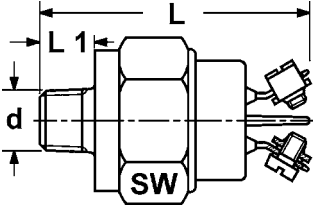
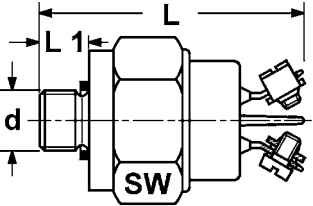
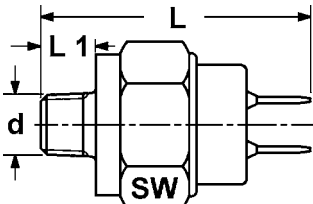
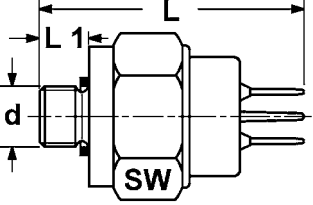
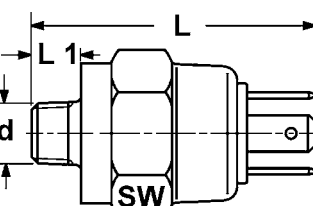

# Armaturen

## Fittings - Attrezzature - Composants et accessoires - Accesorios

| Bremslichtschalter<br>Stop-light switch<br>Interruttore luce di arresto<br>Contacteur de stop<br>Interruptor de luz de freno           | Abmessungen - Dimensions -<br>Dimensioni - Dimensions - Medidas [mm]                                       |          |      |                |                |  |                                |
|--|--|----------|------|----------------|----------------|---|--------------------------------|
|  | Ausführung - Design -<br>Esecuzione - Exécution -<br>Ejecución   | d        | L    | L <sub>1</sub> | L <sub>2</sub> |   | SW                             |
|   | Steck-Anschluß<br>Plug connection<br>Attacco a spina<br>Contact à fiches<br>Enchufe de conexión            | M 12 x 1 | 47,0 | 21,0           | 10,0           | 19  | <b>24.3525-9120.1 340015</b>   |
|  |  |          |      |                |                |   |                                |
|   | Klemm-Anschluß<br>Clamp connection<br>Collegamento a morsetto<br>Borne de serrage<br>Conexión por fijación | M 10 x 1 | 46,0 | 9,0            |                | 24  | <b>24.3526-0100.3 340017</b>   |
|  |  | M 10 x 1 | 46,0 | 9,0            |                | 24  | <b>24.3526-0600.3 340027 M</b> |
|    | Klemm-Anschluß<br>Clamp connection<br>Collegamento a morsetto<br>Borne de serrage<br>Conexión por fijación | M 10 x 1 | 46,0 | 8,0            |                | 24  | <b>24.3526-0110.3 340018</b>   |
|  |  | M 10 x 1 | 46,0 | 8,0            |                | 24  | <b>24.3526-0610.3 340030 M</b> |
|   | Steck-Anschluß<br>Plug connection<br>Attacco a spina<br>Contact à fiches<br>Enchufe de conexión            | M 10 x 1 | 42,0 | 9,0            |                | 22  | <b>03.3526-2002.3 340010</b>   |
|  |  |          |      |                |                |   |                                |
|   | Steck-Anschluß<br>Plug connection<br>Attacco a spina<br>Contact à fiches<br>Enchufe de conexión            | M 10 x 1 | 46,0 | 8,0            |                | 22  | <b>24.3526-0810.3 340037</b>   |
|  |  |          |      |                |                |   |                                |
|   | Steck-Anschluß<br>Plug connection<br>Attacco a spina<br>Contact à fiches<br>Enchufe de conexión            | M 10 x 1 | 48,0 | 9,0            |                | 24  | <b>24.3526-0800.3 340033</b>   |
|  |  | M 10 x 1 | 48,0 | 9,0            |                | 24  | <b>24.3526-1900.0 340038 M</b> |
|  |  | M 10 x 1 | 48,0 | 9,0            |                | 24  | <b>24.3526-2200.0 340039</b>   |
| <b>M</b> nur für Mineralöl - only for mineral oil - solo per olio minerale<br>seulement pour huile minérale - sólo para aceite mineral |  |          |      |                |                |   |                                |

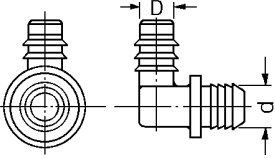

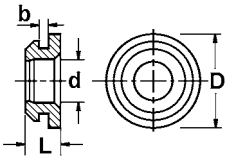
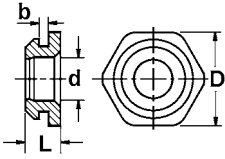

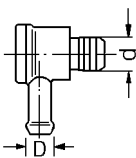
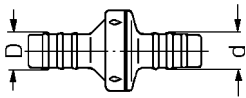



# Armaturen

Fittings - Attrezzature - Composants et accessoires - Accesorios

| <b>Vakuum-Anschlußstück</b><br>Vacuum connection<br>Pezzo di raccordo per depressione<br>Raccord à dépression<br>Terminal de empalme al vacío   | <b>Abmessungen - Dimensions -<br/>                     Dimensioni - Dimensions - Medidas [mm]</b> |     |      |      |    |
|---|---|-----|------|------|---|
|   | L   | b   | D    | d    |   |
|    |   |     | 12,0 | 14,0 | 03.6118-6811.1 990030   |
| <b>Dichtung</b> für Vakuum-Anschlußstück<br><b>Hexagon</b> for vacuum connection<br><b>Guarnizione</b> per pezzo di raccordo per depressione<br><b>Hexagone</b> pour raccord à dépression<br><b>Retén</b> para terminal de empalme al vacío | <b>Abmessungen - Dimensions -<br/>                     Dimensioni - Dimensions - Medidas [mm]</b> |     |      |      |    |
|   | L   | b   | D    | d    |   |
|   | 9,5   | 1,5 | 28,0 | 13,0 | 03.7718-7203.1 390360   |
|    | 9,5   | 2,5 | 28,0 | 13,0 | 03.7718-7202.1 390378   |
| <b>Vakuum-Rückschlagventil</b><br>Vacuum check valve<br>Valvola di non ritorno<br>per depressione<br>Soupape à dépression<br>Válvula de retención al vacío  | <b>Abmessungen - Dimensions -<br/>                     Dimensioni - Dimensions - Medidas [mm]</b> |     |      |      |  |
|   | L   | b   | D    | d    |   |
|    |   |     | 12,4 | 16,5 | 03.6118-7305.2 990032   |
|   |   |     | 10,5 | 16,5 | 03.6718-9931.2 990002   |
|    |   |     | 11,8 | 11,8 | 24.7718-7301.2 990024   |
|   |   |     | 13,0 | 13,0 | 03.6118-7307.2 990033   |

# Armaturen

## Fittings - Attrezzature - Composants et accessoires - Accesorios

|  |   |  |   |  |
|--|---|--|---|--|
| <p><b>Prüfanschlüsse</b><br/>Testing connectors<br/>attacchi di prova<br/>connexion d'essai<br/>conexiones de ensayo</p>   | <p>Für den festen Einbau in die Bremsanlage (z.B. anstelle eines Verteilerstückes). Druckprüfgeräte können hier direkt über die Anschlußschlauchleitung verbunden werden, ohne die Bremsanlage nachträglich zu entlüften.<br/>For permanent installation in the braking system (e.g. in the place of a distributor piece). The pressure testing units can be connected here directly to the connection hose line without having to bleed the braking system afterwards.<br/>Per montaggio fisso nell'impianto di frenatura (p.e. al posto di un ripartitore a più vie). Apparecchi prova pressione possono essere collegati direttamente tramite il tubo di collegamento, senza dover spurgare l'impianto freni a posteriori.<br/>Pour installation permanente dans le système de freinage (par ex: à la place d' une pièce de distribution). Les appareils de vérification de la pression peuvent être directement reliés à la connexion. Le système de freinage n' a pas besoin d' être purgé par la suite.<br/>Para el montaje fijo en la instalación de frenos (p. ej. en lugar de un distribuidor). Los controladores de presión no pueden unirse aquí directamente a través de la línea de conexión sin tener que airear posteriormente la instalación de frenos.</p> |  |   |  |
|   | <br>03.9305-0501.3 390481  | <br>03.9305-0510.3 390483                                       | <br>03.9305-0520.3 390485  | <br>03.9305-0530.3 390486 |
| <p>Anzahl der Befestigungslaschen<br/>Number of mounting links<br/>Numero delle fascette<br/>Nombre de trous de fixation<br/>Número de las bridas de fijación</p>  | 1   | 1  | 2   | 2  |
| <p>Anzahl der Anschlüsse<br/>Number of connections<br/>Numero di attacchi<br/>Nombre de raccordement<br/>Número de conexiones</p>  | 2   | 3  | 2   | 2  |
| <p>Gewinde Ausführung<br/>Thread design<br/>Esecuzione filettata<br/>Exécution filet<br/>Ejecución de rosca</p>  | M 12 x 1<br>A1  | M 12 x 1<br>A1   | M 10 x 1<br>A2  | M 12 x 1<br>A1   |
| <p>Richtung des Prüfanschlusses zur Befestigungslasche<br/>Direction of the testing connector to the mounting link<br/>Direzione del raccordo di prova alla fascetta di fissaggio<br/>Nens du raccord d' essai par rapport aux trous de fixation<br/>Dirección de la conexión de ensayo a la brida de fijación</p> | horizontal<br>orizzontale   | vertical<br>verticale  | vertical<br>verticale   | vertical<br>verticale  |
|   | <br>03.9305-0570.3 390488  | <br>03.9305-0590.3 390489                                     | <br>03.9305-0700.3 390491  |  |
| <p>Anzahl der Befestigungslaschen<br/>Number of mounting links<br/>Numero delle fascette<br/>Nombre de trous de fixation<br/>Número de las bridas de fijación</p>  | 1   | 1  | -   |  |
| <p>Anzahl der Anschlüsse<br/>Number of connections<br/>Numero di attacchi<br/>Nombre de raccordement<br/>Número de conexiones</p>  | 3   | 3  | 1   |  |
| <p>Gewinde Ausführung<br/>Thread design<br/>Esecuzione filettata<br/>Exécution filet<br/>Ejecución de rosca</p>  | M 12 x 1<br>A1  | M 10 x 1<br>A2   | M 10 x 1  |  |
| <p>Richtung des Prüfanschlusses zur Befestigungslasche<br/>Direction of the testing connector to the mounting link<br/>Direzione del raccordo di prova alla fascetta di fissaggio<br/>Nens du raccord d' essai par rapport aux trous de fixation<br/>Dirección de la conexión de ensayo a la brida de fijación</p> | vertical<br>verticale   | horizontal<br>orizzontale  | -   |  |
| <p><b>Prüfanschlüsse - Einzelteile</b><br/>Testing connectors - individual parts<br/>Attacchi di prova - pezzi singoli<br/>Connexion d' essai - pièces détachées<br/>Piezas sueltas - conexión de ensayo</p>   | <p>03.9305-0502.0 390482<br/>Schraubverschlusskappe<br/>Screw-type sealing cap<br/>Calotta per tappo filettato<br/>Capuchon à vis<br/>Tapa roscable</p>   | <p>03.9305-0501.1 390480<br/>Verbindungskette<br/>Connecting chain<br/>catena di collegamento<br/>chaîne de raccordement<br/>cadena de unión</p> | <p>03.3501-0021.1 390242<br/>Gummidichtung in der Verschlusskappe<br/>Rubber seal in the sealing cap<br/>guarnizione in gomma nella calotta<br/>joint dans le capuchon<br/>junta de goma en la tapa de cierre</p> |  |

# Armaturen

Fittings - Attrezzature - Composants et accessoires - Accesorios

Sortimente  
Assortments  
Assortimenti  
Assortiments  
Surtidos

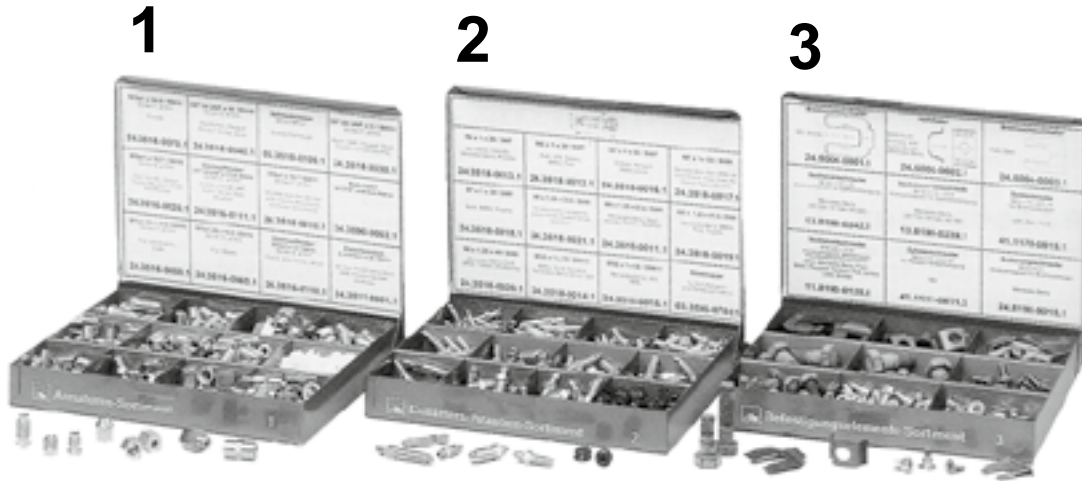

|  |   |  |  |   |
|--|---|--|--|---|
| ① M10x1 x 24,8 / SW11<br>Bördel F, Ø5mm<br>● 24.3516-0070.1 390546   | ① 3/8"-24 UNF x 18/SW10<br>Bördel E, Ø5mm<br>● 24.3516-0040.1 390543  | ② Schraubstutzen<br>M10x1/M10x1<br>■ 03.3510-0100.1 390271   | ① 3/8"-24 UNF x 21/SW11<br>Bördel F, Ø5mm<br>● 24.3516-0030.1 390542   | <p><b>1</b><br/>24.3516-0210.2 390553<br/><b>Armaturen Sortiment</b><br/>Fittings collection<br/>Serie di accessori<br/>Armatures collection<br/>Surtido de accesorios</p>  |
| ① M10x1 x 16,7 / SW10<br>Bördel E, Ø5mm<br>● 24.3516-0020.1 390541   | ③ Überwurfmutter<br>3/8"-24UNFx17,5/SW11/E, Ø5mm<br>● 24.3516-0111.1 390550   | ① M10x1 x 16,7 / SW11<br>Bördel F, Ø5mm<br>● 24.3516-0010.1 390540   | Rohrhalter<br>④ für 3/16" und 5mm<br>● 24.3590-0002.1 390567   |   |
| ① M10x1,25 x 10,5 / SW10<br>Bördel F, Ø5mm<br>● 24.3516-0050.1 390544                                      | ① M10x1,25 x 14,2 / SW10<br>Bördel E, Ø5mm<br>● 24.3516-0060.1 390545   | ③ Überwurfmutter<br>M10x1 x 13 / SW14 / E, Ø5mm<br>● 24.3516-0110.1 390549   | ⑤ Zwischenstück<br>2 x M10x1 x 24 SW14<br>● 03.3511-0800.1 390285  |   |
| M6 x 1 x 29<br>SW7<br>● 24.3518-0013.1 390558  | M6 x 1 x 38<br>SW7<br>● 24.3518-0012.1 390557   | M7 x 1 x 26<br>SW7<br>● 24.3518-0016.1 390561  | M7 x 1 x 33<br>SW9<br>● 24.3518-0017.1 390562  | <p><b>2</b><br/>24.3516-0220.2 390554<br/><b>Entlüfterschrauben Sortiment</b><br/>Bleeder valve collection<br/>Viti di spurgo assortimento<br/>Vis de purge collection<br/>Surtido de tornillos de ventilador</p> |
| M7 x 1 x 38<br>SW7<br>● 24.3518-0018.1 390563  | M8 x 1,25 x 24,5<br>SW8<br>● 24.3518-0021.1 390566  | M8 x 1,25 x 32,5<br>SW9<br>● 24.3518-0011.1 390556   | M8 x 1,25 x 41,5<br>SW9<br>● 24.3518-0019.1 390564   |   |
| M8 x 1,25 x 49<br>SW9<br>● 24.3518-0020.1 390565   | M10 x 1 x 30<br>SW11<br>● 24.3518-0014.1 390559   | M10 x 1 x 36<br>SW11<br>● 24.3518-0015.1 390560  | ⑥ Staubkappe<br>■ 03.3590-0700.1 390456  |   |
| ⑦ Bremschlauchhalter<br>● 24.5004-0001.1 390568  | ⑧ Haltefeder<br>● 24.5004-0002.1 390569   | ⑦ Bremschlauchhalter<br>● 24.5004-0003.1 390570  |  |   |
| ⑨ Sechskantschraube<br>M12 x 1,5 x 45<br>■ 13.8190-0242.1 990124   | ⑩ Sechskant-Paßschraube<br>M12 x 1,5 - 10.9<br>■ 13.8190-0239.1 990122  | ⑪ Senkschraube<br>M6 x 14 -4.8 - H<br>● 41.1178-0815.1 990137  | <p><b>3</b><br/>24.3516-0230.2 390555<br/><b>Befestigungselemente Sortiment</b><br/>Fittings Collection<br/>Pezzi di fissaggio assortimento<br/>Fixation collection<br/>Surtido de elementos de fijación</p> |   |
| ⑨ Sechskantschraube<br>M8 x 21 - 10.9<br>● 11.8190-0125.1 990054   | ⑫ Zylinderschraube<br>M6 x 10 -8.8<br>● 41.1111-0811.3 990136   | ⑬ Sicherungsschraube<br>M6 x 15,5<br>● 24.8190-9015.1 990133   |  |   |
| ① Bördel<br>Flare<br>Bordatura tipo<br>Colet<br>Reborde  | ② Schraubstutzen<br>Screw adapters<br>Raccordi filettati<br>Raccord fiteté<br>Racores   | ③ Überwurfmutter<br>Union nut<br>Dadi con risvolto<br>Écrou-chapeau<br>Tuerca de racor   |  | ④ Rohrhalter<br>Pipe holder<br>Supporto<br>Support de tube<br>Soporte de tubo   |
| ⑤ Zwischenstück<br>Pipe adapter<br>Raccordi intermedi<br>Raccord intermédiaire<br>Piezas intercaladas      | ⑥ Staubkappe<br>Dust cap<br>Parapolvere<br>Capuchon de protection<br>Guardapolvo  | ⑦ Bremschlauchhalter<br>Hose spring-clamp<br>Mollette per flessibile freni<br>Ressort de retenue de flexible de frein<br>Soporte manguera de freno | ⑧ Haltefeder<br>Fixation spring<br>Molla di ritegno<br>Ressort d'arret<br>Resorte de retención   |   |
| ⑨ Sechskantschraube<br>Hexagon screw<br>Vite a testa esagonale<br>Boulon hexagonal<br>Resorte de retención | ⑩ Sechskant-Paßschraube<br>Hexagone-fitting screw<br>Vite calibrata a testa esagonale<br>Boulon hexagonal-vis<br>Tornillo hexagonal                               | ⑪ Senkschraube<br>Countersunk screw<br>Vite a testa svasata<br>Vis a tête conique<br>Tornillo calibrado hexagonal                                  | ⑫ Zylinderschraube<br>Cylinder screw<br>Vite a testa cilindrica<br>Vis cylindrique<br>Tornillo cilíndrico  |   |
| ⑬ Sicherungsschraube<br>Locking screw<br>Vite autobloccante<br>Vis d'appui<br>Tornillo de seguridad        | ● Nachfüllbeutel 10 Stück<br>Refillbag with 10 pieces<br>Sacchetto di riassortimento 10 pezzi<br>Sac de remplissage à 10 pièces<br>Bolsa de relleno con 10 piezas | ■ Einzelteil<br>Single part<br>Pezzo singolo<br>Pièces dé tachées<br>Pieza suelta  |  |   |





- Ⓓ Bremsgeräte komplett
- Ⓔ Booster units complete
- Ⓕ Servo-Freins complets
- Ⓖ Servofreni completi
- Ⓔ Servofreno completo
- Ⓖ Complete remapparaten
- Ⓓ Bremseenheder (kompl.)
- Ⓔ Bromsapparater komplett
- Ⓖ Teljes fékberendezés
- Ⓖ Aparelho de travagem completo
- Ⓔ Тормозные усилители в сборе
- Ⓖ Brzdová zařízení kompletní
- Ⓖ Serwa hamulcowe kompletne
- Ⓖ Μονάδες φρένων κομπλέ
- Ⓖ Tüm fren cihazları
- Ⓔ 制动器总成
- Ⓖ ブレーキ機器 全品
- Ⓖ أنظمة المكابح بالكامل

# Bremsgeräte komplett

**Booster units complete - Servofreni completi -  
Servo-freins complets - Servofreno completo**

● Die Nr. befindet sich auf dem im Fahrzeug eingebautem Aggregat.  
the number is on the unit build in the car  
il numero si trova sull'aggregato montato nella macchina  
le numéro se trouve sur la pièce montée dans le véhicule  
el n° se encuentra en el equipo montado en el vehículo



|                |  |                  |                            |
|----------------|--|------------------|----------------------------|
| 03.6127-0801.4 | <b>03.2122-0142.3</b><br><b>03.3558-0676.3</b> | 010128<br>310077 | THz 22,20<br>Behälter + WE |
| 03.6127-0804.4 | <b>03.3558-0676.3</b>                          | 310077           | Behälter + WE              |
| 03.6132-0702.4 | <b>03.3508-8302.3</b>                          | 310046           | Behälter                   |
| 03.6132-1103.4 | <b>03.2120-0148.3</b>                          | 010070           | THz 20,64 + Behälter       |
| 03.6132-1401.4 | <b>03.3508-8302.3</b>                          | 310046           | Behälter                   |
| 03.6132-1501.4 | <b>03.2122-0142.3</b><br><b>03.3558-0676.3</b> | 010128<br>310077 | THz 22,20<br>Behälter + WE |
| 03.6132-1502.4 | <b>03.2122-0142.3</b><br><b>03.3558-0676.3</b> | 010128<br>310077 | THz 22,20<br>Behälter + WE |
| 03.6132-1701.4 | <b>03.2123-1003.3</b>                          | 010175           | THz 23,81                  |
| 03.6132-1901.4 | <b>03.2120-5503.3</b>                          | 010124           | THz 20,64 + Behälter       |
| 03.6132-2001.4 | <b>03.3508-8302.3</b>                          | 310046           | Behälter                   |
| 03.6132-2701.4 | <b>03.3508-7504.3</b>                          | 310045           | Behälter                   |
| 03.6132-2901.4 | <b>03.2120-0148.3</b>                          | 010070           | THz 20,64 + Behälter       |
| 03.6132-3401.4 | <b>03.3508-8302.3</b>                          | 310046           | Behälter                   |
| 03.6132-3905.4 | <b>03.3508-7504.3</b>                          | 310045           | Behälter                   |
| 03.6132-3907.4 | <b>03.2120-1531.3</b><br><b>03.3508-7504.3</b> | 010092<br>310045 | THz 20,64<br>Behälter      |
| 03.6132-3908.4 | <b>03.3508-7504.3</b>                          | 310045           | Behälter                   |
| 03.6132-3912.4 | <b>03.2120-1531.3</b>                          | 010092           | THz 20,64                  |
| 03.6132-4201.4 | <b>03.2120-0148.3</b>                          | 010070           | THz 20,64 + Behälter       |
| 03.6132-4202.4 | <b>03.2120-0148.3</b>                          | 010070           | THz 20,64 + Behälter       |
| 03.6132-4203.4 | <b>03.2120-0148.3</b>                          | 010070           | THz 20,64 + Behälter       |
| 03.6132-4207.4 | <b>03.2120-0148.3</b>                          | 010070           | THz 20,64 + Behälter       |
| 03.6132-4401.4 | <b>03.2120-5503.3</b>                          | 010124           | THz 20,64 + Behälter       |
| 03.6132-4601.4 | <b>03.3508-7504.3</b>                          | 310045           | Behälter                   |
| 03.6132-4703.4 | <b>03.3508-8302.3</b>                          | 310046           | Behälter                   |
| 03.6132-4704.4 | <b>03.3508-8302.3</b>                          | 310046           | Behälter                   |
| 03.6132-4901.4 | <b>03.3508-7504.3</b>                          | 310045           | Behälter                   |
| 03.6132-5201.4 | <b>03.3508-7504.3</b>                          | 310045           | Behälter                   |
| 03.6132-5405.4 | <b>03.2120-0538.3</b>                          | 010077           | THz 20,64                  |

|                |  |                  |                            |
|----------------|--|------------------|----------------------------|
| 03.6132-5501.4 | <b>03.2120-1531.3</b><br><b>03.3508-7504.3</b> | 010092<br>310045 | THz 20,64<br>Behälter      |
| 03.6132-5502.4 | <b>03.3508-7504.3</b>                          | 310045           | Behälter                   |
| 03.6132-5701.4 | <b>03.2120-1531.3</b>                          | 010092           | THz 20,64                  |
| 03.6132-5802.4 | <b>03.3508-7504.3</b>                          | 310045           | Behälter                   |
| 03.6132-6301.4 | <b>03.2120-2598.3</b>                          | 010116           | THz 20,64                  |
| 03.6132-6302.4 | <b>03.2120-2598.3</b>                          | 010116           | THz 20,64                  |
| 03.6132-6304.4 | <b>03.2120-2598.3</b>                          | 010116           | THz 20,64                  |
| 03.6132-6305.4 | <b>03.2120-2598.3</b>                          | 010116           | THz 20,64                  |
| 03.6132-6306.4 | <b>03.2120-2598.3</b>                          | 010116           | THz 20,64                  |
| 03.6132-6501.4 | <b>03.2120-1531.3</b>                          | 010092           | THz 20,64                  |
| 03.6132-6512.4 | <b>03.2120-1531.3</b>                          | 010092           | THz 20,64                  |
| 03.6132-6515.4 | <b>03.2120-1491.3</b>                          | 010089           | THz 20,64 + WE             |
| 03.6132-6706.4 | <b>03.2120-1491.3</b>                          | 010089           | THz 20,64 + WE             |
| 03.6142-0301.4 | <b>03.3508-8302.3</b>                          | 310046           | Behälter                   |
| 03.6142-0701.4 | <b>03.3508-8302.3</b>                          | 310046           | Behälter                   |
| 03.6142-1201.4 | <b>03.2123-2604.3</b>                          | 010178           | THz 23,81 + WE             |
| 03.6142-1202.4 | <b>03.2123-2604.3</b>                          | 010178           | THz 23,81 + WE             |
| 03.6142-1205.4 | <b>03.2123-2604.3</b>                          | 010178           | THz 23,81 + WE             |
| 03.6142-1502.4 | <b>03.2122-2202.3</b>                          | 010140           | THz 22,20                  |
| 03.6142-1701.4 | <b>03.2119-6207.3</b><br><b>03.3558-0676.3</b> | 010060<br>310077 | THz 19,05<br>Behälter + WE |
| 03.6142-1703.4 | <b>03.2120-4504.3</b><br><b>03.3558-0676.3</b> | 010123<br>310077 | THz 20,64<br>Behälter + WE |
| 03.6142-1704.4 | <b>03.2120-4504.3</b><br><b>03.3558-0676.3</b> | 010123<br>310077 | THz 20,64<br>Behälter + WE |
| 03.6142-2101.4 | <b>03.2122-2202.3</b>                          | 010140           | THz 22,20                  |
| 03.6142-2402.4 | <b>03.2123-6207.3</b><br><b>03.3508-7504.3</b> | 010185<br>310045 | THz 23,81<br>Behälter      |
| 03.6142-2403.4 | <b>03.3508-7504.3</b>                          | 310045           | Behälter                   |
| 03.6142-3001.4 | <b>03.2120-5503.3</b>                          | 010124           | THz 20,64 + Behälter       |
| 03.6142-3201.4 | <b>03.6058-0301.3</b>                          | 320072           | BR 25/5 (3)                |
| 03.6142-3203.4 | <b>03.6058-0301.3</b>                          | 320072           | BR 25/5 (3)                |

# Bremsgeräte komplett

## Booster units complete - Servofreni completi - Servo-freins complets - Servofreno completo

● Die Nr. befindet sich auf dem im Fahrzeug eingebautem Aggregat.  
the number is on the unit build in the car  
il numero si trova sull'aggregato montato nella macchina  
le numéro se trouve sur la pièce montée dans le véhicule  
el n° se encuentra en el equipo montado en el vehículo



|                |  |                  |                            |
|----------------|--|------------------|----------------------------|
| 03.6142-3204.4 | <b>03.6058-0301.3</b>                          | 320072           | BR 25/5 (3)                |
| 03.6142-3205.4 | <b>03.6058-0301.3</b>                          | 320072           | BR 25/5 (3)                |
| 03.6142-3301.4 | <b>03.2123-6207.3</b><br><b>03.3508-7504.3</b> | 010185<br>310045 | THz 23,81<br>Behälter      |
| 03.6142-3302.4 | <b>03.3508-7504.3</b>                          | 310045           | Behälter                   |
| 03.6142-4401.4 | <b>03.2123-2604.3</b>                          | 010178           | THz 23,81 + WE             |
| 03.6142-4601.4 | <b>03.2122-0142.3</b><br><b>03.3558-0676.3</b> | 010128<br>310077 | THz 22,20<br>Behälter + WE |
| 03.6142-4602.4 | <b>03.2122-0142.3</b><br><b>03.3558-0676.3</b> | 010128<br>310077 | THz 22,20<br>Behälter + WE |
| 03.6142-4603.4 | <b>03.2122-0142.3</b><br><b>03.3558-0676.3</b> | 010128<br>310077 | THz 22,20<br>Behälter + WE |
| 03.6142-4604.4 | <b>03.2122-0142.3</b><br><b>03.3558-0676.3</b> | 010128<br>310077 | THz 22,20<br>Behälter + WE |
| 03.6142-4605.4 | <b>03.2122-0142.3</b><br><b>03.3558-0676.3</b> | 010128<br>310077 | THz 22,20<br>Behälter + WE |
| 03.6142-4701.4 | <b>03.2122-4902.3</b>                          | 010144           | THz 22,20                  |
| 03.6142-4702.4 | <b>03.2122-4902.3</b>                          | 010144           | THz 22,20                  |
| 03.6142-4704.4 | <b>03.2122-4902.3</b>                          | 010144           | THz 22,20                  |
| 03.6142-4801.4 | <b>03.2123-6207.3</b><br><b>03.3508-7504.3</b> | 010185<br>310045 | THz 23,81<br>Behälter      |
| 03.6142-4802.4 | <b>03.3508-7504.3</b>                          | 310045           | Behälter                   |
| 03.6142-4803.4 | <b>03.3508-7504.3</b>                          | 310045           | Behälter                   |
| 03.6142-5201.4 | <b>03.2123-6207.3</b><br><b>03.3508-7504.3</b> | 010185<br>310045 | THz 23,81<br>Behälter      |
| 03.6142-5202.4 | <b>03.3508-7504.3</b>                          | 310045           | Behälter                   |
| 03.6142-5203.4 | <b>03.3508-7504.3</b>                          | 310045           | Behälter                   |
| 03.6142-5205.4 | <b>03.2123-4911.3</b>                          | 010182           | THz 23,81                  |
| 03.6142-5301.4 | <b>03.3508-8302.3</b>                          | 310046           | Behälter                   |
| 03.6142-5502.4 | <b>03.3508-7504.3</b>                          | 310045           | Behälter                   |
| 03.6142-6803.4 | <b>03.2122-4902.3</b>                          | 010144           | THz 22,20                  |
| 03.6142-7203.4 | <b>03.2120-1491.3</b>                          | 010089           | THz 20,64 + WE             |
| 03.6142-7204.4 | <b>03.2120-1491.3</b>                          | 010089           | THz 20,64 + WE             |
| 03.6142-7205.4 | <b>03.2120-1491.3</b>                          | 010089           | THz 20,64 + WE             |

|                |   |                            |                                  |
|----------------|---|----------------------------|----------------------------------|
| 03.6142-7301.4 | <b>03.2120-1491.3</b>   | 010089                     | THz 20,64 + WE                   |
| 03.6142-7302.4 | <b>03.2120-1491.3</b>   | 010089                     | THz 20,64 + WE                   |
| 03.6142-7303.4 | <b>03.2120-1491.3</b>   | 010089                     | THz 20,64 + WE                   |
| 03.6147-0401.4 | <b>03.2125-1102.3</b><br><b>03.3508-3600.3</b>                          | 010202<br>310030           | THz 25,40<br>Behälter            |
| 03.6147-0501.4 | <b>03.2125-1102.3</b>   | 010202                     | THz 25,40                        |
| 03.6147-1101.4 | <b>03.2125-1302.3</b>   | 010203                     | THz 25,40                        |
| 03.6147-1102.4 | <b>03.2125-1302.3</b>   | 010203                     | THz 25,40                        |
| 03.6147-1103.4 | <b>03.2125-1302.3</b>   | 010203                     | THz 25,40                        |
| 03.6147-1301.4 | <b>03.2123-6802.3</b>   | 010186                     | THz 23,81                        |
| 03.6147-1703.4 | <b>03.2125-1302.3</b>   | 010203                     | THz 25,40                        |
| 03.6147-2402.4 | <b>03.2123-8611.3</b>   | 010195                     | THz 23,81                        |
| 03.6152-0206.4 | <b>03.2123-3402.3</b><br><b>03.3508-8753.3</b><br><b>03.6850-0202.4</b> | 010181<br>310049<br>300043 | THz 23,81<br>Behälter + WE<br>9" |
| 03.6152-0209.4 | <b>03.2023-0166.3</b><br><b>03.6850-0202.4</b>                          | 010015<br>300043           | THz 23,81/19,05<br>9"            |
| 03.6152-0210.4 | <b>03.2023-0166.3</b><br><b>03.6850-0202.4</b>                          | 010015<br>300043           | THz 23,81/19,05<br>9"            |
| 03.6152-0401.4 | <b>03.2122-6202.3</b>   | 010148                     | THz 22,20                        |
| 03.6152-0601.4 | <b>03.3508-8302.3</b>   | 310046                     | Behälter                         |
| 03.6152-0701.4 | <b>03.2123-6802.3</b>   | 010186                     | THz 23,81                        |
| 03.6152-0702.4 | <b>03.2122-6202.3</b>   | 010148                     | THz 22,20                        |
| 03.6152-0703.4 | <b>03.2122-6202.3</b>   | 010148                     | THz 22,20                        |
| 03.6152-0803.4 | <b>03.2123-6207.3</b><br><b>03.3508-7504.3</b>                          | 010185<br>310045           | THz 23,81<br>Behälter            |
| 03.6152-1002.4 | <b>03.2123-3302.3</b>   | 010180                     | THz 23,81                        |
| 03.6152-1101.4 | <b>03.3508-8302.3</b>   | 310046                     | Behälter                         |
| 03.6152-1401.4 | <b>03.2123-6802.3</b>   | 010186                     | THz 23,81                        |
| 03.6152-1502.4 | <b>03.2123-3302.3</b>   | 010180                     | THz 23,81                        |
| 03.6152-1701.4 | <b>03.2123-6207.3</b><br><b>03.3508-7504.3</b>                          | 010185<br>310045           | THz 23,81<br>Behälter            |
| 03.6152-1801.4 | <b>03.2122-0142.3</b><br><b>03.3558-0676.3</b>                          | 010128<br>310077           | THz 22,20<br>Behälter + WE       |

# Bremsgeräte komplett

**Booster units complete - Servofreni completi -  
Servo-freins complets - Servofreno completo**

● Die Nr. befindet sich auf dem im Fahrzeug eingebautem Aggregat.  
the number is on the unit build in the car  
il numero si trova sull'aggregato montato nella macchina  
le numéro se trouve sur la pièce montée dans le véhicule  
el n° se encuentra en el equipo montado en el vehículo



|                |   |                            |   |
|----------------|---|----------------------------|---|
| 03.6152-2001.4 | <b>03.2123-6207.3</b><br><b>03.3508-7504.3</b>                          | 010185<br>310045           | THz 23,81<br>Behälter                   |
| 03.6152-2002.4 | <b>03.3508-7504.3</b>   | 310045                     | Behälter                                |
| 03.6152-2003.4 | <b>03.2123-4911.3</b>   | 010182                     | THz 23,81                               |
| 03.6152-2101.4 | <b>03.3508-8302.3</b>   | 310046                     | Behälter                                |
| 03.6157-0201.4 | <b>03.3508-8302.3</b>   | 310046                     | Behälter                                |
| 03.6157-0301.4 | <b>03.2123-1003.3</b><br><b>03.3508-8753.3</b><br><b>03.6855-1202.4</b> | 010175<br>310049<br>300056 | THz 23,81<br>Behälter + WE<br>9" Tandem |
| 03.6157-0302.4 | <b>03.2123-1003.3</b><br><b>03.3508-8753.3</b><br><b>03.6855-1202.4</b> | 010175<br>310049<br>300056 | THz 23,81<br>Behälter + WE<br>9" Tandem |
| 03.6157-0303.4 | <b>03.2123-1003.3</b><br><b>03.3508-8753.3</b><br><b>03.6855-1202.4</b> | 010175<br>310049<br>300056 | THz 23,81<br>Behälter + WE<br>9" Tandem |
| 03.6157-0304.4 | <b>03.2123-3402.3</b><br><b>03.3508-8753.3</b><br><b>03.6855-1202.4</b> | 010181<br>310049<br>300056 | THz 23,81<br>Behälter + WE<br>9" Tandem |
| 03.6157-0305.4 | <b>03.2123-1003.3</b><br><b>03.3508-8753.3</b><br><b>03.6855-1202.4</b> | 010175<br>310049<br>300056 | THz 23,81<br>Behälter + WE<br>9" Tandem |
| 03.6157-0306.4 | <b>03.2123-3402.3</b><br><b>03.3508-8753.3</b><br><b>03.6855-1202.4</b> | 010181<br>310049<br>300056 | THz 23,81<br>Behälter + WE<br>9" Tandem |
| 03.6157-0307.4 | <b>03.2023-0112.3</b><br><b>03.6855-1202.4</b>                          | 010013<br>300056           | THz 23,81/19,05<br>9" Tandem            |
| 03.6157-0308.4 | <b>03.2023-0166.3</b><br><b>03.6855-1202.4</b>                          | 010015<br>300056           | THz 23,81/19,05<br>9" Tandem            |
| 03.6157-0309.4 | <b>03.2023-0112.3</b><br><b>03.6855-1202.4</b>                          | 010013<br>300056           | THz 23,81/19,05<br>9" Tandem            |
| 03.6157-0310.4 | <b>03.2023-0166.3</b><br><b>03.6855-1202.4</b>                          | 010015<br>300056           | THz 23,81/19,05<br>9" Tandem            |
| 03.6157-0501.4 | <b>03.2123-7002.3</b>   | 010187                     | THz 23,81                               |
| 03.6157-0503.4 | <b>03.2123-7002.3</b>   | 010187                     | THz 23,81                               |
| 03.6197-1501.4 | <b>03.3508-8302.3</b>   | 310046                     | Behälter                                |
| 03.6197-2101.4 | <b>03.3508-8302.3</b>   | 310046                     | Behälter                                |
| 03.6197-2201.4 | <b>03.3508-8302.3</b>   | 310046                     | Behälter                                |
| 03.6197-2202.4 | <b>03.3508-8302.3</b>   | 310046                     | Behälter                                |
| 03.6197-2203.4 | <b>03.3508-8302.3</b>   | 310046                     | Behälter                                |

|                |                       |        |           |
|----------------|-----------------------|--------|-----------|
| 03.6197-2204.4 | <b>03.3508-8302.3</b> | 310046 | Behälter  |
| 03.6197-2801.4 | <b>03.3508-8302.3</b> | 310046 | Behälter  |
| 03.6197-3301.4 | <b>03.3508-8302.3</b> | 310046 | Behälter  |
| 03.6197-3302.4 | <b>03.3508-8302.3</b> | 310046 | Behälter  |
| 03.6732-0101.4 | <b>03.2120-2031.3</b> | 010106 | THz 20,64 |
| 03.6732-0201.4 | <b>03.2120-2031.3</b> | 010106 | THz 20,64 |
| 03.6732-0203.4 | <b>03.2120-2031.3</b> | 010106 | THz 20,64 |
| 03.6732-0401.4 | <b>03.2120-2031.3</b> | 010106 | THz 20,64 |
| 03.6732-0503.4 | <b>03.2120-2598.3</b> | 010116 | THz 20,64 |
| 03.6732-0504.4 | <b>03.2120-2598.3</b> | 010116 | THz 20,64 |
| 03.6732-0601.4 | <b>03.2120-2031.3</b> | 010106 | THz 20,64 |
| 03.6732-0901.4 | <b>03.2119-3389.3</b> | 010057 | THz 19,05 |
| 03.6732-1001.4 | <b>03.2119-3389.3</b> | 010057 | THz 19,05 |
| 03.6732-1101.4 | <b>03.2119-3389.3</b> | 010057 | THz 19,05 |
| 03.6732-1103.4 | <b>03.2119-3389.3</b> | 010057 | THz 19,05 |
| 03.6732-1201.4 | <b>03.2119-3389.3</b> | 010057 | THz 19,05 |
| 03.6732-3301.4 | <b>03.2119-3389.3</b> | 010057 | THz 19,05 |
| 03.6732-3501.4 | <b>03.2119-3389.3</b> | 010057 | THz 19,05 |
| 03.6742-0101.4 | <b>03.2120-2598.3</b> | 010116 | THz 20,64 |
| 03.6742-0102.4 | <b>03.2120-2598.3</b> | 010116 | THz 20,64 |
| 03.6742-0103.4 | <b>03.2120-2598.3</b> | 010116 | THz 20,64 |
| 03.6742-0104.4 | <b>03.2120-2598.3</b> | 010116 | THz 20,64 |
| 03.6742-0105.4 | <b>03.2120-2598.3</b> | 010116 | THz 20,64 |
| 03.6742-0106.4 | <b>03.2120-2598.3</b> | 010116 | THz 20,64 |
| 03.6742-0107.4 | <b>03.2120-2598.3</b> | 010116 | THz 20,64 |
| 03.6742-0108.4 | <b>03.2120-2598.3</b> | 010116 | THz 20,64 |
| 03.6742-0109.4 | <b>03.2120-2598.3</b> | 010116 | THz 20,64 |
| 03.6742-0110.4 | <b>03.2120-2598.3</b> | 010116 | THz 20,64 |
| 03.6742-0111.4 | <b>03.2120-2598.3</b> | 010116 | THz 20,64 |
| 03.6742-0112.4 | <b>03.2120-2598.3</b> | 010116 | THz 20,64 |
| 03.6742-0113.4 | <b>03.2120-2598.3</b> | 010116 | THz 20,64 |



# Bremsgeräte komplett

## Booster units complete - Servofreni completi - Servo-freins complets - Servofreno completo

● Die Nr. befindet sich auf dem im Fahrzeug eingebautem Aggregat.  
the number is on the unit build in the car  
il numero si trova sull'aggregato montato nella macchina  
le numéro se trouve sur la pièce montée dans le véhicule  
el n° se encuentra en el equipo montado en el vehículo



|                |                       |        |           |
|----------------|-----------------------|--------|-----------|
| 03.6742-0114.4 | <b>03.2120-2598.3</b> | 010116 | THz 20,64 |
| 03.6742-0115.4 | <b>03.2120-2598.3</b> | 010116 | THz 20,64 |
| 03.6742-0116.4 | <b>03.2120-2598.3</b> | 010116 | THz 20,64 |
| 03.6742-0117.4 | <b>03.2120-2598.3</b> | 010116 | THz 20,64 |
| 03.6742-0118.4 | <b>03.2120-2598.3</b> | 010116 | THz 20,64 |
| 03.6742-0119.4 | <b>03.2120-2597.3</b> | 010115 | THz 20,64 |
| 03.6742-0120.4 | <b>03.2120-2597.3</b> | 010115 | THz 20,64 |
| 03.6742-0121.4 | <b>03.2120-2597.3</b> | 010115 | THz 20,64 |
| 03.6742-0122.4 | <b>03.2120-2597.3</b> | 010115 | THz 20,64 |
| 03.6742-0123.4 | <b>03.2120-2597.3</b> | 010115 | THz 20,64 |
| 03.6742-0124.4 | <b>03.2120-2597.3</b> | 010115 | THz 20,64 |
| 03.6742-0201.4 | <b>03.2123-4911.3</b> | 010182 | THz 23,81 |
| 03.6742-0202.4 | <b>03.2120-0538.3</b> | 010077 | THz 20,64 |
| 03.6742-0203.4 | <b>03.2120-2598.3</b> | 010116 | THz 20,64 |
| 03.6742-0204.4 | <b>03.2120-2598.3</b> | 010116 | THz 20,64 |
| 03.6742-0301.4 | <b>03.2120-2598.3</b> | 010116 | THz 20,64 |
| 03.6742-0302.4 | <b>03.2120-2598.3</b> | 010116 | THz 20,64 |
| 03.6742-0401.4 | <b>03.2120-2598.3</b> | 010116 | THz 20,64 |
| 03.6742-0402.4 | <b>03.2120-2598.3</b> | 010116 | THz 20,64 |
| 03.6742-0404.4 | <b>03.2120-2598.3</b> | 010116 | THz 20,64 |
| 03.6742-0406.4 | <b>03.2120-2598.3</b> | 010116 | THz 20,64 |
| 03.6742-0407.4 | <b>03.2120-2598.3</b> | 010116 | THz 20,64 |
| 03.6742-0409.4 | <b>03.2120-2597.3</b> | 010115 | THz 20,64 |
| 03.6742-0410.4 | <b>03.2120-2597.3</b> | 010115 | THz 20,64 |
| 03.6742-0411.4 | <b>03.2120-2597.3</b> | 010115 | THz 20,64 |
| 03.6742-0412.4 | <b>03.2120-2597.3</b> | 010115 | THz 20,64 |
| 03.6742-0413.4 | <b>03.2120-2597.3</b> | 010115 | THz 20,64 |
| 03.6742-0414.4 | <b>03.2120-2597.3</b> | 010115 | THz 20,64 |
| 03.6742-0415.4 | <b>03.2120-2597.3</b> | 010115 | THz 20,64 |
| 03.6742-0416.4 | <b>03.2120-2597.3</b> | 010115 | THz 20,64 |
| 03.6742-0419.4 | <b>03.2120-2597.3</b> | 010115 | THz 20,64 |

|                |  |                  |                            |
|----------------|--|------------------|----------------------------|
| 03.6742-0420.4 | <b>03.2120-2597.3</b>                          | 010115           | THz 20,64                  |
| 03.6742-0421.4 | <b>03.2120-2597.3</b>                          | 010115           | THz 20,64                  |
| 03.6742-0422.4 | <b>03.2120-2597.3</b>                          | 010115           | THz 20,64                  |
| 03.6742-0423.4 | <b>03.2120-2597.3</b>                          | 010115           | THz 20,64                  |
| 03.6742-0601.4 | <b>03.2122-0142.3</b><br><b>03.3558-0676.3</b> | 010128<br>310077 | THz 22,20<br>Behälter + WE |
| 03.6742-0701.4 | <b>03.2119-3389.3</b>                          | 010057           | THz 19,05                  |
| 03.6742-1201.4 | <b>03.2119-3389.3</b>                          | 010057           | THz 19,05                  |
| 03.6742-1501.4 | <b>03.2120-2031.3</b>                          | 010106           | THz 20,64                  |
| 03.6742-1701.4 | <b>03.2120-2031.3</b>                          | 010106           | THz 20,64                  |
| 03.6742-1801.4 | <b>03.2119-3391.3</b>                          | 010058           | THz 19,05                  |
| 03.6742-2001.4 | <b>03.2120-1897.3</b>                          | 010103           | THz 20,64                  |
| 03.6752-0201.4 | <b>03.2120-2031.3</b><br><b>03.6750-0202.4</b> | 010106<br>300033 | THz 20,64<br>9"            |
| 03.6752-0302.4 | <b>03.2120-2031.3</b>                          | 010106           | THz 20,64                  |
| 03.6752-0305.4 | <b>03.2120-2331.3</b>                          | 010110           | THz 20,64                  |
| 03.6752-0306.4 | <b>03.2120-2031.3</b>                          | 010106           | THz 20,64                  |
| 03.6752-0501.4 | <b>03.2120-2598.3</b>                          | 010116           | THz 20,64                  |
| 03.6752-0502.4 | <b>03.2120-2598.3</b>                          | 010116           | THz 20,64                  |
| 03.6752-0505.4 | <b>03.2120-2597.3</b>                          | 010115           | THz 20,64                  |
| 03.6752-0506.4 | <b>03.2120-2597.3</b>                          | 010115           | THz 20,64                  |
| 03.6752-0507.4 | <b>03.2120-2597.3</b>                          | 010115           | THz 20,64                  |
| 03.6752-0508.4 | <b>03.2120-2597.3</b>                          | 010115           | THz 20,64                  |
| 03.6752-0701.4 | <b>03.2120-2482.3</b>                          | 010114           | THz 20,64                  |
| 03.6752-0801.4 | <b>03.2122-9812.3</b>                          | 010161           | THz 22,20                  |
| 03.6752-0902.4 | <b>03.2120-2331.3</b><br><b>03.7750-0302.4</b> | 010110<br>300071 | THz 20,64<br>9"            |
| 03.6752-0903.4 | <b>03.2120-2191.3</b><br><b>03.7750-0302.4</b> | 010108<br>300071 | THz 20,64<br>9"            |
| 03.6752-1002.4 | <b>03.2120-2682.3</b><br><b>03.6750-3502.4</b> | 010118<br>300162 | THz 20,64<br>9"            |
| 03.6752-1101.4 | <b>03.2120-2331.3</b>                          | 010110           | THz 20,64                  |
| 03.6752-1102.4 | <b>03.2122-9612.3</b>                          | 010159           | THz 22,20                  |

# Bremsgeräte komplett

**Booster units complete - Servofreni completi -  
Servo-freins complets - Servofreno completo**

● Die Nr. befindet sich auf dem im Fahrzeug eingebautem Aggregat.  
the number is on the unit build in the car  
il numero si trova sull'aggregato montato nella macchina  
le numéro se trouve sur la pièce montée dans le véhicule  
el n° se encuentra en el equipo montado en el vehículo



|                |  |                  |                              |
|----------------|--|------------------|------------------------------|
| 03.6752-1201.4 | <b>03.2120-2331.3</b>                          | 010110           | THz 20,64                    |
| 03.6752-1301.4 | <b>03.2126-0512.3</b>                          | 010217           | THz 26,99                    |
| 03.6752-1401.4 | <b>03.2120-2331.3</b>                          | 010110           | THz 20,64                    |
| 03.6752-1501.4 | <b>03.2120-2482.3</b>                          | 010114           | THz 20,64                    |
| 03.6752-1607.4 | <b>03.2120-2597.3</b>                          | 010115           | THz 20,64                    |
| 03.6752-1608.4 | <b>03.2120-2597.3</b>                          | 010115           | THz 20,64                    |
| 03.6752-1609.4 | <b>03.2120-2597.3</b>                          | 010115           | THz 20,64                    |
| 03.6752-1610.4 | <b>03.2120-2597.3</b>                          | 010115           | THz 20,64                    |
| 03.6752-1611.4 | <b>03.2120-2597.3</b>                          | 010115           | THz 20,64                    |
| 03.6752-1703.4 | <b>03.2120-2597.3</b>                          | 010115           | THz 20,64                    |
| 03.6752-1704.4 | <b>03.2120-2597.3</b>                          | 010115           | THz 20,64                    |
| 03.6752-1901.4 | <b>03.2120-2031.3</b>                          | 010106           | THz 20,64                    |
| 03.6752-2101.4 | <b>03.2120-2682.3</b>                          | 010118           | THz 20,64                    |
| 03.6752-2502.4 | <b>03.2122-9631.3</b>                          | 010160           | THz 22,20                    |
| 03.6752-2601.4 | <b>03.2122-9631.3</b>                          | 010160           | THz 22,20                    |
| 03.6752-2901.4 | <b>03.6750-2902.4</b>                          | 300037           | 9"                           |
| 03.6752-2902.4 | <b>03.2122-9631.3</b><br><b>03.6750-2902.4</b> | 010160<br>300037 | THz 22,20<br>9"              |
| 03.6752-2903.4 | <b>03.2120-2682.3</b><br><b>03.6750-2902.4</b> | 010118<br>300037 | THz 20,64<br>9"              |
| 03.6752-3103.4 | <b>03.2120-2682.3</b>                          | 010118           | THz 20,64                    |
| 03.6752-3201.4 | <b>03.2120-2031.3</b>                          | 010106           | THz 20,64                    |
| 03.6752-3501.4 | <b>03.2120-2682.3</b><br><b>03.6750-3502.4</b> | 010118<br>300162 | THz 20,64<br>9"              |
| 03.6752-3601.4 | <b>03.2120-2682.3</b>                          | 010118           | THz 20,64                    |
| 03.6752-3701.4 | <b>03.2122-0626.3</b>                          | 010539           | THz 22,20                    |
| 03.6752-3702.4 | <b>03.2122-9631.3</b>                          | 010160           | THz 22,20                    |
| 03.6757-1004.4 | <b>03.2023-0166.3</b><br><b>03.6855-1202.4</b> | 010015<br>300056 | THz 23,81/19,05<br>9" Tandem |
| 03.6762-0101.4 | <b>03.2123-8311.3</b><br><b>03.7760-0902.4</b> | 010192<br>300088 | THz 23,81<br>10"             |
| 03.6762-0102.4 | <b>03.2122-6911.3</b><br><b>03.7760-0902.4</b> | 010153<br>300088 | THz 22,20<br>10"             |

|                |  |                  |                        |
|----------------|--|------------------|------------------------|
| 03.6762-0103.4 | <b>03.2122-6911.3</b><br><b>03.7760-0902.4</b> | 010153<br>300088 | THz 22,20<br>10"       |
| 03.6762-0104.4 | <b>03.7760-0902.4</b>                          | 300088           | 10"                    |
| 03.6762-0105.4 | <b>03.2020-0402.3</b><br><b>03.7760-0902.4</b> | 010001<br>300088 | THz 20,64/19,05<br>10" |
| 03.6762-0106.4 | <b>03.2123-8311.3</b><br><b>03.7760-0902.4</b> | 010192<br>300088 | THz 23,81<br>10"       |
| 03.6762-0107.4 | <b>03.7760-0902.4</b>                          | 300088           | 10"                    |
| 03.6762-0108.4 | <b>03.2120-2082.3</b><br><b>03.7760-0902.4</b> | 010107<br>300088 | THz 20,64<br>10"       |
| 03.6762-0110.4 | <b>03.2120-1802.3</b><br><b>03.7760-0902.4</b> | 010099<br>300088 | THz 20,64<br>10"       |
| 03.6762-0111.4 | <b>03.2020-0402.3</b><br><b>03.7760-0902.4</b> | 010001<br>300088 | THz 20,64/19,05<br>10" |
| 03.6762-0112.4 | <b>03.2120-1802.3</b><br><b>03.7760-0902.4</b> | 010099<br>300088 | THz 20,64<br>10"       |
| 03.6762-0114.4 | <b>03.2020-0402.3</b><br><b>03.7760-0902.4</b> | 010001<br>300088 | THz 20,64/19,05<br>10" |
| 03.6762-0115.4 | <b>03.2120-2082.3</b><br><b>03.7760-0902.4</b> | 010107<br>300088 | THz 20,64<br>10"       |
| 03.6762-0116.4 | <b>03.2123-8311.3</b><br><b>03.7760-0902.4</b> | 010192<br>300088 | THz 23,81<br>10"       |
| 03.6762-0117.4 | <b>03.7760-0902.4</b>                          | 300088           | 10"                    |
| 03.6762-0118.4 | <b>03.2123-8311.3</b><br><b>03.7760-0902.4</b> | 010192<br>300088 | THz 23,81<br>10"       |
| 03.6762-0312.4 | <b>03.7760-2702.4</b>                          | 300090           | 10"                    |
| 03.6762-0401.4 | <b>03.2023-0825.3</b><br><b>03.7760-2702.4</b> | 010028<br>300090 | THz 23,81/19,05<br>10" |
| 03.6762-0402.4 | <b>03.2023-0825.3</b><br><b>03.7760-2702.4</b> | 010028<br>300090 | THz 23,81/19,05<br>10" |
| 03.6762-0501.4 | <b>03.2022-0702.3</b>                          | 010007           | THz 22,20/19,05        |
| 03.6762-0502.4 | <b>03.2022-0702.3</b>                          | 010007           | THz 22,20/19,05        |
| 03.6762-0503.4 | <b>03.2022-0702.3</b>                          | 010007           | THz 22,20/19,05        |
| 03.6762-0504.4 | <b>03.2022-1402.3</b>                          | 010010           | THz 22,20/19,05        |
| 03.6762-0505.4 | <b>03.2022-1402.3</b>                          | 010010           | THz 22,20/19,05        |
| 03.6762-0508.4 | <b>03.2022-1602.3</b>                          | 010011           | THz 22,20/19,05        |
| 03.6762-0509.4 | <b>03.2022-1602.3</b>                          | 010011           | THz 22,20/19,05        |



# Bremsgeräte komplett

**Booster units complete - Servofreni completi -  
Servo-freins complets - Servofreno completo**

● Die Nr. befindet sich auf dem im Fahrzeug eingebautem Aggregat.  
the number is on the unit build in the car  
il numero si trova sull'aggregato montato nella macchina  
le numéro se trouve sur la pièce montée dans le véhicule  
el n° se encuentra en el equipo montado en el vehículo



|                |  |                  |                        |                |   |                            |                                  |
|----------------|--|------------------|------------------------|----------------|---|----------------------------|----------------------------------|
| 03.6762-0519.4 | <b>03.2022-1402.3</b>                          | 010010           | THz 22,20/19,05        | 03.6842-1605.4 | <b>03.2120-2598.3</b>   | 010116                     | THz 20,64                        |
| 03.6762-0520.4 | <b>03.2022-1602.3</b>                          | 010011           | THz 22,20/19,05        | 03.6842-1606.4 | <b>03.2120-2598.3</b>   | 010116                     | THz 20,64                        |
| 03.6762-0522.4 | <b>03.2022-0702.3</b>                          | 010007           | THz 22,20/19,05        | 03.6842-1607.4 | <b>03.2120-2598.3</b>   | 010116                     | THz 20,64                        |
| 03.6762-0523.4 | <b>03.2022-1402.3</b>                          | 010010           | THz 22,20/19,05        | 03.6842-1608.4 | <b>03.2120-2598.3</b>   | 010116                     | THz 20,64                        |
| 03.6762-0525.4 | <b>03.2022-1602.3</b>                          | 010011           | THz 22,20/19,05        | 03.6842-1609.4 | <b>03.2120-2598.3</b>   | 010116                     | THz 20,64                        |
| 03.6762-0601.4 | <b>03.2020-0402.3</b><br><b>03.7760-0902.4</b> | 010001<br>300088 | THz 20,64/19,05<br>10" | 03.6842-1610.4 | <b>03.2120-2598.3</b>   | 010116                     | THz 20,64                        |
| 03.6762-0602.4 | <b>03.2120-1802.3</b><br><b>03.7760-0902.4</b> | 010099<br>300088 | THz 20,64<br>10"       | 03.6842-1611.4 | <b>03.2120-2598.3</b>   | 010116                     | THz 20,64                        |
| 03.6832-0101.4 | <b>03.2120-3412.3</b>                          | 010121           | THz 20,64              | 03.6842-1612.4 | <b>03.2120-2598.3</b>   | 010116                     | THz 20,64                        |
| 03.6832-0104.4 | <b>03.6058-0501.3</b>                          | 320074           | BR 25/5 (4)            | 03.6842-1613.4 | <b>03.2120-2598.3</b>   | 010116                     | THz 20,64                        |
| 03.6832-0201.4 | <b>03.2120-1531.3</b>                          | 010092           | THz 20,64              | 03.6842-1614.4 | <b>03.2120-2598.3</b>   | 010116                     | THz 20,64                        |
| 03.6832-0202.4 | <b>03.2120-1531.3</b>                          | 010092           | THz 20,64              | 03.6842-3401.4 | <b>03.2123-0162.3</b>   | 010162                     | THz 23,81 + WE                   |
| 03.6832-0601.4 | <b>03.2120-0322.3</b>                          | 010074           | THz 20,64 + WE         | 03.6852-0201.4 | <b>03.2123-1003.3</b><br><b>03.3508-8753.3</b><br><b>03.6850-0202.4</b> | 010175<br>310049<br>300043 | THz 23,81<br>Behälter + WE<br>9" |
| 03.6832-0701.4 | <b>03.2120-2462.3</b>                          | 010113           | THz 20,64 + WE         | 03.6852-0202.4 | <b>03.2123-3402.3</b><br><b>03.3508-8753.3</b><br><b>03.6850-0202.4</b> | 010181<br>310049<br>300043 | THz 23,81<br>Behälter + WE<br>9" |
| 03.6832-1001.4 | <b>03.2120-2462.3</b>                          | 010113           | THz 20,64 + WE         | 03.6852-0203.4 | <b>03.2123-1003.3</b><br><b>03.3508-8753.3</b><br><b>03.6850-0202.4</b> | 010175<br>310049<br>300043 | THz 23,81<br>Behälter + WE<br>9" |
| 03.6832-1102.4 | <b>03.2120-0148.3</b>                          | 010070           | THz 20,64 + Behälter   | 03.6852-0204.4 | <b>03.2023-0112.3</b><br><b>03.6850-0202.4</b>                          | 010013<br>300043           | THz 23,81/19,05<br>9"            |
| 03.6832-1301.4 | <b>03.2120-0151.3</b>                          | 010071           | THz 20,64              | 03.6852-0205.4 | <b>03.2023-0166.3</b><br><b>03.6850-0202.4</b>                          | 010015<br>300043           | THz 23,81/19,05<br>9"            |
| 03.6832-1505.4 | <b>03.2120-1531.3</b>                          | 010092           | THz 20,64              | 03.6852-0207.4 | <b>03.2023-0166.3</b><br><b>03.6850-0202.4</b>                          | 010015<br>300043           | THz 23,81/19,05<br>9"            |
| 03.6832-1704.4 | <b>03.2120-1531.3</b>                          | 010092           | THz 20,64              | 03.6852-0210.4 | <b>03.2023-0166.3</b><br><b>03.6850-0202.4</b>                          | 010015<br>300043           | THz 23,81/19,05<br>9"            |
| 03.6832-1705.4 | <b>03.2120-1531.3</b>                          | 010092           | THz 20,64              | 03.6852-0211.4 | <b>03.2023-0166.3</b><br><b>03.6850-0202.4</b>                          | 010015<br>300043           | THz 23,81/19,05<br>9"            |
| 03.6832-1706.4 | <b>03.2120-1531.3</b>                          | 010092           | THz 20,64              | 03.6852-0501.4 | <b>03.2123-2604.3</b><br><b>03.6850-0502.4</b>                          | 010178<br>300044           | THz 23,81 + WE<br>9"             |
| 03.6842-0301.4 | <b>03.2120-0622.3</b>                          | 010079           | THz 20,64              | 03.6852-0503.4 | <b>03.2123-2604.3</b><br><b>03.6850-0502.4</b>                          | 010178<br>300044           | THz 23,81 + WE<br>9"             |
| 03.6842-0601.4 | <b>03.2120-0538.3</b>                          | 010077           | THz 20,64              | 03.6852-1001.4 | <b>03.2123-5212.3</b><br><b>03.6850-5402.4</b>                          | 010183<br>300055           | THz 23,81<br>9"                  |
| 03.6842-0701.4 | <b>03.2120-0538.3</b>                          | 010077           | THz 20,64              | 03.6852-1002.4 | <b>03.2123-5212.3</b><br><b>03.6850-5402.4</b>                          | 010183<br>300055           | THz 23,81<br>9"                  |
| 03.6842-0702.4 | <b>03.2120-0538.3</b>                          | 010077           | THz 20,64              |                |   |                            |                                  |
| 03.6842-0703.4 | <b>03.2123-4911.3</b>                          | 010182           | THz 23,81              |                |   |                            |                                  |
| 03.6842-0704.4 | <b>03.2120-0538.3</b>                          | 010077           | THz 20,64              |                |   |                            |                                  |
| 03.6842-1001.4 | <b>03.2123-0162.3</b>                          | 010162           | THz 23,81 + WE         |                |   |                            |                                  |
| 03.6842-1002.4 | <b>03.2120-2462.3</b>                          | 010113           | THz 20,64 + WE         |                |   |                            |                                  |
| 03.6842-1003.4 | <b>03.2123-0162.3</b>                          | 010162           | THz 23,81 + WE         |                |   |                            |                                  |
| 03.6842-1401.4 | <b>03.2120-0151.3</b>                          | 010071           | THz 20,64              |                |   |                            |                                  |

# Bremsgeräte komplett

**Booster units complete - Servofreni completi -  
Servo-freins complets - Servofreno completo**

● Die Nr. befindet sich auf dem im Fahrzeug eingebautem Aggregat.  
the number is on the unit build in the car  
il numero si trova sull'aggregato montato nella macchina  
le numéro se trouve sur la pièce montée dans le véhicule  
el n° se encuentra en el equipo montado en el vehículo



|                |  |                  |                      |
|----------------|--|------------------|----------------------|
| 03.6852-1006.4 | <b>03.2123-0271.3</b><br><b>03.6850-5402.4</b> | 010164<br>300055 | THz 23,81 + WE<br>9" |
| 03.6852-1007.4 | <b>03.2123-0271.3</b><br><b>03.6850-5402.4</b> | 010164<br>300055 | THz 23,81 + WE<br>9" |
| 03.6852-1008.4 | <b>03.2123-0291.3</b><br><b>03.6850-5402.4</b> | 010165<br>300055 | THz 23,81<br>9"      |
| 03.6852-1009.4 | <b>03.2123-0291.3</b><br><b>03.6850-5402.4</b> | 010165<br>300055 | THz 23,81<br>9"      |
| 03.6852-1012.4 | <b>03.2123-0271.3</b><br><b>03.6850-5402.4</b> | 010164<br>300055 | THz 23,81 + WE<br>9" |
| 03.6852-1013.4 | <b>03.2123-0271.3</b><br><b>03.6850-5402.4</b> | 010164<br>300055 | THz 23,81 + WE<br>9" |
| 03.6852-1014.4 | <b>03.6850-5402.4</b>                          | 300055           | 9"                   |
| 03.6852-1015.4 | <b>03.6850-5402.4</b>                          | 300055           | 9"                   |
| 03.6852-1301.4 | <b>03.2123-6802.3</b>                          | 010186           | THz 23,81            |
| 03.6852-1302.4 | <b>03.2123-6802.3</b>                          | 010186           | THz 23,81            |
| 03.6852-1303.4 | <b>03.2123-6802.3</b>                          | 010186           | THz 23,81            |
| 03.6852-1304.4 | <b>03.2122-6202.3</b>                          | 010148           | THz 22,20            |
| 03.6852-1601.4 | <b>03.2123-6002.3</b><br><b>03.6850-2602.4</b> | 010184<br>300049 | THz 23,81<br>9"      |
| 03.6852-1701.4 | <b>03.2123-9002.3</b>                          | 010198           | THz 23,81 + WE       |
| 03.6852-1702.4 | <b>03.2123-9002.3</b>                          | 010198           | THz 23,81 + WE       |
| 03.6852-1902.4 | <b>03.2123-4911.3</b>                          | 010182           | THz 23,81            |
| 03.6852-1903.4 | <b>03.2123-6207.3</b>                          | 010185           | THz 23,81            |
| 03.6852-2001.4 | <b>03.2123-6002.3</b><br><b>03.6850-2602.4</b> | 010184<br>300049 | THz 23,81<br>9"      |
| 03.6852-2101.4 | <b>03.2120-0562.3</b>                          | 010078           | THz 20,64            |
| 03.6852-2201.4 | <b>03.2123-4911.3</b>                          | 010182           | THz 23,81            |
| 03.6852-2202.4 | <b>03.2123-6207.3</b>                          | 010185           | THz 23,81            |
| 03.6852-2205.4 | <b>03.2120-0538.3</b>                          | 010077           | THz 20,64            |
| 03.6852-2307.4 | <b>03.2120-1491.3</b>                          | 010089           | THz 20,64 + WE       |
| 03.6852-2401.4 | <b>03.2120-0622.3</b>                          | 010079           | THz 20,64            |
| 03.6852-2402.4 | <b>03.2120-0622.3</b>                          | 010079           | THz 20,64            |
| 03.6852-2404.4 | <b>03.2120-1362.3</b>                          | 010087           | THz 20,64            |
| 03.6852-2405.4 | <b>03.2120-0622.3</b>                          | 010079           | THz 20,64            |

|                |  |                  |                              |
|----------------|--|------------------|------------------------------|
| 03.6852-3801.4 | <b>03.2120-1142.3</b>                          | 010085           | THz 20,64                    |
| 03.6852-3802.4 | <b>03.2123-9207.3</b>                          | 010199           | THz 23,81                    |
| 03.6852-4403.4 | <b>03.2122-8806.3</b>                          | 010157           | THz 22,20                    |
| 03.6852-4404.4 | <b>03.2122-8806.3</b>                          | 010157           | THz 22,20                    |
| 03.6852-4405.4 | <b>03.2122-8806.3</b>                          | 010157           | THz 22,20                    |
| 03.6852-4406.4 | <b>03.2122-8806.3</b>                          | 010157           | THz 22,20                    |
| 03.6852-4407.4 | <b>03.2122-8806.3</b>                          | 010157           | THz 22,20                    |
| 03.6852-4408.4 | <b>03.2122-8806.3</b>                          | 010157           | THz 22,20                    |
| 03.6852-4409.4 | <b>03.2122-8806.3</b>                          | 010157           | THz 22,20                    |
| 03.6852-4603.4 | <b>03.2123-7902.3</b><br><b>03.7750-5702.4</b> | 010191<br>300083 | THz 23,81 + WE<br>9"         |
| 03.6852-4604.4 | <b>03.2123-8902.3</b><br><b>03.7750-5702.4</b> | 010197<br>300083 | THz 23,81<br>9"              |
| 03.6852-4605.4 | <b>03.2023-0172.3</b><br><b>03.7750-5702.4</b> | 010016<br>300083 | THz 23,81/19,05<br>9"        |
| 03.6852-4606.4 | <b>03.2023-0172.3</b><br><b>03.7750-5702.4</b> | 010016<br>300083 | THz 23,81/19,05<br>9"        |
| 03.6852-4702.4 | <b>03.2123-7902.3</b>                          | 010191           | THz 23,81 + WE               |
| 03.6852-4703.4 | <b>03.2123-8902.3</b>                          | 010197           | THz 23,81                    |
| 03.6852-5002.4 | <b>03.2120-1491.3</b>                          | 010089           | THz 20,64 + WE               |
| 03.6852-5003.4 | <b>03.2120-1531.3</b>                          | 010092           | THz 20,64                    |
| 03.6852-5401.4 | <b>03.2123-5212.3</b><br><b>03.6850-5402.4</b> | 010183<br>300055 | THz 23,81<br>9"              |
| 03.6852-5402.4 | <b>03.2123-5212.3</b><br><b>03.6850-5402.4</b> | 010183<br>300055 | THz 23,81<br>9"              |
| 03.6852-5403.4 | <b>03.2123-5212.3</b><br><b>03.6850-5402.4</b> | 010183<br>300055 | THz 23,81<br>9"              |
| 03.6852-5404.4 | <b>03.2123-5212.3</b><br><b>03.6850-5402.4</b> | 010183<br>300055 | THz 23,81<br>9"              |
| 03.6852-5902.4 | <b>03.2122-8012.3</b>                          | 010156           | THz 22,20                    |
| 03.6852-6202.4 | <b>03.2122-8012.3</b><br><b>03.6058-0301.3</b> | 010156<br>320072 | THz 22,20<br>BR 25/5 (3)     |
| 03.6857-0101.4 | <b>03.2023-0166.3</b><br><b>03.6855-1202.4</b> | 010015<br>300056 | THz 23,81/19,05<br>9" Tandem |
| 03.6857-0102.4 | <b>03.2023-0112.3</b>                          | 010013           | THz 23,81/19,05              |

# Bremsgeräte komplett

## Booster units complete - Servofreni completi - Servo-freins complets - Servofreno completo

● Die Nr. befindet sich auf dem im Fahrzeug eingebautem Aggregat.  
the number is on the unit build in the car  
il numero si trova sull'aggregato montato nella macchina  
le numéro se trouve sur la pièce montée dans le véhicule  
el n° se encuentra en el equipo montado en el vehículo



|                |  |                  |                              |
|----------------|--|------------------|------------------------------|
| 03.6857-0104.4 | <b>03.2023-0112.3</b><br><b>03.6855-1202.4</b> | 010013<br>300056 | THz 23,81/19,05<br>9" Tandem |
| 03.6857-0105.4 | <b>03.2023-0166.3</b><br><b>03.6855-1202.4</b> | 010015<br>300056 | THz 23,81/19,05<br>9" Tandem |
| 03.6857-0108.4 | <b>03.2023-0166.3</b><br><b>03.6855-1202.4</b> | 010015<br>300056 | THz 23,81/19,05<br>9" Tandem |
| 03.6857-0303.4 | <b>03.2023-0166.3</b><br><b>03.6855-1202.4</b> | 010015<br>300056 | THz 23,81/19,05<br>9" Tandem |
| 03.6857-0304.4 | <b>03.2023-0166.3</b><br><b>03.6855-1202.4</b> | 010015<br>300056 | THz 23,81/19,05<br>9" Tandem |
| 03.6857-0501.4 | <b>03.2125-1712.3</b>                          | 010204           | THz 25,40                    |
| 03.6857-0502.4 | <b>03.2125-1712.3</b>                          | 010204           | THz 25,40                    |
| 03.6857-0503.4 | <b>03.2125-1712.3</b>                          | 010204           | THz 25,40                    |
| 03.6857-0504.4 | <b>03.2125-1712.3</b>                          | 010204           | THz 25,40                    |
| 03.6857-1001.4 | <b>03.2023-0166.3</b><br><b>03.6855-1202.4</b> | 010015<br>300056 | THz 23,81/19,05<br>9" Tandem |
| 03.6857-1002.4 | <b>03.2023-0166.3</b><br><b>03.6855-1202.4</b> | 010015<br>300056 | THz 23,81/19,05<br>9" Tandem |
| 03.6857-1003.4 | <b>03.2023-0166.3</b><br><b>03.6855-1202.4</b> | 010015<br>300056 | THz 23,81/19,05<br>9" Tandem |
| 03.6857-1106.4 | <b>03.2123-8512.3</b>                          | 010194           | THz 23,81                    |
| 03.6857-1201.4 | <b>03.2023-0166.3</b><br><b>03.6855-1202.4</b> | 010015<br>300056 | THz 23,81/19,05<br>9" Tandem |
| 03.6857-1202.4 | <b>03.2023-0166.3</b><br><b>03.6855-1202.4</b> | 010015<br>300056 | THz 23,81/19,05<br>9" Tandem |
| 03.6857-1203.4 | <b>03.2025-0111.3</b><br><b>03.6855-1202.4</b> | 010033<br>300056 | THz 25,40/19,05<br>9" Tandem |
| 03.6857-1204.4 | <b>03.2025-0111.3</b><br><b>03.6855-1202.4</b> | 010033<br>300056 | THz 25,40/19,05<br>9" Tandem |
| 03.6857-1205.4 | <b>03.2025-0111.3</b><br><b>03.6855-1202.4</b> | 010033<br>300056 | THz 25,40/19,05<br>9" Tandem |
| 03.6857-1401.4 | <b>03.2126-0512.3</b><br><b>03.6855-1402.4</b> | 010217<br>300057 | THz 26,99<br>9" Tandem       |
| 03.6857-1402.4 | <b>03.2125-1902.3</b><br><b>03.6855-1402.4</b> | 010206<br>300057 | THz 25,40<br>9" Tandem       |
| 03.6857-1403.4 | <b>03.2125-1902.3</b><br><b>03.6855-1402.4</b> | 010206<br>300057 | THz 25,40<br>9" Tandem       |
| 03.6857-1404.4 | <b>03.6855-1402.4</b>                          | 300057           | 9" Tandem                    |

|                |  |                  |                            |
|----------------|--|------------------|----------------------------|
| 03.6857-1405.4 | <b>03.6855-1402.4</b>                          | 300057           | 9" Tandem                  |
| 03.6857-1406.4 | <b>03.6855-1402.4</b>                          | 300057           | 9" Tandem                  |
| 03.6857-1407.4 | <b>03.6855-1402.4</b>                          | 300057           | 9" Tandem                  |
| 03.6857-1408.4 | <b>03.6855-1402.4</b>                          | 300057           | 9" Tandem                  |
| 03.6857-1409.4 | <b>03.6855-1402.4</b>                          | 300057           | 9" Tandem                  |
| 03.6857-1410.4 | <b>03.6855-1402.4</b>                          | 300057           | 9" Tandem                  |
| 03.6857-1411.4 | <b>03.6855-1402.4</b>                          | 300057           | 9" Tandem                  |
| 03.6857-1413.4 | <b>03.6855-1402.4</b>                          | 300057           | 9" Tandem                  |
| 03.6857-1501.4 | <b>03.2125-1712.3</b>                          | 010204           | THz 25,40                  |
| 03.6857-1502.4 | <b>03.2125-1712.3</b>                          | 010204           | THz 25,40                  |
| 03.6857-1503.4 | <b>03.2125-1712.3</b>                          | 010204           | THz 25,40                  |
| 03.6857-1504.4 | <b>03.2125-1712.3</b>                          | 010204           | THz 25,40                  |
| 03.6857-1701.4 | <b>03.2123-6002.3</b><br><b>03.3558-0676.3</b> | 010184<br>310077 | THz 23,81<br>Behälter + WE |
| 03.6857-1801.4 | <b>03.2125-3801.3</b>                          | 010215           | THz 25,40                  |
| 03.6857-1901.4 | <b>03.6855-1902.4</b>                          | 300059           | 9" Tandem                  |
| 03.6857-1902.4 | <b>03.6855-1902.4</b>                          | 300059           | 9" Tandem                  |
| 03.6857-1905.4 | <b>03.6855-1902.4</b>                          | 300059           | 9" Tandem                  |
| 03.6857-1906.4 | <b>03.2125-1902.3</b><br><b>03.6855-1902.4</b> | 010206<br>300059 | THz 25,40<br>9" Tandem     |
| 03.6857-1907.4 | <b>03.6855-1902.4</b>                          | 300059           | 9" Tandem                  |
| 03.6857-1910.4 | <b>03.6855-1902.4</b>                          | 300059           | 9" Tandem                  |
| 03.6857-1911.4 | <b>03.6855-1902.4</b>                          | 300059           | 9" Tandem                  |
| 03.6857-2101.4 | <b>03.2130-0102.3</b><br><b>03.6855-2202.4</b> | 010221<br>300061 | THz 30,00<br>9" Tandem     |
| 03.6857-2103.4 | <b>03.2123-0522.3</b><br><b>03.6855-2202.4</b> | 010168<br>300061 | THz 23,81<br>9" Tandem     |
| 03.6857-2201.4 | <b>03.2130-0102.3</b><br><b>03.6855-2202.4</b> | 010221<br>300061 | THz 30,00<br>9" Tandem     |
| 03.6857-2202.4 | <b>03.2123-0522.3</b><br><b>03.6855-2202.4</b> | 010168<br>300061 | THz 23,81<br>9" Tandem     |
| 03.6857-2203.4 | <b>03.6855-2202.4</b>                          | 300061           | 9" Tandem                  |
| 03.6857-2204.4 | <b>03.6855-2202.4</b>                          | 300061           | 9" Tandem                  |
| 03.6857-2301.4 | <b>03.2123-8512.3</b>                          | 010194           | THz 23,81                  |

# Bremsgeräte komplett

**Booster units complete - Servofreni completi -  
Servo-freins complets - Servofreno completo**

● Die Nr. befindet sich auf dem im Fahrzeug eingebautem Aggregat.  
the number is on the unit build in the car  
il numero si trova sull'aggregato montato nella macchina  
le numéro se trouve sur la pièce montée dans le véhicule  
el n° se encuentra en el equipo montado en el vehículo



|                |                       |        |                 |
|----------------|-----------------------|--------|-----------------|
| 03.6857-2401.4 | <b>03.2125-3801.3</b> | 010215 | THz 25,40       |
|                | <b>03.6855-2402.4</b> | 300094 | 9" Tandem       |
| 03.6857-2402.4 | <b>03.2125-3701.3</b> | 010627 | THz 25,40       |
|                | <b>03.6855-2402.4</b> | 300094 | 9" Tandem       |
| 03.6857-2403.4 | <b>03.2123-9207.3</b> | 010199 | THz 23,81       |
|                | <b>03.6855-2402.4</b> | 300094 | 9" Tandem       |
| 03.6862.0904.4 | <b>03.7760-0902.4</b> | 300088 | 10"             |
| 03.6862-0201.4 | <b>03.2023-0166.3</b> | 010015 | THz 23,81/19,05 |
| 03.6862-0202.4 | <b>03.2023-0166.3</b> | 010015 | THz 23,81/19,05 |
| 03.6862-0203.4 | <b>03.2023-0166.3</b> | 010015 | THz 23,81/19,05 |
| 03.6862-0204.4 | <b>03.2023-0166.3</b> | 010015 | THz 23,81/19,05 |
| 03.6862-0301.4 | <b>03.2123-9002.3</b> | 010198 | THz 23,81 + WE  |
| 03.6862-0501.4 | <b>03.2123-4911.3</b> | 010182 | THz 23,81       |
| 03.6862-0502.4 | <b>03.2123-4911.3</b> | 010182 | THz 23,81       |
| 03.6862-0505.4 | <b>03.2123-4911.3</b> | 010182 | THz 23,81       |
| 03.6862-0506.4 | <b>03.2123-6207.3</b> | 010185 | THz 23,81       |
| 03.6862-0507.4 | <b>03.2123-4911.3</b> | 010182 | THz 23,81       |
| 03.6862-0508.4 | <b>03.2123-4911.3</b> | 010182 | THz 23,81       |
| 03.6862-0801.4 | <b>03.2123-9002.3</b> | 010198 | THz 23,81 + WE  |
|                | <b>03.7760-0402.4</b> | 300087 | 10"             |
| 03.6862-0802.4 | <b>03.2023-0183.3</b> | 010017 | THz 23,81/19,05 |
|                | <b>03.7760-0402.4</b> | 300087 | 10"             |
| 03.6862-0803.4 | <b>03.7760-0402.4</b> | 300087 | 10"             |
| 03.6862-0901.4 | <b>03.2122-6911.3</b> | 010153 | THz 22,20       |
|                | <b>03.7760-0902.4</b> | 300088 | 10"             |
| 03.6862-0902.4 | <b>03.2122-6911.3</b> | 010153 | THz 22,20       |
|                | <b>03.7760-0902.4</b> | 300088 | 10"             |
| 03.6862-0903.4 | <b>03.2123-8311.3</b> | 010192 | THz 23,81       |
|                | <b>03.7760-0902.4</b> | 300088 | 10"             |
| 03.6862-1001.4 | <b>03.2123-9207.3</b> | 010199 | THz 23,81       |
| 03.6862-1101.4 | <b>03.2125-3801.3</b> | 010215 | THz 25,40       |
| 03.6862-1103.4 | <b>03.2123-9207.3</b> | 010199 | THz 23,81       |
| 03.6862-1201.4 | <b>03.2023-0262.3</b> | 010020 | THz 23,81/20,64 |
| 03.6862-1303.4 | <b>03.2125-7002.3</b> | 010628 | THz 25,40       |
| 03.6952-0201.4 | <b>03.2122-8012.3</b> | 010156 | THz 22,20       |

|                |                       |        |                 |
|----------------|-----------------------|--------|-----------------|
| 03.6952-0202.4 | <b>03.2122-8012.3</b> | 010156 | THz 22,20       |
|                | <b>03.6058-0301.3</b> | 320072 | BR 25/5 (3)     |
| 03.6952-0301.4 | <b>03.2023-0172.3</b> | 010016 | THz 23,81/19,05 |
|                | <b>03.7750-5702.4</b> | 300083 | 9"              |
| 03.6952-0302.4 | <b>03.2023-0172.3</b> | 010016 | THz 23,81/19,05 |
|                | <b>03.7750-5702.4</b> | 300083 | 9"              |
| 03.6952-0401.4 | <b>03.2122-9612.3</b> | 010159 | THz 22,20       |
|                | <b>03.7750-0302.4</b> | 300071 | 9"              |
| 03.6952-0501.4 | <b>03.2122-9612.3</b> | 010159 | THz 22,20       |
|                | <b>03.7750-0302.4</b> | 300071 | 9"              |
| 03.6952-0601.4 | <b>03.2122-9612.3</b> | 010159 | THz 22,20       |
|                | <b>03.7750-0302.4</b> | 300071 | 9"              |
| 03.6952-0701.4 | <b>03.2122-9612.3</b> | 010159 | THz 22,20       |
|                | <b>03.7750-0302.4</b> | 300071 | 9"              |
| 03.7732-0201.4 | <b>03.2120-2031.3</b> | 010106 | THz 20,64       |
| 03.7732-0401.4 | <b>03.2120-2031.3</b> | 010106 | THz 20,64       |
| 03.7742-0801.4 | <b>03.2120-2031.3</b> | 010106 | THz 20,64       |
|                | <b>03.7740-3002.4</b> | 300068 | 8"              |
| 03.7742-0901.4 | <b>03.2120-2031.3</b> | 010106 | THz 20,64       |
| 03.7742-1402.4 | <b>03.7740-1402.4</b> | 300133 | 8"              |
| 03.7742-1403.4 | <b>03.7740-1402.4</b> | 300133 | 8"              |
| 03.7742-1404.4 | <b>03.7740-1402.4</b> | 300133 | 8"              |
| 03.7742-1405.4 | <b>03.7740-1402.4</b> | 300133 | 8"              |
| 03.7742-2001.4 | <b>03.2120-2031.3</b> | 010106 | THz 20,64       |
| 03.7742-2101.4 | <b>03.2120-2031.3</b> | 010106 | THz 20,64       |
| 03.7742-2501.4 | <b>03.2119-3391.3</b> | 010058 | THz 19,05       |
| 03.7742-2601.4 | <b>03.2120-1897.3</b> | 010103 | THz 20,64       |
| 03.7742-3301.4 | <b>03.2120-4166.3</b> | 010452 | THz 20,64       |
|                | <b>03.7740-3302.4</b> | 300107 | 8"              |
| 03.7742-3501.4 | <b>03.2120-4166.3</b> | 010452 | THz 20,64       |
| 03.7742-3701.4 | <b>03.2120-4166.3</b> | 010452 | THz 20,64       |
| 03.7742-3901.4 | <b>03.2120-4241.3</b> | 010524 | THz 20,64       |
| 03.7742-3902.4 | <b>03.2120-4246.3</b> | 010614 | THz 20,64       |
| 03.7742-4001.4 | <b>03.2120-4221.3</b> | 010605 | THz 20,64       |
| 03.7742-4601.4 | <b>03.2120-4321.3</b> | 010525 | THz 20,64       |



# Bremsgeräte komplett

**Booster units complete - Servofreni completi -  
Servo-freins complets - Servofreno completo**

● Die Nr. befindet sich auf dem im Fahrzeug eingebautem Aggregat.  
the number is on the unit build in the car  
il numero si trova sull'aggregato montato nella macchina  
le numéro se trouve sur la pièce montée dans le véhicule  
el n° se encuentra en el equipo montado en el vehículo



|                |                       |        |                  |
|----------------|-----------------------|--------|------------------|
| 03.7742-4701.4 | <b>03.2123-2181.3</b> | 010608 | THz 23,81        |
| 03.7742-4801.4 | <b>03.2123-2181.3</b> | 010608 | THz 23,81        |
| 03.7747-0601.4 | <b>03.2123-0921.3</b> | 010174 | THz 23,81 (MKIV) |
| 03.7747-0701.4 | <b>03.2123-0921.3</b> | 010174 | THz 23,81 (MKIV) |
| 03.7747-1301.4 | <b>03.2123-0921.3</b> | 010174 | THz 23,81 (MKIV) |
| 03.7747-1401.4 | <b>03.2123-0921.3</b> | 010174 | THz 23,81 (MKIV) |
| 03.7747-1501.4 | <b>03.2123-1622.3</b> | 010470 | THz 23,81        |
|                | <b>03.7745-3003.4</b> | 300157 | 8" Tandem        |
| 03.7747-1502.4 | <b>03.7745-3003.4</b> | 300157 | 8" Tandem        |
| 03.7747-1503.4 | <b>03.7745-3003.4</b> | 300157 | 8" Tandem        |
| 03.7747-1602.4 | <b>03.2125-7502.3</b> | 010616 | THz 25,40        |
| 03.7747-1603.4 | <b>03.2125-7502.3</b> | 010616 | THz 25,40        |
| 03.7747-3901.4 | <b>03.2125-9901.3</b> | 010634 | THz 25,40        |
|                | <b>03.7745-3902.4</b> | 300129 | 8" Tandem        |
| 03.7747-6301.4 | <b>03.7745-6302.4</b> | 300261 | 8"               |
| 03.7747-6302.4 | <b>03.7745-6302.4</b> | 300261 | 8"               |
| 03.7750-2333.4 | <b>03.2122-1588.3</b> | 010733 | THz 22,20        |
|                | <b>03.7750-2332.4</b> | 300113 | 9"               |
| 03.7752-0101.4 | <b>03.2022-0602.3</b> | 010006 | THz 22,20/19,05  |
| 03.7752-0102.4 | <b>03.2022-0602.3</b> | 010006 | THz 22,20/19,05  |
| 03.7752-0104.4 | <b>03.2022-0602.3</b> | 010006 | THz 22,20/19,05  |
| 03.7752-0132.4 | <b>03.2122-1421.3</b> | 010615 | THz 22,20        |
| 03.7752-0201.4 | <b>03.2122-9612.3</b> | 010159 | THz 22,20        |
|                | <b>03.7750-0302.4</b> | 300071 | 9"               |
| 03.7752-0204.4 | <b>03.2122-9612.3</b> | 010159 | THz 22,20        |
|                | <b>03.7750-0302.4</b> | 300071 | 9"               |
| 03.7752-0232.4 | <b>03.2122-1461.3</b> | 010610 | THz 22,20        |
| 03.7752-0302.4 | <b>03.2122-9612.3</b> | 010159 | THz 22,20        |
|                | <b>03.7750-0302.4</b> | 300071 | 9"               |
| 03.7752-0341.4 | <b>03.2120-4611.3</b> | 010937 | THz 20,64        |
| 03.7752-0342.4 | <b>03.2122-2031.3</b> | 010938 | THz 22,20        |
| 03.7752-0401.4 | <b>03.2023-0562.3</b> | 010025 | THz 23,81/20,64  |
|                | <b>03.7750-0302.4</b> | 300071 | 9"               |
| 03.7752-0402.4 | <b>03.2023-0542.3</b> | 010024 | THz 23,81/20,64  |
|                | <b>03.7750-0302.4</b> | 300071 | 9"               |

|                |                       |        |                 |
|----------------|-----------------------|--------|-----------------|
| 03.7752-0404.4 | <b>03.7750-5702.4</b> | 300083 | 9"              |
| 03.7752-0405.4 | <b>03.2023-0542.3</b> | 010024 | THz 23,81/20,64 |
|                | <b>03.7750-5702.4</b> | 300083 | 9"              |
| 03.7752-0442.4 | <b>03.2122-2031.3</b> | 010938 | THz 22,20       |
| 03.7752-0443.4 | <b>03.2120-4611.3</b> | 010937 | THz 20,64       |
| 03.7752-0501.4 | <b>03.2122-9612.3</b> | 010159 | THz 22,20       |
|                | <b>03.7750-0302.4</b> | 300071 | 9"              |
| 03.7752-0532.4 | <b>03.2120-4321.3</b> | 010525 | THz 20,64       |
|                | <b>03.7750-0532.4</b> | 300110 | 9"              |
| 03.7752-0541.4 | <b>03.2120-4611.3</b> | 010937 | THz 20,64       |
| 03.7752-0707.4 | <b>03.2122-0264.3</b> | 010129 | THz 22,20       |
| 03.7752-0708.4 | <b>03.2122-0264.3</b> | 010129 | THz 22,20       |
| 03.7752-0709.4 | <b>03.2122-0264.3</b> | 010129 | THz 22,20       |
| 03.7752-0710.4 | <b>03.2122-0282.3</b> | 010130 | THz 22,20       |
| 03.7752-0713.4 | <b>03.2122-0264.3</b> | 010129 | THz 22,20       |
| 03.7752-0714.4 | <b>03.2122-0264.3</b> | 010129 | THz 22,20       |
| 03.7752-0715.4 | <b>03.2122-0264.3</b> | 010129 | THz 22,20       |
| 03.7752-0716.4 | <b>03.2122-0264.3</b> | 010129 | THz 22,20       |
| 03.7752-0717.4 | <b>03.2122-0264.3</b> | 010129 | THz 22,20       |
| 03.7752-0718.4 | <b>03.2122-0264.3</b> | 010129 | THz 22,20       |
| 03.7752-0722.4 | <b>03.2122-0264.3</b> | 010129 | THz 22,20       |
| 03.7752-0723.4 | <b>03.2123-1121.3</b> | 010176 | THz 23,81       |
| 03.7752-0808.4 | <b>03.2122-0264.3</b> | 010129 | THz 22,20       |
| 03.7752-0809.4 | <b>03.2122-0264.3</b> | 010129 | THz 22,20       |
| 03.7752-0810.4 | <b>03.2122-0282.3</b> | 010130 | THz 22,20       |
| 03.7752-0813.4 | <b>03.2122-0264.3</b> | 010129 | THz 22,20       |
| 03.7752-0814.4 | <b>03.2122-0264.3</b> | 010129 | THz 22,20       |
| 03.7752-0815.4 | <b>03.2122-0264.3</b> | 010129 | THz 22,20       |
| 03.7752-0816.4 | <b>03.2122-0264.3</b> | 010129 | THz 22,20       |
| 03.7752-0819.4 | <b>03.2122-0264.3</b> | 010129 | THz 22,20       |
| 03.7752-0820.4 | <b>03.2123-1121.3</b> | 010176 | THz 23,81       |
| 03.7752-0901.4 | <b>03.2122-1042.3</b> | 010137 | THz 22,20       |
|                | <b>03.7750-4302.4</b> | 300076 | 9"              |

# Bremsgeräte komplett

**Booster units complete - Servofreni completi -  
Servo-freins complets - Servofreno completo**

● Die Nr. befindet sich auf dem im Fahrzeug eingebautem Aggregat.  
the number is on the unit build in the car  
il numero si trova sull'aggregato montato nella macchina  
le numéro se trouve sur la pièce montée dans le véhicule  
el n° se encuentra en el equipo montado en el vehículo



|                |                       |        |           |
|----------------|-----------------------|--------|-----------|
| 03.7752-0902.4 | <b>03.2120-3943.3</b> | 010532 | THz 20,64 |
|                | <b>03.7750-4302.4</b> | 300076 | 9"        |
| 03.7752-1001.4 | <b>03.7750-7402.4</b> | 300084 | 9"        |
| 03.7752-1005.4 | <b>03.2122-0646.3</b> | 010133 | THz 22,20 |
|                | <b>03.7750-7402.4</b> | 300084 | 9"        |
| 03.7752-1006.4 | <b>03.2122-0646.3</b> | 010133 | THz 22,20 |
|                | <b>03.7750-7402.4</b> | 300084 | 9"        |
| 03.7752-1201.4 | <b>03.2122-1042.3</b> | 010137 | THz 22,20 |
|                | <b>03.7750-4902.4</b> | 300079 | 9"        |
| 03.7752-1202.4 | <b>03.2120-3943.3</b> | 010532 | THz 20,64 |
|                | <b>03.7750-4902.4</b> | 300079 | 9"        |
| 03.7752-1204.4 | <b>03.2120-3943.3</b> | 010532 | THz 20,64 |
|                | <b>03.7750-4902.4</b> | 300079 | 9"        |
| 03.7752-1331.4 | <b>03.7750-1332.4</b> | 300155 | 9"        |
| 03.7752-1332.4 | <b>03.7750-1332.4</b> | 300155 | 9"        |
| 03.7752-1631.4 | <b>03.2123-2181.3</b> | 010608 | THz 23,81 |
| 03.7752-1831.4 | <b>03.2122-1356.3</b> | 010529 | THz 22,20 |
|                | <b>03.7750-1832.4</b> | 300111 | 9"        |
| 03.7752-1832.4 | <b>03.2122-1351.3</b> | 010528 | THz 22,20 |
|                | <b>03.7750-1832.4</b> | 300111 | 9"        |
| 03.7752-1833.4 | <b>03.2122-1351.3</b> | 010528 | THz 22,20 |
|                | <b>03.7750-1832.4</b> | 300111 | 9"        |
| 03.7752-1834.4 | <b>03.2122-1356.3</b> | 010529 | THz 22,20 |
|                | <b>03.7750-1832.4</b> | 300111 | 9"        |
| 03.7752-2041.4 | <b>03.2120-4611.3</b> | 010937 | THz 20,64 |
| 03.7752-2042.4 | <b>03.2122-2031.3</b> | 010938 | THz 22,20 |
| 03.7752-2142.4 | <b>03.2122-2031.3</b> | 010938 | THz 22,20 |
| 03.7752-2231.4 | <b>03.4122-0031.3</b> | 010611 | THz 22,20 |
| 03.7752-2232.4 | <b>03.4122-0041.3</b> | 010612 | THz 22,20 |
|                | <b>03.7750-2232.4</b> | 300112 | 9"        |
| 03.7752-2402.4 | <b>03.2122-0621.3</b> | 010131 | THz 22,20 |
|                | <b>03.7750-5402.4</b> | 300080 | 9"        |
| 03.7752-2601.4 | <b>03.0101-0025.2</b> | 320014 | BRES 3/35 |
|                | <b>03.2120-3943.3</b> | 010532 | THz 20,64 |
| 03.7752-2601.4 | <b>03.7750-5502.4</b> | 300081 | 9"        |
| 03.7752-2603.4 | <b>03.2120-3943.3</b> | 010532 | THz 20,64 |
|                | <b>03.7750-5502.4</b> | 300081 | 9"        |

|                |                       |        |           |
|----------------|-----------------------|--------|-----------|
| 03.7752-2604.4 | <b>03.0101-0025.2</b> | 320014 | BRES 3/35 |
|                | <b>03.2120-3943.3</b> | 010532 | THz 20,64 |
|                | <b>03.7750-5502.4</b> | 300081 | 9"        |
| 03.7752-2607.4 | <b>03.2120-3943.3</b> | 010532 | THz 20,64 |
|                | <b>03.7750-5502.4</b> | 300081 | 9"        |
| 03.7752-2608.4 | <b>03.2120-3943.3</b> | 010532 | THz 20,64 |
|                | <b>03.7750-5502.4</b> | 300081 | 9"        |
| 03.7752-2701.4 | <b>03.2120-3943.3</b> | 010532 | THz 20,64 |
|                | <b>03.7750-5602.4</b> | 300082 | 9"        |
| 03.7752-2801.4 | <b>03.2122-0264.3</b> | 010129 | THz 22,20 |
| 03.7752-2931.4 | <b>03.2123-1626.3</b> | 010727 | THz 23,81 |
|                | <b>03.7750-2932.4</b> | 300175 | 9"        |
| 03.7752-3101.4 | <b>03.2120-3943.3</b> | 010532 | THz 20,64 |
| 03.7752-3103.4 | <b>03.2120-3943.3</b> | 010532 | THz 20,64 |
| 03.7752-3401.4 | <b>03.2122-0264.3</b> | 010129 | THz 22,20 |
| 03.7752-3402.4 | <b>03.2122-0282.3</b> | 010130 | THz 22,20 |
| 03.7752-3403.4 | <b>03.2123-1121.3</b> | 010176 | THz 23,81 |
| 03.7752-3405.4 | <b>03.2122-0282.3</b> | 010130 | THz 22,20 |
| 03.7752-3501.4 | <b>03.2122-0264.3</b> | 010129 | THz 22,20 |
| 03.7752-3502.4 | <b>03.2122-0282.3</b> | 010130 | THz 22,20 |
| 03.7752-3504.4 | <b>03.2123-1121.3</b> | 010176 | THz 23,81 |
| 03.7752-3510.4 | <b>03.2122-0282.3</b> | 010130 | THz 22,20 |
| 03.7752-3531.4 | <b>03.7750-3532.4</b> | 300149 | 9"        |
| 03.7752-3532.4 | <b>03.7750-3532.4</b> | 300149 | 9"        |
| 03.7752-3533.4 | <b>03.7750-3532.4</b> | 300149 | 9"        |
| 03.7752-3534.4 | <b>03.7750-3532.4</b> | 300149 | 9"        |
| 03.7752-4302.4 | <b>03.2122-1042.3</b> | 010137 | THz 22,20 |
|                | <b>03.7750-4302.4</b> | 300076 | 9"        |
| 03.7752-4401.4 | <b>03.2123-1121.3</b> | 010176 | THz 23,81 |
| 03.7752-4402.4 | <b>03.2123-1121.3</b> | 010176 | THz 23,81 |
| 03.7752-4501.4 | <b>03.2123-1121.3</b> | 010176 | THz 23,81 |
| 03.7752-4503.4 | <b>03.2123-1121.3</b> | 010176 | THz 23,81 |
| 03.7752-4701.4 | <b>03.2120-2031.3</b> | 010106 | THz 20,64 |
|                | <b>03.7750-4702.4</b> | 300153 | 9"        |
| 03.7752-4702.4 | <b>03.7750-4702.4</b> | 300153 | 9"        |





# Bremsgeräte komplett

## Booster units complete - Servofreni completi - Servo-freins complets - Servofreno completo

● Die Nr. befindet sich auf dem im Fahrzeug eingebautem Aggregat.  
the number is on the unit build in the car  
il numero si trova sull'aggregato montato nella macchina  
le numéro se trouve sur la pièce montée dans le véhicule  
el n° se encuentra en el equipo montado en el vehículo



|                |   |                            |                              |
|----------------|---|----------------------------|------------------------------|
| 03.7752-4703.4 | <b>03.7750-4702.4</b>   | 300153                     | 9"                           |
| 03.7752-4901.4 | <b>03.2122-1042.3</b><br><b>03.7750-4902.4</b>                          | 010137<br>300079           | THz 22,20<br>9"              |
| 03.7752-5401.4 | <b>03.7750-5402.4</b>   | 300080                     | 9"                           |
| 03.7752-5431.4 | <b>03.7750-5432.4</b>   | 300248                     | 9"                           |
| 03.7752-5432.4 | <b>03.7750-5432.4</b>   | 300248                     | 9"                           |
| 03.7752-5433.4 | <b>03.7750-5432.4</b>   | 300248                     | 9"                           |
| 03.7752-5509.4 | <b>03.7750-5502.4</b>   | 300081                     | 9"                           |
| 03.7752-5510.4 | <b>03.7750-5502.4</b>   | 300081                     | 9"                           |
| 03.7752-5511.4 | <b>03.7750-5502.4</b>   | 300081                     | 9"                           |
| 03.7752-5512.4 | <b>03.7750-5502.4</b>   | 300081                     | 9"                           |
| 03.7752-5513.4 | <b>03.7750-5502.4</b>   | 300081                     | 9"                           |
| 03.7752-5514.4 | <b>03.7750-5502.4</b>   | 300081                     | 9"                           |
| 03.7752-6001.4 | <b>03.7750-6002.4</b>   | 300134                     | 9"                           |
| 03.7752-6002.4 | <b>03.7750-6002.4</b>   | 300134                     | 9"                           |
| 03.7752-6003.4 | <b>03.7750-6002.4</b>   | 300134                     | 9"                           |
| 03.7752-6102.4 | <b>03.2122-1042.3</b>   | 010137                     | THz 22,20                    |
| 03.7752-6301.4 | <b>03.7750-6302.4</b>   | 300161                     | 9"                           |
| 03.7752-6302.4 | <b>03.7750-6302.4</b>   | 300161                     | 9"                           |
| 03.7752-6303.4 | <b>03.7750-6302.4</b>   | 300161                     | 9"                           |
| 03.7752-6304.4 | <b>03.7750-6302.4</b>   | 300161                     | 9"                           |
| 03.7752-6305.4 | <b>03.7750-6302.4</b>   | 300161                     | 9"                           |
| 03.7752-6306.4 | <b>03.7750-6302.4</b>   | 300161                     | 9"                           |
| 03.7752-6331.4 | <b>03.7750-6332.4</b>   | 300226                     | 9"                           |
| 03.7752-7332.4 | <b>03.2120-4641.3</b>   | 010932                     | THz 20,64                    |
| 03.7752-7401.4 | <b>03.2122-1042.3</b><br><b>03.7750-7402.4</b>                          | 010137<br>300084           | THz 22,20<br>9"              |
| 03.7752-8105.4 | <b>03.2122-1326.3</b><br><b>03.2122-1331.3</b><br><b>03.7750-8102.4</b> | 010617<br>010607<br>300114 | THz 22,20<br>THz 22,20<br>9" |
| 03.7752-8107.4 | <b>03.2122-1281.3</b><br><b>03.7750-8102.4</b>                          | 010606<br>300114           | THz 22,20<br>9"              |
| 03.7752-8108.4 | <b>03.2122-1331.3</b><br><b>03.7750-8102.4</b>                          | 010607<br>300114           | THz 22,20<br>9"              |

|                |  |                  |                 |
|----------------|--|------------------|-----------------|
| 03.7752-8201.4 | <b>03.2122-1281.3</b><br><b>03.7750-8202.4</b> | 010606<br>300115 | THz 22,20<br>9" |
| 03.7752-8432.4 | <b>03.2120-4611.3</b>                          | 010937           | THz 20,64       |
| 03.7752-8437.4 | <b>03.2120-4611.3</b>                          | 010937           | THz 20,64       |
| 03.7752-8533.4 | <b>03.7750-8532.4</b>                          | 300264           | 9"              |
| 03.7752-8534.4 | <b>03.2120-4611.3</b><br><b>03.7750-8532.4</b> | 010937<br>300264 | THz 20,64<br>9" |
| 03.7752-8535.4 | <b>03.2122-2031.3</b><br><b>03.7750-8532.4</b> | 010938<br>300264 | THz 22,20<br>9" |
| 03.7752-8536.4 | <b>03.2120-4611.3</b><br><b>03.7750-8532.4</b> | 010937<br>300264 | THz 20,64<br>9" |
| 03.7752-8537.4 | <b>03.2122-2031.3</b><br><b>03.7750-8532.4</b> | 010938<br>300264 | THz 22,20<br>9" |
| 03.7752-8631.4 | <b>03.2120-4611.3</b>                          | 010937           | THz 20,64       |
| 03.7752-8633.4 | <b>03.2122-2031.3</b>                          | 010938           | THz 22,20       |
| 03.7752-8731.4 | <b>03.7750-8732.4</b>                          | 300199           | 9"              |
| 03.7752-8732.4 | <b>03.7750-8732.4</b>                          | 300199           | 9"              |
| 03.7752-8733.4 | <b>03.7750-8732.4</b>                          | 300199           | 9"              |
| 03.7752-8734.4 | <b>03.7750-8732.4</b>                          | 300199           | 9"              |
| 03.7752-9201.4 | <b>03.2122-1291.3</b>                          | 010527           | THz 22,20       |
| 03.7752-9202.4 | <b>03.2122-1296.3</b>                          | 010609           | THz 22,20       |
| 03.7752-9231.4 | <b>03.2120-4611.3</b>                          | 010937           | THz 20,64       |
| 03.7752-9233.4 | <b>03.2122-2031.3</b>                          | 010938           | THz 22,20       |
| 03.7752-9301.4 | <b>03.2120-4321.3</b><br><b>03.7750-9302.4</b> | 010525<br>300116 | THz 20,64<br>9" |
| 03.7752-9302.4 | <b>03.2122-1356.3</b><br><b>03.7750-9302.4</b> | 010529<br>300116 | THz 22,20<br>9" |
| 03.7752-9303.4 | <b>03.2120-4321.3</b><br><b>03.7750-9302.4</b> | 010525<br>300116 | THz 20,64<br>9" |
| 03.7752-9304.4 | <b>03.2122-1356.3</b><br><b>03.7750-9302.4</b> | 010529<br>300116 | THz 22,20<br>9" |
| 03.7752-9305.4 | <b>03.2120-4321.3</b><br><b>03.7750-9302.4</b> | 010525<br>300116 | THz 20,64<br>9" |
| 03.7752-9306.4 | <b>03.2122-1356.3</b><br><b>03.7750-9302.4</b> | 010529<br>300116 | THz 22,20<br>9" |
| 03.7752-9307.4 | <b>03.2122-1351.3</b><br><b>03.7750-9302.4</b> | 010528<br>300116 | THz 22,20<br>9" |

# Bremsgeräte komplett

**Booster units complete - Servofreni completi -  
Servo-freins complets - Servofreno completo**

● Die Nr. befindet sich auf dem im Fahrzeug eingebautem Aggregat.  
the number is on the unit build in the car  
il numero si trova sull'aggregato montato nella macchina  
le numéro se trouve sur la pièce montée dans le véhicule  
el n° se encuentra en el equipo montado en el vehículo



|                |                       |        |                 |
|----------------|-----------------------|--------|-----------------|
| 03.7752-9308.4 | <b>03.2122-1351.3</b> | 010528 | THz 22,20       |
|                | <b>03.7750-9302.4</b> | 300116 | 9"              |
| 03.7752-9309.4 | <b>03.2122-1356.3</b> | 010529 | THz 22,20       |
|                | <b>03.7750-9302.4</b> | 300116 | 9"              |
| 03.7752-9310.4 | <b>03.2122-1351.3</b> | 010528 | THz 22,20       |
|                | <b>03.7750-9302.4</b> | 300116 | 9"              |
| 03.7752-9401.4 | <b>03.2122-1351.3</b> | 010528 | THz 22,20       |
|                | <b>03.7750-9402.4</b> | 300117 | 9"              |
| 03.7752-9402.4 | <b>03.2122-1351.3</b> | 010528 | THz 22,20       |
|                | <b>03.7750-9402.4</b> | 300117 | 9"              |
| 03.7752-9403.4 | <b>03.2122-1351.3</b> | 010528 | THz 22,20       |
|                | <b>03.7750-9402.4</b> | 300117 | 9"              |
| 03.7752-9532.4 | <b>03.2122-2031.3</b> | 010938 | THz 22,20       |
| 03.7752-9803.4 | <b>03.7750-2532.4</b> | 300225 | 9"              |
| 03.7752-9804.4 | <b>03.7750-2532.4</b> | 300225 | 9"              |
| 03.7752-9805.4 | <b>03.7750-2532.4</b> | 300225 | 9"              |
| 03.7752-9806.4 | <b>03.7750-2532.4</b> | 300225 | 9"              |
| 03.7757-0101.4 | <b>03.2023-0230.3</b> | 010019 | THz 23,81/19,05 |
| 03.7757-0102.4 | <b>03.2023-0825.3</b> | 010028 | THz 23,81/19,05 |
| 03.7757-0131.4 | <b>03.7755-0132.4</b> | 300265 | 9/8" Tandem     |
| 03.7757-0201.4 | <b>03.2025-0211.3</b> | 010034 | THz 25,40/19,05 |
| 03.7757-0203.4 | <b>03.7750-0302.4</b> | 300071 | 9"              |
| 03.7757-0204.4 | <b>03.7750-0302.4</b> | 300071 | 9"              |
| 03.7757-0314.4 | <b>03.2023-0642.3</b> | 010026 | THz 23,81/20,64 |
| 03.7757-0319.4 | <b>03.2023-0642.3</b> | 010026 | THz 23,81/20,64 |
| 03.7757-0321.4 | <b>03.2023-0642.3</b> | 010026 | THz 23,81/20,64 |
| 03.7757-0324.4 | <b>03.2023-0642.3</b> | 010026 | THz 23,81/20,64 |
| 03.7757-0631.4 | <b>03.2125-0651.3</b> | 010935 | THz 25,40       |
| 03.7757-0632.4 | <b>03.2125-0651.3</b> | 010935 | THz 25,40       |
| 03.7757-0633.4 | <b>03.2125-0651.3</b> | 010935 | THz 25,40       |
| 03.7757-0803.4 | <b>03.2123-1548.3</b> | 010478 | THz 23,81       |
|                | <b>03.7755-4202.4</b> | 300164 | 9/8" Tandem     |
| 03.7757-0805.4 | <b>03.2125-8111.3</b> | 010479 | THz 25,40       |
|                | <b>03.7755-4202.4</b> | 300164 | 9/8" Tandem     |
| 03.7757-0901.4 | <b>03.2123-1486.3</b> | 010488 | THz 23,81       |

|                |                       |        |             |
|----------------|-----------------------|--------|-------------|
| 03.7757-0902.4 | <b>03.2123-1741.3</b> | 010537 | THz 23,81   |
| 03.7757-1001.4 | <b>03.2123-1486.3</b> | 010488 | THz 23,81   |
| 03.7757-1031.4 | <b>03.2125-0651.3</b> | 010935 | THz 25,40   |
| 03.7757-1032.4 | <b>03.2125-0651.3</b> | 010935 | THz 25,40   |
| 03.7757-1033.4 | <b>03.2125-0651.3</b> | 010935 | THz 25,40   |
| 03.7757-1034.4 | <b>03.2125-0651.3</b> | 010935 | THz 25,40   |
| 03.7757-1201.4 | <b>03.7755-3402.4</b> | 300189 | 9/8" Tandem |
| 03.7757-1202.4 | <b>03.7755-3402.4</b> | 300189 | 9/8" Tandem |
| 03.7757-1203.4 | <b>03.7755-3402.4</b> | 300189 | 9/8" Tandem |
| 03.7757-1204.4 | <b>03.7755-3402.4</b> | 300189 | 9/8" Tandem |
| 03.7757-1205.4 | <b>03.7755-3402.4</b> | 300189 | 9/8" Tandem |
| 03.7757-1206.4 | <b>03.7755-3402.4</b> | 300189 | 9/8" Tandem |
| 03.7757-1207.4 | <b>03.7755-3402.4</b> | 300189 | 9/8" Tandem |
| 03.7757-1208.4 | <b>03.7755-3402.4</b> | 300189 | 9/8" Tandem |
| 03.7757-1209.4 | <b>03.7755-3402.4</b> | 300189 | 9/8" Tandem |
| 03.7757-1210.4 | <b>03.2125-7743.3</b> | 010921 | THz 25,40   |
|                | <b>03.7755-3402.4</b> | 300189 | 9/8" Tandem |
| 03.7757-1501.4 | <b>03.7755-1902.4</b> | 300138 | 9" Tandem   |
| 03.7757-1902.4 | <b>03.7755-1902.4</b> | 300138 | 9" Tandem   |
| 03.7757-1903.4 | <b>03.7755-1902.4</b> | 300138 | 9" Tandem   |
| 03.7757-2501.4 | <b>03.2123-1486.3</b> | 010488 | THz 23,81   |
| 03.7757-2601.4 | <b>03.2123-1486.3</b> | 010488 | THz 23,81   |
| 03.7757-2801.4 | <b>03.2125-0343.3</b> | 010896 | THz 25,40   |
|                | <b>03.7755-6302.4</b> | 300221 | 9/8" Tandem |
| 03.7757-2802.4 | <b>03.2125-0343.3</b> | 010896 | THz 25,40   |
|                | <b>03.7755-6302.4</b> | 300221 | 9/8" Tandem |
| 03.7757-2803.4 | <b>03.2125-0343.3</b> | 010896 | THz 25,40   |
|                | <b>03.7755-6302.4</b> | 300221 | 9/8" Tandem |
| 03.7757-2804.4 | <b>03.2125-0343.3</b> | 010896 | THz 25,40   |
|                | <b>03.7755-6302.4</b> | 300221 | 9/8" Tandem |
| 03.7757-2805.4 | <b>03.2125-0343.3</b> | 010896 | THz 25,40   |
|                | <b>03.7755-6302.4</b> | 300221 | 9/8" Tandem |
| 03.7757-2806.4 | <b>03.2125-0343.3</b> | 010896 | THz 25,40   |
|                | <b>03.7755-6302.4</b> | 300221 | 9/8" Tandem |

# Bremsgeräte komplett

## Booster units complete - Servofreni completi - Servo-freins complets - Servofreno completo

● Die Nr. befindet sich auf dem im Fahrzeug eingebautem Aggregat.  
the number is on the unit build in the car  
il numero si trova sull'aggregato montato nella macchina  
le numéro se trouve sur la pièce montée dans le véhicule  
el n° se encuentra en el equipo montado en el vehículo



|                |                       |        |             |
|----------------|-----------------------|--------|-------------|
| 03.7757-2807.4 | <b>03.2125-0343.3</b> | 010896 | THz 25,40   |
|                | <b>03.7755-6302.4</b> | 300221 | 9/8" Tandem |
| 03.7757-2808.4 | <b>03.2125-0343.3</b> | 010896 | THz 25,40   |
|                | <b>03.7755-6302.4</b> | 300221 | 9/8" Tandem |
| 03.7757-2811.4 | <b>03.2125-0343.3</b> | 010896 | THz 25,40   |
|                | <b>03.7755-6302.4</b> | 300221 | 9/8" Tandem |
| 03.7757-2812.4 | <b>03.2125-0343.3</b> | 010896 | THz 25,40   |
|                | <b>03.7755-6302.4</b> | 300221 | 9/8" Tandem |
| 03.7757-2931.4 | <b>03.2125-0651.3</b> | 010935 | THz 25,40   |
| 03.7757-3201.4 | <b>03.7755-4202.4</b> | 300164 | 9/8" Tandem |
| 03.7757-3202.4 | <b>03.7755-4202.4</b> | 300164 | 9/8" Tandem |
| 03.7757-3203.4 | <b>03.7755-4202.4</b> | 300164 | 9/8" Tandem |
| 03.7757-3204.4 | <b>03.7755-4202.4</b> | 300164 | 9/8" Tandem |
| 03.7757-3205.4 | <b>03.7755-4202.4</b> | 300164 | 9/8" Tandem |
| 03.7757-3206.4 | <b>03.7755-4202.4</b> | 300164 | 9/8" Tandem |
| 03.7757-3301.4 | <b>03.7755-4302.4</b> | 300165 | 9/8" Tandem |
| 03.7757-3401.4 | <b>03.2125-7743.3</b> | 010921 | THz 25,40   |
|                | <b>03.7755-3402.4</b> | 300189 | 9/8" Tandem |
| 03.7757-3402.4 | <b>03.7755-3402.4</b> | 300189 | 9/8" Tandem |
| 03.7757-3531.4 | <b>03.2125-0651.3</b> | 010935 | THz 25,40   |
| 03.7757-3701.4 | <b>03.2125-7743.3</b> | 010921 | THz 25,40   |
| 03.7757-4501.4 | <b>03.2125-7743.3</b> | 010921 | THz 25,40   |
| 03.7757-4701.4 | <b>03.2125-7743.3</b> | 010921 | THz 25,40   |
|                | <b>03.7755-4702.4</b> | 300224 | 9/8" Tandem |
| 03.7757-4702.4 | <b>03.2125-7637.3</b> | 010707 | THz 25,40   |
|                | <b>03.7755-4702.4</b> | 300224 | 9/8" Tandem |
| 03.7757-4703.4 | <b>03.7755-4702.4</b> | 300224 | 9/8" Tandem |
| 03.7757-4704.4 | <b>03.7755-4702.4</b> | 300224 | 9/8" Tandem |
| 03.7757-4705.4 | <b>03.7755-4702.4</b> | 300224 | 9/8" Tandem |
| 03.7757-4706.4 | <b>03.7755-4702.4</b> | 300224 | 9/8" Tandem |
| 03.7757-4707.4 | <b>03.7755-4702.4</b> | 300224 | 9/8" Tandem |
| 03.7757-4708.4 | <b>03.7755-4702.4</b> | 300224 | 9/8" Tandem |
| 03.7757-5001.4 | <b>03.2125-7743.3</b> | 010921 | THz 25,40   |
| 03.7757-7701.4 | <b>03.7755-7703.4</b> | 300247 | 9/8" Tandem |

|                |                       |        |                 |
|----------------|-----------------------|--------|-----------------|
| 03.7757-7702.4 | <b>03.2125-0651.3</b> | 010935 | THz 25,40       |
|                | <b>03.7755-7703.4</b> | 300247 | 9/8" Tandem     |
| 03.7757-8201.4 | <b>03.2126-3146.3</b> | 010936 | THz 26,99       |
| 03.7757-9001.4 | <b>03.2126-3146.3</b> | 010936 | THz 26,99       |
| 03.7757-9002.4 | <b>03.2126-3146.3</b> | 010936 | THz 26,99       |
| 03.7762-0101.4 | <b>03.2123-8311.3</b> | 010192 | THz 23,81       |
|                | <b>03.7760-0902.4</b> | 300088 | 10"             |
| 03.7762-0102.4 | <b>03.2122-6911.3</b> | 010153 | THz 22,20       |
|                | <b>03.7760-0902.4</b> | 300088 | 10"             |
| 03.7762-0103.4 | <b>03.2122-6911.3</b> | 010153 | THz 22,20       |
|                | <b>03.7760-0902.4</b> | 300088 | 10"             |
| 03.7762-0104.4 | <b>03.7760-0902.4</b> | 300088 | 10"             |
| 03.7762-0108.4 | <b>03.2120-2082.3</b> | 010107 | THz 20,64       |
|                | <b>03.7760-0902.4</b> | 300088 | 10"             |
| 03.7762-0110.4 | <b>03.2120-1802.3</b> | 010099 | THz 20,64       |
|                | <b>03.7760-0902.4</b> | 300088 | 10"             |
| 03.7762-0112.4 | <b>03.2120-1802.3</b> | 010099 | THz 20,64       |
|                | <b>03.7760-0902.4</b> | 300088 | 10"             |
| 03.7762-0114.4 | <b>03.2020-0402.3</b> | 010001 | THz 20,64/19,05 |
|                | <b>03.7760-0902.4</b> | 300088 | 10"             |
| 03.7762-0115.4 | <b>03.2120-2082.3</b> | 010107 | THz 20,64       |
|                | <b>03.7760-0902.4</b> | 300088 | 10"             |
| 03.7762-0116.4 | <b>03.2123-8311.3</b> | 010192 | THz 23,81       |
|                | <b>03.7760-0902.4</b> | 300088 | 10"             |
| 03.7762-0117.4 | <b>03.7760-0902.4</b> | 300088 | 10"             |
| 03.7762-0118.4 | <b>03.2123-8311.3</b> | 010192 | THz 23,81       |
|                | <b>03.7760-0902.4</b> | 300088 | 10"             |
| 03.7762-0119.4 | <b>03.2120-2082.3</b> | 010107 | THz 20,64       |
|                | <b>03.7760-0902.4</b> | 300088 | 10"             |
| 03.7762-0120.4 | <b>03.2120-2082.3</b> | 010107 | THz 20,64       |
|                | <b>03.7760-0902.4</b> | 300088 | 10"             |
| 03.7762-0121.4 | <b>03.2120-1802.3</b> | 010099 | THz 20,64       |
|                | <b>03.7760-0902.4</b> | 300088 | 10"             |
| 03.7762-0122.4 | <b>03.2120-1802.3</b> | 010099 | THz 20,64       |
|                | <b>03.7760-0902.4</b> | 300088 | 10"             |
| 03.7762-0123.4 | <b>03.2020-0402.3</b> | 010001 | THz 20,64/19,05 |
|                | <b>03.7760-0902.4</b> | 300088 | 10"             |
| 03.7762-0124.4 | <b>03.7760-0902.4</b> | 300088 | 10"             |

# Bremsgeräte komplett

**Booster units complete - Servofreni completi -  
Servo-freins complets - Servofreno completo**

● Die Nr. befindet sich auf dem im Fahrzeug eingebautem Aggregat.  
the number is on the unit build in the car  
il numero si trova sull'aggregato montato nella macchina  
le numéro se trouve sur la pièce montée dans le véhicule  
el n° se encuentra en el equipo montado en el vehículo



|                |  |                  |                        |                |  |                  |                        |
|----------------|--|------------------|------------------------|----------------|--|------------------|------------------------|
| 03.7762-0201.4 | <b>03.2020-0402.3</b><br><b>03.7760-0902.4</b> | 010001<br>300088 | THz 20,64/19,05<br>10" | 03.7762-0802.4 | <b>03.2022-1201.3</b><br><b>03.7760-0902.4</b> | 010009<br>300088 | THz 22,20/17,46<br>10" |
| 03.7762-0202.4 | <b>03.2120-1802.3</b><br><b>03.7760-0902.4</b> | 010099<br>300088 | THz 20,64<br>10"       | 03.7762-0901.4 | <b>03.2022-1201.3</b><br><b>03.7760-0902.4</b> | 010009<br>300088 | THz 22,20/17,46<br>10" |
| 03.7762-0204.4 | <b>03.2120-2082.3</b><br><b>03.7760-0902.4</b> | 010107<br>300088 | THz 20,64<br>10"       | 03.7762-0902.4 | <b>03.2022-1201.3</b><br><b>03.7760-0902.4</b> | 010009<br>300088 | THz 22,20/17,46<br>10" |
| 03.7762-0301.4 | <b>03.2023-0825.3</b><br><b>03.7760-2702.4</b> | 010028<br>300090 | THz 23,81/19,05<br>10" | 03.7762-1001.4 | <b>03.2125-3011.3</b>                          | 010211           | THz 25,40              |
| 03.7762-0302.4 | <b>03.2023-0825.3</b><br><b>03.7760-2702.4</b> | 010028<br>300090 | THz 23,81/19,05<br>10" | 03.7762-1002.4 | <b>03.2125-3011.3</b>                          | 010211           | THz 25,40              |
| 03.7762-0312.4 | <b>03.2023-0825.3</b><br><b>03.7760-2702.4</b> | 010028<br>300090 | THz 23,81/19,05<br>10" | 03.7762-1203.4 | <b>03.2125-3011.3</b>                          | 010211           | THz 25,40              |
| 03.7762-0313.4 | <b>03.2023-0825.3</b><br><b>03.7760-2702.4</b> | 010028<br>300090 | THz 23,81/19,05<br>10" | 03.7762-1204.4 | <b>03.2125-3011.3</b>                          | 010211           | THz 25,40              |
| 03.7762-0401.4 | <b>03.2023-0262.3</b><br><b>03.7760-0402.4</b> | 010020<br>300087 | THz 23,81/20,64<br>10" | 03.7762-1801.4 | <b>03.2125-3011.3</b>                          | 010211           | THz 25,40              |
| 03.7762-0402.4 | <b>03.7760-0402.4</b>                          | 300087           | 10"                    | 03.7762-1802.4 | <b>03.2125-3011.3</b>                          | 010211           | THz 25,40              |
| 03.7762-0501.4 | <b>03.2120-1802.3</b><br><b>03.7760-0902.4</b> | 010099<br>300088 | THz 20,64<br>10"       | 03.7762-1901.4 | <b>03.2125-3011.3</b>                          | 010211           | THz 25,40              |
| 03.7762-0502.4 | <b>03.2120-2082.3</b><br><b>03.7760-0902.4</b> | 010107<br>300088 | THz 20,64<br>10"       | 03.7762-1902.4 | <b>03.2125-3011.3</b>                          | 010211           | THz 25,40              |
| 03.7762-0503.4 | <b>03.7760-0902.4</b>                          | 300088           | 10"                    | 03.7762-2001.4 | <b>03.2125-3011.3</b>                          | 010211           | THz 25,40              |
| 03.7762-0504.4 | <b>03.2120-1802.3</b><br><b>03.7760-0902.4</b> | 010099<br>300088 | THz 20,64<br>10"       | 03.7762-2002.4 | <b>03.2125-3011.3</b>                          | 010211           | THz 25,40              |
| 03.7762-0505.4 | <b>03.2120-2082.3</b><br><b>03.7760-0902.4</b> | 010107<br>300088 | THz 20,64<br>10"       | 03.7762-2231.4 | <b>03.7760-2232.4</b>                          | 300266           | 10"                    |
| 03.7762-0506.4 | <b>03.7760-0902.4</b>                          | 300088           | 10"                    | 03.7762-2232.4 | <b>03.7760-2232.4</b>                          | 300266           | 10"                    |
| 03.7762-0701.4 | <b>03.2022-1201.3</b><br><b>03.7760-0902.4</b> | 010009<br>300088 | THz 22,20/17,46<br>10" | 03.7762-2233.4 | <b>03.7760-2232.4</b>                          | 300266           | 10"                    |
| 03.7762-0702.4 | <b>03.2022-1201.3</b><br><b>03.7760-0902.4</b> | 010009<br>300088 | THz 22,20/17,46<br>10" | 03.7762-2234.4 | <b>03.7760-2232.4</b>                          | 300266           | 10"                    |
| 03.7762-0703.4 | <b>03.2022-1201.3</b><br><b>03.7760-0902.4</b> | 010009<br>300088 | THz 22,20/17,46<br>10" | 03.7762-2331.4 | <b>03.7760-2332.4</b>                          | 300267           | 10"                    |
| 03.7762-0704.4 | <b>03.2022-1201.3</b><br><b>03.7760-0902.4</b> | 010009<br>300088 | THz 22,20/17,46<br>10" | 03.7762-2332.4 | <b>03.7760-2332.4</b>                          | 300267           | 10"                    |
| 03.7762-0705.4 | <b>03.2022-1201.3</b><br><b>03.7760-0902.4</b> | 010009<br>300088 | THz 22,20/17,46<br>10" | 03.7762-2333.4 | <b>03.7760-2332.4</b>                          | 300267           | 10"                    |
| 03.7762-0801.4 | <b>03.2022-1201.3</b><br><b>03.7760-0902.4</b> | 010009<br>300088 | THz 22,20/17,46<br>10" | 03.7762-2334.4 | <b>03.7760-2332.4</b>                          | 300267           | 10"                    |
|                |  |                  |                        | 03.7762-2701.4 | <b>03.2023-0825.3</b><br><b>03.7760-2702.4</b> | 010028<br>300090 | THz 23,81/19,05<br>10" |
|                |  |                  |                        | 03.7762-3102.4 | <b>03.7760-3102.4</b>                          | 300139           | 10"                    |
|                |  |                  |                        | 03.7762-3103.4 | <b>03.7760-3102.4</b>                          | 300139           | 10"                    |
|                |  |                  |                        | 03.7762-3109.4 | <b>03.7760-3102.4</b>                          | 300139           | 10"                    |
|                |  |                  |                        | 03.7762-3110.4 | <b>03.7760-3102.4</b>                          | 300139           | 10"                    |
|                |  |                  |                        | 03.7762-3111.4 | <b>03.7760-3102.4</b>                          | 300139           | 10"                    |
|                |  |                  |                        | 03.7762-3120.4 | <b>03.7760-3102.4</b>                          | 300139           | 10"                    |
|                |  |                  |                        | 03.7762-3121.4 | <b>03.7760-3102.4</b>                          | 300139           | 10"                    |



# Bremsgeräte komplett

## Booster units complete - Servofreni completi - Servo-freins complets - Servofreno completo

● Die Nr. befindet sich auf dem im Fahrzeug eingebautem Aggregat.  
the number is on the unit build in the car  
il numero si trova sull'aggregato montato nella macchina  
le numéro se trouve sur la pièce montée dans le véhicule  
el n° se encuentra en el equipo montado en el vehículo



|                |                       |        |                      |                |                       |        |                 |
|----------------|-----------------------|--------|----------------------|----------------|-----------------------|--------|-----------------|
| 03.7762-4101.4 | <b>03.2023-1066.3</b> | 010032 | THz 23,81/19,05      | 03.7767-0108.4 | <b>03.2026-0562.3</b> | 010729 | THz 26,99/25,40 |
|                | <b>03.7760-4102.4</b> | 300091 | 10"                  |                |                       |        |                 |
| 03.7762-4102.4 | <b>03.2023-1066.3</b> | 010032 | THz 23,81/19,05      | 03.7767-1001.4 | <b>03.2126-3014.3</b> | 010811 | THz 26,99       |
|                | <b>03.7760-4102.4</b> | 300091 | 10"                  |                | <b>03.7765-1002.4</b> | 300246 | 10/9" Tandem    |
| 03.7762-4201.4 | <b>03.7760-4202.4</b> | 300145 | 10"                  | 03.7847-0101.4 | <b>03.7845-0103.4</b> | 300268 | 8"              |
| 03.7762-4202.4 | <b>03.7760-4202.4</b> | 300145 | 10"                  | 03.7847-0102.4 | <b>03.7845-0103.4</b> | 300268 | 8"              |
| 03.7762-4203.4 | <b>03.2123-1486.3</b> | 010488 | THz 23,81            | 03.7847-0103.4 | <b>03.7845-0103.4</b> | 300268 | 8"              |
|                | <b>03.7760-4202.4</b> | 300145 | 10"                  | 03.7847-0104.4 | <b>03.7845-0103.4</b> | 300268 | 8"              |
| 03.7762-4204.4 | <b>03.7760-4202.4</b> | 300145 | 10"                  | 03.7849-9401.4 | <b>03.7848-9402.4</b> | 300227 | 7/8" Tandem     |
| 03.7762-4301.4 | <b>03.2123-1486.3</b> | 010488 | THz 23,81            | 03.7854-0101.4 | <b>03.7853-0102.4</b> | 300252 | 9"              |
| 03.7762-5101.4 | <b>03.2123-2146.3</b> | 010572 | THz 23,81            | 03.7854-0102.4 | <b>03.7853-0102.4</b> | 300252 | 9"              |
|                | <b>03.7760-5102.4</b> | 300140 | 10"                  | 03.7854-0201.4 | <b>03.7853-0202.4</b> | 300181 | 9"              |
| 03.7762-5102.4 | <b>03.2123-1551.3</b> | 010512 | THz 23,81            | 03.7854-0202.4 | <b>03.7853-0202.4</b> | 300181 | 9"              |
|                | <b>03.7760-5102.4</b> | 300140 | 10"                  | 03.7854-0701.4 | <b>03.7853-0702.4</b> | 300195 | 9"              |
| 03.7762-5103.4 | <b>03.7760-5102.4</b> | 300140 | 10"                  | 03.7854-0702.4 | <b>03.7853-0702.4</b> | 300195 | 9"              |
| 03.7762-5104.4 | <b>03.7760-5102.4</b> | 300140 | 10"                  | 03.7854-0901.4 | <b>03.7853-0902.4</b> | 300150 | 9"              |
| 03.7762-5501.4 | <b>03.7760-5502.4</b> | 300151 | 10"                  | 03.7854-0902.4 | <b>03.7853-0902.4</b> | 300150 | 9"              |
| 03.7762-5503.4 | <b>03.7760-5502.4</b> | 300151 | 10"                  | 03.7854-0903.4 | <b>03.7853-0902.4</b> | 300150 | 9"              |
| 03.7762-5602.4 | <b>03.2123-1551.3</b> | 010512 | THz 23,81            | 03.7854-0904.4 | <b>03.7853-0902.4</b> | 300150 | 9"              |
|                | <b>03.7760-5602.4</b> | 300121 | 10"                  | 03.7854-0905.4 | <b>03.7853-0902.4</b> | 300150 | 9"              |
| 03.7762-5603.4 | <b>03.2122-1541.3</b> | 010511 | THz 22,20            | 03.7854-0906.4 | <b>03.7853-0902.4</b> | 300150 | 9"              |
|                | <b>03.7760-5602.4</b> | 300121 | 10"                  | 03.7854-0907.4 | <b>03.7853-0902.4</b> | 300150 | 9"              |
| 03.7762-8101.4 | <b>03.7760-8103.4</b> | 300240 | 10"                  | 03.7854-0908.4 | <b>03.7853-0902.4</b> | 300150 | 9"              |
| 03.7762-8102.4 | <b>03.7760-8103.4</b> | 300240 | 10"                  | 03.7854-1301.4 | <b>03.2123-2181.3</b> | 010608 | THz 23,81       |
| 03.7762-8104.4 | <b>03.7760-8103.4</b> | 300240 | 10"                  | 03.7854-1501.4 | <b>03.2120-4461.3</b> | 010571 | THz 20,64       |
| 03.7762-8105.4 | <b>03.7760-8103.4</b> | 300240 | 10"                  |                | <b>03.7853-1502.4</b> | 300200 | 9"              |
| 03.7762-9701.4 | <b>03.4152-0020.3</b> | 010929 | THz 22,20 + Behälter | 03.7854-1502.4 | <b>03.7853-1502.4</b> | 300200 | 9"              |
| 03.7767-0101.4 | <b>03.2026-0462.3</b> | 010728 | THz 26,99/25,40      | 03.7854-1601.4 | <b>03.2122-1351.3</b> | 010528 | THz 22,20       |
| 03.7767-0102.4 | <b>03.2026-0462.3</b> | 010728 | THz 26,99/25,40      |                | <b>03.7853-1602.4</b> | 300167 | 9"              |
| 03.7767-0103.4 | <b>03.2026-0512.3</b> | 010038 | THz 26,99/25,40      | 03.7854-1603.4 | <b>03.2122-1351.3</b> | 010528 | THz 22,20       |
| 03.7767-0104.4 | <b>03.2026-0512.3</b> | 010038 | THz 26,99/25,40      | 03.7854-1604.4 | <b>03.2122-1942.3</b> | 010700 | THz 22,20       |
| 03.7767-0105.4 | <b>03.2026-0462.3</b> | 010728 | THz 26,99/25,40      | 03.7854-1703.4 | <b>03.4122-0041.3</b> | 010612 | THz 22,20       |
| 03.7767-0106.4 | <b>03.2026-0562.3</b> | 010729 | THz 26,99/25,40      | 03.7854-2101.4 | <b>03.7853-2102.4</b> | 300201 | 9"              |
| 03.7767-0107.4 | <b>03.2026-0462.3</b> | 010728 | THz 26,99/25,40      |                |                       |        |                 |

# Bremsgeräte komplett

**Booster units complete - Servofreni completi -  
Servo-freins complets - Servofreno completo**

● Die Nr. befindet sich auf dem im Fahrzeug eingebautem Aggregat.  
the number is on the unit build in the car  
il numero si trova sull'aggregato montato nella macchina  
le numéro se trouve sur la pièce montée dans le véhicule  
el n° se encuentra en el equipo montado en el vehículo



|                |                       |        |           |
|----------------|-----------------------|--------|-----------|
| 03.7854-2102.4 | <b>03.7853-2102.4</b> | 300201 | 9"        |
| 03.7854-2103.4 | <b>03.7853-2102.4</b> | 300201 | 9"        |
| 03.7854-2104.4 | <b>03.7853-2102.4</b> | 300201 | 9"        |
| 03.7854-2105.4 | <b>03.7853-2102.4</b> | 300201 | 9"        |
| 03.7854-2106.4 | <b>03.7853-2102.4</b> | 300201 | 9"        |
| 03.7854-2107.4 | <b>03.7853-2102.4</b> | 300201 | 9"        |
| 03.7854-2108.4 | <b>03.7853-2102.4</b> | 300201 | 9"        |
| 03.7854-2109.4 | <b>03.7853-2102.4</b> | 300201 | 9"        |
| 03.7854-2110.4 | <b>03.7853-2102.4</b> | 300201 | 9"        |
| 03.7854-2111.4 | <b>03.7853-2102.4</b> | 300201 | 9"        |
| 03.7854-2112.4 | <b>03.7853-2102.4</b> | 300201 | 9"        |
| 03.7854-2113.4 | <b>03.7853-2102.4</b> | 300201 | 9"        |
| 03.7854-2114.4 | <b>03.7853-2102.4</b> | 300201 | 9"        |
| 03.7854-2115.4 | <b>03.7853-2102.4</b> | 300201 | 9"        |
| 03.7854-2116.4 | <b>03.7853-2102.4</b> | 300201 | 9"        |
| 03.7854-2601.4 | <b>03.7853-2602.4</b> | 300196 | 9"        |
| 03.7854-2602.4 | <b>03.7853-2602.4</b> | 300196 | 9"        |
| 03.7854-2701.4 | <b>03.7853-2702.4</b> | 300269 | 9"        |
| 03.7854-2702.4 | <b>03.7853-2702.4</b> | 300269 | 9"        |
| 03.7854-3901.4 | <b>03.7853-3902.4</b> | 300270 | 9"        |
| 03.7854-4101.4 | <b>03.2120-4611.3</b> | 010937 | THz 20,64 |
|                | <b>03.7853-4102.4</b> | 300271 | 9"        |
| 03.7854-4103.4 | <b>03.2122-2031.3</b> | 010938 | THz 22,20 |
|                | <b>03.7853-4102.4</b> | 300271 | 9"        |
| 03.7854-4105.4 | <b>03.2120-4611.3</b> | 010937 | THz 20,64 |
|                | <b>03.7853-4102.4</b> | 300271 | 9"        |
| 03.7854-4106.4 | <b>03.2120-4611.3</b> | 010937 | THz 20,64 |
|                | <b>03.7853-4102.4</b> | 300271 | 9"        |
| 03.7854-4108.4 | <b>03.7853-4102.4</b> | 300271 | 9"        |
| 03.7854-4501.4 | <b>03.2120-4611.3</b> | 010937 | THz 20,64 |
| 03.7854-4502.4 | <b>03.2122-2031.3</b> | 010938 | THz 22,20 |
| 03.7854-4601.4 | <b>03.2120-4611.3</b> | 010937 | THz 20,64 |
| 03.7854-4602.4 | <b>03.2122-2031.3</b> | 010938 | THz 22,20 |

|                |                       |        |             |
|----------------|-----------------------|--------|-------------|
| 03.7854-4701.4 | <b>03.2120-4611.3</b> | 010937 | THz 20,64   |
| 03.7854-4702.4 | <b>03.2122-2031.3</b> | 010938 | THz 22,20   |
| 03.7854-5401.4 | <b>03.2120-4611.3</b> | 010937 | THz 20,64   |
| 03.7854-5402.4 | <b>03.2122-2031.3</b> | 010938 | THz 22,20   |
| 03.7854-5404.4 | <b>03.2122-2031.3</b> | 010938 | THz 22,20   |
| 03.7854-5406.4 | <b>03.2120-4611.3</b> | 010937 | THz 20,64   |
| 03.7854-5501.4 | <b>03.2120-4611.3</b> | 010937 | THz 20,64   |
| 03.7854-5502.4 | <b>03.2122-2031.3</b> | 010938 | THz 22,20   |
| 03.7854-6001.4 | <b>03.2122-2031.3</b> | 010938 | THz 22,20   |
| 03.7857-0301.4 | <b>03.2125-0421.3</b> | 010934 | THz 25,40   |
| 03.7859-0101.4 | <b>03.7858-0102.4</b> | 300262 | 9/8" Tandem |
| 03.7859-0103.4 | <b>03.7858-0102.4</b> | 300262 | 9/8" Tandem |
| 03.7859-0731.4 | <b>03.7858-0732.4</b> | 300272 | 9/8" Tandem |
| 03.7859-0732.4 | <b>03.2125-0421.3</b> | 010934 | THz 25,40   |
|                | <b>03.7858-0732.4</b> | 300272 | 9/8" Tandem |
| 03.7859-0932.4 | <b>03.2125-0421.3</b> | 010934 | THz 25,40   |
| 03.7859-0933.4 | <b>03.2125-0421.3</b> | 010934 | THz 25,40   |
| 03.7859-1931.4 | <b>03.7858-1932.4</b> | 300263 | 9/8" Tandem |
| 03.7859-3301.4 | <b>03.2125-9604.3</b> | 010581 | THz 25,40   |
|                | <b>03.7858-3302.4</b> | 300122 | 9/8" Tandem |
| 03.7859-3302.4 | <b>03.2125-9604.3</b> | 010581 | THz 25,40   |
|                | <b>03.7858-3302.4</b> | 300122 | 9/8" Tandem |
| 03.7859-3631.4 | <b>03.7858-3632.4</b> | 300234 | 9/8" Tandem |
| 03.7859-4001.4 | <b>03.7858-3532.4</b> | 300233 | 9/8" Tandem |
| 03.7859-4002.4 | <b>03.7858-3532.4</b> | 300233 | 9/8" Tandem |
| 03.7859-4502.4 | <b>03.7858-4502.4</b> | 300202 | 9/8" Tandem |
| 03.7859-4631.4 | <b>03.7858-4632.4</b> | 300273 | 9/8" Tandem |
| 03.7859-4632.4 | <b>03.7858-4632.4</b> | 300273 | 9/8" Tandem |
| 03.7859-4831.4 | <b>03.7858-4832.4</b> | 300274 | 9/8" Tandem |
| 03.7859-5031.4 | <b>03.7858-5032.4</b> | 300275 | 9/8" Tandem |
| 03.7859-5131.4 | <b>03.7858-5132.4</b> | 300276 | 9/8" Tandem |
| 03.7859-5232.4 | <b>03.2125-0421.3</b> | 010934 | THz 25,40   |





# Bremsgeräte komplett

## Booster units complete - Servofreni completi - Servo-freins complets - Servofreno completo

● Die Nr. befindet sich auf dem im Fahrzeug eingebautem Aggregat.  
the number is on the unit build in the car  
il numero si trova sull'aggregato montato nella macchina  
le numéro se trouve sur la pièce montée dans le véhicule  
el n° se encuentra en el equipo montado en el vehículo



|                |                       |        |             |                |                       |        |                 |
|----------------|-----------------------|--------|-------------|----------------|-----------------------|--------|-----------------|
| 03.7859-5233.4 | <b>03.2125-0421.3</b> | 010934 | THz 25,40   | 03.7862-8601.4 | <b>03.2123-3421.3</b> | 010933 | THz 23,81       |
| 03.7859-5234.4 | <b>03.2125-0421.3</b> | 010934 | THz 25,40   | 03.7864-0101.4 | <b>03.7863-0102.4</b> | 300142 | 10"             |
| 03.7859-5331.4 | <b>03.2125-0421.3</b> | 010934 | THz 25,40   | 03.7864-0102.4 | <b>03.7863-0102.4</b> | 300142 | 10"             |
| 03.7859-6001.4 | <b>03.7858-3532.4</b> | 300233 | 9/8" Tandem | 03.7864-0331.4 | <b>03.7863-0332.4</b> | 300203 | 10"             |
| 03.7859-6002.4 | <b>03.7858-3532.4</b> | 300233 | 9/8" Tandem | 03.7864-0332.4 | <b>03.7863-0332.4</b> | 300203 | 10"             |
| 03.7859-6101.4 | <b>03.7858-3632.4</b> | 300234 | 9/8" Tandem | 03.7864-0401.4 | <b>03.2123-2024.3</b> | 010597 | THz 23,81       |
| 03.7859-6102.4 | <b>03.7858-3632.4</b> | 300234 | 9/8" Tandem |                | <b>03.7863-0402.4</b> | 300124 | 10"             |
| 03.7859-6103.4 | <b>03.7858-3632.4</b> | 300234 | 9/8" Tandem | 03.7864-0402.4 | <b>03.2123-2024.3</b> | 010597 | THz 23,81       |
| 03.7859-7601.4 | <b>03.7858-7602.4</b> | 300277 | 9/8" Tandem |                | <b>03.7863-0402.4</b> | 300124 | 10"             |
| 03.7862-0601.4 | <b>03.7860-0602.4</b> | 300141 | 10"         | 03.7864-0831.4 | <b>03.2123-3593.3</b> | 010919 | THz 23,81       |
| 03.7862-0602.4 | <b>03.7860-0602.4</b> | 300141 | 10"         |                | <b>03.7863-0832.4</b> | 300229 | 10"             |
| 03.7862-0603.4 | <b>03.7860-0602.4</b> | 300141 | 10"         | 03.7864-0901.4 | <b>03.7863-0903.4</b> | 300244 | 10"             |
| 03.7862-0604.4 | <b>03.7860-0602.4</b> | 300141 | 10"         | 03.7864-0902.4 | <b>03.7863-0903.4</b> | 300244 | 10"             |
| 03.7862-0605.4 | <b>03.7860-0602.4</b> | 300141 | 10"         | 03.7864-1101.4 | <b>03.2023-2004.3</b> | 010788 | THz 23,81/19,05 |
| 03.7862-0606.4 | <b>03.7860-0602.4</b> | 300141 | 10"         |                | <b>03.7863-0903.4</b> | 300244 | 10"             |
| 03.7862-1201.4 | <b>03.7860-1202.4</b> | 300187 | 10"         | 03.7864-1102.4 | <b>03.7863-0903.4</b> | 300244 | 10"             |
| 03.7862-1403.4 | <b>03.7860-1402.4</b> | 300228 | 10"         | 03.7864-2001.4 | <b>03.2123-2146.3</b> | 010572 | THz 23,81       |
| 03.7862-1405.4 | <b>03.7860-1402.4</b> | 300228 | 10"         |                | <b>03.7863-2002.4</b> | 300126 | 10"             |
| 03.7862-1406.4 | <b>03.7860-1402.4</b> | 300228 | 10"         | 03.7864-2003.4 | <b>03.2123-2621.3</b> | 010701 | THz 23,81       |
| 03.7862-2801.4 | <b>03.2123-3421.3</b> | 010933 | THz 23,81   |                | <b>03.7863-2002.4</b> | 300126 | 10"             |
| 03.7862-3301.4 | <b>03.2123-3421.3</b> | 010933 | THz 23,81   | 03.7864-2101.4 | <b>03.2122-1521.3</b> | 010494 | THz 22,20       |
| 03.7862-3901.4 | <b>03.7860-3902.4</b> | 300278 | 10"         |                | <b>03.7863-2002.4</b> | 300126 | 10"             |
| 03.7862-3902.4 | <b>03.7860-3902.4</b> | 300278 | 10"         | 03.7864-2201.4 | <b>03.2123-2581.3</b> | 010613 | THz 23,81       |
| 03.7862-3903.4 | <b>03.7860-3902.4</b> | 300278 | 10"         |                | <b>03.7863-2202.4</b> | 300127 | 10"             |
| 03.7862-4301.4 | <b>03.2122-2163.3</b> | 010800 | THz 22,20   | 03.7864-2301.4 | <b>03.2123-2581.3</b> | 010613 | THz 23,81       |
|                | <b>03.7860-4302.4</b> | 300231 | 10"         |                | <b>03.2123-2561.3</b> | 010629 | THz 23,81       |
| 03.7862-4701.4 | <b>03.2123-3421.3</b> | 010933 | THz 23,81   |                | <b>03.7863-2802.4</b> | 300188 | 10"             |
| 03.7862-4801.4 | <b>03.2123-3421.3</b> | 010933 | THz 23,81   | 03.7864-3001.4 | <b>03.7863-3002.4</b> | 300223 | 10"             |
| 03.7862-5301.4 | <b>03.2123-3421.3</b> | 010933 | THz 23,81   | 03.7864-3503.4 | <b>03.2123-2715.3</b> | 010802 | THz 23,81       |
| 03.7862-5701.4 | <b>03.7860-5702.4</b> | 300279 | 10"         |                | <b>03.7863-3502.4</b> | 300128 | 10"             |
| 03.7862-7801.4 | <b>03.7860-7802.4</b> | 300280 | 10"         | 03.7864-3504.4 | <b>03.2123-2715.3</b> | 010802 | THz 23,81       |
|                |                       |        |             |                | <b>03.7863-3502.4</b> | 300128 | 10"             |
|                |                       |        |             | 03.7864-4401.4 | <b>03.2122-1351.3</b> | 010528 | THz 22,20       |
|                |                       |        |             |                | <b>03.7863-6502.4</b> | 300232 | 10"             |
|                |                       |        |             | 03.7864-4402.4 | <b>03.2122-1942.3</b> | 010700 | THz 22,20       |
|                |                       |        |             |                | <b>03.7863-6502.4</b> | 300232 | 10"             |
|                |                       |        |             | 03.7864-4501.4 | <b>03.7863-4502.4</b> | 300230 | 10"             |

# Bremsgeräte komplett

Booster units complete - Servofreni completi -  
Servo-freins complets - Servofreno completo

● Die Nr. befindet sich auf dem im Fahrzeug eingebautem Aggregat.  
the number is on the unit build in the car  
il numero si trova sull'aggregato montato nella macchina  
le numéro se trouve sur la pièce montée dans le véhicule  
el n° se encuentra en el equipo montado en el vehículo



|                |                       |        |                      |
|----------------|-----------------------|--------|----------------------|
| 03.7864-4502.4 | <b>03.2123-3493.3</b> | 010792 | THz 23,81            |
|                | <b>03.7863-4502.4</b> | 300230 | 10"                  |
| 03.7864-5001.4 | <b>03.2122-1351.3</b> | 010528 | THz 22,20            |
| 03.7864-5003.4 | <b>03.2122-1351.3</b> | 010528 | THz 22,20            |
| 03.7864-5004.4 | <b>03.2122-1942.3</b> | 010700 | THz 22,20            |
| 03.7864-5301.4 | <b>03.2122-2129.3</b> | 010799 | THz 22,20            |
| 03.7864-5302.4 | <b>03.2122-2129.3</b> | 010799 | THz 22,20            |
| 03.7864-6001.4 | <b>03.7863-6002.4</b> | 300249 | 10"                  |
| 03.7864-6002.4 | <b>03.7863-6002.4</b> | 300249 | 10"                  |
| 03.7864-6302.4 | <b>03.2122-2129.3</b> | 010799 | THz 22,20            |
| 03.7864-7801.4 | <b>03.7863-7803.4</b> | 300237 | 10"                  |
| 03.7864-7802.4 | <b>03.7863-7803.4</b> | 300237 | 10"                  |
| 03.7864-7803.4 | <b>03.4155-0153.3</b> | 010927 | THz 25,40            |
|                | <b>03.7863-7803.4</b> | 300237 | 10"                  |
| 03.7864-7804.4 | <b>03.4155-0156.3</b> | 010862 | THz 25,40            |
|                | <b>03.7863-7803.4</b> | 300237 | 10"                  |
| 03.7864-8501.4 | <b>03.7863-3932.4</b> | 300288 | 10"                  |
| 03.7864-8502.4 | <b>03.7863-3932.4</b> | 300288 | 10"                  |
| 03.7864-9101.4 | <b>03.4152-0020.3</b> | 010929 | THz 22,20 + Behälter |
| 03.7864-9201.4 | <b>03.4152-0020.3</b> | 010929 | THz 22,20 + Behälter |
| 03.7864-9501.4 | <b>03.7863-9502.4</b> | 300204 | 10"                  |
| 03.7864-9502.4 | <b>03.7863-9502.4</b> | 300204 | 10"                  |
| 03.7864-9801.4 | <b>03.7863-9802.4</b> | 300281 | 10"                  |
| 03.7869-4101.4 | <b>03.7868-4102.4</b> | 300250 | 10/8" Tandem         |
| 03.7869-4701.4 | <b>03.7868-4702.4</b> | 300253 | 10/8" Tandem         |
| 03.7869-4702.4 | <b>03.7868-4702.4</b> | 300253 | 10/8" Tandem         |
| 03.7869-4703.4 | <b>03.7868-4702.4</b> | 300253 | 10/8" Tandem         |
| 03.7869-5301.4 | <b>03.7868-5302.4</b> | 300251 | 10/8" Tandem         |
| 03.7872-1101.4 | <b>03.2123-3421.3</b> | 010933 | THz 23,81            |
| 03.7872-1201.4 | <b>03.2123-3421.3</b> | 010933 | THz 23,81            |
| 03.7872-1601.4 | <b>03.2123-3421.3</b> | 010933 | THz 23,81            |
| 03.7874-0201.4 | <b>03.7873-0202.4</b> | 300152 | 11"                  |

|                |                       |        |           |
|----------------|-----------------------|--------|-----------|
| 03.7874-1201.4 | <b>03.7873-1202.4</b> | 300197 | 11"       |
| 03.7874-1202.4 | <b>03.7873-1202.4</b> | 300197 | 11"       |
| 03.7874-1205.4 | <b>03.4153-0063.3</b> | 010773 | THz 23,81 |
|                | <b>03.7873-1202.4</b> | 300197 | 11"       |
| 03.7874-1305.4 | <b>03.4153-0063.3</b> | 010773 | THz 23,81 |
| 03.7874-1801.4 | <b>03.2122-2129.3</b> | 010799 | THz 22,20 |
| 03.7874-2601.4 | <b>03.4153-0063.3</b> | 010773 | THz 23,81 |
| 03.7874-2701.4 | <b>03.4153-0063.3</b> | 010773 | THz 23,81 |
| 03.7874-3001.4 | <b>03.2122-2129.3</b> | 010799 | THz 22,20 |
| 03.7874-3701.4 | <b>03.7873-3702.4</b> | 300283 | 11"       |
| 03.7874-3702.4 | <b>03.7873-3702.4</b> | 300283 | 11"       |
| 03.7874-3901.4 | <b>03.7873-3902.4</b> | 300254 | 11"       |
| 03.7874-3902.4 | <b>03.7873-3902.4</b> | 300254 | 11"       |
| 03.7874-4501.4 | <b>03.7873-4502.4</b> | 300284 | 11"       |
| 03.7874-4502.4 | <b>03.7873-4502.4</b> | 300284 | 11"       |
| 03.7874-4503.4 | <b>03.7873-4502.4</b> | 300284 | 11"       |
| 03.7874-4504.4 | <b>03.7873-4502.4</b> | 300284 | 11"       |
| 03.7874-4505.4 | <b>03.7873-4502.4</b> | 300284 | 11"       |
| 03.7874-4506.4 | <b>03.7873-4502.4</b> | 300284 | 11"       |
| 10.0016-0902.4 | <b>10.6360-1602.4</b> | 300194 | 10"       |
| 10.0016-0903.4 | <b>10.6360-1602.4</b> | 300194 | 10"       |
| 10.0016-1002.4 | <b>10.6360-1602.4</b> | 300194 | 10"       |
| 10.0016-1003.4 | <b>10.6360-1602.4</b> | 300194 | 10"       |
| 10.6350-2002.4 | <b>10.6123-0522.3</b> | 010633 | THz 23,81 |
| 10.6352-0601.4 | <b>10.6350-0603.4</b> | 300159 | 9"        |
| 10.6352-0602.4 | <b>10.6350-0603.4</b> | 300159 | 9"        |
| 10.6352-0603.4 | <b>10.6350-0603.4</b> | 300159 | 9"        |
| 10.6352-0604.4 | <b>10.6350-0603.4</b> | 300159 | 9"        |
| 10.6352-2901.4 | <b>10.6350-3902.4</b> | 300213 | 9"        |
| 10.6352-2902.4 | <b>10.6350-3902.4</b> | 300213 | 9"        |
| 10.6352-4001.4 | <b>03.2122-1421.3</b> | 010615 | THz 22,20 |
|                | <b>10.6350-4002.4</b> | 300285 | 9"        |

# Bremsgeräte komplett

Booster units complete - Servofreni completi -  
Servo-freins complets - Servofreno completo

● Die Nr. befindet sich auf dem im Fahrzeug eingebautem Aggregat.  
the number is on the unit build in the car  
il numero si trova sull'aggregato montato nella macchina  
le numéro se trouve sur la pièce montée dans le véhicule  
el n° se encuentra en el equipo montado en el vehículo



|                |                       |        |            |
|----------------|-----------------------|--------|------------|
| 10.6353-2901.4 | <b>10.6350-3902.4</b> | 300213 | 9"         |
| 10.6353-2902.4 | <b>10.6350-3902.4</b> | 300213 | 9"         |
| 10.6362-0403.4 | <b>10.6360-1903.4</b> | 300093 | 10" (MKIV) |
| 10.6362-0501.4 | <b>10.6360-1003.4</b> | 300156 | 10"        |
| 10.6362-0502.4 | <b>10.6360-1003.4</b> | 300156 | 10"        |
| 10.6362-0503.4 | <b>10.6360-1003.4</b> | 300156 | 10"        |
| 10.6362-0504.4 | <b>10.6360-1003.4</b> | 300156 | 10"        |
| 10.6362-1001.4 | <b>10.6360-1003.4</b> | 300156 | 10"        |
| 10.6362-1002.4 | <b>10.6360-1003.4</b> | 300156 | 10"        |
| 10.6362-1003.4 | <b>10.6360-1003.4</b> | 300156 | 10"        |
| 10.6362-1004.4 | <b>10.6360-1003.4</b> | 300156 | 10"        |
| 10.6362-1301.4 | <b>10.6360-1302.4</b> | 300286 | 10"        |
| 10.6362-1302.4 | <b>10.6360-1302.4</b> | 300286 | 10"        |
| 10.6362-1905.4 | <b>10.6360-1903.4</b> | 300093 | 10" (MKIV) |
| 10.6362-2001.4 | <b>10.6360-2002.4</b> | 300143 | 10"        |
| 10.6362-2002.4 | <b>10.6360-2002.4</b> | 300143 | 10"        |
| 10.6362-2101.4 | <b>10.6360-2102.4</b> | 300147 | 10"        |

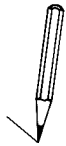

A large rectangular area containing 30 horizontal lines, intended for writing or drawing.









- Ⓓ **Reparatursätze**
- Ⓔ**N** **Repair kits**
- Ⓕ**R** **Kits de réparation**
- Ⓖ**I** **Corredi riparazione**
- Ⓔ**S** **Juegos de reparación**
- Ⓖ**L** **Reparatiesets**
- Ⓕ**A** **Reparationsæt**
- Ⓔ**S** **Reparationsatser**
- Ⓖ**U** **Javitókészletek**
- Ⓕ**T** **Kit de reparação**
- Ⓖ**U** **Ремонтные комплекты**
- Ⓖ**Z** **Sady pro opravu**
- Ⓕ**L** **Zestawy naprawcze**
- Ⓔ**L** **ΣΕΤ ΕΠΙΣΚΕΥΗΣ**
- Ⓕ**R** **Tamir takımları**
- Ⓖ**H** **維修組**
- Ⓖ**A** **リペアキット**
- Ⓕ**R** **طواقم التصليح**



# Reparatursätze







Repair kits - Corredi riparazione - Nécessaires de réparation - Juegos de reparación

|  |  |  |  |  |  |
|---|---|---|---|---|---|
| 03.2022-0702.3 010007   | <b>03.0370-7522.2</b> 057522  | THz Reparatursatz   | 03.3508-0501.3 310017   | <b>03.3556-1164.2</b> 390437  | Verschraubung   |
| 03.2022-1002.3 010008   | <b>03.0370-7522.2</b> 057522  | THz Reparatursatz   | 03.3508-0801.3 310023   | <b>03.3556-1164.2</b> 390437  | Verschraubung   |
| 03.2122-2202.3 010140   | <b>03.0370-3922.2</b> 053922  | THz Reparatursatz   | 03.3508-3600.3 310030   | <b>03.3556-1164.2</b> 390437  | Verschraubung   |
| 03.2122-4902.3 010144   | <b>03.0370-3922.2</b> 053922  | THz Reparatursatz   | 03.3508-5201.3 310037   | <b>03.3556-1164.2</b> 390437  | Verschraubung   |
| 03.2415-0512.3 030001   | <b>03.0350-1508.2</b> 071508  | Gz Reparatursatz  | 03.3508-5851.3 310039   | <b>03.3556-1164.2</b> 390437  | Verschraubung   |
| 03.2415-0514.3 030002   | <b>03.0350-1508.2</b> 071508  | Gz Reparatursatz  | 03.3508-5951.3 310041   | <b>03.3556-1164.2</b> 390437  | Verschraubung   |
| 03.2415-0515.3 030003   | <b>03.0350-1508.2</b> 071508  | Gz Reparatursatz  | 03.3508-8302.3 310046   | <b>03.3556-1164.2</b> 390437  | Verschraubung   |
| 03.2419-3307.3 030014   | <b>03.0350-1906.2</b> 071906  | Gz Reparatursatz  | 03.3508-8326.3 310047   | <b>03.3556-1164.2</b> 390437  | Verschraubung   |
| 03.2419-7800.3 030016   | <b>03.0350-1919.2</b> 071919  | Gz Reparatursatz  | 03.3508-8753.3 310049   | <b>03.3556-1164.2</b> 390437  | Verschraubung   |
| 03.2419-9000.3 030025   | <b>03.0350-1919.2</b> 071919  | Gz Reparatursatz  | 03.3508-8801.3 310050   | <b>03.3556-1164.2</b> 390437  | Verschraubung   |
| 03.2515-1101.3 040001   | <b>03.0450-1502.2</b> 081502  | Nz Reparatursatz  | 03.3508-8802.3 310051   | <b>03.3556-1094.2</b> 390427  | Verschraubung + WE  |
| 03.2520-1201.3 040011   | <b>03.0450-2006.2</b> 082006  | Nz Reparatursatz  | 03.3508-8901.3 310054   | <b>03.3556-1164.2</b> 390437  | Verschraubung   |
| 03.2523-0811.3 040019   | <b>03.0450-2311.2</b> 082311  | Nz Reparatursatz  | 03.3508-8902.3 310055   | <b>03.3556-1094.2</b> 390427  | Verschraubung + WE  |
| 03.2525-1802.3 040025   | <b>03.0450-2509.2</b> 082509  | Nz Reparatursatz  | 03.3508-9503.3 310056   | <b>03.3556-1141.2</b> 390434  | Verschraubung   |
| 03.2525-2602.3 040029   | <b>03.0450-2510.2</b> 082510  | Nz Reparatursatz  | 03.3509-0100.3 310057   | <b>03.3556-1164.2</b> 390437  | Verschraubung   |
| 03.2525-2711.3 040030   | <b>03.0450-2510.2</b> 082510  | Nz Reparatursatz  | 03.3509-0218.3 310062   | <b>03.3506-0016.2</b> 390255  | Ausgleichskappe   |
| 03.2528-1301.3 040032   | <b>03.0450-2805.2</b> 082805  | Nz Reparatursatz  | 03.3509-0600.3 310065   | <b>03.3556-1164.2</b> 390437  | Verschraubung   |
| 03.2538-0102.3 040033   | <b>03.0450-3801.2</b> 083801  | Nz Reparatursatz  | 03.3509-1000.3 310066   | <b>03.3556-1164.2</b> 390437  | Verschraubung   |
| 03.2538-0104.3 040035   | <b>03.0450-3801.2</b> 083801  | Nz Reparatursatz  | 03.3558-0408.3 310069   | <b>03.3556-1141.2</b> 390434  | Verschraubung   |
| 03.2728-2101.3 020008   | <b>03.0402-1128.2</b> 060027  | Rz Reparatursatz  | 03.3558-0603.3 310074   | <b>03.3556-1141.2</b> 390434  | Verschraubung   |
| 03.2728-2201.3 020009   | <b>03.0402-1128.2</b> 060027  | Rz Reparatursatz  | 03.3558-0606.3 310075   | <b>03.3556-1113.2</b> 390428  | Verschraubung + WE  |
| 03.3128-1401.3 010295   | <b>03.0370-1828.2</b> 051828  | Hz Reparatursatz  | 03.3558-0657.3 310076   | <b>03.3556-1141.2</b> 390434  | Verschraubung   |
| 03.3131-2201.3 010300   | <b>03.0370-1131.2</b> 051131  | Hz Reparatursatz  | 03.3558-0704.3 310078   | <b>03.3556-1094.2</b> 390427  | Verschraubung + WE  |
| 03.3131-2401.3 010303   | <b>03.0370-1131.2</b> 051131  | Hz Reparatursatz  | 03.3558-0706.3 310079   | <b>03.3556-1113.2</b> 390428  | Verschraubung + WE  |
| 03.3138-2001.3 010310   | <b>03.0370-1038.2</b> 051038  | Hz Reparatursatz  | 11.1361-0004.2 200001   | <b>11.0441-3601.2</b> 250007  | Dichtungssatz   |
| 010310  | <b>03.0370-9998.2</b> 059998  | Hz Rep. Satz,-Kolben  | 11.1441-8035.2 200002   | <b>11.0441-4402.2</b> 250014  | Dichtungssatz   |
| 03.3219-0102.3 020036   | <b>03.0470-2619.2</b> 060051  | Rz Dichtungssatz  | 11.1441-8036.2 200003   | <b>11.0441-4402.2</b> 250014  | Dichtungssatz   |
| 03.3219-0411.3 020038   | <b>03.0470-2619.2</b> 060051  | Rz Dichtungssatz  | 11.1541-0013.2 200005   | <b>11.0441-5401.2</b> 250027  | Dichtungssatz   |
| 03.3231-3401.3 020120   | <b>03.0401-2031.2</b> 052031  | Rz Reparatursatz  | 11.3331-0033.2 220001   | <b>11.0441-3305.2</b> 250006  | Dichtungssatz   |
| 03.3241-1801.3 020130   | <b>03.0403-0341.2</b> 060031  | Rz Reparatursatz  | 11.3331-0034.2 220002   | <b>11.0441-3305.2</b> 250006  | Dichtungssatz   |
| 03.3241-1802.3 020131   | <b>03.0403-0341.2</b> 060031  | Rz Reparatursatz  | 11.3331-0037.2 220395   | <b>11.0441-3305.2</b> 250006  | Dichtungssatz   |
| 03.3508-0100.3 310002   | <b>03.3556-1164.2</b> 390437  | Verschraubung   | 11.3331-0038.2 220396   | <b>11.0441-3305.2</b> 250006  | Dichtungssatz   |
| 03.3508-0264.3 310009   | <b>03.3556-1164.2</b> 390437  | Verschraubung   | 11.3331-0039.2 220387   | <b>11.0441-3305.2</b> 250006  | Dichtungssatz   |
| 03.3508-0401.3 310014   | <b>03.3556-1164.2</b> 390437  | Verschraubung   | 11.3331-0040.2 220388   | <b>11.0441-3305.2</b> 250006  | Dichtungssatz   |
| 03.3508-0500.3 310016   | <b>03.3556-1164.2</b> 390437  | Verschraubung   |   |   |   |









# Reparatursätze

Repair kits - Corredi riparazione - Nécessaires de réparation - Juegos de reparación

|    |        |                                      |    |        |                                      |
|---|--------|--------------------------------------|---|--------|--------------------------------------|
| 11.3331-8016.2  | 220003 | 11.0101-5402.2 260009 Hülsensatz     | 11.3361-8505.2  | 220024 | 11.0101-5402.2 260009 Hülsensatz     |
|   | 220003 | 11.0441-3302.2 250004 Dichtungssatz  |   | 220024 | 11.0441-3602.2 250008 Dichtungssatz  |
|   | 220003 | 11.8171-0008.1 990049 Führungsbolzen |   | 220024 | 11.8116-0185.1 390592 Haltefeder     |
|   |        |                                      |   | 220024 | 11.8171-0008.1 990049 Führungsbolzen |
| 11.3331-8501.2  | 220004 | 11.0101-5402.2 260009 Hülsensatz     | 11.3361-8506.2  | 220025 | 11.0101-5402.2 260009 Hülsensatz     |
|   | 220004 | 11.0441-3302.2 250004 Dichtungssatz  |   | 220025 | 11.0441-3602.2 250008 Dichtungssatz  |
|   | 220004 | 11.8116-0015.1 390492 Haltefeder     |   | 220025 | 11.8116-0185.1 390592 Haltefeder     |
|   | 220004 | 11.8171-0008.1 990049 Führungsbolzen |   | 220025 | 11.8171-0008.1 990049 Führungsbolzen |
| 11.3331-8502.2  | 220005 | 11.0101-5402.2 260009 Hülsensatz     | 11.3361-9975.2  | 220281 | 11.0101-5407.2 260011 Hülsensatz     |
|   | 220005 | 11.0441-3302.2 250004 Dichtungssatz  |   | 220281 | 11.0441-3602.2 250008 Dichtungssatz  |
|   | 220005 | 11.8116-0015.1 390492 Haltefeder     |   | 220281 | 11.8116-0073.1 390498 Haltefeder     |
|   | 220005 | 11.8171-0008.1 990049 Führungsbolzen |   | 220281 | 11.8171-0008.1 990049 Führungsbolzen |
| 11.3334-8001.2  | 220006 | 11.0101-5407.2 260011 Hülsensatz     | 11.3361-9976.2  | 220282 | 11.0101-5407.2 260011 Hülsensatz     |
|   | 220006 | 11.0441-3302.2 250004 Dichtungssatz  |   | 220282 | 11.0441-3602.2 250008 Dichtungssatz  |
|   | 220006 | 11.8116-0047.1 390494 Haltefeder     |   | 220282 | 11.8116-0073.1 390498 Haltefeder     |
|   | 220006 | 11.8171-0008.1 990049 Führungsbolzen |   | 220282 | 11.8171-0008.1 990049 Führungsbolzen |
| 11.3334-8002.2  | 220007 | 11.0101-5407.2 260011 Hülsensatz     | 11.3381-8501.2  | 220018 | 11.0101-5402.2 260009 Hülsensatz     |
|   | 220007 | 11.0441-3302.2 250004 Dichtungssatz  |   | 220018 | 11.0441-3802.2 250009 Dichtungssatz  |
|   | 220007 | 11.8116-0047.1 390494 Haltefeder     |   | 220018 | 11.8116-0066.1 390577 Haltefeder     |
|   | 220007 | 11.8171-0008.1 990049 Führungsbolzen |   | 220018 | 11.8171-0008.1 990049 Führungsbolzen |
| 11.3334-9995.2  | 220008 | 11.0101-5402.2 260009 Hülsensatz     | 11.3381-8502.2  | 220019 | 11.0101-5402.2 260009 Hülsensatz     |
|   | 220008 | 11.0441-3303.2 250005 Dichtungssatz  |   | 220019 | 11.0441-3802.2 250009 Dichtungssatz  |
|   | 220008 | 11.8116-0047.1 390494 Haltefeder     |   | 220019 | 11.8116-0066.1 390577 Haltefeder     |
|   | 220008 | 11.8171-0008.1 990049 Führungsbolzen |   | 220019 | 11.8171-0008.1 990049 Führungsbolzen |
| 11.3334-9996.2  | 220009 | 11.0101-5402.2 260009 Hülsensatz     | 11.3381-8503.2  | 220020 | 11.0101-5402.2 260009 Hülsensatz     |
|   | 220009 | 11.0441-3303.2 250005 Dichtungssatz  |   | 220020 | 11.0441-3803.2 250010 Dichtungssatz  |
|   | 220009 | 11.8116-0047.1 390494 Haltefeder     |   | 220020 | 11.8116-0066.1 390577 Haltefeder     |
|   | 220009 | 11.8171-0008.1 990049 Führungsbolzen |   | 220020 | 11.8171-0008.1 990049 Führungsbolzen |
| 11.3341-8501.2  | 220010 | 11.0101-5402.2 260009 Hülsensatz     | 11.3381-8504.2  | 220021 | 11.0101-5402.2 260009 Hülsensatz     |
|   | 220010 | 11.0441-3401.2 250151 Dichtungssatz  |   | 220021 | 11.0441-3803.2 250010 Dichtungssatz  |
|   | 220010 | 11.8116-0066.1 390577 Haltefeder     |   | 220021 | 11.8116-0066.1 390577 Haltefeder     |
|   | 220010 | 11.8171-0008.1 990049 Führungsbolzen |   | 220021 | 11.8171-0008.1 990049 Führungsbolzen |
| 11.3341-8502.2  | 220011 | 11.0101-5402.2 260009 Hülsensatz     | 11.3381-8505.2  | 220022 | 11.0101-5402.2 260009 Hülsensatz     |
|   | 220011 | 11.0441-3401.2 250151 Dichtungssatz  |   | 220022 | 11.0441-3802.2 250009 Dichtungssatz  |
|   | 220011 | 11.8116-0066.1 390577 Haltefeder     |   | 220022 | 11.8116-0066.1 390577 Haltefeder     |
|   | 220011 | 11.8171-0008.1 990049 Führungsbolzen |   | 220022 | 11.8171-0008.1 990049 Führungsbolzen |
| 11.3351-8501.2  | 220012 | 11.0101-5402.2 260009 Hülsensatz     | 11.3381-8506.2  | 220023 | 11.0101-5402.2 260009 Hülsensatz     |
|   | 220012 | 11.8116-0015.1 390492 Haltefeder     |   | 220023 | 11.0441-3802.2 250009 Dichtungssatz  |
|   | 220012 | 11.8171-0008.1 990049 Führungsbolzen |   | 220023 | 11.8116-0066.1 390577 Haltefeder     |
| 11.3351-8502.2  | 220013 | 11.0101-5402.2 260009 Hülsensatz     |   | 220023 | 11.8171-0008.1 990049 Führungsbolzen |
|   | 220013 | 11.8116-0015.1 390492 Haltefeder     | 11.3401-0055.2  | 220519 | 11.0101-5407.2 260011 Hülsensatz     |
|   | 220013 | 11.8171-0008.1 990049 Führungsbolzen |   | 220519 | 11.8116-0143.1 390513 Haltefeder     |
| 11.3351-8503.2  | 220014 | 11.0101-5402.2 260009 Hülsensatz     |   | 220519 | 11.8171-0008.1 990049 Führungsbolzen |
|   | 220014 | 11.8116-0015.1 390492 Haltefeder     | 11.3401-0056.2  | 220520 | 11.0101-5407.2 260011 Hülsensatz     |
|   | 220014 | 11.8171-0008.1 990049 Führungsbolzen |   | 220520 | 11.8116-0143.1 390513 Haltefeder     |
| 11.3351-8504.2  | 220015 | 11.0101-5402.2 260009 Hülsensatz     |   | 220520 | 11.8171-0008.1 990049 Führungsbolzen |
|   | 220015 | 11.8116-0015.1 390492 Haltefeder     | 11.3401-8501.2  | 220028 | 11.0101-5402.2 260009 Hülsensatz     |
|   | 220015 | 11.8171-0008.1 990049 Führungsbolzen |   | 220028 | 11.0441-4002.2 250011 Dichtungssatz  |
| 11.3361-8503.2  | 220016 | 11.0101-5402.2 260009 Hülsensatz     |   | 220028 | 11.8116-0066.1 390577 Haltefeder     |
|   | 220016 | 11.0441-3602.2 250008 Dichtungssatz  |   | 220028 | 11.8171-0008.1 990049 Führungsbolzen |
|   | 220016 | 11.8116-0066.1 390577 Haltefeder     | 11.3401-8502.2  | 220029 | 11.0101-5402.2 260009 Hülsensatz     |
|   | 220016 | 11.8171-0008.1 990049 Führungsbolzen |   | 220029 | 11.0441-4002.2 250011 Dichtungssatz  |
| 11.3361-8504.2  | 220017 | 11.0101-5402.2 260009 Hülsensatz     |   | 220029 | 11.8116-0066.1 390577 Haltefeder     |
|   | 220017 | 11.0441-3602.2 250008 Dichtungssatz  |   | 220029 | 11.8171-0008.1 990049 Führungsbolzen |
|   | 220017 | 11.8116-0066.1 390577 Haltefeder     |   |        |                                      |
|   | 220017 | 11.8171-0008.1 990049 Führungsbolzen |   |        |                                      |







# Reparatursätze

Repair kits - Corredi riparazione - Nécessaires de réparation - Juegos de reparación

|    |        |    |                       |                |        |                       |                       |
|---|--------|---|-----------------------|----------------|--------|-----------------------|-----------------------|
| 11.3401-8503.2  | 220030 | <b>11.0101-5402.2</b>   | 260009 Hülsensatz     | 11.3456-8003.2 | 220038 | <b>11.0101-4504.2</b> | 260004 Tragbolzensatz |
|   | 220030 | <b>11.0441-4002.2</b>   | 250011 Dichtungssatz  |                | 220038 | <b>11.0441-4501.2</b> | 250015 Dichtungssatz  |
|   | 220030 | <b>11.8116-0066.1</b>   | 390577 Haltefeder     | 11.3456-8004.2 | 220039 | <b>11.0101-4504.2</b> | 260004 Tragbolzensatz |
|   | 220030 | <b>11.8171-0008.1</b>   | 990049 Führungsbolzen |                | 220039 | <b>11.0441-4501.2</b> | 250015 Dichtungssatz  |
| 11.3401-8504.2  | 220031 | <b>11.0101-5402.2</b>   | 260009 Hülsensatz     | 11.3481-0106.2 | 220040 | <b>11.0101-4802.2</b> | 260007 Hülsensatz     |
|   | 220031 | <b>11.0441-4002.2</b>   | 250011 Dichtungssatz  |                | 220040 | <b>11.0441-4810.2</b> | 250023 Dichtungssatz  |
|   | 220031 | <b>11.8116-0066.1</b>   | 390577 Haltefeder     | 11.3481-0107.2 | 220041 | <b>11.0101-4802.2</b> | 260007 Hülsensatz     |
|   | 220031 | <b>11.8171-0008.1</b>   | 990049 Führungsbolzen |                |        |                       |                       |
| 11.3401-8505.2  | 220032 | <b>11.0101-5402.2</b>   | 260009 Hülsensatz     | 11.3481-0108.2 | 220042 | <b>11.0101-4802.2</b> | 260007 Hülsensatz     |
|   | 220032 | <b>11.0441-4002.2</b>   | 250011 Dichtungssatz  |                |        |                       |                       |
|   | 220032 | <b>11.8116-0094.1</b>   | 390504 Haltefeder     | 11.3481-0167.2 | 220285 | <b>11.0101-5407.2</b> | 260011 Hülsensatz     |
|   | 220032 | <b>11.8171-0008.1</b>   | 990049 Führungsbolzen |                | 220285 | <b>11.0441-4811.2</b> | 250024 Dichtungssatz  |
| 11.3401-8506.2  | 220033 | <b>11.0101-5402.2</b>   | 260009 Hülsensatz     | 11.3481-0168.2 | 220286 | <b>11.0101-5407.2</b> | 260011 Hülsensatz     |
|   | 220033 | <b>11.0441-4002.2</b>   | 250011 Dichtungssatz  |                | 220286 | <b>11.0441-4811.2</b> | 250024 Dichtungssatz  |
|   | 220033 | <b>11.8116-0094.1</b>   | 390504 Haltefeder     | 11.3481-8014.2 | 220045 | <b>11.0101-4802.2</b> | 260007 Hülsensatz     |
|   | 220033 | <b>11.8171-0008.1</b>   | 990049 Führungsbolzen |                | 220045 | <b>11.0441-4803.2</b> | 250018 Dichtungssatz  |
| 11.3401-8507.2  | 220034 | <b>11.0101-5402.2</b>   | 260009 Hülsensatz     | 11.3481-8015.2 | 220046 | <b>11.0101-4802.2</b> | 260007 Hülsensatz     |
|   | 220034 | <b>11.0441-4002.2</b>   | 250011 Dichtungssatz  |                | 220046 | <b>11.0441-4803.2</b> | 250018 Dichtungssatz  |
|   | 220034 | <b>11.8116-0296.1</b>   | 390445 Haltefeder     | 11.3481-8016.2 | 220047 | <b>11.0101-4802.2</b> | 260007 Hülsensatz     |
|   | 220034 | <b>11.8171-0008.1</b>   | 990049 Führungsbolzen |                | 220047 | <b>11.0441-4803.2</b> | 250018 Dichtungssatz  |
| 11.3401-8508.2  | 220035 | <b>11.0101-5402.2</b>   | 260009 Hülsensatz     | 11.3481-8029.2 | 220048 | <b>11.0101-4802.2</b> | 260007 Hülsensatz     |
|   | 220035 | <b>11.0441-4002.2</b>   | 250011 Dichtungssatz  |                | 220048 | <b>11.0441-4803.2</b> | 250018 Dichtungssatz  |
|   | 220035 | <b>11.8116-0296.1</b>   | 390445 Haltefeder     | 11.3481-8030.2 | 220049 | <b>11.0101-4802.2</b> | 260007 Hülsensatz     |
|   | 220035 | <b>11.8171-0008.1</b>   | 990049 Führungsbolzen |                | 220049 | <b>11.0441-4803.2</b> | 250018 Dichtungssatz  |
| 11.3401-8511.2  | 220026 | <b>11.0101-5402.2</b>   | 260009 Hülsensatz     | 11.3481-8037.2 | 220050 | <b>11.0101-5407.2</b> | 260011 Hülsensatz     |
|   | 220026 | <b>11.0441-4002.2</b>   | 250011 Dichtungssatz  |                | 220050 | <b>11.0441-4805.2</b> | 250020 Dichtungssatz  |
|   | 220026 | <b>11.8116-0296.1</b>   | 390445 Haltefeder     |                | 220050 | <b>11.8171-0008.1</b> | 990049 Führungsbolzen |
|   | 220026 | <b>11.8171-0008.1</b>   | 990049 Führungsbolzen | 11.3481-8038.2 | 220051 | <b>11.0101-5407.2</b> | 260011 Hülsensatz     |
| 11.3401-8512.2  | 220027 | <b>11.0101-5402.2</b>   | 260009 Hülsensatz     |                | 220051 | <b>11.0441-4805.2</b> | 250020 Dichtungssatz  |
|   | 220027 | <b>11.0441-4002.2</b>   | 250011 Dichtungssatz  |                | 220051 | <b>11.8171-0008.1</b> | 990049 Führungsbolzen |
|   | 220027 | <b>11.8116-0296.1</b>   | 390445 Haltefeder     | 11.3481-8075.2 | 220053 | <b>11.0101-5407.2</b> | 260011 Hülsensatz     |
|   | 220027 | <b>11.8171-0008.1</b>   | 990049 Führungsbolzen |                | 220053 | <b>11.0441-4811.2</b> | 250024 Dichtungssatz  |
| 11.3401-8513.2  | 220036 | <b>11.0101-5402.2</b>   | 260009 Hülsensatz     |                | 220053 | <b>11.8171-0008.1</b> | 990049 Führungsbolzen |
|   | 220036 | <b>11.0441-4002.2</b>   | 250011 Dichtungssatz  | 11.3481-8076.2 | 220054 | <b>11.0101-5407.2</b> | 260011 Hülsensatz     |
|   | 220036 | <b>11.8116-0315.2</b>   | 390447 Haltefeder     |                | 220054 | <b>11.0441-4811.2</b> | 250024 Dichtungssatz  |
|   | 220036 | <b>11.8171-0008.1</b>   | 990049 Führungsbolzen |                | 220054 | <b>11.8171-0008.1</b> | 990049 Führungsbolzen |
| 11.3401-8514.2  | 220037 | <b>11.0101-5402.2</b>   | 260009 Hülsensatz     | 11.3481-8083.2 | 220057 | <b>11.0101-5407.2</b> | 260011 Hülsensatz     |
|   | 220037 | <b>11.0441-4002.2</b>   | 250011 Dichtungssatz  |                | 220057 | <b>11.0441-4811.2</b> | 250024 Dichtungssatz  |
|   | 220037 | <b>11.8116-0315.2</b>   | 390447 Haltefeder     |                | 220057 | <b>11.8116-0129.1</b> | 390591 Haltefeder     |
|   | 220037 | <b>11.8171-0008.1</b>   | 990049 Führungsbolzen |                | 220057 | <b>11.8171-0008.1</b> | 990049 Führungsbolzen |
| 11.3421-8501.2  | 220405 | <b>11.0101-6004.2</b>   | 260014 Hülsensatz     | 11.3481-8084.2 | 220058 | <b>11.0101-5407.2</b> | 260011 Hülsensatz     |
|   | 220405 | <b>11.8116-0133.1</b>   | 390511 Haltefeder     |                | 220058 | <b>11.0441-4811.2</b> | 250024 Dichtungssatz  |
|   | 220405 | <b>11.8171-0008.1</b>   | 990049 Führungsbolzen |                | 220058 | <b>11.8116-0129.1</b> | 390591 Haltefeder     |
| 11.3421-8502.2  | 220406 | <b>11.0101-6004.2</b>   | 260014 Hülsensatz     |                | 220058 | <b>11.8171-0008.1</b> | 990049 Führungsbolzen |
|   | 220406 | <b>11.8116-0133.1</b>   | 390511 Haltefeder     | 11.3481-8085.2 | 220059 | <b>11.0101-5407.2</b> | 260011 Hülsensatz     |
|   | 220406 | <b>11.8171-0008.1</b>   | 990049 Führungsbolzen |                | 220059 | <b>11.0441-4811.2</b> | 250024 Dichtungssatz  |
| 11.3451-8501.2  | 220389 | <b>11.0101-5407.2</b>   | 260011 Hülsensatz     |                | 220059 | <b>11.8116-0129.1</b> | 390591 Haltefeder     |
|   | 220389 | <b>11.0101-5409.2</b>   | 260035 Hülsensatz     |                | 220059 | <b>11.8171-0008.1</b> | 990049 Führungsbolzen |
|   | 220389 | <b>11.0441-4502.2</b>   | 250143 Dichtungssatz  | 11.3481-8086.2 | 220060 | <b>11.0101-5407.2</b> | 260011 Hülsensatz     |
|   | 220389 | <b>11.8116-0172.1</b>   | 390500 Haltefeder     |                | 220060 | <b>11.0441-4811.2</b> | 250024 Dichtungssatz  |
|   | 220389 | <b>11.8171-0008.1</b>   | 990049 Führungsbolzen |                | 220060 | <b>11.8116-0129.1</b> | 390591 Haltefeder     |
| 11.3451-8502.2  | 220390 | <b>11.0101-5407.2</b>   | 260011 Hülsensatz     |                | 220060 | <b>11.8171-0008.1</b> | 990049 Führungsbolzen |
|   | 220390 | <b>11.0101-5409.2</b>   | 260035 Hülsensatz     |                |        |                       |                       |
|   | 220390 | <b>11.0441-4502.2</b>   | 250143 Dichtungssatz  |                |        |                       |                       |
|   | 220390 | <b>11.8116-0172.1</b>   | 390500 Haltefeder     |                |        |                       |                       |
|   | 220390 | <b>11.8171-0008.1</b>   | 990049 Führungsbolzen |                |        |                       |                       |

# Reparatursätze







Repair kits - Corredi riparazione - Nécessaires de réparation - Juegos de reparación

|    |        |  |    |        |   |
|---|--------|--|---|--------|---|
| 11.3481-8503.2  | 220061 | <b>11.0101-4801.2</b> 260006 Hülsensatz            | 11.3481-9834.2  | 220562 | <b>11.0101-5407.2</b> 260011 Hülsensatz     |
|   | 220061 | <b>11.0441-4804.2</b> 250019 Dichts.a.(+Sich.Ring) |   | 220562 | <b>11.0441-4811.2</b> 250024 Dichtungssatz  |
|   | 220061 | <b>11.0441-4808.2</b> 250022 Dichtungssatz         |   | 220562 | <b>11.8116-0129.1</b> 390591 Haltefeder     |
|   | 220061 | <b>24.0102-4801.2</b> 260085 Hülsensatz+Schrauben  |   | 220562 | <b>11.8171-0008.1</b> 990049 Führungsbolzen |
| 11.3481-8504.2  | 220062 | <b>11.0101-4801.2</b> 260006 Hülsensatz            | 11.3521-8003.2  | 220070 | <b>11.0101-4802.2</b> 260007 Hülsensatz     |
|   | 220062 | <b>11.0441-4804.2</b> 250019 Dichts.a.(+Sich.Ring) |   |        |   |
|   | 220062 | <b>11.0441-4808.2</b> 250022 Dichtungssatz         | 11.3521-8004.2  | 220071 | <b>11.0101-4802.2</b> 260007 Hülsensatz     |
|   | 220062 | <b>24.0102-4801.2</b> 260085 Hülsensatz+Schrauben  |   |        |   |
| 11.3481-8505.2  | 220063 | <b>11.0101-5407.2</b> 260011 Hülsensatz            | 11.3521-8011.2  | 220072 | <b>11.0441-5202.2</b> 250026 Dichtungssatz  |
|   | 220063 | <b>11.0441-4805.2</b> 250020 Dichtungssatz         |   |        |   |
|   | 220063 | <b>11.8171-0008.1</b> 990049 Führungsbolzen        | 11.3521-8012.2  | 220073 | <b>11.0441-5202.2</b> 250026 Dichtungssatz  |
| 11.3481-8506.2  | 220064 | <b>11.0101-5407.2</b> 260011 Hülsensatz            | 11.3521-8501.2  | 220391 | <b>11.0101-5407.2</b> 260011 Hülsensatz     |
|   | 220064 | <b>11.0441-4805.2</b> 250020 Dichtungssatz         |   | 220391 | <b>11.0101-5409.2</b> 260035 Hülsensatz     |
|   | 220064 | <b>11.8171-0008.1</b> 990049 Führungsbolzen        |   | 220391 | <b>11.0441-5203.2</b> 250144 Dichtungssatz  |
|   |        |  |   | 220391 | <b>11.8116-0191.1</b> 390522 Haltefeder     |
|   |        |  |   | 220391 | <b>11.8171-0008.1</b> 990049 Führungsbolzen |
| 11.3481-8507.2  | 220065 | <b>11.0101-5402.2</b> 260009 Hülsensatz            | 11.3521-8502.2  | 220392 | <b>11.0101-5407.2</b> 260011 Hülsensatz     |
|   | 220065 | <b>11.0441-4810.2</b> 250023 Dichtungssatz         |   | 220392 | <b>11.0101-5409.2</b> 260035 Hülsensatz     |
|   | 220065 | <b>11.8171-0008.1</b> 990049 Führungsbolzen        |   | 220392 | <b>11.0441-5203.2</b> 250144 Dichtungssatz  |
| 11.3481-8508.2  | 220066 | <b>11.0101-5402.2</b> 260009 Hülsensatz            |   | 220392 | <b>11.8116-0191.1</b> 390522 Haltefeder     |
|   | 220066 | <b>11.0441-4810.2</b> 250023 Dichtungssatz         |   | 220392 | <b>11.8171-0008.1</b> 990049 Führungsbolzen |
|   | 220066 | <b>11.8171-0008.1</b> 990049 Führungsbolzen        | 11.3541-0257.2  | 220074 | <b>11.0101-5407.2</b> 260011 Hülsensatz     |
| 11.3481-8509.2  | 220329 | <b>11.0101-4801.2</b> 260006 Hülsensatz            |   | 220074 | <b>11.8171-0008.1</b> 990049 Führungsbolzen |
|   | 220329 | <b>11.0441-4808.2</b> 250022 Dichtungssatz         | 11.3541-0258.2  | 220075 | <b>11.0101-5407.2</b> 260011 Hülsensatz     |
|   | 220329 | <b>24.0102-4801.2</b> 260085 Hülsensatz+Schrauben  |   | 220075 | <b>11.8171-0008.1</b> 990049 Führungsbolzen |
| 11.3481-8510.2  | 220330 | <b>11.0101-4801.2</b> 260006 Hülsensatz            | 11.3541-8017.2  | 220076 | <b>11.0101-5407.2</b> 260011 Hülsensatz     |
|   | 220330 | <b>11.0441-4808.2</b> 250022 Dichtungssatz         |   | 220076 | <b>11.0441-5402.2</b> 250028 Dichtungssatz  |
|   | 220330 | <b>24.0102-4801.2</b> 260085 Hülsensatz+Schrauben  |   | 220076 | <b>11.8171-0008.1</b> 990049 Führungsbolzen |
| 11.3481-8511.2  | 220337 | <b>11.0101-5407.2</b> 260011 Hülsensatz            | 11.3541-8018.2  | 220077 | <b>11.0101-5407.2</b> 260011 Hülsensatz     |
|   | 220337 | <b>11.0441-4805.2</b> 250020 Dichtungssatz         |   | 220077 | <b>11.0441-5402.2</b> 250028 Dichtungssatz  |
|   | 220337 | <b>11.8171-0008.1</b> 990049 Führungsbolzen        |   | 220077 | <b>11.8171-0008.1</b> 990049 Führungsbolzen |
| 11.3481-8512.2  | 220338 | <b>11.0101-5407.2</b> 260011 Hülsensatz            | 11.3541-8039.2  | 220078 | <b>11.0441-5404.2</b> 250029 Dichtungssatz  |
|   | 220338 | <b>11.0441-4805.2</b> 250020 Dichtungssatz         |   |        |   |
|   | 220338 | <b>11.8171-0008.1</b> 990049 Führungsbolzen        | 11.3541-8040.2  | 220079 | <b>11.0441-5404.2</b> 250029 Dichtungssatz  |
| 11.3481-8513.2  | 220335 | <b>11.0101-5407.2</b> 260011 Hülsensatz            | 11.3541-8045.2  | 220080 | <b>11.0101-5407.2</b> 260011 Hülsensatz     |
|   | 220335 | <b>11.0230-0165.2</b> 260073 Haltersatz            |   | 220080 | <b>11.0441-5405.2</b> 250030 Dichtungssatz  |
|   | 220335 | <b>11.0441-4805.2</b> 250020 Dichtungssatz         |   | 220080 | <b>11.8171-0008.1</b> 990049 Führungsbolzen |
|   | 220335 | <b>11.8116-0264.1</b> 390594 Haltefeder            | 11.3541-8061.2  | 220081 | <b>11.0101-5407.2</b> 260011 Hülsensatz     |
|   | 220335 | <b>11.8171-0008.1</b> 990049 Führungsbolzen        |   | 220081 | <b>11.0441-5402.2</b> 250028 Dichtungssatz  |
| 11.3481-8514.2  | 220336 | <b>11.0101-5407.2</b> 260011 Hülsensatz            |   | 220081 | <b>11.8171-0008.1</b> 990049 Führungsbolzen |
|   | 220336 | <b>11.0230-0165.2</b> 260073 Haltersatz            | 11.3541-8062.2  | 220082 | <b>11.0101-5407.2</b> 260011 Hülsensatz     |
|   | 220336 | <b>11.0441-4805.2</b> 250020 Dichtungssatz         |   | 220082 | <b>11.0441-5402.2</b> 250028 Dichtungssatz  |
|   | 220336 | <b>11.8116-0264.1</b> 390594 Haltefeder            |   | 220082 | <b>11.8171-0008.1</b> 990049 Führungsbolzen |
|   | 220336 | <b>11.8171-0008.1</b> 990049 Führungsbolzen        | 11.3541-8065.2  | 220083 | <b>11.0441-5404.2</b> 250029 Dichtungssatz  |
| 11.3481-8515.2  | 220365 | <b>11.0101-5407.2</b> 260011 Hülsensatz            |   |        |   |
|   | 220365 | <b>11.8116-0264.1</b> 390594 Haltefeder            | 11.3541-8066.2  | 220084 | <b>11.0441-5404.2</b> 250029 Dichtungssatz  |
|   | 220365 | <b>11.8171-0008.1</b> 990049 Führungsbolzen        |   |        |   |
| 11.3481-8516.2  | 220366 | <b>11.0101-5407.2</b> 260011 Hülsensatz            | 11.3541-8067.2  | 220085 | <b>11.0101-5407.2</b> 260011 Hülsensatz     |
|   | 220366 | <b>11.8116-0264.1</b> 390594 Haltefeder            |   | 220085 | <b>11.0441-5405.2</b> 250030 Dichtungssatz  |
|   | 220366 | <b>11.8171-0008.1</b> 990049 Führungsbolzen        | 11.3541-8068.2  | 220086 | <b>11.0101-5407.2</b> 260011 Hülsensatz     |
| 11.3481-9833.2  | 220561 | <b>11.0101-5407.2</b> 260011 Hülsensatz            |   | 220086 | <b>11.0441-5405.2</b> 250030 Dichtungssatz  |
|   | 220561 | <b>11.0441-4811.2</b> 250024 Dichtungssatz         | 11.3541-8083.2  | 220241 | <b>11.0101-5407.2</b> 260011 Hülsensatz     |
|   | 220561 | <b>11.8116-0129.1</b> 390591 Haltefeder            |   | 220241 | <b>11.8116-0292.1</b> 390521 Haltefeder     |
|   | 220561 | <b>11.8171-0008.1</b> 990049 Führungsbolzen        |   | 220241 | <b>11.8171-0008.1</b> 990049 Führungsbolzen |









# Reparatursätze

Repair kits - Corredi riparazione - Nécessaires de réparation - Juegos de reparación

|    |        |                                      |    |        |                                      |
|---|--------|--------------------------------------|---|--------|--------------------------------------|
| 11.3541-8084.2  | 220242 | 11.0101-5407.2 260011 Hülsensatz     | 11.3541-8507.2  | 220099 | 11.0101-5407.2 260011 Hülsensatz     |
|   | 220242 | 11.8116-0292.1 390521 Haltefeder     |   | 220099 | 11.0441-5402.2 250028 Dichtungssatz  |
|   | 220242 | 11.8171-0008.1 990049 Führungsbolzen |   | 220099 | 11.8171-0008.1 990049 Führungsbolzen |
| 11.3541-8085.2  | 220287 | 11.0101-5407.2 260011 Hülsensatz     | 11.3541-8508.2  | 220100 | 11.0101-5407.2 260011 Hülsensatz     |
|   | 220287 | 11.8116-0129.1 390591 Haltefeder     |   | 220100 | 11.0441-5402.2 250028 Dichtungssatz  |
|   | 220287 | 11.8116-0292.1 390521 Haltefeder     |   | 220100 | 11.8171-0008.1 990049 Führungsbolzen |
|   | 220287 | 11.8171-0008.1 990049 Führungsbolzen |   |        |                                      |
| 11.3541-8086.2  | 220288 | 11.0101-5407.2 260011 Hülsensatz     | 11.3541-8509.2  | 220101 | 11.0101-5407.2 260011 Hülsensatz     |
|   | 220288 | 11.8116-0129.1 390591 Haltefeder     |   | 220101 | 11.0441-5402.2 250028 Dichtungssatz  |
|   | 220288 | 11.8116-0292.1 390521 Haltefeder     |   | 220101 | 11.8171-0008.1 990049 Führungsbolzen |
|   | 220288 | 11.8171-0008.1 990049 Führungsbolzen |   |        |                                      |
| 11.3541-8089.2  | 220087 | 11.0101-5407.2 260011 Hülsensatz     | 11.3541-8510.2  | 220102 | 11.0101-5407.2 260011 Hülsensatz     |
|   | 220087 | 11.0441-5402.2 250028 Dichtungssatz  |   | 220102 | 11.0441-5402.2 250028 Dichtungssatz  |
|   | 220087 | 11.8171-0008.1 990049 Führungsbolzen |   | 220102 | 11.8171-0008.1 990049 Führungsbolzen |
| 11.3541-8090.2  | 220088 | 11.0101-5407.2 260011 Hülsensatz     | 11.3541-8511.2  | 220103 | 11.0101-5402.2 260009 Hülsensatz     |
|   | 220088 | 11.0441-5402.2 250028 Dichtungssatz  |   | 220103 | 11.0441-5402.2 250028 Dichtungssatz  |
|   | 220088 | 11.8171-0008.1 990049 Führungsbolzen |   | 220103 | 11.8116-0091.1 390502 Haltefeder     |
|   |        |                                      |   | 220103 | 11.8171-0008.1 990049 Führungsbolzen |
| 11.3541-8091.2  | 220089 | 11.0101-5407.2 260011 Hülsensatz     | 11.3541-8512.2  | 220104 | 11.0101-5402.2 260009 Hülsensatz     |
|   | 220089 | 11.0441-5402.2 250028 Dichtungssatz  |   | 220104 | 11.0441-5402.2 250028 Dichtungssatz  |
|   | 220089 | 11.8171-0008.1 990049 Führungsbolzen |   | 220104 | 11.8116-0091.1 390502 Haltefeder     |
|   |        |                                      |   | 220104 | 11.8171-0008.1 990049 Führungsbolzen |
| 11.3541-8092.2  | 220090 | 11.0101-5407.2 260011 Hülsensatz     | 11.3541-8513.2  | 220105 | 11.0101-5402.2 260009 Hülsensatz     |
|   | 220090 | 11.0441-5402.2 250028 Dichtungssatz  |   | 220105 | 11.0441-5402.2 250028 Dichtungssatz  |
|   | 220090 | 11.8171-0008.1 990049 Führungsbolzen |   | 220105 | 11.8170-0729.1 260107 Halter         |
|   |        |                                      |   | 220105 | 11.8171-0008.1 990049 Führungsbolzen |
| 11.3541-8101.2  | 220091 | 11.0101-5407.2 260011 Hülsensatz     | 11.3541-8514.2  | 220106 | 11.0101-5402.2 260009 Hülsensatz     |
|   | 220091 | 11.0441-5402.2 250028 Dichtungssatz  |   | 220106 | 11.0441-5402.2 250028 Dichtungssatz  |
|   | 220091 | 11.8116-0097.1 390590 Haltefeder     |   | 220106 | 11.8170-0729.1 260107 Halter         |
|   | 220091 | 11.8171-0008.1 990049 Führungsbolzen |   | 220106 | 11.8171-0008.1 990049 Führungsbolzen |
| 11.3541-8102.2  | 220092 | 11.0101-5407.2 260011 Hülsensatz     | 11.3541-8515.2  | 220107 | 11.0101-5402.2 260009 Hülsensatz     |
|   | 220092 | 11.0441-5402.2 250028 Dichtungssatz  |   | 220107 | 11.0441-5402.2 250028 Dichtungssatz  |
|   | 220092 | 11.8116-0097.1 390590 Haltefeder     |   | 220107 | 11.8171-0008.1 990049 Führungsbolzen |
|   | 220092 | 11.8171-0008.1 990049 Führungsbolzen |   |        |                                      |
| 11.3541-8105.2  | 220339 | 11.0101-5407.2 260011 Hülsensatz     | 11.3541-8516.2  | 220108 | 11.0101-5402.2 260009 Hülsensatz     |
|   | 220339 | 11.8171-0008.1 990049 Führungsbolzen |   | 220108 | 11.0441-5402.2 250028 Dichtungssatz  |
|   |        |                                      |   | 220108 | 11.8171-0008.1 990049 Führungsbolzen |
| 11.3541-8106.2  | 220340 | 11.0101-5407.2 260011 Hülsensatz     | 11.3541-8517.2  | 220109 | 11.0101-5402.2 260009 Hülsensatz     |
|   | 220340 | 11.8171-0008.1 990049 Führungsbolzen |   | 220109 | 11.0441-5402.2 250028 Dichtungssatz  |
|   |        |                                      |   | 220109 | 11.8116-0091.1 390502 Haltefeder     |
|   |        |                                      |   | 220109 | 11.8171-0008.1 990049 Führungsbolzen |
| 11.3541-8501.2  | 220093 | 11.0101-5409.2 260035 Hülsensatz     | 11.3541-8518.2  | 220110 | 11.0101-5402.2 260009 Hülsensatz     |
|   | 220093 | 11.0441-5405.2 250030 Dichtungssatz  |   | 220110 | 11.0441-5402.2 250028 Dichtungssatz  |
|   | 220093 | 11.8171-0008.1 990049 Führungsbolzen |   | 220110 | 11.8116-0091.1 390502 Haltefeder     |
|   |        |                                      |   | 220110 | 11.8171-0008.1 990049 Führungsbolzen |
| 11.3541-8502.2  | 220094 | 11.0101-5409.2 260035 Hülsensatz     | 11.3541-8519.2  | 220111 | 11.0101-5409.2 260035 Hülsensatz     |
|   | 220094 | 11.0441-5405.2 250030 Dichtungssatz  |   | 220111 | 11.0441-5405.2 250030 Dichtungssatz  |
|   | 220094 | 11.8171-0008.1 990049 Führungsbolzen |   |        |                                      |
| 11.3541-8503.2  | 220095 | 11.0101-5409.2 260035 Hülsensatz     | 11.3541-8520.2  | 220112 | 11.0101-5409.2 260035 Hülsensatz     |
|   | 220095 | 11.0441-5405.2 250030 Dichtungssatz  |   | 220112 | 11.0441-5405.2 250030 Dichtungssatz  |
|   | 220095 | 11.8171-0008.1 990049 Führungsbolzen |   |        |                                      |
| 11.3541-8504.2  | 220096 | 11.0101-5409.2 260035 Hülsensatz     | 11.3541-8521.2  | 220113 | 11.0101-5409.2 260035 Hülsensatz     |
|   | 220096 | 11.0441-5405.2 250030 Dichtungssatz  |   | 220113 | 11.0441-5405.2 250030 Dichtungssatz  |
|   | 220096 | 11.8171-0008.1 990049 Führungsbolzen |   |        |                                      |
| 11.3541-8505.2  | 220097 | 11.0101-5407.2 260011 Hülsensatz     | 11.3541-8522.2  | 220114 | 11.0101-5409.2 260035 Hülsensatz     |
|   | 220097 | 11.0441-5402.2 250028 Dichtungssatz  |   | 220114 | 11.0441-5405.2 250030 Dichtungssatz  |
|   | 220097 | 11.8171-0008.1 990049 Führungsbolzen |   |        |                                      |
| 11.3541-8506.2  | 220098 | 11.0101-5407.2 260011 Hülsensatz     |   |        |                                      |
|   | 220098 | 11.0441-5402.2 250028 Dichtungssatz  |   |        |                                      |
|   | 220098 | 11.8171-0008.1 990049 Führungsbolzen |   |        |                                      |







# Reparatursätze

Repair kits - Corredi riparazione - Nécessaires de réparation - Juegos de reparación

|    |        |    |                       |                |        |                |                       |
|---|--------|---|-----------------------|----------------|--------|----------------|-----------------------|
| 11.3541-8523.2  | 220115 | 11.0101-5409.2  | 260035 Hülsensatz     | 11.3571-8505.2 | 220125 | 11.0101-5409.2 | 260035 Hülsensatz     |
|   | 220115 | 11.0441-5409.2  | 250031 Dichtungssatz  |                | 220125 | 11.0441-5704.2 | 250034 Dichtungssatz  |
|   | 220115 | 11.8116-0143.1  | 390513 Haltefeder     |                | 220125 | 11.8116-0143.1 | 390513 Haltefeder     |
|   | 220115 | 11.8170-0306.1  | 260102 Halter         |                | 220125 | 11.8171-0008.1 | 990049 Führungsbolzen |
|   | 220115 | 11.8171-0008.1  | 990049 Führungsbolzen |                |        |                |                       |
| 11.3541-8524.2  | 220116 | 11.0101-5409.2  | 260035 Hülsensatz     | 11.3571-8506.2 | 220126 | 11.0101-5409.2 | 260035 Hülsensatz     |
|   | 220116 | 11.0441-5409.2  | 250031 Dichtungssatz  |                | 220126 | 11.0441-5704.2 | 250034 Dichtungssatz  |
|   | 220116 | 11.8116-0143.1  | 390513 Haltefeder     |                | 220126 | 11.8116-0143.1 | 390513 Haltefeder     |
|   | 220116 | 11.8170-0306.1  | 260102 Halter         |                | 220126 | 11.8171-0008.1 | 990049 Führungsbolzen |
|   | 220116 | 11.8171-0008.1  | 990049 Führungsbolzen |                |        |                |                       |
| 11.3541-8529.2  | 220341 | 11.0101-5407.2  | 260011 Hülsensatz     | 11.3571-8507.2 | 220127 | 11.0101-5409.2 | 260035 Hülsensatz     |
|   | 220341 | 11.0441-5402.2  | 250028 Dichtungssatz  |                | 220127 | 11.0441-5704.2 | 250034 Dichtungssatz  |
|   | 220341 | 11.8116-0264.1  | 390594 Haltefeder     |                | 220127 | 11.8116-0143.1 | 390513 Haltefeder     |
|   | 220341 | 11.8171-0008.1  | 990049 Führungsbolzen |                | 220127 | 11.8170-0306.1 | 260102 Halter         |
|   |        |   |                       |                | 220127 | 11.8171-0008.1 | 990049 Führungsbolzen |
| 11.3541-8530.2  | 220342 | 11.0101-5407.2  | 260011 Hülsensatz     | 11.3571-8508.2 | 220128 | 11.0101-5409.2 | 260035 Hülsensatz     |
|   | 220342 | 11.0441-5402.2  | 250028 Dichtungssatz  |                | 220128 | 11.0441-5704.2 | 250034 Dichtungssatz  |
|   | 220342 | 11.8116-0264.1  | 390594 Haltefeder     |                | 220128 | 11.8116-0143.1 | 390513 Haltefeder     |
|   | 220342 | 11.8171-0008.1  | 990049 Führungsbolzen |                | 220128 | 11.8170-0306.1 | 260102 Halter         |
|   |        |   |                       |                | 220128 | 11.8171-0008.1 | 990049 Führungsbolzen |
| 11.3541-8531.2  | 220367 | 11.0101-5407.2  | 260011 Hülsensatz     | 11.3571-8509.2 | 220313 | 11.0101-5407.2 | 260011 Hülsensatz     |
|   | 220367 | 11.8116-0264.1  | 390594 Haltefeder     |                | 220313 | 11.0441-5703.2 | 250145 Dichtungssatz  |
|   | 220367 | 11.8116-0356.1  | 390586 Haltefeder     |                | 220313 | 11.8116-0253.1 | 390512 Haltefeder     |
|   | 220367 | 11.8171-0008.1  | 990049 Führungsbolzen |                | 220313 | 11.8171-0008.1 | 990049 Führungsbolzen |
|   |        |   |                       |                |        |                |                       |
| 11.3541-8532.2  | 220368 | 11.0101-5407.2  | 260011 Hülsensatz     | 11.3571-8510.2 | 220314 | 11.0101-5407.2 | 260011 Hülsensatz     |
|   | 220368 | 11.8116-0264.1  | 390594 Haltefeder     |                | 220314 | 11.0441-5703.2 | 250145 Dichtungssatz  |
|   | 220368 | 11.8116-0356.1  | 390586 Haltefeder     |                | 220314 | 11.8116-0253.1 | 390512 Haltefeder     |
|   | 220368 | 11.8171-0008.1  | 990049 Führungsbolzen |                | 220314 | 11.8171-0008.1 | 990049 Führungsbolzen |
|   |        |   |                       |                |        |                |                       |
| 11.3571-8007.2  | 220117 | 11.0101-5407.2  | 260011 Hülsensatz     | 11.3571-8511.2 | 220315 | 11.0101-5407.2 | 260011 Hülsensatz     |
|   | 220117 | 11.0441-5702.2  | 250033 Dichtungssatz  |                | 220315 | 11.0230-0096.2 | 260033 Haltersatz     |
|   | 220117 | 11.8116-0073.1  | 390498 Haltefeder     |                | 220315 | 11.0441-5703.2 | 250145 Dichtungssatz  |
|   | 220117 | 11.8171-0008.1  | 990049 Führungsbolzen |                | 220315 | 11.8116-0253.1 | 390512 Haltefeder     |
|   |        |   |                       |                | 220315 | 11.8171-0008.1 | 990049 Führungsbolzen |
| 11.3571-8008.2  | 220118 | 11.0101-5407.2  | 260011 Hülsensatz     | 11.3571-8512.2 | 220316 | 11.0101-5407.2 | 260011 Hülsensatz     |
|   | 220118 | 11.0441-5702.2  | 250033 Dichtungssatz  |                | 220316 | 11.0230-0096.2 | 260033 Haltersatz     |
|   | 220118 | 11.8116-0073.1  | 390498 Haltefeder     |                | 220316 | 11.0441-5703.2 | 250145 Dichtungssatz  |
|   | 220118 | 11.8171-0008.1  | 990049 Führungsbolzen |                | 220316 | 11.8116-0253.1 | 390512 Haltefeder     |
|   |        |   |                       |                | 220316 | 11.8171-0008.1 | 990049 Führungsbolzen |
| 11.3571-8009.2  | 220119 | 11.0101-5407.2  | 260011 Hülsensatz     | 11.3571-8515.2 | 220333 | 11.0101-5409.2 | 260035 Hülsensatz     |
|   | 220119 | 11.0441-5702.2  | 250033 Dichtungssatz  |                | 220333 | 11.0441-5704.2 | 250034 Dichtungssatz  |
|   |        |   |                       |                | 220333 | 11.8116-0237.1 | 390509 Haltefeder     |
|   |        |   |                       |                | 220333 | 11.8171-0008.1 | 990049 Führungsbolzen |
| 11.3571-8010.2  | 220120 | 11.0101-5407.2  | 260011 Hülsensatz     | 11.3571-8516.2 | 220334 | 11.0101-5409.2 | 260035 Hülsensatz     |
|   | 220120 | 11.0441-5702.2  | 250033 Dichtungssatz  |                | 220334 | 11.0441-5704.2 | 250034 Dichtungssatz  |
|   |        |   |                       |                | 220334 | 11.8116-0237.1 | 390509 Haltefeder     |
|   |        |   |                       |                | 220334 | 11.8171-0008.1 | 990049 Führungsbolzen |
| 11.3571-8501.2  | 220121 | 11.0101-5402.2  | 260009 Hülsensatz     | 11.3571-8517.2 | 220321 | 11.0101-5409.2 | 260035 Hülsensatz     |
|   | 220121 | 11.0101-5407.2  | 260011 Hülsensatz     |                | 220321 | 11.0441-5704.2 | 250034 Dichtungssatz  |
|   | 220121 | 11.0441-5702.2  | 250033 Dichtungssatz  |                | 220321 | 11.8116-0143.1 | 390513 Haltefeder     |
|   | 220121 | 11.8116-0091.1  | 390502 Haltefeder     |                | 220321 | 11.8171-0008.1 | 990049 Führungsbolzen |
|   | 220121 | 11.8171-0008.1  | 990049 Führungsbolzen |                |        |                |                       |
| 11.3571-8502.2  | 220122 | 11.0101-5402.2  | 260009 Hülsensatz     | 11.3571-8518.2 | 220322 | 11.0101-5409.2 | 260035 Hülsensatz     |
|   | 220122 | 11.0101-5407.2  | 260011 Hülsensatz     |                | 220322 | 11.0441-5704.2 | 250034 Dichtungssatz  |
|   | 220122 | 11.0441-5702.2  | 250033 Dichtungssatz  |                | 220322 | 11.8116-0143.1 | 390513 Haltefeder     |
|   | 220122 | 11.8116-0091.1  | 390502 Haltefeder     |                | 220322 | 11.8171-0008.1 | 990049 Führungsbolzen |
|   | 220122 | 11.8171-0008.1  | 990049 Führungsbolzen |                |        |                |                       |
| 11.3571-8503.2  | 220123 | 11.0101-5402.2  | 260009 Hülsensatz     | 11.3571-8521.2 | 220319 | 11.0101-5409.2 | 260035 Hülsensatz     |
|   | 220123 | 11.0441-5702.2  | 250033 Dichtungssatz  |                | 220319 | 11.0441-5704.2 | 250034 Dichtungssatz  |
|   | 220123 | 11.8116-0091.1  | 390502 Haltefeder     |                | 220319 | 11.8116-0143.1 | 390513 Haltefeder     |
|   | 220123 | 11.8171-0008.1  | 990049 Führungsbolzen |                | 220319 | 11.8170-0306.1 | 260102 Halter         |
|   |        |   |                       |                | 220319 | 11.8171-0008.1 | 990049 Führungsbolzen |
| 11.3571-8504.2  | 220124 | 11.0101-5402.2  | 260009 Hülsensatz     |                |        |                |                       |
|   | 220124 | 11.0441-5702.2  | 250033 Dichtungssatz  |                |        |                |                       |
|   | 220124 | 11.8116-0091.1  | 390502 Haltefeder     |                |        |                |                       |
|   | 220124 | 11.8171-0008.1  | 990049 Führungsbolzen |                |        |                |                       |

# Reparatursätze







Repair kits - Corredi riparazione - Nécessaires de réparation - Juegos de reparación

|    |        |   |    |        |   |
|---|--------|---|---|--------|---|
| 11.3571-8522.2  | 220320 | <b>11.0101-5409.2</b> 260035 Hülsensatz     | 11.3601-8065.2  | 220137 | <b>11.0101-5407.2</b> 260011 Hülsensatz     |
|   | 220320 | <b>11.0441-5704.2</b> 250034 Dichtungssatz  |   | 220137 | <b>11.0441-6003.2</b> 250037 Dichtungssatz  |
|   | 220320 | <b>11.8116-0143.1</b> 390513 Haltefeder     |   | 220137 | <b>11.8171-0008.1</b> 990049 Führungsbolzen |
|   | 220320 | <b>11.8170-0306.1</b> 260102 Halter         | 11.3601-8066.2  | 220138 | <b>11.0101-5407.2</b> 260011 Hülsensatz     |
|   | 220320 | <b>11.8171-0008.1</b> 990049 Führungsbolzen |   | 220138 | <b>11.0441-6003.2</b> 250037 Dichtungssatz  |
|   |        |   |   | 220138 | <b>11.8171-0008.1</b> 990049 Führungsbolzen |
| 11.3571-8523.2  | 220343 | <b>11.0101-5407.2</b> 260011 Hülsensatz     | 11.3601-8067.2  | 220139 | <b>11.0101-5407.2</b> 260011 Hülsensatz     |
|   | 220343 | <b>11.0101-5409.2</b> 260035 Hülsensatz     |   | 220139 | <b>11.0441-6005.2</b> 250150 Dichtungssatz  |
|   | 220343 | <b>11.0441-5704.2</b> 250034 Dichtungssatz  |   | 220139 | <b>11.8171-0008.1</b> 990049 Führungsbolzen |
|   | 220343 | <b>11.8116-0143.1</b> 390513 Haltefeder     | 11.3601-8068.2  | 220140 | <b>11.0101-5407.2</b> 260011 Hülsensatz     |
|   | 220343 | <b>11.8171-0008.1</b> 990049 Führungsbolzen |   | 220140 | <b>11.0441-6005.2</b> 250150 Dichtungssatz  |
| 11.3571-8524.2  | 220344 | <b>11.0101-5407.2</b> 260011 Hülsensatz     |   | 220140 | <b>11.8171-0008.1</b> 990049 Führungsbolzen |
|   | 220344 | <b>11.0101-5409.2</b> 260035 Hülsensatz     | 11.3601-8071.2  | 220141 | <b>11.0101-5407.2</b> 260011 Hülsensatz     |
|   | 220344 | <b>11.0441-5704.2</b> 250034 Dichtungssatz  |   | 220141 | <b>11.0230-0170.2</b> 260078 Haltersatz     |
|   | 220344 | <b>11.8116-0143.1</b> 390513 Haltefeder     |   | 220141 | <b>11.0441-6005.2</b> 250150 Dichtungssatz  |
|   | 220344 | <b>11.8171-0008.1</b> 990049 Führungsbolzen |   | 220141 | <b>11.8171-0008.1</b> 990049 Führungsbolzen |
| 11.3571-8525.2  | 220363 | <b>11.0101-5407.2</b> 260011 Hülsensatz     | 11.3601-8072.2  | 220142 | <b>11.0101-5407.2</b> 260011 Hülsensatz     |
|   | 220363 | <b>11.0441-5704.2</b> 250034 Dichtungssatz  |   | 220142 | <b>11.0230-0170.2</b> 260078 Haltersatz     |
|   | 220363 | <b>11.8116-0292.1</b> 390521 Haltefeder     |   | 220142 | <b>11.0441-6005.2</b> 250150 Dichtungssatz  |
|   | 220363 | <b>11.8171-0008.1</b> 990049 Führungsbolzen |   | 220142 | <b>11.8171-0008.1</b> 990049 Führungsbolzen |
| 11.3571-8526.2  | 220364 | <b>11.0101-5407.2</b> 260011 Hülsensatz     | 11.3601-8073.2  | 220143 | <b>11.0101-5407.2</b> 260011 Hülsensatz     |
|   | 220364 | <b>11.0441-5704.2</b> 250034 Dichtungssatz  |   | 220143 | <b>11.0441-6005.2</b> 250150 Dichtungssatz  |
|   | 220364 | <b>11.8116-0292.1</b> 390521 Haltefeder     |   | 220143 | <b>11.8171-0008.1</b> 990049 Führungsbolzen |
|   | 220364 | <b>11.8171-0008.1</b> 990049 Führungsbolzen | 11.3601-8074.2  | 220144 | <b>11.0101-5407.2</b> 260011 Hülsensatz     |
| 11.3601-0011.2  | 220129 | <b>11.0101-5407.2</b> 260011 Hülsensatz     |   | 220144 | <b>11.0441-6005.2</b> 250150 Dichtungssatz  |
|   | 220129 | <b>11.0441-6003.2</b> 250037 Dichtungssatz  |   | 220144 | <b>11.8171-0008.1</b> 990049 Führungsbolzen |
|   | 220129 | <b>11.8171-0008.1</b> 990049 Führungsbolzen | 11.3601-8074.2  | 220144 | <b>11.0101-5407.2</b> 260011 Hülsensatz     |
| 11.3601-0012.2  | 220130 | <b>11.0101-5407.2</b> 260011 Hülsensatz     |   | 220144 | <b>11.0441-6005.2</b> 250150 Dichtungssatz  |
|   | 220130 | <b>11.0441-6003.2</b> 250037 Dichtungssatz  |   | 220144 | <b>11.8171-0008.1</b> 990049 Führungsbolzen |
|   | 220130 | <b>11.8171-0008.1</b> 990049 Führungsbolzen | 11.3601-8501.2  | 220145 | <b>11.0101-5402.2</b> 260009 Hülsensatz     |
| 11.3601-0073.2  | 220131 | <b>11.0101-5407.2</b> 260011 Hülsensatz     |   | 220145 | <b>11.0230-0020.2</b> 260023 Haltersatz     |
|   | 220131 | <b>11.0441-6003.2</b> 250037 Dichtungssatz  |   | 220145 | <b>11.0441-6003.2</b> 250037 Dichtungssatz  |
|   | 220131 | <b>11.8171-0008.1</b> 990049 Führungsbolzen |   | 220145 | <b>11.8116-0083.1</b> 390501 Haltefeder     |
| 11.3601-0074.2  | 220132 | <b>11.0101-5407.2</b> 260011 Hülsensatz     |   | 220145 | <b>11.8171-0008.1</b> 990049 Führungsbolzen |
|   | 220132 | <b>11.0441-6003.2</b> 250037 Dichtungssatz  | 11.3601-8502.2  | 220146 | <b>11.0101-5402.2</b> 260009 Hülsensatz     |
|   | 220132 | <b>11.8171-0008.1</b> 990049 Führungsbolzen |   | 220146 | <b>11.0230-0020.2</b> 260023 Haltersatz     |
| 11.3601-8001.2  | 220133 | <b>11.0101-5407.2</b> 260011 Hülsensatz     |   | 220146 | <b>11.0441-6003.2</b> 250037 Dichtungssatz  |
|   | 220133 | <b>11.0441-6003.2</b> 250037 Dichtungssatz  |   | 220146 | <b>11.8116-0083.1</b> 390501 Haltefeder     |
|   | 220133 | <b>11.8116-0052.1</b> 390496 Haltefeder     |   | 220146 | <b>11.8171-0008.1</b> 990049 Führungsbolzen |
|   | 220133 | <b>11.8171-0008.1</b> 990049 Führungsbolzen | 11.3601-8503.2  | 220147 | <b>11.0101-5402.2</b> 260009 Hülsensatz     |
| 11.3601-8002.2  | 220134 | <b>11.0101-5407.2</b> 260011 Hülsensatz     |   | 220147 | <b>11.0441-6003.2</b> 250037 Dichtungssatz  |
|   | 220134 | <b>11.0441-6003.2</b> 250037 Dichtungssatz  |   | 220147 | <b>11.8116-0083.1</b> 390501 Haltefeder     |
|   | 220134 | <b>11.8116-0052.1</b> 390496 Haltefeder     |   | 220147 | <b>11.8171-0008.1</b> 990049 Führungsbolzen |
|   | 220134 | <b>11.8171-0008.1</b> 990049 Führungsbolzen | 11.3601-8504.2  | 220148 | <b>11.0101-5402.2</b> 260009 Hülsensatz     |
| 11.3601-8049.3  | 220327 | <b>11.0441-6007.2</b> 250146 Dichtungssatz  |   | 220148 | <b>11.0441-6003.2</b> 250037 Dichtungssatz  |
| 11.3601-8050.3  | 220328 | <b>11.0441-6007.2</b> 250146 Dichtungssatz  |   | 220148 | <b>11.8116-0083.1</b> 390501 Haltefeder     |
| 11.3601-8063.2  | 220135 | <b>11.0101-5407.2</b> 260011 Hülsensatz     |   | 220148 | <b>11.8171-0008.1</b> 990049 Führungsbolzen |
|   | 220135 | <b>11.0441-6005.2</b> 250150 Dichtungssatz  | 11.3601-8505.2  | 220149 | <b>11.0101-5402.2</b> 260009 Hülsensatz     |
|   | 220135 | <b>11.8116-0073.1</b> 390498 Haltefeder     |   | 220149 | <b>11.0441-6003.2</b> 250037 Dichtungssatz  |
|   | 220135 | <b>11.8171-0008.1</b> 990049 Führungsbolzen |   | 220149 | <b>11.8116-0083.1</b> 390501 Haltefeder     |
| 11.3601-8064.2  | 220136 | <b>11.0101-5407.2</b> 260011 Hülsensatz     |   | 220149 | <b>11.8171-0008.1</b> 990049 Führungsbolzen |
|   | 220136 | <b>11.0441-6005.2</b> 250150 Dichtungssatz  | 11.3601-8506.2  | 220150 | <b>11.0101-5402.2</b> 260009 Hülsensatz     |
|   | 220136 | <b>11.8116-0073.1</b> 390498 Haltefeder     |   | 220150 | <b>11.0441-6003.2</b> 250037 Dichtungssatz  |
|   | 220136 | <b>11.8171-0008.1</b> 990049 Führungsbolzen |   | 220150 | <b>11.8116-0083.1</b> 390501 Haltefeder     |
|   | 220136 | <b>11.8171-0008.1</b> 990049 Führungsbolzen |   | 220150 | <b>11.8171-0008.1</b> 990049 Führungsbolzen |









# Reparatursätze

Repair kits - Corredi riparazione - Nécessaires de réparation - Juegos de reparación

|    |                                      |    |                |                                      |  |
|---|--------------------------------------|---|----------------|--------------------------------------|--|
| 11.3601-8507.2  | 220151<br>220151<br>220151<br>220151 | <b>11.0101-5407.2</b> 260011 Hülsensatz<br><b>11.0441-6003.2</b> 250037 Dichtungssatz<br><b>11.8116-0052.1</b> 390496 Haltefeder<br><b>11.8171-0008.1</b> 990049 Führungsbolzen   | 11.3601-8523.2 | 220349<br>220349<br>220349<br>220349 | <b>11.0101-5407.2</b> 260011 Hülsensatz<br><b>11.0441-6005.2</b> 250150 Dichtungssatz<br><b>11.8116-0073.1</b> 390498 Haltefeder<br><b>11.8171-0008.1</b> 990049 Führungsbolzen  |
| 11.3601-8508.2  | 220152<br>220152<br>220152<br>220152 | <b>11.0101-5407.2</b> 260011 Hülsensatz<br><b>11.0441-6003.2</b> 250037 Dichtungssatz<br><b>11.8116-0052.1</b> 390496 Haltefeder<br><b>11.8171-0008.1</b> 990049 Führungsbolzen   | 11.3601-8524.2 | 220350<br>220350<br>220350<br>220350 | <b>11.0101-5407.2</b> 260011 Hülsensatz<br><b>11.0441-6005.2</b> 250150 Dichtungssatz<br><b>11.8116-0073.1</b> 390498 Haltefeder<br><b>11.8171-0008.1</b> 990049 Führungsbolzen  |
| 11.3601-8509.2  | 220153<br>220153                     | <b>11.0101-6004.2</b> 260014 Hülsensatz<br><b>11.0441-6003.2</b> 250037 Dichtungssatz   | 11.3601-8525.2 | 220351<br>220351<br>220351<br>220351 | <b>11.0101-5407.2</b> 260011 Hülsensatz<br><b>11.0441-6005.2</b> 250150 Dichtungssatz<br><b>11.8116-0143.1</b> 390513 Haltefeder<br><b>11.8171-0008.1</b> 990049 Führungsbolzen  |
| 11.3601-8510.2  | 220154<br>220154                     | <b>11.0101-6004.2</b> 260014 Hülsensatz<br><b>11.0441-6003.2</b> 250037 Dichtungssatz   | 11.3601-8526.2 | 220352<br>220352<br>220352<br>220352 | <b>11.0101-5407.2</b> 260011 Hülsensatz<br><b>11.0441-6005.2</b> 250150 Dichtungssatz<br><b>11.8116-0143.1</b> 390513 Haltefeder<br><b>11.8171-0008.1</b> 990049 Führungsbolzen  |
| 11.3601-8511.2  | 220155<br>220155<br>220155<br>220155 | <b>11.0101-5402.2</b> 260009 Hülsensatz<br><b>11.0441-6003.2</b> 250037 Dichtungssatz<br><b>11.8116-0092.1</b> 390503 Haltefeder<br><b>11.8171-0008.1</b> 990049 Führungsbolzen   | 11.3601-8527.2 | 220353<br>220353<br>220353<br>220353 | <b>11.0101-5407.2</b> 260011 Hülsensatz<br><b>11.0230-0170.2</b> 260078 Haltersatz<br><b>11.0441-6005.2</b> 250150 Dichtungssatz<br><b>11.8116-0301.1</b> 390610 Haltefeder<br><b>11.8171-0008.1</b> 990049 Führungsbolzen |
| 11.3601-8512.2  | 220156<br>220156<br>220156<br>220156 | <b>11.0101-5402.2</b> 260009 Hülsensatz<br><b>11.0441-6003.2</b> 250037 Dichtungssatz<br><b>11.8116-0092.1</b> 390503 Haltefeder<br><b>11.8171-0008.1</b> 990049 Führungsbolzen   | 11.3601-8528.2 | 220354<br>220354<br>220354<br>220354 | <b>11.0101-5407.2</b> 260011 Hülsensatz<br><b>11.0230-0170.2</b> 260078 Haltersatz<br><b>11.0441-6005.2</b> 250150 Dichtungssatz<br><b>11.8116-0301.1</b> 390610 Haltefeder<br><b>11.8171-0008.1</b> 990049 Führungsbolzen |
| 11.3601-8513.2  | 220393<br>220393<br>220393<br>220393 | <b>11.0101-5704.2</b> 260095 Hülsensatz<br><b>11.0441-6007.2</b> 250146 Dichtungssatz<br><b>11.8116-0200.1</b> 390505 Haltefeder<br><b>11.8171-0008.1</b> 990049 Führungsbolzen   | 11.3601-8529.2 | 220355<br>220355<br>220355<br>220355 | <b>11.0101-5407.2</b> 260011 Hülsensatz<br><b>11.0441-6005.2</b> 250150 Dichtungssatz<br><b>11.8171-0008.1</b> 990049 Führungsbolzen   |
| 11.3601-8514.2  | 220394<br>220394<br>220394<br>220394 | <b>11.0101-5704.2</b> 260095 Hülsensatz<br><b>11.0441-6007.2</b> 250146 Dichtungssatz<br><b>11.8116-0200.1</b> 390505 Haltefeder<br><b>11.8171-0008.1</b> 990049 Führungsbolzen   | 11.3601-8530.2 | 220356<br>220356<br>220356           | <b>11.0101-5407.2</b> 260011 Hülsensatz<br><b>11.0441-6005.2</b> 250150 Dichtungssatz<br><b>11.8171-0008.1</b> 990049 Führungsbolzen   |
| 11.3601-8515.2  | 220323<br>220323<br>220323<br>220323 | <b>11.0101-5402.2</b> 260009 Hülsensatz<br><b>11.0441-6003.2</b> 250037 Dichtungssatz<br><b>11.8116-0083.1</b> 390501 Haltefeder<br><b>11.8171-0008.1</b> 990049 Führungsbolzen   | 11.4601-8001.3 | 220157                               | <b>11.0441-6002.2</b> 250036 Dichtungssatz   |
| 11.3601-8516.2  | 220324<br>220324<br>220324<br>220324 | <b>11.0101-5402.2</b> 260009 Hülsensatz<br><b>11.0441-6003.2</b> 250037 Dichtungssatz<br><b>11.8116-0083.1</b> 390501 Haltefeder<br><b>11.8171-0008.1</b> 990049 Führungsbolzen   | 11.4601-8002.3 | 220158                               | <b>11.0441-6002.2</b> 250036 Dichtungssatz   |
| 11.3601-8519.2  | 220345<br>220345<br>220345<br>220345 | <b>11.0101-5407.2</b> 260011 Hülsensatz<br><b>11.0441-6005.2</b> 250150 Dichtungssatz<br><b>11.8116-0073.1</b> 390498 Haltefeder<br><b>11.8171-0008.1</b> 990049 Führungsbolzen   | 11.4601-8003.3 | 220159                               | <b>11.0441-6002.2</b> 250036 Dichtungssatz   |
| 11.3601-8520.2  | 220346<br>220346<br>220346<br>220346 | <b>11.0101-5407.2</b> 260011 Hülsensatz<br><b>11.0441-6005.2</b> 250150 Dichtungssatz<br><b>11.8116-0073.1</b> 390498 Haltefeder<br><b>11.8171-0008.1</b> 990049 Führungsbolzen   | 11.4601-8004.3 | 220160                               | <b>11.0441-6002.2</b> 250036 Dichtungssatz   |
| 11.3601-8521.2  | 220347<br>220347<br>220347<br>220347 | <b>11.0101-5407.2</b> 260011 Hülsensatz<br><b>11.0441-6003.2</b> 250037 Dichtungssatz<br><b>11.8116-0052.1</b> 390496 Haltefeder<br><b>11.8171-0008.1</b> 990049 Führungsbolzen   | 11.9341-9991.2 | 220407<br>220407<br>220407<br>220407 | <b>11.0101-5402.2</b> 260009 Hülsensatz<br><b>11.0441-3401.2</b> 250151 Dichtungssatz<br><b>11.8116-0185.1</b> 390592 Haltefeder<br><b>11.8171-0008.1</b> 990049 Führungsbolzen  |
| 11.3601-8522.2  | 220348<br>220348<br>220348<br>220348 | <b>11.0101-5407.2</b> 260011 Hülsensatz<br><b>11.0441-6003.2</b> 250037 Dichtungssatz<br><b>11.8116-0052.1</b> 390496 Haltefeder<br><b>11.8171-0008.1</b> 990049 Führungsbolzen   | 11.9341-9992.2 | 220408<br>220408<br>220408<br>220408 | <b>11.0101-5402.2</b> 260009 Hülsensatz<br><b>11.0441-3401.2</b> 250151 Dichtungssatz<br><b>11.8116-0185.1</b> 390592 Haltefeder<br><b>11.8171-0008.1</b> 990049 Führungsbolzen  |
|   |                                      |   | 11.9347-7001.2 | 220473<br>220473<br>220473           | <b>11.0101-5407.2</b> 260011 Hülsensatz<br><b>11.0230-0162.2</b> 260090 Haltersatz<br><b>11.8171-0008.1</b> 990049 Führungsbolzen  |
|   |                                      |   | 11.9347-7002.2 | 220474<br>220474<br>220474           | <b>11.0101-5407.2</b> 260011 Hülsensatz<br><b>11.0230-0162.2</b> 260090 Haltersatz<br><b>11.8171-0008.1</b> 990049 Führungsbolzen  |







# Reparatursätze

Repair kits - Corredi riparazione - Nécessaires de réparation - Juegos de reparación

|    |        |   |    |        |   |
|---|--------|---|---|--------|---|
| 11.9347-7003.2  | 220565 | <b>11.0101-5407.2</b> 260011 Hülsensatz     | 11.9387-7005.2  | 220569 | <b>11.0101-5407.2</b> 260011 Hülsensatz     |
|   | 220565 | <b>11.0230-0162.2</b> 260090 Haltersatz     |   | 220569 | <b>11.8116-0340.1</b> 390595 Haltefeder     |
|   | 220565 | <b>11.8116-0340.1</b> 390595 Haltefeder     |   | 220569 | <b>11.8171-0008.1</b> 990049 Führungsbolzen |
|   | 220565 | <b>11.8171-0008.1</b> 990049 Führungsbolzen | 11.9387-7006.2  | 220570 | <b>11.0101-5407.2</b> 260011 Hülsensatz     |
| 11.9347-7004.2  | 220566 | <b>11.0101-5407.2</b> 260011 Hülsensatz     |   | 220570 | <b>11.8116-0340.1</b> 390595 Haltefeder     |
|   | 220566 | <b>11.0230-0162.2</b> 260090 Haltersatz     |   | 220570 | <b>11.8171-0008.1</b> 990049 Führungsbolzen |
|   | 220566 | <b>11.8116-0340.1</b> 390595 Haltefeder     | 11.9387-7015.2  | 220627 | <b>11.0101-5407.2</b> 260011 Hülsensatz     |
|   | 220566 | <b>11.8171-0008.1</b> 990049 Führungsbolzen |   | 220627 | <b>11.0230-0698.2</b> 260091 Halter         |
| 11.9347-7005.2  | 220643 | <b>11.0101-5407.2</b> 260011 Hülsensatz     |   | 220627 | <b>11.8116-0340.1</b> 390595 Haltefeder     |
|   | 220643 | <b>11.8116-0340.1</b> 390595 Haltefeder     |   | 220627 | <b>11.8171-0008.1</b> 990049 Führungsbolzen |
|   | 220643 | <b>11.8171-0008.1</b> 990049 Führungsbolzen | 11.9387-7016.2  | 220628 | <b>11.0101-5407.2</b> 260011 Hülsensatz     |
| 11.9347-7006.2  | 220644 | <b>11.0101-5407.2</b> 260011 Hülsensatz     |   | 220628 | <b>11.0230-0698.2</b> 260091 Halter         |
|   | 220644 | <b>11.8116-0340.1</b> 390595 Haltefeder     |   | 220628 | <b>11.8116-0340.1</b> 390595 Haltefeder     |
|   | 220644 | <b>11.8171-0008.1</b> 990049 Führungsbolzen |   | 220628 | <b>11.8171-0008.1</b> 990049 Führungsbolzen |
| 11.9367-7001.2  | 220733 | <b>11.0101-5407.2</b> 260011 Hülsensatz     | 11.9387-7021.2  | 220629 | <b>11.0101-5407.2</b> 260011 Hülsensatz     |
|   | 220733 | <b>11.8116-0340.1</b> 390595 Haltefeder     |   | 220629 | <b>11.8116-0340.1</b> 390595 Haltefeder     |
|   | 220733 | <b>11.8171-0008.1</b> 990049 Führungsbolzen |   | 220629 | <b>11.8171-0008.1</b> 990049 Führungsbolzen |
| 11.9367-7002.2  | 220734 | <b>11.0101-5407.2</b> 260011 Hülsensatz     | 11.9387-7022.2  | 220630 | <b>11.0101-5407.2</b> 260011 Hülsensatz     |
|   | 220734 | <b>11.8116-0340.1</b> 390595 Haltefeder     |   | 220630 | <b>11.8116-0340.1</b> 390595 Haltefeder     |
|   | 220734 | <b>11.8171-0008.1</b> 990049 Führungsbolzen |   | 220630 | <b>11.8171-0008.1</b> 990049 Führungsbolzen |
| 11.9381-9957.2  | 220661 | <b>11.0101-5407.2</b> 260011 Hülsensatz     | 11.9387-7045.2  | 220797 | <b>11.0101-5407.2</b> 260011 Hülsensatz     |
|   | 220661 | <b>11.8116-0143.1</b> 390513 Haltefeder     |   | 220797 | <b>11.0230-0698.2</b> 260091 Halter         |
|   | 220661 | <b>11.8171-0008.1</b> 990049 Führungsbolzen |   | 220797 | <b>11.8116-0340.1</b> 390595 Haltefeder     |
| 11.9381-9958.2  | 220662 | <b>11.0101-5407.2</b> 260011 Hülsensatz     |   | 220797 | <b>11.8171-0008.1</b> 990049 Führungsbolzen |
|   | 220662 | <b>11.8116-0143.1</b> 390513 Haltefeder     | 11.9387-7046.2  | 220798 | <b>11.0101-5407.2</b> 260011 Hülsensatz     |
|   | 220662 | <b>11.8171-0008.1</b> 990049 Führungsbolzen |   | 220798 | <b>11.0230-0698.2</b> 260091 Halter         |
| 11.9381-9959.2  | 220433 | <b>11.0101-5402.2</b> 260009 Hülsensatz     |   | 220798 | <b>11.8116-0340.1</b> 390595 Haltefeder     |
|   | 220433 | <b>11.0441-3803.2</b> 250010 Dichtungssatz  |   | 220798 | <b>11.8171-0008.1</b> 990049 Führungsbolzen |
|   | 220433 | <b>11.8116-0066.1</b> 390577 Haltefeder     | 11.9401-9951.2  | 220463 | <b>11.0101-5402.2</b> 260009 Hülsensatz     |
|   | 220433 | <b>11.8171-0008.1</b> 990049 Führungsbolzen |   | 220463 | <b>11.8116-0296.1</b> 390445 Haltefeder     |
| 11.9381-9960.2  | 220434 | <b>11.0101-5402.2</b> 260009 Hülsensatz     |   | 220463 | <b>11.8171-0008.1</b> 990049 Führungsbolzen |
|   | 220434 | <b>11.0441-3803.2</b> 250010 Dichtungssatz  | 11.9401-9952.2  | 220464 | <b>11.0101-5402.2</b> 260009 Hülsensatz     |
|   | 220434 | <b>11.8116-0066.1</b> 390577 Haltefeder     |   | 220464 | <b>11.8116-0296.1</b> 390445 Haltefeder     |
|   | 220434 | <b>11.8171-0008.1</b> 990049 Führungsbolzen |   | 220464 | <b>11.8171-0008.1</b> 990049 Führungsbolzen |
| 11.9381-9961.2  | 220435 | <b>11.0101-5402.2</b> 260009 Hülsensatz     | 11.9401-9959.2  | 220833 | <b>11.0101-5402.2</b> 260009 Hülsensatz     |
|   | 220435 | <b>11.0441-3803.2</b> 250010 Dichtungssatz  |   | 220833 | <b>11.0441-4002.2</b> 250011 Dichtungssatz  |
|   | 220435 | <b>11.8116-0066.1</b> 390577 Haltefeder     |   | 220833 | <b>11.8171-0008.1</b> 990049 Führungsbolzen |
|   | 220435 | <b>11.8171-0008.1</b> 990049 Führungsbolzen | 11.9401-9960.2  | 220834 | <b>11.0101-5402.2</b> 260009 Hülsensatz     |
| 11.9381-9962.2  | 220436 | <b>11.0101-5402.2</b> 260009 Hülsensatz     |   | 220834 | <b>11.0441-4002.2</b> 250011 Dichtungssatz  |
|   | 220436 | <b>11.0441-3803.2</b> 250010 Dichtungssatz  |   | 220834 | <b>11.8171-0008.1</b> 990049 Führungsbolzen |
|   | 220436 | <b>11.8116-0066.1</b> 390577 Haltefeder     | 11.9401-9975.2  | 220495 | <b>11.0101-5402.2</b> 260009 Hülsensatz     |
|   | 220436 | <b>11.8171-0008.1</b> 990049 Führungsbolzen |   | 220495 | <b>11.0441-4003.2</b> 250001 Dichtungssatz  |
| 11.9387-7001.2  | 220397 | <b>11.0101-5407.2</b> 260011 Hülsensatz     |   | 220495 | <b>11.8116-0094.1</b> 390504 Haltefeder     |
|   | 220397 | <b>11.8116-0340.1</b> 390595 Haltefeder     |   | 220495 | <b>11.8171-0008.1</b> 990049 Führungsbolzen |
|   | 220397 | <b>11.8171-0008.1</b> 990049 Führungsbolzen | 11.9401-9976.2  | 220496 | <b>11.0101-5402.2</b> 260009 Hülsensatz     |
| 11.9387-7002.2  | 220398 | <b>11.0101-5407.2</b> 260011 Hülsensatz     |   | 220496 | <b>11.0441-4003.2</b> 250001 Dichtungssatz  |
|   | 220398 | <b>11.8116-0340.1</b> 390595 Haltefeder     |   | 220496 | <b>11.8116-0094.1</b> 390504 Haltefeder     |
|   | 220398 | <b>11.8171-0008.1</b> 990049 Führungsbolzen |   | 220496 | <b>11.8171-0008.1</b> 990049 Führungsbolzen |
| 11.9387-7003.2  | 220567 | <b>11.0101-5407.2</b> 260011 Hülsensatz     | 11.9401-9977.2  | 220439 | <b>11.0101-5402.2</b> 260009 Hülsensatz     |
|   | 220567 | <b>11.8116-0340.1</b> 390595 Haltefeder     |   | 220439 | <b>11.0441-4003.2</b> 250001 Dichtungssatz  |
|   | 220567 | <b>11.8171-0008.1</b> 990049 Führungsbolzen |   | 220439 | <b>11.8116-0094.1</b> 390504 Haltefeder     |
| 11.9387-7004.2  | 220568 | <b>11.0101-5407.2</b> 260011 Hülsensatz     |   | 220439 | <b>11.8171-0008.1</b> 990049 Führungsbolzen |
|   | 220568 | <b>11.8116-0340.1</b> 390595 Haltefeder     |   |        |   |
|   | 220568 | <b>11.8171-0008.1</b> 990049 Führungsbolzen |   |        |   |

# Reparatursätze







Repair kits - Corredi riparazione - Nécessaires de réparation - Juegos de reparación

|    |        |    |                       |                |        |                       |                       |
|---|--------|---|-----------------------|----------------|--------|-----------------------|-----------------------|
| 11.9401-9978.2  | 220440 | <b>11.0101-5402.2</b>   | 260009 Hülsensatz     | 11.9421-9979.2 | 220497 | <b>11.0101-5407.2</b> | 260011 Hülsensatz     |
|   | 220440 | <b>11.0441-4003.2</b>   | 250001 Dichtungssatz  |                | 220497 | <b>11.8116-0236.1</b> | 390507 Haltefeder     |
|   | 220440 | <b>11.8116-0094.1</b>   | 390504 Haltefeder     |                | 220497 | <b>11.8171-0008.1</b> | 990049 Führungsbolzen |
|   | 220440 | <b>11.8171-0008.1</b>   | 990049 Führungsbolzen |                |        |                       |                       |
| 11.9406-9993.2  | 220413 | <b>11.0101-5402.2</b>   | 260009 Hülsensatz     | 11.9421-9980.2 | 220498 | <b>11.0101-5407.2</b> | 260011 Hülsensatz     |
|   | 220413 | <b>11.0441-4004.2</b>   | 250012 Dichtungssatz  |                | 220498 | <b>11.8116-0236.1</b> | 390507 Haltefeder     |
|   | 220413 | <b>11.8116-0168.1</b>   | 390499 Haltefeder     |                | 220498 | <b>11.8171-0008.1</b> | 990049 Führungsbolzen |
|   | 220413 | <b>11.8171-0008.1</b>   | 990049 Führungsbolzen |                |        |                       |                       |
| 11.9406-9994.2  | 220414 | <b>11.0101-5402.2</b>   | 260009 Hülsensatz     | 11.9426-9957.2 | 220895 | <b>11.0101-5402.2</b> | 260009 Hülsensatz     |
|   | 220414 | <b>11.0441-4004.2</b>   | 250012 Dichtungssatz  |                | 220895 | <b>11.0441-4203.2</b> | 250013 Dichtungssatz  |
|   | 220414 | <b>11.8116-0168.1</b>   | 390499 Haltefeder     |                | 220895 | <b>11.8116-0330.1</b> | 390472 Haltefeder     |
|   | 220414 | <b>11.8171-0008.1</b>   | 990049 Führungsbolzen |                | 220895 | <b>11.8171-0008.1</b> | 990049 Führungsbolzen |
| 11.9406-9995.2  | 220415 | <b>11.0101-5402.2</b>   | 260009 Hülsensatz     | 11.9426-9958.2 | 220896 | <b>11.0101-5402.2</b> | 260009 Hülsensatz     |
|   | 220415 | <b>11.0441-4004.2</b>   | 250012 Dichtungssatz  |                | 220896 | <b>11.0441-4203.2</b> | 250013 Dichtungssatz  |
|   | 220415 | <b>11.8116-0168.1</b>   | 390499 Haltefeder     |                | 220896 | <b>11.8116-0330.1</b> | 390472 Haltefeder     |
|   | 220415 | <b>11.8171-0008.1</b>   | 990049 Führungsbolzen |                | 220896 | <b>11.8171-0008.1</b> | 990049 Führungsbolzen |
| 11.9406-9996.2  | 220416 | <b>11.0101-5402.2</b>   | 260009 Hülsensatz     | 11.9426-9959.2 | 220801 | <b>11.0101-5407.2</b> | 260011 Hülsensatz     |
|   | 220416 | <b>11.0441-4004.2</b>   | 250012 Dichtungssatz  |                | 220801 | <b>11.8116-0323.1</b> | 390459 Haltefeder     |
|   | 220416 | <b>11.8116-0168.1</b>   | 390499 Haltefeder     |                | 220801 | <b>11.8171-0008.1</b> | 990049 Führungsbolzen |
|   | 220416 | <b>11.8171-0008.1</b>   | 990049 Führungsbolzen |                |        |                       |                       |
| 11.9407-7001.2  | 220573 | <b>11.0101-5407.2</b>   | 260011 Hülsensatz     | 11.9426-9960.2 | 220802 | <b>11.0101-5407.2</b> | 260011 Hülsensatz     |
|   | 220573 | <b>11.8116-0340.1</b>   | 390595 Haltefeder     |                | 220802 | <b>11.8116-0323.1</b> | 390459 Haltefeder     |
|   | 220573 | <b>11.8171-0008.1</b>   | 990049 Führungsbolzen |                | 220802 | <b>11.8171-0008.1</b> | 990049 Führungsbolzen |
| 11.9407-7002.2  | 220574 | <b>11.0101-5407.2</b>   | 260011 Hülsensatz     | 11.9426-9977.2 | 220897 | <b>11.0101-5402.2</b> | 260009 Hülsensatz     |
|   | 220574 | <b>11.8116-0340.1</b>   | 390595 Haltefeder     |                | 220897 | <b>11.0441-4203.2</b> | 250013 Dichtungssatz  |
|   | 220574 | <b>11.8171-0008.1</b>   | 990049 Führungsbolzen |                | 220897 | <b>11.8116-0330.1</b> | 390472 Haltefeder     |
|   |        |   |                       |                | 220897 | <b>11.8171-0008.1</b> | 990049 Führungsbolzen |
| 11.9407-7005.2  | 220637 | <b>11.0101-5407.2</b>   | 260011 Hülsensatz     | 11.9426-9989.2 | 220639 | <b>11.0441-4203.2</b> | 250013 Dichtungssatz  |
|   | 220637 | <b>11.8116-0340.1</b>   | 390595 Haltefeder     |                | 220639 | <b>11.8116-0323.1</b> | 390459 Haltefeder     |
|   | 220637 | <b>11.8171-0008.1</b>   | 990049 Führungsbolzen |                |        |                       |                       |
| 11.9407-7006.2  | 220638 | <b>11.0101-5407.2</b>   | 260011 Hülsensatz     | 11.9426-9990.2 | 220640 | <b>11.0441-4203.2</b> | 250013 Dichtungssatz  |
|   | 220638 | <b>11.8116-0340.1</b>   | 390595 Haltefeder     |                | 220640 | <b>11.8116-0323.1</b> | 390459 Haltefeder     |
|   | 220638 | <b>11.8171-0008.1</b>   | 990049 Führungsbolzen |                |        |                       |                       |
| 11.9421-9911.2  | 220825 | <b>11.0101-5402.2</b>   | 260009 Hülsensatz     | 11.9426-9991.2 | 220641 | <b>11.0441-4203.2</b> | 250013 Dichtungssatz  |
|   | 220825 | <b>11.8116-0066.1</b>   | 390577 Haltefeder     |                | 220641 | <b>11.8116-0323.1</b> | 390459 Haltefeder     |
|   | 220825 | <b>11.8171-0008.1</b>   | 990049 Führungsbolzen |                |        |                       |                       |
| 11.9421-9912.2  | 220826 | <b>11.0101-5402.2</b>   | 260009 Hülsensatz     | 11.9426-9992.2 | 220642 | <b>11.0441-4203.2</b> | 250013 Dichtungssatz  |
|   | 220826 | <b>11.8116-0066.1</b>   | 390577 Haltefeder     |                | 220642 | <b>11.8116-0323.1</b> | 390459 Haltefeder     |
|   | 220826 | <b>11.8171-0008.1</b>   | 990049 Führungsbolzen |                |        |                       |                       |
| 11.9421-9963.2  | 220465 | <b>11.0101-5402.2</b>   | 260009 Hülsensatz     | 11.9426-9993.2 | 220443 | <b>11.0101-5402.2</b> | 260009 Hülsensatz     |
|   | 220465 | <b>11.0230-0119.2</b>   | 260089 Haltersatz     |                | 220443 | <b>11.0441-4203.2</b> | 250013 Dichtungssatz  |
|   | 220465 | <b>11.8116-0296.1</b>   | 390445 Haltefeder     |                | 220443 | <b>11.8116-0168.1</b> | 390499 Haltefeder     |
|   | 220465 | <b>11.8171-0008.1</b>   | 990049 Führungsbolzen |                | 220443 | <b>11.8171-0008.1</b> | 990049 Führungsbolzen |
| 11.9421-9964.2  | 220466 | <b>11.0101-5402.2</b>   | 260009 Hülsensatz     | 11.9426-9994.2 | 220444 | <b>11.0101-5402.2</b> | 260009 Hülsensatz     |
|   | 220466 | <b>11.0230-0119.2</b>   | 260089 Haltersatz     |                | 220444 | <b>11.0441-4203.2</b> | 250013 Dichtungssatz  |
|   | 220466 | <b>11.8116-0296.1</b>   | 390445 Haltefeder     |                | 220444 | <b>11.8116-0168.1</b> | 390499 Haltefeder     |
|   | 220466 | <b>11.8171-0008.1</b>   | 990049 Führungsbolzen |                | 220444 | <b>11.8171-0008.1</b> | 990049 Führungsbolzen |
| 11.9421-9965.2  | 220799 | <b>11.0101-5407.2</b>   | 260011 Hülsensatz     | 11.9441-9949.2 | 220803 | <b>11.0101-5409.2</b> | 260035 Hülsensatz     |
|   | 220799 | <b>11.8116-0323.1</b>   | 390459 Haltefeder     |                | 220803 | <b>11.8171-0008.1</b> | 990049 Führungsbolzen |
|   | 220799 | <b>11.8171-0008.1</b>   | 990049 Führungsbolzen |                |        |                       |                       |
| 11.9421-9966.2  | 220800 | <b>11.0101-5407.2</b>   | 260011 Hülsensatz     | 11.9441-9950.2 | 220804 | <b>11.0101-5409.2</b> | 260035 Hülsensatz     |
|   | 220800 | <b>11.8116-0323.1</b>   | 390459 Haltefeder     |                | 220804 | <b>11.8171-0008.1</b> | 990049 Führungsbolzen |
|   | 220800 | <b>11.8171-0008.1</b>   | 990049 Führungsbolzen |                |        |                       |                       |
|   |        |   |                       | 11.9441-9955.2 | 220805 | <b>11.8116-0133.1</b> | 390511 Haltefeder     |
|   |        |   |                       |                |        |                       |                       |
|   |        |   |                       | 11.9441-9956.2 | 220806 | <b>11.8116-0133.1</b> | 390511 Haltefeder     |
|   |        |   |                       |                |        |                       |                       |
|   |        |   |                       | 11.9441-9957.2 | 220827 | <b>11.0101-5402.2</b> | 260009 Hülsensatz     |
|   |        |   |                       |                | 220827 | <b>11.8116-0296.1</b> | 390445 Haltefeder     |
|   |        |   |                       |                | 220827 | <b>11.8171-0008.1</b> | 990049 Führungsbolzen |









# Reparatursätze

Repair kits - Corredi riparazione - Nécessaires de réparation - Juegos de reparación

|    |        |   |    |        |   |
|---|--------|---|---|--------|---|
| 11.9441-9958.2  | 220828 | <b>11.0101-5402.2</b> 260009 Hülsensatz     | 11.9541-9549.2  | 220575 | <b>11.0101-5409.2</b> 260035 Hülsensatz     |
|   | 220828 | <b>11.8116-0296.1</b> 390445 Haltefeder     |   | 220575 | <b>11.0441-5409.2</b> 250031 Dichtungssatz  |
|   | 220828 | <b>11.8171-0008.1</b> 990049 Führungsbolzen |   |        |   |
| 11.9441-9967.2  | 220807 | <b>11.0101-5409.2</b> 260035 Hülsensatz     | 11.9541-9550.2  | 220576 | <b>11.0101-5409.2</b> 260035 Hülsensatz     |
|   | 220807 | <b>11.8171-0008.1</b> 990049 Führungsbolzen |   | 220576 | <b>11.0441-5409.2</b> 250031 Dichtungssatz  |
| 11.9441-9968.2  | 220808 | <b>11.0101-5409.2</b> 260035 Hülsensatz     | 11.9541-9553.2  | 220563 | <b>11.0101-5409.2</b> 260035 Hülsensatz     |
|   | 220808 | <b>11.8171-0008.1</b> 990049 Führungsbolzen |   | 220563 | <b>11.8116-0351.1</b> 390538 Haltefeder     |
|   |        |   |   | 220563 | <b>11.8171-0008.1</b> 990049 Führungsbolzen |
| 11.9461-9981.2  | 220899 | <b>11.0101-5402.2</b> 260009 Hülsensatz     | 11.9541-9554.2  | 220564 | <b>11.0101-5409.2</b> 260035 Hülsensatz     |
|   | 220899 | <b>11.8116-0296.1</b> 390445 Haltefeder     |   | 220564 | <b>11.8116-0351.1</b> 390538 Haltefeder     |
|   | 220899 | <b>11.8171-0008.1</b> 990049 Führungsbolzen |   | 220564 | <b>11.8171-0008.1</b> 990049 Führungsbolzen |
| 11.9461-9982.2  | 220900 | <b>11.0101-5402.2</b> 260009 Hülsensatz     | 11.9541-9569.2  | 220725 | <b>11.0101-5407.2</b> 260011 Hülsensatz     |
|   | 220900 | <b>11.8116-0296.1</b> 390445 Haltefeder     |   | 220725 | <b>11.8116-0264.1</b> 390594 Haltefeder     |
|   | 220900 | <b>11.8171-0008.1</b> 990049 Führungsbolzen |   | 220725 | <b>11.8171-0008.1</b> 990049 Führungsbolzen |
| 11.9461-9983.2  | 220467 | <b>11.0101-5402.2</b> 260009 Hülsensatz     | 11.9541-9570.2  | 220726 | <b>11.0101-5407.2</b> 260011 Hülsensatz     |
|   | 220467 | <b>11.0230-0176.2</b> 260088 Haltersatz     |   | 220726 | <b>11.8116-0264.1</b> 390594 Haltefeder     |
|   | 220467 | <b>11.0441-4203.2</b> 250013 Dichtungssatz  |   | 220726 | <b>11.8171-0008.1</b> 990049 Führungsbolzen |
|   | 220467 | <b>11.8116-0296.1</b> 390445 Haltefeder     |   |        |   |
|   | 220467 | <b>11.8171-0008.1</b> 990049 Führungsbolzen | 11.9541-9575.2  | 220829 | <b>11.0101-5402.2</b> 260009 Hülsensatz     |
| 11.9461-9984.2  | 220468 | <b>11.0101-5402.2</b> 260009 Hülsensatz     |   | 220829 | <b>11.8116-0206.1</b> 390593 Haltefeder     |
|   | 220468 | <b>11.0230-0176.2</b> 260088 Haltersatz     |   | 220829 | <b>11.8171-0008.1</b> 990049 Führungsbolzen |
|   | 220468 | <b>11.0441-4203.2</b> 250013 Dichtungssatz  | 11.9541-9576.2  | 220830 | <b>11.0101-5402.2</b> 260009 Hülsensatz     |
|   | 220468 | <b>11.8116-0296.1</b> 390445 Haltefeder     |   | 220830 | <b>11.8116-0206.1</b> 390593 Haltefeder     |
|   | 220468 | <b>11.8171-0008.1</b> 990049 Führungsbolzen |   | 220830 | <b>11.8171-0008.1</b> 990049 Führungsbolzen |
| 11.9481-9811.2  | 220445 | <b>11.0101-5407.2</b> 260011 Hülsensatz     | 11.9541-9587.2  | 220419 | <b>11.0101-5402.2</b> 260009 Hülsensatz     |
|   | 220445 | <b>11.8116-0274.1</b> 390516 Haltefeder     |   | 220419 | <b>11.0230-0234.2</b> 260084 Haltersatz     |
|   | 220445 | <b>11.8171-0008.1</b> 990049 Führungsbolzen |   | 220419 | <b>11.0441-5402.2</b> 250028 Dichtungssatz  |
| 11.9481-9812.2  | 220446 | <b>11.0101-5407.2</b> 260011 Hülsensatz     |   | 220419 | <b>11.8116-0109.1</b> 390495 Haltefeder     |
|   | 220446 | <b>11.8116-0274.1</b> 390516 Haltefeder     |   | 220419 | <b>11.8116-0206.1</b> 390593 Haltefeder     |
|   | 220446 | <b>11.8171-0008.1</b> 990049 Führungsbolzen |   | 220419 | <b>11.8170-0729.1</b> 260107 Halter         |
| 11.9481-9871.2  | 220681 | <b>11.0101-5407.2</b> 260011 Hülsensatz     |   | 220419 | <b>11.8171-0008.1</b> 990049 Führungsbolzen |
|   | 220681 | <b>11.0441-4811.2</b> 250024 Dichtungssatz  | 11.9541-9588.2  | 220420 | <b>11.0101-5402.2</b> 260009 Hülsensatz     |
|   | 220681 | <b>11.8116-0129.1</b> 390591 Haltefeder     |   | 220420 | <b>11.0230-0234.2</b> 260084 Haltersatz     |
|   | 220681 | <b>11.8171-0008.1</b> 990049 Führungsbolzen |   | 220420 | <b>11.0441-5402.2</b> 250028 Dichtungssatz  |
| 11.9481-9872.2  | 220682 | <b>11.0101-5407.2</b> 260011 Hülsensatz     |   | 220420 | <b>11.8116-0109.1</b> 390495 Haltefeder     |
|   | 220682 | <b>11.0441-4811.2</b> 250024 Dichtungssatz  |   | 220420 | <b>11.8116-0206.1</b> 390593 Haltefeder     |
|   | 220682 | <b>11.8116-0129.1</b> 390591 Haltefeder     |   | 220420 | <b>11.8170-0729.1</b> 260107 Halter         |
|   | 220682 | <b>11.8171-0008.1</b> 990049 Führungsbolzen |   | 220420 | <b>11.8171-0008.1</b> 990049 Führungsbolzen |
| 11.9521-7001.2  | 220499 | <b>11.0101-5407.2</b> 260011 Hülsensatz     | 11.9541-9595.2  | 220501 | <b>11.0101-5409.2</b> 260035 Hülsensatz     |
|   | 220499 | <b>11.8171-0008.1</b> 990049 Führungsbolzen |   | 220501 | <b>11.0441-5409.2</b> 250031 Dichtungssatz  |
| 11.9521-7002.2  | 220500 | <b>11.0101-5407.2</b> 260011 Hülsensatz     |   | 220501 | <b>11.8116-0143.1</b> 390513 Haltefeder     |
|   | 220500 | <b>11.8171-0008.1</b> 990049 Führungsbolzen |   | 220501 | <b>11.8171-0008.1</b> 990049 Führungsbolzen |
| 11.9541-9543.2  | 220645 | <b>11.0101-5407.2</b> 260011 Hülsensatz     | 11.9541-9596.2  | 220502 | <b>11.0101-5409.2</b> 260035 Hülsensatz     |
|   | 220645 | <b>11.8116-0301.1</b> 390610 Haltefeder     |   | 220502 | <b>11.0441-5409.2</b> 250031 Dichtungssatz  |
|   | 220645 | <b>11.8171-0008.1</b> 990049 Führungsbolzen |   | 220502 | <b>11.8116-0143.1</b> 390513 Haltefeder     |
| 11.9541-9544.2  | 220646 | <b>11.0101-5407.2</b> 260011 Hülsensatz     |   | 220502 | <b>11.8171-0008.1</b> 990049 Führungsbolzen |
|   | 220646 | <b>11.8116-0301.1</b> 390610 Haltefeder     | 11.9541-9667.2  | 220421 | <b>11.0101-5402.2</b> 260009 Hülsensatz     |
|   | 220646 | <b>11.8171-0008.1</b> 990049 Führungsbolzen |   | 220421 | <b>11.0230-0097.2</b> 260092 Haltersatz     |
| 11.9541-9545.2  | 220625 | <b>11.0101-5407.2</b> 260011 Hülsensatz     |   | 220421 | <b>11.0441-5402.2</b> 250028 Dichtungssatz  |
|   | 220625 | <b>11.8116-0301.1</b> 390610 Haltefeder     |   | 220421 | <b>11.8116-0109.1</b> 390495 Haltefeder     |
|   | 220625 | <b>11.8171-0008.1</b> 990049 Führungsbolzen |   | 220421 | <b>11.8116-0206.1</b> 390593 Haltefeder     |
| 11.9541-9546.2  | 220626 | <b>11.0101-5407.2</b> 260011 Hülsensatz     |   | 220421 | <b>11.8171-0008.1</b> 990049 Führungsbolzen |
|   | 220626 | <b>11.8116-0301.1</b> 390610 Haltefeder     | 11.9541-9668.2  | 220422 | <b>11.0101-5402.2</b> 260009 Hülsensatz     |
|   | 220626 | <b>11.8171-0008.1</b> 990049 Führungsbolzen |   | 220422 | <b>11.0230-0097.2</b> 260092 Haltersatz     |
|   |        |   |   | 220422 | <b>11.0441-5402.2</b> 250028 Dichtungssatz  |
|   |        |   |   | 220422 | <b>11.8116-0109.1</b> 390495 Haltefeder     |
|   |        |   |   | 220422 | <b>11.8116-0206.1</b> 390593 Haltefeder     |
|   |        |   |   | 220422 | <b>11.8171-0008.1</b> 990049 Führungsbolzen |







# Reparatursätze

Repair kits - Corredi riparazione - Nécessaires de réparation - Juegos de reparación

|    |        |   |    |        |   |
|---|--------|---|---|--------|---|
| 11.9541-9805.2  | 220503 | <b>11.0101-5407.2</b> 260011 Hülsensatz     | 11.9571-9812.2  | 220486 | <b>11.0101-5407.2</b> 260011 Hülsensatz     |
|   | 220503 | <b>11.8116-0073.1</b> 390498 Haltefeder     |   | 220486 | <b>11.0101-5706.2</b> 260097 Hülsensatz     |
|   | 220503 | <b>11.8171-0008.1</b> 990049 Führungsbolzen |   | 220486 | <b>11.0441-5704.2</b> 250034 Dichtungssatz  |
|   |        |   |   | 220486 | <b>11.8116-0326.1</b> 390471 Haltefeder     |
| 11.9541-9806.2  | 220504 | <b>11.0101-5407.2</b> 260011 Hülsensatz     |   | 220486 | <b>11.8171-0008.1</b> 990049 Führungsbolzen |
|   | 220504 | <b>11.8116-0073.1</b> 390498 Haltefeder     |   | 220486 | <b>11.8171-0067.1</b> 250153 Führungsbolzen |
|   | 220504 | <b>11.8171-0008.1</b> 990049 Führungsbolzen |   |        |   |
| 11.9546-9997.2  | 220399 | <b>11.0101-5407.2</b> 260011 Hülsensatz     | 11.9571-9813.2  | 220647 | <b>11.0101-5407.2</b> 260011 Hülsensatz     |
|   |        |   |   | 220647 | <b>11.8116-0356.1</b> 390586 Haltefeder     |
| 11.9546-9998.2  | 220400 | <b>11.0101-5407.2</b> 260011 Hülsensatz     |   | 220647 | <b>11.8171-0008.1</b> 990049 Führungsbolzen |
| 11.9571-9757.2  | 220857 | <b>11.8116-0301.1</b> 390610 Haltefeder     | 11.9571-9814.2  | 220648 | <b>11.0101-5407.2</b> 260011 Hülsensatz     |
|   |        |   |   | 220648 | <b>11.8116-0356.1</b> 390586 Haltefeder     |
| 11.9571-9758.2  | 220858 | <b>11.8116-0301.1</b> 390610 Haltefeder     |   | 220648 | <b>11.8171-0008.1</b> 990049 Führungsbolzen |
| 11.9571-9765.2  | 220663 | <b>11.0101-5704.2</b> 260095 Hülsensatz     | 11.9571-9819.2  | 220469 | <b>11.0101-5705.2</b> 260096 Hülsensatz     |
|   | 220663 | <b>11.8116-0351.1</b> 390538 Haltefeder     |   | 220469 | <b>11.0441-5704.2</b> 250034 Dichtungssatz  |
|   | 220663 | <b>11.8171-0008.1</b> 990049 Führungsbolzen |   | 220469 | <b>11.8116-0326.1</b> 390471 Haltefeder     |
|   |        |   |   | 220469 | <b>11.8171-0067.1</b> 250153 Führungsbolzen |
| 11.9571-9766.2  | 220664 | <b>11.0101-5704.2</b> 260095 Hülsensatz     | 11.9571-9820.2  | 220470 | <b>11.0101-5705.2</b> 260096 Hülsensatz     |
|   | 220664 | <b>11.8116-0351.1</b> 390538 Haltefeder     |   | 220470 | <b>11.0441-5704.2</b> 250034 Dichtungssatz  |
|   | 220664 | <b>11.8171-0008.1</b> 990049 Führungsbolzen |   | 220470 | <b>11.8116-0326.1</b> 390471 Haltefeder     |
|   |        |   |   | 220470 | <b>11.8171-0067.1</b> 250153 Führungsbolzen |
| 11.9571-9779.2  | 220657 | <b>11.0101-5407.2</b> 260011 Hülsensatz     | 11.9571-9821.2  | 220579 | <b>11.0101-5407.2</b> 260011 Hülsensatz     |
|   | 220657 | <b>11.8116-0356.1</b> 390586 Haltefeder     |   | 220579 | <b>11.8116-0279.1</b> 390519 Haltefeder     |
|   | 220657 | <b>11.8171-0008.1</b> 990049 Führungsbolzen |   | 220579 | <b>11.8171-0008.1</b> 990049 Führungsbolzen |
| 11.9571-9780.2  | 220658 | <b>11.0101-5407.2</b> 260011 Hülsensatz     | 11.9571-9822.2  | 220580 | <b>11.0101-5407.2</b> 260011 Hülsensatz     |
|   | 220658 | <b>11.8116-0356.1</b> 390586 Haltefeder     |   | 220580 | <b>11.8116-0279.1</b> 390519 Haltefeder     |
|   | 220658 | <b>11.8171-0008.1</b> 990049 Führungsbolzen |   | 220580 | <b>11.8171-0008.1</b> 990049 Führungsbolzen |
| 11.9571-9781.2  | 220659 | <b>11.0101-5407.2</b> 260011 Hülsensatz     | 11.9571-9823.2  | 220471 | <b>11.0101-5407.2</b> 260011 Hülsensatz     |
|   | 220659 | <b>11.8116-0295.2</b> 390524 Haltefeder     |   | 220471 | <b>11.0441-5704.2</b> 250034 Dichtungssatz  |
|   | 220659 | <b>11.8116-0356.1</b> 390586 Haltefeder     |   | 220471 | <b>11.8116-0292.1</b> 390521 Haltefeder     |
|   | 220659 | <b>11.8171-0008.1</b> 990049 Führungsbolzen |   | 220471 | <b>11.8171-0008.1</b> 990049 Führungsbolzen |
| 11.9571-9782.2  | 220660 | <b>11.0101-5407.2</b> 260011 Hülsensatz     | 11.9571-9824.2  | 220472 | <b>11.0101-5407.2</b> 260011 Hülsensatz     |
|   | 220660 | <b>11.8116-0295.2</b> 390524 Haltefeder     |   | 220472 | <b>11.0441-5704.2</b> 250034 Dichtungssatz  |
|   | 220660 | <b>11.8116-0356.1</b> 390586 Haltefeder     |   | 220472 | <b>11.8116-0292.1</b> 390521 Haltefeder     |
|   | 220660 | <b>11.8171-0008.1</b> 990049 Führungsbolzen |   | 220472 | <b>11.8171-0008.1</b> 990049 Führungsbolzen |
| 11.9571-9785.2  | 220595 | <b>11.0101-5407.2</b> 260011 Hülsensatz     | 11.9571-9835.2  | 220427 | <b>11.0101-5409.2</b> 260035 Hülsensatz     |
|   | 220595 | <b>11.8116-0356.1</b> 390586 Haltefeder     |   | 220427 | <b>11.0441-5704.2</b> 250034 Dichtungssatz  |
|   | 220595 | <b>11.8171-0008.1</b> 990049 Führungsbolzen |   | 220427 | <b>11.8116-0143.1</b> 390513 Haltefeder     |
| 11.9571-9786.2  | 220596 | <b>11.0101-5407.2</b> 260011 Hülsensatz     |   | 220427 | <b>11.8116-0347.2</b> 390535 Haltefeder     |
|   | 220596 | <b>11.8116-0356.1</b> 390586 Haltefeder     |   | 220427 | <b>11.8171-0008.1</b> 990049 Führungsbolzen |
|   | 220596 | <b>11.8171-0008.1</b> 990049 Führungsbolzen |   |        |   |
| 11.9571-9793.2  | 220665 | <b>11.8116-0351.1</b> 390538 Haltefeder     | 11.9571-9836.2  | 220428 | <b>11.0101-5409.2</b> 260035 Hülsensatz     |
|   |        |   |   | 220428 | <b>11.0441-5704.2</b> 250034 Dichtungssatz  |
| 11.9571-9794.2  | 220666 | <b>11.8116-0351.1</b> 390538 Haltefeder     |   | 220428 | <b>11.8116-0143.1</b> 390513 Haltefeder     |
|   |        |   |   | 220428 | <b>11.8116-0347.2</b> 390535 Haltefeder     |
|   |        |   |   | 220428 | <b>11.8171-0008.1</b> 990049 Führungsbolzen |
| 11.9571-9801.2  | 220577 | <b>11.0101-5407.2</b> 260011 Hülsensatz     | 11.9571-9841.2  | 220401 | <b>11.0101-5407.2</b> 260011 Hülsensatz     |
|   | 220577 | <b>11.8116-0279.1</b> 390519 Haltefeder     |   | 220401 | <b>11.8116-0301.1</b> 390610 Haltefeder     |
|   | 220577 | <b>11.8171-0008.1</b> 990049 Führungsbolzen |   | 220401 | <b>11.8171-0008.1</b> 990049 Führungsbolzen |
| 11.9571-9802.2  | 220578 | <b>11.0101-5407.2</b> 260011 Hülsensatz     | 11.9571-9842.2  | 220402 | <b>11.0101-5407.2</b> 260011 Hülsensatz     |
|   | 220578 | <b>11.8116-0279.1</b> 390519 Haltefeder     |   | 220402 | <b>11.8116-0301.1</b> 390610 Haltefeder     |
|   | 220578 | <b>11.8171-0008.1</b> 990049 Führungsbolzen |   | 220402 | <b>11.8171-0008.1</b> 990049 Führungsbolzen |
| 11.9571-9811.2  | 220485 | <b>11.0101-5407.2</b> 260011 Hülsensatz     | 11.9571-9847.2  | 220487 | <b>11.0101-5407.2</b> 260011 Hülsensatz     |
|   | 220485 | <b>11.0101-5706.2</b> 260097 Hülsensatz     |   | 220487 | <b>11.0101-5409.2</b> 260035 Hülsensatz     |
|   | 220485 | <b>11.0441-5704.2</b> 250034 Dichtungssatz  |   | 220487 | <b>11.0441-5704.2</b> 250034 Dichtungssatz  |
|   | 220485 | <b>11.8116-0326.1</b> 390471 Haltefeder     |   | 220487 | <b>11.8116-0143.1</b> 390513 Haltefeder     |
|   | 220485 | <b>11.8171-0008.1</b> 990049 Führungsbolzen |   | 220487 | <b>11.8116-0143.1</b> 390513 Haltefeder     |
|   | 220485 | <b>11.8171-0067.1</b> 250153 Führungsbolzen |   | 220487 | <b>11.8171-0008.1</b> 990049 Führungsbolzen |

# Reparatursätze







Repair kits - Corredi riparazione - Nécessaires de réparation - Juegos de reparación

|    |        |   |    |        |   |
|---|--------|---|---|--------|---|
| 11.9571-9848.2  | 220488 | <b>11.0101-5407.2</b> 260011 Hülsensatz     | 11.9576-9996.2  | 220652 | <b>11.0101-5409.2</b> 260035 Hülsensatz     |
|   | 220488 | <b>11.0101-5409.2</b> 260035 Hülsensatz     |   | 220652 | <b>11.8116-0410.2</b> 390589 Haltefeder     |
|   | 220488 | <b>11.0441-5704.2</b> 250034 Dichtungssatz  |   | 220652 | <b>11.8171-0008.1</b> 990049 Führungsbolzen |
|   | 220488 | <b>11.8116-0143.1</b> 390513 Haltefeder     | 11.9601-8501.2  | 220593 | <b>11.0101-5706.2</b> 260097 Hülsensatz     |
|   | 220488 | <b>11.8171-0008.1</b> 990049 Führungsbolzen |   | 220593 | <b>11.0441-6008.2</b> 250038 Dichtungssatz  |
| 11.9571-9861.2  | 220403 | <b>11.0101-5407.2</b> 260011 Hülsensatz     |   | 220593 | <b>11.8116-0237.1</b> 390509 Haltefeder     |
|   | 220403 | <b>11.8116-0301.1</b> 390610 Haltefeder     |   | 220593 | <b>11.8171-0067.1</b> 250153 Führungsbolzen |
|   | 220403 | <b>11.8171-0008.1</b> 990049 Führungsbolzen | 11.9601-8502.2  | 220594 | <b>11.0101-5706.2</b> 260097 Hülsensatz     |
| 11.9571-9862.2  | 220404 | <b>11.0101-5407.2</b> 260011 Hülsensatz     |   | 220594 | <b>11.0441-6008.2</b> 250038 Dichtungssatz  |
|   | 220404 | <b>11.8116-0301.1</b> 390610 Haltefeder     |   | 220594 | <b>11.8116-0237.1</b> 390509 Haltefeder     |
|   | 220404 | <b>11.8171-0008.1</b> 990049 Führungsbolzen |   | 220594 | <b>11.8171-0067.1</b> 250153 Führungsbolzen |
| 11.9571-9863.2  | 220513 | <b>11.0101-5407.2</b> 260011 Hülsensatz     | 11.9601-9717.2  | 220901 | <b>11.0441-6008.2</b> 250038 Dichtungssatz  |
|   | 220513 | <b>11.8116-0366.2</b> 390587 Haltefeder     | 11.9601-9718.2  | 220902 | <b>11.0441-6008.2</b> 250038 Dichtungssatz  |
|   | 220513 | <b>11.8171-0008.1</b> 990049 Führungsbolzen | 11.9601-9721.2  | 220875 | <b>11.8116-0367.1</b> 390600 Haltefeder     |
|   | 220513 | <b>11.8171-0067.1</b> 250153 Führungsbolzen | 11.9601-9722.2  | 220876 | <b>11.8116-0367.1</b> 390600 Haltefeder     |
| 11.9571-9864.2  | 220514 | <b>11.0101-5407.2</b> 260011 Hülsensatz     | 11.9601-9731.2  | 220853 | <b>11.0441-6008.2</b> 250038 Dichtungssatz  |
|   | 220514 | <b>11.8116-0366.2</b> 390587 Haltefeder     | 11.9601-9732.2  | 220854 | <b>11.0441-6008.2</b> 250038 Dichtungssatz  |
|   | 220514 | <b>11.8171-0008.1</b> 990049 Führungsbolzen | 11.9601-9745.2  | 220653 | <b>11.0101-5407.2</b> 260011 Hülsensatz     |
|   | 220514 | <b>11.8171-0067.1</b> 250153 Führungsbolzen |   | 220653 | <b>11.8116-0206.1</b> 390593 Haltefeder     |
| 11.9571-9867.2  | 220423 | <b>11.0101-5704.2</b> 260095 Hülsensatz     |   | 220653 | <b>11.8171-0008.1</b> 990049 Führungsbolzen |
|   | 220423 | <b>11.0441-5704.2</b> 250034 Dichtungssatz  | 11.9601-9746.2  | 220654 | <b>11.0101-5407.2</b> 260011 Hülsensatz     |
|   | 220423 | <b>11.8171-0008.1</b> 990049 Führungsbolzen |   | 220654 | <b>11.8116-0206.1</b> 390593 Haltefeder     |
| 11.9571-9868.2  | 220424 | <b>11.0101-5704.2</b> 260095 Hülsensatz     |   | 220654 | <b>11.8171-0008.1</b> 990049 Führungsbolzen |
|   | 220424 | <b>11.0441-5704.2</b> 250034 Dichtungssatz  | 11.9601-9759.2  | 220811 | <b>11.0101-5704.2</b> 260095 Hülsensatz     |
|   | 220424 | <b>11.8171-0008.1</b> 990049 Führungsbolzen |   | 220811 | <b>11.8116-0356.1</b> 390586 Haltefeder     |
| 11.9571-9871.2  | 220425 | <b>11.0101-5407.2</b> 260011 Hülsensatz     |   | 220811 | <b>11.8171-0008.1</b> 990049 Führungsbolzen |
|   | 220425 | <b>11.8171-0008.1</b> 990049 Führungsbolzen | 11.9601-9760.2  | 220812 | <b>11.0101-5704.2</b> 260095 Hülsensatz     |
| 11.9571-9872.2  | 220426 | <b>11.0101-5407.2</b> 260011 Hülsensatz     |   | 220812 | <b>11.8116-0356.1</b> 390586 Haltefeder     |
|   | 220426 | <b>11.8171-0008.1</b> 990049 Führungsbolzen |   | 220812 | <b>11.8171-0008.1</b> 990049 Führungsbolzen |
| 11.9571-9971.2  | 220605 | <b>11.0101-5407.2</b> 260011 Hülsensatz     | 11.9601-9765.2  | 220813 | <b>11.0101-5407.2</b> 260011 Hülsensatz     |
|   | 220605 | <b>11.0441-5702.2</b> 250033 Dichtungssatz  |   | 220813 | <b>11.8116-0237.1</b> 390509 Haltefeder     |
|   | 220605 | <b>11.8116-0073.1</b> 390498 Haltefeder     |   | 220813 | <b>11.8171-0008.1</b> 990049 Führungsbolzen |
|   | 220605 | <b>11.8171-0008.1</b> 990049 Führungsbolzen | 11.9601-9766.2  | 220814 | <b>11.0101-5407.2</b> 260011 Hülsensatz     |
| 11.9571-9972.2  | 220606 | <b>11.0101-5407.2</b> 260011 Hülsensatz     |   | 220814 | <b>11.8116-0237.1</b> 390509 Haltefeder     |
|   | 220606 | <b>11.0441-5702.2</b> 250033 Dichtungssatz  |   | 220814 | <b>11.8171-0008.1</b> 990049 Führungsbolzen |
|   | 220606 | <b>11.8116-0073.1</b> 390498 Haltefeder     | 11.9601-9771.2  | 220583 | <b>11.0101-5706.2</b> 260097 Hülsensatz     |
|   | 220606 | <b>11.8171-0008.1</b> 990049 Führungsbolzen |   | 220583 | <b>11.0441-6008.2</b> 250038 Dichtungssatz  |
| 11.9576-9947.2  | 220809 | <b>11.0101-5409.2</b> 260035 Hülsensatz     |   | 220583 | <b>11.8116-0237.1</b> 390509 Haltefeder     |
|   | 220809 | <b>11.8116-0410.2</b> 390589 Haltefeder     |   | 220583 | <b>11.8171-0067.1</b> 250153 Führungsbolzen |
|   | 220809 | <b>11.8171-0008.1</b> 990049 Führungsbolzen | 11.9601-9772.2  | 220584 | <b>11.0101-5706.2</b> 260097 Hülsensatz     |
| 11.9576-9948.2  | 220810 | <b>11.0101-5409.2</b> 260035 Hülsensatz     |   | 220584 | <b>11.0441-6008.2</b> 250038 Dichtungssatz  |
|   | 220810 | <b>11.8116-0410.2</b> 390589 Haltefeder     |   | 220584 | <b>11.8116-0237.1</b> 390509 Haltefeder     |
|   | 220810 | <b>11.8171-0008.1</b> 990049 Führungsbolzen |   | 220584 | <b>11.8171-0067.1</b> 250153 Führungsbolzen |
| 11.9576-9975.2  | 220649 | <b>11.0101-5407.2</b> 260011 Hülsensatz     | 11.9601-9787.2  | 220585 | <b>11.0101-5407.2</b> 260011 Hülsensatz     |
|   | 220649 | <b>11.8116-0345.2</b> 390596 Haltefeder     |   | 220585 | <b>11.0441-6008.2</b> 250038 Dichtungssatz  |
|   | 220649 | <b>11.8116-0410.2</b> 390589 Haltefeder     |   | 220585 | <b>11.8116-0301.1</b> 390610 Haltefeder     |
|   | 220649 | <b>11.8171-0008.1</b> 990049 Führungsbolzen |   | 220585 | <b>11.8171-0008.1</b> 990049 Führungsbolzen |
| 11.9576-9976.2  | 220650 | <b>11.0101-5407.2</b> 260011 Hülsensatz     | 11.9601-9788.2  | 220586 | <b>11.0101-5407.2</b> 260011 Hülsensatz     |
|   | 220650 | <b>11.8116-0345.2</b> 390596 Haltefeder     |   | 220586 | <b>11.0441-6008.2</b> 250038 Dichtungssatz  |
|   | 220650 | <b>11.8116-0410.2</b> 390589 Haltefeder     |   | 220586 | <b>11.8116-0301.1</b> 390610 Haltefeder     |
|   | 220650 | <b>11.8171-0008.1</b> 990049 Führungsbolzen |   | 220586 | <b>11.8171-0008.1</b> 990049 Führungsbolzen |
| 11.9576-9995.2  | 220651 | <b>11.0101-5409.2</b> 260035 Hülsensatz     |   | 220586 | <b>11.8116-0301.1</b> 390610 Haltefeder     |
|   | 220651 | <b>11.8116-0410.2</b> 390589 Haltefeder     |   | 220586 | <b>11.8171-0008.1</b> 990049 Führungsbolzen |
|   | 220651 | <b>11.8171-0008.1</b> 990049 Führungsbolzen |   | 220586 | <b>11.8171-0008.1</b> 990049 Führungsbolzen |









# Reparatursätze

Repair kits - Corredi riparazione - Nécessaires de réparation - Juegos de reparación

|    |        |                                      |    |        |                                      |
|---|--------|--------------------------------------|---|--------|--------------------------------------|
| 11.9601-9823.2  | 220849 | 11.0101-5402.2 260009 Hülsensatz     | 11.9606-9965.2  | 220817 | 11.0101-5409.2 260035 Hülsensatz     |
|   | 220849 | 11.0441-6003.2 250037 Dichtungssatz  |   | 220817 | 11.0101-5704.2 260095 Hülsensatz     |
|   |        |                                      |   | 220817 | 11.0441-6008.2 250038 Dichtungssatz  |
| 11.9601-9824.2  | 220850 | 11.0101-5402.2 260009 Hülsensatz     |   | 220817 | 11.8116-0299.1 390446 Haltefeder     |
|   | 220850 | 11.0441-6003.2 250037 Dichtungssatz  |   | 220817 | 11.8116-0327.1 390599 Haltefeder     |
|   |        |                                      |   | 220817 | 11.8171-0008.1 990049 Führungsbolzen |
| 11.9601-9829.2  | 220505 | 11.0101-5407.2 260011 Hülsensatz     | 11.9606-9966.2  | 220818 | 11.0101-5409.2 260035 Hülsensatz     |
|   | 220505 | 11.8116-0366.2 390587 Haltefeder     |   | 220818 | 11.0101-5704.2 260095 Hülsensatz     |
|   | 220505 | 11.8171-0008.1 990049 Führungsbolzen |   | 220818 | 11.0441-6008.2 250038 Dichtungssatz  |
|   | 220505 | 11.8171-0067.1 250153 Führungsbolzen |   | 220818 | 11.8116-0299.1 390446 Haltefeder     |
| 11.9601-9830.2  | 220506 | 11.0101-5407.2 260011 Hülsensatz     |   | 220818 | 11.8116-0327.1 390599 Haltefeder     |
|   | 220506 | 11.8116-0366.2 390587 Haltefeder     |   | 220818 | 11.8171-0008.1 990049 Führungsbolzen |
|   | 220506 | 11.8171-0008.1 990049 Führungsbolzen | 11.9606-9967.2  | 220905 | 11.0101-5402.2 260009 Hülsensatz     |
|   | 220506 | 11.8171-0067.1 250153 Führungsbolzen |   | 220905 | 11.0441-6008.2 250038 Dichtungssatz  |
| 11.9601-9883.2  | 220917 | 11.0441-6008.2 250038 Dichtungssatz  |   | 220905 | 11.8116-0339.2 390528 Haltefeder     |
|   |        |                                      |   | 220905 | 11.8171-0008.1 990049 Führungsbolzen |
| 11.9601-9884.2  | 220918 | 11.0441-6008.2 250038 Dichtungssatz  | 11.9606-9968.2  | 220906 | 11.0101-5402.2 260009 Hülsensatz     |
|   |        |                                      |   | 220906 | 11.0441-6008.2 250038 Dichtungssatz  |
| 11.9606-9945.2  | 220727 | 11.0101-5704.2 260095 Hülsensatz     |   | 220906 | 11.8116-0339.2 390528 Haltefeder     |
|   | 220727 | 11.8116-0388.2 390588 Haltefeder     |   | 220906 | 11.8171-0008.1 990049 Führungsbolzen |
|   | 220727 | 11.8171-0008.1 990049 Führungsbolzen | 11.9606-9969.2  | 220731 | 11.0101-6006.2 260098 Hülsensatz     |
| 11.9606-9946.2  | 220728 | 11.0101-5704.2 260095 Hülsensatz     |   | 220731 | 11.8116-0366.2 390587 Haltefeder     |
|   | 220728 | 11.8116-0388.2 390588 Haltefeder     |   | 220731 | 11.8171-0008.1 990049 Führungsbolzen |
|   | 220728 | 11.8171-0008.1 990049 Führungsbolzen |   | 220731 | 11.8171-0067.1 250153 Führungsbolzen |
| 11.9606-9953.2  | 220587 | 11.0101-5409.2 260035 Hülsensatz     | 11.9606-9970.2  | 220732 | 11.0101-6006.2 260098 Hülsensatz     |
|   | 220587 | 11.0441-6008.2 250038 Dichtungssatz  |   | 220732 | 11.8116-0366.2 390587 Haltefeder     |
|   | 220587 | 11.8116-0347.2 390535 Haltefeder     |   | 220732 | 11.8171-0008.1 990049 Führungsbolzen |
|   | 220587 | 11.8116-0410.2 390589 Haltefeder     |   | 220732 | 11.8171-0067.1 250153 Führungsbolzen |
|   | 220587 | 11.8171-0008.1 990049 Führungsbolzen | 11.9606-9971.2  | 220589 | 11.0101-5407.2 260011 Hülsensatz     |
| 11.9606-9954.2  | 220588 | 11.0101-5409.2 260035 Hülsensatz     |   | 220589 | 11.0441-6008.2 250038 Dichtungssatz  |
|   | 220588 | 11.0441-6008.2 250038 Dichtungssatz  |   | 220589 | 11.8116-0345.2 390596 Haltefeder     |
|   | 220588 | 11.8116-0347.2 390535 Haltefeder     |   | 220589 | 11.8171-0008.1 990049 Führungsbolzen |
|   | 220588 | 11.8116-0410.2 390589 Haltefeder     | 11.9606-9972.2  | 220590 | 11.0101-5407.2 260011 Hülsensatz     |
|   | 220588 | 11.8171-0008.1 990049 Führungsbolzen |   | 220590 | 11.0441-6008.2 250038 Dichtungssatz  |
| 11.9606-9957.2  | 220815 | 11.0101-5409.2 260035 Hülsensatz     |   | 220590 | 11.8116-0345.2 390596 Haltefeder     |
|   | 220815 | 11.0441-6008.2 250038 Dichtungssatz  |   | 220590 | 11.8171-0008.1 990049 Führungsbolzen |
|   | 220815 | 11.8116-0410.2 390589 Haltefeder     | 11.9606-9979.2  | 220907 | 11.0101-6006.2 260098 Hülsensatz     |
|   | 220815 | 11.8171-0008.1 990049 Führungsbolzen |   | 220907 | 11.0441-6008.2 250038 Dichtungssatz  |
| 11.9606-9958.2  | 220816 | 11.0101-5409.2 260035 Hülsensatz     |   | 220907 | 11.8116-0315.2 390447 Haltefeder     |
|   | 220816 | 11.0441-6008.2 250038 Dichtungssatz  |   | 220907 | 11.8171-0008.1 990049 Führungsbolzen |
|   | 220816 | 11.8116-0410.2 390589 Haltefeder     |   | 220907 | 11.8171-0067.1 250153 Führungsbolzen |
|   | 220816 | 11.8171-0008.1 990049 Führungsbolzen | 11.9606-9980.2  | 220908 | 11.0101-6006.2 260098 Hülsensatz     |
| 11.9606-9959.2  | 220729 | 11.0101-6006.2 260098 Hülsensatz     |   | 220908 | 11.0441-6008.2 250038 Dichtungssatz  |
|   | 220729 | 11.8116-0366.2 390587 Haltefeder     |   | 220908 | 11.8116-0315.2 390447 Haltefeder     |
|   | 220729 | 11.8171-0008.1 990049 Führungsbolzen |   | 220908 | 11.8171-0008.1 990049 Führungsbolzen |
|   | 220729 | 11.8171-0067.1 250153 Führungsbolzen |   | 220908 | 11.8171-0067.1 250153 Führungsbolzen |
| 11.9606-9960.2  | 220730 | 11.0101-6006.2 260098 Hülsensatz     | 11.9606-9981.2  | 220591 | 11.0101-5407.2 260011 Hülsensatz     |
|   | 220730 | 11.8116-0366.2 390587 Haltefeder     |   | 220591 | 11.8116-0325.2 390461 Haltefeder     |
|   | 220730 | 11.8171-0008.1 990049 Führungsbolzen |   | 220591 | 11.8171-0008.1 990049 Führungsbolzen |
|   | 220730 | 11.8171-0067.1 250153 Führungsbolzen | 11.9606-9982.2  | 220592 | 11.0101-5407.2 260011 Hülsensatz     |
| 11.9606-9961.2  | 220655 | 11.0101-5409.2 260035 Hülsensatz     |   | 220592 | 11.8116-0325.2 390461 Haltefeder     |
|   | 220655 | 11.0441-6008.2 250038 Dichtungssatz  |   | 220592 | 11.8171-0008.1 990049 Führungsbolzen |
|   | 220655 | 11.8116-0410.2 390589 Haltefeder     | 11.9606-9991.2  | 220429 | 11.0101-5402.2 260009 Hülsensatz     |
|   | 220655 | 11.8171-0008.1 990049 Führungsbolzen |   | 220429 | 11.0441-6008.2 250038 Dichtungssatz  |
| 11.9606-9962.2  | 220656 | 11.0101-5409.2 260035 Hülsensatz     |   | 220429 | 11.8116-0239.2 390510 Haltefeder     |
|   | 220656 | 11.0441-6008.2 250038 Dichtungssatz  |   | 220429 | 11.8171-0008.1 990049 Führungsbolzen |
|   | 220656 | 11.8116-0410.2 390589 Haltefeder     |   |        |                                      |
|   | 220656 | 11.8171-0008.1 990049 Führungsbolzen |   |        |                                      |

# Reparatursätze

Repair kits - Corredi riparazione - Nécessaires de réparation - Juegos de reparación

|  |  |  |  |  |  |
|---|---|---|---|---|---|
| 11.9606-9992.2 220430   | <b>11.0101-5402.2</b> 260009  | Hülsensatz  | 13.2381-8027.2 210033   | <b>13.0441-3811.2</b> 250067  | Dichtungssatz   |
| 220430  | <b>11.0441-6008.2</b> 250038  | Dichtungssatz   | 13.2381-8028.2 210034   | <b>13.0441-3811.2</b> 250067  | Dichtungssatz   |
| 220430  | <b>11.8116-0239.2</b> 390510  | Haltefeder  | 13.2381-8029.2 210035   | <b>13.0441-3811.2</b> 250067  | Dichtungssatz   |
| 220430  | <b>11.8171-0008.1</b> 990049  | Führungsbolzen  | 13.2381-8030.2 210036   | <b>13.0441-3811.2</b> 250067  | Dichtungssatz   |
| 13.2351-0011.2 210008   | <b>13.0441-3506.2</b> 250052  | Dichtungssatz   | 13.2381-8033.2 210222   | <b>13.0441-3817.2</b> 250071  | Dichtungssatz   |
| 13.2351-0012.2 210009   | <b>13.0441-3506.2</b> 250052  | Dichtungssatz   | 13.2381-8034.2 210223   | <b>13.0441-3817.2</b> 250071  | Dichtungssatz   |
| 13.2351-0013.2 210010   | <b>13.0441-3506.2</b> 250052  | Dichtungssatz   | 13.2381-8035.2 210037   | <b>13.0441-3817.2</b> 250071  | Dichtungssatz   |
| 13.2351-0014.2 210011   | <b>13.0441-3506.2</b> 250052  | Dichtungssatz   | 13.2381-8036.2 210038   | <b>13.0441-3817.2</b> 250071  | Dichtungssatz   |
| 13.2351-0017.2 210012   | <b>13.0441-3506.2</b> 250052  | Dichtungssatz   | 13.2381-9996.2 210039   | <b>13.0441-3801.2</b> 250058  | Dichtungssatz   |
| 13.2351-0018.2 210013   | <b>13.0441-3506.2</b> 250052  | Dichtungssatz   | 13.2381-9997.2 210040   | <b>13.0441-3801.2</b> 250058  | Dichtungssatz   |
| 13.2351-0025.2 210210   | <b>13.0441-3506.2</b> 250052  | Dichtungssatz   | 13.2383-0001.2 210041   | <b>13.0441-3803.2</b> 250060  | Dichtungssatz   |
| 13.2351-0026.2 210211   | <b>13.0441-3506.2</b> 250052  | Dichtungssatz   | 13.2383-0002.2 210042   | <b>13.0441-3803.2</b> 250060  | Dichtungssatz   |
| 13.2351-0051.2 210180   | <b>13.0441-3507.2</b> 250053  | Dichtungssatz   | 13.2384-0013.2 210043   | <b>13.0441-3810.2</b> 250066  | Dichtungssatz   |
| 13.2351-0052.2 210181   | <b>13.0441-3507.2</b> 250053  | Dichtungssatz   | 13.2384-0014.2 210044   | <b>13.0441-3810.2</b> 250066  | Dichtungssatz   |
| 13.2351-8005.2 210014   | <b>13.0441-3505.2</b> 250051  | Dichtungssatz   | 13.2401-0025.2 210224   | <b>13.0441-4022.2</b> 250149  | Dichtungssatz   |
| 13.2351-8006.2 210015   | <b>13.0441-3505.2</b> 250051  | Dichtungssatz   | 13.2401-0026.2 210225   | <b>13.0441-4022.2</b> 250149  | Dichtungssatz   |
| 13.2351-8019.2 210139   | <b>13.0441-3507.2</b> 250053  | Dichtungssatz   | 13.2401-0027.2 210045   | <b>13.0441-4014.2</b> 250079  | Dichtungssatz   |
| 13.2351-8020.2 210140   | <b>13.0441-3507.2</b> 250053  | Dichtungssatz   | 13.2401-0028.2 210046   | <b>13.0441-4014.2</b> 250079  | Dichtungssatz   |
| 13.2353-8003.2 210016   | <b>13.0441-3504.2</b> 250050  | Dichtungssatz   | 13.2401-0039.2 210153   | <b>13.0441-4022.2</b> 250149  | Dichtungssatz   |
| 13.2353-8004.2 210017   | <b>13.0441-3504.2</b> 250050  | Dichtungssatz   | 13.2401-0040.2 210154   | <b>13.0441-4022.2</b> 250149  | Dichtungssatz   |
| 13.2361-8001.2 210214   | <b>13.0441-3606.2</b> 250147  | Dichtungssatz   | 13.2401-8007.2 210047   | <b>13.0441-4002.2</b> 250074  | Dichtungssatz   |
| 13.2361-8002.2 210215   | <b>13.0441-3606.2</b> 250147  | Dichtungssatz   | 210047  | <b>13.0441-4008.2</b> 250076  | Dichtungssatz   |
| 13.2361-8003.2 210220   | <b>13.0441-3609.2</b> 250057  | Dichtungssatz   | 13.2401-8008.2 210048   | <b>13.0441-4002.2</b> 250074  | Dichtungssatz   |
| 13.2361-8004.2 210221   | <b>13.0441-3609.2</b> 250057  | Dichtungssatz   | 210048  | <b>13.0441-4008.2</b> 250076  | Dichtungssatz   |
| 13.2361-8005.2 210237   | <b>13.0441-3609.2</b> 250057  | Dichtungssatz   | 13.2401-8013.2 210051   | <b>13.0441-4020.2</b> 250084  | Dichtungssatz   |
| 13.2361-8006.2 210238   | <b>13.0441-3609.2</b> 250057  | Dichtungssatz   | 13.2401-8014.2 210052   | <b>13.0441-4020.2</b> 250084  | Dichtungssatz   |
| 13.2381-0039.2 210020   | <b>13.0441-3812.2</b> 250068  | Dichtungssatz   | 13.2421-0025.2 210145   | <b>13.0441-4206.2</b> 250087  | Dichtungssatz   |
| 13.2381-0040.2 210021   | <b>13.0441-3812.2</b> 250068  | Dichtungssatz   | 13.2421-0026.2 210146   | <b>13.0441-4206.2</b> 250087  | Dichtungssatz   |
| 13.2381-0067.2 210024   | <b>13.0441-3815.2</b> 250069  | Dichtungssatz   | 13.2421-0043.2 210193   | <b>13.0441-4216.2</b> 250093  | Dichtungssatz   |
| 13.2381-0068.2 210025   | <b>13.0441-3815.2</b> 250069  | Dichtungssatz   | 13.2421-0044.2 210194   | <b>13.0441-4216.2</b> 250093  | Dichtungssatz   |
| 13.2381-0083.2 210026   | <b>13.0441-3819.2</b> 250072  | Dichtungssatz   | 13.2421-8005.2 210053   | <b>13.0441-4205.2</b> 250086  | Dichtungssatz   |
| 13.2381-0084.2 210027   | <b>13.0441-3819.2</b> 250072  | Dichtungssatz   | 13.2421-8006.2 210054   | <b>13.0441-4205.2</b> 250086  | Dichtungssatz   |
| 13.2381-0085.2 210028   | <b>13.0441-3819.2</b> 250072  | Dichtungssatz   | 13.2421-8007.2 210055   | <b>13.0441-4205.2</b> 250086  | Dichtungssatz   |
| 13.2381-0086.2 210029   | <b>13.0441-3819.2</b> 250072  | Dichtungssatz   | 13.2421-8008.2 210056   | <b>13.0441-4205.2</b> 250086  | Dichtungssatz   |
| 13.2381-0087.2 210149   | <b>13.0441-3819.2</b> 250072  | Dichtungssatz   | 13.2421-8021.2 210057   | <b>13.0441-4206.2</b> 250087  | Dichtungssatz   |
| 13.2381-0088.2 210150   | <b>13.0441-3819.2</b> 250072  | Dichtungssatz   | 13.2421-8022.2 210058   | <b>13.0441-4206.2</b> 250087  | Dichtungssatz   |

# Reparatursätze







Repair kits - Corredi riparazione - Nécessaires de réparation - Juegos de reparación

|  |  |  |  |  |  |
|---|---|---|---|---|---|
| 13.2421-8025.2 210061   | <b>13.0441-4216.2</b>   | 2250093 Dichtungssatz   | 13.2481-9999.2 210103   | <b>13.0441-4815.2</b>   | 2250102 Dichtungssatz   |
| 13.2421-8026.2 210062   | <b>13.0441-4216.2</b>   | 2250093 Dichtungssatz   | 13.2483-8001.2 210104   | <b>13.0441-4825.2</b>   | 2250107 Dichtungssatz   |
| 13.2423-8009.2 210063   | <b>13.0441-4206.2</b>   | 2250087 Dichtungssatz   | 13.2483-8002.2 210105   | <b>13.0441-4825.2</b>   | 2250107 Dichtungssatz   |
| 13.2423-8010.2 210064   | <b>13.0441-4206.2</b>   | 2250087 Dichtungssatz   | 13.2541-8001.2 210110   | <b>13.0441-5416.2</b>   | 2250117 Dichtungssatz   |
| 13.2424-0009.2 210065   | <b>13.0441-4212.2</b>   | 2250089 Dichtungssatz   | 13.2541-8002.2 210111   | <b>13.0441-5416.2</b>   | 2250117 Dichtungssatz   |
| 13.2424-0010.2 210066   | <b>13.0441-4212.2</b>   | 2250089 Dichtungssatz   | 13.2541-8008.2 210112   | <b>13.0441-5411.2</b>   | 2250114 Dichtungssatz   |
| 13.2424-8001.2 210072   | <b>13.0441-4212.2</b>   | 2250089 Dichtungssatz   | 13.2541-9998.2 210113   | <b>13.0441-5409.2</b>   | 2250112 Dichtungssatz   |
| 13.2424-8002.2 210073   | <b>13.0441-4212.2</b>   | 2250089 Dichtungssatz   | 13.2541-9999.2 210114   | <b>13.0441-5409.2</b>   | 2250112 Dichtungssatz   |
| 13.2461-8001.2 210226   | <b>13.0441-4601.2</b>   | 2250099 Dichtungssatz   | 13.2544-8001.2 210115   | <b>13.0441-5417.2</b>   | 2250118 Dichtungssatz   |
| 13.2461-8002.2 210227   | <b>13.0441-4601.2</b>   | 2250099 Dichtungssatz   | 210115  | <b>13.0471-5405.2</b>   | 2250136 Rep.Satz Nachstellung   |
| 13.2481-0024.2 210074   | <b>13.0441-4819.2</b>   | 2250104 Dichtungssatz   | 210115  | <b>13.0471-5407.2</b>   | 2250137 Verbindungsschrauben  |
| 13.2481-0026.2 210075   | <b>13.0441-4825.2</b>   | 2250107 Dichtungssatz   | 210115  | <b>13.0471-5408.2</b>   | 2250138 Rep.Satz Rückstellwelle   |
| 13.2481-0033.2 210076   | <b>13.0441-4819.2</b>   | 2250104 Dichtungssatz   | 210115  | <b>13.0471-5409.2</b>   | 2250139 Rep.Satz Bremshebel   |
| 13.2481-0034.2 210077   | <b>13.0441-4819.2</b>   | 2250104 Dichtungssatz   | 210115  | <b>13.8158-0020.1</b>   | 1990113 Handbremshebel  |
| 13.2481-0057.2 210078   | <b>13.0441-4819.2</b>   | 2250104 Dichtungssatz   | 210115  | <b>13.8158-0021.1</b>   | 1990114 Handbremshebel  |
| 13.2481-0073.2 210079   | <b>13.0441-4819.2</b>   | 2250104 Dichtungssatz   | 13.2544-8002.2 210116   | <b>13.0441-5417.2</b>   | 2250118 Dichtungssatz   |
| 13.2481-0074.2 210080   | <b>13.0441-4819.2</b>   | 2250104 Dichtungssatz   | 210116  | <b>13.0471-5405.2</b>   | 2250136 Rep.Satz Nachstellung   |
| 13.2481-0075.2 210081   | <b>13.0441-4819.2</b>   | 2250104 Dichtungssatz   | 210116  | <b>13.0471-5407.2</b>   | 2250137 Verbindungsschrauben  |
| 13.2481-0076.2 210082   | <b>13.0441-4819.2</b>   | 2250104 Dichtungssatz   | 210116  | <b>13.0471-5408.2</b>   | 2250138 Rep.Satz Rückstellwelle   |
| 13.2481-2311.3 210085   | <b>13.0441-4819.2</b>   | 2250104 Dichtungssatz   | 210116  | <b>13.0471-5409.2</b>   | 2250139 Rep.Satz Bremshebel   |
| 13.2481-2411.3 210086   | <b>13.0441-4819.2</b>   | 2250104 Dichtungssatz   | 210116  | <b>13.8158-0020.1</b>   | 1990113 Handbremshebel  |
| 13.2481-7404.3 210089   | <b>13.0441-4819.2</b>   | 2250104 Dichtungssatz   | 210116  | <b>13.8158-0021.1</b>   | 1990114 Handbremshebel  |
| 13.2481-8007.2 210090   | <b>13.0441-4825.2</b>   | 2250107 Dichtungssatz   | 13.2571-8011.2 210121   | <b>13.0441-5718.2</b>   | 2250120 Dichtungssatz   |
| 13.2481-8008.2 210091   | <b>13.0441-4825.2</b>   | 2250107 Dichtungssatz   | 13.2571-8012.2 210122   | <b>13.0441-5718.2</b>   | 2250120 Dichtungssatz   |
| 13.2481-8011.2 210092   | <b>13.0441-4825.2</b>   | 2250107 Dichtungssatz   | 13.2571-8013.2 210123   | <b>13.0441-5718.2</b>   | 2250120 Dichtungssatz   |
| 13.2481-8012.2 210093   | <b>13.0441-4825.2</b>   | 2250107 Dichtungssatz   | 13.2571-8014.2 210124   | <b>13.0441-5718.2</b>   | 2250120 Dichtungssatz   |
| 13.2481-8013.2 210094   | <b>13.0441-4825.2</b>   | 2250107 Dichtungssatz   | 13.2571-8015.2 210125   | <b>13.0441-5720.2</b>   | 2250122 Dichtungssatz   |
| 13.2481-8014.2 210095   | <b>13.0441-4825.2</b>   | 2250107 Dichtungssatz   | 13.2571-8016.2 210126   | <b>13.0441-5720.2</b>   | 2250122 Dichtungssatz   |
| 13.2481-8057.2 210096   | <b>13.0441-4825.2</b>   | 2250107 Dichtungssatz   | 13.2571-8023.2 210127   | <b>13.0441-5724.2</b>   | 2250125 Dichtungssatz   |
| 13.2481-8058.2 210097   | <b>13.0441-4825.2</b>   | 2250107 Dichtungssatz   | 13.2571-8024.2 210128   | <b>13.0441-5724.2</b>   | 2250125 Dichtungssatz   |
| 13.2481-8067.2 210098   | <b>13.0441-4819.2</b>   | 2250104 Dichtungssatz   | 13.2571-8027.2 210129   | <b>13.0441-5720.2</b>   | 2250122 Dichtungssatz   |
| 13.2481-8068.2 210099   | <b>13.0441-4819.2</b>   | 2250104 Dichtungssatz   | 13.2571-8028.2 210130   | <b>13.0441-5720.2</b>   | 2250122 Dichtungssatz   |
| 13.2481-9992.2 210100   | <b>13.0441-4819.2</b>   | 2250104 Dichtungssatz   | 13.2571-9994.2 210131   | <b>13.0441-5720.2</b>   | 2250122 Dichtungssatz   |
| 13.2481-9993.2 210101   | <b>13.0441-4819.2</b>   | 2250104 Dichtungssatz   | 13.2571-9995.2 210132   | <b>13.0441-5720.2</b>   | 2250122 Dichtungssatz   |
| 13.2481-9998.2 210102   | <b>13.0441-4815.2</b>   | 2250102 Dichtungssatz   | 13.2571-9998.2 210133   | <b>13.0441-5718.2</b>   | 2250120 Dichtungssatz   |
|   |   |   | 13.2571-9999.2 210134   | <b>13.0441-5718.2</b>   | 2250120 Dichtungssatz   |
|   |   |   | 13.2601-0179.3 210141   | <b>13.0441-6012.2</b>   | 2250133 Dichtungssatz   |
|   |   |   | 13.2601-0180.3 210142   | <b>13.0441-6012.2</b>   | 2250133 Dichtungssatz   |
|   |   |   | 13.2601-7015.2 210230   | <b>03.3518-6100.2</b>   | 390364 Entlüfterventil  |
|   |   |   | 210230  | <b>03.3518-8000.2</b>   | 390373 Entlüfterventil  |
|   |   |   | 210230  | <b>13.0441-6012.2</b>   | 2250133 Dichtungssatz   |









# Reparatursätze

Repair kits - Corredi riparazione - Nécessaires de réparation - Juegos de reparación

|  |   |  |  |    |  |
|---|--|---|---|---|---|
| 13.2601-7016.2 210231<br>210231<br>210231   | <b>03.3518-6100.2</b> 390364 Entlüfterventil<br><b>03.3518-8000.2</b> 390373 Entlüfterventil<br><b>13.0441-6012.2</b> 250133 Dichtungssatz |   | 13.4421-8003.2 210197   | <b>13.0441-4214.2</b> 250091 Dichtungssatz  |   |
|   |  |   | 13.4421-8004.2 210198   | <b>13.0441-4214.2</b> 250091 Dichtungssatz  |   |
| 13.2601-8025.2 210157   | <b>13.0441-6001.2</b> 250126 Dichtungssatz   |   | 13.4421-8007.2 210235   | <b>13.0441-4214.2</b> 250091 Dichtungssatz  |   |
| 13.2601-8026.2 210158   | <b>13.0441-6001.2</b> 250126 Dichtungssatz   |   | 13.4421-8008.2 210236   | <b>13.0441-4214.2</b> 250091 Dichtungssatz  |   |
| 13.2601-8027.2 210159   | <b>13.0441-6001.2</b> 250126 Dichtungssatz   |   | 13.4421-8009.2 210228   | <b>13.0441-4214.2</b> 250091 Dichtungssatz  |   |
| 13.2601-8028.2 210160   | <b>13.0441-6001.2</b> 250126 Dichtungssatz   |   | 13.4421-8010.2 210229   | <b>13.0441-4214.2</b> 250091 Dichtungssatz  |   |
| 13.2601-8029.2 210161   | <b>13.0441-6003.2</b> 250128 Dichtungssatz   |   | 13.4441-8011.3 210216   | <b>13.0441-4408.2</b> 250096 Dichtungssatz  |   |
| 13.2601-8030.2 210162   | <b>13.0441-6003.2</b> 250128 Dichtungssatz   |   | 13.4441-8012.3 210217   | <b>13.0441-4408.2</b> 250096 Dichtungssatz  |   |
| 13.2601-8031.2 210163   | <b>13.0441-6003.2</b> 250128 Dichtungssatz   |   | 13.4441-8013.3 210199   | <b>13.0441-4408.2</b> 250096 Dichtungssatz  |   |
| 13.2601-8032.2 210164   | <b>13.0441-6003.2</b> 250128 Dichtungssatz   |   | 13.4441-8014.3 210200   | <b>13.0441-4408.2</b> 250096 Dichtungssatz  |   |
| 13.2601-8033.2 210165   | <b>13.0441-6003.2</b> 250128 Dichtungssatz   |   | 13.4441-8015.3 210201   | <b>13.0441-4408.2</b> 250096 Dichtungssatz  |   |
| 13.2601-8034.2 210166   | <b>13.0441-6003.2</b> 250128 Dichtungssatz   |   | 13.4441-8016.3 210202   | <b>13.0441-4408.2</b> 250096 Dichtungssatz  |   |
| 13.2601-8035.2 210167<br>210167<br>210167   | <b>03.3518-6100.2</b> 390364 Entlüfterventil<br><b>03.3518-8000.2</b> 390373 Entlüfterventil<br><b>13.0441-6012.2</b> 250133 Dichtungssatz |   | 13.4441-8017.3 210203   | <b>13.0441-4408.2</b> 250096 Dichtungssatz  |   |
| 13.2601-8036.2 210168<br>210168<br>210168   | <b>03.3518-6100.2</b> 390364 Entlüfterventil<br><b>03.3518-8000.2</b> 390373 Entlüfterventil<br><b>13.0441-6012.2</b> 250133 Dichtungssatz |   | 13.4441-8018.3 210204   | <b>13.0441-4408.2</b> 250096 Dichtungssatz  |   |
| 13.2601-8037.2 210169<br>210169<br>210169   | <b>03.3518-6100.2</b> 390364 Entlüfterventil<br><b>03.3518-8000.2</b> 390373 Entlüfterventil<br><b>13.0441-6012.2</b> 250133 Dichtungssatz |   | 13.4571-0019.3 210249   | <b>13.0441-5721.2</b> 250123 Dichtungssatz  |   |
| 13.2601-8038.2 210170<br>210170<br>210170   | <b>03.3518-6100.2</b> 390364 Entlüfterventil<br><b>03.3518-8000.2</b> 390373 Entlüfterventil<br><b>13.0441-6012.2</b> 250133 Dichtungssatz |   | 13.4571-0020.3 210250   | <b>13.0441-5721.2</b> 250123 Dichtungssatz  |   |
| 13.2601-9996.2 210176   | <b>13.0441-6001.2</b> 250126 Dichtungssatz   |   | 13.4571-8005.3 210205   | <b>13.0441-5721.2</b> 250123 Dichtungssatz  |   |
| 13.2601-9997.2 210177   | <b>13.0441-6001.2</b> 250126 Dichtungssatz   |   | 13.4571-8006.3 210206   | <b>13.0441-5721.2</b> 250123 Dichtungssatz  |   |
| 13.4341-8001.2 210151   | <b>13.0441-3401.2</b> 250044 Dichtungssatz   |   | 13.4574-8005.3 210207   | <b>13.0441-5721.2</b> 250123 Dichtungssatz  |   |
| 13.4341-8002.2 210152   | <b>13.0441-3401.2</b> 250044 Dichtungssatz   |   | 13.4574-8006.3 210208   | <b>13.0441-5721.2</b> 250123 Dichtungssatz  |   |
| 13.4401-8005.2 210182   | <b>13.0441-4018.2</b> 250083 Dichtungssatz   |   | 13.9361-0023.2 210241   | <b>13.0441-3609.2</b> 250057 Dichtungssatz  |   |
| 13.4401-8006.2 210183   | <b>13.0441-4018.2</b> 250083 Dichtungssatz   |   | 13.9361-0024.2 210242   | <b>13.0441-3609.2</b> 250057 Dichtungssatz  |   |
| 13.4401-8009.2 210184   | <b>13.0441-4018.2</b> 250083 Dichtungssatz   |   | 13.9361-0029.2 210243   | <b>13.0441-3609.2</b> 250057 Dichtungssatz  |   |
| 13.4401-8010.2 210185   | <b>13.0441-4018.2</b> 250083 Dichtungssatz   |   | 13.9361-0030.2 210244   | <b>13.0441-3609.2</b> 250057 Dichtungssatz  |   |
| 13.4401-8018.2 210186   | <b>13.0441-4018.2</b> 250083 Dichtungssatz   |   | 13.9361-0035.2 210253   | <b>13.0441-3609.2</b> 250057 Dichtungssatz  |   |
| 13.4401-8019.2 210187   | <b>13.0441-4018.2</b> 250083 Dichtungssatz   |   | 13.9361-0036.2 210254   | <b>13.0441-3609.2</b> 250057 Dichtungssatz  |   |
| 13.4401-8020.2 210188   | <b>13.0441-4018.2</b> 250083 Dichtungssatz   |   | 13.9544-0021.2 210257<br>210257<br>210257<br>210257<br>210257<br>210257           | <b>13.0441-5417.2</b> 250118 Dichtungssatz<br><b>13.0471-5405.2</b> 250136 Rep.Satz Nachstellung<br><b>13.0471-5407.2</b> 250137 Verbindungsschrauben<br><b>13.0471-5408.2</b> 250138 Rep.Satz Rückstellwelle<br><b>13.0471-5409.2</b> 250139 Rep.Satz Bremshebel<br><b>13.8158-0020.1</b> 990113 Handbremshebel<br><b>13.8158-0021.1</b> 990114 Handbremshebel |   |
| 13.4401-8021.2 210189   | <b>13.0441-4018.2</b> 250083 Dichtungssatz   |   | 13.9544-0022.2 210258<br>210258<br>210258<br>210258<br>210258<br>210258           | <b>13.0441-5417.2</b> 250118 Dichtungssatz<br><b>13.0471-5405.2</b> 250136 Rep.Satz Nachstellung<br><b>13.0471-5407.2</b> 250137 Verbindungsschrauben<br><b>13.0471-5408.2</b> 250138 Rep.Satz Rückstellwelle<br><b>13.0471-5409.2</b> 250139 Rep.Satz Bremshebel<br><b>13.8158-0020.1</b> 990113 Handbremshebel<br><b>13.8158-0021.1</b> 990114 Handbremshebel |   |
| 13.4401-8022.2 210190   | <b>13.0441-4018.2</b> 250083 Dichtungssatz   |   | 24.0530-3801.3 220161   | <b>24.0101-3601.2</b> 260044 Einbausatz   |   |
| 13.4401-8027.2 210191   | <b>13.0441-4016.2</b> 250081 Dichtungssatz   |   |   |   |   |
| 13.4401-8028.2 210192   | <b>13.0441-4016.2</b> 250081 Dichtungssatz   |   |   |   |   |







# Reparatursätze

Repair kits - Corredi riparazione - Nécessaires de réparation - Juegos de reparación

|  |  |  |  |  |  |
|---|---|---|---|---|---|
| 24.1441-1701.5 239001   | <b>11.0441-4402.2</b> 250014  | Dichtungssatz   | 24.3361-9975.5 240541   | <b>11.0101-5407.2</b> 260011  | Hülsensatz  |
| 24.1441-1702.5 239002   | <b>11.0441-4402.2</b> 250014  | Dichtungssatz   | 240541  | <b>11.0441-3602.2</b> 250008  | Dichtungssatz   |
| 24.3301-1703.7 220683   | <b>24.0101-3802.2</b> 260100  | Einbausatz  | 240541  | <b>11.8116-0073.1</b> 390498  | Haltefeder  |
| 24.3301-1704.7 220684   | <b>24.0101-3802.2</b> 260100  | Einbausatz  | 240541  | <b>11.8171-0008.1</b> 990049  | Führungsbolzen  |
| 24.3304-1701.5 240113   | <b>24.0101-3004.2</b> 260042  | Einbausatz  | 24.3361-9976.5 240542   | <b>11.0101-5407.2</b> 260011  | Hülsensatz  |
| 24.3304-1702.5 240114   | <b>24.0101-3004.2</b> 260042  | Einbausatz  | 240542  | <b>11.0441-3602.2</b> 250008  | Dichtungssatz   |
| 24.3304-1703.5 240091   | <b>24.0101-3004.2</b> 260042  | Einbausatz  | 240542  | <b>11.8116-0073.1</b> 390498  | Haltefeder  |
| 24.3304-1704.5 240092   | <b>24.0101-3004.2</b> 260042  | Einbausatz  | 240542  | <b>11.8171-0008.1</b> 990049  | Führungsbolzen  |
| 24.3304-1707.5 240097   | <b>24.0101-3001.2</b> 260039  | Einbausatz  | 24.3364-1603.5 240009   | <b>24.0101-3601.2</b> 260044  | Einbausatz  |
| 24.3304-1708.5 240098   | <b>24.0101-3001.2</b> 260039  | Einbausatz  | 24.3364-1604.5 240010   | <b>24.0101-3601.2</b> 260044  | Einbausatz  |
| 24.3331-0037.5 240547   | <b>11.0441-3305.2</b> 250006  | Dichtungssatz   | 24.3364-1605.5 240011   | <b>11.0101-5403.2</b> 260010  | Faltenbalgsatz  |
| 24.3331-0038.5 240548   | <b>11.0441-3305.2</b> 250006  | Dichtungssatz   | 240011  | <b>24.0101-3601.2</b> 260044  | Einbausatz  |
| 24.3331-8501.5 240509   | <b>11.0101-5402.2</b> 260009  | Hülsensatz  | 24.3364-1606.5 240012   | <b>11.0101-5403.2</b> 260010  | Faltenbalgsatz  |
| 240509  | <b>11.0441-3302.2</b> 250004  | Dichtungssatz   | 240012  | <b>24.0101-3601.2</b> 260044  | Einbausatz  |
| 240509  | <b>11.8116-0015.1</b> 390492  | Haltefeder  | 24.3364-1701.5 240053   | <b>24.0101-3601.2</b> 260044  | Einbausatz  |
| 240509  | <b>11.8171-0008.1</b> 990049  | Führungsbolzen  | 24.3364-1702.5 240054   | <b>24.0101-3601.2</b> 260044  | Einbausatz  |
| 24.3331-8502.5 240510   | <b>11.0101-5402.2</b> 260009  | Hülsensatz  | 24.3367-1711.7 220753   | <b>24.0101-3803.2</b> 260101  | Einbausatz  |
| 240510  | <b>11.0441-3302.2</b> 250004  | Dichtungssatz   | 24.3367-1712.7 220754   | <b>24.0101-3803.2</b> 260101  | Einbausatz  |
| 240510  | <b>11.8116-0015.1</b> 390492  | Haltefeder  | 24.3381-1701.5 240071   | <b>24.0101-3801.2</b> 260045  | Einbausatz  |
| 240510  | <b>11.8171-0008.1</b> 990049  | Führungsbolzen  | 24.3381-1702.5 240072   | <b>24.0101-3801.2</b> 260045  | Einbausatz  |
| 24.3341-9991.5 240511   | <b>11.0101-5402.2</b> 260009  | Hülsensatz  | 24.3381-8503.5 240515   | <b>11.0101-5402.2</b> 260009  | Hülsensatz  |
| 240511  | <b>11.0441-3401.2</b> 250151  | Dichtungssatz   | 240515  | <b>11.0441-3803.2</b> 250010  | Dichtungssatz   |
| 240511  | <b>11.8116-0185.1</b> 390592  | Haltefeder  | 240515  | <b>11.8116-0066.1</b> 390577  | Haltefeder  |
| 240511  | <b>11.8171-0008.1</b> 990049  | Führungsbolzen  | 240515  | <b>11.8171-0008.1</b> 990049  | Führungsbolzen  |
| 24.3341-9992.5 240512   | <b>11.0101-5402.2</b> 260009  | Hülsensatz  | 24.3381-8504.5 240516   | <b>11.0101-5402.2</b> 260009  | Hülsensatz  |
| 240512  | <b>11.0441-3401.2</b> 250151  | Dichtungssatz   | 240516  | <b>11.0441-3803.2</b> 250010  | Dichtungssatz   |
| 240512  | <b>11.8116-0185.1</b> 390592  | Haltefeder  | 240516  | <b>11.8116-0066.1</b> 390577  | Haltefeder  |
| 240512  | <b>11.8171-0008.1</b> 990049  | Führungsbolzen  | 240516  | <b>11.8171-0008.1</b> 990049  | Führungsbolzen  |
| 24.3344-1701.5 240087   | <b>24.0101-3401.2</b> 260043  | Einbausatz  | 24.3381-9959.5 240517   | <b>11.0101-5402.2</b> 260009  | Hülsensatz  |
| 24.3344-1702.5 240088   | <b>24.0101-3401.2</b> 260043  | Einbausatz  | 240517  | <b>11.0441-3803.2</b> 250010  | Dichtungssatz   |
| 24.3344-1703.5 240117   | <b>24.0101-3601.2</b> 260044  | Einbausatz  | 240517  | <b>11.8116-0066.1</b> 390577  | Haltefeder  |
| 24.3344-1704.5 240118   | <b>24.0101-3601.2</b> 260044  | Einbausatz  | 240517  | <b>11.8171-0008.1</b> 990049  | Führungsbolzen  |
| 24.3347-1703.7 220685   | <b>24.0101-3803.2</b> 260101  | Einbausatz  | 24.3381-9960.5 240518   | <b>11.0101-5402.2</b> 260009  | Hülsensatz  |
| 24.3347-1704.7 220686   | <b>24.0101-3803.2</b> 260101  | Einbausatz  | 240518  | <b>11.0441-3803.2</b> 250010  | Dichtungssatz   |
| 24.3347-1705.7 220751   | <b>24.0101-3803.2</b> 260101  | Einbausatz  | 240518  | <b>11.8116-0066.1</b> 390577  | Haltefeder  |
| 24.3347-1706.7 220752   | <b>24.0101-3803.2</b> 260101  | Einbausatz  | 240518  | <b>11.8171-0008.1</b> 990049  | Führungsbolzen  |
| 24.3361-8503.5 240513   | <b>11.0101-5402.2</b> 260009  | Hülsensatz  | 24.3381-9961.5 240519   | <b>11.0101-5402.2</b> 260009  | Hülsensatz  |
| 240513  | <b>11.0441-3602.2</b> 250008  | Dichtungssatz   | 240519  | <b>11.0441-3803.2</b> 250010  | Dichtungssatz   |
| 240513  | <b>11.8116-0066.1</b> 390577  | Haltefeder  | 240519  | <b>11.8116-0066.1</b> 390577  | Haltefeder  |
| 240513  | <b>11.8171-0008.1</b> 990049  | Führungsbolzen  | 240519  | <b>11.8171-0008.1</b> 990049  | Führungsbolzen  |
| 24.3361-8504.5 240514   | <b>11.0101-5402.2</b> 260009  | Hülsensatz  | 24.3381-9962.5 240520   | <b>11.0101-5402.2</b> 260009  | Hülsensatz  |
| 240514  | <b>11.0441-3602.2</b> 250008  | Dichtungssatz   | 240520  | <b>11.0441-3803.2</b> 250010  | Dichtungssatz   |
| 240514  | <b>11.8116-0066.1</b> 390577  | Haltefeder  | 240520  | <b>11.8116-0066.1</b> 390577  | Haltefeder  |
| 240514  | <b>11.8171-0008.1</b> 990049  | Führungsbolzen  | 240520  | <b>11.8171-0008.1</b> 990049  | Führungsbolzen  |
|   |   |   | 24.3384-1601.5 240013   | <b>24.0101-3601.2</b> 260044  | Einbausatz  |
|   |   |   | 24.3384-1602.5 240014   | <b>24.0101-3601.2</b> 260044  | Einbausatz  |
|   |   |   | 24.3384-1603.5 240015   | <b>24.0101-3601.2</b> 260044  | Einbausatz  |
|   |   |   | 24.3384-1604.5 240016   | <b>24.0101-3601.2</b> 260044  | Einbausatz  |

# Reparatursätze







Repair kits - Corredi riparazione - Nécessaires de réparation - Juegos de reparación

|    |                              |    |                       |                              |                |
|---|------------------------------|---|-----------------------|------------------------------|----------------|
| 24.3384-1703.5 240055   | <b>24.0101-3601.2</b> 260044 | Einbausatz  | 24.3401-9977.5 240523 | <b>11.0101-5402.2</b> 260009 | Hülsensatz     |
| 24.3384-1704.5 240056   | <b>24.0101-3601.2</b> 260044 | Einbausatz  | 240523                | <b>11.0441-4003.2</b> 250001 | Dichtungssatz  |
| 24.3384-1705.5 240063   | <b>24.0101-3601.2</b> 260044 | Einbausatz  | 240523                | <b>11.8116-0094.1</b> 390504 | Haltefeder     |
| 24.3384-1706.5 240064   | <b>24.0101-3601.2</b> 260044 | Einbausatz  | 240523                | <b>11.8171-0008.1</b> 990049 | Führungsbolzen |
| 24.3384-1707.5 240171   | <b>11.0101-5403.2</b> 260010 | Faltenbalsatz   | 24.3401-9978.5 240524 | <b>11.0101-5402.2</b> 260009 | Hülsensatz     |
| 240171  | <b>24.0101-3601.2</b> 260044 | Einbausatz  | 240524                | <b>11.0441-4003.2</b> 250001 | Dichtungssatz  |
| 24.3384-1708.5 240172   | <b>11.0101-5403.2</b> 260010 | Faltenbalsatz   | 240524                | <b>11.8116-0094.1</b> 390504 | Haltefeder     |
| 240172  | <b>24.0101-3601.2</b> 260044 | Einbausatz  | 240524                | <b>11.8171-0008.1</b> 990049 | Führungsbolzen |
| 24.3384-1769.7 220791   | <b>24.0101-3802.2</b> 260100 | Einbausatz  | 24.3417-1703.7 220759 | <b>24.0101-3803.2</b> 260101 | Einbausatz     |
| 24.3384-1770.7 220792   | <b>24.0101-3802.2</b> 260100 | Einbausatz  | 24.3417-1704.7 220760 | <b>24.0101-3803.2</b> 260101 | Einbausatz     |
| 24.3387-1707.7 220701   | <b>24.0101-3803.2</b> 260101 | Einbausatz  | 24.3421-1705.5 240353 | <b>11.0101-5402.2</b> 260009 | Hülsensatz     |
| 24.3387-1708.7 220702   | <b>24.0101-3803.2</b> 260101 | Einbausatz  | 240353                | <b>11.8116-0296.1</b> 390445 | Haltefeder     |
| 24.3387-1717.7 220757   | <b>24.0101-3803.2</b> 260101 | Einbausatz  | 240353                | <b>11.8171-0008.1</b> 990049 | Führungsbolzen |
| 24.3387-1718.7 220758   | <b>24.0101-3803.2</b> 260101 | Einbausatz  | 24.3421-1706.5 240354 | <b>11.0101-5402.2</b> 260009 | Hülsensatz     |
| 24.3387-1719.7 220773   | <b>24.0101-3803.2</b> 260101 | Einbausatz  | 240354                | <b>11.8116-0296.1</b> 390445 | Haltefeder     |
| 24.3387-1720.7 220774   | <b>24.0101-3803.2</b> 260101 | Einbausatz  | 240354                | <b>11.8171-0008.1</b> 990049 | Führungsbolzen |
| 24.3401-1601.5 240173   | <b>24.0101-3401.2</b> 260043 | Einbausatz  | 24.3421-9979.5 240475 | <b>11.0101-5407.2</b> 260011 | Hülsensatz     |
| 24.3401-1602.5 240174   | <b>24.0101-3401.2</b> 260043 | Einbausatz  | 240475                | <b>11.8116-0236.1</b> 390507 | Haltefeder     |
| 24.3401-1603.5 240017   | <b>24.0101-3401.2</b> 260043 | Einbausatz  | 240475                | <b>11.8171-0008.1</b> 990049 | Führungsbolzen |
| 240017  | <b>24.0101-3601.2</b> 260044 | Einbausatz  | 24.3421-9980.5 240476 | <b>11.0101-5407.2</b> 260011 | Hülsensatz     |
| 24.3401-1604.5 240018   | <b>24.0101-3401.2</b> 260043 | Einbausatz  | 240476                | <b>11.8116-0236.1</b> 390507 | Haltefeder     |
| 240018  | <b>24.0101-3601.2</b> 260044 | Einbausatz  | 240476                | <b>11.8171-0008.1</b> 990049 | Führungsbolzen |
| 24.3401-1703.5 240351   | <b>11.0101-5402.2</b> 260009 | Hülsensatz  | 24.3434-1601.5 240019 | <b>24.0101-4301.2</b> 260047 | Einbausatz     |
| 240351  | <b>11.0441-4002.2</b> 250011 | Dichtungssatz   | 24.3434-1602.5 240020 | <b>24.0101-4301.2</b> 260047 | Einbausatz     |
| 240351  | <b>11.8116-0066.1</b> 390577 | Haltefeder  | 24.3434-1701.5 240357 | <b>11.0101-5403.2</b> 260010 | Faltenbalsatz  |
| 240351  | <b>11.8171-0008.1</b> 990049 | Führungsbolzen  | 24.3434-1702.5 240358 | <b>11.0101-5403.2</b> 260010 | Faltenbalsatz  |
| 24.3401-1704.5 240352   | <b>11.0101-5402.2</b> 260009 | Hülsensatz  | 24.3451-1703.5 240059 | <b>11.0101-5403.2</b> 260010 | Faltenbalsatz  |
| 240352  | <b>11.0441-4002.2</b> 250011 | Dichtungssatz   | 240059                | <b>24.0101-3401.2</b> 260043 | Einbausatz     |
| 240352  | <b>11.8116-0066.1</b> 390577 | Haltefeder  | 24.3451-1704.5 240060 | <b>11.0101-5403.2</b> 260010 | Faltenbalsatz  |
| 240352  | <b>11.8171-0008.1</b> 990049 | Führungsbolzen  | 240060                | <b>24.0101-3401.2</b> 260043 | Einbausatz     |
| 24.3401-1705.5 240423   | <b>11.0101-5402.2</b> 260009 | Hülsensatz  | 24.3481-0705.5 240021 | <b>24.0101-4801.2</b> 990131 | Einbausatz     |
| 240423  | <b>11.0441-4002.2</b> 250011 | Dichtungssatz   | 24.3481-0706.5 240022 | <b>24.0101-4801.2</b> 990131 | Einbausatz     |
| 240423  | <b>11.8116-0066.1</b> 390577 | Haltefeder  | 24.3481-0707.5 240023 | <b>24.0101-4801.2</b> 990131 | Einbausatz     |
| 240423  | <b>11.8171-0008.1</b> 990049 | Führungsbolzen  | 24.3481-0708.5 240024 | <b>24.0101-4801.2</b> 990131 | Einbausatz     |
| 24.3401-1706.5 240424   | <b>11.0101-5402.2</b> 260009 | Hülsensatz  | 24.3481-0711.5 240025 | <b>24.0101-4801.2</b> 990131 | Einbausatz     |
| 240424  | <b>11.0441-4002.2</b> 250011 | Dichtungssatz   | 24.3481-0712.5 240026 | <b>24.0101-4801.2</b> 990131 | Einbausatz     |
| 240424  | <b>11.8116-0066.1</b> 390577 | Haltefeder  | 24.3481-0713.5 240027 | <b>24.0101-4801.2</b> 990131 | Einbausatz     |
| 240424  | <b>11.8171-0008.1</b> 990049 | Führungsbolzen  | 24.3481-0714.5 240028 | <b>24.0101-4801.2</b> 990131 | Einbausatz     |
| 24.3401-8503.5 240521   | <b>11.0101-5402.2</b> 260009 | Hülsensatz  | 24.3481-1505.5 240047 | <b>24.0101-4803.2</b> 260049 | Einbausatz     |
| 240521  | <b>11.0441-4002.2</b> 250011 | Dichtungssatz   | 24.3481-1506.5 240048 | <b>24.0101-4803.2</b> 260049 | Einbausatz     |
| 240521  | <b>11.8116-0066.1</b> 390577 | Haltefeder  | 24.3481-1611.5 240029 | <b>24.0101-4807.2</b> 260053 | Einbausatz     |
| 240521  | <b>11.8171-0008.1</b> 990049 | Führungsbolzen  | 24.3481-1612.5 240030 | <b>24.0101-4807.2</b> 260053 | Einbausatz     |
| 24.3401-8504.5 240522   | <b>11.0101-5402.2</b> 260009 | Hülsensatz  | 24.3481-1615.5 240031 | <b>24.0101-4806.2</b> 260052 | Einbausatz     |
| 240522  | <b>11.0441-4002.2</b> 250011 | Dichtungssatz   |                       |                              |                |
| 240522  | <b>11.8116-0066.1</b> 390577 | Haltefeder  |                       |                              |                |
| 240522  | <b>11.8171-0008.1</b> 990049 | Führungsbolzen  |                       |                              |                |









# Reparatursätze

Repair kits - Corredi riparazione - Nécessaires de réparation - Juegos de reparación

|  |  |  |  |  |  |
|---|---|---|---|---|---|
| 24.3481-1616.5 240032   | <b>24.0101-4806.2</b> 260052  | Einbausatz  | 24.3481-1753.5 240287   | <b>11.0101-4803.2</b> 260008  | Hülsensatz  |
| 24.3481-1617.5 240115   | <b>24.0101-3601.2</b> 260044  | Einbausatz  | 240287  | <b>11.0441-4808.2</b> 250022  | Dichtungssatz   |
| 24.3481-1618.5 240116   | <b>24.0101-3601.2</b> 260044  | Einbausatz  | 240287  | <b>24.0102-4803.2</b> 260086  | Hülsensatz+Schrauben  |
| 24.3481-1703.5 240051   | <b>24.0101-4301.2</b> 260047  | Einbausatz  | 24.3481-1754.5 240288   | <b>11.0101-4803.2</b> 260008  | Hülsensatz  |
| 24.3481-1704.5 240052   | <b>24.0101-4301.2</b> 260047  | Einbausatz  | 240288  | <b>11.0441-4808.2</b> 250022  | Dichtungssatz   |
| 24.3481-1707.5 240073   | <b>24.0101-3601.2</b> 260044  | Einbausatz  | 240288  | <b>24.0102-4803.2</b> 260086  | Hülsensatz+Schrauben  |
| 24.3481-1708.5 240074   | <b>24.0101-3601.2</b> 260044  | Einbausatz  | 24.3481-1805.7 220765   | <b>24.0101-3802.2</b> 260100  | Einbausatz  |
| 24.3481-1709.5 240065   | <b>24.0101-4804.2</b> 260050  | Einbausatz  | 24.3481-1806.7 220766   | <b>24.0101-3802.2</b> 260100  | Einbausatz  |
| 24.3481-1710.5 240066   | <b>24.0101-4804.2</b> 260050  | Einbausatz  | 24.3481-8515.5 240477   | <b>11.0101-5407.2</b> 260011  | Hülsensatz  |
| 24.3481-1731.5 240209   | <b>11.0101-5407.2</b> 260011  | Hülsensatz  | 240477  | <b>11.8116-0264.1</b> 390594  | Haltefeder  |
| 240209  | <b>11.0441-4805.2</b> 250020  | Dichtungssatz   | 240477  | <b>11.8171-0008.1</b> 990049  | Führungsbolzen  |
| 240209  | <b>11.8171-0008.1</b> 990049  | Führungsbolzen  | 24.3481-8516.5 240478   | <b>11.0101-5407.2</b> 260011  | Hülsensatz  |
| 24.3481-1732.5 240210   | <b>11.0101-5407.2</b> 260011  | Hülsensatz  | 240478  | <b>11.8116-0264.1</b> 390594  | Haltefeder  |
| 240210  | <b>11.0441-4805.2</b> 250020  | Dichtungssatz   | 240478  | <b>11.8171-0008.1</b> 990049  | Führungsbolzen  |
| 240210  | <b>11.8171-0008.1</b> 990049  | Führungsbolzen  | 24.3481-9833.5 240479   | <b>11.0101-5407.2</b> 260011  | Hülsensatz  |
| 24.3481-1733.5 240213   | <b>11.0101-5407.2</b> 260011  | Hülsensatz  | 240479  | <b>11.0441-4811.2</b> 250024  | Dichtungssatz   |
| 240213  | <b>11.0441-4811.2</b> 250024  | Dichtungssatz   | 240479  | <b>11.8116-0129.1</b> 390591  | Haltefeder  |
| 240213  | <b>11.8116-0129.1</b> 390591  | Haltefeder  | 240479  | <b>11.8171-0008.1</b> 990049  | Führungsbolzen  |
| 240213  | <b>11.8171-0008.1</b> 990049  | Führungsbolzen  | 24.3481-9834.5 240480   | <b>11.0101-5407.2</b> 260011  | Hülsensatz  |
| 24.3481-1734.5 240214   | <b>11.0101-5407.2</b> 260011  | Hülsensatz  | 240480  | <b>11.0441-4811.2</b> 250024  | Dichtungssatz   |
| 240214  | <b>11.0441-4811.2</b> 250024  | Dichtungssatz   | 240480  | <b>11.8116-0129.1</b> 390591  | Haltefeder  |
| 240214  | <b>11.8116-0129.1</b> 390591  | Haltefeder  | 240480  | <b>11.8171-0008.1</b> 990049  | Führungsbolzen  |
| 240214  | <b>11.8171-0008.1</b> 990049  | Führungsbolzen  | 24.3511-1701.5 240101   | <b>24.0101-5102.2</b> 260056  | Einbausatz  |
| 24.3481-1735.5 240283   | <b>11.0101-4801.2</b> 260006  | Hülsensatz  | 24.3511-1702.5 240102   | <b>24.0101-5102.2</b> 260056  | Einbausatz  |
| 240283  | <b>11.0441-4808.2</b> 250022  | Dichtungssatz   | 24.3521-0701.7 220209   | <b>24.0101-4801.2</b> 990131  | Einbausatz  |
| 240283  | <b>24.0102-4801.2</b> 260085  | Hülsensatz+Schrauben  | 24.3521-0702.7 220210   | <b>24.0101-4801.2</b> 990131  | Einbausatz  |
| 24.3481-1736.5 240284   | <b>11.0101-4801.2</b> 260006  | Hülsensatz  | 24.3521-0705.5 240033   | <b>24.0101-4801.2</b> 990131  | Einbausatz  |
| 240284  | <b>11.0441-4808.2</b> 250022  | Dichtungssatz   | 24.3521-0706.5 240034   | <b>24.0101-4801.2</b> 990131  | Einbausatz  |
| 240284  | <b>24.0102-4801.2</b> 260085  | Hülsensatz+Schrauben  | 24.3521-1701.5 240001   | <b>11.0101-5407.2</b> 260011  | Hülsensatz  |
| 24.3481-1745.5 240277   | <b>11.0101-4803.2</b> 260008  | Hülsensatz  | 240001  | <b>11.0441-5202.2</b> 250026  | Dichtungssatz   |
| 240277  | <b>11.0441-4808.2</b> 250022  | Dichtungssatz   | 240001  | <b>11.8116-0097.1</b> 390590  | Haltefeder  |
| 240277  | <b>24.0102-4803.2</b> 260086  | Hülsensatz+Schrauben  | 240001  | <b>11.8171-0008.1</b> 990049  | Führungsbolzen  |
| 24.3481-1746.5 240278   | <b>11.0101-4803.2</b> 260008  | Hülsensatz  | 24.3521-1702.5 240002   | <b>11.0101-5407.2</b> 260011  | Hülsensatz  |
| 240278  | <b>11.0441-4808.2</b> 250022  | Dichtungssatz   | 240002  | <b>11.0441-5202.2</b> 250026  | Dichtungssatz   |
| 240278  | <b>24.0102-4803.2</b> 260086  | Hülsensatz+Schrauben  | 240002  | <b>11.8116-0097.1</b> 390590  | Haltefeder  |
| 24.3481-1747.5 240279   | <b>11.0101-4803.2</b> 260008  | Hülsensatz  | 240002  | <b>11.8171-0008.1</b> 990049  | Führungsbolzen  |
| 240279  | <b>11.0441-4808.2</b> 250022  | Dichtungssatz   | 24.3521-7001.5 240481   | <b>11.0101-5407.2</b> 260011  | Hülsensatz  |
| 240279  | <b>24.0102-4803.2</b> 260086  | Hülsensatz+Schrauben  | 240481  | <b>11.8171-0008.1</b> 990049  | Führungsbolzen  |
| 24.3481-1748.5 240280   | <b>11.0101-4803.2</b> 260008  | Hülsensatz  | 24.3521-7002.5 240482   | <b>11.0101-5407.2</b> 260011  | Hülsensatz  |
| 240280  | <b>11.0441-4808.2</b> 250022  | Dichtungssatz   | 240482  | <b>11.8171-0008.1</b> 990049  | Führungsbolzen  |
| 240280  | <b>24.0102-4803.2</b> 260086  | Hülsensatz+Schrauben  | 24.3541-0701.5 240035   | <b>24.0101-4801.2</b> 990131  | Einbausatz  |
| 24.3481-1749.5 240281   | <b>11.0101-4801.2</b> 260006  | Hülsensatz  | 24.3541-0702.5 240036   | <b>24.0101-4801.2</b> 990131  | Einbausatz  |
| 240281  | <b>11.0441-4808.2</b> 250022  | Dichtungssatz   | 24.3541-1603.5 240037   | <b>24.0101-3601.2</b> 260044  | Einbausatz  |
| 240281  | <b>24.0102-4801.2</b> 260085  | Hülsensatz+Schrauben  | 24.3541-1604.5 240038   | <b>24.0101-3601.2</b> 260044  | Einbausatz  |
| 24.3481-1750.5 240282   | <b>11.0101-4801.2</b> 260006  | Hülsensatz  | 24.3541-1609.5 240039   | <b>11.0101-5403.2</b> 260010  | Faltenbalgsatz  |
| 240282  | <b>11.0441-4808.2</b> 250022  | Dichtungssatz   | 240039  | <b>11.0101-5409.2</b> 260035  | Hülsensatz  |
| 240282  | <b>24.0102-4801.2</b> 260085  | Hülsensatz+Schrauben  | 240039  | <b>24.0101-4301.2</b> 260047  | Einbausatz  |







# Reparatursätze

Repair kits - Corredi riparazione - Nécessaires de réparation - Juegos de reparación

|  |   |  |  |   |  |
|---|--|---|---|--|---|
| 24.3541-1610.5 240040<br>240040<br>240040   | <b>11.0101-5403.2</b> 260010 Faltenbalgsatz<br><b>11.0101-5409.2</b> 260035 Hülsensatz<br><b>24.0101-4301.2</b> 260047 Einbausatz    |   | 24.3541-1740.5 240224   | <b>11.0101-5403.2</b> 260010 Faltenbalgsatz  |   |
| 24.3541-1611.5 240041   | <b>24.0101-3401.2</b> 260043 Einbausatz  |   | 24.3541-1773.7 220527<br>220527   | <b>11.0101-5403.2</b> 260010 Faltenbalgsatz<br><b>24.0101-3401.2</b> 260043 Einbausatz   |   |
| 24.3541-1612.5 240042   | <b>24.0101-3401.2</b> 260043 Einbausatz  |   | 24.3541-1774.7 220528<br>220528   | <b>11.0101-5403.2</b> 260010 Faltenbalgsatz<br><b>24.0101-3401.2</b> 260043 Einbausatz   |   |
| 24.3541-1619.5 240043   | <b>24.0101-3601.2</b> 260044 Einbausatz  |   | 24.3541-1779.5 240249   | <b>11.0101-5403.2</b> 260010 Faltenbalgsatz  |   |
| 24.3541-1620.5 240044   | <b>24.0101-3601.2</b> 260044 Einbausatz  |   | 24.3541-1780.5 240250   | <b>11.0101-5403.2</b> 260010 Faltenbalgsatz  |   |
| 24.3541-1631.7 220325<br>220325   | <b>11.0101-5403.2</b> 260010 Faltenbalgsatz<br><b>11.0441-5404.2</b> 250029 Dichtungssatz  |   | 24.3541-1821.7 220695   | <b>24.0101-3802.2</b> 260100 Einbausatz  |   |
| 24.3541-1632.7 220326<br>220326   | <b>11.0101-5403.2</b> 260010 Faltenbalgsatz<br><b>11.0441-5404.2</b> 250029 Dichtungssatz  |   | 24.3541-1822.7 220696   | <b>24.0101-3802.2</b> 260100 Einbausatz  |   |
| 24.3541-1701.5 240005<br>240005<br>240005   | <b>11.0101-5407.2</b> 260011 Hülsensatz<br><b>11.0441-5402.2</b> 250028 Dichtungssatz<br><b>11.8171-0008.1</b> 990049 Führungsbolzen |   | 24.3541-8083.5 240483<br>240483<br>240483   | <b>11.0101-5407.2</b> 260011 Hülsensatz<br><b>11.8116-0292.1</b> 390521 Haltefeder<br><b>11.8171-0008.1</b> 990049 Führungsbolzen  |   |
| 24.3541-1702.5 240006<br>240006<br>240006   | <b>11.0101-5407.2</b> 260011 Hülsensatz<br><b>11.0441-5402.2</b> 250028 Dichtungssatz<br><b>11.8171-0008.1</b> 990049 Führungsbolzen |   | 24.3541-8084.5 240484<br>240484<br>240484   | <b>11.0101-5407.2</b> 260011 Hülsensatz<br><b>11.8116-0292.1</b> 390521 Haltefeder<br><b>11.8171-0008.1</b> 990049 Führungsbolzen  |   |
| 24.3541-1705.5 240111   | <b>24.0101-5405.2</b> 260063 Einbausatz  |   | 24.3541-8085.5 240525<br>240525<br>240525<br>240525                               | <b>11.0101-5407.2</b> 260011 Hülsensatz<br><b>11.8116-0129.1</b> 390591 Haltefeder<br><b>11.8116-0292.1</b> 390521 Haltefeder<br><b>11.8171-0008.1</b> 990049 Führungsbolzen   |   |
| 24.3541-1706.5 240112   | <b>24.0101-5405.2</b> 260063 Einbausatz  |   | 24.3541-8086.5 240526<br>240526<br>240526<br>240526                               | <b>11.0101-5407.2</b> 260011 Hülsensatz<br><b>11.8116-0129.1</b> 390591 Haltefeder<br><b>11.8116-0292.1</b> 390521 Haltefeder<br><b>11.8171-0008.1</b> 990049 Führungsbolzen   |   |
| 24.3541-1707.5 240067   | <b>24.0101-5401.2</b> 260059 Einbausatz  |   | 24.3541-8105.5 240485<br>240485   | <b>11.0101-5407.2</b> 260011 Hülsensatz<br><b>11.8171-0008.1</b> 990049 Führungsbolzen   |   |
| 24.3541-1708.5 240068   | <b>24.0101-5401.2</b> 260059 Einbausatz  |   | 24.3541-8106.5 240486<br>240486   | <b>11.0101-5407.2</b> 260011 Hülsensatz<br><b>11.8171-0008.1</b> 990049 Führungsbolzen   |   |
| 24.3541-1711.5 240107   | <b>24.0101-5102.2</b> 260056 Einbausatz  |   | 24.3541-8521.5 240487<br>240487   | <b>11.0101-5409.2</b> 260035 Hülsensatz<br><b>11.0441-5405.2</b> 250030 Dichtungssatz  |   |
| 24.3541-1712.5 240108   | <b>24.0101-5102.2</b> 260056 Einbausatz  |   | 24.3541-8522.5 240488<br>240488   | <b>11.0101-5409.2</b> 260035 Hülsensatz<br><b>11.0441-5405.2</b> 250030 Dichtungssatz  |   |
| 24.3541-1717.5 240121   | <b>24.0101-3601.2</b> 260044 Einbausatz  |   | 24.3541-8523.5 240551<br>240551<br>240551<br>240551<br>240551                     | <b>11.0101-5409.2</b> 260035 Hülsensatz<br><b>11.0441-5409.2</b> 250031 Dichtungssatz<br><b>11.8116-0143.1</b> 390513 Haltefeder<br><b>11.8170-0306.1</b> 260102 Halter<br><b>11.8171-0008.1</b> 990049 Führungsbolzen |   |
| 24.3541-1718.5 240122   | <b>24.0101-3601.2</b> 260044 Einbausatz  |   | 24.3541-8524.5 240552<br>240552<br>240552<br>240552                               | <b>11.0101-5409.2</b> 260035 Hülsensatz<br><b>11.0441-5409.2</b> 250031 Dichtungssatz<br><b>11.8116-0143.1</b> 390513 Haltefeder<br><b>11.8170-0306.1</b> 260102 Halter<br><b>11.8171-0008.1</b> 990049 Führungsbolzen |   |
| 24.3541-1719.5 240057<br>240057<br>240057   | <b>11.0101-5403.2</b> 260010 Faltenbalgsatz<br><b>11.0101-5409.2</b> 260035 Hülsensatz<br><b>24.0101-4301.2</b> 260047 Einbausatz    |   | 24.3541-8529.5 240553<br>240553<br>240553<br>240553                               | <b>11.0101-5407.2</b> 260011 Hülsensatz<br><b>11.0441-5402.2</b> 250028 Dichtungssatz<br><b>11.8116-0264.1</b> 390594 Haltefeder<br><b>11.8171-0008.1</b> 990049 Führungsbolzen  |   |
| 24.3541-1720.5 240058<br>240058<br>240058   | <b>11.0101-5403.2</b> 260010 Faltenbalgsatz<br><b>11.0101-5409.2</b> 260035 Hülsensatz<br><b>24.0101-4301.2</b> 260047 Einbausatz    |   | 24.3541-8530.5 240554<br>240554<br>240554<br>240554                               | <b>11.0101-5407.2</b> 260011 Hülsensatz<br><b>11.0441-5402.2</b> 250028 Dichtungssatz<br><b>11.8116-0264.1</b> 390594 Haltefeder<br><b>11.8171-0008.1</b> 990049 Führungsbolzen  |   |
| 24.3541-1721.5 240075   | <b>24.0101-3601.2</b> 260044 Einbausatz  |   |   |  |   |
| 24.3541-1722.5 240076   | <b>24.0101-3601.2</b> 260044 Einbausatz  |   |   |  |   |
| 24.3541-1723.5 240077   | <b>24.0101-3601.2</b> 260044 Einbausatz  |   |   |  |   |
| 24.3541-1724.5 240078   | <b>24.0101-3601.2</b> 260044 Einbausatz  |   |   |  |   |
| 24.3541-1725.5 240003<br>240003   | <b>11.0101-5403.2</b> 260010 Faltenbalgsatz<br><b>11.0441-5404.2</b> 250029 Dichtungssatz  |   |   |  |   |
| 24.3541-1726.5 240004<br>240004   | <b>11.0101-5403.2</b> 260010 Faltenbalgsatz<br><b>11.0441-5404.2</b> 250029 Dichtungssatz  |   |   |  |   |
| 24.3541-1731.5 240061   | <b>24.0101-4301.2</b> 260047 Einbausatz  |   |   |  |   |
| 24.3541-1732.5 240062   | <b>24.0101-4301.2</b> 260047 Einbausatz  |   |   |  |   |
| 24.3541-1739.5 240223   | <b>11.0101-5403.2</b> 260010 Faltenbalgsatz  |   |   |  |   |

# Reparatursätze







Repair kits - Corredi riparazione - Nécessaires de réparation - Juegos de reparación

|  |  |  |  |  |  |
|---|---|---|---|---|---|
| 24.3541-9587.5 240527   | <b>11.0101-5402.2</b> 260009  | Hülsensatz  | 24.3571-1744.7 220688   | <b>24.0101-3803.2</b> 260101  | Einbausatz  |
| 240527  | <b>11.0230-0234.2</b> 260084  | Haltersatz  | 24.3571-1745.7 220689   | <b>24.0101-3802.2</b> 260100  | Einbausatz  |
| 240527  | <b>11.0441-5402.2</b> 250028  | Dichtungssatz   | 24.3571-1746.7 220690   | <b>24.0101-3802.2</b> 260100  | Einbausatz  |
| 240527  | <b>11.8116-0109.1</b> 390495  | Haltefeder  | 24.3571-1747.7 220691   | <b>24.0101-3802.2</b> 260100  | Einbausatz  |
| 240527  | <b>11.8116-0206.1</b> 390593  | Haltefeder  | 24.3571-1748.7 220692   | <b>24.0101-3802.2</b> 260100  | Einbausatz  |
| 240527  | <b>11.8170-0729.1</b> 260107  | Halter  | 24.3571-1749.7 220693   | <b>24.0101-3802.2</b> 260100  | Einbausatz  |
| 240527  | <b>11.8171-0008.1</b> 990049  | Führungsbolzen  | 24.3571-1750.7 220694   | <b>24.0101-3802.2</b> 260100  | Einbausatz  |
| 24.3541-9588.5 240528   | <b>11.0101-5402.2</b> 260009  | Hülsensatz  | 24.3571-1761.5 240461   | <b>11.0101-5407.2</b> 260011  | Hülsensatz  |
| 240528  | <b>11.0230-0234.2</b> 260084  | Haltersatz  | 240461  | <b>11.0441-5704.2</b> 250034  | Dichtungssatz   |
| 240528  | <b>11.0441-5402.2</b> 250028  | Dichtungssatz   | 240461  | <b>11.8116-0292.1</b> 390521  | Haltefeder  |
| 240528  | <b>11.8116-0109.1</b> 390495  | Haltefeder  | 240461  | <b>11.8171-0008.1</b> 990049  | Führungsbolzen  |
| 240528  | <b>11.8116-0206.1</b> 390593  | Haltefeder  | 24.3571-1762.5 240462   | <b>11.0101-5407.2</b> 260011  | Hülsensatz  |
| 240528  | <b>11.8170-0729.1</b> 260107  | Halter  | 240462  | <b>11.0441-5704.2</b> 250034  | Dichtungssatz   |
| 240528  | <b>11.8171-0008.1</b> 990049  | Führungsbolzen  | 240462  | <b>11.8116-0292.1</b> 390521  | Haltefeder  |
| 24.3541-9667.5 240529   | <b>11.0101-5402.2</b> 260009  | Hülsensatz  | 240462  | <b>11.8171-0008.1</b> 990049  | Führungsbolzen  |
| 240529  | <b>11.0230-0097.2</b> 260092  | Haltersatz  | 24.3571-1762.5 240462   | <b>11.0101-5407.2</b> 260011  | Hülsensatz  |
| 240529  | <b>11.0441-5402.2</b> 250028  | Dichtungssatz   | 240462  | <b>11.0441-5704.2</b> 250034  | Dichtungssatz   |
| 240529  | <b>11.8116-0109.1</b> 390495  | Haltefeder  | 240462  | <b>11.8116-0292.1</b> 390521  | Haltefeder  |
| 240529  | <b>11.8116-0206.1</b> 390593  | Haltefeder  | 240462  | <b>11.8171-0008.1</b> 990049  | Führungsbolzen  |
| 240529  | <b>11.8171-0008.1</b> 990049  | Führungsbolzen  | 24.3571-8505.5 240489   | <b>11.0101-5409.2</b> 260035  | Hülsensatz  |
| 24.3541-9668.5 240530   | <b>11.0101-5402.2</b> 260009  | Hülsensatz  | 240489  | <b>11.0441-5704.2</b> 250034  | Dichtungssatz   |
| 240530  | <b>11.0230-0097.2</b> 260092  | Haltersatz  | 240489  | <b>11.8116-0143.1</b> 390513  | Haltefeder  |
| 240530  | <b>11.0441-5402.2</b> 250028  | Dichtungssatz   | 240489  | <b>11.8171-0008.1</b> 990049  | Führungsbolzen  |
| 240530  | <b>11.8116-0109.1</b> 390495  | Haltefeder  | 24.3571-8506.5 240490   | <b>11.0101-5409.2</b> 260035  | Hülsensatz  |
| 240530  | <b>11.8116-0206.1</b> 390593  | Haltefeder  | 240490  | <b>11.0441-5704.2</b> 250034  | Dichtungssatz   |
| 240530  | <b>11.8171-0008.1</b> 990049  | Führungsbolzen  | 240490  | <b>11.8116-0143.1</b> 390513  | Haltefeder  |
| 24.3546-1707.7 220597   | <b>11.0101-5407.2</b> 260011  | Hülsensatz  | 240490  | <b>11.8171-0008.1</b> 990049  | Führungsbolzen  |
| 24.3546-1708.7 220598   | <b>11.0101-5407.2</b> 260011  | Hülsensatz  | 24.3571-8507.5 240555   | <b>11.8170-0306.1</b> 260102  | Halter  |
| 24.3571-1703.5 240099   | <b>24.0101-5701.2</b> 260065  | Einbausatz  | 24.3571-8508.5 240556   | <b>11.8170-0306.1</b> 260102  | Halter  |
| 24.3571-1704.5 240100   | <b>24.0101-5701.2</b> 260065  | Einbausatz  | 24.3571-8511.5 240491   | <b>11.0101-5407.2</b> 260011  | Hülsensatz  |
| 24.3571-1705.5 240069   | <b>24.0101-3401.2</b> 260043  | Einbausatz  | 240491  | <b>11.0230-0096.2</b> 260033  | Haltersatz  |
| 24.3571-1706.5 240070   | <b>24.0101-3401.2</b> 260043  | Einbausatz  | 240491  | <b>11.0441-5703.2</b> 250145  | Dichtungssatz   |
| 24.3571-1707.5 240079   | <b>24.0101-3601.2</b> 260044  | Einbausatz  | 240491  | <b>11.8116-0253.1</b> 390512  | Haltefeder  |
| 24.3571-1708.5 240080   | <b>24.0101-3601.2</b> 260044  | Einbausatz  | 240491  | <b>11.8171-0008.1</b> 990049  | Führungsbolzen  |
| 24.3571-1725.5 240313   | <b>11.0101-5407.2</b> 260011  | Hülsensatz  | 24.3571-8512.5 240492   | <b>11.0101-5407.2</b> 260011  | Hülsensatz  |
| 240313  | <b>11.0441-5704.2</b> 250034  | Dichtungssatz   | 240492  | <b>11.0230-0096.2</b> 260033  | Haltersatz  |
| 240313  | <b>11.8116-0292.1</b> 390521  | Haltefeder  | 240492  | <b>11.0441-5703.2</b> 250145  | Dichtungssatz   |
| 240313  | <b>11.8171-0008.1</b> 990049  | Führungsbolzen  | 240492  | <b>11.8116-0253.1</b> 390512  | Haltefeder  |
| 24.3571-1726.5 240314   | <b>11.0101-5407.2</b> 260011  | Hülsensatz  | 24.3571-8517.5 240493   | <b>11.8171-0008.1</b> 990049  | Führungsbolzen  |
| 240314  | <b>11.0441-5704.2</b> 250034  | Dichtungssatz   | 240493  | <b>11.0101-5409.2</b> 260035  | Hülsensatz  |
| 240314  | <b>11.8116-0292.1</b> 390521  | Haltefeder  | 240493  | <b>11.0441-5704.2</b> 250034  | Dichtungssatz   |
| 240314  | <b>11.8171-0008.1</b> 990049  | Führungsbolzen  | 240493  | <b>11.8116-0143.1</b> 390513  | Haltefeder  |
| 24.3571-1733.5 240349   | <b>11.0101-5402.2</b> 260009  | Hülsensatz  | 24.3571-8518.5 240494   | <b>11.8171-0008.1</b> 990049  | Führungsbolzen  |
| 240349  | <b>11.8116-0273.1</b> 390515  | Haltefeder  | 240494  | <b>11.0101-5409.2</b> 260035  | Hülsensatz  |
| 240349  | <b>11.8171-0008.1</b> 990049  | Führungsbolzen  | 240494  | <b>11.0441-5704.2</b> 250034  | Dichtungssatz   |
| 24.3571-1734.5 240350   | <b>11.0101-5402.2</b> 260009  | Hülsensatz  | 240494  | <b>11.8116-0143.1</b> 390513  | Haltefeder  |
| 240350  | <b>11.8116-0273.1</b> 390515  | Haltefeder  | 240495  | <b>11.8170-0306.1</b> 260102  | Halter  |
| 240350  | <b>11.8171-0008.1</b> 990049  | Führungsbolzen  | 240495  | <b>11.8171-0008.1</b> 990049  | Führungsbolzen  |
| 24.3571-1739.7 220667   | <b>24.0101-3803.2</b> 260101  | Einbausatz  | 24.3571-8521.5 240495   | <b>11.0101-5409.2</b> 260035  | Hülsensatz  |
| 24.3571-1740.7 220668   | <b>24.0101-3803.2</b> 260101  | Einbausatz  | 240495  | <b>11.0441-5704.2</b> 250034  | Dichtungssatz   |
| 24.3571-1743.7 220687   | <b>24.0101-3803.2</b> 260101  | Einbausatz  | 240495  | <b>11.8116-0143.1</b> 390513  | Haltefeder  |
|   |   |   | 240495  | <b>11.8170-0306.1</b> 260102  | Halter  |
|   |   |   | 240495  | <b>11.8171-0008.1</b> 990049  | Führungsbolzen  |









# Reparatursätze

Repair kits - Corredi riparazione - Nécessaires de réparation - Juegos de reparación

|    |        |   |    |        |   |
|---|--------|---|---|--------|---|
| 24.3571-8522.5  | 240496 | <b>11.0101-5409.2</b> 260035 Hülsensatz     | 24.3601-1713.5  | 240355 | <b>11.0101-5402.2</b> 260009 Hülsensatz     |
|   | 240496 | <b>11.0441-5704.2</b> 250034 Dichtungssatz  |   | 240355 | <b>11.0441-6003.2</b> 250037 Dichtungssatz  |
|   | 240496 | <b>11.8116-0143.1</b> 390513 Haltefeder     |   | 240355 | <b>11.8116-0197.1</b> 390523 Haltefeder     |
|   | 240496 | <b>11.8170-0306.1</b> 260102 Halter         |   | 240355 | <b>11.8116-0290.2</b> 390520 Haltefeder     |
|   | 240496 | <b>11.8171-0008.1</b> 990049 Führungsbolzen |   | 240355 | <b>11.8171-0008.1</b> 990049 Führungsbolzen |
| 24.3571-9801.5  | 240497 | <b>11.0101-5407.2</b> 260011 Hülsensatz     | 24.3601-1714.5  | 240356 | <b>11.0101-5402.2</b> 260009 Hülsensatz     |
|   | 240497 | <b>11.8116-0279.1</b> 390519 Haltefeder     |   | 240356 | <b>11.0441-6003.2</b> 250037 Dichtungssatz  |
|   | 240497 | <b>11.8171-0008.1</b> 990049 Führungsbolzen |   | 240356 | <b>11.8116-0197.1</b> 390523 Haltefeder     |
| 24.3571-9802.5  | 240498 | <b>11.0101-5407.2</b> 260011 Hülsensatz     |   | 240356 | <b>11.8116-0290.2</b> 390520 Haltefeder     |
|   | 240498 | <b>11.8116-0279.1</b> 390519 Haltefeder     |   | 240356 | <b>11.8171-0008.1</b> 990049 Führungsbolzen |
|   | 240498 | <b>11.8171-0008.1</b> 990049 Führungsbolzen | 24.3601-8501.5  | 240533 | <b>11.0101-5402.2</b> 260009 Hülsensatz     |
| 24.3571-9811.5  | 240531 | <b>11.0101-5407.2</b> 260011 Hülsensatz     |   | 240533 | <b>11.0230-0020.2</b> 260023 Haltersatz     |
|   | 240531 | <b>11.0101-5706.2</b> 260097 Hülsensatz     |   | 240533 | <b>11.0441-6003.2</b> 250037 Dichtungssatz  |
|   | 240531 | <b>11.0441-5704.2</b> 250034 Dichtungssatz  |   | 240533 | <b>11.8116-0083.1</b> 390501 Haltefeder     |
|   | 240531 | <b>11.8116-0326.1</b> 390471 Haltefeder     |   | 240533 | <b>11.8171-0008.1</b> 990049 Führungsbolzen |
|   | 240531 | <b>11.8171-0008.1</b> 990049 Führungsbolzen | 24.3601-8502.5  | 240534 | <b>11.0101-5402.2</b> 260009 Hülsensatz     |
|   | 240531 | <b>11.8171-0067.1</b> 250153 Führungsbolzen |   | 240534 | <b>11.0230-0020.2</b> 260023 Haltersatz     |
| 24.3571-9812.5  | 240532 | <b>11.0101-5407.2</b> 260011 Hülsensatz     |   | 240534 | <b>11.0441-6003.2</b> 250037 Dichtungssatz  |
|   | 240532 | <b>11.0101-5706.2</b> 260097 Hülsensatz     |   | 240534 | <b>11.8116-0083.1</b> 390501 Haltefeder     |
|   | 240532 | <b>11.0441-5704.2</b> 250034 Dichtungssatz  |   | 240534 | <b>11.8171-0008.1</b> 990049 Führungsbolzen |
|   | 240532 | <b>11.8116-0326.1</b> 390471 Haltefeder     | 24.3601-8503.5  | 240535 | <b>11.0101-5402.2</b> 260009 Hülsensatz     |
|   | 240532 | <b>11.8171-0008.1</b> 990049 Führungsbolzen |   | 240535 | <b>11.0441-6003.2</b> 250037 Dichtungssatz  |
|   | 240532 | <b>11.8171-0067.1</b> 250153 Führungsbolzen |   | 240535 | <b>11.8116-0083.1</b> 390501 Haltefeder     |
| 24.3571-9813.5  | 240557 | <b>11.0101-5407.2</b> 260011 Hülsensatz     |   | 240535 | <b>11.8171-0008.1</b> 990049 Führungsbolzen |
|   | 240557 | <b>11.8116-0356.1</b> 390586 Haltefeder     | 24.3601-8504.5  | 240536 | <b>11.0101-5402.2</b> 260009 Hülsensatz     |
|   | 240557 | <b>11.8171-0008.1</b> 990049 Führungsbolzen |   | 240536 | <b>11.0441-6003.2</b> 250037 Dichtungssatz  |
| 24.3571-9814.5  | 240558 | <b>11.0101-5407.2</b> 260011 Hülsensatz     |   | 240536 | <b>11.8116-0083.1</b> 390501 Haltefeder     |
|   | 240558 | <b>11.8116-0356.1</b> 390586 Haltefeder     |   | 240536 | <b>11.8171-0008.1</b> 990049 Führungsbolzen |
|   | 240558 | <b>11.8171-0008.1</b> 990049 Führungsbolzen | 24.3601-8505.5  | 240537 | <b>11.0101-5402.2</b> 260009 Hülsensatz     |
| 24.3571-9823.5  | 240499 | <b>11.0101-5407.2</b> 260011 Hülsensatz     |   | 240537 | <b>11.0441-6003.2</b> 250037 Dichtungssatz  |
|   | 240499 | <b>11.0441-5704.2</b> 250034 Dichtungssatz  |   | 240537 | <b>11.8116-0083.1</b> 390501 Haltefeder     |
|   | 240499 | <b>11.8116-0292.1</b> 390521 Haltefeder     |   | 240537 | <b>11.8171-0008.1</b> 990049 Führungsbolzen |
|   | 240499 | <b>11.8171-0008.1</b> 990049 Führungsbolzen | 24.3601-8506.5  | 240538 | <b>11.0101-5402.2</b> 260009 Hülsensatz     |
| 24.3571-9824.5  | 240500 | <b>11.0101-5407.2</b> 260011 Hülsensatz     |   | 240538 | <b>11.0441-6003.2</b> 250037 Dichtungssatz  |
|   | 240500 | <b>11.0441-5704.2</b> 250034 Dichtungssatz  |   | 240538 | <b>11.8116-0083.1</b> 390501 Haltefeder     |
|   | 240500 | <b>11.8116-0292.1</b> 390521 Haltefeder     |   | 240538 | <b>11.8171-0008.1</b> 990049 Führungsbolzen |
|   | 240500 | <b>11.8171-0008.1</b> 990049 Führungsbolzen | 24.3601-8511.5  | 240539 | <b>11.0101-5402.2</b> 260009 Hülsensatz     |
| 24.3571-9841.5  | 240501 | <b>11.0101-5407.2</b> 260011 Hülsensatz     |   | 240539 | <b>11.0441-6003.2</b> 250037 Dichtungssatz  |
|   | 240501 | <b>11.8171-0008.1</b> 990049 Führungsbolzen |   | 240539 | <b>11.8116-0092.1</b> 390503 Haltefeder     |
| 24.3571-9842.5  | 240502 | <b>11.0101-5407.2</b> 260011 Hülsensatz     |   | 240539 | <b>11.8171-0008.1</b> 990049 Führungsbolzen |
|   | 240502 | <b>11.8171-0008.1</b> 990049 Führungsbolzen | 24.3601-8512.5  | 240540 | <b>11.0101-5402.2</b> 260009 Hülsensatz     |
| 24.3601-1601.5  | 240203 | <b>11.0101-5403.2</b> 260010 Faltenbalgsatz |   | 240540 | <b>11.0441-6003.2</b> 250037 Dichtungssatz  |
| 24.3601-1602.5  | 240204 | <b>11.0101-5403.2</b> 260010 Faltenbalgsatz |   | 240540 | <b>11.8116-0092.1</b> 390503 Haltefeder     |
| 24.3601-1701.5  | 240007 | <b>11.0101-5407.2</b> 260011 Hülsensatz     |   | 240540 | <b>11.8171-0008.1</b> 990049 Führungsbolzen |
|   | 240007 | <b>11.0441-6003.2</b> 250037 Dichtungssatz  | 24.3601-8527.5  | 240503 | <b>11.0101-5407.2</b> 260011 Hülsensatz     |
|   | 240007 | <b>11.8171-0008.1</b> 990049 Führungsbolzen |   | 240503 | <b>11.0230-0170.2</b> 260078 Haltersatz     |
| 24.3601-1702.5  | 240008 | <b>11.0101-5407.2</b> 260011 Hülsensatz     |   | 240503 | <b>11.0441-6005.2</b> 250150 Dichtungssatz  |
|   | 240008 | <b>11.0441-6003.2</b> 250037 Dichtungssatz  |   | 240503 | <b>11.8116-0301.1</b> 390610 Haltefeder     |
|   | 240008 | <b>11.8171-0008.1</b> 990049 Führungsbolzen |   | 240503 | <b>11.8171-0008.1</b> 990049 Führungsbolzen |
| 24.3601-1709.5  | 240275 | <b>11.0101-6004.2</b> 260014 Hülsensatz     | 24.3601-8528.5  | 240504 | <b>11.0101-5407.2</b> 260011 Hülsensatz     |
|   | 240275 | <b>11.0441-6003.2</b> 250037 Dichtungssatz  |   | 240504 | <b>11.0230-0170.2</b> 260078 Haltersatz     |
| 24.3601-1710.5  | 240276 | <b>11.0101-6004.2</b> 260014 Hülsensatz     |   | 240504 | <b>11.0441-6005.2</b> 250150 Dichtungssatz  |
|   | 240276 | <b>11.0441-6003.2</b> 250037 Dichtungssatz  |   | 240504 | <b>11.8116-0301.1</b> 390610 Haltefeder     |
|   |        |   |   | 240504 | <b>11.8171-0008.1</b> 990049 Führungsbolzen |

# Reparatursätze

Repair kits - Corredi riparazione - Nécessaires de réparation - Juegos de reparación

|    |   |    |  |
|---|---|---|--|
| 24.3601-9785.5 240545   | <b>11.0101-5706.2</b> 260097 Hülsensatz     | 24.9240-0028.5 230018   | <b>13.0441-4014.2</b> 250079 Dichtungssatz |
| 240545  | <b>11.0441-6008.2</b> 250038 Dichtungssatz  | 24.9240-0039.5 230055   | <b>13.0441-4022.2</b> 250149 Dichtungssatz |
| 240545  | <b>11.8116-0237.1</b> 390509 Haltefeder     | 24.9240-0040.5 230056   | <b>13.0441-4022.2</b> 250149 Dichtungssatz |
| 240545  | <b>11.8171-0067.1</b> 250153 Führungsbolzen | 24.9240-8013.5 230019   | <b>13.0441-4020.2</b> 250084 Dichtungssatz |
| 24.3601-9786.5 240546   | <b>11.0101-5706.2</b> 260097 Hülsensatz     | 24.9240-8014.5 230020   | <b>13.0441-4020.2</b> 250084 Dichtungssatz |
| 240546  | <b>11.0441-6008.2</b> 250038 Dichtungssatz  | 24.9242-8005.5 230027   | <b>13.0441-4205.2</b> 250086 Dichtungssatz |
| 240546  | <b>11.8116-0237.1</b> 390509 Haltefeder     | 24.9242-8006.5 230028   | <b>13.0441-4205.2</b> 250086 Dichtungssatz |
| 240546  | <b>11.8171-0067.1</b> 250153 Führungsbolzen | 24.9242-8007.5 230029   | <b>13.0441-4205.2</b> 250086 Dichtungssatz |
| 24.3601-9787.5 240505   | <b>11.0101-5407.2</b> 260011 Hülsensatz     | 24.9242-8008.5 230030   | <b>13.0441-4205.2</b> 250086 Dichtungssatz |
| 240505  | <b>11.0441-6008.2</b> 250038 Dichtungssatz  | 24.9242-8021.5 230031   | <b>13.0441-4206.2</b> 250087 Dichtungssatz |
| 240505  | <b>11.8171-0008.1</b> 990049 Führungsbolzen | 24.9242-8022.5 230032   | <b>13.0441-4206.2</b> 250087 Dichtungssatz |
| 24.3601-9788.5 240506   | <b>11.0101-5407.2</b> 260011 Hülsensatz     | 24.9246-8001.5 230021   | <b>13.0441-4601.2</b> 250099 Dichtungssatz |
| 240506  | <b>11.0441-6008.2</b> 250038 Dichtungssatz  | 24.9246-8002.5 230022   | <b>13.0441-4601.2</b> 250099 Dichtungssatz |
| 240506  | <b>11.8171-0008.1</b> 990049 Führungsbolzen | 24.9257-8023.5 230033   | <b>13.0441-5724.2</b> 250125 Dichtungssatz |
| 24.3601-9829.5 240507   | <b>11.0101-5407.2</b> 260011 Hülsensatz     | 24.9257-8024.5 230034   | <b>13.0441-5724.2</b> 250125 Dichtungssatz |
| 240507  | <b>11.8116-0366.2</b> 390587 Haltefeder     | 24.9257-8027.5 230039   | <b>13.0441-5720.2</b> 250122 Dichtungssatz |
| 240507  | <b>11.8171-0008.1</b> 990049 Führungsbolzen | 24.9257-8028.5 230040   | <b>13.0441-5720.2</b> 250122 Dichtungssatz |
| 240507  | <b>11.8171-0067.1</b> 250153 Führungsbolzen | 24.9260-8025.5 230041   | <b>13.0441-6001.2</b> 250126 Dichtungssatz |
| 24.3601-9830.5 240508   | <b>11.0101-5407.2</b> 260011 Hülsensatz     | 24.9260-8026.5 230042   | <b>13.0441-6001.2</b> 250126 Dichtungssatz |
| 240508  | <b>11.8116-0366.2</b> 390587 Haltefeder     | 24.9260-8029.5 230043   | <b>13.0441-6003.2</b> 250128 Dichtungssatz |
| 240508  | <b>11.8171-0008.1</b> 990049 Führungsbolzen | 24.9260-8030.5 230044   | <b>13.0441-6003.2</b> 250128 Dichtungssatz |
| 240508  | <b>11.8171-0067.1</b> 250153 Führungsbolzen | 24.9260-8031.5 230045   | <b>13.0441-6003.2</b> 250128 Dichtungssatz |
| 24.9235-0013.5 230001   | <b>13.0441-3506.2</b> 250052 Dichtungssatz  | 24.9260-8032.5 230046   | <b>13.0441-6003.2</b> 250128 Dichtungssatz |
| 24.9235-0014.5 230002   | <b>13.0441-3506.2</b> 250052 Dichtungssatz  | 24.9440-8027.5 230051   | <b>13.0441-4016.2</b> 250081 Dichtungssatz |
| 24.9235-0051.5 230003   | <b>13.0441-3507.2</b> 250053 Dichtungssatz  | 24.9440-8028.5 230052   | <b>13.0441-4016.2</b> 250081 Dichtungssatz |
| 24.9235-0052.5 230004   | <b>13.0441-3507.2</b> 250053 Dichtungssatz  | 24.9442-8003.5 230053   | <b>13.0441-4214.2</b> 250091 Dichtungssatz |
| 24.9235-8005.5 230023   | <b>13.0441-3505.2</b> 250051 Dichtungssatz  | 24.9442-8004.5 230054   | <b>13.0441-4214.2</b> 250091 Dichtungssatz |
| 24.9235-8006.5 230024   | <b>13.0441-3505.2</b> 250051 Dichtungssatz  | 24.9936-0035.5 230047   | <b>13.0441-3609.2</b> 250057 Dichtungssatz |
| 24.9236-8001.5 230007   | <b>13.0441-3606.2</b> 250147 Dichtungssatz  | 24.9936-0036.5 230048   | <b>13.0441-3609.2</b> 250057 Dichtungssatz |
| 24.9236-8002.5 230008   | <b>13.0441-3606.2</b> 250147 Dichtungssatz  |   |  |
| 24.9236-8003.5 230009   | <b>13.0441-3609.2</b> 250057 Dichtungssatz  |   |  |
| 24.9236-8004.5 230010   | <b>13.0441-3609.2</b> 250057 Dichtungssatz  |   |  |
| 24.9238-0087.5 230035   | <b>13.0441-3819.2</b> 250072 Dichtungssatz  |   |  |
| 24.9238-0088.5 230036   | <b>13.0441-3819.2</b> 250072 Dichtungssatz  |   |  |
| 24.9238-8027.5 230011   | <b>13.0441-3811.2</b> 250067 Dichtungssatz  |   |  |
| 24.9238-8028.5 230012   | <b>13.0441-3811.2</b> 250067 Dichtungssatz  |   |  |
| 24.9238-8029.5 230013   | <b>13.0441-3811.2</b> 250067 Dichtungssatz  |   |  |
| 24.9238-8030.5 230014   | <b>13.0441-3811.2</b> 250067 Dichtungssatz  |   |  |
| 24.9238-8033.5 230015   | <b>13.0441-3817.2</b> 250071 Dichtungssatz  |   |  |
| 24.9238-8034.5 230016   | <b>13.0441-3817.2</b> 250071 Dichtungssatz  |   |  |
| 24.9238-8035.5 230025   | <b>13.0441-3817.2</b> 250071 Dichtungssatz  |   |  |
| 24.9238-8036.5 230026   | <b>13.0441-3817.2</b> 250071 Dichtungssatz  |   |  |
| 24.9240-0027.5 230017   | <b>13.0441-4014.2</b> 250079 Dichtungssatz  |   |  |



A large rectangular area containing numerous horizontal lines, intended for writing or drawing.





- Ⓓ Abbildungen Bremssättel
- Ⓔ Illustrations brake calipers
- Ⓕ Illustrations étriers de frein
- Ⓖ Illustrazioni pinze freno
- Ⓔ Ilustraciones pinzas de freno
- Ⓗ Afbeeldingen remzadel
- Ⓓ Tegning bremsecaliper
- Ⓔ Avbildningar bromssade
- Ⓗ Ábrák féknyereg
- Ⓓ Figuras pinças de travões
- Ⓔ Изображение суппортов дисковых тормозных механизмов
- Ⓒ Zobrazení třmenů kotoučové brzdy
- Ⓓ Rysunki gniazda hamulcowe
- Ⓔ Εικόνες διχάλων φρένων
- Ⓓ Fren kaliperi resimleri
- Ⓔ 制动钳的图示
- Ⓓ 図: ブレーキキャリパ
- Ⓓ لم ارفلل ةي كفل ا ت ايل آل ا ل اكش أ

# Abbildungen Bremssättel

Illustrations brake calipers - Illustrazioni pinze de freno - Illustrations Étriers de frein -  
 Ilustraciones pinzas de freno

11.3331-0037.2 220395 

11.3331-0038.2 220396 



## PEUGEOT

406 Limousine (95-04)  
 406 Kombi (96-04)  
 406 Coupe (97-05)



11.0441-3305.2 250006

Dichtungssatz  
 gasket set

11.3331-0039.2 220387 

11.3331-0040.2 220388 

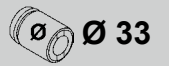

## MERCEDES BENZ

V-Klasse (BM638) (96-03)  
 VITO (BM638) (96-03)



11.0441-3305.2 250006

Dichtungssatz  
 gasket set

11.3331-8501.2 220004 

11.3331-8502.2 220005 

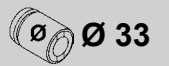

## BMW

3er Reihe/E30 (82-93)  
 5er Reihe/E28 (81-87)  
 6er Reihe/E24 (76-89)  
 7er Reihe/E23 (77-86)



11.0441-3302.2 250004  
 Dichtungssatz - gasket set

11.8116-0015.1 390492

11.0101-5402.2 260009

11.8171-0008.1 990049

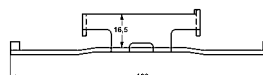

# Abbildungen Bremssättel

Illustrations brake calipers - Illustrazioni pinze de freno - Illustrations Étriers de frein -  
Ilustraciones pinzas de freno

11.3334-8001.2 220006 

11.3334-8002.2 220007 



ATE



Ø 33



## SAAB

900 (79-93)  
9000 (85-93)  
9000 (94-98)



11.0441-3302.2 250004  
Dichtungssatz - gasket set  
11.8116-0047.1 390494

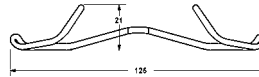

11.0101-5407.2 260011



11.8171-0008.1 990049



11.3361-8503.2 220016 

11.3361-8504.2 220017 



ATE



Ø 36



## BMW

3er Reihe/E36 (91-00)  
Z1 (88-91)



11.0441-3602.2 250008  
Dichtungssatz - gasket set  
11.8116-0066.1 390557

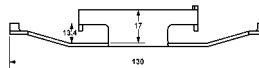

11.0101-5402.2 260009



11.8171-0008.1 990049



11.3361-8505.2 220024 

11.3361-8506.2 220025 



ATE



Ø 36



## BMW

Z3 (95-02)



11.0441-3602.2 250008  
Dichtungssatz - gasket set  
11.8116-0185.1 390592

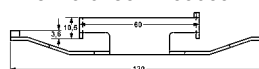

11.0101-5402.2 260009



11.8171-0008.1 990049



# Abbildungen Bremssättel

Illustrations brake calipers - Illustrazioni pinze de freno - Illustrations Étriers de frein -  
 Ilustraciones pinzas de freno

11.3361-9975.2 220281   
 11.3361-9976.2 220282 



## CITROEN

EVASION (94-02)

## FIAT

ULYSSE (94-02)

## LANCIA

ZETA (94-02)

## PEUGEOT

806 (94-02)



11.0441-3602.2 250008  
 Dichtungssatz - gasket set

11.8116-0073.1 390498

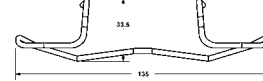



11.0101-5407.2 260011



11.8171-0008.1 990049



11.3381-8501.2 220018   
 11.3381-8502.2 220019 



## BMW

3er Reihe/E30 (82-93)

7er Reihe/E32 (86-94)



11.0441-3802.2 250009  
 Dichtungssatz - gasket set

11.8116-0066.1 390557

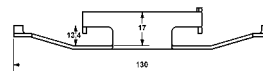



11.0101-5402.2 260009



11.8171-0008.1 990049



11.3381-8503.2 220020   
 11.3381-8504.2 220021 

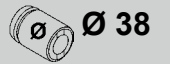

## BMW

5er Reihe/E34 (88-96)

7er Reihe/E32 (86-94)



11.0441-3803.2 250010  
 Dichtungssatz - gasket set

11.8116-0066.1 390557

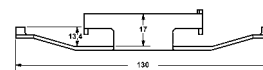

11.0101-5402.2 260009



11.8171-0008.1 990049





# Abbildungen Bremssättel

Illustrations brake calipers - Illustrazioni pinze de freno - Illustrations Étriers de frein -  
 Ilustraciones pinzas de freno

11.3401-0055.2 220519   
 11.3401-0056.2 220520 





## SAAB

9-5 Limousine (YS3E) (97-10)  
 9-5 Kombi (YS3E) (98-10)

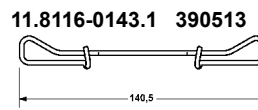

11.0441-3803.2 250010 11.0101-5407.2 260011 11.8171-0008.1 990049



11.3401-8503.2 220030   
 11.3401-8504.2 220031 



## BMW

5er Reihe/E34 (88-96)





11.0441-4002.2 250011 11.0101-5402.2 260009 11.8171-0008.1 990049

Dichtungssatz - gasket set

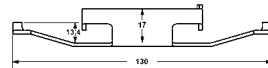
11.8116-0066.1 390557



11.3421-8501.2 220405   
 11.3421-8502.2 220406 



## BMW

7er Reihe/E38 (93-01)



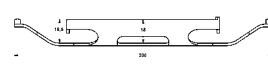

11.0101-6004.2 260014 11.8171-0008.1 990049

11.8116-0133.1 390511



# Abbildungen Bremssättel

Illustrations brake calipers - Illustrazioni pinze de freno - Illustrations Étriers de frein - Ilustraciones pinzas de freno

11.3451-8501.2 220389   
 11.3451-8502.2 220390 



## MERCEDES BENZ

Transporter (BM 901/902) SPRINTER (95-06)

## VOLKSWAGEN

LT/- 4x4 (96-06)



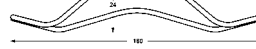

11.0441-4502.2 250143  
 Dichtungssatz - gasket set  
 11.8116-0172.1 390500



11.0101-5407.2 260011  
 (VW)  
 11.0101-5409.2 260035  
 (MB)

11.8171-0008.1 990049



11.3481-8511.2 220337   
 11.3481-8512.2 220338 



## FORD

FIESTA III (89-96)





11.0441-4805.2 250020  
 Dichtungssatz  
 gasket set

11.0101-5407.2 260011

11.8171-0008.1 990049



11.3481-8513.2 220335   
 11.3481-8514.2 220336 



## FORD

FIESTA IV (96-02)  
 KA I (96-08)

## MAZDA

121 (96-03)



11.0441-4805.2 250020  
 Dichtungssatz - gasket set  
 11.8116-0264.1 390594

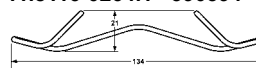

11.0101-5407.2 260011

11.8171-0008.1 990049





11.0230-0165.2 260073  
 Haltersatz - anchor set



# Abbildungen Bremssättel

Illustrations brake calipers - Illustrazioni pinze de freno - Illustrations Étriers de frein - Ilustraciones pinzas de freno

11.3481-8515.2 220365   
 11.3481-8516.2 220366 



## FORD

FIESTA IV (96-02)  
 KAI (96-08)

## MAZDA

121 (96-03)

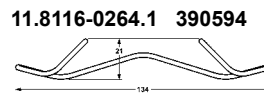

11.0101-5407.2 260011 11.8171-0008.1 990049

11.8116-0264.1 390594

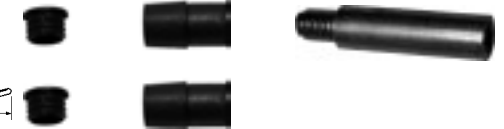

11.3481-9833.2 220561   
 11.3481-9834.2 220562 



## CITROEN

SAXO (96-04)  
 XSARA (N1) Limousine (97-05)  
 XSARA (N2) Kombi (97-05)  
 XSARA (N0) Coupe (97-05)

## PEUGEOT

106 (91-96)  
 106 (96-04)  
 205 (91-98)  
 306 Lim. (3/5-türig) (93-01)  
 306 Lim. (4-türig) (94-01)  
 306 Cabriolet (94-03)  
 306 Kombi (97-02)

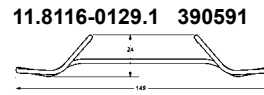



11.0441-4811.2 250024 11.0101-5407.2 260011 11.8171-0008.1 990049

Dichtungssatz - gasket set

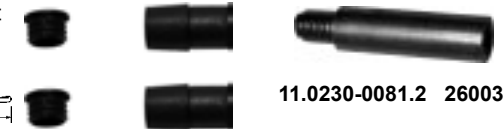
11.8116-0129.1 390591



11.0230-0081.2 260038

11.3521-8501.2 220391   
 11.3521-8502.2 220392 



## MERCEDES BENZ

Transporter (BM 901/902) SPRINTER (95-06)  
 Transporter (BM 903/904) SPRINTER (95-06)

## VOLKSWAGEN

LT/- 4x4 (96-06)

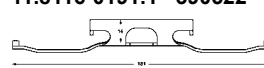

11.0441-5203.2 250144 11.0101-5407.2 260011 11.8171-0008.1 990049

Dichtungssatz - gasket set

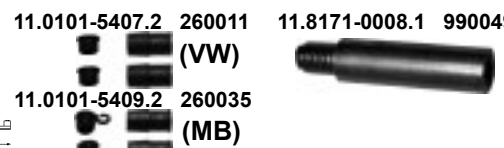

11.8116-0191.1 390522



11.0101-5409.2 260035 (VW) (MB)

# Abbildungen Bremssättel

Illustrations brake calipers - Illustrazioni pinze de freno - Illustrations Étriers de frein -  
 Ilustraciones pinzas de freno

11.3541-8083.2 220241   
 11.3541-8084.2 220242 



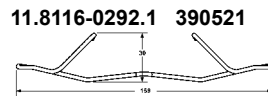

## OPEL

OMEGA B / Vauxhall Omega (94-03)



11.0101-5407.2 260011 11.8171-0008.1 990049



11.3541-8085.2 220287   
 11.3541-8086.2 220288 



## OPEL

CALIBRA / Vauxhall Calibra (89-97)  
 VECTRA A / Vauxhall Cavalier (89-95)

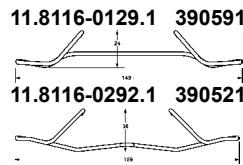

## SAAB

900 (94-98)



11.8116-0129.1 390591 11.0101-5407.2 260011 11.8171-0008.1 990049



11.3541-8091.2 220089   
 11.3541-8092.2 220090 



## FORD

ESCORT / ORION (81-85)  
 ESCORT / ORION (86-90)  
 SIERRA (82-86)  
 SIERRA (87-93)



11.0441-5402.2 250028  
 Dichtungssatz  
 gasket set

11.0101-5407.2 260011 11.8171-0008.1 990049



# Abbildungen Bremssättel

Illustrations brake calipers - Illustrazioni pinze de freno - Illustrations Étriers de frein - Ilustraciones pinzas de freno

11.3541-8105.2 220339 

11.3541-8106.2 220340 



ATE



Ø 54



## FORD

FOCUS I (98-04)



11.0101-5407.2 260011

11.8171-0008.1 990049



11.3541-8521.2 220113 

11.3541-8522.2 220114 



ATE



Ø 54



## AUDI

80 (87-91)  
80 Quattro (87-91)  
90 (87-91)  
90 Quattro (87-91)

## AUDI

100 (83-90)  
CABRIO (91-00)  
COUPE (89-96)  
COUPE Quattro (87-96)



11.0441-5405.2 250030  
Dichtungssatz  
gasket set

11.0101-5409.2 260035



11.3541-8523.2 220115 

11.3541-8524.2 220116 



ATE



Ø 54



## AUDI

A3 (96-03)

## SEAT

LEON I (1M1) (99-05)  
TOLEDO II (1M2) (98-04)

## SKODA

OCTAVIA I (1U) (97-10)

## VOLKSWAGEN

BORA (98-04)  
GOLF III (92-97)  
GOLF III Variant (93-99)  
GOLF IV (98-03)  
GOLF IV Variant (99-06)  
NEW BEETLE (98-10)  
NEW BEETLE Cabriolet (03-10)  
PASSAT (94-96)  
VENTO (92-98)



11.0441-5409.2 250031  
Dichtungssatz - gasket set

11.8116-0143.1 390513

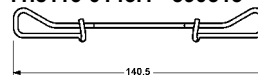

11.0101-5409.2 260035



11.0230-0042.2 260027  
Haltersatz - anchor set

# Abbildungen Bremssättel

Illustrations brake calipers - Illustrazioni pinze de freno - Illustrations Étriers de frein -  
 Ilustraciones pinzas de freno

11.3541-8529.2 220341 

11.3541-8530.2 220342 



## FORD

FIESTA IV (96-02)  
 PUMA (97-01)

## MAZDA

121 (96-03)



11.0441-5402.2 250028  
 Dichtungssatz - gasket set  
 11.8116-0264.1 390594

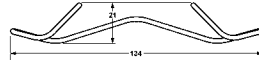

11.0101-5407.2 260011



11.8171-0008.1 990049



11.3541-8531.2 220367 

11.3541-8532.2 220368 



## FORD

FIESTA IV (96-02)  
 FIESTA V (02-08)  
 FUSION (02-12)  
 KA I (96-08)  
 PUMA (97-01)  
 STREET KA (03-06)

## MAZDA

121 (96-03)  
 2 (DY) (03-07)  
 DEMIO (03-)



11.8116-0356.1 390586  
 11.8116-0264.1 390594

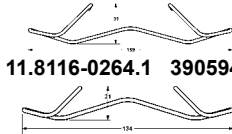

11.0101-5407.2 260011



11.8171-0008.1 990049



11.3571-8007.2 220117 

11.3571-8008.2 220118 



## SAAB

9000 (85-93)  
 9000 (94-98)



11.0441-5701.2 250032  
 Dichtungssatz gasket set  
 11.8116-0073.1 390498

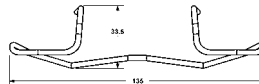

11.0101-5407.2 260011



11.8171-0008.1 990049





# Abbildungen Bremssättel

Illustrations brake calipers - Illustrazioni pinze de freno - Illustrations Étriers de frein -  
 Ilustraciones pinzas de freno

11.3571-8507.2 220127 

11.3571-8508.2 220128 



## AUDI

100 (91-94)  
 100 Quattro (91-94)  
 A6 / A6 Avant (4A/C4) (94-97)



11.0441-5704.2 250034  
 Dichtungssatz - gasket set

11.8116-0143.1 390513

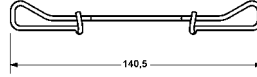

11.0101-5409.2 260035



11.8171-0008.1 990049



11.0230-0042.2 260027  
 Haltersatz - anchor set

11.3571-8509.2 220313 

11.3571-8510.2 220314 



## MERCEDES BENZ

CLK-Klasse (C208) Coupe (97-02)  
 CLK-Klasse (A208) Cabrio (98-03)  
 E-Klasse (W210) Limousine (95-02)  
 E-Klasse (S210) Kombi (96-03)  
 SLK-Klasse (R170) (96-04)



11.0441-5703.2 250145  
 Dichtungssatz gasket set

11.8116-0253.1 390512

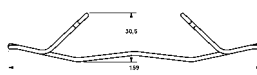

11.0101-5407.2 260011



11.8171-0008.1 990049



11.3571-8511.2 220315 

11.3571-8512.2 220316 



## MERCEDES BENZ

C-Klasse (W202) Limousine (93-00)  
 C-Klasse (S202) Kombi (96-01)  
 CLK-Klasse (C208) Coupe (97-02)  
 CLK-Klasse (A208) Cabrio (98-03)  
 E-Klasse (W210) Limousine (95-02)  
 E-Klasse (S210) Kombi (96-03)  
 SLK-Klasse (R170) (96-04)



11.0441-5703.2 250145  
 Dichtungssatz gasket set

11.8116-0253.1 390512

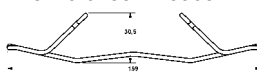

11.0101-5407.2 260011



11.8171-0008.1 990049



11.0230-0096.2 260033  
 Haltersatz - anchor set

# Abbildungen Bremssättel

Illustrations brake calipers - Illustrazioni pinze de freno - Illustrations Étriers de frein -  
 Ilustraciones pinzas de freno

11.3571-8518.2 220322 

11.3571-8517.2 220321 



ATE



Ø 57



## AUDI

A4 (B5) (95-01)



11.0441-5704.2 250034  
 Dichtungssatz - gasket set

11.8116-0143.1 390513

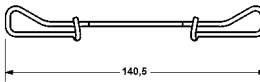

11.0101-5407.2 260011



11.8171-0008.1 990049



11.3571-8522.2 220320 

11.3571-8521.2 220319 



ATE



Ø 57



## AUDI

A4 (B5) (95-01)  
 A4 (B6/B7) (01-08)  
 A4 Cabrio (02-08)  
 A6 / A6 Avant (4B/C5) (97-05)

## SEAT

EXEO / ST (09-13)

## SKODA

SUPERB I (02-08)

## VOLKSWAGEN

PASSAT (97-05)



11.0441-5704.2 250034  
 Dichtungssatz - gasket set

11.8116-0143.1 390513

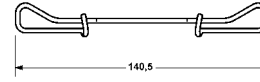

11.0101-5409.2 260035



11.8171-0008.1 990049



11.0230-0042.2 260027  
 Haltersatz - anchor set

11.3571-8525.2 220363 

11.3571-8526.2 220364 



ATE



Ø 57



## OPEL

CALIBRA (89-97)  
 Vauxhall Calibra (89-97)  
 VECTRA B (96-02)  
 Vauxhall Vectra (96-02)

## SAAB

9-3 (YS3D) (98-02)  
 9-3 Cabriolet (YS3D) (98-03)  
 9-5 Limousine (YS3E) (97-10)  
 9-5 Kombi (YS3E) (98-10)  
 900 (94-98)



11.0441-5704.2 250034  
 Dichtungssatz - gasket set

11.8116-0292.1 390521

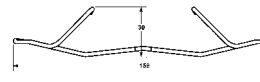

11.0101-5407.2 260011





11.8171-0008.1 990049





# Abbildungen Bremssättel

Illustrations brake calipers - Illustrazioni pinze de freno - Illustrations Étriers de frein -  
 Ilustraciones pinzas de freno



11.3601-8501.2 220145   
 11.3601-8502.2 220146 



**BMW**  
 5er Reihe/E34 (88-96)



11.0441-6003.2 250037 11.0101-5402.2 260009 11.8171-0008.1 990049  
 Dichtungssatz - gasket set  
 11.8116-0083.1 390501  
  
 11.0230-0020.2 260023  
 Haltersatz - anchor set



11.3601-8503.2 220147   
 11.3601-8504.2 220148 



**BMW**  
 5er Reihe/E34 (88-96)  
 7er Reihe/E32 (86-94)



11.0441-6003.2 250037 11.0101-5402.2 260009 11.8171-0008.1 990049  
 Dichtungssatz - gasket set  
 11.8116-0083.1 390501  
  
 11.0230-0020.2 260023  
 Haltersatz - anchor set

11.3601-8505.2 220149   
 11.3601-8506.2 220150 





**BMW**  
 5er Reihe/E34 (88-96)  
 7er Reihe/E32 (86-94)



11.0441-6003.2 250037 11.0101-5402.2 260009 11.8171-0008.1 990049  
 Dichtungssatz - gasket set  
 11.8116-0083.1 390501  
  
 11.0230-0009.2 260018  
 Haltersatz - anchor set

# Abbildungen Bremssättel

Illustrations brake calipers - Illustrazioni pinze de freno - Illustrations Étriers de frein -  
 Ilustraciones pinzas de freno

11.3601-8511.2 220155   
 11.3601-8512.2 220156 



## BMW



8er Reihe/E31 (90-99)

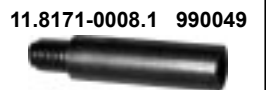
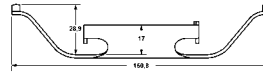

11.0441-6003.2 250037  
 Dichtungssatz - gasket set

11.8116-0092.1 390503



11.3601-8515.2 220323   
 11.3601-8516.2 220324 



## BMW



3er Reihe/E36 (91-00)  
 Z3 (95-02)

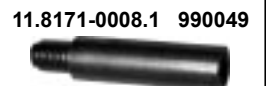
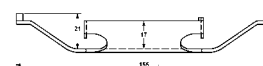

11.0441-6003.2 250037  
 Dichtungssatz - gasket set

11.8116-0083.1 390501



11.9347-7001.2 220473   
 11.9347-7002.2 220474 



## MINI

R50/R53 (00-06)



11.0230-0162.2 260090  
 Haltersatz - anchor set

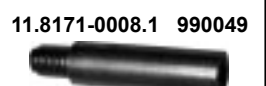

# Abbildungen Bremssättel

Illustrations brake calipers - Illustrazioni pinze de freno - Illustrations Étriers de frein -  
 Ilustraciones pinzas de freno

11.9347-7003.2 220565   
 11.9347-7004.2 220566 





## MINI

R50/R53 (00-06)  
 R52 Cabrio (04-08)

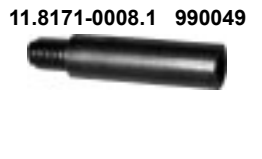
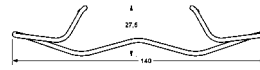

11.0230-0162.2 260090  
 Haltersatz - anchor set  
 11.8116-0340.1 390595



11.9347-7005.2 220643   
 11.9347-7006.2 220644 



**DAIHATSU**  
 CHARADE (11-)

## TOYOTA

YARIS (06-)  
 YARIS (11-)



11.8116-0340.1 390595

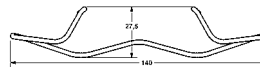

11.9381-9957.2 220661   
 11.9381-9958.2 220662 



## SAAB

9-5 Limousine (YS3E) (97-10)  
 9-5 Kombi (YS3E) (98-10)



11.8116-0143.1 390513

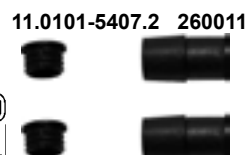
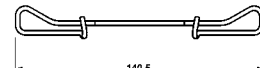

# Abbildungen Bremssättel

Illustrations brake calipers - Illustrazioni pinze de freno - Illustrations Étriers de frein -  
 Ilustraciones pinzas de freno

11.9381-9959.2 220433   
 11.9381-9960.2 220434 



## BMW

3er Reihe/E36 (91-00)



11.0441-3803.2 250010  
 Dichtungssatz - gasket set  
 11.8116-0066.1 390577

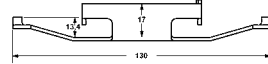

11.9381-9961.2 220435   
 11.9381-9962.2 220436 





## BMW

3er Reihe/E36 (91-00)

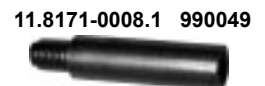
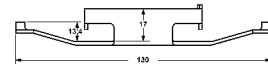

11.0441-3803.2 250010  
 Dichtungssatz - gasket set  
 11.8116-0066.1 390577



11.9387-7001.2 220397   
 11.9387-7002.2 220398 



## RENAULT

ESPACE IV (JK\_) (02-)  
 LAGUNA II Limousine (BG\_) (01-07)  
 LAGUNA II Grandtour (KG\_) (01-07)  
 MEGANE II Limousine 3/5-türig (BM/CM\_) (02-)  
 MEGANE II Limousine 4-türig (LM\_) (03-)  
 VEL SATIS (BJO\_) (02-)



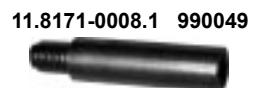
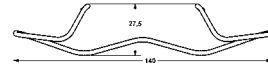

11.8116-0340.1 390595





# Abbildungen Bremssättel

Illustrations brake calipers - Illustrazioni pinze de freno - Illustrations Étriers de frein -  
 Ilustraciones pinzas de freno

11.9387-7003.2 220567   
 11.9387-7004.2 220568 



## OPEL

VECTRA C (F68,F69) (02-08)  
 Vauxhall Vectra MK II (02-08)

## SAAB

9-3 Limousine (YS3F) (03-12)  
 9-3 Sport Combi (05-12)  
 9-3 Cabriolet (YS3F) (03-12)  
 9-3 X (09-12)

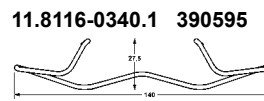

11.8116-0340.1 390595

11.0101-5407.2 260011 11.8171-0008.1 990049



11.9387-7005.2 220569   
 11.9387-7006.2 220570 



## OPEL

VECTRA C (F68,F69) (02-08)  
 Vauxhall Vectra MK II (02-08)

## SAAB

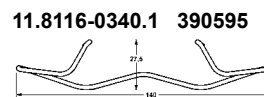

9-3 Limousine (YS3F) (03-12)  
 9-3 Sport Combi (05-12)  
 9-3 Cabriolet (YS3F) (03-12)  
 9-3 X (09-12)



11.8116-0340.1 390595

11.0101-5407.2 260011 11.8171-0008.1 990049



11.9387-7015.2 220627   
 11.9387-7016.2 220628 



## FORD

C-MAX (07-10)  
 FOCUS II (05-11)  
 FOCUS C-MAX (03-07)

## MAZDA

3 (BK) (03-09)

## VOLVO

C30 Coupe (06-12)  
 C70 II Cabrio (06-13)  
 S40 II (04-12)  
 V50 (04-12)

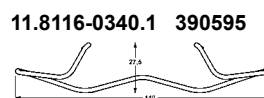

11.8116-0340.1 390595



11.0101-5407.2 260011 11.8171-0008.1 990049



11.0230-0698.2 260091  
 Halter - anchor

# Abbildungen Bremssättel

Illustrations brake calipers - Illustrazioni pinze de freno - Illustrations Étriers de frein -  
 Ilustraciones pinzas de freno

11.9387-7021.2 220629   
 11.9387-7022.2 220630 



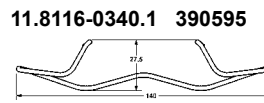

## NISSAN

PRIMERA (P12E) Limousine (02-08)  
 PRIMERA (W12) Kombi (02-08)



11.0101-5407.2 260011 11.8171-0008.1 990049



11.9401-9951.2 220463   
 11.9401-9952.2 220464 



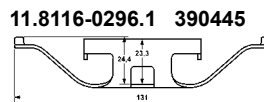

## BMW

3er Reihe/E46 (98-06)



11.0101-5402.2 260009 11.8171-0008.1 990049



11.9401-9975.2 220495   
 11.9401-9976.2 220496 



## BMW

7er Reihe/E38 (93-01)

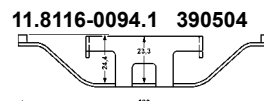

11.0441-4003.2 250001 11.0101-5402.2 260009 11.8171-0008.1 990049

Dichtungssatz - gasket set

11.8116-0094.1 390504





# Abbildungen Bremssättel

Illustrations brake calipers - Illustrazioni pinze de freno - Illustrations Étriers de frein -  
 Ilustraciones pinzas de freno

11.9401-9977.2 220439   
 11.9401-9978.2 220440 





**BMW**  
 7er Reihe/E38 (93-01)

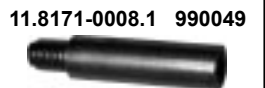
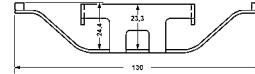

11.0441-4003.2 250001  
 Dichtungssatz - gasket set

11.8116-0094.1 390504



11.9406-9995.2 220415   
 11.9406-9996.2 220416 





**BMW**  
 5er Reihe/E39 (96-03)

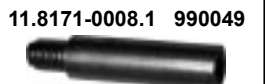
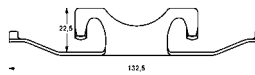

11.0441-4004.2 250012  
 Dichtungssatz - gasket set

11.8116-0168.1 390499



11.9407-7001.2 220573   
 11.9407-7002.2 220574 



**OPEL**  
 SIGNUM / Vauxhall Signum (03-08)  
 VECTRA C Caravan (F35) / Vauxhall MK II (03-08)



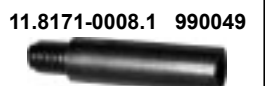
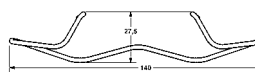

11.8116-0340.1 390595



# Abbildungen Bremssättel

Illustrations brake calipers - Illustrazioni pinze de freno - Illustrations Étriers de frein -  
 Ilustraciones pinzas de freno

11.9407-7005.2 220637   
 11.9407-7006.2 220638 



## OPEL

SIGNUM / Vauxhall Signum (03-08)

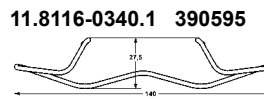



11.8116-0340.1 390595

11.0101-5407.2 260011

11.8171-0008.1 990049



11.9421-9979.2 220497   
 11.9421-9980.2 220498 



## VOLVO

S60 (00-09)  
 S80 I (98-06)  
 V70 II (00-07)  
 XC70 I CROSS COUNTRY (00-07)

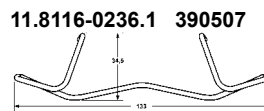



11.8116-0236.1 390507

11.0101-5407.2 260011

11.8171-0008.1 990049



11.9481-9811.2 220445   
 11.9481-9812.2 220446 



## MINI

R50/R53 (00-06)  
 R52 Cabrio (04-08)

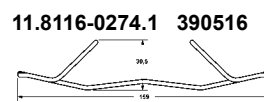

11.8116-0274.1 390516

11.0101-5407.2 260011

11.8171-0008.1 990049



# Abbildungen Bremssättel

Illustrations brake calipers - Illustrazioni pinze de freno - Illustrations Étriers de frein -  
 Ilustraciones pinzas de freno

11.9521-7001.2 220499 

11.9521-7002.2 220500 



## OPEL

ASTRA G / Vauxhall Astra MKIV (98-04)



11.0101-5407.2 260011 11.8171-0008.1 990049



11.9541-9543.2 220645 

11.9541-9544.2 220646 



## RENAULT

SCENIC II (JM\_) (03-09)  
 GRAND SCENIC (JM\_) (04-09)



11.0101-5407.2 260011 11.8171-0008.1 990049



11.9541-9545.2 220625 

11.9541-9546.2 220626 



## RENAULT

CLIO III (BR\_/CR\_) (05-12)  
 MEGANE II Limousine 3/5-türig (BM/CM\_) (02-08)  
 MEGANE II Limousine 4-türig (LM\_) (03-08)  
 MEGANE II Coupe/Cabrio (EM\_) (03-10)  
 MEGANE II Grandtour (KM\_) (03-08)  
 SCENIC II (JM\_) (03-09)



11.0101-5403.2 260010 11.0101-5407.2 260011 11.8171-0008.1 990049



# Abbildungen Bremssättel

Illustrations brake calipers - Illustrazioni pinze de freno - Illustrations Étriers de frein - Ilustraciones pinzas de freno

11.9541-9549.2 220575 

11.9541-9550.2 220576 



ATE



Ø 54



## AUDI

A1 (10-)/A2 (00-05)/A3 (96-13)

## SEAT

ALTEA (5P1) ALTEA XL (5P5)  
CORDOBA III (6L2)  
IBIZA IV / V  
LEON I / II  
Mii (12-)  
TOLEDO II / III / IV (KG3) (12-)



11.0441-5409.2 250031  
Dichtungssatz - gasket set

## SKODA

CITIGO (12-)/FABIA I / II / OCTAVIA I / II  
RAPID (12-)

## VOLKSWAGEN

BORA / CADDY III / FOX (05-)  
GOLF IV (98-05) / GOLF V (03-08)  
GOLF VI (08-)  
JETTA V (05-10) / JETTA VI (11-)  
NEW BEETLE (98-10) / BEETLE (11-)  
POLO IV (02-09) / POLO V (09-)  
up (11-)



11.9541-9553.2 220563 

11.9541-9554.2 220564 



ATE



Ø 54



## AUDI

A1 (10-)  
A3 (03-13)  
TT Coupe (06-)  
TT Roadster (07-)

## SEAT

ALTEA (5P1) / ALTEA XL (5P5)  
LEON II (1P1) (05-12)  
TOLEDO III (5P2) (05-09)  
TOLEDO IV (KG3) (12-)



11.8116-0351.1 390538

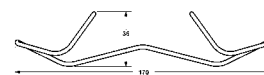

## SKODA

OCTAVIA II (1Z) (04-13) RAPID (12-)  
ROOMSTER (5J) (06-)/SUPERB II (08-)  
SUPERB Kombi (09-)/YETI (09-)

## VOLKSWAGEN

CADDY III (04-)  
CC COUPE (11-)/EOS (06-)  
GOLF V / GOLF VI / GOLF Plus  
JETTA V (05-10) / JETTA VI (11-)/BEETLE (11-)  
PASSAT (05-10) / PASSAT (10-)  
PASSAT CC (08-11) / PASSAT ALLTRACK (12-)  
POLO V (09-)/SCIROCCO (08-)/TOURAN (03-)

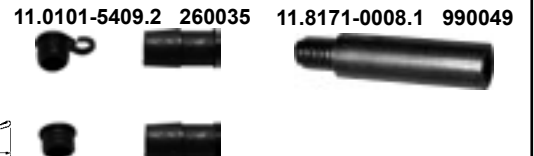

11.9541-9587.2 220419 

11.9541-9588.2 220420 



ATE



Ø 54



## BMW

3er Reihe/E36 (91-00)  
3er Reihe/E46 (98-06)  
Z3 (95-02)  
Z4 Roadster (03-08)



11.0441-5402.2 250028  
Dichtungssatz gasket set

11.8116-0109.1 390495

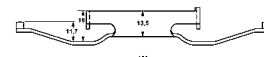



# Abbildungen Bremssättel

Illustrations brake calipers - Illustrazioni pinze de freno - Illustrations Étriers de frein - Ilustraciones pinzas de freno

11.9541-9595.2 220501 

11.9541-9596.2 220502 



ATE



Ø 54



## AUDI

A3 (96-03)  
TT Coupe (98-06)  
TT Roadster (99-06)

## SEAT

IBIZA IV (6L1) (02-10)  
LEON I (1M1) (99-05)  
TOLEDO II (1M2) (98-04)



11.0441-5409.2 250031  
Dichtungssatz - gasket set

11.8116-0143.1 390513

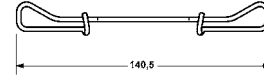

## SKODA

OCTAVIA I (1U) (97-10)

## VOLKSWAGEN

BORA (98-04)  
GOLF IV (98-03)  
GOLF IV Variant (99-06)  
NEW BEETLE (98-10)  
POLO IV (02-09)

11.0101-5409.2 260035 11.8171-0008.1 990049



11.9541-9667.2 220421 

11.9541-9668.2 220422 



ATE



Ø 54



## BMW

3er Reihe/E36 (91-00)  
Z3 (95-02)



11.8116-0109.1 390495

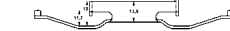

11.8116-0206.1 390593

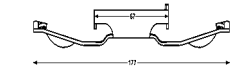

11.0101-5402.2 260009 11.8171-0008.1 990049

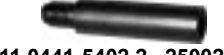

11.0441-5402.2 250028  
Dichtungssatz - gasket set

11.0230-0097.2 260092  
Haltersatz - anchor set

11.9541-9805.2 220503 

11.9541-9806.2 220504 



ATE



Ø 54



## VOLVO

440 (88-96)  
460 (88-96)  
480 (86-96)





11.0101-5407.2 260011 11.8171-0008.1 990049



# Abbildungen Bremssättel

Illustrations brake calipers - Illustrazioni pinze de freno - Illustrations Étriers de frein -  
 Ilustraciones pinzas de freno

11.9571-9779.2 220657   
 11.9571-9780.2 220658 



## OPEL

SIGNUM (03-08)  
 Vauxhall Signum (03-08)  
 VECTRA C (F68,F69) (02-08)  
 Vauxhall Vectra MK II (02-08)  
 VECTRA C Caravan (F35) (02-08)  
 Vauxhall MK II (03-08)

## SAAB

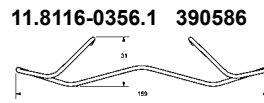

9-3 Limousine (YS3F) (03-12)  
 9-3 Sport Combi (05-12)  
 9-3 Cabriolet (YS3F) (03-12)  
 9-3 X (09-12)



11.0101-5407.2 260011 11.8171-0008.1 990049

11.8116-0356.1 390586



11.9571-9785.2 220595   
 11.9571-9786.2 220596 



## MAZDA

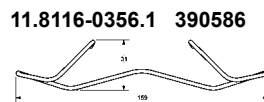

3 (BK) (03-09)  
 3 (BL) (09-)  
 5 (CR) (05-10)  
 5 (CW) (10-)  
 PREMACY (CR) (05-10)



11.0101-5407.2 260011 11.8171-0008.1 990049

11.8116-0356.1 390586



11.9571-9801.2 220577   
 11.9571-9802.2 220578 



## TOYOTA

AVENSIS (97-03)



11.0101-5407.2 260011 11.8171-0008.1 990049

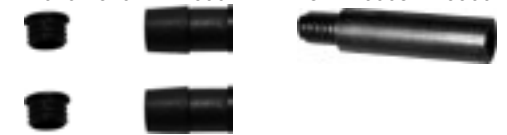



# Abbildungen Bremssättel

Illustrations brake calipers - Illustrazioni pinze de freno - Illustrations Étriers de frein -  
 Ilustraciones pinzas de freno

11.9571-9811.2 220485 

11.9571-9812.2 220486 



ATE



Ø 57



## FORD

GALAXY I (95-06)

## SEAT

ALHAMBRA I (96-10)



11.0441-5704.2 250034  
 Dichtungssatz - gasket set

11.8116-0326.1 390471

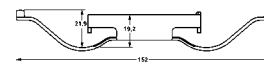

11.0101-5407.2 260011



11.8171-0008.1 990049



11.9571-9819.2 220469 

11.9571-9820.2 220470 



ATE



Ø 57



## FORD

GALAXY I (95-06)

## SEAT

ALHAMBRA I (96-10)



11.0441-5704.2 250034  
 Dichtungssatz gasket set

11.8116-0326.1 390471



11.0101-5705.2 260096



11.9571-9821.2 220579 

11.9571-9822.2 220580 



ATE



Ø 57



## TOYOTA

AVENSIS (97-03)



11.8116-0279.1 390519

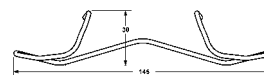

11.0101-5407.2 260011





11.8171-0008.1 990049



# Abbildungen Bremssättel

Illustrations brake calipers - Illustrazioni pinze de freno - Illustrations Étriers de frein - Ilustraciones pinzas de freno

11.9571-9823.2 220471 

11.9571-9824.2 220472 



## OPEL

ASTRA G (98-04)  
Vauxhall Astra MKIV (98-04)  
ASTRA H / GTC (04-10)  
Vauxhall Astra Mk V (04-10)  
ASTRA H Caravan (04-10)  
Vauxhall Astra MKV Estate (04-10)  
ASTRA TWIN TOP (06-10)



11.0441-5704.2 250034  
Dichtungssatz gasket set

11.8116-0292.1 390521

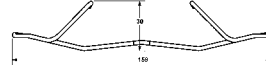

11.0101-5407.2 260011



11.8171-0008.1 990049



11.9571-9836.2 220428 

11.9571-9835.2 220427 



## AUDI

A4 (B6/B7) (01-08)  
A4 Cabrio (02-08)  
A6 / A6 Avant (4B/C5) (97-05)  
A6 (4F2/C6) Limousine (04-11)  
A6 (4F5/C6) Avant (05-11)



11.0441-5704.2 250034  
Dichtungssatz - gasket set

11.8116-0143.1 390513

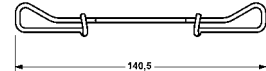

11.0101-5409.2 260035



11.8171-0008.1 990049



11.9571-9841.2 220401 

11.9571-9842.2 220402 



## RENAULT

LAGUNA II Limousine (BG\_) (01-07)  
LAGUNA II Grandtour (KG\_) (01-07)



11.0101-5403.2 260010



11.0101-5407.2 260011





11.8171-0008.1 990049



# Abbildungen Bremssättel

Illustrations brake calipers - Illustrazioni pinze de freno - Illustrations Étriers de frein -  
 Ilustraciones pinzas de freno

11.9571-9861.2 220403   
 11.9571-9862.2 220404 



## RENAULT

LAGUNA II Limousine (BG\_) (01-07)  
 LAGUNA II Grandtour (KG\_) (01-07)



11.0101-5403.2 260010 11.0101-5407.2 260011 11.8171-0008.1 990049



11.9571-9863.2 220513   
 11.9571-9864.2 220514 



## VOLVO

S60 (00-09)  
 S80 I (98-06)  
 V70 II (00-07)  
 XC70 I CROSS COUNTRY (00-07)



11.0101-5407.2 260011 11.8171-0008.1 990049

11.8116-0366.2 390587

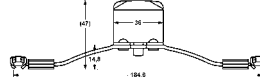

11.9571-9871.2 220425   
 11.9571-9872.2 220426 



## MG

ZT Limousine (01-05)  
 ZT-T Kombi (01-05)

## ROVER

75-Serie (RJ) (99-04)  
 75 Serie (RX) (04-)





11.0101-5407.2 260011 11.8171-0008.1 990049



# Abbildungen Bremssättel

Illustrations brake calipers - Illustrazioni pinze de freno - Illustrations Étriers de frein - Ilustraciones pinzas de freno

11.9571-9971.2 220605   
11.9571-9972.2 220606 





## VOLVO

850 Limousine (91-96)  
850 Kombi (92-96)  
C70 Coupe (97-02)  
C70 I Cabrio (98-06)  
S70 (97-00)  
V70 I (97-00)

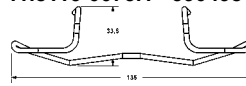

11.0441-5702.2 250033 11.0101-5407.2 260011 11.8171-0008.1 990049  
Dichtungssatz - gasket set  
11.8116-0073.1 390498



11.9576-9995.2 220651   
11.9576-9996.2 220652 

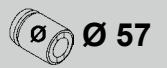

## AUDI

A3 / A3 Sportback (03-13)

## SEAT

LEON II (1P1) (05-12)

## SKODA

SUPERB II (08-)  
SUPERB Kombi (09-)



## VOLKSWAGEN

EOS (06-)  
GOLF V (03-08)  
GOLF VI (08-)  
PASSAT Limousine (05-10)  
PASSAT Variant (05-10)  
PASSAT CC (08-11)

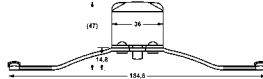

11.8116-0410.2 390589 11.0101-5409.2 260035 11.8171-0008.1 990049



11.9601-8501.2 220593   
11.9601-8502.2 220594 



## VOLKSWAGEN

TOUAREG I (03-10)  
TRANSPORTER (T5) BUS / MULTIVAN / KASTEN (03-)  
TRANSPORTER (T5) PRITSCHEN / FAHRGESTELL (03-)



11.0441-6008.2 250038 11.0101-5706.2 260097  
Dichtungssatz - gasket set  
11.8116-0237.1 390509

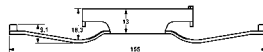



# Abbildungen Bremssättel

Illustrations brake calipers - Illustrazioni pinze de freno - Illustrations Étriers de frein -  
 Ilustraciones pinzas de freno

11.9601-9787.2 220585 

11.9601-9788.2 220586 



## RENAULT

ESPACE IV (JK\_) (02-)  
 LAGUNA II Limousine (BG\_) (01-07)  
 LAGUNA II Grandtour (KG\_) (01-07)  
 VEL SATIS (BJ0\_) (02-09)



11.0101-5403.2 260010 11.0101-5407.2 260011 11.8171-0008.1 990049



11.9601-9829.2 220505 

11.9601-9830.2 220506 



## VOLVO

S60 (00-09)  
 S80 I (98-06)  
 V70 II (00-07)  
 XC70 I CROSS COUNTRY (00-07)



11.8116-0366.2 390587

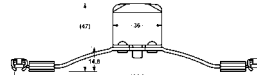

11.0101-5407.2 260011 11.8171-0008.1 990049



11.9606-9953.2 220587 

11.9606-9954.2 220588 



## AUDI

A4 (B6/B7) (01-08)  
 A6 (4F2/C6) Limousine (04-11)  
 A6 (4F5/C6) Avant (05-11)  
 A6 Allroad (06-11)  
 A8 (03-09)



11.8116-0410.2 390589

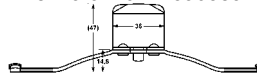

## SEAT

EXEO / ST (09-13)

11.0101-5409.2 260035 11.8171-0008.1 990049



# Abbildungen Bremssättel

Illustrations brake calipers - Illustrazioni pinze de freno - Illustrations Étriers de frein -  
 Ilustraciones pinzas de freno

11.9606-9961.2 220655   
 11.9606-9962.2 220656 



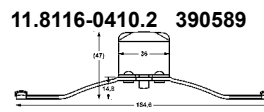

## AUDI

A4 (B6/B7) (01-08)  
 A4 Cabrio (02-08)  
 A6 (4F2/C6) Limousine (04-11)  
 A6 (4F5/C6) Avant (05-11)  
 A6 Allroad (06-11)



11.0101-5409.2 260035 11.8171-0008.1 990049



11.9606-9971.2 220589   
 11.9606-9972.2 220590 



## OPEL

SIGNUM (03-08)  
 Vauxhall Signum (03-08)  
 VECTRA C (F68,F69) (02-08)  
 Vauxhall Vectra MK II (02-08)  
 VECTRA C Caravan (F35) (03-08)  
 Vauxhall MK II (03-08)

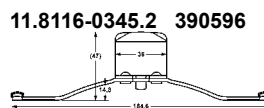



## SAAB

9-3 Limousine (YS3F) (03-12)  
 9-3 Sport Combi (05-12)  
 9-3 Cabriolet (YS3F) (03-12)  
 9-3 X (09-12)

11.0101-5407.2 260011 11.8171-0008.1 990049



13.2331-8007.2 210143   
 13.2331-8008.2 210144 



## FORD

ESCORT / ORION (91-94)  
 ESCORT VII (95-00)



# Abbildungen Bremssättel

Illustrations brake calipers - Illustrazioni pinze de freno - Illustrations Étriers de frein -  
 Ilustraciones pinzas de freno

13.2351-0013.2 210010 

13.2351-0014.2 210011 



## OPEL

ASTRA F (91-01)  
 Vauxhall Astra MKIII (91-01)  
 CALIBRA (89-97)  
 Vauxhall Calibra (89-97)  
 KADETT E / Vauxhall Astra E/Belmont (84-93)  
 VECTRA A / Vauxhall Cavalier (89-95)

## SAAB

900 (94-98)



13.0441-3506.2 250052

Dichtungssatz  
 gasket set

13.2351-0025.2 210210 

13.2351-0026.2 210211 



## OPEL

VECTRA B (96-02)  
 Vauxhall Vectra (96-02)

## SAAB

9-3 (YS3D) (98-02)  
 9-3 Cabriolet (YS3D) (98-03)  
 900 (94-98)



13.0441-3506.2 250052

Dichtungssatz  
 gasket set

13.2351-0051.2 210180 

13.2351-0052.2 210181 



## OPEL

VECTRA B / Vauxhall Vectra (96-02)



13.0441-3507.2 250053

Dichtungssatz  
 gasket set

# Abbildungen Bremssättel

Illustrations brake calipers - Illustrazioni pinze de freno - Illustrations Étriers de frein -  
Ilustraciones pinzas de freno

13.2351-8005.2 210014 

13.2351-8006.2 210015 



## MERCEDES BENZ

(W124) E-Klasse (85-93)  
(W201) 190-190 E 2,6 (82-93)  
C-Klasse (W202) Limousine (93-00)  
E-Klasse (W124) Limousine (93-95)  
E-Klasse (C124) Coupe (93-97)



13.0441-3505.2 250051

Dichtungssatz  
gasket set

13.2351-8017.2 210218 

13.2351-8018.2 210219 



## MERCEDES BENZ

C-Klasse (W202) Limousine (93-00)  
E-Klasse (W124) Limousine (93-95)

13.2351-8019.2 210139 

13.2351-8020.2 210140 



## MERCEDES BENZ

C-Klasse (W202) Limousine (93-00)



13.0441-3507.2 250053

Dichtungssatz  
gasket set

# Abbildungen Bremssättel

Illustrations brake calipers - Illustrazioni pinze de freno - Illustrations Étriers de frein -  
Ilustraciones pinzas de freno

13.2353-8003.2 210016 

13.2353-8004.2 210017 



ATE



## MERCEDES BENZ

(W108) 250 S-300 SEb (65-72)

(W109) 300 SEL (65-72)

(W111) 220-280 (59-71)



13.0441-3504.2 250050

Dichtungssatz  
gasket set

13.2361-8001.2 210214 

13.2361-8002.2 210215 



ATE



## MERCEDES BENZ

C-Klasse (W202) Limousine (93-00)

CLK-Klasse (C208) Coupe (97-02)

CLK-Klasse (A208) Cabrio (98-03)

E-Klasse (W210) Limousine (95-02)

SL-Klasse (R129) (93-01)



13.0441-3606.2 250147

Dichtungssatz  
gasket set

13.2361-8003.2 210220 

13.2361-8004.2 210221 



ATE



## MERCEDES BENZ

C-Klasse (W202) Limousine (93-00)

C-Klasse (S202) Kombi (96-01)

CLK-Klasse (C208) Coupe (97-02)

CLK-Klasse (A208) Cabrio (98-03)

E-Klasse (W210) Limousine (95-02)

SLK-Klasse (R170) (96-04)



13.0441-3609.2 250057

Dichtungssatz  
gasket set

# Abbildungen Bremssättel

Illustrations brake calipers - Illustrazioni pinze de freno - Illustrations Étriers de frein -  
 Ilustraciones pinzas de freno

13.2361-8005.2 210237 

13.2361-8006.2 210238 



## MERCEDES BENZ

E-Klasse (W210) Limousine (95-02)



13.0441-3609.2 250057

Dichtungssatz  
gasket set

13.2381-0039.2 210020 

13.2381-0040.2 210021 



## VOLVO

240 Limousine (74-93)  
 240 Kombi (74-93)  
 260 Limousine (74-82)  
 260 Kombi (75-82)  
 260 Coupe (77-78)



13.0441-3812.2 250068

Dichtungssatz  
gasket set

13.2381-0087.2 210149 

13.2381-0088.2 210150 



## VOLVO

740 Limousine (83-92)  
 740 Kombi (85-92)  
 760 Limousine (82-92)  
 760 Kombi (82-92)



13.0441-3819.2 250072

Dichtungssatz  
gasket set

## VOLVO

940 I Limousine (90-95)  
 940 I Kombi (90-95)  
 940 II Limousine (95-98)  
 940 II Kombi (95-98)  
 960 I Limousine (90-94)  
 960 I Kombi (90-94)

# Abbildungen Bremssättel

Illustrations brake calipers - Illustrazioni pinze de freno - Illustrations Étriers de frein -  
Ilustraciones pinzas de freno

13.2381-0097.2 210239 

13.2381-0098.2 210240 



ATE



Ø 38

## VOLVO

850 Limousine (91-96)  
850 Kombi (92-96)  
C70 Coupe (97-02)  
C70 I Cabrio (98-06)  
S70 (97-00)  
V70 I (97-00)



13.2381-8027.2 210033 

13.2381-8028.2 210034 



ATE



Ø 38

## MERCEDES BENZ

(R107) 280 SL-560 SL (71-89)  
(W114) 230.6-280 CE (67-76)  
(W115) 200-240 D 3,0 (67-76)  
(W116) 280 S-450 SEL 6,9 (72-80)  
(W123) 200-300 TD Turbo (76-85)  
(W126) 260 SE-560 SEC (80-91)



13.0441-3811.2 250067

Dichtungssatz  
gasket set

13.2381-8029.2 210035 

13.2381-8030.2 210036 



ATE



Ø 38

## MERCEDES BENZ

(R107) 280 SL-560 SL (71-89)  
(W114) 230.6-280 CE (67-76)  
(W115) 200-240 D 3,0 (67-76)  
(W116) 280 S-450 SEL 6,9 (72-80)  
(W126) 260 SE-560 SEC (80-91)



13.0441-3811.2 250067

Dichtungssatz  
gasket set



# Abbildungen Bremssättel

Illustrations brake calipers - Illustrazioni pinze de freno - Illustrations Étriers de frein -  
 Ilustraciones pinzas de freno

13.2381-8033.2 210222 

13.2381-8034.2 210223 



## MERCEDES BENZ

(W124) E-Klasse (85-93)  
 C-Klasse (W202) Limousine (93-00)  
 E-Klasse (W124) Limousine (93-95)  
 SL-Klasse (R129) (93-01)



13.0441-3817.2 250071

Dichtungssatz  
 gasket set

13.2381-8035.2 210037 

13.2381-8036.2 210038 



## MERCEDES BENZ

(R129) SL-Klasse (89-93)  
 (W124) E-Klasse (85-93)  
 (W201) 190-190 E 2,6 (82-93)  
 C-Klasse (W202) Limousine (93-00)  
 C-Klasse (S202) Kombi (96-01)  
 E-Klasse (W124) Limousine (93-95)  
 E-Klasse (S124) Kombi (93-96)

## MERCEDES BENZ

E-Klasse (C124) Coupe (93-97)  
 E-Klasse (A124) Cabrio (93-98)  
 E-Klasse (W210) Limousine (95-02)  
 SL-Klasse (R129) (93-01)  
 SLK-Klasse (R170) (96-04)



13.0441-3817.2 250071

Dichtungssatz  
 gasket set

13.2381-9996.2 210039 

13.2381-9997.2 210040 



## PORSCHE

911 (63-90)



13.0441-3801.2 250058

Dichtungssatz  
 gasket set



# Abbildungen Bremssättel

Illustrations brake calipers - Illustrazioni pinze de freno - Illustrations Étriers de frein -  
Ilustraciones pinzas de freno

13.2401-0027.2 210045 

13.2401-0028.2 210046 



ATE



Ø 40

## VOLVO

740 Limousine (83-92)  
740 Kombi (85-92)  
760 Limousine (82-92)  
760 Kombi (82-92)

## VOLVO

940 I Limousine (90-95)  
940 I Kombi (90-95)  
940 II Limousine (95-98)  
940 II Kombi (95-98)  
960 I Limousine (90-94)  
960 I Kombi (90-94)  
960 II Limousine (94-96)  
960 II Kombi (94-96)



13.2401-0039.2 210153 

13.2401-0040.2 210154 



ATE



Ø 40

## OPEL

OMEGA B / Vauxhall Omega (94-03)



13.0441-4022.2 250149

Dichtungssatz  
gasket set

13.2401-8007.2 210047 

13.2401-8008.2 210048 



ATE



Ø 40

## VOLKSWAGEN

KÄFER (TYP 1) (49-03)



13.0441-4002.2 250074 bis 07.72 verwenden - reuse up to 07.72  
Dichtungssatz  
gasket set

13.0441-4008.2 250076 ab 08.72 verwenden - reuse from 08.72  
Dichtungssatz  
gasket set

# Abbildungen Bremssättel

Illustrations brake calipers - Illustrazioni pinze de freno - Illustrations Étriers de frein -  
Ilustraciones pinzas de freno

13.2401-8013.2 210051 

13.2401-8014.2 210052 



## MERCEDES BENZ

E-Klasse (S210) Kombi (96-03)

S-Klasse (W140) (91-93)

S-Klasse (W140) (93-98)



13.0441-4020.2 250084

Dichtungssatz  
gasket set

13.2421-0026.2 210146 

13.2421-0025.2 210145 



## PORSCHE

911 (63-90)



13.0441-4206.2 250087

Dichtungssatz  
gasket set

13.2421-0043.2 210193 

13.2421-0044.2 210194 



## OPEL

OMEGA B / Vauxhall Omega (94-03)



13.0441-4216.2 250093

Dichtungssatz  
gasket set

# Abbildungen Bremssättel

Illustrations brake calipers - Illustrazioni pinze de freno - Illustrations Étriers de frein -  
Ilustraciones pinzas de freno

13.2421-8005.2 210053 

13.2421-8006.2 210054 



## BMW

2,5/2,8/3,0/3,3 (68-77)  
5er Reihe/E12 (72-81)



13.0441-4205.2 250086

Dichtungssatz  
gasket set

13.2421-8007.2 210055 

13.2421-8008.2 210056 



## BMW

2,5/2,8/3,0/3,3 (68-77)  
6er Reihe/E24 (76-89)



13.0441-4205.2 250086

Dichtungssatz  
gasket set

13.2421-8021.2 210057 

13.2421-8022.2 210058 



## MERCEDES BENZ

(W123) 200-300 TD Turbo (76-85)



13.0441-4206.2 250087

Dichtungssatz  
gasket set

# Abbildungen Bremssättel

Illustrations brake calipers - Illustrazioni pinze de freno - Illustrations Étriers de frein -  
 Ilustraciones pinzas de freno

13.2421-8025.2 210061 

13.2421-8026.2 210062 



ATE



Ø 42



## MERCEDES BENZ

(R129) SL-Klasse (89-93)  
 (W124) E-Klasse (85-93)  
 C-Klasse (W202) Limousine (93-00)  
 C-Klasse (S202) Kombi (96-01)  
 C-Klasse (S203) Kombi (01-07)  
 CLK-Klasse (C208) Coupe (97-02)  
 CLK-Klasse (A208) Cabrio (98-03)

## MERCEDES BENZ

E-Klasse (W124) Limousine (93-95)  
 E-Klasse (W210) Limousine (95-02)  
 Limousine (95-02)  
 SL-Klasse (R129) (93-01)  
 SLK-Klasse (R170) (96-04)



13.0441-4216.2 250093

Dichtungssatz  
 gasket set

13.2423-8009.2 210063 

13.2423-8010.2 210064 



ATE



Ø 42



## MERCEDES BENZ

(R113) 230 SL-280 SL (63-71)  
 (W108) 250 S-300 SEb (65-72)  
 (W109) 300 SEL (65-72)  
 (W111) 220-280 (59-71)



13.0441-4206.2 250087

Dichtungssatz  
 gasket set

13.2461-8001.2 210226 

13.2461-8002.2 210227 



ATE



Ø 46



## MERCEDES BENZ

CL-Klasse (C140) Coupe (96-99)  
 E-Klasse (S210) Kombi (96-03)  
 S-Klasse (W140) (91-93)  
 S-Klasse (W140) (93-98)  
 S-Klasse (W220) (98-06)



13.0441-4601.2 250099

Dichtungssatz  
 gasket set

# Abbildungen Bremssättel

Illustrations brake calipers - Illustrazioni pinze de freno - Illustrations Étriers de frein -  
Ilustraciones pinzas de freno

13.2481-0075.2 210081 

13.2481-0076.2 210082 



ATE



## PORSCHE

911 (63-90)



13.0441-4819.2 250104

Dichtungssatz  
gasket set

13.2481-8011.2 210092 

13.2481-8012.2 210093 



ATE



## BMW

3er Reihe/E21 (75-83)



13.0441-4825.2 250107

Dichtungssatz  
gasket set

13.2481-8013.2 210094 

13.2481-8014.2 210095 



ATE

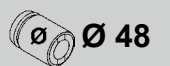

## BMW

3er Reihe/E21 (75-83)

## STEYR DAIMLER PUCH

CITY-BUS (82-92)



13.0441-4825.2 250107

Dichtungssatz  
gasket set



# Abbildungen Bremssättel

Illustrations brake calipers - Illustrazioni pinze de freno - Illustrations Étriers de frein -  
Ilustraciones pinzas de freno

13.2481-8067.2 210098 

13.2481-8068.2 210099 



## PORSCHE

911 (63-90)



13.0441-4819.2 250104

Dichtungssatz  
gasket set

13.2481-9999.2 210103 

13.2481-9998.2 210102 



## PORSCHE

911 (63-90)  
914/6 (70-73)



13.0441-4815.2 250102

Dichtungssatz  
gasket set

13.2541-8002.2 210111 

13.2541-8001.2 210110 



## VOLKSWAGEN

TRANSPORTER (Typ 2) (60-79)  
TRANSPORTER (Typ 2) (79-92)



13.0441-5416.2 250117

Dichtungssatz  
gasket set



# Abbildungen Bremssättel

Illustrations brake calipers - Illustrazioni pinze de freno - Illustrations Étriers de frein -  
 Ilustraciones pinzas de freno

13.2544-0019.2 210251 

13.2544-0020.2 210252 



## MERCEDES BENZ

UNIMOG (BM 427) 1000-1650  
 UNIMOG (BM 437) 1350-2450  
 UNIMOG 20 (BM 405.050) (07-)  
 UNIMOG 300-400 (BM 405.1) (00-)  
 UNIMOG 3000-5000 (BM 437.4) (02-)

13.2571-8011.2 210121 

13.2571-8012.2 210122 



## MERCEDES BENZ

(W108) 250 S-300 SEb (65-72)  
 (W109) 300 SEL (65-72)  
 (W111) 220-280 (59-71)



13.0441-5718.2 250120

Dichtungssatz  
 gasket set

13.2571-8013.2 210123 

13.2571-8014.2 210124 



## MERCEDES BENZ

(R107) 280 SL-560 SL (71-89)



13.0441-5718.2 250120

Dichtungssatz  
 gasket set

# Abbildungen Bremssättel

Illustrations brake calipers - Illustrazioni pinze de freno - Illustrations Étriers de frein -  
Ilustraciones pinzas de freno

13.2571-8023.2 210127 

13.2571-8024.2 210128 



## MERCEDES BENZ

(W126) 260 SE-560 SEC (80-91)



13.0441-5724.2 250125

Dichtungssatz  
gasket set

13.2571-8027.2 210129 

13.2571-8028.2 210130 



## VOLKSWAGEN

LT/- 4x4 (75-96)



13.0441-5720.2 250122

Dichtungssatz  
gasket set

13.2571-9998.2 210133 

13.2571-9999.2 210134 



## MERCEDES BENZ

(R113) 230 SL-280 SL (63-71)  
(W108) 250 S-300 SEb (65-72)  
(W109) 300 SEL (65-72)  
(W110) 190 c-230 (61-68)  
(W111) 220-280 (59-71)  
(W114) 230.6-280 CE (67-76)  
(W115) 200-240 D 3,0 (67-76)



13.0441-5718.2 250120

Dichtungssatz  
gasket set

# Abbildungen Bremssättel

Illustrations brake calipers - Illustrazioni pinze de freno - Illustrations Étriers de frein -  
Ilustraciones pinzas de freno

13.2601-0145.2 210247 

13.2601-0146.2 210248 



## MERCEDES BENZ

UNIMOG (BM 427) 1000-1650  
UNIMOG (BM 437) 1350-2450  
UNIMOG 20 (BM 405.050) (07-)  
UNIMOG 300-400 (BM 405.1) (00-)  
UNIMOG 3000-5000 (BM 437.4) (02-)

13.2601-7015.2 210230 

13.2601-7016.2 210231 



## MERCEDES BENZ

MB-TRAC (BM 441) 1000  
UNIMOG (BM 403) 54/66/72/800  
UNIMOG (BM 406) 65/70/80/84/900  
UNIMOG (BM 413) 72/80/800 L  
UNIMOG (BM 416) 80/90/100/110/1100/1100 L  
UNIMOG (BM 417) 800-1150  
UNIMOG (BM 424) 1000/1200  
UNIMOG (BM 427) 1000-1650  
UNIMOG (BM 435) 435/1300 L/1700/1700 L

## MERCEDES BENZ

UNIMOG (BM 436) 1300/1700  
UNIMOG (BM 437) 1350-2450



13.0441-6012.2 250133 03.3518-6100.2 390364 03.3518-8000.2 390373

Dichtungssatz  
gasket set

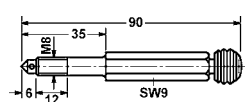
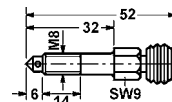

13.2601-8025.2 210157 

13.2601-8026.2 210158 



## MERCEDES BENZ

(W116) 280 S-450 SEL 6,9 (72-80)



13.0441-6001.2 250126

Dichtungssatz  
gasket set

# Abbildungen Bremssättel

Illustrations brake calipers - Illustrazioni pinze de freno - Illustrations Étriers de frein -  
Ilustraciones pinzas de freno

13.2601-8027.2 210159 

13.2601-8028.2 210160 



## MERCEDES BENZ

(R107) 280 SL-560 SL (71-89)



13.0441-6001.2 250126

Dichtungssatz  
gasket set

13.2601-8029.2 210161 

13.2601-8030.2 210162 



## MERCEDES BENZ

(W123) 200-300 TD Turbo (76-85)



13.0441-6003.2 250128

Dichtungssatz  
gasket set

13.2601-8031.2 210163 

13.2601-8032.2 210164 



## MERCEDES BENZ

(W126) 260 SE-560 SEC (80-91)



13.0441-6003.2 250128

Dichtungssatz  
gasket set

# Abbildungen Bremssättel

Illustrations brake calipers - Illustrazioni pinze de freno - Illustrations Étriers de frein -  
 Ilustraciones pinzas de freno

13.2601-8034.2 210166 

13.2601-8033.2 210165 



## MERCEDES BENZ

(R107) 280 SL-560 SL (71-89)



13.0441-6003.2 250128

Dichtungssatz  
gasket set

13.2601-8035.2 210167 

13.2601-8036.2 210168 



## MERCEDES BENZ

MB-TRAC (BM 441) 1000  
 UNIMOG (BM 403) 54/66/72/800  
 UNIMOG (BM 406) 65/70/80/84/900  
 UNIMOG (BM 413) 72/80/800 L  
 UNIMOG (BM 416) 80/90/100/110/1100/1100 L  
 UNIMOG (BM 417) 800-1150  
 UNIMOG (BM 424) 1000/1200  
 UNIMOG (BM 427) 1000-1650  
 UNIMOG (BM 435) 435/1300 L/1700/1700 L

## MERCEDES BENZ

UNIMOG (BM 436) 1300/1700  
 UNIMOG (BM 437) 1350-2450



13.0441-6012.2 250133 03.3518-6100.2 390364 03.3518-8000.2 390373

Dichtungssatz  
gasket set

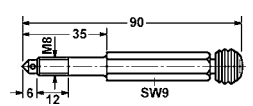
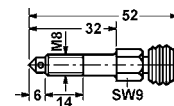

13.2601-8037.2 210169 

13.2601-8038.2 210170 



## MERCEDES BENZ

MB-TRAC (BM 440) 65/70/700/800/900  
 MB-TRAC (BM 441) 1000  
 UNIMOG (BM 403) 54/66/72/800  
 UNIMOG (BM 406) 65/70/80/84/900  
 UNIMOG (BM 413) 72/80/800 L  
 UNIMOG (BM 416) 80/90/100/110/1100/1100 L  
 UNIMOG (BM 417) 800-1150 / UNIMOG (BM 424) 1000/1200  
 UNIMOG (BM 427) 1000-1650  
 UNIMOG (BM 435) 435/1300 L/1700/1700 L

## MERCEDES BENZ

UNIMOG (BM 436) 1300/1700  
 UNIMOG (BM 437) 1350-2450



13.0441-6012.2 250133 03.3518-6100.2 390364 03.3518-8000.2 390373

Dichtungssatz  
gasket set

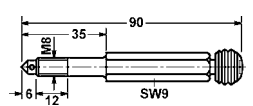
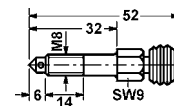



# Abbildungen Bremssättel

Illustrations brake calipers - Illustrazioni pinze de freno - Illustrations Étriers de frein -  
Ilustraciones pinzas de freno

13.2601-9996.2 210176 

13.2601-9997.2 210177 



ATE



## MERCEDES BENZ

(W114) 230.6-280 CE (67-76)

(W115) 200-240 D 3,0 (67-76)



13.0441-6001.2 250126

Dichtungssatz  
gasket set

13.4341-8002.2 210152 

13.4341-8001.2 210151 



ATE



## BMW

1502 - 2002 (65-77)



13.0441-3401.2 250044

Dichtungssatz  
gasket set

13.4401-8021.2 210189 

13.4401-8022.2 210190 



ATE



## BMW

1502 - 2002 (65-77)

2,5/2,8/3,0/3,3 (68-77)

5er Reihe/E12 (72-81)



13.0441-4018.2 250083

Dichtungssatz  
gasket set



# Abbildungen Bremssättel

Illustrations brake calipers - Illustrazioni pinze de freno - Illustrations Étriers de frein -  
Ilustraciones pinzas de freno

13.4401-8027.2 210191 

13.4401-8028.2 210192 



## MERCEDES BENZ

(R107) 280 SL-560 SL (71-89)



13.0441-4016.2 250081

Dichtungssatz  
gasket set

13.4421-8009.2 210228 

13.4421-8010.2 210229 



## MERCEDES BENZ

C-Klasse (W202) Limousine (93-00)  
CLK-Klasse (C208) Coupe (97-02)  
E-Klasse (W210) Limousine (95-02)  
E-Klasse (S210) Kombi (96-03)



13.0441-4214.2 250091

Dichtungssatz  
gasket set

13.4441-8017.3 210203 

13.4441-8018.3 210204 



## MERCEDES BENZ

Transporter (BM 602) 307 D-310 D  
Transporter (BM 611) 407 D-410 D  
Transporter (BM 667) 507 D-510



13.0441-4408.2 250096

Dichtungssatz  
gasket set

# Abbildungen Bremssättel

Illustrations brake calipers - Illustrazioni pinze de freno - Illustrations Étriers de frein -  
 Ilustraciones pinzas de freno

13.4571-0019.3 210249 

13.4571-0020.3 210250 

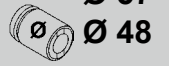

## MERCEDES BENZ

UNIMOG (BM 425) 120/150/1300/1500  
 UNIMOG (BM 427) 1000-1650  
 UNIMOG (BM 435) 435/1300 L/1700/1700 L  
 UNIMOG (BM 436) 1300/1700  
 UNIMOG (BM 437.1) 1350-2450  
 UNIMOG 3000-5000 (BM 437.4) (02-)



13.0441-5721.2 250123

Dichtungssatz  
 gasket set

13.4571-8005.3 210205 

13.4571-8006.3 210206 

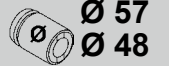

## MERCEDES BENZ

UNIMOG (BM 425) 120/150/1300/1500  
 UNIMOG (BM 435) 435/1300 L/1700/1700 L



13.0441-5721.2 250123

Dichtungssatz  
 gasket set

13.4574-8005.3 210207 

13.4574-8006.3 210208 

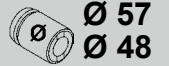

## MERCEDES BENZ

UNIMOG (BM 425) 120/150/1300/1500  
 UNIMOG (BM 427) 1000-1650  
 UNIMOG (BM 435) 435/1300 L/1700/1700 L  
 UNIMOG (BM 436) 1300/1700  
 UNIMOG (BM 437) 1350-2450  
 UNIMOG 3000-5000 (BM 437.4) (02-)



13.0441-5721.2 250123

Dichtungssatz  
 gasket set

# Abbildungen Bremssättel

Illustrations brake calipers - Illustrazioni pinze de freno - Illustrations Étriers de frein -  
Ilustraciones pinzas de freno

13.9361-0023.2 210241 

13.9361-0024.2 210242 



## MERCEDES BENZ

C-Klasse (W203) Limousine (00-07)  
C-Klasse (S203) Kombi (01-07)  
C-Klasse (CL203) Sportcoupe (01-08)  
C-Klasse (CLC203) Coupe (08-10)  
CLK-Klasse (C209) Coupe (02-09)  
CLK-Klasse (A209) Cabrio (03-09) / SLK-Klasse (R171) (04-11)



13.0441-3609.2 250057

Dichtungssatz  
gasket set

13.9361-0035.2 210253 

13.9361-0036.2 210254 



## MERCEDES BENZ

C-Klasse (W203) Limousine (00-07)  
C-Klasse (S203) Kombi (01-07)  
C-Klasse (CL203) Sportcoupe (01-08)  
C-Klasse (CLC203) Coupe (08-10)  
CLK-Klasse (C209) Coupe (02-09)  
CLK-Klasse (A209) Cabrio (03-09) / SLK-Klasse (R171) (04-11)



13.0441-3609.2 250057

Dichtungssatz  
gasket set

20.5154-9449.2 220461 

20.5154-9450.2 220462 



## FIAT

FIORINO (93-01)

# Abbildungen Bremssättel

Illustrations brake calipers - Illustrazioni pinze de freno - Illustrations Étriers de frein -  
Ilustraciones pinzas de freno

24.3301-1703.7 220683 

24.3301-1704.7 220684 



LUC



Ø 30



## MERCEDES BENZ

A-Klasse (W169 ) (04-11)

B-Klasse (W245) (05-11)

24.3331-0037.5 240547 

24.3331-0038.5 240548 



ATE



Ø 33



## PEUGEOT

406 Limousine (95-04)

406 Kombi (96-04)

406 Coupe (97-05)



11.0441-3305.2 250006

Dichtungssatz  
gasket set

24.3331-1701.7 220611 

24.3331-1702.7 220612 



BOS



Ø 33





## MERCEDES BENZ

V-Klasse (BM638) (96-03)

VITO (BM638) (96-03)

# Abbildungen Bremssättel

Illustrations brake calipers - Illustrazioni pinze de freno - Illustrations Étriers de frein -  
 Ilustraciones pinzas de freno

24.3331-8501.5 240509   
 24.3331-8502.5 240510 





## BMW

3er Reihe/E30 (82-93)  
 5er Reihe/E28 (81-87)  
 6er Reihe/E24 (76-89)  
 7er Reihe/E23 (77-86)

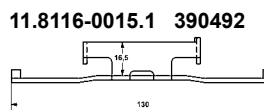

11.0441-3302.2 250004 11.0101-5402.2 260009 11.8171-0008.1 990049  
 Dichtungssatz - gasket set



24.3341-9991.5 240511   
 24.3341-9992.5 240512 



## BMW

3er Reihe/E36 (91-00)



11.0441-3401.2 250151 11.0101-5402.2 260009 11.8171-0008.1 990049  
 Dichtungssatz - gasket set

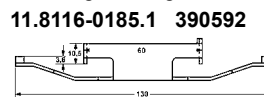

24.3344-1703.5 240117   
 24.3344-1704.5 240118 



## ALFA ROMEO

145 (94-01) / 146 (94-01)  
 155 (92-97) / SPIDER (95-05)

## FIAT

BARCETTA (95-04)



24.0101-3601.2 260044



## FIAT

BRAVO (95-01) / COUPE (94-00)  
 TEMPRA (90-93) / TEMPRA (93-96)  
 TIPO (88-93) / TIPO (93-95)

## LANCIA

DEDRA (90-93) / DEDRA (94-99)  
 DELTA (94-99)



# Abbildungen Bremssättel

Illustrations brake calipers - Illustrazioni pinze de freno - Illustrations Étriers de frein -  
Ilustraciones pinzas de freno

24.3344-1705.5 240273 

24.3344-1706.5 240274 



## FORD

FOCUS I (98-04)

24.3344-1707.7 220531 

24.3344-1708.7 220532 



## RENAULT

MEGANE I Grandtour (KA\_) (98-03)

MEGANE SCENIC (JA\_) (96-99)

SCENIC I (JA\_) (99-03)

24.3344-1709.7 220537 

24.3344-1710.7 220538 



## AUDI

A2 (00-05)

## SEAT

CORDOBA III (6L2) (02-09)

IBIZA IV (6L1) (02-10)

IBIZA V / ST / SPORTCOUPE (08-)

## VOLKSWAGEN

POLO IV (02-09)



# Abbildungen Bremssättel

Illustrations brake calipers - Illustrazioni pinze de freno - Illustrations Étriers de frein -  
Ilustraciones pinzas de freno

24.3344-1711.7 220539 

24.3344-1712.7 220540 



LUC



Ø 34





## SEAT

AROSA (6H) (97-05)  
CORDOBA III (6L2) (02-09)  
IBIZA III (6K1) (99-02)

## VOLKSWAGEN

LUPO (98-05)  
POLO III (95-01)  
POLO Classic (96-01)

24.3344-1713.7 220559 

24.3344-1714.7 220560 



LUC



Ø 34



## OPEL

ASTRA G / Vauxhall Astra MKIV (98-04)

24.3344-1715.5 240327 

24.3344-1716.5 240328 



LUC



Ø 34



## ALFA ROMEO

145 (94-01)  
146 (94-01)

## FIAT

MAREA (96-02)

# Abbildungen Bremssättel

Illustrations brake calipers - Illustrazioni pinze de freno - Illustrations Étriers de frein -  
Ilustraciones pinzas de freno

24.3344-1717.5 240341 

24.3344-1718.5 240342 



LUC



Ø 34



## NISSAN

ALMERA (N16) (00-06)

PRIMERA (P11E) Limousine (96-02)

24.3344-1719.5 240343 

24.3344-1720.5 240344 



Ø 34



## NISSAN

ALMERA (N15) (95-00)

ALMERA (N16) (00-06)

24.3347-1703.7 220685 

24.3347-1704.7 220686 



LUC



Ø 34



## RENAULT

CLIO III (BR\_/CR\_) (05-12)

CLIO III Grandtour (KR\_) (08-12)

MODUS/GRAND MODUS (JP0\_) (04-13)

# Abbildungen Bremssättel

Illustrations brake calipers - Illustrazioni pinze de freno - Illustrations Étriers de frein -  
Ilustraciones pinzas de freno

24.3354-1701.5 240347 

24.3354-1702.5 240348 



AKE





## MAZDA

323 Limousine/323 F/323 P/323 S (98-03)

626 Kombi (98-02)

PREMACY (99-05)

24.3361-8503.5 240513 

24.3361-8504.5 240514 



ATE



## BMW

3er Reihe/E36 (91-00)

Z1 (88-91)





11.0441-3602.2 250008  
Dichtungssatz - gasket set

11.8116-0066.1 390557

11.0101-5402.2 260009

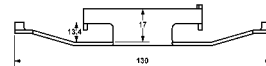
11.8171-0008.1 990049



24.3361-9975.5 240541 

24.3361-9976.5 240542 



ATE

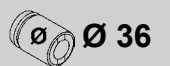

## CITROEN

EVASION (94-02)

## FIAT

ULYSSE (94-02)

## LANCIA

ZETA (94-02)

## PEUGEOT

806 (94-02)



11.0441-3602.2 250008  
Dichtungssatz - gasket set

11.8116-0073.1 390498

11.0101-5407.2 260011

11.8171-0008.1 990049



# Abbildungen Bremssättel

Illustrations brake calipers - Illustrazioni pinze de freno - Illustrations Étriers de frein -  
 Ilustraciones pinzas de freno

24.3364-1605.5 240011 

24.3364-1606.5 240012 



LUC



Ø 36



## VOLKSWAGEN

GOLF II (84-93)  
 JETTA II (84-92)



24.0101-3601.2 260044

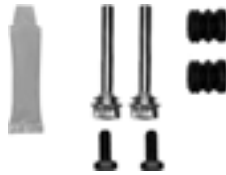

## VOLKSWAGEN

PASSAT Limousine (85-88)  
 PASSAT Variant (85-88)  
 SCIROCCO II (84-92)

24.3367-1501.7 220271 

24.3367-1502.7 220272 



BDX



Ø 36



## RENAULT

ESPACE I (J/S 11\_) (84-90)  
 ESPACE II (J/S 63\_) (91-96)  
 FUEGO (80-85)  
 R18 Limousine (78-86)  
 R18 Variable (79-86)  
 R25 (84-92)  
 R30 (75-84)

24.3367-1707.7 220669 

24.3367-1708.7 220670 



LUC



Ø 36





## OPEL

ASTRA H / GTC / Vauxhall Astra Mk V (04-10)  
 ASTRA H Caravan/Vau. Astra MKV Estate (04-10)  
 ASTRA TWIN TOP (06-10)  
 MERIVA A / Vauxhall Meriva A (03-10)

# Abbildungen Bremssättel

Illustrations brake calipers - Illustrazioni pinze de freno - Illustrations Étriers de frein -  
 Ilustraciones pinzas de freno

24.3381-8503.5 240515   
 24.3381-8504.5 240516 



## BMW

5er Reihe/E34 (88-96)  
 7er Reihe/E32 (86-94)



11.0441-3803.2 250010 11.0101-5402.2 260009 11.8171-0008.1 990049  
 Dichtungssatz - gasket set  
 11.8116-0066.1 390557

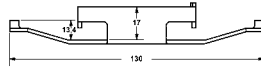

24.3381-9959.5 240517   
 24.3381-9960.5 240518 



## BMW

3er Reihe/E36 (91-00)



11.0441-3803.2 250010 11.0101-5402.2 260009 11.8171-0008.1 990049  
 Dichtungssatz - gasket set  
 11.8116-0066.1 390577

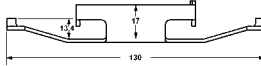

24.3381-9961.5 240519   
 24.3381-9962.5 240520 



## BMW

3er Reihe/E36 (91-00)



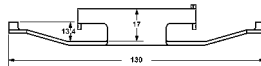

11.0441-3803.2 250010 11.0101-5402.2 260009 11.8171-0008.1 990049  
 Dichtungssatz - gasket set  
 11.8116-0066.1 390577





# Abbildungen Bremssättel

Illustrations brake calipers - Illustrazioni pinze de freno - Illustrations Étriers de frein -  
 Ilustraciones pinzas de freno

24.3384-1601.5 240013   
 24.3384-1602.5 240014 



## AUDI

80 (87-91)  
 90 (87-91)



24.0101-3601.2 260044

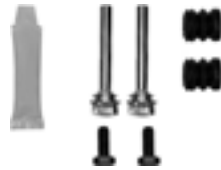

## AUDI

100 (83-90)  
 100 (91-94)  
 CABRIO (91-00)  
 COUPE (89-96)

24.3384-1603.5 240015   
 24.3384-1604.5 240016 



## AUDI

200 (84-91)



24.0101-3601.2 260044

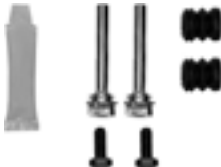

## SEAT

CORDOBA I (93-99)  
 IBIZA II (93-99)  
 TOLEDO I (1L) (91-98)

## VOLKSWAGEN

CORRADO (88-95)  
 GOLF II (84-93)  
 GOLF III (92-97)  
 JETTA II (84-92)  
 PASSAT Variant (85-88)  
 PASSAT (88-93)  
 VENTO (92-98)

24.3384-1605.5 240295   
 24.3384-1606.5 240296 



## PEUGEOT

405 (87-92)  
 405 (93-95)



# Abbildungen Bremssättel

Illustrations brake calipers - Illustrazioni pinze de freno - Illustrations Étriers de frein -  
Ilustraciones pinzas de freno

24.3384-1607.5 240167 

24.3384-1608.5 240168 



## ALFA ROMEO

164 (87-91)

164 (92-98)

## FIAT

CROMA (85-90)

CROMA (91-96)

## LANCIA

THEMA (92-94)

24.3384-1701.5 240169 

24.3384-1702.5 240170 



## AUDI

80 (91-95)

24.3384-1703.5 240055 

24.3384-1704.5 240056 



## AUDI

80 Quattro (87-91)

90 Quattro (87-91)

## AUDI

100 Quattro (85-90)

100 Quattro (91-94)

200 Quattro (85-91)

A6 / A6 Avant (4A/C4) (94-97)

A8 (94-02)

COUPE Quattro (87-96)



24.0101-3601.2 260044



# Abbildungen Bremssättel

Illustrations brake calipers - Illustrazioni pinze de freno - Illustrations Étriers de frein -  
Ilustraciones pinzas de freno

24.3384-1707.5 240171 

24.3384-1708.5 240172 



LUC



Ø 38



**FORD**  
GALAXY I (95-06)

**SEAT**  
ALHAMBRA I (96-10)  
CORDOBA I (93-99)



24.0101-3601.2 260044

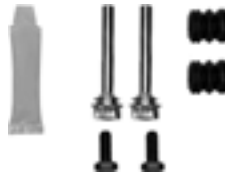

**SEAT**  
IBIZA II (93-99)  
TOLEDO I (1L) (91-98)

**VOLKSWAGEN**  
CORRADO (88-95)  
GOLF III (92-97)  
GOLF III Variant (93-99)  
GOLF III Cabriolet (94-02)  
PASSAT (88-93)  
PASSAT (94-96)  
SHARAN I (95-10)  
VENTO (92-98)

24.3384-1709.5 240257 

24.3384-1710.5 240258 



LUC



Ø 38



**AUDI**  
100 (91-94)  
A6 / A6 Avant (4A/C4) (94-97)  
CABRIO (91-00)  
COUPE (89-96)

24.3384-1713.5 240431 

24.3384-1714.5 240432 



BOS



Ø 38



**FORD**  
MONDEO III (00-07)

# Abbildungen Bremssättel

Illustrations brake calipers - Illustrazioni pinze de freno - Illustrations Étriers de frein -  
Ilustraciones pinzas de freno

24.3384-1715.5 240265 

24.3384-1716.5 240266 



LUC



Ø 38



## FORD

GALAXY I (95-06)

## SEAT

ALHAMBRA I (96-10)

## VOLKSWAGEN

SHARAN I (95-10)

TRANSPORTER (T4) (90-03)

24.3384-1717.5 240267 

24.3384-1718.5 240268 



LUC



Ø 38



## VOLKSWAGEN

TRANSPORTER (T4) (90-03)

24.3384-1719.5 240259 

24.3384-1720.5 240260 



LUC



Ø 38



## AUDI

A4 (B5) (95-01)

# Abbildungen Bremssättel

Illustrations brake calipers - Illustrazioni pinze de freno - Illustrations Étriers de frein -  
Ilustraciones pinzas de freno

24.3384-1721.5 240255 

24.3384-1722.5 240256 



LUC



Ø 38



## VOLVO

S40 I (95-03)

V40 (95-04)

24.3384-1723.7 220523 

24.3384-1724.7 220524 



LUC



Ø 38



## AUDI

A3 (96-03)

TT Coupe (98-06)

TT Roadster (99-06)

## SEAT

CORDOBA I (93-99) / CORDOBA

II (6K2) (99-02)

IBIZA II (93-99)

IBIZA III (6K1) (99-02)

TOLEDO II (1M2) (98-04)

## SKODA

OCTAVIA I (1U) (97-10)

## VOLKSWAGEN

GOLF III Cabriolet (94-02)

GOLF IV (98-03)

NEW BEETLE (98-10)

POLO Variant (97-01)

24.3384-1725.5 240261 

24.3384-1726.5 240262 



LUC



Ø 38



## AUDI

A4 (B5) (95-01)

# Abbildungen Bremssättel

Illustrations brake calipers - Illustrazioni pinze de freno - Illustrations Étriers de frein - Ilustraciones pinzas de freno

24.3384-1727.7 220533 

24.3384-1728.7 220534 



## ALFA ROMEO

156 (97-05)

166 (98-07)

24.3384-1729.7 220541 

24.3384-1730.7 220542 



## AUDI

A3 (96-03)

TT Coupe (98-06)

TT Roadster (99-06)

## SKODA

FABIA I (6Y) (99-07)

FABIA II (5J) (07-)

ROOMSTER (5J) (06-)

## SEAT

CORDOBA III (6L2) (02-09)

IBIZA IV (6L1) (02-10)

LEON I (1M1) (99-05)

TOLEDO II (1M2) (98-04)

## VOLKSWAGEN

GOLF IV (98-03)

NEW BEETLE (98-10)

NEW BEETLE Cabriolet (03-10)

POLO IV (02-09)

24.3384-1731.7 220543 

24.3384-1732.7 220544 



## AUDI

A4 (B5) (95-01)

A6 / A6 Avant (4B/C5) (97-05)

## SKODA

SUPERB I (02-08)

## VOLKSWAGEN

PASSAT (97-05)



# Abbildungen Bremssättel

Illustrations brake calipers - Illustrazioni pinze de freno - Illustrations Étriers de frein -  
Ilustraciones pinzas de freno

24.3384-1733.7 220545 

24.3384-1734.7 220546 



LUC



Ø 38



## AUDI

A6 / A6 Avant (4B/C5) (97-05)  
A6 Allroad (00-05)

## VOLKSWAGEN

PASSAT (97-05)

24.3384-1735.7 220547 

24.3384-1736.7 220548 



LUC



Ø 38





## AUDI

A4 (B6/B7) (01-08)  
A4 Cabrio (02-08)

## SEAT

EXEO / ST (09-13)

24.3384-1737.5 240301 

24.3384-1738.5 240302 



LUC



Ø 38



## SEAT

CORDOBA I (93-99)  
IBIZA II (93-99)

## VOLKSWAGEN

POLO III (95-01)  
POLO Classic (96-01)



# Abbildungen Bremssättel

Illustrations brake calipers - Illustrazioni pinze de freno - Illustrations Étriers de frein -  
Ilustraciones pinzas de freno

24.3384-1741.7 220599 

24.3384-1742.7 220600 



## ALFA ROMEO

147 (01-10)

156 (97-05)

GT (04-)

## FIAT

LINEA (07-11)

## LANCIA

LYBRA (99-05)

24.3384-1743.5 240319 

24.3384-1744.5 240320 



## MITSUBISHI

CARISMA (95-06)

SPACE STAR (98-06)

## VOLVO

S40 I (95-03)

V40 (95-04)

24.3384-1745.7 220609 

24.3384-1746.7 220610 



## AUDI

A3 (96-03)

TT Coupe (98-06)

TT Roadster (99-06)

## SEAT

LEON I (1M1) (99-05)

TOLEDO II (1M2) (98-04)

## VOLKSWAGEN

BORA (98-04)

GOLF IV (98-03)

GOLF IV Variant (99-06)

NEW BEETLE (98-10)

# Abbildungen Bremssättel

Illustrations brake calipers - Illustrazioni pinze de freno - Illustrations Étriers de frein -  
Ilustraciones pinzas de freno

24.3384-1753.7 220633 

24.3384-1754.7 220634 



LUC



Ø 38



## OPEL

ASTRA G / Vauxhall Astra MKIV (98-04)  
MERIVA A / Vauxhall Meriva Mk I (03-10)  
ZAFIRA I / Vauxhall Zafira I (99-05)

24.3384-1755.7 220635 

24.3384-1756.7 220636 



LUC



Ø 38



## AUDI

A3 / A3 Sportback (03-13)  
A3 Cabrio (08-13)

## SEAT

ALTEA (5P1) (04-)  
ALTEA XL (5P5) (06-)  
LEON II (1P1) (05-12)  
TOLEDO III (5P2) (05-09)

## SKODA

OCTAVIA II (1Z) (04-13)  
YETI (09-)

## VOLKSWAGEN

EOS (06-)  
GOLF V (03-08)  
GOLF VI (08-)  
GOLF VI Cabriolet (11-)  
GOLF Plus (05-)  
SCIROCCO (08-)  
JETTA VI (11-)  
BEETLE (11-)  
BEETLE Cabriolet (12-)  
SCIROCCO (08-)

24.3384-1761.7 220671 

24.3384-1762.7 220672 



LUC



Ø 38



## CITROEN

C8 (02-)

## FIAT

ULYSSE (02-11)

## LANCIA

PHEDRA (02-10)

## PEUGEOT

807 (02-)

# Abbildungen Bremssättel

Illustrations brake calipers - Illustrazioni pinze de freno - Illustrations Étriers de frein - Ilustraciones pinzas de freno

24.3387-1701.7 220673 

24.3387-1702.7 220674 



## OPEL

ASTRA H / GTC / Vauxhall Astra Mk V (04-10)  
 ASTRA H Caravan/Vauxhall Astra MKV Estate (04-10)  
 ASTRA TWIN TOP (06-10)  
 COMBO / Vauxhall Combo (01-11)  
 MERIVA A / Vauxhall Meriva A (03-10)

24.3387-1705.7 220675 

24.3387-1706.7 220676 

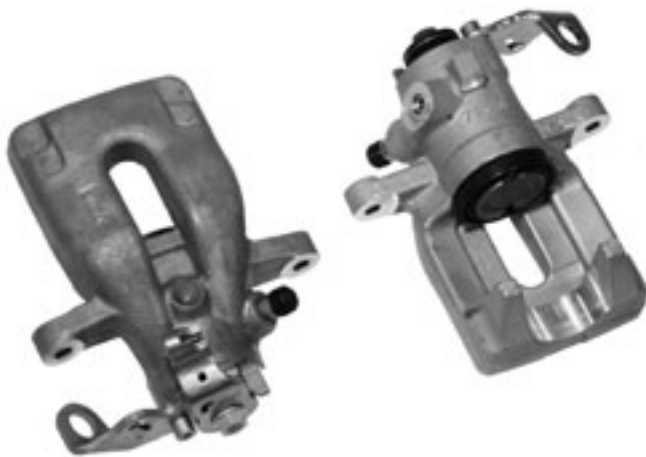



## CITROEN

C2 (03-09)  
 C3 (02-09)  
 C3 II (09-)  
 C3 Pluriel (03-10)

## PEUGEOT

1007 (05-11)

24.3401-8503.5 240521 

24.3401-8504.5 240522 



## BMW

5er Reihe/E34 (88-96)



11.0441-4002.2 250011 11.0101-5402.2 260009 11.8171-0008.1 990049  
 Dichtungssatz - gasket set

11.8116-0066.1 390557

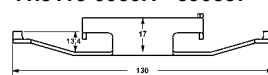

# Abbildungen Bremssättel

Illustrations brake calipers - Illustrazioni pinze de freno - Illustrations Étriers de frein -  
 Ilustraciones pinzas de freno

24.3401-9977.5 240523 

24.3401-9978.5 240524 



ATE



Ø 40



## BMW

7er Reihe/E38 (93-01)



11.0441-4003.2 250001  
 Dichtungssatz - gasket set

11.8116-0094.1 390504

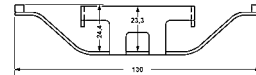



11.0101-5402.2 260009



11.8171-0008.1 990049



24.3411-1701.5 240361 

24.3411-1702.5 240362 



AKE



Ø 41



## OPEL

FRONTERA A (92-98)  
 FRONTERA B (98-04)  
 MONTEREY (92-98)  
 MONTEREY (98-99)

24.3414-1703.7 220535 

24.3414-1704.7 220536 



LUC



Ø 41



## SEAT

TOLEDO II (1M2) (98-04)

## SKODA

OCTAVIA I (1U) (97-10)

## VOLKSWAGEN

BORA (98-04)  
 GOLF IV Variant (99-06)

# Abbildungen Bremssättel

Illustrations brake calipers - Illustrazioni pinze de freno - Illustrations Étriers de frein -  
Ilustraciones pinzas de freno

24.3414-1705.7 220549 

24.3414-1706.7 220550 



LUC



Ø 41



## AUDI

A3 (96-03)  
TT Coupe (98-06)  
TT Roadster (99-06)

## VOLKSWAGEN

BORA (98-04)  
GOLF IV (98-03)  
GOLF IV Variant (99-06)

## SEAT

LEON I (1M1) (99-05)  
TOLEDO II (1M2) (98-04)

## SKODA

OCTAVIA I (1U) (97-10)

24.3414-1711.7 220677 

24.3414-1712.7 220678 



LUC



Ø 41



## VOLKSWAGEN

TRANSPORTER (T5) BUS / MULTIVAN / KASTEN (03-)  
TRANSPORTER (T5) PRITSCHKE / FAHRGESTELL (03-)

24.3417-1701.7 220679 

24.3417-1702.7 220680 



LUC



Ø 41



## VOLKSWAGEN

CADDY III (04-)



# Abbildungen Bremssättel

Illustrations brake calipers - Illustrazioni pinze de freno - Illustrations Étriers de frein - Ilustraciones pinzas de freno

24.3421-9979.5 240475   
24.3421-9980.5 240476 



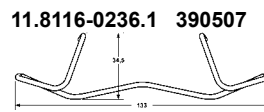

## VOLVO

S60 (00-09)  
S80 I (98-06)  
V70 II (00-07)  
XC70 I CROSS COUNTRY (00-07)



11.0101-5407.2 260011 11.8171-0008.1 990049



24.3424-1701.5 240561   
24.3424-1702.5 240562 



## NISSAN

INTERSTAR (X70) (02-)

## OPEL

MOVANO A (98-10)

## RENAULT

MASTER II Bus (JD/ND\_) (98-06)  
MASTER II Kasten (FD\_) (98-06)  
MASTER II Pritsche/Fahrgestell (ED/HD/UD\_) (98-06)  
MASTER III Bus (JD\_) (06-10)  
MASTER III Kasten (FD\_) (06-10)  
MASTER III Pritsche/Fahrgestell (ED/HD/UD\_) (06-10)

24.3431-1705.5 240365   
24.3431-1706.5 240366 

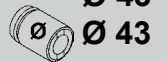

## HYUNDAI

GALLOPER (98-03)

## MITSUBISHI

L 200 (92-96)  
L 200 (96-06)  
L 400 (96-02)  
PAJERO (90-00)  
PAJERO SPORT / MONTERO (USA) (98-09)  
SPACE GEAR (95-00)



# Abbildungen Bremssättel

Illustrations brake calipers - Illustrazioni pinze de freno - Illustrations Étriers de frein - Ilustraciones pinzas de freno

24.3434-1601.5 240019 

24.3434-1602.5 240020 





## FORD

SCORPIO / GRANADA (GB) (85-91)  
 SCORPIO / GRANADA (GB) (95-98)  
 SIERRA (82-86)  
 SIERRA (87-92)

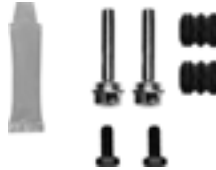

24.0101-4301.2 260047



24.3434-1701.5 240357 

24.3434-1702.5 240358 



## AUDI

100 (83-90)  
 100 Quattro (85-90)  
 100 Quattro (91-94)  
 200 Quattro (85-91)  
 A6 / A6 Avant (4A/C4) (94-97)  
 QUATTRO (80-91)  
 V8 (88-94)





24.3441-1701.5 240331 

24.3441-1702.5 240332 



## MERCEDES BENZ

Transporter (BM 901/902) SPRINTER (95-06) 

Transporter (BM 903/904) SPRINTER (95-06) 

Transporter (BM 905) SPRINTER (01-06) 

## VOLKSWAGEN

LT/- 4x4 (96-06) 



# Abbildungen Bremssättel

Illustrations brake calipers - Illustrazioni pinze de freno - Illustrations Étriers de frein -  
 Ilustraciones pinzas de freno

24.3451-1501.5 240263 

24.3451-1502.5 240264 



BDX





Ø 45



## RENAULT

CLIO I Limousine (B/C 57\_) (90-98)  
 CLIO I Kasten (S 57\_) (91-98)  
 EXPRESS/RAPID (F40\_) (85-98)  
 R5 SUPER (85-96)

24.3451-1711.5 240251 

24.3451-1712.5 240252 



BDX





Ø 45



## RENAULT

TWINGO I Limousine (C06\_) (93-07)  
 TWINGO I Kasten (S06\_) (93-07)

24.3481-0705.5 240021 

24.3481-0706.5 240022 



DEL



Ø 48



## OPEL

CORSA A / Vauxhall Nova (83-92)  
 KADETT D / Vauxhall Astra D (79-84)  
 KADETT E / Vauxhall Astra E/Belmont (84-93)



24.0101-4801.2 990131



# Abbildungen Bremssättel

Illustrations brake calipers - Illustrazioni pinze de freno - Illustrations Étriers de frein -  
Ilustraciones pinzas de freno

24.3481-0707.5 240023 

24.3481-0708.5 240024 



DEL



Ø 48

## OPEL

ASCONA C / Vauxhall Cavalier (82-88)  
CORSA A / Vauxhall Nova (83-92)  
KADETT D / Vauxhall Astra D (79-84)  
KADETT E / Vauxhall Astra E/Belmont (84-93)



24.0101-4801.2 990131



24.3481-1505.5 240047 

24.3481-1506.5 240048 



BDX



Ø 48

## RENAULT

CLIO I Limousine (B/C 57\_) (90-98)  
CLIO I Kasten (S 57\_) (91-98)  
EXPRESS/RAPID (F40\_) (85-98) / R5 SUPER (85-96)  
R19 (3/5-türig) (B53/C53/S53\_) (88-95)  
R19 CHAMADE (L53\_) (89-95)



24.0101-4803.2 260049



24.3481-1607.5 240211 

24.3481-1608.5 240212 



LUC



Ø 48

## BMW

3er Reihe/E30 (82-93)  
Z1 (88-91)



# Abbildungen Bremssättel

Illustrations brake calipers - Illustrazioni pinze de freno - Illustrations Étriers de frein -  
Ilustraciones pinzas de freno

24.3481-1609.7 220197 

24.3481-1610.7 220198 



## CITROEN

C15 (84-)  
VISA (78-89)  
ZX (N2) Limousine (91-97)

## PEUGEOT

205 (83-90)  
205 (91-98)  
309 (85-93)

24.3481-1611.5 240029 

24.3481-1612.5 240030 



## DACIA

LOGAN Limousine (LS\_) (04-13)  
SANDERO (08-13)





24.0101-4807.2 260053



## RENAULT

CLIO I (90-98) / CLIO II (98-)  
EXPRESS/RAPID (F40\_) (85-98)  
LOGAN (LS\_) (04-13)  
LOGAN Kombi (KS\_) (04-13)  
MEGANE I (96-02)  
R5 SUPER(85-96) / R9(82-89) / R11(83-89)  
R19 (3/5-türig) (B53/C53/S53\_) (88-95)  
R19 CHAMADE (L53\_) (89-95)  
R21 Limousine (B48/L48\_) (86-93)  
THALIA (LB\_) (98-)  
THALIA II / SYMBOL (LU\_) (08-)  
TWINGO I Limousine (C06\_) (93-06)  
TWINGO I Kasten (S06\_) (93-07)  
TWINGO II (CN0\_) (07-)

24.3481-1615.5 240031 

24.3481-1616.5 240032 



## CITROEN

ZX (N2) Limousine (91-97)  
ZX (N2) Kombi (93-98)

## DACIA

LOGAN Limousine (LS\_) (04-13)  
LOGAN MCV Kombi (KS\_) (07-13)  
SANDERO (08-13)



24.0101-4806.2 260052



## PEUGEOT

205 (83-98) / 309 (85-93)

## RENAULT

CLIO I Limousine (B/C 57\_) (90-98) / CLIO I Kasten (S 57\_) (91-98)  
CLIO II Limousine (BB\_/CB\_) (98-05) / CLIO II Kasten (SB\_) (98-05)  
LOGAN (LS\_) (04-)  
LOGAN Kombi (KS\_) (04-)  
MEGANE I Limousine 3/5-türig (BA/SA\_) (96-02)  
MEGANE I Classic (LA\_) (96-02) / MEGANE I Coach (DA\_) (95-03)  
MEGANE I Cabrio (EA\_) (96-03) / MEGANE I Grandtour (KA\_) (98-03)  
MEGANE SCENIC (JA\_) (96-99)  
R5 SUPER (85-96) / R9 (82-89) / R11 (83-89) / R19 (88-95)  
R19 Cabriolet (D53\_) (91-96) / R21 Limousine (B48/L48\_) (86-93)  
R21 NEVADA (K48\_) (86-95) / THALIA I (LB\_) (98-)  
THALIA II / SYMBOL (LU\_) (08-)  
TWINGO I Limousine (C06\_) (93-06)  
TWINGO II (CN0\_) (07-)

# Abbildungen Bremssättel

Illustrations brake calipers - Illustrazioni pinze de freno - Illustrations Étriers de frein -  
 Ilustraciones pinzas de freno

24.3481-1703.5 240051 

24.3481-1704.5 240052 



## FIAT

PUNTO (93-00)  
 TEMPRA (90-93)  
 TIPO (88-93)  
 UNO (90-95)

## LANCIA

Y (96-03)



24.0101-4301.2 260047

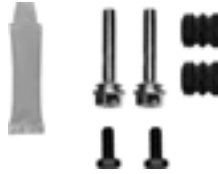

24.3481-1707.5 240073 

24.3481-1708.5 240074 





## PEUGEOT

405 (87-92)  
 405 (93-95)

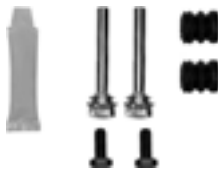

24.0101-3601.2 260044



24.3481-1725.5 240187 

24.3481-1726.5 240188 



## NISSAN

100 NX (B13) (90-94)  
 SUNNY (N14) Limousine (90-95)



# Abbildungen Bremssättel

Illustrations brake calipers - Illustrazioni pinze de freno - Illustrations Étriers de frein -  
 Ilustraciones pinzas de freno

24.3481-1733.5 240213 

24.3481-1734.5 240214 





## OPEL

ASTRA F / Vauxhall Astra MKIII (91-01)  
 CORSA A / Vauxhall Nova (83-92)  
 CORSA B / Vauxhall Corsa (93-00)

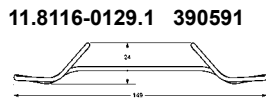

11.0441-4811.2 250024 11.0101-5407.2 260011 11.8171-0008.1 990049  
 Dichtungssatz - gasket set



24.3481-1735.5 240283 

24.3481-1736.5 240284 

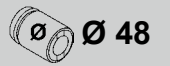

## SEAT

AROSA (6H) (97-05)

## SKODA

FABIA I (6Y) (99-07)  
 FABIA II (5J) (07-)

## VOLKSWAGEN

FOX (05-)  
 LUPO (98-05)  
 POLO III (95-01)  
 POLO IV (02-09)



11.0441-4808.2 250022 11.0101-4801.2 260006 24.0102-4801.2 260085  
 Dichtungssatz gasket set

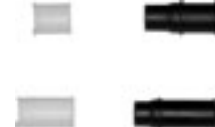

24.3481-1739.5 240243 

24.3481-1740.5 240244 



## PEUGEOT

206 Limousine (98-09)



# Abbildungen Bremssättel

Illustrations brake calipers - Illustrazioni pinze de freno - Illustrations Étriers de frein -  
Ilustraciones pinzas de freno

24.3481-1741.5 240245 

24.3481-1742.5 240246 



BOS



Ø 48





## CITROEN

XSARA (N1) Limousine (97-05)  
XSARA (N0) Coupe (97-05)

## PEUGEOT

206 Limousine (98-09)  
306 Limousine (3/5-türig) (93-01)  
306 Limousine (4-türig) (94-01)

24.3481-1743.5 240305 

24.3481-1744.5 240306 



BDX



Ø 48





## FIAT

CINQUECENTO (92-98)  
PANDA (03-13)  
PUNTO (93-00)  
PUNTO (00-03)  
SEICENTO (98-08)

## LANCIA

Y (96-03)

24.3481-1745.5 240277 

24.3481-1746.5 240278 



ATE



Ø 48



## SEAT

CORDOBA I (93-99)  
IBIZA II (93-99)  
IBIZA III (6K1) (99-02)

## VOLKSWAGEN

DERBY/POLO Stufenheck (77-88)  
GOLF II (84-93)  
JETTA II (84-92)  
POLO II (81-94)  
POLO Classic (96-01)  
POLO Variant (97-01)



11.0441-4808.2 250022  
Dichtungssatz - gasket set



11.0101-4803.2 260008

24.0102-4803.2 260086



# Abbildungen Bremssättel

Illustrations brake calipers - Illustrazioni pinze de freno - Illustrations Étriers de frein -  
 Ilustraciones pinzas de freno

24.3481-1749.5 240281   
 24.3481-1750.5 240282 

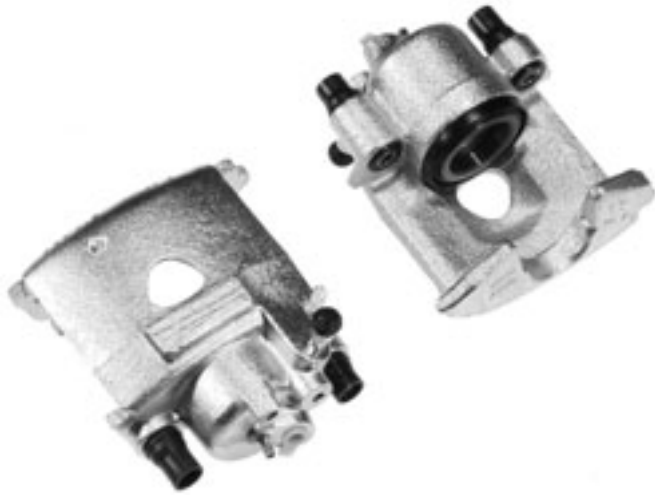

## VOLKSWAGEN

POLO III (95-01)



11.0441-4808.2 250022 11.0101-4801.2 260006 24.0102-4801.2 260085  
 Dichtungssatz - gasket set



24.3481-1751.5 240285   
 24.3481-1752.5 240286 



## FIAT

PUNTO (93-00)  
 PUNTO (00-03)  
 PUNTO (03-06)

## LANCIA

Y (96-03)

24.3481-1755.5 240297   
 24.3481-1756.5 240298 



## RENAULT

LAGUNA I Limousine (B56/556\_) (93-00)

# Abbildungen Bremssättel

Illustrations brake calipers - Illustrazioni pinze de freno - Illustrations Étriers de frein -  
Ilustraciones pinzas de freno

24.3481-1757.5 240325 

24.3481-1758.5 240326 



BOS



Ø 48

## OPEL

AGILA / Vauxhall Agila Mk I (00-07)

## SUZUKI

WAGON R+ (00-08)



24.3481-1759.5 240339 

24.3481-1759.5 240339 



BDX



Ø 48

Ø 48

## MERCEDES BENZ

Transporter (BM 631) MB 100 D (87-96)



24.3481-1761.5 240393 

24.3481-1762.5 240394 



LUC



Ø 48

## CITROEN

C2 (03-09)

C3 (02-09)



# Abbildungen Bremssättel

Illustrations brake calipers - Illustrazioni pinze de freno - Illustrations Étriers de frein -  
Ilustraciones pinzas de freno

24.3481-1763.5 240367 

24.3481-1764.5 240368 





AKE



**NISSAN**

MICRA (K11E) (92-02)

24.3481-1765.5 240369 

24.3481-1766.5 240370 



LUC



**OPEL**

CORSA C / Vauxhall Corsa MK II (00-06)

24.3481-1767.5 240371 

24.3481-1768.5 240372 



LUC



**OPEL**

CORSA C / Vauxhall Corsa MK II (00-06)

# Abbildungen Bremssättel

Illustrations brake calipers - Illustrazioni pinze de freno - Illustrations Étriers de frein -  
Ilustraciones pinzas de freno

24.3481-1769.5 240373 

24.3481-1770.5 240374 



BOS



## PEUGEOT

206 Limousine (98-09)

206 SW (02-07)

206 PLUS (09-)

24.3481-1771.5 240375 

24.3481-1772.5 240376 



BOS



## PEUGEOT

206 Limousine (98-09)

206 SW (02-07)

206 PLUS (09-)

24.3481-1773.5 240377 

24.3481-1774.5 240378 



## CHEVROLET

MATIZ (05-)

SPARK (05-10)

## DAEWOO

MATIZ (98-05)



# Abbildungen Bremssättel

Illustrations brake calipers - Illustrazioni pinze de freno - Illustrations Étriers de frein -  
 Ilustraciones pinzas de freno

24.3481-8515.5 240477 

24.3481-8516.5 240478 



ATE



Ø 48



## FORD

FIESTA IV (96-02)  
 KA I (96-08)

## MAZDA

121 (96-03)

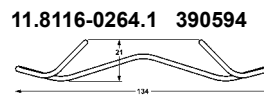



11.8116-0264.1 390594

11.0101-5407.2 260011

11.8171-0008.1 990049



24.3481-9833.5 240479 

24.3481-9834.5 240480 



ATE



Ø 48



## CITROEN

SAXO (96-04)  
 XSARA (N1) Limousine (97-05)  
 XSARA (N2) Kombi (97-05)  
 XSARA (N0) Coupe (97-05)

## PEUGEOT

106 (91-96)  
 106 (96-04)  
 205 (91-98)  
 306 Lim. (3/5-türig) (93-01)  
 306 Lim. (4-türig) (94-01)  
 306 Cabriolet (94-03)  
 306 Kombi (97-02)

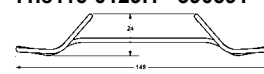

11.0441-4811.2 250024  
 Dichtungssatz - gasket set

11.8116-0129.1 390591

11.0101-5407.2 260011

11.8171-0008.1 990049



11.0230-0081.2 260038

24.3511-1709.5 240333 

24.3511-1710.5 240334 



Ø 51



## HONDA

CIVIC (3/4-türig) (95-01)  
 CIVIC COUPE (96-01)  
 LOGO (99-02)



# Abbildungen Bremssättel

Illustrations brake calipers - Illustrazioni pinze de freno - Illustrations Étriers de frein -  
Ilustraciones pinzas de freno

24.3511-1711.5 240379 

24.3511-1712.5 240380 



## TOYOTA

YARIS (99-05)  
YARIS VERSO (99-05)

24.3521-1701.5 240001 

24.3521-1702.5 240002 



ATE



## CHEVROLET

LANOS (05-)

## DAEWOO

ESPERO (95-99)  
LANOS (97-02)  
NEXIA (95-97)

## OPEL

ASCONA C / Vauxhall Cavalier (82-88)  
ASTRA F / Vauxhall Astra MKIII (91-01)  
CALIBRA / Vauxhall Calibra (89-97)  
KADETT E / Vauxhall Astra E/Belmont (84-93)  
VECTRA A / Vauxhall Cavalier (89-95)  
VECTRA B / Vauxhall Vectra (96-02)



11.0441-5202.2 250026  
Dichtungssatz gasket set

11.8116-0097.1 390590

11.0101-5407.2 260011

11.8171-0008.1 990049

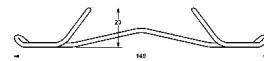

24.3521-1707.5 240471 

24.3521-1708.5 240472 



BOS



## MERCEDES BENZ

Transporter (BM 901/902) SPRINTER (95-06)  
Transporter (BM 903/904) SPRINTER (95-06)



## VOLKSWAGEN

LT/LT 4x4 (96-06)



# Abbildungen Bremssättel

Illustrations brake calipers - Illustrazioni pinze de freno - Illustrations Étriers de frein -  
Ilustraciones pinzas de freno

24.3521-7001.5 240481   
24.3521-7002.5 240482 



## OPEL

ASTRA G / Vauxhall Astra MKIV (98-04)

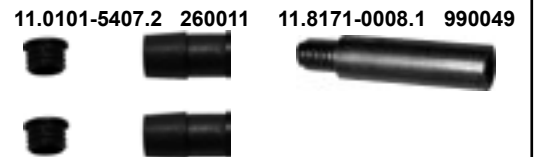

24.3541-1603.5 240037   
24.3541-1604.5 240038 



## MERCEDES BENZ

(W124) E-Klasse (85-93)  
(W201) 190-190 E 2,6 (82-93)

## MERCEDES BENZ

E-Klasse (W124) Limousine (93-95)  
E-Klasse (S124) Kombi (93-96)  
E-Klasse (C124) Coupe (93-97)  
E-Klasse (A124) Cabrio (93-98)

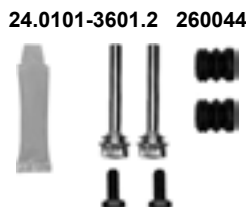

24.3541-1609.5 240039   
24.3541-1610.5 240040 



## AUDI

80 (87-95) / 80 Quattro (78-91)  
90 (85-91) / 90 Quattro (84-87)  
100 (83-90)  
COUPE (81-96) / COUPE Quattro (85-87)

## SEAT

CORDOBA I (93-99)  
CORDOBA II (6K2) (99-02)  
IBIZA II (93-99) / IBIZA III (6K1) (99-02)  
INCA (6K9) (96-03)  
TOLEDO I (1L) (91-98)

## VOLKSWAGEN

CADDY II (96-03) / CORRADO (88-95)  
GOLF II (84-93) / GOLF III (92-97)  
GOLF III Variant (93-99)  
GOLF III Cabriolet (94-02)  
JETTA II (84-92)  
PASSAT Limousine (85-88)  
PASSAT Variant (85-88)  
PASSAT (88-96)  
POLO Classic (96-01)  
POLO Variant (97-01)  
SCIROCCO II (84-92)  
VENTO (92-98)



# Abbildungen Bremssättel

Illustrations brake calipers - Illustrazioni pinze de freno - Illustrations Étriers de frein -  
 Ilustraciones pinzas de freno

24.3541-1617.7 220227 

24.3541-1618.7 220228 



## MERCEDES BENZ

C-Klasse (W202) Limousine (93-00)

24.3541-1625.5 240045 

24.3541-1626.5 240046 



## RENAULT

ESPACE I (J/S 11\_) (84-90)  
 ESPACE II (J/S 63\_) (91-96)  
 FUEGO (80-85)

## RENAULT

R18 Limousine (78-86)  
 R18 Variable (79-86)  
 R20 (76-84)  
 R21 Limousine (B48/L48\_) (86-93)  
 R21 NEVADA (K48\_) (86-95)  
 R25 (84-92)  
 R30 (75-84)



24.0101-5404.2 260062



24.3541-1631.5 240413 

24.3541-1632.5 240414 



## MERCEDES BENZ

(W201) 190-190 E 2,6 (82-93)





11.0441-5404.2 250029 11.0101-5403.2 260010  
 Dichtungssatz - gasket set



# Abbildungen Bremssättel

Illustrations brake calipers - Illustrazioni pinze de freno - Illustrations Étriers de frein -  
 Ilustraciones pinzas de freno

24.3541-1701.5 240005   
 24.3541-1702.5 240006 



## FORD

FIESTA (76-89)  
 FIESTA III (89-96)



11.0441-5402.2 250028

Dichtungssatz  
 gasket set

11.0101-5407.2 260011

11.8171-0008.1 990049



24.3541-1705.5 240111   
 24.3541-1706.5 240112 



## TOYOTA

COROLLA (92-97)



24.0101-5405.2 260063



24.3541-1707.5 240067   
 24.3541-1708.5 240068 



## FORD

ESCORT / ORION (91-94)  
 ESCORT VII (95-00)





24.0101-5401.2 260059



# Abbildungen Bremssättel

Illustrations brake calipers - Illustrazioni pinze de freno - Illustrations Étriers de frein -  
Ilustraciones pinzas de freno

24.3541-1723.5 240077 

24.3541-1724.5 240078 



## VOLVO

440 (88-96)

460 (88-96)

480 (86-96)



24.0101-3601.2 260044

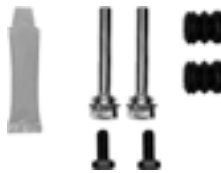

24.3541-1725.5 240003 

24.3541-1726.5 240004 



## MERCEDES BENZ

(W124) E-Klasse (85-93)

E-Klasse (W124) Limousine (93-95)

E-Klasse (S124) Kombi (93-96)



24.0101-3601.2 260044

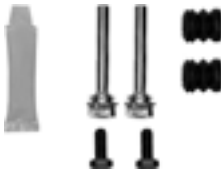

24.3541-1731.5 240061 

24.3541-1732.5 240062 



## SEAT

CORDOBA I (93-99)

CORDOBA II (6K2) (99-02)

IBIZA III (6K1) (99-02)

TOLEDO I (1L) (91-98)



24.0101-4301.2 260047



## VOLKSWAGEN

CORRADO (88-95)

GOLF II (84-93)

GOLF III (92-97)

PASSAT (88-93)

PASSAT (94-96)

VENTO (92-98)



# Abbildungen Bremssättel

Illustrations brake calipers - Illustrazioni pinze de freno - Illustrations Étriers de frein -  
Ilustraciones pinzas de freno

24.3541-1737.5 240197 

24.3541-1738.5 240198 



LUC



Ø 54

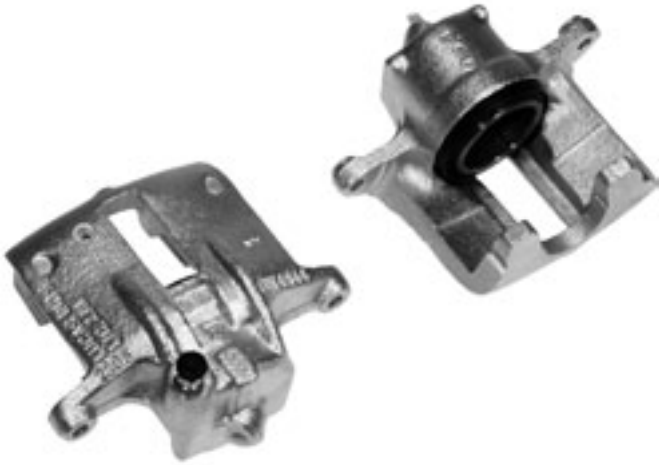



## SKODA

FELICIA I (791/795) (95-97)  
FELICIA II (6U) (98-01)  
FELICIA PICK-UP (797) (97-00)

## VOLKSWAGEN

CADDY Pickup (97-02)

24.3541-1739.5 240223 

24.3541-1740.5 240224 



LUC





Ø 54



## VOLKSWAGEN

GOLF III (92-97)  
GOLF III Variant (93-99)  
GOLF III Cabriolet (94-02)  
VENTO (92-98)

24.3541-1741.5 240215 

24.3541-1742.5 240216 



LUC



Ø 54



## RENAULT

LAGUNA I Limousine (B56/556\_) (93-00)  
LAGUNA I Grandtour (K56\_) (95-00)  
MEGANE I Limousine 3/5-türig (BA/SA\_) (96-02)  
MEGANE I Coach (DA\_) (95-03)  
MEGANE I Cabrio (EA\_) (96-03)  
MEGANE SCENIC (JA\_) (96-99)  
SAFRANE (B54\_) (92-00)



# Abbildungen Bremssättel

Illustrations brake calipers - Illustrazioni pinze de freno - Illustrations Étriers de frein -  
Ilustraciones pinzas de freno

24.3541-1743.5 240219 

24.3541-1744.5 240220 



LUC



Ø 54



**AUDI**

80 (91-95)

24.3541-1745.5 240217 

24.3541-1746.5 240218 



LUC



Ø 54



**AUDI**

A4 (B5) (95-01)

24.3541-1747.5 240221 

24.3541-1748.5 240222 



LUC



Ø 54





**FIAT**

CROMA (85-90)  
TEMPRA (93-96)  
TIPO (93-95)

# Abbildungen Bremssättel

Illustrations brake calipers - Illustrazioni pinze de freno - Illustrations Étriers de frein -  
Ilustraciones pinzas de freno

24.3541-1749.5 240427 

24.3541-1750.5 240428 



LUC



Ø 54



## RENAULT

CLIO II Limousine (BB\_/CB\_) (98-05)  
ESPACE III (JE\_) (96-02)  
LAGUNA I Limousine (B56/556\_) (93-00)  
LAGUNA I Grandtour (K56\_) (95-00)  
MEGANE I Limousine 3/5-türig (BA/SA\_) (96-02)  
MEGANE I Classic (LA\_) (96-02)  
MEGANE I Coach (DA\_) (95-03)  
MEGANE I Cabrio (EA\_) (96-03)  
MEGANE I Grandtour (KA\_) (98-03)  
MEGANE SCENIC (JA\_) (96-99)  
SCENIC I (JA\_) (99-03)

24.3541-1751.7 220477 

24.3541-1752.7 220478 



LUC



Ø 54



## MERCEDES BENZ

C-Klasse (W202) Limousine (93-00)  
C-Klasse (S202) Kombi (96-01)

24.3541-1753.7 220479 

24.3541-1754.7 220480 



LUC



Ø 54



## MERCEDES BENZ

A-Klasse (W168) (97-04)

# Abbildungen Bremssättel

Illustrations brake calipers - Illustrazioni pinze de freno - Illustrations Étriers de frein -  
Ilustraciones pinzas de freno

24.3541-1755.7 220481 

24.3541-1756.7 220482 



LUC



Ø 54



## MERCEDES BENZ

C-Klasse (W202) Limousine (93-00)

24.3541-1757.7 220483 

24.3541-1758.7 220484 



LUC



Ø 54



## CITROEN

BERLINGO (MF) Kombi (96-08)  
BERLINGO (M\_) Kasten (96-08)  
XSARA (N1) Limousine (97-05)  
XSARA (N2) Kombi (97-05)  
XSARA (N0) Coupe (97-05)  
XSARA Picasso (N68) (00-)

## PEUGEOT

306 Cabriolet (94-03)  
306 Kombi (97-02)  
PARTNER Kombi (96-08)  
PARTNER Kasten (96-08)

## PEUGEOT

306 Limousine (3/5-türig) (93-01)  
306 Limousine (4-türig) (94-01)

24.3541-1759.7 220491 

24.3541-1760.7 220492 



LUC



Ø 54





## MERCEDES BENZ

A-Klasse (W168) (97-04)

# Abbildungen Bremssättel

Illustrations brake calipers - Illustrazioni pinze de freno - Illustrations Étriers de frein -  
Ilustraciones pinzas de freno

24.3541-1761.5 240233 

24.3541-1762.5 240234 



BOS



Ø 54





## CITROEN

BERLINGO (MF) Kombi (96-08)  
C3 (02-09)  
C4 I Limousine (LC\_) (04-10)  
C4 I Coupe (04-10)  
XSARA (N1) Limousine (97-05)  
XSARA (N2) Kombi (97-05)  
XSARA (N0) Coupe (97-05)  
XSARA Picasso (N68) (00-)

## PEUGEOT

207 Limousine (06-12)  
207 CC (07-)  
207 SW (07-)  
307 Limousine (00-07)  
307 Break (02-08)  
307 CC (03-09)  
307 SW (02-08)  
1007 (05-01)  
PARTNER Kombi (96-08)  
PARTNER Kasten (96-08)

24.3541-1763.5 240231 

24.3541-1764.5 240232 



LUC



Ø 54



## AUDI

A4 (B5) (95-01)  
A4 (B6/B7) (01-08)

## SEAT

EXEO / ST (09-13)

## VOLKSWAGEN

PASSAT (97-05)

24.3541-1765.5 240235 

24.3541-1766.5 240236 



BOS



Ø 54



## NISSAN

KUBISTAR (X76) Kombi (03-09)

## RENAULT

KANGOO I (KC\_) (98-07)  
KANGOO Express/Rapid (FC\_) (98-07)

# Abbildungen Bremssättel

Illustrations brake calipers - Illustrazioni pinze de freno - Illustrations Étriers de frein -  
 Ilustraciones pinzas de freno

24.3541-1767.5 240237 

24.3541-1768.5 240238 



BOS



Ø 54





## CITROEN

XSARA (N1) Limousine (97-05)  
 XSARA (N2) Kombi (97-05)  
 XSARA (N0) Coupe (97-05)

## PEUGEOT

206 Limousine (98-09)  
 206 CC (00-07)  
 306 Limousine (3/5-türig) (93-01)  
 306 Limousine (4-türig) (94-01)  
 306 Cabriolet (94-03)  
 306 Kombi (97-02)

24.3541-1771.5 240239 

24.3541-1772.5 240240 



BOS



Ø 54



## CITROEN

BERLINGO (MF) Kombi (96-08)  
 BERLINGO (M\_) Kasten (96-08)  
 C2 (03-09)  
 C3 (02-09)  
 C3 II (09-)  
 C3 Picasso (09-)  
 C4 I Limousine (LC\_) (04-10)  
 C4 I Coupe (04-10)  
 C-ELYSEE (12-) / DS 3 (09-)  
 XSARA (N1) Limousine (97-05)  
 XSARA (N2) Kombi (97-05)  
 XSARA (N0) Coupe (97-05)  
 XSARA Picasso (N68) (00-)

## PEUGEOT

206 Limousine (98-09)  
 206 CC (00-07)  
 206 SW (02-07)  
 207 Limousine (06-12)  
 207 SW (07-)  
 208 (12-) / 301 (12-)  
 307 Limousine (00-07)  
 307 Break (02-08)  
 307 SW (02-08)  
 1007 (05-11) / 2008 (13-)  
 PARTNER Kombi (96-08)  
 PARTNER Kasten (96-08)

24.3541-1775.7 220529 

24.3541-1776.7 220530 



LUC



Ø 54



## VOLKSWAGEN

TRANSPORTER (T4) (90-03)



# Abbildungen Bremssättel

Illustrations brake calipers - Illustrazioni pinze de freno - Illustrations Étriers de frein -  
Ilustraciones pinzas de freno

24.3541-1777.5 240247 

24.3541-1778.5 240248 



LUC



Ø 54





## CITROEN

BERLINGO (MF) Kombi (96-08)  
BERLINGO (M\_) Kasten (96-08)

## PEUGEOT

PARTNER Kombi (96-08)  
PARTNER Kasten (96-08)

24.3541-1779.5 240249 

24.3541-1780.5 240250 



LUC



Ø 54





## SEAT

AROSA (6H) (97-05)

## VOLKSWAGEN

LUPO (98-05)  
POLO III (95-01)

24.3541-1783.5 240269 

24.3541-1784.5 240270 



LUC



Ø 54



## MITSUBISHI

CARISMA (95-06)  
SPACE STAR (98-06)

## VOLVO

S40 I (95-03)  
V40 (95-04)



# Abbildungen Bremssättel

Illustrations brake calipers - Illustrazioni pinze de freno - Illustrations Étriers de frein -  
Ilustraciones pinzas de freno

24.3541-1785.5 240271 

24.3541-1786.5 240272 



LUC



Ø 54



## mitsubishi

CARISMA (95-06)

## VOLVO

S40 I (95-03)

V40 (95-04)

24.3541-1787.5 240289 

24.3541-1788.5 240290 



ATE



Ø 54



## FIAT

BRAVA (95-01)

BRAVO (95-01)

MAREA (96-02)

PUNTO (00-03)

PUNTO (03-06)

24.3541-1789.5 240291 

24.3541-1790.5 240292 



ATE



Ø 54



## ALFA ROMEO

145 (94-01)

146 (94-01)

## FIAT

BARCETTA (95-04)

BRAVA (95-01)

BRAVO (95-01)

MAREA (96-02)

PUNTO (00-03)

PUNTO (03-06)

# Abbildungen Bremssättel

Illustrations brake calipers - Illustrazioni pinze de freno - Illustrations Étriers de frein -  
Ilustraciones pinzas de freno

24.3541-1791.5 240293 

24.3541-1792.5 240294 



ATE



Ø 54



## ALFA ROMEO

145 (94-01)  
146 (94-01)  
SPIDER (95-05)

## FIAT

BRAVO (95-01)  
COUPE (94-00)  
MAREA (96-02)  
MULTIPLA (98-08)

## LANCIA

LYBRA (99-05)

24.3541-1793.5 240299 

24.3541-1794.5 240300 



BOS



Ø 54



## ALFA ROMEO

147 (01-10)  
156 (97-05)

24.3541-1795.7 220551 

24.3541-1796.7 220552 



LUC



Ø 54



## OPEL

COMBO / Vauxhall Combo (01-11)  
CORSA C / Vauxhall Corsa MK II (00-06)  
MERIVA A / Vauxhall Meriva A (03-10)  
TIGRA TWIN TOP / Vauxhall Tigra Twin Top (04-09)

# Abbildungen Bremssättel

Illustrations brake calipers - Illustrazioni pinze de freno - Illustrations Étriers de frein -  
Ilustraciones pinzas de freno

24.3541-1797.7 220553 

24.3541-1798.7 220554 



LUC



Ø 54



## SEAT

CORDOBA III (6L2) (02-09)  
IBIZA IV (6L1) (02-10)  
IBIZA V / ST / SPORTCOUPE (08-)

## SKODA

FABIA I (6Y) (99-07)  
FABIA II (5J) (07-)  
ROOMSTER (5J) (06-)

## VOLKSWAGEN

POLO IV (02-09)

24.3541-1803.7 220603 

24.3541-1804.7 220604 



LUC





Ø 54



## CITROEN

C2 (03-09)  
C3 (02-09)  
C3 Pluriel (03-10)

24.3541-1805.5 240323 

24.3541-1806.5 240324 



Ø 54



## HONDA

CIVIC (3/4-türig) (95-01)  
CIVIC COUPE (96-01)  
CRX (92-98)

# Abbildungen Bremssättel

Illustrations brake calipers - Illustrazioni pinze de freno - Illustrations Étriers de frein -  
Ilustraciones pinzas de freno

24.3541-1807.5 240335 

24.3541-1808.5 240336 



AKE



## HYUNDAI

ACCENT II (00-05)  
GETZ (02-09)  
LANTRA/ELANTRA (90-95)  
PONY/EXCEL (89-94)  
S-COUPE (90-96)

24.3541-1809.7 220613 

24.3541-1810.7 220614 



BOS



## FIAT

BRAVO (07-)  
STILO / STILO Multi Wagon (01-08)

24.3541-1811.5 240429 

24.3541-1812.5 240430 



BOS



## FIAT



BRAVO (07-)  
IDEA (04-12)  
STILO / STILO Multi Wagon (01-08)

## LANCIA

MUSA (04-12)

# Abbildungen Bremssättel

Illustrations brake calipers - Illustrazioni pinze de freno - Illustrations Étriers de frein -  
 Ilustraciones pinzas de freno

24.3541-1813.5 240381   
 24.3541-1814.5 240382 





## HONDA

CIVIC (5-türig) (94-96)  
 CIVIC AERODECK (98-01)  
 CONCERTO (90-95)

## ROVER

200 II-Serie (RF) (96-00)

24.3541-1815.5 240383   
 24.3541-1816.5 240384 



## MITSUBISHI

GALANT (4-türig) (87-92)  
 GALANT (5-türig) (88-92)  
 SPACE RUNNER (91-99)  
 SPACE WAGON (91-98)

24.3541-8083.5 240483   
 24.3541-8084.5 240484 



## OPEL

OMEGA B / Vauxhall Omega (94-03)



11.8116-0292.1 390521 11.0101-5407.2 260011 11.8171-0008.1 990049





# Abbildungen Bremssättel

Illustrations brake calipers - Illustrazioni pinze de freno - Illustrations Étriers de frein -  
Ilustraciones pinzas de freno

24.3541-8105.5 240485 

24.3541-8106.5 240486 



ATE



Ø 54



**FORD**

FOCUS I (98-04)



11.0101-5407.2 260011 11.8171-0008.1 990049



24.3541-8521.5 240487 

24.3541-8522.5 240488 



ATE



Ø 54



**AUDI**

80 (87-91)  
80 Quattro (87-91)  
90 (87-91)  
90 Quattro (87-91)

**AUDI**

100 (83-90)  
CABRIO (91-00)  
COUPE (89-96)  
COUPE Quattro (87-96)



11.0441-5405.2 250030 11.0101-5409.2 260035  
Dichtungssatz  
gasket set



24.3541-8523.5 240551 

24.3541-8524.5 240552 



ATE



Ø 54



**AUDI**

A3 (96-03)

**SEAT**

LEON I (1M1) (99-05)  
TOLEDO II (1M2) (98-04)

**SKODA**

OCTAVIA I (1U) (97-10)

**VOLKSWAGEN**

BORA (98-04)  
GOLF III (92-97)  
GOLF III Variant (93-99)  
GOLF IV (98-05)  
GOLF IV Variant (99-06)  
NEW BEETLE (98-10)  
NEW BEETLE Cabriolet (03-10)  
PASSAT (94-96)  
VENTO (92-98)



11.0441-5409.2 250031 11.0101-5409.2 260035 11.8171-0008.1 990049  
Dichtungssatz - gasket set

11.8116-0143.1 390513

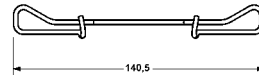

11.0230-0042.2 260027  
Haltersatz - anchor set



# Abbildungen Bremssättel

Illustrations brake calipers - Illustrazioni pinze de freno - Illustrations Étriers de frein -  
Ilustraciones pinzas de freno

24.3541-8529.5 240553 

24.3541-8530.5 240554 



ATE



Ø 54



## FORD

FIESTA III (89-96)  
FIESTA IV (96-02)  
PUMA (97-01)



11.0441-5402.2 250028  
Dichtungssatz - gasket set  
11.8116-0264.1 390594

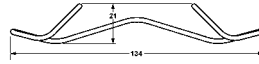



11.0101-5407.2 260011



11.8171-0008.1 990049



24.3541-9587.5 240527 

24.3541-9588.5 240528 



ATE



Ø 54



## BMW

3er Reihe/E36 (91-00)  
3er Reihe/E46 (98-06)  
Z3 (95-02)  
Z4 Roadster/E85 (03-08)



11.0441-5402.2 250028  
Dichtungssatz gasket set  
11.8116-0109.1 390495

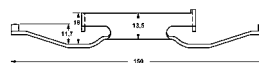



11.0101-5402.2 260009



11.8171-0008.1 990049



24.3541-9667.5 240529 

24.3541-9668.5 240530 



ATE



Ø 54



## BMW

3er Reihe/E36 (91-00)  
Z3 (95-02)



11.8116-0109.1 390495  
11.8116-0206.1 390593

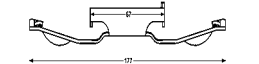

11.0101-5402.2 260009



11.8171-0008.1 990049

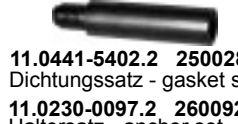

11.0441-5402.2 250028  
Dichtungssatz - gasket set  
11.0230-0097.2 260092  
Haltersatz - anchor set

# Abbildungen Bremssättel

Illustrations brake calipers - Illustrazioni pinze de freno - Illustrations Étriers de frein -  
 Ilustraciones pinzas de freno

24.3571-1703.5 240099 

24.3571-1704.5 240100 



AKE



Ø 57



## MAZDA

626 (91-97)  
 MX-6 (91-97)  
 XEDOS 6 (92-00)



24.0101-5701.2 260065



24.3571-1705.5 240069 

24.3571-1706.5 240070 



LUC



Ø 57



## OPEL

OMEGA A / Vauxhall Carlton (87-93)  
 OMEGA B / Vauxhall Omega (94-03)  
 SENATOR B / Vauxhall Royal (88-93)



24.0101-3401.2 260043



24.3571-1707.5 240079 

24.3571-1708.5 240080 



LUC



Ø 57



## VOLVO

740 Limousine (83-92)  
 740 Kombi (85-92)



24.0101-3601.2 260044



## VOLVO

940 I Limousine (90-95)  
 940 I Kombi (90-95)  
 940 II Limousine (95-98)  
 940 II Kombi (95-98)  
 960 I Limousine (90-94)  
 960 I Kombi (90-94)  
 960 II Limousine (94-96)  
 960 II Kombi (94-96)  
 S90 (97-98)  
 V90 (97-98)

# Abbildungen Bremssättel

Illustrations brake calipers - Illustrazioni pinze de freno - Illustrations Étriers de frein -  
Ilustraciones pinzas de freno

24.3571-1709.5 240153 

24.3571-1710.5 240154 



LUC



Ø 57



## CITROEN

EVASION (94-02)  
JUMPY Kombi (95-06)  
JUMPY Kasten (95-06)  
JUMPY Pritsche/Fahrgestell (99-06)

## FIAT

SCUDO (95-06)  
ULYSSE (94-02)

## LANCIA

ZETA (94-02)

## PEUGEOT

806 (94-02)  
EXPERT Kombi (95-06)  
EXPERT Kasten (95-06)  
EXPERT Pritsche/Fahrgestell (95-06)

24.3571-1713.5 240201 

24.3571-1714.5 240202 



SUM





Ø 57



## TOYOTA

CARINA E (92-97)  
CELICA (93-99)

24.3571-1715.5 240225 

24.3571-1716.5 240226 



LUC



Ø 57





## PEUGEOT

406 Limousine (95-04)  
406 Kombi (96-04)  
406 Coupe (97-05)

# Abbildungen Bremssättel

Illustrations brake calipers - Illustrazioni pinze de freno - Illustrations Étriers de frein -  
Ilustraciones pinzas de freno

24.3571-1717.5 240227 

24.3571-1718.5 240228 



LUC



Ø 57



## PEUGEOT

406 Limousine (95-04)

406 Kombi (96-04)

24.3571-1719.5 240303 

24.3571-1720.5 240304 



ATE



Ø 57



## ALFA ROMEO

166 (98-07)

## LANCIA

KAPPA (95-01)

24.3571-1721.7 220555 

24.3571-1722.7 220556 



LUC



Ø 57



## MERCEDES BENZ

C-Klasse (W203) Limousine (00-07)

C-Klasse (S203) Kombi (01-07)

C-Klasse (CL203) Sportcoupe (01-08)

C-Klasse (CLC203) Coupe (08-10)

CLK-Klasse (C209) Coupe (02-09)

CLK-Klasse (A209) Cabrio (03-09)

SLK-Klasse (R171) (04-11)

# Abbildungen Bremssättel

Illustrations brake calipers - Illustrazioni pinze de freno - Illustrations Étriers de frein -  
 Ilustraciones pinzas de freno

24.3571-1723.5 240307 

24.3571-1724.5 240308 





BDX



**PEUGEOT**

605 (90-99)

24.3571-1725.5 240313 

24.3571-1726.5 240314 



ATE



**SAAB**

9-3 (YS3D) (98-02)

9-3 Cabriolet (YS3D) (98-03)

9-5 Limousine (YS3E) (97-10)

9-5 Kombi (YS3E) (98-10)



11.0441-5704.2 250034  
 Dichtungssatz - gasket set

11.8116-0292.1 390521

11.0101-5407.2 260011

11.8171-0008.1 990049

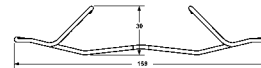

24.3571-1727.7 220601 

24.3571-1728.7 220602 



LUC



**PEUGEOT**

607 (00-10)



# Abbildungen Bremssättel

Illustrations brake calipers - Illustrazioni pinze de freno - Illustrations Étriers de frein -  
Ilustraciones pinzas de freno

24.3571-1729.5 240317 

24.3571-1730.5 240318 



LUC



Ø 57





## CITROEN

XSARA (N1) Limousine (97-05)  
XSARA (N2) Kombi (97-05)  
XSARA (N0) Coupe (97-05)  
ZX (N2) Limousine (91-97)

## PEUGEOT

306 Limousine (3/5-türig) (93-01)

24.3571-1731.5 240321 

24.3571-1732.5 240322 



LUC





Ø 57



## NISSAN

ALMERA (N16) (00-06)  
PRIMERA (P11E) Limousine (96-02)  
PRIMERA (W11) Kombi (98-02)

24.3571-1733.5 240349 

24.3571-1734.5 240350 



ATE



Ø 57



## BMW

3er Reihe/E46 (98-06)  
X3 (03-10)  
Z4 Roadster/E85 (03-08)  
Z4 Coupe/E86 (06-08)

## MG

ZT Limousine (01-05)  
ZT-T Kombi (01-05)

## ROVER

75 Serie (RX) (04-)



# Abbildungen Bremssättel

Illustrations brake calipers - Illustrazioni pinze de freno - Illustrations Étriers de frein -  
Ilustraciones pinzas de freno

24.3571-1735.5 240385 

24.3571-1736.5 240386 



BOS



Ø 57



## FORD

MONDEO III (01-07)

## JAGUAR

X-Type (CF1) Limousine (01-09)

X-Type (CF1) Kombi (03-09)

24.3571-1737.5 240387 

24.3571-1738.5 240388 



Ø 57



## MITSUBISHI

L 200 (86-96)

L 300 (86-94)

24.3571-1739.7 220667 

24.3571-1740.7 220668 



LUC



Ø 57



## MERCEDES BENZ

C-Klasse (W203) Limousine (00-07)

C-Klasse (S203) Kombi (01-07)

C-Klasse (CL203) Sportcoupe (01-08)

C-Klasse (CLC203) Coupe (08-10)

CLK-Klasse (C209) Coupe (02-09)

CLK-Klasse (A209) Cabrio (03-09)

SLK-Klasse (R171) (04-11)

# Abbildungen Bremssättel

Illustrations brake calipers - Illustrazioni pinze de freno - Illustrations Étriers de frein -  
Ilustraciones pinzas de freno

24.3571-1743.7 220687 

24.3571-1744.7 220688 



LUC



Ø 57



**MERCEDES BENZ**  
Vaneo (BM414) (02-05)

24.3571-1745.7 220689 

24.3571-1746.7 220690 



LUC



Ø 57



**PEUGEOT**  
407 Limousine (04-11)

24.3571-1747.7 220691 

24.3571-1748.7 220692 



LUC



Ø 57



**MERCEDES BENZ**  
A-Klasse (W169 ) (04-11)  
B-Klasse (W245) (05-11)

# Abbildungen Bremssättel

Illustrations brake calipers - Illustrazioni pinze de freno - Illustrations Étriers de frein - Ilustraciones pinzas de freno

24.3571-1749.7 220693 

24.3571-1750.7 220694 



## MERCEDES BENZ

A-Klasse (W169 ) (04-11)

B-Klasse (W245) (05-11)

24.3571-8505.5 240489 

24.3571-8506.5 240490 



## AUDI

100 (91-94)

100 Quattro (91-94)

A6 / A6 Avant (4A/C4) (94-97)





11.0441-5704.2 250034 11.0101-5409.2 260035 11.8171-0008.1 990049

Dichtungssatz - gasket set

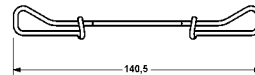
11.8116-0143.1 390513



24.3571-8511.5 240491 

24.3571-8512.5 240492 



## MERCEDES BENZ

C-Klasse (W202) Limousine (93-00)

C-Klasse (S202) Kombi (96-01)

CLK-Klasse (C208) Coupe (97-02)

CLK-Klasse (A208) Cabrio (98-03)

E-Klasse (W210) Limousine (95-02)

E-Klasse (S210) Kombi (96-03)

SLK-Klasse (R170) (96-04)



11.0441-5703.2 250145 11.0101-5407.2 260011 11.8171-0008.1 990049

Dichtungssatz gasket set

11.8116-0253.1 390512

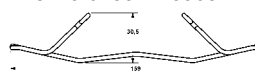

11.0230-0096.2 260033  
Haltersatz - anchor set

# Abbildungen Bremssättel

Illustrations brake calipers - Illustrazioni pinze de freno - Illustrations Étriers de frein -  
 Ilustraciones pinzas de freno

24.3571-8518.2 240494 

24.3571-8517.2 240493 



## AUDI

A4 (B5) (95-01)



11.0441-5704.2 250034  
 Dichtungssatz - gasket set

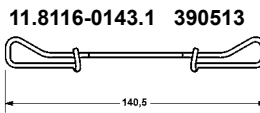



11.0101-5407.2 260011



11.8171-0008.1 990049



24.3571-8522.5 240496 

24.3571-8521.5 240495 



## AUDI

A4 (B5) (95-01)  
 A4 (B6/B7) (01-08)  
 A4 Cabrio (02-08)  
 A6 / A6 Avant (4B/C5) (97-05)



11.0441-5704.2 250034  
 Dichtungssatz - gasket set

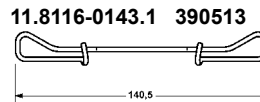

11.0101-5409.2 260035

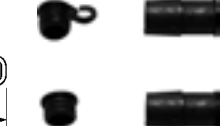

11.8171-0008.1 990049



11.0230-0042.2 260027  
 Haltersatz - anchor set

24.3571-9801.5 240497 

24.3571-9802.5 240498 



## TOYOTA

AVENSIS (97-03)



11.0101-5407.2 260011





11.8171-0008.1 990049



# Abbildungen Bremssättel

Illustrations brake calipers - Illustrazioni pinze de freno - Illustrations Étriers de frein - Ilustraciones pinzas de freno

24.3571-9823.5 240499 

24.3571-9824.5 240500 



ATE



Ø 57



## OPEL

ASTRA G (98-04)  
Vauxhall Astra MKIV (98-04)  
ASTRA H / GTC (04-10)  
Vauxhall Astra Mk V (04-10)  
ASTRA H Caravan (04-10)  
Vauxhall Astra MKV Estate (04-10)  
ASTRA TWIN TOP (06-10)



11.0441-5704.2 250034  
Dichtungssatz gasket set

11.8116-0292.1 390521

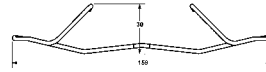

## OPEL

COMBO / Vaux.Combo (01-)  
CORSA C (00-06)  
Vauxhall Corsa MK II (00-06)  
CORSA D (06-)  
Vauxhall Corsa MK III (06-)  
MERIVA A / Vaux. Meriva A (03-10)  
MERIVA B (10-)  
ZAFIRA I / Vauxhall Zafira I (99-05)  
ZAFIRA II / Vauxhall Zafira II (05-11)

11.0101-5407.2 260011

11.8171-0008.1 990049



24.3571-9841.5 240501 

24.3571-9842.5 240502 



ATE



Ø 57



## RENAULT

LAGUNA II Limousine (BG\_) (01-07)  
LAGUNA II Grandtour (KG\_) (01-07)  
SCENIC I (JA\_) (99-03)



11.0101-5403.2 260010

11.0101-5407.2 260011

11.8171-0008.1 990049



24.3572-1703.7 220375 

24.3572-1704.7 220376 



BDX



Ø 57



## CITROEN

XANTIA (X1) Limousine (93-97)  
XM (Y3) Limousine (89-94)  
XM (Y4) Limousine (94-00)  
XM (Y3) Kombi (91-94)  
XM (Y4) Kombi (94-00)



# Abbildungen Bremssättel

Illustrations brake calipers - Illustrazioni pinze de freno - Illustrations Étriers de frein -  
Ilustraciones pinzas de freno

24.3572-1707.7 220619 

24.3572-1708.7 220620 



BOS





Ø 57



## CITROEN

C5 I Limousine (01-04)  
C5 I Kombi (01-04)  
C5 II Limousine (04-08)  
C5 II Kombi (04-08)

24.3601-1601.5 240203 

24.3601-1602.5 240204 



LUC





Ø 60



## VOLKSWAGEN

TRANSPORTER (Typ 2) (79-92)

24.3601-1707.5 240229 

24.3601-1708.5 240230 



LUC



Ø 60



## RENAULT

ESPACE III (JE\_) (96-02)  
LAGUNA I Limousine (B56/556\_) (93-00)  
LAGUNA I Grandtour (K56\_) (95-00)  
MEGANE I Coach (DA\_) (95-03)  
MEGANE I Cabrio (EA\_) (96-03)  
MEGANE SCENIC (JA\_) (96-99)  
SAFRANE (B54\_) (92-00)



# Abbildungen Bremssättel

Illustrations brake calipers - Illustrazioni pinze de freno - Illustrations Étriers de frein -  
Ilustraciones pinzas de freno

24.3601-1709.5 240275 

24.3601-1710.5 240276 



## VOLKSWAGEN

TRANSPORTER (Typ 2) (79-92)

24.3601-1711.7 220607 

24.3601-1712.7 220608 



## CITROEN

C8 (02-)  
JUMPY Kombi (95-06)  
JUMPY Kasten (95-06)  
JUMPY Pritsche/Fahrgestell(99-06)

## FIAT

SCUDO (95-06)  
ULYSSE (02-11)

## LANCIA

PHEDRA (02-10)

## PEUGEOT

807 (02-)  
EXPERT Kombi (95-06)  
EXPERT Kasten (95-06)  
EXPERT Pritsche/Fahrgestell  
(95-06)

24.3601-1717.5 240391 

24.3601-1718.5 240392 

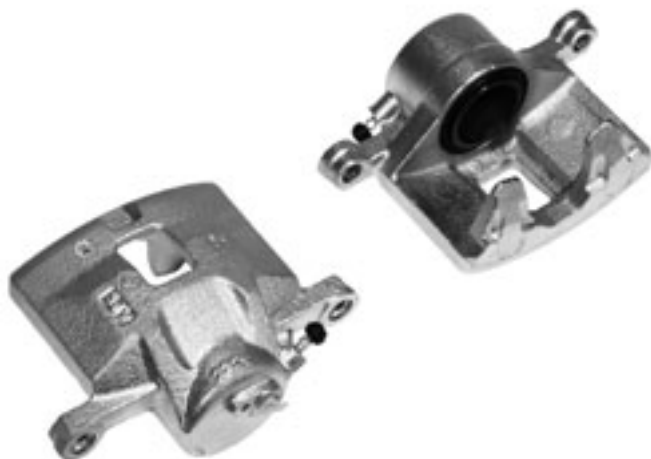



## OPEL

FRONTERA A (92-98)  
FRONTERA B (98-04)  
MONTEREY (92-98)  
MONTEREY (98-99)

# Abbildungen Bremssättel

Illustrations brake calipers - Illustrazioni pinze de freno - Illustrations Étriers de frein -  
 Ilustraciones pinzas de freno

24.3601-8501.5 240533   
 24.3601-8502.5 240534 



ATE



Ø 60



## BMW

5er Reihe/E34 (88-96)



11.0441-6003.2 250037  
 Dichtungssatz - gasket set

11.8116-0083.1 390501

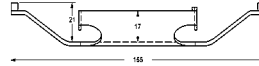

11.0101-5402.2 260009



11.8171-0008.1 990049



11.0230-0020.2 260023  
 Haltersatz - anchor set

24.3601-8503.5 240535   
 24.3601-8504.5 240536 



ATE



Ø 60



## BMW

5er Reihe/E34 (88-96)  
 7er Reihe/E32 (86-94)



11.0441-6003.2 250037  
 Dichtungssatz - gasket set

11.8116-0083.1 390501

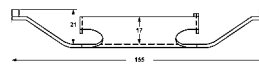

11.0101-5402.2 260009



11.8171-0008.1 990049



24.3601-8505.5 240537   
 24.3601-8506.5 240538 



ATE



Ø 60



## BMW

5er Reihe/E34 (88-96)  
 7er Reihe/E32 (86-94)



11.0441-6003.2 250037  
 Dichtungssatz - gasket set

11.8116-0083.1 390501

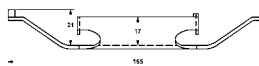

11.0101-5402.2 260009



11.8171-0008.1 990049



11.0230-0009.2 260018  
 Haltersatz - anchor set

# Abbildungen Bremssättel

Illustrations brake calipers - Illustrazioni pinze de freno - Illustrations Étriers de frein -  
 Ilustraciones pinzas de freno

24.3601-8527.5 240503   
 24.3601-8528.5 240504 





## FORD

COUGAR (98-00)  
 MONDEO I (93-96)  
 MONDEO II (96-00)  
 SCORPIO / GRANADA (GB) (95-98)

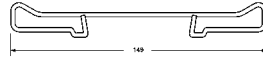

11.0441-6005.2 250150 11.0101-5407.2 260011 11.8171-0008.1 990049  
 Dichtungssatz - gasket set  
 11.8116-0118.1 390508  
 11.0230-0170.2 260078  
 Haltersatz - anchor set



24.3601-9787.5 240505   
 24.3601-9788.5 240506 



## RENAULT

ESPACE IV (JK\_) (02-)  
 LAGUNA II Limousine (BG\_) (01-07)  
 LAGUNA II Grandtour (KG\_) (01-07)  
 VEL SATIS (BJ0\_) (02-09)



11.0101-5403.2 260010 11.0101-5407.2 260011 11.8171-0008.1 990049

24.3601-9829.5 240507   
 24.3601-9830.5 240508 



## VOLVO

S60 (00-09)  
 S80 I (98-06)  
 V70 II (00-07)  
 XC70 I CROSS COUNTRY (00-07)



11.0101-5407.2 260011 11.8171-0008.1 990049  
 11.8116-0366.2 390587

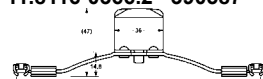

# Abbildungen Bremssättel

Illustrations brake calipers - Illustrazioni pinze de freno - Illustrations Étriers de frein -  
 Ilustraciones pinzas de freno

24.3602-1701.7 220509 

24.3602-1702.7 220510 



BDX





Ø 60

## CITROEN

XANTIA (X1) Limousine (93-97)  
 XANTIA (X2) Limousine (98-01)  
 XANTIA (X2) Kombi (98-01)  
 XM (Y4) Limousine (94-00)  
 XM (Y4) Kombi (94-00)



24.9235-0013.5 230001 

24.9235-0014.5 230002 



ATE



Ø 35

## OPEL

ASTRA F (91-01)  
 Vauxhall Astra MKIII (91-01)  
 CALIBRA (89-97)  
 Vauxhall Calibra (89-97)  
 KADETT E / Vauxhall Astra E/Belmont (84-93)  
 VECTRA A / Vauxhall Cavalier (89-95)

## SAAB

900 (94-98)



13.0441-3506.2 250052

Dichtungssatz  
 gasket set

24.9235-0051.5 230003 

24.9235-0052.5 230004 



ATE



Ø 35

## OPEL

VECTRA B / Vauxhall Vectra (96-02)





13.0441-3507.2 250053

Dichtungssatz  
 gasket set

# Abbildungen Bremssättel

Illustrations brake calipers - Illustrazioni pinze de freno - Illustrations Étriers de frein -  
Ilustraciones pinzas de freno

24.9235-8005.5 230023 

24.9235-8006.5 230024 



ATE



Ø 35

## MERCEDES BENZ

(W124) E-Klasse (85-93)  
(W201) 190-190 E 2,6 (82-93)  
C-Klasse (W202) Limousine (93-00)  
E-Klasse (W124) Limousine (93-95)  
E-Klasse (C124) Coupe (93-97)



13.0441-3505.2 250051

Dichtungssatz  
gasket set



24.9236-0001.5 230005 

24.9236-0002.5 230006 



ATE





Ø 36

## VOLVO

740 Limousine (83-92)  
740 Kombi (85-92)  
760 Limousine (82-92)  
760 Kombi (82-92)



24.9236-8001.5 230007 

24.9236-8002.5 230008 



ATE



Ø 36

## MERCEDES BENZ

C-Klasse (W202) Limousine (93-00)  
CLK-Klasse (C208) Coupe (97-02)  
CLK-Klasse (A208) Cabrio (98-03)  
E-Klasse (W210) Limousine (95-02)  
SL-Klasse (R129) (93-01)



13.0441-3606.2 250147

Dichtungssatz  
gasket set





# Abbildungen Bremssättel

Illustrations brake calipers - Illustrazioni pinze de freno - Illustrations Étriers de frein -  
Ilustraciones pinzas de freno

24.9238-0087.5 230035 

24.9238-0088.5 230036 



## VOLVO

740 Limousine (83-92)  
740 Kombi (85-92)  
760 Limousine (82-92)  
760 Kombi (82-92)

## VOLVO

940 I Limousine (90-95)  
940 I Kombi (90-95)  
940 II Limousine (95-98)  
940 II Kombi (95-98)  
960 I Limousine (90-94)  
960 I Kombi (90-94)



13.0441-3819.2 250072

Dichtungssatz  
gasket set

24.9238-0097.5 230037 

24.9238-0098.5 230038 



## VOLVO

850 Limousine (91-96)  
850 Kombi (92-96)  
C70 Coupe (97-02)  
C70 I Cabrio (98-06)  
S70 (97-00)  
V70 I (97-00)

24.9238-8033.5 230015 

24.9238-8034.5 230016 



## MERCEDES BENZ

(W124) E-Klasse (85-93)  
C-Klasse (W202) Limousine (93-00)  
E-Klasse (W124) Limousine (93-95)  
SL-Klasse (R129) (93-01)



13.0441-3817.2 250071

Dichtungssatz  
gasket set



# Abbildungen Bremssättel

Illustrations brake calipers - Illustrazioni pinze de freno - Illustrations Étriers de frein -  
Ilustraciones pinzas de freno

24.9238-8035.5 230025 

24.9238-8036.5 230026 



ATE



Ø 38

## MERCEDES BENZ

(R129) SL-Klasse (89-93)  
(W124) E-Klasse (85-93)  
(W201) 190-190 E 2,6 (82-93)  
C-Klasse (W202) Limousine (93-00)  
C-Klasse (S202) Kombi (96-01)  
E-Klasse (W124) Limousine (93-95)  
E-Klasse (S124) Kombi (93-96)



13.0441-3817.2 250071

Dichtungssatz  
gasket set

## MERCEDES BENZ

E-Klasse (A124) Cabrio (93-98)  
SL-Klasse (R129) (93-01)  
SLK-Klasse (R170) (96-04)



24.9240-0027.5 230017 

24.9240-0028.5 230018 



ATE



Ø 40

## VOLVO

740 Limousine (83-92)  
740 Kombi (85-92)  
760 Limousine (82-92)  
760 Kombi (82-92)

## VOLVO

940 I Limousine (90-95)  
940 I Kombi (90-95)  
940 II Limousine (95-98)  
940 II Kombi (95-98)  
960 I Limousine (90-94)  
960 I Kombi (90-94)  
960 II Limousine (94-96)  
960 II Kombi (94-96)



24.9240-0039.5 230055 

24.9240-0040.5 230056 



ATE



Ø 40

## OPEL

OMEGA B / Vauxhall Omega (94-03)



13.0441-4022.2 250149

Dichtungssatz  
gasket set



# Abbildungen Bremssättel

Illustrations brake calipers - Illustrazioni pinze de freno - Illustrations Étriers de frein -  
Ilustraciones pinzas de freno

24.9240-8013.5 230019 

24.9240-8014.5 230020 



ATE



## MERCEDES BENZ

E-Klasse (S210) Kombi (96-03)

S-Klasse (W140) (91-93)

S-Klasse (W140) (93-98)



13.0441-4020.2 250084

Dichtungssatz  
gasket set

24.9242-8005.5 230027 

24.9242-8006.5 230028 



ATE



## BMW

2,5/2,8/3,0/3,3 (68-77)

5er Reihe/E12 (72-81)



13.0441-4205.2 250086

Dichtungssatz  
gasket set

24.9242-8007.5 230029 

24.9242-8008.5 230030 



ATE



## BMW

2,5/2,8/3,0/3,3 (68-77)

6er Reihe/E24 (76-89)



13.0441-4205.2 250086

Dichtungssatz  
gasket set

# Abbildungen Bremssättel

Illustrations brake calipers - Illustrazioni pinze de freno - Illustrations Étriers de frein -  
Ilustraciones pinzas de freno

24.9242-8021.5 230031 

24.9242-8022.5 230032 



## MERCEDES BENZ

(W123) 200-300 TD Turbo (76-85)



13.0441-4206.2 250087

Dichtungssatz  
gasket set

24.9246-8001.5 230021 

24.9246-8002.5 230022 



## MERCEDES BENZ

CL-Klasse (C140) Coupe (96-99)  
E-Klasse (S210) Kombi (96-03)  
S-Klasse (W140) (91-93)  
S-Klasse (W140) (93-98)  
S-Klasse (W220) (98-06)



13.0441-4601.2 250099

Dichtungssatz  
gasket set

24.9257-8023.5 230033 

24.9257-8024.5 230034 



## MERCEDES BENZ

(W126) 260 SE-560 SEC (80-91)





13.0441-5724.2 250125

Dichtungssatz  
gasket set

# Abbildungen Bremssättel

Illustrations brake calipers - Illustrazioni pinze de freno - Illustrations Étriers de frein -  
Ilustraciones pinzas de freno

24.9257-8027.5 230039 

24.9257-8028.5 230040 



## VOLKSWAGEN

LT/- 4x4 (75-96)



13.0441-5720.2 250122

Dichtungssatz  
gasket set

24.9260-8025.5 230041 

24.9260-8026.5 230042 



## MERCEDES BENZ

(W116) 280 S-450 SEL 6,9 (72-80)



13.0441-6001.2 250126

Dichtungssatz  
gasket set

24.9260-8029.5 230043 

24.9260-8030.5 230044 



## MERCEDES BENZ

(W123) 200-300 TD Turbo (76-85)



13.0441-6003.2 250128

Dichtungssatz  
gasket set

# Abbildungen Bremssättel

Illustrations brake calipers - Illustrazioni pinze de freno - Illustrations Étriers de frein -  
Ilustraciones pinzas de freno

24.9260-8031.5 230045 

24.9260-8032.5 230046 



## MERCEDES BENZ

(W126) 260 SE-560 SEC (80-91)



13.0441-6003.2 250128

Dichtungssatz  
gasket set

24.9440-8027.5 230051 

24.9440-8028.5 230052 



## MERCEDES BENZ

(R107) 280 SL-560 SL (71-89)



13.0441-4016.2 250081

Dichtungssatz  
gasket set

24.9421-8003.5 230053 

24.9421-8004.5 230054 



## MERCEDES BENZ

(R129) SL-Klasse (89-93)  
(W124) E-Klasse (85-93)  
(W201) 190-190 E 2,6 (82-93)  
E-Klasse (W124) Limousine (93-95)  
SL-Klasse (R129) (93-01)



13.0441-4214.2 250091

Dichtungssatz  
gasket set







- ⓓ Abbildungen Bremsschläuche
- Ⓔ Illustrations brake hoses
- Ⓕ Illustrations flexibles de frein
- ⓐ Illustrazioni flessibile freno
- Ⓔ Illustraciones tubos flexible de freno
- Ⓔ Afbeeldingen remslangen
- Ⓓ Tegning bremseslange
- Ⓔ Avbildningar bromsslang
- Ⓔ Ábrák féktömlő
- Ⓓ Figuras tubos de travão
- Ⓔ Изображение Тормозной шланг
- Ⓒ hadice brzdy
- Ⓓ Rysunki Przewód hamulcowy giętki
- Ⓔ Εικόνες Εύκαμπτος σωλήνας φρένου
- Ⓓ Fren hortumu resimleri
- Ⓔ 制动器软管图
- Ⓓ 図: ブレーキホース
- Ⓓ خرطوم المكبح لالكشأ

# Abbildungen Bremssättel, Kupplungsschläuche

Illustrations brake callipers, clutch hoses - Illustrazioni freni, flessibili di frizione - Illustrations flexible de frein, flexibles d'embrague - Ilustraciones pinzas de freno, flexibles de freno



24.1253-0020.3 331067

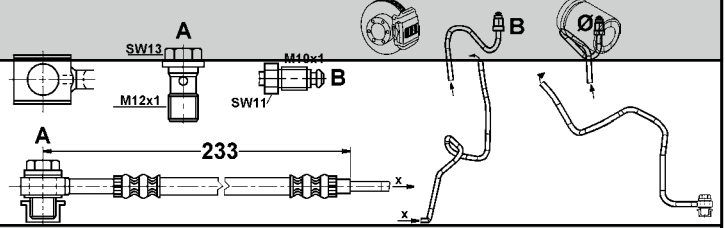

24.1253-0030.3 331126

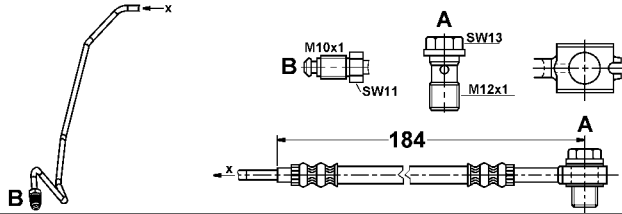

24.1253-0040.3 331127

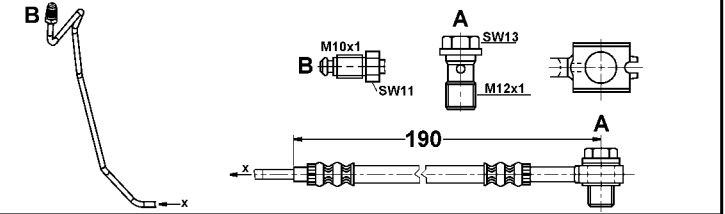

24.1253-0050.3 331148

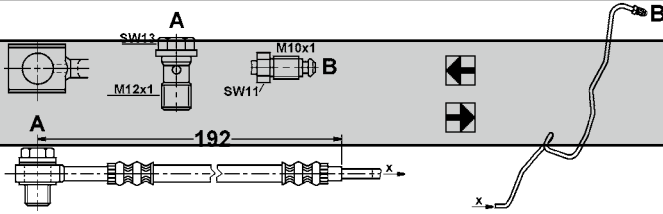

24.1253-0060.3 331149

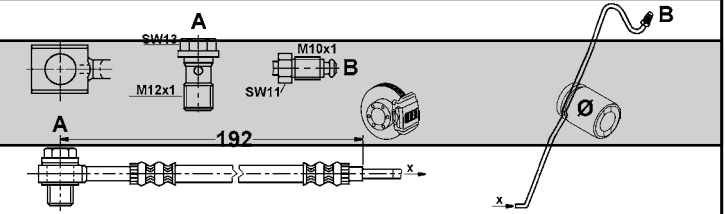

24.1294-0010.3 331253

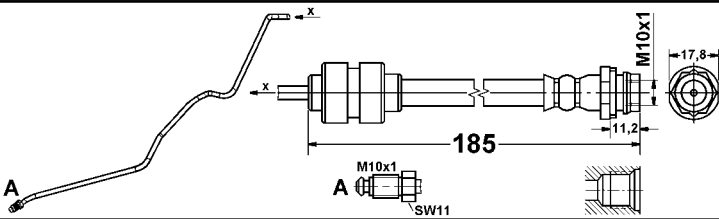

24.1294-0011.3 331254

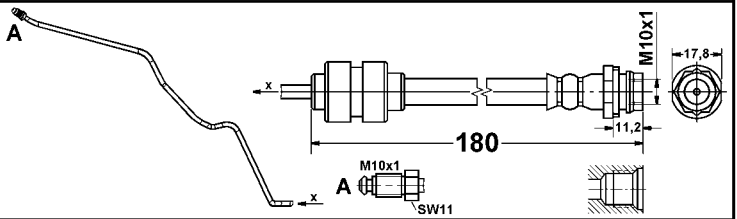

24.5105-0139.3 331216

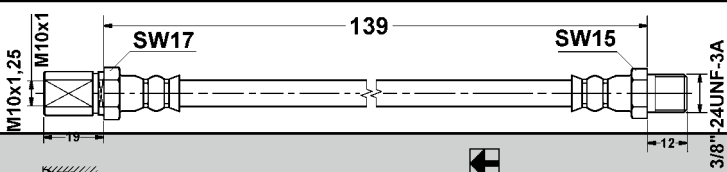

24.5108-0266.3 330038

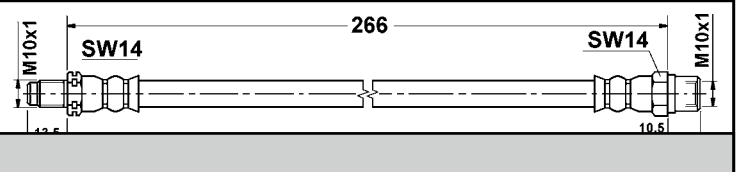

24.5110-0155.3 330040

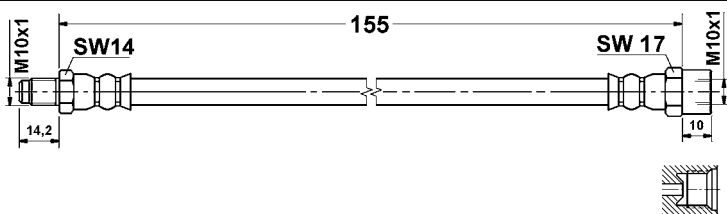

24.5111-0150.3 330497

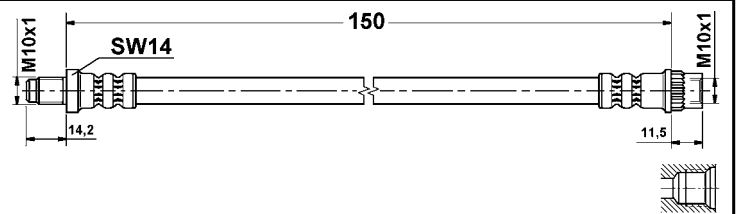

24.5111-0201.3 330498

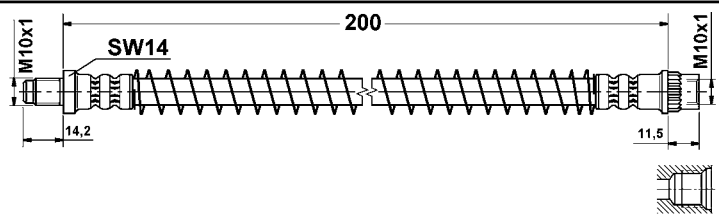

24.5111-0210.3 330765

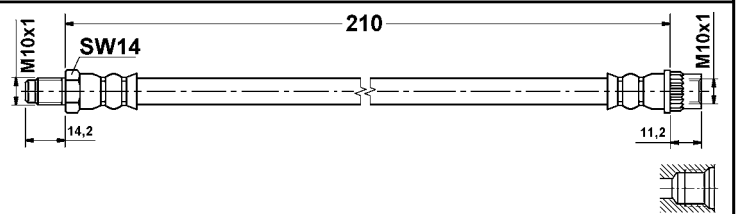

# Abbildungen Bremsschläuche, Kupplungsschläuche

Illustrations brake hoses, clutch hoses - Illustrations fessibilli freno, fessibilli frizione - Illustrations Flexible de frein, Flexibles d'embrayages - Ilustraciones flexibles de freno, flexibles d'embrague

**24.5111-0221.3 330818**

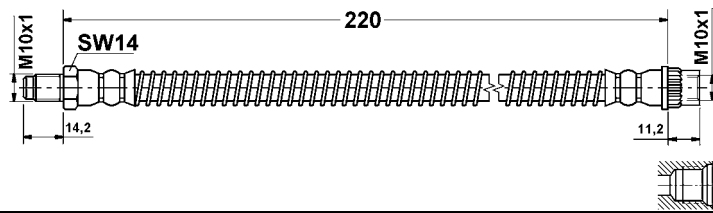

**24.5111-0235.3 330477**

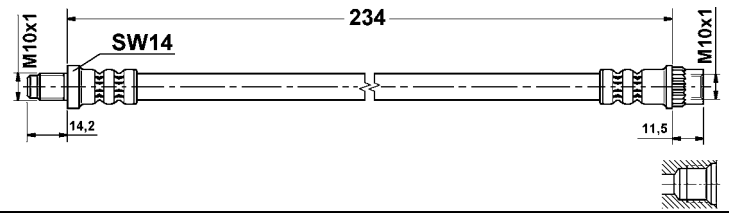

**24.5111-0241.3 330680**

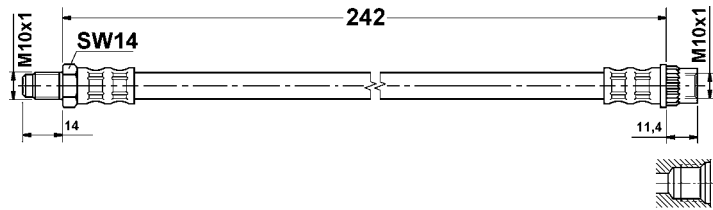

**24.5111-0260.3 330408**

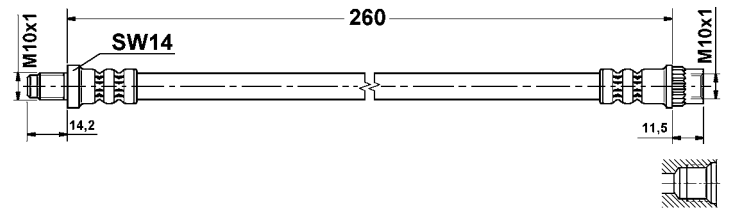

**24.5111-0280.3 330389**

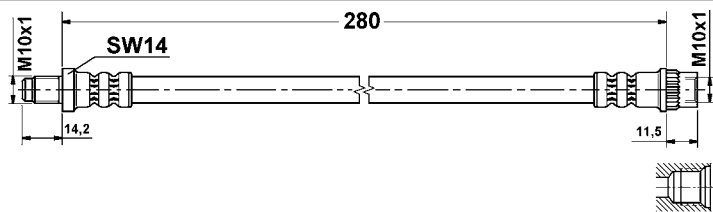

**24.5111-0285.3 330608**

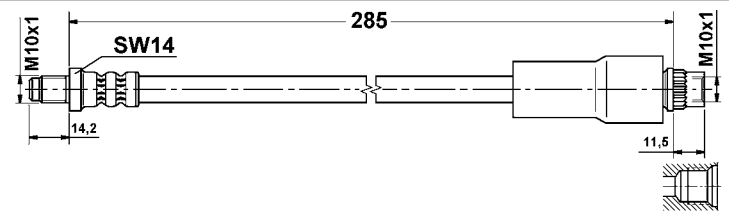

**24.5111-0290.3 330108**

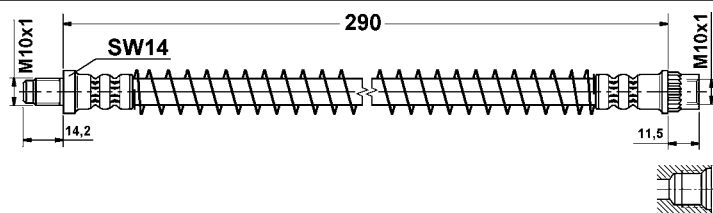

**24.5111-0300.3 330407**

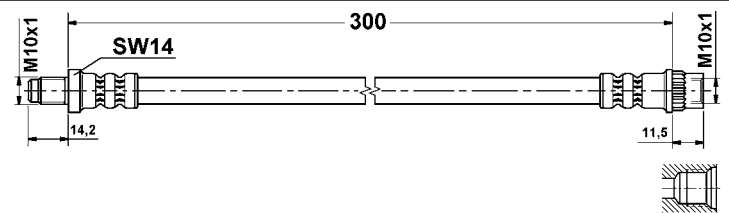

**24.5111-0301.3 330499**

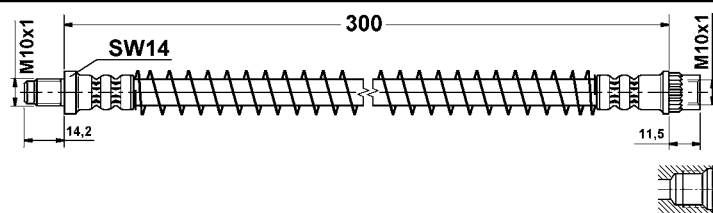

**24.5111-0306.3 330596**

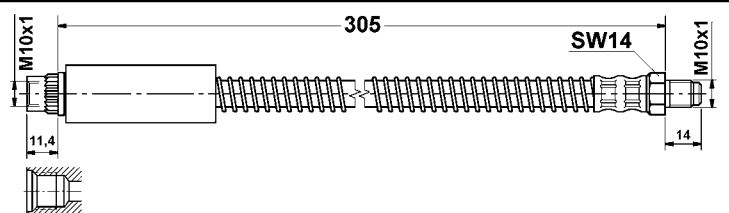

**24.5111-0315.3 330390**

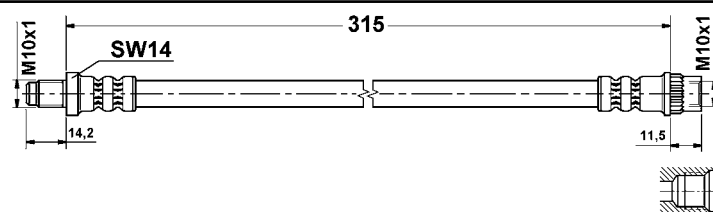

**24.5111-0317.3 330501**

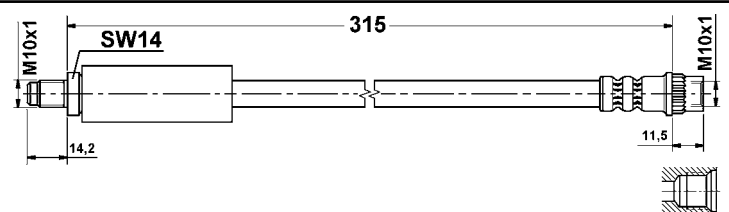

**24.5111-0320.3 330487**

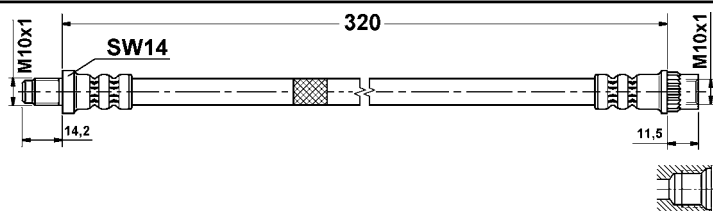

**24.5111-0321.3 330597**

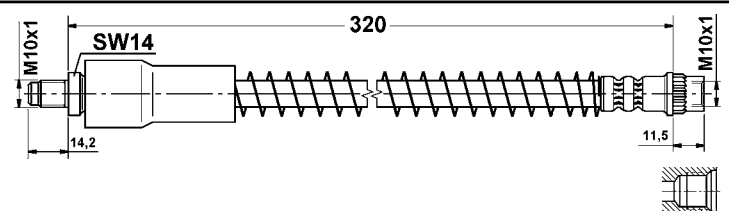

# Abbildungen Bremsschläuche, Kupplungsschläuche

Illustrations brake hoses, clutch hoses - Illustrations fessibili freno, fessibili frizione - Illustrations Flexible de frein, Flexibles d'embrayages - Ilustraciones flexibles de freno, flexibles d'embrague

|  |                                     |
|--|-------------------------------------|
| <p><b>24.5111-0325.3 330109</b></p>  | <p><b>24.5111-0326.3 330766</b></p> |
| <p><b>24.5111-0330.3 330160</b></p>  | <p><b>24.5111-0335.3 330778</b></p> |
| <p><b>24.5111-0336.3 330570</b></p>  | <p><b>24.5111-0345.3 330406</b></p> |
| <p><b>24.5111-0355.3 330757</b></p> <p>NUR FÜR MINERALÖL    ONLY FOR MINERAL OIL</p> | <p><b>24.5111-0375.3 331128</b></p> |
| <p><b>24.5111-0386.3 330503</b></p>  | <p><b>24.5111-0390.3 330566</b></p> |
| <p><b>24.5111-0396.3 330609</b></p>  | <p><b>24.5111-0405.3 330410</b></p> |
| <p><b>24.5111-0410.3 330681</b></p>  | <p><b>24.5111-0420.3 330682</b></p> |

# Abbildungen Bremsschläuche, Kupplungsschläuche

Illustrations brake hoses, clutch hoses - Illustrations fessibilli freno, fessibilli frizione - Illustrations Flexible de frein, Flexibles d'embrayages - Ilustraciones flexibles de freno, flexibles d'embrague

**24.5111-0424.3 331014**

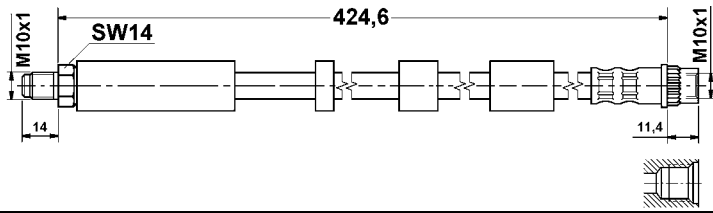

**24.5111-0425.3 330278**

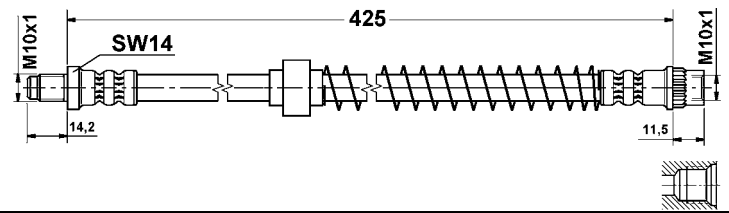

**24.5111-0429.3 331015**

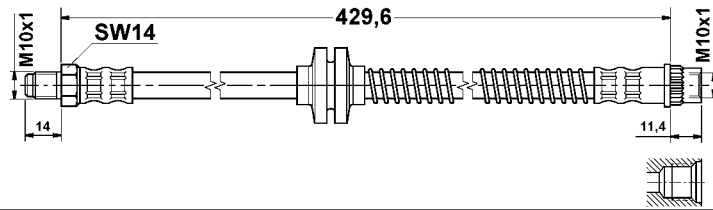

**24.5111-0438.3 330568**

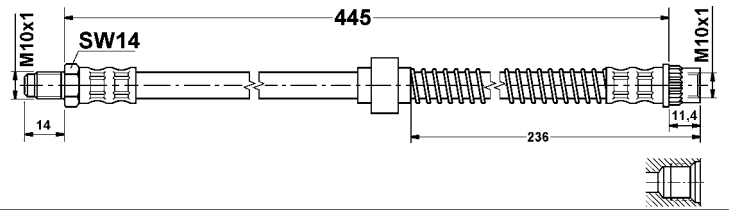

**24.5111-0440.3 330391**

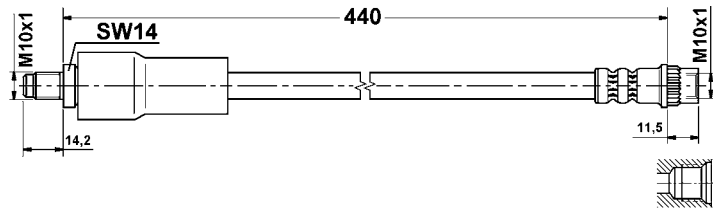

**24.5111-0445.3 330504**

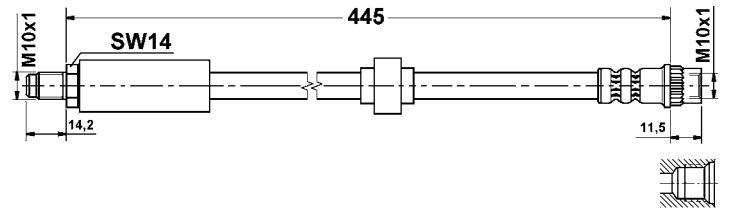

**24.5111-0446.3 331055**

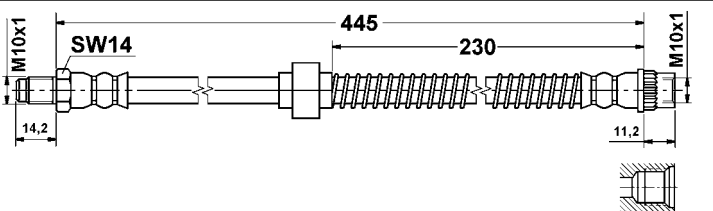

**24.5111-0455.3 330914**

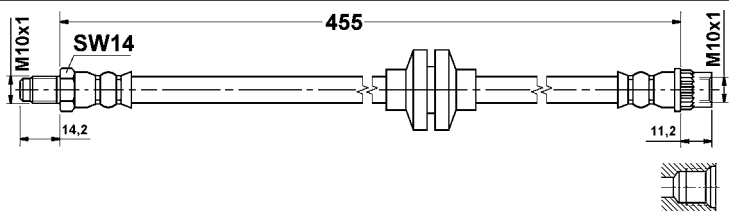

**24.5111-0459.3 330683**

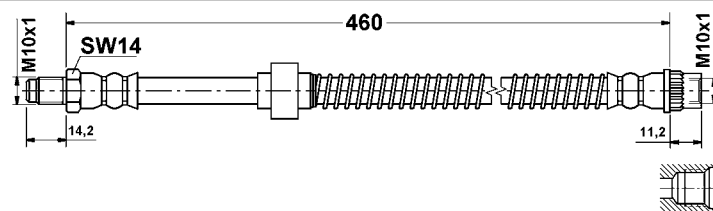

**24.5111-0460.3 330603**

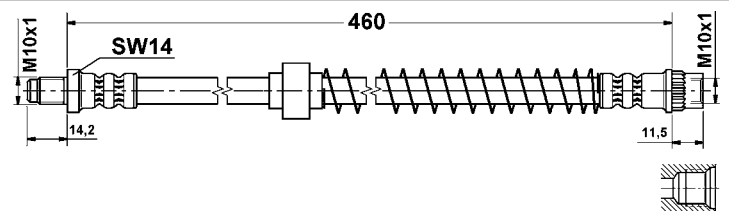

**24.5111-0462.3 330555**

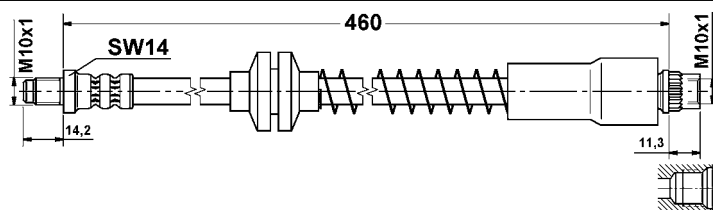

**24.5111-0490.3 330598**

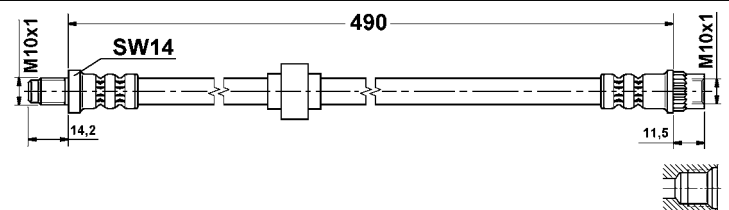

**24.5111-0495.3 330505**

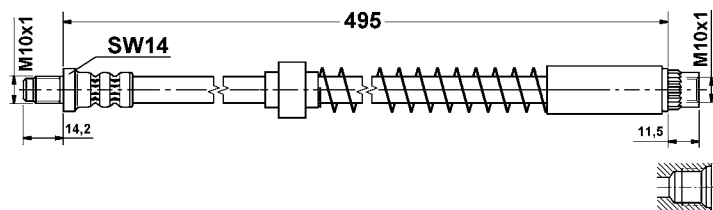

**24.5111-0510.3 330819**

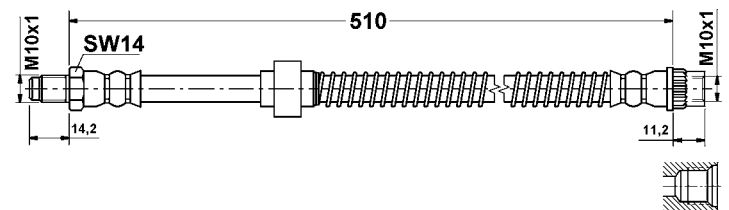

# Abbildungen Bremsschläuche, Kupplungsschläuche

Illustrations brake hoses, clutch hoses - Illustrations fessibilli freno, fessibilli frizione - Illustrations Flexible de frein, Flexibles d'embrayages - Ilustraciones flexibles de freno, flexibles d'embrague

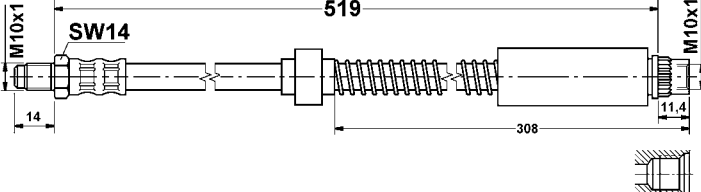
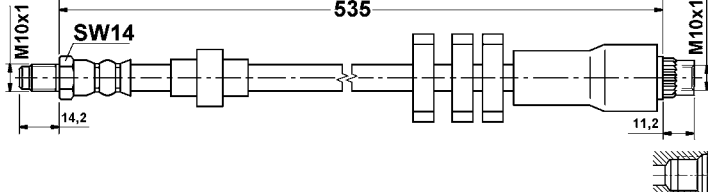
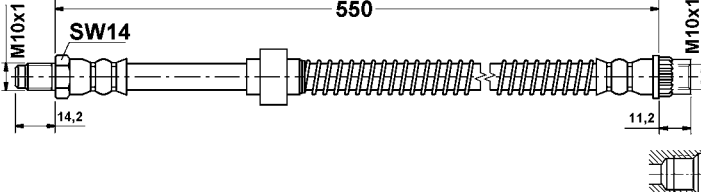
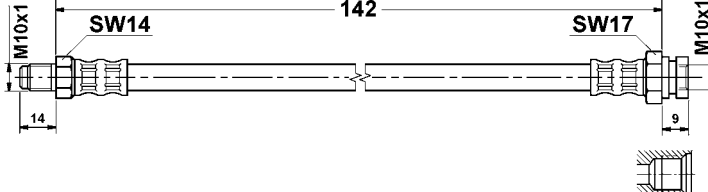
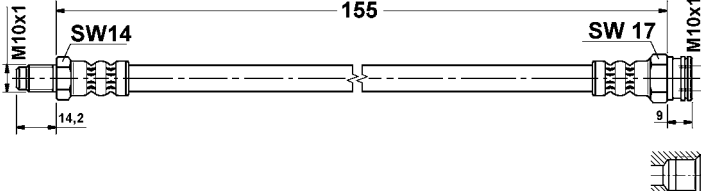
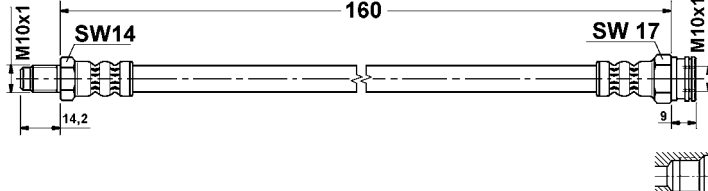
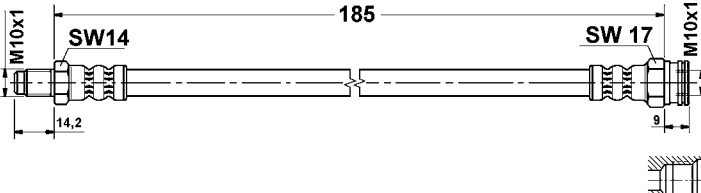
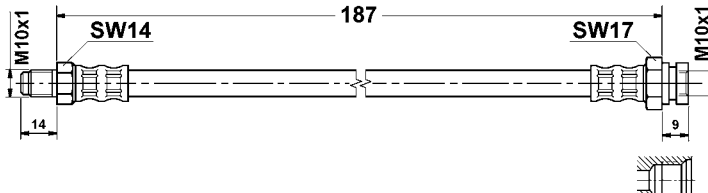
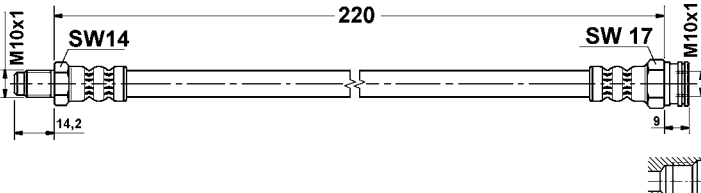
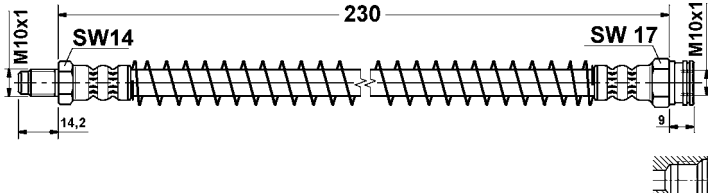
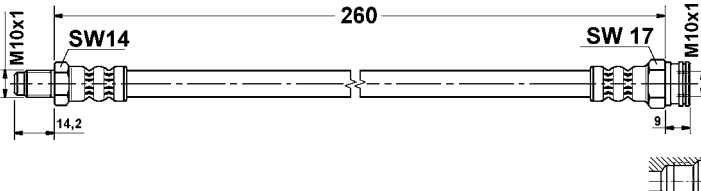
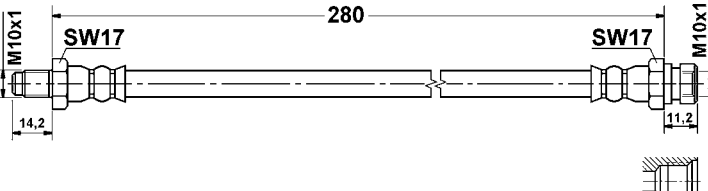
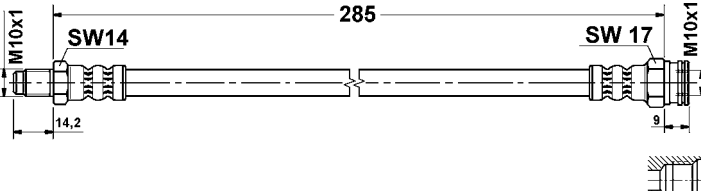
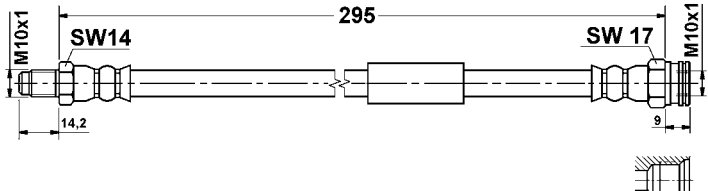
|  |  |
|--|--|
| <p><b>24.5111-0520.3 330506</b></p>    | <p><b>24.5111-0535.3 330684</b></p>    |
| <p><b>24.5111-0550.3 330665</b></p>    | <p><b>24.5112-0142.3 331016</b></p>    |
| <p><b>24.5112-0155.3 330507</b></p>   | <p><b>24.5112-0160.3 330612</b></p>   |
| <p><b>24.5112-0185.3 330654</b></p>  | <p><b>24.5112-0187.3 331150</b></p>  |
| <p><b>24.5112-0220.3 330613</b></p>  | <p><b>24.5112-0230.3 330508</b></p>  |
| <p><b>24.5112-0260.3 330577</b></p>  | <p><b>24.5112-0280.3 331200</b></p>  |
| <p><b>24.5112-0285.3 330604</b></p>  | <p><b>24.5112-0295.3 330907</b></p>  |



# Abbildungen Bremsschläuche, Kupplungsschläuche

Illustrations brake hoses, clutch hoses - Illustrations fessibilli freno, fessibilli frizione - Illustrations Flexible de frein, Flexibles d'embrayages - Ilustraciones flexibles de freno, flexibles d'embrague

|                                     |                                     |
|-------------------------------------|-------------------------------------|
| <p><b>24.5112-0300.3 330696</b></p> | <p><b>24.5112-0315.3 330509</b></p> |
| <p><b>24.5112-0325.3 330415</b></p> | <p><b>24.5112-0327.3 330417</b></p> |
| <p><b>24.5112-0339.3 330771</b></p> | <p><b>24.5112-0340.3 330511</b></p> |
| <p><b>24.5112-0341.3 330655</b></p> | <p><b>24.5112-0355.3 330758</b></p> |
| <p><b>24.5112-0356.3 331129</b></p> | <p><b>24.5112-0360.3 330513</b></p> |
| <p><b>24.5112-0361.3 330649</b></p> | <p><b>24.5112-0362.3 330512</b></p> |
| <p><b>24.5112-0363.3 330650</b></p> | <p><b>24.5112-0370.3 330515</b></p> |

# Abbildungen Bremsschläuche, Kupplungsschläuche

Illustrations brake hoses, clutch hoses - Illustrations fessibili freno, fessibili frizione - Illustrations Flexible de frein, Flexibles d'embrayages - Ilustraciones flexibles de freno, flexibles d'embrague

**24.5112-0376.3 330514**

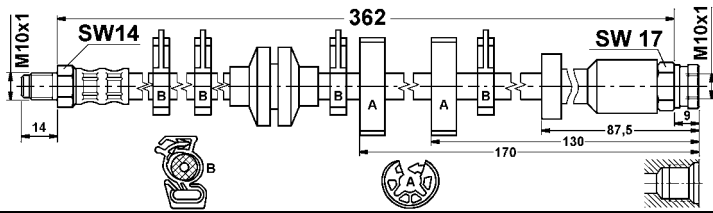

**24.5112-0381.3 330711**

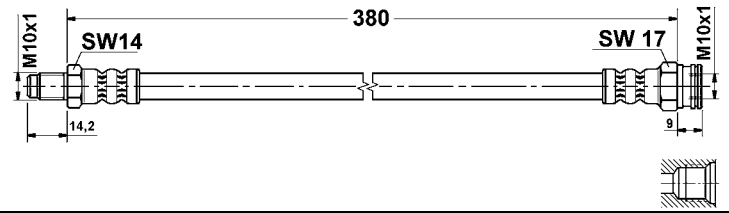

**24.5112-0384.3 330651**

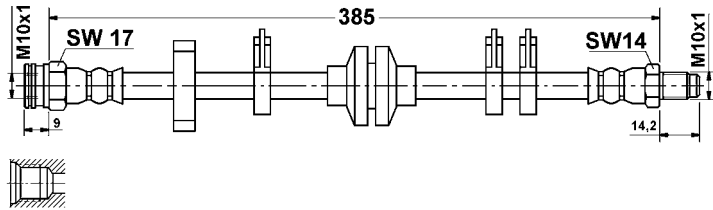

**24.5112-0385.3 330392**

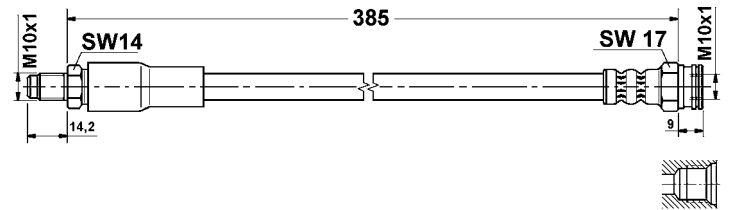

**24.5112-0386.3 330516**

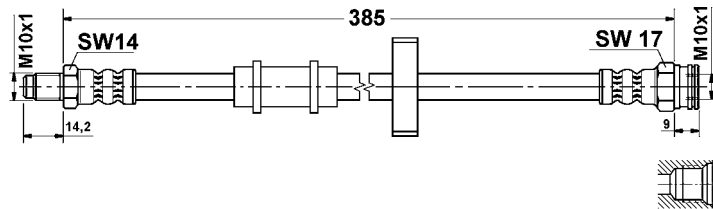

**24.5112-0387.3 330519**

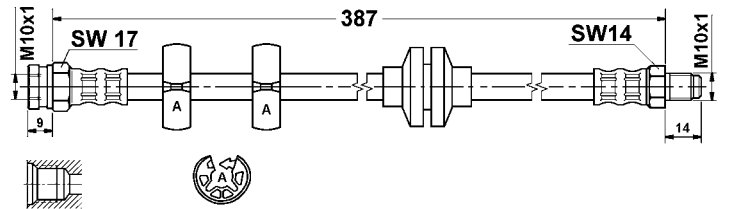

**24.5112-0388.3 330518**

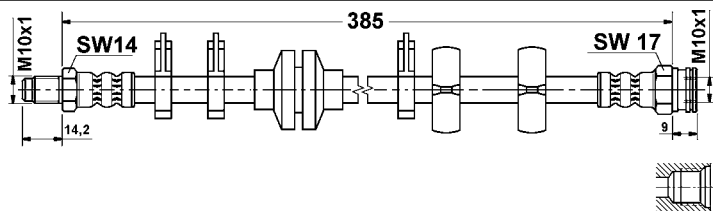

**24.5112-0390.3 330517**

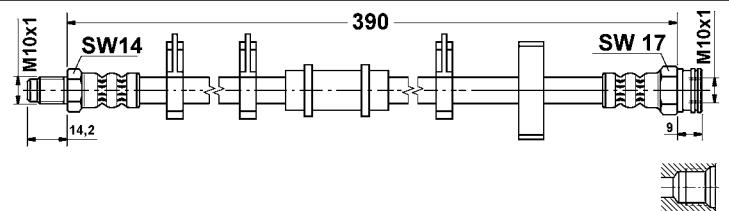

**24.5112-0395.3 330521**

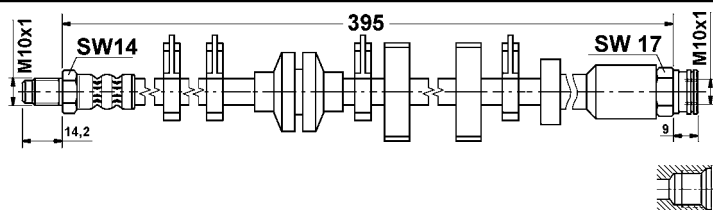

**24.5112-0396.3 330520**

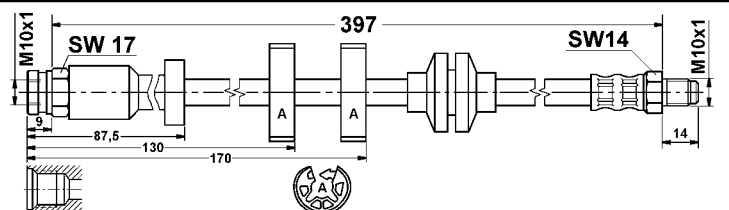

**24.5112-0397.3 330666**

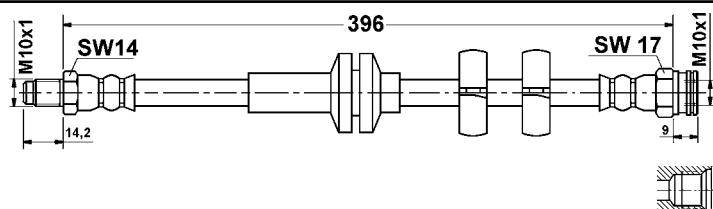

**24.5112-0405.3 330428**

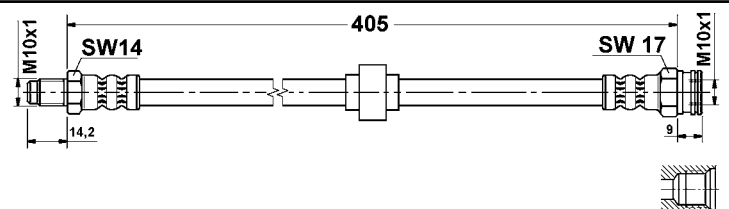

**24.5112-0408.3 330667**

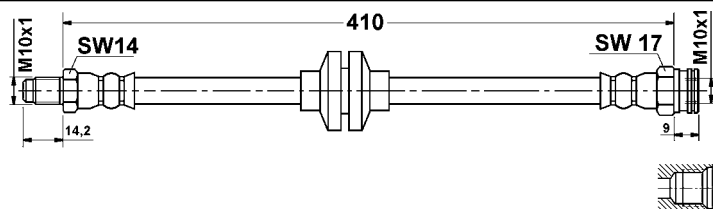

**24.5112-0402.3 331297**

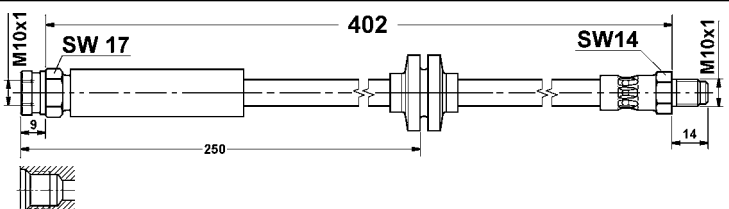

# Abbildungen Bremsschläuche, Kupplungsschläuche

Illustrations brake hoses, clutch hoses - Illustrations fessibilli freno, fessibilli frizione - Illustrations Flexible de frein, Flexibles d'embrayages - Ilustraciones flexibles de freno, flexibles d'embrague

**24.5112-0410.3 330494**

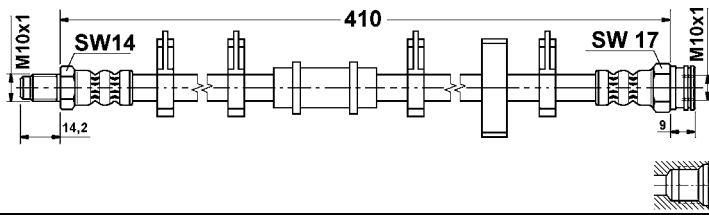

**24.5112-0412.3 330569**

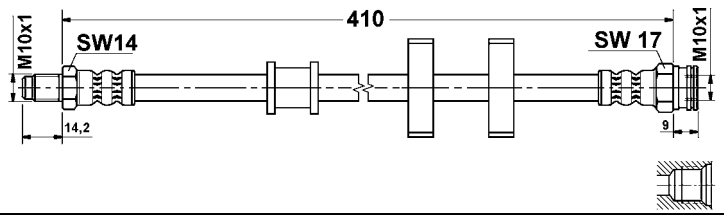

**24.5112-0413.3 331151**

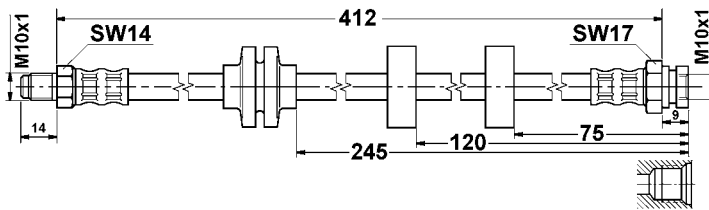

**24.5112-0417.3 331298**

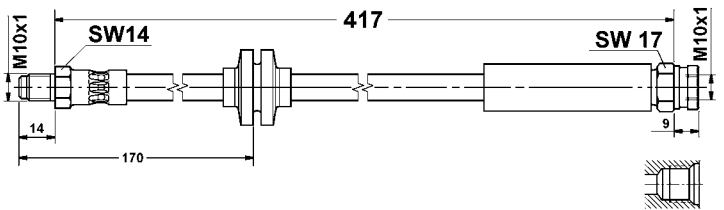

**24.5112-0430.3 330615**

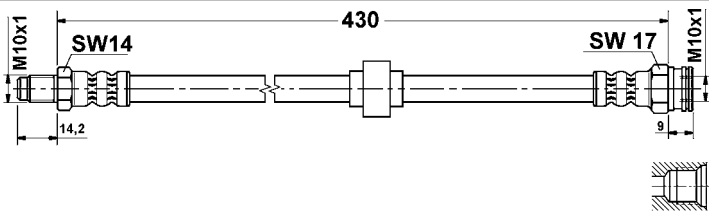

**24.5112-0433.3 330522**

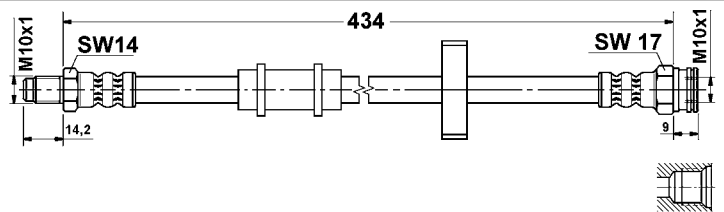

**24.5112-0435.3 330524**

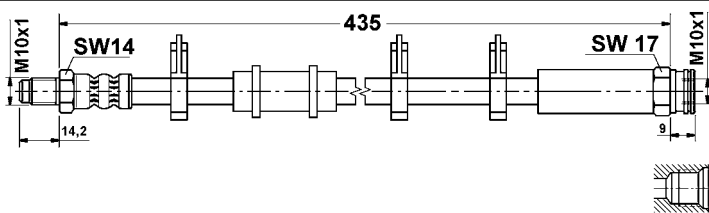

**24.5112-0436.3 330574**

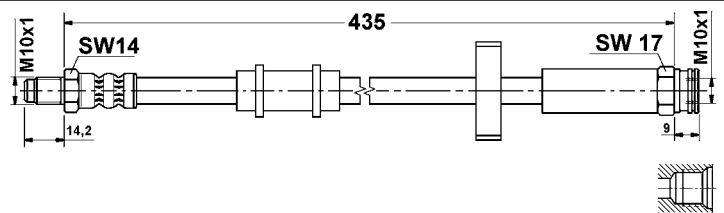

**24.5112-0437.3 330886**

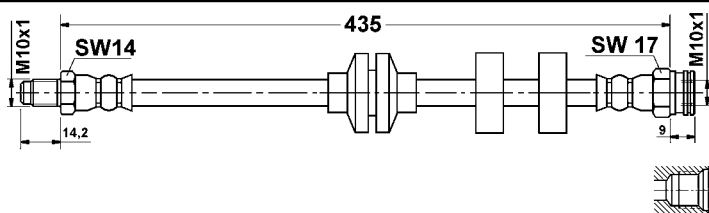

**24.5112-0440.3 330887**

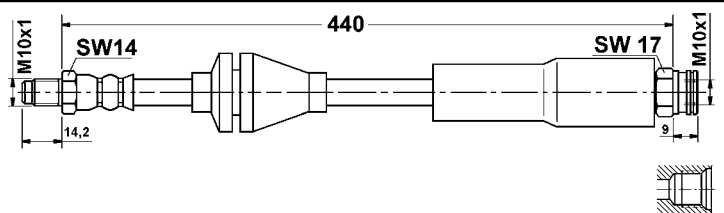

**24.5112-0445.3 330564**

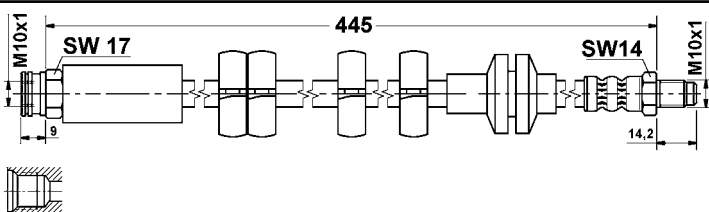

**24.5112-0455.3 330527**

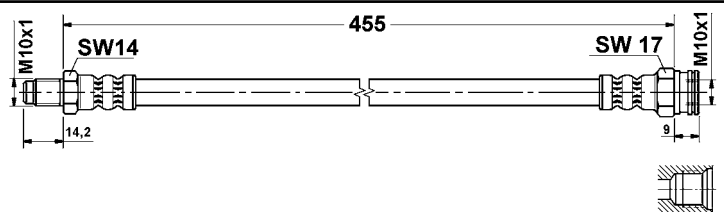

**24.5112-0456.3 330875**

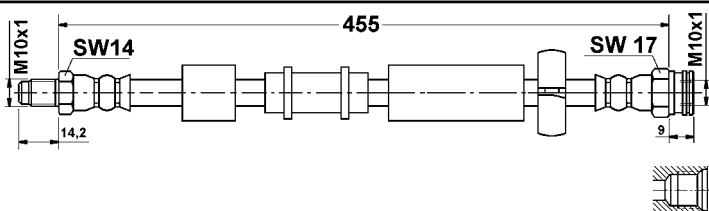

**24.5112-0460.3 330599**

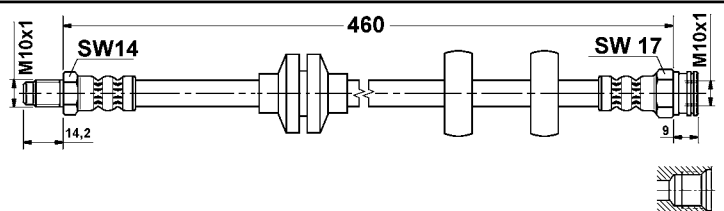

# Abbildungen Bremsschläuche, Kupplungsschläuche

Illustrations brake hoses, clutch hoses - Illustrations fessibili freno, fessibili frizione - Illustrations Flexible de frein, Flexibles d'embrayages - Ilustraciones flexibles de freno, flexibles d'embrague

**24.5112-0461.3 330616**

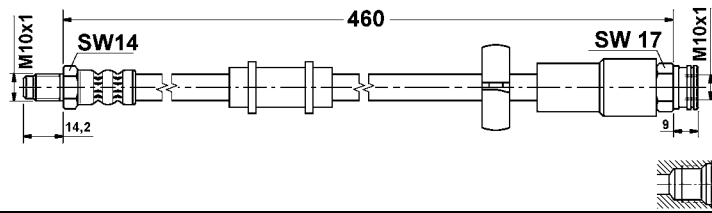

**24.5112-0465.3 330526**

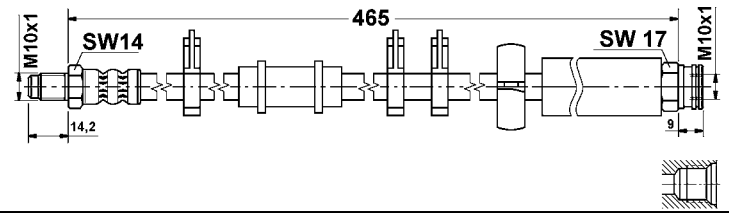

**24.5112-0466.3 330579**

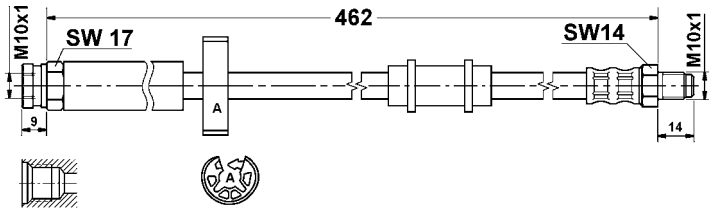

**24.5112-0475.3 330698**

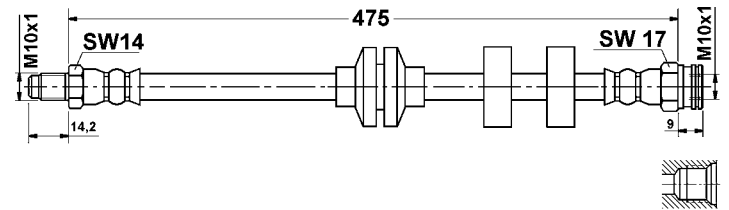

**24.5112-0490.3 330876**

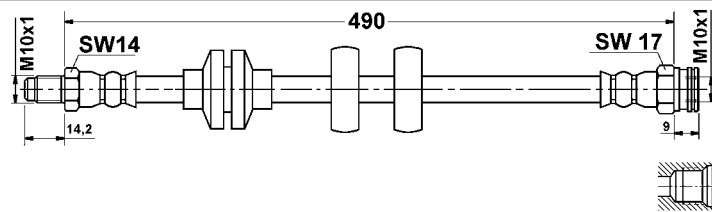

**24.5112-0492.3 331217**

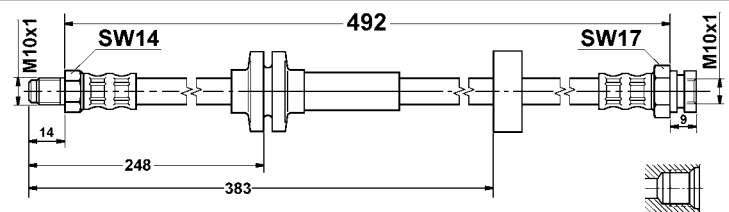

**24.5113-0275.3 330653**

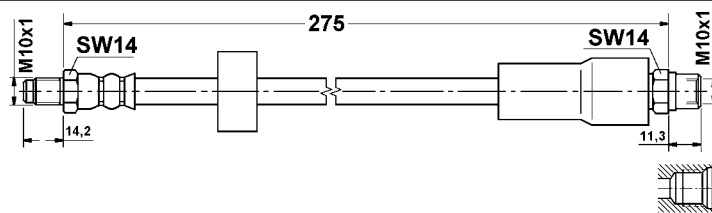

**24.5113-0280.3 330393**

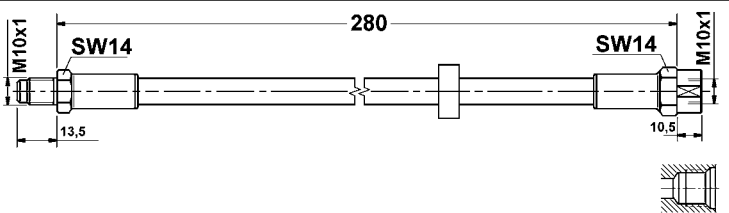

**24.5113-0440.3 331239**

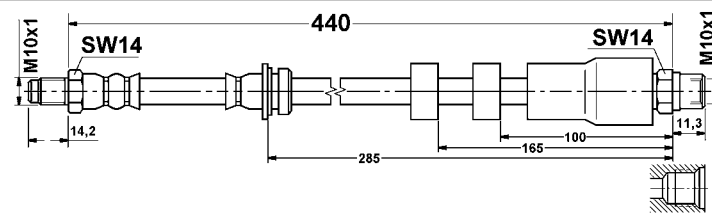

**24.5113-0515.3 330668**

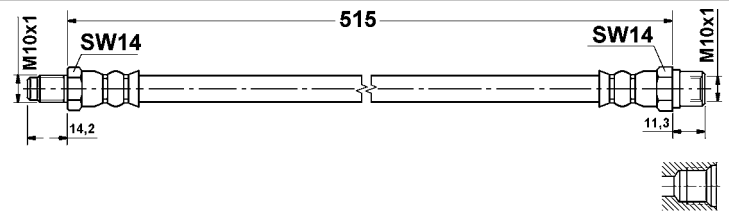

**24.5115-0400.3 330413**

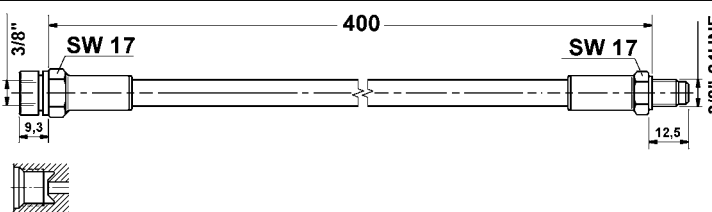

**24.5117-0195.3 330565**

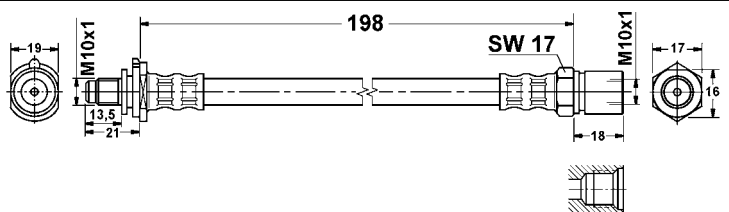

**24.5117-0205.3 330669**

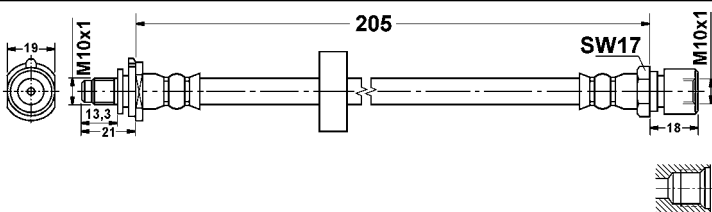

**24.5118-0420.3 330444**

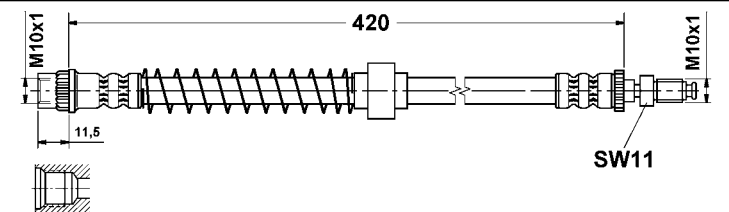

# Abbildungen Bremsschläuche, Kupplungsschläuche

Illustrations brake hoses, clutch hoses - Illustrations fessibilli freno, fessibilli frizione - Illustrations Flexible de frein, Flexibles d'embrayages - Ilustraciones flexibles de freno, flexibles d'embrague

**24.5118-0470.3 330462**

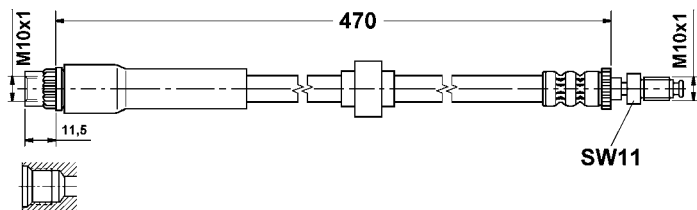

**24.5118-0471.3 330528**

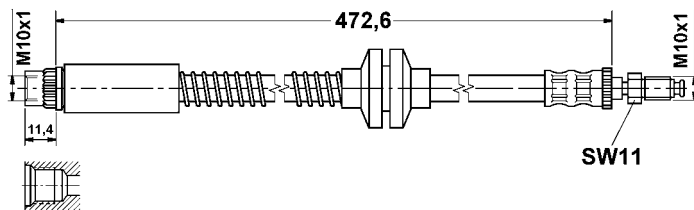

**24.5118-0520.3 330600**

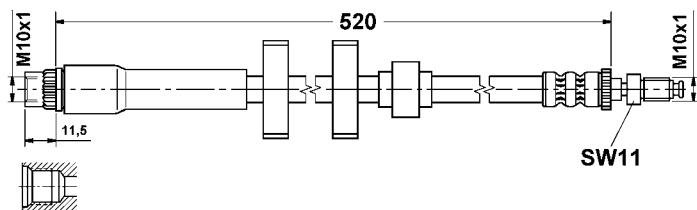

**24.5119-0435.3 330472**

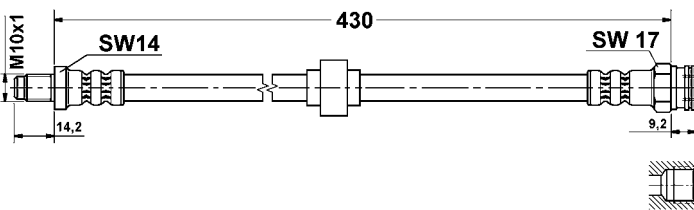

**24.5119-0447.3 330990**

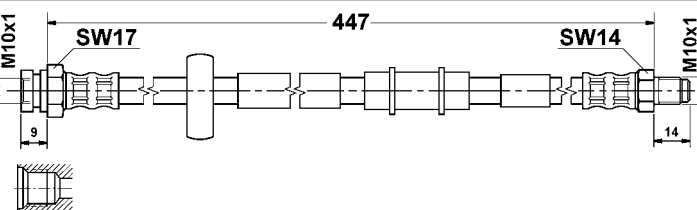

**24.5119-0477.3 330991**

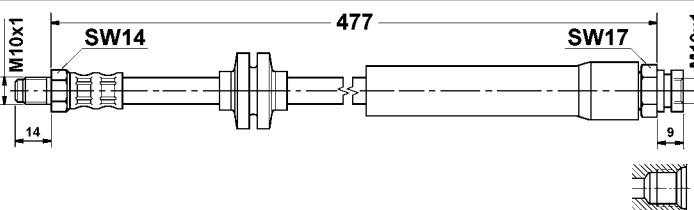

**24.5120-0435.3 330488**

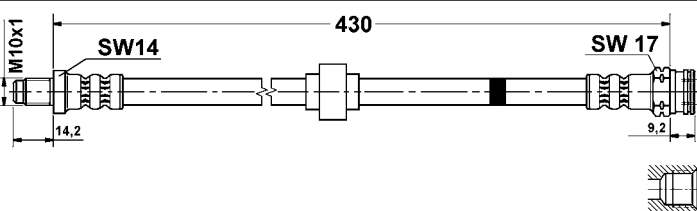

**24.5122-0460.3 330493**

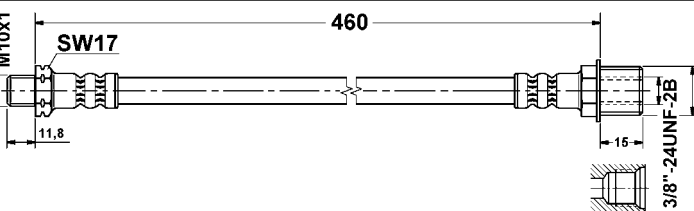

**24.5123-0240.3 330759**

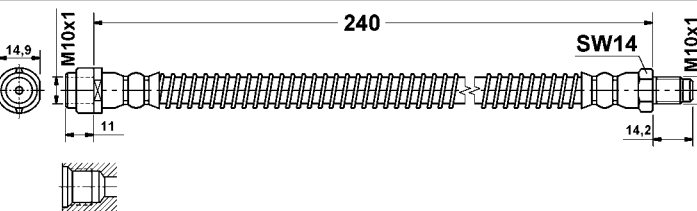

**24.5123-0295.3 330820**

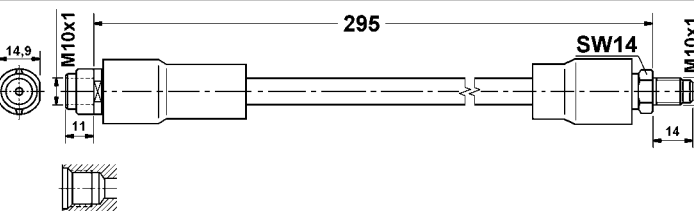

**24.5123-0328.3 330910**

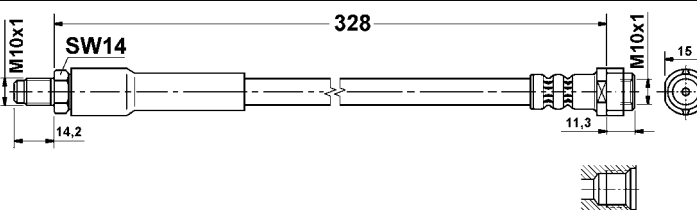

**24.5123-0350.3 330963**

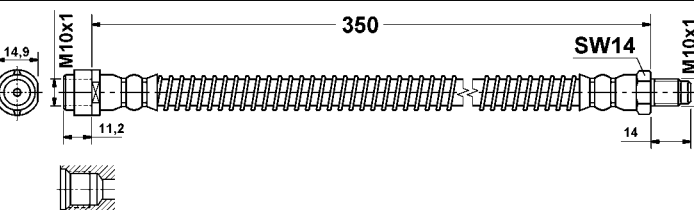

**24.5123-0380.3 331256**

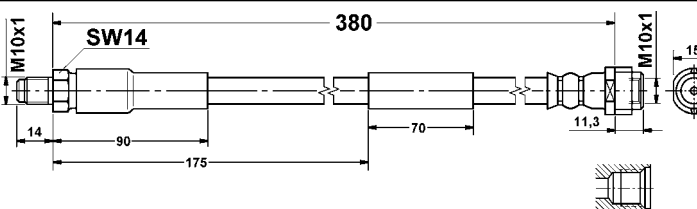

**24.5123-0545.3 331240**

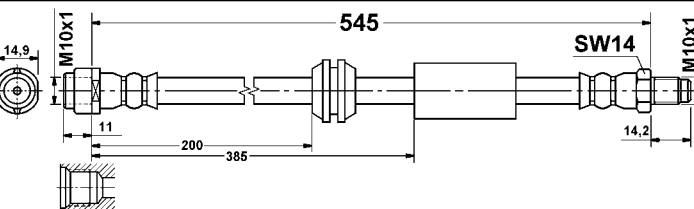

# Abbildungen Bremsschläuche, Kupplungsschläuche

Illustrations brake hoses, clutch hoses - Illustrations fessibilli freno, fessibilli frizione - Illustrations Flexible de frein, Flexibles d'embrayages - Ilustraciones flexibles de freno, flexibles d'embrague

**24.5123-0610.3 331241**

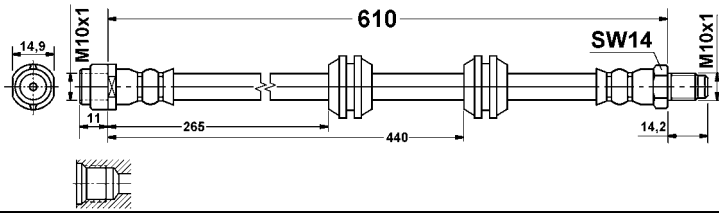

**24.5124-0252.3 331218**

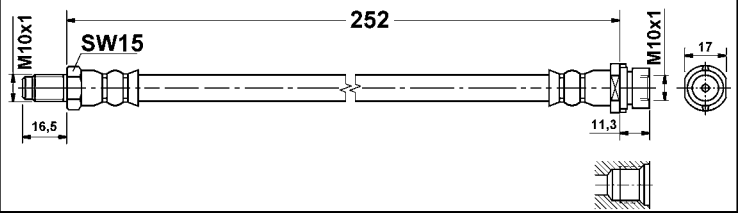

**24.5124-0390.3 331050**

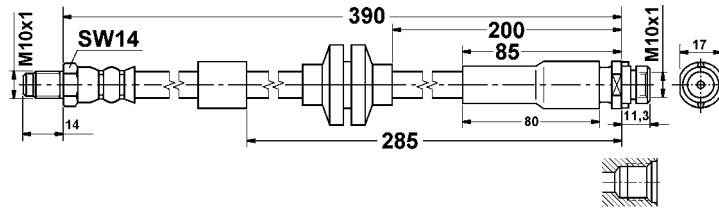

**24.5124-0410.3 330760**

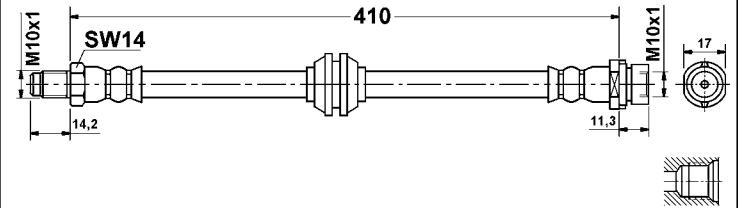

**24.5124-0411.3 330774**

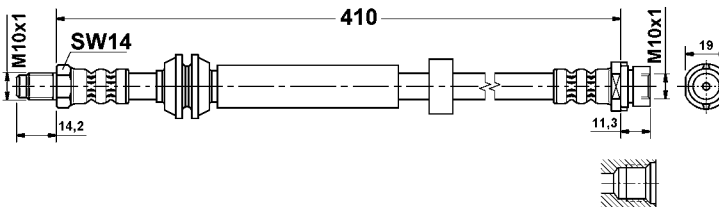

**24.5124-0420.3 331276**

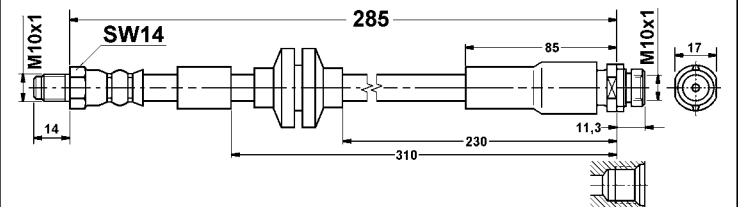

**24.5125-0230.3 331277**

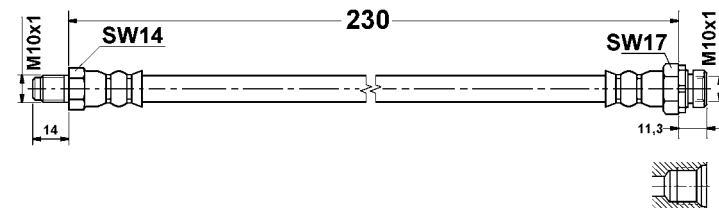

**24.5125-0323.3 330911**

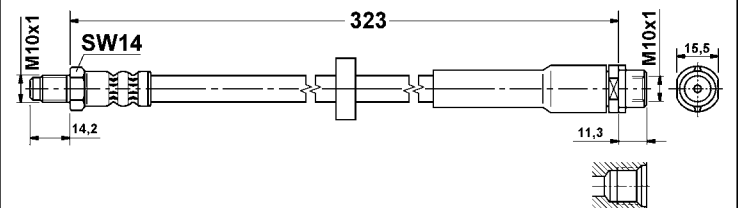

**24.5125-0415.3 330821**

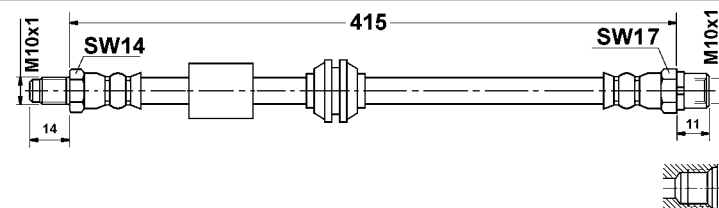

**24.5126-0474.3 331017**

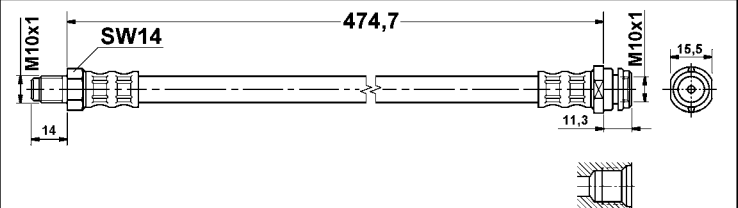

**24.5127-0305.3 330578**

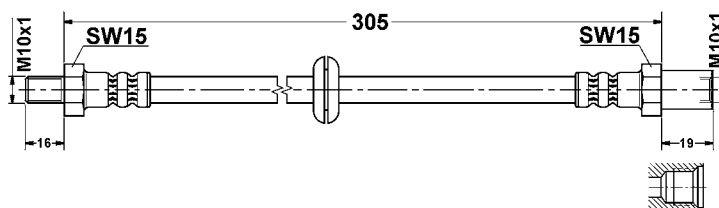

**24.5129-0395.3 330582**

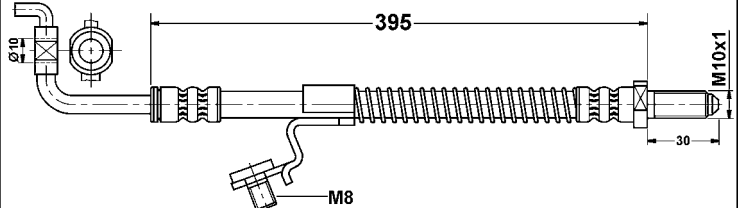

**24.5129-0396.3 330583**

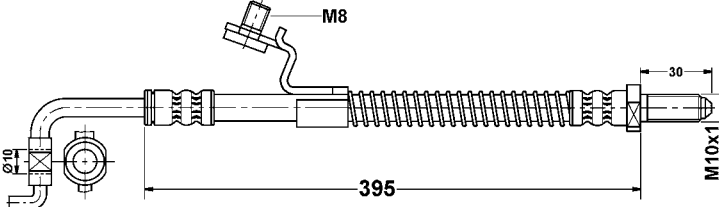

**24.5130-0526.3 330584**

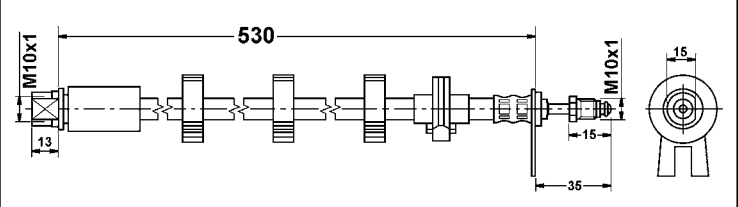



# Abbildungen Bremsschläuche, Kupplungsschläuche

Illustrations brake hoses, clutch hoses - Illustrations fessibilli freno, fessibilli frizione - Illustrations Flexible de frein, Flexibles d'embrayages - Ilustraciones flexibles de freno, flexibles d'embrague

**24.5130-0527.3 330585**

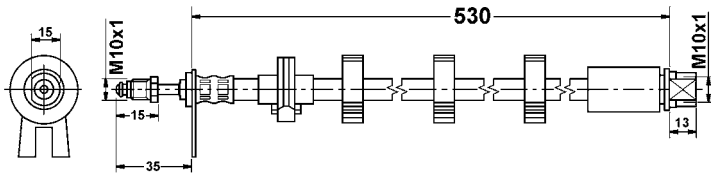

**24.5131-0415.3 331238**

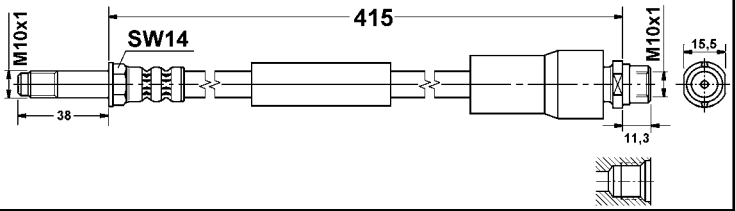

**24.5131-0495.3 330677**

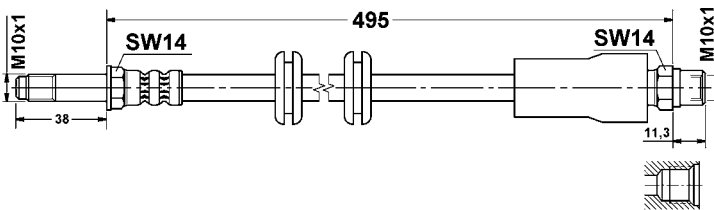

**24.5133-0310.3 331197**

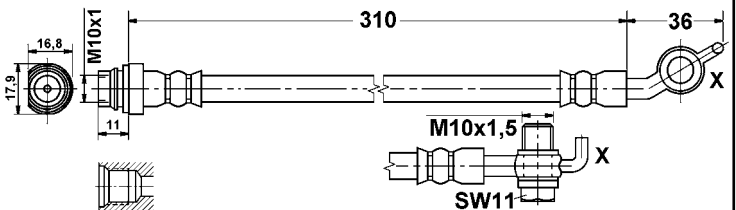

**24.5133-0311.3 331198**

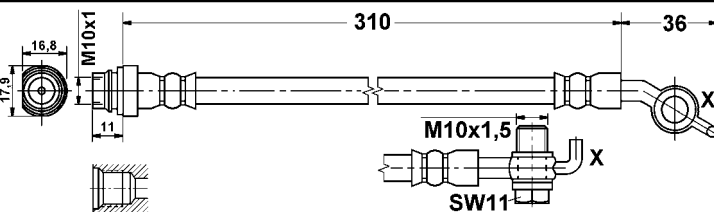

**24.5134-0457.3 330752**

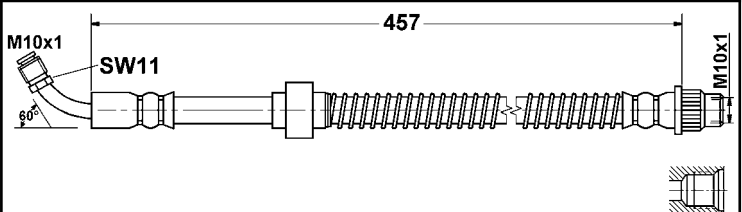

**24.5134-0468.3 330704**

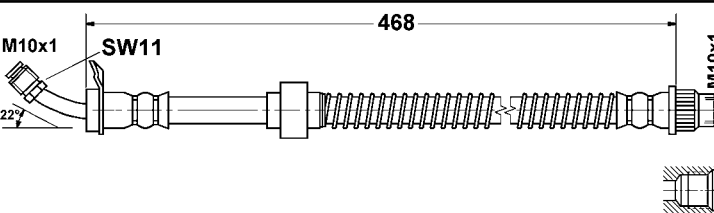

**24.5134-0518.3 330705**

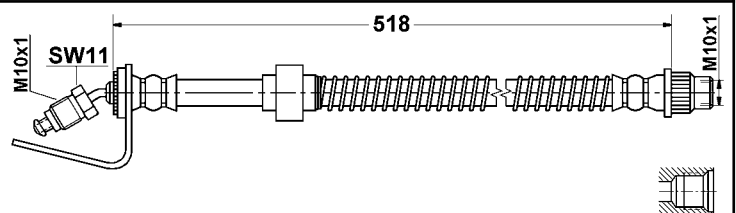

**24.5134-0562.3 330706**

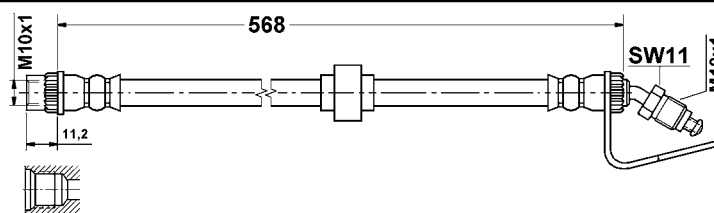

**24.5135-0280.3 330775**

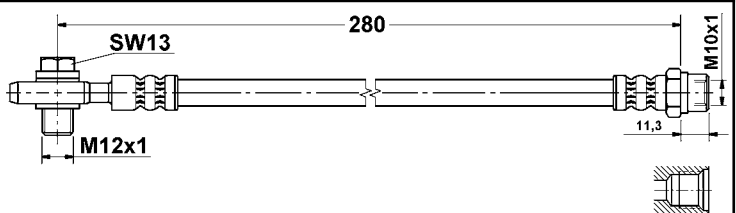

**24.5137-0190.3 330878**

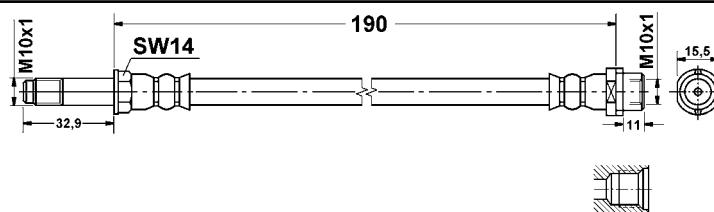

**24.5137-0221.3 331302**

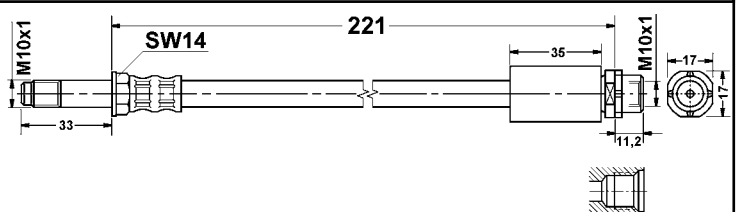

**24.5137-0365.3 331130**

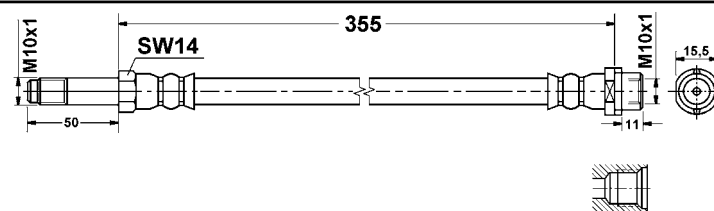

**24.5137-0385.3 331089**

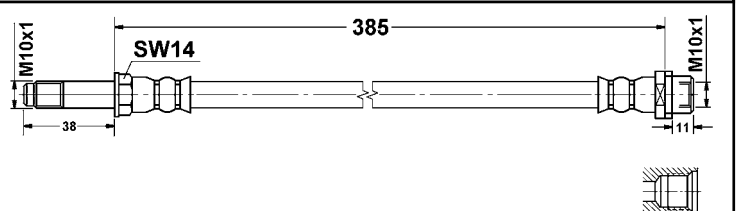

# Abbildungen Bremsschläuche, Kupplungsschläuche

Illustrations brake hoses, clutch hoses - Illustrations fessibilli freno, fessibilli frizione - Illustrations Flexible de frein, Flexibles d'embrayages - Ilustraciones flexibles de freno, flexibles d'embrague

|                                     |                                     |
|-------------------------------------|-------------------------------------|
| <p><b>24.5137-0455.3 331131</b></p> | <p><b>24.5137-0470.3 331090</b></p> |
| <p><b>24.5137-0490.3 330964</b></p> | <p><b>24.5137-0495.3 331132</b></p> |
| <p><b>24.5138-0263.3 330885</b></p> | <p><b>24.5140-0240.3 330947</b></p> |
| <p><b>24.5140-0241.3 330948</b></p> | <p><b>24.5140-0498.3 330912</b></p> |
| <p><b>24.5141-0320.3 330949</b></p> | <p><b>24.5141-0472.3 330915</b></p> |
| <p><b>24.5141-0473.3 331303</b></p> | <p><b>24.5142-0290.3 330950</b></p> |
| <p><b>24.5143-0257.3 331167</b></p> | <p><b>24.5143-0578.3 331168</b></p> |

# Abbildungen Bremsschläuche, Kupplungsschläuche

Illustrations brake hoses, clutch hoses - Illustrations fessibili freno, fessibili frizione - Illustrations Flexible de frein, Flexibles d'embrayages - Ilustraciones flexibles de freno, flexibles d'embrague

**24.5144-0410.3 331242**

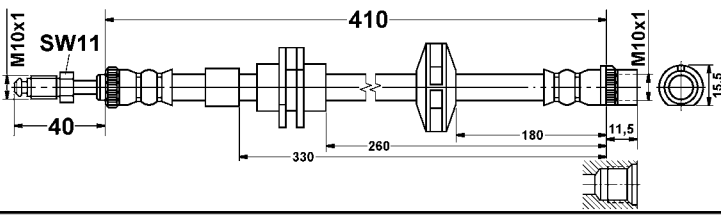

**24.5144-0455.3 331201**

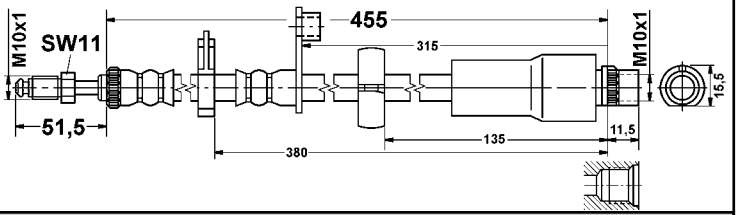

**24.5144-0480.3 330961**

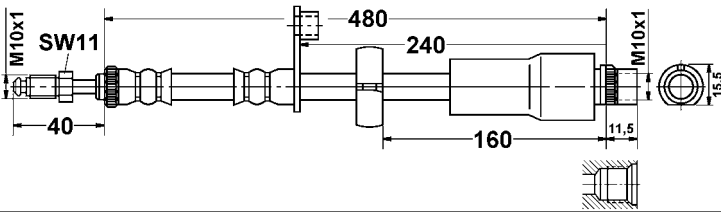

**24.5144-0500.3 331169**

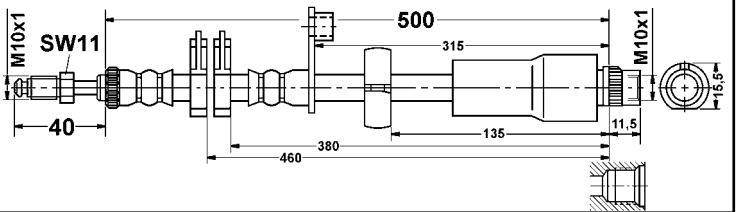

**24.5146-0330.3 330973**

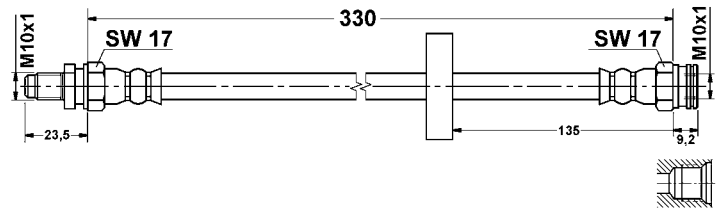

**24.5148-0354.3 330992**

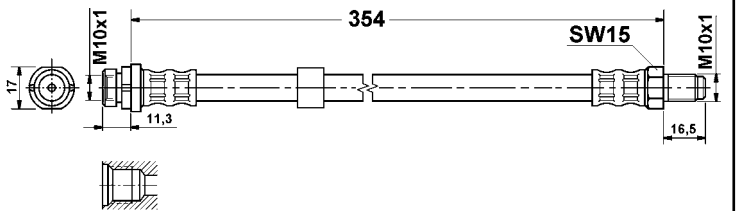

**24.5149-0431.3 330993**

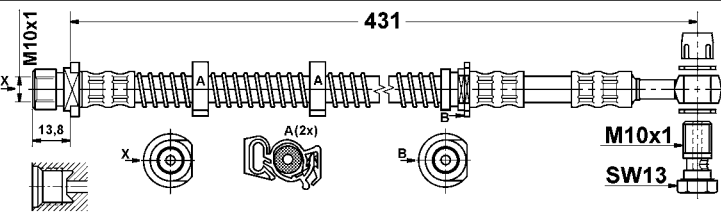

**24.5150-0459.3 331018**

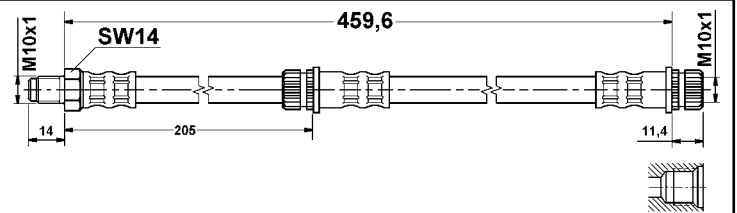

**24.5151-0583.3 331019**

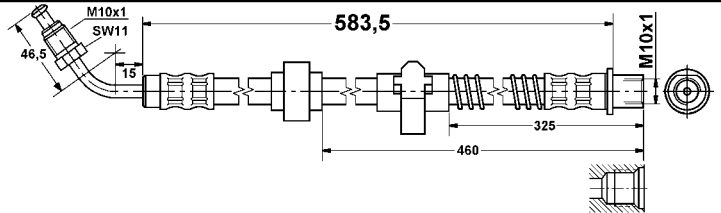

**24.5151-0584.3 331020**

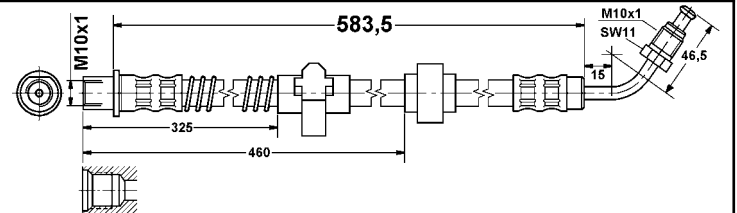

**24.5151-0638.3 331141**

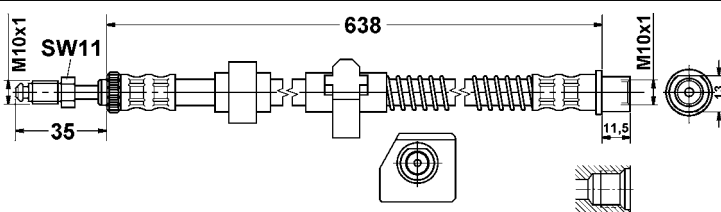

**24.5151-0639.3 331142**

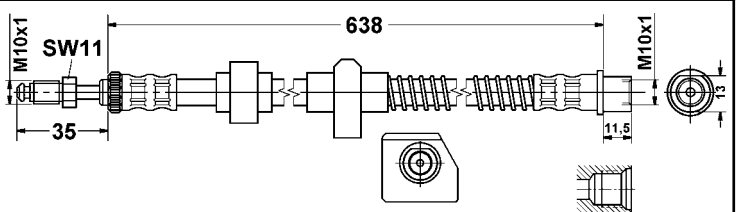

**24.5152-0218.3 331042**

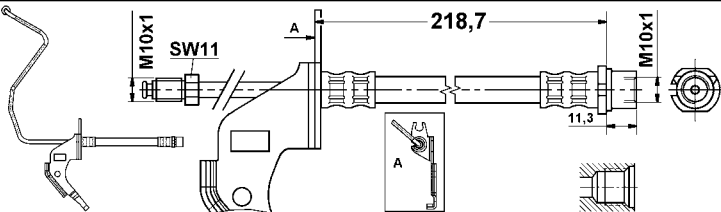

**24.5152-0219.3 331043**

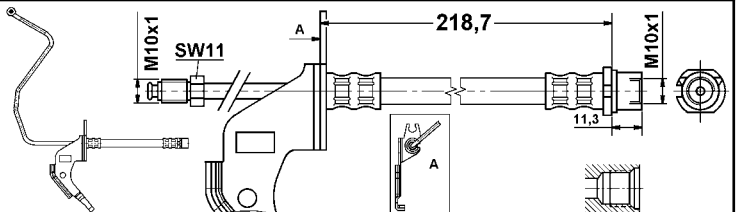

# Abbildungen Bremsschläuche, Kupplungsschläuche

Illustrations brake hoses, clutch hoses - Illustrations fessibili freno, fessibili frizione - Illustrations Flexible de frein, Flexibles d'embrayages - Ilustraciones flexibles de freno, flexibles d'embrague

**24.5153-0380.3 331044**

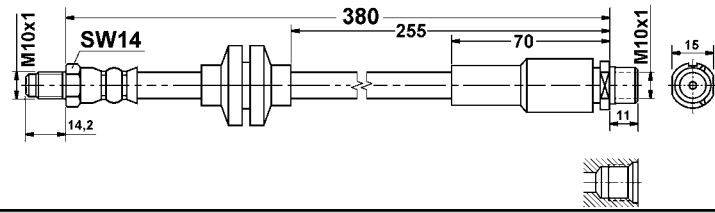

**24.5154-0190.3 331056**

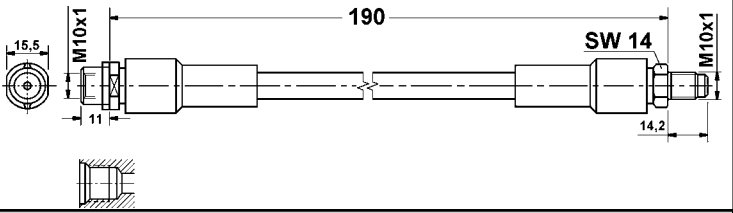

**24.5155-0445.3 331057**

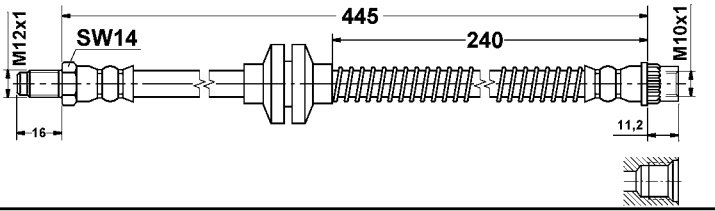

**24.5156-0230.3 331068**

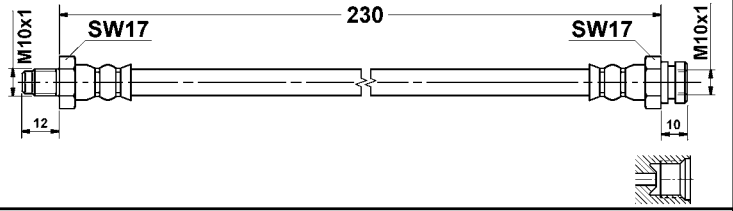

**24.5157-0218.3 331095**

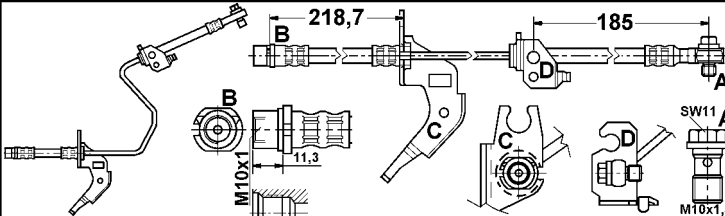

**24.5157-0219.3 331096**

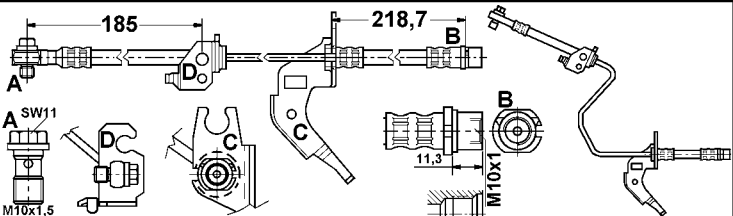

**24.5157-0273.3 331305**

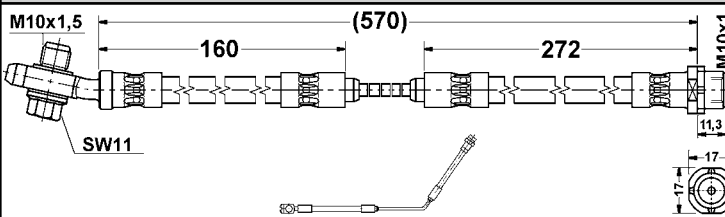

**24.5158-0164.3 331152**



**24.5159-0195.3 331153**

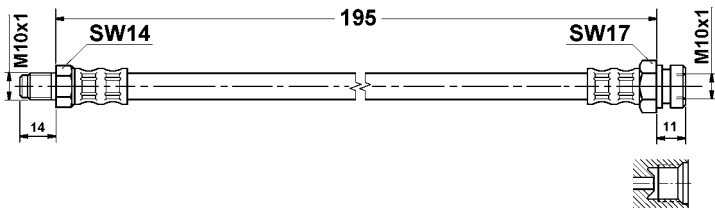

**24.5160-0215.3 331154**

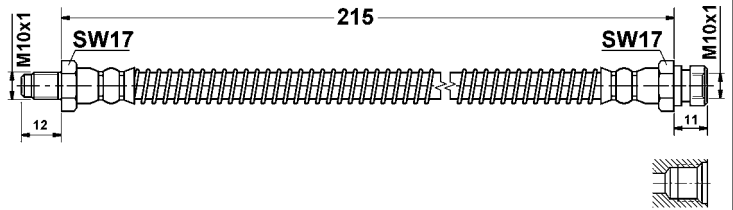

**24.5161-0313.3 331219**

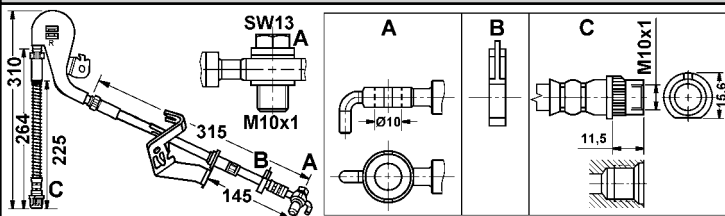

**24.5161-0314.3 331220**

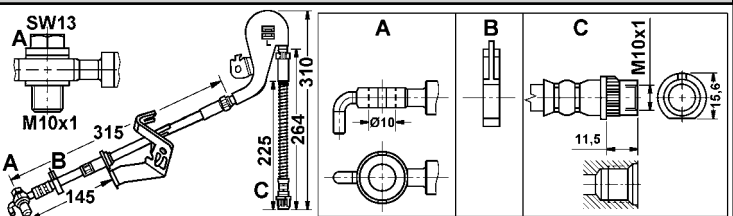

**24.5161-0315.3 331186**

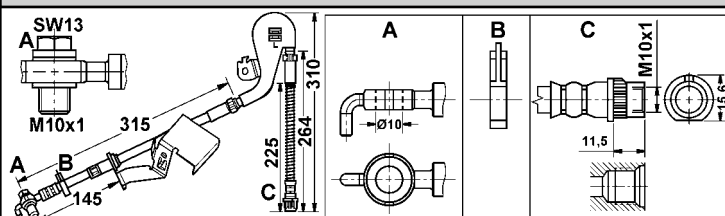

**24.5161-0316.3 331187**

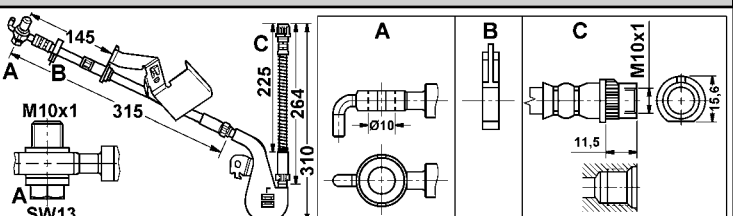

# Abbildungen Bremsschläuche, Kupplungsschläuche

Illustrations brake hoses, clutch hoses - Illustrations fessibilli freno, fessibilli frizione - Illustrations Flexible de frein, Flexibles d'embrayages - Ilustraciones flexibles de freno, flexibles d'embrague

|                                     |                                     |
|-------------------------------------|-------------------------------------|
| <p><b>24.5162-0185.3 331202</b></p> | <p><b>24.5162-0375.3 331203</b></p> |
| <p><b>24.5162-0390.3 331199</b></p> | <p><b>24.5162-0405.3 331194</b></p> |
| <p><b>24.5163-0155.3 331204</b></p> | <p><b>24.5164-0315.3 331209</b></p> |
| <p><b>24.5164-0316.3 331210</b></p> | <p><b>24.5164-0317.3 331211</b></p> |
| <p><b>24.5165-0350.3 331257</b></p> | <p><b>24.5165-0425.3 331258</b></p> |
| <p><b>24.5165-0450.3 331259</b></p> | <p><b>24.5166-0325.3 331293</b></p> |
| <p><b>24.5166-0454.3 331306</b></p> | <p><b>24.5167-0420.3 331278</b></p> |

# Abbildungen Bremsschläuche, Kupplungsschläuche

Illustrations brake hoses, clutch hoses - Illustrations fessibili freno, fessibili frizione - Illustrations Flexible de frein, Flexibles d'embrayages - Ilustraciones flexibles de freno, flexibles d'embrague

**24.5170-0361.3 331310**

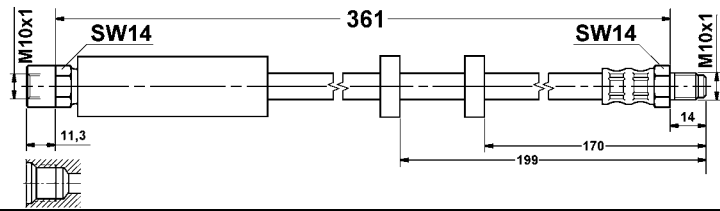

**24.5171-0393.3 331311**

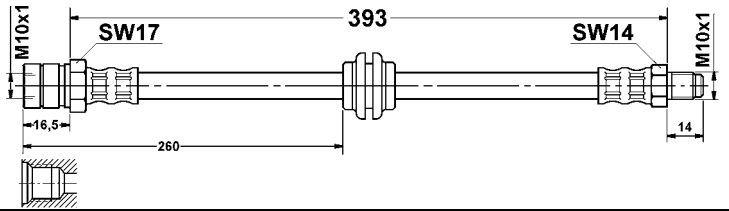

**24.5201-0220.3 331272**

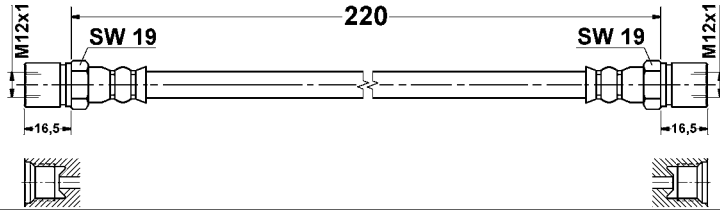

**24.5205-0205.3 330780**

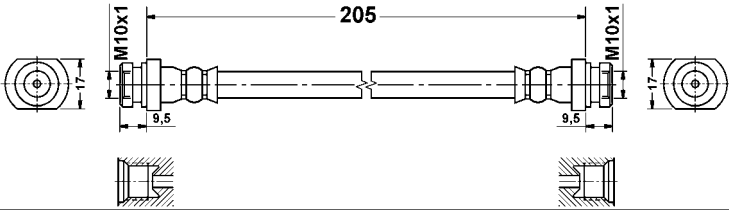

**24.5207-0205.3 330042**

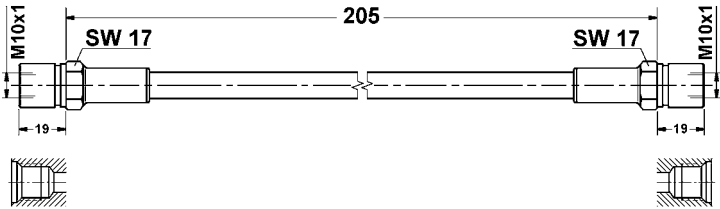

**24.5209-0250.3 330043**

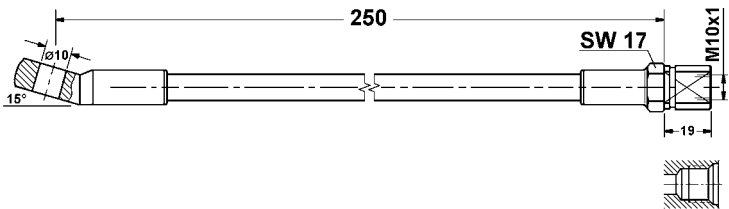

**24.5209-0280.3 330044**

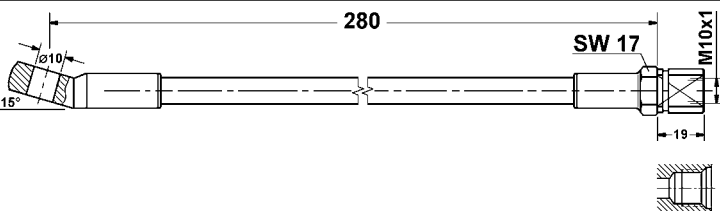

**24.5209-0353.3 330046**

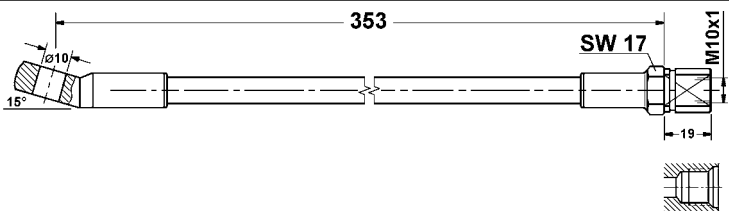

**24.5223-0294.3 330576**

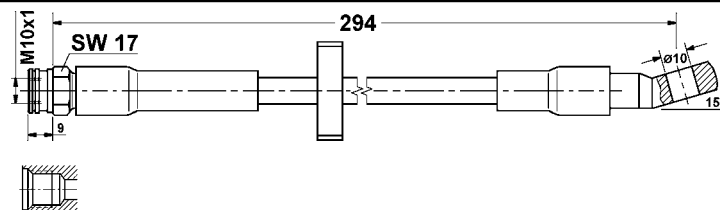

**24.5224-0240.3 331260**

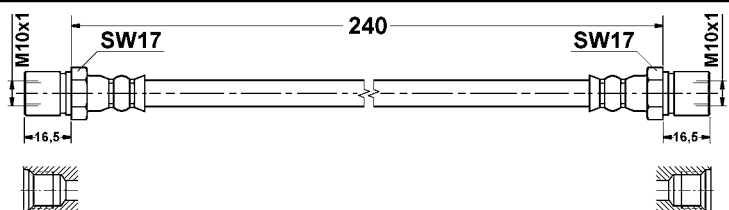

**24.5224-0295.3 331261**

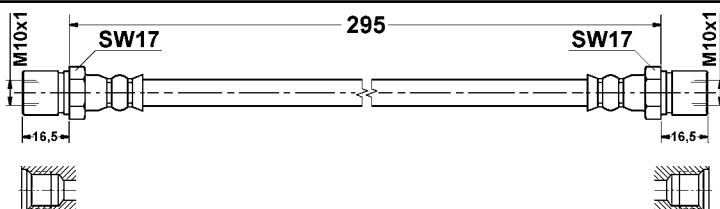

**24.5224-0299.3 331262**

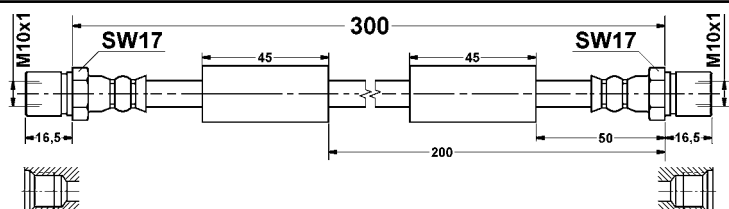

**24.5224-0330.3 331263**

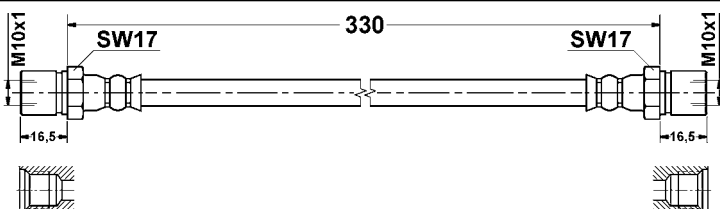

**24.5224-0460.3 331264**

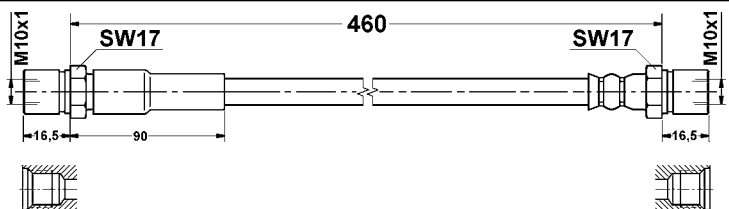



# Abbildungen Bremsschläuche, Kupplungsschläuche

Illustrations brake hoses, clutch hoses - Illustrations fessibilli freno, fessibilli frizione - Illustrations

Flexible de frein, Flexibles d'embrayages - Ilustraciones flexibles de freno, flexibles d'embrague

**24.5225-0300.3 331266**

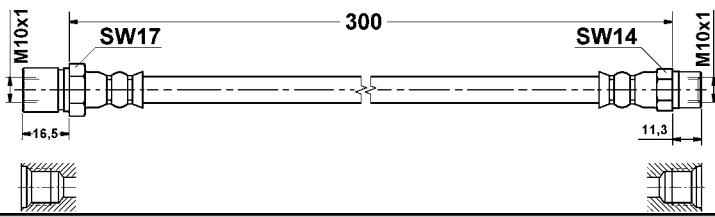

**24.5226-0485.3 331048**

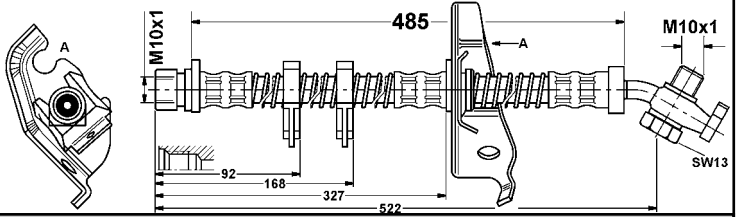

**24.5226-0489.3 331049**

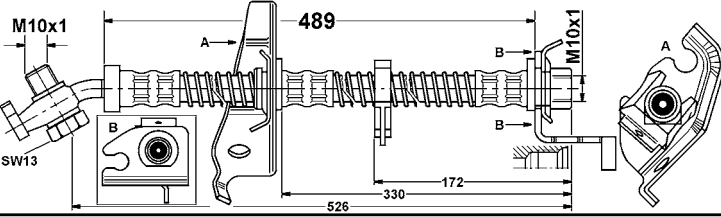

**24.5228-0165.3 330879**

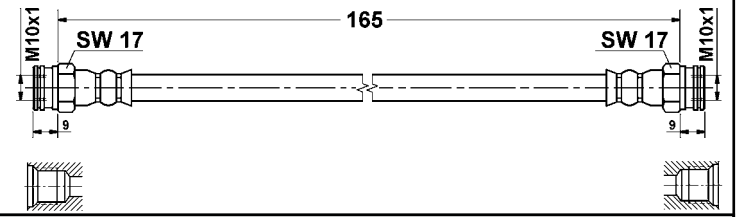

**24.5228-0180.3 330761**

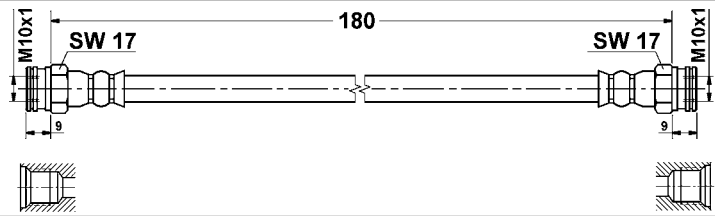

**24.5228-0181.3 331279**

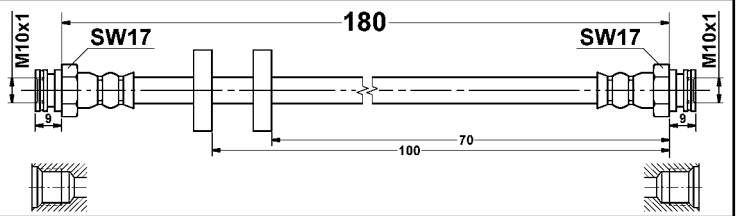

**24.5228-0185.3 330107**

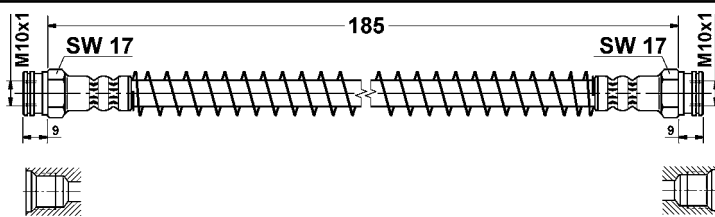

**24.5228-0195.3 330469**

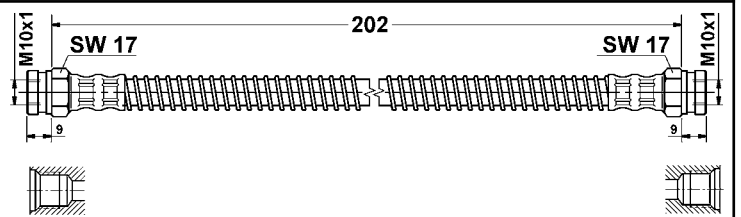

**24.5228-0196.3 330656**

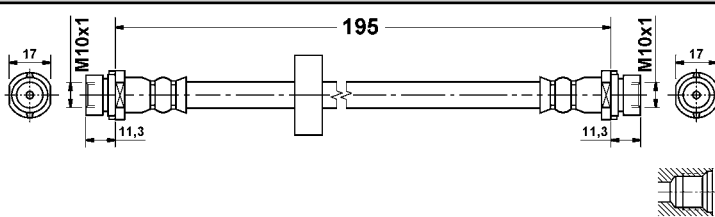

**24.5228-0200.3 330470**

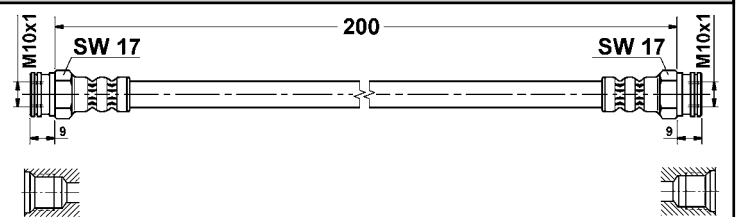

**24.5228-0215.3 330529**

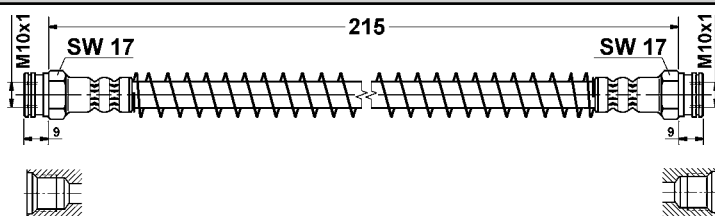

**24.5228-0216.3 330908**

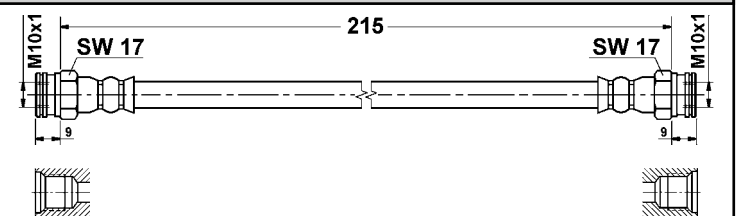

**24.5228-0223.3 330530**

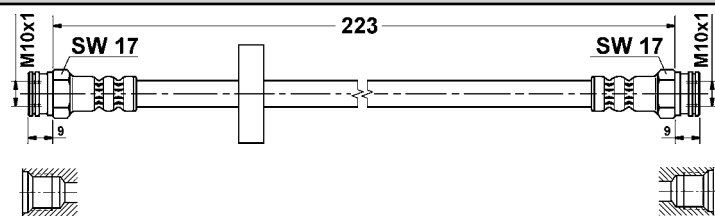

**24.5228-0235.3 330395**

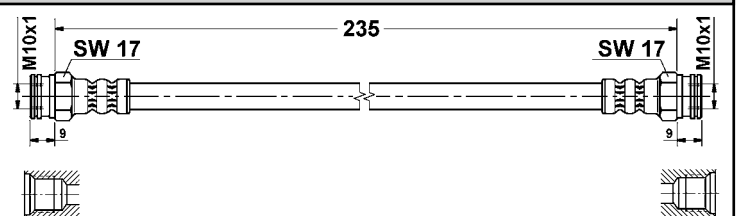

# Abbildungen Bremsschläuche, Kupplungsschläuche

Illustrations brake hoses, clutch hoses - Illustrations fessibili freno, fessibili frizione - Illustrations Flexible de frein, Flexibles d'embrayages - Ilustraciones flexibles de freno, flexibles d'embrague

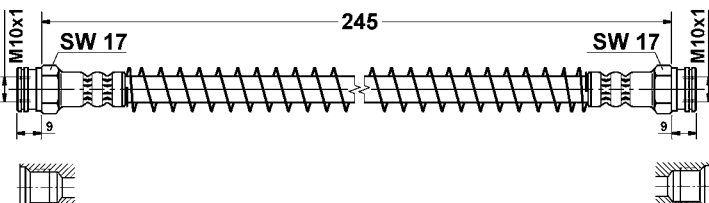
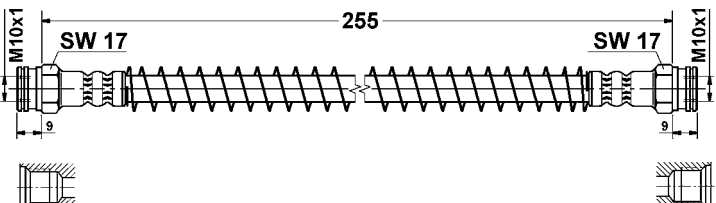
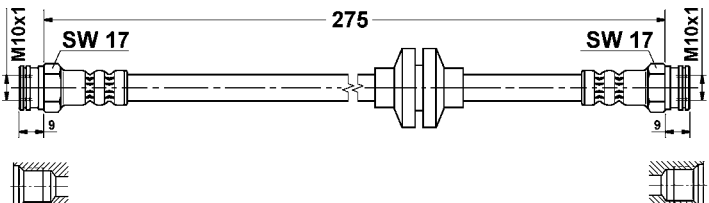
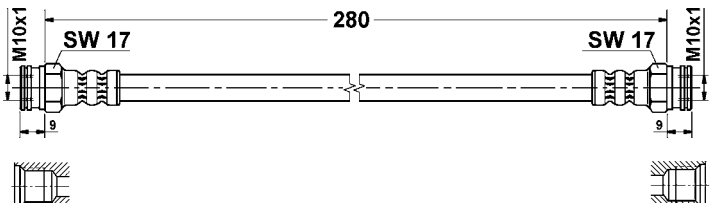
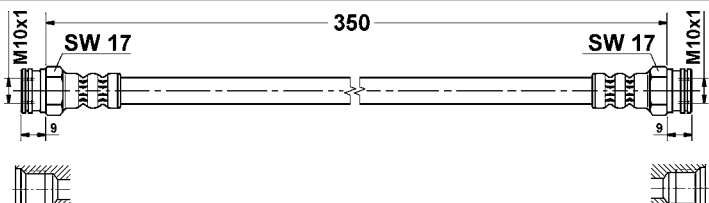
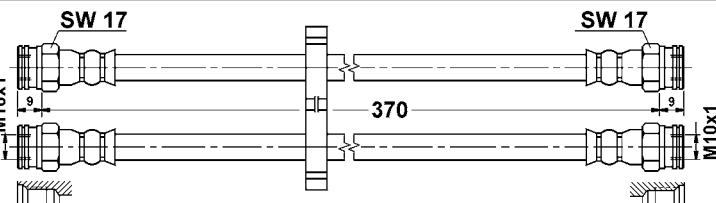
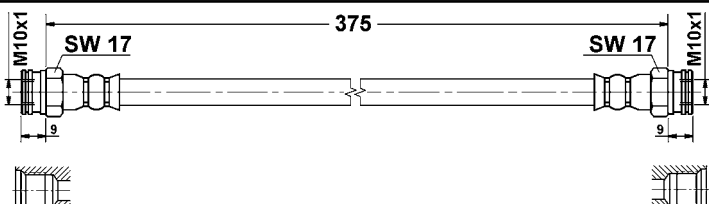
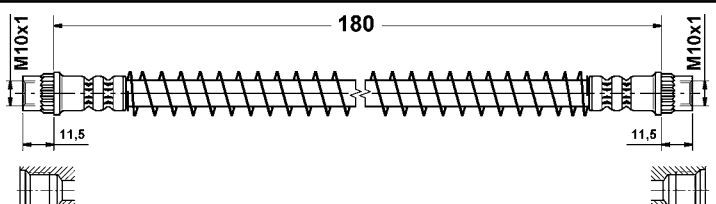
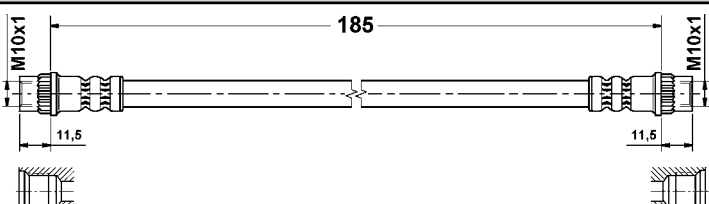
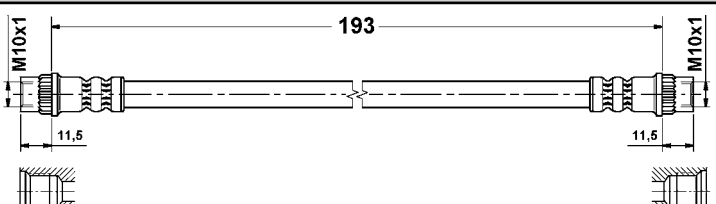
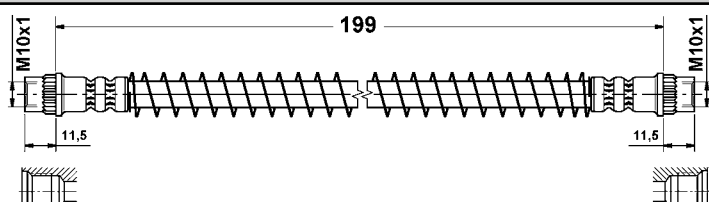
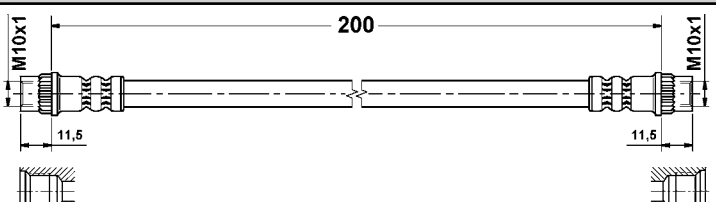
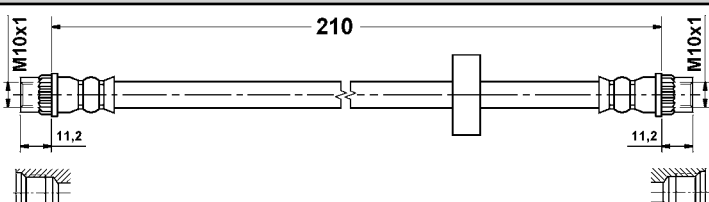
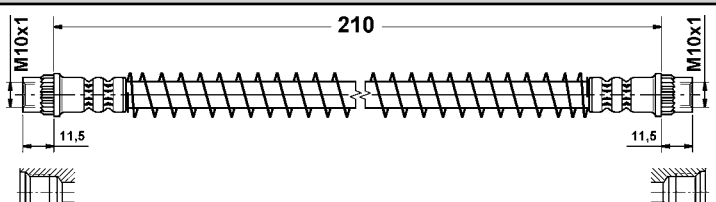
|  |  |
|--|--|
| <p><b>24.5228-0245.3 330531</b></p>    | <p><b>24.5228-0255.3 330409</b></p>    |
| <p><b>24.5228-0275.3 330035</b></p>    | <p><b>24.5228-0280.3 330532</b></p>    |
| <p><b>24.5228-0350.3 330396</b></p>   | <p><b>24.5228-0370.3 330762</b></p>   |
| <p><b>24.5228-0375.3 330699</b></p>  | <p><b>24.5229-0181.3 330533</b></p>  |
| <p><b>24.5229-0185.3 330397</b></p>  | <p><b>24.5229-0193.3 330571</b></p>  |
| <p><b>24.5229-0199.3 330534</b></p>  | <p><b>24.5229-0200.3 330572</b></p>  |
| <p><b>24.5229-0209.3 330670</b></p>  | <p><b>24.5229-0211.3 330573</b></p>  |

# Abbildungen Bremsschläuche, Kupplungsschläuche

Illustrations brake hoses, clutch hoses - Illustrations fessibilli freno, fessibilli frizione - Illustrations Flexible de frein, Flexibles d'embrayages - Ilustraciones flexibles de freno, flexibles d'embrague

**24.5229-0220.3 330399**

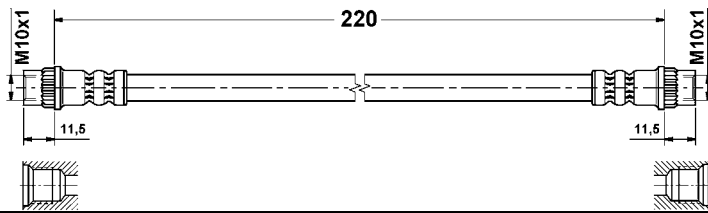

**24.5229-0235.3 330671**

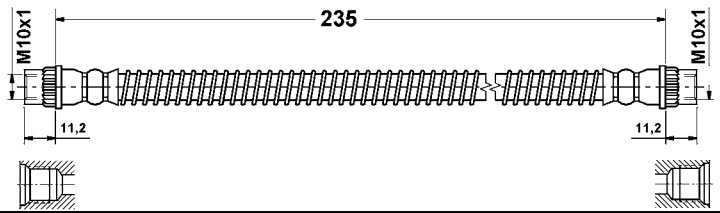

**24.5229-0240.3 330400**

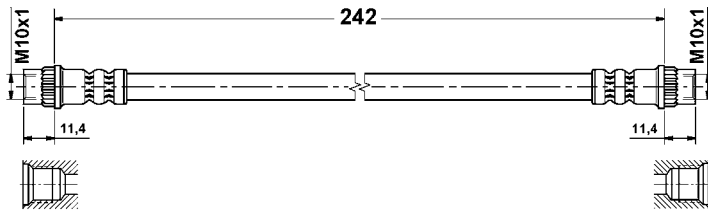

**24.5229-0251.3 330535**

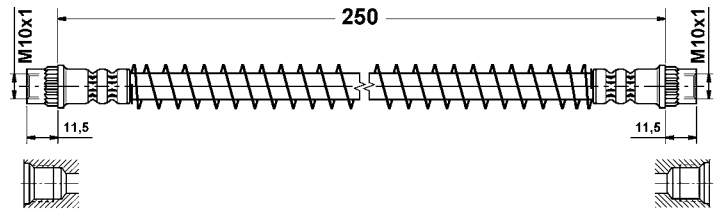

**24.5229-0255.3 330581**

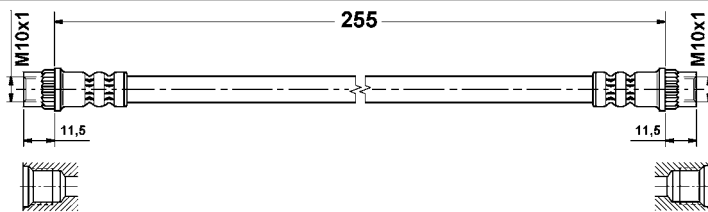

**24.5229-0265.3 330540**

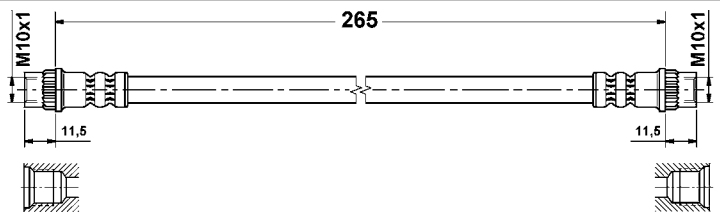

**24.5229-0285.3 330032**

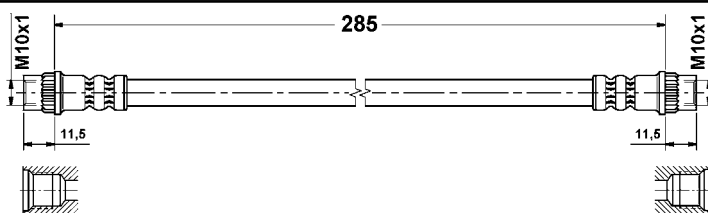

**24.5229-0325.3 330617**

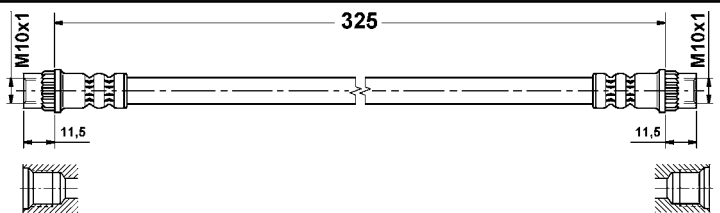

**24.5230-0143.3 330402**

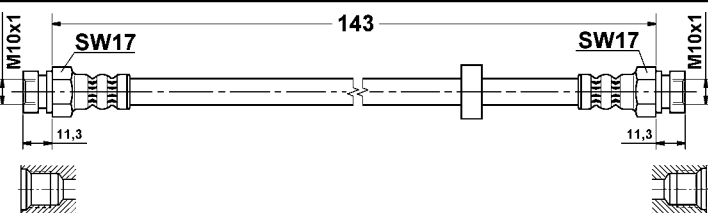

**24.5230-0243.3 331155**

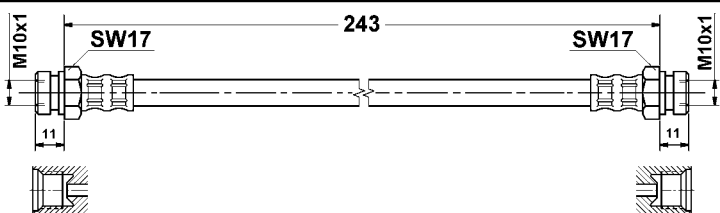

**24.5231-0320.3 330496**

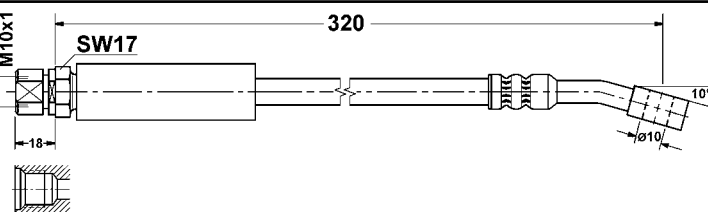

**24.5232-0388.3 330580**

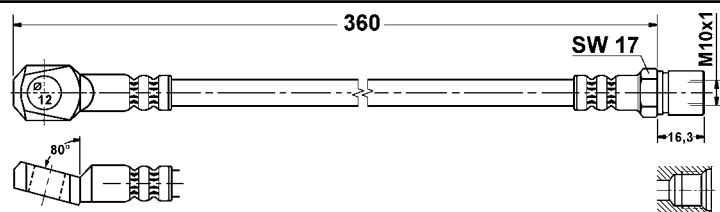

**24.5233-0180.3 330888**

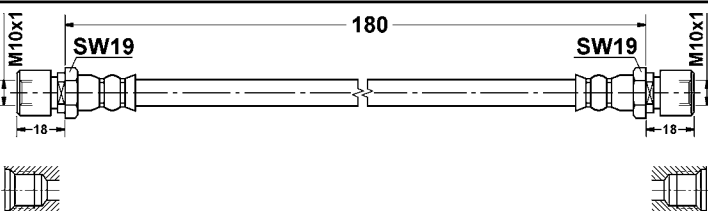

**24.5233-0200.3 330425**

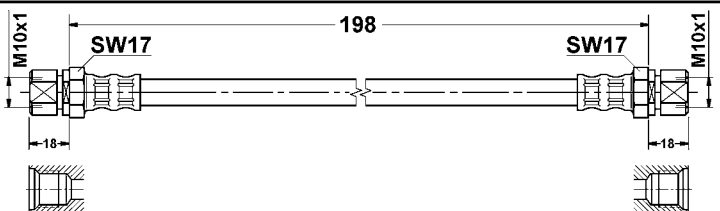

# Abbildungen Bremsschläuche, Kupplungsschläuche

Illustrations brake hoses, clutch hoses - Illustrations fessibili freno, fessibili frizione - Illustrations Flexible de frein, Flexibles d'embrayages - Ilustraciones flexibles de freno, flexibles d'embrague

|                                     |                                     |
|-------------------------------------|-------------------------------------|
| <p><b>24.5235-0190.3 330916</b></p> | <p><b>24.5235-0200.3 331280</b></p> |
| <p><b>24.5235-0205.3 331093</b></p> | <p><b>24.5235-0250.3 330917</b></p> |
| <p><b>24.5235-0275.3 331179</b></p> | <p><b>24.5235-0360.3 331058</b></p> |
| <p><b>24.5236-0429.3 330586</b></p> | <p><b>24.5236-0430.3 330587</b></p> |
| <p><b>24.5237-0235.3 330781</b></p> | <p><b>24.5237-0360.3 331212</b></p> |
| <p><b>24.5237-0490.3 330672</b></p> | <p><b>24.5238-0230.3 330673</b></p> |
| <p><b>24.5238-0255.3 330674</b></p> | <p><b>24.5239-0165.3 330606</b></p> |

# Abbildungen Bremsschläuche, Kupplungsschläuche

Illustrations brake hoses, clutch hoses - Illustrations fessibilli freno, fessibilli frizione - Illustrations Flexible de frein, Flexibles d'embrayages - Ilustraciones flexibles de freno, flexibles d'embrague

|                                     |                                     |
|-------------------------------------|-------------------------------------|
| <p><b>24.5239-0190.3 330966</b></p> | <p><b>24.5239-0240.3 331170</b></p> |
| <p><b>24.5239-0260.3 331171</b></p> | <p><b>24.5239-0355.3 331243</b></p> |
| <p><b>24.5239-0365.3 331281</b></p> | <p><b>24.5240-0195.3 330753</b></p> |
| <p><b>24.5240-0220.3 330619</b></p> | <p><b>24.5241-0200.3 330620</b></p> |
| <p><b>24.5241-0401.3 331021</b></p> | <p><b>24.5241-0430.3 330918</b></p> |
| <p><b>24.5242-0190.3 330675</b></p> | <p><b>24.5243-0190.3 330678</b></p> |
| <p><b>24.5243-0310.3 330755</b></p> | <p><b>24.5244-0240.3 330679</b></p> |

# Abbildungen Bremsschläuche, Kupplungsschläuche

Illustrations brake hoses, clutch hoses - Illustrations fessibili freno, fessibili frizione - Illustrations Flexible de frein, Flexibles d'embrayages - Ilustraciones flexibles de freno, flexibles d'embrague

|                                     |                                     |
|-------------------------------------|-------------------------------------|
| <p><b>24.5245-0398.3 331188</b></p> | <p><b>24.5245-0405.3 330686</b></p> |
| <p><b>24.5246-0185.3 330881</b></p> | <p><b>24.5246-0190.3 330697</b></p> |
| <p><b>24.5246-0216.3 331022</b></p> | <p><b>24.5246-0260.3 330782</b></p> |
| <p><b>24.5247-0195.3 330919</b></p> | <p><b>24.5247-0205.3 331094</b></p> |
| <p><b>24.5247-0210.3 331023</b></p> | <p><b>24.5247-0275.3 331244</b></p> |
| <p><b>24.5247-0276.3 331245</b></p> | <p><b>24.5247-0280.3 330700</b></p> |
| <p><b>24.5247-0281.3 330967</b></p> | <p><b>24.5247-0310.3 330951</b></p> |



# Abbildungen Bremsschläuche, Kupplungsschläuche

Illustrations brake hoses, clutch hoses - Illustrations fessibilli freno, fessibilli frizione - Illustrations Flexible de frein, Flexibles d'embrayages - Ilustraciones flexibles de freno, flexibles d'embrague

|                                     |                                     |
|-------------------------------------|-------------------------------------|
| <p><b>24.5247-0311.3 330952</b></p> | <p><b>24.5248-0461.3 330707</b></p> |
| <p><b>24.5248-0466.3 330920</b></p> | <p><b>24.5248-0467.3 330921</b></p> |
| <p><b>24.5249-0416.3 330708</b></p> | <p><b>24.5250-0313.3 331024</b></p> |
| <p><b>24.5251-0185.3 330701</b></p> | <p><b>24.5251-0465.3 330822</b></p> |
| <p><b>24.5252-0390.3 330702</b></p> | <p><b>24.5254-0435.3 330763</b></p> |
| <p><b>24.5256-0298.3 330756</b></p> | <p><b>24.5257-0480.3 330823</b></p> |
| <p><b>24.5258-0450.3 330824</b></p> | <p><b>24.5259-0315.3 330882</b></p> |

# Abbildungen Bremsschläuche, Kupplungsschläuche

Illustrations brake hoses, clutch hoses - Illustrations fessibili freno, fessibili frizione - Illustrations Flexible de frein, Flexibles d'embrayages - Ilustraciones flexibles de freno, flexibles d'embrague

|                                     |                                     |
|-------------------------------------|-------------------------------------|
| <p><b>24.5260-0155.3 331156</b></p> | <p><b>24.5260-0280.3 330883</b></p> |
| <p><b>24.5261-0195.3 331077</b></p> | <p><b>24.5261-0225.3 330909</b></p> |
| <p><b>24.5261-0255.3 331078</b></p> | <p><b>24.5261-0256.3 331246</b></p> |
| <p><b>24.5261-0291.3 330994</b></p> | <p><b>24.5262-0180.3 331180</b></p> |
| <p><b>24.5262-0501.3 331025</b></p> | <p><b>24.5262-0575.3 330922</b></p> |
| <p><b>24.5262-0576.3 330923</b></p> | <p><b>24.5263-0440.3 331282</b></p> |
| <p><b>24.5263-0441.3 331283</b></p> | <p><b>24.5263-0575.3 330924</b></p> |

# Abbildungen Bremsschläuche, Kupplungsschläuche

Illustrations brake hoses, clutch hoses - Illustrations fessibilli freno, fessibilli frizione - Illustrations Flexible de frein, Flexibles d'embrayages - Ilustraciones flexibles de freno, flexibles d'embrague

|                                     |                                     |
|-------------------------------------|-------------------------------------|
| <p><b>24.5263-0576.3 330925</b></p> | <p><b>24.5263-0592.3 331284</b></p> |
| <p><b>24.5263-0593.3 331285</b></p> | <p><b>24.5263-0594.3 331286</b></p> |
| <p><b>24.5263-0595.3 331287</b></p> | <p><b>24.5264-0205.3 331059</b></p> |
| <p><b>24.5264-0221.3 330995</b></p> | <p><b>24.5264-0245.3 331133</b></p> |
| <p><b>24.5264-0525.3 330926</b></p> | <p><b>24.5264-0526.3 330927</b></p> |
| <p><b>24.5265-0263.3 331157</b></p> | <p><b>24.5265-0264.3 331158</b></p> |
| <p><b>24.5265-0275.3 331069</b></p> | <p><b>24.5265-0335.3 331070</b></p> |

# Abbildungen Bremsschläuche, Kupplungsschläuche

Illustrations brake hoses, clutch hoses - Illustrations fessibilli freno, fessibilli frizione - Illustrations Flexible de frein, Flexibles d'embrayages - Ilustraciones flexibles de freno, flexibles d'embrague

**24.5265-0345.3 331091**

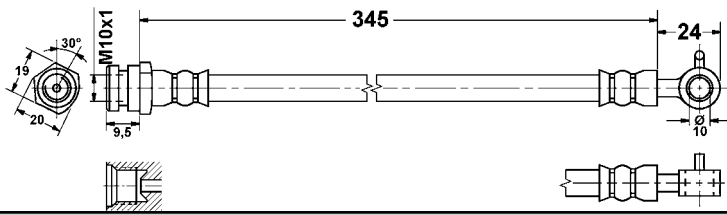

**24.5265-0346.3 331092**

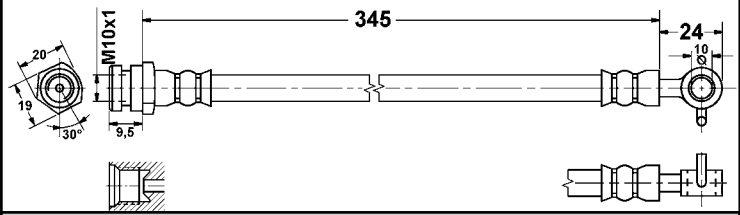

**24.5265-0365.3 331159**

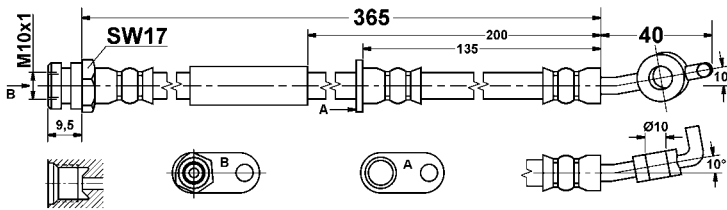

**24.5265-0366.3 331160**

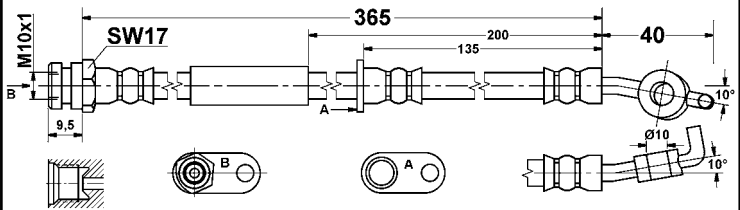

**24.5265-0445.3 331071**

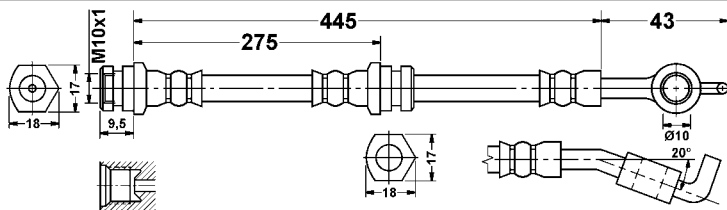

**24.5265-0557.3 330928**

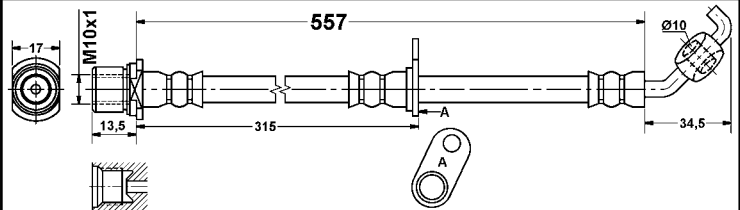

**24.5265-0558.3 330929**

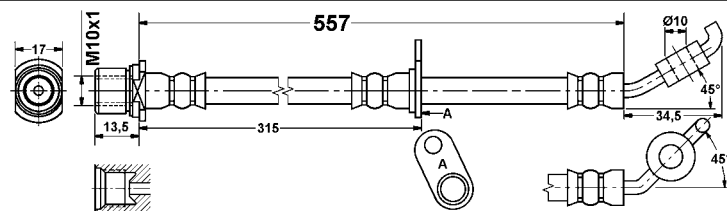

**24.5266-0452.3 330930**

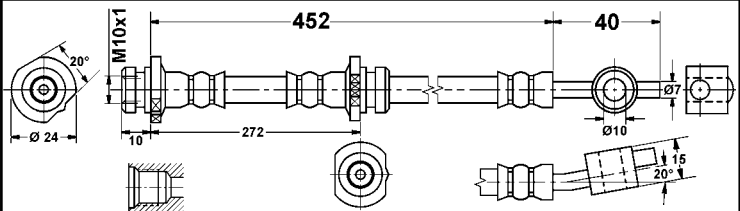

**24.5266-0453.3 330931**

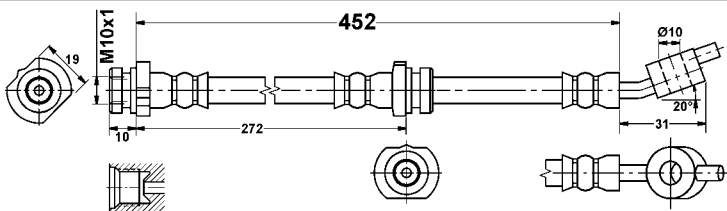

**24.5266-0475.3 331139**

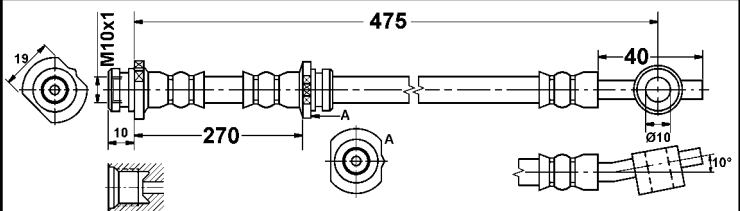

**24.5266-0476.3 331140**

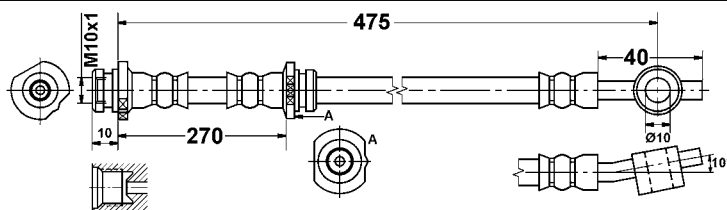

**24.5266-0600.3 331161**

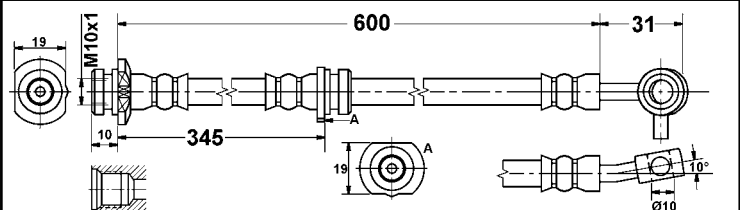

**24.5266-0601.3 331162**

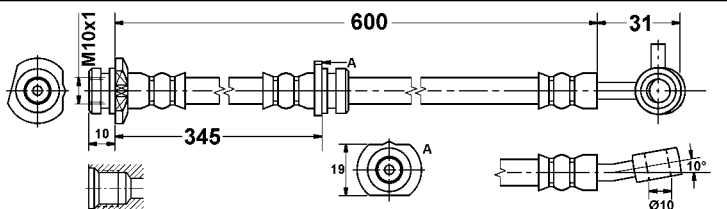

**24.5267-0390.3 330932**

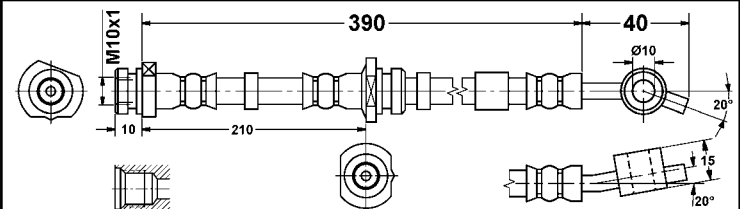

# Abbildungen Bremsschläuche, Kupplungsschläuche

Illustrations brake hoses, clutch hoses - Illustrations fessibilli freno, fessibilli frizione - Illustrations Flexible de frein, Flexibles d'embrayages - Ilustraciones flexibles de freno, flexibles d'embrague

**24.5267-0391.3 330974**

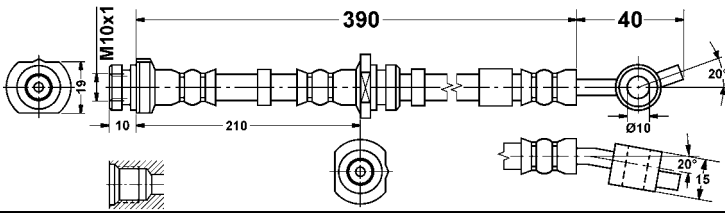

**24.5268-0270.3 331072**

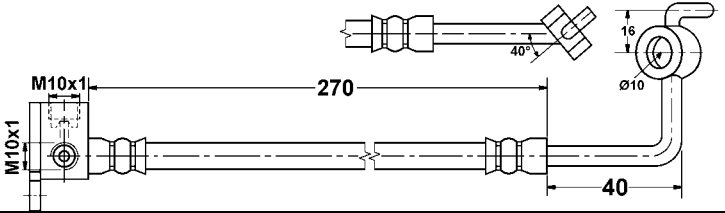

**24.5268-0495.3 330933**

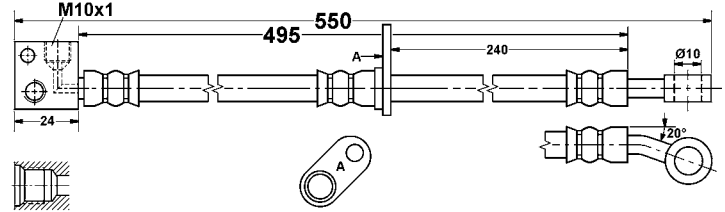

**24.5268-0496.3 330934**

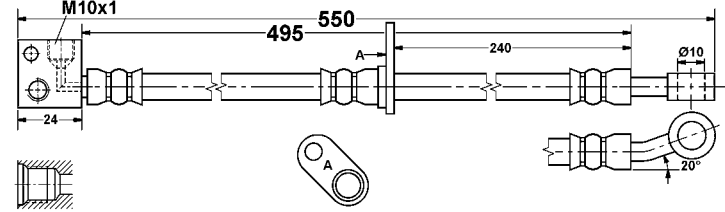

**24.5268-0510.3 331143**

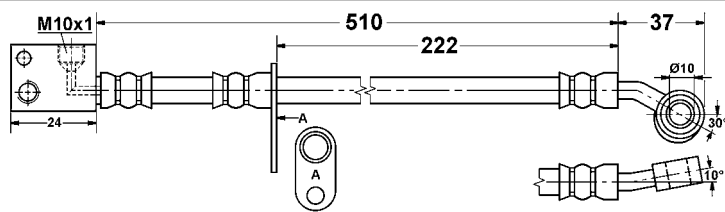

**24.5268-0511.3 331144**

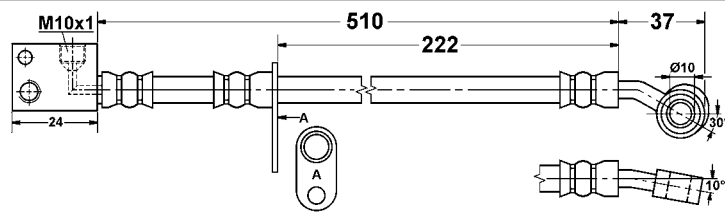

**24.5269-0195.3 330935**

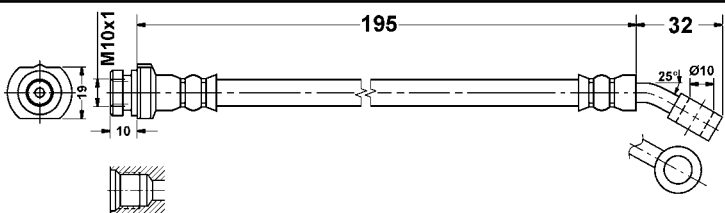

**24.5269-0460.3 331026**

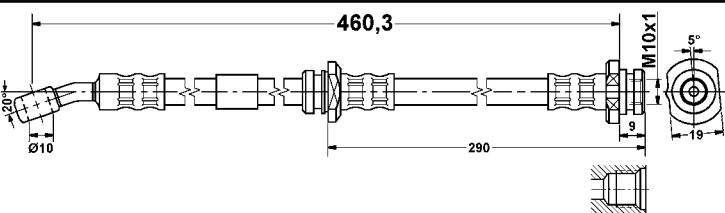

**24.5269-0462.3 331027**

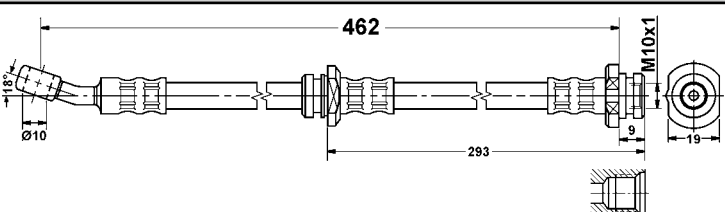

**24.5270-0200.3 331247**

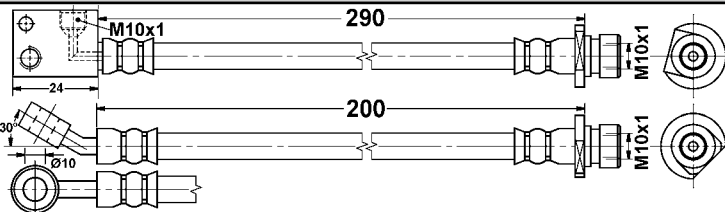

**24.5270-0201.3 331248**

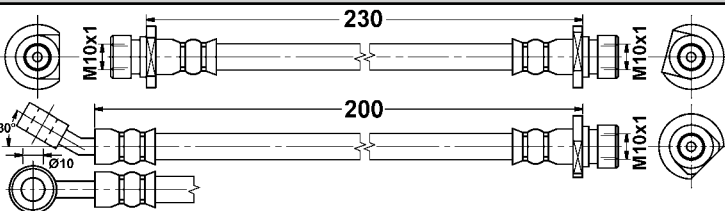

**24.5270-0390.3 330936**

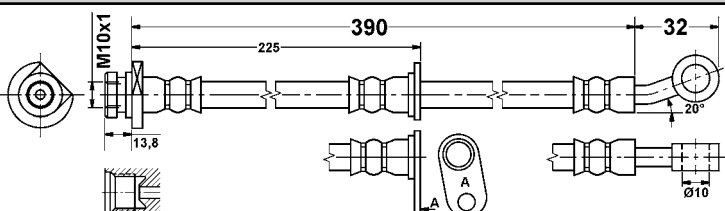

**24.5270-00395.3 330937**

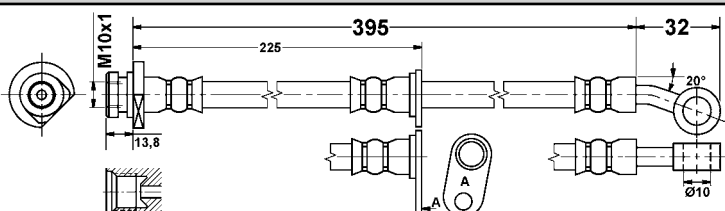

**24.5270-0410.3 331181**

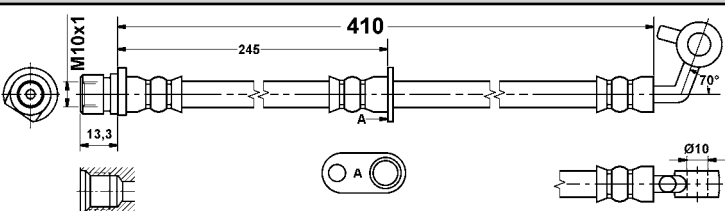

# Abbildungen Bremsschläuche, Kupplungsschläuche

Illustrations brake hoses, clutch hoses - Illustrations fessibili freno, fessibili frizione - Illustrations Flexible de frein, Flexibles d'embrayages - Ilustraciones flexibles de freno, flexibles d'embrague

**24.5270-0411.3 331182**

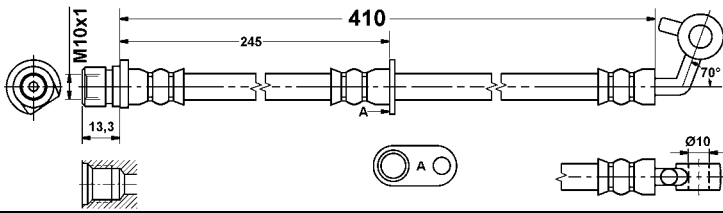

**24.5270-0435.3 331134**

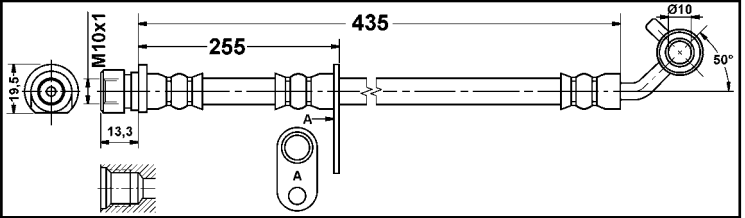

**24.5270-0450.3 331183**

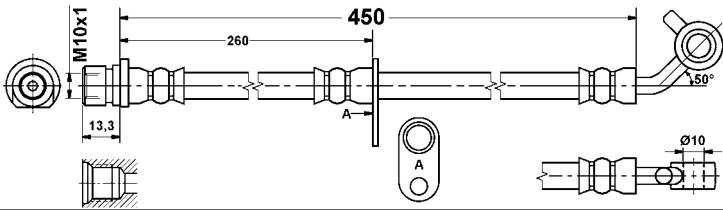

**24.5270-0456.3 330996**

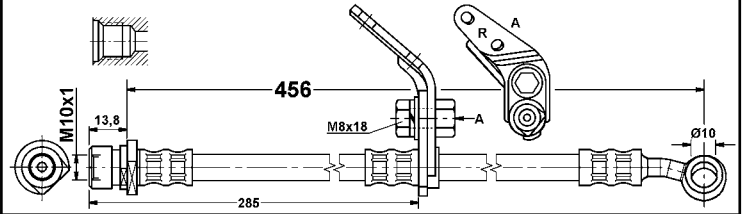

**24.5270-0457.3 330997**

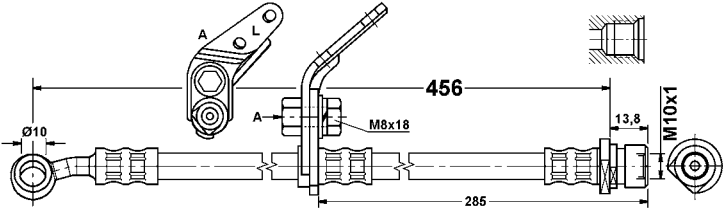

**24.5270-0461.3 330998**

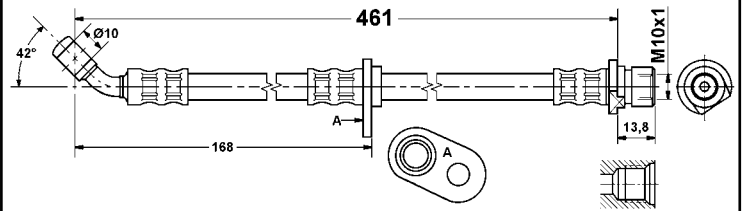

**24.5270-0462.3 330999**

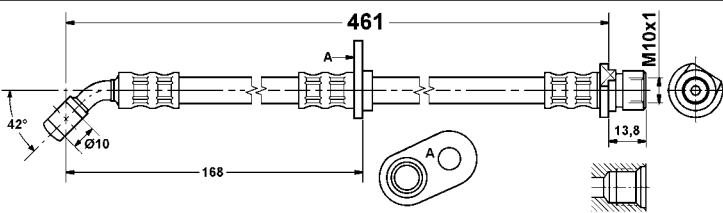

**24.5270-0490.3 331079**

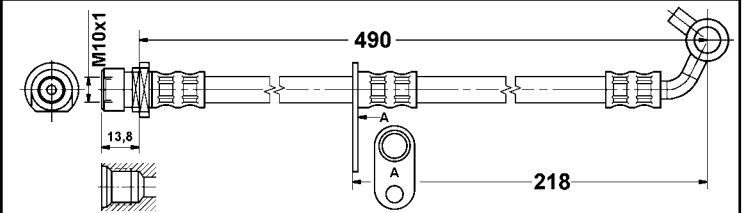

**24.5270-0515.3 331145**

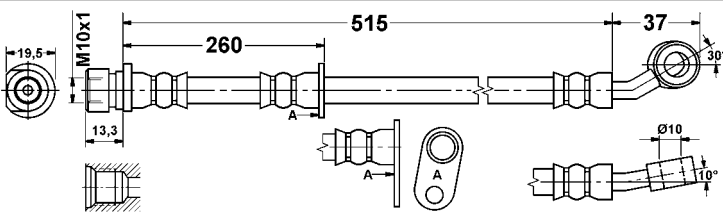

**24.5270-0516.3 331146**

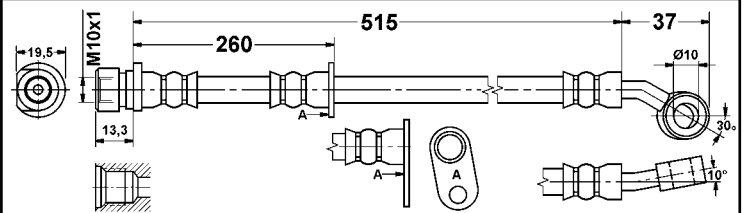

**24.5270-0581.3 331000**

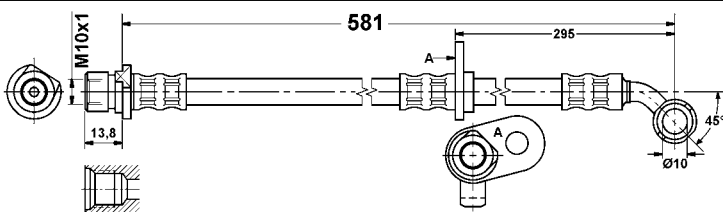

**24.5270-0582.3 331001**

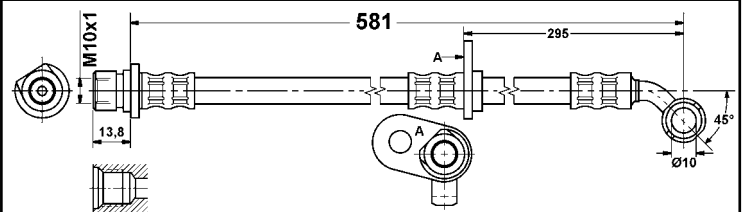

**24.5271-0303.3 330938**

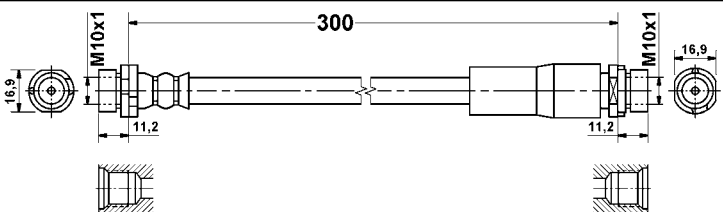

**24.5272-0205.3 330975**

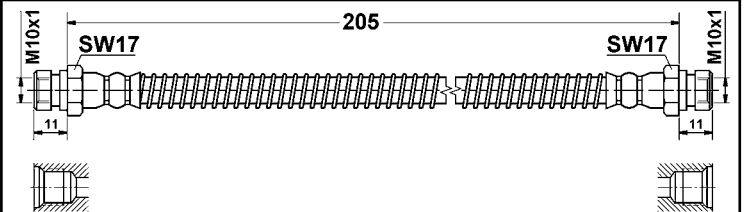



# Abbildungen Bremsschläuche, Kupplungsschläuche

Illustrations brake hoses, clutch hoses - Illustrations fessibilli freno, fessibilli frizione - Illustrations Flexible de frein, Flexibles d'embrayages - Ilustraciones flexibles de freno, flexibles d'embrague

|                                     |                                     |
|-------------------------------------|-------------------------------------|
| <p><b>24.5272-0258.3 330939</b></p> | <p><b>24.5273-0375.3 331147</b></p> |
| <p><b>24.5273-0490.3 330940</b></p> | <p><b>24.5274-0180.3 330941</b></p> |
| <p><b>24.5275-0200.3 330942</b></p> | <p><b>24.5276-0240.3 330943</b></p> |
| <p><b>24.5277-0420.3 330944</b></p> | <p><b>24.5277-0530.3 331002</b></p> |
| <p><b>24.5277-0531.3 331003</b></p> | <p><b>24.5278-0335.3 330945</b></p> |
| <p><b>24.5278-0467.3 331073</b></p> | <p><b>24.5278-0652.3 331189</b></p> |
| <p><b>24.5278-0661.3 331190</b></p> | <p><b>24.5279-0225.3 331163</b></p> |

# Abbildungen Bremsschläuche, Kupplungsschläuche

Illustrations brake hoses, clutch hoses - Illustrations fessibilli freno, fessibilli frizione - Illustrations Flexible de frein, Flexibles d'embrayages - Ilustraciones flexibles de freno, flexibles d'embrague

|                                     |                                     |
|-------------------------------------|-------------------------------------|
| <p><b>24.5279-0300.3 331135</b></p> | <p><b>24.5279-0305.3 330946</b></p> |
| <p><b>24.5279-0360.3 331045</b></p> | <p><b>24.5280-0500.3 330953</b></p> |
| <p><b>24.5281-0553.3 331004</b></p> | <p><b>24.5281-0554.3 331005</b></p> |
| <p><b>24.5281-0555.3 330954</b></p> | <p><b>24.5281-0556.3 330955</b></p> |
| <p><b>24.5281-0557.3 330956</b></p> | <p><b>24.5281-0580.3 331006</b></p> |
| <p><b>24.5281-0585.3 331007</b></p> | <p><b>24.5281-0640.3 330968</b></p> |
| <p><b>24.5281-0641.3 330969</b></p> | <p><b>24.5282-0315.3 330957</b></p> |

# Abbildungen Bremsschläuche, Kupplungsschläuche

Illustrations brake hoses, clutch hoses - Illustrations fessibilli freno, fessibilli frizione - Illustrations Flexible de frein, Flexibles d'embrayages - Ilustraciones flexibles de freno, flexibles d'embrague

**24.5282-0316.3 330958**

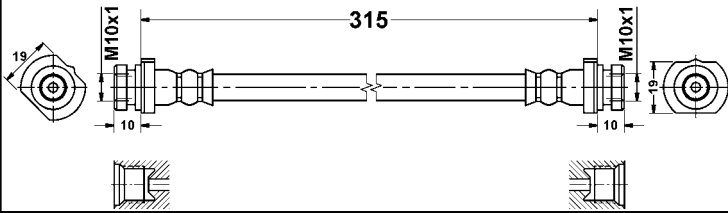

**24.5283-0403.3 331136**

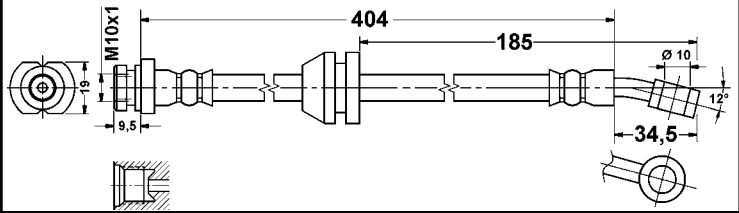

**24.5283-0470.3 330959**

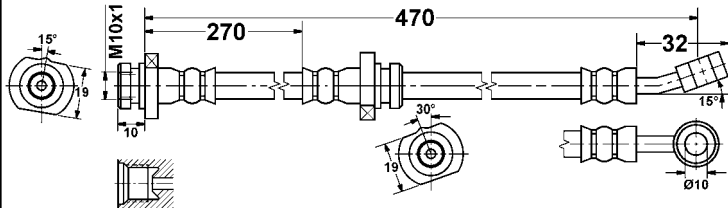

**24.5283-0471.3 330960**

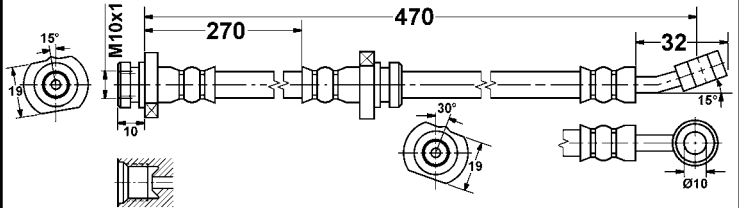

**24.5284-0220.3 330970**

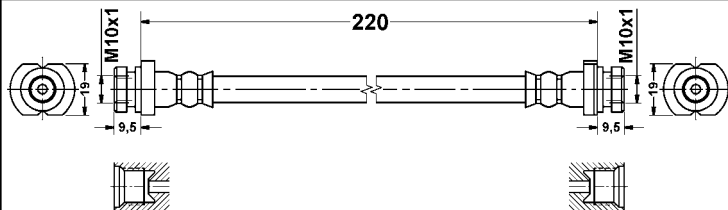

**24.5284-0283.3 331080**

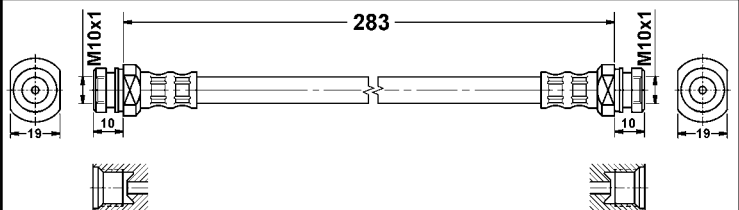

**24.5284-0400.3 331060**

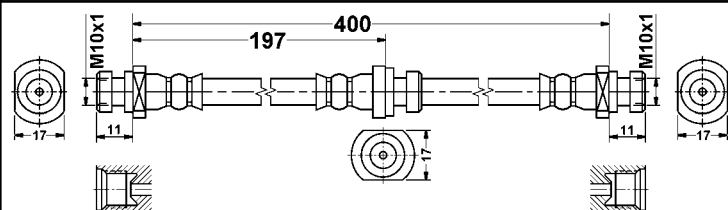

**24.5285-0240.3 330976**

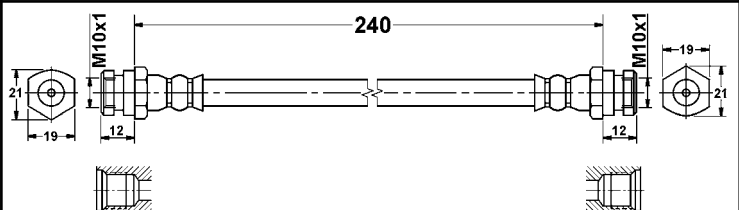

**24.5285-0250.3 331074**

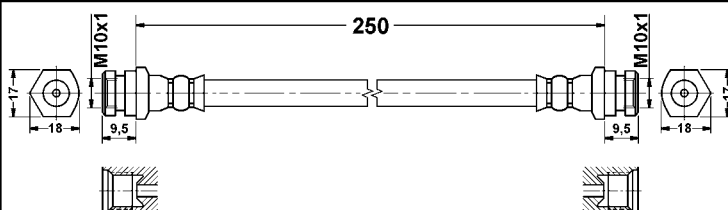

**24.5285-0265.3 331184**

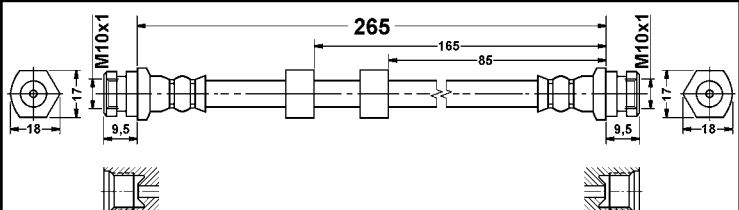

**24.5285-0269.3 331137**

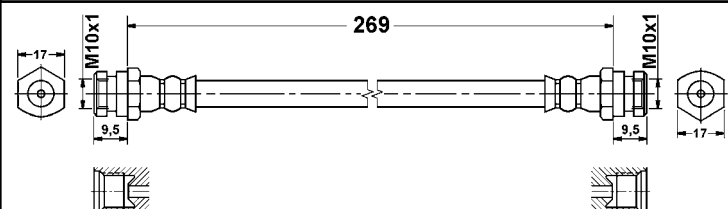

**24.5286-0265.3 331046**

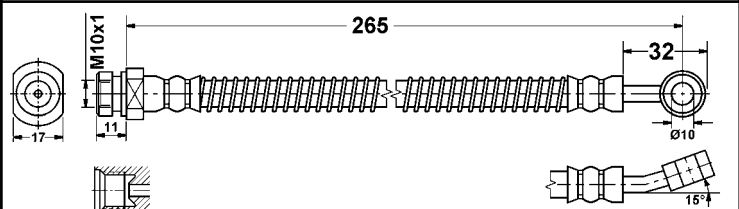

**24.5286-0340.3 330977**

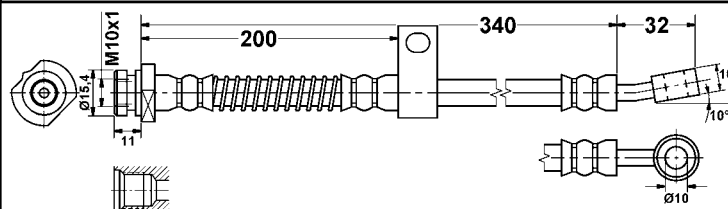

**24.5286-0341.3 330989**

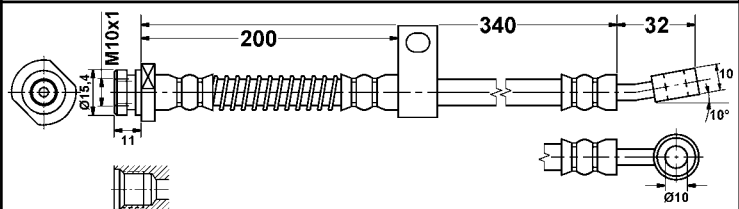

# Abbildungen Bremsschläuche, Kupplungsschläuche

Illustrations brake hoses, clutch hoses - Illustrations fessibili freno, fessibili frizione - Illustrations Flexible de frein, Flexibles d'embrayages - Ilustraciones flexibles de freno, flexibles d'embrague

**24.5286-0342.3 331138**

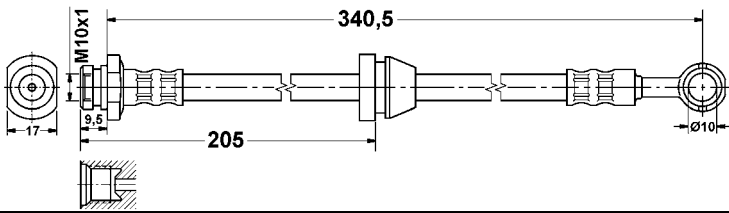

**24.5286-0405.3 331061**

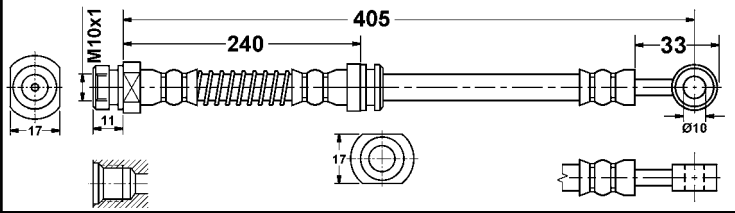

**24.5286-0485.3 331172**

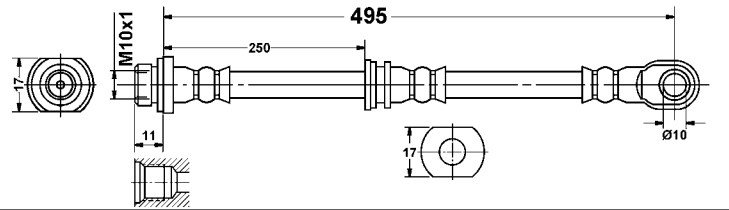

**24.5286-0488.3 331221**

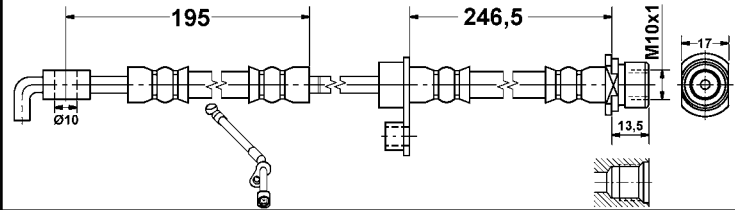

**24.5286-0489.3 331222**

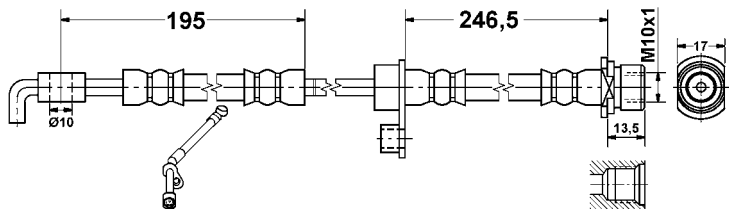

**24.5286-0524.3 331223**

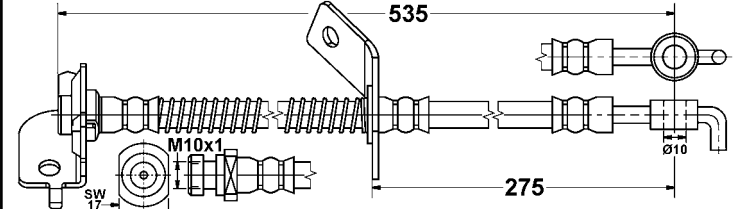

**24.5286-0525.3 331224**

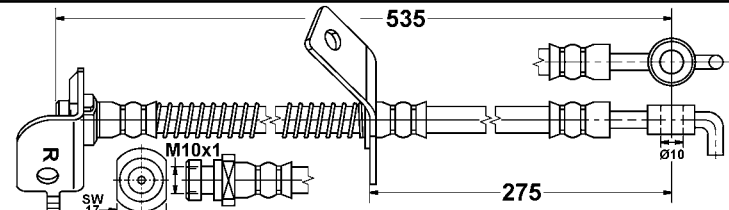

**24.5286-0540.3 331249**

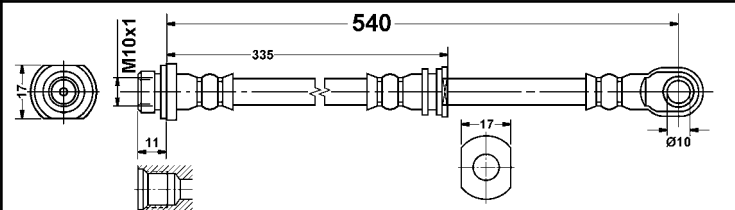

**24.5286-0545.3 331250**

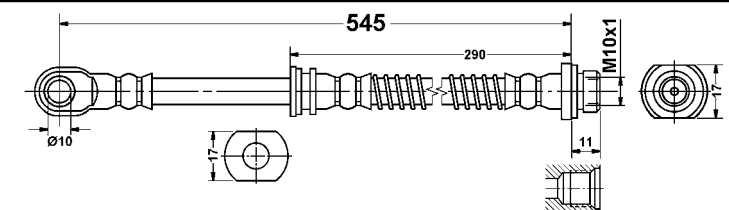

**24.5286-0555.3 331075**

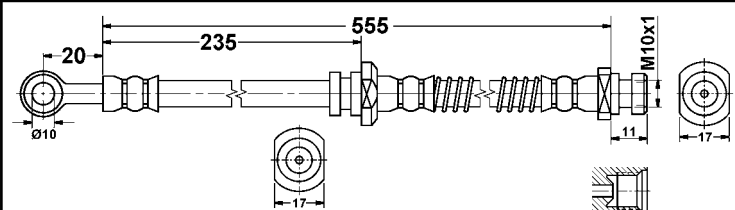

**24.5286-0556.3 331251**

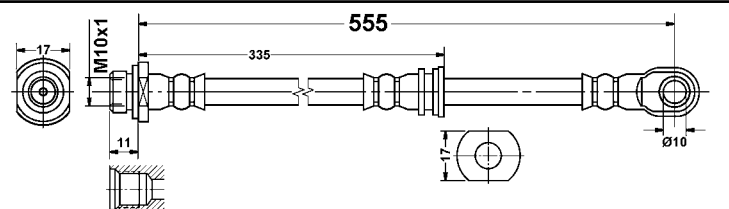

**24.5286-0600.3 331173**

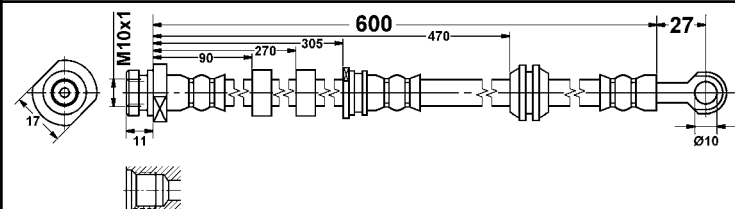

**24.5286-0601.3 331174**

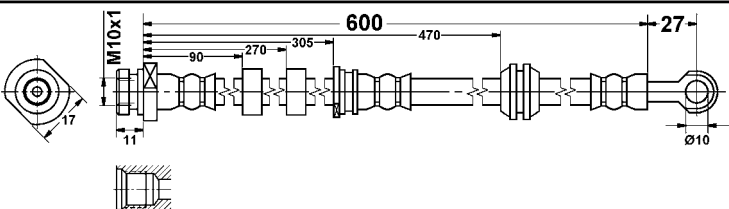

**24.5286-0660.3 331252**

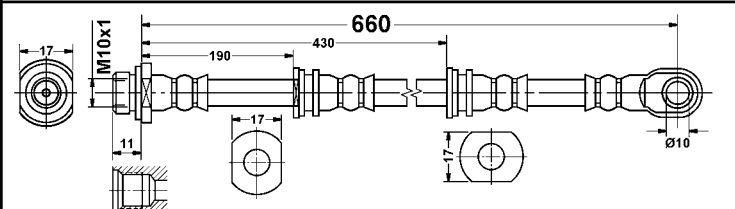

# Abbildungen Bremsschläuche, Kupplungsschläuche

Illustrations brake hoses, clutch hoses - Illustrations fessibilli freno, fessibilli frizione - Illustrations Flexible de frein, Flexibles d'embrayages - Ilustraciones flexibles de freno, flexibles d'embrague

**24.5287-0441.3 331008**

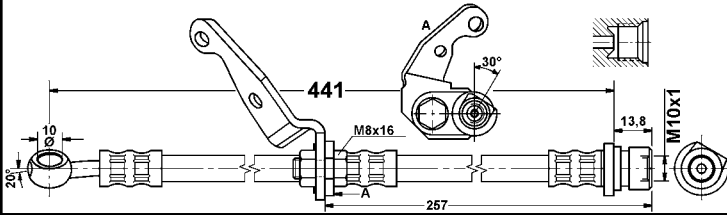

**24.5287-0442.3 331009**

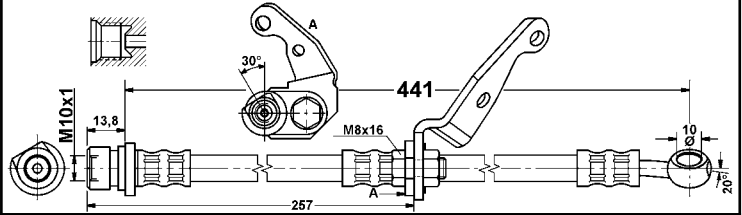

**24.5287-0451.3 331010**

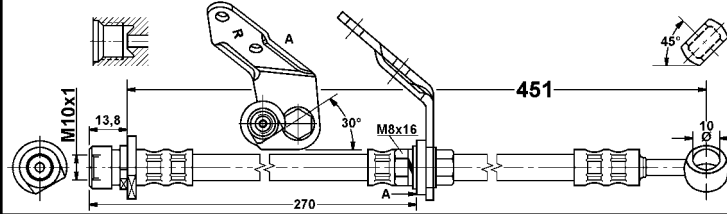

**24.5287-0452.3 331011**

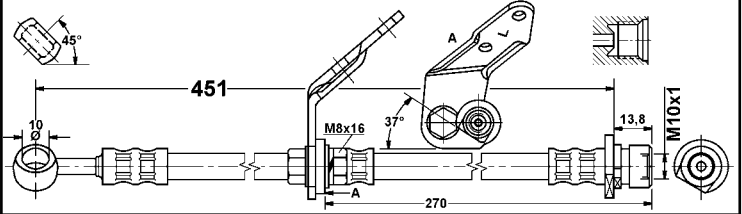

**24.5288-0265.3 331062**

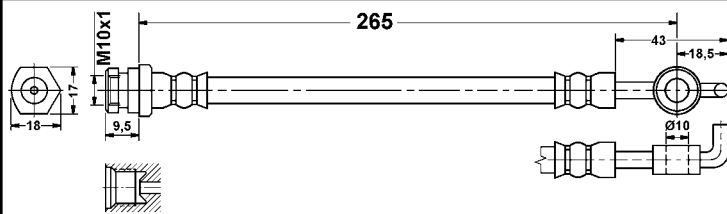

**24.5288-0270.3 331227**

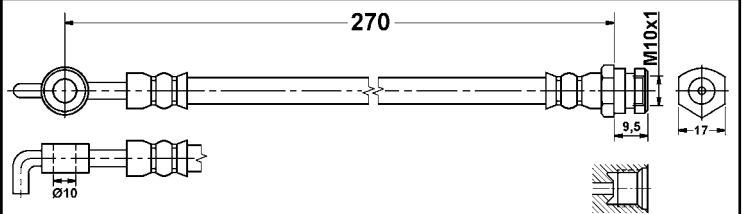

**24.5288-0295.3 331185**

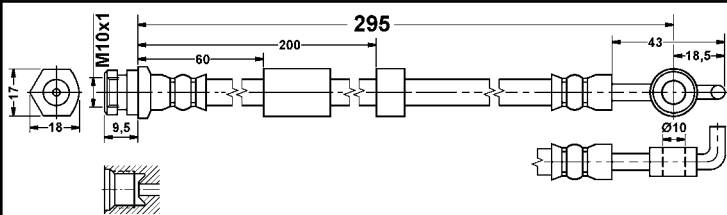

**24.5288-0375.3 331012**

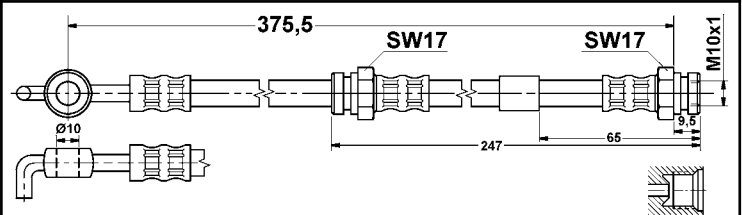

**24.5289-0277.3 331013**

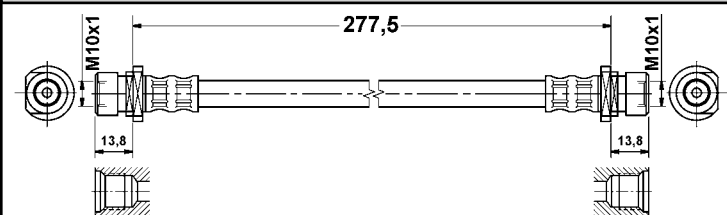

**24.5290-0180.3 331028**

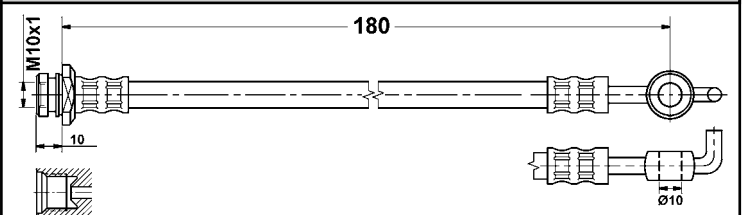

**24.5290-0410.3 331081**

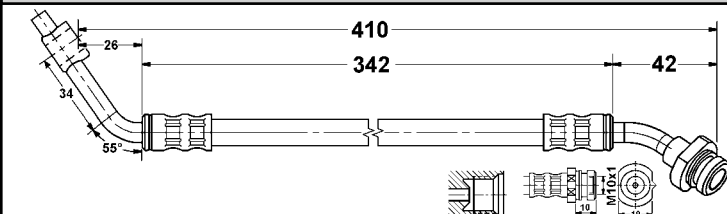

**24.5290-0414.3 331175**

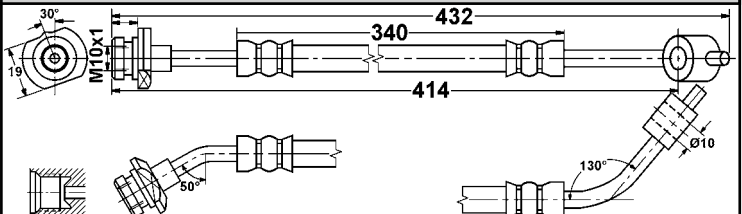

**24.5290-0439.3 331176**

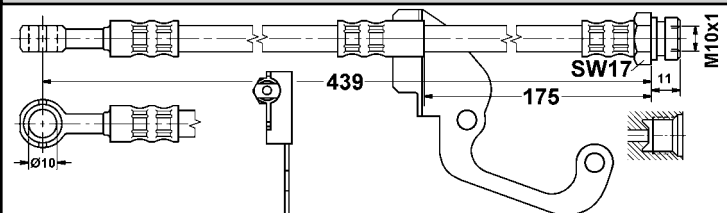

**24.5290-0440.3 331177**

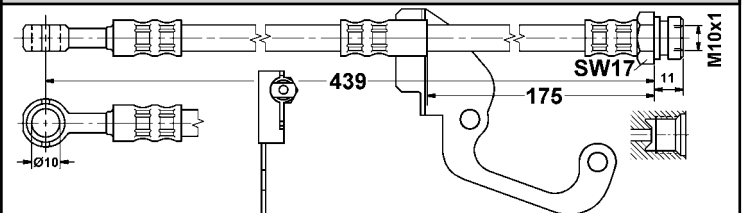

# Abbildungen Bremsschläuche, Kupplungsschläuche

Illustrations brake hoses, clutch hoses - Illustrations fessibili freno, fessibili frizione - Illustrations Flexible de frein, Flexibles d'embrayages - Ilustraciones flexibles de freno, flexibles d'embrague

|                                     |                                     |
|-------------------------------------|-------------------------------------|
| <p><b>24.5290-0485.3 331082</b></p> | <p><b>24.5290-0486.3 331178</b></p> |
| <p><b>24.5290-0502.3 331164</b></p> | <p><b>24.5290-0505.3 331083</b></p> |
| <p><b>24.5290-0545.3 331063</b></p> | <p><b>24.5291-0345.3 331165</b></p> |
| <p><b>24.5291-0425.3 331029</b></p> | <p><b>24.5291-0430.3 331084</b></p> |
| <p><b>24.5291-0508.3 331085</b></p> | <p><b>24.5291-0755.3 331195</b></p> |
| <p><b>24.5291-0756.3 331196</b></p> | <p><b>24.5292-0240.3 331225</b></p> |
| <p><b>24.5292-0241.3 331226</b></p> | <p><b>24.5292-0605.3 331030</b></p> |



# Abbildungen Bremsschläuche, Kupplungsschläuche

Illustrations brake hoses, clutch hoses - Illustrations fessibilli freno, fessibilli frizione - Illustrations Flexible de frein, Flexibles d'embrayages - Ilustraciones flexibles de freno, flexibles d'embrague

**24.5293-0605.3 331031**

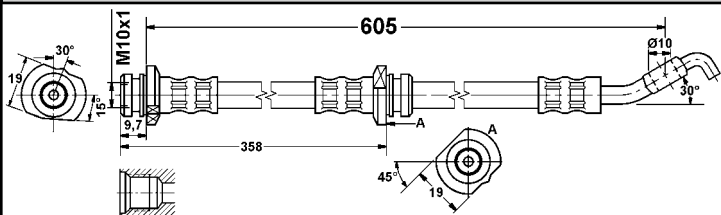

**24.5294-0463.3 331032**

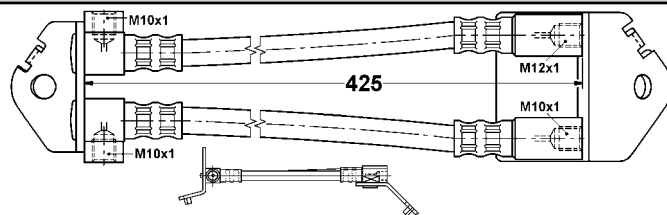

**24.5295-0496.3 331033**

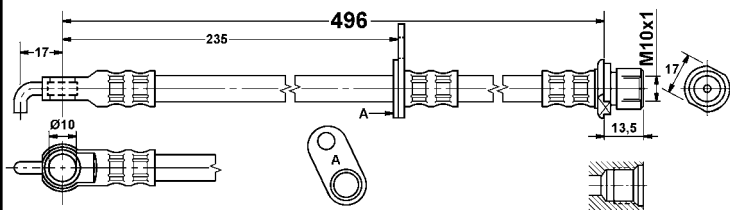

**24.5296-0280.3 331034**

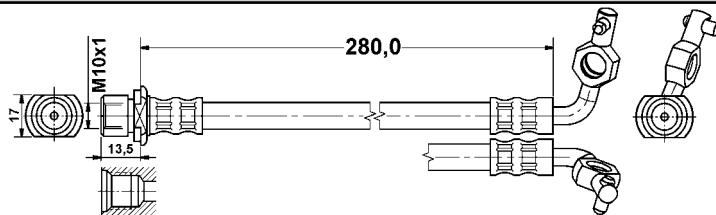

**24.5296-0281.3 331035**

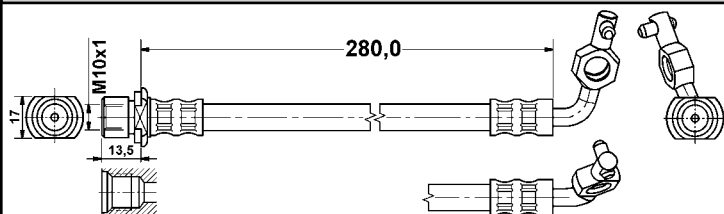

**24.5297-0272.3 331036**

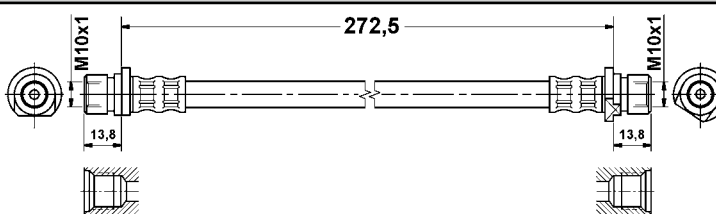

**24.5297-0332.3 331037**

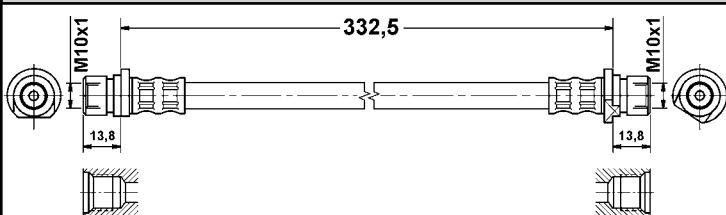

**24.5297-0385.3 331047**

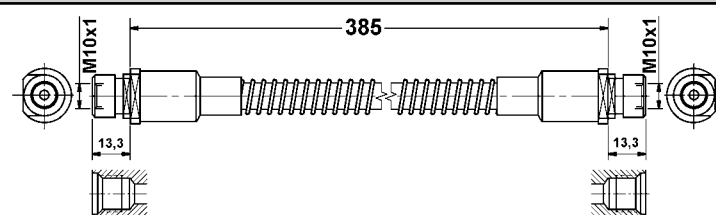

**24.5298-0270.3 331086**

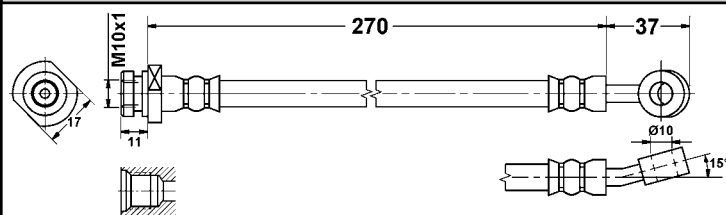

**24.5298-0271.3 331087**

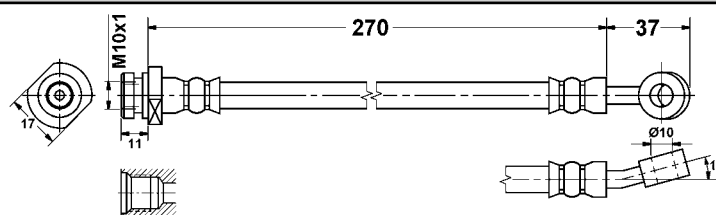

**24.5298-0322.3 331314**

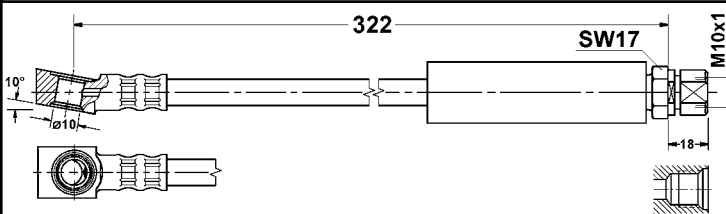

**24.5298-0469.3 331191**

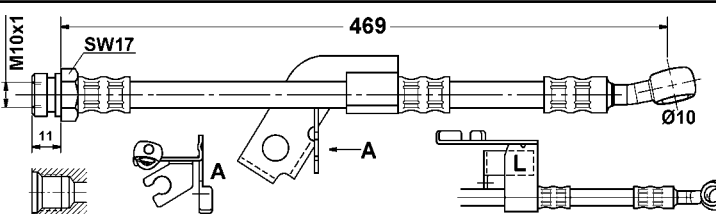

**24.5298-0470.3 331192**

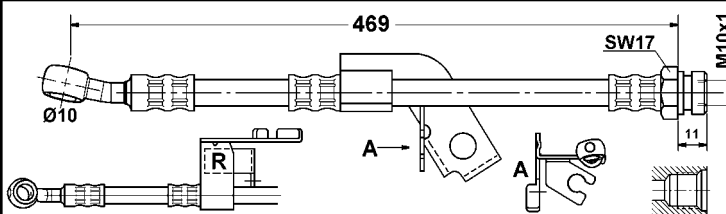

**24.5298-0474.3 331038**

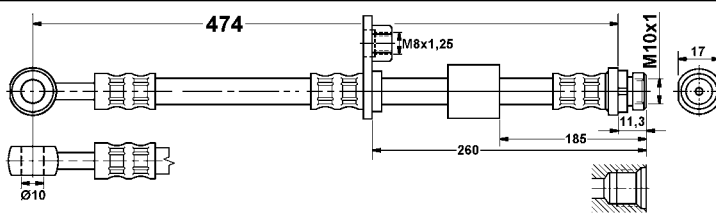

# Abbildungen Bremsschläuche, Kupplungsschläuche

Illustrations brake hoses, clutch hoses - Illustrations fessibilli freno, fessibilli frizione - Illustrations Flexible de frein, Flexibles d'embrayages - Ilustraciones flexibles de freno, flexibles d'embrague

**24.5298-0475.3 331255**

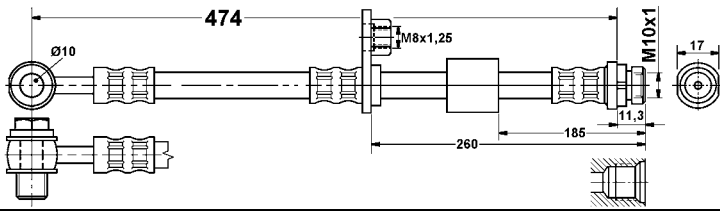

**24.5298-0485.3 331064**

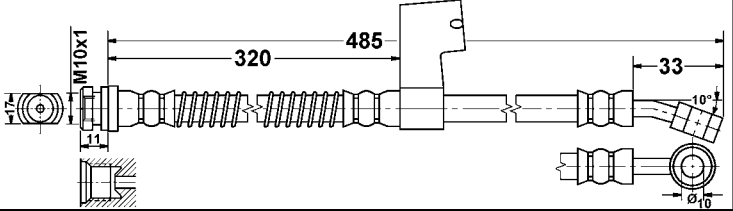

**24.5298-0486.3 331065**

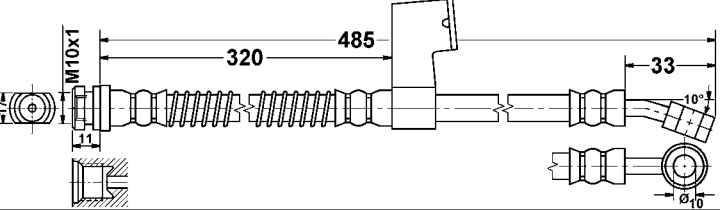

**24.5298-0514.3 331088**

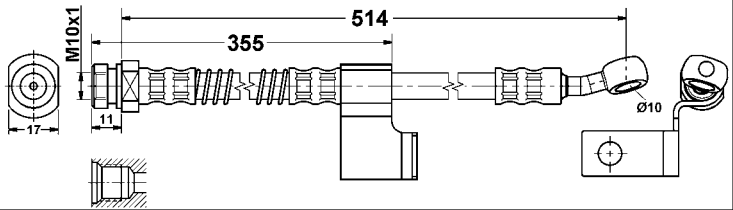

**24.5298-0515.3 331166**

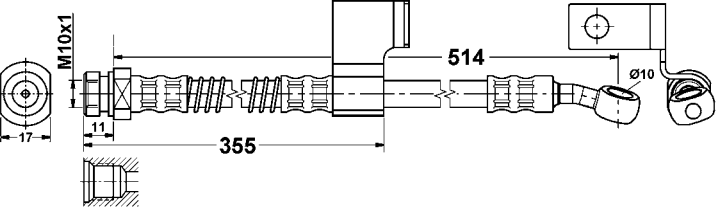

**24.5299-0449.3 331039**

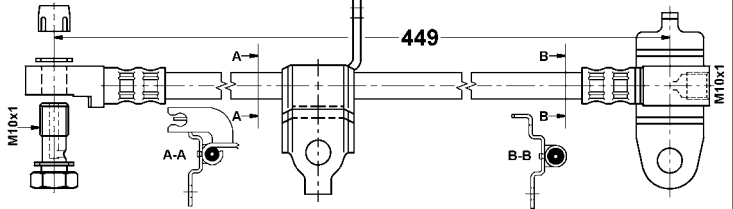

**24.5299-0452.3 331040**

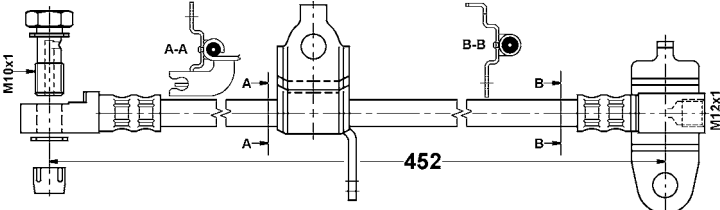

**24.5302-0295.3 330403**

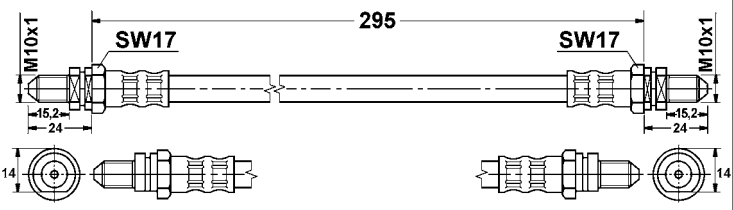

**24.5302-0296.3 330476**

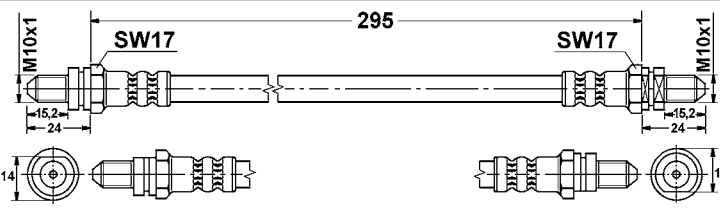

**24.5303-0275.3 331213**

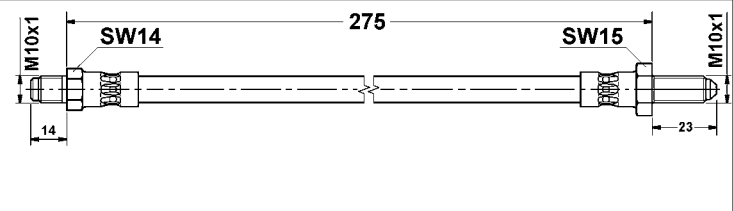

**24.5303-0400.3 330404**

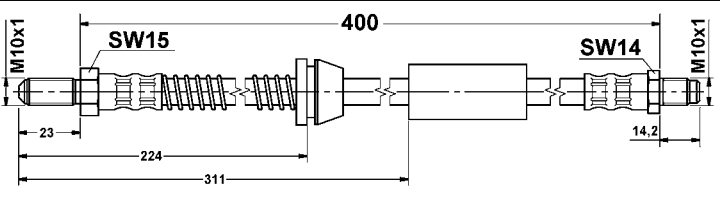

**24.5303-0455.3 330588**

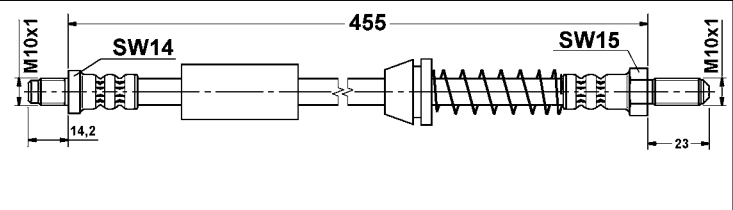

**24.5304-0280.3 330589**

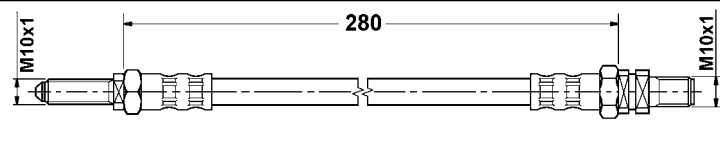

**24.5305-0295.3 330657**

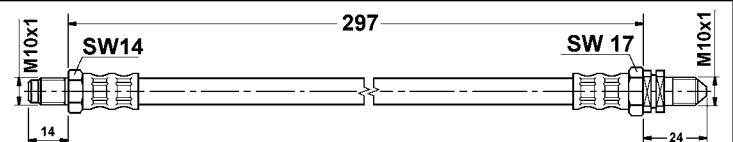

# Abbildungen Bremsschläuche, Kupplungsschläuche

Illustrations brake hoses, clutch hoses - Illustrations fessibilli freno, fessibilli frizione - Illustrations Flexible de frein, Flexibles d'embrayages - Ilustraciones flexibles de freno, flexibles d'embrague

**24.5305-0300.3 330658**

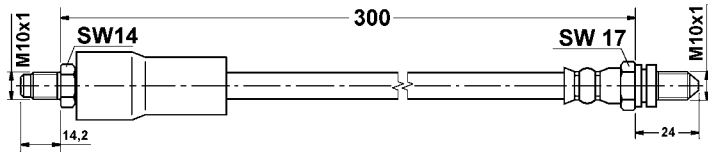

**24.5305-0320.3 330764**

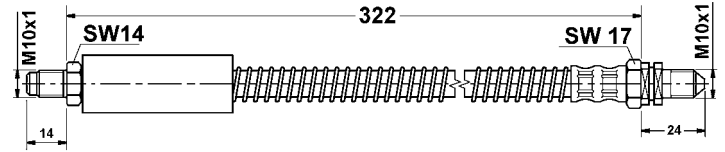

**24.5305-0340.3 330659**

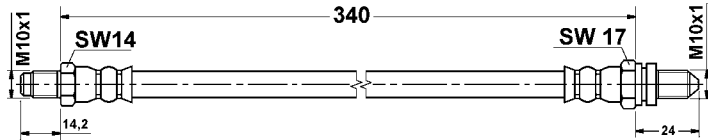

**24.5305-0350.3 330660**

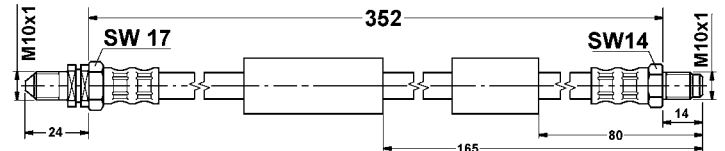

**24.5305-0351.3 330687**

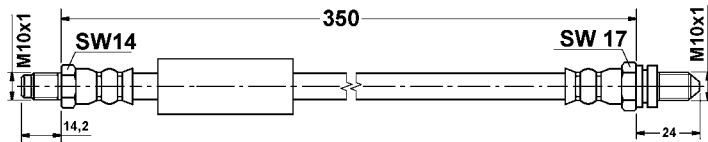

**24.5305-0352.3 331041**

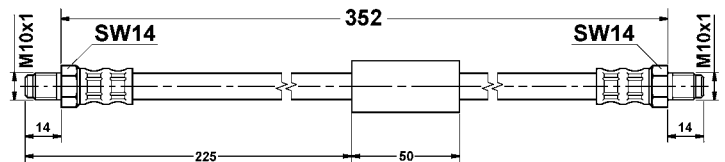

**24.5305-0355.3 330688**

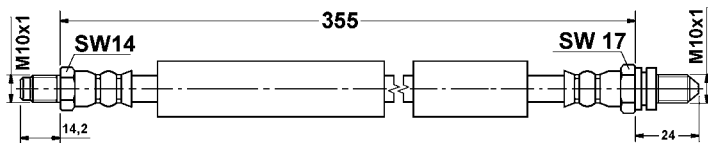

**24.5305-0420.3 330661**

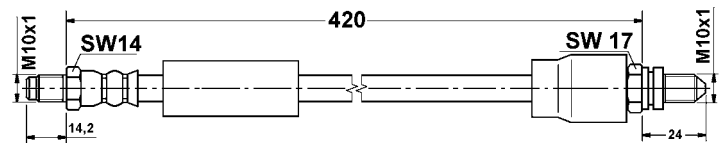

**24.5306-0295.3 330662**

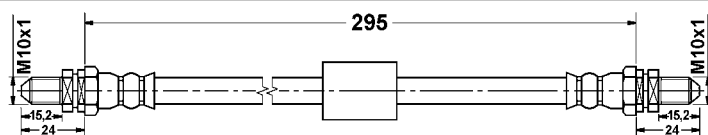

**24.5306-0380.3 330783**

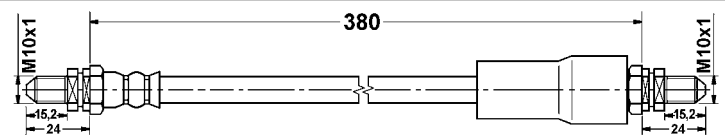

**24.5307-0320.3 330703**

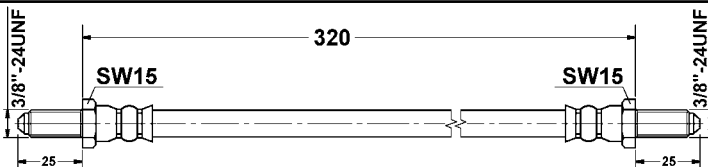

**24.5308-0488.3 330776**

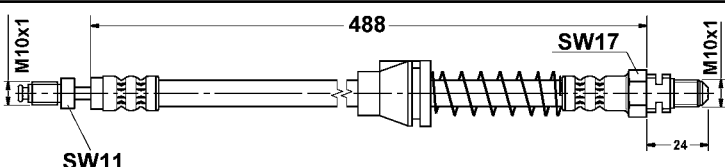

**24.5308-0489.3 330777**

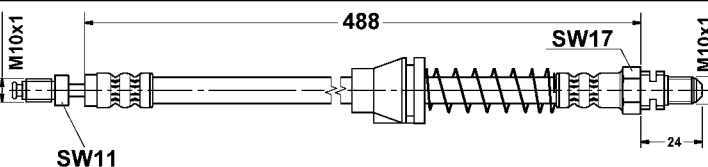

**24.5411-0550.3 330567**

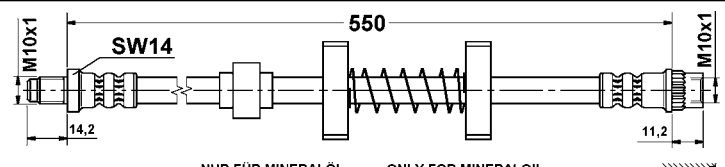

NUR FÜR MINERALÖL ONLY FOR MINERAL OIL



# Abbildungen Bremsschläuche, Kupplungsschläuche

Illustrations brake hoses, clutch hoses - Illustrations fessibili freno, fessibili frizione - Illustrations Flexible de frein, Flexibles d'embrayages - Ilustraciones flexibles de freno, flexibles d'embrague

|  |  |
|--|--|
| <p><b>24.5802-0320.3 330050</b></p> <p>Kupplungsschlauch<br/>Clutch hose</p> | <p><b>24.5803-0325.3 330051</b></p> <p>Kupplungsschlauch<br/>Clutch hose</p> |
| <p><b>24.5901-0225.3 331288</b></p>  | <p><b>24.5901-0517.3 330054</b></p> <p>Kupplungsschlauch<br/>Clutch hose</p> |
| <p><b>24.5905-0320.3 330058</b></p>  | <p><b>83.1064-0050.3 330784</b></p> <p>SW11</p>                              |
| <p><b>83.1064-0060.3 330785</b></p> <p>SW11</p>                              | <p><b>83.1294-0250.3 331267</b></p> <p>SW11, SW17</p>                        |
| <p><b>83.1294-0260.3 331268</b></p> <p>SW12, SW17</p>                        | <p><b>83.6101-0210.3 330201</b></p> <p>SW14, SW17</p>                        |
| <p><b>83.6101-0240.3 330202</b></p> <p>SW14, SW17</p>                        | <p><b>83.6101-0250.3 330203</b></p> <p>SW14, SW17</p>                        |
| <p><b>83.6101-0325.3 330206</b></p> <p>SW14, SW17</p>                        | <p><b>83.6101-0393.3 330210</b></p> <p>SW14, SW17</p>                        |

# Abbildungen Bremsschläuche, Kupplungsschläuche

Illustrations brake hoses, clutch hoses - Illustrations fessibilli freno, fessibilli frizione - Illustrations Flexible de frein, Flexibles d'embrayages - Ilustraciones flexibles de freno, flexibles d'embrague

**83.6101-0412.3 330212**

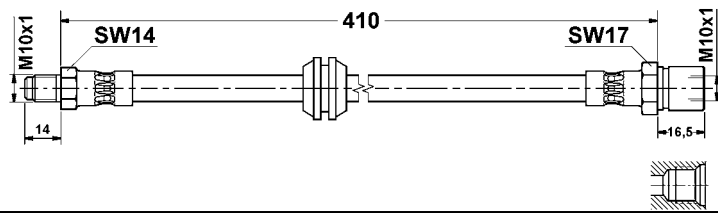

**83.6101-0413.3 330213**

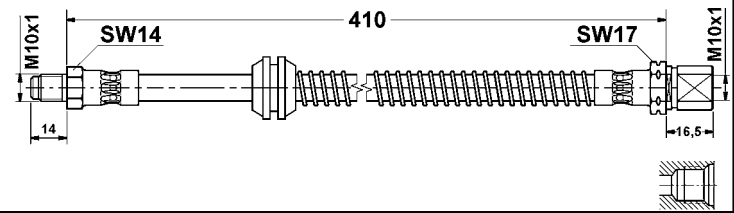

**83.6101-0520.3 330215**

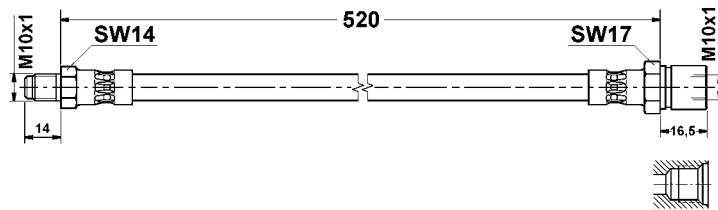

**83.6103-0190.3 330218**

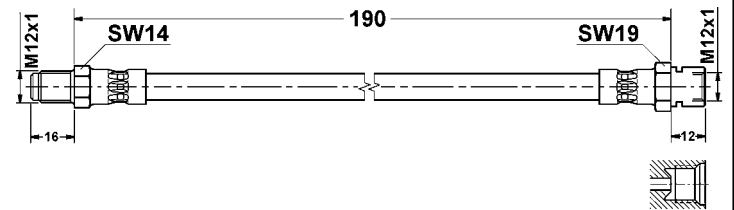

**83.6103-0200.3 330219**

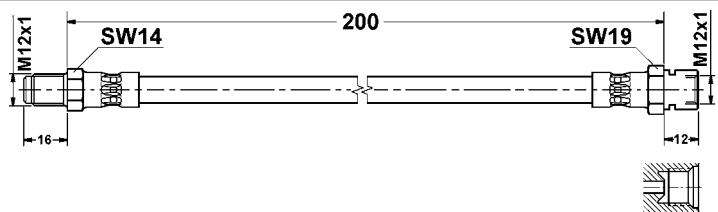

**83.6103-0240.3 330220**

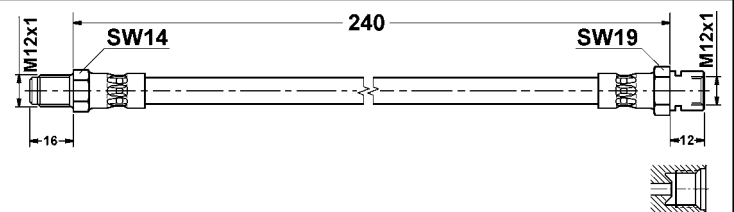

**83.6103-0260.3 330221**

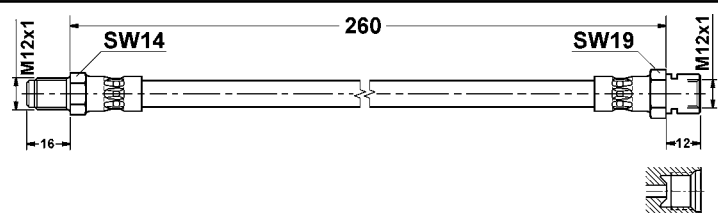

**83.6103-0300.3 330223**

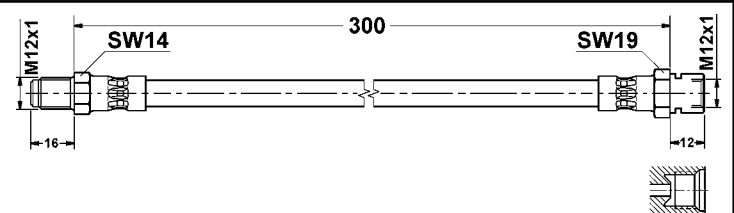

**83.6103-0320.3 330224**

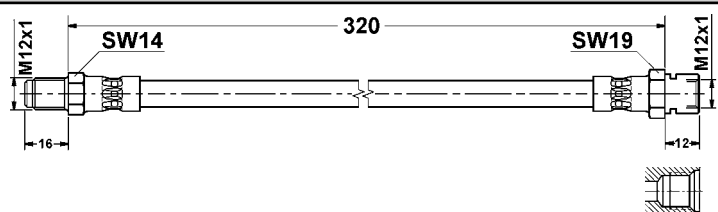

**83.6103-0350.3 330225**

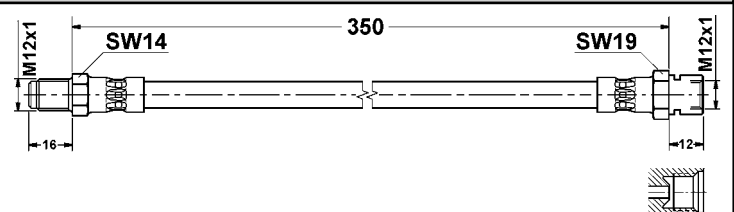

**83.6103-0400.3 330226**

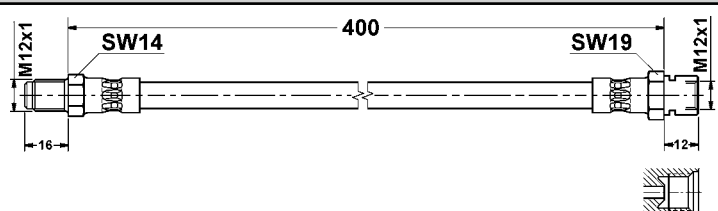

**83.6103-0450.3 330228**

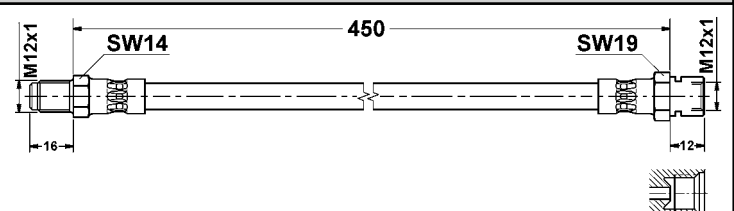

**83.6103-0470.3 330229**

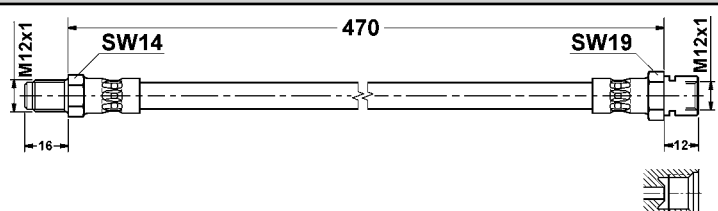

**83.6103-0500.3 330230**

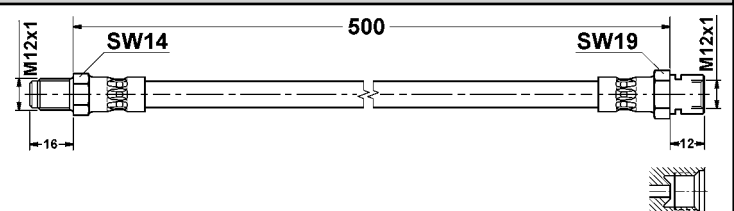

# Abbildungen Bremsschläuche, Kupplungsschläuche

Illustrations brake hoses, clutch hoses - Illustrations fessibili freno, fessibili frizione - Illustrations Flexible de frein, Flexibles d'embrayages - Ilustraciones flexibles de freno, flexibles d'embrague

|                                     |                                     |
|-------------------------------------|-------------------------------------|
| <p><b>83.6103-0550.3 330231</b></p> | <p><b>83.6103-0600.3 330233</b></p> |
| <p><b>83.6103-0620.3 330234</b></p> | <p><b>83.6103-0650.3 330235</b></p> |
| <p><b>83.6103-0700.3 330236</b></p> | <p><b>83.6103-0800.3 330237</b></p> |
| <p><b>83.6104-0170.3 330500</b></p> | <p><b>83.6104-0180.3 330510</b></p> |
| <p><b>83.6104-0210.3 330473</b></p> | <p><b>83.6104-0220.3 330474</b></p> |
| <p><b>83.6104-0241.3 330731</b></p> | <p><b>83.6104-0245.3 330525</b></p> |
| <p><b>83.6104-0250.3 330720</b></p> | <p><b>83.6104-0295.3 330244</b></p> |



# Abbildungen Bremsschläuche, Kupplungsschläuche

Illustrations brake hoses, clutch hoses - Illustrations fessibilli freno, fessibilli frizione - Illustrations Flexible de frein, Flexibles d'embrayages - Ilustraciones flexibles de freno, flexibles d'embrague

**83.6101-0315.3 330889**

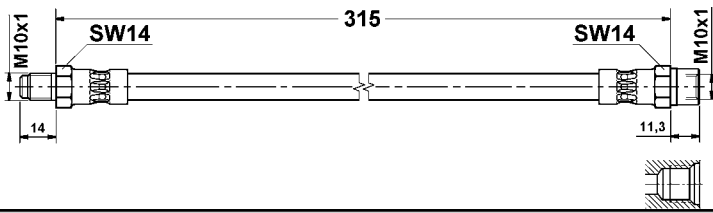

**83.6104-0325.3 330246**

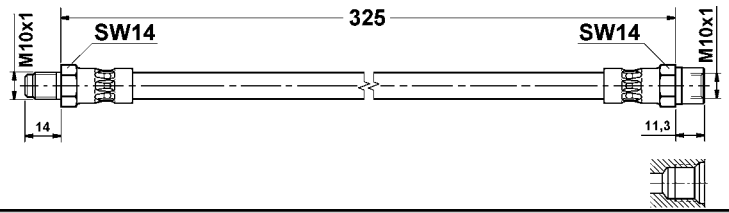

**83.6104-0336.3 330451**

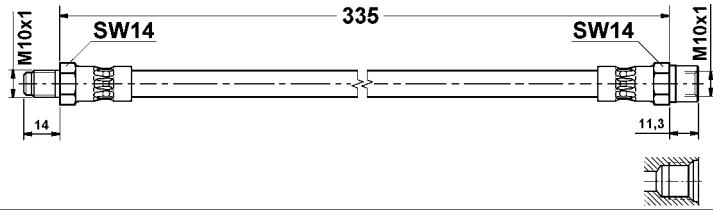

**83.6104-0360.3 330475**

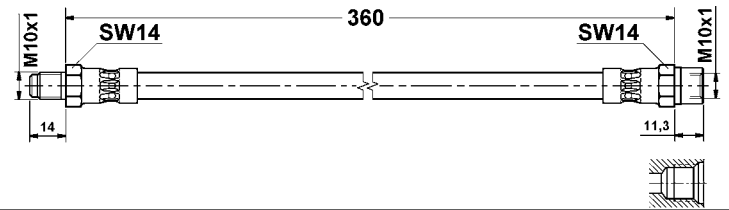

**83.6104-0440.3 330714**

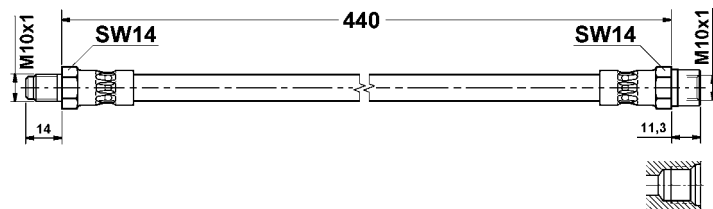

**83.6104-0450.3 330251**

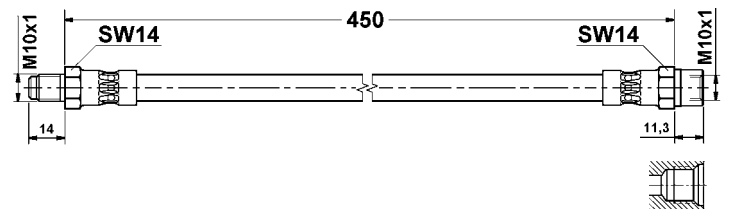

**83.6104-0462.3 330378**

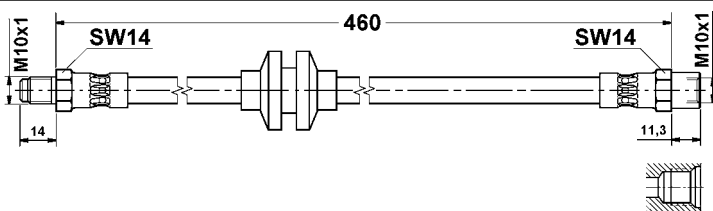

**83.6104-0470.3 330253**

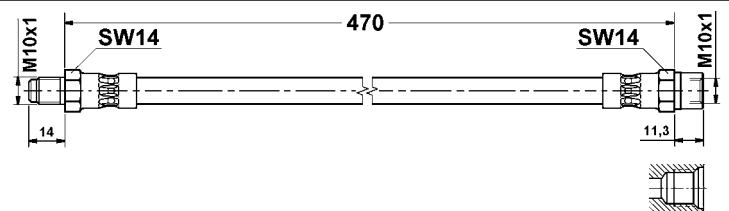

**83.6105-0200.3 330453**

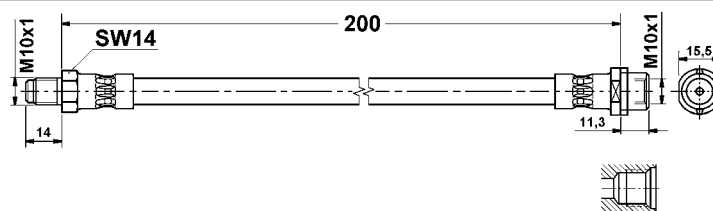

**83.6105-0300.3 330537**

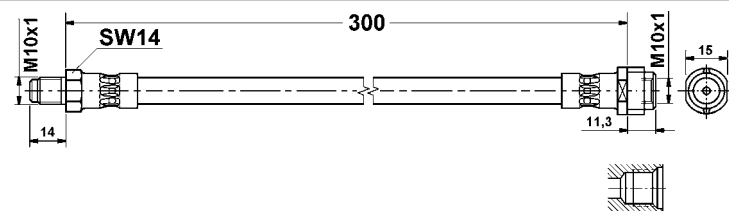

**83.6105-0360.3 330635**

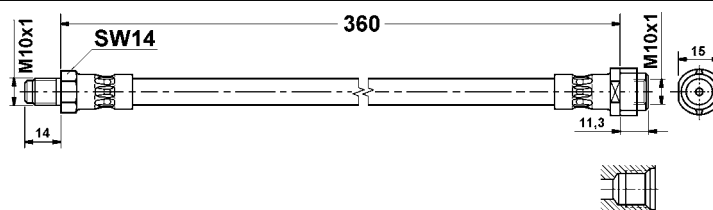

**83.6105-0510.3 330622**

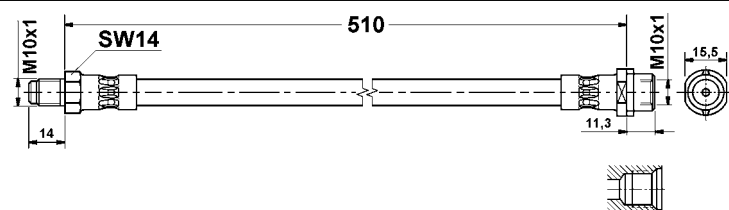

**83.6113-0140.3 330482**

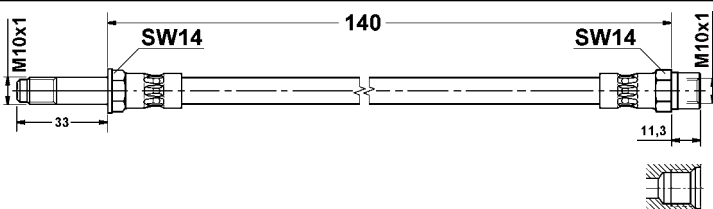

**83.6113-0276.3 330538**

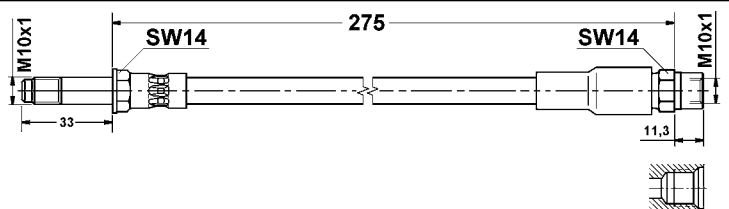

# Abbildungen Bremsschläuche, Kupplungsschläuche

Illustrations brake hoses, clutch hoses - Illustrations fessibili freno, fessibili frizione - Illustrations Flexible de frein, Flexibles d'embrayages - Ilustraciones flexibles de freno, flexibles d'embrague

|                                     |                                     |
|-------------------------------------|-------------------------------------|
| <p><b>83.6113-0321.3 330621</b></p> | <p><b>83.6113-0331.3 330982</b></p> |
| <p><b>83.6113-0510.3 330863</b></p> | <p><b>83.6113-0552.3 330864</b></p> |
| <p><b>83.6114-0300.3 330258</b></p> | <p><b>83.6115-0480.3 330385</b></p> |
| <p><b>83.6116-0226.3 330454</b></p> | <p><b>83.6118-0281.3 330483</b></p> |
| <p><b>83.6121-0250.3 330260</b></p> | <p><b>83.6121-0340.3 330261</b></p> |
| <p><b>83.6123-0381.3 330262</b></p> | <p><b>83.6123-0465.3 330379</b></p> |
| <p><b>83.6123-0471.3 330263</b></p> | <p><b>83.6124-0218.3 330455</b></p> |

# Abbildungen Bremsschläuche, Kupplungsschläuche

Illustrations brake hoses, clutch hoses - Illustrations fessibilli freno, fessibilli frizione - Illustrations Flexible de frein, Flexibles d'embrayages - Ilustraciones flexibles de freno, flexibles d'embrague

**83.6124-0252.3 330456**

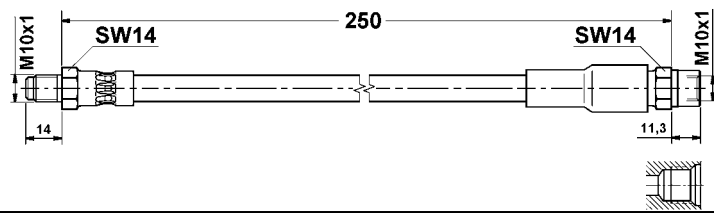

**83.6124-0275.3 330458**

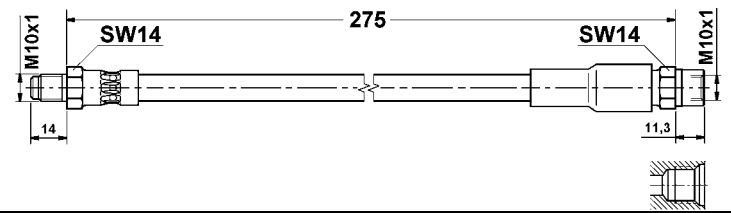

**83.6124-0282.3 330490**

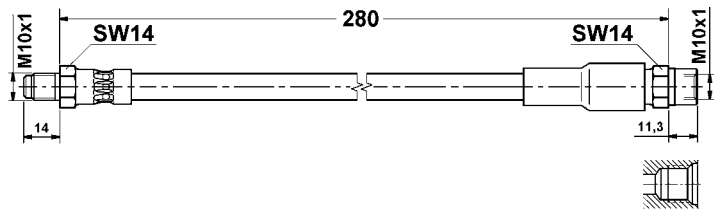

**83.6124-0285.3 330722**

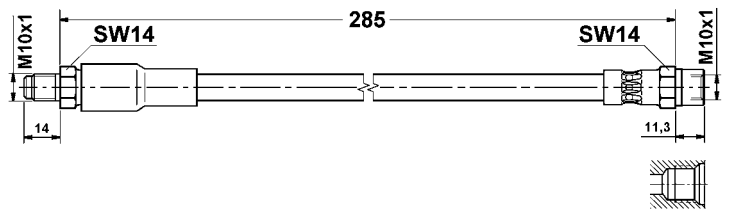

**83.6124-0303.3 330689**

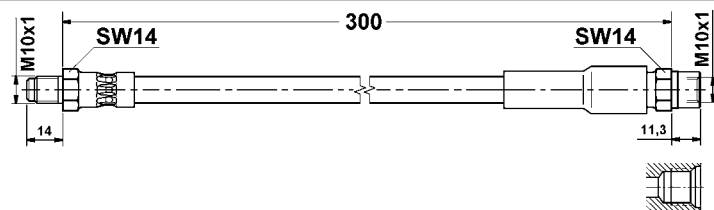

**83.6124-0304.3 330983**

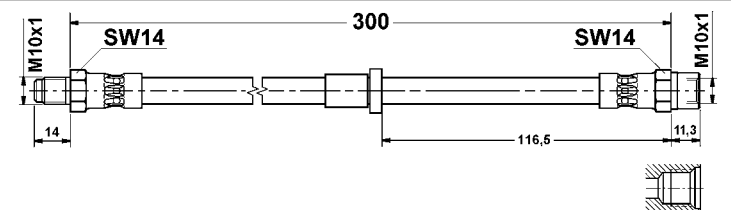

**83.6124-0305.3 330723**

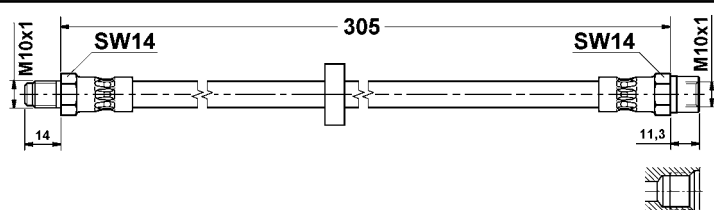

**83.6124-0331.3 330267**

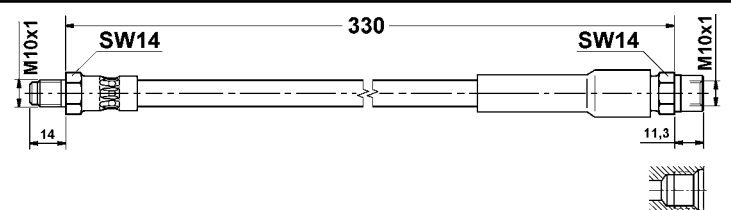

**83.6124-0362.3 330715**

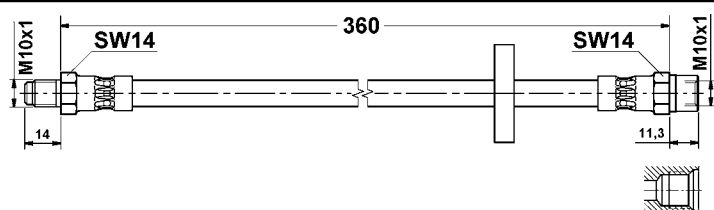

**83.6124-0380.3 330268**

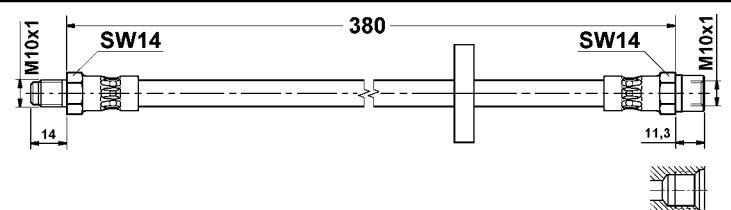

**83.6124-0382.3 330724**

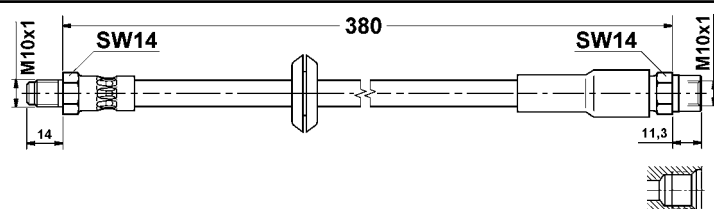

**83.6124-0422.3 330269**

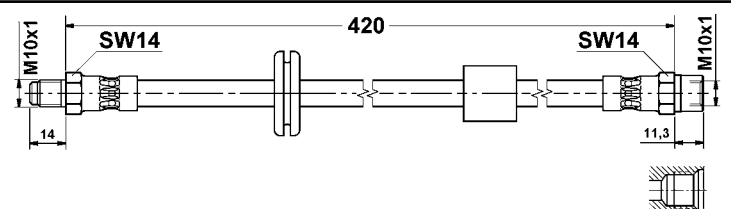

**83.6133-0500.3 330272**

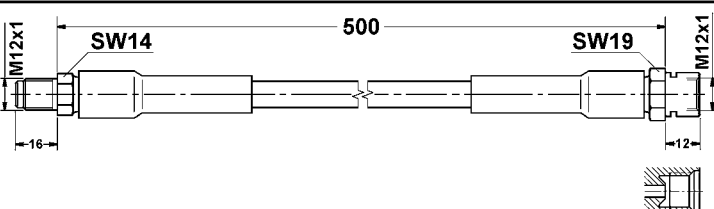

**83.6133-0551.3 330273**

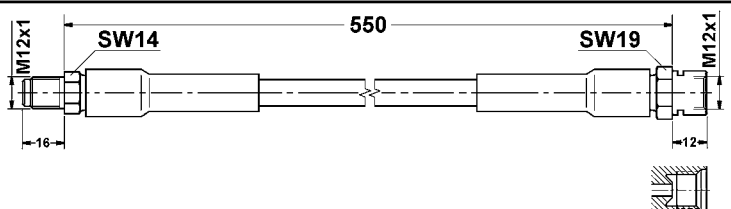

# Abbildungen Bremsschläuche, Kupplungsschläuche

Illustrations brake hoses, clutch hoses - Illustrations fessibilli freno, fessibilli frizione - Illustrations Flexible de frein, Flexibles d'embrayages - Ilustraciones flexibles de freno, flexibles d'embrague

|                                     |                                     |
|-------------------------------------|-------------------------------------|
| <p><b>83.6133-0651.3 330274</b></p> | <p><b>83.6134-0205.3 330380</b></p> |
| <p><b>83.6134-0270.3 330779</b></p> | <p><b>83.6134-0300.3 330725</b></p> |
| <p><b>83.6134-0332.3 330716</b></p> | <p><b>83.6134-0335.3 330277</b></p> |
| <p><b>83.6134-0355.3 330541</b></p> | <p><b>83.6134-0420.3 330279</b></p> |
| <p><b>83.6150-0206.3 330978</b></p> | <p><b>83.6150-0426.3 330282</b></p> |
| <p><b>83.6150-0436.3 330890</b></p> | <p><b>83.6150-0451.3 330283</b></p> |
| <p><b>83.6150-0481.3 330542</b></p> | <p><b>83.6150-0556.3 330712</b></p> |

# Abbildungen Bremsschläuche, Kupplungsschläuche

Illustrations brake hoses, clutch hoses - Illustrations fessibilli freno, fessibilli frizione - Illustrations Flexible de frein, Flexibles d'embrayages - Ilustraciones flexibles de freno, flexibles d'embrague

|                                     |                                     |
|-------------------------------------|-------------------------------------|
| <p><b>83.6151-0356.3 330460</b></p> | <p><b>83.6151-0411.3 330461</b></p> |
| <p><b>83.6151-0552.3 330857</b></p> | <p><b>83.6151-0602.3 330893</b></p> |
| <p><b>83.6152-0406.3 330789</b></p> | <p><b>83.6152-0455.3 330545</b></p> |
| <p><b>83.6154-0526.3 330285</b></p> | <p><b>83.6154-0536.3 330286</b></p> |
| <p><b>83.6155-0160.3 330717</b></p> | <p><b>83.6155-0327.3 330287</b></p> |
| <p><b>83.6169-0325.3 330546</b></p> | <p><b>83.6169-0418.3 330894</b></p> |
| <p><b>83.6169-0505.3 330288</b></p> | <p><b>83.6169-0685.3 330984</b></p> |

# Abbildungen Bremsschläuche, Kupplungsschläuche

Illustrations brake hoses, clutch hoses - Illustrations fessibilli freno, fessibilli frizione - Illustrations Flexible de frein, Flexibles d'embrayages - Ilustraciones flexibles de freno, flexibles d'embrague

|                                     |                                     |
|-------------------------------------|-------------------------------------|
| <p><b>83.6188-0311.3 330291</b></p> | <p><b>83.6192-0250.3 330726</b></p> |
| <p><b>83.6196-0325.3 330727</b></p> | <p><b>83.6201-0175.3 330663</b></p> |
| <p><b>83.6201-0285.3 330294</b></p> | <p><b>83.6203-0200.3 330298</b></p> |
| <p><b>83.6203-0250.3 330299</b></p> | <p><b>83.6203-0260.3 330300</b></p> |
| <p><b>83.6203-0300.3 330386</b></p> | <p><b>83.6203-0400.3 330302</b></p> |
| <p><b>83.6204-0100.3 330441</b></p> | <p><b>83.6204-0143.3 330304</b></p> |
| <p><b>83.6204-0158.3 330773</b></p> | <p><b>83.6204-0180.3 330547</b></p> |



# Abbildungen Bremsschläuche, Kupplungsschläuche

Illustrations brake hoses, clutch hoses - Illustrations fessibilli freno, fessibilli frizione - Illustrations Flexible de frein, Flexibles d'embrayages - Ilustraciones flexibles de freno, flexibles d'embrague

|                                     |                                     |
|-------------------------------------|-------------------------------------|
| <p><b>83.6204-0200.3 330306</b></p> | <p><b>83.6204-0220.3 330308</b></p> |
| <p><b>83.6204-0240.3 330718</b></p> | <p><b>83.6204-0280.3 330732</b></p> |
| <p><b>83.6204-0282.3 330309</b></p> | <p><b>83.6204-0286.3 330733</b></p> |
| <p><b>83.6204-0290.3 330310</b></p> | <p><b>83.6204-0300.3 330548</b></p> |
| <p><b>83.6204-0350.3 330382</b></p> | <p><b>83.6204-0400.3 330311</b></p> |
| <p><b>83.6204-0470.3 330312</b></p> | <p><b>83.6205-0240.3 330314</b></p> |
| <p><b>83.6205-0252.3 330315</b></p> | <p><b>83.6211-0531.3 330551</b></p> |

# Abbildungen Bremsschläuche, Kupplungsschläuche

Illustrations brake hoses, clutch hoses - Illustrations fessibili freno, fessibili frizione - Illustrations Flexible de frein, Flexibles d'embrayages - Ilustraciones flexibles de freno, flexibles d'embrague

**83.6211-0532.3 330552**

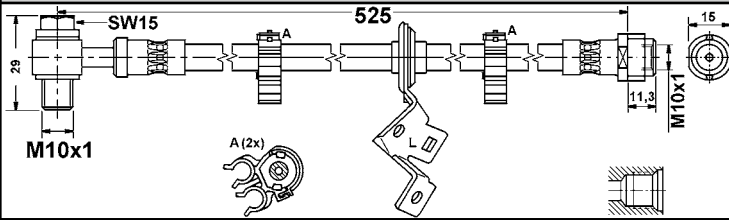

**83.6211-0535.3 330627**

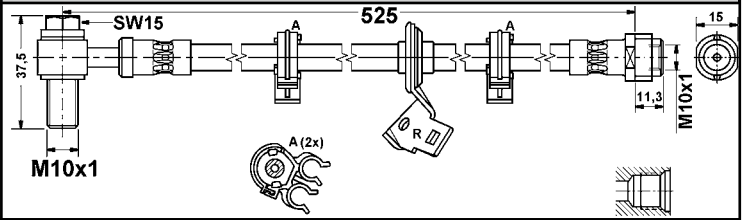

**83.6211-0536.3 330628**

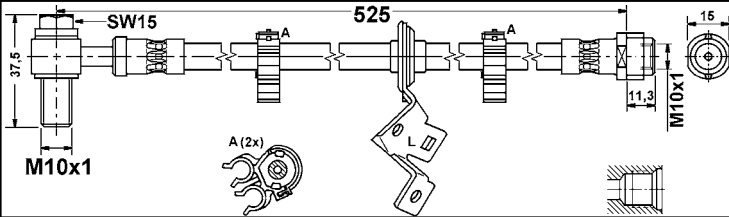

**83.6212-0160.3 330318**

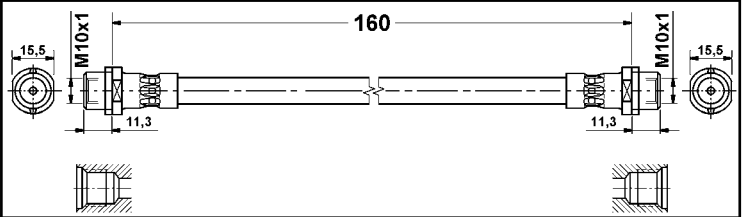

**83.6212-0170.3 330625**

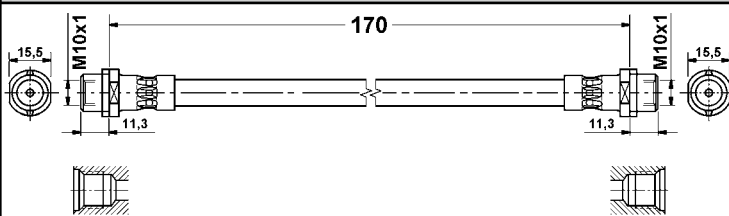

**83.6212-0340.3 330626**

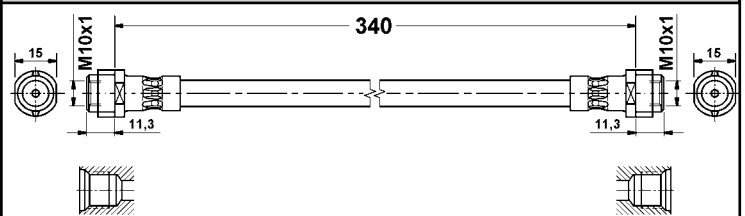

**83.6213-0335.3 330459**

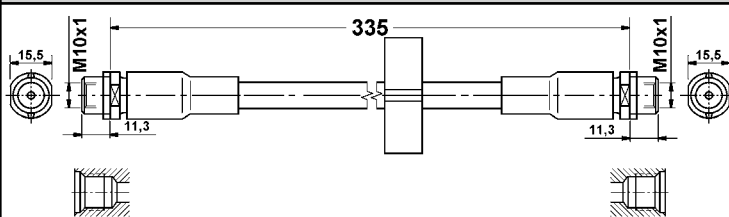

**83.6213-0340.3 330743**

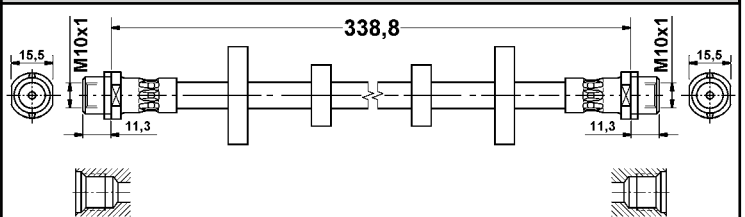

**83.6213-0515.3 330866**

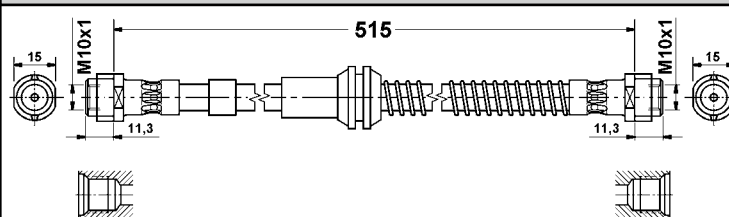

**83.6215-0400.3 330323**

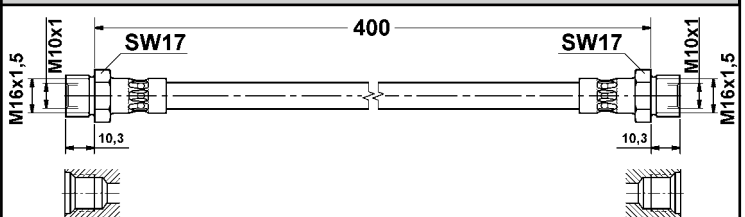

**83.6219-0455.3 330592**

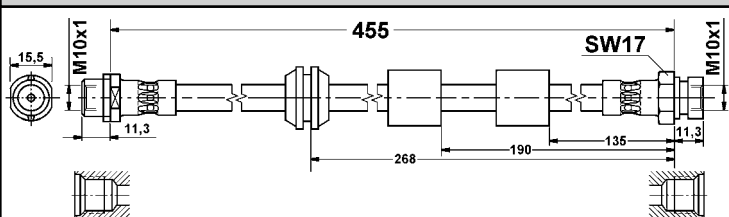

**83.6220-0296.3 330324**

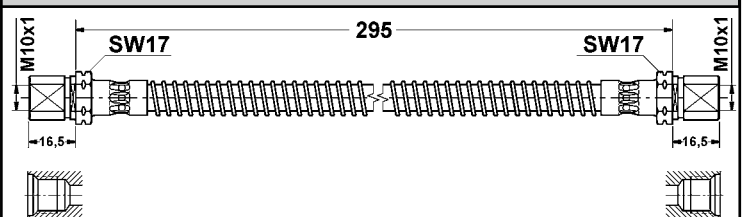

**83.6224-0200.3 330729**

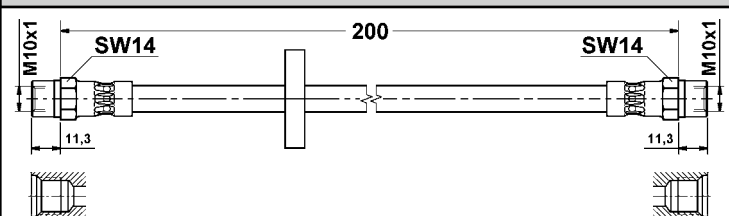

**83.6224-0300.3 330730**

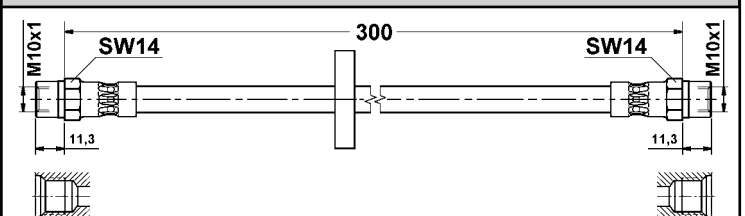

# Abbildungen Bremsschläuche, Kupplungsschläuche

Illustrations brake hoses, clutch hoses - Illustrations fessibilli freno, fessibilli frizione - Illustrations Flexible de frein, Flexibles d'embrayages - Ilustraciones flexibles de freno, flexibles d'embrague

**83.6225-0287.3 330735**

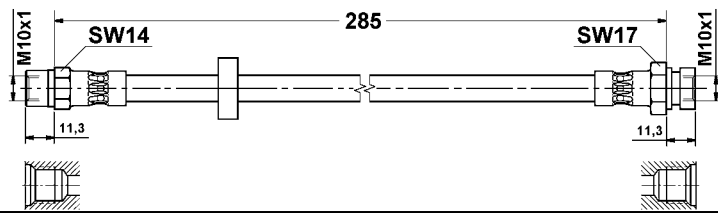

**83.6225-0370.3 330768**

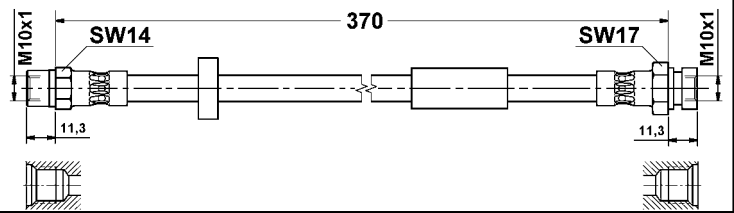

**83.6227-0281.3 330424**

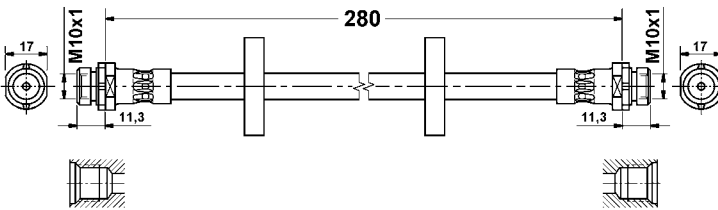

**83.6232-0465.3 330736**

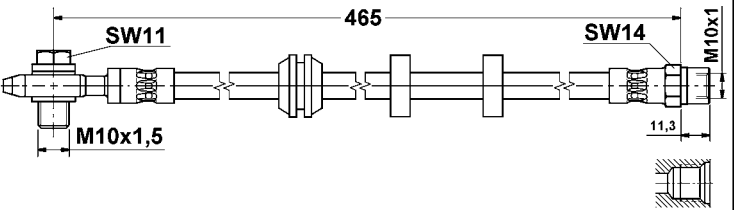

**83.6235-0100.3 330463**

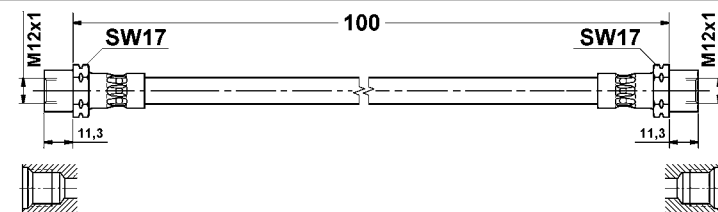

**83.6236-0175.3 330710**

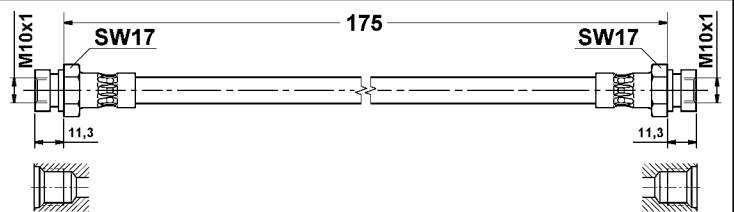

**83.6236-0402.3 330464**

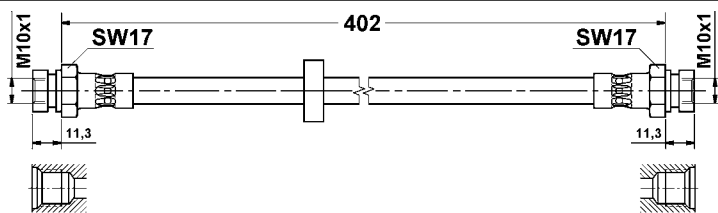

**83.6238-0408.3 330895**

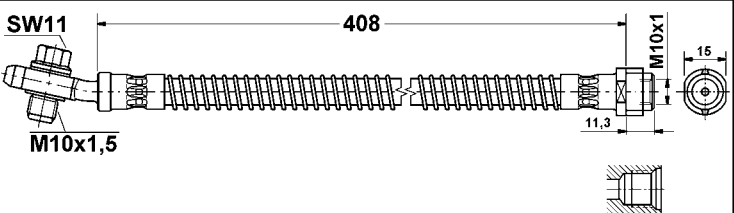

**83.6238-0508.3 330631**

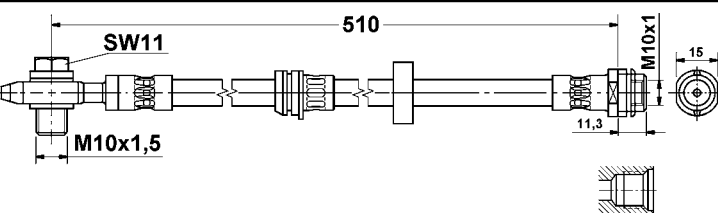

**83.6239-0297.3 330643**

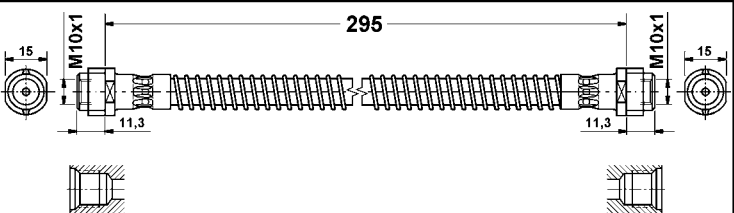

**83.6240-0200.3 330329**

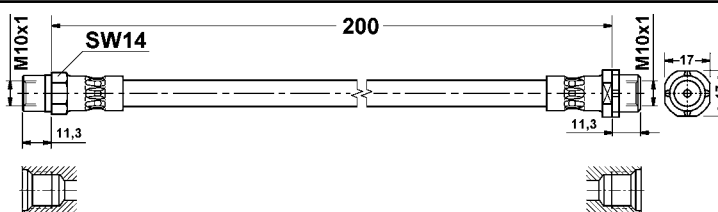

**83.6240-0220.3 330465**

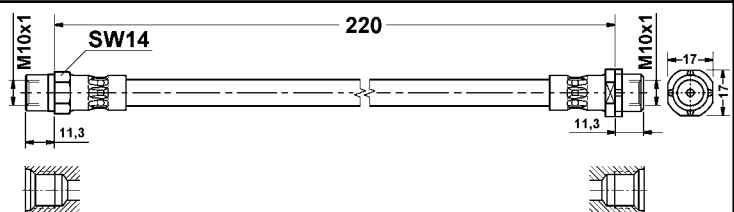

**83.6243-0385.3 330632**

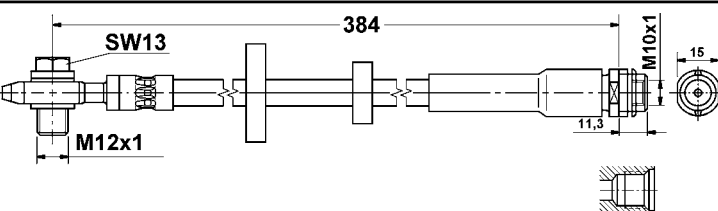

**83.6243-0393.3 330629**

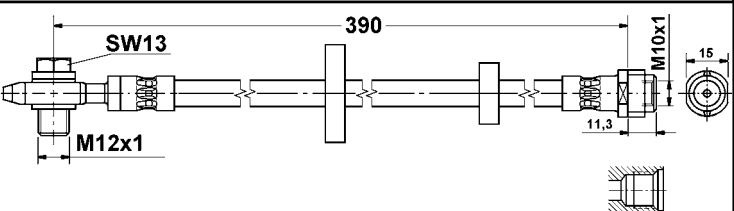

# Abbildungen Bremsschläuche, Kupplungsschläuche

Illustrations brake hoses, clutch hoses - Illustrations fessibili freno, fessibili frizione - Illustrations Flexible de frein, Flexibles d'embrayages - Ilustraciones flexibles de freno, flexibles d'embrague

|                                     |                                     |
|-------------------------------------|-------------------------------------|
| <p><b>83.6247-0522.3 330595</b></p> | <p><b>83.6247-0562.3 330594</b></p> |
| <p><b>83.6248-0432.3 330713</b></p> | <p><b>83.6248-0565.3 330644</b></p> |
| <p><b>83.6251-0301.3 330556</b></p> | <p><b>83.6252-0560.3 330557</b></p> |
| <p><b>83.6255-0200.3 330896</b></p> | <p><b>83.6255-0337.3 330744</b></p> |
| <p><b>83.6255-0340.3 330745</b></p> | <p><b>83.6255-0353.3 330481</b></p> |
| <p><b>83.6266-0315.3 330331</b></p> | <p><b>83.6267-0195.3 330737</b></p> |
| <p><b>83.6267-0285.3 330332</b></p> | <p><b>83.6267-0330.3 330333</b></p> |

# Abbildungen Bremsschläuche, Kupplungsschläuche

Illustrations brake hoses, clutch hoses - Illustrations flessibili freno, flessibili frizione - Illustrations Flexible de frein, Flexibles d'embrayages - Ilustraciones flexibles de freno, flexibles d'embrague

**83.6288-0280.3 330336**

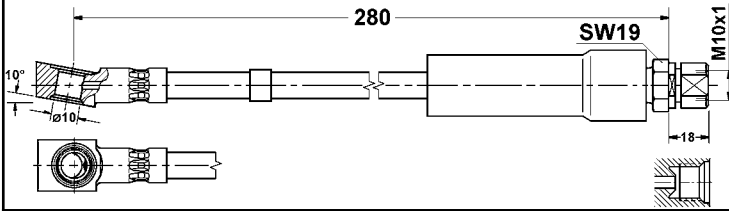

**83.6288-0281.3 330337**

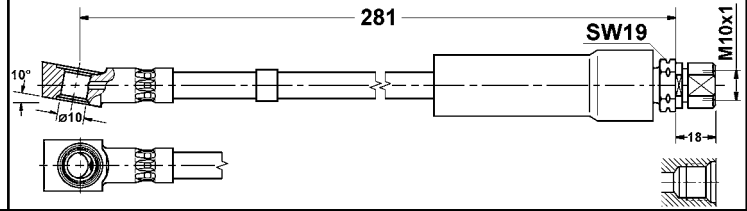

**83.6288-0314.3 330338**

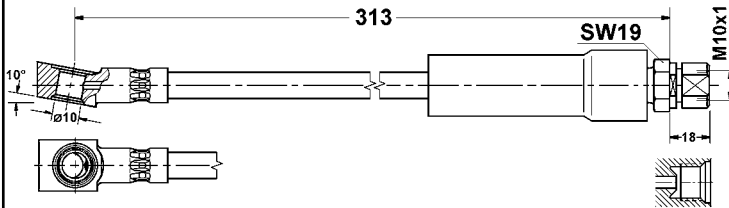

**83.6289-0391.3 330341**

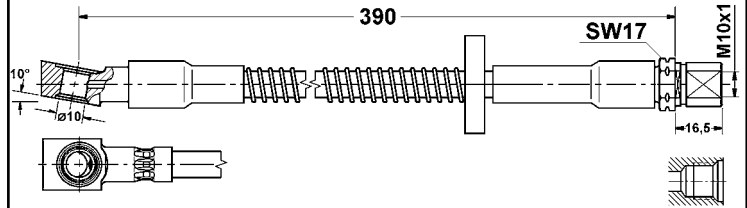

**83.6294-0315.3 330738**

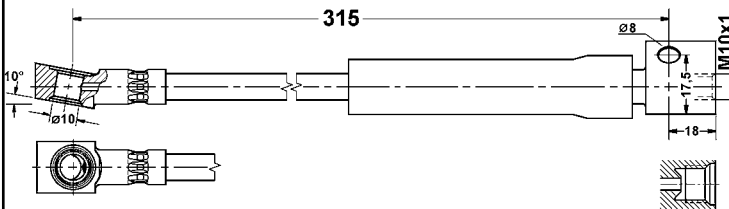

**83.6299-0807.3 330901**

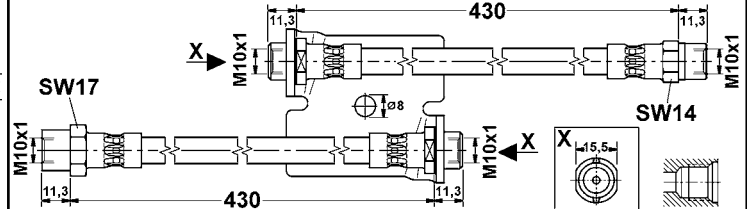

**83.6301-0150.3 330342**

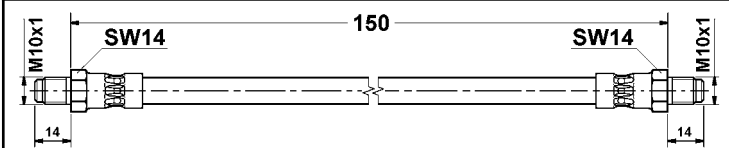

**83.6301-0355.3 330343**

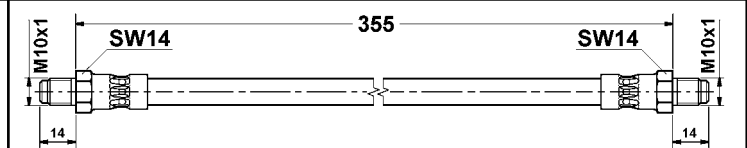

**83.6308-0270.3 330739**

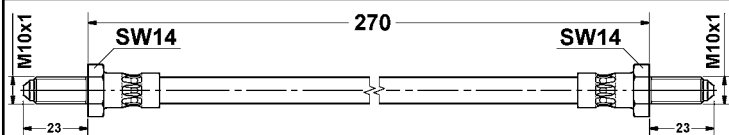

**83.6314-0375.3 330558**

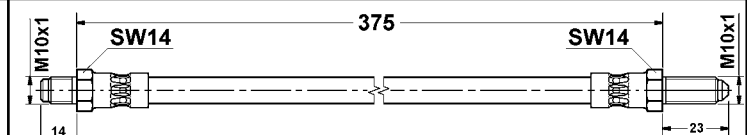

**83.6327-0180.3 330740**

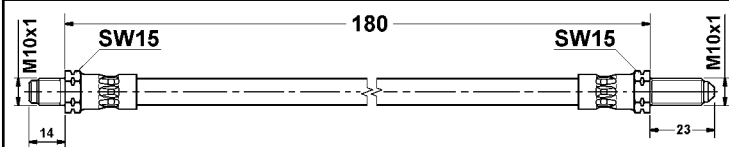

**83.6327-0372.3 330742**

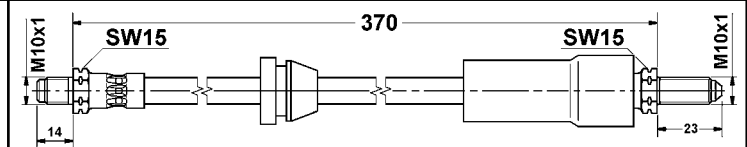

**83.6339-0228.3 330361**

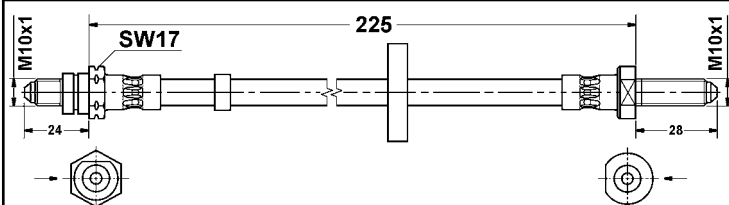

**83.6339-0253.3 330362**

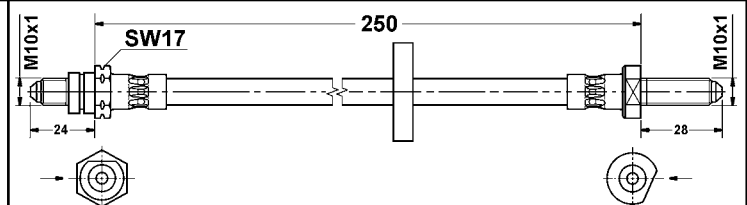

# Abbildungen Bremsschläuche, Kupplungsschläuche

Illustrations brake hoses, clutch hoses - Illustrations fessibilli freno, fessibilli frizione - Illustrations Flexible de frein, Flexibles d'embrayages - Ilustraciones flexibles de freno, flexibles d'embrague

|                                     |                                     |
|-------------------------------------|-------------------------------------|
| <p><b>83.6352-0310.3 330370</b></p> | <p><b>83.6362-0542.3 330485</b></p> |
| <p><b>83.6383-0300.3 330371</b></p> | <p><b>83.6401-0159.3 330746</b></p> |
| <p><b>83.6401-0413.3 330748</b></p> | <p><b>83.6401-0454.3 330860</b></p> |
| <p><b>83.6401-0469.3 330749</b></p> | <p><b>83.6401-0471.3 330750</b></p> |
| <p><b>83.6501-0282.3 330769</b></p> | <p><b>83.7101-9219.3 330903</b></p> |
| <p><b>83.7101-9399.3 330904</b></p> | <p><b>83.7101-9414.3 330905</b></p> |
| <p><b>83.7101-9489.3 330906</b></p> | <p><b>83.7101-9504.3 330898</b></p> |



# Abbildungen Bremsschläuche, Kupplungsschläuche

Illustrations brake hoses, clutch hoses - Illustrations fessibilli freno, fessibilli frizione - Illustrations Flexible de frein, Flexibles d'embrayages - Ilustraciones flexibles de freno, flexibles d'embrague

**83.7114-0376.3 330373**

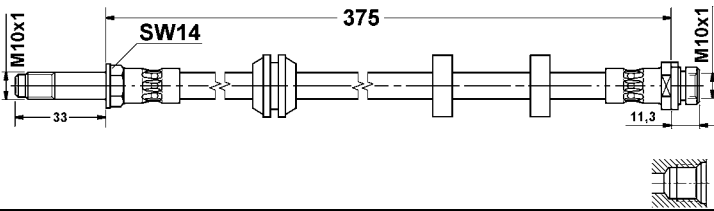

**83.7119-0180.3 330634**

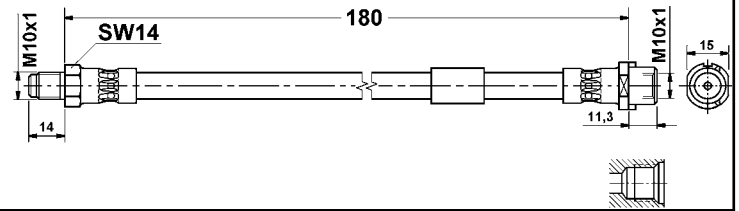

**83.7188-0446.3 330664**

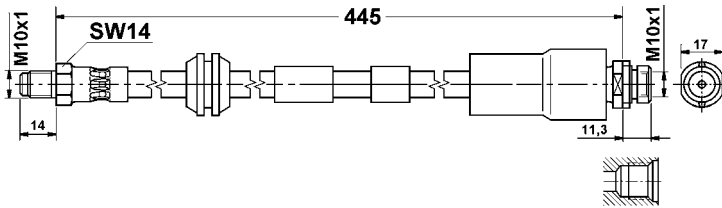

**83.7201-9173.3 330868**

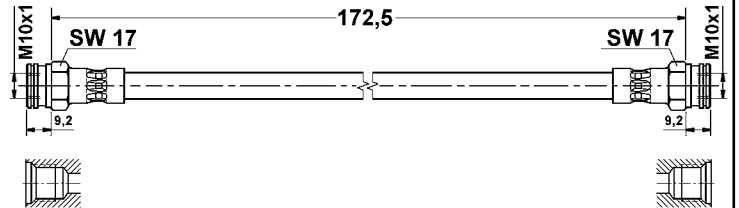

**83.7207-0396.3 330560**

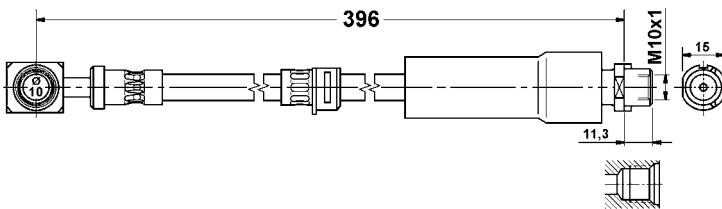

**83.7213-0307.3 330791**

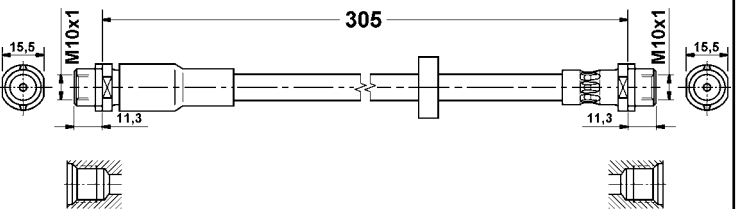

**83.7216-0404.3 330374**

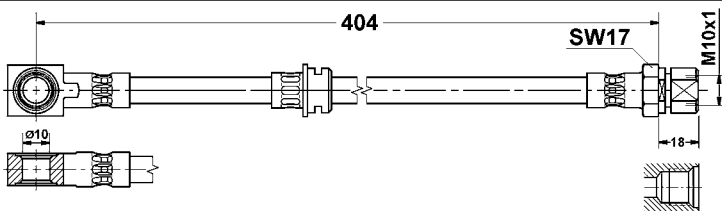

**83.7247-0603.3 330899**

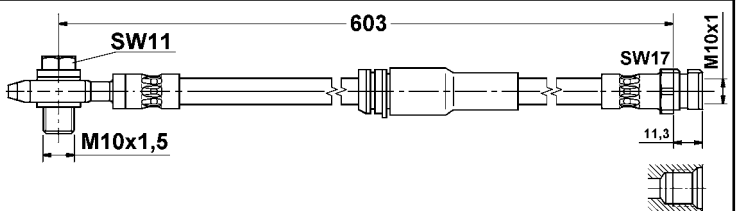

**83.7249-0536.3 330900**

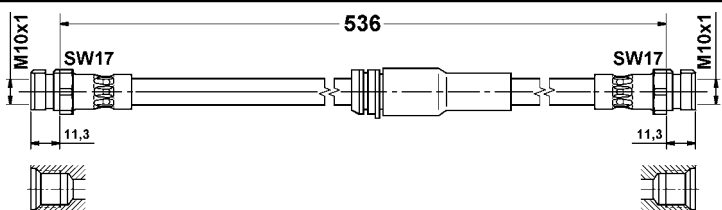

**83.7257-0388.3 330486**

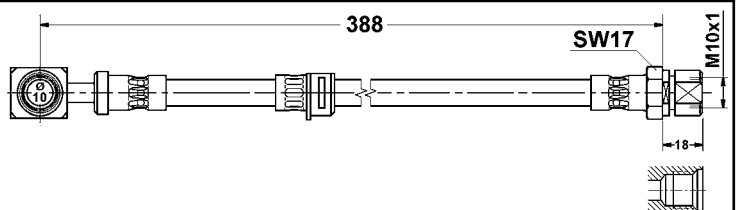

**83.7257-0424.3 330985**

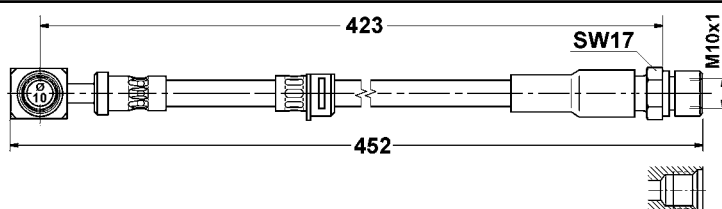

**83.7288-0318.3 330375**

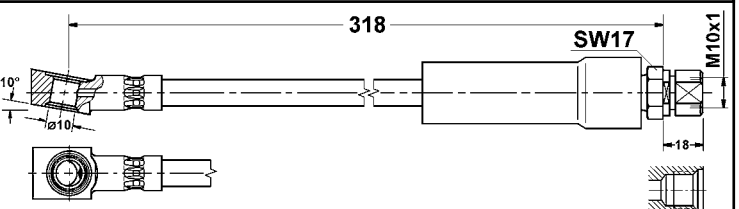

**83.7701-0390.3 330849**

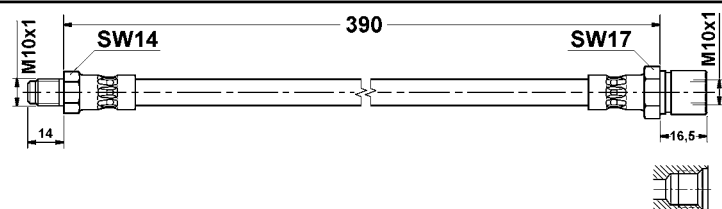

**83.7704-0160.3 330805**

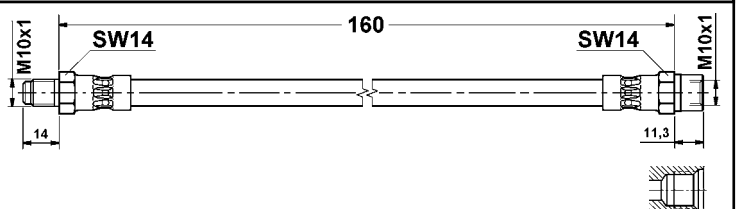

# Abbildungen Bremsschläuche, Kupplungsschläuche

Illustrations brake hoses, clutch hoses - Illustrations fessibilli freno, fessibilli frizione - Illustrations Flexible de frein, Flexibles d'embrayages - Ilustraciones flexibles de freno, flexibles d'embrague

|                                     |                                     |
|-------------------------------------|-------------------------------------|
| <p><b>83.7704-0200.3 330825</b></p> | <p><b>83.7704-0266.3 330979</b></p> |
| <p><b>83.7704-0281.3 330804</b></p> | <p><b>83.7704-0290.3 330826</b></p> |
| <p><b>83.7704-0320.3 330851</b></p> | <p><b>83.7704-0421.3 330827</b></p> |
| <p><b>83.7705-0386.3 330828</b></p> | <p><b>83.7713-0347.3 330986</b></p> |
| <p><b>83.7713-0366.3 331100</b></p> | <p><b>83.7713-0435.3 330792</b></p> |
| <p><b>83.7713-0476.3 331116</b></p> | <p><b>83.7714-0391.3 330980</b></p> |
| <p><b>83.7715-0280.3 330806</b></p> | <p><b>83.7715-0299.3 331117</b></p> |

# Abbildungen Bremsschläuche, Kupplungsschläuche

Illustrations brake hoses, clutch hoses - Illustrations fessibilli freno, fessibilli frizione - Illustrations Flexible de frein, Flexibles d'embrayages - Ilustraciones flexibles de freno, flexibles d'embrague

**83.7716-0363.3 330829**

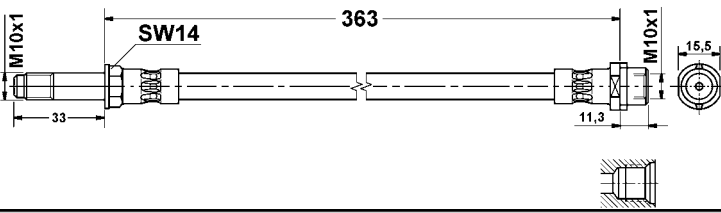

**83.7716-0397.3 330790**

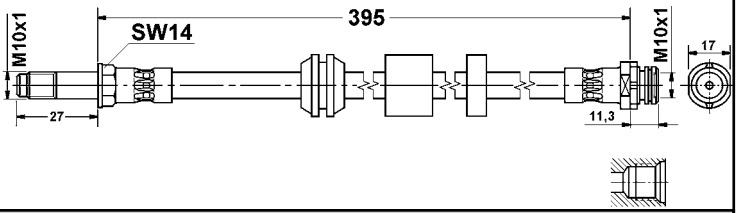

**83.7716-0398.3 330987**

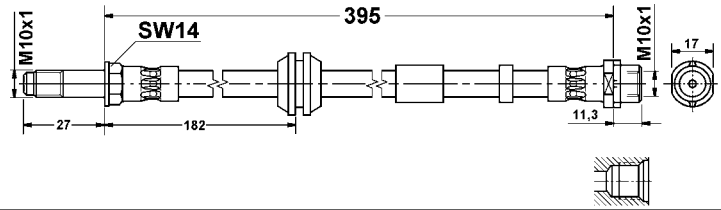

**83.7717-0450.3 330807**

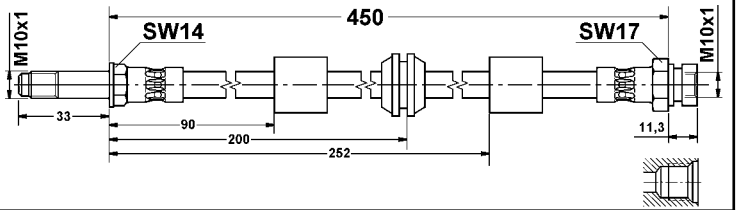

**83.7724-0202.3 330852**

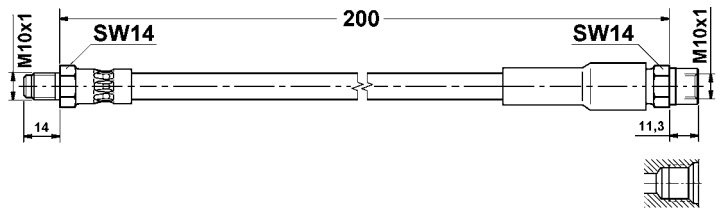

**83.7724-0204.3 331206**

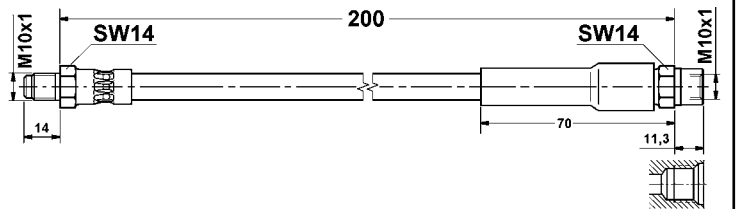

**83.7724-0215.3 330843**

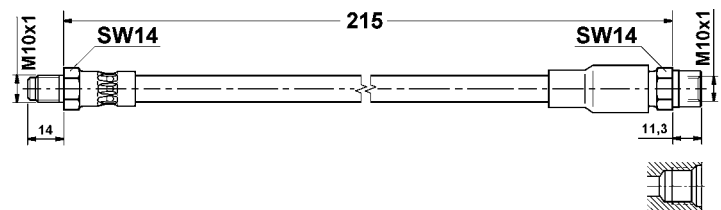

**83.7724-0268.3 331076**

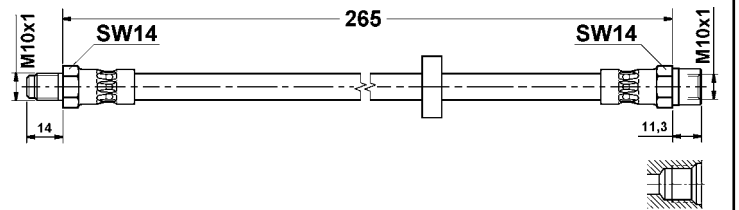

**83.7734-0290.3 330809**

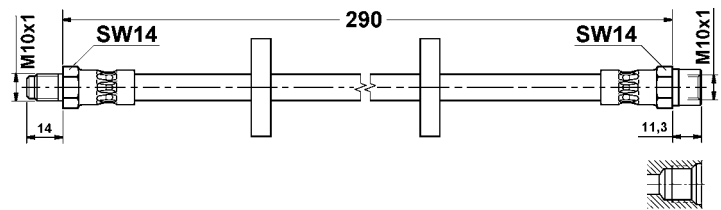

**83.7750-0513.3 331051**

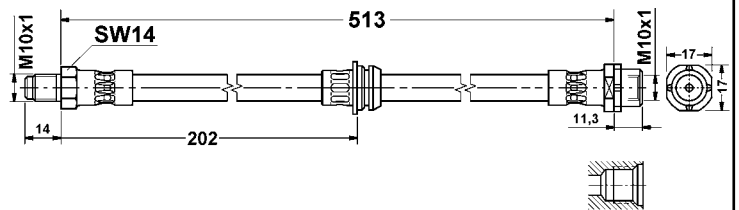

**83.7750-0523.3 331101**

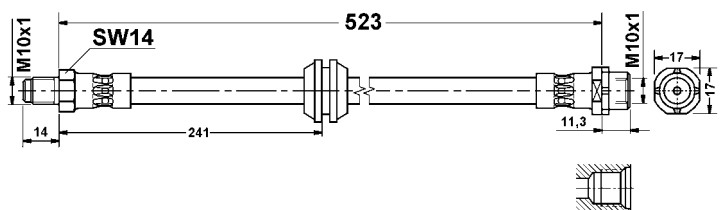

**83.7750-0524.3 331230**

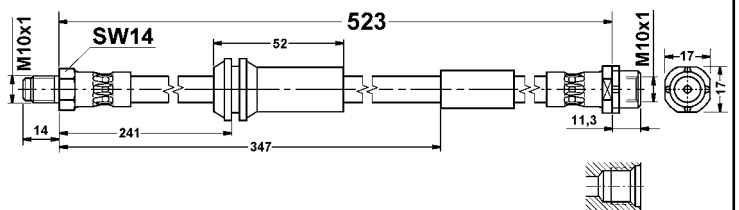

**83.7751-0417.3 331102**

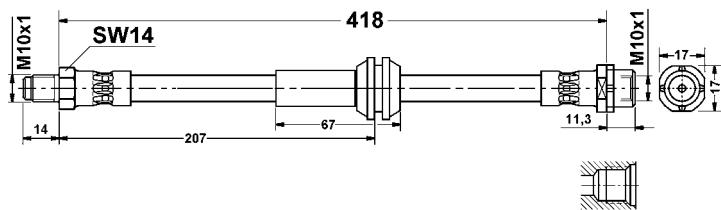

**83.7751-0495.3 331104**

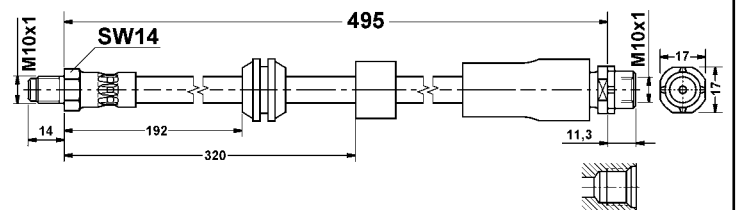

# Abbildungen Bremsschläuche, Kupplungsschläuche

Illustrations brake hoses, clutch hoses - Illustrations fessibili freno, fessibili frizione - Illustrations Flexible de frein, Flexibles d'embrayages - Ilustraciones flexibles de freno, flexibles d'embrague

**83.7751-0502.3 331109**

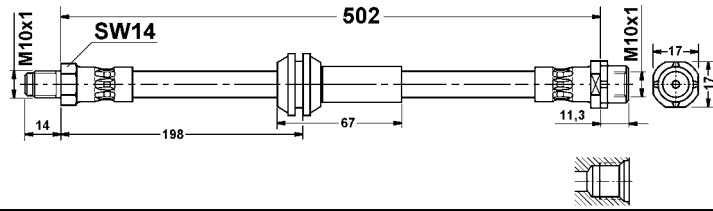

**83.7751-0520.3 331052**

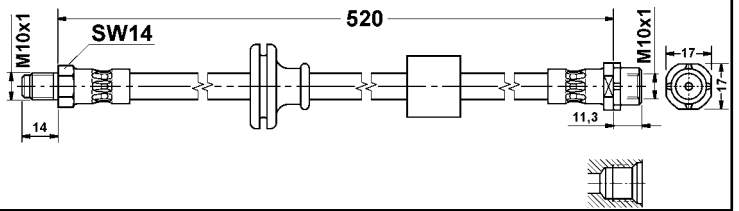

**83.7750-0553.3 331103**

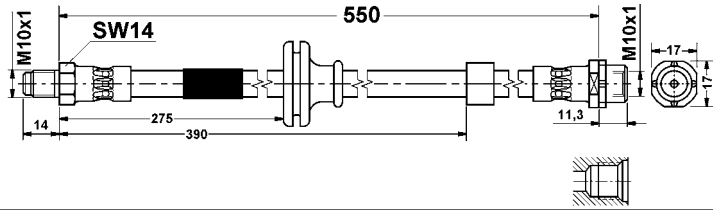

**83.7752-0221.3 331053**

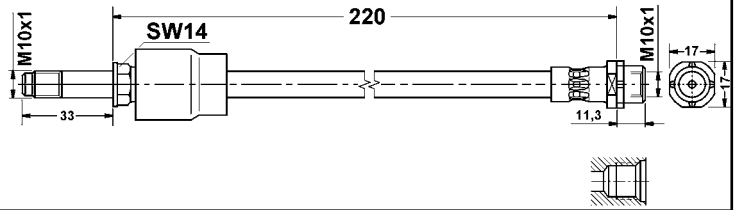

**83.7752-0236.3 331118**

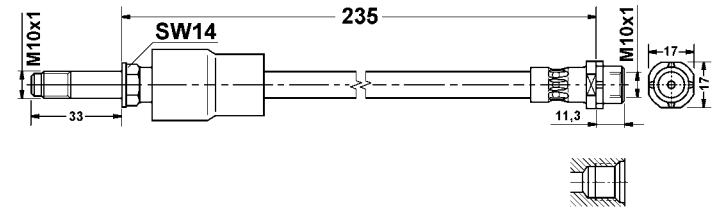

**83.7754-0340.3 330794**

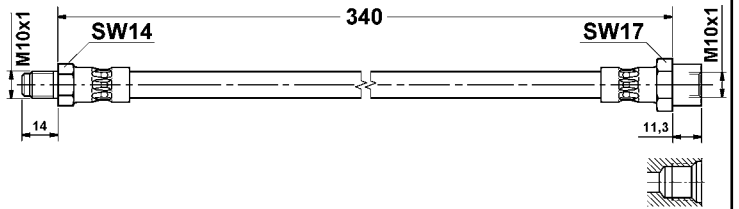

**83.7769-0275.3 331207**

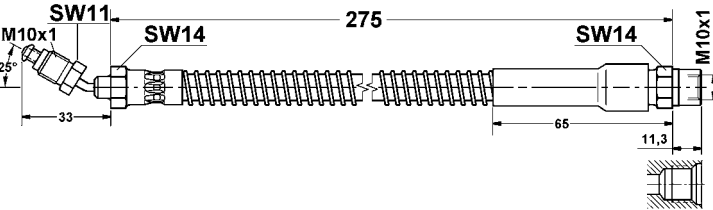

**83.7769-0493.3 330861**

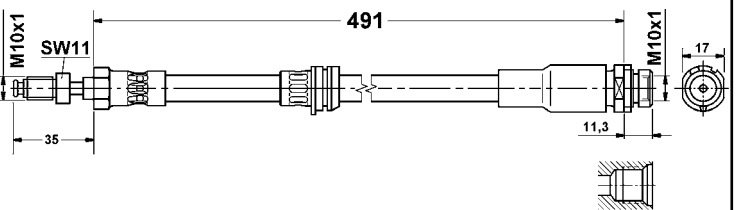

**83.7769-0561.3 331105**

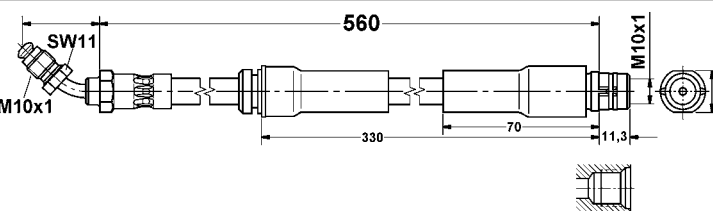

**83.7769-0713.3 331097**

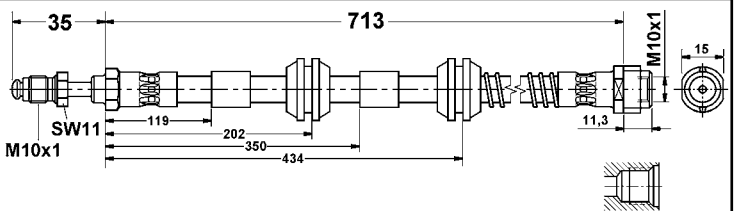

**83.7775-0312.3 330795**

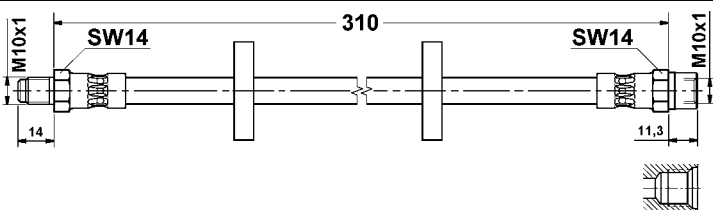

**83.7788-0280.3 330836**

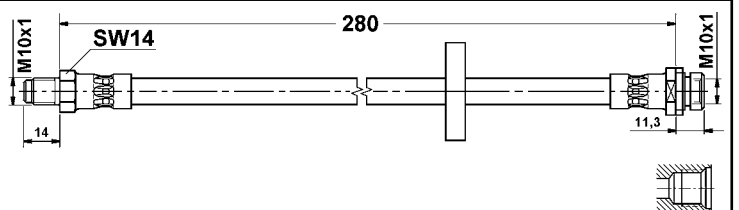

**83.7788-0382.3 330971**

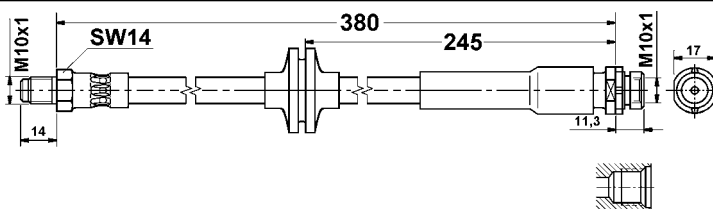

**83.7788-0383.3 330972**

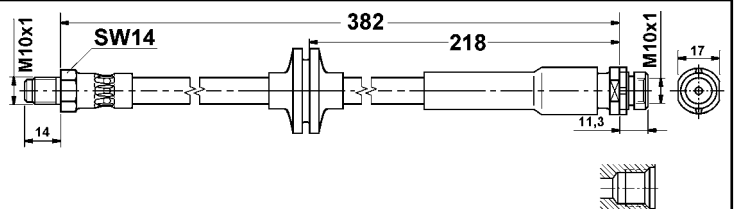

# Abbildungen Bremsschläuche, Kupplungsschläuche

Illustrations brake hoses, clutch hoses - Illustrations fessibilli freno, fessibilli frizione - Illustrations Flexible de frein, Flexibles d'embrayages - Ilustraciones flexibles de freno, flexibles d'embrague

**83.7788-0409.3 330981**

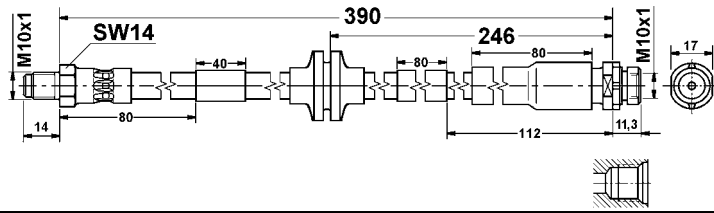

**83.7788-0414.3 330988**

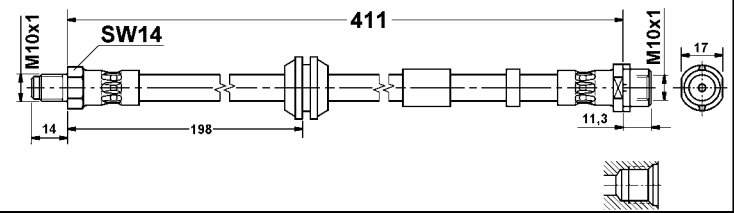

**83.7788-0416.3 330884**

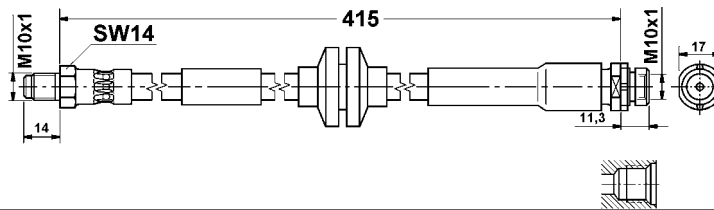

**83.7788-0435.3 331119**

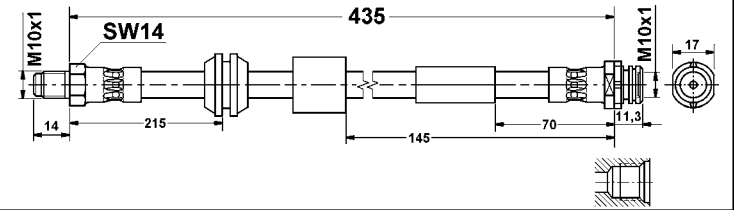

**83.7788-0472.3 331120**

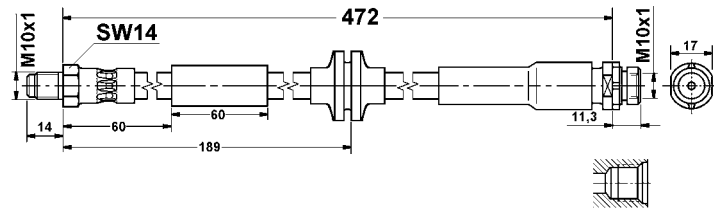

**83.7804-0150.3 330853**

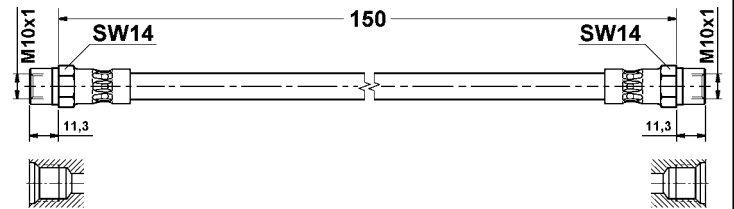

**83.7804-0160.3 330811**

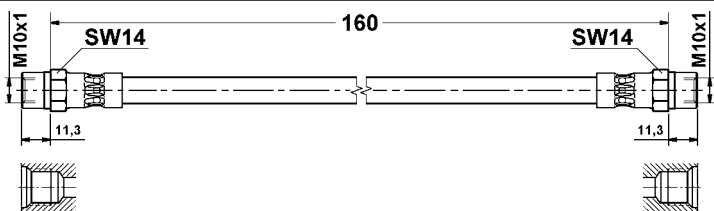

**83.7807-0412.3 331098**

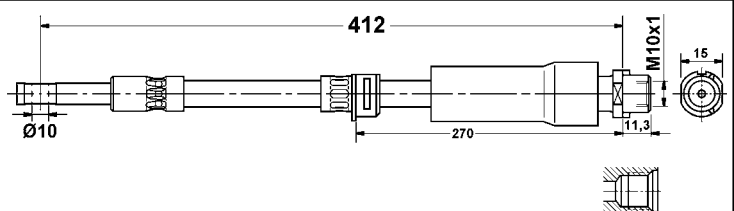

**83.7812-0180.3 330854**

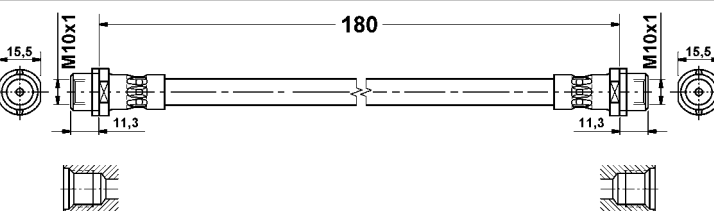

**83.7812-0200.3 330846**

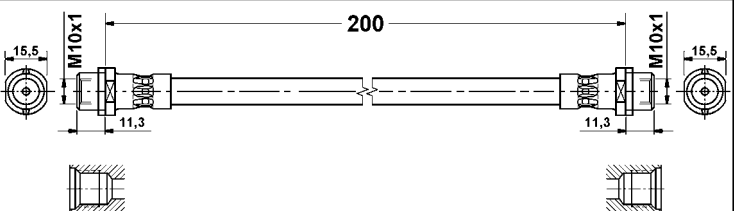

**83.7812-0400.3 331214**

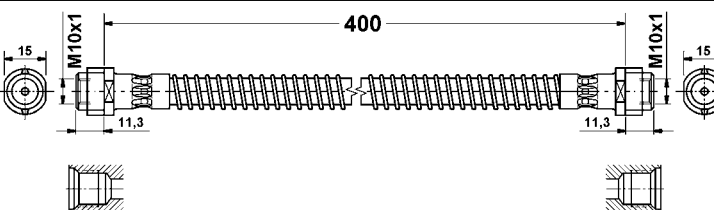

**83.7813-0252.3 330796**

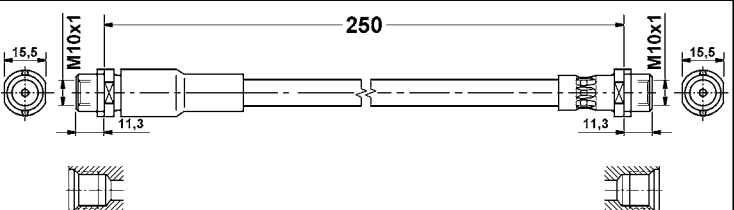

**83.7813-0270.3 330797**

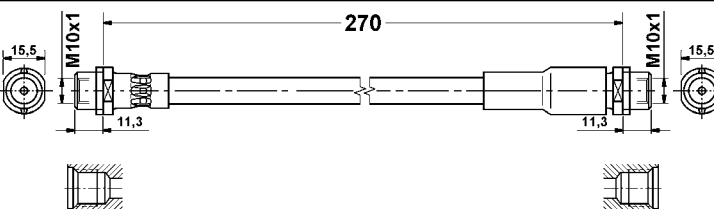

**83.7813-0285.3 330798**

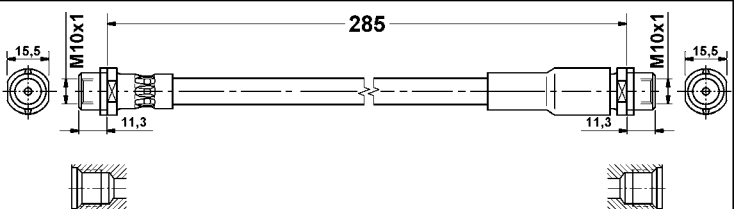

# Abbildungen Bremsschläuche, Kupplungsschläuche

Illustrations brake hoses, clutch hoses - Illustrations fessibilli freno, fessibilli frizione - Illustrations Flexible de frein, Flexibles d'embrayages - Ilustraciones flexibles de freno, flexibles d'embrague

|                                     |                                     |
|-------------------------------------|-------------------------------------|
| <p><b>83.7813-0295.3 330799</b></p> | <p><b>83.7813-0315.3 330870</b></p> |
| <p><b>83.7813-0330.3 330800</b></p> | <p><b>83.7813-0332.3 330801</b></p> |
| <p><b>83.7824-0180.3 330812</b></p> | <p><b>83.7824-0383.3 330856</b></p> |
| <p><b>83.7827-0245.3 331113</b></p> | <p><b>83.7827-0300.3 330902</b></p> |
| <p><b>83.7827-0321.3 330862</b></p> | <p><b>83.7834-0440.3 330813</b></p> |
| <p><b>83.7836-0135.3 330816</b></p> | <p><b>83.7838-0370.3 331122</b></p> |
| <p><b>83.7838-0371.3 331123</b></p> | <p><b>83.7838-0435.3 330834</b></p> |



# Abbildungen Bremsschläuche, Kupplungsschläuche

Illustrations brake hoses, clutch hoses - Illustrations fessibilli freno, fessibilli frizione - Illustrations Flexible de frein, Flexibles d'embrayages - Ilustraciones flexibles de freno, flexibles d'embrague

|                                     |                                     |
|-------------------------------------|-------------------------------------|
| <p><b>83.7847-0563.3 331124</b></p> | <p><b>83.7847-0620.3 331110</b></p> |
| <p><b>83.7849-0145.3 331106</b></p> | <p><b>83.7849-0231.3 330872</b></p> |
| <p><b>83.7849-0236.3 330873</b></p> | <p><b>83.7849-0243.3 331099</b></p> |
| <p><b>83.7849-0250.3 331111</b></p> | <p><b>83.7849-0419.3 331114</b></p> |
| <p><b>83.7849-0502.3 331125</b></p> | <p><b>83.7849-0554.3 331112</b></p> |
| <p><b>83.7850-0180.3 331054</b></p> | <p><b>83.7850-0205.3 331115</b></p> |
| <p><b>83.7852-0377.3 330835</b></p> | <p><b>83.7855-0362.3 331108</b></p> |

# Abbildungen Bremsschläuche, Kupplungsschläuche

Illustrations brake hoses, clutch hoses - Illustrations fessibilli freno, fessibilli frizione - Illustrations Flexible de frein, Flexibles d'embrayages - Ilustraciones flexibles de freno, flexibles d'embrague

**83.7856-0369.3 331237**

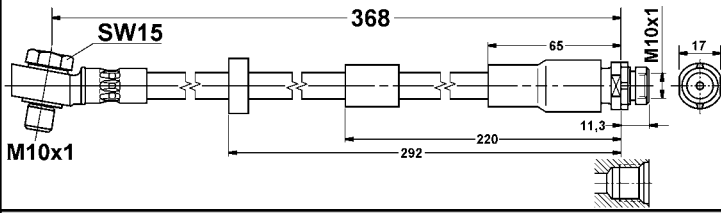

**83.7858-0140.3 330837**

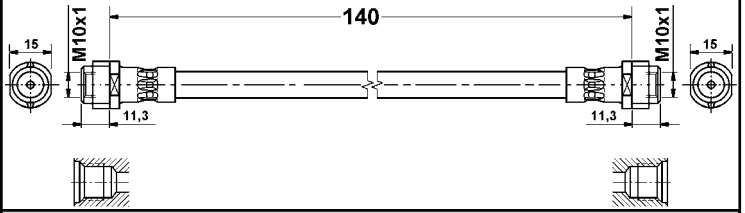

**83.7858-0165.3 331107**

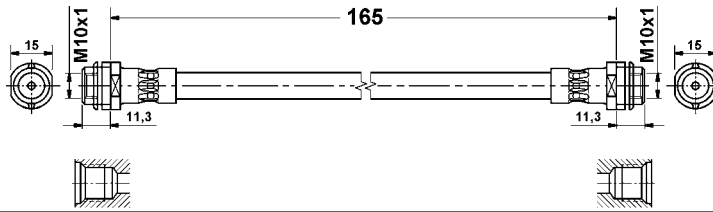

**83.7894-0316.3 330814**

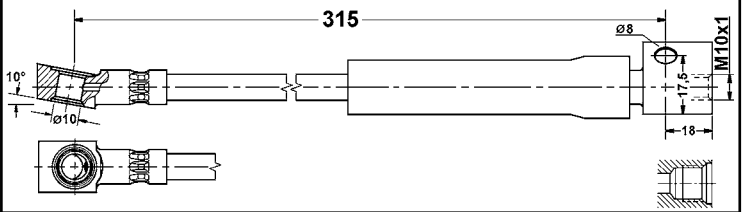



- ① Technische Übersetzungen
- ② Technical translations
- ③ Traductions techniques
- ④ Traduzioni tecniche
- ⑤ Traducciones técnicas
- ⑥ Technische vertalingen
- ⑦ Tekniske oversættelser
- ⑧ Tekniska översättningar
- ⑨ Műszaki fordítás
- ⑩ Glossário técnico
- ⑪ Перевод технических терминов
- ⑫ Technické překlady
- ⑬ Tłumaczenia techniczne
- ⑭ Τεχνικές Ίεταφράσεις
- ⑮ Teknik çeviriler
- ⑯ 技术翻译
- ⑰ テクニカルトランスミッション
- ⑱ الترجمات التقنية

|  |                                       |   |
|--|---------------------------------------|---|
| 1-Kammer-Druckluftbremse               | single-chamber air brake              | frein pneumatique à 1 chambre             |
| 1-Kolbensattel D=xx                    | single-piston caliper D=xx            | étrier à 1 piston D=xx                    |
| 2-Kolbensattel D=xx                    | 2-piston caliper D=xx                 | étrier à 2 pistons D=xx                   |
| 4-Kolbensattel                         | 4-piston caliper                      | étrier à 4 pistons                        |
| 1-Kreis-Bremse                         | single-circuit brake                  | frein à 1 circuit                         |
| 2-Kreis-Bremse                         | two-circuit-brake                     | frein à deux circuits                     |
| 1-Kreis-Sättel                         | single-circuit caliper                | étriers frein à 1 circuit                 |
| 2-Kreis-Sättel                         | two-circuit-caliper                   | étriers frein à 2 circuits                |
| 1. Hinterachse                         | first rear axle                       | 1. essieu arrière                         |
| 1. und 2. Hinterachse                  | first and second rear axle            | 1. et 2. essieu arrière                   |
| 4-Loch-Bremsscheibe                    | 4-bore brake disc                     | disques de frein à 4 trous                |
| 6-Loch-Bremsscheibe                    | 6-bore brake disc                     | disques de frein à 6 trous                |
| 3-Loch-Felge                           | 3-bore wheel rim                      | jante à 3 trous                           |
| 4-Loch-Felge                           | 4-bore wheel rim                      | jante à 4 trous                           |
| 5-Loch-Felge                           | 5-bore wheel rim                      | jante à 5 trous                           |
| 6kt-Schraube                           | hexagon head screw                    | vis hex.                                  |
| 6kt-Schraube (innen)                   | hexagon socket screw                  | vis hex. (intérieure)                     |
| 6“-Tandem                              | 6“-tandem                             | 6“-tandem                                 |
| 8“-Tandem mit Gabelkopf                | 8“-tandem with yoke                   | 8“-tandem avec chape                      |
| 8“-Tandem ohne Gabelkopf               | 8“-tandem without yoke                | 8“-tandem sauf chape                      |
| ABS                                    | ABS (anti-lock brake system)          | ABS (système anti-blocage)                |
| ABS-Dichtungssatz                      | ABS-gasket kit                        | jeu de joints de ABS                      |
| Achtung: Kolbenstellung ändern !       | attention: change piston position !   | attention: position du piston à changer ! |
| Adapter für Bördel E                   | adapter for bead type E               | adapteur pour colet E                     |
| alle Typen                             | all types                             | tous types                                |
| Alu-Pumpe                              | alu-pump                              | pompe en alu                              |
| Alu-Sättel                             | alu-calipers                          | étriers en alu                            |
| am Bremssattel                         | on the brake caliper                  | sur l'étrier de frein                     |
| am Hauptzylinder                       | on the master cylinder                | sur le maître-cylindre                    |
| A-Motor                                | A engine                              | moteur A                                  |
| Anschlagschraube oben                  | stop screw, top                       | vis de butée en haut                      |
| Anschluß/Anschlüsse                    | connection/connections                | raccordement/raccordements                |
| Anti-Noise-Blech                       | shim                                  | tôle anti-bruit                           |
| ASC (Automatische Stabilitäts Control) | ASC (automatic stability control)     | ASC (contrôle de stabilité)               |
| ASR (Antriebsschlupfregelsystem)       | ASR (traction control system TCS)     | ASR (anti-patinage)                       |
| ATE nur über VAG erhältlich            | ATE only available through VAG        | ATE (Teves) en vente chez VAG seulement   |
| auf Typenschild                        | on identification plate               | sur plaque d'identification               |
| aufgeschraubt                          | screwed on                            | vissé                                     |
| Auslaß seitlich links                  | outlet lateral left-hand              | échappement latéral gauche                |
| Auslaß seitlich rechts                 | outlet lateral right-hand             | échappement latéral droit                 |
| außen                                  | outer                                 | mâle                                      |
| automatische Nachstellung              | automatic adjustment                  | ajustage automatique                      |
| Behälter                               | reservoir                             | réservoir                                 |
| Behälter Doppel-WE                     | reservoir with double warning device  | réservoir avec témoin d'usure double      |
| Behälterbefestigung                    | reservoir fastening                   | fixation réservoir                        |
| Behälterstopfen                        | reservoir plug                        | bouchon de réservoir                      |
| Behälterverschraubung                  | reservoir cap                         | vissage de réservoir                      |
| Behörde                                | authority cars                        | véhicule communal                         |
| Beläge                                 | brake pads                            | plaquettes de frein                       |
| belüftete Scheiben                     | ventilated discs                      | disques ventilés                          |
| Betätigungseinheit                     | actuation unit                        | unité de commande                         |
| blau                                   | blue                                  | bleu                                      |
| Bodenventil                            | residual pressure center valve        | soupape de pression résiduelle            |
| Bodenventile tauschen                  | change residual pressure center valve | soupape de pression résiduelle à changer  |
| Bördel x                               | flare type x                          | colet x                                   |
| braun                                  | brown                                 | marron                                    |
| breite Ausführung                      | wide design                           | exécution large                           |
| Bremse                                 | brake                                 | frein                                     |
| Bremsgerät                             | booster unit                          | servo-frein                               |
| Bremskraftregler                       | brake pressure regulator              | correcteur de freinage                    |
| Bremsleitungen erneuern !              | renew brake lines !                   | conduits de frein à renouveler !          |
| Bremslichtschalter                     | stop-light switch                     | contacteur stop                           |
| Bremsscheiben                          | brake discs                           | disques de frein                          |
| Bremsschlauch beachten !               | notice brake hose !                   | faire attention flexible de frein !       |
| Buchse + Ausgleichbügel                | bushing + compensating clip           | douille + étrier de compensation          |
| Bus                                    | bus (van)                             | autobus/car                               |
| Bypassregler                           | by-pass regulator                     | régulateur à by-pass                      |
| Citroen-Bremse                         | Citroen-brake                         | freins Citroen                            |
| D (Durchmesser) =                      | D (diameter) =                        | D (diamètre) =                            |
| Dichtring                              | sealing ring                          | rondelle d'étanchéité                     |
| Dichtung                               | seal                                  | joint                                     |
| Dichtungssatz                          | gasket kit                            | jeu de joints                             |
| Differentialsperre                     | differential lock                     | blocage de différentiel                   |
| Differenzdruckschalter                 | differential-pressure switch          | interrupteur à pression différentielle    |
| Differenzdruckventil                   | differential pressure valve           | pression différentielle de soupape        |
| diverse Typen                          | various types                         | types diverses                            |
| Doppelbereifung                        | twin tyres                            | pneu double                               |



|   |   |   |
|---|---|---|
| freno pneumatico a camera singola           | freno de aire de 1 cámara               | geluiddempende plaat                          |
| pinza freno a un pistoncino D = xx          | mordaza de freno D=xx                   | 1-zuigerklauw D=xx                            |
| pinza freno a 2 pistoncini D=xx             | mordaza con dos pistones D=xx           | 2-zuigerklauw D=xx                            |
| pinza freno a 4 pistoncini                  | mordaza con 4 pistones                  | 4-zuigerklauw                                 |
| impianto frenante circuito semplice         | freno de 1 circuito                     | enkel remcircuit                              |
| impianto frenante doppio circuito           | freno de 2 circuitos                    | gescheiden remcircuit                         |
| pinza freno a 1 circuito                    | pinza de 1 circuito                     | remklauwen voor enkel remcircuit              |
| pinza freno a 2 circuiti                    | pinza de 2 circuitos                    | remklauwen voor gescheiden remcircuit         |
| primo assale posteriore                     | 1. eje trasero                          | 1e achteras                                   |
| primo e secondo assale posteriore           | 1. + 2. eje trasero                     | 1e en 2e achteras                             |
| disco freno 4 fori                          | disco freno con 4 taladros              | 4-gats remschijf                              |
| disco freno 6 fori                          | disco freno con 6 taladros              | 6-gats remschijf                              |
| cerchione a 3 fori                          | Llantas de 3 taladros                   | 3-gats velg                                   |
| cerchione a 4 fori                          | Llantas de 4 taladros                   | 4-gats velg                                   |
| cerchione a 5 fori                          | Llantas de 5 taladros                   | 5-gats velg                                   |
| vite testa esagonale                        | tornillo hexagonal                      | zeskantbout                                   |
| brugola                                     | tornillo hexagonal ( interior)          | zeskantbout (binnen)                          |
| tandem 6"                                   | 6"-tándem                               | 6"-tandem                                     |
| tandem 8" con testa a forcella              | 8"-tándem con cabeza de horquilla       | 8"-tandem met gaffel                          |
| tandem 8" senza testa a forcella            | 8"-tándem sin cabeza de horquilla       | 8"-tandem zonder gaffel                       |
| ABS (sistema antibloccaggio in frenata)     | ABS (sistema de frenado antibloqueo)    | ABS   |
| serie guarnizioni ABS                       | juego de reparación de juntas ABS       | ABS-pakkingset                                |
| attenzione: cambiare posizione pistone !    | atención: cambiar posición pistón !     | Attentie: positie zuiger wijzigen !           |
| adattatore per bordatura E                  | adaptador para rebordes E               | adapter voor felsrand E                       |
| tutti tipi                                  | todos tipo                              | alle typen                                    |
| pompa in alluminio                          | bomba de aluminio                       | alu-pomp                                      |
| pinza in alluminio                          | mordaza de freno de aluminio            | alu-klauwen                                   |
| sulla pinza freno                           | a la pinza de freno                     | op de remklauw                                |
| sulla pompa freno                           | a la bomba principal de freno           | op de hoofdremscilinder                       |
| motore A                                    | motor de A                              | A-motor                                       |
| vite di fermo in alto                       | tornillo de tope arriba                 | aanslagschroef boven                          |
| attacco / attacchi                          | conexion/conexiones                     | aansluiting/aansluitingen                     |
| lamierino antirumore                        | placa anti-ruídos                       | geluiddempende plaat                          |
| ASC (controllo automatico stabilità)        | ASC (control automático de estabilidad) | ASC (Automatische Stabiiliteits Controle)     |
| ASR (sistema antislittamento in accelerata) | ASR (sistemas antiderrapaje)            | ASR (tractieregelingssysteem)                 |
| ATE distribuito esclusivamente da VAG       | ATE solamente através de VAG            | ATE alleen verkrijgbaar via VAG               |
| vedi targhetta di identificazione           | placa de identificación                 | op typeplaatje                                |
| avvitato                                    | fijado                                  | opgeschroefd                                  |
| scarico laterale sinistro                   | salida lateral izquierda                | uitlaat opzij links                           |
| scarico laterale destro                     | salida lateral derecha                  | uitlaat opzij rechts                          |
| esterno                                     | exterior                                | buiten  |
| correzione automatica                       | reajuste automatico                     | automatische bijstelling                      |
| serbatoio                                   | recipiente                              | reservoir                                     |
| serbatoio con doppia spia                   | recipiente con doble aparato de aviso   | reservoir dubbele noodknipperlichtinstallatie |
| fissaggio serbatoio                         | recipiente de fijación                  | bevestiging reservoir                         |
| tappo serbatoio                             | tapon                                   | plug reservoir                                |
| tappo filettato serbatoio                   | fijación depósito                       | schroefkoppeling reservoir                    |
| enti statali                                | vehiculos oficiales                     | overheid                                      |
| pastiglie freno                             | pastillas de freno                      | voeringen                                     |
| dischi ventilati                            | disco ventilado                         | geventileerde schijven                        |
| unità di comando                            | unidad de accionamiento                 | bedieningseenheid                             |
| blu   | azul                                    | blauw   |
| valvola di fondo                            | válvula de fondo                        | bodemventiel                                  |
| sostituire valvola di fondo                 | cambiar válvula de fondo                | bodemventielen vervangen                      |
| bordatura tipo x                            | reborde x                               | felsrand x                                    |
| marrone                                     | marron                                  | bruin   |
| versione larga                              | variante ancha                          | brede uitvoering                              |
| freno                                       | freno                                   | rem   |
| servofreno                                  | servofreno                              | remapparaat                                   |
| correttore di frenata                       | corrector de frenado                    | remdrukregelaar                               |
| sostituire tubi freni !                     | renovar latiguillos de freno !          | remleidingen vernieuwen !                     |
| interruttore luce stop                      | interruptor de luz de freno             | remlichtschakelaar                            |
| dischi freno                                | discos de freno                         | remschijven                                   |
| attenzione ai flessibili freni !            | atención al latiguillo de freno !       | let op de remslang !                          |
| bussola + staffa di compensazione           | casquillo + estribo de compensación     | bus + expansiebeugel                          |
| autobus                                     | autobus                                 | bus   |
| regolatore by-pass                          | regulador de by-pass                    | bypassregelaar                                |
| freno Citroen                               | freno Citroen                           | citroen-rem                                   |
| D (diametro) =                              | D (diámetro) =                          | D (diameter) =                                |
| guarnizione anulare                         | reten                                   | afdichtring                                   |
| guarnizione                                 | junta                                   | pakking                                       |
| serie guarnizioni                           | juego de reparación de juntas           | pakkingset                                    |
| differenziale autobloccante                 | bloqueo diferencial                     | differentieelslot                             |
| interruttore pressione differenziale        | interruptor de presión diferencial      | verschilddrukschakelaar                       |
| valvola pressione differenziale             | válvula de presión diferencial          | verschilddrukklep                             |
| vari tipi                                   | diversos tipo                           | diverse typen                                 |
| ruote gemellate                             | cubierta doble                          | dubbele banden                                |



|                             |                                      |  |
|-----------------------------|--------------------------------------|--|
| Doppelkabine                | double cab                           | cabine double                              |
| Druckbegrenzungsventil      | pressure limiting valve              | soupape à réglage de pression              |
| Druckbolzen                 | tappet                               | boulon de pression                         |
| Druckbolzen (kurz)          | tappet (short)                       | boulon de pression (court)                 |
| Druckbolzen (lang)          | tappet (long)                        | boulon de pression (long)                  |
| Druckluftbremse             | air brake                            | frein à pneumatique                        |
| Druckluftleitung            | compressed-air line                  | conduite pneumatique                       |
| Druckluftunterstützung      | air brake assistance                 | assistance à pneumatique                   |
| Druckluftverstärker         | air brake booster                    | amplificateur à pneumatique                |
| Druck-Warnschalter          | pressure warning switch              | avertisseur d'alerte de pression           |
| DS-Regler                   | DS-valve                             | correcteur de DS                           |
| EDS                         | EDS (electronic differential lock)   | EDS (blocage de différentiel électronique) |
| EDS-Ventilblock             | EDS-valve block                      | EDS-bloc de vannes                         |
| EG-Vorschrift               | accordance with EC regulation        | aux prescriptions CEE                      |
| Einbau hinter der Achse     | installation aft of axle             | montage derrière l'essieu                  |
| Einbau vor der Achse        | installation forward of axle         | montage devant l'essieu                    |
| Einbausatz                  | installation kit                     | lot de montage                             |
| Einfachbereifung            | single tyre                          | pneu simple                                |
| Einknöpfmaß xx mm           | button-in dimension xx mm            | mesure à boutonner xx mm                   |
| Einlaß D=xx mm              | inlet diameter=xx mm                 | admission diamètre=xx mm                   |
| Einlaß mit Gummistopfen     | inlet with rubber plug               | admission avec bouchon de caoutchouc       |
| Einschraubregler            | screw-in proportioning valve         | compensateurs à visser                     |
| elektr. Vergaser            | electr. carburetor                   | carburateur électrique                     |
| Entlüfteranschluß           | bleeding connection                  | raccordement de purge                      |
| Entlüfterventil             | bleeder valve                        | soupape de purge                           |
| erhöhte Zuladung            | increased payload                    | charge utile augmentée                     |
| Ersatz für Sättel D=xx      | replacement for calipers D=xx        | remplacement pour étriers D=xx             |
| ETS                         | ETS (electronic trac control system) | ETS (contrôle trajectoire)                 |
| Europa                      | Europe                               | Europe                                     |
| Export                      | Export                               | Export                                     |
| Fahrschule                  | driving school                       | auto-école                                 |
| Faltenbalgsatz              | bellow seal set                      | jeu de joints-soufflets                    |
| Faustsättel                 | fist-type calipers                   | étriers à griffe                           |
| Fenster                     | window                               | fenêtre                                    |
| Festsättel                  | fixed calipers                       | étriers fixes                              |
| Flanschdicke x mm           | flange thickness x mm                | épaisseur de la bride x mmm                |
| Flanschmaß = xx,x           | flange dimension = xx,x              | dimension de la bride = xx,x               |
| Fuller-Getriebe             | fuller-gearbox                       | boîte à vitesse fuller                     |
| für Belagsätze ohne Zubehör | for brake pads without accessories   | pour garnitures de frein sauf accessoire   |
| für Bremssättel/Vorgänger   | for calipers/predecessor             | pour étriers de frein/prédécesseur         |
| für Doppelmembran-Gerät     | for twin diaphragm booster           | pour appareil à double membrane            |
| Gabelkopfsatz               | yoke kit                             | jeu de chape                               |
| Gehäuse L=                  | housing L=                           | corps L=                                   |
| gelb                        | yellow                               | jaune                                      |
| gepanzerte Fahrzeuge        | armoured vehicles                    | véhicule blindé                            |
| Getriebe                    | gearbox                              | boîte de vitesse                           |
| Getriebe-Nr.                | gearbox-no.                          | no. boîte de vitesse                       |
| GG-Pumpe                    | cast-iron-pump                       | pompe en fonte                             |
| GG-Sättel                   | cast iron-caliper                    | étriers en fonte                           |
| GG-THz/Vorgänger            | cast-iron-TMC/predecessor            | MCT fonte/predécesseur                     |
| Golf-Staaten                | Gulf States                          | pays du Golfe Persique                     |
| Gz mit senkrechtem Flansch  | CC with vertical flange              | émetteur d'embrayage avec bride            |
| Gz (Geberzylinder)          | CC (clutch cylinder)                 | EE (émetteur d'embrayage)                  |
| Gz-Reparaturset             | CC-repair kit                        | néc. de réparation EE                      |
| HA (Hinterachse)            | RA (rear axle)                       | AR (essieu arrière)                        |
| Haltefeder                  | retaining spring                     | ressort à retenu                           |
| Halter                      | anchor                               | support                                    |
| Haltersatz                  | anchor set                           | jeu de support                             |
| Halterschraube              | anchor screw                         | vis de support                             |
| Handbremsbetätigung         | hand brake actuation                 | frein à main                               |
| Handbremshebel              | handbrake lever                      | levier de frein à main                     |
| HA-Scheibenbremse           | rear axle disc brake                 | frein à disque essieu AR                   |
| HA-Trommelbremse            | rear axle drum brake                 | frein à tambour essieu AR                  |
| Hebel                       | lever                                | levier                                     |
| Hochdach                    | high roof                            | toit surélevé                              |
| Hohlschraube                | hollow screw                         | vis creuse                                 |
| Hosei-Bremse                | Hosei brake                          | freins Hosei                               |
| Hub                         | stroke                               | course                                     |
| Hülsensatz                  | sleeve kit                           | jeu de douilles                            |
| Hydraulikspeicher           | hydraulic accumulator                | accumulateur hydraulique                   |
| Hydraulikverstärker         | hydraulic booster                    | amplificateur hydraulique                  |
| Hydraulikzylinder           | hydraulic cylinder                   | cylindre de hydraulique                    |
| Hydr. Steuereinheit         | hydraulic unit                       | modulateur                                 |
| Hz (Hauptzylinder)          | MC (master cylinder)                 | MC (maître cylindre)                       |
| Hz-Reparaturset             | MC-repair kit                        | néc. de réparation MC                      |
| im Fahrerhaus               | in cab                               | dans la cabine du conducteur               |
| im Motorraum                | in engine compartment                | dans compartiment moteur                   |





|  |  |                                       |
|--|--|---------------------------------------|
| cabina doppia                              | cabina doble                                 | dubbele cabine                        |
| valvola limitatrice pressione              | valvula de limitación de presión             | drukregelaar                          |
| perno pressione (oliva)                    | perno de presión                             | drukpen                               |
| perno pressione (corto) (oliva)            | perno de presión (corto)                     | drukpen (kort)                        |
| perno pressione (lungo) (oliva)            | perno de presión (largo)                     | drukpen (lang)                        |
| freno pneumatico                           | freno de aire comprimido                     | pneumatische rem                      |
| tubo aria compressa                        | aire comprimido de flexible                  | pneumatische leiding                  |
| comando aria compressa                     | freno de aire auxiliár                       | luchtdrukbevestiging                  |
| servofreno pneumatico                      | servo de aire a presión                      | luchtdrukbevestiging                  |
| interruttore spia pressione                | interruptor de aviso de presión              | druk-waarschuwingsschakelaar          |
| regolatore flusso pressione                | regulador DS                                 | DS-regelaar                           |
| EDS (bloccaggio elettronico differenziale) | EDS (bloqueo diferencial electrónico)        | EDS                                   |
| gruppo valvole EDS                         | EDS válvula de bloqueo                       | EDS-kleppenblok                       |
| normativa CE                               | según normativa CEE                          | EG-voorschrift                        |
| montaggio dietro l'assale                  | instalación despues del eje                  | montage achter de as                  |
| montaggio davanti l'assale                 | instalación antes del eje                    | montage vóór de as                    |
| serie di montaggio                         | juego de montaje                             | inbouwset                             |
| ruota singola                              | cubierta simple                              | enkele banden                         |
| misura alloggiamento xx mm                 | medida de alojamiento xx mm                  | inknoopmaat xx mm                     |
| diametro mandata = xx mm                   | admisión diámetro = xx mm                    | inlaat D=xx mm                        |
| mandata con tappo in gomma                 | admisión con tapon de goma                   | inlaat met rubberen plug              |
| regolatore a vite                          | regulador roscado                            | inschroefregelaar                     |
| carburatore elettronico                    | carburador eléctrico                         | elektr. carburateur                   |
| attacco per spurgo                         | conexión de purga                            | ontluchtingsaansluiting               |
| valvola di spurgo                          | válvula de purga                             | ontluchtingsventiel                   |
| carico utile maggiorato                    | incremento de carga                          | verhoogd laadvermogen                 |
| ricambio per pinza freno D=xx              | sustitución para pinzas D=xx                 | reserve voor remklauwen D=xx          |
| ETS (controllo elettronico della trazione) | ETS (sistema de control electr. de tracción) | ETS                                   |
| Europa                                     | Europa                                       | Europa                                |
| export                                     | Exportación                                  | export                                |
| scuola guida                               | escuela de conducción                        | rijkschool                            |
| serie soffiati                             | juego de reparac. de suspensión neumática    | rolbalgset                            |
| pinza freno flottante                      | pinza de puno                                | zwevende remklauwen                   |
| finestralla                                | ventana                                      | venster                               |
| pinza freno fissa                          | pinza de fija                                | vaste remklauwen                      |
| spessore flangia x mm                      | grosor de la brida x mm                      | flensdikte x mm                       |
| misura flangia = xx,x                      | medida de brida = xx,x                       | flensmaat = xx,x                      |
| scatola cambio Fuller                      | Fuller caja de cambios                       | Fuller-transmissie                    |
| per pastiglie freno senza accessori        | para juego de pastilla sin accesorios        | voor remvoeringsets zonder toebehoren |
| per pinze freno / precedente               | para pinza/avisador                          | voor remklauwen/voorlopers            |
| per servofreno a doppia membrana           | para servo freno con doble membrana          | voor dubbel-membraantoestel           |
| serie forcelle                             | juego de cabeza de horquilla                 | gaffelset                             |
| carcassa L =                               | carcasa L=                                   | huis L=                               |
| giallo                                     | amarillo                                     | geel                                  |
| veicoli blindati                           | vehículo blindado                            | gepantserde voertuigen                |
| scatola cambio                             | caja de cambios                              | transmissie                           |
| scatola cambio n.                          | número de caja de cambios                    | transmissie-nr.                       |
| pompa in ghisa                             | bomba de fundición de gris                   | GG-pomp                               |
| pinza in ghisa                             | pinza de fundición de gris                   | GG-klauwen                            |
| pompa tandem in ghisa / precedente         | cil. principal de fundición de gris/avisador | GG-tandemhoofdcilinder/voorloper      |
| Stati del Golfo                            | estados del Golfo Pérsico                    | Golfstaten                            |
| pompa frizione con flangia verticale       | cilindro distribuidor con brida vertical     | hoofdcilinder met verticale flens     |
| cilindro di comando                        | CTR (cilindro distribuidor)                  | hoofdcilinder                         |
| serie riparazione cilindro di comando      | juego de reparación de juntas CTR            | reparatieset hoofdcilinder            |
| P (asse posteriore)                        | HA (eje trasero)                             | achteras                              |
| molla di ritegno                           | muelle de sujeción                           | klemveer                              |
| supporto                                   | soporte                                      | houder                                |
| serie di supporti                          | juego de soporte                             | houderset                             |
| vite supporto                              | tomillo de soporte                           | houderschroef                         |
| azionamento freno a mano                   | activación de freno de mano                  | bediening handrem                     |
| leva freno a mano                          | palanca freno de mano                        | handremhendel                         |
| dischi freno asse posteriore               | eje trasero disco de freno                   | schijfrem achteras                    |
| tamburi freno asse posteriore              | eje trasero tambores de freno                | trommelrem achteras                   |
| leva                                       | palanca                                      | hendel                                |
| tetto sopraelevato                         | techo sobrealzado                            | hoog dak                              |
| vite cava                                  | tomillo hueco                                | holle bout                            |
| freni Hosei                                | freno de Hosei                               | Hosei-rem                             |
| corsa                                      | elevación                                    | slag                                  |
| serie boccole                              | juego de vaina                               | doppenset                             |
| accumulatore idraulico                     | acumulador de hidráulico                     | hydraulisch reservoir                 |
| servofreno idraulico                       | servo hidráulico                             | hydraulische versterker               |
| cilindro idraulico                         | cilindro de hidráulico                       | hydraulische cilinder                 |
| modulatore idraulico                       | modulador de hidráulico                      | hydr. regelenheid                     |
| pompa freno                                | CM (cilindro maestro)                        | hoofdcilinder                         |
| serie riparazione pompa freno              | juego de reparación CM                       | reparatieset hoofdcilinder            |
| in cabina                                  | en cabina                                    | in de stuurcabine                     |
| nel vano motore                            | en compartimento de motor                    | in de motorruimte                     |

|                                       |                                     |  |
|---------------------------------------|-------------------------------------|--|
| innen                                 | inside                              | intérieur  |
| Innengewinde                          | inner thread                        | taraudage intérieure                               |
| Kastenwagen                           | van                                 | fourgonnette                                       |
| Katalysator                           | catalytic converter                 | catalyseur   |
| Kennzeichen: xx                       | registration number: xx             | indice: xx   |
| Kerbe am Flansch                      | notch on flange                     | entaille sur la bride                              |
| Klasse                                | class                               | classe   |
| Kleinbus                              | minibus                             | petit autobus                                      |
| Klimaanlage                           | air conditioning                    | air conditionné                                    |
| Kolbenstange D=                       | piston rod diameter=                | tige de commande diamètre=                         |
| Kolbenstange L=                       | piston rod length=                  | tige de commande longueur=                         |
| Kombiwagen                            | station wagon                       | voiture familière                                  |
| Kompakt THz                           | compact TMC                         | MCT compact  |
| Krankenwagen                          | ambulance                           | véhicule à ambulance                               |
| Kupplung                              | clutch                              | embrayage  |
| Kupplungsabgang                       | outlet port for clutch connection   | sortie d'embrayage                                 |
| Kupplungsverstärker                   | clutch booster                      | amplificateur d'embrayage                          |
| kurzer Radstand                       | short wheel base                    | empattement court                                  |
| kurzes Bremsgerät                     | short brake booster                 | servo-frein court                                  |
| L (Länge) =                           | L (length) =                        | L (longueur) =                                     |
| langer Radstand                       | long wheel base                     | empattement long                                   |
| Leckageanzeige                        | leakage indicator                   | avertissement de fuite                             |
| lieferbar                             | available                           | disponible   |
| links oben und rechts unten           | upper left and lower right          | à gauche, en haut et à droite, en bas              |
| links vor und rechts hinter der Achse | left in front and right behind axle | à gauche devant essieu et à droite derrière essieu |
| Linksenker                            | left hand drive                     | direction à gauche                                 |
| Luftfederung                          | pneumatic suspension                | suspension pneumatique                             |
| luftgekühlt                           | air-cooled                          | refroidir par air                                  |
| M8-Führungsbolzen                     | M8-guide pin                        | boulon de guidage M8                               |
| MA-Getriebe                           | MA gearbox                          | boîte de vitesse MA                                |
| mit 1 Haltestift                      | with 1 retaining pin                | avec 1 bouchon d'arrêt                             |
| mit 2 Haltestiften                    | with 2 retaining pins               | avec 2 bouchon d'arrêts                            |
| mit Alufelgen                         | with alu wheel rim                  | avec jante en alu                                  |
| mit angegossenem Behälter             | with cast-on reservoir              | réservoir en fonte commun                          |
| mit geregeltm Katalysator             | with controlled catalytic converter | avec cataliseur réglé                              |
| mit Laschen                           | with straps                         | avec collier                                       |
| mit Leichtmetallrädern                | with light alloy rims               | avec jantes en aluminium                           |
| MKII-Aggregat kpl.                    | MKII complete unit                  | agrégat MKII complet                               |
| Mod. (Modell)                         | Mod. (model)                        | Mod. (modèle)                                      |
| Motor                                 | engine                              | moteur   |
| Motor-Nr.                             | engine number                       | numéro de moteur                                   |
| Motor-Pumpen-Aggregat                 | motor pump unit                     | agrégat moteur pompe                               |
| Multi-Link-Achse                      | multi-link axle                     | essieu multi-link                                  |
| m.Z. (mit Zubehör)                    | m.Z. (with accessories)             | m.Z. (avec accessoire)                             |
| Nachstellteile-Satz                   | adjuster parts set                  | jeu de pièces d'ajustage                           |
| ND-Schlauch                           | ND low pressure hose                | flexible de ND                                     |
| Nebenabtrieb                          | power take-off                      | propulsion secondaire                              |
| Niveauregulierung                     | suspension level-control            | correcteur d'assiette                              |
| Nz (Nehmerzylinder)                   | SC (slave cylinder)                 | RE (récepteur d'embrayage)                         |
| Nz-Reparatursatz                      | SC-repair kit                       | néc. de réparation RE                              |
| ohne Alufelgen                        | without alu wheel rim               | sauf jante en alu                                  |
| ohne geregelten Katalysator           | uncontrolled catalytic converter    | sauf cataliseur réglé                              |
| ohne Laschen                          | without straps                      | sans collier                                       |
| ohne Leichtmetallräder                | without light alloy rim             | sauf jantes en aluminium                           |
| O-Ring                                | O-ring                              | joint torique                                      |
| Pedal Feststeller                     | lockable pedal                      | fixation des pédales                               |
| Polizei                               | Police                              | Police   |
| Rad                                   | wheel                               | roue   |
| Radsensor                             | wheel sensor                        | capteur de roue                                    |
| Radstand xxxx mm                      | wheel base xxxx mm                  | empattement xxxx mm                                |
| rechts oben und links unten           | upper right and lower left          | à droite, en haut et à gauche, en bas              |
| Rechtslenker                          | right hand drive                    | direction à droite                                 |
| Regler                                | regulator                           | régulateur   |
| Reihenmotor                           | R engine                            | moteur en ligne                                    |
| Reisebus/Hochdecker                   | tourist bus/high decker             | autobus/car avec cabine élevée                     |
| Reparatursatz                         | repair kit                          | néc. de réparation                                 |
| Ringstutzen-Satz                      | ring type nipple set                | jeux de raccord annulaire                          |
| Rohrleitung                           | pipe line                           | conduite tube                                      |
| rot                                   | red                                 | rouge  |
| roter Sattel                          | red caliper                         | étrier rouge                                       |
| Rückschlagventil                      | non-return valve                    | clapet antiretour                                  |
| Rückstellwellen-Satz                  | resetting shaft set                 | jeu d'arbres de rappel                             |
| Rz (Radzylinder)                      | WC (wheel cylinder)                 | CR (cylindre roue)                                 |
| Rz-Dichtungssatz                      | WC-seal kit                         | jeu de joints CR                                   |
| Rz-Reparatursatz                      | WC-repair kit                       | néc. de réparation CR                              |
| Salisbury-Achse                       | Salisbury axle                      | essieu Salisbury                                   |
| Sattel mit 1 Haltestift               | caliper with 1 retaining pin        | étrier avec 1 bouchon d'arrêt                      |

|  |   |                                   |
|--|---|-----------------------------------|
| interno  | interior                                | binnen                            |
| filettatura interna                              | rosca interior                          | binnendraad                       |
| furgone  | furgon                                  | bestelwagen                       |
| catalizzatore                                    | catalizador                             | katalysator                       |
| sigla: xx  | distintivo: xx                          | kenmerk: xx                       |
| centraggio su flangia                            | muesca en brida                         | kerf in de flens                  |
| classe   | classe                                  | klasse                            |
| minibus  | mini-bus                                | kleine bus                        |
| aria condizionata                                | aire acondicionado                      | airconditioning                   |
| biella D=  | varilla de pistón diámetro =            | zuigerstang D=                    |
| biella L=  | varilla de pistón largo=                | zuigerstang L=                    |
| station wagon                                    | break (familiar)                        | stationwagen                      |
| pompa freno tandem compatta                      | cilindro maestro tandem compacto        | compacte tandemhoofdcilinder      |
| ambulanza  | ambulancia                              | ziekenwagen                       |
| frizione   | embrague                                | koppeling                         |
| uscita per frizione                              | salida conexión embrague                | koppelingsuitlaat                 |
| servofrizione                                    | refuerzo embrague                       | koppelingsbekrachtiger            |
| passo corto                                      | distancia corta entre ejes              | korte wielbasis                   |
| servofreno corto                                 | servofreno corto                        | kort remapparaat                  |
| L (lunghezza) =                                  | L (largo) =                             | L (lengte) =                      |
| passo lungo                                      | distancia larga entre ejes              | lange wielbasis                   |
| spia perdite                                     | indicador pérdida liquido de freno      | lekkagedetector                   |
| disponibile                                      | suministrable                           | leverbaar                         |
| a sinistra in alto e a destra in basso           | izquierda arriba + derecha abajo        | links boven en rechts onder       |
| davanti a sinistra e dietro a destra dell'assale | izquierda adelante+derecha atrás de eje | links voor en rechts achter de as |
| guida a sinistra                                 | volante a la izquierda                  | auto met stuur links              |
| sospensione pneumatica                           | suspensión neumática                    | luchtvering                       |
| raffreddato ad aria                              | refrigeración por aire                  | luchtgekoeld                      |
| perni di guida M8                                | perno de guía M8                        | M8-geleidingspen                  |
| scatola cambio MA                                | caja de cambios MA                      | MA-transmissie                    |
| con 1 spina di fissaggio                         | con 1 pasador                           | met 1 borgstift                   |
| con 2 spine di fissaggio                         | con 2 pasadores                         | met 2 borgstiften                 |
| con cerchioni in alluminio                       | con Llantas de aluminio                 | met aluminium velgen              |
| con serbatoio stampato                           | con depósito anadido                    | met aangegoten reservoir          |
| con catalizzatore regolato                       | con catalizador regulado                | met geregelde katalysator         |
| con coprigiunto                                  | con brida                               | met verbindingselementen          |
| con ruote in lega leggera                        | con Llantas de aluminio                 | met lichtmetalen wielen           |
| gruppo completo MKII                             | MKII sistema completo                   | MKII-aggregaat compl.             |
| mod. (modello)                                   | Mod. (modelo)                           | mod. (model)                      |
| motore   | motor                                   | motor                             |
| motore n.  | número de motor                         | motornr.                          |
| gruppo motore-pompa                              | systema motor-bomba                     | motor-pomp-aggregaat              |
| assale Multi-link                                | eje Multi-Link                          | multi-link-as                     |
| con acc. (con accessori)                         | m.Z. (con accesorios)                   | met toebehoren (met toebehoren)   |
| serie parti registrazione                        | juego de acoplamiento                   | set stelonderdelen                |
| flessibile bassa pressione                       | ND flexible                             | ND-slang                          |
| attacco di forza                                 | potencia adicional                      | pto                               |
| correttore d'assetto                             | regulación de altura de suspensión      | niveauregeling                    |
| cilindro ricevitore                              | CRE (cilindro receptor)                 | werkcilinder                      |
| serie riparazione cilindro ricevitore            | juego de reparación de juntas CRE       | reparatieset werkcilinder         |
| cerchioni in alluminio                           | sin Llantas de aluminio                 | zonder aluminium velgen           |
| senza catalizzatore regolato                     | sin catalizador regulado                | zonder geregelde katalysator      |
| senza coprigiunto                                | sin brida                               | zonder verbindingselementen       |
| senza ruote in lega leggera                      | sin Llantas de aluminio                 | zonder lichtmetalen wielen        |
| O-Ring   | junta torica                            | O-ring                            |
| blocca-pedale                                    | eje pedal                               | pedaalvastzetter                  |
| Polizia  | Police                                  | politie                           |
| ruota  | rueda                                   | wiel                              |
| sensore ruota                                    | sensor de rueda                         | wielsensor                        |
| passo xxxx mm                                    | distancia entre rueda xxxx mm           | wielbasis xxxx mm                 |
| a destra in alto e a sinistra in basso           | derecha arriba + izquierda abajo        | rechts boven en links onder       |
| guida a destra                                   | volante a la derecha                    | auto met het stuur rechts         |
| correttore di frenata                            | regulador                               | regelaar                          |
| motore in linea                                  | motor de R                              | lijnmotor                         |
| pullman / pianale alto                           | autobús                                 | Reisbus/hoogdekker                |
| serie di riparazione                             | juego de reparación                     | reparatieset                      |
| serie raccordi anulari                           | juego de tubuladura anular              | set ringaansluitingen             |
| tubazione  | latiguillo                              | pijpleiding                       |
| rosso  | rojo                                    | rood                              |
| pinza rossa                                      | pinza roja                              | rood zadel                        |
| valvola di non ritorno                           | valvula de retención                    | terugslagklep                     |
| serie alberi di richiamo                         | juego de onda de retroceso              | set terugstelasjes                |
| cil. ruota (cilindretto ruota)                   | CR (cilindro de rueda)                  | wielcilinder                      |
| serie guarnizioni cil. ruota                     | juego de reparación de juntas CR        | pakkingset wielcilinder           |
| serie riparazione cil. ruota                     | juego de reparación CR                  | reparatieset wielcilinder         |
| assale Salisbury                                 | Salisbury eje                           | Salisbury-as                      |
| pinza con una spina di fissaggio                 | pinza con 1 pasador                     | klaauw met 1 borgstift            |

|                                |                                     |   |
|--------------------------------|-------------------------------------|---|
| Sattel mit 2 Haltestiften      | caliper with 2 retaining pins       | étrier avec 2 bouchon d'arrêt                 |
| Sättel mit Gussnoppen          | calipers with cast-naps             | étriers avec nopés en fonte                   |
| Sattelschraube                 | caliper screw                       | vis d'étrier                                  |
| Scheibenbremse                 | disc brake                          | disques de frein                              |
| Scheibenkupplung               | disc clutch                         | embrayage du disque                           |
| Scheibenschraube               | disc screw                          | disque vis                                    |
| Schlauchleitung                | line hose                           | conduite flexible                             |
| Schraubstutzen                 | screw neck                          | raccordement à vis                            |
| schwarz                        | black                               | noir  |
| Schwimmsättel                  | floating caliper                    | étrier flottant                               |
| Schwingblech WE                | sheet metal warning device          | tôle oscillante dispositif d'avertissement    |
| SCS                            | SCS (stop control system)           | SCS (système de contrôle stop)                |
| separater Behälter             | separate reservoir                  | réservoir séparé                              |
| separates Druckstück/Vorgänger | separate thrust member/predecessor  | pièce d'appui/prédécesseur                    |
| Servolenkung                   | power steering                      | direction assistée                            |
| Skandinavien                   | Scandinavia                         | Scandinavie                                   |
| Sitzplätze                     | seats                               | sièges  |
| Sonderfahrzeuge                | special vehicle                     | véhicule spécial                              |
| Spezialaufbau                  | special body                        | carrosserie spéciale                          |
| Sportfahrwerk                  | sports suspension                   | châssis sport                                 |
| Spur                           | track                               | voie  |
| Standard-Bremsgerät            | standard booster unit               | servo-frein standard                          |
| Standard-THz                   | standard tandem master cylinder     | MC-tandem standard                            |
| staubfeste Ausführung          | dustproof design                    | exécution anti poussière                      |
| Stufenheck                     | saloon                              | à coffre                                      |
| T50-Reparaturatz               | T50-repair kit                      | néc. de réparation T50                        |
| Tandemregler                   | tandem proportioning valve          | compensateur tandem                           |
| THz mit 3 Anschlüssen          | TMC with 3 connections              | MCT avec 3 raccords                           |
| THz mit Anschlagsschraube      | TMC with stop screw                 | MCT avec vis de butée                         |
| THz (Tandemhauptzylinder)      | TMC (tandem master cylinder)        | MCT (maître cylindre tandem)                  |
| THz-Reparaturatz               | TMC-repair kit                      | néc. de réparation MCT                        |
| THz-RS (Montagehülse)          | TMC-repair kit (assembly sleeve)    | néc. de réparation MCT (douille d'assemblage) |
| Timken-Achse                   | Timken axle                         | essieu Timken                                 |
| Topfmanschette                 | pot seal                            | coupelle                                      |
| Tragbolzensatz                 | supporting bolt set                 | jeu de boulons de suspension                  |
| Transporter                    | transporters                        | transporter                                   |
| Triebkopf                      | drive head                          | tête de propulsion                            |
| Trommelbremse                  | drum brake                          | frein à tambour                               |
| TBB (Trommelbremsbacken)       | DBS (drum brake shoes)              | SGT (mâchoires de frein à tambour)            |
| Umbau 1-teilig auf 2-teilig    | reconstruction 1-piece to 2-piece   | reconstruction 1 partie sur 2 parties         |
| Unterdruckverstärker           | vacuum booster                      | amplificateur à dépression                    |
| ursprüngl. verschraubte Beläge | initial screwed pads                | à l'origine garnitures vissés                 |
| VA (Vorderachse)               | FA (front axle)                     | VA (essieu avant)                             |
| VA-Girling-Bremse              | front axle girling-brake            | frein à girling essieu avant                  |
| VA-Scheibenbremse              | front axle disc brake               | frein à disque essieu avant                   |
| VA-Trommelbremse               | front axle brake drums              | tambours de frein essieu avant                |
| Ventilblock                    | valve block                         | bloc de vanes                                 |
| Ventilblock kpl.               | valve block complete                | bloc de vanes complet                         |
| Verbindungsschrauben           | connection screws                   | vis de raccordement                           |
| Verschlußschraube              | screw plug                          | vis de fermeture                              |
| Verschraubung                  | screw fitting                       | couvercle                                     |
| Verschraubung kpl.             | screw fitting cpl.                  | couvercle complet                             |
| verstärkte Bremse              | heavy-duty brake                    | frein renforcé                                |
| verstärkte Stoßdämpfer         | reinforced dampers (shock absorber) | amortisseurs renforcés                        |
| verstärktes Fahrwerk           | reinforced suspension               | châssis renforcé                              |
| Verteilerstück wiederverwenden | reuse distributor piece             | distributeur à remettre                       |
| V-Motor                        | V engine                            | moteur en V                                   |
| Vorder- und Hinterachse        | front and rear axle                 | essieu avant et essieu arrière                |
| Vorderachse                    | front axle                          | essieu avant                                  |
| Vorderachse und 2. Hinterachse | front axle and second rear axle     | essieu avant et 2. essieu arrière             |
| Vordruckventil                 | residual pressure valve             | soupape pression d'admission                  |
| Vorgänger                      | predecessor                         | prédécesseur                                  |
| Vorgänger / Abschirmkappe      | predecessor / deflector cap         | prédécesseur/défecteur                        |
| Vorgänger-THz, Einlaß D=xx     | predecessor-TMC, inlet diameter=xx  | MCT prédécesseur, admission diamètre=xx       |
| Vorspannzylinder               | pre-loaded cylinder                 | cylindre relais                               |
| WK (Warnkontakt)               | WI (wear indicator)                 | TU (témoin d'usure)                           |
| Warnkontakt 1-polig            | wear indicator single connector     | témoin d'usure 1-borne                        |
| Warnkontakt 2-polig            | wear indicator twin connector       | témoin d'usure 2-bornes                       |
| Warnschalter                   | warning switch                      | interrupteur d'avertissement                  |
| WE (Warneinrichtung)           | WD (warning device)                 | DA (dispositif d'avertissement)               |
| WE-Befestigung                 | WD fixture                          | fixation de DA                                |
| Wegsensor                      | travel sensor                       | capteur de course                             |
| weiß                           | white                               | blanc   |
| Zylinderschraube               | cylinder screw                      | vis cylindre                                  |



|   |  |   |
|---|--|---|
| pinza con due spine di fissaggio                  | pinza con 2 pasadores                        | klaauw met 2 borgstiften                    |
| pinze freno con borchie fuse                      | pinzas con protuberancias de fundición       | klauwen met aangegoten noppen               |
| vite pinza  | tornillo de pinza                            | klaaubouten                                 |
| freni a disco                                     | disco de freno                               | schijfrem                                   |
| frizione a disco                                  | disco de embrague                            | plaatkoppeling                              |
| viti disco freno                                  | tornillo de disco                            | schijfbout                                  |
| flessibile (tubo flessibile)                      | latiguillo flexible                          | slangleiding                                |
| raccordo filettato                                | tornillo de fijación                         | schroefaansluiting                          |
| nero  | negro  | zwart                                       |
| pinza freno flottante                             | pinza flotante                               | zwevende klauwen                            |
| spia a lamierino vibrante                         | chapa para avisador de desgaste              | trilplaat                                   |
| SCS (sistema controllo frenata)                   | SCS (sistema de control de frenada)          | SCS   |
| serbatoio separato                                | depósito independiente                       | apart reservoir                             |
| pezzo di pressione separato / precedente          | tubería de presión independiente/avisador    | apart drukstuk/voorloper                    |
| servosterzo                                       | dirección asistida                           | stuurbekrachting                            |
| Scandinavia                                       | Escandinavia                                 | Scandinavië                                 |
| posti a sedere                                    | plazas                                       | zitplaatsen                                 |
| veicolo speciale                                  | vehículos especial                           | speciale voertuigen                         |
| carrozzeria speciale                              | construcción carrocería especial             | speciale opbouw                             |
| assetto sportivo                                  | suspensión deportiva                         | sportonderstel                              |
| carreggiata                                       | distancia entre ruedas                       | spoor                                       |
| servofreno standard                               | servo freno standard                         | standaard remapparaat                       |
| pompa freno tandem standard                       | cilindro tándem standard                     | standaard tandemhoofdcilinder               |
| versione antipolvere                              | version antipolucción                        | stofvaste uitvoering                        |
| a 3 volumi  | parte trasera escalonada                     | notch-back                                  |
| serie riparazione T50                             | juego de reparación T50                      | T50-reparatieset                            |
| regolatore tandem                                 | tándem regulador                             | tandemregelaar                              |
| pompa freno tandem con 3 attacchi                 | cilindro tándem con 3 conexions              | tandemhoofdcilinder met 3 aansluitingen     |
| pompa freno tandem con vite di fermo              | cilindro tándem con tornillo de tope         | tandemhoofdcilinder met aanslagbout         |
| pompa freno tandem                                | CMT ( cilindro tándem)                       | tandemhoofdcilinder                         |
| serie riparazione pompa freno tandem              | juego de reparación CMT                      | reparatieset tandemhoofdcilinder            |
| serie rip. pompa freno tandem (bussola montaggio) | juego de reparación CMT (vainas de montaje)  | tandemhoofdcilinder RS (montagehuls)        |
| assale Timken                                     | Timken eje                                   | Timken-as                                   |
| guarnizione a tazza                               | retén  | cupmanchet                                  |
| serie perni di supporto                           | juego de tornillo de soporte                 | set draagpennen                             |
| furgoncino  | furgoneta                                    | transporter                                 |
| motrice con sola cabina (telaio nudo)             | grupo motriz                                 | aandrijfkop                                 |
| freni a tamburo                                   | tambores de freno                            | trommelrem                                  |
| ganasce freno                                     | ZDF (zapatas de freno)                       | trommelremschoenen                          |
| modifica da 1 a 2 sezioni                         | reconstrucción de 1 a 2 piezas               | ombouw 1-delig naar 2-delig                 |
| servofreno a depressione                          | amplificador de depresion                    | onderdrukbekrachtiger                       |
| pastiglie freno avvitare in origine               | pastillas inicialmente montadas              | oorspr. vastgeschroefde remvoeringen        |
| A (asse anteriore)                                | VA (eje delantero)                           | vooras                                      |
| asse anteriore con impianto Girling               | eje delantero - Girling freno                | Girling-rem vooras                          |
| dischi freno asse anteriore                       | eje delantero - disco de freno               | schijfrem vooras                            |
| tamburi freno asse anteriore                      | eje delantero - tambores de freno            | trommelrem vooras                           |
| blocco valvole                                    | válvula de bloqueo                           | kleppenblok                                 |
| blocco valvole completo                           | bloque de valvulas completo                  | kleppenblok compl.                          |
| viti di collegamento                              | tornillo de conexión                         | verbindingsschroeven                        |
| vite di chiusura                                  | tornillo de cierre                           | schroefop                                   |
| attacco filettato                                 | tornillo de fijación                         | schroefkoppeling                            |
| attacco filettato completo                        | fijación completa                            | schroefkoppeling compl.                     |
| freno rinforzato                                  | freno reforzado                              | bekrachtigde rem                            |
| ammortizzatori rinforzati                         | amortiguadores reforzados                    | versterkte schokdemper                      |
| autotelaio rinforzato                             | suspensión reforzada                         | versterkt onderstel                         |
| riutilizzare il distributore                      | distribuidor de reemplazo                    | verdeelblok opnieuw gebruiken               |
| motore a V  | motor de V                                   | V-motor                                     |
| assi anteriore e posteriore                       | eje delantero + eje trasero                  | voor- en achteras                           |
| asse anteriore                                    | eje delantero                                | vooras                                      |
| asse anteriore e secondo asse posteriore          | eje delantero + 2. eje trasero               | vooras en 2e achteras                       |
| valvola anticipo pressione                        | válvula de presión previa                    | restdrukklep                                |
| precedente  | predecesor                                   | voorloper                                   |
| precedente / calotta di protezione                | predecesor / tapa deflector                  | voorloper / verdelerkap                     |
| pompa freno tandem precedente, D mandata = xx     | predecesor cilindro principal, admision D=xx | voorloper tandemhoofdcilinder, inlaat D=xx  |
| convertitore di pressione                         | cilindro preajustado                         | voorspancilinder                            |
| RU (rilevatore usura)                             | CD (contacto de desgaste)                    | contact noodknipperlichtinstallatie         |
| rivelatore usura unipolare                        | contacto de desgaste con 1 conexión          | contact noodknipperlichtinstallatie 1-polig |
| rivelatore usura bipolare                         | contacto de desgaste con 2 conexiones        | contact noodknipperlichtinstallatie 2-polig |
| interuttore spia                                  | interruptor de desgaste                      | schakelaar noodknipperlichtinstallatie      |
| DS disp. spia (dispositivo spia)                  | DD (dispositivo de desgaste)                 | noodknipperlichtinstallatie                 |
| fissaggio dispositivo spia                        | fijación del dispositivo de desgaste         | bevestiging noodknipperlichtinstallatie     |
| sensore di corsa                                  | sensor de ruta                               | wegsensor                                   |
| bianco  | blanco                                       | wit   |
| vite cilindrica                                   | tornillo cilíndrico                          | cilinderkopbout                             |



|  |                                      |  |
|--|--------------------------------------|--|
| 1-Kammer-Druckluftbremse               | pneumatisk bremse med et kammer      | enkammartryckluftsbroms                |
| 1-Kolbensattel D=xx                    | 1-bremseåg Ø=xx                      | 1-kolvsok d=xx                         |
| 2-Kolbensattel D=xx                    | 2-bremseåg Ø=xx                      | 2-kolvsok d=xx                         |
| 4-Kolbensattel                         | 4-bremseåg                           | 4-kolvsok                              |
| 1-Kreis-Bremse                         | 1-kreds-bremse                       | 1-krets broms                          |
| 2-Kreis-Bremse                         | 2-kreds-bremse                       | 2-krets broms                          |
| 1-Kreis-Sättel                         | 1-kreds-bremseåg                     | 1-krets bromsok                        |
| 2-Kreis-Sättel                         | 2-kreds-bremseåg                     | 2-krets bromsok                        |
| 1. Hinterachse                         | 1. bagaksel                          | 1:a bakaxeln                           |
| 1. und 2. Hinterachse                  | 1. og 2. bagaksel                    | 1:a och 2:a bakaxeln                   |
| 4-Loch-Bremsscheibe                    | 4-hul-bremsskive                     | 4-håls bromsskiva                      |
| 6-Loch-Bremsscheibe                    | 6-hul-bremsskive                     | 6-håls bromsskiva                      |
| 3-Loch-Felge                           | 3-hul-fælg                           | 3-håls fälg                            |
| 4-Loch-Felge                           | 4-hul-fælg                           | 4-håls fälg                            |
| 5-Loch-Felge                           | 5-hul-fælg                           | 5-håls fälg                            |
| 6kt-Schraube                           | 6-kant skrue                         | sekskantsskrub                         |
| 6kt-Schraube (innen)                   | 6-kant skrue (indvendigt)            | sekskanthåls skrub                     |
| 6"-Tandem                              | 6"-tandem                            | 6"-tandem                              |
| 8"-Tandem mit Gabelkopf                | 8"-tandem med gaffelhoved            | 8"-tandem med gaffelhuvud              |
| 8"-Tandem ohne Gabelkopf               | 8"-tandem uden gaffelhoved           | 8"-tandem utan gaffelhuvud             |
| ABS                                    | ABS                                  | ABS (låsningsfria bromsar)             |
| ABS-Dichtungssatz                      | ABS-pakningssæt                      | ABS packningssats                      |
| Achtung: Kolbenstellung ändern !       | Bemærk: Stempelstilling skal ændres! | OBS! Ändra kolvläge !                  |
| Adapter für Bördel E                   | adapter til krave E                  | adapter för fläns E                    |
| alle Typen                             | alle typer                           | alla typer                             |
| Alu-Pumpe                              | alu-pumpe                            | aluminiumpump                          |
| Alu-Sättel                             | alu-åg                               | aluminium-ok                           |
| am Bremssattel                         | på bremseåg                          | på bromsoket                           |
| am Hauptzylinder                       | på hovedcylindren                    | på huvudcylindern                      |
| A-Motor                                | A-motor                              | A-motor                                |
| Anschlagschraube oben                  | stoppskrue oppe                      | stoppskrub upptill                     |
| Anschluß/Anschlüsse                    | tilslutning/tilslutninger            | anslutning/anslutningar                |
| Anti-Noise-Blech                       | Anti-Noise-plade                     | anti-noise-plåt                        |
| ASC (Automatische Stabilitäts Control) | ASC (automatisk stabilitetskontrol)  | ASC (automatisk stabilitetskontroll)   |
| ASR (Antriebsschlupfregelsystem)       | ASR (traktionskontrolsystem)         | ASR (antispinnreglering)               |
| ATE nur über VAG erhältlich            | ATE kan kun leveres via VAG          | ATE erhålls endast via VAG             |
| auf Typenschild                        | på typeskiltet                       | på typskylten                          |
| aufgeschraubt                          | skruet på                            | påskruvad                              |
| Auslaß seitlich links                  | udløb i siden til venstre            | utlopp vänster sida                    |
| Auslaß seitlich rechts                 | udløb i siden til højre              | utlopp höger sida                      |
| außen                                  | udvendigt                            | yttre                                  |
| automatische Nachstellung              | automatisk justering                 | automatisk efterjustering              |
| Behälter                               | beholder                             | behållare                              |
| Behälter Doppel-WE                     | beholder dobbelt advarselsudstyr     | behållare med dubbel varningsanordning |
| Behälterbefestigung                    | beholderfastgørelse                  | behållarinfastning                     |
| Behälterstopfen                        | beholderprop                         | behållareplugg                         |
| Behälterverschraubung                  | beholderforskruning                  | behållarförskruvning                   |
| Behörde                                | myndighed                            | myndighet                              |
| Beläge                                 | belægninger                          | belägg                                 |
| belüftete Scheiben                     | ventilerede skiver                   | ventilerade skivor                     |
| Betätigungseinheit                     | aktiveringsenhed                     | manövreringsenhet                      |
| blau                                   | blå                                  | blå                                    |
| Bodenventil                            | bundventil                           | bottenventil                           |
| Bodenventile tauschen                  | udskift bundventilerne               | byta bottenventil                      |
| Bördel x                               | krave x                              | fläns typ x                            |
| braun                                  | brun                                 | brun                                   |
| breite Ausführung                      | bred udførelse                       | brett utförande                        |
| Bremse                                 | bremse                               | broms                                  |
| Bremserät                              | bremseenhed                          | bromsenhet                             |
| Bremskraftregler                       | bremsekraftregulator                 | bromskraftregulator                    |
| Bremisleitungen erneuern !             | Udskift bremseledninger!             | förnya bromsledningarna !              |
| Bremslightschalter                     | bremselygtekontakt                   | bromsljusomkopplare                    |
| Bremsscheiben                          | bremsseskiver                        | bromsskivor                            |
| Bremsschlauch beachten !               | Bemærk bremseslange!                 | Observera bromsslangen !               |
| Buchse + Ausgleichbügel                | bøsning + udligningsbøjle            | bussning med utjämningsbygel           |
| Bus                                    | bus                                  | buss                                   |
| Bypassregler                           | bypass-regulator                     | bypassregulator                        |
| Citroen-Bremse                         | Citroen-bremse                       | Citroen-broms                          |
| D (Durchmesser) =                      | Ø (diameter) =                       | D (diameter) =                         |
| Dichtring                              | pakring                              | packningsring                          |
| Dichtung                               | pakning                              | packning                               |
| Dichtungssatz                          | pakningssæt                          | packningssats                          |
| Differentialsperre                     | differentialspærre                   | differentialspärr                      |
| Differenzdruckschalter                 | differenstrykkontakt                 | omkopplare för differenstryck          |
| Differenzdruckventil                   | differenstrykventil                  | differenstrycksventil                  |
| diverse Typen                          | diverse typer                        | diverse typer                          |
| Doppelbereifung                        | dobbelte dæk                         | dubbeldäck                             |



|   |   |  |
|---|---|--|
| travão pneumático de 1 câmara             | 1-kamrás sűrített levegős fék                         | однокамерный пневматический тормоз                       |
| pinça de travão de 1 piston D=xx          | 1-dugattyús nyereg D=xx                               | однопоршневой суппорт D=xx                               |
| pinça de travão de 2 pistons D=xx         | 2-dugattyús nyereg D=xx                               | двухпоршневой суппорт D=xx                               |
| pinça de travão de 4 pistons              | 4-dugattyús nyereg                                    | четырёхпоршневой суппорт                                 |
| travão mono-circuito                      | 1 fékkörös fék  | одноконтурная тормозная система                          |
| travão de circuito duplo                  | 2 fékkörös fék  | двухконтурная тормозная система                          |
| pinça de travão mono-circuito             | 1 körös nyereg  | одноконтурные суппорта                                   |
| pinça de travão de circuito duplo         | 2 körös nyereg  | двухконтурные суппорта                                   |
| 1º eixo traseiro                          | 1. hátsó tengely                                      | 1-й задний мост  |
| 1º e 2º eixos traseiros                   | 1. és 2. hátsó tengely                                | 1-й и 2-й задний мост                                    |
| disco de travão com 4 furos               | 4 lyukas féktárcsa                                    | тормозной диск с 4 отверстиями                           |
| disco de travão com 6 furos               | 6 lyukas féktárcsa                                    | тормозной диск с 6 отверстиями                           |
| jante de 3 furos                          | 3 lyukas keréktárcsa                                  | колесный обод с 3 отверстиями                            |
| jante de 4 furos                          | 4 lyukas keréktárcsa                                  | колесный обод с 4 отверстиями                            |
| jante de 5 furos                          | 5 lyukas keréktárcsa                                  | колесный обод с 5 отверстиями                            |
| parafuso hexagonal                        | Hatlapfejű csavar                                     | болт с шестигранной головкой                             |
| parafuso hexagonal (interior)             | Belső hatlapfejű csavar                               | болт с шестигранной головкой (внутренней)                |
| 6" - tandem                               | 6"-tandem   | тандем 6"  |
| 8" - tandem com cabeça de garfo           | 8"-tandem villafejfel                                 | тандем 8" с вильчатой головкой                           |
| 8" - tandem sem cabeça de garfo           | 8"-tandem villafej nélkül                             | тандем 8" без вильчатой головки                          |
| ABS - sistema de travagem anti-bloqueio   | ABS   | ABS (антиблокировочная система)                          |
| ABS - jogo de juntas                      | ABS-tömítéskészlet                                    | комплект прокладок для ABS                               |
| atenção: mudar a posição do piston !      | Figyelem: a dugattyúk helyzetét meg kell változtatni! | Внимание: изменить положение поршня!                     |
| adaptador para rebordo E                  | Adapter az „E” peremhez                               | адаптер для бортика типа E                               |
| todos os tipos                            | valamennyi típus                                      | все типы   |
| bomba em alumínio                         | Alumíniumszivattyú                                    | алюминиевый насос  |
| pinça de travão em alumínio               | Alumíniumnyereg                                       | алюминиевые суппорта                                     |
| no pinça de travão                        | a féknyergen  | на суппорте тормоза                                      |
| na bomba central de travões               | a főfékhengeren                                       | на главном цилиндре                                      |
| motor em A                                | A-motor   | двигатель типа A   |
| parafuso limitador de curso, em cima      | felső útközőcsavar                                    | упорный винт сверху                                      |
| ligação / ligações                        | Csatlakozás/csatlakozások                             | подключение/подключения                                  |
| placa anti-ruído                          | Zajcsökkentő lemez                                    | противопопыховый экран                                   |
| ASC (controlo automático de estabilidade) | ASC (automata stabilitás-ellenőző rendszer)           | ASC (автоматическая система курсовой устойчивости)       |
| ASR (sistema de controlo de tracção)      | ASR (hajítás csúszásszabályozó rendszer)              | ASR (противобуксовочная система)                         |
| ATE só disponível através da VAG          | Az ATE csak a VAG-nál kapható                         | Приобрести продукцию ATE можно только через компанию VAG |
| na placa de identificação                 | a típustáblára  | на заводской табличке с обозначением модели              |
| aparafusado                               | felcsavarozva   | на винтах  |
| escape lateral esquerdo                   | Bal kieresztőnyílás                                   | выпускное отверстие сбоку слева                          |
| escape lateral direito                    | Jobb kieresztőnyílás                                  | выпускное отверстие сбоку справа                         |
| macho                                     | kívül   | снаружи  |
| ajuste automático                         | automatikus utánállítás                               | автоматическая подстройка (регулировка)                  |
| depósito                                  | Tartály   | емкость (бачок)  |
| depósito com sistema de avisador duplo    | Tartály, kettős WE                                    | емкость с двойным сигнальным устройством                 |
| fixação do depósito                       | Tartályrögzítés                                       | крепление емкости  |
| bujão do depósito                         | Tartálydugó   | пробка емкости   |
| tampa do depósito                         | Tartály csavarkötés                                   | винтовое крепление емкости                               |
| oficial                                   | Hivatal   | автомобили для госслужб                                  |
| pastilhas de travão de disco              | Fékbetétek  | тормозные накладки (колодки)                             |
| discos ventilados                         | Hűtött tárcsák  | вентилируемые диски                                      |
| unidade de accionamento                   | Kezelő egység   | блок включения   |
| azul                                      | kék   | синий  |
| válvula de pressão residual               | Fenékszelep   | клапан избыточного давления главного тормозного цилиндра |
| mudar válvula de pressão residual         | Fenékszelep kicserélése                               | Заменить клапаны избыточного давления                    |
| rebordo tipo X                            | Perem x   | фланец x   |
| castanho                                  | barna   | коричневый   |
| modelo largo                              | Széles kivitel  | широкая модификация                                      |
| travão                                    | Fék   | тормоз   |
| servo-assistida                           | Fékberendezés   | тормозное устройство                                     |
| regulador da força de travagem            | Fékerőszabályzó                                       | регулятор тормозного усилия                              |
| substituir tubagem do sistema de travagem | Cserélje ki a fékvezetékeket !                        | Заменить тормозные шланги !                              |
| interruptor da luz de stop                | Féklámpa kapcsoló                                     | выключатель сигнала торможения                           |
| discos de travão                          | Féktárcsák  | тормозные диски  |
| atenção ao tubo de travão !               | Ügyeljen a féktömlőre !                               | Обратить внимание на тормозной шланг!                    |
| bucha + cabo de compensação               | Hüvely + kiegyenlítő kengyel                          | втулка + компенсационная скоба                           |
| autocarro                                 | Busz  | автобус  |
| regulador by-pass                         | Bypass szabályozó                                     | байпасный регулятор                                      |
| travão Citroen                            | Citroen-fék   | тормоз „Ситроен“   |
| D (diâmetro) =                            | D (átmérő) =  | D (диаметр) =  |
| retentor                                  | Tömítőgyűrű   | уплотнительное кольцо                                    |
| junta                                     | Tömítés   | прокладка уплотнительная                                 |
| jogo de juntas                            | Tömítéskészlet  | комплект прокладок                                       |
| bloqueio do diferencial                   | Differenciálzár                                       | блокировка дифференциала                                 |
| interruptor do diferencial de pressão     | Nyomáskülönbség kapcsoló                              | дифференциальное реле давления                           |
| válvula do diferencial de pressão         | Nyomáskülönbség szelep                                | дифференциальный регулирующий клапан                     |
| diversos tipos                            | Különböző típusok                                     | различные типы   |
| pneu duplo                                | Dupla kerékkészlet                                    | сдвоенные шины   |

|                             |                                   |                                      |
|-----------------------------|-----------------------------------|--------------------------------------|
| Doppelkabine                | dobbelt kabine                    | dubbelhytt                           |
| Druckbegrenzungsventil      | trykbegrænsningsventil            | tryckbegränsningsventil              |
| Druckbolzen                 | trykbolt                          | tryckbolt                            |
| Druckbolzen (kurz)          | trykbolt (kort)                   | tryckbolt (kort)                     |
| Druckbolzen (lang)          | trykbolt (lang)                   | tryckbolt (lång)                     |
| Druckluftbremse             | trykluftbremse                    | tryckluftsbroms                      |
| Druckluftleitung            | trykluftledning                   | tryckluftsledning                    |
| Druckluftunterstützung      | trykluftunderstøttet              | tryckluftsstöd                       |
| Druckluftverstärker         | trykluftforstærker                | tryckluftsförstärkare                |
| Druck-Warnschalter          | tryk-advarselskontakt             | tryck-varningsomkopplare             |
| DS-Regler                   | DS-regulator                      | DS regulator                         |
| EDS                         | EDS                               | EDS (elektronisk differential spærr) |
| EDS-Ventilblock             | EDS-ventilblok                    | EDS ventilblock                      |
| EG-Vorschrift               | EF-forskrift                      | EG direktiv                          |
| Einbau hinter der Achse     | indbygning bagved akslen          | inmontering bakom axeln              |
| Einbau vor der Achse        | indbygning foran akslen           | inmontering framför axeln            |
| Einbausatz                  | indbygningssæt                    | monteringssats                       |
| Einfachbereifung            | enkelt dæk                        | enkeldäck                            |
| Einknopfmaß xx mm           | indknæpningsmål xx mm             | inknåppningsmått xx mm               |
| Einlaß D=xx mm              | indløb Ø=xx mm                    | inlopp D=xx mm                       |
| Einlaß mit Gummistopfen     | indløb med gummiprof              | inlopp med gummiplugg                |
| Einschraubregler            | indskruningsregulator             | insskruv-utjämningsventil            |
| elektr. Vergaser            | elektr. karburator                | elektrisk förgasare                  |
| Entlüfteranschluß           | udluftningstilslutning            | avlutningsanslutning                 |
| Entlüfterventil             | udluftningsventil                 | avlutningsventil                     |
| erhöhte Zuladung            | øget last                         | förhöjd tillsatsvikt                 |
| Ersatz für Sättel D=xx      | erstatning for åg Ø=xx            | ersättning för ok D=xx               |
| ETS                         | ETS (elektronisk traktionssystem) | ETS antispinningsystem               |
| Europa                      | Europa                            | Europa                               |
| Export                      | eksport                           | export                               |
| Fahrschule                  | køreskole                         | körskola                             |
| Faltenbaldsatz              | foldebælgssæt                     | bælgsats                             |
| Faustsättel                 | håndåg                            | flytande bromsok                     |
| Fenster                     | vindue                            | fönster                              |
| Festsättel                  | faste åg                          | fasta ok                             |
| Flanschdicke x mm           | flangetykkelse x mm               | flånstjocklek x mm                   |
| Flanschmaß = xx,x           | flangemål = xx,x                  | flånsmått = xx,x                     |
| Fuller-Getriebe             | Fuller-gear                       | Fuller växellåda                     |
| für Belagsätze ohne Zubehör | til belægningssæt uden tilbehør   | för beläggsatser utan tillbehör      |
| für Bremssättel/Vorgänger   | til bremseåg/forgænger            | för bromsok/förgångare               |
| für Doppelmembran-Gerät     | til dobbeltmembran-enhed          | för dubbelmembran-enhet              |
| Gabelkopfsatz               | gaffelhovedsæt                    | gaffelhuvudsats                      |
| Gehäuse L=                  | hus L=                            | hus L=                               |
| gelb                        | gul                               | gul                                  |
| gepanzerte Fahrzeuge        | pansrede køretøjer                | bepansrade fordon                    |
| Getriebe                    | gear                              | växellåda                            |
| Getriebe-Nr.                | gear-nr.                          | växellåds-nr.                        |
| GG-Pumpe                    | støbejerns-pumpe                  | pump av grått gjutjärn               |
| GG-Sättel                   | støbejerns-åg                     | ok av grått gjutjärn                 |
| GG-THz/Vorgänger            | støbejerns-TMC/forgænger          | Thc av grått gjutjärn/förgångare     |
| Golf-Staaten                | Golfstaterne                      | Golfstaterna                         |
| Gz mit senkrechtem Flansch  | givercylinder med lodret flange   | givarcylinder med vertikal flåns     |
| Gz (Geberzylinder)          | givercylinder                     | Gc (givarcylinder)                   |
| Gz-Reparaturatz             | givercylinder-reparationssæt      | Gc-reparationssats                   |
| HA (Hinterachse)            | BA (bagaksel)                     | BA (bakaxel)                         |
| Haltefeder                  | holdefeder                        | spærrfjæder                          |
| Halter                      | holder                            | hållare                              |
| Haltersatz                  | holdesæt                          | hållaresats                          |
| Halterschraube              | holderskrue                       | hållareskruv                         |
| Handbremsbetätigung         | aktivering af håndbremse          | handbromsmanövrering                 |
| Handbremshebel              | håndbremsestang                   | handbromsspak                        |
| HA-Scheibenbremse           | BA-skivebremse                    | BA skivbroms                         |
| HA-Trommelbremse            | BA-tromlebremse                   | BA trumbroms                         |
| Hebel                       | håndtag                           | spak                                 |
| Hochdach                    | højt tag                          | høgt tak                             |
| Hohlschraube                | hulskrue                          | ihålig skruv                         |
| Hosei-Bremse                | Hosei-bremse                      | Hosei-broms                          |
| Hub                         | slag                              | slag                                 |
| Hülsensatz                  | bøsningesæt                       | hylssats                             |
| Hydraulikspeicher           | hydraulikkumulator                | hydraulackumulator                   |
| Hydraulikverstärker         | hydraulikforstærker               | hydraulförstärkare                   |
| Hydraulikzylinder           | hydraulikcylinder                 | hydraulicylinder                     |
| Hydr. Steuereinheit         | hydraulisk styreenhed             | hydr. styrenhet                      |
| Hz (Hauptzylinder)          | hovedcylinder                     | Hc (huvudcylinder)                   |
| Hz-Reparaturatz             | hovedcylinder-reparationssæt      | Hc-reparationssats                   |
| im Fahrerhaus               | i førerhuset                      | i förarhytten                        |
| im Motorraum                | i motorrummet                     | i motorrummet                        |



|  |                                     |  |
|--|-------------------------------------|--|
| cabina dupla                                     | Dupla vezetőfülke                   | двойная кабина   |
| válvula limitadora de pressão                    | Nyomáskorlátozó szelep              | редукционный клапан  |
| perno de pressão                                 | Nyomócsap                           | зажимный болт  |
| perno de pressão (curto)                         | Nyomócsap (rövid)                   | зажимный болт (короткий)   |
| perno de pressão (longo)                         | Nyomócsap (hosszú)                  | зажимный болт (длинный)  |
| travão pneumático                                | Sűrített levegős fék                | пневматический тормоз  |
| conduta pneumática                               | Sűrített levegő vezeték             | трубопровод сжатого воздуха  |
| assistência pneumática                           | Sűrített levegő segítség            | поддержка сжатым воздухом  |
| servofreio pneumático                            | Sűrített levegő erősítő             | пневматический усилитель (бустер)                                      |
| interruptor de aviso de pressão                  | Nyomás figyelmeztető kapcsoló       | сигнальное реле давления   |
| regulador DS                                     | DS-szabályozó                       | DS-регулятор   |
| EDS (bloqueio electrónico do diferencial )       | EDS                                 | EDS (электронная блокировка дифференциала)                             |
| EDS-válvula de bloqueio                          | EDS-szelepblokk                     | клапанный блок EDS   |
| de acordo com as normas da CE                    | EG-előírás                          | Соответствует предписаниям Европейского Сообщества                     |
| instalação atrás do eixo                         | Beszereles a tengely mögött         | установка позади оси   |
| instalação à frente do eixo                      | Beszereles a tengely előtt          | установка перед осью   |
| jogo de montagem                                 | Beszereelő készlet                  | монтажный комплект   |
| pneu simples                                     | Egyszeres kerékkészlet              | одинарные шины   |
| medida p/ instalar botão xx mm                   | Begombolási méret xx mm             | размер закрепления xx мм   |
| diâmetro de admissão = xx mm                     | Bemenőnyílás D=xx mm                | впускное отверстие D=xx мм   |
| admissão com ficha de borracha                   | Bemenőnyílás gumidugóval            | впускное отверстие с резиновой пробкой                                 |
| regulador de parafuso                            | Becsavarható szabályozó             | ввинчиваемый регулятор   |
| carburador eléctrico                             | Elektr. porlasztó                   | электр. карбюратор   |
| ligação de purga                                 | Légtelenítő csatlakozó              | подсоединение устройства для удаления воздуха                          |
| válvula de purga                                 | Légtelenítő szelep                  | клапан сапуна  |
| carga útil aumentada                             | Megnövelt rakomány                  | повышенная полезная нагрузка   |
| sobressalente para pinça de travão D=xx          | Nyeregptöltés D=xx                  | замена по суппортам D=xx   |
| ETS (sistema electrónico da tracção)             | ETS                                 | ETS (электронная система контроля тягового усилия)                     |
| Europa   | Európa                              | Европа   |
| exportação                                       | Export                              | экспорт  |
| escola de condução                               | Járművezető iskola                  | автошкола  |
| jogo de foles                                    | Harmonika-készlet                   | комплект гофрированных чехлов  |
| pinça de travão tipo „Faust“                     | Mozgó nyergek                       | тормозной механизм с плавающей скобой                                  |
| janela   | Ablak                               | окно   |
| pinça de travão fixa                             | Rögzített nyereg                    | фиксированная скоба дискового тормоза                                  |
| espessura da flange x mm                         | Karimavastagság x mm                | толщина фланца x мм  |
| medida da flange = xx,x                          | Karimaméret = xx,x                  | размер фланца=xx,x   |
| caixa de velocidades Fuller                      | Fuller-sebességváltó                | коробка передач Фуллера  |
| para pastilhas de travão sem acessórios          | Fékbetétkészletkhez tartozék nélkül | для комплектов колодок без принадлежностей                             |
| para pinças de travão / anterior                 | Féknyergekhez/előző kivitel         | для тормозных суппортов / предшественники                              |
| para servofreio de dupla membrana                | Kétmembrános berendezéshez          | для устройства с двойной мембраной                                     |
| jogo de cabeça de garfo                          | Villafekészlet                      | комплект вильчатых головок   |
| caixa L =  | Ház L=                              | корпус L=  |
| amarelo  | sárga                               | желтый   |
| veículos blindados                               | Páncélozott járművek                | бронированные автомобили   |
| caixa de velocidades                             | Sebességváltó                       | коробка передач  |
| caixa de velocidades nr.                         | Sebességváltó száma                 | номер коробки передач  |
| bomba em ferro fundido                           | GG-szivattyú                        | насос из серого чугуна   |
| pinça de travão em ferro fundido                 | GG-nyergek                          | суппорта из серого чугуна  |
| bomba central tandem em ferro fundido / anterior | GG-tandem főfékhenger/előző kivitel | двулопостной главный тормозной цилиндр из серого чугуна/предшественник |
| países do Golfo Pérsico                          | Öbölmenti országok                  | государства Персидского залива   |
| bomba central de embraiagem com flange vertical  | Munkahenger függőleges karimával    | главный цилиндр сцепления с вертикальным фланцем                       |
| BCE (bomba central de embraiagem)                | Gz (munkahenger)                    | Gz (главный цилиндр привода сцепления)                                 |
| BCE-jogo de reparação                            | Munkahenger-javítókészlet           | ремкомплект главного цилиндра привода сцепления                        |
| ET (eixo traseiro)                               | HA (hátsó tengely)                  | HA (задний мост)   |
| mola de retenção                                 | Tartórugó                           | стопорная пружина  |
| suporte  | Tartó                               | держатель, крепление   |
| jogo de suportes                                 | Tartókészlet                        | комплект крепления   |
| parafuso de suporte                              | Tartócsavar                         | болт крепления   |
| actuação do travão de mão                        | Kézifék működtetés                  | устройство включения ручного тормоза                                   |
| alavanca do travão de mão                        | Kézifékkar                          | рычаг ручного тормоза  |
| disco de travão do eixo traseiro                 | Hátsó tengely tárcsafék             | дисковый тормоз задней оси   |
| tambor do eixo traseiro                          | Hátsó tengely dobfék                | барабанный тормоз задней оси   |
| alavanca   | Kar                                 | рычаг  |
| tejadilho alto                                   | Magas tető                          | высокая крыша  |
| parafuso oco                                     | Üreges csavar                       | полый болт   |
| travões Hosei                                    | Hosei-fék                           | тормоз Хосай   |
| curso  | Lökét                               | ход поршня   |
| jogo de guias                                    | Hüvelykészlet                       | комплект втулок  |
| acumulador hidráulico                            | Hidraulikai tároló                  | гидравлический аккумулятор   |
| servofreio hidráulico                            | Hidraulikus erősítő                 | гидравлический усилитель   |
| cilindro hidráulico                              | Hidraulikus henger                  | гидравлический цилиндр   |
| unidade hidráulica                               | Hidr. vezérlőegység                 | гидравлический блок управления   |
| BCT (bomba central de travões)                   | HZ (főfékhenger)                    | HZ (главный цилиндр)   |
| BCT-jogo de reparação                            | Főfékhenger javítókészlet           | ремкомплект главного цилиндра  |
| na cabina  | a vezetőfülkében                    | в кабине водителя  |
| no compartimento do motor                        | a motortérben                       | в моторном отделении   |

|                                       |  |                                       |
|---------------------------------------|--|---------------------------------------|
| innen                                 | indvendigt                                   | inuti                                 |
| Innengewinde                          | indvendigt gevind                            | innergånga                            |
| Kastenwagen                           | kassevogn                                    | skåpvagn                              |
| Katalysator                           | katalysator                                  | katalysator                           |
| Kennzeichen: xx                       | indregistreringsnr.: xx                      | registreringsnummer: xx               |
| Kerbe am Flansch                      | kærv på flangen                              | hack i flänsen                        |
| Klasse                                | klasse                                       | klass                                 |
| Kleinbus                              | minibus                                      | minibuss                              |
| Klimaanlage                           | klimaanlæg                                   | luftkonditionering                    |
| Kolbenstange D=                       | stempelstang Ø=                              | kolvstång D=                          |
| Kolbenstange L=                       | stempelstang L=                              | kolvstång L=                          |
| Kombiwagen                            | stationcar                                   | kombibil                              |
| Kompakt THz                           | kompakt TMC                                  | kompakt THC                           |
| Krankenwagen                          | ambulance                                    | ambulans                              |
| Kupplung                              | kobling                                      | koppling                              |
| Kupplungsabgang                       | koblingsudgang                               | kopplingsutlopp                       |
| Kupplungsverstärker                   | koblingsforstærker                           | kopplingsförstärkare                  |
| kurzer Radstand                       | kort hjulafstand                             | kort hjulbas                          |
| kurzes Bremsgerät                     | kort bremseenhed                             | kort bromsenhet                       |
| L (Länge) =                           | L (længde) =                                 | L (längd) =                           |
| langer Radstand                       | lang hjulafstand                             | lång hjulbas                          |
| Leckageanzeige                        | lækage-indikator                             | läckageindikator                      |
| lieferbar                             | kan leveres                                  | tillgänglig                           |
| links oben und rechts unten           | oppe til venstre og nede til højre           | vänster upptill och höger nedtill     |
| links vor und rechts hinter der Achse | til venstre foran og til højre bagved akslen | vänster framför och höger bakom axeln |
| Linklenker                            | venstrestyret                                | vänsterstyrt fordon                   |
| Luftfederung                          | luftaffjedring                               | luftfjædring                          |
| luftgekühlt                           | luftkølet                                    | luftkyld                              |
| M8-Führungsbolzen                     | M8-styrebolt                                 | M8-styrbult                           |
| MA-Getriebe                           | MA-gear                                      | MA-væxellåda                          |
| mit 1 Haltestift                      | med 1 holdetap                               | med 1 insatspinne                     |
| mit 2 Haltestiften                    | med 2 holdetapper                            | med 2 insatspinnar                    |
| mit Alufelgen                         | med alu-fælg                                 | med aluminiumfælger                   |
| mit angegossenem Behälter             | med påstøbt beholder                         | med pågjuten behållare                |
| mit regeltem Katalysator              | med reguleret katalysator                    | med reglerad katalysator              |
| mit Laschen                           | med lasker                                   | med stroppar/flikar/länkar            |
| mit Leichtmetallrädern                | med letmetalhjul                             | med lättmetalhjul                     |
| MKII-Aggregat kpl.                    | MKII-aggregat kpl.                           | MKII-aggregat kompl.                  |
| Mod. (Modell)                         | mod. (model)                                 | mod. (modell)                         |
| Motor                                 | motor  | motor                                 |
| Motor-Nr.                             | motor-nr.                                    | motor-nr.                             |
| Motor-Pumpen-Aggregat                 | motor-pumpe-aggregat                         | motor-pump-aggregat                   |
| Multi-Link-Achse                      | multi-link-aksel                             | multilänkaxel                         |
| m.Z. (mit Zubehör)                    | m.t. (med tilbehør)                          | m.t. (med tillbehör)                  |
| Nachstellteile-Satz                   | sæt justeringsdele                           | sæt med efterjusteringsdelar          |
| ND-Schlauch                           | lavtryksslange                               | LT-slang (lågtrycks-)                 |
| Nebenabtrieb                          | sekundært kraftudtag                         | extra drivning                        |
| Niveauregulierung                     | niveauregulering                             | nivåreglering                         |
| Nz (Nehmerzylinder)                   | slavecylinder                                | SC slavcylinder                       |
| Nz-Reparatursatz                      | slavecylinder-reparationssæt                 | SC reparationssats                    |
| ohne Alufelgen                        | uden alu-fælg                                | utan aluminiumfælger                  |
| ohne regeltem Katalysator             | uden reguleret katalysator                   | utan reglerad katalysator             |
| ohne Laschen                          | uden lasker                                  | utan stroppar/flikar/länkar           |
| ohne Leichtmetallräder                | uden letmetalhjul                            | utan lättmetalhjul                    |
| O-Ring                                | O-ring                                       | O-ring                                |
| Pedal Feststeller                     | pedal lås                                    | pedallås                              |
| Polizei                               | politi                                       | polis                                 |
| Rad                                   | hjul   | hjul                                  |
| Radsensor                             | hjulsensor                                   | hjulsensor                            |
| Radstand xxxx mm                      | hjulafstand xxxx mm                          | hjulbas xxxx mm                       |
| rechts oben und links unten           | oppe til højre og nede til venstre           | höger upptill och vänster nedtill     |
| Rechtslenker                          | højrestyret                                  | högerstyrt fordon                     |
| Regler                                | regulator                                    | regulator                             |
| Reihenmotor                           | seriemotor                                   | radmotor                              |
| Reisebus/Hochdecker                   | rejsebus/høj bus                             | turistbuss/ hög buss                  |
| Reparatursatz                         | reparationssæt                               | reparationssats                       |
| Ringstutzen-Satz                      | ringstuds-sæt                                | ringstuts-sats                        |
| Rohrleitung                           | rørledning                                   | rörledning                            |
| rot                                   | rød  | röd                                   |
| roter Sattel                          | rødt åg                                      | rött ok                               |
| Rückschlagventil                      | kontraventil                                 | backventil                            |
| Rückstellwellen-Satz                  | sæt tilbagesstillingsaksel                   | återställningsaxel-sats               |
| Rz (Radzylinder)                      | hjulcylinder                                 | Hc (hjulcylinder)                     |
| Rz-Dichtungssatz                      | hjulcylinder-pakningssæt                     | Hc-O268pakningssats                   |
| Rz-Reparatursatz                      | hjulcylinder-reparationssæt                  | Hc-reparationssats                    |
| Salisbury-Achse                       | Salisbury-aksel                              | Salisbury-axel                        |
| Sattel mit 1 Haltestift               | åg med 1 holdetap                            | ok med 1 insatspinne                  |



|   |   |   |
|---|---|---|
| interior                                      | belül   | внутри  |
| rosca interior                                | Belső menet   | внутренняя резьба   |
| furgão  | Szekrényes kocsi  | автомобиль-фургон   |
| catalisador                                   | Katalizátor   | катализатор   |
| identificação: xx                             | Rendszám: xx  | номер: xx   |
| corte na flange                               | Bemetszés a karimán   | насечка на фланце   |
| classe  | Osztály   | класс   |
| mini-autocarro                                | Kisbusz   | микроавтобус  |
| ar condicionado                               | Klímaberendezés   | кондиционер   |
| biela D=                                      | Dugattyúrúd D=  | поршневой шток D=   |
| biela L=                                      | Dugattyúrúd L=  | поршневой шток L=   |
| carrinha station                              | Kombikocsi  | автомобиль-универсал (пикап)  |
| bomba central tandem compacta                 | Kompakt tandem-főfékhenger                                      | компактный двухполостной главный тормозной цилиндр                                      |
| ambulância                                    | Betegszállító kocsi   | санитарный автомобиль   |
| embraiagem                                    | Tengelykapcsoló   | сцепление   |
| saída p/ ligação da embraiagem                | Tengelykapcsoló kivezetés                                       | выходное отверстие муфты  |
| servo-embraiagem                              | Tengelykapcsoló erősítő   | усилитель сцепления   |
| distância curta entre eixos                   | Rövid tengelytávolság   | короткая колесная база  |
| servofreio curto                              | Rövid fékberendezés   | короткое тормозное устройство   |
| L (comprimento) =                             | L (hosszúság) =   | L (длина) =   |
| distância longa entre eixos                   | Hosszú kerék bázis  | длинная колесная база   |
| indicador de fuga                             | Szivárgásjelző  | сигнализация утечки   |
| disponível                                    | szállítható   | может быть поставлено   |
| em cima à esquerda e em baixo à direita       | a bal oldalon fent és a jobb oldalon lent                       | слева сверху и справа внизу   |
| à esquerda à frente e à direita atrás do eixo | a baloldalon a tengely előtt és a jobb oldalon a tengely mögött | слева перед осью и справа позади оси  |
| volante à esquerda                            | Balkormányos  | леворульный автомобиль  |
| suspensão pneumática                          | Pneumatikus felfüggesztés                                       | пневматическая подвеска   |
| refrigerado por ar                            | léghűtéses  | с воздушным охлаждением   |
| perno-guia M8                                 | M8-vezetőcsap   | направляющий болт M8  |
| caixa de velocidades MA                       | MA-sebességváltó  | коробка передач MA  |
| com 1 perno retentor                          | 1 tartócsappal  | с 1 упорным болтом  |
| com 2 pernos retentores                       | 2 tartócsappal  | с двумя упорными болтами  |
| com jante em alumínio                         | alumínium keréktárcsákkal                                       | с алюминиевыми колесными дисками (ободами)  |
| com reservatório fundido                      | öntött tartállyal   | с резервуаром, выполненным литьем   |
| com catalizador regulável                     | szabályozott katalizátorral                                     | с регулируемым катализатором  |
| com encaixes                                  | hevederekkel  | с накладками  |
| com jantes em liga                            | könnyűfém kerekkel  | с колесами из легкого сплава  |
| unidade completa MKII                         | Komplett MKII-aggregát  | агрегат MKII в сборе  |
| Mod. (Modelo)                                 | Mod. (modell)   | мод. (модель)   |
| motor   | Motor   | двигатель   |
| nr. do motor                                  | Motor-szám  | номер двигателя   |
| sistema bomba-motor                           | Motor-szivattyú aggregát  | агрегат двигатель-помпа   |
| eixo multi-link                               | Multi-Link tengely  | ось „мульти-линк“   |
| com acessórios                                | m.Z. (tartozékokkal)  | m.Z. (с принадлежностями)   |
| jogo de peças de afinação                     | Utánállító alkatrész-készlet                                    | комплект деталей для регулировки  |
| tubo ND                                       | Alacsony nyomású tömlő  | шланг низкого давления  |
| propulsão secundária                          | Melléklehajtás  | вспомогательный привод  |
| regulação nível                               | Magasság szabályozó modul                                       | регулировка высоты дорожного просвета   |
| BAE-bomba auxiliar de embraiagem              | Nz (vezérelt henger)  | NZ (рабочий цилиндр привода выключения сцепления)                                       |
| BAE-jogo de reparação                         | Nz-javítókészlet  | ремкомплект рабочего цилиндра сцепления   |
| sem jante em alumínio                         | Alumínium keréktárcsák nélkül                                   | без алюминиевых ободов  |
| sem catalizador regulável                     | Szabályozott katalizátor nélkül                                 | без регулируемого катализатора  |
| sem encaixes                                  | Hevederek nélkül  | без накладок  |
| sem jantes em liga leve                       | Könnyűfém kerek nélkül  | без колес из легкого сплава   |
| vedante / O-ring                              | Körkeresztmetszetű gyűrű  | кольцо круглого сечения   |
| pedal com bloqueio                            | Padálrögzítő  | фиксатор педали   |
| Polícia                                       | Rendőrség   | полиция   |
| roda  | Kerék   | колесо  |
| sensor da roda                                | Kerékérzékelő   | датчик колеса   |
| distância entre eixos xxxx mm                 | Tengelytávolság xxxx mm   | колесная база автомобиля xxxx мм  |
| à direita em cima e à esquerda em baixo       | a jobb oldalon fent és a bal oldalon lent                       | справа сверху и слева внизу   |
| volante à direita                             | Jobbkormányos   | праворульный автомобиль   |
| regulador                                     | Szabályozó  | регулятор   |
| motor em linha                                | Soros motor   | рядный двигатель  |
| autocarro de turismo / cabina alta            | Autóbusz/emeletes busz  | междугородный автобус/туристский автобус с высоко расположенным пассажирским помещением |
| jogo de reparação                             | Javító készlet  | ремкомплект   |
| jogo de suportes / anilhas                    | Gyűrűs talpkészlet  | комплект кольцевых патрубков  |
| tubagem                                       | Csővezeték  | трубопровод   |
| vermelho                                      | Piros   | красный   |
| pinça de travão vermelha                      | Piros nyereg  | красный суппорт   |
| válvula de sentido único                      | Visszacsapó szelep  | обратный клапан   |
| jogo para reset de árvores                    | Visszaállító tengely-készlet                                    | комплект валов возврата в исходное положение  |
| CR (cilindro de roda)                         | Rz (kerékfékhenger)   | Rz (колесный тормозной цилиндр)   |
| CR-jogo de juntas                             | Kerékfékhenger tömítőkészlet                                    | комплект прокладок колесного тормозного цилиндра  |
| CR-jogo de reparação                          | Kerékfékhenger javítókészlet                                    | ремкомплект колесного тормозного цилиндра   |
| eixo Salisbury                                | Salisbury-tengely   | ось Солсбери  |
| pinça de travão com 1 perno retentor          | Nyereg 1 tartócsappal   | суппорт с 1 штифтовым ограничителем   |

|                                |                                     |                                  |
|--------------------------------|-------------------------------------|----------------------------------|
| Sattel mit 2 Haltestiften      | åg med 2 holdetapper                | ok med 2 insatspinnar            |
| Sättel mit Gussnoppen          | åg med støbte nopper                | ok med gjutna noppor             |
| Sattelschraube                 | ågskrue                             | okskrue                          |
| Scheibenbremse                 | skivebremse                         | skivbroms                        |
| Scheibenkupplung               | skivekobling                        | skivkoppling                     |
| Scheibenschraube               | skiveskrue                          | skivskrue                        |
| Schlauchleitung                | slangeledning                       | slangedning                      |
| Schraubstutzen                 | skruerstuds                         | skruvstuts                       |
| schwarz                        | sort                                | svart                            |
| Schwimmsättel                  | flydeåg                             | flytande ok                      |
| Schwingblech WE                | svingplade advarselsudstyr          | svängplåt VA (varningsanordning) |
| SCS                            | SCS (stopp kontrolsystem)           | SCS (stopp kontroll system)      |
| separater Behälter             | separat beholder                    | separat behållare                |
| separates Druckstück/Vorgänger | separat trykstykke/forgænger        | separat trykstykke/föregångare   |
| Servolenkung                   | servostyring                        | servostyrning                    |
| Skandinavien                   | Skandinavien                        | Skandinavien                     |
| Sitzplätze                     | siddelpladser                       | sittplatser                      |
| Sonderfahrzeuge                | specialkøretøj                      | speciella fordon                 |
| Spezialaufbau                  | specialopbygning                    | speciell oppbyggnad              |
| Sportfahrwerk                  | sportkøretøj                        | sportchassi                      |
| Spur                           | spor                                | spår                             |
| Standard-Bremsgerät            | standard-bremseenhed                | standard bromsenhet              |
| Standard-THz                   | standard-TMC                        | standard Thc                     |
| staubfeste Ausführung          | støvfast udførelse                  | dammsäkert utförande             |
| Stufenheck                     | sedan                               | sedan-bakdel                     |
| T50-Reparaturatz               | T50-reparationssæt                  | T50-reparationssats              |
| Tandemregler                   | tandemregulator                     | tandemregulator                  |
| THz mit 3 Anschlüssen          | TMC med 3 tilslutninger             | Thc med 3 anslutningar           |
| THz mit Anschlagsschraube      | TMC med stoppskrue                  | Thc med anslagskrue              |
| THz (Tandemhauptzylinder)      | TMC (tandemhovedcylinder)           | Thc (tandemhovedcylinder)        |
| THz-Reparaturatz               | TMC-reparationssæt                  | Thc-reparationssats              |
| THz-RS (Montagehülse)          | TMC-reparationssæt (montagebøsning) | Thc-RS (monteringshylsa)         |
| Timken-Achse                   | Timken-aksel                        | Timken-axel                      |
| Topfmanschette                 | kopmanchet                          | övergångshylsa                   |
| Tragbolzensatz                 | sæt bærebolte                       | bårskruvsats                     |
| Transporter                    | transporter                         | transportfordon                  |
| Triebkopf                      | drivhoved                           | drivhuvud                        |
| Trommelbremse                  | tromlebremse                        | trumbroms                        |
| TBB (Trommelbremsbacken)       | TBB (tromlebremsebakker)            | TBB (trumbromsbackar)            |
| Umbau 1-teilig auf 2-teilig    | ombygning fra 1 del til 2 dele      | ombyggnad 1-delad till 2-delad   |
| Unterdruckverstärker           | undertryksforstærker                | undertrycksförstärkare           |
| ursprüngl. verschraubte Beläge | oprind. fastskruede belægninger     | ursprungl. förskruvade belägg    |
| VA (Vorderachse)               | FA (foraksel)                       | FA (framaxel)                    |
| VA-Girling-Bremse              | FA-Girling-bremse                   | FA-Girling-broms                 |
| VA-Scheibenbremse              | FA-skivebremse                      | FA-skivbroms                     |
| VA-Trommelbremse               | FA-tromlebremse                     | FA-trumbroms                     |
| Ventilblock                    | ventilblok                          | ventilblock                      |
| Ventilblock kpl.               | ventilblok komplet                  | ventilblock kompl.               |
| Verbindungsschrauben           | forbindelsesskruer                  | kopplingsskruevar                |
| Verschlußschraube              | låseskrue                           | låsplugg                         |
| Verschraubung                  | forskruning                         | förskruvning                     |
| Verschraubung kpl.             | forskruning komplet                 | förskruvning kompl.              |
| verstärkte Bremse              | forstærket bremse                   | förstärkt broms                  |
| verstärkte Stoßdämpfer         | forstærket støddæmper               | förstärkta stötdämpare           |
| verstärktes Fahrwerk           | forstærket chassis                  | förstärkt chassi                 |
| Verteilerstück wiederverwenden | genbrug fordelerstykke              | återanvänd fördelarstycket       |
| V-Motor                        | V-motor                             | V-motor                          |
| Vorder- und Hinterachse        | for- og bagaksel                    | fram- och bakaxel                |
| Vorderachse                    | foraksel                            | framaxel                         |
| Vorderachse und 2. Hinterachse | foraksel og 2. bagaksel             | framaxel och 2:a bakaxeln        |
| Vordruckventil                 | fortryksventil                      | förtrycksventil                  |
| Vorgänger                      | forgænger                           | föregångare                      |
| Vorgänger / Abschirmkappe      | forgænger / afskærmningshætte       | föregångare / avskärmningskåpa   |
| Vorgänger-THz, Einlaß D=xx     | forgænger-TMC, indløb Ø=xx          | föregångare-Thc, inlopp D=xx     |
| Vorspannzylinder               | forspændecylinder                   | förspänncylinder                 |
| WK (Warnkontakt)               | advarselskontakt                    | VK (varningskontakt)             |
| Warnkontakt 1-polig            | 1-polet advarselskontakt            | varningskontakt 1-polig          |
| Warnkontakt 2-polig            | 2-polet advarselskontakt            | varningskontakt 2-polig          |
| Warnschalter                   | advarselskontakt                    | varningsbrytare                  |
| WE (Warneinrichtung)           | advarselsanordning                  | VA (varningsanordning)           |
| WE-Befestigung                 | fastgøring advarselsanordning       | infästning för varningsanordning |
| Wegsensor                      | vejsensor                           | vägsensor                        |
| weiß                           | hvid                                | vit                              |
| Zylinderschraube               | cylinderskrue                       | cylinderskrue                    |





|   |   |  |
|---|---|--|
| pinça de travão com 2 pernos retentores       | Nyereg 2 tartócsappal                                 | суппорт с 2 штифтовым ограничителем  |
| pinças de travão c/ saliências fundidas       | Nyergek öntött szemcsékkal                            | суппорта с литыми утолщениями  |
| parafuso da pinça de travão                   | Nyeregcsavar  | болт суппорта  |
| discos de travão                              | Tárcsafék   | дисковый тормоз  |
| discos de embraiagem                          | Tárcsás tengelykapcsoló                               | дисковая муфта, сцепление  |
| parafuso do disco                             | Tárcsacsavar  | болт диска   |
| tubo  | Tömlővezeték  | шланг  |
| terminal roscado                              | Csavarcsomók  | горловина под резьбовую пробку   |
| preto   | Fekete  | черный   |
| pinça de travão oscilante                     | Úszónyereg  | плавающие скобы (суппорта)   |
| avisador em chapa oscilante                   | Rezgőlemez WE   | металлический лист сигнального устройства                                  |
| SCS (sistema de controlo de stop)             | SCS   | система SCS (stop control system)  |
| reservatório isolado                          | Külön tartály   | отдельный резервуар  |
| peça de pressão / anterior                    | Külön nyomóidom/előző kivétel                         | отдельный упор/предшественник  |
| direcção assistida                            | Szervokormány   | рулевое управление с сервоприводом   |
| Escandinávia                                  | Skandinávia   | Скандинавия  |
| assentos                                      | Ülőhelyek   | сидячие места  |
| veículo especial                              | Különleges gépkocsik                                  | специальные автомобили   |
| carroçaria especial                           | Különleges felépítmény                                | специальный кузов  |
| suspensão desportiva                          | Sportos futómű  | спортивная ходовая часть   |
| via   | Nyom  | полоса движения  |
| servofreio standard                           | Standard fékberendezés                                | стандартное тормозное устройство   |
| bomba central tandem standard                 | Standard tandem főfékhenger                           | стандартный двухполостной главный тормозной цилиндр                        |
| construção anti-poeiras                       | Porvédett kivétel                                     | пыленепроницаемая модификация  |
| 3 volumes                                     | Lépcsőshátú   | задняя часть кузова с углом между стеклом задка и багажником               |
| jogo de reparação T50                         | T50-javitókészlet                                     | ремкомплект T50  |
| regulador tandem                              | Tandemszabályozó                                      | двухполостной ограничитель давления  |
| BCT com 3 ligações                            | THz 3 csatlakozóval                                   | двухполостной главный тормозной цилиндр с 3 подключениями                  |
| BCT com parafuso de retenção                  | Tandem főfékhenger ütközőcsavarral                    | двухполостной главный тормозной цилиндр с упорным винтом                   |
| BCT-bomba central tandem                      | THz (tandem főfékhenger)                              | THz (двухполостной главный тормозной цилиндр)                              |
| BCT-jogo de reparação                         | Tandem főfékhenger javító készlet                     | ремкомплект двухполостного главного тормозного цилиндра                    |
| BCT-invólucro de montagem                     | Tandem főfékhenger-RS (szerelőhüvely)                 | ремкомплект двухполостного главного тормозного цилиндра (монтажная гильза) |
| eixo Timken                                   | Timken-tengely  | ось Тимкена  |
| vedante                                       | Edénytömítőgallér                                     | пыльник стакана  |
| jogo de pernos de suporte                     | Tartócsapkészlet                                      | комплект опорных болтов  |
| furgoneta                                     | Szállítókosci   | автомобиль-фургон малой грузоподъемности                                   |
| cabeça de propulsão                           | Hajtófej  | приводной агрегат  |
| travão de tambor                              | Dobfék  | барабанный тормоз  |
| MTT (Maxilas de Travão de Tambor)             | TBB (dobfékpofák)                                     | ТВВ (колодки барабанного тормоза)  |
| reconstrução de 1 peça a partir de 2 peças    | Átéptés 1-részesről 2-részesre                        | переоборудование с 1 части на 2 части                                      |
| servofreio de vácuo                           | VÁkuum erősítő  | вакуумный усилитель  |
| pastilhas aparafusadas de origem              | eredetileg felcsavarozott fékbetétek                  | первоначально прикручиваемые колодки                                       |
| ED (eixo dianteiro)                           | VA (első tengely)                                     | VA (передний мост)   |
| travões Girling do eixo dianteiro             | Első tengely Girling-fék                              | передний тормоз Girlinga   |
| travão de disco do eixo dianteiro             | Első tengely tárcsafék                                | передний дисковый тормоз   |
| travão de tambor do eixo dianteiro            | Első tengely dobfék                                   | передний барабанный тормоз   |
| válvula de bloqueio                           | Szelepblokk   | клапанный блок   |
| válvula de bloqueio - completa                | Komplett szelepblokk                                  | клапанный блок в сборе   |
| parafusos de união                            | Összekötő csavarok                                    | соединительные болты   |
| parafuso de fecho                             | Zárócsavar  | навинчивающаяся крышка   |
| aparafusamento                                | Csavarokötés  | резьбовое соединение   |
| aparafusamento completo                       | Komplett csavarokötés                                 | резьбовое соединение в сборе   |
| travão reforçado                              | Megerősített fék                                      | усиленные тормоза  |
| amortecedor reforçado                         | Megerősített lengéscsillapító                         | усиленный амортизаторы   |
| suspensão reforçada                           | Megerősített futómű                                   | усиленная ходовая часть  |
| reutilizar peça de distribuição               | Az elosztóidomot újra fel kell használni              | использовать снова распределитель  |
| motor em V                                    | V-motor   | V-образный двигатель   |
| eixos dianteiro e traseiro                    | Első és hátsó tengely                                 | передний и задний мост   |
| eixo dianteiro                                | Első tengely  | передний мост  |
| eixo dianteiro e 2º eixo traseiro             | Első tengely és 2. hátsó tengely                      | передний мост и 2-й задний мост  |
| válvula de pressão dianteira                  | Előnyomásszelep                                       | подпорный клапан   |
| anterior                                      | Előző kivétel   | предшественник   |
| anterior / capa de protecção                  | Előző kivétel / árnyékoló sapka                       | предшественник/ экранирующая головка                                       |
| anterior bomba central tandem, Ø entrada = xx | Előző kivétel - tandem főfékhenger, bemenőnyílás D=xx | предшествовавший двухполостной главный тормозной цилиндр, вход D=xx        |
| cilindro pré-tensionado                       | Előfeszítő henger                                     | предварительный цилиндр  |
| AD (avisador de desgaste)                     | WK (figyelmeztető érintkező)                          | сигнальный контакт   |
| AD c/ 1 terminal                              | 1-pólusú kopásfigyelmeztető érintkező                 | сигнальный контакт 1-полюсный  |
| AD c/ 2 terminais                             | 2-pólusú kopásfigyelmeztető érintkező                 | сигнальный контакт 2-полюсный  |
| interruptor de aviso                          | Figyelmeztető kapcsoló                                | сигнальное реле  |
| DA (dispositivo de aviso)                     | WE (figyelmeztető berendezés)                         | WE (сигнальное устройство)   |
| fixação do dispositivo de aviso               | Figyelmeztető berendezés rögzítés                     | крепление сигнального устройства   |
| sensor de curso                               | Útérzékelő  | датчик скорости автомобиля   |
| branco  | fehér   | белый  |
| parafuso do cilindro                          | Hengeres fejű csavar                                  | болт головки блока цилиндров   |

|  |   |  |
|--|---|--|
| 1-Kammer-Druckluftbremse               | 1komorová pneumatická brzda             | 1 - komorowy hamulec pneumatyczny                    |
| 1-Kolbensattel D=xx                    | 1pístový třmen D=xx                     | zacisk z jednym tłoczkiem D=xx                       |
| 2-Kolbensattel D=xx                    | 2pístový třmen D=xx                     | zacisk z dwoma tłoczkami D=xx                        |
| 4-Kolbensattel                         | 4pístový třmen                          | zacisk z 4 tłoczkami                                 |
| 1-Kreis-Bremse                         | jednookruhová brzda                     | hamulec jednoobwodowy                                |
| 2-Kreis-Bremse                         | dvouokruhová brzda                      | hamulec dwuobwodowy                                  |
| 1-Kreis-Sättel                         | jednookruhový třmen                     | zaciski jednoobwodowe                                |
| 2-Kreis-Sättel                         | dvouokruhový třmen                      | zaciski dwuobwodowe                                  |
| 1. Hinterachse                         | 1. zadní náprava                        | pierwsza oś tylna                                    |
| 1. und 2. Hinterachse                  | 1. a 2. zadní náprava                   | pierwsza i druga oś tylna                            |
| 4-Loch-Bremsscheibe                    | brzdový kotouč se 4 otvory              | tarcza hamulca z 4 otworami                          |
| 6-Loch-Bremsscheibe                    | brzdový kotouč se 6 otvory              | tarcza hamulca z 6 otworami                          |
| 3-Loch-Felge                           | ráfek se 3 otvory                       | obřezč kola z 3 otvorami                             |
| 4-Loch-Felge                           | ráfek se 4 otvory                       | obřezč kola z 4 otvorami                             |
| 5-Loch-Felge                           | ráfek s 5 otvory                        | obřezč kola z 5 otvorami                             |
| 6kt-Schraube                           | šroub se 6hrannou hlavou                | šruba z 6buntem sześciokątným                        |
| 6kt-Schraube (innen)                   | šroub se 6hrannou hlavou (vnitřní)      | šruba z 6buntem sześciokątným (wewnątrz)             |
| 6"-Tandem                              | 6" tandem                               | tandem 6"  |
| 8"-Tandem mit Gabelkopf                | 8" tandem s vidlicovou hlavou           | tandem 8" z główką rozwidloną                        |
| 8"-Tandem ohne Gabelkopf               | 8" tandem bez vidlicové hlavy           | tandem 8" bez główki rozwidłonej                     |
| ABS                                    | ABS                                     | ABS  |
| ABS-Dichtungssatz                      | sada těsnění pro ABS                    | komplet uszczelniający do ABS                        |
| Achtung: Kolbenstellung ändern !       | Pozor! Změnit polohu pístu!             | Uwaga: zmienić położenie tłoka!                      |
| Adapter für Bördel E                   | Adaptér pro obrubu typu E               | adapter do zwinięcia obwodowego typu E               |
| alle Typen                             | všechny typy                            | wszystkie typy                                       |
| Alu-Pumpe                              | hliníkové čerpadlo                      | pompa aluminiowa                                     |
| Alu-Sättel                             | hliníkové třmeny                        | zaciski aluminiowe                                   |
| am Bremssattel                         | u třmenu kotoučové brzdy                | na zacisku aluminiowym                               |
| am Hauptzylinder                       | u hlavního válce                        | na pompie hamulca                                    |
| A-Motor                                | A motor                                 | silnik A   |
| Anschlagschraube oben                  | dorazový šroub nahoře                   | wkręt zderzakowy, góra                               |
| Anschluß/Anschlüsse                    | přípoj/přípoje                          | przyłącze / przylączca                               |
| Anti-Noise-Blech                       | vymezovací podložka                     | blacha tłumiąca hałas                                |
| ASC (Automatische Stabilitäts Control) | ASC (automatická kontrola stability)    | ASC (automatyczny system kontroli stabilności jazdy) |
| ASR (Antriebsschlupfregelsystem)       | ASR (systém pro protismykovou regulaci) | ASR (układ antypoślizgowej stabilizacji napędu)      |
| ATE nur über VAG erhältlich            | ATE lze obdržet jen přes VAG            | ATE dostępne tylko przez VAG                         |
| auf Typenschild                        | na typovém štítku                       | na tabliczce znamionowej                             |
| aufgeschraubt                          | našroubováno                            | nakręcone  |
| Auslaß seitlich links                  | výfuk na straně vlevo                   | wylot z lewej strony z boku                          |
| Auslaß seitlich rechts                 | výfuk na straně vpravo                  | wylot z prawej strony z boku                         |
| außen                                  | vně                                     | na zewnątrz  |
| automatische Nachstellung              | automatické seřizování                  | automatyczna regulacja                               |
| Behälter                               | nádržka                                 | zbiorniczek  |
| Behälter Doppel-WE                     | dvojitě VZ nádržky                      | zbiorniczek z podwójnym urządzeniem ostrzegawczym    |
| Behälterbefestigung                    | upevnění nádržky                        | mocowanie zbiorniczka                                |
| Behälterstopfen                        | zátká nádržky                           | korek zbiorniczka                                    |
| Behälterverschraubung                  | šroubení nádržky                        | zakrętka zbiorniczka                                 |
| Behörde                                | úřad                                    | urząd  |
| Beläge                                 | obložení                                | okładziny hamulcowe                                  |
| belüftete Scheiben                     | větrané kotouče                         | tarcze wentylowane                                   |
| Betätigungseinheit                     | ovládací jednotka                       | jednostka obsługowa                                  |
| blau                                   | modrý                                   | niebieski  |
| Bodenventil                            | dnový ventil                            | zawór denny  |
| Bodenventile tauschen                  | vyměnit dnové ventily                   | wymienić zawory denne                                |
| Bördel x                               | obrubá x                                | zawinięcie obwodowe x                                |
| braun                                  | hnědý                                   | brązowy  |
| breite Ausführung                      | široké provedení                        | typ szeroki  |
| Bremse                                 | brzda                                   | hamulec  |
| Bremsgerät                             | brzdové zařízení                        | urządzenie hamulcowe                                 |
| Bremskraftregler                       | regulátor brzdné síly                   | regulator siły hamowania                             |
| Bremsleitungen erneuern !              | vyměnit brzdová vedení!                 | Wymienić przewody hamulcowe!                         |
| Bremslichtschalter                     | spínač brzdového světla                 | włącznik światła stopu                               |
| Bremsscheiben                          | brzdové kotouče                         | tarcze hamulcowe                                     |
| Bremsschlauch beachten !               | Dbejte na brzdovou hadici!              | Zwrócić uwagę na przewód hamulcowy!                  |
| Buchse + Ausgleichbügel                | pouzdro + vyrovnávací třmen             | tuleja + kabłąk wyrównawczy                          |
| Bus                                    | autobus                                 | bus (van)  |
| Bypassregler                           | obtokový regulátor                      | regulator obejściowy                                 |
| Citroen-Bremse                         | brzda Citroenu                          | hamulec Citroen'a                                    |
| D (Durchmesser) =                      | D (průměr) =                            | D (średnica) =                                       |
| Dichtring                              | těsnící kroužek                         | pierścień uszczelniający                             |
| Dichtung                               | těsnění                                 | uszczelka  |
| Dichtungssatz                          | sada těsnění                            | zestaw uszczelniający                                |
| Differentialsperr                      | uzávěrka diferenciálu                   | blokada układu różnicowego                           |
| Differenzdruckschalter                 | diferenční tlakový spínač               | włącznik różnicy ciśnień                             |
| Differenzdruckventil                   | diferenční tlakový ventil               | zawór różnicy ciśnień                                |
| diverse Typen                          | různé typy                              | różne typy   |
| Doppelbereifung                        | dvojí pneumatiky                        | podwójne ogumienie                                   |

|  |   |                   |
|--|---|-------------------|
| Φρένο πεπιεσμένου αέρα 1 θαλάμου                     | tek odalı havalı fren                     | 抗噪音板              |
| Δίχαλο πέδησης 1 εμβόλου D=xx                        | 1 pistonlu kaliper D=xx                   | 1活塞制动钳 D=xx       |
| Δίχαλο πέδησης 2 εμβόλων D=xx                        | 2 pistonlu kaliper D=xx                   | 2活塞制动钳 D=xx       |
| Δίχαλο πέδησης 4 εμβόλων                             | 4 pistonlu kaliper                        | 4活塞制动钳            |
| Φρένο 1 κυκλώματος                                   | 1 devreli fren                            | 1回路制动器            |
| Φρένο 2 κυκλωμάτων                                   | 2 devreli fren                            | 2回路制动器            |
| Δίχαλα πέδησης 1 κυκλώματος                          | 1 devreli kaliperler                      | 1回路制动钳            |
| Δίχαλα πέδησης 2 κυκλωμάτων                          | 2 devreli kaliperler                      | 2回路制动钳            |
| 1ος πίσω άξονας                                      | 1. arka aks                               | 第1后桥              |
| 1ος και 2ος πίσω άξονας                              | 1. ve 2. arka aks                         | 第1和第2后桥           |
| Δίσκος φρένου 4 οπών                                 | 4 delikli fren diskı                      | 4孔式制动圆盘           |
| Δίσκος φρένου 6 οπών                                 | 6 delikli fren diskı                      | 6孔式制动圆盘           |
| Ζάντα 3 οπών   | 3 delikli jant                            | 3孔式轮辋             |
| Ζάντα 4 οπών   | 4 delikli jant                            | 4孔式轮辋             |
| Ζάντα 5 οπών   | 5 delikli jant                            | 5孔式轮辋             |
| Βίδα εξαγωνικής κεφαλής                              | 6 köşeli civata                           | 6角螺栓              |
| Βίδα κεφαλής κοίλου εξαγώνου                         | 6 köşeli civata (iç)                      | 内6角螺栓             |
| Δίδυμος 6"   | 6 inç tandem                              | 6英寸串联制动液缸         |
| Δίδυμος 8" με διχαλωτή κεφαλή                        | 8 inç tandem, çatal başlıklı              | 8英寸串联制动液缸带有叉头     |
| Δίδυμος 8" χωρίς διχαλωτή κεφαλή                     | 8 inç tandem, çatal başlıksız             | 8英寸串联制动液缸不带叉头     |
| Σύστημα ανιμπλοκαρίσματος (ABS)                      | ABS (anti blokaj sistemi)                 | 防抱死制动系统           |
| Σε στεγανοποίησης συστήματος ανιμπλοκαρίσματος (ABS) | ABS conta takımı                          | 防抱死制动系统密封套件       |
| Προσοχή: Αλλαγή της θέσης του εμβόλου !              | Dikkat: Piston pozisyonunu değiştirin !   | 注意: 活塞位置变更 !      |
| Προσαρμογέας για περιχέλιωση τύπου E                 | havşa E için adaptör                      | 用于卷边E的适配件         |
| όλοι οι τύποι  | tüm tipler                                | 所有型号              |
| Αλουμινένια αντλία                                   | alüminyum pompa                           | 铝制泵               |
| Αλουμινένια δίχαλα πέδησης                           | alüminyum kaliperler                      | 铝制制动钳             |
| στο δίχαλο πέδησης                                   | fren kaliperinde                          | 制动钳旁              |
| στον κεντρικό κύλινδρο                               | ana merkez silindirinde                   | 主液缸旁              |
| Κινητήρας A  | A motor                                   | A发动机              |
| Κοχλίας αναστολής επάνω                              | üst dayanak civatası                      | 上限位螺钉             |
| Σύνδεση/Συνδέσεις                                    | bağlantı/bağlantılar                      | 接口/连接             |
| Ηχομωνωτική λαμαρίνα                                 | susturucu                                 | 抗噪音板              |
| ASC (Αυτόματος Έλεγχος Ευστάθειας)                   | ASC (Otomatik Stabilite Kontrolü)         | ASC (汽车稳定性自动控制装置) |
| ASR (Διάταξη Ρύθμισης Έλξης και Ολίσθησης)           | ASR (Anti Patınaj Sistemi)                | ASR (防侧滑调节系统)     |
| ATE διατίθεται μόνο μέσω VAG                         | ATE sadece VAG üzerinden temin edilebilir | 只能通过VAG购置ATE      |
| πάνω στην πινακίδα τύπου                             | tip levhası üzerinde                      | 在铭牌上              |
| βιδωμένο   | vidalanmış                                | 拧上                |
| Εξαγωγή πλάγια αριστερά                              | çıkış yeri sol yan taraf                  | 左侧排气              |
| Εξαγωγή πλάγια δεξιά                                 | çıkış yeri sağ yan taraf                  | 右侧排气              |
| εξωτερικά  | dış                                       | 外部                |
| Αυτόματη επαναρύθμιση                                | otomatik ayarlama                         | 自动调整              |
| Δοχείο   | hazne                                     | 容器                |
| Δοχείο με διπλή διάταξη προειδοποίησης (ΔΠ)          | çift ikaz sistemli hazne                  | 双层WE的容器           |
| Στήριξη δοχείου                                      | hazne tespitleme                          | 容器的固定             |
| Τάπα δοχείου   | hazne tapası                              | 容器堵头              |
| Πώμα δοχείου   | hazne vida bağlantısı                     | 容器螺帽              |
| Υψηρεσία   | resmi araç                                | 政府机关              |
| Τακάκια φρένων                                       | fren balataları                           | 摩擦片               |
| Αεριζόμενοι δίσκοι                                   | havalandırılmalı diskler                  | 通风的制动盘            |
| Μονάδα χειρισμού                                     | çalıştırma ünitesi                        | 操纵单元              |
| μπλε   | mavi                                      | 蓝色                |
| Βαλβίδα πυθμένα                                      | taban valfi                               | 底阀                |
| Αντικατάσταση βαλβίδων πυθμένα                       | taban valflerini değiştirin               | 更换底阀              |
| Περιχέλιωση x  | havşa x                                   | 卷边 x              |
| καφέ   | kahverengi                                | 棕色                |
| Πλατιά έκδοση  | geniş model                               | 宽结构形式             |
| Φρένο  | fren                                      | 制动器               |
| Μονάδα πέδησης                                       | fren cihazı                               | 制动器               |
| Ρυθμιστής δύναμης πέδησης                            | fren regülatörü                           | 制动力调节器            |
| Αντικατάσταση σωλήνων φρένων !                       | fren hatlarını yenileyin !                | 更新制动管路 !          |
| Διακόπτης φώτων φρένων                               | fren lambası şalteri                      | 制动灯开关             |
| Δίσκοι φρένων  | fren diskleri                             | 制动圆盘              |
| Προσοχή στον εύκαμπο σωλήνα φρένου !                 | fren hortumunu dikkate alın !             | 注意制动软管 !          |
| Δακτύλιος + Κλιπ εξισορρόπηση                        | buç + dengeleme elemanı                   | 轴套 + 补偿卡箍         |
| Λεωφορείο  | otobüs                                    | 大客车               |
| Ρυθμιστής παράκαμψης                                 | bypass regülatörü                         | 旁路调节器             |
| Φρένο Citroen  | Citroen freni                             | 雪铁龙制动器            |
| D (Διάμετρος) =                                      | Ç (Çap) =                                 | D (直径) =          |
| Στεγανοποιητικός δακτύλιος                           | conta halkası                             | 密封圈               |
| Στεγανοποίηση  | conta                                     | 密封                |
| Σε στεγανοποίησης                                    | conta takımı                              | 密封套件              |
| Εμπλοκέας διαφορικού                                 | diferansiyal kilidi                       | 差动锁止机构            |
| Διακόπτης διαφοράς πίεσης                            | fark basınç şalteri                       | 差动压力开关            |
| Βαλβίδα διαφοράς πίεσης                              | fark basınç valfi                         | 差动压力阀             |
| διάφοροι τύποι                                       | muhtelif tipler                           | 各种型号              |
| Διπλά ελαστικά                                       | çift lastik                               | 双轮胎               |

|                             |                                       |   |
|-----------------------------|---------------------------------------|---|
| Doppelkabine                | dvojitá kabina                        | kabina podwójna   |
| Druckbegrenzungsventil      | tlakový omezovací ventil              | zawór ograniczenia ciśnienia                            |
| Druckbolzen                 | tlakový čep                           | trzcierń naciskowy                                      |
| Druckbolzen (kurz)          | tlakový čep (krátký)                  | trzcierń naciskowy (krótki)                             |
| Druckbolzen (lang)          | tlakový čep (dlouhý)                  | trzcierń naciskowy (długi)                              |
| Druckluftbremse             | vzduchová brzda                       | hamulec pneumatyczny                                    |
| Druckluftleitung            | tlakovzdušné vedení                   | przewód sprężonego powietrza                            |
| Druckluftunterstützung      | tlakovzdušná podpora                  | wspomaganie sprężonym powietrzem                        |
| Druckluftverstärker         | tlakovzdušný zesilovač                | wspomaganie pneumatyczne                                |
| Druck-Warnschalter          | výstražný spínač tlaku                | ciśnieniowy włącznik ostrzegawczy                       |
| DS-Regler                   | regulátor DS                          | regulator DS  |
| EDS                         | EDS                                   | EDS (elektronická blokada układu różnicowego)           |
| EDS-Ventilblock             | blok ventilů EDS                      | EDS - blok zaworůw                                      |
| EG-Vorschrift               | předpis ES                            | przepis EC (unijný)                                     |
| Einbau hinter der Achse     | montáž za nápravou                    | montaż za osią  |
| Einbau vor der Achse        | montáž před nápravou                  | montaż przed osią                                       |
| Einbausatz                  | montážní sada                         | komplet montażowy                                       |
| Einfachbereifung            | jedna sada pneumatik                  | pojedyncze ogumienie                                    |
| Einknöpfmaß xx mm           | rozměr zapínání xx mm                 | wymiar zapięcia na guzik xx mm                          |
| Einlaß D=xx mm              | sání D=xx mm                          | wlot D=xx mm  |
| Einlaß mit Gummistopfen     | sání s pryžovou zátkou                | wlot z korkiem gumowym                                  |
| Einschraubregler            | regulátor k zašroubování              | regulator wkręcany                                      |
| elektr. Vergaser            | elektr. karburátor                    | gaźnik elektroniczny                                    |
| Entlüfteranschluß           | připoj odvodušňovače                  | przyłącze odpowietrzacza                                |
| Entlüfterventil             | odvodušňovací ventil                  | zawór odpowietrzacza                                    |
| erhöhte Zuladung            | zvýšené užitečné zatížení             | zwiększone doładowanie                                  |
| Ersatz für Sättel D=xx      | náhrada za třmeny D=xx                | zastępczo za zaciski D=xx                               |
| ETS                         | ETS                                   | ETS (elektronický systém kontroli trakci)               |
| Europa                      | Evropa                                | Europa  |
| Export                      | export                                | eksport   |
| Fahrschule                  | autoškola                             | nauka jazdy   |
| Faltenbalsatz               | sada vlnovců                          | komplet mieszków  |
| Faustsättel                 | plovoucí třmeny                       | zaciski ruchome   |
| Fenster                     | okno                                  | szyba   |
| Festsättel                  | pevné třmeny                          | zaciski stałe   |
| Flanschdicke x mm           | tloušťka příruby x mm                 | grubość kołnierza x mm                                  |
| Flanschmaß = xx,x           | rozměr příruby = xx,x                 | wymiar kołnierza = xx,x                                 |
| Fuller-Getriebe             | převodovka fuller                     | przekładnia Fullera                                     |
| für Belagsätze ohne Zubehör | pro sady obložení bez příslušenství   | do kompletu klocek hamulcowych bez osprzętu             |
| für Bremssättel/Vorgänger   | pro třmeny kotoučové brzdy/předchůdce | do zaciskůw hamulców / poprzednicy                      |
| für Doppelmembran-Gerät     | pro zařízení s dvojitou membránou     | do urządzienia z podwójną membraną                      |
| Gabelkopfsatz               | sada vidlicových hlav                 | zestaw główek rozwidloných                              |
| Gehäuse L=                  | plášť L=                              | obudowa L=  |
| gelb                        | žlutý                                 | żółty   |
| gepanzerte Fahrzeuge        | obrněná vozidla                       | pojazdy opancerzone                                     |
| Getriebe                    | převodovka                            | skrzynia biegów   |
| Getriebe-Nr.                | čís. převodovky                       | nr skrzyni biegów                                       |
| GG-Pumpe                    | čerpadlo z šedé litiny                | pompa z żeliwa szarego                                  |
| GG-Sättel                   | třmeny z šedé litiny                  | zaciski z żeliwa szarego                                |
| GG-THz/Vorgänger            | THV ze šedé litiny/předchůdce         | pompa hamulca typu tandem z želiwa szarego / poprzednik |
| Golf-Staaten                | Golfské státy                         | państwa Zatoki Perskiej                                 |
| Gz mit senkrechtem Flansch  | válec vysílače se svislou přírubou    | pompa sprzęgła z prostopadłym kołnierzem                |
| Gz (Geberzylinder)          | VV (válec vysílače)                   | pompa sprzęgła  |
| Gz-Reparaturatz             | sada dílů pro opravu VV               | zestaw naprawczy do pompy sprzęgła                      |
| HA (Hinterachse)            | ZN (zadní náprava)                    | oś tylna  |
| Haltefeder                  | přidržná pružina                      | sprężyna mocująca                                       |
| Halter                      | držák                                 | uchwyt  |
| Haltersatz                  | sada držáků                           | komplet uchwytůw  |
| Halterschraube              | šroub držáků                          | šruba uchwytu   |
| Handbremsbetätigung         | ovládání ruční brzdy                  | uruchomienie hamulca ręcznego                           |
| Handbremshebel              | páka ruční brzdy                      | dźwignia hamulca ręcznego                               |
| HA-Scheibenbremse           | kotoučová brzda ZN                    | hamulec tarczowy na osi tylnej                          |
| HA-Trommelbremse            | bubnová brzda ZN                      | hamulec bębnowy na osi tylnej                           |
| Hebel                       | páka                                  | dźwignia  |
| Hochdach                    | vysoká střecha                        | wysoki dach   |
| Hohlschraube                | dutý šroub                            | šruba wydrążona   |
| Hosei-Bremse                | brzda Hosei                           | hamulec Hosei   |
| Hub                         | zdvih                                 | skok  |
| Hülsensatz                  | sada pouzder                          | komplet tulejek   |
| Hydraulikspeicher           | hydraulický zásobník                  | akumulator hydrauliczny                                 |
| Hydraulikverstärker         | hydraulický posilovač                 | hydrauliczny siłownik wspomagający                      |
| Hydraulikzylinder           | hydraulický válec                     | cylinder hydrauliczny                                   |
| Hydr. Steuereinheit         | hydraulická řidič jednotka            | hydrauliczny blok sterujący                             |
| Hv (Hauptzylinder)          | HV (hlavní válec)                     | PH (pompa hamulcowa)                                    |
| Hv-Reparaturatz             | sada dílů pro opravu HV               | zestaw naprawczy do pompy hamulcovej                    |
| im Fahrerhaus               | v kabině řidiče                       | w kabinie   |
| im Motorraum                | v motorovém prostoru                  | w maszynowni  |





|   |  |                      |
|---|--|----------------------|
| Διπλός θάλαμος  | çift kabin   | 双驾驶室                 |
| Βαλβίδα περιορισμού της πίεσης                                  | basınç sınırlama valfi                             | 限压阀                  |
| Πείρος πίεσης   | baskı pimi   | 压力销                  |
| Πείρος πίεσης (κοντός)  | baskı pimi (kısa)                                  | 压力销 (短)              |
| Πείρος πίεσης (μακρύς)  | baskı pimi (uzun)                                  | 压力销 (长)              |
| Φρένο πεπιεσμένου αέρα  | havalı fren  | 压缩空气制动器              |
| Σωλήνες πεπιεσμένου αέρα  | basınçlı hava hattı                                | 压缩空气管路               |
| Υποστήριξη πεπιεσμένου αέρα                                     | basınçlı hava desteği                              | 压缩空气支承               |
| Ενισχυτής πεπιεσμένου αέρα                                      | basınçlı hava amplifikatörü                        | 压缩空气放大器              |
| Διακόπτης προειδοποίησης πίεσης                                 | basınç ikaz şalteri                                | 压力报警开关               |
| Ρυθμιστής DS  | DS regülatörü                                      | DS差动锁止装置调节器          |
| EDS (ηλεκτρονικό κλειδίωμα διαφορικού)                          | EDS  | EDS电动差动锁止装置          |
| Μπλοκ βαλβίδων EDS  | EDS valf bloğu                                     | EDS阀块                |
| Προδιαγραφή EK  | AB direktifi                                       | EG欧盟规定               |
| Τοποθέτηση πίσω από τον άξονα                                   | aksın arkasına montaj                              | 装在轴后                 |
| Τοποθέτηση μπροστά από τον άξονα                                | aksın önüne montaj                                 | 装在轴前                 |
| Σετ τοποθέτησης   | montaj seti  | 安装套件                 |
| Μονά ελαστικά   | tek lastik   | 单轮胎                  |
| Διάσταση μπουτόν xx mm  | düğümleme ölçüsü xx mm                             | 按钮尺寸 xx mm           |
| Εισαγωγή D=xx mm  | giriş Ç=xx mm                                      | 进气口 D=xx mm          |
| Εισαγωγή με λαστιχένια πώματα                                   | lastik tapalı giriş                                | 带有橡胶堵头的进气口           |
| Βιδωτός ρυθμιστής   | vidalanarak montajlı regülatör                     | 拧进调节器                |
| Ηλεκτρικό καρμπυρατέρ   | elektrikli karbüratör                              | 电气化器                 |
| Σύνδεση εξαερισμού  | hava boşaltma bağlantısı                           | 排气接口                 |
| Βαλβίδα εξαέρωσης   | hava boşaltma valfi                                | 排气阀                  |
| Αυξημένο πρόσθετο φορτίο  | fazla yüklemeye                                    | 增大的载重                |
| Αντικατάσταση για δίχαρα πέδησης D=xx                           | kaliperler için yedek D=xx                         | 用于制动钳 D=xx           |
| ETS   | ETS  | ETS                  |
| Ευρώπη  | Avrupa   | 欧洲                   |
| Εξαγωγή   | export   | 出口                   |
| Σχολή οδηγών  | sürücü kursu                                       | 驾驶学校                 |
| Σετ φούσκας   | körük takımı                                       | 波纹管组                 |
| Ολισθαίνοντα δίχαρα πέδησης                                     | yumruk tip kaliperler                              | 浮式制动钳                |
| Παράθυρο  | pencere  | 车窗                   |
| Σταθερά δίχαρα πέδησης  | sabit kaliperler                                   | 固定式制动钳               |
| Πάχος φλάντζας x mm   | flaş kalınlığı x mm                                | 法兰厚度 x mm            |
| Διάσταση φλάντζας = xx,x  | flaş ölçüsü = xx,x                                 | 法兰尺寸 = xx,x          |
| Κιβώτιο ταχυτήτων Fuller  | Fuller şanzıman                                    | 变速箱                  |
| για σετ τακακιών χωρίς εξαρτήματα                               | aksesuarsız balata takımları için                  | 用于不带辅件的刹车片组          |
| για δίχαρα πέδησης/προηγούμενος τύπος                           | fren kaliperleri için/önceki                       | 用于制动钳/牵引车            |
| για συσκαυή διπλής μεμβράνης                                    | çift diyaframlı cihaz için                         | 用于双膜片装置              |
| Σετ διχαλωτής κεφαλής   | çatal başlık takımı                                | 叉头套件                 |
| Περίβλημα L=  | gövde L=   | 壳体 L=                |
| κίτρινο   | sarı   | 黄色                   |
| Θωρακισμένα οχήματα   | zırhlı araçlar                                     | 装甲车辆                 |
| Κιβώτιο ταχυτήτων   | şanzıman   | 变速箱                  |
| Αριθ. κιβωτίου ταχυτήτων  | şanzıman no.                                       | 变速箱编号                |
| Χυτοσιδηρή αντλία   | gri dökme demir pompa                              | 灰铸铁泵                 |
| Χυτοσιδηρά δίχαρα πέδησης                                       | gri dökme demir kaliperler                         | 灰铸铁制动钳               |
| Χυτοσιδηρός διδυμος κύριος κύλινδρος πέδησης/προηγούμενος τύπος | gri dökme demir tandem ana merkez silindiri/önceki | 灰铸铁串联式主液缸/牵引车        |
| Χώρες περσικού κόλπου   | Körfez Ülkeleri                                    | 海湾国家                 |
| Εντολοδότης κύλινδρος με κάθετη φλάντζα                         | Dikey flaşlı kumanda silindiri                     | 带有垂直法兰的传感器缸          |
| Εντολοδότης κύλινδρος   | KS (kumanda silindiri)                             | Gz (传感器缸)            |
| Σετ επισκευής εντολοδότη κυλίνδρου                              | KS onarım seti                                     | 传感器缸维修组件             |
| ΠΑ (πίσω άξονας)  | AA (arka aks)                                      | HA (后桥)              |
| Ελατήριο συγκράτησης  | tutma yayı   | 保持弹簧                 |
| Στήριγμα  | tutucu   | 保持器                  |
| Σετ στήριξης  | tutucu seti  | 保持器组件                |
| Βίδα στήριξης   | ankraj civatası                                    | 保持螺钉                 |
| Χειρισμός χειρόφρενου   | el freni kumandası                                 | 手刹车                  |
| Μοχλός χειρόφρενου  | el freni kolu                                      | 手刹车杆                 |
| Δισκόφρενο ΠΑ   | AA diskli fren                                     | 后桥盘式制动器              |
| Ταμπουρόφρενο ΠΑ  | AA kampanalı fren                                  | 后桥鼓式制动器              |
| Μοχλός  | kol  | 摇杆                   |
| Ψηλή οροφή  | yüksek tavan                                       | 高顶篷                  |
| Κοίλος κοχλίας  | içi oyuk vida                                      | 空心螺钉                 |
| Φρένα Hosei   | Hosei freni  | Hosei制动器             |
| Διαδρομή εμβόλου  | strok  | 行程                   |
| Σετ χιτωνίων  | kovan takımı                                       | 套筒组                  |
| Υδραυλικό πιεστικό δοχείο                                       | hidrolik akümülatör                                | 液压蓄能器                |
| Υδραυλικός ενισχυτής  | hidrolik amplifikatör                              | 液压放大器                |
| Υδραυλικός κύλινδρος  | hidrolik silindiri                                 | 液压缸                  |
| Υδραυλική μονάδα ελέγχου  | hidr. kumanda ünitesi                              | 液压控制单元               |
| Κεντρικός κύλινδρος   | AMS (ana merkez silindiri)                         | H <sub>z</sub> (主液缸) |
| Σετ επισκευής κεντρικού κυλίνδρου                               | AMS onarım seti                                    | 主液缸维修套件              |
| στην καμπίνα του οδηγού   | sürücü kabini içinde                               | 在驾驶室                 |
| στο χώρο του κινητήρα   | motor bölümü içinde                                | 在发动机舱                |

|                                       |                                    |  |
|---------------------------------------|------------------------------------|--|
| innen                                 | uvnitř                             | wewnątrz   |
| Innengewinde                          | vnitřní závit                      | gwint wewnętrzny                                   |
| Kastenwagen                           | skříňový automobil                 | furgon   |
| Katalysator                           | katalyzátor                        | katalizator  |
| Kennzeichen: xx                       | registrační značka: xx             | numery rejestracyjne: xx                           |
| Kerbe am Flansch                      | zářez na přírubě                   | nacięcie w kołnierzu                               |
| Klasse                                | třída                              | klasa  |
| Kleinbus                              | mikrobus                           | mini bus   |
| Klimaanlage                           | klimatizační zařízení              | klimatyzacja                                       |
| Kolbenstange D=                       | pístnice D=                        | łoczysko, średnica D=                              |
| Kolbenstange L=                       | pístnice L=                        | łoczysko, długość L=                               |
| Kombiwagen                            | kombi                              | kombi  |
| Kompakt THz                           | kompaktní THV                      | kompaktowa tandemowa pompa hamulcowa               |
| Krankenwagen                          | sanitní vůz                        | karetka pogotowia                                  |
| Kupplung                              | spojka                             | sprzęgło   |
| Kupplungsabgang                       | výstup spojky                      | odprowadzenie sprzęgła                             |
| Kupplungsverstärker                   | zesilovač spojky                   | układ wspomagania sprzęgła                         |
| kurzer Radstand                       | krátký rozvor kol                  | krótki rozstaw osi                                 |
| kurzes Bremsgerät                     | krátké brzdové zařízení            | krótkie urządzenie hamujące                        |
| L (Länge) =                           | L (délka)                          | L (długość) =                                      |
| langer Radstand                       | dlouhý rozvor kol                  | duży rozstaw osi                                   |
| Leckageanzeige                        | indikátor průsaku                  | wskaźnik wycieku                                   |
| lieferbar                             | k dodání                           | dostępny   |
| links oben und rechts unten           | vlevo nahoře a vpravo dole         | z lewej strony u góry oraz z prawej strony na dole |
| links vor und rechts hinter der Achse | vlevo před a vpravo za nápravou    | z lewej strony z przodu i z prawej strony za osią  |
| Linkslenker                           | volant vlevo                       | układ kierowniczy z kierownicą z lewej strony      |
| Luftfederung                          | vzduchové odpružení                | zawieszenie pneumatyczne                           |
| luftgekühlt                           | chlazené vzduchem                  | chłodzone powietrzem                               |
| M8-Führungsbolzen                     | vodící čep M8                      | M8 - bolce prowadzące                              |
| MA-Getriebe                           | MA-převodovka                      | skrzynia biegów MA                                 |
| mit 1 Haltestift                      | s 1 přídržným kolíkem              | z 1 przpieniem ustalajícím                         |
| mit 2 Haltestiften                    | se 2 přídržnými kolíky             | z 2 trzpieniami ustalającymi                       |
| mit Alufelgen                         | s hliníkovými ráfky                | z aluminiowymi obręczami kół                       |
| mit angegossenem Behälter             | s nalitou nádrží                   | z odlanym zbiorniczkiem                            |
| mit geregeltm Katalysator             | s řízeným katalyzátorem            | z katalizatorem regulowanym                        |
| mit Laschen                           | s lamelami                         | z wypustkami                                       |
| mit Leichtmetallrädern                | s koly z lehkého kovu              | z kołami z metali lekkich                          |
| MKII-Aggregat kpl.                    | MKII kompletní jednotka            | MKII - kompletny agregat                           |
| Mod. (Modell)                         | Mod. (model)                       | mod. (model)                                       |
| Motor                                 | Motor                              | silnik   |
| Motor-Nr.                             | čís. motoru                        | nr silnika   |
| Motor-Pumpen-Aggregat                 | agregát motorového čerpadla        | silnik-pompy-agregat                               |
| Multi-Link-Achse                      | náprava multi-link                 | oś multi - link                                    |
| m.Z. (mit Zubehör)                    | m.Z. (s příslušenstvím)            | z o. (z osprzętem)                                 |
| Nachstellteile-Satz                   | sada seřizovacích dílů             | komplet części regulacyjnych                       |
| ND-Schlauch                           | nížkotlaká hadice                  | przewód n.c. (niskiego ciśnienia)                  |
| Nebenabtrieb                          | vedlejší výstupní člen             | dodatkowy odbiornik napędu                         |
| Niveauregulierung                     | regulace hladiny                   | regulacja poziomu                                  |
| Nz (Nehmerzylinder)                   | VS (válec snímače)                 | SW (silownik wysprężlający)                        |
| Nz-Reparatursatz                      | sada dílů pro opravu VS            | zestaw naprawczy SW                                |
| ohne Alufelgen                        | bez hliníkových ráfků              | bez aluminiowych obręczy kół                       |
| ohne geregelten Katalysator           | bez řízeného katalyzátoru          | bez katalizatora regulowanego                      |
| ohne Laschen                          | bez lamel                          | bez wypustek                                       |
| ohne Leichtmetallräder                | bez kol z lehkého kovu             | bez kół z metali lekkich                           |
| O-Ring                                | kroužek O                          | O -ring  |
| Pedal Feststeller                     | zajištění pedálu                   | ustalacz pedálu                                    |
| Polizei                               | Policie                            | Policja  |
| Rad                                   | kolo                               | koło   |
| Radsensor                             | senzor kola                        | czujnik koła                                       |
| Radstand xxxx mm                      | rozvor kol xxxx mm                 | rozstaw osi xxxx mm                                |
| rechts oben und links unten           | vpravo nahoře a vlevo dole         | z prawej strony u góry i z lewej na dole           |
| Rechtslenker                          | volant vpravo                      | układ kierowniczy z kierownicą z prawej strony     |
| Regler                                | regulátor                          | regulator  |
| Reihenmotor                           | řadový motor                       | silnik jednorzędowy                                |
| Reisebus/Hochdecker                   | autokar/autobus s vysokou střechou | autobus wycieczkowy / wysokopokładowy              |
| Reparatursatz                         | sada dílů pro opravu               | zestaw naprawczy                                   |
| Ringstutzen-Satz                      | sada kruhových hrdel               | komplet króćców pierścieniowych                    |
| Rohrleitung                           | potrubí                            | rurociąg   |
| rot                                   | červený                            | czerwony   |
| roter Sattel                          | červený třmen                      | czerwony zacisk                                    |
| Rückschlagventil                      | zpětný ventil                      | zawór jednokierunkowy                              |
| Rückstellwellen-Satz                  | sada vratných hřídelů              | walki zwrotne                                      |
| Rz (Radzylinder)                      | KV (kolový váleček)                | CHK (cylinděrki hamulcowe koła)                    |
| Rz-Dichtungssatz                      | sada těsnění KV                    | zestaw uszczelniający CHK                          |
| Rz-Reparatursatz                      | sada dílů pro opravu KV            | zestaw naprawczy CHK                               |
| Salisbury-Achse                       | náprava Salisbury                  | oś Salisbury                                       |
| Sattel mit 1 Haltestift               | třmen s 1 přídržným kolíkem        | zacisk z 1 kolíkiem ustalajícím                    |





|   |  |             |
|---|--|-------------|
| εσωτερικά                                     | iç   | 内部          |
| εσωτερικό σπείρωμα                            | iç vida dışı                               | 内螺纹         |
| Κλούβα  | kapalı kasa araç                           | 厢式汽车        |
| Καταλυτικός μετατροπέας                       | katalitik konvertör                        | 催化器         |
| Πινάκιδα αριθμού κυκλοφορίας: xx              | plaka no: xx                               | 车牌: xx      |
| Εγκοπές στη φλάντζα                           | flanştaki çentik                           | 法兰上的刻痕      |
| Κατηγορία                                     | sınıf                                      | 等级          |
| Μικρό λεωφορείο                               | minibüs                                    | 小巴          |
| Κλιματιστικό                                  | klima sistemi                              | 空调装置        |
| Στέλεχος εμβόλου D=                           | piston kolu Ç=                             | 活塞杆D=       |
| Στέλεχος εμβόλου L=                           | piston kolu U=                             | 活塞杆L=       |
| Στέισον βάγκον                                | station wagon                              | 客货两用车       |
| Κομπάκτ διδυμος κύριος κύλινδρος πέδησης      | kompakt tandem ana merkez silindiri        | 紧凑型串联式主液缸   |
| Ασθενοφόρο αυτοκίνητο                         | ambulans                                   | 救护车         |
| Συμπλέκτης                                    | debriyaj                                   | 离合器         |
| Έξοδος συμπλέκτη                              | debriyaj çıkışı                            | 离合器输出端      |
| Ενισχυτής συμπλέκτη                           | debriyaj güçlendirici                      | 离合放大器       |
| μικρό μεταξόνιο                               | kısa aks aralığı                           | 短轴距         |
| κοντή μονάδα πέδησης                          | kısa fren cihazı                           | 短制动器        |
| L (μήκος) =                                   | U (Uzunluk) =                              | L(长)=       |
| μεγάλο μεταξόνιο                              | uzun aks aralığı                           | 长轴距         |
| Ένδειξη διαρροής                              | sızıntı göstergesi                         | 泄漏显示        |
| διαθέσιμο                                     | stokta var                                 | 可供货         |
| αριστερά επάνω και δεξιά κάτω                 | sol üst ve sağ alt                         | 左上和右下       |
| αριστερά μπροστά και δεξιά πίσω από τον άξονα | solda önde ve sağda aksın arkasında        | 轴的左前和右后     |
| Αριστεροτίμονα οχήματα                        | soldan direksiyonlu                        | 左侧驾驶的汽车     |
| Σύστημα ανάρτησης πεπιεσμένου αέρα            | havalı süspansiyon                         | 空气弹簧        |
| Αερόψυκτο                                     | hava soğutmalı                             | 风冷          |
| Πείρος οδηγός M8                              | M8 kılavuz pim                             | M8导向螺纹销     |
| Κιβώτιο ταχυτήτων MA                          | MA şanzıman                                | MA变速箱       |
| με 1 πείρο στήριξης                           | 1 tutucu pim ile                           | 带有1个固定销     |
| με 2 πείρους στήριξης                         | 2 tutucu pim ile                           | 带有2个固定销     |
| με ζάντες αλουμινίου                          | alüminyum jantlı                           | 带有铝制轮辋      |
| με χυτό δοχείο                                | dökme hazneli                              | 带有铸造容器      |
| με ρυθμιζόμενο καταλυτικό μετατροπέα          | kontrollü katalitik konvertörlü            | 带有可调节的催化器   |
| με ελάσματα                                   | bağlantı kulakları ile                     | 带有连接板       |
| με ζάντες κράματος ελαφρού μετάλλου           | hafif metal                                | 带有轻金属车轮     |
| MKII συγκρότημα πλήρες                        | MKII ünitesi komple                        | 整套MKII装置    |
| Μοντ. (μοντέλο)                               | mod. (model)                               | Mod. (车型)   |
| Κινητήρας                                     | motor                                      | 发动机         |
| Αριθμός κινητήρα                              | motor no.                                  | 发动机号码       |
| Συγκρότημα κινητήρα-αντλίας                   | motor-pompa ünitesi                        | 发动机泵组       |
| Άξονας Multi-Link                             | multi-link aks                             | 多连接轴        |
| με εξαρτ. (με εξαρτήματα)                     | aksesuarları ile                           | 带有Z. (带有辅件) |
| Σετ τεμαχίων ρύθμισης                         | ayarlama parçaları takımı                  | 调整套件        |
| ND εύκαμπτου σωλήνα                           | ND hortum                                  | 低压软管        |
| Βοηθητικός μηχανισμός κίνησης                 | yavru şanzıman                             | 辅助驱动        |
| Σύστημα οριζοντιώσεως                         | seviye ayarlama sistemi                    | 水平位调节       |
| Εντολοδόχος κύλινδρος                         | AS (alıcı silindir)                        | Nz (输出缸)    |
| Σετ επισκευής εντολοδόχου κυλίνδρου           | AS onarım seti                             | 输出缸维修组件     |
| χωρίς ζάντες αλουμινίου                       | alüminyum jantsız                          | 不带铝制轮辋      |
| χωρίς ρυθμιζόμενο καταλυτικό μετατροπέα       | kontrollü katalitik konvertörsüz           | 不带可调节的催化器   |
| χωρίς λωρίδες                                 | kulaksız                                   | 不带连接板       |
| χωρίς ζάντες κράματος ελαφρού μετάλλου        | hafif metal jantsız                        | 不带轻金属车轮     |
| Δακτύλιος O                                   | O-ring                                     | O型圈         |
| Διάταξη ακινητοποίησης πεντάλ                 | pedal sabitleyici                          | 踏板限位器       |
| Αστυνομία                                     | Polis                                      | 警察          |
| Τροχός  | tekerlek                                   | 车轮          |
| Αισθητήρας τροχού                             | tekerlek sensörü                           | 车轮传感器       |
| Μεταξόνιο xxxx mm                             | aks aralığı xxxx mm                        | 轮距 xxxx mm  |
| δεξιά επάνω και αριστερά κάτω                 | sağ üst ve sol alt                         | 右上和左下       |
| Δεξιότιμονα οχήματα                           | sağdan direksiyonlu                        | 右侧驾驶的汽车     |
| Ρυθμιστής                                     | regülatör                                  | 调节器         |
| Κινητήρας σειράς                              | sıra motor                                 | 直列式发动机      |
| Υπεραστικό λεωφορείο/Υπερωρυμένο              | şehirlerarası otobüs/yüksek tavanlı otobüs | 长途客车/高顶盖车   |
| Σετ επισκευής                                 | onarım seti                                | 维修套件        |
| Σετ στρογγυλού στομίου                        | yüzüklü rakor takımı                       | 环形管接头组件     |
| Σωλήνωση                                      | boru hattı                                 | 管道          |
| κόκκινο                                       | kırmızı                                    | 红色          |
| Κόκκινο δίχало πέδησης                        | kırmızı kaliper                            | 红色制动钳       |
| Βαλβίδα αντεπιστροφής                         | çekvalf                                    | 单向阀         |
| Σετ άξονα επαναφοράς                          | sıfırlama mili takımı                      | 复位轴组件       |
| Κύλινδρος τροχού                              | TFM (tekerlek fren merkezi)                | Rz (车轮制动缸)  |
| Σετ στεγανοποίησης κυλίνδρου τροχού           | TFM conta takımı                           | 车轮制动缸密封套件   |
| Σετ επισκευής κυλίνδρου τροχού                | TFM onarım seti                            | 车轮制动缸维修套件   |
| Άξονας Salisbury                              | Salisbury aks                              | 索尔兹伯里轴      |
| Δίχало πέδησης με 1 πείρο στήριξης            | 1 tutucu pimli kaliper                     | 制动钳带有1个固定销  |

|                                |  |  |
|--------------------------------|--|--|
| Sattel mit 2 Haltestiften      | třmen se 2 přídržnými kolíky                     | zaciśki z 2 kołkami ustalajúcymi             |
| Sättel mit Gussnoppen          | třmen s litými nopkami                           | zaciśki z odlewanými vypustkami              |
| Sattelschraube                 | šroub třmenu                                     | šruba zacisku                                |
| Scheibenbremse                 | kotoučová brzda                                  | hamulec tarczowy                             |
| Scheibenkupplung               | kotoučová spojka                                 | sprzęgło tarczowe                            |
| Scheibenschraube               | kotoučový šroub                                  | šruba tarczy                                 |
| Schlauchleitung                | hadicové vedení                                  | przewód giętki                               |
| Schraubstutzen                 | šroubovací hrdlo                                 | króciec śrubowy                              |
| schwarz                        | černý  | czarny                                       |
| Schwimmsättel                  | plovoucí třmeny                                  | zaciśki pływające                            |
| Schwingblech WE                | kov výstražného zařízení                         | urządzenie ostrzegawcze z blachy wahlivej    |
| SCS                            | SCS  | SCS (system kontroli stopu)                  |
| separater Behälter             | samostatná nádrž                                 | oddzielny zbiornik                           |
| separates Druckstück/Vorgänger | samostatný tlačný element/předchůdce             | oddzielny element dociskowy / poprzednik     |
| Servolenkung                   | servořízení                                      | wspomagany układ kierowniczy                 |
| Skandinavien                   | Skandinávie                                      | Skandynawia                                  |
| Sitzplätze                     | místa k sezení                                   | miejsca siedzące                             |
| Sonderfahrzeuge                | speciální vozidla                                | pojazdy specjalne                            |
| Spezialaufbau                  | speciální karosérie                              | specjalne nadwozie                           |
| Sportfahrwerk                  | sportovní podvozek                               | podwozie sportowe                            |
| Spur                           | stopa  | rozstaw kół                                  |
| Standard-Bremsgerät            | standardní posilovač brzd                        | standardowe urządzenie hamulcowe             |
| Standard-THz                   | standardní tandemový hlavní válec                | standardowa pompa hamulcowa typu tandem      |
| staubfeste Ausführung          | provedení odolné proti prachu                    | wykonanie odporne na kurz                    |
| Stufenheck                     | stupňovitá záď                                   | tył kaskadowy                                |
| T50-Reparaturatz               | T50 sada dílů pro opravu                         | zestaw naprawczy T50                         |
| Tandemregler                   | tandemový regulátor                              | regulator tandemowy                          |
| THz mit 3 Anschlüssen          | THV se 3 přípoji                                 | pompa hamulcowa tandemowa z 3 przyłączami    |
| THz mit Anschlagsschraube      | THV s dorazovým šroubem                          | PHT z wkrętem zderzakowym                    |
| THz (Tandemhauptzylinder)      | THV (tandemový hlavní válec)                     | PHT (pompa hamulcowa typu tandem)            |
| THz-Reparaturatz               | sada dílů pro opravu THV                         | PHT - zestaw naprawczy                       |
| THz-RS (Montagehülse)          | sada dílů pro opravu THV (montážní pouzdro)      | PHT - zestaw naprawczy (tuleja montażowa)    |
| Timken-Achse                   | náprava Timken                                   | oś Timkena                                   |
| Topfmanschette                 | hrcová manžeta                                   | pierścień samouszczelniający garnkowy        |
| Tragbolzensatz                 | sada nosných čepů                                | komplet trzpieni nośnych                     |
| Transporter                    | dodávkové vozidlo                                | furgonetka                                   |
| Triebkopf                      | pohonná jednotka                                 | głowica napędowa                             |
| Trommelbremse                  | bubnová brzda                                    | hamulec bębnowy                              |
| TBB (Trommelbremsbacken)       | ČBB (čelisti bubnové brzdy)                      | SHB (szczęki hamulca bębnowego)              |
| Umbau 1-teilig auf 2-teilig    | přestavba z 1dílného na 2dílné                   | przebudowa z 1 - częściowej na 2 - częściową |
| Unterdruckverstärker           | podtlakový posilovač                             | wspomaganie podciśnieniowe                   |
| ursprüngl. verschraubte Beläge | původně našroubovaná obložení                    | pierwotnie przykręcone okładziny             |
| VA (Vorderachse)               | PN (přední náprava)                              | OP (oś przednia)                             |
| VA-Girling-Bremse              | brzda Girling PN                                 | hamulec Girlinga osi przedniej               |
| VA-Scheibenbremse              | kotoučová brzda PN                               | hamulec tarczowy osi przedniej               |
| VA-Trommelbremse               | bubnová brzda PN                                 | hamulec bębnowy osi przedniej                |
| Ventilblock                    | ventilový blok                                   | blok zaworów                                 |
| Ventilblock kpl.               | ventilový blok kompl.                            | blok zaworów kompletny                       |
| Verbindungsschrauben           | spojovací šrouby                                 | śruby połączeniowe                           |
| Verschlußschraube              | závěrný šroub                                    | śruby zamykające                             |
| Verschraubung                  | šroubení   | połączenie śrubowe                           |
| Verschraubung kpl.             | šroubení kompl.                                  | połączenie śrubowe kompletne                 |
| verstärkte Bremse              | zesílená brzda                                   | wzmocniony hamulec                           |
| verstärkte Stoßdämpfer         | zesílený tlumič nárazů                           | wzmocnione amortyzatory                      |
| verstärktes Fahrwerk           | zesílený podvozek                                | wzmocniony układ jezdny                      |
| Verteilerstück wiederverwenden | opět použít díl rozdělovače                      | ponowne użycie rozdzielacza                  |
| V-Motor                        | V motor  | silnik w układzie V                          |
| Vorder- und Hinterachse        | přední a zadní náprava                           | oś przednia i tylna                          |
| Vorderachse                    | přední náprava                                   | oś przednia                                  |
| Vorderachse und 2. Hinterachse | přední náprava a 2. zadní náprava                | oś przednia i druga oś tylna                 |
| Vordruckventil                 | ventil zabraňující vniku vzduchu do brzd. okruhu | zawór ciśnienia wstępnego                    |
| Vorgänger                      | předchůdce                                       | poprzednik                                   |
| Vorgänger / Abschirmkappe      | předchůdce / stínicí čepička                     | poprzednik / pokrywa ekranująca              |
| Vorgänger-THz, Einlaß D=xx     | předchůdce THV, sání D=xx                        | poprzednik - PHT, wlot D=xx                  |
| Vorspannzylinder               | předpinací válec                                 | cylinder naprężenia pierwotnego              |
| WK (Warnkontakt)               | VK (výstražný kontakt)                           | SO (styk ostrzegawczy)                       |
| Warnkontakt 1-polig            | výstražný kontakt 1pólový                        | styk ostrzegawczy 1 - biegunowy              |
| Warnkontakt 2-polig            | výstražný kontakt 2pólový                        | styk ostrzegawczy 2 - biegunowy              |
| Warnschalter                   | výstražný spínač                                 | włącznik ostrzegawczy                        |
| WE (Warneinrichtung)           | VZ (výstražné zařízení)                          | UO (urządzenie ostrzegawcze)                 |
| WE-Befestigung                 | připevnění VZ                                    | mocowanie UO                                 |
| Wegsensor                      | dráhový senzor                                   | sensor drogi                                 |
| weiß                           | bílý   | biały  |
| Zylinderschraube               | válcový šroub                                    | śruba cylindra                               |



|   |   |                    |
|---|---|--------------------|
| Δίχαλο πέδησης με 2 πείρους στήριξης                                    | 2 tutucu pimli kaliper                                  | 制动钳带有2个固定销         |
| Δίχαλα πέδησης με μεγάλα κομβία   | dökme pimli kaliperler                                  | 制动钳带有铸造轴头          |
| Βίδα δίχαλου πέδησης  | kaliper civatası  | 制动钳螺钉              |
| Δισκόφρενο  | diskli fren   | 盘式制动器              |
| Συμπλέκτης δίσκων   | diskli debriyaj   | 盘式离合器              |
| Βίδα δίσκου   | disk civatası   | 盘式螺钉               |
| Εύκαμπος σωλήνας  | hortum hattı  | 软管                 |
| Βιδωτά στόμια   | vidalı rakor  | 丝堵                 |
| μαύρο   | siyah   | 黑色                 |
| Πλωτά δίχαλα πέδησης  | hareketli kaliperler                                    | 浮式制动钳              |
| Έλασμα ταλάντωσης ΔΠ  | İS titreşim sacı  | 平衡板 WE             |
| SCS (σύστημα ελέγχου στοπ)  | SCS   | SCS停车控制系统          |
| Ξεχωριστό δοχείο  | ayrı hazne  | 单独的容器              |
| Ξεχωριστό τεμάχιο πίεσης/προηγούμενος τύπος                             | ayrı baskı parçası/önceki                               | 单独的压力件/牵引车         |
| Σερβομηχανισμός διεύθυνσης  | havali direksiyon                                       | 转向助力机构             |
| Σκανδιναβία   | İskandinavya  | 斯堪地维亚              |
| Καθίσματα   | koltuk sayısı   | 座位                 |
| Ειδικά οχήματα  | özel araçlar  | 专用车辆               |
| Ειδική κατασκευή  | özel üst yapı   | 特殊结构               |
| Σπορ ανάρτηση   | spor yürüyen aksam                                      | 运动型底盘              |
| Ίχνος   | iz  | 轮距                 |
| Στάνταρ μονάδα πέδησης  | standart fren   | 标准制动器              |
| Στάνταρ δίδυμος κύριος κύλινδρος πέδησης                                | standard tandem ana merkez silindiri                    | 标准串联式主液缸           |
| Έκδοση ανθεκτική στη σκόνη  | toz geçirmez model                                      | 除尘型                |
| Σεντάν  | limuzin   | 阶背车尾               |
| Σετ επισκευής T50   | T50 onarım seti   | T50维修套件            |
| Δίδυμος ρυθμιστής   | tandem regülatörü                                       | 串联式主液缸调节器          |
| Δίδυμος κύριος κύλινδρος πέδησης με 3 συνδέσεις                         | 3 bağlantılı tandem ana merkez silindiri                | 带有3个接口的串联式主液缸      |
| Δίδυμος κύριος κύλινδρος πέδησης με κοχλία αναστολής                    | dayanak civatalı tandem ana merkez silindiri            | 带有限位螺钉的串联式主液缸      |
| Δίδυμος κύριος κύλινδρος πέδησης  | tandem ana merkez silindiri                             | 串联式主液缸             |
| Σετ επισκευής δίδυμου κύριου κυλίνδρου πέδησης                          | tandem ana merkez silindiri onarım seti                 | 串联式主液缸维修套件         |
| Σετ επισκευής δίδυμου κύριου κυλίνδρου πέδησης (χιτώνιο συναρμολόγησης) | tandem ana merkez silindiri onarım seti (montaj kovani) | 串联式主液缸维修套件 (安装轴套)  |
| Άξονας Timken   | Timken aks  | 泰姆肯轴               |
| Δισκοειδής μανσέτα  | çanak conta   | 固定鼓涨圈              |
| Σετ πείρων στήριξης   | tutucu pim takımı                                       | 支承螺栓组件             |
| Μεταφορικό όχημα  | transporter   | 运输车                |
| Κεφαλή κίνησης  | tahrik kafası   | 牵引车                |
| Ταμπουράφρενο   | kampanalı fren  | 鼓式制动器              |
| ΣΤΠ (σιαγόνες τυμπάνου πέδησης)   | KFP (kampanalı fren pabuçları)                          | TBB (鼓式制动爪)        |
| Μετατροπή 1 τεμαχίου σε 2 τεμάχια                                       | 1 parçalıdan 2 parçalıya tadilat                        | 从一体改装为两体           |
| Ενισχυτής υποπίεσης   | vakumlu güçlendirici                                    | 负压放大器              |
| Αρχ. βιδωνόμενα τακάκια φρένων  | orijinal vidalanan balatalar                            | 原有螺丝连接的刹车片         |
| ΜΑ (μπροστινός άξονας)  | ÖA (Ön Aks)   | 前桥                 |
| Φρένο ΜΑ Girling  | ÖA girling fren   | 前桥Girling制动器       |
| Δισκόφρενο ΜΑ   | ÖA diskli fren  | 前桥盘式制动器            |
| Ταμπουράφρενο ΜΑ  | ÖA kampanalı fren                                       | 前桥鼓式制动器            |
| Συγκρότημα βαλβίδων   | valf bloğu  | 阀块                 |
| Συγκρότημα βαλβίδων πλήρες  | komple valf bloğu                                       | 阀块整体               |
| Κοχλίες σύνδεσης  | bağlantı civataları                                     | 连接螺丝               |
| Κοχλίας φραγής  | kör tapa  | 封闭螺帽               |
| Κοχλιοσύνδεση   | vidalı bağlantı   | 螺纹连接               |
| Κοχλιοσύνδεση πλήρες  | vidalı bağlantı komple                                  | 螺纹连接整体             |
| Ενισχυμένα φρένα  | güçlendirilmiş fren                                     | 增强的制动器             |
| Ενισχυμένα αμορτισέρ  | güçlendirilmiş amortisör                                | 增强的减震器             |
| Ενισχυμένο σύστημα ανάρτησης  | güçlendirilmiş yürüyen aksam                            | 增强的底盘              |
| Επαναχρησιμοποιήστε το εξάρτημα διανομέα                                | dağıtıcı parçayı tekrar kullanın                        | 重新利用分配件            |
| Κινητήρας V   | V motor   | V型发动机              |
| Μπροστινός και πίσω άξονας  | ön ve arka aks  | 前桥和后桥              |
| Μπροστινός άξονας   | ön aks  | 前桥                 |
| Μπροστινός άξονας και 2ος πίσω άξονας                                   | ön aks ve 2. arka aks                                   | 前桥和第2后桥            |
| Βαλβίδα προπίεσης   | ön basınç valfi   | 预压力阀               |
| Προηγούμενος τύπος  | önceki  | 牵引车                |
| Προηγούμενος τύπος / πώμα θωράκισης                                     | önceki / deflektör                                      | 牵引车 / 屏蔽盖          |
| Προηγούμενος τύπος δίδυμου κύριου κυλίνδρου πέδησης, εισαγωγή D=xx      | önceki tandem ana merkez silindiri, giriş Ç=xx          | 牵引车串联式主液缸, 进口 D=xx |
| Κύλινδρος προέντασης  | ön yüklemeli silindir                                   | 预夹紧缸               |
| ΕΠ (επαφή προειδοποίησης)   | İK (İkaz Kontaklı)                                      | WK (警示触点)          |
| Επαφή προειδοποίησης 1-πολική   | 1 kutuplu ikaz kontaklı                                 | 1极警示触点             |
| Επαφή προειδοποίησης 2-πολική   | 2 kutuplu ikaz kontaklı                                 | 2极警示触点             |
| Διακόπτης προειδοποίησης  | ikaz şalteri  | 警示开关               |
| ΔΠ (διάταξη προειδοποίησης)   | İS (İkaz Sistemi)                                       | WE (警示装置)          |
| Στερέωση ΔΠ   | İS tespitleme   | 警示装置的固定            |
| Αισθητήρας διαδρομής  | hareket sensörü   | 行程传感器              |
| λευκό   | beyaz   | 白色                 |
| Βίδα κυλινδρικής κεφαλής  | silindirik civata                                       | 圆柱头螺钉              |

|  |  |                         |
|--|--|-------------------------|
| 1-Kammer-Druckluftbremse               | جيجضليل عنام جاص حول   | 防音プレート(シングルチャンバ・エアブレーキ) |
| 1-Kolbensattel D=xx                    | D=xx دحو سابلب ةيئف ةيلا                                       | 1ピストンキャリパ D=xx          |
| 2-Kolbensattel D=xx                    | D=xx تاسابلبا ةجوزم ةيئف ةيلا                                  | 2ピストンキャリパ D=xx          |
| 4-Kolbensattel                         | تاسابلبا ةيئف ةيلا   | 4ピストンキャリパ               |
| 1-Kreis-Bremse                         | دحو ةيبرك ةريئاب ؤلمرف   | 1サイクルブレーキ               |
| 2-Kreis-Bremse                         | نيتيبرك نيتريئاب ؤلمرف   | 2サイクルブレーキ               |
| 1-Kreis-Sättel                         | ةيبرك ةريئاب ةيئف ةيلا   | 1サイクルキャリパ               |
| 2-Kreis-Sättel                         | نيتيبرك نيتريئاب ةيئف ةيلا                                     | 2サイクルキャリパ               |
| 1. Hinterachse                         | لوالا يفلخا روجلما   | 1番目のリアシャフト              |
| 1. und 2. Hinterachse                  | يناشل لوالا يفلخا روجلما                                       | 1番目と2番目のリアシャフト          |
| 4-Loch-Bremsscheibe                    | بوقئلا يلمرف صرق   | 4穴ブレーキディスク              |
| 6-Loch-Bremsscheibe                    | بوقئلا يسلس يلمرف صرق  | 6穴ブレーキディスク              |
| 3-Loch-Felge                           | تاحتف تالشب طن ج   | 3穴ホイール                  |
| 4-Loch-Felge                           | تاحتف عبراب طن ج   | 4穴ホイール                  |
| 5-Loch-Felge                           | تاحتف سمخب طن ج  | 5穴ホイール                  |
| 6kt-Schraube                           | معلقلا ةيسلس سارب رامسم  | 6角ネジ                    |
| 6kt-Schraube (innen)                   | (لخادل) نم ععلقلا ةيسلس سارب رامسم                             | 6角ネジ(内側)                |
| 6"-Tandem                              | صروب 6 ساقم ةيفدارت ؤواطس                                      | 6面タンデム                  |
| 8"-Tandem mit Gabelkopf                | يفرط نرقمب ؤوزم صروب 8 ساقم ةيفدارت ؤواطس                      | ヨーク付8面タンデム              |
| 8"-Tandem ohne Gabelkopf               | يفرط نرقمب ؤوزم ريغ صروب 8 ساقم ةيفدارت ؤواطس                  | ヨークなし8面タンデム             |
| ABS                                    | ABS ؤال غلال عنالما لمرفلا ماظن                                | ABS(アンチロックブレーキシステム)     |
| ABS-Dichtungssatz                      | ABS ؤال غلال عنالما لمرفلا ماظنل ماكحل مالق                    | ABSガスケットキット             |
| Achtung: Kolbenstellung ändern !       | سابلبا ةيئف ةيلا ليدعتب مق :هيبنت                              | 注意:ピストンポジション変更 !        |
| Adapter für Bördel E                   | E ؤوزلا نم ؤرخل ئيام   | ビードタイプE用アダプター           |
| alle Typen                             | عؤلما عيجم   | 全タイプ                    |
| Alu-Pumpe                              | مويجولال نم ةخضم   | アルミポンプ                  |
| Alu-Sättel                             | مويجولال نم ةيئف ةيلا  | アルミキャリパ                 |
| am Bremsattel                          | لمرفلل ةيئف ةيلا ؤلع   | ブレーキキャリパ上に              |
| am Hauptzylinder                       | ةيس يئولا ؤواطسالا ؤلع   | マスターシリンダー上に             |
| A-Motor                                | A ةئيي ؤلع لفرم  | Aエンジン                   |
| Anschlagschraube oben                  | ؤلع ؤنز رامسم  | ストップネジ、上側               |
| Anschluß/Anschlüsse                    | تالصرؤ/تالصرؤ  | 接続/コネクション               |
| Anti-Noise-Blech                       | جيجضليل عنام جاص حول   | 防音プレート                  |
| ASC (Automatische Stabilitäts Control) | (نازتال) يف ليكييتاموتوالا مكحتل ماظن ASC                      | ASC(アクエプスタビリティコントロール)   |
| ASR (Antriebschlupfregelsystem)        | (رچلا ؤردق يف مكحتل ماظن) ASR, ماظن                            | ASR(トラクションコントロールシステム)   |
| ATE nur über VAG erhältlich            | VAG ؤرؤر لاغ نم ATE يلهيتاموتوالا مرخدا ؤريجت ؤلع لوصخا نامي ل | ATEはVAGを通じてのみ入手可能       |
| auf Typenschild                        | (عنصرلا) فيرعتلا ؤحول ؤلع                                      | 車種認識プレート上               |
| aufgeschraubt                          | لؤكفم  | ネジ止め                    |
| Auslaß seitlich links                  | عرس يلا ؤهچلا ؤلع يبناج جورخ نفنم                              | 左側面の出口                  |
| Auslaß seitlich rechts                 | نم يلا ؤهچلا ؤلع يبناج جورخ نفنم                               | 右側面の出口                  |
| außen                                  | چراخا نم   | 外側                      |
| automatische Nachstellung              | يتاموتوالا ؤشيب ؤئيهو طبض دواع                                 | 自動調節(アジャストメント)          |
| Behälter                               | نازخ ءءاؤ ءءواؤ  | 容器(タンク)                 |
| Behälter Doppel-WE                     | ريذيت يتزيهچشب ؤوزم نازخ                                       | ダブルウォーニングデバイス付容器(タンク)   |
| Behälterbefestigung                    | نازخا تيبيئت   | 容器(タンク)固定               |
| Behälterstopfen                        | نازخا ؤلس  | 容器(タンク)プラグ              |
| Behälterverschraubung                  | ريمسب نازخا تيبيئت   | 容器(タンク)ネジ式キャップ          |
| Behörde                                | قلسب ؤلؤم ؤهچ ءئيي   | 省庁、オーソリティーカー            |
| Beläge                                 | لمرفلا لي  | ブレーキパッド                 |
| belüftete Scheiben                     | لوم صارق   | 換気付ディスク                 |
| Betätigungseinheit                     | ليئيت ؤحو  | アクチュエーターユニット            |
| blau                                   | قرزا   | 青色                      |
| Bodenventil                            | عؤلما مامص   | 残留圧センターバルブ              |
| Bodenventile tauschen                  | عؤلما تامامص ليديت   | 残留圧センターバルブ交換            |
| Bördel x                               | x ؤرد ؤرؤر   | フレアタイプx                 |
| braun                                  | رچس - يوب  | 茶色                      |
| breite Ausführung                      | ضيرع ميمصت   | ワイドデザイン(ワイドバージョン)       |
| Bremse                                 | لمرف   | ブレーキ                    |
| Bremsgerät                             | لمرفلا زيذعت ؤحو   | ブースターユニット               |
| Bremskraftregler                       | ةيلمرفلا ؤولما مظم   | ブレーキ圧調節器                |
| Bremsleitungen erneuern !              | ةيلمرفلا تالصرؤلا ديذجت  | ブレーキ管刷新 !               |
| Bremslichtschalter                     | لمرفلا عوض خلتفم   | ブレーキランプスイッチ             |
| Bremsscheiben                          | لمرفلا صارق  | ブレーキディスク                |
| Bremsschlauch beachten !               | لمرفلا موطرخل هبتنا  | ブレーキチューブに注意 !           |
| Buchse + Ausgleichbügel                | قداؤم ؤوسنلق + قبل ج   | ジャック+バランスクリップ           |
| Bus                                    | قلفاؤ  | バス                      |
| Bypassregler                           | رورملا نفنم مظم  | バイパス調節器                 |
| Citroen-Bremse                         | نيورتس ؤلمرف   | シトロエンブレーキ               |
| D (Durchmesser) =                      | D (رطق) =  | D(直径) =                 |
| Dichtring                              | مكحال ؤقح  | 密閉リング                   |
| Dichtung                               | مكحال ةيشح ؤاؤج  | 密閉(シーリング)               |
| Dichtungssatz                          | مكحال مالق   | ガスケットキット                |
| Differentialsperre                     | يلضافت لعق   | デフエレンシャルロック             |
| Differenzdruckschalter                 | يلضافتل طمخؤلما خلتفم  | デフエレンシャル圧スイッチ           |
| Differenzdruckventil                   | يلضافتل طمخؤلما مامص   | デフエレンシャル圧バルブ            |
| diverse Typen                          | ةمؤنتم تازارط  | 様々な種類(タイプ)              |
| Doppelbereifung                        | ةجوزم تاراطا   | ツインタイヤ                  |





|                             |   |                              |
|-----------------------------|---|------------------------------|
| Doppelkabine                | تجوديم قروصقم، قن ييباك                                   | ダブルキャブ                       |
| Druckbegrenzungsventil      | طغضللا مي جحت مامص  | 圧力制限バルブ                      |
| Druckbolzen                 | تيطاغضنلا (روباخ) قرامغ                                   | タペット                         |
| Druckbolzen (kurz)          | (قريصق) تيطاغضنلا (روباخ) قرامغ                           | タペット(ショート)                   |
| Druckbolzen (lang)          | (قريوط) تيطاغضنلا (روباخ) قرامغ                           | タペット(ロング)                    |
| Druckluftbremse             | طوغضنلا ءاوطاب لمعت ظمرف                                  | エアブレーキ                       |
| Druckluftleitung            | طوغضنلا ءاوطاب لاصرو                                      | 圧縮エア管                        |
| Druckluftunterstützung      | طوغضنلا ءاوطاب ظم اغلا ظمرفلا مي عت                       | エアブレーキアシスト                   |
| Druckluftverstärker         | طوغضنلا ءاوطاب ظم اغلا ظمرفلا زرم                         | エアブレーキブースター                  |
| Druck-Warnschalter          | طغضنلا اب صاخ ريذحت حاتغم                                 | 圧力警告スイッチ                     |
| DS-Regler                   | DS، مظنم  | DSバルブ                        |
| EDS                         | يظلم افغلا لغولا يف ينورتكللا لكحتلا مظن EDS، مظن         | EDS(電子式ディフェレンシャルロック)         |
| EDS-Ventilblock             | EDS، مظن تامامص ءموم جم                                   | EDS/バルブブロック                  |
| EG-Vorschrift               | تيفروروالا ءموم جملا تاميل عت ءحئال                       | EGヨーロッパ共同体規則                 |
| Einbau hinter der Achse     | روحنلا فلخ بيفلرتنلا                                      | シャフト後部への設置                   |
| Einbau vor der Achse        | روحنلا امامأ بيفلرتنلا                                    | シャフト前部への設置                   |
| Einbausatz                  | بيفلرتنلا مقاط  | インストールキット                    |
| Einfachbereifung            | درفم راطا   | 一重タイヤ                        |
| Einknopfmaß xx mm           | مم xx (ظمرفلا) ظمرفلا ءمطق (سايقم) دعب                    | ボタンイン寸法xxmm                  |
| Einlaß D=xx mm              | مم D=xx لوخ ذفنم  | 吸入直径 =xxmm                   |
| Einlaß mit Gummistopfen     | تيطلمم كئاسب بوزم لوخ ذفنم                                | ゴムプラグ付吸気部                    |
| Einschraubregler            | ظمرفلا فوق مظنم   | ネジ式調節バルブ                     |
| elektr. Vergaser            | يفيرك نبركفم  | 電子式キャリブレター                   |
| Entlüfteranschluß           | (سيفنت) تيووت ظمرف  | 排気コネクター                      |
| Entlüfterventil             | (سيفنت) تيووت مامص  | 排気バルブ                        |
| erhöhte Zuladung            | دئاز ليمحت بن حش  | 高くなったペイロード(負荷)               |
| Ersatz für Sättel D=xx      | D=xx تيفغلا تايلا لايديت                                  | キャリバーD=xxの代用パーツ              |
| ETS                         | راسنلا يف ينورتكللا لكحتلا مظن                            | ETS(電子式トラクションコントロールシステム)     |
| Europa                      | ايوروا  | ヨーロッパ                        |
| Export                      | ريصت  | 輸出                           |
| Fahrschule                  | ءايقلا ميل عت صررم  | 自動車学校                        |
| Faltenbalsatz               | بيرسنللا عنام خيفانم مقاط                                 | シールセット                       |
| Faustsättel                 | تضباق تيفف تايلا  | げんこつ型キャピラ                    |
| Fenster                     | قنفا  | 窓                            |
| Festsättel                  | تعبث تيفف تايلا   | 固定式キャピラ                      |
| Flanschdicke x mm           | مم x عوتنلا فرط كيمس                                      | フランジ厚xmm                     |
| Flanschmaß = xx,x           | xx,x = عوتنلا فرط داعبا                                   | フランジ寸法=xxx                   |
| Fuller-Getriebe             | رللوف سورق قونص   | フラー式ギアボックス                   |
| für Belagsätze ohne Zubehör | تيفل يلمقت تاقلم زونب لمرفلا ليتب صاخ                     | 付属品のないブレーキパッド用               |
| für Bremsättel/Vorgänger    | قباسنلا امرفلل تيفغلا تايلا اب صاخ                        | ブレーキキャピラー/従前モデル用             |
| für Doppelmembran-Gerät     | تيفرلا تيفش غلا ءئيفي ئانث زيغلا كدحوب صاخ                | 2重皮膜ブースター用                   |
| Gabelkopfsatz               | تيفرظ نراقم ءموم جم                                       | ヨークキット                       |
| Gehäuse L=                  | L= قبل ع تيفيم  | ハウジングL=                      |
| gelb                        | رفصا  | 黄色                           |
| gepanzerte Fahrzeuge        | ءمدم تابلرم   | 防弾武装車両                       |
| Getriebe                    | سورق قونص   | ギアボックス                       |
| Getriebe-Nr.                | سورقلا قونص مقدر  | ギアボックス番号                     |
| GG-Pumpe                    | بصللا ديدجلا نم ءمونصم ءخضم                               | 鑄鉄ポンプ                        |
| GG-Sättel                   | بصللا ديدجلا نم ءمونصم تيفف تايلا                         | 鑄鉄キャピラ                       |
| GG-THz/Vorgänger            | قباسنلا ابصللا ديدجلا نم ءمونصم تيففارت تيفي يور قن اوطنأ | 鑄鉄THz(タンデムマスターシリンダー) / 従前モデル |
| Golf-Staaten                | جئيل غلا لود  | 湾岸諸国                         |
| Gz mit senkrechtem Flansch  | يدومع فرطب ءموزم تضباق قن اوطنأ                           | 垂直フランジ付クラッチシリンダー             |
| Gz (Geberzylinder)          | تضباق قن اوطنأ  | Gzクラッチシリンダー                  |
| Gz-Reparaturset             | تضباق قن اوطنأ حالصا مقاط                                 | Gzクラッチシリンダー修理キット             |
| HA (Hinterachse)            | يفل خلا روحنلا  | HA(リアシャフト)                   |
| Haltefeder                  | تيفبشت تضبان  | 固定用スプリング                     |
| Halter                      | تيفبشت وضع  | アンカー                         |
| Haltersatz                  | تيفبشت مقاط   | アンカーセット                      |
| Halterschraube              | تيفبشت رامسم  | アンカーネジ                       |
| Handbremsbetätigung         | تيفودئلا ظمرفلا لي غشت                                    | サイドブレーキ稼動                    |
| Handbremshebel              | تيفودئلا ظمرفلا عارذ                                      | サイドブレーキレバー                   |
| HA-Scheibenbremse           | يفل خلا روحنلا تيفصرق ظمرف                                | リアシャフトディスクブレーキ               |
| HA-Trommelbremse            | يفل خلا روحنلا تيفن اوطنأ ظمرف                            | リアシャフトドラムブレーキ                |
| Hebel                       | ءعفار، عارذ   | レバー                          |
| Hochdach                    | لا ع فقس  | ハイルーフ                        |
| Hohlschraube                | فومج بلول، رامسم  | 空洞ネジ                         |
| Hosei-Bremse                | ياسروه ظمرف   | 豊生ブレーキ                       |
| Hub                         | راوشم، طوش  | ストローク                        |
| Hülsensatz                  | بلج مقاط  | スリーブキット                      |
| Hydraulikspeicher           | تيفلورديه قن زاخ  | 油圧アキュムレーター(蓄圧器)              |
| Hydraulikverstärker         | تيفلورديه زرم   | 油圧ブースター                      |
| Hydraulikzylinder           | تيفلورديه قن اوطنأ  | 油圧シリンダー                      |
| Hydr. Steuereinheit         | تيفلورديه لكحت كدح  | 油圧制御ユニット                     |
| Hz (Hauptzylinder)          | تيفي يورلا قن اوطنأ                                       | Hz(マスターシリンダー)                |
| Hz-Reparaturset             | تيفي يورلا قن اوطنأ حالصا مقاط                            | マスターシリンダー修理キット               |
| im Fahrerhaus               | قئاسنلا قروصقم يف   | キャブ内                         |
| im Motorraum                | لقرننلا زيغ يف  | エンジンルーム                      |

|                                       |   |                   |
|---------------------------------------|---|-------------------|
| innen                                 | ل داخل نم                                       | 内側                |
| Innengewinde                          | يل داخل ببلول                                   | 内側スレッド            |
| Kastenwagen                           | تقوونص قبلقم                                    | ワンボックスカー          |
| Katalysator                           | يزفح لوح  | 触媒                |
| Kennzeichen: xx                       | XX تقريم قمالع                                  | 車番: xx            |
| Kerbe am Flansch                      | (طقن الفلش) قفشللا يلع قفلث                     | フランジ上のノッチ         |
| Klasse                                | قتبترم قحرد                                     | 等級                |
| Kleinbus                              | ري قخص سي بيوتوا صاب ينيم                       | ミニバス              |
| Klimaanlage                           | ءاوه في قلم                                     | エアコン              |
| Kolbenstange D=                       | D= سابلقلل عارذ                                 | ピストンロッド径 D=       |
| Kolbenstange L=                       | L= سابلقلل عارذ                                 | ピストンロッド長 L=       |
| Kombiwagen                            | (يبموك) رافسا قرايس                             | ステーションワゴン         |
| Kompakt THz                           | ة قچم قيفدارت قيس يئر قن اوطنأ                  | コンパクトタデムマスターシリンダー |
| Krankenwagen                          | فاحس! قبلقم                                     | 救急車               |
| Kupplung                              | ضباقلل  | クラッチ              |
| Kupplungsabgang                       | ضباقلل لقصو جرحم                                | クラッチ接続用出力ポート      |
| Kupplungsverstärker                   | ضباقلل ام قچم                                   | クラッチブースター         |
| kurzer Radstand                       | قري صرق تال جع قذعاق                            | 短いホイールベース         |
| kurzes Bremsgerät                     | قري قخص لم لرف زيذعت قذجو                       | 短いブレーキブースター       |
| L (Länge) =                           | L (لوطنل) =                                     | L(長さ) =           |
| langer Radstand                       | قل يوط تال جع قذعاق                             | 長いホイールベース         |
| Leckageanzeige                        | بوس قتلل نايب بن ييم                            | 漏えいインジケーター        |
| lieferbar                             | مديروت ن قلمم ، حابتم                           | 納品可能              |
| links oben und rechts unten           | لفسا اولل ان يمي قلا قهجو اولع اولل رلس قلا قهج | 左上と右下             |
| links vor und rechts hinter der Achse | روح قلا لفسا ان يمي قو امام ان رلس ي            | シャフトの左前部と右後部      |
| Linkslenker                           | يرلس ي هي قوت                                   | 左ハンドル             |
| Luftfederung                          | ي ي اوه ق قيل عت                                | エアスプリング           |
| luftgekühlt                           | اي ي اوه دربم                                   | 空冷式               |
| M8-Führungsbolzen                     | M8, قيل يلد روباخ                               | M8ガイドピン           |
| MA-Getriebe                           | سورت قونص                                       | MAギアボックス          |
| mit 1 Haltestift                      | قنز روباخ بوزم                                  | 固定ピン1本で           |
| mit 2 Haltestiften                    | قنز يروباخ بوزم                                 | 固定ピン2本で           |
| mit Alufelgen                         | جوي هولل اطنونج بوزم                            | アルミホイール付          |
| mit angegossenem Behälter             | ببص نازخ بوزم                                   | キャストオンタンク付        |
| mit regeltem Katalysator              | جوك جم يزفاح لوح بوزم                           | 制御式触媒付            |
| mit Laschen                           | (فاسطل) يش او بوزم                              | ストラップ付            |
| mit Leichtmetallrädern                | في قفخ نذم نم ة جمنصم تال جع بوزم               | 軽金属ホイール付          |
| MKII-Aggregat kpl.                    | قلم القلا MKII قذجو                             | MKIIユニット 全体       |
| Mod. (Modell)                         | لي قوم  | モデル(年式)           |
| Motor                                 | ل قرحم  | エンジン              |
| Motor-Nr.                             | ل قرحملا قمر                                    | エンジン番号            |
| Motor-Pumpen-Aggregat                 | ل قرحملا ة خصم قذجو                             | エンジンポンプユニット       |
| Multi-Link-Achse                      | تال صولل دد عتم روحم                            | マルチリンクシャフト        |
| m.Z. (mit Zubehör)                    | قيل ي قلمت تفاق ل ج بوزم                        | m.Z.(付属品付)        |
| Nachstellteile-Satz                   | قيل ي اهل وطبضلل اعز ج ققاط                     | アジャスターパーツセット      |
| ND-Schlauch                           | ND, ضف خن جمل ط بخن جملل مو طرخ                 | ND低圧チューブ(ホース)     |
| Nebenabtrieb                          | ي قراخ قنجد                                     | パワーテイクオフ          |
| Niveauregulierung                     | قيل عتلل اوتسم يف مك حتلل ملظن                  | サスペンションレベルコントロール  |
| Nz (Nehmerzylinder)                   | ة عبات قن اوطنأ                                 | Nz(スレイブシリンダー)     |
| Nz-Reparatursatz                      | ة عبات قن اوطنأ ال حالص! ققاط                   | スレイブシリンダー修理キット    |
| ohne Alufelgen                        | جوي هولل اطنونج نوب                             | アルミホイールなし         |
| ohne geregelten Katalysator           | جوك جم يزفاح لوح نوب                            | 制御式触媒なし           |
| ohne Laschen                          | (فاسطل) يش او بوزم                              | ストラップなし           |
| ohne Leichtmetallräder                | في قفخ نذم نم ة جمنصم تال جع نوب                | 軽金属ホイールなし         |
| O-Ring                                | O قيل يه يلع ققلح                               | Oリング              |
| Pedal Feststeller                     | قن اولل تبتتم                                   | ロックが可能なペダル        |
| Polizei                               | قطرشلل  | 警察                |
| Rad                                   | قل جع   | 車輪                |
| Radsensor                             | قل ج علل س ل سح                                 | ホイールセンサー          |
| Radstand xxxx mm                      | مم XXXX تال ج علل قذعاق                         | ホイールベースxxxxmm     |
| rechts oben und links unten           | لفسا اولل رلس قلا قهجو اولع اولل ان يمي قلا قهج | 右上と左下             |
| Rechtslenker                          | ين يمي هي قوت                                   | 右ハンドル             |
| Regler                                | مظنم  | レギュレーター           |
| Reihenmotor                           | مدي قنسم ل قرحم                                 | 直列型エンジン Rエンジン     |
| Reisebus/Hochdecker                   | ة قحتبترم بباقر قروص قحب تال ج حر قلفاح         | 旅行用バス/ハイルーフ型      |
| Reparaturatz                          | حلص! ققاط                                       | 修理キット             |
| Ringstutzen-Satz                      | قيل قلح تاما ة قوم جم                           | リング型ニツベルセット       |
| Rohrleitung                           | ي بوبن ا طخ                                     | パイプライン            |
| rot                                   | رم حأ   | 赤色                |
| roter Sattel                          | ءارم ة قيل قف قلا                               | レッド キャピラ          |
| Rückschlagventil                      | ي عجر ال ءاوه ملص                               | 逆行防止バルブ           |
| Rückstellwellen-Satz                  | طبضللل قذعاق قنم ءا قوم جم                      | リセットシャフトセット       |
| Rz (Radzylinder)                      | قل ج علل قن اوطنأ                               | Rz(ホイールシリンダー)     |
| Rz-Dichtungssatz                      | قل ج علل قن اوطنأ مك ح! ققاط                    | ホイールシリンダー密閉キット    |
| Rz-Reparaturatz                       | قل ج علل قن اوطنأ ال حالص! ققاط                 | ホイールシリンダー修理キット    |
| Salisbury-Achse                       | يروبس قلس روحم                                  | ソールズベリー型シャフト      |
| Sattel mit 1 Haltestift               | قنز وباخ بوزم قيل قف قلا                        | 固定ピン1つのキャピラ       |





|                                |   |                              |
|--------------------------------|---|------------------------------|
| Sattel mit 2 Haltestiften      | قنز يروب اخب فوزم هيئف فيلأ                             | 固定ピン2つのキャピラ                  |
| Sättel mit Gussnoppen          | بصلال ديديلأ نم هيئف ع تاظل عت اب هيئف تايلأ            | 鑄造ナット付キャリパー                  |
| Sättelschraube                 | هيئفلا فيلأال رامبم                                     | キャリパーネジ                      |
| Scheibenbremse                 | هيئف رق طبرف  | ディスクブレーキ                     |
| Scheibenkupplung               | يئف رق ضرباق  | ディスククラッチ                     |
| Scheibenschraube               | صروقلا رامبم  | ディスクネジ                       |
| Schlauchleitung                | (هيئف رق) هيئف ع تاظل ع                                 | ホース(チューブ)配管                  |
| Schraubstützen                 | هيئف رق تاظل ع  | ネジネック(スクリューネック)              |
| schwarz                        | دوسأ  | 黒色                           |
| Schwimmsättel                  | قمعاع هيئف تايلأ  | フローティング キャリパー                |
| Schwingblech WE                | حجر لقم حجر لقم ريئف ع تريه عت                          | シートメタル型警告デバイス                |
| SCS                            | (فقوئفلا) يف مك حئفلا م اظن) SCS, م اظن                 | SCS(ストップコントロールシステム)          |
| separater Behälter             | لصرفنم نازح   | セパレータータンク                    |
| separates Druckstück/Vorgänger | قباسل الصرفنم يطاغئفنا وضع                              | セパレーター圧カピース/従前モデル            |
| Servolenkung                   | هيئف رق تاظل ع  | パワーステアリング                    |
| Skandinavier                   | ايئف ين الفس!   | スカンジナビア                      |
| Sitzplätze                     | سروق لكأ  | 座席 シート                       |
| Sonderfahrzeuge                | قصاخ تاظفص او ماب تاظف م                                | 特別車                          |
| Spezialaufbau                  | صاخ لكيفه   | 特別車体                         |
| Sportfahrwerk                  | هيئف رق تاظل ع عوم جم                                   | スポーツ仕様サスペンション                |
| Spur                           | رامبم   | 軌跡                           |
| Standard-Bremsgerät            | هيئف رق لمارف زيئف عت كدح                               | 標準ブースターユニット                  |
| Standard-THz                   | هيئف رق هيئف رق هيئف رق هيئف رق هيئف رق                 | 標準タンデムマスターシリンダー              |
| staubfeste Ausführung          | راب غلا مكارتل موقم م هيئف رق                           | 埃に強い仕様                       |
| Stufenheck                     | (نلديس) عئف م قوئف ص اب قرايس قرحوم                     | セダン(サルーン)                    |
| T50-Reparatursatz              | T50 حلصا م قاط  | T50修理キット                     |
| Tandemregler                   | يئف رق مظنم   | タンデム比率調節バルブ                  |
| THz mit 3 Anschlüssen          | تاظل عت ماب هيئف رق هيئف رق هيئف رق                     | コネクタが3つあるタンデムマスターシリンダー       |
| THz mit Anschlagsschraube      | قنز رامبم فوزم هيئف رق هيئف رق هيئف رق                  | ストップネジが付いたタンデムマスターシリンダー      |
| THz (Tandemhauptzylinder)      | يئف رق هيئف رق هيئف رق                                  | タンデムマスターシリンダー                |
| THz-Reparatursatz              | يئف رق تاظل ع هيئف رق هيئف رق حلصا م قاط                | タンデムマスターシリンダー修理キット           |
| THz-RS (Montagehülse)          | (بهيئف رق) هيئف رق هيئف رق هيئف رق هيئف رق              | タンデムマスターシリンダー修理キット(組み立てスリーブ) |
| Timken-Achse                   | نكسميت روم  | ティムケン社シャフト                   |
| Topfmanschette                 | هيئف رق بيريئف عت عنام                                  | ポットシール                       |
| Tragbolzensatz                 | قم عا (ريم لقم) ريئف رق عوم جم                          | 補助ボルトセット                     |
| Transporter                    | لاقن وضع  | 輸送車                          |
| Triebkopf                      | (لي غئف تاظل ع) عئفلا سار                               | ドライブヘッド                      |
| Trommelbremse                  | هيئف رق او طبرف   | ドラムブレーキ                      |
| TBB (Trommelbremsbacken)       | هيئف رق او طبرف (هيئف رق) تاظل ع                        | TBB(ドラムブレーキパッド)              |
| Umbau 1-teilig auf 2-teilig    | نيت عطق ولأ كدح او عطق نم لكيفه عا ع!                   | 1部ものを2部ものへ改造                 |
| Unterdruckverstärker           | غئف رق تاظل ع طرئف روم                                  | 負圧(真空)ブースター                  |
| ursprüngl. verschraubte Beläge | ريم لقم ماب تاظف م يلوأ لريت                            | もとはねじ止めされていたパッド              |
| VA (Vorderachse)               | يمامالا روم   | VA(フロントシャフト)                 |
| VA-Girling-Bremse              | يمامالا روم ماب جن يئف رق طبرف                          | フロントシャフト・ガーリングブレーキ           |
| VA-Scheibenbremse              | يمامالا روم ماب هيئف رق طبرف                            | フロントシャフトディスクブレーキ             |
| VA-Trommelbremse               | يمامالا روم ماب هيئف رق او طبرف                         | フロントシャフトドラムブレーキ              |
| Ventilblock                    | تامامص عوم جم   | バルブブロック                      |
| Ventilblock kpl.               | ظم لك تامامص عوم جم                                     | バルブブロック 全体                   |
| Verbindungsschrauben           | ظبير ريم لقم  | 接続ネジ                         |
| Verschlußschraube              | هيئف رق عا  | 密閉ネジ (スクリュープラグ)              |
| Verschraubung                  | رامبم ماب طبرف مك ع!                                    | ネジ止め (スクリューフィッティング)          |
| Verschraubung kpl.             | رامبم ماب طبرف ماب ماب ماب ماب                          | ネジ止め 全部                      |
| verstärkte Bremse              | قم عوم لمارف  | 強化ブレーキ                       |
| verstärkte Stoßdämpfer         | م عوم تامامص صام  | 強化ショックアブソーバー(強化ダンパー)         |
| verstärktes Fahrwerk           | قم عوم قيل عت عوم جم                                    | 強化サスペンション                    |
| Verteilerstück wiederverwenden | عزوم ماب عطقلا ماب عتس ا عا ع!                          | ディストリビューターパーツの再利用            |
| V-Motor                        | V هيئف رق ع لك عوم                                      | V字型エンジン                      |
| Vorder- und Hinterachse        | يئف رق او يئف رق او                                     | フロント&リアシャフト                  |
| Vorderachse                    | يمامالا روم   | フロントシャフト                     |
| Vorderachse und 2. Hinterachse | يئف رق او يئف رق او يئف رق او                           | フロントシャフトと2番目のリアシャフト          |
| Vordruckventil                 | صاخ او طبرف ماب   | 残留圧バルブ                       |
| Vorgänger                      | قباسلأ  | 従前モデル                        |
| Vorgänger / Abschirmkappe      | (قصاخ) عاب عا قوئف رق / قباسلأ                          | 従前モデル/シールドキャップ               |
| Vorgänger-THz, Einlaß D=xx     | D=xx لو ع نقم (هيئف رق) ماب ماب هيئف رق هيئف رق هيئف رق | 従前モデル-タンデムマスターシリンダー、吸気部径D=xx |
| Vorspannzylinder               | يئف رق او ماب ماب ماب ماب                               | 事前負荷をかけられたシリンダー(プリロードシリンダー)  |
| WK (Warnkontakt)               | لكا ئفلا نم ريئف رق روم                                 | WK(ウェアインジケーター)               |
| Warnkontakt 1-polig            | دح او قسطب ريئف رق روم                                  | ウェアインジケーター 1相                |
| Warnkontakt 2-polig            | فارطالا يئف رق ريئف رق روم                              | ウェアインジケーター 2相                |
| Warnschalter                   | ريئف رق حلصم  | 警告スイッチ                       |
| WE (Warneinrichtung)           | ريئف رق تريه عت   | WE(警告デバイス)                   |
| WE-Befestigung                 | ريئف رق تريه عت تيئف رق                                 | WE(警告デバイス)固定                 |
| Wegsensor                      | تاظف ماب ماب ماب ماب                                    | トラベルセンサー                     |
| weiß                           | صاخ   | 白色                           |
| Zylinderschraube               | قن او طبرف رامبم  | シリンダーネジ                      |













































A large rectangular area containing 30 horizontal lines, intended for writing or drawing.



- Ⓛ So benutzen Sie den K21-H
- ⓔⓃ How to use the K21-H
- ⓕⓇ Utilisation du catalogue K21-H
- ⓔⓣ Come consultare il catalogo K21-H
- ⓔⓈ Use así el K21-H
- ⓃⓁ Zo gebruikt u de K21-H
- Ⓛⓐ Sådan anvendes K21-H
- ⓈⓋ Så använder du K21-H
- ⓗⓤ How to use the K21-H
- ⓔⓟ Como utilizar o K21-H
- Ⓡⓤ Как пользоваться каталогом K21-H
- Ⓢⓐ Jak používat K21-H
- ⓔⓁ Tak należy korzystać z K21-H
- ⓔⓁ Έτσι χρησιμοποιείτε τον K21-H
- ⓣⓇ K21-H'i Broşürünü Nasıl Kullanacaksınız
- Ⓢⓗ 这样使用 K21-H
- ⓙⓐ カタログNo.21-Hのご利用法
- ⓐⓇ K21-H طريقة استعمال الكتالوج



# Artikelinformationen

|    |   | KURZNUMMER   |    |   |    | KURZNUMMER   |  |        |                  |        |                     |        |                  |        |                     |         |  |   |   |   |
|--|--|--|---|--|--|--|---|--------|------------------|--------|---------------------|--------|------------------|--------|---------------------|---------|--|---|---|---|
|    | 03.6199-xxxx.4 → 30nnnn<br>03.61dy-xxxx.4 → 30nnnn<br>03.67dy-xxxx.4 → 30nnnn<br>03.68dy-xxxx.4 → 30nnnn<br>03.69dy-xxxx.4 → 30nnnn<br>03.77dy-xxxx.4 → 30nnnn<br>03.78dy-xxxx.4 → 30nnnn<br>03.78dy-xxxx.4 → 30nnnn<br>03.78dy-xxxx.4 → 30nnnn<br>03.78dy-xxxx.4 → 30nnnn<br>03.78dy-xxxx.4 → 30nnnn<br>03.78dy-xxxx.4 → 30nnnn         | Bremskraftverstärker<br>T50<br>T51<br>T52/3<br>T52<br>T53<br>T52/4<br>T52/4<br>T52/4Z<br>T52/5<br>T52/5Z<br>T55/1<br>T55/1Z  | <table border="1"> <tr> <td>d</td> <td>y</td> </tr> <tr> <td></td> <td>0 = Einfachgerät<br/>5 = Tandemgerät</td> </tr> <tr> <td>2 = 6"</td> <td>0 = Einfachgerät</td> </tr> <tr> <td>3 = 7"</td> <td>3 = Einfachgerät BA</td> </tr> <tr> <td>4 = 8"</td> <td>5 = Einfachgerät</td> </tr> <tr> <td>5 = 9"</td> <td>8 = Einfachgerät BA</td> </tr> <tr> <td>6 = 10"</td> <td>BA = Bremsassistent<br/>Z = Zugankerbremsgeräte</td> </tr> </table>  | d  | y  |  | 0 = Einfachgerät<br>5 = Tandemgerät   | 2 = 6" | 0 = Einfachgerät | 3 = 7" | 3 = Einfachgerät BA | 4 = 8" | 5 = Einfachgerät | 5 = 9" | 8 = Einfachgerät BA | 6 = 10" | BA = Bremsassistent<br>Z = Zugankerbremsgeräte | <br>▲ 03.27dd-xxxx.3 → 02nnnn<br>▲ 03.32dd-xxxx.3 → 02nnnn<br>03.040x-xxdd.2 → 06nnnn<br>03.0470-xxdd.2 → 06nnnn<br>24.3727-xxxx.2 → 58xxxx<br><br><br><br><br><br><br><br><br><br><br> | 03.27dd-xxxx.3 → 02nnnn<br>03.32dd-xxxx.3 → 02nnnn<br>03.040x-xxdd.2 → 06nnnn<br>03.0470-xxdd.2 → 06nnnn<br>24.3727-xxxx.2 → 58xxxx<br>83.1xxx-xxxx.3 → 33nnnn<br>83.5yxx-LLLL.3 → 33nnnn<br>83.6yxx-LLLL.3 → 33nnnn<br>83.7yxx-LLLL.3 → 33nnnn | einseitig wirkender Radzylinder<br>Radzylinder<br>Reparatur-Satz (mit Kolben)<br>Dichtungs-Satz (ohne Kolben)<br>Handbremsseil<br>Bremsschlauch + Rohrleitung<br>Brems-/Kupplungsschlauch<br>Brems-/Kupplungsschlauch<br>Brems-/Kupplungsschlauch<br>y = 1: Gewinde 1× innen/1× außen<br>y = 2: Gewinde 2× innen<br>y = 3: Gewinde 2× außen |
| d  | y  |  |   |  |  |  |   |        |                  |        |                     |        |                  |        |                     |         |  |   |   |   |
|  | 0 = Einfachgerät<br>5 = Tandemgerät  |  |   |  |  |  |   |        |                  |        |                     |        |                  |        |                     |         |  |   |   |   |
| 2 = 6"   | 0 = Einfachgerät   |  |   |  |  |  |   |        |                  |        |                     |        |                  |        |                     |         |  |   |   |   |
| 3 = 7"   | 3 = Einfachgerät BA  |  |   |  |  |  |   |        |                  |        |                     |        |                  |        |                     |         |  |   |   |   |
| 4 = 8"   | 5 = Einfachgerät   |  |   |  |  |  |   |        |                  |        |                     |        |                  |        |                     |         |  |   |   |   |
| 5 = 9"   | 8 = Einfachgerät BA  |  |   |  |  |  |   |        |                  |        |                     |        |                  |        |                     |         |  |   |   |   |
| 6 = 10"  | BA = Bremsassistent<br>Z = Zugankerbremsgeräte   |  |   |  |  |  |   |        |                  |        |                     |        |                  |        |                     |         |  |   |   |   |
|    | ▲ 03.20dd-xxxx.3 → 01nnnn<br>▲ 03.21dd-xxxx.3 → 01nnnn<br>▲ 03.23dd-xxxx.3 → 01nnnn<br>▲ 03.31dd-xxxx.3 → 01nnnn<br>03.0370-xxdd.2 → 05xxxx  | Tandem-Hauptzylinder gestuft<br>Tandem-Hauptzylinder<br>Stufen-Hauptzylinder<br>Hauptzylinder<br>(z. B. 03.2122-: Ø=22,20)<br>Reparatursatz  | <br><br><br><br><br><br><br><br> | 03.20dd-xxxx.3 → 01nnnn<br>03.21dd-xxxx.3 → 01nnnn<br>03.23dd-xxxx.3 → 01nnnn<br>03.31dd-xxxx.3 → 01nnnn<br>03.0370-xxdd.2 → 05xxxx<br>03.60xx-xxxx.3 → 32nnnn<br>03.65xx-xxxx.3 → 32nnnn<br>03.0101-xxxx.2 → 32nnnn<br>35/3 braun (4)   | 03.60xx-xxxx.3 → 32nnnn<br>03.65xx-xxxx.3 → 32nnnn<br>03.0101-xxxx.2 → 32nnnn<br>35/3 braun (4)  | Bremskraftregler (BR)<br>Bremskraftbegrenzer (BG)<br>Einschraubregler (BRE)<br>Bremskraftregler lastabhängig (BRL)<br>Einschraubregler-Satz (BRES)<br>Kennzeichen, Farbmarkierung<br>(Anzahl der Anschlüsse) |   |        |                  |        |                     |        |                  |        |                     |         |  |   |   |   |
|  | 03.3508-xxxx.x → 31nnnn<br>03.3509-xxxx.x → 31nnnn<br>03.3558-xxxx.x → 31nnnn<br>03.0101-xxxx.2 → 39nnnn   | Ausgleichsbehälter<br>Ausgleichsbehälter<br>Ausgleichsbehälter<br>Reparatursatz  | <br><br><br><br><br><br>   | 03.24dd-xxxx.3 → 03nnnn<br>03.0350-ddxx.2 → 07ddxx<br>03.25dd-xxxx.3 → 04nnnn<br>03.0450-ddxx.2 → 08ddxx<br>24.3728-xxxx.2 → 59xxxx  | ▲ 03.24dd-xxxx.3 → 03nnnn<br>03.0350-ddxx.2 → 07ddxx<br>▲ 03.25dd-xxxx.3 → 04nnnn<br>03.0450-ddxx.2 → 08ddxx<br>24.3728-xxxx.2 → 59xxxx  | Kupplungs-Geberzylinder<br>(z. B. 03.2419-: Ø=19,05)<br>Dichtungs-Satz<br>Kupplungs-Nehmerzylinder<br>(z. B. 03.2525-: Ø=25,40)<br>Dichtungs-Satz<br>Kupplungsseil   |   |        |                  |        |                     |        |                  |        |                     |         |  |   |   |   |
|  | ▲ 11.3ddx-xxxx.2 → 22nnnn<br>11.9ddx-xxxx.2 → 22nnnn<br>▲ 13.2ddx-xxxx.2 → 21nnnn<br>▲ 13.4ddx-xxxx.2 → 21nnnn<br>13.9ddx-xxxx.2 → 21nnnn<br>24.3ddx-xxxx.5 → 24nnnn<br>11.0441-ddxx.2 → 25nnnn<br>13.0441-ddxx.2 → 25nnnn<br>11.0230-xxxx.2 → 26nnnn<br>24.0101-xxxx.2 → 26nnnn<br>▲ 11.0101-xxxx.2 → 26nnnn<br>11.8116-xxxx.1 → 39nnnn | Faustsattel<br>Faustsattel<br>2-Zyl. Festsattel<br>4-Zyl. Festsattel<br>Festsattel<br>Austauschsattel Faustsattel<br>Dichtungs-Satz<br>Dichtungs-Satz<br>Faustsattelhalter-Satz (Halter,<br>Schiebehülsensatz, Führungsbolzen)<br>Einbausatz<br>(Schiebehülsensatz, Führungsbolzen)<br>Schiebehülsensatz<br>Haltefeder | <br><br><br><br>   | ▲ 11.3ddx-xxxx.2 → 22nnnn<br>11.9ddx-xxxx.2 → 22nnnn<br>▲ 13.2ddx-xxxx.2 → 21nnnn<br>▲ 13.4ddx-xxxx.2 → 21nnnn<br>13.9ddx-xxxx.2 → 21nnnn<br>24.3ddx-xxxx.5 → 24nnnn<br>11.0441-ddxx.2 → 25nnnn<br>13.0441-ddxx.2 → 25nnnn<br>11.0230-xxxx.2 → 26nnnn<br>24.0101-xxxx.2 → 26nnnn<br>▲ 11.0101-xxxx.2 → 26nnnn<br>11.8116-xxxx.1 → 39nnnn | ▲ 11.3ddx-xxxx.2 → 22nnnn<br>11.9ddx-xxxx.2 → 22nnnn<br>▲ 13.2ddx-xxxx.2 → 21nnnn<br>▲ 13.4ddx-xxxx.2 → 21nnnn<br>13.9ddx-xxxx.2 → 21nnnn<br>24.3ddx-xxxx.5 → 24nnnn<br>11.0441-ddxx.2 → 25nnnn<br>13.0441-ddxx.2 → 25nnnn<br>11.0230-xxxx.2 → 26nnnn<br>24.0101-xxxx.2 → 26nnnn<br>▲ 11.0101-xxxx.2 → 26nnnn<br>11.8116-xxxx.1 → 39nnnn | Kupplungs-Geberzylinder<br>(z. B. 03.2419-: Ø=19,05)<br>Dichtungs-Satz<br>Kupplungs-Nehmerzylinder<br>(z. B. 03.2525-: Ø=25,40)<br>Dichtungs-Satz<br>Kupplungsseil   |   |        |                  |        |                     |        |                  |        |                     |         |  |   |   |   |

nnnn = Die letzten vier Ziffern entsprechen einer Zählnummer.

dd = Nennmaß

▲ Auch 24. bei gleicher Benummerungssystematik möglich.

■ Auch 03., 24. und 83. bei gleicher Benummerungssystematik möglich.

Nachdruck, auch auszugsweise, nur mit unserer Genehmigung gestattet. Ersatzansprüche auf Grund von Angaben in diesem Katalog können nicht anerkannt werden. Konstruktionsänderungen vorbehalten. Soweit wir in unseren Unterlagen Bezug nehmen auf die Ersatzteilnummer des Fahrzeugherstellers, dient dies nur zu Vergleichszwecken. Eine Verwendung derartiger Angaben in Rechnungen an den Fahrzeugbesitzer ist nicht statthaft.

Die Modell- und Ersatzteilvielfalt einiger Fahrzeughersteller erlaubt nicht immer eine genaue Zuordnung. Bitte beachten Sie daher besonders die im Katalog aufgeführten Bemerkungen und Ersatzteilbeschreibungen.



# How to use the K21-H

| Product groups              |   | Type of vehicle                 |                              | Installation period (from/to)                      |  | ATE number   |                                      | Remark (spare part) |   |                          |
|-----------------------------|---|---------------------------------|------------------------------|--|--|--|--------------------------------------|---------------------|---|--------------------------|
| Front/rear axle             |   | Chassis number                  |                              | Remark (car)                                       |  | Short number   |                                      | Definition          |   |                          |
|                             |   |                                 |                              |  |  |  |                                      |                     |   |                          |
| <b>AUDI A4 CABRIO (02-)</b> |   |                                 |                              |  |  |  |                                      |                     |   |                          |
|                             | 1,8 T<br>1,8 T Quattro<br>2,0<br>2,0 TFSI | ◀ 120<br>◀ 120<br>◀ 96<br>◀ 120 | 8E-55-999999<br>8E-55-400001 | 04.02<br>05.03<br>08.06<br>05.04<br>08.06<br>08.06 | PR: 1LB,1LE<br>PR: 1LB,1LE<br>PR: 1LB,1LE<br>PR: 1LB,1LE | 11.3571-8522.2<br>11.3571-8521.2<br>11.0441-5704.2<br>11.0101-5409.2 | 220320<br>220319<br>250034<br>260035 | + ESP<br>+ ESP      | D=57, - Halter<br>D=57, - Halter<br>Dichtungssatz<br>Hülzensatz | ATE<br>ATE<br>ATE<br>ATE |
| *                           |   | **                              |                              |  |  |  | ***                                  |                     | ****  |                          |

## \*Product groups

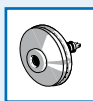

Booster unit



Handbrake cable

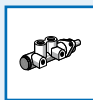

Master cylinder

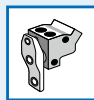

Brake pressure regulator



Reservoir



Clutch cylinder



Brake caliper



Slave cylinder



Brake hose



Clutch hose

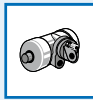

Wheel cylinder



Clutch cable

## \*\*Hand drive

- ◀ Left hand drive
- ▶ Right hand drive

## \*\*\*\*Manufacturer

|     |                         |
|-----|-------------------------|
| ATE | Continental Teves (ATE) |
| AKE | Akebono                 |
| AIS | Aisin                   |
| AP  | AP Lockheed             |
| BDX | Bendix                  |
| BOS | Bosch                   |
| BRE | Brembo                  |
| CIT | Citroën                 |
| DEL | Delco                   |
| FI  | Fiat                    |
| FTE | FTE Automotive          |
| LUC | Lucas (TRW)             |
| MAN | Mando                   |
| NIS | Nissin                  |
| PER | Perrot                  |
| SUM | Sumitomo                |
| TOK | Tokico                  |
| VW  | Volkswagen              |

## \*\*\*Installation Position

- ⬆ front
- ⬇ rear
- ⬅ left
- ➡ right
- ⬆⬅ upper left
- ⬇⬅ lower left
- ⬆➡ upper right
- ⬇➡ lower right
- center
- ⬆ top
- ⬇ bottom
- front axle
- front left
- front right
- rear axle
- rear left
- rear right

All position details are based on vehicle facing forwards.















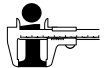











## Abbreviations

|      |   |     |   |     |                        |  |
|------|---|-----|---|-----|------------------------|--|
| -    | Without / not                               | HEB | Lever                                     | WE  | Warning device         | Coupe  |
| +    | With / only / for                           | HZ  | Master cylinder                           | WK  | Wear indicator         | Convertible                                  |
| AUT  | Automatic adjustment                        | L   | Alloyed / highly carburized               | Zub | Accessories            | Bus  |
| B    | Coated                                      | L=  | Length                                    |     |                        | Van / Panel van                              |
| BG   | Brake force limiter                         | Nz  | Slave cylinder                            |     |                        | Fastback / Hatchback                         |
| BR   | Brake pressure regulator                    | PD  | PowerDisc                                 |     | Brake hose + pipe line | Pickup/Chassis Platform truck/<br>chassis    |
| BRE  | Screw-in regulator                          | Rz  | Wheel cylinder                            |     | 2-door                 | Series                                       |
| BRES | Screw-in regulator set                      | RzR | Wheel cylinder with built-in<br>corrector |     | 3-door                 | DKW master class/special class/<br>universal |
| BRL  | Brake pressure regulator, load<br>sensitive | S   | Fixing screw / caliper screw              |     | 4-door                 | FAUN powered cart (Kraka)                    |
| D=   | Diameter                                    | THz | Tandem master cylinder                    |     | 5-door                 | Transporter / Van                            |
| Gz   | Clutch cylinder                             | V   | Ventilated                                |     | Saloon / Sedan         |  |
|      |   |     |   |     | Estate / Station wagon |  |





# Parts information

|    |   | SHORT NUMBER   |   |    |    | SHORT NUMBER   |    |
|---|--|--|--|---|--|--|---|
|    | 03.6199-xxxx.4 →<br>03.61dy-xxxx.4 →<br>03.67dy-xxxx.4 →<br>03.68dy-xxxx.4 →<br>03.69dy-xxxx.4 →<br>03.77dy-xxxx.4 →<br>03.78dy-xxxx.4 →<br>03.78dy-xxxx.4 →<br>03.78dy-xxxx.4 →<br>03.78dy-xxxx.4 →<br>03.78dy-xxxx.4 →<br>03.78dy-xxxx.4 →         | 30nnnn<br>30nnnn<br>30nnnn<br>30nnnn<br>30nnnn<br>30nnnn<br>30nnnn<br>30nnnn<br>30nnnn<br>30nnnn<br>30nnnn<br>30nnnn | Brake booster<br>T50<br>T51<br>T52/3<br>T52<br>T53<br>T52/4<br>T52/4<br>T52/4Z<br>T52/5<br>T52/5Z<br>T55/1<br>T55/1Z   | <br><br><br><br><br><br><br><br> | ▲ 03.27dd-xxxx.3 →<br>▲ 03.32dd-xxxx.3 →<br>03.040x-xxdd.2 →<br>03.0470-xxdd.2 →<br>24.3727-xxxx.2 →<br>■ 83.5yx-LLLL.3 →<br>■ 83.5yx-LLLL.3 →<br>■ 83.6yx-LLLL.3 →<br>■ 83.7yx-LLLL.3 →<br>03.60xx-xxxx.3 →<br>03.65xx-xxxx.3 →<br>03.0101-xxxx.2 →<br>35/3 braun (4)<br>▲ 03.24dd-xxxx.3 →<br>03.0350-ddxx.2 →<br>▲ 03.25dd-xxxx.3 →<br>03.0450-ddxx.2 →<br>24.3728-xxxx.2 → | 02nnnn<br>02nnnn<br>06nnnn<br>06nnnn<br>58xxxx<br>33nnnn<br>33nnnn<br>33nnnn<br>33nnnn<br>32nnnn<br>32nnnn<br>32nnnn<br>03nnnn<br>07ddxx<br>04nnnn<br>08ddxx<br>59xxxx | Single piston wheel cylinder<br>Wheel cylinder<br>Repair kit (with pistons)<br>Gasket kit (without pistons)<br>Handbrake cable<br>Brake hose + pipe line<br>Brake/clutch hose<br>Brake/clutch hose<br>Brake/clutch hose<br>Brake pressure regulator (BR)<br>Brake force limiter (BG)<br>Screw-in regulator (BRE)<br>Brake pressure regulator,<br>load-sensitive (BRL)<br>Screw-in regulator set (BRES)<br>Markings, coloured markings<br>(number of connections)<br>Clutch cylinder<br>(e.g. 03.2419-: Ø=19,05)<br>Gasket kit<br>Slave cylinder<br>(e.g. 03.2525-: Ø=25,40)<br>Gasket kit<br>Clutch cable |
|    | ▲ 03.20dd-xxxx.3 →<br>▲ 03.21dd-xxxx.3 →<br>▲ 03.23dd-xxxx.3 →<br>▲ 03.31dd-xxxx.3 →<br>03.0370-xxdd.2 →   | 01nnnn<br>01nnnn<br>01nnnn<br>01nnnn<br>05xxdd   | Step-bore tandem master cylinder<br>Tandem master cylinder<br>Step-bore master cylinder<br>Master cylinder<br>(e.g. 03.2122-: Ø=22,20)<br>Repair kit   | <br><br><br><br><br>   | LLLL<br>LLLL   | y = 1: Thread 1× inner/1× outer<br>y = 2: Thread 2× inner<br>y = 3: Thread 2× outer  |   |
|  | 03.3508-xxxx.x →<br>03.3509-xxxx.x →<br>03.3558-xxxx.x →<br>03.0101-xxxx.2 →   | 31nnnn<br>31nnnn<br>31nnnn<br>39nnnn   | Reservoir<br>Reservoir<br>Reservoir<br>Repair kit  |   |  |  |   |
|  | ▲ 11.3ddx-xxxx.2 →<br>11.9ddx-xxxx.2 →<br>▲ 13.2ddx-xxxx.2 →<br>▲ 13.4ddx-xxxx.2 →<br>13.9ddx-xxxx.2 →<br>24.3ddx-xxxx.5 →<br>11.0441-ddxx.2 →<br>13.0441-ddxx.2 →<br>11.0230-xxxx.2 →<br>24.0101-xxxx.2 →<br>▲ 11.0101-xxxx.2 →<br>11.8116-xxxx.1 → | 22nnnn<br>22nnnn<br>21nnnn<br>21nnnn<br>21nnnn<br>24nnnn<br>25nnnn<br>25nnnn<br>26nnnn<br>26nnnn<br>26nnnn<br>39nnnn | Fist-type caliper<br>Fist-type caliper<br>2 cyl. fixed caliper<br>4 cyl. fixed caliper<br>Fixed caliper<br>Remanufactured fist-type caliper<br>Gasket kit<br>Gasket kit<br>Fist caliper holder set (holder,<br>sliding sleeve set, guide pins)<br>Installation kit<br>(sliding sleeve set, guide pins)<br>Sliding sleeve set<br>Retaining spring | <br><br>   |  |  |   |

| d       | y                              |
|---------|--------------------------------|
| 0       | Single unit                    |
| 5       | Tandem unit                    |
| 2 = 6"  | 0 = Single unit                |
| 3 = 7"  | 3 = Single unit BA             |
| 4 = 8"  | 5 = Single unit                |
| 5 = 9"  | 8 = Single unit BA             |
| 6 = 10" | BA = Electronic brake actuator |
|         | Z = Tension bolt brake booster |

nnnn = The last four digits correspond to a running number.

dd = Nominal dimension

- ▲ 24. also possible using same numbering system.
- and 03., 24. and 83. also possible using same numbering system.

Complete copies or extracts of this catalog only by permission. Damage claims on the basis of data in this catalog cannot be recognized. The right of modification in construction or design is reserved. As far as we refer in our documents to part numbers of the vehicle makers, this is for comparison purposes only. The use of such information on invoices to the vehicle owner is not admissible.

The multitude of car models and spare parts from numerous vehicle manufacturers do not always allow an exact allocation. Therefore please pay attention to the corresponding remarks and spare part descriptions.

# Utilisation du catalogue K21-H

| Groupes de produit          |   | Type de véhicule                | Date de montage (du/au)      |  | Référence ATE  | Remarque (référence)   |                                      |                        |   |                          |
|-----------------------------|---|---------------------------------|------------------------------|--|--|--|--------------------------------------|------------------------|---|--------------------------|
| Essieu avant/arrière        |   |                                 | No. de châssis (du/au)       | Remarque (véhicule)                                |  | Référence Courte   | Indication                           |                        |   |                          |
|                             |   |                                 |                              |  |  |  |                                      |                        |   |                          |
| <b>AUDI A4 CABRIO (02-)</b> |   |                                 |                              |  |  |  |                                      |                        |   |                          |
|                             | 1,8 T<br>1,8 T Quattro<br>2,0<br>2,0 TFSI | ◀ 120<br>◀ 120<br>◀ 96<br>◀ 120 | 8E-55-999999<br>8E-55-400001 | 04.02<br>05.03<br>08.06<br>05.04<br>08.06<br>08.06 | PR: 1LB,1LE<br>PR: 1LB,1LE<br>PR: 1LB,1LE<br>PR: 1LB,1LE | 11.3571-8522.2<br>11.3571-8521.2<br>11.0441-5704.2<br>11.0101-5409.2 | 220320<br>220319<br>250034<br>260035 | <br>+ ESP<br><br>+ ESP | D=57, - Halter<br>D=57, - Halter<br>Dichtungssatz<br>Hülzensatz | ATE<br>ATE<br>ATE<br>ATE |
| *                           |   | **                              |                              |  |  |  | ***                                  | ****                   |   |                          |

## \*Groupes de produit

|  |                   |  |                        |
|--|-------------------|--|------------------------|
|  | Servo-frein       |  | Câble de frein à main  |
|  | Maître cylindre   |  | Correcteur de freinage |
|  | Réservoir         |  | Emetteur d'embrayage   |
|  | Etrier de frein   |  | Récepteur d'embrayage  |
|  | Flexible de frein |  | Flexible d'embrayage   |
|  | Cylindre de roue  |  | Câble d'embrayage      |

## \*\*Direction

- ◀ Conduite à gauche
- ▶ Conduite à droite

## \*\*\*Fabricant

|     |                         |
|-----|-------------------------|
| ATE | Continental Teves (ATE) |
| AKE | Akebono                 |
| AIS | Aisin                   |
| AP  | AP Lockheed             |
| BDX | Bendix                  |
| BOS | Bosch                   |
| BRE | Brembo                  |
| CIT | Citroën                 |
| DEL | Delco                   |
| FI  | Fiat                    |
| FTE | FTE Automotive          |
| LUC | Lucas (TRW)             |
| MAN | Mando                   |
| NIS | Nissin                  |
| PER | Perrot                  |
| SUM | Sumitomo                |
| TOK | Tokico                  |
| VW  | Volkswagen              |

## \*\*\*Positionnement















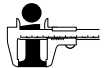



- 
- avant
- 
- arrière
- 
- gauche
- 
- droite
- 
- avant gauche
- 
- arrière gauche
- 
- avant droite
- 
- arrière droite
- 
- milieu
- 
- en haut
- 
- en bas
- 
- essieu avant
- 
- essieu avant gauche
- 
- essieu avant droite
- 
- essieu arrière
- 
- essieu arrière gauche
- 
- essieu arrière droite

Toutes positions vues en position de conduite

## Abréviations

|      |  |     |  |     |                              |   |
|------|--|-----|--|-----|------------------------------|---|
| -    | Sauf / sans                                | HEB | Lever                                    | WE  | Dispositif d'avertissement   | Break   |
| +    | Avec / seulement / pour                    | HZ  | Maître cylindre                          | WK  | Témoin d'usure               | Coupé   |
| AUT  | Ajustage Automatique                       | L   | Allié / carbonisé                        | Zub | Accessoires                  | Décapotable                                     |
| B    | Revêtu                                     | L = | Longueur                                 |     |                              | Autobus/car                                     |
| BG   | Limiteur de freinage                       | Nz  | Récepteur d'embrayage                    |     |                              | Fourgon   |
| BR   | Correcteur de freinage                     | PD  | PowerDisc                                |     |                              | Arrière profilé                                 |
| BRE  | Correcteur à visser                        | Rz  | Cylindre de roue                         |     | Flexible de frein + conduite | Camion-plateau/Châssis                          |
| BRES | Jeu de correcteur à visser                 | RzR | Cylindre de roue avec correcteur intégré |     | 2 portes                     | Série   |
| BRL  | Correcteur de freinage asservi à la charge | S   | Vis d'étrier / vis de fixation           |     | 3 portes                     | DKW Classe supérieure/Classe spéciale/Universel |
| D =  | Diamètre                                   | THz | Maître cylindre tandem                   |     | 4 portes                     | FAUN Chariot motorisé (Kraka)                   |
| Gz   | Emetteur 'embrayage                        | V   | Ventilé                                  |     | 5 portes                     | Camionnette                                     |
|      |  |     |  |     | Berline                      |   |

# Explications des références

|    |   | RÉF. COURTE  |    |   |    | RÉF. COURTE  |   |
|---|--|--|---|--|--|--|--|
|    | 03.6199-xxxx.4 →<br>03.61dy-xxxx.4 →<br>03.67dy-xxxx.4 →<br>03.68dy-xxxx.4 →<br>03.69dy-xxxx.4 →<br>03.77dy-xxxx.4 →<br>03.78dy-xxxx.4 →<br>03.78dy-xxxx.4 →<br>03.78dy-xxxx.4 →<br>03.78dy-xxxx.4 →<br>03.78dy-xxxx.4 →<br>03.78dy-xxxx.4 →         | 30nnnn<br>30nnnn<br>30nnnn<br>30nnnn<br>30nnnn<br>30nnnn<br>30nnnn<br>30nnnn<br>30nnnn<br>30nnnn<br>30nnnn<br>30nnnn | Servo-frein<br>T50<br>T51<br>T52/3<br>T52<br>T53<br>T52/4<br>T52/4<br>T52/4Z<br>T52/5<br>T52/5Z<br>T55/1<br>T55/1Z  | <br><br><br> | ▲ 03.27dd-xxxx.3 →<br>▲ 03.32dd-xxxx.3 →<br>03.040x-xxdd.2 →<br>03.0470-xxdd.2 →<br>24.3727-xxxx.2 →<br>■ 83.1xxx-xxxx.3 →<br>■ 83.5yxx-LLLL.3 →<br>■ 83.6yxx-LLLL.3 →<br>■ 83.7yxx-LLLL.3 → | 02nnnn<br>02nnnn<br>06nnnn<br>06nnnn<br>58xxxx<br>33nnnn<br>33nnnn<br>33nnnn<br>33nnnn | Cylindre de roue borgne<br>Cylindre de roue<br>Néc. de réparation (avec pistons)<br>Jeu de joints (sans pistons)<br>Câble de frein à main<br>Flexible de frein + conduite<br>Flexible de frein-/d'embrayages<br>Flexible de frein-/d'embrayages<br>Flexible de frein-/d'embrayages |
|    | ▲ 03.20dd-xxxx.3 →<br>▲ 03.21dd-xxxx.3 →<br>▲ 03.23dd-xxxx.3 →<br>▲ 03.31dd-xxxx.3 →<br>03.0370-xxdd.2 →   | 01nnnn<br>01nnnn<br>01nnnn<br>01nnnn<br>05xxdd   | Maître cylindre tandem étagé<br>Maître cylindre tandem<br>Maître cylindre étagé<br>Maître cylindre simple circuit<br>(p.ex. 03.2122-: Ø=22,20)<br>Néc. de réparation  | <br>   | 03.60xx-xxxx.3 →<br>03.65xx-xxxx.3 →<br>03.0101-xxxx.2 →<br>35/3 braun (4)   | 32nnnn<br>32nnnn<br>32nnnn   | Correcteur de freinage (BR)<br>Limiteur de freinage (BG)<br>Correcteur à visser (BRE)<br>Correcteur de freinage asservi<br>à la charge (BRL)<br>Jeu de correcteur à visser (BRES)<br>Indice, repère de couleur<br>(nombre de raccords)   |
|  | 03.3508-xxxx.x →<br>03.3509-xxxx.x →<br>03.3558-xxxx.x →<br>03.0101-xxxx.2 →   | 31nnnn<br>31nnnn<br>31nnnn<br>39nnnn   | Réservoir<br>Réservoir<br>Réservoir<br>Néc. de réparation   |  |  |  |  |
|  | ▲ 11.3ddx-xxxx.2 →<br>11.9ddx-xxxx.2 →<br>▲ 13.2ddx-xxxx.2 →<br>▲ 13.4ddx-xxxx.2 →<br>13.9ddx-xxxx.2 →<br>24.3ddx-xxxx.5 →<br>11.0441-ddxx.2 →<br>13.0441-ddxx.2 →<br>11.0230-xxxx.2 →<br>24.0101-xxxx.2 →<br>▲ 11.0101-xxxx.2 →<br>11.8116-xxxx.1 → | 22nnnn<br>22nnnn<br>21nnnn<br>21nnnn<br>21nnnn<br>24nnnn<br>25nnnn<br>25nnnn<br>26nnnn<br>26nnnn<br>26nnnn<br>39nnnn | Etrier à griffe<br>Etrier à griffe<br>Etrier à 2 pistons<br>Etrier à 4 pistons<br>Etrier fixe<br>Etrier à griffe de réchange<br>Jeu de joints<br>Jeu de joints<br>Jeu de supports d'étriers à griffe (support, jeu de douilles de guidage, boulon de guidage)<br>Lot de montage (jeu de douilles de guidage, boulon de guidage)<br>Jeu de douilles de guidage<br>Ressort à retenu | <br><br>  | ▲ 03.24dd-xxxx.3 →<br>03.0350-ddxx.2 →<br>▲ 03.25dd-xxxx.3 →<br>03.0450-ddxx.2 →<br>24.3728-xxxx.2 →   | 03nnnn<br>07ddxx<br>04nnnn<br>08ddxx<br>59xxxx   | Emetteur d'embrayage<br>(p. ex. 03.2419-: Ø=19,05)<br>Jeu de joints<br>Récepteur d'embrayage<br>(e.g. 03.2525-: Ø=25,40)<br>Jeu de joints<br>Câble d'embrayage   |

| d       | y                                    |
|---------|--------------------------------------|
| 0       | Appareil simple                      |
| 5       | Appareil tandem                      |
| 2 = 6"  | 0 = Appareil simple                  |
| 3 = 7"  | 3 = Appareil simple BA               |
| 4 = 8"  | 5 = Appareil simple                  |
| 5 = 9"  | 8 = Appareil simple BA               |
| 6 = 10" | BA = Assistance de freinage avec AFU |
|         | Z = Servo-frein à tirant             |

nnnn = Les quatre derniers chiffres correspondent à un ordre numérique.

dd = Dimension nominale

▲ Le préfixe de ces familles de produit peut également être 24.

■ Le préfixe de ces familles de produit peut également être 03., 24. ou 83.

Toute reproduction totale ou partielle de ce catalogue est interdite sauf notre autorisation préalable. Une demande de dommages et intérêts qui se baserait ou aurait pour objet un renseignement donné par le présent catalogue ne saurait être retenue. Nous nous réservons le droit de modifier les spécifications de nos produits sans préavis et, si cela est nécessaire, pour assurer les performances optimales de nos gammes de produits. Les références constructeurs fournies dans le présent catalogue sont données seulement à titre indicatif. L'utilisation de telles informations dans les factures d'un détenteur de véhicule n'est pas admise.

La diversité des modèles et des pièces de rechange ne permet pas toujours une affectation correcte. Par conséquent nous vous prions de bien vouloir tenir compte des observations et des descriptions contenues dans ce catalogue.

# Come consultare il catalogo K21-H

| Gruppi prodotto             |   | Veicolo                         |              | Anno di produzione veicolo       |                                  |  | Codice lungo   |                                      | Altri dettagli ricambio |   |  |
|-----------------------------|---|---------------------------------|--------------|----------------------------------|----------------------------------|--|--|--------------------------------------|-------------------------|---|--|
| Asse anteriore/posteriore   |   | Numero telaio                   |              | Altri dettagli veicolo           |                                  |  | Codice breve   |                                      | Altre informazioni      |   |  |
| kW                          |   |                                 |              |                                  |                                  |  |  |                                      |                         |   |  |
| <b>AUDI A4 CABRIO (02-)</b> |   |                                 |              |                                  |                                  |  |  |                                      |                         |   |  |
|                             | 1,8 T<br>1,8 T Quattro<br>2,0<br>2,0 TFSI | ◀ 120<br>◀ 120<br>◀ 96<br>◀ 120 | 8E-55-400001 | 04.02<br>05.03<br>08.06<br>08.06 | 08.06<br>08.06<br>08.06<br>08.06 | PR: 1LB,1LE<br>PR: 1LB,1LE<br>PR: 1LB,1LE<br>PR: 1LB,1LE | 11.3571-8522.2<br>11.3571-8521.2<br>11.0441-5704.2<br>11.0101-5409.2 | 220320<br>220319<br>250034<br>260035 | <br>+ ESP<br>+ ESP      | D=57, - Halter ATE<br>D=57, - Halter ATE<br>Dichtungssatz ATE<br>Hülsensatz ATE |  |
|                             |   | **                              |              |                                  |                                  |  |  |                                      | ***                     |   |  |

## \*Gruppi prodotto

|  |                                |  |                            |
|--|--------------------------------|--|----------------------------|
|  | <b>Servofreno</b>              |  | <b>Cavi freno a mano</b>   |
|  | <b>Pompa freno</b>             |  | <b>Correttore frenata</b>  |
|  | <b>Serbatoio compensazione</b> |  | <b>Cilindro comando</b>    |
|  | <b>Pinza freno</b>             |  | <b>Cilindro ricevitore</b> |
|  | <b>Flessibile freno</b>        |  | <b>Flessibile frizione</b> |
|  | <b>Cilindretto ruota</b>       |  | <b>Cavi frizione</b>       |

## \*\*Guida

- ◀ Guida sinistra
- ▶ Guida destra

## \*\*\*Produttore

|     |                         |
|-----|-------------------------|
| ATE | Continental Teves (ATE) |
| AKE | Akebono                 |
| AIS | Aisin                   |
| AP  | AP Lockheed             |
| BDX | Bendix                  |
| BOS | Bosch                   |
| BRE | Brembo                  |
| CIT | Citroën                 |
| DEL | Delco                   |
| FI  | Fiat                    |
| FTE | FTE Automotive          |
| LUC | Lucas (TRW)             |
| MAN | Mando                   |
| NIS | Nissin                  |
| PER | Perrot                  |
| SUM | Sumitomo                |
| TOK | Tokico                  |
| VW  | Volkswagen              |

## \*\*\*Posizione di montaggio

















|  |                            |
|--|----------------------------|
|  | davanti                    |
|  | dietro                     |
|  | a sinistra                 |
|  | a destra                   |
|  | davanti a sinistra         |
|  | dietro a sinistra          |
|  | davanti a destra           |
|  | dietro a destra            |
|  | al centro                  |
|  | in alto                    |
|  | in basso                   |
|  | asse anteriore             |
|  | asse anteriore a sinistra  |
|  | asse anteriore a destra    |
|  | asse posteriore            |
|  | asse posteriore a sinistra |
|  | asse posteriore a destra   |

Le indicazioni dei simboli si riferiscono alla direzione di marcia.

## Abbreviazioni

|      |  |     |  |     |                                  |  |
|------|--|-----|--|-----|----------------------------------|--|
| -    | Senza / non                                  | HEB | Leva                                     | V   | Ventilato                        | Station Wagon                                |
| +    | Con / solo / per                             | HZ  | Pompa freno                              | WE  | Rilevatore usura incollato       | Coupé  |
| AUT  | Regolazione automatica                       | L   | In lega / lega di carbonio               | WK  | Rilevatore usura a clip          | Cabriolet                                    |
| B    | Rivestito                                    | L = | Lunghezza                                | Zub | Accessori                        | Autobus                                      |
| BG   | Limitatore potenza freno                     | Nz  | Cilindro ricevitore frizione             |     |                                  | Furgone                                      |
| BR   | Correttore di frenata                        | PD  | PowerDisc                                |     |                                  | Coda spiovente                               |
| BRE  | Correttore avvitabile                        | Rz  | Cilindretto ruota                        |     | Flessibile del freno + tubazione | Autocarro cassonato/Autotelaio               |
| BRES | Correttore (da avvitare)                     | RzR | Cilindretto ruota con corretore          |     | a 2 porte                        | Serie  |
| BRL  | Correttore di frenate, dipendente dal carico | S   | Viti fissaggio pinza / viti di fissaggio |     | a 3 porte                        | DKW Classe superiore/Classe spec./Universale |
| D =  | Diametro                                     | THz | Pompa freno tandem                       |     | a 4 porte                        | FAUN Motocarri (Kraka)                       |
| Gz   | Pompa frizione                               |     |  |     | a 5 porte                        | Furgoncino                                   |
|      |  |     |  |     | Berlina                          |  |

# Informazioni sugli articoli

|    |  | CODICE BREVE                         |    |    |                       | CODICE BREVE  |  |        |                        |        |                         |        |                            |         |                         |  |                         |  |                            |  |                                      |  |                                      |   |
|---|---|--------------------------------------|---|---|---|---|---|--------|------------------------|--------|-------------------------|--------|----------------------------|---------|-------------------------|--|-------------------------|--|----------------------------|--|--------------------------------------|--|--------------------------------------|---|
|    | 03.6199-xxxx.4 →  | 30nnnn                               | Servofreno<br>T50<br>T51<br>T52/3<br>T52<br>T53<br>T52/4<br><table border="1" data-bbox="582 459 821 694"> <tr> <td>d</td> <td>y</td> </tr> <tr> <td>2 = 6"</td> <td>0 = Dispositivo singolo</td> </tr> <tr> <td>3 = 7"</td> <td>5 = Dispositivo tandem</td> </tr> <tr> <td>4 = 8"</td> <td>0 = Dispositivo singolo</td> </tr> <tr> <td>5 = 9"</td> <td>3 = Dispositivo singolo BA</td> </tr> <tr> <td>6 = 10"</td> <td>5 = Dispositivo singolo</td> </tr> <tr> <td></td> <td>8 = Dispositivo singolo</td> </tr> <tr> <td></td> <td>BA = Assistente di frenata</td> </tr> <tr> <td></td> <td>Z = Apparecchi per freni con tirante</td> </tr> </table> | d   | y   | 2 = 6"  | 0 = Dispositivo singolo   | 3 = 7" | 5 = Dispositivo tandem | 4 = 8" | 0 = Dispositivo singolo | 5 = 9" | 3 = Dispositivo singolo BA | 6 = 10" | 5 = Dispositivo singolo |  | 8 = Dispositivo singolo |  | BA = Assistente di frenata |  | Z = Apparecchi per freni con tirante | ▲ 03.27dd-xxxx.3 →<br>▲ 03.32dd-xxxx.3 →<br>03.040x-xxdd.2 →<br>03.0470-xxdd.2 → | 02nnnn<br>02nnnn<br>06nnnn<br>06nnnn | Cilindretto ruota a un pistone<br>Cilindretto ruota<br>Serie di riparazione (con pistoni)<br>Serie di guarnizioni (senza pistoni) |
|   | d   | y                                    |   |   |   |   |   |        |                        |        |                         |        |                            |         |                         |  |                         |  |                            |  |                                      |  |                                      |   |
|   | 2 = 6"  | 0 = Dispositivo singolo              |   |   |   |   |   |        |                        |        |                         |        |                            |         |                         |  |                         |  |                            |  |                                      |  |                                      |   |
|   | 3 = 7"  | 5 = Dispositivo tandem               |   |   |   |   |   |        |                        |        |                         |        |                            |         |                         |  |                         |  |                            |  |                                      |  |                                      |   |
|   | 4 = 8"  | 0 = Dispositivo singolo              |   |   |   |   |   |        |                        |        |                         |        |                            |         |                         |  |                         |  |                            |  |                                      |  |                                      |   |
|   | 5 = 9"  | 3 = Dispositivo singolo BA           |   |   |   |   |   |        |                        |        |                         |        |                            |         |                         |  |                         |  |                            |  |                                      |  |                                      |   |
|   | 6 = 10"   | 5 = Dispositivo singolo              |   |   |   |   |   |        |                        |        |                         |        |                            |         |                         |  |                         |  |                            |  |                                      |  |                                      |   |
|   |   | 8 = Dispositivo singolo              |   |   |   |   |   |        |                        |        |                         |        |                            |         |                         |  |                         |  |                            |  |                                      |  |                                      |   |
|   |   | BA = Assistente di frenata           |   |   |   |   |   |        |                        |        |                         |        |                            |         |                         |  |                         |  |                            |  |                                      |  |                                      |   |
|   |   | Z = Apparecchi per freni con tirante |   |   |   |   |   |        |                        |        |                         |        |                            |         |                         |  |                         |  |                            |  |                                      |  |                                      |   |
| 03.78dy-xxxx.4 →  | 30nnnn  | T52/4                                | 24.3727-xxxx.2 →  | 58xxxx  | Cavi freno a mano   |   |   |        |                        |        |                         |        |                            |         |                         |  |                         |  |                            |  |                                      |  |                                      |   |
| 03.78dy-xxxx.4 →  | 30nnnn  | T52/4Z                               | <br><br>   | ■ 83.1xxx-xxxx.3 →<br>■ 83.5yxx-LLLL.3 →<br>■ 83.6yxx-LLLL.3 →<br>■ 83.7yxx-LLLL.3 →  | 33nnnn<br>33nnnn<br>33nnnn<br>33nnnn  | Flessibile del freno + tubazione<br>Flessibile freno/frizione<br>Flessibile freno/frizione<br>Flessibile freno/frizione |   |        |                        |        |                         |        |                            |         |                         |  |                         |  |                            |  |                                      |  |                                      |   |
| 03.78dy-xxxx.4 →  | 30nnnn  | T52/5                                |   | <br><br> | y = 1: Raccordo 1 × interno / 1 × esterno<br>y = 2: Raccordo 2 × interno<br>y = 3: Raccordo 2 × esterno |   |   |        |                        |        |                         |        |                            |         |                         |  |                         |  |                            |  |                                      |  |                                      |   |
| 03.78dy-xxxx.4 →  | 30nnnn  | T52/5Z                               |   |   | 03.60xx-xxxx.3 →  | 32nnnn  | Corretore frenata (BR)  |        |                        |        |                         |        |                            |         |                         |  |                         |  |                            |  |                                      |  |                                      |   |
| 03.78dy-xxxx.4 →  | 30nnnn  | T55/1                                |   |   | 03.65xx-xxxx.3 →  | 32nnnn  | Limitatore potenza freno (BG)   |        |                        |        |                         |        |                            |         |                         |  |                         |  |                            |  |                                      |  |                                      |   |
| 03.78dy-xxxx.4 →  | 30nnnn  | T55/1Z                               |   |   | 03.0101-xxxx.2 →  | 32nnnn  | Regolatore a vite (BRE)   |        |                        |        |                         |        |                            |         |                         |  |                         |  |                            |  |                                      |  |                                      |   |
|   |   |                                      | 35/3 marrone (4)  |   |   | Correctore frenata dipendente dal carico (BRL)  |   |        |                        |        |                         |        |                            |         |                         |  |                         |  |                            |  |                                      |  |                                      |   |
|    | ▲ 03.20dd-xxxx.3 →  | 01nnnn                               | Pompa freno tandem a stadi<br>Pompa freno tandem<br>Pompa freno a stadi<br>Pompa freno<br>(p. ej. 03.2122-: Ø=22,20)<br>Serie di riparazione  | 03.0101-xxxx.2 →  | 32nnnn  | Mini / regolatore (da avvitare) (BRES)  |   |        |                        |        |                         |        |                            |         |                         |  |                         |  |                            |  |                                      |  |                                      |   |
|   | ▲ 03.21dd-xxxx.3 →  | 01nnnn                               |   |   |   |   |   |        |                        |        |                         |        |                            |         |                         |  |                         |  |                            |  |                                      |  |                                      |   |
|   | ▲ 03.23dd-xxxx.3 →  | 01nnnn                               |   |   |   |   |   |        |                        |        |                         |        |                            |         |                         |  |                         |  |                            |  |                                      |  |                                      |   |
|   | ▲ 03.31dd-xxxx.3 →  | 01nnnn                               |   |   |   |   |   |        |                        |        |                         |        |                            |         |                         |  |                         |  |                            |  |                                      |  |                                      |   |
|  | 03.3508-xxxx.x →  | 31nnnn                               | Serbatoio compensazione<br>Serbatoio compensazione<br>Serbatoio compensazione<br>Serie di riparazioni   |   |   |   |   |        |                        |        |                         |        |                            |         |                         |  |                         |  |                            |  |                                      |  |                                      |   |
|   | 03.3509-xxxx.x →  | 31nnnn                               |   |   |   |   |   |        |                        |        |                         |        |                            |         |                         |  |                         |  |                            |  |                                      |  |                                      |   |
|   | 03.3558-xxxx.x →  | 31nnnn                               |   |   |   |   |   |        |                        |        |                         |        |                            |         |                         |  |                         |  |                            |  |                                      |  |                                      |   |
|   | 03.0101-xxxx.2 →  | 39nnnn                               |   |   |   |   |   |        |                        |        |                         |        |                            |         |                         |  |                         |  |                            |  |                                      |  |                                      |   |
|  | ▲ 11.3ddx-xxxx.2 →  | 22nnnn                               | Pinza freno flottante<br>Pinza freno flottante<br>Pinza a 2 pistoncini<br>Pinza a 4 pistoncini<br>Pinza a 4 pistoncini<br>Pinza a 4 pistoncini<br>Pinza freno flottante di sostituzione<br>Serie di guarnizioni<br>Serie di guarnizioni<br>Serie staffe per pinze flottanti (supporto, serie di guarnizioni, guide scorrimento)<br>Serie di montaggio (serie di guarnizioni, guide scorrimento)<br>Serie di guarnizioni<br>Serie di guarnizioni<br>Molla di ritegno   | ▲ 03.24dd-xxxx.3 →  | 03nnnn  | Cilindro comando (p.es. 03.2419-: Ø=19,05)  |   |        |                        |        |                         |        |                            |         |                         |  |                         |  |                            |  |                                      |  |                                      |   |
|   | 11.9ddx-xxxx.2 →  | 22nnnn                               |   |   | 03.0350-ddxx.2 →  | 07ddxx  | Serie guarnizioni   |        |                        |        |                         |        |                            |         |                         |  |                         |  |                            |  |                                      |  |                                      |   |
|   | ▲ 13.2ddx-xxxx.2 →  | 21nnnn                               |   |   | ▲ 03.24dd-xxxx.3 →  | 03nnnn  | Cilindro comando (p.es. 03.2419-: Ø=19,05)  |        |                        |        |                         |        |                            |         |                         |  |                         |  |                            |  |                                      |  |                                      |   |
|   | ▲ 13.4ddx-xxxx.2 →  | 21nnnn                               |   |   | 03.0350-ddxx.2 →  | 07ddxx  | Serie guarnizioni   |        |                        |        |                         |        |                            |         |                         |  |                         |  |                            |  |                                      |  |                                      |   |
|   | 13.9ddx-xxxx.2 →  | 21nnnn                               |   |   | 24.3728-xxxx.2 →<br> |   |   |        |                        |        |                         |        |                            |         |                         |  |                         |  |                            |  |                                      |  |                                      |   |
|   | 24.3ddx-xxxx.5 →  | 24nnnn                               |   |   |   |   |   |        |                        |        |                         |        |                            |         |                         |  |                         |  |                            |  |                                      |  |                                      |   |
|   | 11.0441-ddxx.2 →  | 25nnnn                               |   |   |   |   |   |        |                        |        |                         |        |                            |         |                         |  |                         |  |                            |  |                                      |  |                                      |   |
|   | 13.0441-ddxx.2 →  | 25nnnn                               |   |   |   |   |   |        |                        |        |                         |        |                            |         |                         |  |                         |  |                            |  |                                      |  |                                      |   |
|   | 11.0230-xxxx.2 →  | 26nnnn                               |   |   |   |   |   |        |                        |        |                         |        |                            |         |                         |  |                         |  |                            |  |                                      |  |                                      |   |
|   | 24.0101-xxxx.2 →  | 26nnnn                               |   |   |   |   |   |        |                        |        |                         |        |                            |         |                         |  |                         |  |                            |  |                                      |  |                                      |   |
| ▲ 11.0101-xxxx.2 →  | 26nnnn  |                                      |   |   |   |   |   |        |                        |        |                         |        |                            |         |                         |  |                         |  |                            |  |                                      |  |                                      |   |
| 11.8116-xxxx.1 →  | 39nnnn  |                                      |   |   |   |   |   |        |                        |        |                         |        |                            |         |                         |  |                         |  |                            |  |                                      |  |                                      |   |

nnnn = Nessun riferimento a codice ATE (esteso).

dd = Dimensione nominale

- ▲ E' possibile anche 24. con un sistema di numerazione uguale.
- E' possibile anche 03., 24. e 83. con un sistema di numerazione uguale.

La ristampa anche parziale di questo catalogo può essere effettuata solo con nostro permesso. Richieste di sostituzione in base ai dati di questo catalogo non possono essere accettate. Salvo modifiche. Un riferimento nei nostri documenti ai numeri dei particolari di ricambio del produttore dell'autovettura viene fatto esclusivamente a scopo comparativo. L'utilizzo di questi dati in fatture al proprietario dell'autovettura non è ammissibile.

La molteplicità dei modelli e delle parti di ricambio di alcuni costruttori di autoveicoli non sempre consente una correlazione esatta. Si consiglia quindi di fare particolarmente attenzione alle osservazioni riportate nel catalogo ed alle descrizioni delle parti di ricambio.

# Use así el K21-H

| Grupo de producto           |   | Modelo                          | periodo de montaje (desde/hasta) |                         | Referencias ATE         |  | Indicaciones (repuesto)  |                                      |                    |   |                          |
|-----------------------------|---|---------------------------------|----------------------------------|-------------------------|-------------------------|--|--|--------------------------------------|--------------------|---|--------------------------|
| Eje delantero-/ trasero     | Número de chasis (desde/hasta)            | Indicaciones (vehículo)         | Referencia corta                 | Información adicional   |                         |  |  |                                      |                    |   |                          |
| kW                          |   |                                 |                                  |                         |                         |  |  |                                      |                    |   |                          |
| <b>AUDI A4 CABRIO (02-)</b> |   |                                 |                                  |                         |                         |  |  |                                      |                    |   |                          |
|                             | 1,8 T<br>1,8 T Quattro<br>2,0<br>2,0 TFSI | ◀ 120<br>◀ 120<br>◀ 96<br>◀ 120 | 8E-55-999999<br>8E-55-400001     | 04.02<br>05.03<br>05.04 | 08.06<br>08.06<br>08.06 | PR: 1LB,1LE<br>PR: 1LB,1LE<br>PR: 1LB,1LE<br>PR: 1LB,1LE | 11.3571-8522.2<br>11.3571-8521.2<br>11.0441-5704.2<br>11.0101-5409.2 | 220320<br>220319<br>250034<br>260035 | <br>+ ESP<br>+ ESP | D=57, - Halter<br>D=57, - Halter<br>Dichtungssatz<br>Hülsensatz | ATE<br>ATE<br>ATE<br>ATE |
| *                           |   | **                              |                                  |                         |                         |  | ***  |                                      | ****               |   |                          |

## \*Grupo de producto



Servofreno



Cable de freno de mano



Cilindro maestro



Corrector de frenado



Depósito



Cilindro transmisor de embrague



Pinza de freno



Cilindro receptor de embrague



Tubo flexible de freno



Tubo flexible de embrague



Cilindro de rueda



Cable de embrague

## \*\*Dirección

- ◀ Volante a la izquierda
- ▶ Volante a la derecha

## \*\*\*\*Fabricante

|     |                         |
|-----|-------------------------|
| ATE | Continental Teves (ATE) |
| AKE | Akebono                 |
| AIS | Aisin                   |
| AP  | AP Lockheed             |
| BDX | Bendix                  |
| BOS | Bosch                   |
| BRE | Brembo                  |
| CIT | Citroën                 |
| DEL | Delco                   |
| FI  | Fiat                    |
| FTE | FTE Automotive          |
| LUC | Lucas (TRW)             |
| MAN | Mando                   |
| NIS | Nissin                  |
| PER | Perrot                  |
| SUM | Sumitomo                |
| TOK | Tokico                  |
| VW  | Volkswagen              |

## \*\*\*Posición de montaje

- ⬆ adelante
- ⬇ atrás
- ⬅ izquierda
- ➡ derecha
- ⬆ izquierda arriba
- ⬇ izquierda abajo
- ⬆ derecha arriba
- ⬇ derecha abajo
- ◻ medio
- ⬆ arriba
- ⬇ abajo
- ◻ eje delantero
- ⬆ izquierda adelante
- ⬆ derecha adelante
- ◻ eje trasero
- ⬆ izquierda atrás
- ⬆ derecha atrás

Todas las indicaciones de posición se refieren siempre al sentido de la marcha.













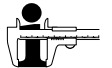

## Abreviaturas

|      |   |     |   |                      |                                       |  |
|------|---|-----|---|----------------------|---------------------------------------|--|
| -    | Sin / no                                  | Gz  | Cilindro transmisor de embrague           | S                    | Tornillo para pinza/tornillo querfija | Break                                      |
| +    | Con / solo / para                         | HEB | Palanca                                   | THz                  | Cilindro maestro tándem               | Coupé                                      |
| AUT  | Reajuste automático                       | HZ  | Cilindro maestro                          | V                    | Ventilado                             | Cabrióle                                   |
| B    | Recubierto                                | L   | Aleación especial                         | WE                   | Dispositivo de desgaste               | Autobús                                    |
| BG   | Limitador de frenado                      | L = | Largo                                     | WK                   | Contacto de desgaste                  | Furgón                                     |
| BR   | Corrector de frenado                      | Nz  | Cilindro receptor de embrague             | Zub                  | Accesorios                            | Portón trasero alargado                    |
| BRE  | Regulador de rosca                        | PD  | PowerDisc                                 | Latiguillo + tubería |                                       | Camión con plataforma/Chasis Serie         |
| BRES | Juego regulador de rosca                  | Rz  | Cilindro de rueda                         | 2-puertas            |                                       | DKW Clase maestra/Clase especial/Universal |
| BRL  | Corrector de frenado dependiente de carga | RzR | Cilindro de rueda con regulador integrado | 3-puertas            |                                       | FAUN carretilla (Kraka)                    |
| D =  | Diámetro                                  |     |   | 4-puertas            |                                       | Furgoneta                                  |
|      |   |     |   | 5-puertas            |                                       |  |
|      |   |     |   | Berlina              |                                       |  |





# Información artículos

|    |   | REF. CORTA   |   |    |    | REF. CORTA   |    |
|---|--|--|--|---|--|--|---|
|    | 03.6199-xxxx.4 →<br>03.61dy-xxxx.4 →<br>03.67dy-xxxx.4 →<br>03.68dy-xxxx.4 →<br>03.69dy-xxxx.4 →<br>03.77dy-xxxx.4 →<br>03.78dy-xxxx.4 →<br>03.78dy-xxxx.4 →<br>03.78dy-xxxx.4 →<br>03.78dy-xxxx.4 →<br>03.78dy-xxxx.4 →<br>03.78dy-xxxx.4 → | 30nnnn<br>30nnnn<br>30nnnn<br>30nnnn<br>30nnnn<br>30nnnn<br>30nnnn<br>30nnnn<br>30nnnn<br>30nnnn<br>30nnnn<br>30nnnn | Refuerzo de la presión de frenada<br>T50<br>T51<br>T52/3<br>T52<br>T53<br>T52/4<br>T52/4<br>T52/4Z<br>T52/5<br>T52/5Z<br>T55/1<br>T55/1Z | <br><br><br><br><br><br><br><br> | ▲ 03.27dd-xxxx.3 →<br>▲ 03.32dd-xxxx.3 →<br>03.040x-xxdd.2 →<br>03.0470-xxdd.2 →<br>24.3727-xxxx.2 →<br>■ 83.1xxx-xxxx.3 →<br>■ 83.5yxx-LLLL.3 →<br>■ 83.6yxx-LLLL.3 →<br>■ 83.7yxx-LLLL.3 →<br>03.20dd-xxxx.3 →<br>03.21dd-xxxx.3 →<br>03.23dd-xxxx.3 →<br>03.31dd-xxxx.3 →<br>03.0370-xxdd.2 →<br>03.3508-xxxx.x →<br>03.3509-xxxx.x →<br>03.3558-xxxx.x →<br>03.0101-xxxx.2 →<br>▲ 11.3ddx-xxxx.2 →<br>11.9ddx-xxxx.2 →<br>▲ 13.2ddx-xxxx.2 →<br>▲ 13.4ddx-xxxx.2 →<br>13.9ddx-xxxx.2 →<br>24.3ddx-xxxx.5 →<br>11.0441-ddxx.2 →<br>13.0441-ddxx.2 →<br>11.0230-xxxx.2 →<br>24.0101-xxxx.2 →<br>▲ 11.0101-xxxx.2 →<br>11.8116-xxxx.1 → | 02nnnn<br>02nnnn<br>06nnnn<br>06nnnn<br>58xxxx<br>33nnnn<br>33nnnn<br>33nnnn<br>33nnnn<br>01nnnn<br>01nnnn<br>01nnnn<br>01nnnn<br>05xxdd<br>31nnnn<br>31nnnn<br>31nnnn<br>39nnnn<br>22nnnn<br>22nnnn<br>21nnnn<br>21nnnn<br>21nnnn<br>21nnnn<br>24nnnn<br>25nnnn<br>25nnnn<br>26nnnn<br>26nnnn<br>26nnnn<br>26nnnn<br>39nnnn | Cilindro de rueda de un pistón<br>Cilindro de rueda<br>Juego de reparación (con pistón)<br>Juego de reparación de juntas (sin pistón)<br>Cable de freno mano<br>Latiguillo + tubería<br>Tubo flexible de freno-/embrague<br>Tubo flexible de freno-/embrague<br>Tubo flexible de freno-/embrague<br>y = 1: Roscas 1 × interior/1 × exterior<br>y = 2: Roscas 2 × interior<br>y = 3: Roscas 2 × exterior<br>Corrector de frenado (BR)<br>Limitador de frenado (BG)<br>Regulador de rosca (BRE)<br>Corrector de frenado dependiente de la carga (BRL)<br>Juego de reguladores de rosca (BRES)<br>35/3 marrón (4)<br>Característica / marcación de color (número de conexiones)<br>Cilindro transmisor de embrague (p.ej. 03.2419-: Ø=19,05)<br>Juego de reparación de juntas<br>Cilindro receptor de embrague (e.ej. 03.2525-: Ø=25,40)<br>Juego de reparación de juntas<br>Cable de embrague |
| <p>nnnn = Las cuatro últimas cifras son números correlativos.</p> <p>dd = Medida nominal</p> <p>▲ También posible el 24. en caso del mismo sistema de numeración.<br/>                     ■ También posible el 03., 24. y 83. en caso del mismo sistema de numeración de numeración.</p> |  |  |  |   |  |  |   |

| d       | y                                |
|---------|----------------------------------|
| 2 = 6"  | 0 = Simple                       |
| 3 = 7"  | 5 = Tandem                       |
| 4 = 8"  | 0 = Simple                       |
| 5 = 9"  | 3 = Simple BA                    |
| 6 = 10" | 5 = Simple                       |
|         | 8 = Simple BA                    |
|         | BA = Asistente de frenado        |
|         | Z = Aparato de freno por tirante |

Sólo se permite la reproducción total o parcial con nuestra autorización. No se atenderán reclamaciones motivadas por los datos contenidos en este catálogo. Quedan reservados los derechos de modificaciones en la construcción. Si en nuestros documentos hacemos referencia a números de piezas de recambio de los constructores de vehículos, esto únicamente es para establecer una comparación. No está permitido el uso de datos de este tipo en las facturas emitidas al propietario del vehículo.

La variedad de modelos y de piezas de recambio de algunos constructores de vehículos no permite siempre una distribución exacta. Por este motivo, por favor fíjese atentamente en las observaciones y descripciones de las piezas de recambio detalladas en el catálogo.

# Zo gebruikt u de K21-H

| Produktgroep                | Voertuigtype            | Inbouwperiode (van/tot) | ATE-artikelnummer (lang) | Opmerking (artikel) |
|-----------------------------|-------------------------|-------------------------|--------------------------|---------------------|
| Voor- achteras              | Chassisnummer (van/tot) | Opmerking (voertuig)    | ATE-artikelnummer (kort) | Info                |
| kW                          |                         |                         |                          |                     |
| <b>AUDI A4 CABRIO (02-)</b> |                         |                         |                          |                     |
|                             | 120                     | 04.02                   | PR: 1LB,1LE              | 11.3571-8522.2      |
|                             | 120                     | 05.03                   | PR: 1LB,1LE              | 220320              |
|                             | 96                      | 08.06                   | PR: 1LB,1LE              | 11.3571-8521.2      |
|                             | 120                     | 05.04                   | PR: 1LB,1LE              | 11.0441-5704.2      |
|                             | 8E-55-400001            | 08.06                   | PR: 1LB,1LE              | 250034              |
|                             |                         | 08.06                   | PR: 1LB,1LE              | 260035              |
|                             |                         |                         |                          | + ESP               |
|                             |                         |                         |                          | + ESP               |
|                             |                         |                         |                          | D=57, - Halter      |
|                             |                         |                         |                          | D=57, - Halter      |
|                             |                         |                         |                          | Dichtungssatz       |
|                             |                         |                         |                          | Hülsensatz          |

## \*Productgroepen



Remkrachtversterker



Handremkabel



Hoofdremcilinder



Remkrachtregelaar



Remvloeistof-reservoir



Koppelingshoofdcilinder



Remzadel



Koppelingshulpcilinder



Remslangen



Koppelingsslang



Wielremcilinder



Koppelingskabel

## \*\*Soort besturing

- ◀ links gestuurd
- ▶ rechts gestuurd

## \*\*\*\*Fabrikant

|     |                         |
|-----|-------------------------|
| ATE | Continental Teves (ATE) |
| AKE | Akebono                 |
| AIS | Aisin                   |
| AP  | AP Lockheed             |
| BDX | Bendix                  |
| BOS | Bosch                   |
| BRE | Brembo                  |
| CIT | Citroën                 |
| DEL | Delco                   |
| FI  | Fiat                    |
| FTE | FTE Automotive          |
| LUC | Lucas (TRW)             |
| MAN | Mando                   |
| NIS | Nissin                  |
| PER | Perrot                  |
| SUM | Sumitomo                |
| TOK | Tokico                  |
| VW  | Volkswagen              |





















## \*\*\*Inbouwpositie

- ⬆ voor
- ⬇ achter
- ⬅ links
- ➡ rechts
- ⬆ links voor
- ⬇ links achter
- ⬅ rechts voor
- ➡ rechts achter
- midden
- ⬆ boven
- ⬇ onder
- vooras
- ⬆ vooras links
- ⬇ vooras rechts
- achteras
- ⬆ achteras links
- ⬇ achteras rechts

Alle positieopgaven hebben altijd betrekking op de rijrichting.

## Afkortingen

|      |                                    |     |   |     |                        |  |
|------|------------------------------------|-----|---|-----|------------------------|--|
| -    | Zonder / niet                      | HEB | Handel                                  | V   | Geventileerd           | Combi  |
| +    | Met / alleen / voor                | HZ  | Hoofdremcilinder                        | WE  | Warschuwingsinrichting | Coupé  |
| AUT  | Automatische instelling            | L   | Gelegeerd / hoog gecarboniseerd         | WK  | Warschuwingscontact    | Cabrio                                       |
| B    | Coated                             | L = | Lengte                                  | Zub | Accessoires            | Bus  |
| BG   | Remkrachtbegrenzer                 | Nz  | Hulpcilinder                            |     |                        | Bestelwagen                                  |
| BR   | Remkrachtregelaar                  | PD  | PowerDisc                               |     |                        | Fastback                                     |
| BRE  | Inschroefregelaar                  | Rz  | Wielcilinder                            |     |                        | Pickup/chassis                               |
| BRES | Inschroefregelaarset               | RzR | Wielcilinder met geïntegreerde regelaar |     |                        | Serie  |
| BRL  | Lastafhankelijke remkrachtregelaar | S   | Fixeerschroef / zadelschroef            |     |                        | DKW meesterklasse/speciale klasse/universeel |
| D =  | Diameter                           | THz | Tandem-hoofdcilinder                    |     |                        | FAUN trekkers                                |
| Gz   | Hoofdcilinder                      |     |   |     |                        | Vrachtauto's                                 |

|    |   | VERKORT NUMMER   |   |    |    | VERKORT NUMMER   |   |
|---|--|--|--|---|--|--|--|
|    | 03.6199-xxxx.4 →<br>03.61dy-xxxx.4 →<br>03.67dy-xxxx.4 →<br>03.68dy-xxxx.4 →<br>03.69dy-xxxx.4 →<br>03.77dy-xxxx.4 →<br>03.78dy-xxxx.4 →<br>03.78dy-xxxx.4 →<br>03.78dy-xxxx.4 →<br>03.78dy-xxxx.4 →<br>03.78dy-xxxx.4 →<br>03.78dy-xxxx.4 →         | 30nnnn<br>30nnnn<br>30nnnn<br>30nnnn<br>30nnnn<br>30nnnn<br>30nnnn<br>30nnnn<br>30nnnn<br>30nnnn<br>30nnnn<br>30nnnn | Rembekrachtiger<br>T50<br>T51<br>T52/3<br>T52<br>T53<br>T52/4<br>T52/4<br>T52/4Z<br>T52/5<br>T52/5Z<br>T55/1<br>T55/1Z   | <br><br><br><br> | ▲ 03.27dd-xxxx.3 →<br>▲ 03.32dd-xxxx.3 →<br>03.040x-xxdd.2 →<br>03.0470-xxdd.2 →<br>24.3727-xxxx.2 →<br>■ 83.1xxx-xxxx.3 →<br>■ 83.5yxx-LLLL.3 →<br>■ 83.6yxx-LLLL.3 →<br>■ 83.7yxx-LLLL.3 → | 02nnnn<br>02nnnn<br>06nnnn<br>06nnnn<br>58xxxx<br>33nnnn<br>33nnnn<br>33nnnn<br>33nnnn | enkelzijdig werkende wielremcilinder<br>Wielremcilinder<br>Reparatieset (met zuiger)<br>Pakkingset (zonder zuiger)<br>Handremkabel<br>Remslang + pijpleiding<br>Rem-/koppelingsslang<br>Rem-/koppelingsslang<br>Rem-/koppelingsslang |
|    | ▲ 03.20dd-xxxx.3 →<br>▲ 03.21dd-xxxx.3 →<br>▲ 03.23dd-xxxx.3 →<br>▲ 03.31dd-xxxx.3 →<br>03.0370-xxdd.2 →   | 01nnnn<br>01nnnn<br>01nnnn<br>01nnnn<br>05xxdd   | Tandem-hoofdcilinder trapsgewijs<br>Tandem-hoofdcilinder<br>Hoofdremcilinder trapsgewijs<br>Hoofdremcilinder<br>(bijv. 03.2122-: Ø=22,20)<br>Reparatieset  | <br>  | 03.60xx-xxxx.3 →<br>03.65xx-xxxx.3 →<br>03.0101-xxxx.2 →   | 32nnnn<br>32nnnn<br>32nnnn   | Remkrachtregelaar (BR)<br>Remkrachtbegrenzer (BG)<br>Inschroefregelaar (BRE)<br>Lastafhankelijke Remkrachtregelaar (BRL)<br>Inschroefregelaar-set (BRES)   |
|  | 03.3508-xxxx.x →<br>03.3509-xxxx.x →<br>03.3558-xxxx.x →<br>03.0101-xxxx.2 →   | 31nnnn<br>31nnnn<br>31nnnn<br>39nnnn   | Remvloestofreservoir<br>Remvloestofreservoir<br>Remvloestofreservoir<br>Reparatieset   |   | 35/3 bruin (4)   |  | Kenmerk, kleurmarkering<br>(aantal aansluitingen)  |
|  | ▲ 11.3ddx-xxxx.2 →<br>11.9ddx-xxxx.2 →<br>▲ 13.2ddx-xxxx.2 →<br>▲ 13.4ddx-xxxx.2 →<br>13.9ddx-xxxx.2 →<br>24.3ddx-xxxx.5 →<br>11.0441-ddxx.2 →<br>13.0441-ddxx.2 →<br>11.0230-xxxx.2 →<br>24.0101-xxxx.2 →<br>▲ 11.0101-xxxx.2 →<br>11.8116-xxxx.1 → | 22nnnn<br>22nnnn<br>21nnnn<br>21nnnn<br>21nnnn<br>24nnnn<br>25nnnn<br>25nnnn<br>26nnnn<br>26nnnn<br>26nnnn<br>39nnnn | Vuistzadel<br>Vuistzadel<br>2-cil. vast remzadel<br>4-cil. vast remzadel<br>Vast remzadel<br>Ruilzadel vuistzadel<br>Pakkingset<br>Pakkingset<br>Vuistzadelhouder -set<br>(houder, centreerstift)<br>Inbouwset<br>(geleidebussen set, geleidbouten)<br>Geleidebussen set<br>Bevestigingsveer | <br><br>   | ▲ 03.24dd-xxxx.3 →<br>03.0350-ddxx.2 →<br>▲ 03.25dd-xxxx.3 →<br>03.0450-ddxx.2 →<br>24.3728-xxxx.2 →   | 03nnnn<br>07ddxx<br>04nnnn<br>08ddxx<br>59xxxx   | Koppelingshoofdcilinder<br>(bijv. 03.2419-: Ø=19,05)<br>Pakkingset<br>Koppelingshoofdcilinder<br>(bijv. 03.2419-: Ø=19,05)<br>Pakkingset<br>Koppelingshoofdcilinder<br>(bijv. 03.3219-: Ø=19,08)<br>Pakkingset                       |

| d       | y                           |
|---------|-----------------------------|
| 0       | Enkelvoudig apparaat        |
| 5       | Tandem apparaat             |
| 2 = 6"  |                             |
| 3 = 7"  |                             |
| 4 = 8"  | 0 = Enkelvoudig apparaat    |
| 5 = 9"  | 3 = Enkelvoudig apparaat BA |
| 6 = 10" | 5 = Enkelvoudig apparaat    |
|         | 8 = Enkelvoudig apparaat BA |
|         | BA = Remassistent           |
|         | Z = Trekankerremapparaten   |

nnnn = de laatste vier cijfers houden een tellernummer in.

dd = Standaard Maat

▲ Ook 24. met hetzelfde volgnummer mogelijk

■ Ook 03., 24. en 83. met hetzelfde volgnummer mogelijk.

Het nadrukken ook gedeeltelijk, is alleen met onze toestemming toegestaan. Schadeclaims op basis van informatie in deze catalogus kunnen niet worden aanvaard. Constructiewijzigingen voorbehouden. Voor zover wij in onze documentatie refereren naar onderdeelnummers van de voertuigfabrikant, dienen die slechts om te vergelijken. Een gebruik van dergelijke gegevens in rekeningen aan de voertuigeigenaar is niet geoorloofd.

De verschillen in modellen en onderdelen van enige voertuigfabrikanten maken niet altijd een nauwkeurige indeling mogelijk. Let daarom vooral op de in de catalogus vermelde opmerkingen en onderdeelbeschrijvingen.

# Sådan anvendes K21-H

| Produktgruppe               | Køretøjstyper        | Montageperiode (fra/til) | ATE-artikelnr. (langt) | Bemærkning (artikel) |
|-----------------------------|----------------------|--------------------------|------------------------|----------------------|
| For-/bagaksel               | Stelnummer (fra/til) | Bemærkning (køretøj)     | ATE-artikelnr. (kort)  | Artikel              |
|                             | kW                   |                          |                        |                      |
| <b>AUDI A4 CABRIO (02-)</b> |                      |                          |                        |                      |
|                             | 120                  | 04.02                    | 11.3571-8522.2         | + ESP                |
|                             | 120                  | 05.03                    | 11.3571-8521.2         | + ESP                |
|                             | 96                   | 08.06                    | 11.0441-5704.2         |                      |
|                             | 120                  | 08.06                    | 11.0101-5409.2         |                      |
|                             | 8E-55-400001         |                          |                        |                      |

## \*Produktgruppen



Bremseforstærker



Håndbremsekabel



Hovedbremsecylinder



Bremsekraftfordeler



Ekspansionsbeholder



Koblingsmastercylinder



Bremsecaliper



Koblingsslavecylinder



Bremseslange



Koblingsslange



Hjulcylinder



Koblingskabel

## \*\*Styring

◀ Venstrestyring

▶ Højrestyring

## \*\*\*\*Producentkode

|     |                         |
|-----|-------------------------|
| ATE | Continental Teves (ATE) |
| AKE | Akebono                 |
| AIS | Aisin                   |
| AP  | AP Lockheed             |
| BDX | Bendix                  |
| BOS | Bosch                   |
| BRE | Brembo                  |
| CIT | Citroën                 |
| DEL | Delco                   |
| FI  | Fiat                    |
| FTE | FTE Automotive          |
| LUC | Lucas (TRW)             |
| MAN | Mando                   |
| NIS | Nissin                  |
| PER | Perrot                  |
| SUM | Sumitomo                |
| TOK | Tokico                  |
| VW  | Volkswagen              |























## \*\*\*Monteringssted

|   |                    |
|---|--------------------|
| ⬆ | for                |
| ⬇ | bag                |
| ⬅ | venstre            |
| ➡ | højre              |
| ⬆ | foran til venstre  |
| ⬇ | bagved til venstre |
| ⬆ | foran til højre    |
| ⬇ | bagved til højre   |
| ■ | midt               |
| ⬆ | oppe               |
| ⬇ | nede               |
| ■ | Foraksel           |
| ■ | Venstre foraksel   |
| ■ | Højre foraksel     |
| ■ | Bagaksel           |
| ■ | Venstre bagaksel   |
| ■ | Højre bagaksel     |

Samtlige monteringssteder er altid i relation til kørselsretningen.

## Forkortelser

|      |                                  |     |                                       |     |                           |                             |
|------|----------------------------------|-----|---------------------------------------|-----|---------------------------|-----------------------------|
| -    | Uden / ikke                      | HEB | Arm                                   | V   | Ventileret                | Kombination                 |
| +    | Med / kun / til                  | HZ  | Hovedcylinder                         | WE  | Advarselsanordning        | Coupé                       |
| AUT  | Automatisk indstilling           | L   | Legeret / højt kulstofindhold         | WK  | Advarselskontakt          | Cabriolet                   |
| B    | Coated                           | L = | Længde                                | Zub | Tilbehør                  | bus                         |
| BG   | Bremsekraftbegrænser             | Nz  | Slavecylinder                         |     |                           | kassevogn                   |
| BR   | Bremsekraftfordeler              | PD  | PowerDisc                             |     |                           | Hatchback                   |
| BRE  | Iskruningsregulator              | Rz  | Hjulcylinder                          |     | Bremseslange + rørledning | Lad/chassis                 |
| BRES | Iskruningsregulatorsæt           | RzR | Hjulcylinder med integreret regulator |     | 2-dørs                    | Serie                       |
| BRL  | Bremsekraftfordeler lastafhængig | S   | Fastgørings skrue / caliperskrue      |     | 3-dørs                    | DKW mesterklasse/særklasse/ |
| D =  | Diameter                         | THz | Tandem-hovedcylinder                  |     | 4-dørs                    | universal                   |
| Gz   | Mastercylinder                   |     |                                       |     | 5-dørs                    | FAUN Kraka                  |
|      |                                  |     |                                       |     | Limousine                 | Transporter                 |

|    |   | KORT NUMMER  |   |    |    | KORT NUMMER  |    |
|---|--|--|--|---|--|--|---|
|    | 03.6199-xxxx.4 →<br>03.61dy-xxxx.4 →<br>03.67dy-xxxx.4 →<br>03.68dy-xxxx.4 →<br>03.69dy-xxxx.4 →<br>03.77dy-xxxx.4 →<br>03.78dy-xxxx.4 →<br>03.78dy-xxxx.4 →<br>03.78dy-xxxx.4 →<br>03.78dy-xxxx.4 →<br>03.78dy-xxxx.4 →                             | 30nnnn<br>30nnnn<br>30nnnn<br>30nnnn<br>30nnnn<br>30nnnn<br>30nnnn<br>30nnnn<br>30nnnn<br>30nnnn<br>30nnnn                     | Bremsforstærker<br>T50<br>T51<br>T52/3<br>T52<br>T53<br>T52/4<br>T52/4<br>T52/4Z<br>T52/5<br>T52/5Z<br>T55/1<br>T55/1Z   | <br><br><br><br><br><br><br><br> | ▲ 03.27dd-xxxx.3 →<br>▲ 03.32dd-xxxx.3 →<br>03.040x-xxdd.2 →<br>03.0470-xxdd.2 →<br>24.3727-xxxx.2 →<br>■ 83.5yx-LLLL.3 →<br>■ 83.1xxx-xxxx.3 →<br>■ 83.6yx-LLLL.3 →<br>■ 83.7yx-LLLL.3 →<br>03.60xx-xxxx.3 →<br>03.65xx-xxxx.3 →<br>03.0101-xxxx.2 →<br>35/3 brun (4)<br>▲ 03.24dd-xxxx.3 →<br>03.0350-ddxx.2 →<br>▲ 03.25dd-xxxx.3 →<br>03.0450-ddxx.2 →<br>24.3728-xxxx.2 → | 02nnnn<br>02nnnn<br>06nnnn<br>06nnnn<br>58xxxx<br>33nnnn<br>33nnnn<br>33nnnn<br>33nnnn<br>32nnnn<br>32nnnn<br>32nnnn<br>03nnnn<br>07ddxx<br>04nnnn<br>08ddxx<br>59xxxx | Ensidig virkende hjulcylinder<br>Hjulcylinder<br>Reparationssæt (med stempel)<br>Pakningssæt (uden stempel)<br>Håndbremsekabel<br>Bremseslange + rørledning<br>Bremse-/Koblingslange<br>Bremse-/Koblingslange<br>Bremse-/Koblingslange<br>y = 1: Gevind 1× indvendig/1× udvendig<br>y = 2: Gevind 2× indvendig<br>y = 3: Gevind 2× udvendig<br>Bremsekraftfordeler (BR)<br>Bremsekraftbegrænser (BG)<br>Iskruningsregulator (BRE)<br>Bremsekraftfordeler lastafhængig (BRL)<br>Iskruningsregulator-sæt (BRES)<br>Kendetegn, farvemærkning<br>(Antal tilslutninger)<br>Koblings-mastercylinder<br>(F.eks. 03.2419-: Ø=19,05)<br>Pakningssæt<br>Koblings-slavecylinder<br>((F.eks. 03.2525-: Ø=25,40)<br>Pakningssæt<br>Koblingskabel |
|    | ▲ 03.20dd-xxxx.3 →<br>▲ 03.21dd-xxxx.3 →<br>▲ 03.23dd-xxxx.3 →<br>▲ 03.31dd-xxxx.3 →<br>03.0370-xxdd.2 →   | 01nnnn<br>01nnnn<br>01nnnn<br>01nnnn<br>05xxdd   | Tandem-hovedcylinder trindelt<br>Tandem-hovedcylinder<br>Trin-hovedcylinder<br>Hovedcylinder<br>(F.eks. 03.2122-: Ø=22,20)<br>Reparationssæt   |    | LLLL<br>LLLL   |  |   |
|  | 03.3508-xxxx.x →<br>03.3509-xxxx.x →<br>03.3558-xxxx.x →<br>03.0101-xxxx.2 →   | 31nnnn<br>31nnnn<br>31nnnn<br>39nnnn   | Ekspansionsbeholder<br>Ekspansionsbeholder<br>Ekspansionsbeholder<br>Reparationssæt  |   |  |  |   |
|  | ▲ 11.3ddx-xxxx.2 →<br>11.9ddx-xxxx.2 →<br>▲ 13.2ddx-xxxx.2 →<br>▲ 13.4ddx-xxxx.2 →<br>13.9ddx-xxxx.2 →<br>24.3ddx-xxxx.5 →<br>11.0441-ddxx.2 →<br>13.0441-ddxx.2 →<br>11.0230-xxxx.2 →<br>24.0101-xxxx.2 →<br>▲ 11.0101-xxxx.2 →<br>11.8116-xxxx.1 → | 22nnnn<br>22nnnn<br>21nnnn<br>21nnnn<br>21nnnn<br>24nnnn<br>25nnnn<br>25nnnn<br>26nnnn<br>26nnnn<br>26nnnn<br>26nnnn<br>39nnnn | Flydende bremsecaliper<br>Flydende bremsecaliper<br>2-cyl. Fast bremsecaliper<br>4-cyl. Fast bremsecaliper<br>Fast bremsecaliper<br>Udskiftningssæt Flydende bremsecaliper<br>Pakningssæt<br>Pakningssæt<br>Flydende bremsesattelholder-sæt<br>(holder, glidemuffesæt, styrebolte)<br>Monteringssæt<br>(glidemuffesæt, styrebolte)<br>Glidemuffesæt<br>Holdefjeder | <br><br>   |  |  |   |

| d       | y                                       |
|---------|---|
| 0       | Enkeltkreds enhed                       |
| 5       | Tandemenhed                             |
| 2 = 6"  | 0 = Enkeltkreds enhed                   |
| 3 = 7"  | 3 = Enkeltkreds enhed BA                |
| 4 = 8"  | 5 = Enkeltkreds enhed                   |
| 5 = 9"  | 8 = Enkeltkreds enhed BA                |
| 6 = 10" | BA = Bremseassistent                    |
|         | Z = Bremseenheder til ækanker trækanker |

nnnn = De sidste fire cifre svarer til et aritmetiknummer.

dd = Nominelt mål

▲ Også 24. mulig ved samme nummersystem.

■ Også 03., 24. og 83. mulig ved samme nummersystem.

Eftertryk, også i uddrag, er kun tilladt efter vores godkendelse. Erstatningskrav som følge af angivelser i dette katalog godkendes ikke. Forbehold for konstruktionsændringer. Så vidt vi refererer til køretøjproducentens reservedelsnummer i vores bilag, bør disse kun anvendes til sammenligningsformål. En anvendelse af sådanne angivelser på fakturaer til ejeren af køretøjet er ikke tilladt.

Køretøjproducenterne har mange modeller og reservedele. Derfor er en nøjagtig angivelse ikke altid mulig. Vær derfor specielt opmærksom på de angivne bemærkninger og reservedelsbeskrivelser i kataloget.

# Så använder du K21-H

| Produktgrupper              | Fordonstyper                              | monteringstid (fom/tom)         |                              | ATE-artikelnummer (långt) |                         | Kommentar (artikel)                                      |  |                                      |      |                |   |                          |
|-----------------------------|---|---------------------------------|------------------------------|---------------------------|-------------------------|--|--|--------------------------------------|------|----------------|---|--------------------------|
| Fram-/bakaxel               | Chassinummer (från/till)                  | Kommentar (fordon)              |                              | ATE-artikelnummer (kort)  |                         | Artikeldefinition  |  |                                      |      |                |   |                          |
|                             |   |                                 |                              |                           |                         |  |  |                                      |      |                |   |                          |
| <b>AUDI A4 CABRIO (02-)</b> |   |                                 |                              |                           |                         |  |  |                                      |      |                |   |                          |
|                             | 1,8 T<br>1,8 T Quattro<br>2,0<br>2,0 TFSI | ◀ 120<br>◀ 120<br>◀ 96<br>◀ 120 | 8E-55-999999<br>8E-55-400001 | 04.02<br>05.03<br>05.04   | 08.06<br>08.06<br>08.06 | PR: 1LB,1LE<br>PR: 1LB,1LE<br>PR: 1LB,1LE<br>PR: 1LB,1LE | 11.3571-8522.2<br>11.3571-8521.2<br>11.0441-5704.2<br>11.0101-5409.2 | 220320<br>220319<br>250034<br>260035 |      | + ESP<br>+ ESP | D=57, - Halter<br>D=57, - Halter<br>Dichtungssatz<br>Hülsensatz | ATE<br>ATE<br>ATE<br>ATE |
| *                           |   | **                              |                              |                           |                         |  | ***  |                                      | **** |                |   |                          |

## \*Produktgrupper



**Bromskraftförstärkare**



**Handbromswire**



**Huvudbromscylinder**



**Bromskraftregulator**



**Utjämningsbehållare**



**Kopplingshuvudcylinder**



**Bromssadel**



**Kopplingslavcylinder**



**Bromsslang**



**Kopplings slang**



**Hjulcylinder**



**Kopplingslina**

## \*\*Styrning

◀ Vänsterstyrning

▶ Högerstyrning

## \*\*\*\*Tillverkarkod

|     |                         |
|-----|-------------------------|
| ATE | Continental Teves (ATE) |
| AKE | Akebono                 |
| AIS | Aisin                   |
| AP  | AP Lockheed             |
| BDX | Bendix                  |
| BOS | Bosch                   |
| BRE | Brembo                  |
| CIT | Citroën                 |
| DEL | Delco                   |
| FI  | Fiat                    |
| FTE | FTE Automotive          |
| LUC | Lucas (TRW)             |
| MAN | Mando                   |
| NIS | Nissin                  |
| PER | Perrot                  |
| SUM | Sumitomo                |
| TOK | Tokico                  |
| VW  | Volkswagen              |

## \*\*\*Inbyggnadsposition

|  |                  |
|--|------------------|
|  | Fram             |
|  | Bak              |
|  | Vänster          |
|  | Höger            |
|  | Vänster fram     |
|  | Vänster bak      |
|  | Höger fram       |
|  | Höger bak        |
|  | Mitten           |
|  | Upppe            |
|  | Nere             |
|  | Framaxel         |
|  | Framaxel vänster |
|  | Framaxel höger   |
|  | Bakaxel          |
|  | Bakaxel vänster  |
|  | Bakaxel höger    |

Alla positionsuppgifter ges anges alltid i färdriktning.















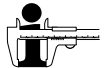





## Förkortningar

|      |                                 |     |                                       |     |                         |  |
|------|---------------------------------|-----|---------------------------------------|-----|-------------------------|--|
| -    | Utan / inte                     | HEB | Spak                                  | WE  | Varningsutrustning      | Kombi                                    |
| +    | Med /bara / för                 | HZ  | Huvudcylinder                         | WK  | Varningskontakt         | Coupé                                    |
| AUT  | Automatisk justering            | L   | Legerad / högkolad                    | Zub | Tillbehör               | Cabriolet                                |
| B    | Beskiktad                       | L = | Längd                                 |     |                         | Buss                                     |
| BG   | Bromskraftbegränsare            | Nz  | Slavcylinder                          |     |                         | Skåpbil                                  |
| BR   | Bromskraftregulator             | PD  | PowerDisc                             |     |                         | Fastback                                 |
| BRE  | Inskruvningsregulator           | Rz  | Hjulcylinder                          |     | Bromsslang + rörledning | Pickup/chassi                            |
| BRES | Inskruvningsregulatorsats       | RzR | Hjulcylinder med integrerad regulator |     | 2-dörrars               | Serie                                    |
| BRL  | Bromskraftregulator lastkännare | S   | Fixeringskrav / sadelskrav            |     | 3-dörrars               | DKW mästartklass/specialklass/universell |
| D =  | Diameter                        | THz | Tandemhuvudcylinder                   |     | 4-dörrars               | FAUN tungdragare (Kraka)                 |
| Gz   | Givarcylinder                   | V   | Ventilerad                            |     | 5-dörrars               | Transportbil                             |
|      |                                 |     |                                       |     | Limousine               |  |





# Produktinformationer

|    |   | KORTNUMMER   |    |    |    | KORTNUMMER   |   |
|---|--|--|---|---|--|--|--|
|    | 03.6199-xxxx.4 →<br>03.61dy-xxxx.4 →<br>03.67dy-xxxx.4 →<br>03.68dy-xxxx.4 →<br>03.69dy-xxxx.4 →<br>03.77dy-xxxx.4 →<br>03.78dy-xxxx.4 →<br>03.78dy-xxxx.4 →<br>03.78dy-xxxx.4 →<br>03.78dy-xxxx.4 →<br>03.78dy-xxxx.4 →<br>03.78dy-xxxx.4 →         | 30nnnn<br>30nnnn<br>30nnnn<br>30nnnn<br>30nnnn<br>30nnnn<br>30nnnn<br>30nnnn<br>30nnnn<br>30nnnn<br>30nnnn<br>30nnnn           | Bromskraftförstärkare<br>T50<br>T51<br>T52/3<br>T52<br>T53<br>T52/4<br>T52/4<br>T52/4Z<br>T52/5<br>T52/5Z<br>T55/1<br>T55/1Z  | <br><br><br><br> | ▲ 03.27dd-xxxx.3 →<br>▲ 03.32dd-xxxx.3 →<br>03.040x-xxdd.2 →<br>03.0470-xxdd.2 →<br>24.3727-xxxx.2 →<br>■ 83.1xxx-xxxx.3 →<br>■ 83.5yxx-LLLL.3 →<br>■ 83.6yxx-LLLL.3 →<br>■ 83.7yxx-LLLL.3 → | 02nnnn<br>02nnnn<br>06nnnn<br>06nnnn<br>58xxxx<br>33nnnn<br>33nnnn<br>33nnnn<br>33nnnn | Ensidigt verkande hjulcylander<br>Hjulcylander<br>Reparationssats (med kolv)<br>Tätningssats (utan kolv)<br>Handbromslina<br>Bromssläng + rörledning<br>Broms-/kopplingsläng<br>Broms-/kopplingsläng<br>Broms-/kopplingsläng<br>Broms-/kopplingsläng<br>y = 1: gänga 1× inner/1× ytter<br>y = 2: gänga 2× inner<br>y = 3: gänga 2× ytter<br>Bromskraftregulator (BR)<br>Bromskraftbegränsare (BG)<br>Inskruvningsregulator (BRE)<br>Bromskraftregulator lastavhängig (BRL)<br>Inskruvningsregulatorsats (BRES) |
|    | ▲ 03.20dd-xxxx.3 →<br>▲ 03.21dd-xxxx.3 →<br>▲ 03.23dd-xxxx.3 →<br>▲ 03.31dd-xxxx.3 →<br>03.0370-xxdd.2 →   | 01nnnn<br>01nnnn<br>01nnnn<br>01nnnn<br>05xxdd   | Tandemhuvudcylander stegad<br>Tandemhuvudcylander<br>Steghuvudcylander<br>Huvudcylander<br>(t. ex. 03.2122-: Ø=22,20)<br>Reparationssats  | <br><br>   | 03.60xx-xxxx.3 →<br>03.65xx-xxxx.3 →<br>03.0101-xxxx.2 →   | 32nnnn<br>32nnnn<br>32nnnn   | 35/3 braun (4)<br>märkning, färgmarkering<br>(antal anslutningar)  |
|  | 03.3508-xxxx.x →<br>03.3509-xxxx.x →<br>03.3558-xxxx.x →<br>03.0101-xxxx.2 →   | 31nnnn<br>31nnnn<br>31nnnn<br>39nnnn   | Utjämningsbehållare<br>Utjämningsbehållare<br>Utjämningsbehållare<br>Reparationssats  |   | 35/3 braun (4)   |  | märkning, färgmarkering<br>(antal anslutningar)  |
|  | ▲ 11.3ddx-xxxx.2 →<br>11.9ddx-xxxx.2 →<br>▲ 13.2ddx-xxxx.2 →<br>▲ 13.4ddx-xxxx.2 →<br>13.9ddx-xxxx.2 →<br>24.3ddx-xxxx.5 →<br>11.0441-ddxx.2 →<br>13.0441-ddxx.2 →<br>11.0230-xxxx.2 →<br>24.0101-xxxx.2 →<br>▲ 11.0101-xxxx.2 →<br>11.8116-xxxx.1 → | 22nnnn<br>22nnnn<br>21nnnn<br>21nnnn<br>21nnnn<br>24nnnn<br>25nnnn<br>25nnnn<br>26nnnn<br>26nnnn<br>26nnnn<br>26nnnn<br>39nnnn | Flytande bromsok<br>Flytande bromsok<br>Fast bromsok<br>4-cyl. fast bromsok<br>Fast bromsok<br>Utbytessadel flytande bromsok<br>Tätningssats<br>Tätningssats<br>Fäste flytande bromsok (fäste,<br>sats skjuthylsor, styrbult)<br>Inbyggnadssats<br>(sats skjuthylsor, styrbult)<br>Sats skjuthylsor<br>Klämfjäder | <br><br>   | ▲ 03.24dd-xxxx.3 →<br>03.0350-ddxx.2 →<br>▲ 03.25dd-xxxx.3 →<br>03.0450-ddxx.2 →<br>24.3728-xxxx.2 →   | 03nnnn<br>07ddxx<br>04nnnn<br>08ddxx<br>59xxxx   | Kopplingshuvudcylander<br>(t. ex. 03.2419-: Ø=19,05)<br>Tätningssats<br>Kopplingslavcylander<br>(t. ex. 03.2525-: Ø=25,40)<br>Tätningssats<br>Kopplingslina  |

nnnn = De sista fyra siffrorna motsvarar ett räknenummer.

dd = nominellt mått

▲ Även 24. möjlig vid samma nummertilldelningssystem.

■ Även 03., 24. och 83. möjlig vid samma nummertilldelningssystem.

Eftertryck – även delvis – är förbjudet utan vårt medgivande. Ersättningsanspråk pga uppgifterna i denna katalog godkänns ej. Konstruktionsändringar förbehålles. När vi hänvisar till fordonstillverkarens reservdelsnummer i våra underlag, så är det bara för jämförelsens skull. Dylåka uppgifter får inte anges på fakturor till fordonets ägare.

Fordonstillverkarna har många modeller och reservdelar. Därför är en exakt tillämpning inte alltid möjlig. Beakta därför de i katalogen anförda kommentarerna och reservdelsbeskrivningarna.

# Como utilizar o K21-H

| Grupos de Produto        |   | Marca e Modelo                  |              | período de montagem (de/até)            |                         | Referência ATE   |  | Info adicional peça                  |                    |   |
|--------------------------|---|---------------------------------|--------------|---|-------------------------|--|--|--------------------------------------|--------------------|---|
| Eixo dianteiro-/traseiro |   | Número de chassis (de/até)      |              | Info adicional Veículo                  |                         | Referência curta ATE                                     |  | Especificações Técnicas              |                    |   |
| kW                       |   |                                 |              |   |                         |  |  |                                      |                    |   |
| AUDI A4 CABRIO (02-)     |   |                                 |              |   |                         |  |  |                                      |                    |   |
|                          | 1,8 T<br>1,8 T Quattro<br>2,0<br>2,0 TFSI | ◀ 120<br>◀ 120<br>◀ 96<br>◀ 120 | 8E-55-400001 | 8E-55-999999<br>04.02<br>05.03<br>05.04 | 08.06<br>08.06<br>08.06 | PR: 1LB,1LE<br>PR: 1LB,1LE<br>PR: 1LB,1LE<br>PR: 1LB,1LE | 11.3571-8522.2<br>11.3571-8521.2<br>11.0441-5704.2<br>11.0101-5409.2 | 220320<br>220319<br>250034<br>260035 | <br>+ ESP<br>+ ESP | D=57, - Halter ATE<br>D=57, - Halter ATE<br>Dichtungssatz ATE<br>Hülsensatz ATE |
| *                        |   | **                              |              |   |                         |  |  | ***                                  | ****               |   |

## \*Grupos de Produto

|  |                          |  |                              |
|--|--------------------------|--|------------------------------|
|  | Servofreio               |  | Cabo do travão de mão        |
|  | Bomba Central de Travões |  | Regulador de Travagem        |
|  | Depósito                 |  | Bomba Central de Embraiagem  |
|  | Pinça de travão          |  | Bomba Auxiliar de Embraiagem |
|  | Tubo de Travão           |  | Mangueira da embraiagem      |
|  | Cilindro de Roda         |  | Cabo de Embraiagem           |

## \*\*Direção

- ◀ Volante à esquerda
- ▶ Volante à direita

## \*\*\*\*Fabricante

|     |                         |
|-----|-------------------------|
| ATE | Continental Teves (ATE) |
| AKE | Akebono                 |
| AIS | Aisin                   |
| AP  | AP Lockheed             |
| BDX | Bendix                  |
| BOS | Bosch                   |
| BRE | Brembo                  |
| CIT | Citroën                 |
| DEL | Delco                   |
| FI  | Fiat                    |
| FTE | FTE Automotive          |
| LUC | Lucas (TRW)             |
| MAN | Mando                   |
| NIS | Nissin                  |
| PER | Perrot                  |
| SUM | Sumitomo                |
| TOK | Tokico                  |
| VW  | Volkswagen              |

## \*\*\*Posição de Montagem

























- ↕ à frente
- ↕ atrás
- ↔ esquerda
- ↔ direita
- ◻ esquerda à frente
- ◻ esquerda atrás
- ◻ direita à frente
- ◻ direita atrás
- ◻ centro
- ◻ em cima
- ◻ em baixo
- ◻ eixo dianteiro
- ◻ eixo dianteiro do lado esquerdo
- ◻ eixo dianteiro do lado direito
- ◻ eixo traseiro
- ◻ eixo traseiro esquerdo
- ◻ eixo traseiro direito

Todas as indicações de posição referem-se ao lado de condução.

## Abreviaturas

|      |   |     |  |     |                                 |  |
|------|---|-----|--|-----|---------------------------------|--|
| -    | Salvo / sem                               | HEB | Alavanca                                   | THz | Bomba central de travões tandem | Carrinha   |
| +    | Com / apenas / para                       | HZ  | Bomba central de travões!                  | V   | Ventilado                       | Coupé  |
| AUT  | Regulação automática                      | L   | Liga de Carbono                            | WE  | Dispositivo de Aviso            | Cabrio   |
| B    | Revestido                                 | L = | Comprimento                                | WK  | Avisador de Desgaste            | Autocarro  |
| BG   | Limitador de travagem                     | Nz  | Bomba auxiliar de embraiagem               | Zub | Acessórios                      | Furgão   |
| BR   | Regulador de travagem                     | PD  | PowerDisc                                  |     |                                 | Hatchback  |
| BRE  | Regulador de parafuso                     | Rz  | Cilindro de roda                           |     |                                 | Pick-Up/Chassis  |
| BRES | Jogo de reguladores de parafuso           | RzR | Cilindro de roda com regulador incorporado |     |                                 | Série  |
| BRL  | Regulador de travagem dependente da carga | S   | Parafuso de fixação / parafuso da maxila   |     |                                 | DKW Meisterklasse/Sonderklasse/Universal (classe mestre/classe especial/universal) |
| D =  | Diâmetro                                  |     |  |     |                                 | FAUN Veiculo tractor (Kraka)   |
| Gz   | Bomba central de                          |     |  |     |                                 | Furgoneta  |

# Informações sobre artigos

|    |   | REF. CURTA   |    |    |   | REF. CURTA   |    |
|---|--|--|---|---|---|--|---|
|    | 03.6199-xxxx.4 →<br>03.61dy-xxxx.4 →<br>03.67dy-xxxx.4 →<br>03.68dy-xxxx.4 →<br>03.69dy-xxxx.4 →<br>03.77dy-xxxx.4 →<br>03.78dy-xxxx.4 →<br>03.78dy-xxxx.4 →<br>03.78dy-xxxx.4 →<br>03.78dy-xxxx.4 →<br>03.78dy-xxxx.4 →<br>03.78dy-xxxx.4 →         | 30nnnn<br>30nnnn<br>30nnnn<br>30nnnn<br>30nnnn<br>30nnnn<br>30nnnn<br>30nnnn<br>30nnnn<br>30nnnn<br>30nnnn<br>30nnnn | Servofreio<br>T50<br>T51<br>T52/3<br>T52<br>T53<br>T52/4<br>T52/4<br>T52/4Z<br>T52/5<br>T52/5Z<br>T55/1<br>T55/1Z   | <br><br><br><br> | ▲ 03.27dd-xxxx.3 →<br>▲ 03.32dd-xxxx.3 →<br>03.040x-xxdd.2 →<br>03.0470-xxdd.2 →<br>24.3727-xxxx.2 →<br>■ 83.1xxx-xxxx.3 →<br>■ 83.5yx-LLLL.3 →<br>■ 83.6yx-LLLL.3 →<br>■ 83.7yx-LLLL.3 → | 02nnnn<br>02nnnn<br>06nnnn<br>06nnnn<br>58xxxx<br>33nnnn<br>33nnnn<br>33nnnn<br>33nnnn   | Cilindro de Roda de 1 pistón<br>Cilindro da Roda<br>Kit de Reparação (com pistons)<br>Jogo de Juntas (sem pistons)<br>Cabo do Travão de Mão<br>Mangueira de travão + tubagem<br>Tubo de Travão / Embraiagem<br>Tubo de Travão / Embraiagem<br>Tubo de Travão / Embraiagem |
|    | ▲ 03.20dd-xxxx.3 →<br>▲ 03.21dd-xxxx.3 →<br>▲ 03.23dd-xxxx.3 →<br>▲ 03.31dd-xxxx.3 →<br>03.0370-xxdd.2 →   | 01nnnn<br>01nnnn<br>01nnnn<br>01nnnn<br>05xxdd   | Bomba Central de Travões Tandem Escalonada<br>Bomba Central de Travões Tandem<br>Bomba Central de Travões Escalonada<br>Bomba Central de Travões<br>(por ex. 03.2122-: Ø=22,20)<br>Kit de Reparação   | <br><br>   | y = 1: Roscas 1× interior/1× externa<br>y = 2: Roscas 2× interior<br>y = 3: Roscas 2× exterior  | 32nnnn<br>32nnnn<br>32nnnn   | Regulador de travagem (BR)<br>Limitador de travagem (BG)<br>Regulador de parafuso (BRE)<br>Regulador de travagem dependente da carga (BRL)<br>Jogo reguladores de parafuso (BRES)   |
|  | 03.3508-xxxx.x →<br>03.3509-xxxx.x →<br>03.3558-xxxx.x →<br>03.0101-xxxx.2 →   | 31nnnn<br>31nnnn<br>31nnnn<br>39nnnn   | Depósito<br>Depósito<br>Depósito<br>Kit de Reparação  | <br><br><br>  | 35/3 castanho (4)<br>▲ 03.24dd-xxxx.3 →<br>03.0350-ddxx.2 →<br>▲ 03.25dd-xxxx.3 →<br>03.0450-ddxx.2 →<br>24.3728-xxxx.2 →   | 32nnnn<br>32nnnn<br>32nnnn<br>03nnnn<br>07ddxx<br>04nnnn<br>08ddxx<br>59xxxx   | Característica / marca de cor (no. de ligações)<br>Bomba Central de Embraiagem (por ex. 03.2419-: Ø=19,05)<br>Jogo de juntas<br>Bomba auxiliar de embraiagem (por ex. 03.2525-: Ø=25,40)<br>Jogo de juntas<br>Cabo da embraiagem  |
|  | ▲ 11.3ddx-xxxx.2 →<br>11.9ddx-xxxx.2 →<br>▲ 13.2ddx-xxxx.2 →<br>▲ 13.4ddx-xxxx.2 →<br>13.9ddx-xxxx.2 →<br>24.3ddx-xxxx.5 →<br>11.0441-ddxx.2 →<br>13.0441-ddxx.2 →<br>11.0230-xxxx.2 →<br>24.0101-xxxx.2 →<br>▲ 11.0101-xxxx.2 →<br>11.8116-xxxx.1 → | 22nnnn<br>22nnnn<br>21nnnn<br>21nnnn<br>21nnnn<br>24nnnn<br>25nnnn<br>25nnnn<br>26nnnn<br>26nnnn<br>26nnnn<br>39nnnn | Pinça de Travão<br>Pinça de Travão<br>Pinça de Travão Fixa c/ 2 pistons<br>Pinça de Travão Fixa c/ 4 piston<br>Pinca de Travao Fixa<br>Pinça de Travão Recondicionada<br>Jogo de juntas<br>Jogo de juntas<br>Jogo Suporte da Pinça de Travão (suporte, jogo de guias, perno guia)<br>Kit de Montagem (jogo de guias, perno guia)<br>Jogo de Guias<br>Mola de Retenção | <br><br>   | 26nnnn<br>26nnnn<br>26nnnn<br>26nnnn<br>26nnnn<br>26nnnn<br>26nnnn<br>26nnnn<br>26nnnn<br>26nnnn<br>26nnnn<br>26nnnn  | 26nnnn<br>26nnnn<br>26nnnn<br>26nnnn<br>26nnnn<br>26nnnn<br>26nnnn<br>26nnnn<br>26nnnn<br>26nnnn<br>26nnnn<br>26nnnn<br>26nnnn | Jogo de Guias<br>Mola de Retenção   |

|         |  |
|---------|--|
| d       | y  |
| 2 = 6"  | 0 = aparelho simples                               |
| 3 = 7"  | 5 = aparelho Tandem                                |
| 4 = 8"  | 0 = aparelho simples                               |
| 5 = 9"  | 3 = aparelho simples BA                            |
| 6 = 10" | 5 = aparelho simples                               |
|         | 8 = aparelho simples BA                            |
|         | BA = assistente de travagem                        |
|         | Z = aparelhos de travagem com tirante de ancoragem |

nnnn = Os quatro últimos dígitos são números sequenciais

dd = Medida nominal

- ▲ o prefixo desta famílias de produto pode também ser 24.
- o prefixo desta famílias de produto pode também ser 03., 24. ou 83.

Cópias integrais ou parciais deste catálogo estão interditas salvo autorização prévia. Reclamações motivadas por informação constante neste catálogo não serão aceites. Reservamo-nos ao direito de proceder a alterações de construção ou desenho sem aviso prévio. Quando indicamos a referência de origem, tal destina-se apenas para efeito de comparação. Não é permitido utilizar essa informação nas facturas emitadas ao proprietário do veículo.

A diversidade de modelos de viaturas e de peças de substituição nem sempre permite uma conversão exacta. Por esta razão agradecemos que leia atentamente as correspondentes notas e descrições indicadas neste catálogo.

# Как пользоваться каталогом K21-H

| Группы продукции              | Тип автомобиля                            | период монтажа (от/до)  | Номер артикула ATE           | Ссылка (артикул)                 |  |  |                                      |  |                |   |                          |
|-------------------------------|---|-------------------------|------------------------------|----------------------------------|--|--|--------------------------------------|--|----------------|---|--------------------------|
| Передний мост/<br>задний мост | Номер шасси томобля<br>kW                 | Ссылка<br>(автомобиль)  | Короткий номер               | артикул                          |  |  |                                      |  |                |   |                          |
|                               |   |                         |                              |                                  |  |  |                                      |  |                |   |                          |
| <b>AUDI A4 CABRIO (02-)</b>   |   |                         |                              |                                  |  |  |                                      |  |                |   |                          |
|                               | 1,8 T<br>1,8 T Quattro<br>2,0<br>2,0 TFSI | 120<br>120<br>96<br>120 | 8E-55-999999<br>8E-55-400001 | 04.02<br>05.03<br>08.06<br>08.06 | PR: 1LB,1LE<br>PR: 1LB,1LE<br>PR: 1LB,1LE<br>PR: 1LB,1LE | 11.3571-8522.2<br>11.3571-8521.2<br>11.0441-5704.2<br>11.0101-5409.2 | 220320<br>220319<br>250034<br>260035 |  | + ESP<br>+ ESP | D=57, - Halter<br>D=57, - Halter<br>Dichtungssatz<br>Hülsensatz | ATE<br>ATE<br>ATE<br>ATE |
| *                             | **  |                         |                              | ***                              | ****   |  |                                      |  |                |   |                          |

## \*Группы продукции



Усилитель  
тормозного  
привода



Трос ручного  
тормоза



Главный  
тормозной  
цилиндр



Регулятор  
тормозного усилия



Компенсационный  
бачок



Главный цилиндр  
привода сцепления



Тормозной  
суппорт (скоба)



Рабочий цилиндр  
привода выключения  
сцепления



Тормозной шланг



Тормозной шланг



Колесный  
тормозной  
цилиндр



Трос сцепления

## \*\*Вид рулевого управления

- ◀ Автомобиль с левым рулем
- ▶ Автомобиль с правым рулем

## \*\*\*\*Производитель

|     |                         |
|-----|-------------------------|
| ATE | Continental Teves (ATE) |
| AKE | Akebono                 |
| AIS | Aisin                   |
| AP  | AP Lockheed             |
| BDX | Bendix                  |
| BOS | Bosch                   |
| BRE | Brembo                  |
| CIT | Citroën                 |
| DEL | Delco                   |
| FI  | Fiat                    |
| FTE | FTE Automotive          |
| LUC | Lucas (TRW)             |
| MAN | Mando                   |
| NIS | Nissin                  |
| PER | Perrot                  |
| SUM | Sumitomo                |
| TOK | Tokico                  |
| VW  | Volkswagen              |

## \*\*\*Место установки

- ↗ спереди
- ↘ сзади
- ↖ слева
- ↗ справа
- ◻ слева спереди
- ◻ слева снизу
- ◻ справа спереди
- ◻ справа внизу
- ◻ в середине
- ◻ сверху
- ◻ снизу
- ◻ передняя ось
- ◻ передняя ось слева
- ◻ передняя ось справа
- ◻ задняя ось
- ◻ задняя ось слева
- ◻ задняя ось справа



















Все данные расположения  
всегда относятся к  
направлению движения

## Сокращения

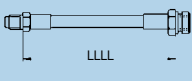
|      |  |     |  |     |  |  |
|------|--|-----|--|-----|--|--|
| -    | без/не   | D = | диаметр  | S   | винт фиксирующий / болтом суппорта           | 5-дверный седан                                  |
| +    | с/только/для                                   | Gz  | Цилиндр датчик рычагом                               | THz | Двуполостной главный тормозной цилиндр       | универсал  |
| AUT  | автоматической регулировкой                    | HEB | Главный цилиндр легированный / высокоуглеродистый    | V   | вентилируемый                                | купе   |
| B    | покрытое                                       | L   | легированный / высокоуглеродистый                    | WE  | Сигнальное устройство с сигнальным контактом | кабриолет  |
| BG   | Ограничитель тормозных сил                     | L = | Длина  | WK  | принадлежностями                             | автобус  |
| BR   | Регулятор тормозного сил                       | Nz  | Принимающий цилиндр                                  | Zub |  | фургон   |
| BR   | Вкручивающийся регулятор                       | PD  | PowerDisc  |     |  | хетчбэк  |
| BRES | Набор вкручивающихся регуляторов               | Rz  | Колесный тормозной цилиндр                           |     |  | платформа/шасси                                  |
| BRL  | Регулятор тормозных сил, зависимый от нагрузки | RzR | Колесный тормозной цилиндр со встроенным регулятором |     |  | серия DKW мастер класс/специальный/универсальный |
|      |  |     |  |     |  | FAUN электрокар (Kraka)                          |
|      |  |     |  |     |  | грузовой автомобиль                              |



# Информация об изделиях

|    |   | КОРОТКИЙ НОМЕР   |   |   |    | КОРОТКИЙ НОМЕР                       |   |                              |        |                              |        |                              |        |                                 |         |                              |  |                                 |  |  |   |                  |        |                      |
|---|--|--|--|--|--|--------------------------------------|--|------------------------------|--------|------------------------------|--------|------------------------------|--------|---------------------------------|---------|------------------------------|--|---------------------------------|--|--|---|------------------|--------|----------------------|
|    | 03.6199-xxxx.4 →<br>03.61dy-xxxx.4 →<br>03.67dy-xxxx.4 →<br>03.68dy-xxxx.4 →<br>03.69dy-xxxx.4 →<br>03.77dy-xxxx.4 →   | 30nnnn<br>30nnnn<br>30nnnn<br>30nnnn<br>30nnnn<br>30nnnn   | Усилитель тормозного привода<br>T50<br>T51<br>T52/3<br>T52<br>T53<br>T52/4   |   | ▲ 03.27dd-xxxx.3 →<br>▲ 03.32dd-xxxx.3 →<br>03.040x-xxdd.2 →<br>03.0470-xxdd.2 →     | 02nnnn<br>02nnnn<br>06nnnn<br>06nnnn | Односторонне работающий колесный тормозной цилиндр<br>Колесный тормозной цилиндр<br>Ремонтный комплект (с поршнем)<br>Комплект прокладок (без поршня)  |                              |        |                              |        |                              |        |                                 |         |                              |  |                                 |  |  |   |                  |        |                      |
|   | 03.78dy-xxxx.4 →<br>03.78dy-xxxx.4 →<br>03.78dy-xxxx.4 →<br>03.78dy-xxxx.4 →<br>03.78dy-xxxx.4 →<br>03.78dy-xxxx.4 →   | 30nnnn<br>30nnnn<br>30nnnn<br>30nnnn<br>30nnnn<br>30nnnn   | T52/4<br>T52/4Z<br>T52/5<br>T52/5Z<br>T55/1<br>T55/1Z  | <table border="1"> <tr> <td>d</td> <td>y</td> </tr> <tr> <td>2 = 6"</td> <td>0 = Однополостное устройство</td> </tr> <tr> <td>3 = 7"</td> <td>5 = Двухполостное устройство</td> </tr> <tr> <td>4 = 8"</td> <td>0 = Однополостное устройство</td> </tr> <tr> <td>5 = 9"</td> <td>3 = Однополостное устройство BA</td> </tr> <tr> <td>6 = 10"</td> <td>5 = Однополостное устройство</td> </tr> <tr> <td></td> <td>8 = Однополостное устройство BA</td> </tr> <tr> <td></td> <td>BA = устройство „ассистент при торможении“</td> </tr> </table> | d  | y                                    | 2 = 6"   | 0 = Однополостное устройство | 3 = 7" | 5 = Двухполостное устройство | 4 = 8" | 0 = Однополостное устройство | 5 = 9" | 3 = Однополостное устройство BA | 6 = 10" | 5 = Однополостное устройство |  | 8 = Однополостное устройство BA |  | BA = устройство „ассистент при торможении“ |  | 24.3727-xxxx.2 → | 58xxxx | Трос ручного тормоза |
| d   | y  |  |  |  |  |                                      |  |                              |        |                              |        |                              |        |                                 |         |                              |  |                                 |  |  |   |                  |        |                      |
| 2 = 6"  | 0 = Однополостное устройство   |  |  |  |  |                                      |  |                              |        |                              |        |                              |        |                                 |         |                              |  |                                 |  |  |   |                  |        |                      |
| 3 = 7"  | 5 = Двухполостное устройство   |  |  |  |  |                                      |  |                              |        |                              |        |                              |        |                                 |         |                              |  |                                 |  |  |   |                  |        |                      |
| 4 = 8"  | 0 = Однополостное устройство   |  |  |  |  |                                      |  |                              |        |                              |        |                              |        |                                 |         |                              |  |                                 |  |  |   |                  |        |                      |
| 5 = 9"  | 3 = Однополостное устройство BA  |  |  |  |  |                                      |  |                              |        |                              |        |                              |        |                                 |         |                              |  |                                 |  |  |   |                  |        |                      |
| 6 = 10"   | 5 = Однополостное устройство   |  |  |  |  |                                      |  |                              |        |                              |        |                              |        |                                 |         |                              |  |                                 |  |  |   |                  |        |                      |
|   | 8 = Однополостное устройство BA  |  |  |  |  |                                      |  |                              |        |                              |        |                              |        |                                 |         |                              |  |                                 |  |  |   |                  |        |                      |
|   | BA = устройство „ассистент при торможении“   |  |  |  |  |                                      |  |                              |        |                              |        |                              |        |                                 |         |                              |  |                                 |  |  |   |                  |        |                      |
|   |  |  |  |   | ■ 83.1xxx-xxxx.3 →<br>■ 83.5yxx-LLLL.3 →<br>■ 83.6yxx-LLLL.3 →<br>■ 83.7yxx-LLLL.3 → | 33nnnn<br>33nnnn<br>33nnnn<br>33nnnn | тормозной шланг + трубопровод<br>Шланг тормоза/сцепления<br>Шланг тормоза/сцепления<br>Шланг тормоза/сцепления   |                              |        |                              |        |                              |        |                                 |         |                              |  |                                 |  |  |   |                  |        |                      |
|    | ▲ 03.20dd-xxxx.3 →<br>▲ 03.21dd-xxxx.3 →<br>▲ 03.23dd-xxxx.3 →<br>▲ 03.31dd-xxxx.3 →<br>03.0370-xxdd.2 →   | 01nnnn<br>01nnnn<br>01nnnn<br>01nnnn<br>05xxdd   | ступенчатый Двухполостной вный тормозной цилиндр<br>Двухполостной главный тормозной цилиндр<br>Ступенчатый главный тормозной цилиндр<br>Главный тормозной цилиндр (напр., 03.2122-: Ø=22,20)<br>Ремкомплект  |   |    |                                      | y = 1: резьба 1× внутр/1× наружн<br>y = 2: резьба 2× внутр<br>y = 3: резьба 2× наружн  |                              |        |                              |        |                              |        |                                 |         |                              |  |                                 |  |  |   |                  |        |                      |
|   |  |  |  |   | 03.60xx-xxxx.3 →<br>03.65xx-xxxx.3 →<br>03.0101-xxxx.2 →                             | 32nnnn<br>32nnnn<br>32nnnn           | Регулятор тормозных сил (BR)<br>Ограничитель тормозных сил (BG)<br>тормозных сил регулятор (BRE)<br>Регулятор тормозных сил в зависимости от загрузки автомобиля (BRL)<br>Комплект вкручиваемого регулятора (BRES) |                              |        |                              |        |                              |        |                                 |         |                              |  |                                 |  |  |   |                  |        |                      |
|  | 03.3508-xxxx.x →<br>03.3509-xxxx.x →<br>03.3558-xxxx.x →<br>03.0101-xxxx.2 →   | 31nnnn<br>31nnnn<br>31nnnn<br>39nnnn   | Компенсационный бачок<br>Компенсационный бачок<br>Компенсационный бачок<br>Ремкомплект   |  | 35/3 brown (4)   |                                      | Обозначение, цветная маркировка (количество подсоединений)   |                              |        |                              |        |                              |        |                                 |         |                              |  |                                 |  |  |   |                  |        |                      |
|   |  |  |  |   | ▲ 03.24dd-xxxx.3 →<br>03.0350-ddxx.2 →   | 03nnnn<br>07ddxx                     | Главный цилиндр привода сцепления (напр., 03.2419-: Ø=19,05)<br>Комплект прокладок   |                              |        |                              |        |                              |        |                                 |         |                              |  |                                 |  |  |   |                  |        |                      |
|  | ▲ 11.3ddx-xxxx.2 →<br>11.9ddx-xxxx.2 →<br>▲ 13.2ddx-xxxx.2 →<br>▲ 13.4ddx-xxxx.2 →<br>13.9ddx-xxxx.2 →<br>24.3ddx-xxxx.5 →<br>11.0441-ddxx.2 →<br>13.0441-ddxx.2 →<br>11.0230-xxxx.2 →<br>24.0101-xxxx.2 →<br>▲ 11.0101-xxxx.2 →<br>11.8116-xxxx.1 → | 22nnnn<br>22nnnn<br>21nnnn<br>21nnnn<br>21nnnn<br>24nnnn<br>25nnnn<br>25nnnn<br>26nnnn<br>26nnnn<br>26nnnn<br>39nnnn | Плавающая скоба (суппорт)<br>Плавающая скоба (суппорт)<br>2-цил. фиксированный суппорт<br>4-цил. фиксированный суппорт<br>Фиксированная скоба<br>Восстановленный суппорт, плавающий суппорт<br>Комплект прокладок<br>Комплект прокладок<br>Комплект крепежа для плавающего суппорта (держатель, комплект подвижных втулок, направляющие болты)<br>Монтажный комплект (комплект подвижных втулок, направляющие болты)<br>Комплект подвижных втулок<br>Прижимная пружина |   | ▲ 03.25dd-xxxx.3 →<br>03.0450-ddxx.2 →   | 04nnnn<br>08ddxx                     | Рабочий цилиндр привода сцепления (напр., 03.2525-: Ø=25,40)<br>Комплект прокладок   |                              |        |                              |        |                              |        |                                 |         |                              |  |                                 |  |  |   |                  |        |                      |
|   |  |  |  |   | 24.3728-xxxx.2 →   | 59xxxx                               | Трос сцепления   |                              |        |                              |        |                              |        |                                 |         |                              |  |                                 |  |  |   |                  |        |                      |

nnnn = последние четыре цифры соответствуют номеру по порядку

dd = номинальный размер

▲ При такой же системе нумерации возможен также и номер 24.











■ ри такой же системе нумерации возможны также и номера 03, 24 и 83

Воспроизведение данного издания, в том числе частичное, допускается только с нашего разрешения. Претензии на возмещение ущерба на основании приводимых в данном каталоге сведений не признаются. Сохраняем за собой право на изменение конструкции. Если в нашей документации содержится ссылка на номера запасных частей какого-либо производителя автомобилей, то это служит только для сравнения. Использование такого рода сведений в счетах, адресованных производителям автомобилей, не допускается.

Вследствие того, что некоторые производители автомобилей предлагают широкий спектр моделей и запасных частей, их не всегда можно точно сочетать. Просим Вас в связи с этим обращать особое внимание на примечания и описания заменяемых деталей, содержащиеся в данном каталоге.

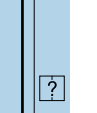

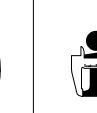
# Jak používat K21-H

| Skupiny produktů   |   | Typ vozidla   |   | Doba vestavby (od/do)   |   | Katalogové číslo ATE   |   | Upozornění (díl)  |   |
|--|---|---|---|---|---|--|---|---|---|
| Přední/zadní náprava   |   | Číslo podvozku  |   | Upozornění (vozidlo)  |   | Zkratkové číslo  |   | Definice  |   |
|  |  |  |  |  |  |  |  |  |          |
| <b>AUDI A4 CABRIO (02-)</b>  |   |   |   |   |   |  |   |   |   |
|  | 1,8 T<br>1,8 T Quattro<br>2,0<br>2,0 TFSI   | 120<br>120<br>96<br>120   | 8E-55-999999<br>8E-55-400001  | 04.02<br>05.03<br>08.06<br>08.06  | PR: 1LB,1LE<br>PR: 1LB,1LE<br>PR: 1LB,1LE<br>PR: 1LB,1LE                          | 11.3571-8522.2<br>11.3571-8521.2<br>11.0441-5704.2<br>11.0101-5409.2               | 220320<br>220319<br>250034<br>260035  | + ESP<br>+ ESP  | D=57, - Halter<br>D=57, - Halter<br>Dichtungssatz<br>Hülsensatz<br>ATE<br>ATE<br>ATE<br>ATE |
| *  |   | **  |   | ***   |   |  |   | ****  |   |

## \*Skupiny výrobků



**Posilovač  
brzdného účinku**



**Lano ruční brzd**



**Hlavní  
brzdový válec**



**Regulátor  
brzdné síly**



**Vyrovnávací  
nádržka**



**Válec vysílače  
spojky**



**Třmen  
kotoučové brzd**



**Válec snímače  
spojky**



**Hadice brzd**



**Hadice spojky**



**Kolový váleček**



**Lano spojky**

## \*\*Druh řízení

- ◀ Volant vlevo
- ▶ Volant vpravo

## \*\*\*\*Označení výrobce

|     |                         |
|-----|-------------------------|
| ATE | Continental Teves (ATE) |
| AKE | Akebono                 |
| AIS | Aisin                   |
| AP  | AP Lockheed             |
| BDX | Bendix                  |
| BOS | Bosch                   |
| BRE | Brembo                  |
| CIT | Citroën                 |
| DEL | Delco                   |
| FI  | Fiat                    |
| FTE | FTE Automotive          |
| LUC | Lucas (TRW)             |
| MAN | Mando                   |
| NIS | Nissin                  |
| PER | Perrot                  |
| SUM | Sumitomo                |
| TOK | Tokico                  |
| VW  | Volkswagen              |

## \*\*\*Montážní poloha

- ↕ vpředu
- ↕ vzadu
- ↔ vlevo
- ↔ vpravo
- ◻ vlevo nahoře
- ◻ vlevo dole
- ◻ vpravo nahoře
- ◻ vpravo dole
- ◻ uprostřed
- ◻ nahoře
- ◻ dole
- ◻ nahoře
- ◻ vlevo nahoře
- ◻ vpravo nahoře
- ◻ dole
- ◻ vlevo dole
- ◻ vpravo dole

Veškeré údaje o pozicích jsou vždy vztaženy na směr jízdy.



















## Zkratky

|      |   |     |   |     |                          |  |
|------|---|-----|---|-----|--------------------------|--|
| -    | Bez / ne                                | HEB | Pákou                                     | V   | Větráný                  | Kombi  |
| +    | S / jen / pro                           | HZ  | Hlavní válec                              | WE  | Výstražné zařízení       | Kupé   |
| AUT  | Automatickým seřizováním                | L   | Legovaný/vysoce nauhličený                | WK  | Výstražným kontaktem     | Kabriolet  |
| B    | Opatřený povlakem                       | L = | Délka                                     | Zub | Příslušenstvím           | Autobus  |
| BG   | Omezovač brzdné síly                    | Nz  | Válec snímače                             |     |                          | Skříňová dodávka                                       |
| BR   | Regulátor brzdné síly                   | PD  | PowerDisc                                 |     |                          | Splyňavá zád'  |
| BRE  | Regulátor k zašroubování                | Rz  | Kolový váleček                            |     |                          | Pick-up/podvozek                                       |
| BRES | Sada regulátorů k zašroubování          | RzR | Kolový váleček s integrovaným regulátorem |     | Brzdová hadice + potrubí | Série  |
| BRL  | regulátor brzdné síly závislý na zátěži | S   | Upevňovací šroub / šroubem třmenu         |     | 2dvěřový                 | DKW mistrovská třída/speciální třída/univerzální třída |
| D =  | Průměr                                  | THz | Tandemový hlavní válec                    |     | 3dvěřový                 | FAUN čtyřkolka (Kraka)                                 |
| Gz   | Válec vysílače                          |     |   |     | 4dvěřový                 | Dodávkový automobil                                    |
|      |   |     |   |     | 5dvěřový                 |  |
|      |   |     |   |     | Sedan                    |  |





# Informace o výrobku

|    |   | ZKRATKOVÉ ČÍSLO  |   |   |   | ZKRATKOVÉ ČÍSLO  |   |
|---|--|--|--|--|---|--|--|
|    | 03.6199-xxxx.4 →<br>03.61dy-xxxx.4 →<br>03.67dy-xxxx.4 →<br>03.68dy-xxxx.4 →<br>03.69dy-xxxx.4 →<br>03.77dy-xxxx.4 →<br>03.78dy-xxxx.4 →<br>03.78dy-xxxx.4 →<br>03.78dy-xxxx.4 →<br>03.78dy-xxxx.4 →<br>03.78dy-xxxx.4 →<br>03.78dy-xxxx.4 →         | 30nnnn<br>30nnnn<br>30nnnn<br>30nnnn<br>30nnnn<br>30nnnn<br>30nnnn<br>30nnnn<br>30nnnn<br>30nnnn<br>30nnnn<br>30nnnn | Posilovač brzdného účinku<br>T50<br>T51<br>T52/3<br>T52<br>T53<br>T52/4<br>T52/4<br>T52/4Z<br>T52/5<br>T52/5Z<br>T55/1<br>T55/1Z   | <br><br><br><br><br><br><br> | ▲ 03.27dd-xxxx.3 →<br>▲ 03.32dd-xxxx.3 →<br>03.040x-xxdd.2 →<br>03.0470-xxdd.2 →<br>24.3727-xxxx.2 →<br>■ 83.1xxx-xxxx.3 →<br>■ 83.5yx-LLLL.3 →<br>■ 83.6yx-LLLL.3 →<br>■ 83.7yx-LLLL.3 →<br>03.60xx-xxxx.3 →<br>03.65xx-xxxx.3 →<br>03.0101-xxxx.2 →<br>35/3 brown (4)<br>▲ 03.24dd-xxxx.3 →<br>03.0350-ddxx.2 →<br>▲ 03.25dd-xxxx.3 →<br>03.0450-ddxx.2 →<br>24.3728-xxxx.2 → | 02nnnn<br>02nnnn<br>06nnnn<br>06nnnn<br>58xxxx<br>33nnnn<br>33nnnn<br>33nnnn<br>33nnnn<br>32nnnn<br>32nnnn<br>32nnnn<br>03nnnn<br>07ddxx<br>04nnnn<br>08ddxx<br>59xxxx | jednostranně působící kolový váleček<br>Kolový váleček<br>Sada dílů pro opravu (s pístem)<br>Sada těsnění (bez pístu)<br>Lano ruční brzdy<br>brzdová hadice + potrubí<br>Brzdová / spojková hadice<br>Brzdová / spojková hadice<br>Brzdová / spojková hadice<br>y = 1: závit 1× vnitřní/1× vnější<br>y = 2: závit 2× vnitřní<br>y = 3: závit 2× vnější<br>Regulator brzdné síly (BR)<br>Omezovač brzdné síly (BG)<br>Regulator k zašroubování (BRE)<br>Regulator brzdné síly závislý na zatížení (BRL)<br>Sada regulátorů k zašroubování (BRES)<br>Značka, barevné značení (počet přípojů)<br>Válec vysilače spojky (nap. 03.2419-: Ø=19,05)<br>Sada těsnění<br>Válec snímače spojky (nap. 03.2525-: Ø=25,40)<br>Sada těsnění<br>Spojková hadice |
|    | ▲ 03.20dd-xxxx.3 →<br>▲ 03.21dd-xxxx.3 →<br>▲ 03.23dd-xxxx.3 →<br>▲ 03.31dd-xxxx.3 →<br>03.0370-xxdd.2 →   | 01nnnn<br>01nnnn<br>01nnnn<br>01nnnn<br>05xxdd   | Tandemový hlavní válec stupňový<br>Tandemový hlavní válec<br>Stupňový hlavní válec<br>Hlavní válec (nap. 03.2122-: Ø=22,20)<br>Sada dílů pro opravu  |  |   |  |  |
|  | 03.3508-xxxx.x →<br>03.3509-xxxx.x →<br>03.3558-xxxx.x →<br>03.0101-xxxx.2 →   | 31nnnn<br>31nnnn<br>31nnnn<br>39nnnn   | Vyrovnávací nádržka<br>Vyrovnávací nádržka<br>Vyrovnávací nádržka<br>Sada dílů pro opravu  |  |   |  |  |
|  | ▲ 11.3ddx-xxxx.2 →<br>11.9ddx-xxxx.2 →<br>▲ 13.2ddx-xxxx.2 →<br>▲ 13.4ddx-xxxx.2 →<br>13.9ddx-xxxx.2 →<br>24.3ddx-xxxx.5 →<br>11.0441-ddxx.2 →<br>13.0441-ddxx.2 →<br>11.0230-xxxx.2 →<br>24.0101-xxxx.2 →<br>▲ 11.0101-xxxx.2 →<br>11.8116-xxxx.1 → | 22nnnn<br>22nnnn<br>21nnnn<br>21nnnn<br>21nnnn<br>24nnnn<br>25nnnn<br>25nnnn<br>26nnnn<br>26nnnn<br>26nnnn<br>39nnnn | Plovoucí třmen<br>Plovoucí třmen<br>2válc. pevný třmen<br>4válc. pevný třmen<br>Pevný třmen<br>Výměnný třmen plovoucí třmen<br>Sada těsnění<br>Sada těsnění<br>Sada držáků plovoucího třmenu (držák, sada posuvných pouzder, vodící čep)<br>Montážní sada (sada posuvných pouzder, vodící čep)<br>Sada posuvných pouzder<br>Přidrzná pružina |  |   |  |  |

|         |                               |
|---------|-------------------------------|
| d       | y                             |
| 2 = 6"  | 0 = jednoduché zařízení       |
| 3 = 7"  | 5 = tandemové zařízení        |
| 4 = 8"  | 0 = jednoduché zařízení       |
| 5 = 9"  | 3 = jednoduché zařízení BA    |
| 6 = 10" | 5 = jednoduché zařízení       |
|         | 8 = jednoduché zařízení BA    |
|         | BA = brzdový asistent         |
|         | Z = brzdová zařízení s kotvou |

nnnn = Poslední čtyři čísla odpovídají počtu

dd = jmenovitý rozměr









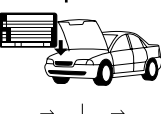

▲ Rovněž 24. při stejné systematicke pojmenování možné

■ Rovněž 03., 24. a 83 při stejné systematicke pojmenování možné

Rozmnožování, i jen jednotlivých částí, je dovoleno jen s naším souhlasem. Nároky na náhradu na základě údajů v tomto katalogu nemohou být uznávány. Změny konstrukce vyhrazeny. Pokud se v našich podkladech odvoláváme na číslo náhradního dílu výrobce vozidla, slouží to jen pro účely porovnání. Používání takovýchto údajů ve fakturách vystavovaných majitelům vozidel není přípustné.

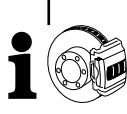
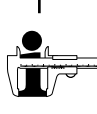
Rozmanitost modelů a náhradních dílů některých výrobců vozidel nedovoluje vždy přesné přiřazení. Věnujte proto prosím zvláštní pozornost poznámkám a popisům náhradních dílů uvedeným v katalogu.

# Tak należy korzystać z K21-H

| Grupy produktów  | Typ pojazdu   | Czas montażu (od/do)  |   | Numer artykułu ATE  | Uwaga (artykuł)  |   |  |   |
|--|---|---|---|---|--|---|--|---|
| Oś tylna / przednia  | Numer podwozia  | Uwaga (pojazd)  |   | Numer skrócony  |  | Definicja   |  |   |
|  | kW  |   |   |   |  |   |  |   |
|  |  |  |  |  |  |  |   |   |
| <b>AUDI A4 CABRIO (02-)</b>  |   |   |   |   |  |   |  |   |
|  | 1,8 T<br>1,8 T Quattro<br>2,0<br>2,0 TFSI   | ◀ 120<br>◀ 120<br>◀ 96<br>◀ 120   | 8E-55-999999<br>04.02<br>05.03<br>08.06<br>08.06<br>08.06                         | PR: 1LB,1LE<br>PR: 1LB,1LE<br>PR: 1LB,1LE<br>PR: 1LB,1LE                          | 11.3571-8522.2<br>11.3571-8521.2<br>11.0441-5704.2<br>11.0101-5409.2               | 220320<br>220319<br>250034<br>260035  |  + ESP<br> + ESP | D=57, - Halter<br>D=57, - Halter<br>Dichtungssatz<br>Hülsensatz<br>ATE<br>ATE<br>ATE<br>ATE |
| *  |   | **  |   |   |  | ***   | ****   |   |

## \*Grupy produktów



Wspomaganie hamulca



Linka hamulca ręcznego



Pompa hamulcowa

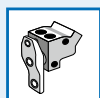

Regulator siły hamowania



Zbiornik wyrównawczy



Pompa sprzęgła



Zacisk hamulca

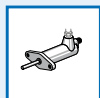

Siłownik wysprzęglający



Przewód hamulcowy giętki



Przewód sprzęgła giętki



Cylinder hamulcowy koła



Linka sprzęgła

















## \*\*Rodzaj układu kierowniczego

- ◀ z kierownicą z lewej strony
- ▶ z kierownicą z prawej strony

## \*\*\*\*Producent

|     |                         |
|-----|-------------------------|
| ATE | Continental Teves (ATE) |
| AKE | Akebono                 |
| AIS | Aisin                   |
| AP  | AP Lockheed             |
| BDX | Bendix                  |
| BOS | Bosch                   |
| BRE | Brembo                  |
| CIT | Citroën                 |
| DEL | Delco                   |
| FI  | Fiat                    |
| FTE | FTE Automotive          |
| LUC | Lucas (TRW)             |
| MAN | Mando                   |
| NIS | Nissin                  |
| PER | Perrot                  |
| SUM | Sumitomo                |
| TOK | Tokico                  |
| VW  | Volkswagen              |

## \*\*\* Pozycja montażu















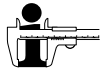











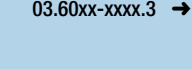

-  z przodu
-  z tyłu
-  z lewej strony
-  z prawej strony
-  z lewej strony u góry
-  z lewej strony na dole
-  z prawej strony u góry
-  z prawej strony na dole
-  po środku
-  u góry
-  na dole
-  Oś przednia
-  z lewej strony z przodu
-  z prawej strony z przodu
-  Oś tylna
-  z lewej strony z tyłu
-  z prawej strony z tyłu

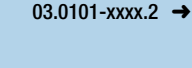
Poszczególne pozycje zawsze w odniesieniu do kierunku jazdy.

## Skróty

|      |  |     |  |     |                                       |  |
|------|--|-----|--|-----|---------------------------------------|--|
| -    | Bez / nie  | Gz  | Pompa sprzęgła                                       | S   | Śruba łącząca / śruba zacisku hamulca | Limuzyna   |
| +    | Z / tylko / do                                   | HEB | Dźwignią   | THz | Pompa hamulcowa typu tandem           | Kombi  |
| AUT  | Automatyczną regulacją                           | HZ  | Pompa hamulcowa                                      | V   | Wentylowane                           | Coupe  |
| B    | Powlekane  | L   | Stopowe / z dużą zawartością węgla                   | WE  | Urządzenie ostrzegawcze               | Cabriolet  |
| BG   | Ogranicznik siły hamowania                       | L = | Długość  | WK  | Stykiem ostrzegawczym                 | Bus  |
| BR   | Regulator siły hamowania                         | Nz  | Siłownik wysprzęglający                              | Zub | Osprzętem                             | Van  |
| BRE  | Regulator wkręcany                               | PD  | PowerDisc  |     | Przewód hamulcowy + rurociąg          | Hatchback  |
| BRES | Zestaw regulatorów wkręcanych                    | Rz  | Cylinder hamulcowy koła                              |     | Dwudrzwiowy                           | Pickup/podwozie                                    |
| BRL  | Regulator siły hamowania w zależności obciążenia | RzR | Cylinder hamulcowy koła ze zintegrowanym regulatorem |     | Trzydrzwiowy                          | Seria  |
| D =  | Średnica   |     |  |     | Czterodrzwiowy                        | DKW klasa master/klasa specjalna/klasa uniwersalna |
|      |  |     |  |     | Pięciodrzwiowy                        | FAUN quad  |
|      |  |     |  |     |                                       | Transporter  |

# Informacje o artykułach

|  |   | NUMER SKRÓCONY   |   |   |    | NUMER SKRÓCONY   |    |                       |        |                          |        |                       |        |                          |         |                       |  |                          |  |                         |  |                        |  |                |  |  |  |  |
|---|--|--|--|--|--|--|---|-----------------------|--------|--------------------------|--------|-----------------------|--------|--------------------------|---------|-----------------------|--|--------------------------|--|-------------------------|--|------------------------|--|----------------|--|--|--|--|
|  | 03.6199-xxxx.4 →<br>03.61dy-xxxx.4 →<br>03.67dy-xxxx.4 →<br>03.68dy-xxxx.4 →<br>03.69dy-xxxx.4 →<br>03.77dy-xxxx.4 →<br>03.78dy-xxxx.4 →<br>03.78dy-xxxx.4 →<br>03.78dy-xxxx.4 →<br>03.78dy-xxxx.4 →<br>03.78dy-xxxx.4 →<br>03.78dy-xxxx.4 → | 30nnnn<br>30nnnn<br>30nnnn<br>30nnnn<br>30nnnn<br>30nnnn<br>30nnnn<br>30nnnn<br>30nnnn<br>30nnnn<br>30nnnn<br>30nnnn | wspomaganie hamulca<br>T50<br>T51<br>T52/3<br>T52<br>T53<br>T52/4<br>T52/4<br>T52/4Z<br>T52/5<br>T52/5Z<br>T55/1<br>T55/1Z | <br><br><br><br><br><br><br><br><br> | ▲ 03.27dd-xxxx.3 →<br>▲ 03.32dd-xxxx.3 →<br>03.040x-xxdd.2 →<br>03.0470-xxdd.2 →<br>24.3727-xxxx.2 →<br>■ 83.1xxx-xxxx.3 →<br>■ 83.5yxx-LLLL.3 →<br>■ 83.6yxx-LLLL.3 →<br>■ 83.7yxx-LLLL.3 →<br>03.20dd-xxxx.3 →<br>03.21dd-xxxx.3 →<br>03.23dd-xxxx.3 →<br>03.31dd-xxxx.3 →<br>03.0370-xxdd.2 →<br>03.3508-xxxx.x →<br>03.3509-xxxx.x →<br>03.3558-xxxx.x →<br>03.0101-xxxx.2 →<br>▲ 11.3ddx-xxxx.2 →<br>11.9ddx-xxxx.2 →<br>▲ 13.2ddx-xxxx.2 →<br>▲ 13.4ddx-xxxx.2 →<br>13.9ddx-xxxx.2 →<br>24.3ddx-xxxx.5 →<br>11.0441-ddxx.2 →<br>13.0441-ddxx.2 →<br>11.0230-xxxx.2 →<br>24.0101-xxxx.2 →<br>▲ 11.0101-xxxx.2 →<br>11.8116-xxxx.1 → | 02nnnn<br>02nnnn<br>06nnnn<br>06nnnn<br>58xxxx<br>33nnnn<br>33nnnn<br>33nnnn<br>33nnnn<br>01nnnn<br>01nnnn<br>01nnnn<br>01nnnn<br>05xxdd<br>31nnnn<br>31nnnn<br>31nnnn<br>39nnnn<br>22nnnn<br>22nnnn<br>21nnnn<br>21nnnn<br>21nnnn<br>24nnnn<br>25nnnn<br>25nnnn<br>26nnnn<br>26nnnn<br>26nnnn<br>26nnnn<br>39nnnn | jednostronnie działający cylinder hamulcowy<br>cylinder hamulcowy koła<br>zestaw naprawczy (z tłoczkiem)<br>zestaw uszczelniający (bez tłoczka)<br>linka hamulca ręcznego<br>przewód hamulcowy + rurociąg<br>przewód hamulcowy/sprzęgła giętki<br>przewód hamulcowy/sprzęgła giętki<br>przewód hamulcowy/sprzęgła giętki<br>tandem- wielostopniowa pompa hamulcowa<br>tandem- pompa hamulcowa<br>wielostopniowa pompa hamulcowa<br>pompa hamulcowa<br>(np. 03.2122-: Ø=22,20)<br>zestaw naprawczy<br>zbiornik wyrównawczy<br>zbiornik wyrównawczy<br>zbiornik wyrównawczy<br>zestaw naprawczy<br>zacisk ruchomy<br>zacisk ruchomy<br>zacisk stały z 2 cylinderkami<br>zacisk stały z 4 cylinderkami<br>Zacisk stały<br>zacisk wymienny - ruchomy<br>komplet uszczelniający<br>komplet uszczelniający<br>uchwyt zacisku ruchomego - komplet (uchwyt,<br>komplet tulei przesuwnych, bolce prowadzące)<br>komplet montażowy<br>(komplet tulei przesuwnych, bolce prowadzące)<br>komplet tulei przesuwnych<br>sprężyna mocująca |                       |        |                          |        |                       |        |                          |         |                       |  |                          |  |                         |  |                        |  |                |  |  |  |  |
|   |  |  |  | <table border="1"> <tr> <td>d</td> <td>y</td> </tr> <tr> <td>2 = 6"</td> <td>0 = urządzenie proste</td> </tr> <tr> <td>3 = 7"</td> <td>5 = urządzenie tandemowe</td> </tr> <tr> <td>4 = 8"</td> <td>0 = urządzenie proste</td> </tr> <tr> <td>5 = 9"</td> <td>3 = urządzenie proste BA</td> </tr> <tr> <td>6 = 10"</td> <td>5 = urządzenie proste</td> </tr> <tr> <td></td> <td>8 = urządzenie proste BA</td> </tr> <tr> <td></td> <td>BA = asystent hamowania</td> </tr> <tr> <td></td> <td>Z = urządzenia hamulco</td> </tr> <tr> <td></td> <td>we ze ściągami</td> </tr> </table>   | d  | y  | 2 = 6"  | 0 = urządzenie proste | 3 = 7" | 5 = urządzenie tandemowe | 4 = 8" | 0 = urządzenie proste | 5 = 9" | 3 = urządzenie proste BA | 6 = 10" | 5 = urządzenie proste |  | 8 = urządzenie proste BA |  | BA = asystent hamowania |  | Z = urządzenia hamulco |  | we ze ściągami |  |  |  |  |
| d   | y  |  |  |  |  |  |   |                       |        |                          |        |                       |        |                          |         |                       |  |                          |  |                         |  |                        |  |                |  |  |  |  |
| 2 = 6"  | 0 = urządzenie proste  |  |  |  |  |  |   |                       |        |                          |        |                       |        |                          |         |                       |  |                          |  |                         |  |                        |  |                |  |  |  |  |
| 3 = 7"  | 5 = urządzenie tandemowe   |  |  |  |  |  |   |                       |        |                          |        |                       |        |                          |         |                       |  |                          |  |                         |  |                        |  |                |  |  |  |  |
| 4 = 8"  | 0 = urządzenie proste  |  |  |  |  |  |   |                       |        |                          |        |                       |        |                          |         |                       |  |                          |  |                         |  |                        |  |                |  |  |  |  |
| 5 = 9"  | 3 = urządzenie proste BA   |  |  |  |  |  |   |                       |        |                          |        |                       |        |                          |         |                       |  |                          |  |                         |  |                        |  |                |  |  |  |  |
| 6 = 10"   | 5 = urządzenie proste  |  |  |  |  |  |   |                       |        |                          |        |                       |        |                          |         |                       |  |                          |  |                         |  |                        |  |                |  |  |  |  |
|   | 8 = urządzenie proste BA   |  |  |  |  |  |   |                       |        |                          |        |                       |        |                          |         |                       |  |                          |  |                         |  |                        |  |                |  |  |  |  |
|   | BA = asystent hamowania  |  |  |  |  |  |   |                       |        |                          |        |                       |        |                          |         |                       |  |                          |  |                         |  |                        |  |                |  |  |  |  |
|   | Z = urządzenia hamulco   |  |  |  |  |  |   |                       |        |                          |        |                       |        |                          |         |                       |  |                          |  |                         |  |                        |  |                |  |  |  |  |
|   | we ze ściągami   |  |  |  |  |  |   |                       |        |                          |        |                       |        |                          |         |                       |  |                          |  |                         |  |                        |  |                |  |  |  |  |
|   |  |  |  |   |    |  |   |                       |        |                          |        |                       |        |                          |         |                       |  |                          |  |                         |  |                        |  |                |  |  |  |  |
|   |  |  |  |   |    |  |   |                       |        |                          |        |                       |        |                          |         |                       |  |                          |  |                         |  |                        |  |                |  |  |  |  |
|   |  |  |  |   |    |  |   |                       |        |                          |        |                       |        |                          |         |                       |  |                          |  |                         |  |                        |  |                |  |  |  |  |
|   |  |  |  |   |    |  |   |                       |        |                          |        |                       |        |                          |         |                       |  |                          |  |                         |  |                        |  |                |  |  |  |  |
|   |  |  |  |   |    |  |   |                       |        |                          |        |                       |        |                          |         |                       |  |                          |  |                         |  |                        |  |                |  |  |  |  |
|   |  |  |  |   |    |  |   |                       |        |                          |        |                       |        |                          |         |                       |  |                          |  |                         |  |                        |  |                |  |  |  |  |
|   |  |  |  |   |    |  |   |                       |        |                          |        |                       |        |                          |         |                       |  |                          |  |                         |  |                        |  |                |  |  |  |  |

nnnn = ostatnie cztery cyfry odpowiadają kolejnemu numerow.

dd = wymiary







▲ Dla tego samego systemu oznaczania numerowego możliwe jest również oznaczenie 24.

■ Dla tego samego systemu oznaczania numerowego możliwe jest również oznaczenie 03., 24. i 83.



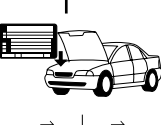



Drukowanie, również fragmentami, dozwolone jest wyłącznie za naszą zgodą. Roszczenia odszkodowawcze wynikające z informacji zawartych w niniejszym katalogu nie będą uznawane. Zastrzega się możliwość zmian konstrukcyjnych. O ile w naszej dokumentacji odnosimy się do numeru części zamiennego producenta pojazdu, to służy to wyłącznie celom porównawczym. Stosowanie tego rodzaju informacji w rachunkach wystawianych posiadaczom pojazdów nie jest dozwolone.

Wielość modeli i części zamiennych kilku producentów pojazdów nie zawsze pozwala na dokładne przyporządkowanie. Z tego względu prosimy o zwracanie szczególnej uwagi na podane w katalogu uwagi i opisy części zamiennych.

# Έτσι χρησιμοποιείτε τον K21-H

| Ομάδες προϊόντων   | Τύπος αυτοκινήτου   | Χρονικό διάστημα τοποθέτησης (από/έως)  | Αριθμός προϊόντος ATE   | Υπόδειξη (προϊόν)  |
|--|---|---|---|--|
| Μπροστινός άξονας/πίσω άξονας  | Αριθμός πλαισίου kW   | Υπόδειξη (όχημα)  | Σύντομος κωδικός  | Ορισμός  |
|    |  |  |  |                 |
| <b>AUDI A4 CABRIO (02-)</b>  |   |   |   |  |
|  1,8 T<br>1,8 T Quattro<br>2,0<br>2,0 TFSI | ◀ 120<br>◀ 120<br>◀ 96<br>◀ 120<br>8E-55-400001                                   | 8E-55-999999<br>04.02<br>05.03<br>08.06<br>08.06<br>08.06                         | PR: 1LB,1LE<br>PR: 1LB,1LE<br>PR: 1LB,1LE<br>PR: 1LB,1LE                          | 11.3571-8522.2 220320<br>11.3571-8521.2 220319<br>11.0441-5704.2 250034<br>11.0101-5409.2 260035 |
| *  | **  |   |   | ***<br>****  |

## \*Μπροστινός

|  |   |
|--|---|
|  Σερβόφρενο                  |  Συρματόσχοινο χειρόφρενο          |
|  Κεντρικός κύλινδρος πέδησης |  Ρυθμιστής δύναμης πέδησης         |
|  Δοχείο διαστολής          |  Εντολοδότης κύλινδρος συμπλέκτη |
|  Δίχαλο πέδησης            |  Εντολοδόχος κύλινδρος συμπλέκτη |
|  Εύκαμπτος σωλήνας φρένου  |  Εύκαμπτος σωλήνας σύνδεσης      |
|  Κύλινδρος τροχού          |  Ντίζα συμπλέκτη                 |

## \*\*Τρόπος διεύθυνσης

- ◀ Αριστεροτίμονα οχήματα
- ▶ Δεξιοτίμονα οχήματα

## \*\*\*Κατασκευαστής

|     |                         |
|-----|-------------------------|
| ATE | Continental Teves (ATE) |
| AKE | Akebono                 |
| AIS | Aisin                   |
| AP  | AP Lockheed             |
| BDX | Bendix                  |
| BOS | Bosch                   |
| BRE | Brembo                  |
| CIT | Citroën                 |
| DEL | Delco                   |
| FI  | Fiat                    |
| FTE | FTE Automotive          |
| LUC | Lucas (TRW)             |
| MAN | Mando                   |
| NIS | Nissin                  |
| PER | Perrot                  |
| SUM | Sumitomo                |
| TOK | Tokico                  |
| VW  | Volkswagen              |

## \*\*\*Θέση τοποθέτησης



























- ⬆️ μπροστά
- ⬆️ πίσω
- ⬅️ αριστερά
- ➡️ δεξιά
- ⬅️ αριστερά επάνω
- ⬅️ αριστερά κάτω
- ⬅️ δεξιά επάνω
- ⬅️ δεξιά κάτω
- ⬆️ μέση
- ⬆️ επάνω
- ⬆️ κάτω
- ⬆️ Μπροστινός άξονας
- ⬆️ αριστερά μπροστά
- ⬆️ δεξιά μπροστά
- ⬆️ Πίσω άξονας
- ⬆️ αριστερά πίσω
- ⬆️ δεξιά πίσω

Όλες οι ενδείξεις θέσεως ανταποκρίνονται πάντα στην κατεύθυνση οδήγησης

## Βραχυγραφίες

|      |  |     |  |     |  |   |
|------|--|-----|--|-----|--|---|
| -    | χωρίς / εκτός                                  | D = | Διάμετρος                                | S   | Βίδα στερέωσης / βίδα                        | Λιμουζίνα   |
| +    | με / μόνο / για                                | Gz  | Εντολοδότης κύλινδρος                    |     | δίχαλο πέδησης                               | Στέισον   |
| AUT  | αυτόματη επαναρρύθμιση                         | HEB | μοχλό                                    | THz | Διπλός κεντρικός κύλινδρος                   | Κουπέ   |
| B    | επικαλυμμένος                                  | HZ  | Κεντρικός κύλινδρος                      | V   | αεριζόμενο                                   | Κάμπριο   |
| BG   | Διάταξη περιορισμού δύναμης πέδησης            | L   | χαλυβόκραμα / υψηλή ανθράκωση            | WE  | Διάταξη προειδοποίησης επαφής προειδοποίησης | Λεωφορείο   |
| BR   | Ρυθμιστής δύναμης πέδησης                      | L = | Μήκος                                    | Zub | εξαρτήματα                                   | Λίφτμπακ  |
| BRE  | Βιδωτός ρυθμιστής                              | Nz  | Εντολοδόχος κύλινδρος                    |     | Εύκαμπτος σωλήνας πέδησης + σωλήνωση         | Ανοιχτό φορτηγάκι/Πλαίσιο                           |
| BRES | Σετ βιδωτού ρυθμιστή                           | PD  | PowerDisc                                |     | 2-πορτο                                      | Σειρά   |
| BRL  | Ρυθμιστής δύναμης πέδησης ανάλογα της φόρτισης | Rz  | Κύλινδρος τροχού                         |     | 3-πορτο                                      | DKW Κύρια κατηγορία/Ειδική κατηγορία/Γενικής χρήσης |
|      |  | RzR | Κύλινδρο τροχού με ενσωματωμένο ρυθμιστή |     | 4-πορτο                                      | FAUN Αυτοκίνητο όχημα (Kraka)                       |
|      |  |     |  |     | 5-πορτο                                      | Μικρό φορτηγό                                       |

# Πληροφορίες προϊόντος

|    |   | ΣΥΝΤΟΜΟΣ ΚΩΔΙΚΟΣ   |   |   |    | ΣΥΝΤΟΜΟΣ ΚΩΔΙΚΟΣ   |   |
|---|--|--|--|--|--|--|--|
|    | 03.6199-xxxx.4 →<br>03.61dy-xxxx.4 →<br>03.67dy-xxxx.4 →<br>03.68dy-xxxx.4 →<br>03.69dy-xxxx.4 →<br>03.77dy-xxxx.4 →<br>03.78dy-xxxx.4 →<br>03.78dy-xxxx.4 →<br>03.78dy-xxxx.4 →<br>03.78dy-xxxx.4 →<br>03.78dy-xxxx.4 →<br>03.78dy-xxxx.4 →         | 30nnnn<br>30nnnn<br>30nnnn<br>30nnnn<br>30nnnn<br>30nnnn<br>30nnnn<br>30nnnn<br>30nnnn<br>30nnnn<br>30nnnn<br>30nnnn           | Σερβόφρενο<br>T50<br>T51<br>T52/3<br>T52<br>T53<br>T52/4<br>T52/4<br>T52/4Z<br>T52/5<br>T52/5Z<br>T55/1<br>T55/1Z  | <br><br><br><br><br><br><br><br><br> | ▲ 03.27dd-xxxx.3 →<br>▲ 03.32dd-xxxx.3 →<br>03.040x-xxdd.2 →<br>03.0470-xxdd.2 →<br>24.3727-xxxx.2 →<br>■ 83.1xxx-xxxx.3 →<br>■ 83.5γxx-LLLL.3 →<br>■ 83.6γxx-LLLL.3 →<br>■ 83.7γxx-LLLL.3 →<br>03.60xx-xxxx.3 →<br>03.65xx-xxxx.3 →<br>03.0101-xxxx.2 →<br>35/3 brown (4)<br>▲ 03.24dd-xxxx.3 →<br>03.0350-ddxx.2 →<br>▲ 03.25dd-xxxx.3 →<br>03.0450-ddxx.2 →<br>24.3728-xxxx.2 → | 02nnnn<br>02nnnn<br>06nnnn<br>06nnnn<br>58xxxx<br>33nnnn<br>33nnnn<br>33nnnn<br>33nnnn<br>32nnnn<br>32nnnn<br>32nnnn<br>03nnnn<br>07ddxx<br>04nnnn<br>08ddxx<br>59xxxx | Μονόπλευρα ενεργός κύλινδρος<br>Κύλινδρος τροχού<br>Σετ επισκευής (με έμβολο)<br>Σετ στεγανοποίησης (χωρίς έμβολο)<br>Συρματόσχοινο χειρόφρενου<br>Εύκαμπτος σωλήνας πέδησης + σωλήνωση<br>Εύκαμπτος σωλήνας φρένου/συμπλέκτη<br>Εύκαμπτος σωλήνας φρένου/συμπλέκτη<br>Εύκαμπτος σωλήνας φρένου/συμπλέκτη<br>y = 1: Σπείρωμα 1× εσωτερικά / 1× εξωτερικά<br>y = 2: Σπείρωμα 2× εσωτερικά<br>y = 3: Σπείρωμα 2× εξωτερικά<br>Ρυθμιστής δύναμης πέδησης (ΡΠ)<br>Διάταξη περιορισμού δύναμης πέδησης (ΠΠ)<br>Βιδωτός ρυθμιστής (ΒΡ)<br>Ρυθμιστής δύναμης πέδησης ανάλογα του φορτίου (ΡΠΦ)<br>Σετ βιδωτού ρυθμιστή (ΣΒΡ)<br>Χαρακτηριστικό, έγχρωμο μαρκάρισμα (αριθμός συνδέσεων)<br>Εντολοδότης κύλινδρος συμπλέκτη (π.χ. 03.2419-: Ø=19,05)<br>Σετ στεγανοποίησης<br>Εντολοδόχος κύλινδρος συμπλέκτη (π.χ. 03.2525-: Ø=25,40)<br>Σετ στεγανοποίησης<br>Ντίζα συμπλέκτη |
|    | ▲ 03.20dd-xxxx.3 →<br>▲ 03.21dd-xxxx.3 →<br>▲ 03.23dd-xxxx.3 →<br>▲ 03.31dd-xxxx.3 →<br>03.0370-xxdd.2 →   | 01nnnn<br>01nnnn<br>01nnnn<br>01nnnn<br>05xxdd   | Βαθμιδωτός διπλός κεντρικός κύλινδρος<br>Διπλός κεντρικός κύλινδρος<br>Βαθμιδωτός κεντρικός κύλινδρος<br>Κεντρικός κύλινδρος (π.χ 03.2122-: Ø=22,20)<br>Σετ επισκευής  |   | LLLL<br>  | y = 1: Σπείρωμα 1× εσωτερικά / 1× εξωτερικά<br>y = 2: Σπείρωμα 2× εσωτερικά<br>y = 3: Σπείρωμα 2× εξωτερικά  |  |
|  | 03.3508-xxxx.x →<br>03.3509-xxxx.x →<br>03.3558-xxxx.x →<br>03.0101-xxxx.2 →   | 31nnnn<br>31nnnn<br>31nnnn<br>39nnnn   | Δοχείο διαστολής<br>Δοχείο διαστολής<br>Δοχείο διαστολής<br>Σετ επισκευής  |   | 35/3 brown (4)   | Χαρακτηριστικό, έγχρωμο μαρκάρισμα (αριθμός συνδέσεων)   |  |
|  | ▲ 11.3ddx-xxxx.2 →<br>11.9ddx-xxxx.2 →<br>▲ 13.2ddx-xxxx.2 →<br>▲ 13.4ddx-xxxx.2 →<br>13.9ddx-xxxx.2 →<br>24.3ddx-xxxx.5 →<br>11.0441-ddxx.2 →<br>13.0441-ddxx.2 →<br>11.0230-xxxx.2 →<br>24.0101-xxxx.2 →<br>▲ 11.0101-xxxx.2 →<br>11.8116-xxxx.1 → | 22nnnn<br>22nnnn<br>21nnnn<br>21nnnn<br>21nnnn<br>24nnnn<br>25nnnn<br>25nnnn<br>26nnnn<br>26nnnn<br>26nnnn<br>26nnnn<br>39nnnn | Ολισθαίνον δίχαλο πέδησης<br>Ολισθαίνον δίχαλο πέδησης<br>2-κύλινδρο σταθερό δίχαλο πέδησης<br>4-κύλινδρο σταθερό δίχαλο πέδησης σταθερή δαγκάνα<br>Αντικαθιστούμενο ολισθαίνον δίχαλο πέδησης<br>Σετ στεγανοποίησης<br>Σετ στεγανοποίησης<br>Σετ στήριγματος ολισθαίνοντος διχάλου πέδησης (στήριγμα, σετ ολισθαίνοντος χιτωνίου, πείρος οδηγός)<br>Σετ τοποθέτησης (σετ ολισθαίνοντος χιτωνίου, πείρος οδηγός)<br>Σετ ολισθαίνοντος χιτωνίου<br>Ελατήριο συγκράτησης | <br><br>  | ▲ 03.24dd-xxxx.3 →<br>03.0350-ddxx.2 →<br>▲ 03.25dd-xxxx.3 →<br>03.0450-ddxx.2 →<br>24.3728-xxxx.2 →   | 03nnnn<br>07ddxx<br>04nnnn<br>08ddxx<br>59xxxx   | Εντολοδότης κύλινδρος συμπλέκτη (π.χ. 03.2419-: Ø=19,05)<br>Σετ στεγανοποίησης<br>Εντολοδόχος κύλινδρος συμπλέκτη (π.χ. 03.2525-: Ø=25,40)<br>Σετ στεγανοποίησης<br>Ντίζα συμπλέκτη  |

nnnn = Τα τελευταία τέσσερα ψηφία αντιστοιχούν σε έναν αριθμό αριθμησης.

dd = Ονομαστική διάσταση

▲ Επίσης δυνατό και το 24. σε περίπτωση ίδιου συστήματος αριθμησης.

■ Επίσης δυνατό και το 03., 24. και 83. σε περίπτωση ίδιου συστήματος αριθμησης.

Η επανεκτύπωση, επίσης και αποσπασματικά, επιτρέπεται μόνο με την έγκρισή μας. Οι αξιώσεις αντικατάστασης βάσει των στοιχείων αυτού του καταλόγου δεν μπορούν να αναγνωριστούν. Διατηρούμε το δικαίωμα των κατασκευαστικών αλλαγών. Στο βαθμό που αναφερόμαστε στα έγγραφα μας στους αριθμούς ανταλλακτικών του κατασκευαστή του οχήματος, χρησιμεύει μόνο για λόγους σύγκρισης. Μια χρήση αυτών των στοιχείων σε λογαριασμούς που απευθύνονται στον ιδιοκτήτη του οχήματος δεν επιτρέπεται.

Ο μεγάλος αριθμός μοντέλων και ανταλλακτικών μερικών κατασκευαστών οχημάτων δεν επιτρέπει πάντοτε ένα ακριβή καταμερισμό. Προσέξτε παρακαλώ γι' αυτό ιδιαίτερα τις σχετικές παρατηρήσεις σ' αυτόν τον κατάλογο και τις περιγραφές των ανταλλακτικών εξαρτημάτων.



# K21-H'i Broşürünü Nasıl Kullanacaksınız

| Ürün grubu           |   | Araç tipleri            |  | Montaj süresi (tarih aralığı)                            |  | ATE-Ürün numarası (uzun)             |                | Tanım (Ürün)  |                          |
|----------------------|---|-------------------------|--|--|--|--------------------------------------|----------------|---|--------------------------|
| Ön-/Arka aks         | Araç şasi numarası (tarih aralığı)        | Tanım (Araç)            | ATE-Ürün numarası (kısa)                         | Ürün   |  |                                      |                |   |                          |
| AUDI A4 CABRIO (02-) |   |                         |  |  |  |                                      |                |   |                          |
|                      | 1,8 T<br>1,8 T Quattro<br>2,0<br>2,0 TFSI | 120<br>120<br>96<br>120 | 8E-55-999999<br>04.02<br>05.03<br>08.06<br>08.06 | PR: 1LB,1LE<br>PR: 1LB,1LE<br>PR: 1LB,1LE<br>PR: 1LB,1LE | 11.3571-8522.2<br>11.3571-8521.2<br>11.0441-5704.2<br>11.0101-5409.2 | 220320<br>220319<br>250034<br>260035 | + ESP<br>+ ESP | D=57, - Halter<br>D=57, - Halter<br>Dichtungssatz<br>Hülsensatz | ATE<br>ATE<br>ATE<br>ATE |
| *                    | **  |                         |  |  | ***  |                                      |                | ****  |                          |

## \*\*Ürün grupları

|  |                                |  |                                    |
|--|--------------------------------|--|------------------------------------|
|  | <b>Booster</b>                 |  | <b>El Freni Teli</b>               |
|  | <b>Fren Merkez Silindiri</b>   |  | <b>Fren Basınç Regülatörü</b>      |
|  | <b>Fren Hidroliği Haznesi</b>  |  | <b>Debriyaj Silindiri</b>          |
|  | <b>Fren Kaliperi</b>           |  | <b>Debriyaj Yardımcı Silindiri</b> |
|  | <b>Fren hortumu</b>            |  | <b>Debriyaj Hortumu</b>            |
|  | <b>Hidrolik Fren Silindiri</b> |  | <b>Debriyaj Teli</b>               |

## \*\*Direksiyon türü

- ◀ Soldan Direksiyonlu araçlar
- ▶ Sağ direksiyon araçlar

## \*\*\*\*Üretici firma tanımı

|     |                         |
|-----|-------------------------|
| ATE | Continental Teves (ATE) |
| AKE | Akebono                 |
| AIS | Aisin                   |
| AP  | AP Lockheed             |
| BDX | Bendix                  |
| BOS | Bosch                   |
| BRE | Brembo                  |
| CIT | Citroën                 |
| DEL | Delco                   |
| FI  | Fiat                    |
| FTE | FTE Automotive          |
| LUC | Lucas (TRW)             |
| MAN | Mando                   |
| NIS | Nissin                  |
| PER | Perrot                  |
| SUM | Sumitomo                |
| TOK | Tokico                  |
| VW  | Volkswagen              |

## \*\*\*Montaj pozisyonu

- ☐ ön
- ☐ arka
- ☐ sol
- ☐ sağ
- ☐ sol ön
- ☐ sol arka
- ☐ sağ ön
- ☐ sağ arka
- ☐ orta
- ☐ üst
- ☐ alt
- ☐ ön aks
- ☐ sol ön aks
- ☐ sağ ön aks
- ☐ arka aks
- ☐ sol arka aks
- ☐ sağ arka aks

































Tüm pozisyon verileri sürüş yönüne göre dir.

## Kısaltmalar

|      |   |     |                                       |     |                         |                                       |
|------|---|-----|---------------------------------------|-----|-------------------------|---------------------------------------|
| -    | Hariç / değil                           | HEB | Levyeli                               | THZ | Tandem Merkezi          | Sedan                                 |
| +    | İle / sadece / için                     | HZ  | Fren Merkez Silindiri                 |     | Fren Hidrolik Silindiri | Station wagon                         |
| AUT  | Otomatik boşluk ayarlayıcı              | L   | Alaşım / karbonlanmış                 | V   | Havalandırma            | Coupe                                 |
| B    | Kaplamalı                               | L = | Uzunluk                               | WE  | İkaz mekanizması        | Cabrio                                |
| BG   | Fren Güç Regülatörü                     | Nz  | Alıcı silindir                        | WK  | Balata aşınma sensörlü  | Otobüs                                |
| BR   | Fren Basınç Regülatörü                  | PD  | PowerDisc                             | Zub | Aksesuarlı              | Kapalı kasa kamyonet                  |
| BRE  | Vidalı tip Regülatör                    | Rz  | Hidrolik Fren Silindiri               |     |                         | Hatchback                             |
| BRES | Vidalı Tip Regülatör Seti               | RzR | Entegre Fren Düzeltme                 |     |                         | Açık kasa kamyonet/Şasi               |
| BRL  | Ağırlığa duyarlı Fren Basınç Regülatörü | S   | Sabitleme civatası / Kaliper civatalı |     |                         | Seri                                  |
| D =  | Çap                                     |     |                                       |     |                         | DKW master sınıf/özel sınıf/üniversal |
| Gz   | Verici Silindir Debriyaj Silindiri      |     |                                       |     |                         | FAUN motorlu araç (Kraka) Transporter |



# Ürün bilgileri

|    |   | KISA NUMARA  |    |    |  | KISA NUMARA                |   |                 |  |                          |        |                 |        |                    |        |                 |        |                    |         |                            |  |                               |  |  |                                      |   |
|---|--|--|---|---|--|----------------------------|--|-----------------|--|--------------------------|--------|-----------------|--------|--------------------|--------|-----------------|--------|--------------------|---------|----------------------------|--|-------------------------------|--|--|--------------------------------------|---|
|    | 03.6199-xxxx.4 →<br>03.61dy-xxxx.4 →<br>03.67dy-xxxx.4 →<br>03.68dy-xxxx.4 →<br>03.69dy-xxxx.4 →<br>03.77dy-xxxx.4 →   | 30nnnn<br>30nnnn<br>30nnnn<br>30nnnn<br>30nnnn<br>30nnnn   | Booster<br>T50<br>T51<br>T52/3<br>T52<br>T53<br>T52/4   | <table border="1"> <tr> <td>d</td> <td>y</td> </tr> <tr> <td></td> <td>0 = Tekli Ünite</td> </tr> <tr> <td></td> <td>5 = Tandem, çiftli ünite</td> </tr> <tr> <td>2 = 6"</td> <td>0 = Tekli Ünite</td> </tr> <tr> <td>3 = 7"</td> <td>3 = Tekli Ünite BA</td> </tr> <tr> <td>4 = 8"</td> <td>5 = Tekli Ünite</td> </tr> <tr> <td>5 = 9"</td> <td>8 = Tekli Ünite BA</td> </tr> <tr> <td>6 = 10"</td> <td>BA = Elektronik Fren Ayarı</td> </tr> <tr> <td></td> <td>Z = Geniş Çatal Fren Boosteri</td> </tr> </table>   | d  | y                          |  | 0 = Tekli Ünite |  | 5 = Tandem, çiftli ünite | 2 = 6" | 0 = Tekli Ünite | 3 = 7" | 3 = Tekli Ünite BA | 4 = 8" | 5 = Tekli Ünite | 5 = 9" | 8 = Tekli Ünite BA | 6 = 10" | BA = Elektronik Fren Ayarı |  | Z = Geniş Çatal Fren Boosteri | <br><br><br><br><br><br><br><br><br> | ▲ 03.27dd-xxxx.3 →<br>▲ 03.32dd-xxxx.3 →<br>03.040x-xxdd.2 →<br>03.0470-xxdd.2 → | 02nnnn<br>02nnnn<br>06nnnn<br>06nnnn | pistonlu Fren hidrolik Silindiri<br>Fren Hidrolik Silindiri<br>Tamir Takımı (pistonları ile birlikte)<br>Conta Takımı (pistonsuz) |
| d   | y  |  |   |   |  |                            |  |                 |  |                          |        |                 |        |                    |        |                 |        |                    |         |                            |  |                               |  |  |                                      |   |
|   | 0 = Tekli Ünite  |  |   |   |  |                            |  |                 |  |                          |        |                 |        |                    |        |                 |        |                    |         |                            |  |                               |  |  |                                      |   |
|   | 5 = Tandem, çiftli ünite   |  |   |   |  |                            |  |                 |  |                          |        |                 |        |                    |        |                 |        |                    |         |                            |  |                               |  |  |                                      |   |
| 2 = 6"  | 0 = Tekli Ünite  |  |   |   |  |                            |  |                 |  |                          |        |                 |        |                    |        |                 |        |                    |         |                            |  |                               |  |  |                                      |   |
| 3 = 7"  | 3 = Tekli Ünite BA   |  |   |   |  |                            |  |                 |  |                          |        |                 |        |                    |        |                 |        |                    |         |                            |  |                               |  |  |                                      |   |
| 4 = 8"  | 5 = Tekli Ünite  |  |   |   |  |                            |  |                 |  |                          |        |                 |        |                    |        |                 |        |                    |         |                            |  |                               |  |  |                                      |   |
| 5 = 9"  | 8 = Tekli Ünite BA   |  |   |   |  |                            |  |                 |  |                          |        |                 |        |                    |        |                 |        |                    |         |                            |  |                               |  |  |                                      |   |
| 6 = 10"   | BA = Elektronik Fren Ayarı   |  |   |   |  |                            |  |                 |  |                          |        |                 |        |                    |        |                 |        |                    |         |                            |  |                               |  |  |                                      |   |
|   | Z = Geniş Çatal Fren Boosteri  |  |   |   |  |                            |  |                 |  |                          |        |                 |        |                    |        |                 |        |                    |         |                            |  |                               |  |  |                                      |   |
|   | 03.78dy-xxxx.4 →<br>03.78dy-xxxx.4 →<br>03.78dy-xxxx.4 →<br>03.78dy-xxxx.4 →<br>03.78dy-xxxx.4 →<br>03.78dy-xxxx.4 →   | 30nnnn<br>30nnnn<br>30nnnn<br>30nnnn<br>30nnnn<br>30nnnn   | T52/4<br>T52/4Z<br>T52/5<br>T52/5Z<br>T55/1<br>T55/1Z   |   | 24.3727-xxxx.2 →   | 58xxxx                     | El Freni teli  |                 |  |                          |        |                 |        |                    |        |                 |        |                    |         |                            |  |                               |  |  |                                      |   |
|    | ▲ 03.20dd-xxxx.3 →<br>▲ 03.21dd-xxxx.3 →<br>▲ 03.23dd-xxxx.3 →<br>▲ 03.31dd-xxxx.3 →<br><br>03.0370-xxdd.2 →   | 01nnnn<br>01nnnn<br>01nnnn<br>01nnnn<br><br>05xxdd   | Kademeli delinmiş çiftli merkezi silindir<br>Çiftli merkezi silindir<br>Kademeli delinmiş merkezi silindir<br>Merkezi silindir<br>(Örnek. 03.2122-: Ø=22,20)<br>Tamir Takımı  | <br><br><br><br><br><br> | 03.60xx-xxxx.3 →<br>03.65xx-xxxx.3 →<br>03.0101-xxxx.2 →                           | 32nnnn<br>32nnnn<br>32nnnn | Fren basınç regülatörü (BR)<br>Fren Güç kısıtlandırıcısı (BG)<br>Vidalı tip Regülatör (BRE)<br>Yüke duyarlı fren basınç regülatörü (BRL)<br>Vidalı tip regülatör seti (BRES) |                 |  |                          |        |                 |        |                    |        |                 |        |                    |         |                            |  |                               |  |  |                                      |   |
|  | 03.3508-xxxx.x →<br>03.3509-xxxx.x →<br>03.3558-xxxx.x →<br>03.0101-xxxx.2 →   | 31nnnn<br>31nnnn<br>31nnnn<br>39nnnn   | Fren Hidroliği Haznesi<br>Fren Hidroliği Haznesi<br>Fren Hidroliği Haznesi<br>Tamir Takımı  |   | 35/3 kahverengi (4)  |                            | İşaretleme, Renkli İşaretleme<br>(Bağlantı sayısı)   |                 |  |                          |        |                 |        |                    |        |                 |        |                    |         |                            |  |                               |  |  |                                      |   |
|  | ▲ 11.3ddx-xxxx.2 →<br>11.9ddx-xxxx.2 →<br>▲ 13.2ddx-xxxx.2 →<br>▲ 13.4ddx-xxxx.2 →<br>13.9ddx-xxxx.2 →<br>24.3ddx-xxxx.5 →<br>11.0441-ddxx.2 →<br>13.0441-ddxx.2 →<br>11.0230-xxxx.2 →<br>24.0101-xxxx.2 →<br>▲ 11.0101-xxxx.2 →<br>11.8116-xxxx.1 → | 22nnnn<br>22nnnn<br>21nnnn<br>21nnnn<br>21nnnn<br>24nnnn<br>25nnnn<br>25nnnn<br>26nnnn<br>26nnnn<br>26nnnn<br>39nnnn | Basit Kaliper<br>Basit Kaliper<br>Çift Silindirli Sabit Kaliper<br>Dört Silindirli Sabit Kaliper<br>Sabit kaliper<br>Tamir edilmiş Basit Kaliper<br>Conta Takımı<br>Conta Takımı<br>Kaliper Tutucu Seti (Tutucu gövde,<br>kayar, gömlek seti, kayıt pimleri)<br>Montaj Takımı (Kayar Gömlek<br>seti, kayıt pimleri)<br>Kayar Gömlek Seti<br>Geri Getirme Yayı | <br><br>   | ▲ 03.24dd-xxxx.3 →<br>03.0350-ddxx.2 →   | 03nnnn<br>07ddxx           | Debriyaj Silindiri<br>(Örneğin. 03.2419-: Ø=19,05)<br>Conta Tamir Takımı   |                 |  |                          |        |                 |        |                    |        |                 |        |                    |         |                            |  |                               |  |  |                                      |   |
|   |  |  |   | <br>  | ▲ 03.25dd-xxxx.3 →<br>03.0450-ddxx.2 →   | 04nnnn<br>08ddxx           | Debriyaj Yardımcı Silindiri<br>(Örneğin 03.2525-: Ø=25,40)<br>Conta Tamir Takımı   |                 |  |                          |        |                 |        |                    |        |                 |        |                    |         |                            |  |                               |  |  |                                      |   |
|   |  |  |   |    | 24.3728-xxxx.2 →   | 59xxxx                     | Debriyaj Teli  |                 |  |                          |        |                 |        |                    |        |                 |        |                    |         |                            |  |                               |  |  |                                      |   |

nnnn = Son dört rakam mevcut bir numaraya karşılıktır.

dd = Nominal çap

▲ 24. aynı numaralama sistemini kullanmak mümkündür  
■ 03., 24. ve 83. aynı numaralama sistemini kullanmak mümkündür.

Bu kataloğun içeriği ve kopyaları yalnız müsaade alınarak kullanılabilir. Bu kataloğtaki bilgileri baz alarak kullanılan parçalar yüzünden zarara uğranılması durumunda mesuliyet kullanıcıya aittir. Dizayn ve montaj değişiklikleri hakkı saklıdır. Dökümanımızda kullanılan araç üreticilerinin verdikleri parça numaraları sadece karşılaştırma içindir. Faturalarda araç üreticilerinin parça numaralarının kullanılmasına müsaade edilmez.

Otomobil modellerindeki ve üretici firmaların çokluğu ve çeşitliliği her zaman her yedek parçanın tam olarak kullanılmasına imkan vermeyebilir. Bu nedenle notlara ve yedek parça talimatlarının içeriğine dikkat ediniz.

# K21-H 这样使用

| 产品组                         | 车型  | 安装期间 (开始/结束)            | 说明 (整车)  | 说明 (零件)  |
|-----------------------------|---|-------------------------|--|--|
| 前/后轴                        | 车辆生产号 (自/至)                               |                         |  |  |
|                             | kW  |                         |  | ATE-零件号 (短)  |
|                             |   |                         |  |  |
| <b>AUDI A4 CABRIO (02-)</b> |   |                         |  |  |
|                             | 1,8 T<br>1,8 T Quattro<br>2,0<br>2,0 TFSI | 120<br>120<br>96<br>120 | 8E-55-99999<br>04.02<br>05.03<br>08.06<br>08.06<br>08.06 | PR: 1LB,1LE<br>PR: 1LB,1LE<br>PR: 1LB,1LE<br>PR: 1LB,1LE             |
|                             |   | 8E-55-400001            |  | 11.3571-8522.2<br>11.3571-8521.2<br>11.0441-5704.2<br>11.0101-5409.2 |
|                             |   |                         |  | 220320<br>220319<br>250034<br>260035                                 |
|                             |   |                         |  | + ESP<br>+ ESP   |
|                             |   |                         |  | D=57, - Halter<br>D=57, - Halter<br>Dichtungssatz<br>Hülssensatz     |
|                             |   |                         |  | ATE<br>ATE<br>ATE<br>ATE   |
| *                           | **  |                         |  | ***  |

## \*产品组

|  |        |  |         |
|--|--------|--|---------|
|  | 制动力放大器 |  | 手制动拉索   |
|  | 主制动缸   |  | 制动力调节器  |
|  | 平衡罐    |  | 离合器-输出缸 |
|  | 制动钳    |  | 离合器-输出缸 |
|  | 制动软管   |  | 连接软管    |
|  | 车轮制动缸  |  | 连接拉索    |

## \*\*转向机类型

- ◀ 左舵
- ▶ 右舵

## \*\*\*\*供应商标识

|     |                         |
|-----|-------------------------|
| ATE | Continental Teves (ATE) |
| AKE | Akebono                 |
| AIS | Aisin                   |
| AP  | AP Lockheed             |
| BDX | Bendix                  |
| BOS | Bosch                   |
| BRE | Brembo                  |
| CIT | Citroën                 |
| DEL | Delco                   |
| FI  | Fiat                    |
| FTE | FTE Automotive          |
| LUC | Lucas (TRW)             |
| MAN | Mando                   |
| NIS | Nissin                  |
| PER | Perrot                  |
| SUM | Sumitomo                |
| TOK | Tokico                  |
| VW  | Volkswagen              |

## \*\*\*安装位置





















- 前
- 后
- 左
- 右
- 左前
- 右前
- 右后
- 中
- 上
- 下
- 后轴
- 左前轴
- 右前轴
- 后轴
- 左后轴
- 右后轴

所有的位置说明都参照汽车行驶方向。

## 缩写

|      |             |     |           |     |           |                    |
|------|-------------|-----|-----------|-----|-----------|--------------------|
| -    | 无 / 否       | HEB | 带杠杆       | WE  | 报警装置      | 客货两用车              |
| +    | 含 / 仅有 / 用于 | HZ  | 主缸        | WK  | 报警触点      | 双门轿车               |
| AUT  | 带自动调整       | L   | 制成合金      | Zub | 带有附件      | 敞篷轿车               |
| B    | 喷层的BG       | L=  | 长         |     |           | 客车                 |
| BG   | 制动力限制器      | Nz  | 输出缸       |     |           | 厢式汽车               |
| BR   | 制动力调节器      | PD  | PowerDisc |     | 制动软管 + 管道 | 阶背式车尾              |
| BRE  | 旋入调节器       | Rz  | 车轮制动缸     |     | 双门        | 载货平板 / 车辆底盘        |
| BRES | 旋入调节器组      | RzR | 车轮制动缸     |     | 三门        | 系列                 |
| BRL  | 与负载相关的制动力   | S   | 固定するネジ    |     | 四门        | DKW 大师级 / 特级 / 普通级 |
| D=   | 直径          | THz | 鼓式制动器后部   |     | 五门        | FAUN 军用越野车 (Kraka) |
| Gz   | 灰口铸铁 输出缸    | V   | 通风        |     | 大型轿车      | 轻型载货车              |



|    |   | 编号   |    |    |    | 编号   |                       |
|---|--|--|---|---|--|--|--|
|    | 03.6199-xxxx.4 →<br>03.61dy-xxxx.4 →<br>03.67dy-xxxx.4 →<br>03.68dy-xxxx.4 →<br>03.69dy-xxxx.4 →<br>03.77dy-xxxx.4 →<br>03.78dy-xxxx.4 →<br>03.78dy-xxxx.4 →<br>03.78dy-xxxx.4 →<br>03.78dy-xxxx.4 →<br>03.78dy-xxxx.4 →<br>03.78dy-xxxx.4 →         | 30nnnn<br>30nnnn<br>30nnnn<br>30nnnn<br>30nnnn<br>30nnnn<br>30nnnn<br>30nnnn<br>30nnnn<br>30nnnn<br>30nnnn<br>30nnnn | 制动力放大器<br>T50<br>T51<br>T52/3<br>T52<br>T53<br>T52/4<br>T52/4<br>T52/4Z<br>T52/5<br>T52/5Z<br>T55/1<br>T55/1Z                             | <br><br><br><br> | ▲ 03.27dd-xxxx.3 →<br>▲ 03.32dd-xxxx.3 →<br>03.040x-xxdd.2 →<br>03.0470-xxdd.2 →<br>24.3727-xxxx.2 →<br>■ 83.1xxx-xxxx.3 →<br>■ 83.5yxx-LLLL.3 →<br>■ 83.6yxx-LLLL.3 →<br>■ 83.7yxx-LLLL.3 → | 02nnnn<br>02nnnn<br>06nnnn<br>06nnnn<br>58xxxx<br>33nnnn<br>33nnnn<br>33nnnn<br>33nnnn | 一侧有效的车轮制动缸<br>车轮制动缸<br>维修组 (带活塞)<br>密封组 (不带活塞)<br>手制动拉索<br>制动软管 + 管道<br>制动-/连接软管<br>制动-/连接软管<br>制动-/连接软管 |
|    | ▲ 03.20dd-xxxx.3 →<br>▲ 03.21dd-xxxx.3 →<br>▲ 03.23dd-xxxx.3 →<br>▲ 03.31dd-xxxx.3 →<br>03.0370-xxdd.2 →   | 01nnnn<br>01nnnn<br>01nnnn<br>01nnnn<br>05xxdd   | 串联-主缸 分级<br>串联-主缸<br>分级-H主缸<br>主缸<br>(如. 03.2122-: 厚度=22,20)<br>维修组   | <br>  | 03.60xx-xxxx.3 →<br>03.65xx-xxxx.3 →<br>03.0101-xxxx.2 →   | 32nnnn<br>32nnnn<br>32nnnn   | 制动力调节器 (BR)<br>制动力限制器 (BG)<br>旋入调节器 (BRE)<br>与载荷相关的制动力调节器 (BRL)<br>旋入调节器-组 (BRES)                        |
|  | 03.3508-xxxx.x →<br>03.3509-xxxx.x →<br>03.3558-xxxx.x →<br>03.0101-xxxx.2 →   | 31nnnn<br>31nnnn<br>31nnnn<br>39nnnn   | 平衡罐<br>平衡罐<br>平衡罐<br>维修组  | 35/3 灰色 (4)   | 名称, 颜色标记<br>(连接的数量)  |  |  |
|  | ▲ 11.3ddx-xxxx.2 →<br>11.9ddx-xxxx.2 →<br>▲ 13.2ddx-xxxx.2 →<br>▲ 13.4ddx-xxxx.2 →<br>13.9ddx-xxxx.2 →<br>24.3ddx-xxxx.5 →<br>11.0441-ddxx.2 →<br>13.0441-ddxx.2 →<br>11.0230-xxxx.2 →<br>24.0101-xxxx.2 →<br>▲ 11.0101-xxxx.2 →<br>11.8116-xxxx.1 → | 22nnnn<br>22nnnn<br>21nnnn<br>21nnnn<br>21nnnn<br>24nnnn<br>25nnnn<br>25nnnn<br>26nnnn<br>26nnnn<br>26nnnn<br>39nnnn | 浮式制动钳<br>浮式制动钳<br>卡式制动钳<br>四缸卡式制动钳<br>卡式制动钳<br>交换钳 浮式制动钳<br>密封组<br>密封组<br>浮式制动钳支架-组<br>(支架, 滑套组, 导向销)<br>安装组<br>(滑套组, 导向销)<br>滑套组<br>止动弹簧 | <br><br>   | ▲ 03.24dd-xxxx.3 →<br>03.0350-ddxx.2 →<br>▲ 03.25dd-xxxx.3 →<br>03.0450-ddxx.2 →<br>24.3728-xxxx.2 →   | 03nnnn<br>07ddxx<br>04nnnn<br>08ddxx<br>59xxxx   | 离合器-输出缸<br>(如. 03.2419-: 厚度=19,05)<br>密封组<br>离合器-输出缸<br>(如. 03.2525-: 厚度=25,40)<br>密封组<br>连接拉索           |

| d       | y           |
|---------|-------------|
| 0       | 简单设备        |
| 5       | 串联设备        |
| 2 = 6"  | 0 = 简单设备    |
| 3 = 7"  | 3 = 简单设备 BA |
| 4 = 8"  | 5 = 简单设备    |
| 5 = 9"  | 8 = 简单设备 BA |
| 6 = 10" | BA = 制动辅助   |
|         | Z = 拉杆制动器   |

nnnn =最后四位数字是顺序号。

dd = 额定尺寸









- ▲ 可以在相同的编号系统中实现第 24. 位编号。
- 可以在相同的编号系统中实现第 03., 24. 和 83. 的编号

简要的强调一下, 就是说必须经过我们的许可。基于该目录说明的替换要求没有进行说明。保留更改结构的权利。只要我们在我们的资料中提到了整车制造商的替代件编号, 只能用于比较。不允许在给用户的帐单中使用同样类型的说明。





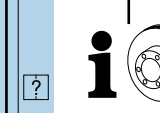
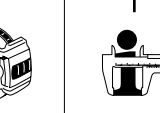
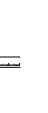







整车制造商多样化的车型和替代件不可能做到精确的划分。所以, 请您注意目录中的说明和替代件描述。



# カタログK21-Hのご利用法

| 製品グループ   |   | 車種  |   | 取り付け期間 (から/まで)  |  | ATE商品番号(長)  |   | 情報(商品)  |   |
|--|---|---|---|---|--|---|---|---|---|
| 前車軸/後車軸  |   | 車台番号(から/まで)   | kw  | 情報(車両)  |  | ATE商品番号(短)  |   | 商品  |   |
|  |  |  |  |  |  |  |  |  |   |
| <b>AUDI A4 CABRIO (02-)</b>  |   |   |   |   |  |   |   |   |   |
|  | 1,8 T<br>1,8 T Quattro<br>2,0<br>2,0 TFSI   | ◀ 120<br>◀ 120<br>◀ 96<br>◀ 120   | 8E-55-400001  | 04.02<br>05.03<br>08.06<br>08.06  | PR: 1LB,1LE<br>PR: 1LB,1LE<br>PR: 1LB,1LE<br>PR: 1LB,1LE                           | 11.3571-8522.2<br>11.3571-8521.2<br>11.0441-5704.2<br>11.0101-5409.2                | 220320<br>220319<br>250034<br>260035  | + ESP<br>+ ESP  | D=57, - Halter<br>D=57, - Halter<br>Dichtungssatz<br>Hülzensatz<br>ATE<br>ATE<br>ATE<br>ATE |
| *  |   | **  |   |   |  |   | ***   |   | ****  |

## \*製品グループ

|  |               |   |                   |
|--|---------------|---|-------------------|
|    | ブレーキブースター     |    | サイドブレーキワイヤー       |
|    | マスターブレーキシリンダー |    | ブレーキプレッシャーレギュレーター |
|  | ブレーキフルードタンク   |  | クラッチマスターシリンダー     |
|  | ブレーキキャリパー     |  | クラッチスレーブシリンダー     |
|  | ブレーキホース       |  | クラッチホース           |
|  | ホイールシリンダー     |  | クラッチワイヤー          |

















## \*\*ステアリング

- ◀ 左ハンドル
- ▶ 右ハンドル

## \*\*\*\*メーカー略号

|     |                         |
|-----|-------------------------|
| ATE | Continental Teves (ATE) |
| AKE | Akebono                 |
| AIS | Aisin                   |
| AP  | AP Lockheed             |
| BDX | Bendix                  |
| BOS | Bosch                   |
| BRE | Brembo                  |
| CIT | Citroën                 |
| DEL | Delco                   |
| FI  | Fiat                    |
| FTE | FTE Automotive          |
| LUC | Lucas (TRW)             |
| MAN | Mando                   |
| NIS | Nissin                  |
| PER | Perrot                  |
| SUM | Sumitomo                |
| TOK | Tokico                  |
| VW  | Volkswagen              |



















## \*\*\*取り付け位置

|   |       |
|---|-------|
|    | 前     |
|    | 後ろ    |
|    | 左     |
|    | 右     |
|    | 左前方   |
|    | 右前方   |
|   | 左後方   |
|  | 右後方   |
|  | 中央    |
|  | 上     |
|  | 下     |
|  | 前車軸   |
|  | 前車軸 左 |
|  | 前車軸 右 |
|  | 後車軸   |
|  | 後車軸 左 |
|  | 後車軸 右 |

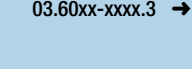
位置表示は全て車の進行方向に即しています。

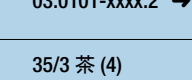
## 略語

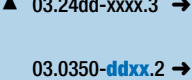
|      |                           |     |                  |                   |               |                                 |
|------|---------------------------|-----|------------------|-------------------|---------------|---------------------------------|
| -    | の付いていない/なし                | D = | 直径               | THz               | タンデムマスターシリンダー | セダン                             |
| +    | の付いた/のみ/～用の               | Gz  | マスターシリンダー        | V                 | 通気機能          | ステーションワゴン                       |
| AUT  | 自動調整機能付き                  | HEB | レバー付き            | WE                | 警告装置          | クーペ                             |
| B    | コーティング仕上げ                 | Hz  | マスターシリンダー        | WK                | ウォーニングコンタクト付き | カブリオ                            |
| BG   | ブレーキプレッシャーリデュサー           | L   | 合金/炭素繊維強化        | Zub               | 付属品付き         | バス                              |
| BR   | ブレーキプレッシャーレギュレーター         | L = | 長さ               |                   |               | バン                              |
| BRE  | スクリュエインコントローラー            | Nz  | スレーブシリンダー        |                   |               | ハッチバック                          |
| BRES | スクリュエインコントローラーキット         | PD  | PowerDisc        |                   |               | ピックアップ/シャシー                     |
| BRL  | ブレーキプレッシャーレギュレーター 負荷により変化 | Rz  | ホイールシリンダー        |                   |               | シリーズ                            |
|      |                           | RzR | 調整器組み込みホイールシリンダー | ブレーキチューブ + パイプライン |               | DKW マスタークラス/<br>スペシャルクラス/ユニバーサル |
|      |                           | S   | 固定するネジ/キャリパーネジ付き | 2ドア               |               | FAUN パワーカート(Kraka)              |
|      |                           |     |                  | 3ドア               |               | トランスポーター                        |
|      |                           |     |                  | 4ドア               |               |                                 |
|      |                           |     |                  | 5ドア               |               |                                 |

|    |  | 略番                                 |  |    |    | 略番  |  |  |  |                         |          |             |        |             |        |                |        |             |        |                |         |               |  |                   |   |                    |        |                   |
|---|---|------------------------------------|---|---|--|---|---|--|--|-------------------------|----------|-------------|--------|-------------|--------|----------------|--------|-------------|--------|----------------|---------|---------------|--|-------------------|---|--------------------|--------|-------------------|
|    | 03.6199-xxxx.4 →  | 30nnnn                             | ブレーキブースター<br>T50  |    | ▲ 03.27dd-xxxx.3 →   | 02nnnn  | 片側に作用するホイールシリンダー  |  |  |                         |          |             |        |             |        |                |        |             |        |                |         |               |  |                   |   |                    |        |                   |
|   | 03.61dy-xxxx.4 →  | 30nnnn                             | T51   |   | ▲ 03.32dd-xxxx.3 →   | 02nnnn  | ホイールシリンダー   |  |  |                         |          |             |        |             |        |                |        |             |        |                |         |               |  |                   |   |                    |        |                   |
|   | 03.67dy-xxxx.4 →  | 30nnnn                             | T52/3   |   | 03.040x-xxdd.2 →   | 06nnnn  | リペアキット(ピストン付き)  |  |  |                         |          |             |        |             |        |                |        |             |        |                |         |               |  |                   |   |                    |        |                   |
|   | 03.68dy-xxxx.4 →  | 30nnnn                             | T52   |   | 03.0470-xxdd.2 →   | 06nnnn  | シールキット(ピストンなし)  |  |  |                         |          |             |        |             |        |                |        |             |        |                |         |               |  |                   |   |                    |        |                   |
|   | 03.69dy-xxxx.4 →  | 30nnnn                             | T53   |   |     | 24.3727-xxxx.2 →  | 58xxxx  | サイドブレーキワイヤー  |  |                         |          |             |        |             |        |                |        |             |        |                |         |               |  |                   |   |                    |        |                   |
|   | 03.77dy-xxxx.4 →  | 30nnnn                             | T52/4   |   |  | <table border="1" data-bbox="574 459 813 683"> <tr> <td>d</td> <td>y</td> </tr> <tr> <td></td> <td>0 = シングルタイプ</td> </tr> <tr> <td></td> <td>5 = タンデムタイプ</td> </tr> <tr> <td>2 = 6"</td> <td>0 = シングルタイプ</td> </tr> <tr> <td>3 = 7"</td> <td>3 = シングルタイプ BA</td> </tr> <tr> <td>4 = 8"</td> <td>5 = シングルタイプ</td> </tr> <tr> <td>5 = 9"</td> <td>8 = シングルタイプ BA</td> </tr> <tr> <td>6 = 10"</td> <td>BA = ブレーキアシスト</td> </tr> <tr> <td></td> <td>Z = タイロッドブレーキユニット</td> </tr> </table> | d   | y  |  | 0 = シングルタイプ             |          | 5 = タンデムタイプ | 2 = 6" | 0 = シングルタイプ | 3 = 7" | 3 = シングルタイプ BA | 4 = 8" | 5 = シングルタイプ | 5 = 9" | 8 = シングルタイプ BA | 6 = 10" | BA = ブレーキアシスト |  | Z = タイロッドブレーキユニット |  | ■ 83.1xxx-xxxx.3 → | 33nnnn | ブレーキチューブ + パイプライン |
|   | d   | y                                  |   |   |  |   |   |  |  |                         |          |             |        |             |        |                |        |             |        |                |         |               |  |                   |   |                    |        |                   |
|   |   | 0 = シングルタイプ                        |   |   |  |   |   |  |  |                         |          |             |        |             |        |                |        |             |        |                |         |               |  |                   |   |                    |        |                   |
|   |   | 5 = タンデムタイプ                        |   |   |  |   |   |  |  |                         |          |             |        |             |        |                |        |             |        |                |         |               |  |                   |   |                    |        |                   |
|   | 2 = 6"  | 0 = シングルタイプ                        |   |   |  |   |   |  |  |                         |          |             |        |             |        |                |        |             |        |                |         |               |  |                   |   |                    |        |                   |
| 3 = 7"  | 3 = シングルタイプ BA  |                                    |   |   |  |   |   |  |  |                         |          |             |        |             |        |                |        |             |        |                |         |               |  |                   |   |                    |        |                   |
| 4 = 8"  | 5 = シングルタイプ   |                                    |   |   |  |   |   |  |  |                         |          |             |        |             |        |                |        |             |        |                |         |               |  |                   |   |                    |        |                   |
| 5 = 9"  | 8 = シングルタイプ BA  |                                    |   |   |  |   |   |  |  |                         |          |             |        |             |        |                |        |             |        |                |         |               |  |                   |   |                    |        |                   |
| 6 = 10"   | BA = ブレーキアシスト   |                                    |   |   |  |   |   |  |  |                         |          |             |        |             |        |                |        |             |        |                |         |               |  |                   |   |                    |        |                   |
|   | Z = タイロッドブレーキユニット   |                                    |   |   |  |   |   |  |  |                         |          |             |        |             |        |                |        |             |        |                |         |               |  |                   |   |                    |        |                   |
| 03.78dy-xxxx.4 →  | 30nnnn  | T52/4                              | ■ 83.5yx-LLLL.3 →   | 33nnnn  | ブレーキホース/クラッチホース  |   |   |  |  |                         |          |             |        |             |        |                |        |             |        |                |         |               |  |                   |   |                    |        |                   |
| 03.78dy-xxxx.4 →  | 30nnnn  | T52/4Z                             | ■ 83.6yx-LLLL.3 →   | 33nnnn  | ブレーキホース/クラッチホース  |   |   |  |  |                         |          |             |        |             |        |                |        |             |        |                |         |               |  |                   |   |                    |        |                   |
| 03.78dy-xxxx.4 →  | 30nnnn  | T52/5                              | ■ 83.7yx-LLLL.3 →   | 33nnnn  | ブレーキホース/クラッチホース  |   |   |  |  |                         |          |             |        |             |        |                |        |             |        |                |         |               |  |                   |   |                    |        |                   |
| 03.78dy-xxxx.4 →  | 30nnnn  | T52/5Z                             |  |   | <p>y = 1: ネジ 1 × 内側/1 × 外側</p> <p>y = 2: ネジ 2 × 内側</p> <p>y = 3: ネジ 2 × 外側</p>       |   |   |  |  |                         |          |             |        |             |        |                |        |             |        |                |         |               |  |                   |   |                    |        |                   |
| 03.78dy-xxxx.4 →  | 30nnnn  | T55/1                              |   |   |  |   |   |  |  |                         |          |             |        |             |        |                |        |             |        |                |         |               |  |                   |   |                    |        |                   |
| 03.78dy-xxxx.4 →  | 30nnnn  | T55/1Z                             |   |   |  |   |   |  |  |                         |          |             |        |             |        |                |        |             |        |                |         |               |  |                   |   |                    |        |                   |
| ▲ 03.20dd-xxxx.3 →  | 01nnnn  | ステップタンデムマスターシリンダー                  |   |   |  |    |   | <p>03.60xx-xxxx.3 → 32nnnn</p> <p>03.65xx-xxxx.3 → 32nnnn</p> <p>03.0101-xxxx.2 → 32nnnn</p> |  |                         |          |             |        |             |        |                |        |             |        |                |         |               |  |                   |   |                    |        |                   |
| ▲ 03.21dd-xxxx.3 →  | 01nnnn  | タンデムマスターシリンダー                      |   |   |  |   |   |  |  |                         |          |             |        |             |        |                |        |             |        |                |         |               |  |                   |   |                    |        |                   |
| ▲ 03.23dd-xxxx.3 →  | 01nnnn  | ステップマスターシリンダー                      |   |   |  |   |   |  |  |                         |          |             |        |             |        |                |        |             |        |                |         |               |  |                   |   |                    |        |                   |
| ▲ 03.31dd-xxxx.3 →  | 01nnnn  | マスターシリンダー<br>(例 03.2122-: Ø=22,20) |   |   |  |   |   |  |  |                         |          |             |        |             |        |                |        |             |        |                |         |               |  |                   |   |                    |        |                   |
|   | 03.0370-xxdd.2 →  | 05xxdd                             |   |   |  | リペアキット  |   |  |  |                         |          |             |        |             |        |                |        |             |        |                |         |               |  |                   |   |                    |        |                   |
|  | 03.3508-xxxx.x →  | 31nnnn                             |   |   |  | ブレーキフルードタンク   |  |          | <p>35/3 茶 (4)</p>  | 記号、カラー標識 (接続箇所数)        |          |             |        |             |        |                |        |             |        |                |         |               |  |                   |   |                    |        |                   |
|   | 03.3509-xxxx.x →  | 31nnnn                             |   |   |  | ブレーキフルードタンク   |   |  |  |                         |          |             |        |             |        |                |        |             |        |                |         |               |  |                   |   |                    |        |                   |
|   | 03.3558-xxxx.x →  | 31nnnn                             | ブレーキフルードタンク   |   |  |   |   |  |  |                         |          |             |        |             |        |                |        |             |        |                |         |               |  |                   |   |                    |        |                   |
|   | 03.0101-xxxx.2 →  | 39nnnn                             | リペアキット  |   |  |   |   |  |  |                         |          |             |        |             |        |                |        |             |        |                |         |               |  |                   |   |                    |        |                   |
|  | ▲ 11.3ddx-xxxx.2 →  | 22nnnn                             | フィストキャリパー   |  |  | <p>▲ 03.24dd-xxxx.3 → 03nnnn</p> <p>03.0350-ddxx.2 → 07ddxx</p>   | クラッチマスターシリンダー<br>(例 03.2419-: Ø=19,05)<br>シールキット                                    |  |  |                         |          |             |        |             |        |                |        |             |        |                |         |               |  |                   |   |                    |        |                   |
|   | 11.9ddx-xxxx.2 →  | 22nnnn                             | フィストキャリパー   |   |  |   |   |  |  |                         |          |             |        |             |        |                |        |             |        |                |         |               |  |                   |   |                    |        |                   |
|   | ▲ 13.2ddx-xxxx.2 →  | 21nnnn                             | 2シリンダー フィックスキャリパー   |   |  |   |   |  |  |                         |          |             |        |             |        |                |        |             |        |                |         |               |  |                   |   |                    |        |                   |
|   | ▲ 13.4ddx-xxxx.2 →  | 21nnnn                             | 4シリンダーフィックスキャリパー  |   |  |   |   |  |  |                         |          |             |        |             |        |                |        |             |        |                |         |               |  |                   |   |                    |        |                   |
|   | 13.9ddx-xxxx.2 →  | 21nnnn                             | フィックスキャリパー  |   |  |   |   |  |  |                         |          |             |        |             |        |                |        |             |        |                |         |               |  |                   |   |                    |        |                   |
|   | 24.3ddx-xxxx.5 →  | 24nnnn                             | 交換キャリパー フィストキャリパー   |   |  |   |   |  |  |                         |          |             |        |             |        |                |        |             |        |                |         |               |  |                   |   |                    |        |                   |
|   | 11.0441-ddxx.2 →  | 25nnnn                             | シールキット  |   |  |   |   |  |  |                         |          |             |        |             |        |                |        |             |        |                |         |               |  |                   |   |                    |        |                   |
|   | 13.0441-ddxx.2 →  | 25nnnn                             | シールキット  |   |  |   |   |  |  |                         |          |             |        |             |        |                |        |             |        |                |         |               |  |                   |   |                    |        |                   |
|   | 11.0230-xxxx.2 →  | 26nnnn                             | フィストキャリパーホルダーキット(ホルダー、スライディングスリーブキット、ガイドピン)                                       |   |  |   |   |  |  |                         |          |             |        |             |        |                |        |             |        |                |         |               |  |                   |   |                    |        |                   |
|   | 24.0101-xxxx.2 →  | 26nnnn                             | 組み込みキット<br>(スライディングスリーブキット、ガイドピン)   |   |  |   |   |  |  |                         |          |             |        |             |        |                |        |             |        |                |         |               |  |                   |   |                    |        |                   |
|   | ▲ 11.0101-xxxx.2 →  | 26nnnn                             | スライディングスリーブキット  |   |  |   |   |  |  |                         |          |             |        |             |        |                |        |             |        |                |         |               |  |                   |   |                    |        |                   |
|   | 11.8116-xxxx.1 →  | 39nnnn                             | リテーニングスプリング   |   |  |   |   |  |  |                         |          |             |        |             |        |                |        |             |        |                |         |               |  |                   |   |                    |        |                   |
|   |   |                                    |   |   |  |   |   |           |  | 24.3728-xxxx.2 → 59xxxx | クラッチワイヤー |             |        |             |        |                |        |             |        |                |         |               |  |                   |   |                    |        |                   |
|   |   |                                    |   |   |  |   |   |  |  |                         |          |             |        |             |        |                |        |             |        |                |         |               |  |                   |   |                    |        |                   |





nnnn = 最後の4つの数字はカウントナンバーです。

dd = 名目寸法

- ▲ この印の項目は、24にもそれ以外の番号は同じものがあります。
- この印の項目は、03、24、および 83にもそれ以外の番号は同じものがあります。

複製は、たとえ一部であっても、必ず当社の許可が必要です。当カタログの記述内容に基づく賠償請求権は認められません。構成の変更に関しては、これを保留します。当社がその資料の中で車両メーカーの交換部品番号に触れる限りにおいては、これは単に比較目的によるものです。このような記述内容を車両所有者あての計算書の中で用いることは許されません。

車両メーカーの数は多種多様なモデルや交換部品を持つため、厳密な分類法を守ることが不可能な場合があります。従って当カタログ中に記載された内容と部品情報には特にご注意ください。部品情報には特にご注意ください。

| مجموعة المنتجات  | موديلات العربات   | فترة التركيب (من / إلى)   | الرقم الكامل للمنتجات  | ملاحظة (المنتجات)   |
|--|---|---|--|---|
| المحور الأمامي / الخلفي  | العدد الترتيبي بالاصنع (من / إلى)   | ملاحظة (العربة)   | الرقم المختصر للمنتجات   | المنتجات  |
|  |  |  |  |  |
| <b>AUDI A4 CABRIO (02-)</b>  |   |   |  |   |
| 1,8 T<br>1,8 T Quattro<br>2,0<br>2,0 TFSI  | 120<br>120<br>96<br>120   | 8E-55-999999<br>04.02<br>05.03<br>05.04<br>08.06<br>08.06<br>08.06                | PR: 1LB,1LE<br>PR: 1LB,1LE<br>PR: 1LB,1LE<br>PR: 1LB,1LE                           | 22032<br>220319<br>250034<br>260035   |
|  | 8E-55-400001  |   |  | + ESP<br>+ ESP  |
|  |   |   |  | D=57, - Halter<br>D=57, - Halter<br>Dichtungssatz<br>Hülsensatz                     |
|  |   |   |  | ATE<br>ATE<br>ATE<br>ATE  |

## مجموعات المنتجات\*

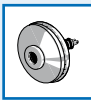

مضخم قوة الفرملة



كبل المكبح اليدوي

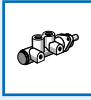

أسطوانة المكابح الرئيسية

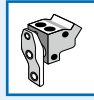

معدّل قوة الفرملة



خزان تعديل المنسوب

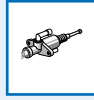

الأسطوانة الضاغطة للواصل



سرج الفرامل

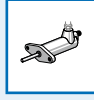

الأسطوانة المضغوطة للواصل



خرطوم المكبح



خرطوم الواصل

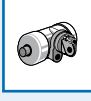

إسطوانة العجلة



كبل الواصل

## نوع المقود\*\*

- ◀ مقود على اليسار
- ▶ مقود على اليمين

## شفرة التعريف للمصنعين\*\*\*

|     |                         |
|-----|-------------------------|
| ATE | Continental Teves (ATE) |
| AKE | Akebono                 |
| AIS | Aisin                   |
| AP  | AP Lockheed             |
| BDX | Bendix                  |
| BOS | Bosch                   |
| BRE | Brembo                  |
| CIT | Citroën                 |
| DEL | Delco                   |
| FI  | Fiat                    |
| FTE | FTE Automotive          |
| LUC | Lucas (TRW)             |
| MAN | Mando                   |
| NIS | Nissin                  |
| PER | Perrot                  |
| SUM | Sumitomo                |
| TOK | Tokico                  |
| VW  | Volkswagen              |



















## موضع التركيب\*\*\*

- ⬆️ أمام
  - ⬇️ خلف
  - ⬅️ وسط
  - ➡️ يمين
  - ⬆️ أمام على اليسار
  - ⬇️ خلف على اليسار
  - ⬅️ أمام على اليمين
  - ⬇️ خلف على اليمين
  - ⬆️ وسط
  - ⬆️ فوق
  - ⬇️ تحت
  - ⬆️ المحور الأمامي
  - ⬆️ المحور الأمامي على اليسار
  - ⬆️ المحور الأمامي على اليمين
  - ⬆️ المحور الخلفي
  - ⬆️ المحور الخلفي على اليسار
  - ⬆️ المحور الخلفي على اليمين
- المذكورة أعلاه حدّدت حسب اتجاه سير العربة المواضع

## اختصارات

|      |                             |     |                          |     |                           |                             |
|------|-----------------------------|-----|--------------------------|-----|---------------------------|-----------------------------|
| -    | بدون / لا                   | HEB | بعثلة                    | V   | ميرد بلاهواء              | صالون                       |
| +    | مع / إلا / ل                | Hz  | الأسطوانة الرئيسية       | WE  | جهاز إنذار                | استيشن                      |
| AUT  | بضبط أوتوماتيكي             | L   | الطول                    | WK  | مجهز بنمّاس لجهاز الإنذار | كوبيه                       |
| B    | نظّم                        | L=  | الطول                    | Zub | بتجهيزات إضافية           | كأبريو                      |
| BG   | معدّد قوة الفرملة           | Nz  | الأسطوانة المضغوطة       |     |                           | حافلة                       |
| BR   | معدّل قوة الفرملة           | PD  | ATE PowerDisc قرص المكبح |     |                           | ناقلة صندوقية               |
| BRE  | معدّل ملولب                 | Rz  | أسطوانة العجلة مع        |     |                           | هانتش باك                   |
| BRES | طقم تعديل ملولب             | RzR | أسطوانة العجلة مع        |     |                           | ناقلة مسطحه/شاسيه           |
| BRL  | معدّل قوة الفرملة حسب الحمل | S   | معدّل مدمج               |     |                           | الفئة                       |
| D=   | قرئ ادلا رطق                | THz | بلولم تيبثت رامهم        |     |                           | الفاخرة/الفئة الخاصة/الشملة |
| Gz   | الأسطوانة الضاغطة           |     | أسطوانة رئيسية مزدوجة    |     |                           | سياره DKW من الفئة          |
|      |                             |     |                          |     |                           | عربة مكشوفة FAUN            |
|      |                             |     |                          |     |                           | ناقلة                       |



|    |  | الرقم المختصر  |  |          |    | الرقم المختصر  |                  |  |  |   |  |  |  |              |   |   |  |  |   |  |   |                   |   |   |         |            |   |           |   |              |   |           |   |              |    |               |   |                               |   |                          |                   |
|---|---|--|---|---|--|--|---|--|--|---|--|--|--|--------------|---|---|--|--|---|--|---|-------------------|---|---|---------|------------|---|-----------|---|--------------|---|-----------|---|--------------|----|---------------|---|-------------------------------|---|--------------------------|-------------------|
|    |  | 03.6199-xxxx.4 → 30 nnnn<br>03.61dy-xxxx.4 → 30 nnnn<br>03.67dy-xxxx.4 → 30 nnnn<br>03.68dy-xxxx.4 → 30 nnnn<br>03.69dy-xxxx.4 → 30 nnnn<br>03.77dy-xxxx.4 → 30 nnnn | مضمخ قوة الفرملة<br>T50<br>T51<br>T52/3<br>T52<br>T53<br>T52/4                    |          |    | 02 nnnn<br>02 nnnn<br>06 nnnn<br>06 nnnn   | أسطوانة تعمل على جانب واحد<br>اسطوانة العجلة<br>طقم تصليح (مع بستون)<br>طقم منع التسرب (بدون بستون) |  |  |   |  |  |  |              |   |   |  |  |   |  |   |                   |   |   |         |            |   |           |   |              |   |           |   |              |    |               |   |                               |   |                          |                   |
|   |   |  |   |   |  |  |   | 03.78dy-xxxx.4 → 30 nnnn<br>03.78dy-xxxx.4 → 30 nnnn<br>03.78dy-xxxx.4 → 30 nnnn<br>03.78dy-xxxx.4 → 30 nnnn<br>03.78dy-xxxx.4 → 30 nnnn<br>03.78dy-xxxx.4 → 30 nnnn | T52/4<br>T52/4Z<br>T52/5<br>T52/5Z<br>T55/1<br>T55/1Z  | <table border="1" data-bbox="582 414 678 638"> <tr> <td>0</td> <td>wy</td> </tr> <tr> <td>0</td> <td>جهاز فردي</td> </tr> <tr> <td>5</td> <td>جهاز مزدوج</td> </tr> <tr> <td>6 = 2</td> <td>بوصات</td> </tr> <tr> <td>7 = 3</td> <td>بوصات</td> </tr> <tr> <td>8 = 4</td> <td>بوصات</td> </tr> <tr> <td>9 = 5</td> <td>بوصات</td> </tr> <tr> <td>10 = 6</td> <td>بوصات</td> </tr> <tr> <td>0</td> <td>جهاز فردي</td> </tr> <tr> <td>3</td> <td>جهاز فردي BA</td> </tr> <tr> <td>5</td> <td>جهاز فردي</td> </tr> <tr> <td>8</td> <td>جهاز فردي BA</td> </tr> <tr> <td>BA</td> <td>مساعد الفرملة</td> </tr> <tr> <td>Z</td> <td>أجهزة الفرملة ذات مرسة اللجذب</td> </tr> </table> | 0  | wy   | 0  | جهاز فردي    | 5   | جهاز مزدوج  | 6 = 2  | بوصات  | 7 = 3   | بوصات  | 8 = 4   | بوصات             | 9 = 5   | بوصات   | 10 = 6  | بوصات      | 0   | جهاز فردي | 3 | جهاز فردي BA | 5 | جهاز فردي | 8 | جهاز فردي BA | BA | مساعد الفرملة | Z | أجهزة الفرملة ذات مرسة اللجذب |  | 24.3727-xxxx.2 → 58 xxxx | كبل المكبح اليدوي |
|   |   |  |   |   |  |  |   |  |  |   | 0  | wy   |  |              |   |   |  |  |   |  |   |                   |   |   |         |            |   |           |   |              |   |           |   |              |    |               |   |                               |   |                          |                   |
|   |   |  |   |   |  |  |   |  |  |   | 0  | جهاز فردي  |  |              |   |   |  |  |   |  |   |                   |   |   |         |            |   |           |   |              |   |           |   |              |    |               |   |                               |   |                          |                   |
|   |   |  |   |   |  |  |   |  |  |   | 5  | جهاز مزدوج   |  |              |   |   |  |  |   |  |   |                   |   |   |         |            |   |           |   |              |   |           |   |              |    |               |   |                               |   |                          |                   |
|   |   |  |   |   |  |  |   |  |  |   | 6 = 2                                    | بوصات  |  |              |   |   |  |  |   |  |   |                   |   |   |         |            |   |           |   |              |   |           |   |              |    |               |   |                               |   |                          |                   |
|   |   |  |   |   |  |  |   |  |  |   | 7 = 3                                    | بوصات  |  |              |   |   |  |  |   |  |   |                   |   |   |         |            |   |           |   |              |   |           |   |              |    |               |   |                               |   |                          |                   |
|   |   |  |   |   |  |  |   |  |  |   | 8 = 4                                    | بوصات  |  |              |   |   |  |  |   |  |   |                   |   |   |         |            |   |           |   |              |   |           |   |              |    |               |   |                               |   |                          |                   |
|   |   |  |   |   |  |  |   |  |  |   | 9 = 5                                    | بوصات  |  |              |   |   |  |  |   |  |   |                   |   |   |         |            |   |           |   |              |   |           |   |              |    |               |   |                               |   |                          |                   |
|   |   |  |   |   |  |  |   |  |  |   | 10 = 6                                   | بوصات  |  |              |   |   |  |  |   |  |   |                   |   |   |         |            |   |           |   |              |   |           |   |              |    |               |   |                               |   |                          |                   |
| 0   | جهاز فردي   |  |   |   |  |  |   |  |  |   |  |  |  |              |   |   |  |  |   |  |   |                   |   |   |         |            |   |           |   |              |   |           |   |              |    |               |   |                               |   |                          |                   |
| 3   | جهاز فردي BA  |  |   |   |  |  |   |  |  |   |  |  |  |              |   |   |  |  |   |  |   |                   |   |   |         |            |   |           |   |              |   |           |   |              |    |               |   |                               |   |                          |                   |
| 5   | جهاز فردي   |  |   |   |  |  |   |  |  |   |  |  |  |              |   |   |  |  |   |  |   |                   |   |   |         |            |   |           |   |              |   |           |   |              |    |               |   |                               |   |                          |                   |
| 8   | جهاز فردي BA  |  |   |   |  |  |   |  |  |   |  |  |  |              |   |   |  |  |   |  |   |                   |   |   |         |            |   |           |   |              |   |           |   |              |    |               |   |                               |   |                          |                   |
| BA  | مساعد الفرملة   |  |   |   |  |  |   |  |  |   |  |  |  |              |   |   |  |  |   |  |   |                   |   |   |         |            |   |           |   |              |   |           |   |              |    |               |   |                               |   |                          |                   |
| Z   | أجهزة الفرملة ذات مرسة اللجذب   |  |   |   |  |  |   |  |  |   |  |  |  |              |   |   |  |  |   |  |   |                   |   |   |         |            |   |           |   |              |   |           |   |              |    |               |   |                               |   |                          |                   |
|    | 33 nnnn<br>33 nnnn<br>33 nnnn<br>33 nnnn  | خط أنبوبى + خرطوم المكابح<br>خرطوم المكبح / الواصل<br>خرطوم المكبح / الواصل<br>خرطوم المكبح / الواصل   |   |   |  |  |   |  |  |   |  |  |  |              |   |   |  |  |   |  |   |                   |   |   |         |            |   |           |   |              |   |           |   |              |    |               |   |                               |   |                          |                   |
|   |   |  |  | 1 = y حز اللولب × داخلي / 1 × خارجي<br>2 = y حز اللولب × داخلي<br>3 = y حز اللولب × خارجي | 03.20dd-xxxx.3 → 01 nnnn<br>03.21dd-xxxx.3 → 01 nnnn<br>03.23dd-xxxx.3 → 01 nnnn<br>03.31dd-xxxx.3 → 01 nnnn<br>03.0370-xxdd.2 → 05 xxdd | أسطوانة رئيسية مزدوجة ومدرجة<br>أسطوانة رئيسية مزدوجة<br>أسطوانة رئيسية مدرجة<br>على سبيل المثال<br>(z. B. 03.2122-: Ø=22,20)<br>طقم للتصليح |                    | 32 nnnn<br>32 nnnn<br>32 nnnn  | معتل قوة الفرملة (BR)<br>محدد قوة الفرملة (BG)<br>معتل ملولب (BRE)<br>معتل قوة الفرملة حسب الجمال (BRL)<br>طقم معتل قوة الفرملة ملولب (BRES) |   |  |  |  |              |   |   |  |  |   |  |   |                   |   |   |         |            |   |           |   |              |   |           |   |              |    |               |   |                               |   |                          |                   |
|   |   |  |   |   |  |  |   |  |  |    | 31 nnnn<br>31 nnnn<br>31 nnnn<br>39 nnnn | خزان لتعديل المنسوب<br>خزان لتعديل المنسوب<br>خزان لتعديل المنسوب<br>طقم للتصليح | 03.60xx-xxxx.3 → 32 nnnn<br>03.65xx-xxxx.3 → 32 nnnn<br>03.0101-xxxx.2 → 32 nnnn | 3/35 بتي (4) | العلامة المميزة اللون المميز<br>(عدد التوصيلات) |   |  |  |   |  |   |                   |   |   |         |            |   |           |   |              |   |           |   |              |    |               |   |                               |   |                          |                   |
|   |   |  |   |   |  |  |   |  |  |   |  |  |  |              |   |  | 22 nnnn<br>22 nnnn<br>21 nnnn<br>21 nnnn<br>21 nnnn<br>21 nnnn<br>24 nnnn<br>25 nnnn<br>25 nnnn<br>26 nnnn<br>26 nnnn<br>26 nnnn<br>26 nnnn<br>26 nnnn<br>26 nnnn<br>39 nnnn | سرج بقبضة<br>سرج بقبضة<br>سرج ثابت<br>سرج ثابت بأربع أسطوانات<br>سرج ثابت<br>سرج للتغيير سرج بقبضة<br>طقم لمنع التسرب<br>طقم لمنع التسرب<br>طقم ماسك لسرج بقبضة (ماسك)<br>طقم لدواة مدفوعة , مسمار تثبيت<br>طقم للتركيب<br>(طقم لدواة مدفوعة , مسمار تثبيت)<br>طقم لدواة مدفوعة<br>زئبرك للتثبيت | 03.24dd-xxxx.3 → 03 nnnn<br>03.0350-ddxx.2 → 07 ddx | الواسل - الأسطوانة المضغوطة<br>على سبيل المثال (Ø=19,05)<br>طقم منع التسرب |   |                   |   |   |         |            |   |           |   |              |   |           |   |              |    |               |   |                               |   |                          |                   |
|   |   |  |   |   |  |  |   |  |  |   |  |  |  |              |   |   |  |  |   |  |  | 04 nnnn<br>08 ddx | الواسل - الأسطوانة المضغوطة<br>لى سبيل المثال (Ø=25,40)<br>طقم منع التسرب |   |         |            |   |           |   |              |   |           |   |              |    |               |   |                               |   |                          |                   |
|   |   |  |   |   |  |  |   |  |  |   |  |  |  |              |   |   |  |  |   |  |   |                   |   |  | 59 xxxx | كبل الواسل |   |           |   |              |   |           |   |              |    |               |   |                               |   |                          |                   |
|   |   |  |   |   |  |  |   |  |  |   |  |  |  |              |   |   |  |  |   |  |   |                   |   |   |         |            | nnnn = الأرقام الأخيرة تمثل العدد الترتيبي  |           |   |              |   |           |   |              |    |               |   |                               |   |                          |                   |
|   |   |  |   |   |  |  |   |  |  |   |  |  |  |              |   |   |  |  |   |  |   |                   |   |   |         |            | dd = المقاييس العادية   |           |   |              |   |           |   |              |    |               |   |                               |   |                          |                   |
|   |   |  |   |   |  |  |   |  |  |   |  |  |  |              |   |   |  |  |   |  |   |                   |   |   |         |            | ▲ رقم 24 جائز أيضا حسب نفس منهجية الترتيم<br>■ الأرقام 03, 24, و 83 جائزة أيضا حسب نفس منهجية الترتيم   |           |   |              |   |           |   |              |    |               |   |                               |   |                          |                   |
|   |   |  |   |   |  |  |   |  |  |   |  |  |  |              |   |   |  |  |   |  |   |                   |   |   |         |            | لا يجوز إعادة طبع أو نسخ هذه الوثيقة ولو جزئيا إلا بترخيص مباشر من طرفنا. لا نعترف بأية طلبات لتعويض أضرار أو خسائر قد تلحق من جراء استعمال البيانات والمعلومات المنصوص عليها بهذا الكتالوج. نحفظ بحق إجراء تعديلات على تصاميمنا. أرقام قطع الغيار لمصنعي السيارات الآتي ذكرها في هذه الوثيقة هي لغرض المقارنة فقط لا يجوز استعمال مثل هذه البيانات في إصدار الفواتير لأصحاب العربات. |           |   |              |   |           |   |              |    |               |   |                               |   |                          |                   |
| نظرا لتعدد موديلات العربات و قطع الغيار فإنه ليس بالإمكان دائما الربط الدقيق بين المنتجات والأرقام. ولذلك فالرجاء الانتباه بالخصوص للملاحظات والبيانات التوضيحية الخاصة بقطع الغيار والمنصوص عليها في الكتالوج. |   |  |   |   |  |  |   |  |  |   |  |  |  |              |   |   |  |  |   |  |   |                   |   |   |         |            |   |           |   |              |   |           |   |              |    |               |   |                               |   |                          |                   |

ATE – A Trademark of the Continental Corporation

**Continental Aftermarket GmbH**

Guerickestraße 7 · D-60488 Frankfurt am Main · Germany  
Tel. +49 (0) 69 7603-1 · Fax +49 (0) 69 761061

**Continental Automotive Trading Italia Srl**

Aftermarket ATE  
Via Matteotti, 62 · I-20092 Cinisello Balsamo MI  
Tel. +39 02 35680 388 · Fax +39 02 35680 325  
www.ate-freni.it

**Continental Automotive France SAS Département Rechange Indépendante**

Aftermarket  
Parc Ariane, Bâtiment Vénus  
Rue Hélène Boucher · F-78280 Guyancourt  
Tél. +33 (0)1 39 44 10 30 · Fax +33 (0)1 39 44 10 40  
www.ate-freinage.fr

**Continental Automotive Spain, S.A.**

Aftermarket ATE  
C/ Sepúlveda, 11 · E-28108 Alcobendas (Madrid)  
Phone +34 (0)91 126 6934 · Fax +34 (0)91 657 2149  
www.frenos-ate.es

